

# Oracle® Communications EAGLE

## Commands User's Guide



Release 46.6

E97328-02

January 2022

The Oracle logo, consisting of a solid red square with the word "ORACLE" in white, uppercase, sans-serif font centered within it.

ORACLE®

Copyright © 1993, 2022, Oracle and/or its affiliates.

This software and related documentation are provided under a license agreement containing restrictions on use and disclosure and are protected by intellectual property laws. Except as expressly permitted in your license agreement or allowed by law, you may not use, copy, reproduce, translate, broadcast, modify, license, transmit, distribute, exhibit, perform, publish, or display any part, in any form, or by any means. Reverse engineering, disassembly, or decompilation of this software, unless required by law for interoperability, is prohibited.

The information contained herein is subject to change without notice and is not warranted to be error-free. If you find any errors, please report them to us in writing.

If this is software or related documentation that is delivered to the U.S. Government or anyone licensing it on behalf of the U.S. Government, then the following notice is applicable:

U.S. GOVERNMENT END USERS: Oracle programs (including any operating system, integrated software, any programs embedded, installed or activated on delivered hardware, and modifications of such programs) and Oracle computer documentation or other Oracle data delivered to or accessed by U.S. Government end users are "commercial computer software" or "commercial computer software documentation" pursuant to the applicable Federal Acquisition Regulation and agency-specific supplemental regulations. As such, the use, reproduction, duplication, release, display, disclosure, modification, preparation of derivative works, and/or adaptation of i) Oracle programs (including any operating system, integrated software, any programs embedded, installed or activated on delivered hardware, and modifications of such programs), ii) Oracle computer documentation and/or iii) other Oracle data, is subject to the rights and limitations specified in the license contained in the applicable contract. The terms governing the U.S. Government's use of Oracle cloud services are defined by the applicable contract for such services. No other rights are granted to the U.S. Government.

This software or hardware is developed for general use in a variety of information management applications. It is not developed or intended for use in any inherently dangerous applications, including applications that may create a risk of personal injury. If you use this software or hardware in dangerous applications, then you shall be responsible to take all appropriate fail-safe, backup, redundancy, and other measures to ensure its safe use. Oracle Corporation and its affiliates disclaim any liability for any damages caused by use of this software or hardware in dangerous applications.

Oracle, Java, and MySQL are registered trademarks of Oracle and/or its affiliates. Other names may be trademarks of their respective owners.

Intel and Intel Inside are trademarks or registered trademarks of Intel Corporation. All SPARC trademarks are used under license and are trademarks or registered trademarks of SPARC International, Inc. AMD, Epyc, and the AMD logo are trademarks or registered trademarks of Advanced Micro Devices. UNIX is a registered trademark of The Open Group.

This software or hardware and documentation may provide access to or information about content, products, and services from third parties. Oracle Corporation and its affiliates are not responsible for and expressly disclaim all warranties of any kind with respect to third-party content, products, and services unless otherwise set forth in an applicable agreement between you and Oracle. Oracle Corporation and its affiliates will not be responsible for any loss, costs, or damages incurred due to your access to or use of third-party content, products, or services, except as set forth in an applicable agreement between you and Oracle.

# Contents

## 1 Introduction

---

Overview	1-1
Scope and Audience	1-1
Documentation Admonishments	1-1
Manual Organization	1-2

## 2 Using Commands

---

Maintenance and Administration Subsystem	2-1
E5-based Control Cards	2-1
Input/Output Devices	2-2
About Commands	2-8
Log into the System for a User Session	2-19
Your User ID and Password were not Accepted	2-20
You Must Change Your Password	2-21
Your Password has Expired	2-22
Your User ID is Already Being Used	2-22
Log Out Of the System	2-23

## 3 Alphabetical List of Commands

---

Commands	3-1
Debug Commands	3-19
Pass-Through Commands	3-21

## 4 Commands

---

## 5 Debug Commands

---

## 6 Pass-Through Commands

---

### A Reference Information

---

Summary of Range Values for :link Parameter	A-1
Valid CIC Ranges for SI and MSU Types in Routing Key Static Entries	A-2
DRANAIV/DRANAI Mapping	A-2
DRANPV/DRANP Mapping	A-2
NAIV/NAI Mapping	A-3
NPV/NP Mapping	A-3
Cards that use the ent-card Command	A-3
Summary of Loopback Testing Commands and Functions	A-5
Commands Listed by Class	A-15
Basic Commands	A-15
Database Administration Commands	A-16
System Maintenance Commands	A-26
Link Maintenance Commands	A-29
Program Update Commands	A-30
Security Administration Commands	A-30
Debug Commands	A-31
Pass-Through Commands	A-31
Possible Values for PST/SST/AST	A-32
PST	A-32
SST	A-33
AST	A-34
Point Code Formats and Conversion	A-36
ANSI Point Codes	A-36
ITU International Point Codes	A-37
ITU National Point Codes	A-38
Converting ITU National Point Code Formats	A-39
Converting Single Number ITU National Point Codes	A-39
Converting Multiple-Part ITU National Point Codes	A-40
24-bit ITU-National Point Codes	A-41
Spare and Private Point Code Subtype Prefixes	A-41

### B Acronyms and Abbreviations

---

Acronyms and Abbreviations	B-1
----------------------------	-----



## List of Figures

---

2-1	System Terminal User Display	2-3
2-2	Telnet Terminal Selection and Login	2-6
2-3	Output Banner Format	2-15
4-1	chg-db:action=backup:dest=fixed	4-160
4-2	chg-db:action=restore:src=fixed	4-160
4-3	chg-db:action=backup:dest=remove	4-162
4-4	Remote Backup or Restore	4-162
4-5	chg-db:action=repair	4-162
4-6	chg-db:action=restore:src=remove	4-163
4-7	Prefix Table References	4-615
A-1	ATM Loopback Tests	A-15

## List of Tables

---

1-1	Admonishments	1-1
2-1	Action Commands and Associated System Entity	2-9
2-2	Keyboard Functions	2-10
2-3	Unsolicited Output Message Groups	2-14
4-1	TRIGTYPE Parameter Values	4-91
4-2	Valid Parameter Combinations for chg-appl-rtkey Routing Key Types	4-98
4-3	Maximum IP Associations and Links	4-109
4-4	Validation Rules for Association Establishment	4-112
4-5	Alias Combination Matrix	4-186
4-6	EIR Response Type Values	4-244
4-7	Valid Parameter Combinations for chg-gtt Routing Parameters	4-317
4-8	Gateway Screening Stop Action Definitions	4-356
4-9	Standard DSCP Values	4-381
4-10	Default Subnet Mask Values	4-387
4-11	slsobit example (chg-ls)	4-482
4-12	NI Mapping Rules	4-499
4-13	Incoming SLS Bit Rotation for ANSI Linksets	4-500
4-14	Supported chg-scr-sio Parameter Combinations	4-755
4-15	Standard DSCP Values	4-786
4-16	NPCFMTI Parameter - ITU National Point Code Values	4-838
4-17	Point Code Format Examples	4-838
4-18	TON2NAI Mapping Default Values	4-913
4-19	NAI2TON Mapping Default Values	4-913
4-20	Valid and Default UAPS Parameter Values	4-915
4-21	Minimum Hardware Required for LNP Quantity Features	4-1211
4-22	TPS Capacities	4-1214
4-23	TRIGTYPE Hexadecimal Codes	4-1264
4-24	Valid ent-gtt Routing Parameter Combinations	4-1375
4-25	ENT-LG-EVENT Generic Parameters	4-1450
4-26	ENT-LG-EVENT Rx MSU Event Type common Parameters	4-1451
4-27	ENT-LG-EVENT Tx MSU Event Type common Parameters	4-1451
4-28	ENT-LG-EVENT Tx MSU Event Type Specific Parameters (SI = 0)	4-1452
4-29	ENT-LG-EVENT Tx MSU Event Type Specific Parameters (SI = 1, 2, 6-12, 14, 15)	4-1452
4-30	ENT-LG-EVENT Tx MSU Event Type Specific Parameters (SI = 3)	4-1452
4-31	ENT-LG-EVENT Tx MSU Event Type Specific Parameters (SI = 4, 5, 13)	4-1452

4-32	Incoming SLS Bit Rotation for ITU	4-1468
4-33	Incoming SLS Bit Rotation for ANSI	4-1469
4-34	SLSOCBIT example (ent-ls)	4-1476
4-35	SLS Bit Rotation	4-1476
4-36	Additional Valid ent-scr-sio Parameter Combinations	4-1618
4-37	DMS.CFG File Location for format-disk Command	4-1699
4-38	Disk Format Capacity	4-1700
4-39	Route Set Test When LNP is Offline	4-1719
4-40	Receiving Messages when LNP is Offline	4-1719
4-41	Using init-card Parameters	4-1730
4-42	rept-ftp-meas Valid Parameter Combinations	4-1774
4-43	rept-imt-info Statistics, Low Speed Summary (rept-imt-info:report=(hmxerr, hiprerr, or hipr2err))	4-1782
4-44	rept-imt-info Statistics, High Speed Summary	4-1786
4-45	rept-imt-info Statistics, Miscellaneous Summary	4-1794
4-46	Hexadecimal/Decimal Values for s and e Parameters	4-1816
4-47	Level 1 IMT Statistics	4-1820
4-48	Level 1 IMT Statistics, High Speed Error Summary	4-1831
4-49	Valid Parameter Combinations for the type Parameter	4-1856
4-50	Maximum Supported Links based on Card Type and GPL	4-1881
4-51	Auto-Inhibit Hardware Verification Codes	4-1912
4-52	IMT Bus States	4-2016
4-53	Baseline Configuration Changes for the E5-ENET-B Card	4-2021
4-54	MaxTPS Per Card	4-2021
4-55	Retrieve Commands for Additional Table Information	4-2978
4-56	Time Zones Set by the set-time Command	4-3046
4-57	Test Disk Execution Times	4-3053
A-1	Summary of Ranges for link Parameter	A-1
A-2	Valid CIC Ranges for SI and MSU Types	A-2
A-3	DRANAIV/DRANAI Mapping	A-2
A-4	DRANPV/DRANP Mapping	A-2
A-5	NAIV/NAI Mapping	A-3
A-6	NPV/NP Mapping	A-3
A-7	Valid Card Applications and Types	A-3
A-8	Loopback Testing Commands and Functions	A-6
A-9	Commands that support the Spare Point Code Prefix	A-42
A-10	Commands that support the Private Point Code Prefix	A-43

---

# My Oracle Support (MOS)

My Oracle Support (<https://support.oracle.com>) is your initial point of contact for all product support and training needs. A representative at Customer Access Support can assist you with My Oracle Support registration.

Call the Customer Access Support main number at 1-800-223-1711 (toll-free in the US), or call the Oracle Support hotline for your local country from the list at <http://www.oracle.com/us/support/contact/index.html>. When calling, make the selections in the sequence shown below on the Support telephone menu:

- For Technical issues such as creating a new Service Request (SR), select **1**.
- For Non-technical issues such as registration or assistance with My Oracle Support, select **2**.
- For Hardware, Networking and Solaris Operating System Support, select **3**.

You are connected to a live agent who can assist you with My Oracle Support registration and opening a support ticket.

My Oracle Support is available 24 hours a day, 7 days a week, 365 days a year.

# 1

## Introduction

This chapter contains a brief description of the *Commands User's Guide*. The contents include sections about the manual scope, audience, and organization; how to find related publications; and how to contact Oracle for assistance.

### Overview

The *Commands User's Guide* provides a description of all commands used in the Oracle Communications EAGLE. The use of the term "the system" indicates that the information is common to all of the functions of the EAGLE.

### Scope and Audience

This manual is intended for those who maintain and perform administration on the EAGLE. It is assumed that the user is familiar with the SS7 network and its associated protocols. The manual describes commands used in the system, and it contains a special section on debug commands and their descriptions.

Debug commands are a special group of commands used in troubleshooting and debugging the system. These commands are intended for Customer Care Center personnel and authorized engineering personnel in the operating companies. The use of these commands is restricted to those personnel who have access to the "Debug" command class.

### Documentation Admonishments

Admonishments are icons and text throughout this manual that alert the reader to assure personal safety, to minimize possible service interruptions, and to warn of the potential for equipment damage.

**Table 1-1 Admonishments**





Icon	Description
 DANGER	Danger: (This icon and text indicate the possibility of <i>personal injury</i> .)
 WARNING	Warning: (This icon and text indicate the possibility of <i>equipment damage</i> .)
 CAUTION	Caution: (This icon and text indicate the possibility of <i>service interruption</i> .)

Table 1-1 (Cont.) Admonishments

Icon	Description
	Topple: (This icon and text indicate the possibility of <i>personal injury and equipment damage.</i> )

## Manual Organization

This document is organized into the following chapters:

- [Introduction](#) contains general information about the Commands Manual, the organization of the manual and how to get technical assistance.
- [Using Commands](#) describes the system's Maintenance and Administration subsystem and input/output devices. This chapter also provides the method for entering commands and logging into and out of the system.
- [Alphabetical List of Commands](#) contains an alphabetical list of the Tekelec Signaling Products (Eagle, STP, IP<sup>7</sup> Secure Gateway, and IP<sup>7</sup> Front End) commands.
- [Commands](#) describes all commands that are not pass-through or debug commands.
- [Debug Commands](#) describes all debug commands.
- [Pass-Through Commands](#) describes all pass-through commands.
- [Reference Information](#) contains general information that is used by multiple commands, including point code format and conversion information, mapping tables, lists of commands by class, and loopback information.
- [Acronyms and Abbreviations](#) contains all acronyms and abbreviations used in the Commands Manual.



### Note:

Throughout this manual, reference to the OAP (Operation System Support Application Processor) applies also to the EOAP (Enhanced Operation System Support Application Process).

# 2

## Using Commands

This chapter provides the following information:

- A description of the system's Maintenance and Administration Subsystem
- A description of the system's input and output devices
- A description of how to enter commands
- The procedures for logging into and out of the system

This chapter is intended to assist personnel responsible for the system.

## Maintenance and Administration Subsystem

The Maintenance and Administration Subsystem (MAS) is the central management point for the EAGLE.

The MAS provides user interface, maintenance communication, peripheral services, alarm processing, system disk interface, and measurements.

Management and redundancy is provided by use of two separate subsystem processors.

The MAS resides on two separate sets of Maintenance and Administration Subsystem Processor (MASP) cards and a Maintenance Disk and Alarm card (collectively referred to as control cards). The control cards are located in slots 1113 through 1118 of the EAGLE Control Shelf.

## E5-based Control Cards

The E5-based set of EAGLE control cards consists of the following cards:

- Two Maintenance and Administration Subsystem Processor cards (E5-MASP cards). Each dual-slot E5-MASP card is made up of two modules:
  - Maintenance Communication Application Processor (E5-MCAP) card
  - Terminal Disk Module (E5-TDM) card
- One Maintenance Disk and Alarm card (E5-MDAL card)

### **Maintenance Communication Application Processor (E5-MCAP) Card**

The E5-MCAP card contains the Communications Processor and Applications Processor and provides connections to the IMT bus. The card controls the maintenance and database administration activity and performs both application and communication processing. E5-MCAP cards are located in slots 1113 and 1115 of the control shelf.

Each E5-MCAP card contains one latched USB port for use with removable flash media ("thumb drive"), and one flush-mounted USB port for use with a plug-in flash drive. The removable media drive is used to install and back up customer data. The flush-mounted USB port is used for upgrade and could be used for disaster recovery.

### Terminal Disk Module (E5-TDM) Card

The E5-TDM card provides the Terminal Processor for the 16 I/O ports, and interfaces to the Maintenance Disk and Alarm (E5-MDAL) card and fixed disk storage. The E5-TDM card also distributes Composite Clocks and High Speed Master clocks throughout the EAGLE, and distributes Shelf ID to the EAGLE. Each E5-TDM card contains one fixed SATA drive that is used to store primary and backup system databases, measurements, and Generic Program Loads (GPLs). E5-TDM cards are located in slots 1114 and 1116 of the control shelf.

### Maintenance Disk and Alarm (E5-MDAL) Card

The E5-MDAL card processes alarm requests and provides fan control. There is only one E5-MDAL card in a control card set. Critical, major, and minor system alarms are provided for up to 6 individual frames. In addition to the 3 system alarms, the E5-MDAL card provides the system audible alarm. The E5-MDAL card provides control of fans on a per-frame basis, and allows for each fan relay to be set individually. The E5-MDAL card is located in slots 1117 and 1118 of the control shelf.

## Input/Output Devices

There are two types of Input/Output (I/O) devices: terminals and printers. All I/O devices are connected to the system through the control shelf backplane. Each I/O device is described in terms of its function and its connection to the system. Refer to *Installation Guide* for backplane connection information.

### Terminals and Printers

The EAGLE uses VT320 terminals for maintenance and database administration. The EAGLE also can be configured to communicate with the SEAS interface (OAP). The terminals enable you to enter information into or receive information from the system. The system is capable of communicating with terminals at data rates from 2400 to 19,200 baud, using the ASCII character set.

You must configure terminals to operate with the system. You also must set printers (and modems) for hardware flow control. To do this, enable Data Terminal Ready (DTR) through your terminal's configuration menu. A modem also must have DCD set on "high." If your terminal has the auto-wrap feature, ensure that it is disabled before using your terminal on the system.

For information on the setup values for printers and terminals on the system, see the [chg-trm](#) command.

Terminals provide the following capabilities:

- cmdname input and output
- Continuous alarm states
- Event/Error messages

You enter commands at the terminal to perform system operations such as displaying the system status, administering system security, and maintaining the database.

An example of a terminal screen is shown in [Figure 2-1](#). Note that the alarm status area is labeled either Total Alarm Status or Active Alarm Status depending on how the VT320 terminal is configured. See the [chg-stpopts](#) command description for configuration information.



Alarms are displayed in the alarm status area of the terminal screen. The alarm levels are as follows:

- Critical – Indicates a severe, service-affecting condition has occurred and that immediate corrective action is needed, regardless of the time of day or the day of the week.
- Major – Indicates a serious disruption of service or the failure of important circuits is taking place. These troubles require attention and response to restore or maintain system capability.
- Minor – Indicates a trouble, but one that does not have a serious affect on service.
- Inhibited – Indicates a device in the system with an inhibited alarm. A temporarily or permanently inhibited alarm does not generate unsolicited output or cause alarm indicators to be turned on. See the `inh-alm` command description for information on inhibited alarms.

Event/Error messages also are issued to terminals to report system conditions or events. If the condition or event affects service, an alarm is issued along with an Event/Error message. Event/Error messages are displayed in the scroll area of the terminal screen.

**Figure 2-1 System Terminal User Display**

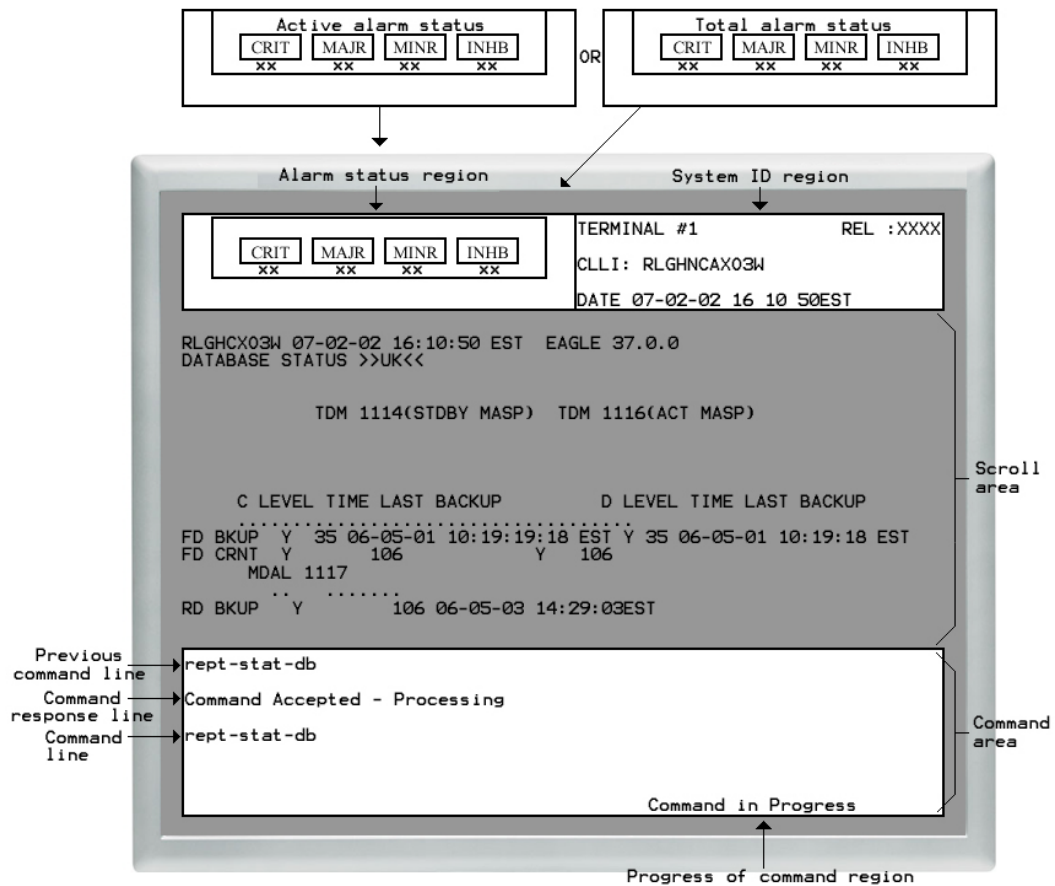

Use the command line region of the terminal display () to enter commands. The command line region consists of two lines. Each of these lines can hold up to 80 characters. If you enter

a command of more than 80 characters in length, the command appears on both lines. When you press the Enter key, only the first 80 characters are displayed in the previous command line, followed by a message on the command response line showing the status of the command. The remaining characters have not been rejected; they are not displayed due to line length limitations. If you recall the command by pressing the Up arrow key or Down arrow key, all the characters in the command are displayed. For a description of the arrow key functions, see [Table 2-2](#).

### Printer Connections

Terminals and printers are connected to the Terminal Disk Module (TDM), using the control shelf backplane. The TDM also provides Keyboard Send and Receive (KSR) function. A description of the TDM can be found in *Installation Guide*.

### KSR Function on VT320 Terminal Devices

The terminals can use the keyboard send and receive (KSR) mode of operation. KSR refers to a device or mode of operation that prints or displays all received data. The KSR mode of operation typically supports a teletype printer, but in the system, it also supports a video display unit and keyboard.

The KSR feature enables you to attach a dumb terminal device or teletype printer to the system's I/O ports or emulate KSR mode of operation on a VT320. KSR enhances the system's dial-up administration functions by allowing faster throughput, because the screen formatting characters associated with the VT320 mode of operation need not be transmitted.

The tested and supported terminal size in KSR mode is 24 rows/80 columns.

### KSR Configuration

This feature allows you to configure the operational characteristics of system's I/O serial ports to support KSR terminal devices. See [Table 2-2](#) for a list of the keyboard functions used by the KSR feature. For information on configuring a serial I/O port for KSR operation, see *Database Administration - SS7 User's Guide*.

### Changing the Mode Of Operation

Before you attempt to change the mode of operation of the terminal, you *must* follow the "Changing the Terminal Characteristics" procedure found in *Database Administration - SS7 User's Guide*. You must perform this procedure from another terminal.

You can change the mode of operation of the terminal by pressing the **F11** key. The **F11** key instructs the system to mimic a KSR. cmdname line editing operates exactly like the VT320.

The KSR emulation resembles a printer when in operation. The entire screen is used for output. Before you enter a command, press <Ctrl-A>. The command prompt (>) is displayed. Enter a carriage return to signify the end of command entry.

While in the KSR mode, all output to the video display unit is buffered. When any character is entered from the terminal, a one-minute timer is started and data reception from the system is stopped. The system responds to the command with the appropriate response, then resumes sending data where it left off.

If a carriage return is not received during command entry, a time-out occurs and the system resumes sending data to the terminal.

## Requirements

The KSR function operates on any combination of terminal type assignments for the 16 available terminal ports.

## Telnet Terminals

Telnet is a user command using the underlying TCP/IP protocol for accessing remote computers. Telnet provides a connection from a remote (client) to a host (server) computer; the client keyboard and monitor (or window) act as if physically attached to the host computer. Remote users log on as if they were local users with whatever privileges may have been granted to the specific applications and data on the remote computer. Remote users, after they log in, can use the same services as a local user.

The IP User Interface feature permits any standard telnet client to act as an EAGLE terminal. This IP-based access provides a standard interface through which EAGLE commands are entered from a telnet session to the EAGLE. The EAGLE then provides command responses back to the remote telnet terminal.

Up to 3 E5-IPSM cards or E5-ENET-B cards running the IPS application (IPSM cards) in the EAGLE, with IP connectivity, enable telnet clients to connect from anywhere on the customer's IP LAN. The EAGLE must be on the customer's LAN or WAN. Each IPSM card provides 8 telnet terminal ports (IDs 17-24 for the first card installed, 25-32 for the second card installed, and 33-40 for the third card installed), which are automatically made available when the card is installed and provisioned. See the `chg-trm` command description in this manual for more information about configuring telnet terminals.

From the telnet client, the remote user connect to any one of the equipped IPSM cards available by entering the command `telnet <IP address>`. For example,

```
telnet 192.168.1.100
```

The remote user then selects a terminal number from a list of available terminals. If an incorrect terminal number (one not listed in the prompt) is selected, the prompt appears again. (After three incorrect tries, the session is closed.) After the session is accepted, an EAGLE welcome message appears. At this point, broadcast messages (if provisioned) will begin to appear. See [Figure 2-2](#).

Figure 2-2 Telnet Terminal Selection and Login

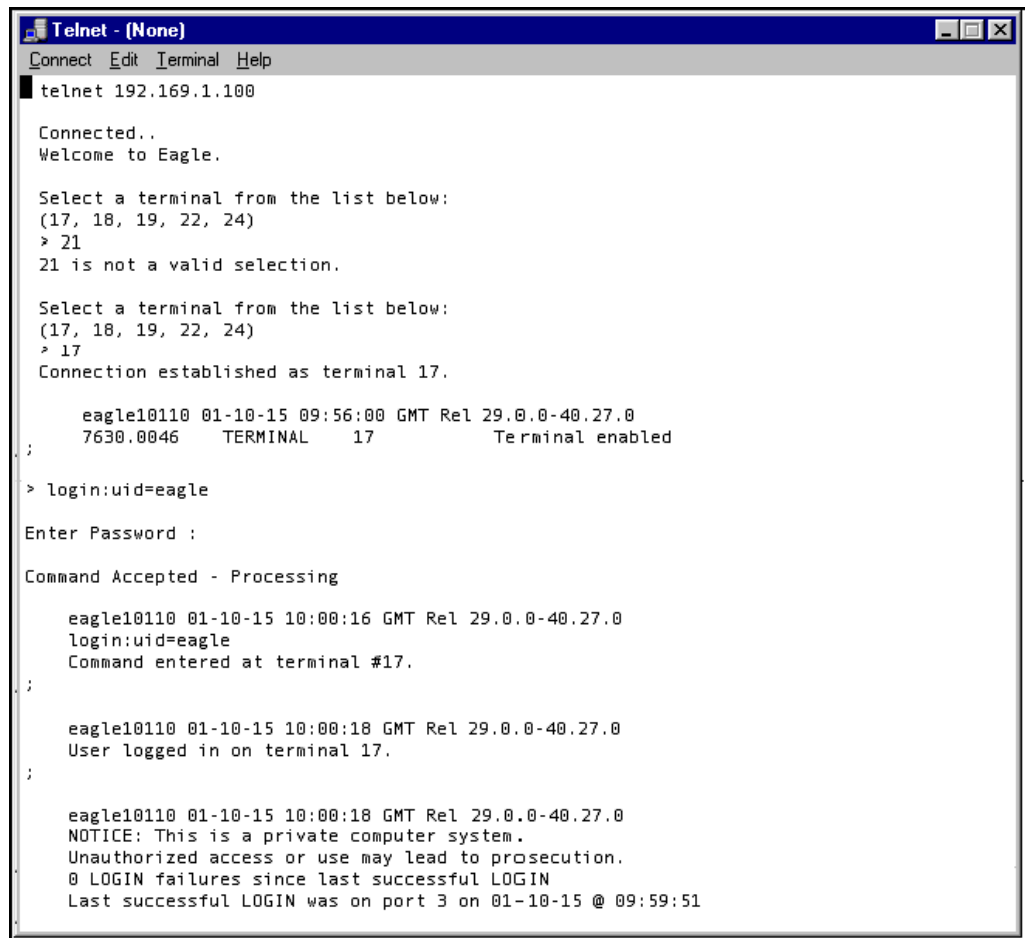

```
Telnet - (None)
Connect Edit Terminal Help
telnet 192.169.1.100

Connected..
Welcome to Eagle.

Select a terminal from the list below:
(17, 18, 19, 22, 24)
> 21
21 is not a valid selection.

Select a terminal from the list below:
(17, 18, 19, 22, 24)
> 17
Connection established as terminal 17.

      eagle10110 01-10-15 09:56:00 GMT Rel 29.0.0-40.27.0
      7630.0046   TERMINAL   17           Terminal enabled
;

> login:uid=eagle

Enter Password :

Command Accepted - Processing

      eagle10110 01-10-15 10:00:16 GMT Rel 29.0.0-40.27.0
      login:uid=eagle
      Command entered at terminal #17.
;

      eagle10110 01-10-15 10:00:18 GMT Rel 29.0.0-40.27.0
      User logged in on terminal 17.
;

      eagle10110 01-10-15 10:00:18 GMT Rel 29.0.0-40.27.0
      NOTICE: This is a private computer system.
      Unauthorized access or use may lead to prosecution.
      0 LOGIN failures since last successful LOGIN
      Last successful LOGIN was on port 3 on 01-10-15 @ 09:59:51
```

After a connection is made, the remote user can log in using a pre-provisioned user ID and password. (The user ID and password must be provisioned from an existing serial terminal.) The `login` command can be typed directly, without typing `<Ctrl-A>` first.

An EAGLE serial terminal emulating a Keyboard Send/Receive (KSR) device is normally in *display mode* (where outgoing messages are displayed). In order to enter a command, the user must interrupt the display by holding down the Ctrl key and typing an “a” (the ATTENTION or Ctrl-A key sequence). When the terminal controller receives an ATTENTION, it enters a *command entry mode*. The output text is temporarily halted, and the prompt symbol “>” appears.

The telnet terminal enters *command entry mode* when any key is pressed; `<Ctrl-A>` is not needed.

After the login is accepted and the user presses a key to receive the standard EAGLE command line prompt, all EAGLE commands assigned to that user ID are now accessible.

The display of broadcast messages can be interrupted with any keystroke, and will resume after a command is entered or a set timeout expires. When in command entry mode, the telnet server holds any outgoing messages in a buffer while a command is entered. A command entry is completed by pressing the Enter key.

The telnet server waits up to 60 seconds between keystrokes for the command text to be completed, before timing out and resuming the broadcast display. If the command entry times out, and output resumes, the incomplete command text might scroll off the screen. Even though the incomplete command was not executed, it is saved as an entry in the command buffer. This incomplete command will be displayed again when any key is pressed. The command string can be finished by continuing the typing where it was interrupted. Pressing the Enter key submits this command as usual.

Broadcast messages are held in a buffer from the time a key is pressed, until the command is complete (timed out, aborted, canceled, or rejected). This is to allow command responses to be completely displayed. After the command completes, broadcast messages (if provisioned) will resume. The IPSM card buffer will hold up to 30 minutes of broadcast output before discarding the oldest messages.

When the user enters the `logout` command to end the telnet session, the user is logged off of the EAGLE, but the port remains assigned to the EAGLE telnet terminal. If the active port connection is lost for a reason such as hardware fault or system interruption, the telnet server resets affected ports, the session is closed, and the user ID is logged off.

The OA&M IP Security Enhancement feature provides secure connections to the EAGLE. Refer to Appendix B of the Database Administration Manual - System Management for information on using the PuTTY client to make a secure telnet connection.

### SEAS Terminals

The SEAS Over IP feature provides a TCP/IP-based interface for SEAS. The SEAS interface constitutes the path between the EAGLE and a Common Channel Signaling Message Router (CCS MR). The EAGLE uses the IP User Interface feature and IPSM cards instead of EOAP to provide the paths for each SEAS TCP/IP link.

The IPSM card allows one of the eight IP terminals to function as a SEAS terminal and provide connectivity between the CCS MR and the EAGLE. The IPSM card also continues to provide the EAGLE with generic IP-based services, such as Telnet and FTP on the remaining seven IP terminals.

A maximum of 2 SEAS terminals can be configured in the EAGLE.

The `chg-trm:type=seas` command can be entered for terminals 17 - 40 when all conditions for a terminal to be set as a SEAS terminal are met.

The SEAS output group cannot be turned off for a SEAS terminal.

### Element Management System Alarm Monitor

EMSALM terminals Element Management System Alarm Monitor (EMSALM) Element Management System Alarm Monitor (EMSALM) terminals display UAM alarm set and clear messages and the UIM 1083 "system alive" messages only. No other messages (including reports and other UIMs) are displayed. EMSALM terminals are designed to display alarm messages only. EMSALM terminals are not restricted in any other way. They can accept login, and commands; however these operations may interfere with alarm monitoring and should be performed on an alternate terminal.

Serial port terminal IDs 1-16 can be assigned as EMSALM terminals. These EMSALM terminals are a refinement of the KSR terminal, and contain all the KSR terminal communication parameters.

Telnet terminal IDs 17-40 can be assigned as EMSALM terminals when the IP User Interface feature is enabled and turned on and up to 3 IPSM cards are equipped in the system (see

"Telnet Terminals" on page 4-6). These EMSALM terminals have all of the functions of a telnet type terminal.

When the `chg-trm` command is entered to change a terminal to the EMSALM type, all output group parameter values for that terminal default to YES, even if they were set to NO before the change. Even though an output group is set to YES for an EMSALM terminal, no reports or UIMS other than UIM 1083 will appear for that output group.

Individual output group values can be changed to NO by entering another `chg-trm` command for an EMSALM terminal (do this only with caution; it can cause loss of UAM alarm messages at the EMSALM terminal).

When the `chg-trm` command is entered to change a terminal from type EMSALM to another type, the output group values remain unchanged. A `chg-trm` command can be entered to change output group settings.

## About Commands

Commands allow you to interact with the system to perform specific functions. Commands are available to perform the following functions:

- Obtain system status and operational status
- Modify system configuration
- Obtain measurement reports

The following sections describe how to enter commands through a system terminal. Command correction, keywords, parameters, and syntax are described.

### Entering Commands

All commands are entered at the command prompt (>), located in the bottom window of the terminal display. After entering a command, you must press the **Enter** key. When the command has executed (an output message appears in the display to indicate execution), you can enter another command. The **F9** function key allows you to interrupt a running command; however, you cannot enter another command until the running command completes its operation.

Commands are not case sensitive; therefore, either uppercase or lowercase characters can be used. Intermixing (using both upper and lower case) characters does not create an error message, but you must use the correct command syntax.

### Action Commands

Throughout this manual, the term "action command" is used in the description of some dependencies, as in the sentence "No other action command can be in progress when this command is entered."

Action commands are used to effect changes to the state of entities within the system, such as cards and signaling links. For example, use the `inh-card` command to change the state of the card to Out-of Service - Maintenance Disabled (OOS-MT-DSBLD).

[Table 2-1](#) lists the action commands and shows which type of system entity they are associated with.

**Table 2-1 Action Commands and Associated System Entity**

Action Commands	System Entity
act-slk, alw-slk, canc-slk, dact-slk, inh-slk, unhb-slk, blk-slk, ublk-slk, tst-slk	Link Commands
act-alm-trns, canc-alm-trns, rls-alm	Alarm Commands
alw-trm, inh-trm	Terminal Commands
alw-card, inh-card, rmv-card	Card Commands

### Command Keywords and Parameters

Commands consist of two parts: keywords and parameters. Keywords identify the principal action to be performed by the system, and consist of one to three words. Most commands also require parameters to further define the command operation.

Parameters are entered after the keyword. Each parameter must be separated from the keyword or the previous parameter with a colon. If a parameter has multiple values, the values entered are discrete and must be separated with a hyphen or comma. The parameters can be entered in any order.

Some command parameters have built-in default values that are used if a value is not specified. To accept a default value, press **Enter** after the desired keyword and parameters have been entered.

Use the following delimiters when entering commands:

- `:` separates parameters
- `-` or `,` — separates multiple values within a parameter block
- `=` — use as delimiter between the parameter and input value

The following is an example of a command entry:

```
> dact-slk:loc=1101:port=a
```

The keyword in the above example is `dact-slk` (Deactivate Signaling Link). The first parameter for this command is `loc=1101` (the actual card location in the system for the link being cancelled, based on equipment location). The second parameter is `port=a`. This parameter signifies which signaling link port on the card in the designated location has the link that is to be cancelled.

If an error is made while typing commands, use the **Delete** key to make corrections, one character at a time.

#### Note:

If the same parameter is entered more than once in a command, the system accepts the last parameter value that was entered. Any values for the parameter that were entered earlier in the command are ignored.

### Keyboard Functions

Some keyboard functions used with commands are described in the previous section. Keyboard functions available for use with commands are listed in [Table 2-2](#). Arrow key functions are further described following the table.

Table 2-2 Keyboard Functions









VT320 Key Sequence	KSR Key Sequence	Description
		The Up arrow key recalls the previous commands entered at the prompt, one command at a time. The Up arrow key scrolls backwards through up to 10 commands for a KSR, VT320, or SCCS terminal, and up to 20 commands for an IP UI telnet terminal. See page 4-13 for a description of the Up arrow key functions.
		The Left arrow key backspaces the underline cursor without erasing.
		The Down arrow key recalls the previous command entered at the prompt, one parameter at a time.  If the Up arrow key is pressed and more than one command has been entered in the session, pressing the Down arrow key displays one previously entered command at a time. The Down arrow key scrolls forward through up to 10 commands for KSR, VT320, and SCCS terminals and up to 20 commands for IP UI telnet terminals.  See page 4-14 for a description of the down arrow key functions.
		The Right arrow key recalls the last command entered at the prompt, one character at a time.
<b>F6</b>	<b>F6</b>	The <b>F6</b> Function key refreshes the terminal screen, including any characters already input on the command line and the command response line.
<b>F7</b>	<b>F7</b>	The <b>F7</b> Function key clears the scroll buffer. This enables a user to stop useless information from passing to the scroll region of the system terminal.



Table 2-2 (Cont.) Keyboard Functions

VT320 Key Sequence	KSR Key Sequence	Description
F8	F8	The <b>F8</b> function key enables you to stop and restart the scrolling of information on the terminal screen.
F9	F9	<p>The <b>F9</b> Function key allows you to interrupt a running command so that you can enter another command. Output and processing of the interrupted command continue. Pressing <b>F9</b> is the same as issuing the <code>canc-cmd</code> command with no parameters.</p> <p>The commands that can be interrupted by pressing <b>F9</b> are listed in the description of the <code>canc-cmd</code> command.</p> <p>If the terminal is running one of the listed commands and you press <b>F9</b>, output and processing are cancelled. This function works only on the same terminal that is running the command you want to cancel. To cancel a command from another terminal, use the <code>canc-cmd:trm=</code> command (see the <code>canc-cmd</code> command description).</p>
F10	F10	The <b>F10</b> Function key displays help information for the last command that was entered, including parameters, parameter formats, and the command class.
F11	F11	The <b>F11</b> Function key allows you to toggle the terminal's mode of operation from VT320 to KSR and from KSR to VT320. This function key has no effect on IP UI telnet terminals.
Not Available	Control-A	Control-A allows you to enter a command in the KSR mode.
Control-S	Control-S	Used with the <code>sw</code> or <code>both</code> flow control (see the <code>chg-trm</code> command description for more information), this key sequence sends the XOFF character to temporarily stop sending data.

**Table 2-2 (Cont.) Keyboard Functions**

VT320 Key Sequence	KSR Key Sequence	Description
Control-Q	Control-Q	Used with the <i>sw</i> or <i>both</i> flow control (see the <i>chg-trm</i> command description for more information), this key sequence sends the XON character to resume sending data.
Ins	Ins	When Insert is toggled on, typed characters are inserted into the command line, moving existing characters to the right. When toggled off, typed characters overwrite existing characters.
Del	Del	Deletes one character at a time from the right; the cursor stays in position.
Backspace	Backspace	Deletes a character and moves the cursor one space to the left.

**Arrow Key Operation**

The arrow keys are used to move the cursor to a different position in a command, and to display part or all of a command that was previously entered.

On KSR, VT320, and SCCS terminals, you can scroll through the last 10 commands that were entered at the terminal during the session. On IP UI telnet terminals, you can scroll through the last 20 commands that were entered at the terminal during the session. Part or all of one command at a time is displayed. When you have scrolled through the complete list of up to 10 or 20 commands, the scrolling wraps back to the beginning of the list.

The list of previously entered commands is cleared when a terminal is inhibited and allowed (*inh-trm:trm=xx* and *alw-trm:trm=xx*) and when a file transfer is initialized with the *act-file-trns* command.

There are two modes of command recall for Up and Down arrow keys:

- **Edit Mode**  
Edit Mode includes any key operation that changes the command at the prompt, such as the Delete key, the Back Space key, or an alphanumeric key. Pressing one of these keys to enter or change a command puts the terminal into Edit Mode. Pressing the Enter key (or carriage return) takes the terminal out of Edit Mode.
- **Non-edit Mode**  
Pressing the Enter key (or carriage return) puts the terminal into Non-edit Mode. A terminal remains in Non-edit Mode when you press an arrow key, a Function key, or the Insert key, which do not change the command at the prompt. When you press a key that changes the command, the terminal goes into Edit Mode until you press the Enter key again.

**Up Arrow Key**

The Up arrow key is used to recall up to the last 10 commands (KSR, VT320, and SCCS terminals) or the last 20 commands (IP UI telnet terminals) entered at the prompt during the session.

- In Edit Mode
  - You enter 3 characters of a command at the prompt and press the Up arrow key. If the previous command was 6 characters long, then the last 3 characters of the previous command are recalled and displayed after the 3 characters that you entered at the prompt.
  - You enter 10 characters of a command at the prompt and press the Up arrow key. If the previous command was 6 characters long, none of the previous command is displayed. The command that you entered remains as you entered it at the prompt.
  - Entering part or all of a command at the prompt puts the terminal into Edit Mode. In Edit Mode, the last (or previous) command is recalled only if the command length of the last command is greater than the command at the prompt. For example,;
- In Non-edit Mode
  - When you have pressed the Enter key and there is no command at the prompt, or you have pressed the Insert key or a Function key, the terminal is in Non-edit Mode.
  - When you press the Up arrow key in Non-edit Mode, and you have entered at least one previous command, the last command that you entered is displayed at the prompt. Pressing the Up arrow key again clears the command at the prompt (if any) and displays the next previous command that you entered (if any). By continuing to press the Up arrow key, you can scroll backwards through the last 10 commands (KSR, VT320, \2nd SCCS terminals) or the last 20 commands (IP UI telnet terminals) that you entered at the terminal. The display wraps back to the most recent of the entered commands when all of the available commands have been recalled. The terminal remains in Non-edit Mode until you press a key that changes the displayed command.

### Down Arrow Key

In Edit Mode, the Down arrow key recalls the last command that was entered at the terminal, one parameter at a time. The recalled parameter is displayed at the end of the entry that currently appears at the prompt.

In Non-edit Mode:

- If the Up arrow has not been pressed just before pressing the Down arrow key, \2he Down arrow key recalls the last command that was entered at the terminal, one parameter at a time.
- If the Up arrow key is the last key that was pressed before the Down arrow key is pressed, the Down arrow key scrolls forward through the last 10 commands (KSR, VT320, \2nd SCCS terminals) or last 20 commands (IP UI telnet terminals), displaying one complete command each time the key is pressed. The scrolling wraps to the beginning of the list when all of the available commands have been displayed.

### Right Arrow Key

Each time the Right arrow key is pressed, one character of the last command is recalled and the cursor moves one position to the right. When the last command is completely displayed, pressing the Right arrow key does not cause any cursor movement or character display.

### Left Arrow Key

The Left arrow key moves the underline cursor one position to the left without erasing the character. The underline cursor can be moved until it reaches the first character at the left of the command. If the Left arrow key is pressed again after the cursor reaches the first character of the command, the bell sounds.

### Command Output and Messages

Reports and outputs generated through retrieve or report status commands are followed by a semi-colon (;) to signify the end of the output (this is in compliance with TL1 standards).

The following types of output messages are used on the system:

- **Command Accepted-Processing:** The command has been accepted by the application's command handler as syntactically correct. This message is displayed in the command area of the terminal display.
- **Command Completed-**The command has been entered, and the system has completed processing. This message is displayed in the scroll area of the terminal display.
- **Command Executed-**The command has been entered, and the system has completed processing. This message is displayed in the command area of the terminal display.
- **Command Failed-**The command was executed but failed due to an external reason, such as the link is not equipped or a disk drive is unable to communicate. The reason for the failure is included in this message.
- **Command Rejected-**The command syntax could be incorrect, or a parameter value is incorrect (semantic error). This message is displayed in the command area of the terminal display. The reason for rejecting the command (command syntax or incorrect parameter value) is included in this message.
- **Command Aborted-**The command syntax and the parameter values are ok, but for some reason the command was aborted (for example, a disk drive is inaccessible). This message is displayed in the scroll area of the terminal display.
- **Command Response Messages-**A command is entered at the terminal, and the response to that command is echoed on that same terminal. These messages are displayed in the scroll area of the terminal display.
- **Unsolicited Messages-**An example of unsolicited messages are the messages delivered in response to alarm conditions. These messages are displayed in the scroll area of the terminal display.

The unsolicited messages can be directed to a specific terminal or printer by using the `chg-trm` command to assign one or more of the groups of unsolicited output messages shown in [Table 2-3](#) to the specified terminal or printer.

**Table 2-3 Unsolicited Output Message Groups**

Application Server	Application Subsystem
Card	Clock
Debug	Global Title Translation
Gateway Screening	Measurements Maintenance
Monitor	MPS

**Table 2-3 (Cont.) Unsolicited Output Message Groups**

SEAS Maintenance	SLAN Maintenance
System Maintenance	Security Administration
Traffic Measurements	Database Administration
Link Maintenance	Program Update
LNP Database Administration	LNP Subscription

To configure a terminal to receive unsolicited LNP database administration and LNP subscription messages, the LNP feature must be turned on (see the `enable-ctrl-feat` command).

### Command Output Banners

When a command is executed in the system, one or more banner lines appear in the output that is displayed for the command.

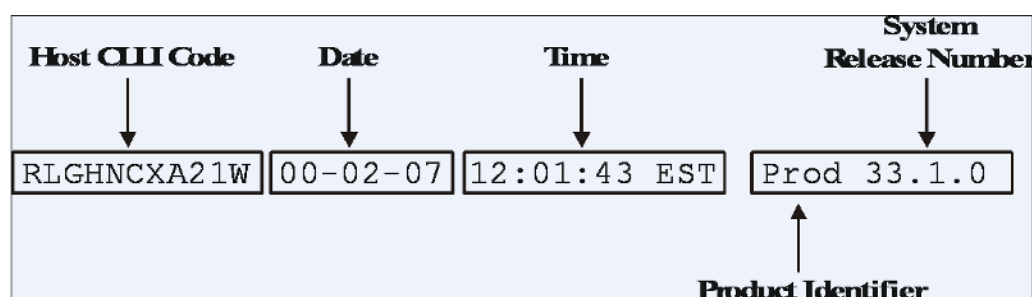
**Figure 2-3 Output Banner Format**

The following fields appear in each output banner:

- **Host CLLI code**—a maximum of one alphabetic character and ten alphanumeric characters. The CLLI code uniquely identifies the system in terms of its physical location. The CLLI code must be unique among all elements in the system. The CLLI code contains the following information:
  - City—4 characters
  - State— 2 characters
  - Building— 2 characters
  - Equipment type —3 characters
- Date—year-month-day
- Time—hour: minute: second time zone
- System Release Number— contains a product identifier and the version ID number. The product identifier, which is shown as 'Prod' in [Figure 2-3](#) and the output examples in this manual, will appear as "EAGLE5".

The version ID number identifies the GPL set that is specific to the software release that is expected to be installed on the system as approved loads. The format of the version ID number is *maj.min.maint.notused.rampspin*, defined as follows:

- *maj*—the major release ID
- *min*—the minor release ID
- *maint*—the maintenance release ID
- *notused*—this field is not used and is always 0
- *rampspin*—the ramp spin release ID

### System Security

User IDs and passwords protect the system from unauthorized entry into the system and enhance system security. To enter the system through a terminal, a user must enter a valid user ID and password at the system prompt, and the user ID and password must be authorized for use together. A user ID identifies a user to the system.

To maintain the security of the system, passwords should be changed periodically and user IDs should be deleted whenever there is a personnel change.

When prompted to enter a new password, a different password should be provided. This is the responsibility of the user, and is not enforced by the EAGLE.

### Rules for User ID and Password Administration

The rules for administering User IDs and passwords, rules for administering passwords are:

- The maximum number of user ID-password combinations is 100.
- The maximum length of the user ID is 16 characters.
- The maximum length of the password is 12 characters; the minimum length is site provisionable using the `chg-secu-dflt` command, and it can be from 1 – 12 characters long.
- User IDs and passwords may contain any printable characters except the characters used as command delimiters: colon (:), comma (,), backslash (\), hyphen (-), or equal sign (=).
- Each user ID must begin with an alpha character.
- A password must contain:
  - At least as many characters as specified on the `minlen` parameter of the `chg-secu-dflt` command
  - At least as many alphabetic characters as specified on the `alpha` parameter of the `chg-secu-dflt` command
  - At least as many numeric characters as specified on the `num` parameter of the `chg-secu-dflt` command
  - At least as many punctuation characters as specified on the `punc` parameter of the `chg-secu-dflt` command
- A password must not contain the associated user ID.

### Command Classes

Each user ID and password combination is assigned to one or more command classes to control the set of system security commands that a user may enter.

There are 8 unique non-configurable command classes: Basic, Database Administration, Debug, Link Maintenance, Program Update, Security Administration, System Maintenance, and LNP Basic. (The Basic command class is assigned to all users as a default.)

There are 32 available configurable command classes. See the `chg-cmd` command description and the `chg-cmdclass` command description for information about naming and assigning commands to configurable command classes.

See the `chg-user` command description or the `ent-user` command description for more information on configuring user IDs and passwords and assigning command classes.

### Login Security Checks

#### loginsystem security

To aid in system security, the system maintains a record of when a password was last changed and requires a user to change the password when it is older than the site-specified maximum password age. The system also keeps track of the elapsed time between successful logins. If the time between successful logins exceeds the site-specified maximum, a user is not allowed access to the system. The site systems administrator also has the ability to revoke a user ID.

When a user first logs into the system, the default unauthorized user warning is displayed as follows

```
NOTICE: This is a private computer system.
```

```
Unauthorized access or use may lead to prosecution.
```

Additional security is available for the system in that multiple logins using the same user ID are prohibited.

### Intrusion Alert

To alert the system administrator to a possible attempt by an unauthorized person trying to log into the system, the system issues a scroll area message. When 5 or more consecutive attempts to log into the system have failed, the following scroll area message is sent to all terminal ports that can receive unsolicited Security Administration messages:

```
Info: xxxxxxxxxxxx successive LOGIN failures on port pp
```

Where:

- `xxxxxxxxxx` is the number of consecutive login failures on the port (1 – 4,294,967,295)
- `pp` is the terminal port (1 – 40) on which the login attempts were made

When the attempt to log into the system is successful after a series of failed consecutive login attempts, or if the active MASP reboots, the count of failed consecutive login attempts for that port is reset to 0.

Attempts to log into the system that are not completed normally, are not considered login attempts and are not included in the count of failed consecutive login attempts. For example,

while prompting for a password you might use the **F9** key to abort the command, or errors might occur when the system is looking up a user ID or password.

### Login Procedure

The commands described in this manual are entered at a terminal connected to the system.

Before you can enter most of the commands, you must enter the `login` command to log into the system and open a user session. You must enter the login command with a valid user ID and password combination. When the system accepts your user ID and password as valid, you can enter commands at the terminal in the user session.

The first procedure in this section explains how to log into the system using the `login` command.

The procedures that follow the login procedure explain how to handle common situations that can arise when you log into the system.

- You must change the password the first time that you log in with a new user ID and password.
- The user ID and password that you enter are not accepted as valid.
- Your password has expired and must be changed.
- Someone else has already logged on with your user ID and password; the system does not allow the same ID and password to be used on two terminals at the same time.



#### Note:

You can enter the `act-user` command instead of the `login` command.

### [Log into the System for a User Session](#)

### [Your User ID and Password were not Accepted](#)

### [You Must Change Your Password](#)

### [Your Password has Expired](#)

### [Your User ID is Already Being Used](#)

### Login Error Messages

- E2262 Cmd Rej: Password too long, 12 maximum
- E2263 Cmd Rej: Password does not contain enough characters
- E2264 Cmd Rej: Password verification failed
- E2750 Cmd Rej: UserID already logged on (or is logging on) another port
- E2751 Cmd Rej: UserID has been revoked
- E2752 Cmd Rej: UserID has become obsolete and cannot be used
- E2753 Cmd Rej: Password does not contain enough alphabetic characters
- E2754 Cmd Rej: Password does not contain enough numeric characters



- E2755 Cmd Rej: Password does not contain enough punctuation characters
- E2756 Cmd Rej: Failed reading the password table
- E2757 Cmd Rej: Invalid userID/password combination
- E2758 Cmd Rej: ALPHA+NUM+PUNC must not be greater than 12
- E2759 Cmd Rej: Revocation of security admin userID not allowed
- E2760 Cmd Rej: Failed reading the security defaults table
- E2761 Cmd Rej: Password cannot contain userID

See the `chg-secu-dflt` command description for information on different options the system administrator has for configuring the system for password requirements.

The following is an example of the information that might be displayed in the scroll area, depending on your site <sup>TM</sup> configuration:

New password must contain

- from 8 to 12 characters
- at least 1 alphabetic character(s) (a - z)
- at least 1 numeric character(s) (0 - 9)
- at least 1 punctuation character(s) (for example, \$%@#)

### Logout Procedure

When a terminal session is completed, perform the following logout procedure to log out of the system [Log Out Of the System](#). The terminal returns to an input idle state.



#### Note:

You can use the `dact-user` command instead of the `logout` command.

## Log into the System for a User Session

1. At the system prompt (`>`), enter the **login** command with your user ID.
2. Press the **Enter** key.

The following message appears:

```
Enter Password:
```

3. At the system prompt, type your password.

For security reasons, the password is not displayed on the terminal screen.

4. Press the **Enter** key.

Follow the remaining steps to complete this procedure or to go to another procedure, depending on the system response to validation of your user ID and password.

5. If your user ID and password combination are accepted and the following messages appear in the terminal input/command response region, the terminal is available for a user session.

```
Command Accepted-Processing  
Command Executed
```

This procedure is complete.

6. If your user ID and password combination are not accepted and the following message appears, go to [Your User ID and Password were not Accepted](#).

```
E2757 Cmd Rej: Invalid UserID/Password Combination
```

7. If you entered a new user ID and password combination for the first time, the following message appears, go to [You Must Change Your Password](#).

```
Enter new password (password must be changed) :
```

8. If you entered your user ID and password combination and your password has expired, the following message appears, go to [Your Password has Expired](#).

```
Enter new password (password has expired and must be changed) :
```

9. If you entered your user ID and password combination and they are already being used at another terminal, the following message appears. Go to [Your User ID is Already Being Used](#).

```
E2750 Cmd Rej: UserID already logged on (or is logging on) another  
port
```

## Your User ID and Password were not Accepted

1. This procedure outlines the steps to follow when you attempt to log into the system and your user ID and password combination are not accepted.

When you entered the `login` command with your user ID and entered your password at the system prompt, the following message appeared:

```
E2757 Cmd Rej: Invalid UserID/Password Combination
```

When this message is displayed, the terminal also presents a message describing the login attempt and the time and date the attempt occurred.

2. Verify that you have the correct user ID and password.

Return to the login procedure, and log in again with the correct user ID and password.

If the problem occurs again, contact your System Administrator.

## You Must Change Your Password

1. This situation can occur when you first log in after the system administrator uses the `ent-user` command to enter a new user ID and password combination, or when you first log in after the `chg-user:pid=yes` command has been entered.

When you entered the `login` command with your user ID and entered your password at the system prompt, the following message appeared:

```
Enter new password (password must be changed) :
```

Type a new password, following your site guidelines.

For security reasons, the password is not displayed on the terminal screen.

2. Press the **Enter** key.  
The system checks the password to ensure that it meets your site's password complexity requirements.
3. If your password does not meet your site's password complexity requirements, the system displays a message based on the password violation (see [Login Error Messages](#) for a list of possible messages).

```
The login process ends.
```

Decide on a new password, and start the login procedure again.

4. If your password meets the complexity requirements, the following message appears:

```
Verify Password:
```

Type the exact password again that you entered in [Step 1](#).

For security reasons, the password is not displayed on the terminal screen.

5. Press the **Enter** key.
6. If the user ID and password combination are accepted and the following messages appear in the terminal input/command response region, the terminal is available for a user session

```
Command Accepted-Processing  
Command Executed
```

7. Record your new password in a secure location.

## Your Password has Expired

1. When you entered the `login` command with your user ID and entered your password at the system prompt, the following message appeared:

```
Enter new password (password has expired and must be changed) :
```

Type a new password, following your site guidelines.

For security reasons, the password is not displayed on the terminal screen.

2. Press the **Enter** key.

The system checks the password to ensure that it adheres to your site's password complexity requirements.

3. If your password does not meet your site's password complexity requirements, the system displays a message based on the password violation (see [Login Error Messages](#) for a list of possible messages).

The login process ends.

Decide on a new password, and start the login procedure again.

4. If your password meets the complexity requirements, the following message appears:

```
Verify Password:
```

Type the exact password again that you entered in [Step 1](#)

For security reasons, the password is not displayed on the terminal screen.

5. Press the **Enter** key.

6. If the user ID and password combination are accepted and the following messages appear in the terminal input/command response region, the terminal is available for a user session

```
Command Accepted-Processing Command Executed
```

7. Record your new password in a secure location.

## Your User ID is Already Being Used

1. When you entered the `login` command with your user ID and entered your password at the system prompt, the following message appeared:

```
E2750 Cmd Rej: UserID already logged on (or is logging on) another port
```

The following information is displayed in the scroll area:

```
Info: UID is currently logged on (or is logging on) to port yy.
```

where yy is in the range of 1 - 40.

2. Find the terminal at port yy, and log off your user ID at that workstation.  
See [Log Out Of the System](#).
3. Return to your terminal and log into the system again.

## Log Out Of the System

1. At the system prompt (>), enter the `logout` command.
2. Press the **Enter** key.

The following messages appear on the terminal screen to confirm command completion:

```
Command Accepted-Processing  
Command Executed
```

# 3

## Alphabetical List of Commands

This chapter contains an alphabetical list of the EAGLE commands.

### Commands

#### A

[act-alm-trns](#)

[act-cdl](#)

[act-dlk](#)

[act-echo](#)

[act-file-trns](#)

[act-flash](#)

[act-ftp-trns](#)

[act-gpl](#)

[act-lbp](#)

[act-lpo](#)

[act-slk](#)

[act-user](#)

[alw-card](#)

[alw-int](#)

[alw-map-ss](#)

[alw-slk](#)

[alw-trm](#)

[aud-data](#)

#### B

[blk-slk](#)

#### C

[canc-alm-trns](#)

[canc-cmd](#)

[canc-dlk](#)

canc-echo  
canc-lpo  
canc-slk  
canc-user  
chg-acg-mic  
chg-acg-noc  
chg-ainpopts  
chg-aiqopts  
chg-appl-rtkey  
chg-as  
chg-assoc  
chg-atinpopts  
chg-atm-lps  
chg-attr-seculog  
chg-card  
chg-clkopts  
chg-cmd  
chg-cmdclass  
chg-csl  
chg-ctrl-feat  
chg-db  
chg-dconn  
chg-deiropts  
chg-dstn  
chg-e1  
chg-eisopts  
chg-enumopts  
chg-enum-prof  
chg-enum-profsel  
chg-feat  
chg-frm-pwr  
chg-ftp-serv  
chg-gpl

chg-gsmmap-scrn  
chg-gsm-msg  
chg-gsmopts  
chg-gsmsmsopts  
chg-gsms-opcode  
chg-gta  
chg-gtcnv  
chg-gtmod  
chg-gtt  
chg-gttact  
chg-gttapath  
chg-gttaset  
chg-gttset  
chg-gttset  
chg-gtw-stp  
chg-gws-actset  
chg-gws-redirect  
chg-inpopts  
chg-ip-card  
chg-ip-conn  
chg-ip-lnk  
chg-is41-msg  
chg-is41opts  
chg-is41smsopts  
chg-isup-msg  
chg-j1  
chg-l2t  
chg-l3t  
chg-lbp  
chg-lnpopts  
chg-lnp-serv  
chg-loopset  
chg-ls



chg-lsopts  
chg-m2pa-tset  
chg-map  
chg-mate-stp  
chg-meas  
chg-measopts  
chg-mrn  
chg-mtc-measopts  
chg-netopts  
chg-npp-as  
chg-npp-serv  
chg-npp-srs  
chg-pid  
chg-ppsopts  
chg-prefix  
chg-rte  
chg-rtx  
chg-sccp-msg  
chg-sccpopts  
chg-sccp-serv  
chg-scr-aftpc  
chg-scr-blkdpc  
chg-scr-blkopc  
chg-scr-cdpa  
chg-scr-cgpa  
chg-scr-destfld  
chg-scr-dpc  
chg-scr-isup  
chg-scr-opc  
chg-scrset  
chg-scr-sio  
chg-scr-tt  
chg-seas-config

chg-secu-dflt  
chg-secu-trm  
chg-sfappopts  
chg-sg-opts  
chg-shlf  
chg-sid  
chg-sip-npp  
chg-sipopts  
chg-slt  
chg-snmp-host  
chg-snmppopts  
chg-srvsel  
chg-ss7opts  
chg-ss-appl  
chg-stpopts  
chg-t1  
chg-tatr-msg  
chg-tatropts  
chg-th-alm  
chg-tifopts  
chg-trm  
chg-ttmap  
chg-ttr-msg  
chg-ttropts  
chg-uaps  
chg-user  
chg-vflx-cd  
chg-vflx-opts  
chg-vflx-rn  
chg-vflx-vmsid  
chg-vlr-prof  
chg-vlr-roaming  
chk-unref-ent

clr-imt-stats  
conn-imt  
copy-disk  
copy-ext-stats  
copy-fta  
copy-gpl  
copy-meas  
copy-seculog

**D**

dact-alm-trns  
dact-cdl  
dact-echo  
dact-lbp  
dact-rstst  
dact-slk  
dact-user  
disc-imt  
disp-fta-dir  
dlt-acg-mic  
dlt-acg-noc  
dlt-appl-rtkey  
dlt-as  
dlt-assoc  
dlt-card  
dlt-csl  
dlt-cspc  
dlt-dconn  
dlt-dlk  
dlt-dstn  
dlt-e1  
dlt-enum-acl  
dlt-enum-prof  
dlt-enum-profsel

dlt-frm-pwr  
dlt-fta  
dlt-ftp-serv  
dlt-gserv-data  
dlt-gsmmap-scrn  
dlt-gsms-opcode  
dlt-gsmssn-scrn  
dlt-gta  
dlt-gtcnv  
dlt-gtmod  
dlt-gtt  
dlt-gttact  
dlt-gttapath  
dlt-gttaset  
dlt-gttset  
dlt-gttset  
dlt-gttset  
dlt-gws-redirect  
dlt-homern  
dlt-home-smsc  
dlt-ip-conn  
dlt-ip-host  
dlt-ip-node  
dlt-ip-rte  
dlt-j1  
dlt-lbp  
dlt-lnp-serv  
dlt-loopset  
dlt-ls  
dlt-map  
dlt-mate-stp  
dlt-mrn  
dlt-na  
dlt-npp-as

dlt-npp-srs  
dlt-pct  
dlt-prefix  
dlt-rmt-appl  
dlt-rte  
dlt-rtx  
dlt-sccp-serv  
dlt-scr-aftpc  
dlt-scr-blkdpc  
dlt-scr-blkopc  
dlt-scr-cdpa  
dlt-scr-cgpa  
dlt-scr-destfld  
dlt-scr-dpc  
dlt-scr-isup  
dlt-scr-opc  
dlt-scrset  
dlt-scr-sio  
dlt-scr-tt  
dlt-shlf  
dlt-sip-npp  
dlt-slk  
dlt-snmp-host  
dlt-spc  
dlt-srvsel  
dlt-ss-appl  
dlt-subnetid  
dlt-t1  
dlt-tt  
dlt-ttmap  
dlt-uim-acthresh  
dlt-user  
dlt-vendid

dlt-vflx-cd  
dlt-vflx-rn  
dlt-vflx-vmsid  
dlt-vlr-prof  
dlt-vlr-roaming

**E**

enable-ctrl-feat  
ent-acg-mic  
ent-acg-noc  
ent-appl-rtkey  
ent-as  
ent-assoc  
ent-card  
ent-csl  
ent-cspc  
ent-dconn  
ent-dlk  
ent-dstn  
ent-e1  
ent-enum-acl  
ent-enum-prof  
ent-enum-profsel  
ent-frm-pwr  
ent-ftp-serv  
ent-gserv-data  
ent-gsmmap-scrn  
ent-gsms-opcode  
ent-gsmssn-scrn  
ent-gta  
ent-gtcnv  
ent-gtmod  
ent-gtt  
ent-gttact

ent-gttapath  
ent-gttaset  
ent-gttset  
ent-gttset  
ent-gws-redirect  
ent-homern  
ent-home-smc  
ent-ip-conn  
ent-ip-host  
ent-ip-node  
ent-ip-rte  
ent-j1  
ent-lbp  
ent-lnp-serv  
ent-loopset  
ent-ls  
ent-map  
ent-mate-stp  
ent-mrn  
ent-na  
ent-npp-as  
ent-npp-srs  
ent-pct  
ent-rmt-appl  
ent-rte  
ent-rtx  
ent-scr-aftp  
ent-scr-blkdpc  
ent-scr-blkopc  
ent-scr-cdpa  
ent-scr-cgpa  
ent-scr-destfld  
ent-scr-dpc

ent-scr-isup  
ent-scr-opc  
ent-scrset  
ent-scr-sio  
ent-scr-tt  
ent-serial-num  
ent-shlf  
ent-sid  
ent-sip-npp  
ent-slk  
ent-snmp-host  
ent-spc  
ent-srvsel  
ent-ss-appl  
ent-subnetid  
ent-t1  
ent-tt  
ent-ttmap  
ent-user  
ent-vendid  
ent-vflx-cd  
ent-vflx-rn  
ent-vflx-vmssid  
ent-vlr-prof  
ent-vlr-roaming

**F**

flash-card  
format-disk

**I**

inh-alm  
inh-card  
inh-imt  
inh-map-ss



inh-slk

inh-trm

init-card

init-ext-stats

init-flash

init-imt-gpl

init-mux

init-network

init-sys

## **L**

lock

login

logout

## **P**

pass

## **R**

rept-ftp-meas

rept-imt-info

rept-imt-lvl1

rept-imt-lvl2

rept-meas

rept-stat-alm

rept-stat-applsock

rept-stat-as

rept-stat-assoc

rept-stat-card

rept-stat-cdl

rept-stat-cdt

rept-stat-clk

rept-stat-cluster

rept-stat-db

rept-stat-ddb

rept-stat-deir

rept-stat-dlk  
rept-stat-dstn  
rept-stat-e1  
rept-stat-enet  
rept-stat-enum  
rept-stat-gpl  
rept-stat-imt  
rept-stat-ipconn  
rept-stat-iptps  
rept-stat-j1  
rept-stat-lfs  
rept-stat-lnp  
rept-stat-ls  
rept-stat-meas  
rept-stat-mfc  
rept-stat-mon  
rept-stat-mps  
rept-stat-mux  
rept-stat-rtd  
rept-stat-rte  
rept-stat-rtkey  
rept-stat-rtx  
rept-stat-sccp  
rept-stat-seas  
rept-stat-seculog  
rept-stat-sfapp  
rept-stat-sflog  
rept-stat-sfthrot  
rept-stat-sip  
rept-stat-slan  
rept-stat-slk  
rept-stat-sys  
rept-stat-t1

rept-stat-trbl  
rept-stat-trm  
rept-stat-tstslk  
rept-stat-user  
rept-stat-xlist  
rls-alm  
rmv-card  
rmv-imt  
rmv-trm  
rst-dstn  
rst-imt  
rst-trm  
rtrv-acg-mic  
rtrv-acg-noc  
rtrv-ainpopts  
rtrv-aiqopts  
rtrv-appl-rtkey  
rtrv-as  
rtrv-assoc  
rtrv-atinpopts  
rtrv-atm-lps  
rtrv-atm-prm  
rtrv-attr-seculog  
rtrv-bip  
rtrv-card  
rtrv-clkopts  
rtrv-cmd  
rtrv-cmdclass  
rtrv-csl  
rtrv-cspc  
rtrv-ctrl-feat  
rtrv-data-rtdb  
rtrv-dconn

rtrv-deiropts  
rtrv-dlk  
rtrv-dstn  
rtrv-e1  
rtrv-eisopts  
rtrv-enum-acl  
rtrv-enumopts  
rtrv-enum-prof  
rtrv-enum-profsel  
rtrv-feat  
rtrv-frm-pwr  
rtrv-ftp-serv  
rtrv-gpl  
rtrv-gserv-data  
rtrv-gsmmap-scrn  
rtrv-gsm-msg  
rtrv-gsmopts  
rtrv-gsmsmsopts  
rtrv-gsms-opcode  
rtrv-gsmssn-scrn  
rtrv-gta  
rtrv-gtcnv  
rtrv-gtmod  
rtrv-gtt  
rtrv-gttact  
rtrv-gttapath  
rtrv-gttaset  
rtrv-gttset  
rtrv-gttset  
rtrv-gtw-stp  
rtrv-gtwy-acthresh  
rtrv-gtwy-prmtrs  
rtrv-gws-actset

rtrv-gws-redirect  
rtrv-homern  
rtrv-home-smsc  
rtrv-inpopts  
rtrv-ip-card  
rtrv-ip-conn  
rtrv-ip-host  
rtrv-ip-lnk  
rtrv-ip-node  
rtrv-ip-rte  
rtrv-is41-msg  
rtrv-is41opts  
rtrv-is41smsopts  
rtrv-isup-msg  
rtrv-j1  
rtrv-l2t  
rtrv-l3t  
rtrv-lbp  
rtrv-lnpopts  
rtrv-lnp-serv  
rtrv-log  
rtrv-loopset  
rtrv-ls  
rtrv-m2pa-tset  
rtrv-map  
rtrv-mate-stp  
rtrv-measopts  
rtrv-meas-sched  
rtrv-mrn  
rtrv-mtc-measopts  
rtrv-na  
rtrv-netopts  
rtrv-npp-as

rtrv-npp-serv  
rtrv-npp-srs  
rtrv-obit  
rtrv-pct  
rtrv-ppsopts  
rtrv-prefix  
rtrv-rmt-appl  
rtrv-rte  
rtrv-rtx  
rtrv-sccp-msg  
rtrv-sccpopts  
rtrv-sccp-serv  
rtrv-scr-aftpc  
rtrv-scr-blkdpc  
rtrv-scr-blkopc  
rtrv-scr-cdpa  
rtrv-scr-cgpa  
rtrv-scr-destfld  
rtrv-scr-dpc  
rtrv-scr-isup  
rtrv-scr-opc  
rtrv-scrset  
rtrv-scr-sio  
rtrv-scr-tt  
rtrv-seas-config  
rtrv-secu-dflt  
rtrv-seculog  
rtrv-secu-trm  
rtrv-secu-user  
rtrv-serial-num  
rtrv-sfappopts  
rtrv-sg-opts  
rtrv-shlf

rtrv-sid  
rtrv-sip-npp  
rtrv-sipopts  
rtrv-slk  
rtrv-slt  
rtrv-snmp-host  
rtrv-snmppopts  
rtrv-spc  
rtrv-srvsel  
rtrv-ss7opts  
rtrv-ss-appl  
rtrv-stp  
rtrv-stpopts  
rtrv-subnetid  
rtrv-t1  
rtrv-tatr-msg  
rtrv-tatropts  
rtrv-tbl-capacity  
rtrv-th-alm  
rtrv-tifopts  
rtrv-tps  
rtrv-trbl  
rtrv-trbltx  
rtrv-trm  
rtrv-tt  
rtrv-ttmap  
rtrv-ttr-msg  
rtrv-ttropts  
rtrv-uaps  
rtrv-uim-acthresh  
rtrv-user  
rtrv-vendid  
rtrv-vflx-cd

rtrv-vflx-opts  
rtrv-vflx-rn  
rtrv-vflx-vmssid  
rtrv-vlr-prof  
rtrv-vlr-roaming

## **S**

set-date  
set-gtwy-acthresh  
set-scrrej-prmtrs  
set-time  
set-uim-acthresh

## **T**

tst-bip  
tst-disk  
tst-dlk  
tst-e1  
tst-imt  
tst-j1  
tst-msg  
tst-npp-msg  
tst-slk  
tst-t1

## **U**

ublk-slk  
unhb-alm  
unhb-slk  
unlock

# Debug Commands

## **A**

act-gedti  
act-upgrade  
act-ip-lnk



## C

chg-bip-flt

chg-bip-rec

chg-ee-card

chg-gedti-card

chg-tbl

chg-upgrade-config

clr-disk-stats

copy-tbl

## D

dact-ee

dact-gedti

dact-ip-lnk

dbg-ddb

disp-bip

disp-bp

disp-disk-dir

disp-disk-stats

dlt-ee-flt

disp-mem

disp-trace

dlt-bp

dlt-trace

## E

ent-bp

ent-ee-flt

ent-trace

## R

rept-stat-ee

rept-stat-gedti

rtrv-ee-card

rtrv-ee-flt

rtrv-upgrade-config

**S**

send-msg

set-mem

## Pass-Through Commands

**A**

arp

aslog

assocrtt

**C**

connmgr

**F**

ftptest

**L**

linkinfo

**M**

msucount

msuroute

msutrace

**N**

netstat

nslookup

**P**

pct

ping

**S**

sctp

sockrtt

soipdata

soiplog

**T**

traceroute

**U**

ualog

# 4

## Commands

This chapter describes the command conventions for commands that are not pass-through or debug commands. The commands are listed in alphabetical order.

### act-alm-trns

Use this command to transfer all alarm indications from the local office to the remote maintenance center.

#### Parameters

This command has no parameters.

#### Example

```
act-alm-trns
```

#### Dependencies

No other action command can be in progress when this command is entered.

#### Notes

After this command is entered, use the `rept-stat-alm` command to verify the action.

New alarms cause the local maintenance center audible alarms to sound for a short period.

#### Output

```
act-alm-trns
```

```
rlghncxa03w 04-01-09:50:17 EST EAGLE 31.3.0  
Alarms transferred to Remote Maintenance Center  
Command Completed.
```

```
;
```

#### Related Topics

- [dact-alm-trns](#)
- [rept-stat-trm](#)
- [rept-stat-trbl](#)
- [rtv-obit](#)
- [rtv-trbl](#)

## act-cdl

Use this command to initiate a command driven loopback for testing a signaling link.

Command Driven Loopback is the ability to locally drive a signaling link into a manual line loopback. The data received on the signaling link is echoed (transmitted) back. This is effectively the reverse of the `tst-slk:loopback=lxvr`, which loops the transmitted data back to the receiver.

### Parameters

#### **link (mandatory)**

SS7 signaling links. The SS7 signaling link to be tested.

##### **Synonym:**

*port*

##### **Range:**

*a, b, a1 - a31, b1 - b31*

Not all card types support all `link` parameter values.

See [Table A-1](#) for valid link parameter range values for each type of card that can have assigned signaling links.

#### **loc (mandatory)**

The card location as stenciled on the shelf of the system.

##### **Range:**

*1101 - 1108, 1111 - 1112, 1201 - 1208, 1211 - 1218, 1301 - 1308, 1311 - 1318,  
2101 - 2108, 2111 - 2118, 2201 - 2208, 2211 - 2218, 2301 - 2308, 2311 - 2318,  
3101 - 3108, 3111 - 3118, 3201 - 3208, 3211 - 3218, 3301 - 3308, 3311 - 3318,  
4101 - 4108, 4111 - 4118, 4201 - 4208, 4211 - 4218, 4301 - 4308, 4311 - 4318,  
5101 - 5108, 5111 - 5118, 5201 - 5208, 5211 - 5218, 5301 - 5308, 5311 - 5318,  
6101 - 6108, 6111 - 6118*

#### **loopback (optional)**

Loopback test type.

##### **Range:**

*line*

*payload*

##### **Default:**

*line*

### Example

```
act-cdl:loc=1205:link=b
```

### Dependencies

The card location specified in the `loc` parameter must be equipped.

The signaling link specified in the `link` parameter must be equipped.

LFS processing must be stopped or must be allowed to complete on the specified signaling link before this command can be entered.

The `loopback=payload` parameter is valid only for LIM-ATM and E1-ATM cards.

Command Driven Loopback testing is not available during upgrade.

A Command Driven Loopback test cannot be in progress on the specified link when this command is entered.

A `tst-slk` command cannot be in progress on the specified link when this command is entered. The `tst-slk` processing must be stopped or must be allowed to complete before this command can be entered.

The card location specified in the `loc` parameter must be in the In-Service-Normal (IS-NR) state.

The card location specified in the `loc` parameter must support Command Driven Loopback testing.

The signaling link specified in the `link` parameter must not be active.

The card location specified in the `loc` parameter cannot be reserved by the system.

### Notes

None

### Output

```
act-cdl:loc=1205:link=b
```

```
tekelecstp 05-01-21 17:00:36 EST EAGLE5 33.0.0
Command Accepted: Command Driven Loopback message is sent.
;

tekelecstp 05-01-21 17:00:36 EST EAGLE5 33.0.0
Command Completed.
;
```

### Related Topics

- [act-lbp](#)
- [dact-cdl](#)
- [dact-lbp](#)
- [rept-stat-cdl](#)
- [tst-slk](#)

## act-dlk

Use this command to activate an IP data link and put the link into service. The state of the link is changed from out of service maintenance disabled (OOS-MT-DSBLD) to in service normal (IS-NR).

## Parameters

### loc (mandatory)

The card location as stenciled on the shelf of the system.

#### Range:

1101 - 1108, 1111 - 1112, 1201 - 1208, 1211 - 1218, 1301 - 1308, 1311 - 1318,  
2101 - 2108, 2111 - 2118, 2201 - 2208, 2211 - 2218, 2301 - 2308, 2311 - 2318,  
3101 - 3108, 3111 - 3118, 3201 - 3208, 3211 - 3218, 3301 - 3308, 3311 - 3318,  
4101 - 4108, 4111 - 4118, 4201 - 4208, 4211 - 4218, 4301 - 4308, 4311 - 4318,  
5101 - 5108, 5111 - 5118, 5201 - 5208, 5211 - 5218, 5301 - 5308, 5311 - 5318,  
6101 - 6108, 6111 - 6118

### Example

```
act-dlk:loc=1308
```

### Dependencies

No other action command can be in progress when this command is entered.

The shelf and card must be equipped.

The card location must contain a card that is running the STPLAN application.

The card location, frame, shelf, or slot must be within the allowed range.

A card location that is valid and defined in the database must be specified.

The card in the location specified by the `loc` parameter must be in service.

The `ipaddr` parameter must specify a valid IP address.

### Notes

None

MTT 2373 deleted per PR 204449 - MB

### Output

```
act-dlk:loc=1308
```

```
rlghncxa03w 04-01-17:00:36 EST EAGLE 31.3.0  
Activate Link message sent to card.  
Command Completed.
```

```
;
```

### Related Topics

- [canc-dlk](#)
- [dlt-dlk](#)
- [ent-dlk](#)
- [rept-stat-dlk](#)
- [rtrv-dlk](#)

- [tst-dlk](#)

## act-echo

Use this command to force responses from the scroll area of a terminal to be printed to a specified terminal or printer. The command supports one terminal echoing to many terminals or many terminals echoing to one terminal.

### ▲ Caution:

Exercise restraint in using this command, because excessive echoing can cause a loss of output at the receiving terminal.

### Parameters

**trm (mandatory)**  
Serial port number.

**Range:**  
1 - 16

### Example

```
act-echo:trm=3
```

### Dependencies

Terminal output cannot be echoed to a terminal that is out of service.

If a terminal is already echoing to a specified terminal, this command cannot be entered to echo the terminal's output to that same terminal.

Echo is not allowed to the terminal from which the command is issued.

Echo is not allowed to or from IP User Interface telnet ports (terminals 17-40).

Terminal output cannot be echoed to a terminal that is inhibited.

The `trm` parameter must be specified.

### Notes

This command can be used to echo only command output responses to a terminal. For alarm and network messages to be sent to a terminal, the `chg-trm` command must be used.

To echo output to a destination port, a user must be logged in at the destination port. The following warning message appears in the scroll area of the issuing terminal if echo is attempted to a terminal that has no user logged in:

```
No user logged in at Terminal X. No echo will occur until a user
logs in.
```

where X is the `trm` parameter value specified in the `act-echo` command.



## Output

```
act-echo:trm=2
```

```
rlghncxa03w 04-01-07 11:11:28 EST EAGLE 31.3.0
act-echo:trm=2
Command entered at terminal #1.
```

```
rlghncxa03w 04-01-07 11:11:28 EST EAGLE 31.3.0
Scroll Area Output is echoed to terminal 2.
```

Caution: Loss of output may occur if too many terminals are echoed.

;

```
act-echo:trm=3
```

```
rlghncxa03w 04-01-07 11:11:28 EST EAGLE 31.3.0
act-echo:trm=3
Command entered at terminal #1.
```

```
rlghncxa03w 04-01-07 11:11:28 EST EAGLE 31.3.0
Scroll Area Output is echoed to terminal 2.
Scroll Area Output is echoed to terminal 3.
```

Caution: Loss of output may occur if too many terminals are echoed.

;

## Related Topics

- [chg-trm](#)
- [dact-echo](#)
- [rept-stat-trm](#)
- [rmv-trm](#)
- [rst-trm](#)
- [rtrv-trm](#)

## act-file-trns

Use this command to start a file transfer between the system and a remote computer.

### Parameters

#### **loc (optional)**

The location of the fixed disk to or from which the file is to be uploaded or downloaded.

**Range:***1114, 1116*

Active and standby TDM locations

**Default:**

The active TDM location

**retries (optional)**

The number of times the system retries a packet before giving up.

**Range:***1 - 20***Default:***10***timeout (optional)**

The number of seconds the system waits for a packet before sending a negative acknowledgment or retransmitting the previous packet. This parameter also specifies the number of seconds to wait for a transfer initiation message from the remote computer.

**Range:***1 - 120***Default:***30***Example**

```
act-file-trns:loc=1116
```

**Dependencies**The `loc` parameter must specify a TDM card.

Only one file transfer can be active at a time.

This command cannot be entered on a telnet terminal (IDs 17-40).

**Notes**

Output messages indicating transfer initiated and transfer terminated (whether successful or not) are sent to the output devices in the Security Administration output group.

When used to output `seculog`, the `copy-seculog` command sends data to the FTA. Extracting `seculog` data from the FTA requires:

- A computer with a VT320 or KSR connection to the system
- A communication program that both emulates VT terminals and supports Kermit file transfer
- A spreadsheet program that can import Comma Separated Value (CSV) text files

A PC running ProComm© for Windows and Microsoft Excel© can be used.

**Extracting `seculog` file from the FTA**

1. Display the contents of the FTA. Enter `disp-fta-dir:loc=xxxx`.

Where `xxxx` = the active TDM (1114 or 1116)

2. Delete any existing files from the FTA. Enter `dlt-fta:loc=xxxx:all=yes`.  
Where `xxxx` = the active TDM (1114 or 1116)
3. Enter the command to send `seculog` to the FTA. For example: `copy-seculog:slog=act:dloc=stb:dfile="seculog_copy"`
4. Activate the file transfer. Enter `act-file-trns:loc=xxxx`.  
Where `xxxx` = the active TDM (1114 or 1116)
5. Display a list of the files transferred to the FTA. Enter `disp-fta-dir:loc=xxxx`.  
Where `xxxx` = the active TDM (1114 or 1116)
6. Use the `get` command from within the communications program configured to run Kermit in ASCII mode to transfer the desired files (with the `.csv` suffixes) to the PC.  
For example:  

```
> get seculog_copy.csv
> finish
```
7. After all files are successfully transferred and confirmed, remove the files from the FTA. Enter `dlt-fta:loc=xxxx:all=yes`.  
Where `xxxx` = the active TDM (1114 or 1116)

## Output

Normal session output to non-Security Administration user's terminal.

```
act-file-trns:loc=1114:timeout=20:retries=2

rlghncxa03w 04-01-05 14:37:05 EST  EAGLE 31.3.0
act-file-trns:loc=1114:timeout=20:retries=2
Command entered at terminal #1.
;
rlghncxa03w 04-01-05 14:37:05 EST  EAGLE 31.3.0
Awaiting File Transfer with remote.
Please initiate binary Kermit session on local computer
;
rlghncxa03w 04-01-05 14:38:33 EST  EAGLE 31.3.0
File Transfer : 0 file(s) DOWNLOADED from location 1114
successfully
File Transfer : 1 file(s) UPLOADED to location 1114 successfully
File Transfer : Kermit Session terminated NORMALLY
```

Normal session output to Security Administration group terminals.

```
act-file-trns:loc=1114:timeout=20:retries=2

rlghncxa03w 04-01-05 14:40:42 EST  EAGLE 31.3.0
File Transfer : INITIATED on terminal #1
;
rlghncxa03w 04-01-05 14:41:07 EST  EAGLE 31.3.0
File Transfer: 511_byte.bin UPLOADED to location 1114
successfully.
```

```
;
rlghncxa03w 04-01-05 14:41:44 EST EAGLE 31.3.0
File Transfer : terminated NORMALLY on terminal #1
```

Normal session output to Security Administration user's terminal.

```
act-file-trns:loc=1114:timeout=20:retries=2
```

```
rlghncxa03w 04-01-05 14:42:51 EST EAGLE 31.3.0
act-file-trns:loc=1114:timeout=20:retries=2
Command entered at terminal #1.
;
rlghncxa03w 04-01-05 14:43:29 EST EAGLE 31.3.0
File Transfer : INITIATED on terminal #1
;
rlghncxa03w 04-01-05 14:43:53 EST EAGLE 31.3.0
Awaiting File Transfer with remote.
Please initiate binary Kermit session on local computer
rlghncxa03w 04-01-05 14:44:19 EST EAGLE 31.3.0
File Transfer: 511_byte.bin UPLOADED to location 1114 successfully.
;
rlghncxa03w 04-01-05 14:44:52 EST EAGLE 31.3.0
File Transfer : 0 file(s) DOWNLOADED from location 1114 successfully
File Transfer : 1 file(s) UPLOADED to location 1114 successfully
File Transfer : Kermit Session terminated NORMALLY
;
rlghncxa03w 04-01-05 14:45:31 EST EAGLE 31.3.0
File Transfer : terminated NORMALLY on terminal #1
;
```

### Related Topics

- [copy-fta](#)
- [disp-fta-dir](#)
- [dlt-fta](#)

## act-flash

Use this command to activate the trial FLASH GPL that is currently running on one target card or on a range of cards.

### Parameters

#### **e1oc (optional)**

End location. The location of the last card of a range of cards to be activated.

#### **Range:**

*1101 - 1113, 1115, 1201 - 1218, 1301 - 1318, 2101 - 2118, 2201 - 2218, 2301 - 2318, 3101 - 3118, 3201 - 3218, 3301 - 3318, 4101 - 4118, 4201 - 4218, 4301 - 4318, 5101 - 5118, 5201 - 5218, 5301 - 5318, 6101 - 6118*

**gpl (optional)**

Generic program load. The flash GPL type that is running on the cards in the specified range of cards.

**Note:**

This parameter must be specified for cards that have more than one flash image (GPL).

**Range:**

xyyyyyyy 1 alphabetic character followed by up to 7 alphanumeric characters. Valid GPLs are: *blmcap*, *hipr2*, and *multiple*.

Use "gpl=multiple" to simultaneously flash multiple E5-class cards running different GPLs, such as BLMCAP, etc. The command will then flash all E5-class cards in the specified range.

**loc (optional)**

The location of a single target card.

**Range:**

1101 - 1113, 1115, 1201 - 1218, 1301 - 1318, 2101 - 2118, 2201 - 2218, 2301 - 2318, 3101 - 3118, 3201 - 3218, 3301 - 3318, 4101 - 4118, 4201 - 4218, 4301 - 4318, 5101 - 5118, 5201 - 5218, 5301 - 5318, 6101 - 6118

**sloc (optional)**

Start location. The location of the first card of a range of cards to be activated.

**Range:**

1101 - 1113, 1115, 1201 - 1218, 1301 - 1318, 2101 - 2118, 2201 - 2218, 2301 - 2318, 3101 - 3118, 3201 - 3218, 3301 - 3318, 4101 - 4118, 4201 - 4218, 4301 - 4318, 5101 - 5118, 5201 - 5218, 5301 - 5318, 6101 - 6118

**Example**

```
act-flash:loc=1105
```

```
act-flash:sloc=1101:eloc=1112:gpl=blmcap
```

**Dependencies**

The card, or cards, in the specified location or range of locations for this command must be actively running a flash GPL in *trial* mode.

The allowed cards are E5-ENET-B, E5-E1T1-B, E5-MCAP, or Service Module. Card locations xy09 and xy10 (x is the frame, y is the shelf) can be specified only for MUX cards.

Each specified card does not have to be defined in the database, but it does have to be aligned on the IMT bus.

If the target card is a MUX card, then both card locations specified in the `sloc` and `eloc` parameters must contain MUX cards on the same IMT bus. For these cards, the bus is implicit based on the specified location. Location xy09 specifies a MUX A Bus, and location xy10 specifies a MUX B Bus (x is the frame and y is the shelf). For example, `sloc=1109:eloc=6109` specifies all MUX cards on the A Bus only;

`sloc=1110:eloc=6110` specifies all MUX cards on the B Bus only. MUX cards from both the A bus and B bus cannot be flash downloaded simultaneously.

The card must be running an inactive flash GPL when this command is executed.

The provisioning subsystem mode (simple, duplex) must be established prior to executing the command.

The `loc` parameter cannot be specified with the `eloc` and `sloc` parameters.

Either the `loc` parameter or the `eloc` and `sloc` parameters must be specified.

The `eloc` and `sloc` parameters must be specified together in the command; one parameter cannot be specified without the other parameter.

The `sloc` parameter value cannot be greater than the `eloc` parameter value.

MUX cards in the specified `sloc` and `eloc` card locations must be present and able to communicate over the IMT. The cards do not have to be provisioned in the database.

The `gpl` parameter must be specified if the `eloc` and `sloc` parameters are specified.

The `gpl` parameter must be specified for cards that have more than one flash image (GPL).

MUX cards in the locations specified by the `sloc` and `eloc` parameters must be running the specified GPL. If the GPL specified is not multiple, then other cards in the range of locations can be running other GPLs but will not be activated, and only cards that are within the range and running the specified GPL will be activated.

A card that is the active MASP cannot be specified for the `loc`, `sloc`, or `eloc` parameter.

No other action command can be in progress when this command is entered.

A card location that is valid and defined in the database must be specified.

MUX cards specified in the `sloc` and `eloc` location parameters must be running the specified general program load (gpl). For other GPLs including multiple, all cards within the range running the specified GPL will be activated.

This command cannot be entered during an Extended Bit Error Rate Test (BERT).

The `gpl=multiple` parameter can be specified only if the `sloc` and `eloc` parameters are specified.

The `gpl=multiple` parameter can be specified only if the cards in the locations specified in the `sloc` and `eloc` parameters are E5-class cards.

## Notes

None

## Output

```
act-flash:loc=1105
```

```
rlghncxa03w 04-01-04 13:05:05 EST EAGLE 31.3.0  
FLASH Memory Activation for card 1105 Started.
```

```
;
```

```
rlghncxa03w 04-01-04 13:05:05 EST EAGLE 31.3.0
FLASH Memory Activation for card 1105 Completed.
;

rlghncxa03w 04-01-04 13:05:05 EST EAGLE 31.3.0
Command Completed.
;

act-flash:sloc=1101:eloc=1112:gpl=blmcap

tekelecstp 18-01-15 02:30:23 EST EAGLE 46.6.0.0.0-71.5.0
FLASH activation for cards 1101 - 1112 Completed.
LOC 1101 : PASSED
LOC 1102 : PASSED
LOC 1112 : PASSED

ALL CARD RESULTS PASSED
;
Command Completed.
;
```

### Related Topics

- [clr-imt-stats](#)
- [flash-card](#)
- [init-flash](#)
- [init-imt-gpl](#)
- [rept-imt-info](#)
- [rept-imt-lvl1](#)
- [rept-imt-lvl2](#)
- [tst-imt](#)

## act-ftp-trns

Use this command to activate an FTP transfer to send database tables from the system to the customer's FTP server.



### Note:

This command is not for customer use. It is for Tekelec use only.

### Parameters

#### **action (mandatory)**

The operation that the command is to perform.

**Range:**

*put*

**filetype (mandatory)**

The system table type to be transferred.

**Range:**

***all***

Transfer all types of tables

***enum***

Transfer all ENUM tables

***exts***

Transfer the Extended Statistics table

***ip***

Transfer all IP tables

***gtt***

Transfer all Global Title Translation tables

***gws***

Transfer all Gateway Screening tables

***mtp***

Transfer all Message Transfer Part tables

***vflex***

Transfer all V-Flex tables

**Example**

```
act-ftp-trns:action=put:filetype=gtt
```

**Dependencies**

This command cannot be entered if another file transfer is already in progress.

The `action` and `filetype` parameters must be specified in the command.

The FTP Server table must be accessible.

The FTP Server table must contain at least one FTP server entry that specifies the *user* application

An IPSM card must be in service before this command can be entered.

This command cannot be entered when CAT2 IPSM to OAM syncing is in progress.

**Notes**

This command communicates with the *user* application, defined in the FTP Server table. The IP address and server details necessary for an FTP transfer are also stored in the FTP Server table. One such *user* application is the FTP-based Table Retrieve Application (FTRA). Refer to the *FTP-Based Table Retrieve Application (FTRA) User Guide* for assistance.



**Output**

```
act-ftp-trns:action=put:filetype=ip

tekelecstp 09-05-06 06:41:17 EST EAGLE 41.0.0
FTP command sent to IPSM card - Processing
;

tekelecstp 09-05-06 06:41:17 EST EAGLE 41.0.0
Copy-table started - tablexxx.tbl
Copy-table COMPLETE.
;

tekelecstp 09-05-06 06:41:17 EST EAGLE 41.0.0
FTP file transfer started - tablexxx.tbl
FTP file transfer SUCCESSFUL.
;

tekelecstp 09-05-06 06:41:17 EST EAGLE 41.0.0
FTP transfer COMPLETE.
;
```

## act-gpl

Use this command to change the status of the trial GPL from “trial” to “approved.” The status of the previously approved GPL is changed to “trial.”

**Parameters****gp1 (mandatory)**

Generic program load. The name of the GPL identifier to be moved from "trial" to "approved" status on the disk.

**Range:**

*xyyyyyyy*

1 alphabetic character followed by up to 7 alphanumeric characters. Valid GPLs are:

*atmhc*—Used by E5-ATM-B cards to allow the card to support up to 3 signaling links.

*bldc32*—Flash GPL containing a tar image with all code required on E5-MCAP cards to support VxWorks6.9 32-bit application, as in OAMHC69.

*bldc64*—Flash GPL containing a tar image with all code required on E5-SM8G-B cards for SCCP64, ENUM64, SIP64 and DEIR64 applications.

*blmcap*—Flash GPL containing a tar image with all code required on E5-MCAP, E5-E1T1-B, E5-MCPM-B, E5-ATM-B, E5-ENET-B, and E5-SM8G-B cards

*blslc32*—Flash GPL containing a tar image with all code required on SLIC cards for 32-bit application i.e. MCPHC, IPSHC etc.

*blslc64*—Flash GPL containing a tar image with all code required on SLIC cards for 64-bit application i.e. SCCP64, ENUM64, SIP64 and DEIR64.

*bis1932*—Flash GPL containing a tar image with all code required on SLIC cards for 32-bit application on VxWorks6.9, as in IPSHC69 and MCPHC69.

*deirhc*— Used by E5-SM8G-B cards to support the S13/S13' EIR feature.

*enumhc*—Used by E5-SM8G-B cards to support the ENUM Mobile Number Portability and Tier One Address Resolution application.

*erthc*—Used by E5-ENET-B cards for EAGLE 5 Integrated Monitoring Support functions

*hipr2*—Communication software used on the High Speed IMT Packet Router (HIPR2) card

*ipsg*—Used by E5-ENET-B cards to support the combined functionality of IPLIMx M2PA and IPGWx M3UA

*ipsg32*—Used by SLIC cards to support IPSEG application with 64-bit addressing either with GTT functionality or without it.

*ipshc*—Used by E5-ENET-B cards to support the IPS application.

*ipshc69*—Used by E5-ENET-B and SLIC cards to support the IPS application when running on VxWorks69.

*mcphc*— Used by E5-MCPM-B cards for the Measurements Platform feature.

*mcphc69*—Used by E5-MCPM-B and SLIC cards for the Measurements Platform feature when running on VxWorks69.

*oamhc*—Used by E5-MCAP cards for enhanced OAM functions.

*oamhc69*—Used by E5-MCAP cards for enhanced OAM functions, when running on VxWorks 69.

*sccphc*—Used by E5-SM8G-B cards to support EPAP-based features and the LNP ELAP Configuration feature. If no EPAP-based or LNP ELAP Configuration feature is turned on, and an E5-SM8G-B card is present, then the GPL processes normal GTT traffic.

*sfapp*—Used by SLIC cards to support the Stateful Firewall Application.

*siphc*— Used by E5-SM8G-B Cards to support the SIP application.

*ss7hc*—Application GPL used by E5-E1T1-B and SLIC cards to support **E1** and **T1** signaling links.

**ver (mandatory)**

Version. The version number of the GPL to be activated, with subfields the format of *major-minor-fix* separated by dashes.

**Range:**

*major-minor-fix*

Specify a value in the range 0–255 for each subfield of the GPL version number (*major-minor-fix*).

**Example**

```
act-gpl:gpl=ss7hc:ver=125-1-0
act-gpl:gpl=deirhc:ver=134-60-0
act-gpl:gpl=enumhc:ver=135-20-0
act-gpl:gpl=ipsg32:ver=140-12-0
```

**Dependencies**

No other activate, change, copy, or retrieve GPL commands, nor a GPL audit, can be in progress when this command is entered.

The value specified for the `gpl` parameter must be supported. See the `gpl` definition for a list of supported GPLs.

## Notes

Test the trial GPL by loading to a card before activating the GPL. Activating the GPL changes it from *trial* to *approved*.

The generic program load is committed on the active system and on the standby system.

Trial GPLs are downloaded to cards manually. Only approved GPLs can be downloaded to cards by the system.

Use the `rtrv-gpl` command to determine the version of the GPL.

## Output

The output indicates that the specified GPL is activated on each TDM card.

```
act-gpl:gpl=ss7hc:ver=125-1-0
```

```
tekelecstp 05-01-03 16:53:23 EST EAGLE5 33.0.0
SS7HC activate to 1114 completed
SS7HC activate to 1116 completed
;
```

The output indicates that the specified GPL is activated on each TDM card.

```
act-gpl:gpl=deirhc:ver=134-60-01
```

```
tekelecstp 13-03-15 19:08:39 EST EAGLE 45.1.0
DEIRHC activate to 1114 completed
DEIRHC activate to 1116 completed
;
```

```
act-gpl:gpl=enumhc:ver=135-20-0
```

```
tekelecstp 14-05-20 14:18:32 EST EAGLE 46.1.0
ENUMHC activate to 1114 completed
ENUMHC activate to 1116 completed
;
```

```
act-gpl:gpl=ipsg32:ver=140-12-0
```

```
tekelecstp 12-08-16 09:35:00 EST EAGLE 46.5.0
IPSG32 activate to 1114 completed
IPSG32 activate to 1116 completed
;
```

The number of "cards of x complete" represents the total number of cards that can communicate on the IMT at the instant that this information is displayed.

```
act-gpl:gpl=hipr2:ver=135-041-000

act-gpl:gpl=hipr2:ver=135-041-000

tekelecstp 15-04-16 11:12:45 EST EAGLE5 46.2.0-65.42.0
5575.1104 CARD 1107,A INFO IP Connection Failed
tekelecstp 15-04-16 11:12:49 EST EAGLE5 46.2.0-65.42.0
act-gpl:gpl=hipr2:ver=135-041-000
Command entered at terminal #20.
;

Command Accepted - Processing
tekelecstp 15-04-16 11:12:50 EST EAGLE5 46.2.0-65.42.0
HIPR2 activate on 1116 completed
HIPR2 activate on 1114 completed
;
```

### Related Topics

- [chg-gpl](#)
- [copy-gpl](#)
- [rept-stat-gpl](#)
- [rtrv-gpl](#)

## act-lbp

Use this command to activate one or more loopback point tests for testing data signaling link elements in an SS7 transmission path. Use this command to:

- Activate a test for a specified loopback point that is defined in the LFS database table
- Activate a test for one loopback point that is not defined in the LFS database table
- Activate tests for all loopback points that have been defined in the LFS database table. See [Summary of Loopback Testing Commands and Functions](#) for information about loopback testing commands and functions.

The `ent-lbp` command can be used to define a maximum of 32 loopback points in the LFS database table.

### Parameters

To activate a test for a single loopback point that is defined in the LFS database table, specify the loopback point number in the `lbp` parameter and do not specify the `lfst`, `rle`, `rep`, or `clli` parameter in the command. Information from the LFS database is used to activate the test for the specified loopback point.

To activate a test for a single loopback point that is not defined in the LFS database table, specify one or more of the `lfst`, `rle`, `rep`, and `clli` parameters in the command. (If the `clli` parameter is not specified, then the value is blank, a null string. If the `rep` parameter is not specified, the default value is **0**.)

To activate tests for all loopback points defined in the LFS database, do not specify the `lbp`, `lfst`, `rle`, `rep`, or `clli` parameter in the command. Information from the LFS database table is used to activate tests for all defined loopback points.

**link (mandatory)**

SS7 signaling link. The SS7 signaling link to be tested.

**Synonym:**

*port*

**Range:**

*a, b, a1 - a31, b1 - b31*

Not all card types support all link parameter values.

See [Table A-1](#) for valid link parameter range values for each type of card that can have assigned signaling link ports.

**loc (mandatory)**

The location of the card containing the signaling link to use for loopback point testing.

**Range:**

*1101 - 1108, 1111 - 1112, 1201 - 1208, 1211 - 1218, 1301 - 1308, 1311 - 1318,  
2101 - 2108, 2111 - 2118, 2201 - 2208, 2211 - 2218, 2301 - 2308, 2311 - 2318,  
3101 - 3108, 3111 - 3118, 3201 - 3208, 3211 - 3218, 3301 - 3308, 3311 - 3318,  
4101 - 4108, 4111 - 4118, 4201 - 4208, 4211 - 4218, 4301 - 4308, 4311 - 4318,  
5101 - 5108, 5111 - 5118, 5201 - 5208, 5211 - 5218, 5301 - 5308, 5311 - 5318,  
6101 - 6108, 6111 - 6118*

**clli (optional)**

Common language location identifier. The CLLI code or other mnemonic identifier, used to refer to the given loopback point.

**Range:**

*ayyyyyyyyy*

1 alphabetic character followed by up to 10 alphanumeric characters

**Default:**

If the `rle`, `lfst`, or `rep` parameter is specified—null string (blank)

If the `rle`, `lfst`, or `rep` parameter is not specified—the value in the LFS database

**data (optional)**

The data used with the *octet* or *alternate* patterns.

**Range:**

*1 - 255*

**Default:**

*255*

**force (optional)**

The `force=yes` parameter must be specified to start a test when there are 256 or more tests already running.

**Range:***yes**no***Default:***no***lbp (optional)**

Loopback point ID. A far-end loopback point that lies along an SS7 signaling link path between the STP and the target device (up to and including the target device).

**Range:***1 - 32***Default:**

If the *rle*, *clli*, *rep*, or *lfst* parameter is specified, the default is *1*.

If the *rle*, *clli*, *rep*, or *lfst* parameter is not specified, the default is all loopback points found in the LFS database (up to 32 loopback points), as shown in the *rtrv-lbp* command output.

**lfst (optional)**

Link fault sectionalization test.

**Note:**

This parameter is mandatory if the *rle*, *clli*, or *rep* parameter is specified.

**Range:***llt*

latching loopback test; a software latch is set at the test point to reverse everything that is received and return it to the sender until the test is complete

*mlt*

manual latch loopback test; an external hardware latch is set to reverse everything that is received and return it to the sender until the test is complete (for equipment that cannot set a software latch for the test)

*nlt*

nonlatching loopback test; no permanent latch is set. Loopback codes are alternated with test data until the test is complete.

**Default:**

The value in the LFS database, as shown in the *rtrv-lbp* command output

**maxerr (optional)**

Bit error threshold. This parameter specifies the actual number of errors allowed for a specific time period during which loopback testing is being performed. If this threshold is exceeded, the *TEST STATUS* field in the output report indicates an error.

**Range:***0 - 4838400*

**Default:**  
56

**pattern (optional)**

This parameter specifies the type of test pattern used to perform the LFS test.

**Range:**

***b2047***

047-bit BERT pattern sent until it is stopped by software

***b511***

511-bit BERT pattern sent until it is stopped by software

***octet***

Data (from the `data` parameter) sent continuously until it is stopped by software

***alternate***

Alternately, a count of 100 octets of the specified data (from the `data` parameter) followed by 100 octets of 0, sent until it is stopped by the software

The *octet* and *alternate* values are valid only when `lfst=llt` is specified.

**Default:**  
*b2047*

**rep (optional)**

Repetition count. The number of link elements of the same type (not including the target device) that lie between the STP and the link element to be tested.

**Range:**  
0 - 31

**Default:**

If the `rle`, `clli`, `rep`, or `lfst` parameter is specified, the default is 0.

If the `rle`, `clli`, `rep`, or `lfst` parameter is not specified, the default is the value in the LFS database, as shown in the `rtrv-lbp` command output.

**rle (optional)**

Remote link element. The link element to be looped back for testing.



**Note:**

This parameter is mandatory if the `lfst`, `clli`, or `rep` parameter is specified.

**Range:**

*ds0*

*ocu*

**csu****dsu****nei****Default:**The value from the LFS database, as shown in the `rtrv-lbp` command output**time (optional)**The length of time the test must be run in order to determine success or failure. If the number of errors that actually occur during this time exceeds the threshold set by the `maxerr` parameter, the loopback test is identified as a failure.**Range:***1 - 240000**hhmmss—hh=hours (00-24), mm=minutes (00-59), ss=seconds (00-59)*For example, *time=1* or *time=000001* is one second; *time=240000* is 24 hours; *time=200* or *time=000200* is 2 minutes**Default:***1 second***Example**

Activate tests for all loopback points that are defined in the LFS database table:

```
act-lbp:loc=1205:link=b:pattern=alternate:maxerr=10:time=000200
```

Activate a test for a single loopback point that is not defined in the LFS database table:

```
act-lbp:loc=1205:link=b:lbp=1:rle=ds0:lfst=llt:clli=rlghncxa05w
```

```
act-
```

```
lbp:loc=1205:link=b:lbp=1:rle=ds0:lfst=llt:clli=rlghncxa05w:pattern=
octet:data=h' ff
```

```
act-
```

```
lbp:loc=1205:link=b:lbp=1:rle=ds0:lfst=llt:clli=rlghncxa05w:maxerr=4
0:time=12000
```

Activate a test for a single loopback point that is defined in the LFS database table:

```
act-
```

```
lbp:loc=1205:link=b:lbp=3:pattern=alternate:maxerr=10:time=000200
```

**Dependencies**

The Link Fault Sectionalization (LFS) feature must be on before this command can be entered.

If the `rle=nei` parameter is specified, the `rep=0` parameter must be specified.The `rep` parameter can be specified only if the `lfst=llt` parameter is specified.The `rle=ds0` or the `rle=nei` parameter cannot be specified if the `lfst=nlt` parameter is specified. The DS0 and Network Element Interface (NEI) link elements do not support non-latching loopbacks.



If one or more of the `rle`, `rep`, `lfst`, or `clli` parameters are specified, the database is not used to look up their values; therefore, the `lfst` and `rle` parameters must be specified when the `rep` or `clli` parameter is specified.

The `data` parameter can be specified only if the `pattern=octet` parameter or `pattern=alternate` parameter is specified.

The `pattern=octet` and `pattern=alternate` parameters cannot be specified for non-latching tests (`rle=nl`).

The card location (`loc` parameter) must contain a provisioned and equipped E5-E1T1-B card, provisioned with the LIMT1 card type, running the SS7ANSI or CCS7ITU application.

The card in the `loc` parameter location must be in the In-Service-Normal state.

The signaling link that is used for LFS testing must be equipped, and must be deactivated before this command is entered.

The loopback points (LBPs) must have been previously defined in the database.

Only one LFS test can be active on a signaling link at a time.

This command cannot be entered for a signaling link LFS test when the maximum number of LFS tests are active for the card. At least one LFS test must complete before this command can be entered again.

Up to 8 LFS tests at a time can be active on an E5-E1T1-B card used as a T1 card.

This command cannot be entered when the maximum combined total number of LFS and link tests (1024) are in progress in the system. At least one test must complete before this command can be entered again.

The `force=yes` parameter must be specified to activate a test when there are 256 or more tests already running in the system.

The specified signaling link must not be running a `tst-slk` test when this command is entered. The `tst-slk` test must be stopped or allowed to complete before this command can be entered for the link.

The specified signaling link must not be in Command Driven Loopback (CDL) when this command is entered. The link must be removed from CDL before this command can be entered for the link.

This command cannot be entered for a link that is already blocked by another link diagnostic test. The test must be canceled or allowed to complete before this command can be entered for the link.

LFS testing is not available during upgrade.

The maximum number of loopback point entries allowed in the LFS table is 32.

## Notes

This command is not supported for E5-ATM-B cards.

If an LFS test is aborted by a card reset, it can leave the remote far-end loopback condition active. Use the `dact-lbp` command to cancel LFS tests.

The E5-E1T1-B cards support this command on up to 8 T1 channels at a time; the command is not supported for E1.

The test can terminate with the status "ERROR, bit error exceeded threshold" for two reasons.

- The number of cumulative bit errors exceeds the specified `maxerr` parameter value.
- The number of bit errors for one second reaches or exceeds 255, without considering the `maxerr` parameter value.

### Output

The LFS report is displayed when the LFS test completes.

This example shows how the test failed because the bit error rate exceeded the threshold. The `maxerr=10` parameter is used for a test time of 2 minutes. Because more than 10 errors occurred within 2 minutes, the test is considered a failure and the TEST STATUS field displays the cause. The parameter values are applied to each loopback point. The `maxerr` value is per test, not cumulative for all tests.

```
act-lbp:loc=1205:link=b:pattern=alternate:maxerr=10:time=002000
```

```
tekelecstp 05-01-21 17:00:36 EST EAGLE5 33.0.0
LOC = 1205 Link = B LSN = ls11345678 Start time = 11:10:34

PATTERN = ALTERNATE DATA= FF MAXERR = 10 TIME = 00:02:00

TEST STATUS = ERROR, bit error exceeded threshold.
LBP CLLI          RLE REP LFST BIT_ERROR ERRORED_SEC DURATION
2   rlghncxa05w  DS0 0   LLT   0           0           00:02:00
3   ----- OCU 0   NLT   8           2           00:02:00
5   ----- NEI 0   LLT  15           1           00:01:20
;
```

In this example, the test failed because the loopback could not be established.

```
act-lbp:loc=1205:link=b:pattern=alternate:maxerr=10:time=000200
```

```
tekelecstp 05-01-21 17:00:36 EST EAGLE5 33.0.0
LOC = 1205 Link = B LSN = ----- Start time = 11:10:34

PATTERN = ALTERNATE DATA= FF MAXERR = 10 TIME = 00:02:00
TEST STATUS = ERROR, loopback was not established.

LBP CLLI          RLE REP LFST BIT_ERROR ERRORED_SEC DURATION
1   rlghncxa05w  DS0 0   LLT   0           0           00:00:00
;
```

### Legend

- **LOC**—Card location that contains the signaling being tested
- **LINK**—Signaling link that is being tested on the card
- **LSN**—Name of the linkset that contains the link being tested
- **Start time**—Time that the test started

- **PATTERN**—Type of test pattern used to perform the LFS test
- **DATA**—Data used with the octet or alternate patterns
- **MAXERR**—Bit error threshold; actual number of errors allowed for the specific time period during which loopback testing is being performed. If this threshold is exceeded in the specified time period, the *TEST STATUS* field in the output report indicates an error.
- **TIME**—Specified length of time to run the test in order to determine success or failure. If the number of errors that actually occur during this time exceeds the threshold set by the `maxerr` parameter, the loopback test is identified as a failure.
- **TEST STATUS**—Any one of the following *TEST STATUS* values can appear:
  - PASS
  - ERROR, LFS HARDWARE is not available.
  - ERROR, loopback could not be established.
  - ERROR, bit error exceeded threshold.
  - ERROR, LFS test aborted.
  - ERROR, LFS hardware failed.
- **LBP**—Loopback point used to perform the LFS test
- **CLLI**—Common Language Location Identifier (CLLI) code, or other mnemonic identifier, used to refer to the given loopback point
- **RLE**—Remote link element to be looped back for testing
- **REP**—Repetition count. The number of link elements of the same type (not including the target device) that lie between the STP and the link element to be tested.
- **LFST**—Type of link fault sectionalization loopback test to be performed
- **BIT\_ERROR**—The number of bit errors observed during the test
- **ERRORED\_SEC**—The number of seconds that contained bit errors during the test. (Bit errors are sampled once per second; each sample that contains bit errors adds one second to this count.)
- **DURATION**—Length of time that the test actually ran for the loopback point. For successful test, the *TIME* and the *DURATION* should be the same. If a test ran for less than the specified amount of time, the *DURATION* will be less than the *TIME*.

#### Related Topics

- [chg-lbp](#)
- [dact-lbp](#)
- [dlt-lbp](#)
- [rept-stat-lfs](#)
- [rtrv-lbp](#)

## act-lg-card

Use this command to activate LG event generation/reception on a given LG card

The command class is TKLC\_INTERNAL inheriting properties of DEBUG class. The Load Generator is supported on IPSTG, IPLHC, IPGHC and SS7HC GPLs.

### Parameters

#### **loc (mandatory)**

The card location as stenciled on the shelf of the system.

#### **Range:**

1101 - 1108, 1111 - 1112, 1201 - 1208, 1211 - 1218, 1301 - 1308, 1311 - 1318, 2101 - 2108, 2111 - 2118, 2201 - 2208, 2211 - 2218, 2301 - 2308, 2311 - 2318, 3101 - 3108, 3111 - 3118, 3201 - 3208, 3211 - 3218, 3301 - 3308, 3311 - 3318, 4101 - 4108, 4111 - 4118, 4201 - 4208, 4211 - 4218, 4301 - 4308, 4311 - 4318, 5101 - 5108, 5111 - 5118, 5201 - 5208, 5211 - 5218, 5301 - 5308, 5311 - 5318, 6101 - 6108, 6111 - 6118

#### **dir (optional)**

The direction in which the event generation or reception is to be activated.

#### **Range:**

##### **Rx**

Receive Direction

##### **Tx**

Transmit Direction

##### **All**

Both in Tx and Rx directions

#### **Default:**

All

### Example

```
act-lg-card:loc=1302
```

```
act-lg-card:loc=1302:dir=tx
```

```
act-lg-card:loc=1302:dir=rx
```

### Dependencies

The card location must not be 1113-1118, xy09, or xy10 where x is the frame and y is the shelf.

The LG Card table is corrupt or cannot be found.

The card location specified in the `loc` parameter must be of a provisioned LG card.

Loc is mandatory

Activating the state of an LG object that is already activated or deactivating the state of an LG object that is already deactivated has no effect.

### Output

None.

**Related Topics**

- [chg-lg-card](#)
- [dact-lg-card](#)
- [dlt-lg-card](#)
- [ent-lg-card](#)
- [rept-stat-lg](#)
- [rtrv-lg-card](#)

## act-lg-engine

Use this command to activate LG event generation/reception on an LG engine hosted on a LG card.

The command class is TKLC\_INTERNAL inheriting properties of DEBUG class. The Load Generator is supported on IPSG, IPLHC, IPGHC and SS7HC GPLs.

**Parameters****dir (optional)**

Traffic Direction.

**Range:*****Rx***

Receive Direction

***Tx***

Transmit Direction

***All***

Both in Tx and Rx directions

**Default:**

*All*

**engine (optional)****Range:**

*ayyyyyyyyy*

Up to 10 alphanumeric characters; the first character must be a letter.

**loc (optional)**

The card location as stenciled on the shelf of the system.

**Range:**

*1101 - 1108, 1111 - 1112, 1201 - 1208, 1211 - 1218, 1301 - 1308, 1311 - 1318,  
2101 - 2108, 2111 - 2118, 2201 - 2208, 2211 - 2218, 2301 - 2308, 2311 - 2318,  
3101 - 3108, 3111 - 3118, 3201 - 3208, 3211 - 3218, 3301 - 3308, 3311 - 3318,  
4101 - 4108, 4111 - 4118, 4201 - 4208, 4211 - 4218, 4301 - 4308, 4311 - 4318,  
5101 - 5108, 5111 - 5118, 5201 - 5208, 5211 - 5218, 5301 - 5308, 5311 - 5318,  
6101 - 6108, 6111 - 6118*

**test (optional)**  
Send Single MSU

**Range:**  
yes

### Example

```
act-lg-engine:loc=1301
act-lg-engine:engine=txengine1
act-lg-engine:loc=1301:dir=tx
act-lg-engine:engine=txengine1:test=yes
```

### Dependencies

The engine name specified must pre-exist in the LG Engine table.

The `loc` parameter cannot be specified with the `engine` parameter.

At least one optional parameter must be specified.

The card location specified in the `loc` parameter must be of a provisioned LG card.

DIR parameter can only be specified along with LOC parameter.

Activating the state of an LG object that is already activated or deactivating the state of an LG object that is already deactivated has no effect.

Test parameter can only be specified with Tx engine.

### Output

None.

### Related Topics

- [chg-lg-engine](#)
- [dact-lg-engine](#)
- [dlt-lg-engine](#)
- [ent-lg-engine](#)
- [rept-stat-lg](#)
- [rtrv-lg-engine](#)

## act-lg-grp

Use this command to activate event generation/reception for a LG group. The command class is TKLC\_INTERNAL inheriting properties of DEBUG class. The Load Generator is supported on IPSG, IPLHC, IPGHC and SS7HC GPLs.

## Parameters

### **grp (mandatory)**

**Range:**

aaaaaaaa Up to 10 alphanumeric characters; the first character must be a letter

### **dir (optional)**

The direction in which the event generation or reception is to be activated.

**Range:****Rx**

Receive Direction

**Tx**

Transmit Direction

**All**

Both in Tx and Rx directions

**Default:**

All

### **Example**

```
act-lg-grp:grp=lgroup1:dir=tx
```

```
act-lg-grp:grp=lgroup1:dir=rx
```

```
act-lg-grp:grp=lgroup2
```

### **Dependencies**

The group name specified must pre-exist in the LG Group table

The LG Group table is corrupt or cannot be found.

The `grp` parameter must be specified.

Activating the state of an LG object that is already activated or deactivating the state of an LG object that is already deactivated has no effect.

### **Output**

None.

### **Related Topics**

- [dlt-lg-grp](#)
- [ent-lg-grp](#)
- [rept-stat-lg](#)
- [rtrv-lg-grp](#)

## act-lg-sys

Use this command to activate the LG event generation/reception on all LG cards configured in the system.

The command class is TKLC\_INTERNAL inheriting properties of DEBUG class. The Load Generator is supported on IPSG, IPLHC, IPGHC and SS7HC GPLs.

### Parameters

#### **dir (mandatory)**

The direction in which the traffic is generated.

#### **Range:**

**Rx**  
Receive Direction

**Tx**  
Transmit Direction

**All**  
Both in Tx and Rx Directions

#### **Default:**

*all*

### Example

```
act-lg-sys:dir=tx
act-lg-sys:dir=rx
act-lg-sys:dir=all
```

### Dependencies

The LG System table is corrupt or cannot be found.

dir is mandatory

Activating the state of an LG object that is already activated or deactivating the state of an LG object that is already deactivated has no effect.

### Output

None.

### Related Topics

- [dact-lg-sys](#)
- [rept-stat-lg](#)
- [rtrv-lg-sys](#)



## act-lpo

Use this command to force a processor outage on the specified link. The system begins sending link status signal units (LSSUs) with a status of SIPO to the adjacent signaling point. Level 2 status remains in service, except when the link is an ATM high-speed signaling link.

**Note:**

The signaling link's blocked status is not preserved across a LIM reboot.

**Parameters****link (mandatory)**

The signaling link on the card specified in the `loc` parameter. The links can be specified in any sequence or pattern.

**Synonym:**

*port*

**Range:**

*a, b, a1 - a63, b1 - b63*

Not all card types support all link parameter values.

See [Table A-1](#) for valid link parameter range values for each type of card that can have assigned signaling links.

**loc (mandatory)**

The card location as stenciled on the shelf of the system.

**Range:**

*1101 - 1108, 1111 - 1112, 1201 - 1208, 1211 - 1218, 1301 - 1308, 1311 - 1318,  
2101 - 2108, 2111 - 2118, 2201 - 2208, 2211 - 2218, 2301 - 2308, 2311 - 2318,  
3101 - 3108, 3111 - 3118, 3201 - 3208, 3211 - 3218, 3301 - 3308, 3311 - 3318,  
4101 - 4108, 4111 - 4118, 4201 - 4208, 4211 - 4218, 4301 - 4308, 4311 - 4318,  
5101 - 5108, 5111 - 5118, 5201 - 5208, 5211 - 5218, 5301 - 5308, 5311 - 5318,  
6101 - 6108, 6111 - 6118*

**Example**

```
act-lpo:loc=1101:link=a
```

```
act-lpo:loc=1102:link=a40
```

**Dependencies**

A card location that is valid and defined in the database must be specified.

No other action command can be in progress when this command is entered.

This command is not valid for cards running the IPGHC GPL.

The card must contain signaling links.

The signaling link must be equipped in the database.

This command is not valid for links belonging to proxy linksets.

The value specified for the `loc` parameter must refer to one of the following cards, and the referenced card must be equipped:

- E5-E1T1-B card running the SS7ANSI or CCS7ITU application
- E5-ATM-B card running the ATMANSI or ATMITU application
- E5-ENET-B card running the IPLHC or IPSG application

An appropriate value must be specified for the `link` parameter when an ATM card is used:

- `a-a1, b`—E5-ATM-B card running the ATMANSI or ATMITU application

The `act-lpo` command is not supported for ITU-N16 links.

This command is not valid for IPSG-M3UA signaling links.

### Notes

The function of this command is the same as the `blk-slk` command.

This command generates an alarm.

If this command is followed by the `init-card` command, the local processor outage is not preserved after the `init-card` command completes.

The *Installation Guide* provides an illustration of card locations.

If the `blk-slk` or `act-lpo` command is issued for an IPSG signaling link, then an MTP3 local processor outage is initiated.

### Output

```
act-lpo:loc=1101:link=a
```

```
tekelecstp 05-01-21 17:00:36 EST  EAGLE5 33.0.0  
Local processor outage being set.
```

```
tekelecstp 05-01-21 17:00:36 EST  EAGLE5 33.0.0  
* 0014.0208 * SLK 1101,A nc00027 slk local blocked
```

```
act-lpo:loc=1102:link=a40
```

```
tekelecstp 16-05-27 17:00:36 EST  EAGLE 69.1.0  
Local processor outage being set.
```

```
tekelecstp 16-05-27 17:00:36 EST  EAGLE 69.1.0  
* 0014.0208 * SLK 1101,A40 lsna40 slk local blocked
```

### Related Topics

- [blk-slk](#)
- [canc-lpo](#)
- [rept-stat-slk](#)
- [ublk-slk](#)

## act-slk

Use this command to change the link from OOS-MT-DSBLD (Out-of-Service-Maintenance-Disabled) to IS-NR (In-Service-Normal).

**Note:**

The signaling link's activated status is preserved across a card reboot.

### Parameters

**link (mandatory)**

The signaling link on the card specified in the `loc` parameter. The links can be specified in any sequence or pattern.

**Synonym:**

*port*

**Range:**

*a, b, a1 - a31, b - b31*

Not all card types support all link parameter values.

See [Table A-1](#) for valid link parameter range values for each type of card that can have a location specified in the `loc` parameter.

**loc (mandatory)**

The card location as stenciled on the shelf of the system.

**Range:**

*1101 - 1108, 1111 - 1112, 1201 - 1208, 1211 - 1218, 1301 - 1308, 1311 - 1318,  
2101 - 2108, 2111 - 2118, 2201 - 2208, 2211 - 2218, 2301 - 2308, 2311 - 2318,  
3101 - 3108, 3111 - 3118, 3201 - 3208, 3211 - 3218, 3301 - 3308, 3311 - 3318,  
4101 - 4108, 4111 - 4118, 4201 - 4208, 4211 - 4218, 4301 - 4308, 4311 - 4318,  
5101 - 5108, 5111 - 5118, 5201 - 5208, 5211 - 5218, 5301 - 5308, 5311 - 5318,  
6101 - 6108, 6111 - 6118*

**Example**

```
act-slk:loc=1301:link=a
```

**Dependencies**

The value specified for the `loc` parameter must refer to one of the following cards, and the referenced card must be equipped:

- E5-E1T1-B, card running the SS7ANSI or CCS7ITU application
- E5-ATM-B card running the ATMANSI or ATMITU application
- E5-ENET-B card running the IPGWI, IPLIMI, IPSG, or SS7IPGW application
- E5-ENET-B or SLIC card running the IPSG application

This command cannot be entered while the `tst-slk` command is in progress.

A card location that is defined in the database must be specified.

The card must contain signaling links.

No other action command can be in progress when this command is entered.

The specified signaling link must be provisioned in the database.

An appropriate value must be specified for the `link` parameter when an ATM card is used:

- `a-a1, b`— E5-ATM-B card running the ATMANSI or ATMITU application

A link cannot be activated if the `tst-j1` command is in progress on the same port on which the particular link being activated is configured.

This command is not valid for IPSPG-M3UA signaling links.

### Notes

*Installation Guide* provides an illustration of card locations.

If Port A32-A63 and B32-B63 is configured when card is not in IS-NR state, then the card won't come up if it's NON-SLIC card.

### Output

```
act-slk:loc=1301:link=a
```

```
tekelecstp 05-01-21 17:00:36 EST EAGLE5 33.0.0
Activate Link message sent to card
;
```

### Related Topics

- [blk-slk](#)
- [dact-slk](#)
- [dlt-slk](#)
- [ent-slk](#)
- [inh-slk](#)
- [rept-stat-slk](#)
- [rtrv-slk](#)
- [tst-slk](#)
- [ublk-slk](#)
- [unhb-slk](#)

## act-user

Use this command to log into the system. This command is an alternate to the `login` command. After the command is entered, the system requests a password. For security reasons the password is not echoed to the terminal.

## Parameters

### **uid (mandatory)**

User ID. The system prompts you for a valid password after this ID is entered.

#### **Range:**

*azzzzzzzzzzzzzzzzzzz*

1 alphabetic character followed by up to 15 alphanumeric characters; the first character must be a letter.

### **Example**

```
act-user:uid=john
```

### **Dependencies**

The first character of the user ID must be a letter.

### **Notes**

#### **Caution:**

If the OA&M IP Security Enhancements feature is not turned on, a serial terminal (terminals 1-16) must be used to log in with a new Userid and password for the first time or to change an expired password. The OA&M IP Security Enhancements feature must be turned on before the password can be changed at the prompt from an IP User Interface telnet terminal (IDs 17-40) when it is the first time the user is logging in with an assigned Userid and password or the password has expired.

The `login` command can be used instead of `act-user`. The command `act-user` has been provided in accordance with OTGR standards.

When a new system is shipped, the user ID and password are set to the system. Change these immediately to ensure system security.

### **Output**

Not applicable.

### **Related Topics**

- [chg-pid](#)
- [chg-user](#)
- [dact-user](#)
- [dlt-user](#)
- [ent-user](#)
- [login](#)
- [logout](#)
- [rept-stat-user](#)
- [rtrv-secu-user](#)

- [rtrv-user](#)

## alw-card

Use this command to change the card from OOS-MT-DSBLD (Out-of-Service-Maintenance-Disabled) to IS-NR (In-Service-Normal) if the loading is successful.

### Parameters

#### **code (optional)**

The GPL type to be loaded.



#### **Note:**

In case `code` is provided along with `sloc` and `eloc` parameters in the command, then `code` parameter's value is applied to all the cards within `sloc-eloc` range, including `sloc` and `eloc`.



#### **Caution:**

Do not enter the `pktgen` or `inactiveprtn` values for this parameter unless instructed to do so by Oracle personnel.

### Range:

#### ***appr***

Downloads the approved GPL

#### ***inactiveprtn***

Downloads the MASP with associated GPL from the inactive partition of the TDM. This value should be specified only during a software upgrade.

#### ***pktgen***

Downloads the PKTGEN GPL for the appropriate hardware type. This GPL is to be used only for engineering test purposes and must not be used in customer installations without engineering oversight.



#### **Note:**

After the PKTGEN GPL is initially downloaded to a card by this command, the PKTGEN GPL will continue to be downloaded to the card until another `alw-card` command is issued.

#### ***trial***

Downloads the trial GPL

### **Default:**

*appr*

**data (optional)**

High memory refresh. This parameter causes data to be reloaded to the specified card.

 **Note:**

Various conditions in the system may prevent the persistence of the data on the cards. In case `data` parameter is provided along with `sloc` and `eloc` parameters in the command, then `data` parameter's value is applied to all the cards within `sloc-eloc` range, including `sloc` and `eloc`.

**Range:*****persist***

Indicates that the database is not to be reloaded to the card. This parameter is used to request that the EAGLE perform a warm restart of the requested cards. The EAGLE performs various checks to ensure that all conditions necessary to initiate the warm restart are in place. During the card initialization and loading sequence, a warm restart is performed if the card meets the warm restart conditions, as described in the Notes section of this command.

***refresh***

Causes data to be reloaded to the specified card.

**Default:**

*refresh*

**loc (optional)**

The card location as stenciled on the shelf of the system.

**Range:**

*1101 - 1108, 1111 - 1113, 1115, 1201 - 1208, 1211 - 1218, 1301 - 1308, 1311 - 1318, 2101 - 2108, 2111 - 2118, 2201 - 2208, 2211 - 2218, 2301 - 2308, 2311 - 2318, 3101 - 3108, 3111 - 3118, 3201 - 3208, 3211 - 3218, 3301 - 3308, 3311 - 3318, 4101 - 4108, 4111 - 4118, 4201 - 4208, 4211 - 4218, 4301 - 4308, 4311 - 4318, 5101 - 5108, 5111 - 5118, 5201 - 5208, 5211 - 5218, 5301 - 5308, 5311 - 5318, 6101 - 6108, 6111 - 6118*

**perdata (optional)**

Persist a particular DB type on all cards (irrespective of the card's type).

**Range:**

*all*

Persist all data (GTT/MPS) that can be persisted on the card

*mps*

Persist only MPS data on the card that supports persistence of MPS DB

*gtt*

Persist only GTT data on the card that supports persistence of GTT DB

**Default**  
*all*



**Note:**

The `perdata` parameter can only be specified where `data=persist` is given.

**Example**

```
alw-card:loc=2301:code=trial
alw-card:loc=1101:data=persist
alw-card:loc=1106:data=persist:perdata=gtt
```

**Dependencies**

The shelf and card must be equipped.

No other action command can be in progress when this command is entered.

An EPAP-based feature or an LNP feature that is warm-restart capable must be enabled; SIP or DEIR must be enabled, or at least one ENUM or one GTT-enabled IPSP card must be present before this command can be entered with the `data=persist` parameter.

The `data` parameter is valid only for SCCP card locations or GPLs, or MPS database (VSCCP) card locations or GPLs, or GTT-enabled IPSP card locations or GPLs.

The card location (`loc`) must be within the allowed range.

A card that is the active MASP cannot be specified for the `loc/sloc/eloc` parameter.

A card location that is valid and defined in the database must be specified.

- Card location equipped with an E5-APP-B card cannot be specified.
- Card location equipped with a Telco Switch cannot be specified.

If an OAM card is installed in the location specified by the `loc` parameter, then only a value of *inactiveprtn* is supported for the `code` parameter.

The S13 EIR feature must be activated before allowing a card running the DEIRHC GPL.

The `PERDATA` parameter is valid only with the `DATA` parameter.

The SIP NP feature must be activated before allowing a card running the SIPHC GPL.

**Notes**

*Installation Guide* provides an illustration of card locations.

The system previously supported the `data` parameter for reloading GTT data. The system does not support persistent GTT data loading, and the `data` parameter is now used in support of a warm restart feature.

A number of reasons exist for not being able to warm restart. If none of these conditions exists, a warm restart is possible and will be attempted following a Service Module card reset.

- The following conditions require a full data reload:



- **AUDIT FAILED**—Checksum comparisons of the LNP database failed during card initialization. Data on the card is determined to be corrupted after the reset (was not yet detected by normal auditing).
  - **AUDIT TIMEOUT**—LNP initialization audit timed out (software failure)
  - **DB LEVEL**—Database level is not supported, or the difference exceeds incremental loading capability. This condition is caused by the reset of OAMs or if the number of updates exceeds the incremental loading capability.
  - **DB STATUS**—Database status of the card is incoherent at the time of a reset. This condition can be caused by a failed network card update or a reset during a database update to the card.
  - **DB VERSION**—LNP Database version has changed from the previous version. An import, or bulk downloads (`chg-db`), or changes from release to release may alter the database version.
  - **HW ERROR**—Hardware error bit checks on the card failed during card initialization
  - **NO AUDIT**—Unable to perform an LNP audit. The LNP audit is not on (for example, LNP options has `audit=off`). This condition can occur if the rate of LNP updates exceeds the ability of the LNP audit to compute checksums (excessive unknown checksums). This condition is more likely on a small database where there are fewer checksums. The percentage of known checksums must be 99% or more. The percentage is based on the number of checksums in use, which is smaller for small databases (such as two million TNs or fewer).
  - **POWER ON**—A power on reset (the card is pulled and reinserted)
  - **UNKNOWN/OTHER**—Unknown or other type of software failure.
  - **USER REQUEST**—User-initiated `init-card` or `init-sys` command `reload type=cold`. The default restart type for these commands is a cold or full LNP data reload. The user must specify `data=persist` for a warm restart on command.
  - **XILINX VERSION**—The M256 Xilinx program version has changed from the previous version.
- The following conditions require a cold restart for the MCPM card:
    - **DB STATUS**—Database status of the card is incoherent at the time of a reset. This condition can be caused by a failed network card update or a reset during a database update to the card.
    - **MEAS DB**—Measurements database initialization failure or corruption.
    - **POWER ON**—A power on reset (card is pulled and reinserted).
    - **UNKNOWN/OTHER**—Unknown or other type of software failure.
    - **XILINX VERSION**—D1G Xilinx program version has changed from previous version.
  - The following conditions require a cold restart for the GTT-enabled IPSG card:
    - **GTT DB LEVEL**— GTT Database level is incoherent at the time of reset. This condition is caused by the reset of OAMs.

- **GTT DB STATUS**— GTT Database status of the card is incoherent at the time of a reset. This condition can be caused by a failed network card update or a reset during a database update to the card.
- **POWER ON**— A power on reset (the card is pulled and reinserted)
- **UNKNOWN/OTHER**— Unknown or other type of software failure.
- **USER REQUEST**— User-initiated init-card or init-sys command reload type=cold. The default restart type for these commands is a cold or full GTT data reload. The user must specify data=persist for a warm restart on command.
- **XILINX VERSION**— The SLIC Xilinx program version has changed from the previous version.

### ▲ Caution:

This command can be used to enable Measurements Platform measurements collection after the collection function has been disabled with the `inh-card` command for ALL MCPM cards in the system. To enable collection, at least 1 MCPM card must be allowed in the system. Disabling collection by inhibiting all MCPM cards CAN RESULT IN LOSING ALL PAST MEASUREMENT DATA ON THE CARDS.

When the OA&M IP Security feature is turned on, and an IPSM card is inserted and initialized for the first time or is removed, inserted, and initialized again, the "SSH Host Keys Regenerated" UIM is displayed. The UIM shows the generated SSH Host Key fingerprint that must be provided at the secure client in order for secure information transfer to occur. The SSH Host Key fingerprint is changed whenever power is lost and restored to an IPSM card.

```
rlghncxa03 03-07-11 07:05:00 EST EAGLE 30.2.0
0021.1493 CARD 1111 INFO SSH Host Keys Regenerated

84 7c 92 8b c 7c ds 19 1c 6 4b de 5c 8f c5 4d

Report Date:03-07-11 Time:22:27:36
;
```

When the OA&M IP Security feature is turned on, and an IPSM card is restarted with this command, the "SSH Host Keys Loaded" UIM is displayed. The UIM shows the current SSH Host Key fingerprint. The SSH Host Key fingerprint is not changed if the IPSM card does not lose power.

```
rlghncxa03 03-07-11 07:05:00 EST EAGLE 30.2.0
0021.1493 CARD 1111 INFO SSH Host Keys Regenerated

DSA Server Host Key FTRA-formatted Fingerprint=
84 7c 92 8b c 7c ds 19 1c 6 4b de 5c 8f c5 4d

Report Date:03-07-11 Time:22:27:36
;
```

If a location for an E5-E1T1-B (type LIME1 or LIMT1), or E5-ATM-B (type LIMATM or LIME1ATM) card is specified, then at least one signaling link must be provisioned for the card before it can be allowed.

When SLOC and ELOC are given in the `alw-card` command, along with DATA and PERDATA parameters, instead of displaying an MTT, a list of card locations will be displayed pointing out the cards on which data was persisted and the cards on which it wasn't.

### Output

```
alw-card:loc=2301:code=trial

      rlgncxa03w 06-06-01 11:11:28 EST  EAGLE 35.0.0
      Card has been allowed.
;

alw-card:sloc=1103:eloc=1106:data=persist:perdata=all

tekelecstp 16-09-08 17:58:00 EST  EAGLE 46.5.0.0.0-70.4.0
      Card 1103 - 1106 have been allowed.
      LOC 1103 : ALLOW OPERATION COMPLETED.
      LOC 1104 : ALLOW OPERATION COMPLETED: Data not persisted.
      LOC 1105 : ALLOW OPERATION COMPLETED.
      LOC 1106 : ALLOW OPERATION COMPLETED.
```

### Related Topics

- [dlt-card](#)
- [ent-card](#)
- [inh-card](#)
- [init-card](#)
- [rept-stat-card](#)
- [rmv-card](#)
- [rtrv-card](#)

## alw-imt

Use this command to change the state of the specified Interprocessor Message Transport (IMT) bus from OOS-MT-DSBLD (Out-of-Service-Maintenance-Disabled) to IS-NR (In-Service-Normal), if the command is successful. If the command fails, the status is IS-ANR (In-Service-Abnormal). The IMT bus is comprised of two 125 Mbps counter-rotating serial busses. If one bus fails, the other immediately assumes control of all messages.

## Parameters

### **bus (mandatory)**

The IMT bus with the status to be changed.

#### **Range:**

***a***

***b***

### **Example**

```
alw-imt:bus=a
```

### **Dependencies**

This command cannot be entered during an IMT Fault Isolation Test or an Extended Bit Error Rate Test (BERT).

This command cannot be entered if an IMT Rate Change sequence is in progress.

Valid IMT bus entries are "A" or "B".

### **Notes**

This command returns an inhibited IMT bus to service.

The function of this command is the same as the `rst-imt` command.

See the `tst-imt` command to determine the location of faults on a failed or abnormal IMT bus.

### **Output**

```
alw-imt:bus=a
```

```
rlghncxa03w 04-01-07 11:11:28 EST EAGLE 31.3.0  
Allow IMT Bus A command issued.
```

```
rlghncxa03w 04-01-07 11:11:28 EST EAGLE 31.3.0  
0100.0097 IMT BUS A Imt allowed
```

```
;
```

### **Related Topics**

- [clr-imt-stats](#)
- [conn-imt](#)
- [disc-imt](#)
- [inh-imt](#)
- [rept-imt-lvl1](#)
- [rept-imt-lvl2](#)
- [rmv-imt](#)

- [rst-imt](#)
- [tst-imt](#)

## alw-map-ss

Use this command to activate a subsystem and bring it online. The AIQ, ATINPQ, EIR, INP, INPQS, LNP, LNPQS, and V-Flex subsystems can be allowed and inhibited.

### Parameters

**ssn (mandatory)**

Subsystem number.

**Range:**

2 - 255

### Example

```
alw-map-ss:ssn=10
```

### Dependencies

No other action command can be in progress when this command is entered.

The system must be configured with at least one Service Module card running the VSCCP application.

The EIR, INP, LNP, or V-Flex feature must be turned on, or the ANSI41 AIQ or ATINPQ feature must be enabled before this command can be entered.

The value specified for the `ssn` parameter must be the AIQ, ATINPQ, EIR, INP, LNP or V-Flex subsystem number.

The LNP subsystem must be online before the LNPQ subsystem number can be specified as a value for the `ssn` parameter.

The V-Flex subsystem must be online before the V-Flex subsystem number can be specified as a value for the `ssn` parameter.

The ATINPQ subsystem must be online before the ATINPQ subsystem number can be specified as a value for the `ssn` parameter.

The INP subsystem must be online before the INP subsystem number can be specified as a value for the `ssn` parameter.

The EIR subsystem must be online before the EIR subsystem number can be specified as a value for the `ssn` parameter.

The AIQ subsystem must be online before the AIQ subsystem number can be specified as a value for the `ssn` parameter.

### Notes

None

## Output

```
alw-map-ss:ssn=11
```

```
integrat40 00-05-24 10:37:22 EST EAGLE5 31.0.0
Allow map subsystem command sent to all SCCP cards.
Command Completed.
```

```
;
```

## Related Topics

- [inh-map-ss](#)
- [rept-stat-lnp](#)
- [rept-stat-sccp](#)

# alw-slk

Use this command to return an inhibited signaling link to service. If the link was aligned when it was inhibited, a changeover occurred. This command causes a changeback on the specified link. MSUs are transmitted on the link after the changeback is issued.



### Note:

The signaling link's inhibited status is not preserved across a card reboot.

## Parameters

### link (mandatory)

The signaling link defined on the card specified in the `loc` parameter. The links can be specified in any sequence or pattern.

#### Synonym:

*port*

#### Range:

*a, b, a1 - a63, b1 - b63*

Not all card types support all link parameter values.

See [Table A-1](#) for valid link parameter range values for each type of card that can have a location specified by the `loc` parameter.

### loc (mandatory)

The card location as stenciled on the shelf of the system.

#### Range:

*1101 - 1108, 1111 - 1112, 1201 - 1208, 1211 - 1218, 1301 - 1308, 1311 - 1318, 2101 - 2108, 2111 - 2118, 2201 - 2208, 2211 - 2218, 2301 - 2308, 2311 - 2318, 3101 - 3108, 3111 - 3118, 3201 - 3208, 3211 - 3218, 3301 - 3308, 3311 - 3318, 4101 - 4108, 4111 - 4118, 4201 - 4208, 4211 - 4218, 4301 - 4308, 4311 - 4318, 5101 - 5108, 5111 - 5118, 5201 - 5208, 5211 - 5218, 5301 - 5308, 5311 - 5318, 6101 - 6108, 6111 - 6118*

### Example

```
alw-slk:loc=1301:link=b
```

### Dependencies

A card location that is valid and defined in the database must be specified.

No other action command can be in progress when this command is entered.

The card must contain signaling links.

The signaling link must be equipped in the database.

This command is not valid for cards running the IPGHC GPL.

The card that contains the specified signaling link must be equipped in the specified card location.

The card in the specified card location cannot be a MUX card or the cards running the OAM application.

If IPSP-M3UA signaling links are used, then this command cannot be entered.

An appropriate value must be specified for the `link` parameter when an ATM card is used:

- `a-a1`, `b`—E5-ATM-B card running the ATMANSI or ATMITU application

This command is not valid for IPSP-M3UA signaling links.

### Notes

The function of this command is the same as the `unhb-slk` command.

Not every card location represents a signaling link. Be sure to address a signaling link in this command.

The *Installation Guide* provides an illustration of card locations.

### Output

```
alw-slk:loc=1301:link=b
```

```
tekelecstp 05-01-21 17:00:36 EST  EAGLE5 33.0.0
Allow Link message sent to card
;
```

### Related Topics

- [act-slk](#)
- [blk-slk](#)
- [canc-slk](#)
- [dact-slk](#)
- [ent-slk](#)
- [inh-slk](#)

- [rept-stat-slk](#)
- [rtrv-slk](#)
- [tst-slk](#)
- [ublk-slk](#)
- [unhb-slk](#)

## alw-trm

Use this command to return the specified serial port to the state IS-NR (in-service normal) from the state OOS-MT-DSBLD (out-of-service maintenance-disabled) if the command is successful. If the command is not successful, the terminal's state is OOS-MT (out-of-service maintenance).

### Parameters

#### **trm (mandatory)**

The ID of the serial or telnet port to be put into service.

#### **Range:**

1 - 40

### Example

```
alw-trm:trm=5
```

### Dependencies

No other action command can be in progress when this command is entered.

The IP User Interface feature must be enabled before terminal ports 17 through 40 can be specified in the `trm` parameter.

The terminal specified by the `trm` parameter must be equipped.

If a SEAS terminal is configured, then the IP address for the associated IPSM card must be specified before this command can be entered.

The SEAS Over IP feature must be turned on before a SEAS terminal can be specified.

The specified SEAS terminal cannot be auto-inhibited.

If a critical thermal alarm is raised against the IPSM card hosting the terminal, then the specified Telnet terminal cannot be returned to the IS-NR state.

The terminal specified by the `trm` parameter cannot be configured as `type=none` (see the `chg-trm` command).

### Notes

The function of this command is the same as the `rst-trm` command.

When you attempt to return to service a terminal that is already in service, a warning message is echoed to the scroll area but no action is taken.



If a SEAS terminal is configured, then the corresponding card must be an IP SM card, and the SEAS Over IP feature must be turned on before the SEAS terminal is allowed. The SEAS terminal is auto-inhibited if the IP Address for the corresponding card is invalid.

### Output

```
alw-trm:trm=12
```

```
rlghncxa03w 04-01-07 11:11:28 EST EAGLE 31.3.0  
Allow message sent to terminal
```

```
rlghncxa03w 04-01-07 11:11:28 EST EAGLE 31.3.0  
1062.0046      TERMINAL      12      Terminal Enabled
```

```
;
```

### Related Topics

- [act-echo](#)
- [canc-echo](#)
- [chg-trm](#)
- [dact-echo](#)
- [inh-card](#)
- [rept-stat-trm](#)
- [rmv-trm](#)
- [rst-trm](#)
- [rtrv-trm](#)

## aud-data

Use this command to perform a data audit, which is used to determine the integrity of the static and dynamic databases. This command can also be used to perform a separate GPL audit.

### Parameters

#### **ddbq** (optional)

DDB quiet period. The minimum DDB idle time, in milliseconds, during which no DDB updates are applied. After the quiet period, it is assumed that all DDB updates in the system have been processed, and no outstanding in-flight multi-cast updates exist. If the idle period that is reported by the network card is less than the quiet period, then additional network responses are discarded, and the DDB audit process restarts. Up to three retries of the DDB audit process are performed by system. If all of the retry efforts fail, then the system status of the DDB audit report is marked as ABORTED.

**Range:**  
0 - 5000

**Default:**

500

**display (optional)**

This parameter specifies whether a brief or full display is provided for the audit. This parameter applies to static and dynamic STP databases.

**Range:*****all***

For the static database, displays the checksum values, in hexadecimal, and details for each GPL and each subset of the current and backup database. For the dynamic database, displays the checksum values, in hexadecimal, for each dynamic database table on MTP cards.

***brief***

For the static database, displays the data collections for the current database, the backup database on the fixed disk, and the approved and trial GPLs. For the dynamic database, displays the system status with number of cards responded with or without checksum, the list of inconsistent cards, list of non-responding cards, number of cards not meeting quiet period requirement, number of cards responded with "DDB update in progress", and active MTP cards in system.

***except***

For GPLs or database subsets with problems, displays the same information as *display=all*

**Default:***brief***gp1qp (optional)**

GPL data audit quiet period. The number of audit cycles between audits of GPL data.

**Note:**

Data audits are always performed on GPLs at the first audit cycle after the EOAM or E5-OAM card recovers from a boot.

**Range:**

0 - 20

0—a GPL data audit is performed for every audit cycle

**Default:**

No change from the current value

**System Default:**

20

**tblid (optional)**

DMS Table ID. The table where the checksum is performed.

**Range:**

0 - 1022

**type (optional)**

The database to be audited.

**Range:*****ddb***

dynamic database

***fixed***

static database

**Default:**

*fixed*

**Example**

```
aud-data:type=ddb:display=brief
```

```
aud-data:type=ddb:ddbqp=1000
```

```
aud-data:display=except
```

```
aud-data:tblid=127
```

```
aud-data:gplqp=3
```

**Dependencies**

Only one `aud-data` command can be in progress at a time.

If the `type=ddb` parameter is specified, then the `except` parameter cannot be specified.

If the `ddbqp` parameter is specified, then the `type=ddb` parameter must be specified.

If the `gplqp` parameter is specified, then the `tblid`, `ddbqp`, and `type=ddb` parameters cannot be specified.

The `display` and `tblid` parameters cannot be specified together in the command.

The DMS table specified by the `tblid` parameter must already exist.

If the system is in upgrade mode, then this command cannot be entered.

**Notes****Static Audit**

The standby OAM must be available when the `aud-data` command for audit begins so that the standby OAM can receive the signal to begin auditing. If the standby OAM is not available when `aud-data` is issued, then the following messages are issued:

```
Extended Processing Time Required
```

```
Standby MASP is (or was) not available at audit start.
```

The above messages may also appear if the standby OAM is not available when the hourly periodic audit, which uses the `aud-data` command, automatically starts. The standby OAM is not performing any data auditing, so no audit results for the standby OAM are displayed in the audit report. Instead, the standby's audit results are as follows:

```
No information currently available
```

If an auditing cycle completes on either the active or standby OAM and does not produce the full set of expected results (checksums), the following message appears:

```
Audit results may be incomplete
```

The audit results may be missing some of the checksums that would normally be displayed (`display=all` or `display=except`). The results may also contain summary status information (`display=brief`) that might have been calculated differently had some of the missing checksums been available. This condition can be caused if the audit results for the backup database are missing, probably because a backup database has not been created.

If the "Audit results may be incomplete" message appears in the audit report, perform the following procedure:

#### Audit Data

1. Ensure that the standby OAM is online and ready.
2. Ensure that a backup database has been created. Use `rept-stat-db` command to check whether a backup database has been created.  
If no backup has ever been created, the output of `rept-stat-db` command shows the fixed disk backup (FD BKUP) database at level 1. There will be no information under the heading "Time Last Backup."
3. If necessary, create a backup on the fixed disk by entering the following command: `chg-db:action=backup:dest=fixed`.
4. Re-enter the `aud-data` command.

If the standby OAM does not run a audit cycle and no audit information is available, the following message appears:

```
Audit results are not available
```

This condition is probably caused by the standby OAM rebooting while a audit cycle is underway. If this message appears, ensure that the standby OAM is available and re-enter the `aud-data` command. Ensure that the standby OAM remains up (is not rebooted) for the duration of the audit cycle.

#### Dynamic Audit

The `aud-data` command is enhanced to allow a Dynamic data audit to be triggered manually.

If a dynamic background audit is already running, and the `aud-data` command is issued for a dynamic audit, then the following message appears.

```
Periodic dynamic database audit is running with default quiet period.
```

```
Results will be displayed on completion.
```

The Standby OAM is not required for a dynamic audit.

## Output

This example shows output for a full display of a fixed database audit:

```
aud-data:display=all
```

```

rlghncxa03w 09-07-07 10:39:04 EST  EAGLE 41.1.0
DATA AUDIT COMPLETE  (GPL AUD Quiet Period set to 3)
CARD          LOC  DATA                      STATUS      NEW CS  OLD CS
REF CS
  TDM-ACTV    1114  CRNT MTP      SUBSET OK      H'ffaf  H'ffaf
H'ffaf
                      CRNT GTT      SUBSET OK      H'5864  H'5864
H'5864
                      CRNT GWS      SUBSET OK      H'd089  H'd089
H'd089
                      CRNT MISC     SUBSET OK      H'2735  H'2735
H'2735
                      CRNT DBMM     SUBSET OK      H'1001  H'1001
H'1001
                      BKUP MTP      SUBSET OK      H'2b85  H'2b85
H'2b85
                      BKUP GTT      SUBSET OK      H'5864  H'5864
H'5864
                      BKUP GWS      SUBSET OK      H'd089  H'd089
H'd089
                      BKUP MISC     SUBSET OK      H'5af1  H'5af1
H'5af1
                      BKUP DBMM     SUBSET OK      H'1001  H'1001
H'1001
                      APPR ATMANSI  GPL      OK      H'1372  H'1372
H'1372
                      TRI  ATMANSI  GPL      OK      H'1372  H'1372
H'1372
                      APPR VSCCP   GPL      OK      H'9251  H'9251
H'9251
                      TRI  VSCCP   GPL      OK      H'9251  H'9251
H'9251
                      APPR GLS     GPL      OK      H'8887  H'8887
H'8887
                      TRI  GLS     GPL      OK      H'8887  H'8887
H'8887

```

```

      APPR UTILITY GPL      OK      H'18de H'18de H'18de
      TRI  UTILITY GPL      OK      H'18de H'18de H'18de
      APPR                                     OK      H'b6c6 H'b6c6 H'b6c6
      TRI                                     OK      H'b6c6 H'b6c6 H'b6c6

```

```
rlghncxa03w 09-07-07 10:39:04 EST EAGLE 41.1.0
```

```
DATA AUDIT COMPLETE (GPL AUD Quiet Period set to 3)
```

```

CARD      LOC  DATA      STATUS      NEW CS  OLD CS  REF CS
TDM-STDBY 1116 CRNT MTP    SUBSET OK      H'ffaf H'ffaf H'ffaf
          CRNT GTT    SUBSET OK      H'5864 H'5864 H'5864
          CRNT GWS    SUBSET OK      H'd089 H'd089 H'd089
          CRNT MISC   SUBSET OK      H'2735 H'2735 H'2735
          CRNT DBMM   SUBSET OK      H'1001 H'1001 H'1001
          BKUP MTP    SUBSET OK      H'2b85 H'2b85 H'2b85
          BKUP GTT    SUBSET OK      H'5864 H'5864 H'5864
          BKUP GWS    SUBSET OK      H'd089 H'd089 H'd089
          BKUP MISC   SUBSET OK      H'5af1 H'5af1 H'5af1
          BKUP DBMM   SUBSET OK      H'1001 H'1001 H'1001
          APPR ATMANSI GPL    OK      H'1372 H'1372 H'1372
          TRI  ATMANSI GPL    OK      H'1372 H'1372 H'1372
          APPR VSCCP  GPL    OK      H'9251 H'9251 H'9251
          TRI  VSCCP  GPL    OK      H'9251 H'9251 H'9251
          APPR GLS    GPL    OK      H'8887 H'8887 H'8887
          TRI  GLS    GPL    OK      H'8887 H'8887 H'8887
          APPR UTILITY GPL    OK      H'18de H'18de H'18de
          TRI  UTILITY GPL    OK      H'18de H'18de H'18de
          APPR                                     OK      H'b6c6 H'b6c6 H'b6c6
          TRI                                     OK      H'b6c6 H'b6c6 H'b6c6

```

```
;
```

```
aud-data:display=except
```

```
rlghncxa03w 09-07-07 10:39:04 EST EAGLE 41.1.0
```

```
Extended Processing Time Required
```

```
Results will be displayed on completion
```

```
rlghncxa03w 09-07-07 10:39:04 EST EAGLE 41.1.0
```

```
DATA AUDIT COMPLETE (GPL AUD Quiet Period set to 3):
```

```

CARD      LOC  DATA      STATUS      NEW CS  OLD CS  REF CS
TDM-ACTV 1116 CRNT MTP    SUBSET DIFFERENT H'aaaa H'aaaa H'cccc
          CRNT GTT    SUBSET CORRUPTED H'aaaa H'bbbb H'aaaa
          APPR MCM    GPL    CORRUPTED H'4321 H'3456 H'4321
          APPR GLS    GPL    CORRUPTED H'4321 H'3456 H'4321
          APPR VSCCP  GPL    CORRUPTED H'4321 H'3456 H'4321

```

```
rlghncxa03w 09-07-07 10:39:01 EST EAGLE 41.1.0
```

```
Extended Processing Time Required
```

```
Results will be displayed on completion
```

```
rlghncxa03w 09-07-07 10:39:04 EST EAGLE 41.1.0
```

```
DATA AUDIT COMPLETE (GPL AUD Quiet Period set to 3):
```

```

CARD      LOC  DATA      STATUS      NEW CS  OLD CS  REF CS
TDM-STDBY 1114 CRNT MTP    SUBSET DIFFERENT H'aaaa H'aaaa H'cccc

```

```

H'aaaa          CRNT GTT      SUBSET  CORRUPTED  H'aaaa H'bbbb
H'4321          APPR MCM      GPL      CORRUPTED  H'4321 H'3456
H'4321          APPR GLS      GPL      CORRUPTED  H'4321 H'3456
H'4321          APPR VSCCP    GPL      CORRUPTED  H'4321 H'3456
;

```

This example shows output for a brief display of a fixed database audit:

```
aud-data or aud-data:display=brief
```

```

rlghncxa03w 09-07-07 10:39:04 EST  EAGLE 41.1.0
DATA AUDIT COMPLETE (GPL AUD Quiet Period set to 3):
CARD          LOC   DATA      STATUS
TDM-ACTV      1114 CRNT DB    OK
              BKUP DB    OK
              GPLS      OK

```

```

rlghncxa03w 09-07-07 10:39:04 EST  EAGLE 41.1.0
DATA AUDIT COMPLETE (GPL AUD Quiet Period set to 3):
CARD          LOC   DATA      STATUS
TDM-STDBY     1116 CRNT DB    OK
              BKUP DB    OK
              GPLS      OK

```

```
;
```

This example shows output for a full dynamic database audit:

```
aud-data:type=ddb:display=all
```

```

tekelecstp 09/07/21 17:04:47 GMT  EAGLE 41.1.0
DDB AUDIT REPORT
SYSTEM STATUS          : INCONSISTENT
ACTIVE MTP CARDS       : 21
NON RESPONDING CARDS   : 7: 1207 1208 1211 1212 2108 2111
2112
RESPONDING CARDS       : 14
CARDS WITH NO DATA    : 2
CARDS WITH DATA       : 12
CARDS FAILING QUIET PRD : 0
CARDS WITH DDB UPD IN PRG : 3
CARDS CONSIDERED FOR CKSM : 9
INCONSISTENT CARDS     : 2: 1203 2103
CONSISTENT CARDS       : 7
AUDIT START TIME       : 21/07/2009 17:04:46
QUIET PERIOD           : 600 ms

RTE          LINK SET  LINK          CM CARD  CM CLSTR  MATED APPL
MTP GLOBL5

```

```

          LOC   STATUS      CAUSE                IDLE      DDB UPD   ADDN'L
STATUS
H'000003e8 H'000003e8 H'000003e8 H'000003e8 H'000003e8 H'000003e8
H'000003e8
      1201  CONSISTENT                700      1000
H'000003e8 H'000003e8 H'000003e8 H'000003e8 H'000003e8 H'000003e8
H'000003e8
      1202  CONSISTENT                700      1000
H'000007d0 H'000007d0 H'000007d0 H'000007d0 H'000007d0 H'000007d0
H'000007d0
      1203  INCONSISTENT              700      1000
-----
-----
      1204  NODATA          (DDB INIT)          -----
H'00000bb8 H'00000bb8 H'00000bb8 H'00000bb8 H'00000bb8 H'00000bb8
H'00000bb8
      1205  IN UPDATE 1    (TSRC,DDB)        700      1000      (IGNORED)
H'000003e8 H'000003e8 H'000003e8 H'000003e8 H'000003e8 H'000003e8
H'000003e8
      1206  CONSISTENT                700      1000
-----
-----
      1207  NORESP                      -----
-----
-----
      1208  NORESP                      -----
-----
-----
      1211  NORESP                      -----
-----
-----
      1212  NORESP                      -----
H'000003e8 H'000003e8 H'000003e8 H'000003e8 H'000003e8 H'000003e8
H'000003e8
      1213  CONSISTENT                700      1000
H'000003e8 H'000003e8 H'000003e8 H'000003e8 H'000003e8 -----
H'000003e8
      2101  CONSISTENT                700      1000
H'000003e8 H'000003e8 H'000003e8 H'000003e8 H'000003e8 -----
H'000003e8
      2102  CONSISTENT                700      1000
H'000007d0 H'000007d0 H'000007d0 H'000007d0 H'000007d0 -----
H'000007d0
      2103  INCONSISTENT              700      1000      (WWA UPD=2)
-----
-----
      2104  NODATA          (DDL XLOAD)          -----
H'00000bb8 H'00000bb8 H'00000bb8 H'00000bb8 H'00000bb8 -----
H'00000bb8
      2105  IN UPDATE 2    (DDB)        700      1000      (IGNORED)
H'00000bb8 H'00000bb8 H'00000bb8 H'00000bb8 H'00000bb8 -----
H'00000bb8
      2106  IN UPDATE 2    (TSRC,DDB)        700      1000      (IGNORED)
H'000003e8 H'000003e8 H'000003e8 H'000003e8 H'000003e8 -----
H'000003e8

```



```

      2107 CONSISTENT              700      1000
-----
      2108 NORESP                  -----
-----
      2111 NORESP                  -----
-----
      2112 NORESP                  -----
;

```

This example shows output for a brief dynamic database audit:

```
aud-data:type=ddb:display=brief
```

```

tekelecstp 09-07-15 07:34:13 GMT  EAGLE 41.1.0
DDB AUDIT REPORT
  SYSTEM STATUS           : OK
  ACTIVE MTP CARDS       : 10
  NON RESPONDING CARDS   : 0
  RESPONDING CARDS       : 10
  CARDS WITH NO DATA    : 0
  CARDS WITH DATA       : 10
  CARDS FAILING QUIET PRD : 0
  CARDS WITH DDB UPD IN PRG : 0
  CARDS CONSIDERED FOR CKSM : 10
  INCONSISTENT CARDS     : 0
  CONSISTENT CARDS       : 0
  AUDIT START TIME       : 15/07/2009 07:34:12
  QUIET PERIOD           : 20 ms
;

```

```
aud-data:tblid=127
```

```

audit 09-08-12 15:49:28 EST  EAGLE 41.1.0
Extended processing time required.
Results will be displayed on completion.
;

audit 09-08-12 15:50:08 EST  EAGLE 41.1.0

CARD      LOC  TABLE ID  STATUS      NEW CS  OLD CS  REF CS
TDM-ACTV  1114  127      OK          H'cb03  H'cb03  H'cb03
;

TABLE mtt.tbl AUDIT COMPLETE:
CARD      LOC  TABLE ID  STATUS      NEW CS  OLD CS  REF CS
TDM-STDBY 1116  127      OK          H'cb03  H'cb03  H'cb03

```

This example shows output for a full DDB audit when the status is ABORTED. Cards marked ("?") reported correct replies but their status was not evaluated.

```
aud-data:type=ddb:display=all:ddbqp=600
```

```
tekelecstp 09-07-21 21:07:57 GMT EAGLE 41.1.0
```

```
DDB AUDIT REPORT
```

```
SYSTEM STATUS           : ABORTED
ACTIVE MTP CARDS        : 21
NON RESPONDING CARDS    : 18: 1207 1208 1211 1212 2108 2111 2112
```

```
2113
```

```
RESPONDING CARDS       : 3
CARDS WITH NO DATA    : 0
CARDS WITH DATA       : 3
CARDS FAILING QUIET PRD : 1
CARDS WITH DDB UPD IN PRG : 1
CARDS CONSIDERED FOR CKSM : 0
INCONSISTENT CARDS     : 0
CONSISTENT CARDS       : 0
AUDIT START TIME       : 21/07/2009 21:07:54
QUIET PERIOD           : 600 ms
```

RTE	LINK SET	LINK	CM CARD	CM CLSTR	MATED APPL MTP
GLOBLS					
LOC	STATUS	CAUSE	IDLE	DDB UPD	ADDN'L
H'000003e8	H'000003e8	H'000003e8	H'000003e8	H'000003e8	H'000003e8
H'000003e8					
1201	NQUIET		100	1000	
H'000003e8	H'000003e8	H'000003e8	H'000003e8	H'000003e8	H'000003e8
H'000003e8					
1202	IN UPDATE 1	(DDB)	700	1000	
H'000003e8	H'000003e8	H'000003e8	H'000003e8	H'000003e8	H'000003e8
H'000003e8					
1203	?		700	1000	
-----					
1204	NORESP				
-----					
1205	NORESP				
-----					
1206	NORESP				
-----					
1207	NORESP				
-----					
1208	NORESP				
-----					
1211	NORESP				
-----					
1212	NORESP				
-----					

```

-----
      1213  NORESP          -----
-----
      2101  NORESP          -----
-----
      2102  NORESP          -----
-----
      2103  NORESP          -----
-----
      2104  NORESP          -----
-----
      2105  NORESP          -----
-----
      2106  NORESP          -----
-----
      2107  NORESP          -----
-----
      2108  NORESP          -----
-----
      2111  NORESP          -----
-----
      2112  NORESP          -----
;

```

```
aud-data:display=all
```

```

tekelecstp 16-08-25 10:39:04 EST  EAGLE 46.5.0
      DATA AUDIT COMPLETE  (GPL AUD Quiet Period set to 3)
      CARD      LOC  DATA          STATUS      NEW CS  OLD CS
REF CS
      TDM-ACTV  1114  CRNT MTP      SUBSET OK      H'ffaf  H'ffaf
H'ffaf
                        CRNT GTT      SUBSET OK      H'5864  H'5864
H'5864
                        CRNT GWS      SUBSET OK      H'd089  H'd089
H'd089
                        CRNT MISC     SUBSET OK      H'2735  H'2735
H'2735
                        CRNT DBMM     SUBSET OK      H'1001  H'1001
H'1001
                        BKUP MTP      SUBSET OK      H'2b85  H'2b85
H'2b85
                        BKUP GTT      SUBSET OK      H'5864  H'5864
H'5864

```

```

BKUP GWS      SUBSET OK          H'd089 H'd089 H'd089
BKUP MISC     SUBSET OK          H'5af1 H'5af1 H'5af1
BKUP DBMM     SUBSET OK          H'1001 H'1001 H'1001
APPR ATMANSI  GPL      OK          H'1372 H'1372 H'1372
TRI  ATMANSI  GPL      OK          H'1372 H'1372 H'1372
APPR VSCCP    GPL      OK          H'9251 H'9251 H'9251
TRI  VSCCP    GPL      OK          H'9251 H'9251 H'9251
APPR IP3G32   GPL      OK          H'4261 H'4261 H'4261
TRI  IP3G32   GPL      OK          H'4261 H'4261 H'4261
APPR GLS      GPL      OK          H'8887 H'8887 H'8887
TRI  GLS      GPL      OK          H'8887 H'8887 H'8887
APPR UTILITY  GPL      OK          H'18de H'18de H'18de
TRI  UTILITY  GPL      OK          H'18de H'18de H'18de
APPR          OK          H'b6c6 H'b6c6 H'b6c6
TRI          OK          H'b6c6 H'b6c6 H'b6c6

```

tekelecstp 16-08-25 10:39:04 EST EAGLE 46.5.0

DATA AUDIT COMPLETE (GPL AUD Quiet Period set to 3)

```

CARD      LOC  DATA          STATUS  NEW CS  OLD CS  REF CS
TDM-STDBY 1116 CRNT MTP      SUBSET OK      H'ffaf H'ffaf H'ffaf
          CRNT GTT      SUBSET OK      H'5864 H'5864 H'5864
          CRNT GWS      SUBSET OK      H'd089 H'd089 H'd089
          CRNT MISC     SUBSET OK      H'2735 H'2735 H'2735
          CRNT DBMM     SUBSET OK      H'1001 H'1001 H'1001
          BKUP MTP      SUBSET OK      H'2b85 H'2b85 H'2b85
          BKUP GTT      SUBSET OK      H'5864 H'5864 H'5864
          BKUP GWS      SUBSET OK      H'd089 H'd089 H'd089
          BKUP MISC     SUBSET OK      H'5af1 H'5af1 H'5af1
          BKUP DBMM     SUBSET OK      H'1001 H'1001 H'1001
          APPR ATMANSI  GPL      OK      H'1372 H'1372 H'1372
          TRI  ATMANSI  GPL      OK      H'1372 H'1372 H'1372
          APPR VSCCP    GPL      OK      H'9251 H'9251 H'9251
          TRI  VSCCP    GPL      OK      H'9251 H'9251 H'9251
          APPR IP3G32   GPL      OK      H'4261 H'4261 H'4261
          TRI  IP3G32   GPL      OK      H'4261 H'4261 H'4261
          APPR GLS      GPL      OK      H'8887 H'8887 H'8887
          TRI  GLS      GPL      OK      H'8887 H'8887 H'8887
          APPR UTILITY  GPL      OK      H'18de H'18de H'18de
          TRI  UTILITY  GPL      OK      H'18de H'18de H'18de
          APPR          OK      H'b6c6 H'b6c6 H'b6c6
          TRI          OK      H'b6c6 H'b6c6 H'b6c6

```

;

## Legend

### Fixed Audit

- **CARD**—Card type
- **LOC**—Card location
- **DATA**—Type of data being audited:
  - **APPR**—Approved GPL
  - **BKUP**—Database in the backup partition
  - **CRNT**—Database in the current partition

- **DBMM**—Database management mechanism database
- **GLS**—GLS GPL
- **GTT**—Global title translation database
- **GWS**—Gateway screening database
- **MISC**—Miscellaneous system configuration database
- **MTP**—Message transfer part database (links, linksets, routing tables)
- **VSCCP**—VSCCP GPL
- **IPSG32**—IPSG32 GPL (GPL to be loaded on SLIC cards to run IPSG application with GTT functionality or without it)
- **ATMANSI**—ATMANSI GPL
- **SUBSET or GPL**—Indicates whether the data is a part of the database or a generic program load.
- **TRI**—Trial GPL
- **STATUS**—Status of the database or GPL:
  - **CORRUPTED**—The database or GPL has been changed by some abnormal process. The GPL cannot be used.
  - **DIFFERENT**—The database or GPL contains information that is not consistent with the reference database or GPL
  - **OK**—The database or GPL is not corrupted and contains the same information as the reference database or GPL
- **NEW CS**—New checksum value calculated by this command
- **OLD CS**—Checksum value stored in the database or GPL
- **REF CS**—Reference checksum value stored on the active MASP

#### Dynamic DDB Audit

- **SYSTEM STATUS:**
  - **OK**—DDB is consistent on all active MTP cards or no active MTP card is present in system
  - **INCONSISTENT**—DDB is inconsistent
  - **UNKNOWN**—"All active MTP cards in the system responded without the checksum of DDB table" or "No active MTP card in the system responded to audit request"
  - **ABORTED**—"Checksums collected failed to meet the quiet period requirement" or "Number of cards responded with "DDB update in progress" greater than 25% number of cards responded with data"
- **ACTIVE MTP CARDS**—Number of active MTP cards
- **NON RESPONDING CARDS**—Number of non-responding cards
- **RESPONDING CARDS**—Number of responding cards
- **CARDS WITH NO DATA**—Cards sending replies without the checksum of dynamic tables, due to incomplete DDL crossload or DDB initialization
- **CARDS WITH DATA**—Cards sending replies with checksums

- **CARDS FAILING QUIET PRD**—Cards failing quiet time requirement
- **CARDS WITH DDB UPD IN PRG**—Cards sending replies marked as "DDB update in progress" due to DDB checksum not evaluated completely or TSRC task is incomplete
- **CARDS CONSIDERED FOR CKSM**—Cards sending correct replies. Replies are not marked with "DDB update in progress" or "Reply with no data".
- **INCONSISTENT CARDS**—Cards that are inconsistent
- **CONSISTENT CARDS**—Cards that are consistent
- **AUDIT START TIME**—Time that the audit started (*DD/MM/YYYYYY hh:ms:ss* format)
- **QUIET PERIOD**—Minimum DDB idle time, in milliseconds, during which no DDB updates are applied
- **RTE**—Checksum of RTE Table
- **LINK SET**—Checksum of Link Set Table
- **LINK**—Checksum of Link Table
- **CM CARD**—Checksum of CM Card
- **CM CLSTR**—Checksum of CM Cluster
- **MATED APPL**—Checksum of Mated Application
- **MTP GLOBS**—Checksum of MTP Globals Table
- **IDLE (PERIOD)**—Time elapsed, in milliseconds, since the last DDB update was received by this card
- **DDB UPD**—Total DDB updates received on the card
- **ADDN'L STATUS**—Display more information for the card, including WWA updates or whether card is considered for audit calculations
- **CAUSE**—Display the reason for sending replies of type "reply with no data " or "DDB update in progress". This value can be DDL (crossload not completed), DDB (dynamic database is not initialised), (TSRC, DDB) (TSRC task is not completed) or DDB (checksums still needs to apply on tables).
- **?**—Card status is not evaluated (inconsistent/consistent) if the system status is marked as "ABORTED"
- **IGNORED**—Card responded with "DDB update in progress" and is not considered for calculating system status
- **WWA UPD**—Number of entries that were updated by the WWA

#### Related Topics

- [chg-gpl](#)
- [rept-stat-db](#)
- [rept-stat-ddb](#)
- [rtrv-gpl](#)

## blk-slk

Use this command to force a local processor outage (LPO) on the specified link. The system begins sending link status signal units (LSSU) with status of processor outage (SIPO) to the adjacent signaling point.

 **Caution:**

Maintenance personnel should use this command only to block MSUs from being sent to the system. Level 2 status remains in service, except when the link is an ATM high-speed signaling link.

 **Note:**

The signaling link's blocked status is not preserved across a card reboot.

**Parameters****link (mandatory)**

The signaling link defined on the card specified in the `loc` parameter. The links can be specified in any sequence or pattern.

**Synonym:**

*port*

**Range:**

*a, b, a1 - a63, b1 - b63*

Not all card types support all link parameter values.

See [Table A-1](#) for valid link parameter range values for each type of card that can have a location specified by the `loc` parameter.

**loc (mandatory)**

The card location as stenciled on the shelf of the system.

**Range:**

*1101 - 1108, 1111 - 1112, 1201 - 1208, 1211 - 1218, 1301 - 1308, 1311 - 1318,  
2101 - 2108, 2111 - 2118, 2201 - 2208, 2211 - 2218, 2301 - 2308, 2311 - 2318,  
3101 - 3108, 3111 - 3118, 3201 - 3208, 3211 - 3218, 3301 - 3308, 3311 - 3318,  
4101 - 4108, 4111 - 4118, 4201 - 4208, 4211 - 4218, 4301 - 4308, 4311 - 4318,  
5101 - 5108, 5111 - 5118, 5201 - 5208, 5211 - 5218, 5301 - 5308, 5311 - 5318,  
6101 - 6108, 6111 - 6118*

**Example**

```
blk-slk:loc=2311:link=a
```

**Dependencies**

A card location that is valid and defined in the database must be specified.

No other action command can be in progress when this command is entered.

The card must contain signaling links.

The signaling link must be equipped in the database.

The card that contains the specified signaling link must be equipped in the specified card location.

The card in the specified card location cannot be a MUX card or the cards running the OAM application.

This command is not valid for links belonging to proxy linksets.

This command is not valid for cards running IPGHC links.

An appropriate value must be specified for the `link` parameter when an ATM card is used:

- `a-a1, b`—E5-ATM-B card running the ATMANSI or ATMITU application

The `blk-slk` command is not supported for links associated with J7 APCs.

## Notes

The function of this command is the same as the `act-lpo` command.

This command generates a minor alarm. Refer to *Maintenance Guide* for information on MRNs 0201 and 0208.

If this command is followed by the `init-card` command, the signaling link blockage is not preserved after the `init-card` command completes.

*Installation Guide* provides an illustration of card locations.

If the `blk-slk` or `act-lpo` command is issued for an IPSG signaling link, then one of the following events occurs:

- IPSG-M2PA signaling link—MTP3 local processor outage is initiated.
- IPSG-M3UA signaling link—The link is prohibited from entering service by rejecting received AS-ACTIVE messages.

## Output

```
blk-slk:loc=2311:link=a
```

```
tekelecstp 05-01-21 17:00:36 EST EAGLE5 33.0.0
Local processor outage being set.
;
```

This example shows the output when no signaling link is defined for link A:

```
blk-slk:loc=2312:link=a
```

```
tekelecstp 05-01-21 17:00:36 EST EAGLE5 33.0.0
Link is UNEQUIPPED in the database.
Local processor outage being set.
;
```

This example shows the output when slot 55 in the card location is not valid:

```
blk-slk:loc=2355:link=a
```

```
tekelecstp 05-01-21 17:00:36 EST EAGLE5 33.0.0
```



```
Command Rejected: Slot ID out of range
;

blk-slk:loc=1101:port=a

tekelecstp 13-06-20 12:37:33 EST 45.0.0-64.56.0
blk-slk:loc=1101:port=a
Command entered at terminal #4.
E2810 Command Rejected: Command is not valid for ITU-N16 links.
```

### Related Topics

- [canc-lpo](#)
- [rept-stat-slk](#)
- [ublk-slk](#)

## canc-alm-trns

Use this command to return all audible alarm indications to the local office.

### Parameters

This command has no parameters.

### Example

```
canc-alm-trns
```

### Dependencies

No other action commands can be in progress when this command is entered.

### Notes

The function of this command is the same as the `dact-alm-trns` command.

After this command is entered, the `rept-stat-alm` command can be entered to verify the status of the alarms.

### Output

```
canc-alm-trns

rlghncxa03w 04-01-07 11:11:28 EST EAGLE 31.3.0
Alarms returned to Local Maintenance Center
Command Completed.
;
```

### Related Topics

- [act-alm-trns](#)

- [dact-alm-trns](#)
- [rept-stat-cdt](#)
- [rept-stat-clk](#)
- [rept-stat-trbl](#)
- [rls-alm](#)
- [rtrv-obit](#)
- [rtrv-trbl](#)

## canc-cmd

This command halts processing and output of the `copy-ext-stats`, `rept-imt-info`, `rept-stat-applsock`, `rept-stat-as`, `rept-stat-assoc`, `rept-stat-card`, `rept-stat-clk`, `rept-stat-dstn`, `rept-stat-ls`, `rept-stat-rte`, `rept-stat-slk`, `rept-stat-trbl`, `rtrv-appl-rtkey`, `rtrv-as`, `rtrv-assoc`, `rtrv-cmd`, `rtrv-dstn`, `rtrv-gta`, `rtrv-gtt`, `rtrv-lbp`, `rtrv-log`, `rtrv-ls`, `rtrv-map`, `rtrv-mrn`, `rtrv-obit`, `rtrv-rte`, `rtrv-scr-aftpc`, `rtrv-scr-blkdpc`, `rtrv-scr-blkopc`, `rtrv-scr-cdpa`, `rtrv-scr-cgpa`, `rtrv-scr-destfld`, `rtrv-scr-dpc`, `rtrv-scr-isup`, `rtrv-scr-opc`, `rtrv-scrset`, `rtrv-scr-sio`, `rtrv-scr-tt`, `rtrv-seculog`, `rtrv-secu-user`, `rtrv-slk`, `rtrv-tbl-capacity`, `rtrv-trbltx`, `rtrv-uaps`, `rtrv-vflx-cd`, `rtrv-vflx-rn`, `rtrv-vflx-vmsid`, [commands](#).

Entering this command without the `trm` parameter executes the command on the terminal that is running the `canc-cmd` command. Entering the command with the `trm` parameter executes the command on the terminal specified by the `trm` parameter.

### Parameters

#### **trm (optional)**

The terminal on which the command is to be canceled.

**Range:**  
*1 - 40*

### Example

```
canc-cmd
```

```
canc-cmd:trm=3
```

### Dependencies

The `trm` parameter cannot be specified in a `canc-cmd` command that is entered on the same terminal that is running the command that is to be cancelled. The terminal will return an error: system is busy.

The `canc-cmd:trm=` command requires the Security Administration command class for the terminal and for the user.

The `canc-cmd:trm=` command requires a Security Administration command class for the terminal.

## Notes

The `canc-cmd` command (without the `trm` parameter) must be entered on the same terminal that is running the command to be cancelled.

If this command is entered on a terminal that is not running a command, the command completes successfully without returning an error. Likewise, if the `canc-cmd:trm=` command is entered and there is no command running on the specified terminal, the command completes successfully without returning an error.

When `canc-cmd` with no parameter is entered, a scroll area message appears to indicate that the command has been cancelled. For example:

```
Command aborted on terminal 2.
```

Some output can still appear after the above abort message if output accumulated in the output queue before the command was entered. When a command is cancelled, the cancellation should take no longer than 25 seconds to take effect.

The **F9** function key provides the same function as this command without the `trm` parameter. On a terminal in KSR mode, pressing **<CTRL>I** also provides the same function.

This command and the **F9** function key cannot be used for pure SEAS commands.

If this command is entered to cancel a command other than ones listed, the terminal will accept another command, but output and processing of the current command continue.

When this command is entered, a command status code of *AB* (command aborted) is logged in the security log as follows:

- When `canc-cmd` (without the `trm` parameter) is entered, no entry is logged.
- When `canc-cmd:trm=` is entered, an entry is logged.
- When `canc-cmd` (without the `trm` parameter) is entered as a SEAS flow-thru command, an entry is logged. The `canc-cmd:trm=` command is not allowed as a SEAS flow-thru command because the `canc-cmd:trm=` command belongs to the Security Administration Command Class.

For examples of the security log entries, see the `rtrv-secu` command.

## Output

```
canc-cmd
```

```
rlghncxa03w 04-07-27 17:00:36 EST  EAGLE 31.6.0
canc-cmd
Command entered at terminal #2.
```

```
rlghncxa03w 04-07-27 17:00:36 EST  EAGLE 31.6.0
Command aborted on terminal 2.
```

```
;
```

### Related Topics

- [copy-ext-stats](#)
- [rept-imt-info](#)
- [rept-stat-applsock](#)
- [rept-stat-as](#)
- [rept-stat-assoc](#)
- [rept-stat-card](#)
- [rept-stat-clk](#)
- [rept-stat-dstn](#)
- [rept-stat-ls](#)
- [rept-stat-rte](#)
- [rept-stat-slk](#)
- [rept-stat-trbl](#)
- [rtrv-appl-rtkey](#)
- [rtrv-as](#)
- [rtrv-assoc](#)
- [rtrv-cmd](#)
- [rtrv-dstn](#)
- [rtrv-gta](#)
- [rtrv-gtt](#)
- [rtrv-lbp](#)
- [rtrv-log](#)
- [rtrv-ls](#)
- [rtrv-map](#)
- [rtrv-mrn](#)
- [rtrv-obit](#)
- [rtrv-rte](#)
- [rtrv-scr-aftpc](#)
- [rtrv-scr-blkdpc](#)
- [rtrv-scr-blkopc](#)
- [rtrv-scr-cdpa](#)
- [rtrv-scr-cgpa](#)
- [rtrv-scr-destfld](#)
- [rtrv-scr-dpc](#)
- [rtrv-scr-isup](#)
- [rtrv-scr-opc](#)
- [rtrv-scrset](#)

- [rtrv-scr-sio](#)
- [rtrv-scr-tt](#)
- [rtrv-seculog](#)
- [rtrv-secu-user](#)
- [rtrv-slk](#)
- [rtrv-tbl-capacity](#)
- [rtrv-trbltx](#)
- [rtrv-uaps](#)
- [rtrv-vflx-cd](#)
- [rtrv-vflx-rn](#)
- [rtrv-vflx-vmsid](#)

## canc-dlk

Use this command to remove an IP data link from service. The state of the link is changed from in service normal (IS-NR) to out of service maintenance disabled (OOS-MT-DSBLD).

### Parameters

#### **loc (mandatory)**

The card location as stenciled on the shelf of the system.

#### **Range:**

*1101 - 1108, 1111 - 1112, 1201 - 1208, 1211 - 1218, 1301 - 1308, 1311 - 1318, 2101 - 2108, 2111 - 2118, 2201 - 2208, 2211 - 2218, 2301 - 2308, 2311 - 2318, 3101 - 3108, 3111 - 3118, 3201 - 3208, 3211 - 3218, 3301 - 3308, 3311 - 3318, 4101 - 4108, 4111 - 4118, 4201 - 4208, 4211 - 4218, 4301 - 4308, 4311 - 4318, 5101 - 5108, 5111 - 5118, 5201 - 5208, 5211 - 5218, 5301 - 5308, 5311 - 5318, 6101 - 6108, 6111 - 6118*

### Example

```
canc-dlk:loc=1308
```

### Dependencies

No other action command can be in progress when this command is entered.

The shelf and card must be equipped.

The card location must contain a STPLAN card.

The card location, frame, shelf, or slot must be within the allowed range.

The signaling link must be equipped in the database.

A card location that is valid and defined in the database must be specified.

### Notes

None

## Output

```
canc-dlk:loc=1308
```

```
rlghncxa03w 04-01-27 17:00:36 EST EAGLE 31.3.0  
Deactivate Link message sent to card.  
Command Completed.
```

```
;
```

## Related Topics

- [act-dlk](#)
- [dlt-dlk](#)
- [ent-dlk](#)
- [rept-stat-dlk](#)
- [rtrv-dlk](#)
- [tst-dlk](#)

# canc-echo

Use this command to halt the echoing of command responses from the user's terminal to other terminals or printers.

## Parameters

### **trm (optional)**

The ID number of the terminal for which the echo is being canceled.

#### **Range:**

1 - 16

#### **Default:**

Cancels all active echoes

## Example

```
canc-echo
```

```
canc-echo:trm=7
```

## Dependencies

The echo cannot be cancelled to the same terminal from which the `canc-echo` command is entered.

An `act-echo` command must be active at the specified terminal before this command can be entered to cancel the echo.

## Notes

Only the echoing of command output responses can be halted by this command. To halt the printing of alarm and network messages, the `chg-trm` command must be used.

## Output

```
canc-echo
```

```
rlghncxa03w 04-01-07 11:11:28 EST EAGLE 31.3.0
canc-echo
Command entered at terminal #6.
Scroll Area Output echo disabled to all terminals.
;
```

```
canc-echo:trm=7
```

```
rlghncxa03w 04-01-07 11:11:28 EST EAGLE 31.3.0
canc-echo:trm=7
Command entered at terminal #6
Scroll Area Output echo disabled for terminal 7.
;
```

## Related Topics

- [act-echo](#)
- [alw-trm](#)
- [chg-trm](#)
- [dact-echo](#)
- [inh-trm](#)
- [rept-stat-trm](#)
- [rmv-trm](#)
- [rst-trm](#)
- [rtrv-trm](#)

# canc-lpo

Use this command to cancel a processor outage and restore the link to its previous state. LSSUs with status of processor outage are terminated, and the link begins sending MSUs.



### Note:

The signaling link's blocked status is not preserved across a card reboot.

## Parameters

### link (mandatory)

The signaling link defined on the card specified in the `loc` parameter. The links can be specified in any sequence or pattern.

#### Synonym:

*port*

#### Range:

*a, b, a1 - a63, b1 - b63*

Not all card types support all link parameter values.

See [Table A-1](#) for valid link parameter range values for each type of card that can have a location specified in the `loc` parameter.

### loc (mandatory)

The address of the card containing the signaling link to be unblocked.

#### Range:

*1101 - 1108, 1111 - 1112, 1201 - 1208, 1211 - 1218, 1301 - 1308, 1311 - 1318, 2101 - 2108, 2111 - 2118, 2201 - 2208, 2211 - 2218, 2301 - 2308, 2311 - 2318, 3101 - 3108, 3111 - 3118, 3201 - 3208, 3211 - 3218, 3301 - 3308, 3311 - 3318, 4101 - 4108, 4111 - 4118, 4201 - 4208, 4211 - 4218, 4301 - 4308, 4311 - 4318, 5101 - 5108, 5111 - 5118, 5201 - 5208, 5211 - 5218, 5301 - 5308, 5311 - 5318, 6101 - 6108, 6111 - 6118*

## Example

```
canc-lpo:loc=2311:link=b
```

## Dependencies

A card location must be specified that is valid and defined in the database.

No other action command can be in progress when this command is entered.

The value specified for the `loc` parameter must refer to one of the following cards, and the referenced card must be equipped:

- E5-E1T1-B, card running the SS7ANSI or CCS7ITU application
- E5-ATM-B card running the ATMANSI or ATMITU application
- E5-ENET-B card running the IPLIMI, or IPSP application
- SLIC card running the IPSP application

The card must contain signaling links.

The signaling link must be equipped in the database.

This command is not valid for links belonging to proxy linksets.

An appropriate value must be specified for the `link` parameter when an ATM card is used:

- *a-a1, b*—E5-ATM-B card running the ATMANSI or ATMITU application

`canc-lpo` command is not supported for links associated with J7 APCs.

This command is not valid for IPSP-M3UA signaling links.



## Notes

The function of this command is the same as the `ublk-slk` command.

Unblocking a signaling link removes a Level 2 failure resulting from a `blk-slk` of an ATM high-speed signaling link.

*Installation Guide* provides an illustration of card locations.

## Output

```
canc-lpo:loc=2311:link=a
```

```
tekelecstp 05-01-21 17:00:36 EST EAGLE5 33.0.0
Local processor outage being cleared.
;
```

In the following example, card location 1113 is not valid:

```
canc-lpo:loc=1113:link=a
```

```
tekelecstp 05-01-21 17:00:36 EST EAGLE5 33.0.0
Command Rejected : Location is not valid for command
;
```

## Related Topics

- [act-lpo](#)
- [blk-slk](#)
- [ublk-slk](#)

# canc-slk

Use this command to change the state of the specified link to OOS-MT-DSBLD (Out-Of-Service Maintenance Disabled).

### **Caution:**

This command impacts network performance and should be used only during periods of low traffic.

## Parameters

### **link (mandatory)**

Signaling link defined on the card specified in the `loc` parameter. The links can be specified in any sequence or pattern.

**Synonym:***port***Range:***a, b, a1 - a63, b1 - b63*Not all card types support all `link` parameter values.See [Table A-1](#) for valid link values for each type of card that can have a location specified in the `loc` parameter.**loc (mandatory)**

The card location as stenciled on the shelf of the system.

**Range:***1101 - 1108, 1111 - 1112, 1201 - 1208, 1211 - 1218, 1301 - 1308, 1311 - 1318, 2101 - 2108, 2111 - 2118, 2201 - 2208, 2211 - 2218, 2301 - 2308, 2311 - 2318, 3101 - 3108, 3111 - 3118, 3201 - 3208, 3211 - 3218, 3301 - 3308, 3311 - 3318, 4101 - 4108, 4111 - 4118, 4201 - 4208, 4211 - 4218, 4301 - 4308, 4311 - 4318, 5101 - 5108, 5111 - 5118, 5201 - 5208, 5211 - 5218, 5301 - 5308, 5311 - 5318, 6101 - 6108, 6111 - 6118***Example**

```
canc-slk:loc=1301:link=a
```

**Dependencies**

A card location must be specified that is valid and defined in the database.

No other action command can be in progress when this command is entered.

The card must contain signaling links.

The signaling link must be equipped in the database.

The card that contains the specified signaling link must be equipped in the specified card location.

The card in the specified card location cannot be a MUX card or the cards running the OAM application.

An appropriate value must be specified for the `link` parameter when an ATM card is used:

- *a-a1, b*—E5-ATM-B card running the ATMANSI or ATMITU application

**Notes**

Not every card location represents a signaling link. Be sure to address a signaling link in this command.

*Installation Guide* provides an illustration of card locations.After this command is entered, the `rept-stat-slk` command can be entered to verify the cancellation.**Output**

```
canc-slk:loc=1301:link=a
```

```
rlghncxa03w 05-02-07 11:11:28 EST EAGLE5 33.0.0
```

```
    Deactivate Link message sent to card  
;
```

### Related Topics

- [act-slk](#)
- [alw-slk](#)
- [blk-slk](#)
- [dact-slk](#)
- [dlt-slk](#)
- [ent-slk](#)
- [inh-slk](#)
- [rept-stat-slk](#)
- [rtrv-slk](#)
- [tst-slk](#)
- [ublk-slk](#)
- [unhb-slk](#)

## canc-user

Use this command to end a user session.

### Parameters

This command has no parameters.

### Example

```
canc-user
```

### Dependencies

None

### Notes

The `dact-echo` or `logout` command can be used in place of this command.

### Output

Not applicable.

### Related Topics

- [act-user](#)
- [chg-pid](#)
- [chg-user](#)
- [dact-user](#)
- [dlt-user](#)

- ent-user
- login
- logout
- rept-stat-user
- rtrv-secu-user
- rtrv-user

## chg-acg-mic

Use this command to change the values of ACG controls assigned to certain queries. The control can apply to all queries or to specific query services and called party digits. A particular control is selected to be changed by either specifying that it is the `type=all` control or specifying its service and digits.

### Parameters

#### **aintvl (optional)**

AIN interval index

**Range:**

1 - 15

**Default:**

No change to the current value

#### **dgts (optional)**

Digits

**Range:**

000 - 999, 000000 - 999999999

Specify 3 digits or 6-10 digits.

#### **drtn (optional)**

Duration index. The amount of time that the ACG is in effect. This number is mapped to a time value at the LNP node.

**Range:**

1 - 13

**Default:**

No change to the current value

#### **intvl (optional)**

Interval index. The amount of time between ACGs. This number is mapped to a time value for the LNP node.

**Range:**

0 - 15

**Default:**

No change to the current value

**nd (optional)**

New number of digits

**Range:**

3, 6 - 10

**Default:**

No change to the current value

**serv (optional)**

Query service

**Range:***ain**in***type (optional)**

Type of control

**Range:***all**sd***Default:***sd***Example**To change the `type=all` MIC to use 3 digits:

```
chg-acg-mic:type=all:nd=3
```

To change the MIC for AIN queries for 919-460-2132 to use an interval index of 15:

```
chg-acg-mic:serv=ain:dgts=9194602132:aintvl=15
```

To change the MIC for IN queries for 919-xxx-xxxx to use a duration index of 9 and an interval index of 5:

```
chg-acg-mic:serv=in:dgts=919:drtn=9:intvl=5
```

**Dependencies**

If the `type=all` parameter is specified, then the `nd`, `drtn`, `intvl`, or `aintvl` parameter must be specified.

If the `type=all` parameter is specified, then the `serv` and `dgts` parameters cannot be specified.

If the `type=sd` parameter is specified, then the `serv` and `dgts` parameters must be specified.

If the `type=sd` parameter is specified, then the `nd` parameter cannot be specified.

If the `serv=ain` parameter is specified, then the `drtn` or `aintvl` parameter must be specified.

If the `serv=ain` parameter is specified, then the `intvl` parameter cannot be specified.

If the `serv=in` parameter is specified, then the `drtn` or `intvl` parameter must be specified.

If the `serv=in` parameter is specified, then the `aintvl` parameter cannot be specified.

The `dgts` parameter value must be either 3 digits in the range 000-999 or 6-10 digits in the range 000000-9999999999.

The `nd` parameter value must be 3 or 6-10 to indicate the number of new digits.

The LNP feature must be turned on before this command can be entered.

If the `type=all` parameter is specified, then a MIC with `type=all` must exist.

If the `type=sd` parameter is specified, then a MIC with the same service and digits must exist.

### Notes

None

### Output

```
chg-acg-mic:type=all:nd=31
```

```
rlghncxa03w 04-01-28 08:50:12 EST EAGLE 31.3.0
ACG MIC table is (11 of 256) 4% full of type SD
CHG-ACG-MIC: MASP A - COMPLTD
;
```

### Related Topics

- [dlt-acg-mic](#)
- [ent-acg-mic](#)
- [rept-stat-lnp](#)
- [rtrv-acg-noc](#)

## chg-acg-noc

Use this command to change the definition of a node overload level. The definition is comprised of the threshold LNP query rates for node overload levels and the values for the automatic call gappings (ACG) to be sent when at the specified level.

### Parameters

#### **lvl** (mandatory)

Overload level.

#### **Range:**

1 - 10

#### **and** (optional)

AIN number of digits. The number of digits in the global title address of an AIN query.

**Range:***6, 10***Default:**

No change to the current value

**drtn (optional)**

Duration index. The amount of time that the ACG is in effect. This number is mapped to a time value at the LNP node.

**Range:***1 - 13***Default:**

No change to the current value

**ind (optional)**

IN number of digits. The number of digits in the global title address of an IN query.

**Range:***6, 10***Default:**

No change to the current value

**intvl (optional)**

Interval index. The amount of time between ACGs. This number is mapped to a time value for the LNP node.

**Range:***0 - 15***Default:**

No change to the current value

**qr (optional)**

Query rate. The number of LNP queries, which define a particular overload level, in a 30-second period.

**Range:***1 - 2147483647***Default:**

No change to the current value

**Example**

To change level 10's query rate and AIN number of digits:

```
chg-acg-noc:lvl=10:qr=900000:and=6
```

To change level 3's duration and interval indexes:

```
chg-acg-noc:lvl=3:drtn=7:intvl=3
```

**Dependencies**

At least one optional parameter must be specified.

The `and` parameter value must be either 6 or 10.

The specified overload level must be defined.

The ACG NOC table must be accessible.

The LNP feature must be turned on before this command can be entered.

The `ind` parameter value must be either 6 or 10.

### Notes

None

### Output

```
chg-acg-noc:lvl=10:qr=900000:and=6
```

```
rlghncxa03w 03-02-28 08:50:12 EST EAGLE 28.1.0
CHG-ACG-NOC: MASP A - COMPLTD
;
```

### Related Topics

- [dlt-acg-noc](#)
- [ent-acg-noc](#)
- [rept-stat-lnp](#)
- [rtrv-acg-noc](#)

## chg-ainpopts

Use this command to provision AINPQ-specific data. This command updates the AINPOPTS table.

### Parameters

#### Note:

The nature of address indicator parameters (`rnaiv` or `rnai`) and numbering plan parameters (`rnp` or `rnpv`) can be specified using a mnemonic or an explicit value. The mnemonic and explicit values cannot be specified at the same time for the same parameter.

### **defrn** (optional)

Default routing number. This parameter specifies a default routing number that is used for own-network subscribers.

#### **Range:**

1 - 15 digits, *none*

#### **Default:**

No change to the current value



**System Default:**

*none*

**dialnai (optional)**

Digits dialed nature of address indicator.

**Range:**

**0**

National

**1**

International

**Default:**

No change to the current value

**System Default:**

*0*

**dialpfx (optional)**

Dialed party number prefix.

**Range:**

1-15 digits

Valid digits are *0-9, A-F, a-f*

**Default:**

No change to the current value

**System Default:**

*none*

**dltpfx (optional)**

Delete prefix. This parameter specifies whether to delete the DIALPFX.

**Range:**

**yes**

**no**

**Default:**

No change to the current value

**System Default:**

*no*

**lnpentpref (optional)**

LNP entity preference is the first preference for the RTDB data / entity associated with a DN to be used as LRN.

 **Note:**

The option is applied only if SPORT is not applied and EPAP lookup results in more than one entity.

**Range*****rn***

Use RN as LRN as the first preference.

***grn***

Send GRN as LRN as the first preference.

***asd***

Send ASD as the first preference.

**Default:**

No change to the current value

**System Default**

rn

**lnpnatl diglen (optional)**

LNP national digit length.

**Range**

1-15

**Default:**

No change to the current value

**System Default**

10

**lnpogdnnai (optional)**

LNP outgoing DN nature of address indicator. This parameter overrides the outgoing Nature of Number if DN is being returned.

**Range:*****inc***

Use the incoming NoN

***sub***

Subscriber

***natl***

National Significant

***intl***

International

***diglen***

If the outgoing digit length is less than or equal to LNPSUBDIGLEN then set NoN = SUBSCRIBER.

If the outgoing digit length is greater than LNPSUBDIGLEN and is less than or equal to LNPATLDIGLEN then set NoN = NATIONAL Significant.

**Default:**

No change to the current value

**System Default:**

*inc*

**lnpoglrrnai (optional)**

LNP outgoing LRN nature of address indicator. This parameter overrides the outgoing Nature of Number if LRN is being returned.

**Range:**

***inc***

Use the incoming NoN

***sub***

Subscriber

***natl***

National Significant

***intl***

International

***diglen***

If LRN digit length is less than or equal to LNPATLDIGLEN then set NoN = NATIONAL SIGNIFICANT.

If LRN digit length is greater than or equal to LNPATLDIGLEN then set NoN = INTERNATIONAL.

**Default:**

No change to the current value

**System Default:**

*inc*

**lnpsnai (optional)**

LNP service nature of address indicator. This parameter overrides the incoming Nature of Number in AIN Info\_Analyzed CalledPartID.

**Range:**

***inc***

Use the incoming NoN

***sub***

Subscriber

***natl***

National Significant

***intl***

International

***diglen***

If the incoming NoN of AIN Info\_Analyzed CalledPartyID is SUBSCRIBER, then do the following, else use the incoming NoN:

If digit length of CalledPartyID = LNPSUBDIGLEN, assume the NoN is Subscriber.

If digit length of CalledPartyID = LNPATLDIGLEN, assume the NoN is NATIONAL (SIGNIFICANT).

If digit length of CalledPartyID is not equal to LNPATLDIGLEN or LNPSUBDIGLEN, raise an error.

**Default:**

No change to the current value

**System Default:**

*inc*

**lnpsport (optional)**

LNP service portability.

**Range**

***gsm***

Apply Service Portability prefix for own-network GSM subscribers.

***is41***

Apply Service Portability prefix for own-network IS41 subscribers.

***all***

Apply Service Portability prefix for all own-network (IS41 and GSM) subscribers.

***none***

Service Portability is not performed for the feature.

**Default:**

No change to the current value

**System Default**

None

**lnpsubdiglen (optional)**

LNP subscriber digit length.

**Range**

1-15

**System Default**

7

**ndialpfx (optional)**

New dialed party number prefix.

**Range:**

1-15 digits, *none*

Valid digits are 0-9, a-f, A-F

**System Default:***none***nec (optional)**

National Escape Code.

**Range:**1-15 digits, *none*Valid digits are *0-9, A-F, a-f***Default:**

No change to the current value

**System Default:***none***rfmt (optional)**

Routing address format. This parameter specifies the routing address format that is supported in the AINPQ "Return Result" response messages.

**Range:*****asdrn***

ASD + RN

***asdrndn***

ASD + RN + [DIALPFX] + DN

***asdrnecdn***

ASD + RN + [DIALPFX] + NEC + DN

***asdrnccdn***

ASD + RN + [DIALPFX] + CC + DN

***ccasdrndn***

[DIALPFX] + CC + ASD + RN + DN

***ccgrndn***

[DIALPFX] + CC + GRN + DN

***ccrngrndn***

[DIALPFX] + CC + RN + GRN + DN

***ccgrnrndn***

[DIALPFX] + CC + GRN + RN + DN

***ccrndn***

[DIALPFX] + CC + RN + DN

***ccrnasddn***

[DIALPFX] + CC + RN + ASD + DN

***homerndn***

Home Routing Number

**grn**  
GRN

**grndn**  
GRN + [DIALPFX] + DN

**grnrndn**  
GRN + RN + [DIALPFX] + DN

**grnrn**  
GRN + RN

**grnrnccdn**  
GRN + RN + [DIALPFX] + CC + DN

**grnrnecdn**  
GRN + RN + [DIALPFX] + NEC + DN

**rn**  
Routing Number

**rnasd**  
RN + ASD

**rnasddn**  
RN + ASD + [DIALPFX] + DN

**rnasdccdn**  
RN + ASD + [DIALPFX] + CC + DN

**rnasdnecdn**  
RN + ASD + [DIALPFX] + NEC + DN

**rndn**  
RN + [DIALPFX] + DN

**rngrn**  
RN + GRN

**rngrndn**  
RN + GRN + [DIALPFX] + DN

**rngrnccdn**  
RN + GRN + [DIALPFX] + CC + DN

**rngrnecdn**  
RN + GRN + [DIALPFX] + NEC + DN

**rnecdn**  
RN + [DIALPFX] + NEC + DN

**Default:**  
No change to the current value

**System Default:**  
*rndn*

**rnai (optional)**

Routing nature of address indicator

**Range:**

***frmsg***

NAI from the incoming message

***intl***

International number

***natl***

National significant number

**Default:**

No change to the current value

**System Default:**

*frmsg*

**rnaiv (optional)**

Routing nature of address indicator value

**Range:**

***0***

National

***1***

International

**Default:**

No change to the current value

**System Default:**

none

**rnp (optional)**

Routing numbering plan

**Range:**

***e164***

IS41 Telephony Number

***e212***

IS41 Land Mobile Number

***priv***

IS41 Private Number

***unknown***

IS41 Numbering Plan Unknown

**Default:**

No change to the current value

**System Default:***e164***rnpv (optional)**

Routing numbering plan value

**Range:***0 - 15***Default:**

No change to the current value

**System Default:***2***snai (optional)**

Service Nature of Address indicator.

**Range:*****sub***

Subscriber Number

***intl***

International Number

***natl***

National Significant Number

***none***

NAI value none

***unknown***

Unknown NAI value

**Default:**

No change to the current value

**System Default:***none***sporttype (optional)**

Service Portability type. This parameter specifies whether Service Portability is performed for the associated feature.

**Note:**

If Service Portability is performed, then the Service Portability prefix (RTDB 'GRN'entity id ) is applied.

The S-Port feature must be enabled before this parameter can be specified. The S-Port feature must be turned on before any change to the parameter will impact the associated feature.



**Range:*****all***

apply Service Portability prefix for all own-network (IS41 and GSM) subscribers

***gsm***

apply Service Portability prefix for own-network GSM subscribers

***is41***

apply Service Portability prefix for own-network IS41 subscribers

***none***

Service Portability is not performed for the feature.

**Default:**

No change to the current value

**System Default:**

*none*

**sprestype (optional)**

SP response type. The type of message sent by the system if an NPREQ message is received, the DN digits match, and the HLR ID is present.

**Range:*****rrwdgts***

The system sends a "Return Results with Digits" message.

***rrwodgts***

The system sends a "Return Results without Digits" message.

**Default:**

No change to the current value

**System Default:**

*rrwodgts*

**Example**

```
chg-ainpopts:rfmt=rn:rnp=e164:rnai=intl:dialpfx=fac:dltpfx=yes
```

```
chg-ainpopts:rfmt=rndn:rnp=e212:rnai=intl:dialpfx=fac:dltpfx=no :di  
alnai=1:snai=natl
```

```
chg-ainpopts:rfmt=rngrnccdn:rnp=e164:rnai=intl:dialpfx=fac:dltpfx=y  
es
```

```
chg-ainpopts:sprestype=rrwdgts:rfmt=rnnecdn:nec=abcd1
```

```
chg-ainpopts:rfmt=rnnecdn:nec=abcd1
```

```
chg-ainpopts:rfmt=rnnecdn:nec=0
```

```
chg-  
ainpopts:rfmt=asdrnccdn:rnp=e164:rnai=intl:dialpfx=fac:dltpfx=yes
```

```
chg-  
ainpopts:rfmt=rn:rnp=e164:lnpsnai=sub:lnpnatldiglen=10:lnpentpref=rn
```

### Dependencies

At least one optional parameter must be specified.

The `rnp` and `rnpv` parameters cannot be specified together in the command.

The `rnai` and `rnai v` parameters cannot be specified together in the command.

If the `ndialpfx` or `dltpfx` parameter is specified, then the `dialpfx` parameter must be specified.

The `dialpfx=none` parameter cannot be specified.

If the `ndialpfx=none` parameter is specified, then the `dltpfx` parameter cannot be specified.

If the `ndialpfx` and `dialpfx` parameters are specified, then the value specified for the `dialpfx` parameter must already exist in the AINPOPTS table.

The value specified for the `ndialpfx` parameter cannot already exist in the AINPOPTS table.

A maximum of 2 Dialed Party Number Nature of Address values are allowed.

The `dialnai` and `snai` parameters must be specified together in the command.

If the `snai=none` parameter is specified, then the value specified for the `dialnai` parameter must already exist in the AINPOPTS table.

The National Escape Code (`nec` parameter) can contain between 1 and 5 digits. Otherwise the value is *none*.

A maximum of 40 Dialed Party Number Prefix values can be provisioned.

If the `nec=none` parameter is specified, then values of `asdrnnecdn`, `masdrnnecdn`, `rnnecdn`, `rngrnnecdn`, and `grnrnnecdn` cannot be specified for the `rfmt` parameter.

The S-Port feature must be enabled before the `sporttype` or `lnsport` parameter can be specified.

The AINPQ feature must be enabled before this command can be entered.

The LNPSUBDIGLEN value should be less than value of LNPATLDIGLEN.

### Output

```
chg-ainpopts:rfmt=rnasd:nec=0
```

```
tekelecstp 09-06-03 15:15:44 EST EAGLE 41.1.0  
CHG-AINPOPTS: MASP A - COMPLTD
```

```
;
```

**Related Topics**

- [rtrv-ainpopts](#)

## chg-aiqopts

Use this command to provision AIQ specific data. This command updates the AIQOPTS table.

**Parameters****digmaxlen (optional)**

Maximum Length of Digit String. The maximum length of a digit string that is considered valid in the *Digits (Dialed)* field of an AnalyzedInformation query.

**Range:**

1 - 32

**Default:**

No change to the current value

**System Default:**

32

**digminlen (optional)**

Minimum Length of Digit String. The minimum length of a digit string that is considered valid in the *Digits (Dialed)* field of an AnalyzedInformation query.

**Range:**

1 - 32

**Default:**

No change to the current value

**System Default:**

1

**pfx (optional)**

Digit String. The digit string associated with a Trigger Type (value of `trigtype` parameter). The value specified for the `pfx` parameter is encoded in the response message.

**Range:**

1-21 digits, *none*  
*none* —deletes the associated Trigger Type value

**Default:**

No change to the current value

**System Default:**

*none*

**resfmt (optional)**

Response format. The format of outgoing routing digits in the AnalyzedInformation response message.

**Range:*****pfxdn***

the value specified for the *pfx* parameter + the incoming dialed digits

***pfx***

the value specified for the *pfx* parameter

**Default:**

No change to the current value

**System Default:**

*pfxdn*

**respar (optional)**

Response Digits. The TCAP field used to encode the AnalyzedInformation response message.

**Range:*****rtdigits***

TCAPRoutingDigitsfield

***digits***

TCAPDigits(Dialed)field

**Default:**

No change to the current value

**System Default:**

*rtdigits*

**tcaperr (optional)**

TCAP Error Code. The TCAP error code used in a Return Error response.

**Range:**

129 - 255

- 129—UnrecognizedMIN
- 130—UnrecognizedESN
- 131—MIN/HLR Mismatch
- 132—OperationSequenceProblem
- 133—ResourceShortage
- 134—OperationNotSupported
- 135—TrunkUnavailable
- 136—ParameterError
- 137—SystemFailure
- 138—UnrecognizedParameterValue
- 139—FeatureInactive

- 140—MissingParameter
- 141-239—Reserved
- 240-255—Reserved for Protocol Extension

**Default:**

No change to the current value

**System Default:**

138

**trigtype (optional)**

TriggerType Value. An individual trigger used to specify an association between a trigger and a corresponding address digit string (value of `prefix` parameter).

A maximum of 20 `trigtype - prefix` entries are supported. The `prefix` digit string corresponding to the specified Trigger Type present in the Incoming AnalyzedInfo Query is encoded in the Response message.

**Range:**

0 - 255

[Table 4-1](#) lists the mnemonic for each TRIGTYPE decimal value.

**Example**

This example specifies the provisioning of a Trigger Type – Prefix string pair:

```
chg-aiqopts:trigtype=2:prefix=65432
```

This example deletes an already provisioned Trigger Type:

```
chg-aiqopts:trigtype=2:prefix=none
```

This example specifies the `digminlen-digmaxlen` range (5-7):

```
chg-aiqopts:digminlen=5:digmaxlen=7
```

This example provisions the response parameter and response format:

```
chg-aiqopts:respar=rtdigits:resfmt=prefix
```

**Dependencies**

The ANSI41 AIQ feature must be enabled before this command can be entered.

The AIQOPTS table is corrupt or cannot be found.

The `prefix` and `trigtype` parameters must be specified together in the command.

The value specified for the `digminlen` parameter must be less than or equal to the value specified for the `digmaxlen` parameter.

A maximum of 20 `trigtype - prefix` entries can be specified in the AIQOPTS table.

A `prefix - trigtype` pair must be specified with a supported value for the `trigtype` parameter before the `prefix=none` parameter can be specified.

**Notes**

If the same value is specified for the `digminlen` and `digmaxlen` parameters, then only MSUs with dialed digits of the specified length are accepted for processing.

The value of the *Digits (Dialed)* length must be between the values specified for the `digminlen` and `digmaxlen` parameters.

A maximum of 20 `pfX - trigtype` pairs can be specified.

[Table 4-1](#) lists the decimal value and mnemonic for each TRIGTYPE parameter value.

**Table 4-1 TRIGTYPE Parameter Values**

Decimal Value	Mnemonic	Decimal Value	Mnemonic
0	Unspecified.	24	Local_Call.
1	All_Calls.	25	Local_Toll_Call.
2	Double_Introducing_Star.	26	Non-Local_Toll_Call
3	Single_Introducing_Star.	27	World_Zone_Call.
4	Reserved [for Home_System_Feature_Code]	28	International_Call.
5	Double_Introducing_Pound.	29	Unrecognized_Number.
6	Single_Introducing_Pound.	30	Prior_Agreement.
7	Revertive_Call.	31	Specific_called_Party_Digit_String.
8	0_Digit.	32	Mobile_Termination.
9	1_Digit.	33	Advanced_Termination.
10	2_Digit.	34	Location.
11	3_Digit.	35-63	Reserved. Treat a reserved value the same as value 0, Unspecified.
12	4_Digit.	64	Terminating_Resource_Available.
13	5_Digit.	65	T_Busy.
14	6_Digit.	66	T_No_Answer.
15	7_Digit.	67	T_No_Page_Response.
16	8_Digit.	68	T_Unroutable.
17	9_Digit.	69-219	Reserved. Treat a reserved value the same as value 0, Unspecified.
18	10_Digit.	220	Reserved for TDP-R DP value.
19	11_Digit.	221	Reserved for TDP-N DP value.
20	12_Digit.	222	Reserved for EDP-R DP value.
21	13_Digit.	223	Reserved for EDP-N DP value.

Table 4-1 (Cont.) TRIGTYPE Parameter Values

Decimal Value	Mnemonic	Decimal Value	Mnemonic
22	14_Digit.	224-255	Reserved for TIA-41 protocol extension. If unknown, treat the same as value 0, Unspecified.
23	15_Digit.		

**Output**

```
chg-aiqopts:trigtype=2:px=65432:respar=rtdigits:tcaperr=135
```

```
tekelecstp 09-12-03 12:40:16 EST EAGLE 42.0.0
CHG-AIQOPTS: MASP A - COMPLTD
;
```

**Related Topics**

- [rtrv-aiqopts](#)

## chg-appl-rtkey

Use this command to change static entries in the Routing Key table. Only one attribute can be changed at a time.

**Parameters****Note:**

See [Point Code Formats and Conversion](#) for a detailed description of point code formats, rules for specification, and examples.

**Note:**

See [Table A-2](#) for valid CIC values for specified SI and MSU types.

**cice (optional)**

The end range of circuit identification codes assigned to the routing key. The `cice` and `cics` parameters identify the routing key to be changed.

**Range:**

0 - 4294967295

**cics (optional)**

The start range of circuit identification codes assigned to the routing key. The `cics` and `cice` parameters identify the routing key to be changed.

**Range:**

0 - 4294967295

**dpc (optional)**

ANSI destination point code with subfields *network indicator-network cluster-network cluster member (ni-nc-ncm)*.

**Synonym:**

*dpca*

**dpc/dpca/dpci/dpcn/dpcn24/dpcn16 (optional)**

Destination point code.

**dpci (optional)**

ITU international destination point code with subfields *zone-area-id*. The *prefix* subfield indicates a spare point code (*prefix-zone-area-id*)

**dpcn (optional)**

ITU national destination point code in the format of a 5-digit number (*nnnnn*); or 2, 3, or 4 numbers (members) separated by dashes (*m1-m2-m3-m4*) as defined by the `chg-stpopts:npcfmti` flexible point code option. A group code must be specified when the ITUDUPPC feature is turned on (*nnnnn-gc*, *m1-m2-m3-m4-gc*). The *prefix* subfield indicates a spare point code (*prefix-nnnnn*, *prefix-nnnnn-gc*, *prefix-m1-m2-m3-m4*, *prefix-m1-m2-m3-m4-gc*).

**dpcn24 (optional)**

24-bit ITU national destination point code with subfields *main signaling area-sub signaling area-signaling point (msa-ssa-sp)*.

**dpcn16 (optional)**

16-bit ITU national point code with subfields *unit number--sub number area--main number area (un-sna-mna)*.

**Range:**

*un--000--127*

*sna--000--15*

*mna--000--31*

**ncics (optional)**

The new start range of circuit identification codes assigned to the routing key. Specify the `ncics` and/or `ncice` parameter to change the range of the circuit identification codes assigned to the routing key.

**Range:**

0 - 4294967295



**ncice (optional)**

The new end range of circuit identification codes assigned to the routing key. Specify the `ncice` and/or `ncics` parameter to change the range of the circuit identification codes assigned to the routing key.

**Range:**

0 - 4294967295

**nrcontext (optional)**

This parameter modifies the routing context value assigned to this routing key. Routing context is mandatory for routing keys associated with SUA Application Servers. Routing context is optional for routing keys associated with M3UA Application Servers.

An AS can be associated with only 1 routing key with routing context. An AS can be associated with multiple routing keys that do not contain routing context. An AS cannot be simultaneously assigned to a routing key with routing contexts and to routing keys without routing contexts.

**Range:**

0 - 4294967295

**opc (optional)**

ANSI originating point code with subfields *network indicator-network cluster-network cluster member* (*ni-nc-ncm*).

**Synonym:**

*opca*

**Range:**

000-255

Specify a valid value for each subfield of the point code, and separate the subfields with a dash (-).

When `chg-sid:pctype=ansi` is specified, *ni = 000* is not valid.

When `chg-sid:pctype=ansi` is specified, *nc = 000* is not valid if *ni = 001–005*.

When `chg-sid:pctype=ansi` is specified, *nc = 000* is valid if *ni = 006–255*.

The point code *000-000-000* is not a valid point code.

**opc/opca/opci/opcn/opcn24/opcn16 (optional)**

Originating point code. Valid only (and required) if *si=4, 5, or 13*.

**opci (optional)**

ITU international originating point code with subfields *zone-area-id*. The *prefix* subfield indicates a spare point code (*prefix-zone-area-id*)

**opcn (optional)**

ITU national originating point code in the format of a 5-digit number (*nnnnn*); or 2, 3, or 4 numbers (members) separated by dashes (*m1-m2-m3-m4*) as defined by the `chg-stpopts:npcfmti` flexible point code option. A group code must be specified when the ITUDUPPC feature is turned on (*nnnnn-gc, m1-m2-m3-m4-gc*). The *prefix* subfield indicates a spare point code (*prefix-nnnnn, prefix-nnnnn-gc, prefix-m1-m2-m3-m4, prefix-m1-m2-m3-m4-gc*).

**opcn24 (optional)**

24-bit ITU national originating point code with subfields *main signaling area-sub signaling area-signaling point* (*msa-ssa-sp*).

**opc16 (optional)**

16-bit ITU national point code with subfields *unit number sub number area main number area (un-sna-mna)*.

**Range:**

000---127

Specify a valid value for each subfield of the point code, and separate the subfields with a dash (-).

*un--000--127*

*sna--000--15*

*mna--000--31*

**rcontext (optional)**

This parameter specifies a routing key by its routing context when a routing key needs to be changed as an alternative to entering the *dpc/si/ssn/opc/cics/cice/type* parameters.

Split operations are invalid for routing keys with routing context.

**Range:**

0 - 4294967295

**si (optional)**

The service indicator.

**Range:**

0-15 or equivalent text values:

**Number =Text—Description**

0=*snm*—Signaling network management messages

1=*regtest*—Signaling network testing and maintenance regular

2=*spltest*—Signaling network testing and maintenance special

3= *sccp* —SCCP

4= *tup* —Telephone user part

5= *isup* —ISDN user part

13= *qbicc*

See [Table A-2](#) and [Table 4-2](#) for valid *si* values in combination with other parameters.

**split (optional)**

The CIC value where the routing key with the specified CICS and CICE range will be split. The specified routing key is split into two entries with adjacent CIC ranges. The existing routing key retains the range of CICs that is lower than the split value. The value of *split* minus 1 is used as the end range for this entry. The range of CICs assigned to the original entry is the values of *cics* to *split* minus 1.

A new routing key entry is created with the high end of the original range. The `split` value is used as the start of the CIC range for this entry. The range of CICs assigned to the new entry is the values of `split` to `cice`.

This parameter is valid only if `si=4, 5, or 13` and is not valid with `ncics` or `ncice`. See [Table A-2](#) and [Table 4-2](#).

**Range:**

*0 - 16363*

**ssn (optional)**

Subsystem number.

**Range:**

*0 - 255*

**type (optional)**

Type of routing key.

**Range:**

*full*

*default*

*partial*

**Default:**

*full*

**Example**

```
chg-appl-  
rtkey:dpc=123-230-245:si=5:opc=123-230-244:cics=1:cice=100:split=50
```

```
chg-appl-  
rtkey:dpc=123-230-245:si=5:opc=123-230-244:cics=1:cice=50:ncice=100
```

```
chg-appl-  
rtkey:dpcn24=10-100-10:si=5:opc24=10-100-11:cics=1:cice=100:ncice=200
```

```
chg-appl-rtkey:dpc=8-8-8:si=3:ssn=5:rcontext=500
```

```
chg-appl-  
rtkey:dpci=s-3-11-1:si=5:opci=s-4-11-1:cics=1:cice=1000:ncice=500
```

```
chg-appl-rtkey:rcontext=5:ncice=100
```

```
chg-appl-rtkey:rcontext=1:nrcontext=2
```

```
chg-appl-  
rtkey:dpcn16=121-10-15:si=5:opc16=121-10-15:cics=1:cice=50:ncice=100
```

## Dependencies

Optional parameters that must be specified with the `chg-appl-rtkey` command depend on the type of routing key being changed. See [Table 4-2](#) for valid parameter combinations.

For SS7IPGW and IPGW applications running on E5-ENET-B cards, there is a limit of 2500 routing keys in the system. The `srkq` parameter (see the `chg-sg-opts` command) limits the maximum number of static routing keys that can be provisioned with the `ent-appl-rtkey` command.

The subsystem number is mandatory and valid only when the `si=3` (or `sccp`) parameter is specified; if the `si` parameter does not equal 3 (or `sccp`), the `ssn` parameter cannot be specified.

The value entered for the starting circuit identification code (`cics`) must be less than or equal to the value entered for the ending circuit identification code (`cice`).

The value entered for the new starting circuit identification code (`ncics`) must be less than or equal to the value entered for the new ending circuit identification code (`ncice`).

A circuit identification code range (`cics` to `cice`) cannot be specified that overlaps an existing routing key.

When `si=4`, `5`, or `13` (or `tup`, `isup`, or `qbicc`), the `opc`, `cics`, and `cice` parameters are required. The `opc`, `cics`, and `cice` parameters can be specified only if `si=4`, `5`, or `13`.

The value entered for the `split` parameter must be greater than the value entered for the `cics` parameter and less than or equal to the value entered for the `cice` parameter.

The value entered for the `ncics` parameter must be less than or equal to the value entered for the `cice` parameter when the `ncice` parameter is not specified.

The value entered for the `ncice` parameter must be greater than or equal to the value entered for the `cics` parameter when the `ncics` parameter is not specified.

The `si` parameter must have a value of `4`, `5`, or `13` (or `tup`, `isup`, or `qbicc`) before the `split`, `ncics`, and `ncice` parameters can be specified.

A DPC/SI routing key must be specified when the DPC is ANSI and the `si=4` parameter is specified (TUP is used only in an ITU network).

[Table A-2](#) shows valid CIC values for SI types 4, 5, and 13.

Partial point codes are not allowed; no asterisks can be specified in the point codes in the command.

Mixed point code types are not allowed; `opc` and `dpc` types must match.

If the `type=partial` or `type=default` parameter is specified, then the `split` and `resize` parameters cannot be specified.

If the `type=default` parameter is specified, then the `dpc`, `si`, `ssn`, `opc`, `cics`, and `cice` parameters cannot be specified.

When the `type=full` parameter is specified, the `dpc` and `si` parameters must be specified.

The following types of partial routing keys are supported:

- DPC-SI-OPC (ignore CIC) can be used as a partial match key for CIC- based traffic.

- DPC-SI (ignore all other fields) can be used as a partial match key for CIC- based traffic or SCCP traffic.
- DPC only (ignore all other fields) can be used as a partial match for any type of traffic.
- SI only (ignore all other fields) can be used as a partial match for any type of traffic.

If the `rcontext` parameter is specified, then the `split`, `ncics` and `ncice` parameters cannot be specified.

The `rcontext` parameter must be specified for routing keys that are associated with SUA Application Servers.

The specified `rcontext` parameter value must already exist in the database.

If specified, the service indicator parameter must be `si=3` for routing keys that are associated with SUA Application Servers.

An AS cannot be simultaneously assigned to a routing key with routing contexts and routing keys without routing context. To assign an M3UA or SUA association to multiple routing keys with routing context, the M3UA/SUA association must be assigned to more than one AS, and each AS must be assigned to a routing key with routing context.

The AS name and parameters specified for a routing key must use an address format that is valid for the adapter type assigned to the AS.

The routing context value should be unique.

**Table 4-2 Valid Parameter Combinations for chg-appl-rtkey Routing Key Types**

Action	dpc	si	ssn	opc	cics	cice	ncics	ncice	split	type
Split CIC Range	X	X		X	X	X			X	full
Re-size CIC Range	X	X		X	X	X	X	X		full
Socket Name Override (SI=ISUP or 5)	X	X		X	X	X				full
Socket Name Override (SI = SCCP or 3)	X	X	X							full
Socket Name Override (SI = not 3, 4, 5, or 13)	X	X								full

**Table 4-2 (Cont.) Valid Parameter Combinations for chg-appl-rtkey Routing Key Types**

Action	dpc	si	ssn	opc	cics	cice	ncics	ncice	split	type
Socket Name Override (SI = 4, 5, or 13)	X	X		X						partial
Socket Name Override (SI = 3, 4, 5 or 13)	X	X								partial
Socket Name Override SI-only key		X								partial
Socket Name Override DPC-only key	X									partial
Socket Name Override Default key										default

The value of the `nrcontext` parameter cannot be changed for a routing key if the `rcontext` parameter has not been configured for that routing key.

The attributes that are required to change a routing key must be specified in the command.

The maintenance data must be accessible.

J7 support feature must be enabled before the `dpcn16/opcn16` parameter can be specified.

The `opc`, `cics`, and `cice` parameters can be specified with the `si` parameter only if the `si` parameter has a value of 4, 5, or 13 (or `tup`, `isup`, or `qbicc`).

### Notes

A routing key entry associates a routing key with a socket name or Application Server (AS) name.

The `dpc`, `si`, `ssn`, `opc`, `cics`, and `cice` parameters are used to identify the routing key to be changed.

The `split`, `ncics`, and `ncice` parameters are used to specify new values for the routing key.

The `opc`, `cics`, and `cice` parameters are not required for partial routing keys.

The `cics`, `cice`, `ncice`, `ncice`, and `split` parameters are required when `si=4` and ITU DPCs (`dpci`, `dpcn`) are specified. These parameters are not valid when an ANSI DPC (`dpc`, `dPCA`) is specified and `si=4`.

The following changes can be made for routing keys. Only one of these changes is allowed per command.

- A routing key can be split into two entries with adjacent CIC ranges. The resulting entries retain the socket associations of the original entry.
- The range of CICs assigned to a routing key can be changed as long as it does not overlap another routing key. The new entry retains the socket associations of the original entry.

Group codes are required for ITU-N point codes (DPCN/OPCN) when the Duplicate Point Code feature is turned on.

Routing context is a routing key parameter that uniquely identifies routing keys. Routing context is mandatory for routing keys associated with SUA Application Servers and optional for routing keys associated with M3UA Application Servers.

An AS cannot be simultaneously assigned to a routing key with routing contexts and routing keys without routing contexts.

In this command, only ITU-international and ITU national point codes support the spare point code subtype prefix (s-).

### Output

```
chg-appl-rtkey:dpc=123-230-245:si=3:ssn=250:nsname=socket5
```

```
rlghncxa03w 04-01-28 08:50:12 EST EAGLE 31.3.0
CHG-APPL-RTKEY: MASP A - COMPLTD
```

```
;
```

### Related Topics

- [dlt-appl-rtkey](#)
- [ent-appl-rtkey](#)
- [rtrv-appl-rtkey](#)

## chg-as

Use this command to change the characteristics of an existing Application Server (AS).

### Parameters

#### **asname (mandatory)**

Application Server name.

#### **Range:**

```
aaaaaaaaaaaaaaaa
```

Up to 15 alphanumeric characters; the first character must be a letter.

**mode (optional)**

Traffic mode assigned to the AS.

**Range:**

*loadshare*

*override*

**Default:**

No change to the current value

**System Default:**

*loadshare*

**tr (optional)**

Recovery timer value for the AS in milliseconds.

**Range:**

*10 - 2000*

**Default:**

No change to the current value

**System Default:**

*200*

**Example**

```
chg-as:asname=asx:mode=override
```

**Dependencies**

The value specified for the `asname` parameter must already exist in the AS table.

Association connection parameters must be unique.

The connection state for all associations assigned to the AS must be `open=no` before the `mode` parameter can be changed.

**Notes**

By default, the AS recovery timer value is set to 200 ms when an AS is entered. This value can be changed at any time using the `chg-as` command. The new timer value will be used the next time the AS enters the AS-Pending state.

**Output**

```
chg-as:asname=asx:mode=override
```

```
rlghncxa03w 04-01-17 15:35:05 EST EAGLE 31.3.0  
CHG-AS: MASP A - COMPLTD
```

```
;
```

**Related Topics**

- [dlt-as](#)





**Range:****yes**

allow the association to carry SS7 traffic.

**no**

prohibit the association from carrying SS7 traffic.

**Default:**

No change to the current value

**System Default:**

*no*

**bufsize (optional)**

Association buffer size in Kilobytes.

**Range:**

*8 - 400*

**cwmin (optional)**

Minimum congestion window. The minimum and initial sizes, in bytes, of the association's congestion window.

**Range:**

*1500 - 409600*

**Default:**

No change to the current value

**System Default:**

*3000*

**hbtimer (optional)**

Heartbeat timer in milliseconds. The Heartbeat timer value + RTO (Retransmission Time Out) is the value of heartbeat interval at which heartbeat request should be sent.

 **Note:**

If the heartbeat timer value is not a multiple of 100, then its value will be set to the largest multiple of 100 that is less than the specified hbtimer value. For example, if the specified hbtimer value is 777, then its value would be set to 700.

**Range:**

*500 - 10000*

**Default:**

*500*

**istrms (optional)**

SCTP Inbound Stream Value. A 16-bit unsigned integer that defines the number of streams the sender allows the peer end to create in this association.



provisioned (see the `chg-uaps` command). If provisioned, then SCTP graceful shutdown for an association occurs after execution of `chg-assoc:open=no`.

**Range:****yes**

The connection manager is to open the association if the association is operational.

**no**

The connection manager will not open the association.

**Default:**

No change to the current value

**System Default:**

*no*

**ostrms (optional)**

SCTP Outbound Stream Value. The 16-bit unsigned integer that defines the number of streams the sender wants to create in this association.

**Range:**

1 - 2

**rhost (optional)**

Remote host. The name of the remote host as defined in the IP Host table.

**Range:**

////////////////////////////////////

Any string of characters beginning with a letter and comprising up to 60 characters in length.

Valid characters are a–z, A–Z, 0–9, - (dash), . (period)

**Default:**

No change to the current value

**rhosttype (optional)**

Remote host type. This parameter specifies whether the remote host is a primary or alternate remote address.

 **Note:**

The alternate remote address is used for multi-homed remote hosts.

**Range:****alternate**

alternate remote address

**primary**

primary remote address

**Default:**

No change to the current value

**System Default:***primary***rhostval (optional)**

Remote host validation. The validation mode for the association when an SCTP INIT/INIT-ACK message is received.

**Range:*****match***

accept the message if the message contains the primary remote host value and the alternate remote host value (if the alternate remote host is provisioned). If the alternate remote host is not provisioned, then accept the message if the message contains the primary remote host value. Reject the message if it contains any IP address other than that of the primary or alternate remote host.

The rules determining the use of the *relaxed* and *match* modes depend on multiple conditions, including whether an alternate remote host is provisioned. See [Table 4-4](#) for validation rules that are used to establish an association for the *relaxed* and *match* modes.

***relaxed***

accept the message if the IP address for the primary or alternate remote host matches the IP address, source IP address, or host name in the message

**Default:**

No change to the current value

**System Default:***relaxed***rmax (optional)**

Maximum retransmission timeout. The maximum value of the calculated retransmission timeout in milliseconds.

**Range:***10 - 1000***Default:**

No change to the current value

**System Default:***800***rmin (optional)**

Minimum retransmission timeout. The minimum value of the calculated retransmission timeout in milliseconds.

**Range:***10 - 1000***Default:**

No change to the current value

**System Default:***120*

**rmode (optional)**

Retransmission mode. The retransmission policy used when packet loss is detected.

**Range:*****lin***

The Oracle Linear Retransmission Policy where each retransmission timeout value is the same as the initial transmission timeout, and only the slow start algorithm is used for congestion control.

***rfc***

Standard RFC 2960 algorithm in the retransmission delay doubles after each retransmission. The RFC 2960 standard for congestion control is also used.

**Default:**

No change to the current value

**System Default:**

*lin*

**rport (optional)**

Remote port. The SCTP port number for the remote host.

**Range:**

*1024 - 65535*

**Default:**

No change to the current value

**rtimes (optional)**

Maximum retransmission retries. The number of times a data retransmission will occur before closing the association.

**Range:**

*1 - 12*

**Default:**

No change to the current value

**System Default:**

*10*

**rtxthr (optional)**

Retransmission threshold. The value of the retransmission threshold to tune the IP Connection Excess Retransmits alarm.

**Range:**

*0 - 65535*

**Default:**

*0*

**uaps (optional)**

User adapter parameter set. The set used by the M3UA, SUA or M2PA associations for various timer and parameter values including False IP Connection Congestion Timer, UA Heartbeat Period Timer, UA Heartbeat Received Timer, ASP SNM options, ASP/AS Notifications, UA Serviceability options, and Payload Protocol Indicator byte order option.

**Range:**  
1 - 10

**ver (optional)**

Version. The M2PA version supported by the association.



**Note:**

The M2PA version is valid only for associations with the `adapter=m2pa` parameter specified.

**Range:**

*d6*

*rfc*

**Example**

```
chg-assoc:aname=a1:lhost=gw105.nc.tekelec.com:lport=1030:
rhost=gw100.nc.tekelec.com:rport=1030:open=yes:alw=yes:uaps=10

chg-assoc:aname=m3ua03:rtxthr=65535

chg-
assoc:aname=a1:lhost=tek1.com:lport=1030:rport=1030:rhost=tek2.
com: rhostval=match:rhosttype=primary

chg-
assoc:aname=a1:rhost=tek.com:rhostval=relaxed:rhosttype=alterna
te

chg-assoc:aname=assoc1:adapter=diam

chg-assoc:aname=a1:hbtimer=1000
```

**Dependencies**

At least one optional parameter must be specified.

The value specified for the `aname` parameter must already exist in the IPAPSOCK table.

An association's connection parameters (`lhost`, `rhost`, `lport`, `rport`) must be unique.

The connection state must be `open=no` to change the `lhost`, `rhost`, `lport`, `rport`, `port`, `alhost`, `adapter`, `m2patset`, `istrms`, `ostrms`, `rmode`, `rmin`, `rmax`, `rtimes`, `cwmin`, `bufsize`, and `hbtimer` parameters.

The `lhost`, `lport`, `rhost`, and `rport` parameters must be specified before the `open=yes` parameter can be specified. The `aname` parameter and at least one other optional parameter must be specified before the `open=no` parameter can be specified.

The value of the `uaps` parameter can be changed for an association if the `open=yes` parameter is specified.

The hostnames specified in the `lhost` and `alhost` parameters must refer to different IP addresses.

The hostnames specified in the `lhost` and `alhost` parameters must refer to IP addresses on the same IP card.

If the LHOST is defined on Port A its ALHOST must be on PORT B.

If the LHOST is defined on Port B its ALHOST must be on PORT A.

If the LHOST is defined on Port C, its ALHOST must be PORT D.

An association with an SUA or M3UA adapter cannot be specified as a local host on a card running the IPLIMI application.

An association with an M2PA adapter cannot be specified as a local host on a card running the SS7IPGW or IPGWI application.

An association with an SUA adapter cannot be specified as the local host on a card running the IPST application.

The local host must have a signaling link assigned to its associated signaling link port before the `open=yes` parameter can be specified.

An association's `lhost` and `alhost` cannot be assigned to the card's Ethernet interface.

The LHOST cannot be PORT D.

The ALHOST cannot be PORT C.

The adapter layer cannot be changed for an association that is already associated with an Application Server (AS).

Before the local host can be changed, the new local host must have a signaling link assigned to its associated signaling link port.

Links A-A7 and B-B7 can be specified for an E5-ENET-B or SLIC card running the IPLIMI application.

The card location for the card associated with the `lhost` and `alhost` must exist in the IP Link table.

The allowed maximum is 1 association per signaling link on IPLIMx cards.

A maximum of 50 connections (association-to-AS assignments) can be specified per local host on IPGWx cards.

A maximum of 4000 connections (association-to-AS assignments + sockets) are allowed per system.

[Table 4-3](#) shows the maximum number of associations and links for E5-ENET-B cards.

**Table 4-3 Maximum IP Associations and Links**

GPL	Max # of Associations	Max # of Links
IPLHC	16	16
IPGHC	50	1
IPSG	32	32
IPSG on SLIC	128	128



**Table 4-3 (Cont.) Maximum IP Associations and Links**

GPL	Max # of Associations	Max # of Links
DEIRHC	32	-

The `rmin` parameter value must be less than or equal to the `rmax` parameter value.

The `cwmin` parameter value must be less than or equal to the `bufsize` parameter value.

If the `m2patset` parameter is specified, the `adapter=m2pa` parameter must be specified.

The trade ratio states the quantity of associations to sockets that may be provisioned on a certain card, as follows:

- Trade Ratio = a:s
- Where: a=associations and s=sockets

The requested buffer size increase cannot exceed available buffer space on the card. Use the `rtrv-assoc` command with the `aname`, `lhost`, or `alhost` parameter to display used and total buffer space on the card.

The `ver` parameter can only be specified if the `adapter=m2pa` parameter is specified.

If the value specified for the `lhost` parameter indicates an IPSPG card or DEIR card running the DEIRHC GPL, then the `link` parameter cannot be specified.

If an IPSPG card is being used, and if the association is referenced by a signaling link, then new values cannot be specified for the `lhost` or `adapter` parameters.

An IPSPG card running on E5--ENET-B card or DEIR card can contain a maximum of 32 associations.

An IPSPG application running on the SLIC card can contain a maximum of 128 associations.

If the value specified for the `aname` parameter refers to an M3UA association on an IPSPG card, then the `alw` parameter cannot be specified.

The value specified for the `lhost` parameter cannot change the local host for the association from an IPLIMx or IPGWx card to an IPSPG card or from an IPSPG card to an IPLIMx or IPGWx card.

The `rhosttype=primary` parameter must be specified before the `rhosttype=alternate` parameter can be specified.

If the `rhosttype` parameter is specified, then the `rhost` parameter must be specified.

The value specified for the alternate remote host cannot be the same as the value specified for the `lhost`, `alhost`, or `rhost` parameter in the same association.

The value specified for the `rhost` parameter cannot be the same as the value specified for the alternate remote host or for the `lhost` or `alhost` parameter in the same association.

The host name specified by the `lhost` parameter must exist in the IP Host table and must be provisioned as local to this EAGLE.

A valid value must be specified for the `host` parameter. If the host name contains a hyphen, then the host name must be enclosed within quotation marks.

Realm must be associated with the RHOST specified in the IPHOST table for diameter association.

RHOST must be present in the IPHOST table.

Remote IP address (RHOST) must not exist in the IPLINK table.

The local host name (`lhost`) parameter must be configured before the alternate local host name (`alhost`) parameter is configured.

The allowed maximum is 1 connection per signaling link on IPLIMx cards.

No two open associations can have the same value for the LHOST/LPORT parameters.

IP address associated with the LHOST and ALHOST should be of the same IP version.

IP address associated with the LHOST and RHOST should be of the same IP version.

### Notes

The command that is entered cannot exceed a total of 150 characters in length.

The IPAPSOCK table is used to associate the Local Host/Local Port to a Remote Host/Remote Port. This fully specifies the connection.

If the `open=yes` parameter is specified, the association's `lhost` and `lport` configuration must not match that of any open association.

If the card's application is IPLIMI, then the `adapter` parameter value and the `iplim12` value for the assigned signaling link must be `m2pa`.

An association with an `adapter` value of `m2pa` cannot be assigned to an SS7IPGW or IPGWI host.

For diameter associations (`adapter=DIAM`), realm must be associated with `lhost` and `rhost` parameters before `open=yes` parameter can be specified.

The `link` parameter is not allowed with diameter associations (`adapter=DIAM`).

While entering `arhost` for an `alhost`, the user needs to specify `rhost` parameter with `rhosttype=alternate`.

If none is specified for either `alhost` or `rhost`, that parameter is removed from the association's entry.

To delete an `arhost`, the user needs to specify `rhost=none` with `rhosttype=alternate`.

The M2PA version is supported if the application is IPLIMx and the `adapter=m2pa` parameter is specified. When changing the association adapter type to `m2pa` and a version is not specified, the `m2pa=rfc` value is assigned by default.

[Table 4-4](#) shows the validation rules used to establish an association.

Table 4-4 Validation Rules for Association Establishment

RHOSTVAL	RHOST Configured	ARHOST Configured	Source Parameter in IP Header	IP Address List in INIT/INIT ACK	Host Name Address Present in INIT/INIT ACK
RELAXED	Y	N	RHOST	NA (1 or more IP addresses can be present, not necessarily match RHOST.)	N
RELAXED	Y	N	NA	RHOST (other IP addresses can also be present)	N
RELAXED	Y	N	RHOST	NA	RHOST
MATCH	Y	N	RHOST	N	N
MATCH	Y	N	RHOST	RHOST only (no additional addresses can be present)	N
MATCH	Y	N	RHOST	NA	RHOST only
RELAXED	Y	Y	RHOST or ARHOST	NA	N
RELAXED	Y	Y	NA	RHOST or ARHOST	N
RELAXED	Y	Y	Same as Hostname	NA (Ignore any IP addresses present)	RHOST or ARHOST
MATCH	Y	Y	RHOST	ARHOST must be present. RHOST can also be present. No other additional addresses.	N
MATCH	Y	Y	ARHOST	RHOST must be present. ARHOST can also be present. No other additional addresses.	N

**Output**

```
chg-assoc:aname=a1:lhost=gw105.nc.tekelec.com:lport=1030:rport=1030:  
uaps=10:rhost=gw100.nc.tekelec.com:alw=yes:rhostval=match:rhosttype=  
primary
```

```
rlghncxa03w 09-03-19 15:35:05 EST EAGLE 41.0.0  
CHG-ASSOC: MASP A - COMPLTD
```

```
;
```

### Related Topics

- [dlt-assoc](#)
- [ent-assoc](#)
- [rept-stat-assoc](#)
- [rtrv-assoc](#)

## chg-atinpqopts

Use this command to provision ATINP-specific data. This command updates the ATINPQOPTS table.

### Parameters

#### **atiackimsi (optional)**

ATIACK IMSI parameter for ATI ACK response message. This parameter specifies formatting of IMSI digits in the ATI ACK response message. The result of formatting determines whether the IMSI parameter will be included in the response.

#### **Range:**

##### ***srfimsi***

If an entity was found during RTDB lookup, and SRFIMSI was provisioned in the EPAP entity, then include the IMSI parameter and encode the IMSI digits as the SRFIMSI.

##### ***asd***

If an entity was found during RTDB lookup and ASD (Additional Subscriber Data) was provisioned in the EPAP entity, then include the IMSI parameter and encode the IMSI digits as ASD.

##### ***grn***

If an entity was found during RTDB lookup, and GRN (Generic Routing Number) was provisioned in the EPAP entity, then include the IMSI parameter and encode the IMSI digits as GRN.

##### ***none***

Do not include the IMSI parameter in the response message.

#### **Default:**

*none*

**atiackmsisdn (optional)**

MSISDN parameter for ATI ACK response message. This parameter specifies the formatting of MSISDN parameter in the ATI ACK response message. The result of formatting determines whether the MSISDN parameter will be included in the response.

**Range:*****msisdn***

Include the MSISDN parameter in the ATI ACK response and encode MSISDN digits as the MSISDN from the incoming ATI query.

***asd***

If an entity was found during RTDB lookup and ASD (Additional Subscriber Data) was provisioned in the entity, then include the MSISDN parameter and encode the MSISDN digits as ASD.

***asddlmsisdn***

Include the MSISDN parameter in the ATI ACK response and encode MSISDN digits as ASD + delimiter (*atidlm*) + MSISDN. ASD is encoded if an entity is found and ASD is provisioned. The specified outbound message digits delimiter (*atidlm*) value is encoded if the value is not *none*. MSISDN is encoded as the MSISDN from the incoming ATI query.

***grn***

If an entity was found during RTDB lookup and GRN (Generic Routing Number) was provisioned in the EPAP entity, then include the IMSI parameter and encode the IMSI digits as GRN.

***grndlmsisdn***

Include the MSISDN parameter in the ATI ACK response and encode MSISDN digits as GRN + delimiter (*atidlm*) + MSISDN. GRN is encoded if GRN entity is found. The specified outbound message digits delimiter (*atidlm*) value is encoded if the value is not *none*. MSISDN is encoded as the MSISDN from the incoming ATI query.

***none***

Do not include the MSISDN parameter in the response message.

**Default:**

*msisdn*

**atiackrn (optional)**

Routing number parameter for ATI ACK response message. This parameter specifies the formatting of the routing number parameter in the ATI ACK response message. The result of formatting determines whether the routing number parameter will be included in the response.

**Range:*****rn***

Routing number.

- If an entity was found in RTDB lookup and the entity type was RN, include the routing number parameter and encode routing number digits as found in the entity ID.
- If MSISDN was found in RTDB lookup, but no entity was found and the default routing number parameter value (`atidfltrn`) is not *none*, include the routing number parameter and encode routing number digits as the `atidfltrn` value.
- If MSISDN was not found in RTDB lookup and the default routing number parameter value (`atidfltrn`) is not *none*, include the routing number parameter and encode routing number digits as the `atidfltrn` value.
- If an entity was found in RTDB lookup, the entity type is SP, and the `atidfltrn` value is not *none*, include the routing number parameter and encode routing number digits as the `atidfltrn` value.

***rnspl***

Routing number or signaling point.

- If an entity was found in RTDB lookup and the entity type was either SP or RN, include routing number parameter and encode routing number digits as found in the entity ID.
- If MSISDN was found in RTDB lookup but no entity was found and the default routing number parameter value (`atidfltrn`) is not *none*, include the routing number parameter and encode routing number digits as the `atidfltrn` value.
- If MSISDN was not found in RTDB lookup and the default routing number parameter value (`atidfltrn`) is not *none*, include the routing number parameter and encode routing number digits as the `atidfltrn` value.
- If an entity was found in RTDB lookup and the entity type was not SP or RN and the default routing number parameter value (`atidfltrn`) is not *none*, include the routing number parameter and encode routing number digits as the `atidfltrn` Entity.

***asddlmrnspl***

ASD, delimiter and routing number or signaling point.

Format routing number digits as ASD (if supported and available from lookup entity) + `atidlm` (if not *none*) + entity digits (as described in the `atiackrn=rnspl` parameter).

- If this format results in 0 digits (no ASD, `atidlm=none`, and no entity digits), the routing number will not be included in the response message.
- If the formatting results only in the specified outbound message digits delimiter (`atidlm`) digits, the routing number parameter will not be encoded in the response.
- If no entity digits (`atiackrn=rnspl`) are found, the result is ASD + delimiter digits.

***rnsplmasd***

Routing number or signaling point, delimiter, ASD

Format routing number digits as entity digits (as described in `atiackrn=rnspl`) + delimiter (if `atidlm` is not *none*) + ASD (if supported and available from lookup entity).

- If this formatting results in 0 digits (no ASD, `atidlm=none`, and no RN digits, the routing number will not be included in the response message.
- If the formatting results only in delimiter digits, the routing number will not be encoded in the response.
- If there are outbound message delimiter digits (the `atidlm` value is not *none*) and ASD digits are available, the delimiter will be included even if entity digits are not found (resulting in delimiter + ASD).

***srfimsi***

Encode routing number digits as SRFIMSI configured in the entity data. If SRFIMSI was not found (MSISDN not found in RTDB lookup, or MSISDN found but no entity found, or entity found but SRFIMSI not configured) then the routing number will not be included in the response message.

***srfimsidlmasd***

SRFIMSI, delimiter, ASD

Encode routing number digits as SRFIMSI + delimiter (if `atidlm` is not *none*) + ASD (if supported and available from lookup entity). SRFIMSI is encoded as described in the `atiackrn=srfimsi` option.

- If this formatting results in 0 digits, the routing number parameter will not be included in the response message.
- If the formatting results only in delimiter digits, the routing number parameter will not be encoded in the response message.

***asddlmsrfimsi***

ASD, delimiter, SRFIMSI

Encode routing number as ASD (if supported and available from lookup entity) + delimiter (if `atidlm` is not *none*) + SRFIMSI (encoded as specified in the `atiackrn=srfimsi` parameter).

- If this format results in 0 digits, the routing number parameter will not be included in the response message.
- If the formatting results only in delimiter digits, the routing number parameter will not be encoded in the response.
- If the outbound message digits delimiter value (`atidlm`) is not *none* and ASD digits are available, the delimiter will be included even if SRFIMSI does not have any digits (resulting in ASD + delimiter).

***grndlmrns***

GRN, delimiter, Routing number or signaling point

Encode routing number as GRN (if supported and available from RTDB lookup) + delimiter (if `atidlm` is not *none*) + RNSP (encoded as specified in the `atiackrn=rns` parameter).

- If this format results in 0 digits, the routing number parameter will not be included in the response message.
- If the formatting results only in delimiter digits, the routing number parameter will not be encoded in the response.

- If the outbound message digits delimiter value (*atidlm*) is not *none* and GRN digits are available, the delimiter will be included even if RNSP does not have any digits (resulting in GRN + delimiter).

***rnsplmgrn***

Routing number or signaling point, delimiter, GRN

Encode routing number as entity digits (as described in *atiackrn=rnspl*) + delimiter (if *atidlm* is not *none*) + GRN (if supported and available from RTDB lookup).

- If this format results in 0 digits, the routing number parameter will not be included in the response message.
- If the formatting results only in delimiter digits, the routing number parameter will not be encoded in the response.
- If the outbound message digits delimiter value (**atidlm**) is not **none** and GRN digits are available, the delimiter will be included even if RNSP does not have any digits (resulting in delimiter + GRN).

***srfimsidmgrn***

SRFIMSI, delimiter, GRN

Encode routing number as SRFIMSI (encoded as specified in the *atiackrn=srfimsi* parameter) + delimiter (if *atidlm* is not *none*) + GRN (if supported and available from RTDB lookup).

- If this format results in 0 digits, the routing number parameter will not be included in the response message.
- If the formatting results only in delimiter digits, the routing number parameter will not be encoded in the response.
- If the outbound message digits delimiter value (*atidlm*) is not *none* and GRN digits are available, the delimiter will be included even if SRFIMSI does not have any digits (resulting in delimiter + GRN).

***grndlmsrfimsi***

GRN, delimiter, SRFIMSI

Encode routing number as GRN (if supported and available from RTDB lookup) + delimiter (if *atidlm* is not *none*) + SRFIMSI (encoded as specified in the *atiackrn=srfimsi* parameter).

- If this format results in 0 digits, the routing number parameter will not be included in the response message.
- If the formatting results only in delimiter digits, the routing number parameter will not be encoded in the response.
- If the outbound message digits delimiter value (*atidlm*) is not *none* and GRN digits are available, the delimiter will be included even if SRFIMSI does not have any digits (resulting in GRN + delimiter).

***none***

Do not include the Routing Number field in the response message.

**Default:**

*rn*



**atiackvlrnum (optional)**

The formatting of the VLR-number in the ATI ACK response message.

**Range:*****rn***

routing number

- If an RN entity was found in RTDB lookup, the VLR-number is formatted as RN.
- If RN entity was found in RTDB lookup, the portability type is zero, and the S-Port feature is enabled or the IGM feature is on, the VLR-number is formatted as GRN (if provisioned).
- If MSISDN was found in RTDB lookup, no entity was found, and the `atidfltrn` value is not *none*, the VLR-number is formatted as the `atidfltrn` value.
- If MSISDN was not found in RTDB lookup, `atinptype=always` and the `atidfltrn` value is not *none*, the VLR-number is formatted as the `atidfltrn` value.
- If an SP entity was found in RTDB lookup, and the `atidfltrn` value is not *none*, the VLR-number is formatted as the `atidfltrn` value.
- If the format results in 0 digits (no entity digits), the VLR-number is formatted as the incoming MSISDN.

***rns***

Routing number or signaling point.

- If an RN or SP entity was found in RTDB lookup, the VLR-number is formatted as the entity ID.
- If MSISDN was found in RTDB lookup, no entity was found, and the `atidfltrn` value is not *none*, the VLR-number is formatted as the `atidfltrn` value.
- If MSISDN was not found in RTDB lookup, `atinptype=always`, and the `atidfltrn` value is not *none*, the VLR-number is formatted as the `atidfltrn` value.
- If an entity was found in RTDB lookup, the entity type was not RN or SP, and the `atidfltrn` value is not *none*, the VLR-number is formatted as the `atidfltrn` value.
- If the format results in 0 digits (no entity digits), the VLR-number is formatted as the incoming MSISDN.

***asddlmrns***

ASD, delimiter and routing number or signaling point.

Format the VLR-number as ASD (if provisioned) + `atidlm` (if not *none*) + entity digits (RN or SP).

- If the formatting results in 0 digits (no ASD, `atidlm=none`, and no entity digits), the VLR-number is formatted as the incoming MSISDN.

- If the formatting results only in `atidlm` digits, the VLR-number is formatted as the incoming MSISDN.
- If no entity digits are found, the VLR-number is formatted as ASD + delimiter digits.

***rnsplmasd***

Routing number or signaling point, delimiter, ASD

- If the formatting results in 0 digits (no ASD, `atidlm=none`, and no RN digits), the VLR-number is formatted as the incoming MSISDN.
- If the formatting results only in delimiter digits, the VLR-number is formatted as the incoming MSISDN. If there are outbound message delimiter digits (the `atidlm` value is not *none*) and ASD digits are available, the delimiter is included even if entity digits are not found (resulting in delimiter + ASD).

***srfimsi***

Format the VLR-number as SRFIMSI configured in the entity data.

If SRFIMSI was not found (MSISDN not found in RTDB lookup, or MSISDN found but no entity found, or entity found but SRFIMSI not configured) then the VLR-number is formatted as the incoming MSISDN.

***srfimsidmasd***

SRFIMSI, delimiter, ASD

Format the VLR-number as SRFIMSI + delimiter (if `atidlm` is not *none*) + ASD (if provisioned).

- If the formatting results in 0 digits, the VLR-number is formatted as the incoming MSISDN.
- If the formatting results only in delimiter digits, the VLR-number is formatted as the incoming MSISDN.  
If `atidlm` value is not *none* and ASD digits are available, the delimiter is included even if SRFIMSI does not have any digits (resulting in delimiter + ASD).

***asddlmsrfimsi***

ASD, delimiter, SRFIMSI

Format the VLR-number as ASD (if provisioned) + delimiter (if `atidlm` is not *none*) + SRFIMSI.

- If the formatting results in 0 digits, the VLR-number is formatted as the incoming MSISDN.
- If the formatting results only in delimiter digits, the VLR-number is formatted as the incoming MSISDN.  
If the `atidlm` value is not *none* and ASD digits are available, the delimiter is included even if SRFIMSI does not have any digits (resulting in ASD + delimiter).

***grndlmrnsp***

GRN, delimiter, Routing number or signaling point

Format VLR-number as GRN (if provisioned) + delimiter (if `atidlm` is not *none*) + entity digits (RN or SP).

- If the formatting results in 0 digits, the VLR-number is formatted as the incoming MSISDN.

- If the formatting results only in delimiter digits, the VLR-number is formatted as the incoming MSISDN.  
If the `atidlm` value is not *none* and GRN digits are available, the delimiter is included even if RNSP does not have any digits (resulting in GRN + delimiter).

***rnsplmgrn***

Routing number or signaling point, delimiter, GRN

Format VLR-number as entity digits (RN or SP) + delimiter (if `atidlm` is not *none*) + GRN (if provisioned).

- If the formatting results in 0 digits, the VLR-number is formatted as the incoming MSISDN.
- If the formatting results only in delimiter digits, the VLR-number is formatted as the incoming MSISDN.  
If the `atidlm` is not *none* and GRN digits are available, the delimiter is included even if RNSP does not have any digits (resulting in delimiter + GRN).

***srfimsidmgrn***

SRFIMSI, delimiter, GRN

Format VLR-number as SRFIMSI + delimiter (if `atidlm` is not *none*) + GRN (if provisioned).

- If the formatting results in 0 digits, the VLR-number is formatted as the incoming MSISDN.
- If the formatting results only in delimiter digits, the VLR-number is formatted as the incoming MSISDN.  
If the `atidlm` is not *none* and GRN digits are available, the delimiter is included even if SRFIMSI does not have any digits (resulting in delimiter + GRN).

***grndlmsrfimsi***

GRN, delimiter, SRFIMSI

Format VLR-number as GRN (if provisioned) + delimiter (if `atidlm` is not *none*) + SRFIMSI.

- If the formatting results in 0 digits, the VLR-number is formatted as the incoming MSISDN.
- If the formatting results only in delimiter digits, the VLR-number is formatted as the incoming MSISDN.  
If the `atidlm` value is not *none* and GRN digits are available, the delimiter is included even if SRFIMSI does not have any digits (resulting in GRN + delimiter).

***rnmsisdn***

- If an RN entity was found in RTDB lookup, the VLR-number is formatted as RN + incoming MSISDN.
- If an SP entity was found in RTDB lookup, and the `atidfltrn` value is not *none*, the VLR-number is formatted as `atidfltrn` + incoming MSISDN

- If MSISDN was found in RTDB lookup, but no entity was found and the `atidfltrn` value is not *none*, then VLR-number is formatted as `atidfltrn` value + incoming MSISDN.
- If MSISDN was not found in RTDB lookup, `atinptype=always`, and the `atidfltrn` value is not *none*, the VLR-number is formatted as `atidfltrn` value + incoming MSISDN.
- If `RN/PT=0` is found in RTDB lookup, the S-Port feature is enabled or the IGM feature is on, and the `atidfltrn` value is not *none*, the VLR-number is formatted as `atidfltrn` + incoming MSISDN. `RN/PT=0` is treated as an SP entity.

#### ***nspmsisdn***

- If an RN or SP entity was found in RTDB lookup, the VLR-number is formatted as entity digits + incoming MSISDN.
- If MSISDN was found in RTDB lookup, but no entity was found and the `atidfltrn` value is not *none*, the VLR-number is formatted as `atidfltrn` value + incoming MSISDN.
- If an entity was found in RTDB lookup, the entity type was not RN or SP, and the `atidfltrn` value is not *none*, then the VLR-number is formatted as the `atidfltrn` value + incoming MSISDN.
- If MSISDN was not found in RTDB lookup, `atinptype=always`, and the `atidfltrn` value is not *none*, then the VLR-number in the ATI ACK response is formatted as `atidfltrn` value + incoming MSISDN.

#### ***msisdn***

Format the VLR-number as incoming MSISDN

#### ***asd***

Format the VLR-number in the ATI ACK message as ASD (if provisioned).

If the formatting results in 0 digits, the VLR-number is formatted as incoming MSISDN.

#### ***asdmsisdn***

Format the VLR-number in the ATI ACK message as ASD (if provisioned) + incoming MSISDN.

#### **Default:**

*nspmsisdn*

#### ***atidfltrn* (optional)**

Default Routing Number. The routing number to be used in outgoing message formats while encoding outgoing digit formats in the ATI ACK response in cases where an RN is not returned from an RTDB lookup.

#### **Range:**

1-15 digits, *none*

Valid digits are 0-9, A-F, a-f

#### **Default:**

*none*

#### ***atidlm* (optional)**

Outbound message digits delimiter. This delimiter is used in outgoing message formats while encoding outbound digits in the ATI ACK response.

**Range:**

1-15 digits, *none*  
Valid digits are 0-9, A-F, a-f

**Default:**

*none*

**atinptype (optional)**

Number Portability Type. The criteria for a successful RTDB lookup.

**Range:*****any***

MSISDN lookup is considered successful if any match is found (RN, SP, PublicDN, PrivateDN, match with no entity, or entity type is GRN or VMS and portability type is *none* (0xff)).

***always***

Lookup is always considered successful whether an MSISDN was found or not found in the RTDB.

**Default:**

*any*

**entitylen (optional)**

Entity Length. The maximum number of digits to be used from entity data (SRFIMSI or entity ID) in the specified encoding format.

**Range:**

1 - 15, *none*  
*none* -SRFIMSI or entity ID is used without modification in the specified `atiackrn` parameter format.

**Default:**

*none*

**off**

Disables or turns off the specified feature options. A comma-separated list of feature options that are requested to be turned off. Up to 8 feature options can be specified in the list.

**Range:**

*atissupplcinfo*

**on**

Disables or turns on the specified feature options. A comma-separated list of feature options that are requested to be turned off. Up to 8 feature options can be specified in the list.

**Range:**

*atissupplcinfo*

**snai (optional)**

Service NAI. The number conditioning that is performed on the MSISDN digits in the incoming ATI query message before RTDB lookup is performed.

**Range:*****intl***

Number conditioning is not performed.

***nat***

The default country code (defined in the `chg-stpopts: defcc=` command) is pre-pended to the MSISDN before RTDB lookup.

***nai***

The NAI from the MSISDN in the incoming ATI query is used to perform number conditioning.. If the message NAI is International (0x1) or Network Specific Number (0x3), then no conditioning is performed. In all other cases, the default country code (defined in the `chg-stpopts: defcc=` command) is pre-pended to the MSISDN before RTDB lookup.

**Default:**

*nai*

**sporttype (optional)**

Service Portability type. The application of Service Portability that is applied to the associated feature.

The S-Port feature must be enabled before this parameter can be specified. The S-Port feature must be turned on before any change to the parameter will impact the associated feature.

If Service Portability is performed, then the Service Portability prefix (RTDB 'GRN' entity id) is applied.

**Range:*****gsm***

apply Service Portability prefix for own-network GSM subscribers

***is41***

apply Service Portability prefix for own-network IS41 subscribers

***all***

apply Service Portability prefix for all own-network (IS41 and GSM) subscribers

***none***

Service Portability is not performed for the feature.

**Default:**

No change to the current value

**System Default:**

*none*

**vlrnumlen**

The maximum number of digits that can be encoded as the VLR-number in ATI ACK message.

**Range:**

1-40

**Default:**

40

### Example

This example specifies that the outbound message delimiter will not be used in outgoing message formats:

```
chg-atinpopts:atidlm=none
```

This example specifies that the NAI of the incoming MSISDN digits will be considered to be National, and that the IMSI parameter will not be included in the ATI ACK response message:

```
chg-atinpopts:snai=nai:atiackimsi=none
```

This example specifies that the lookup is always considered to be successful and that the NAI of the incoming MSISDN digits will be considered to be National:

```
chg-atinpopts:atinptype=always:snai=nat
```

This example specifies that the Routing Number field will not be included in the response, and that the MSISDN in the ATI ACK response will be encoded as the ASD.

```
chg-atinpopts:atiackrn=none:atiackmsisdn=asd
```

The example specifies that the Routing Number field will not be included in the response:

```
chg-atinpopts:atiackrn=none
```

This example specifies that the IMSI and MSISDN in the ATI ACK response will be encoded as GRN:

```
chg-atinpopts:atiackimsi=grn:atiackmsisdn=grn
```

This example specifies that the Location information request in ATI query is supported and the VLR-number in the ATI ACK response will be encoded as *rnspsmsisdn* :

```
chg-atinpopts:atiackvlrnum=rnspsmsisdn:on=atisupplocinfo
```

### Dependencies

At least one optional parameter must be specified.

The ATINP feature must be enabled before this command can be entered.

The EGLEOPTS table is corrupt or cannot be found.

The Service Portability feature must be enabled before the `sporttype` parameter can be specified.

The same value cannot be specified for the `on` and `off` parameters.

### Notes

To process an ATINP query with LocationInformation request:

- The ATINP feature must be turned on
- The `on=atisupplocinfo` parameter must be specified.

## Output

```
chg-
atinpqopts:atiackimsi=grn:atiackmsisdn=grndlmmsisdn:atiackrn=grndlmr
nsp
```

```
tekelecstp 09-06-05 12:40:16 EST EAGLE 41.1.0
CHG-ATINPQOPTS: MASP A - COMPLTD
```

```
;
```

## Related Topics

- [rtrv-atinpqopts](#)

# chg-atm-lps

Use this command to configure a link parameter set with timers and other parameters used by the system to provide level 2 functions for each ATM high-speed signaling link and to copy values from `lpset 20` and `30`, as well as any `lpset` to another.

## Parameters



### Note:

Unless specified, the system default values are meant for both ANSI (T1) and ITU (E1) standards.

### **lpset (mandatory)**

Link parameter set being changed.



### Note:

Sets 1 -19 and 21 -29 can be configured. Link parameter sets 20 and 30 are not configurable and are used to contain the recommended default values for a set.

### **Range:**

1 - 19, 21 - 29

### **Default:**

1 for ANSI

21 for ITU

### **action (optional)**

This parameter copies a set of ATM signaling link parameters from one set to another.

### **Range:**

*copy*



**Default:**

No change to the current value

**maxcc (optional)**

Maximum number of transmissions of BGN, END, ER, or RS PDU.

**Range:**

*1 - 10*

**Default:**

*4*

**maxnrp (optional)**

Maximum number of retransmitted PDUs during proving.

**Range:**

*0 - 10*

**Default:**

*1 for ANSI*

*0 for ITU*

**maxpd (optional)**

Maximum number of SD PDUs that can be sent before a POLL is sent.

**Range:**

*5 - 2120*

**Default:**

*500*

**maxstat (optional)**

Maximum number of list elements in a STAT PDU.

**Range:**

*3 - 67*

**Default:**

*67*

**n1 (optional)**

Number of PDUs sent during proving.

**Range:**

*500 - 64552*

**Default:**

*64552 for ANSI*

*1000 for ITU*

**nb1k (optional)**

Number of monitoring intervals per block.

**Range:**

*1 - 10*

**Default:**

3

**src1pset (optional)**

Source LPSET for a copy action.

**Range:**

1 - 30

**tmrcc (optional)**

Timer value, in milliseconds, used during the connection phase to guard against unacknowledged BGN, END, ER or RS PDUs.

**Range:**

100 - 2000

**Default:**

200

**tmrerm (optional)**

Error rate monitor interval, in milliseconds.

**Range:**

25 - 500

**Default:**

100

**tmridle (optional)**

Timer value, in milliseconds, used during the idle phase when no SD PDUs are being sent to limit time in the idle phase.

**Range:**

25 - 1000

**Default:**

100

**tmrkalive (optional)**

Timer value, in milliseconds, used during the transient phase when no SD PDUs are being sent to keep connection up.

**Range:**

25 - 500

**Default:**

100

**tmrnocred (optional)**

The timer, in milliseconds, used when the no credit exists and PDUs are available to be sent.

**Range:**

1000 - 6000

**Default:**

1500

**tmrnorsp (optional)**

Timer value, in milliseconds, used to check that STAT PDUs are arriving often enough.

**Range:**  
*500 - 2000*

**Default:**  
*1500*

**tmrpoll (optional)**

Timer value, in milliseconds, used to guarantee that POLL PDUs are sent often enough.

**Range:**  
*25 - 500*

**Default:**  
*100*

**tmrprov (optional)**

The timer, in milliseconds, used to monitor the status of a link after it is placed into service.

**Range:**  
*60000 - 1200000*

**Default:**  
*60000*

**tmrprec (optional)**

Timer value, in milliseconds, used to prohibit closely spaced SSCOP recoveries from occurring.

**Range:**  
*60000 - 10800000*

**Default:**  
*3600000*

**tmr1 (optional)**

Time, in milliseconds, between link release action and the next link reestablish action during alignment.

**Range:**  
*1000 - 15000*

**Default:**  
*5000*

**tmr2 (optional)**

Total time, in milliseconds, that SSCF will attempt alignment.

**Range:**  
*15000 - 180000*

**Default:**

120000 for ANSI  
30000 for ITU (E1)

**t<sub>mr</sub>t<sub>3</sub> (optional)**

Time, in microseconds, between proving PDUs.

**Range:**

450 - 23000

**Default:**

925

**Example**

```
chg-atm-lps:lpset=5:tmrprov=1000:tmridle=55
```

```
chg-atm-lps:lpset=3:srclpset=5:action=copy
```

**Dependencies**

The values in link parameter sets 20 and 30 are the system default values. They cannot be changed but can be copied to another link parameter set.

The same value cannot be specified for the `lpset` and `srclpset` parameters.

The `action` and `srclpset` parameters must be specified together.

If `action=copy` parameter is specified, only the `lpset` and `srclpset` parameters can be specified.

At least one optional parameter must be specified.

The Link Parameter Set table is corrupt or cannot be found.

**Notes**

If no parameter value for the `lpset` parameter is included when the `ent-slk` command is entered, the system default value of 1 is assigned for ANSI links and the system default value of 21 is assigned for ITU links.

All timer values for link parameter sets are initialized to the system default values.

**Output**

```
chg-atm-lps:lpset=5:tmrprov=1000:tmridle=55
```

```
rlghncxa03w 04-01-05 16:40:40 EST EAGLE 31.3.0  
CHG-ATM-LPS: MASP A - COMPLTD  
;
```

**Related Topics**

- [ent-slk](#)
- [rtrv-atm-lps](#)

## chg-attr-seculog

Use this command to modify attributes that affect the operation of the security logging feature.

### Parameters

#### **upldalm (optional)**

Enable or disable log alarms that pertain to uploading of the security log.

#### **Range:**

##### **yes**

Enables log alarms pertaining to uploading of the log, as follows:

- Upload required
- Log overflowed
- Standby log contains greater than 0 un-uploaded entries

##### **no**

Prevents log alarms from being raised. If the alarm is already raised when *no* is specified, the alarm is lowered.

#### **Default:**

No change to the current value

#### **upslg (optional)**

Percent full threshold. The percent full threshold for the security logs. If the `upldalm=yes` parameter is specified, an alarm is raised for the security log when the `%full` field (see the `rept-stat-seculog` command) in the log, on the active OAM, reaches or exceeds the value specified for `upslg`. This alarm indicates that the administrator must upload the log.

#### **Range:**

1 - 99

#### **Default:**

No change to the current value

#### **purgeperiod (optional)**

Purge period (in Days). Number of days beyond which security logs will be deleted. If `purgeperiod` is greater than 0, then all the security logs which are older than `purgeperiod` will be deleted from OAM (see `rtrv-seculog` and `rept-stat-seculog`). Log entries will be deleted in background at the rate of one every few seconds until all stale entries have been removed.

#### **Range:**

0 - 180

#### **Default:**

0

### Example

```
chg-attr-seculog:upslg=80:upldalm=yes
```

**Dependencies**

At least one optional parameter must be specified.

The Security Log Attributes table is corrupt or cannot be found by the system.

**Notes**

None

**Output**

```
chg-attr-seculog:upslg=80:upldalm=yes
```

```
rlghncxa03w 04-01-05 16:40:40 EST EAGLE 31.3.0
CHG-ATTR-SECULOG: MASP B - COMPLTD
```

```
;
```

```
chg-attr-seculog:purgeperiod=2
```

```
Command Accepted - Processing
```

```
stpc1081301 20-05-13 17:24:56 EST EAGLE 46.9.0.0.0-76.9.0
chg-attr-seculog:purgeperiod=2
Command entered at terminal #1.
```

```
;
```

```
stpc1081301 20-05-13 17:24:56 EST EAGLE 46.9.0.0.0-76.9.0
CHG-ATTR-SECULOG: MASP B - COMPLTD
```

```
;
```

**Related Topics**

- [rtrv-attr-seculog](#)

## chg-card

Use this command to:

- Change the configuration of a card in the database from an IPLIMx configuration to an IPSG configuration and from an E5-ENET-B or SLIC card.
- Configure the type of EPAP data (DN or IMSI) that is loaded to an E5-SM8G-B or SLIC card.
- If the IPSG application is running on SLIC hardware, the `chg-card` command can be optionally used to change the data type from 'gtt' to 'nosccp' and vice-versa.

**Parameters****loc (mandatory)**

The card location as stenciled on the shelf of the system.

**Range:**

1101 - 1108, 1111 - 1112, 1201 - 1208, 1211 - 1218, 1301 - 1308, 1311 - 1318,  
 2101 - 2108, 2111 - 2118, 2201 - 2208, 2211 - 2218, 2301 - 2308, 2311 - 2318,  
 3101 - 3108, 3111 - 3118, 3201 - 3208, 3211 - 3218, 3301 - 3308, 3311 - 3318,  
 4101 - 4108, 4111 - 4118, 4201 - 4208, 4211 - 4218, 4301 - 4308, 4311 - 4318,  
 5101 - 5108, 5111 - 5118, 5201 - 5208, 5211 - 5218, 5301 - 5308, 5311 - 5318,  
 6101 - 6108, 6111 - 6118

**data (optional)**

Type of OAM/MPS data that can be loaded on an E5-SM8G-B or SLIC card.

**Range:****dn**

only DN related data from EPAP is loaded on the card

**epap**

all RTDB data (DN+IMSI) from EPAP are loaded on the card

 **Note:**

The *epap* value cannot be specified when the EPAP Data Split feature is ON.

**elap**

ELAP data are loaded on the card.

**gtt**

Only OAM data, including GTT data, are loaded on the card. This card will not load any ELAP or EPAP data at all.

**imsi**

Only IMSI related data from EPAP is loaded on the card

**nosccp**

Only OAM data, excluding GTT data is loaded on the card. No GTT or MPS data will be downloaded on the card. This value (=nosccp) of the *data* parameter is valid only for IP SG card(s) with the *type=slic*.

 **Note:**

The *nosccp* value signifies the absence of SCCP functionality on the IP SG card, and that it behaves as a regular IP SG card.

**Default:**

*nosccp*

**napp1 (optional)**

The new application for the card.

**Range:***xyyyyyyy*

1 alphabetic character followed by up to 6 alphanumeric characters.

***ipsg***

Used by E5-ENET-B and SLIC cards to support the combined functionality of IPLIMx M2PA and IPGWx M3UA

**type (optional)**

This parameter specifies whether an E5-ENET-B or a SLIC card is used to support the IPSP configuration.

**Range:*****enetb***

the IPSP configuration is supported on an E5-ENET-B or SLIC card

***slic***

the IPSP (with or without GTT functionality)/ VSCCP/DEIRHC/SIPHC/ENUMHC configuration is supported on a SLIC card

**Example**

```
chg-card:loc=1105:nappl=ipsg
```

```
chg-card:loc=1305:type=enetb
```

```
chg-card:loc=1201:data=imsi
```

```
chg-card:loc=1101:type=slic
```

**Dependencies**

The card location specified by the `loc` parameter cannot be 1113-1118, `xy09`, or `xy10` where `x` is the frame and `y` is the shelf.

The specified shelf location must be provisioned and present in the frame.

The Shelf table is corrupt or cannot be found.

The IMT (Card) table is corrupt or cannot be found.

Only M2PA associations can be configured for the IP link host address for the card indicated by the `loc` parameter value. M3UA IP associations are not supported.

If the HIPR2 High Rate Mode feature is turned off, then the sum of the TPS values assigned to all linksets in the system must be less than or equal to 500,000. If the HIPR2 High Rate Mode feature is turned on, then the sum of the TPS values assigned to all linksets in the system must be less than or equal to 750,000. If the HIPR2 High Rate Mode and 1M System TPS features are turned on, then the sum of the TPS values assigned to all linksets in the system must be less than or equal to 1,000,000.

The resulting total TPS of all signaling links configured for an E5-ENET-B or SLIC card when the `type=enetb` parameter is specified cannot exceed 6500 TPS. The resulting total TPS of all signaling links configured for a SLIC card when the `type=slic` parameter is specified cannot exceed 12,000 TPS

A SLIC card must be installed at the location indicated by the `loc` parameter.

A value of `ipsg` must be specified for the `nappl` parameter.



The card in the location indicated by the `loc` parameter must already be equipped.

The value specified by the `loc` parameter must be within the allowed range.

The Link table is corrupt or cannot be found.

The `loc` parameter must be specified.

All links on the SLIC card must have a matching association configured. For IPSCG-hosted associations, a link and association are matched using the `aname` parameter for the `ent-slk` command.

The `nappl` or `type` parameter must be specified.

If DN or IMSI is specified for the `data` parameter for VSCCP, the EPAP Data Split feature must be turned on.

If the EPAP Data Split feature is ON, or Dual ExAP Config feature is enabled, and the value specified for the `loc` parameter indicates an E5-SM8G-B or SLIC card, then the `data` parameter must be specified. The `data` parameter can be specified only for an E5-SM8G-B or SLIC card running the VSCCP or SIPHC application or IPSCG card.

**Note:**

The DATA parm is valid only for SLIC IPSCG cards, and not ENET/ENETB IPSCG cards.

If ELAP or EPAP is specified for the `data` parameter for VSCCP, the Dual ExAP Config feature must be enabled.

When `data=gtt` is specified for VSCCP, either Dual ExAP Config must be enabled or EPAP Data Split feature must be turned ON.

The `data=gtt` parameter cannot be specified for VSCCP if an IP link has been configured for the card.

To provision card `type=ENETB` or SLIC, the shelf FAN bit must be turned ON for the card's shelf.

If the IPSCG32 GPL is running on the location specified by the `loc` parameter, then `data=gtt` and `data=nosccp` are the only valid values for the DATA parameter. If the GPL is anything but IPSCG32 GPL, `data=nosccp` cannot be used for the card on that location.

If card is `type=SLIC` with `data=GTT` and is changed to `type=ENET/ENETB`, then `data` must be changed to `NOSCCP` first.

A GTT-enabled IPSCG card can only have 32 equipped SS7 links. A SLIC IPSCG card with more than 32 equipped SS7 links cannot be a GTT-enabled IPSCG card.

The `data` parameter can only be specified for IPSCG application running on SLIC card.

**Notes**

If a SLIC card is plugged into a slot provisioned for E5-ENET-B, this command can be used to change the card type from `enet` to `slic` or `enetb` to `slic`. The card must be manually inhibited first in order to allow the command to be processed.

## Output

```
chg-card:loc=1206:nappl=ipsg
```

```
rlghncxa03w 10-03-01 11:11:28 EST EAGLE 42.0.0  
CHG-CARD: MASP A - COMPLTD  
;
```

## Related Topics

- [dlt-card](#)
- [ent-card](#)
- [init-card](#)
- [rept-stat-card](#)
- [rmv-card](#)
- [rtrv-card](#)

# chg-clkopts

Use this command to perform a software update of the clock elements and settings.

## Parameters

### **clock (mandatory)**

Clock to be updated.

#### **Range:**

***all***  
all clocks

***primary***  
primary clock

***secondary***  
secondary clock

E5-TDM cards must be installed before a value of *primary* or *secondary* can be specified.

### **force (optional)**

The *force=yes* parameter is used to change the *hsc1ksrc* parameter value when the TDMs are reporting that the high speed system clocks are currently valid.

**Range:**  
*yes*

### **hsc1k11 (optional)**

High speed master clock line length.

**Range:*****longhaul***

Gain is high for long haul

***shorthaul***

Gain is low for short haul

**Default:**

No change to the current value

**System Default:***longhaul***hsc1ksrc (optional)**

High speed master clock source. The `force=yes` parameter must be specified with this parameter to change the clock source when the TDMs are reporting that the high speed system clocks are currently valid.

 **Caution:**

Changing the high speed master clock source can result in clock outage and loss of traffic on all links, if the new source type does not match the provisioned source for the E1 or T1 cards (what is actually plugged into the backplane).

**Range:*****e1framed***

E1 Framed clock source

***e1unframed***

E1 Unframed clock source

***rs422***

RS-422 clock source

***t1framed***

T1 Framed clock source

***t1unframed***

T1 Unframed clock source

**Default:**

No change to the current value

**System Default:***rs422***Example**

```
chg-clkopts:clock=primary:hsc1ksrc=t1framed
```

```
chg-clkopts:clock=all:hsc1ksrc=rs422:force=yes
```

```
chg-clkopts:hsc1k11=shorthaul:clock=secondary
```



**Range:***ayy*

1 alphabetic character followed by 2 alphanumeric characters  
Specify the parameter value in the format *ayy-no* or *ayy-yes*.  
*ayy-yes-command* class is allowed  
*ayy-no-command* class is not allowed

**Default:**

No change to current value

**class2 (optional)**

This parameter specifies a configurable command class name and indicator to indicate whether the command class is allowed.

**Range:***ayy*

1 alphabetic character followed by 2 alphanumeric characters  
Specify the parameter value in the format *ayy-no* or *ayy-yes*.  
*ayy-yes-command* class is allowed  
*ayy-no-command* class is not allowed

**class3 (optional)**

This parameter specifies a configurable command class name and indicator to indicate whether the command class is allowed.

**Range:***ayy*

1 alphabetic character followed by 2 alphanumeric characters  
Specify the parameter value in the format *ayy-no* or *ayy-yes*.  
*ayy-yes-command* class is allowed  
*ayy-no-command* class is not allowed

**class4 (optional)**

This parameter specifies a configurable command class name and indicator to indicate whether the command class is allowed.

**Range:***ayy*

1 alphabetic character followed by 2 alphanumeric characters  
Specify the parameter value in the format *ayy-no* or *ayy-yes*.  
*ayy-yes-command* class is allowed  
*ayy-no-command* class is not allowed

**class5 (optional)**

This parameter specifies a configurable command class name and indicator to indicate whether the command class is allowed.

**Range:***ayy*

1 alphabetic character followed by 2 alphanumeric characters  
Specify the parameter value in the format *ayy-no* or *ayy-yes*.  
*ayy-yes-command* class is allowed  
*ayy-no-command* class is not allowed

**class6 (optional)**

This parameter specifies a configurable command class name and indicator to indicate whether the command class is allowed.

**Range:**

*ayy*

1 alphabetic character followed by 2 alphanumeric characters

Specify the parameter value in the format *ayy-no* or *ayy-yes*.

**class7 (optional)**

This parameter specifies a configurable command class name and indicator to indicate whether the command class is allowed.

**Range:**

*ayy*

1 alphabetic character followed by 2 alphanumeric characters

Specify the parameter value in the format *ayy-no* or *ayy-yes*.

*ayy-yes-command* class is allowed

*ayy-no-command* class is not allowed

**class8 (optional)**

This parameter specifies a configurable command class name and indicator to indicate whether the command class is allowed.

**Range:**

*ayy*

1 alphabetic character followed by 2 alphanumeric characters

Specify the parameter value in the format *ayy-no* or *ayy-yes*.

*ayy-yes-command* class is allowed

*ayy-no-command* class is not allowed

**Example**

```
chg-cmd:cmd=ent-rte:class1=u11-yes
```

```
chg-cmd:cmd=rept-stat-slk:class7=dab-no
```

**Dependencies**

At least one optional parameter must be specified.

The Command Class Management feature must be enabled before this command can be entered.

The `cmd` parameter value must be a valid system command.

The CCCNAMES table is corrupt or cannot be found.

The CCCMD table is corrupt or cannot be found.

The `class1 - class8` parameter values must be valid default or provisioned configurable command class names.

The `login` command is available to all users and therefore cannot be assigned to a configurable class. If the `login` command is used as a parameter, it will be rejected.



### Example

```
chg-cmdclass:class=abc:descr="my command class description"

chg-cmdclass:class=u23:nclass=dab:descr="his command class
description"

chg-cmdclass:class=dab:nclass=krb
```

### Dependencies

At least one optional parameter must be specified.

The Command Class Management feature must be enabled and turned on before this command can be entered.

The `class` parameter value must be a valid configurable command class name (one of the default configurable command class names or a user-defined command class name).

The CCCNAMES table is corrupt or cannot be found.

The value specified for the `nclass` parameter cannot be the same as an existing configurable or non-configurable command class name.

### Notes

None

### Output

```
chg-cmdclass:class=abc:descr="my command class description"

      rlghncxa03w 04-01-05 16:40:40 EST  EAGLE 31.3.0
      CHG-CMDCLASS:  MASP B - COMPLTD
;
```

### Related Topics

- [rtrv-cmdclass](#)

## chg-csl

Use this command to change an existing entry in the Common Screening List (CSL). The Common Screening List commands are used to tailor certain types of general screening information to specific features.

### Parameters

#### **ds (optional)**

Digit string. A unique string of digits used by the specified screening feature

#### **Range:**

1 - 15 hexadecimal digits.  
Valid digits are 0-9, a-f, A-F





***delpfx***  
Delete Prefix List

***gt***  
Global Title List

***imsipfx***  
IMSI Screening Prefix List

***insl***  
In Network Subscriber List

***npbypass***  
SIP NPBYPASS list

***skbcm***  
SK+BCSM List

***skts***  
SK+TS List

***trig***  
Trigger List

***vmpfx***  
Voice Mail Prefix List

The following screening lists are valid for the indicated features:

- *ccnc*, *gt*— Prepaid IDP Query Relay, Info Analyzed Relay Base
- *imsipfx*— EIR

 **Note:**

If list argument is not specified in this command for EIR feature then `list = imsipfx` by default is taken.

- *npbypass*— SIP Number Portability
- *skbcm*—Prepaid IDP Query Relay and IDP Service Key Routing
- *skts*, *insl*—IDP Screening for Prepaid
- *trig*—Info Analyzed Relay Base
- *vmpfx*—VFLEX

The *delpfx* list is not supported at this time. This list should only be used by Oracle personnel.

**p1 (optional)**

Parameter Value 1. This parameter is specific to the feature and list that use the parameter.

**Range:**

*ZZZZZZZZZZ*

Valid values for the IDP Service Key Routing feature are:

- 3 or *prepaid1*—Prepaid Portability Type 3 for the SKBCSM list
- 4 or *prepaid2*—Prepaid Portability Type 4 for the SKBCSM list
- 6-35 or *prepaid3-prepaid32*—Prepaid Portability Types 6 through 35 for the SKBCSM list
- 255 or *prepaidno*—No Prepaid Portability Type for the SKBCSM list

Valid values for EIR feature are:

- 1 or *range*— Check only range IMEI table for the IMSIPFX list
- 2 or *individual* — Check only individual IMEI table for the IMSIPFX list
- 3 or *both* --- Check individual IMEI table first and then range table for the IMSIPFX list
- 4 or *none* --- No check in either Individual IMEI Table or Range IMEI Table for the IMSIPFX list.

Valid values for the Prepaid IDP Query Relay feature are:

- 0, 1—National or International for the DELPFX list, which is for Tekelec personnel use ONLY.

 **Note:**

The p1 parameter is used by the IDP Service Key Routing feature or EIR feature.

**Default:**

No change to the current value

**p2 (optional)**

Parameter Value 2. The IDP Relay Service that is associated with an SKBCSM list DS entry. Multiple IDP Relay Services can be provisioned for use with NPP or Response Type for EIR feature that is associated with an *imsipfx* list DS Entry.

The parameter value can be entered as a number or as the corresponding mnemonic.

**Range:**

*ZZZZZZZZZZ*

Valid values for Prepaid IDP Query Relay features are:

- 1 or *idprcdpn*—IDPRCDPN Service for the SKBCSM list
- 2 or *idprcdpn2*—IDPRCDPN2 Service for the SKBCSM list
- 3 or *idprcdpn3*—IDPRCDPN3 Service for the SKBCSM list
- 4 or *idprcdpn4*—IDPRCDPN4 Service for the SKBCSM list

Valid values for EIR feature are:

- 1 or *whitelist* ---- Response Type as Whitelist for *imsipfx* list.
- 2 or *graylist* ---- Response Type as Graylist for *imsipfx* list.

- 3 or *blacklist* ---- Response Type as Blacklist for imsipfx list.
- 4 or *unknown* ---- Response Type as Unknown for imsipfx list.

**Note:**

The p2 parameter is used by the Prepaid IDP Query Relay feature or EIR feature.

**Default:**

No change to the current value

**p3 (optional)**

Parameter Value 3. The parameter value is specific to the feature and list name that use this parameter. No feature currently uses this parameter.

**pc (optional)**

ANSI point code with subfields *network indicator-network cluster-network cluster member (ni-nc-ncm)*.

**Synonym:**

*pca*

**pc/pca/pci/pcn/pcn24 (optional)**

Point code. The *ds* parameter or a point code parameter must be specified.

**Note:**

See [Point Code Formats and Conversion](#) for a detailed description of point code formats, rules for specification, and example.

**pci (optional)**

ITU international point code with subfields *zone-area-id*.

**pcn (optional)**

ITU national destination point code in the format of a 5-digit number (*nnnnn*); or 2, 3, or 4 numbers (members) separated by dashes (*m1-m2-m3-m4*) as defined by the `chg-stpopts:npcfmti` flexible point code option. A group code must be specified when the ITUDUPPC feature is turned on (*nnnnn-gc, m1-m2-m3-m4-gc*).

**pcn24 (optional)**

24-bit ITU national point code with subfields *main signaling area-sub signaling area-signaling point (msa-ssa-sp)*.

**pfxstrip (optional)**

This parameter in NPBYPASS list indicates whether matched prefix must be deleted or not.

**Range:**

*yes*

*no*

**Default:***no***pn (optional)**

Part Number. The 9-digit "893xxxxxx" part number of the feature for which the command is entered. The `rtrv-ctrl-feat` command description shows the part number in the command output example.

 **Note:**

The `pn` or `feature` parameter must be specified to identify the feature.

**Range:***893000000 - 893999999*

The first 3 digits are *893*. Do not separate the digits with dashes or spaces. The following part numbers are valid for this command:

- *893012301* --- EIR
- *893015501*—IDP Screening for Prepaid
- *893016001*—Prepaid IDP Query Relay
- *893016701*—VFLEX
- *893034201*—Info Analyzed Relay Base
- *893040601*— SIP Number Portability

**scpgta (optional)**

Signaling Control Point (SCP) Global Title Address (GTA). The value used by the SKGTARTG Service Action in IDP Relay IDPRCDPN(X) NPP Services to replace the SCCP CdPA GTA in the outgoing message.

**Range:**1 - 21 hexadecimal digits, *none*Valid digits are *0-9, a-f, A-F*.*none*-Removes the provisioned digit string **Note:**

The `scpgta` parameter is used by the Prepaid IDP Query Relay feature.

**Default:**

No change to the current value

**Example**

```
chg-csl:feature="IDP Screening for
Prepaid":list=insl:ds=123456789bcdEF
```

```
chg-csl:feature="VFLEX":list=vmpfx:ds=123456789abcdEF
```

```
chg-csl:feature="Prepaid IDP Query
Relay":list=skbcm:ds=0000000056:p2=idprcdpn4:scpgta=abce9875
```

```
chg-csl:pn=893040601:list=npbypass:ds=0000046:pfxstrip=yes
chg-csl:feature="SIP NUMBER
PORTABILITY":list=npbypass:ds=000036:pfxstrip=no
chg-
csl:feature="EIR":list=imsipfx:ds=401134134:p1=range:p2=whitelist
```

## Dependencies

An enabled feature must be specified using a valid part number (`pn`) or feature name (`feature`). The specified feature must use a Common Screening List.

The feature that is specified by the `feature` parameter must already be enabled.

The `list` parameter must be specified for features that use more than one type of screening list.

The value specified for the `list` parameter must be valid for the specified screening feature.

The specified screening list entry must exist in the screening list that is used by the feature.

The length of the digit string that is specified for the `ds` parameter must be valid for the screening feature and list type.

A valid `ds` parameter value is required for the specified feature and list type.

The following parameters are allowed with the indicated common screening list type:

- `list=gt`—`ds` parameter
- `list=ccnc`—`ds` parameter
- `list=skbcsm`—`ds` and `scpgta` parameters
- `list=skts`—`ds` parameter
- `list=insl`—`ds` parameter
- `list=vmpfx`—`ds` parameter
- `list=trig`—`ds` parameter
- `list=imsipfx`—`ds` parameter

The leading digit pattern of the value specified for the `ds` parameter must be unique in the specified screening list for the indicated feature.

The Common Screening List table is corrupt or cannot be found.

The `pc` or `ds` parameter must be specified. The parameters cannot be specified together in the command.

The value specified for the `feature` parameter must be valid feature name for a feature that uses a Common Screening List. The feature name must be specified as it appears in the `rtrv-ctrl-feat` command output. Enough of the name must be specified to make the name unique when two features begin with the same word or acronym.

The `scpgta` and `pc` parameters cannot be specified together in the command.

If the `scpgta` parameter is specified, then the `ds` parameter must be specified.

A valid `p1` and `p2` parameter value is required for the specified feature and list type.

The SIPNP feature must be enabled before changing NP prefix entries for the NPBYPASS list.

PFXSTRIP must be changed when the list specified is NPBYPASS with the SIPNP Feature.

The DS (Digit String) must be between 1 - 15 digits in length for SIPNP Feature

### Notes

None

### Output

```
chg-csl:pn="Prepaid IDP Query
Relay":list=skbcm:ds=0000000056:p2=idprcdpn4:scpgta=abce9875
```

```
tekelecstp 10-10-20 14:46:49 EST EAGLE 43.0.0
SK+BCSM List ( 7 of 150) 5%
CHG-CSL: MASP A - COMPLTD
;
```

```
chg-csl:feature="SIP Number
Portability":list=npbypass:ds=0000000034:pfxstrip=yes
```

```
tekelecstp 12-06-25 15:29:14 EST EAGLE 45.0.0
chg-csl:feature="SIP Number
Portability":list=npbypass:ds=0000000034:pfxstrip=yes
Command entered at terminal #4.
PFX List ( 2 of 1000) 1%
CHG-CSL: MASP A- COMPLTD
;
```

```
chg-csl:pn=893040601:list=npbypass:ds=0000000056:pfxstrip=yes
```

```
tekelecstp 12-06-25 15:29:14 EST EAGLE 45.0.0
chg-csl:pn=893040601:list=npbypass:ds=0000000056:pfxstrip=yes
Command entered at terminal #4.
PFX List (3 or 1000) 1%
CHG-CSL: MASP A-COMPLTD
;
```

### Related Topics

- [dlt-csl](#)
- [ent-csl](#)
- [rtrv-csl](#)
- [rtrv-ctrl-feat](#)

## chg-ctrl-feat

Use this command for controlled features that have been enabled with the `enable-ctrl-feat` command to turn on or turn off On/Off features and to turn on Permanently On features (cannot be turned off after they have been turned on)

Use this command when the system station shows an expired temporary key and the administrator wants to clear the CRITICAL system alarm without enabling a permanent Feature Access Key.

### Parameters

#### **partnum (mandatory)**

Part number. The part number for the feature.

##### **Range:**

*893000000 - 893999999*

Do not include dashes in the 9-digit number.

#### **alarm (optional)**

Clears alarms when temporary feature keys have expired.

##### **Range:**

*clear*

#### **status (optional)**

Changes the operational status of the feature.

##### **Range:**

*on*

*off*

##### **Default:**

No change in current status

### Example

```
chg-ctrl-feat:partnum=893xxxxxx:status=on
```

```
chg-ctrl-feat:partnum=893xxxxxx:alarm=clear
```

### Dependencies

The controlled feature specified by the `partnum` parameter must be enabled (see the `enable-ctrl-feat` command) before this command can be entered.

One of the optional parameters, but not both, must be specified in the command.

To use this command to turn off a feature, the Part Number specified in the command must be for one of the following On/Off features that is currently on. (A Permanently On feature is turned on with this command; after the feature has been turned on, it cannot be turned off with this command):

- 893018001 1100 TPS/DSM for ITU NP



- 893022101 ATI Number Portability Query (ATINP)
- 893017601 Circ Route Auto-Recovery
- 893005801 Command Class Management
- 893400001 EAGLE OA&M IP Security
- 893018101 Enhanced Far-End Loopback
- 893015401 Flexible GTT Load Sharing (FGTTLS)
- 893027401 GTT Load Sharing with Alternate Routing Indicator (GTT LS ARI)
- 893020101 HIPR2 High Rate Mode
- 893025701 IDPR ASD
- 893025601 IDPR GRN
- 893035001 Info Analyzed Relay ASD
- 893035101 Info Analyzed Relay GRN
- 893026101 Info Analyzed Relay NP
- 893038901 Integrated GLS
- 893006901 Intermediate GTT Load Sharing (IGTTLS)
- 893005701 IP User Interface (Telnet)
- 893018401 Large BICC MSU Support for IP Signaling
- 893006601 LNP Short Message Service (LNP SMS)
- 893007001 MNP Circular Route Prevention
- 893026701 MO SMS ASD
- 893024601 MO SMS B-Party Routing
- 893026601 MO SMS GRN
- 893026201 MO SMS IS41-to-GSM Migration
- 893013501 MTP Map Screening
- 893009101 Network Security Enhancement
- 893039301 NPP Unlimited SDWC Characters
- 893009301 Portability Check for Mobile Originated SMS
- 893006701 Prepaid SMS Intercept Phase 1 (PPSMS)
- 893018801 SEAS over IP
- 893034301 Service Portability
- 893024501 TIF ASD
- 893025501 TIF GRN
- 893022501 TIF Number Substitution
- 893037701 TIF Range CgPN Blacklist
- 893037601 TIF Subscriber CgPN Blacklist

Turning on a feature that is already on or turning off a feature that is already off has no effect.

The GTT feature must be turned on (see the `chg-feat` command) before the following features can be turned on:

- Intermediate Global Title Translation Load-Sharing (IGTTLS)
- LNP ELAP Configuration
- SCCP Loop Detection

All IPSM cards in the system must be inhibited before the IP User Interface (Telnet) feature can be turned on or off.

All IPSM cards in the system must be inhibited before the EAGLE OA&M IP Security Enhancements feature can be turned on or off.

Only one of the optional parameters, not both, can be specified in the command.

After a Permanently On feature is turned on, it cannot be turned off with this command. All controlled features with quantity feature access keys (like LNP ported TNS) and the following features are Permanently On features:

- 15 Minute Measurements
- Advanced GTT Modification (AMGTT)
- Advanced GTT Modification Called Party Only (AMGTT CdPA Only)
- Advanced GTT Modification Calling Party Upgrade (AMGTT CgPA Upgrade)
- ANSI-41 INP Query
- ANSI-41 Mobile Number Portability (A-Port)
- ANSI/ITU SCCP Conversion
- Diameter S13/S13' Interface for EIR
- E5-OAM Integrated Measurements (Integrated Measurements)
- Enhanced GSM MAP Screening (EGMS)
- Equipment Identity Register (EIR)
- Flexible Linkset Optional Based Routing (FLOBR)
- G-Flex MAP Layer Routing
- G-Port SRI Query for Prepaid
- GSM Flexible Numbering (G-Flex)
- GSM MAP Screening (GMS)
- GSM MAP SRI Redirect for Serving HLR
- GSM Mobile Number Portability (G-Port)
- GTT Action - DISCARD
- GTT Action - DUPLICATE
- GTT Action - FORWARD
- Hex Digit Support for GTT
- IDP A-Party Blacklist
- IDP A-Party Routing
- IDP Screening for Prepaid

- IDP Service Key Routing
- Info Analyzed Relay Base (IAR)
- INP
- IS41 GSM Migration (IGM)
- ISUP NP with EPAP
- ITU TCAP LRN Query (LRNQT)
- ITUN-ANSI SMS Conversion
- LNP ELAP Configuration
- LOCREQ Query Response
- MO-based GSM SMS NP
- MO-based IS41 SMS NP
- MT-Based GSM SMS NP
- MT-Based GSM MMS NP
- MT-Based IS41 SMS NP
- MTP Msgs for SCCP Apps
- Multiple Linkset to a Single Adjacent Point Code
- Origin-Based MTP Routing
- Origin-based SCCP Routing
- PC & CIC Translation (PCT)
- Prepaid IDP Query Relay
- SCCP Loop Detection
- Service Portability (S-Port) Subscriber Differentiation
- SIP Number Portability
- SLS Bit Rotation by Incoming Linkset (ISLSBR)
- Spare Point Code Support
- Support for 16 GTT Lengths in VGTT
- TCAP Opcode Based Routing (TOBR)
- TCAP Opcode Quantity
- TIF Number Portability
- TIF SCS Forwarding
- TIF Simple Number Substitution
- Transaction-based GTT Loadsharing (TBGTTLS)
- Voice Mail Router (V-Flex)
- Weighted GTT Loadsharing (WGTTLS)
- XUDT UDT Conversion

The value specified for the `partnum` parameter must be the correct part number for the feature.

The `platformenable=on` or the `oamhcmeas=on` parameter must be specified (see the `chg-measopts` command) before the 15 Minute Measurements feature can be turned on.

If the Measurements Platform feature is turned on (see the `chg-feat` command) as a precursor to turning on the 15 Minute Measurements feature, then at least one MCPM card must be available in the IS-NR state before the 15 Minute Measurements feature can be turned on. The `platformenable=on` parameter must be specified (see the `chg-measopts` command) before an MCPM card can be placed in the IS-NR state.

The 15 Minute Measurements feature cannot be turned on when 30 minute measurements collection is in progress.

The Global Title Translation (GTT) feature must be turned on (using the `gtt=on` parameter for the `chg-feat` command) before the Intelligent Network Application Part (INAP) Number-based Portability (INP) feature or the ANSI-41 INP Query (AINPQ) feature can be turned on.

The A-Port, G-Port, or IGM feature must be turned on before the MNP Circular Route Prevention feature can be turned on.

The SEASCLLI must be provisioned (see the `chg-seas-config` command) before the SEAS Over IP feature can be turned on.

At least one SEAS terminal must be configured (see the `chg-trm` command) before the SEAS Over IP feature can be turned on.

The IP address of at least one IPSM card associated with a SEAS terminal must be configured before the SEAS Over IP feature can be turned on.

The IP User Interface feature must be turned on before the SEAS Over IP feature can be turned on.

The `login` and `hname` parameters must be provisioned (see the `chg-seas-config` command) before the SEAS Over IP feature can be turned on.

If the SEAS Over IP feature is turned on, then the IP User Interface feature cannot be turned off.

All card locations that correspond to SEAS terminals must be provisioned with IPSM cards before the SEAS Over IP feature can be turned on.

The A-Port feature must be turned on before the MT-Based IS41 SMS NP feature can be turned on.

The G-Port feature must be turned on before the MT-Based GSM SMS NP feature can be turned on.

HIPR2 cards must be installed in all MUX locations before the HIPR2 High Rate Mode feature can be turned on.

The `defcc` system option (see the `chg-stpopts` command) must be provisioned before the IAR Base feature can be enabled and before the ATINP, MT-based GSM SMS NP, or MT-Based IS41 SMS NP feature can be turned on.

The `defmcc` GSM option (see the `chg-gsmopts` command) must be provisioned before the MT-Based GSM SMS NP feature can be turned on.

The MT-Based GSM SMS NP feature must be turned on before the MT-Based GSM MMS NP feature can be turned on.

An IDPRCDPN(X) NPP service must be ON before the Prepaid IDP Query Relay feature can be turned on.

The `defcc` and `defndc` system options (see the `chg-stpopts` command) must be provisioned before the V-Flex feature can be turned on.

The Prepaid IDP Query Relay feature must be turned on before the IDPR ASD or IDPR GRN feature can be turned on.

The `matchseq=dn` parameter must be specified (see the `chg-tifopts` command) before the TIF ASD feature can be turned on.

The GTT LS ARI feature must be turned off before the IGTTLS feature can be turned off.

The HIPR2 High Rate Mode feature cannot be turned on or off if an IMT Rate Change sequence is in progress.

If the provisioned System TPS (SIGTRAN TPS + ATM TPS) is greater than 500,000, then the HIPR2 High Rate Mode feature cannot be turned off.

The flashing process must be complete on all MUX cards before the HIPR2 High Rate Mode feature can be turned on or off.

The HIPR2 High Rate Mode feature cannot be turned on or off during an Extended Bit Error Rate Test (BERT).

The `matchseq=dn` parameter must be specified (see the `chg-tifopts` command) before the TIF Subscriber CgPN Blacklist feature can be turned on.

The `crptt` parameter must have a value of *none* (see the `chg-gsmopts` command) before the MNP CRP feature can be turned off.

The HIPR2 High Rate Mode feature cannot be turned on or off during upgrade.

The Default Country Code must be provisioned (see the `defcc` parameter in the `chg-stpopts` command) before the Prepaid IDP Query Relay feature can be turned on.

The EGLEOPTS table is corrupt or cannot be found.

The SEASCFG Table must be accessible.

At least one terminal without a Thermal Alarm must exist before the SEAS Over IP feature can be turned on.

The INP and AINPQ features cannot be turned on if the LNP (an LNP ported TNs quantity), LNP 150,000 LRNs, or LNP 300,000 NPANXX feature is enabled and on.

The LNP ELAP Configuration feature and the WNP feature must be turned on before the LNP SMS feature can be turned on.

The STP Options table is corrupt or cannot be found by the system.

If a `chg-ctrl-feat` command is already in progress, then another `chg-ctrl-feat` command cannot be entered.

The Linkset table is corrupt or cannot be found.

The Link table is corrupt or cannot be found.

If a single digit wildcard (?) is specified as a value for the `fpx` parameter more than 25 times across all of the rules for an NPP service (see the `ent-npp-srs` command), then the NPP Unlimited SDWC Characters feature cannot be turned off.

If more than three single digit wildcard characters (?) are specified for the `fpx` parameter in an NPP Service rule (see the `ent-npp-srs` command), then the NPP Unlimited SDWC Characters feature cannot be turned on.

If a single digit wildcard (?) is specified after the sixth digit of the value specified for the `fpx` parameter for an NPP Service rule (see the `ent-npp-srs` command), then the NPP Unlimited SDWC Characters feature cannot be turned on.

A database error occurred while trying to access the NPPFILT table.

The E5-ENET-B IPSP High Throughput feature cannot be turned off if an E5-ENET-B card running the IPSP application in the system has a configured card capacity above 6500 TPS.

The HIPR2 High Rate Mode feature must be ON before the 1M System TPS feature may be turned ON. The HIPR2 High Rate Mode feature cannot be turned OFF if the 1M System TPS feature is turned ON.

If the System TPS is more than 750K then the 1M System TPS feature cannot be turned OFF.

## Notes

### SEAS Terminals

All terminals that are configured as SEAS are automatically allowed or inhibited when the SEAS Over IP feature is turned on or off, respectively.

### Commands blocked during IMT Rate Change sequence:

If the HIPR2 High Rate Mode feature is turned on or off, then an IMT Rate Change sequence is carried out (if required). The `alw-imt`, `disc-imt`, `flash-card`, `inh-imt`, `init-flash`, `init-mux`, and `tst-imt` commands cannot be entered if an IMT Rate Change sequence is in progress.

### Service Portability

If the Service Portability feature is turned on before a dependent feature is turned on, then a warning is issued:

#### **WARNING: No Service Portability dependent feature is on.**

If the Service Portability feature is turned off when more than one dependent feature is turned on, then a warning is issued:

#### **WARNING: Service Portability is OFF.**

### Output

```
chg-ctrl-feat:partnum=893xxxxxx:status=on
```

```
tekelecstp 06-07-26 14:47:49 EST EAGLE 36.0.0
chg-ctrl-feat:partnum=893xxxxxx:status=on
Command entered at terminal #4.
CHG-CTRL-FEAT: MASP A - COMPLTD
```

```
;
```

```
chg-ctrl-feat:partnum=893xxxxxx:alarm=clear
```

```

tekelecstp 06-07-26 14:47:49 EST EAGLE 36.0.0
chg-ctrl-feat:partnum=893xxxxxx:alarm=clear
Command entered at terminal #4.
CHG-CTRL-FEAT: MASP A - COMPLTD
;
tekelecstp 06-07-26 14:47:49 EST EAGLE 36.0.0
0367.0181 * SYSTEM      Temp Key(s) expiration alarm cleared.
;

```

This example shows the output when the 1100 TPS/DSM for ITU NP feature is on, and the `chg-ctrl-feat` command is re-entered within 30 seconds for confirmation:

```
chg-ctrl-feat:partnum=893018001:status=on
```

```

tekelecstp 06-07-26 14:47:49 EST EAGLE 36.0.0
chg-ctrl-feat:partnum=893018001:status=on
Command entered at terminal #4.
CAUTION:Rated TPS for this feature supports an engineered GTT
traffic mix of no more than 70 percent EPAP-based traffic.
Re-enter the command within 30 seconds to confirm change.
CHG-CTRL-FEAT: MASP A - Command Aborted

Command is re-entered within 30 seconds
chg-ctrl-feat:partnum=893018001:status=on

tekelecstp 06-07-26 14:47:58 EST EAGLE 36.0.0
chg-ctrl-feat:partnum=893018001:status=on
Command entered at terminal #4.
CHG-CTRL-FEAT: MASP A - COMPLTD

```

This example shows the output when the 1100 TPS/DSM for ITU NP feature is on, and the `chg-ctrl-feat` command is not re-entered within 30 seconds:

```
chg-ctrl-feat:partnum=893018001:status=on
```

```

tekelecstp 06-07-26 14:47:49 EST EAGLE 36.0.0
chg-ctrl-feat:partnum=893018001:status=on
Command entered at terminal #4.
CAUTION:Rated TPS for this feature supports an engineered GTT
traffic mix of no more than 70 percent EPAP-based traffic.
Re-enter the command within 30 seconds to confirm change.
CHG-CTRL-FEAT: MASP A - Command Aborted

Command is not re-entered within 30 seconds.
CHG-CTRL-FEAT command aborted due to confirmation timeout.

```

This example shows the output when the 1100 TPS/DSM for ITU NP feature is not on, and the `chg-ctrl-feat` command is re-entered within 30 seconds for confirmation:

```
chg-ctrl-feat:partnum=893018001:status=off
```

```
tekelecstp 06-07-26 14:47:49 EST EAGLE 36.0.0
chg-ctrl-feat:partnum=893018001:status=off
Command entered at terminal #4.
CAUTION: This command decreases the total TPS of the
SCCP system from 1100 to 850 TPS for each DSM.
Re-enter the command within 30 seconds to confirm.
CHG-CTRL-FEAT: MASP A - Command Aborted
```

```
Command is re-entered within 30 seconds
chg-ctrl-feat:partnum=893018001:status=off
```

```
tekelecstp 06-07-26 14:47:58 EST EAGLE 36.0.0
chg-ctrl-feat:partnum=893018001:status=off
Command entered at terminal #4.
CHG-CTRL-FEAT: MASP A - COMPLTD
```

### Related Topics

- [enable-ctrl-feat](#)
- [rtrv-ctrl-feat](#)

## chg-db

Use this command to manipulate elements of the database.

### ▲ Caution:

When this command is entered, all other database operations are locked out while the command executes.

### ▲ Caution:

The cards that run both the active and standby OAM reboot whenever the restore operation completes successfully. When a database is repaired successfully, the card with the standby OAM reboots. This action purges old database data from memory and reloads the MASPs with the new data. When the card with the active OAM reboots, all terminals reinitialize, automatically logging off all users. Depending on the new database, the terminals may be initialized to a different configuration, and user IDs and passwords may change.

### Parameters

#### **action (mandatory)**

The database management action.



**Range:****backup**

Copies the database from the current data partitions to the backup partitions on both fixed disks, the backup partition on the removable drive, or to a compressed tar file on a remote FTP server. If the destination is the server a database file with the following naming convention will be created: 'CLLI string' - 'Release number string' - 'yymmddhh'.tar.gz  
(tekelecstp-37.5.0-08012212.tar.gz)

**repair**

Copies the current and backup databases from the active to the standby fixed disk.

**restore**

Copies the backup partitions to the current data partitions on both fixed disks, or copies the database from the removable drive or the remote FTP server to the current data partitions on both fixed disks.

**▲ Caution:**

The `action=restore` parameter initiates an emergency recovery procedure and requires the `init-sys` command to download the restored database to all the cards in the system.

**dest (optional)**

Destination. The destination disk for the database backup.

**Range:****remove**

Back up the database to a removable drive

**fixed**

Back up the database to a fixed disk

**server**

Back up the database to a remote server

**usb**

Argument to be used by Oracle personnel only.

**Default:**

*fixed*

**file (optional)**

The name of the TAR file on the remote server that contains the database to be restored to the system.

The `src=server` parameter must be specified before this parameter can be specified.

**Range:**

yy

Up to 39 alphanumeric characters

**sloc (optional)**

Source location. The location of the removable drive.

This parameter can be used to specify a location in the active or standby E5-MASP.

**Range:**

*1113, 1115*

**Default:**

location in the active E5-MASP

**src (optional)**

Source. The source used to restore the database.

**Range:*****remove***

Restore the database from a removable drive

***fixed***

Restore the database from the fixed disk

***server***

Restore the database from a remote server

***usb***

Argument to be used by Oracle personnel only.

**Default:**

*fixed*

**Example**

```
chg-db:action=backup:dest=server
```

```
chg-db:action=restore:src=remove
```

```
chg-db:action=repair
```

```
chg-db:action=restore:src=server:file="CLLI-37.5.0-08012212.tar.gz"
```

**Dependencies**

This command cannot be entered while the system is in upgrade mode.

The removable drive must be accessible and ready and must be formatted as a system removable disk, NOT as a measurement removable disk.

The `dest` parameter can be specified only when `action=backup`. If the `dest=fixed` parameter is specified, or the `dest` parameter is not specified, the database on the current partition of the fixed disk is copied to the backup partition of the fixed disk. This action is shown in [Figure 4-1](#).

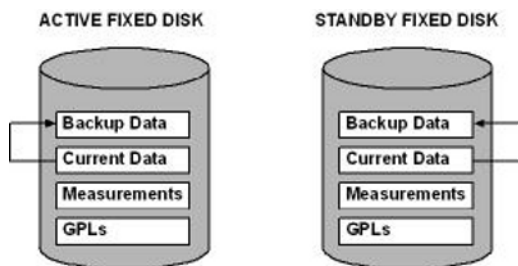
**Figure 4-1** `chg-db:action=backup:dest=fixed`

The current database partition of both fixed disks must be free of integrity violations (for example, incoherency, inconsistency, and data corruption) when `action=backup` is specified.

The `src` parameter can be used only when `action=restore`. To restore the database, if the `src=fixed` parameter is specified or the `src` parameter is not specified, the backup partition of each fixed disk is copied to the current partition of the fixed disk. This action is shown in [Figure 4-2](#).

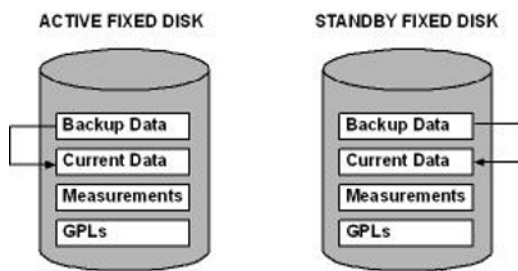
**Figure 4-2** `chg-db:action=restore:src=fixed`

The backup database partition of both fixed disks must be coherent when `chg-db:action=restore:src=fixed` is specified.

The database on the removable drive must be coherent when `chg-db:action=restore:src=remove` is specified.

The current and backup database partitions of the active fixed disk must be free of integrity violations (for example, incoherency and data corruption) when `action=repair` is specified.

When the `action=repair/restore` parameter is specified, the database(s) serving as the source of data for the operation must be free of integrity violations (for example, incoherency and data corruption).

All databases involved in the operation must contain valid database version information.

The `action=restore` and `src=server` parameters must be specified before the `file` parameter can be specified. If the `src=server` parameter is specified, then the `file` parameter must be specified.

The `action=restore` and `src=remove` parameters must be specified before the `sloc` parameter can be specified.

The DB application server must be provisioned (see the `ent-ftp-serv` command) before the `chg-db:action=backup:dest=server` or `chg-db:action=restore:src=server` command can be entered.

An IPSM card must be provisioned before the `chg-db:action=restore:src=server` or `chg-db:action=backup:dest=server` commands can be entered.

The standby MASP must be in the Active state before this command can be entered.

If the `src=usb` or `dest=usb` parameter is specified, then a flash drive must be inserted into the Active OAM's flush-mounted USB port.

During a restore procedure, if removable drives installed in the latched USB port on active and standby E5-MASPs have different DB levels, then the `sloc` parameter must be specified in the `chg-db:action=restore:src=remove` command to specify the removable drive to be used.

The value specified for the `file` parameter must have the correct extension.

A value of 1113 or 1115 must be specified for the `sloc` parameter.

The `chg-db` command cannot be issued when SFAPP(P)->OAM sync is ON.

This command cannot be entered when CAT2 IPSM to OAM syncing is in progress.

### Notes

When the `action=backup` parameter is specified, the following message appears when an audit is in progress:

```
Command In Progress: waiting for database audit to complete
```

The command executes when the audit is finished.

### Performance

The performance time to execute this command varies depending on the number of records allocated for the database, system activity, and system setup. These operations should typically take no longer than 30 minutes. If one of these operations exceeds one hour, contact My Oracle Support. See the "My Oracle Support" section in Chapter 1 of this manual.

If the `dest=remove` parameter is specified, the database on the current partition of the active fixed disk is copied to the removable drive. This action is shown in [Figure 4-3](#).

Figure 4-3 chg-db:action=backup:dest=remove

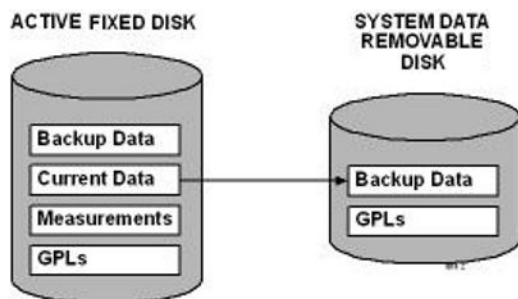

If the `chg-db:action=restore:src=server:filename=xxxxxx.tar` or `chg-db:action=backup:dest=server` command is entered, the database partitions are copied from or to the remote server application through an IPSM card. This action is shown in Figure 4-4.

Figure 4-4 Remote Backup or Restore

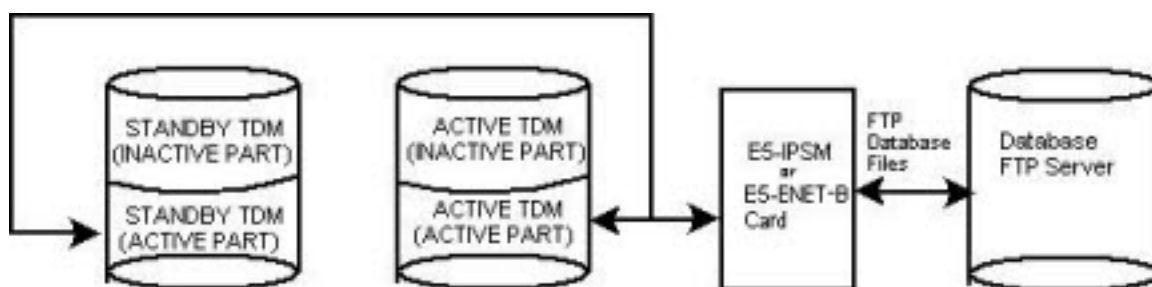

If the `action=repair` parameter is specified, the current and backup database partitions are copied from the active fixed disk to the standby fixed disk. This action is shown in Figure 4-5.

Figure 4-5 chg-db:action=repair

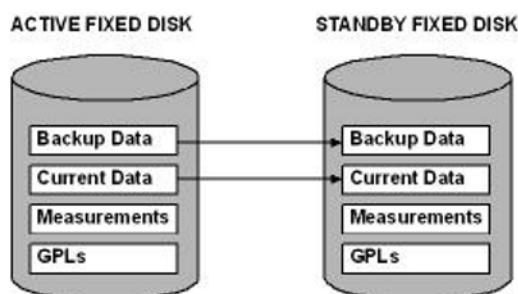

If the `src=remove` parameter is specified, the database on the removable drive is copied to the current partitions on both the active and standby fixed disks. This action is shown in Figure 4-6.

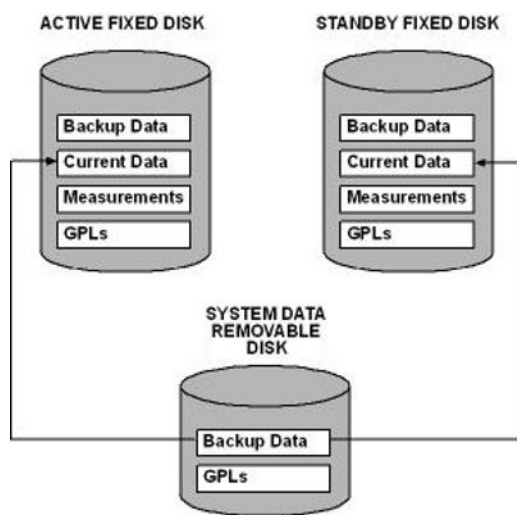
**Figure 4-6** chg-db:action=restore:src=remove

If the `action=restore` and `src=remove` parameters are specified on the E5-MASP hardware, the database of the removable drive (in the latched USB port) is copied to the current partition of each fixed disk. The default is to use the removable drive in the active E5-MASP. The `sloc` parameter can be used to specify the removable drive in the active or standby E5-MASP.

If the `dest=remove` parameter is specified for an E5-MCAP card, the database on the current partition of each fixed disk is copied to the removable drive in both latched USB ports. If only the active OAM has a removable drive, then only the current partition on the active OAM is copied to the removable drive in the active OAM's latched USB port.

If the `chg-db:action=restore:src=usb` or `chg-db:action=backup:dest=usb` command is entered, then the database partitions are copied from or to the flash drive (inserted in the active OAM's flush-mounted USB port). This action is shown in [Figure 4-4](#).

## Output

Messages such as UIMs might appear at your terminal.

```
chg-db:action=backup
```

```
BACKUP (FIXED): MASP B - Backup starts on active MASP.
BACKUP (FIXED): MASP B - Backup on active MASP to fixed disk complete.
BACKUP (FIXED): MASP B - Backup starts on standby MASP.
BACKUP (FIXED): Backup on standby MASP to fixed disk complete.
```

```
chg-db:action=restore
```

```
RESTORE (FIXED): MASP A - Restore starts on active MASP.
RESTORE (FIXED): MASP A - Restore from fixed disk on active MASP
complete.
RESTORE (FIXED): MASP A - Restore starts on standby MASP.
RESTORE (FIXED): MASP A - Restore from fixed disk on standby MASP
```

complete.

RESTORE (FIXED) : MASP A - MASP(s) will reboot to load data.

chg-db:action=backup:dest=remove

BACKUP (REMOVABLE) : MASP A - Backup starts on active MASP.

BACKUP (REMOVABLE) : MASP A - Backup to removable media complete.

chg-db:action=backup:dest=fixed

BACKUP (FIXED) : MASP A - Backup starts on active MASP.

BACKUP (FIXED) : MASP A - Backup on active MASP to fixed disk

complete.

BACKUP (FIXED) : MASP A - Backup starts on standby MASP.

BACKUP (FIXED) : MASP A - Backup on standby MASP to fixed disk

complete.

chg-db:action=restore:src=remove

RESTORE (REMOVABLE) : MASP A - Restore starts on active MASP.

RESTORE (REMOVABLE) : MASP A - Restore starts on standby MASP.

RESTORE (REMOVABLE) : MASP A - MASP(s) will reboot to load data.

RESTORE (REMOVABLE) : MASP A - Restore from removable media

complete.

chg-db:action=restore:src=fixed

RESTORE (FIXED) : MASP A - Restore starts on active MASP.

RESTORE (FIXED) : MASP A - Restore from fixed disk on active MASP

complete.

RESTORE (FIXED) : MASP A - Restore starts on standby MASP.

RESTORE (FIXED) : MASP A - MASP(s) will reboot to load data.

RESTORE (FIXED) : MASP A - Restore from fixed disk on stdby MASP

complete.

chg-db:action=repair

REPAIR: MASP A - Repair starts on standby MASP.

REPAIR: MASP A - Standby MASP will reboot to load data.

REPAIR: MASP A - Repair from fixed disk complete.

chg-db:action=backup:dest=server

BACKUP (SERVER): MASP A - Backup starts on active MASP.

BACKUP (SERVER) : Copy Database to card memory for processing.

```
BACKUP (SERVER) : Compress Database before archiving.  
BACKUP (SERVER) : Send database archive to server.  
BACKUP (SERVER): MASP A - Backup to remote server complete.
```

```
chg-db:action=restore:src=server:file="CLLI-37.5.0-08011112.tar.gz"
```

```
RESTORE (SERVER) : Retrieve database archive from server.  
RESTORE (SERVER) : Validate database archive.  
RESTORE (SERVER) : Restore starts on active MASP.  
RESTORE (SERVER) : Restore from server on active MASP complete.  
RESTORE (SERVER) : Restore starts on standby MASP.  
RESTORE (SERVER) : Restore from server on standby MASP complete.  
RESTORE (SERVER) : MASP(s) will reboot to load data.
```

### Related Topics

- [copy-meas](#)
- [rept-stat-db](#)

## chg-dconn

Use this parameter to change the DEIR connection information. The DCONN table supports the provisioning information related to the Diameter connections.

### Parameters

#### **dcname (mandatory)**

Diameter connection name. This parameter specifies the unique logical name assigned to each diameter connection.

#### **Range:**

*azzzzzzzzzzzzzzz*

A string of alphanumeric characters, beginning with a letter and up to 15 characters in length. Valid values are *a..z*, *A..Z*, *0..9*.

#### **Default:**

No change to the current value.

#### **System Default:**

null

#### **maxtps (optional)**

Maximum TPS. This is the maximum TPS for a diameter connection. The unused card capacity will be allocated among the connections that have exceeded their RSVDTPS up to limit of MAXTPS value provisioned for the particular connection.

#### **Range:**

100 - 8000

#### **Default:**

No change to the current value



**System Default:**  
8000

**rsvdtps (optional)**

Reserved TPS. This is the guaranteed TPS (Transactions per second) for a diameter connection. Total RSVDTPS on a card cannot exceed 8000.

**Range:**  
100 - 8000

**Default:**  
No change to the current value

**System Default:**  
250

**td (optional)**

Diameter Peer Disconnect timer. This timer is used to control how long the DEIR process will wait for a DPA response (Diameter Peer Answer) to a send DPR (Diameter Peer Request). The value given to a timer is in seconds.

**Range:**  
1 - 10

**Default:**  
No change to the current value

**System Default:**  
3

**tw (optional)**

Diameter Watchdog timer. This timer is used to control how long the DEIR (Diameter EIR) process will wait for a DWA (Diameter Watchdog Answer) response to a send DWR (Diameter Watchdog request). The value given to a timer is in seconds.

**Range:**  
6-30

**Default:**  
No change to the current value.

**System Default:**  
6

**Example**

```
chg-dconn:dcname=conn1:rsvdtps=1000:maxtps=5000:td=5:tw=15
```

```
chg-dconn:dcname=conn2:td=6:maxtps=6000
```

**Dependencies**

S13/S13' EIR feature must be enabled before changing any parameter of diameter connection.

DCONN table should be accessible.

At least one optional parameter must be specified.

Diameter connection name is not present in DCONN table.

Sum of RSVDTPS of all the diameter connections on a particular card must not exceed the diameter card TPS (8000).

RSVDTPS of a diameter connection must be less than or equal to its MAXTPS.

### Notes

None.

### Output

```
chg-dconn:dcname=conn1:rsvdtps=1000:maxtps=5000:td=5:tw=15
```

```
tekelecstp 13-03-20 15:44:10 EST EAGLE 45.1.0
chg-dconn:dcname=conn1:rsvdtps=1000:maxtps=5000:td=5:tw=15
Command entered at terminal #4.
CHG-DCONN: MASP A - COMPLTD
;
```

### Related Topics

- [dlt-dconn](#)
- [ent-dconn](#)
- [rtrv-dconn](#)

## chg-deiropts

Use this command to change the S13/S13' EIR configuration. This command updates the DEIROPTS (Diameter Options) table.

### Parameters

#### **applid (optional)**

Authentication Application ID. The application id configured should match with the Auth-Application-Id (AVP Code 258) value in Vendor-Specific-Application-ID AVP. This value is fixed to 16777252 and cannot be changed.

#### **Range:**

0 - 2147483647

#### **Default:**

No change to the current value

#### **System Default:**

16777252

#### **congerr (optional)**

This parameter defines the diameter response to be sent by the DEIRHC card at the time of card congestion. If the card fails in processing the incoming messages, then it shall discard the message and respond with the error code.

**Range:**

3004 - DIAMETER\_TOO\_BUSY

5006 - DIAMETER\_RESOURCES\_EXCEEDED

**Default:**

No change to the current value

**System Default:**

3004

**deirdfltimsilkup (optional)**

Diameter Equipment Identity Register (EIR) default IMSI lookup status. This parameter specifies the order of IMEI table lookup for default IMSI screening. This parameter is analogous to the P1 parameter in the IMSIPFX CSL list but is used only when there is no matching IMSI prefix in the IMSIPFX CSL.

**Range:***range*

Perform lookup on Range IMEI table only.

*individual*

Perform lookup on Individual IMEI table only.

*both*

Perform lookup on Individual IMEI table first &amp; if not found then lookup Range IMEI table.

*none*

Don't perform any lookup. Just return the default IMEI status.

**Default:**

No change to the current value.

**System Default:***whitelist***deirdfltimsiresp (optional)**

Diameter Equipment Identity Register (EIR) default IMSI response. This parameter specifies the default IMEI status for default IMSI screening. This parameter is analogous to the P2 parameter in the IMSIPFX CSL list but is used only when there is no matching IMSI prefix in the IMSIPFX CSL.

**Range: (whitelist, graylist, blacklist, unknown)***whitelist*

The IMEI is "valid". Registration should be allowed for the handset.

*graylist*

The IMEI is "questionable".

*blacklist*

The IMEI is "invalid". Registration should not be allowed for this handset.

*unknown*

The IMEI is not in the White, Gray, or Black list. Registration should not be allowed for this handset.

**Default:**

No change to the current value.

**System Default:**

*whitelist*

**deirgrsp (optional)**

Diameter Equipment Identity Register (EIR) Global Response status.

**Range:**

*off*

EIR Global Response is not used

*whitelst*

The IMEI is "valid". Registration should be allowed for the handset.

*graylst*

The IMEI is "questionable." Registration should be allowed, but the event is logged in the DEIR log and a special measurement peg is incremented.

*blklst*

The IMEI is "invalid". Registration should not be allowed for this handset.

*unknown*

The IMEI is not in the White, Gray, or Black list. Registration should not be allowed for this handset.

**Default:**

No change to the current value

**System Default:**

*off*

**deirrsptype (optional)**

Diameter Equipment Identity Register (EIR) Response Type. The Response Type is used to determine how the lists are to be searched.

**Range:**

*type 1*

*type 2*

*type 3*

EIR Response Type Values contains information to help select the value for this parameter.

Presence in List			EIR Response Type (Equipment Status)		
White	Gray	Black	Type 1	Type 2	Type 3
X			in white list	in white list	in white list
X	X		in gray list	in gray list	in gray list
X	X	X	in black list	in black list	in black list
X		X	in black list	in black list	in black list
	X		in gray list	in gray list	unknown
	X	X	in black list	in black list	unknown
		X	in black list	in black list	unknown
			in white list	Unknown*	unknown *

\*Indicates no match was found for the IMEI in an incoming message within the database.

**Default:**

No change to the current value.

**System Default:**

*type 1*

**dprcause (optional)**

Disconnect Cause in DPR (Disconnect Peer Request) message.

**Range:**

0 - REBOOTING

1 - BUSY

2 - DO\_NOT\_WANT\_TO\_TALK

**Default:**

No change to the current value

**System Default:**

Do not want to talk (2)

**off (optional)**

This parameter turns off the specified options. Up to 8 comma-separated unique options can be specified.

**Range:**

*deirimsiscrn*

*deirlogwl*

*deirdfltimsiscrn**deirimsichk***on (optional)**

This parameter turns on the specified options. Up to 8 comma-separated unique options can be specified.

**Range:***deirimsiscrn**deirlogwl**deirdfltimsiscrn**deirimsichk***product (optional)**

This parameter is the vendor assigned name for the product.

**Range:**

ayyyyyyyyyyyyyyy

An alphanumeric string of 1 to 15 characters with the first character being alphabetic.

**Default:**

No change to the current value

**System Default:**

None

**vendid (optional)**

This parameter indicates the S13/S13' local Vendor ID.

**Range:**

0 - 2147483647

**Default:**

No change to the current value.

**System Default:**

0

**Example**

```
chg-deiropts:on=deirimsichk:deirrsptype=type2:product=abc123
```

```
chg-deiropts:deirgrsp=off:off=deirimsichk:dprcause=1
```

```
chg-deiropts:dprcause=0
```

```
chg-deiropts:on=deirimsiscrn,deirlogwl,deirdfltimsiscrn,deirimsichk
```

```
chg-deiropts:off=deirimsiscrn,deirlogwl,deirdfltimsiscrn,deirimsichk
```

```
chg-deiropts:deirdfltimsilkup=range
```

```
chg-deiropts:deirdfltimsiresp=whitelist
```

## Dependencies

The S13 feature must be enabled before changing any DEIR configuration.

The DEIROPTS table should be accessible.

At least one optional parameter must be specified.

The product name must be alphanumeric.

The S13 Application ID cannot be changed.

The same value cannot be specified for the on and off parameters.

on/off options

- *deirimsiscrn* --- Specifies whether the IMSI Screening for Diameter Equipment Identity Register (EIR) shall be done before the IMEI check. This option has a default of OFF.
- *deirlogwl* --- Specifies whether the white list logging for Diameter Equipment Identity Register (EIR) shall be on. This option has a default of OFF.
- *deirdfltimsiscrn* --- Specifies whether the default IMSI Screening for Diameter Equipment Identity Register (EIR) shall be on. This option has a default of OFF.
- *deirimsichk* --- Specifies the use of Diameter Equipment Identity Register (EIR) IMSI Check status. It specifies whether IMSI lookup shall be performed along with IMEI for blklst numbers. This option has a default of OFF.

## Output

```
chg-deiropts:on=deirimsichk:deirrsptype=type2
```

```
tekelecstp 13-04-13 17:25:00 EST EAGLE 45.1
  chg-deiropts:on=deirimsichk:deirrsptype=type2
  Command entered at terminal #4.
  CHG-DEIROPTS: MASP A - COMPLTD
;
```

## Related Topics

- [rtrv-deiropts](#)

# chg-dstn

Use this command to change the characteristics of the point codes that are considered destinations from this signal transfer point (STP). A destination does not have to be an adjacent signaling point, but the system must be able to route traffic to this destination.

## Parameters



### Note:

See [Point Code Formats and Conversion](#) for a detailed description of point code formats, rules for specification, and examples.

### **dpc/dpca/dpci/dpcn/dpcn24/dpcn16 (mandatory)**

Destination point code.

### **dpc (optional)**

ANSI destination point code with subfields *network indicator-network cluster-network cluster member (ni-nc-ncm)*. The *prefix* subfield indicates a private point code (*prefix-ni-nc-ncm*).

#### **Synonym:**

*dpca*

#### **Range:**

*p-*, *000-255*, \*

Specify a valid value for each subfield of the point code, and separate the subfields with a dash (-).

*prefix—p-*

The asterisk value (\*) is not valid for the *ni* subfield.

When *chg-sid:pctype=ansi* is specified, *ni = 000* is not valid.

When *chg-sid:pctype=ansi* is specified, *nc = 000* is not valid if *ni = 001–005*.

When *chg-sid:pctype=ansi* is specified, *nc = 000* is valid if *ni = 006–255*.

The point code *000-000-000* is not a valid point code.

### **dpci (optional)**

ITU international destination point code with subfields *zone-area-id*. The *prefix* subfield indicates a spare point code, private point code, or private and spare point code (*prefix-zone-area-id*).

#### **Range:**

*s-*, *p-*, *ps-*, *0-255*

Specify a valid value for each subfield of the point code, and separate the subfields with a dash (-).

*prefix—s-, p-, ps*

*zone—0-7*

*area—000-255*

*id—0-7*

The point code *0-000-0* is not a valid point code.

### **dpcn (optional)**

ITU national destination point code in the format of a 5-digit number (*nnnnn*); or 2, 3, or 4 numbers (members) separated by dashes (*m1-m2-m3-m4*) as defined by the *chg-stpopts:npcfmt1* flexible point code option. A group code must be specified when the ITUDUPPC feature is turned on (*nnnnn-gc*, *m1-m2-m3-m4-gc*). The *prefix* subfield indicates a spare point code, private point code, or private and spare point code (*prefix-nnnnn*, *prefix-nnnnn-gc*, *prefix-m1-m2-m3-m4*, *prefix-m1-m2-m3-m4-gc*).



**Range:***s-, p-, ps-, 0-16383, aa-zz*

Specify a valid value for each subfield of the point code, and separate the subfields with a dash (-).

*prefix—s-, p-, ps**nnnnn—0-16383**gc—aa-zz**m1-m2-m3-m4—0-14* for each member; values must sum to 14**dpcn24 (optional)**24-bit ITU national destination point code with subfields *main signaling area-sub signaling area-signaling point (msa-ssa-sp)*. The *prefix* subfield indicates a private point code (*prefix-msa-ssa-sp*).**Range:***s-, p-, ps-, 0-16383, aa-zz*

Specify a valid value for each subfield of the point code, and separate the subfields with a dash (-).

*prefix—s-, p-, ps**nnnnn—0-16383**gc—aa-zz**m1-m2-m3-m4—0-14* for each member; values must sum to 14**dpcn16 (optional)**16-bit ITU national point code with subfields *unit number, sub number area, main number area (un-sna-mna)*. The *prefix* indicates a private point code (*prefix-un-sna-mna*).**Range:***p-, 000-127*

Specify a valid value for each subfield of the point code, and separate the subfields with a dash (-).

*prefix---p**un---000---127**sna---000---15**mna---000---31***aliasa/aliasi/aliasn/aliasn24/aliasn16 (optional)**

Alias point code.

**aliasa (optional)**ANSI destination point code with subfields *network indicator-network cluster-network cluster member (ni-nc-ncm)*.**Range:***000-255, none*

Specify a valid value for each subfield of the point code, and separate the subfields with a dash (-).

When `chg-sid:pctype=ansi` is specified, *ni = 000* is not valid.

When `chg-sid:pctype=ansi` is specified, `nc = 000` is not valid if `ni = 001–005`.

When `chg-sid:pctype=ansi` is specified, `nc = 000` is valid if `ni = 006–255`.

Enter *none* to delete the point code.

The point code `000-000-000` is not a valid point code.

#### **aliasi (optional)**

ITU international alias point code list with subfields *zone-area-id*. The *prefix* subfield indicates a spare point code (*prefix-zone-area-id*).

If an ITU international destination (*dpci*) point code is entered, the *dpci* and *aliasi prefix* subfields cannot be the same, (both spare or both non-spare). Up to 2 comma-delimited entries can be entered in the point code list.

##### **Range:**

*s-*, 0-255, *none*

Specify a valid value for each subfield of the point code, and separate the subfields with a dash (-).

*prefix—s*

*zone—0-7*

*area—000-255*

*id—0-7*

Enter *none* to delete the point code.

The point code `0-000-0` is not a valid point code.

#### **aliasn (optional)**

ITU national alias point code list in the format of a 5-digit number (*nnnnn*); or 2, 3, or 4 numbers (members) separated by dashes (*m1-m2-m3-m4*) as defined by the `chg-stpopts:npcfnti` flexible point code option. A group code must be specified when the ITUDUPPC feature is turned on (*nnnnn-gc*, *m1-m2-m3-m4-gc*). The *prefix* subfield indicates a spare point code (*prefix-nnnnn*, *prefix-nnnnn-gc*, *prefix-m1-m2-m3-m4*, *prefix-m1-m2-m3-m4-gc*).

If an ITU national destination (*dpcn*) point code is entered, then the *dpcn* and *aliasn prefix* subfields cannot be the same (both spare or both non-spare). Up to 2 comma-delimited entries can be entered in the point code list.

##### **Range:**

*s-*, 0-16383, *aa-zz*, *none*

Specify a valid value for each subfield of the point code, and separate the subfields with a dash (-).

*prefix—s*

*nnnnn—0-16383*

*gc—aa-zz*

*m1-m2-m3-m4—0-14* for each member; values must sum to 14

Enter *none* to delete the point code.

#### **aliasn24 (optional)**

24-bit ITU national destination point code with subfields *main signaling area-sub signaling area-signaling point* (*msa-ssa-sp*).

##### **Range:**

000-255, *none*

Specify a valid value for each subfield of the point code, and separate the subfields with a dash (-).

*msa—000-255*

*ssa—000-255*

*sp*—000-255  
Enter *none* to delete the point code.

**aliasn16 (optional)**

16-bit ITU national destination point code with subfields *unit number*, *sub number area*, *main number area* (*un-sna-mna*).

**Range:**  
000---127, *none*

Specify a valid value for each subfield of the point code, and separate the subfields with a dash (-).

*un*---000---127

*sna*---000---15

*mna*---000---31  
Enter *none* to delete the point code.

**bei (optional)**

Broadcast exception indicator. This parameter specifies whether the STP broadcasts network management messages to adjacent signaling points. The network management messages contain information about the indicated cluster and any of that cluster's member signaling points that are on its exception list. The messages whose broadcast is determined by this parameter are:

- TFP—Transfer Prohibited
- TCP—Transfer Cluster Prohibited
- TFA—Transfer Allowed
- TCA—Transfer Cluster Allowed

**Range:**

**yes**  
Network management messages are not broadcast

**no**  
Network management messages are broadcast

**Default:**  
No change to the current value

**c11i (optional)**

Common Language Location Identifier assigned to the destination.

**Range:**  
ayyyyyyyyyy 1 alphabetic character followed by 10 alphanumeric characters

**Default:**  
No change to the current value

**e1ei (optional)**

Exception-list exclusion indicator, for cluster destinations only. This parameter specifies whether the system *excludes* or *includes* (*maintains*) a dynamic status

exception list (x-list) for each cluster route used to reach the member signaling points that make up the cluster.

**Range:****yes**

Do not maintain a dynamic status x-list

**no**

Maintain a dynamic status x-list

**Default:**

No change to current value.

**homescp (optional)**

This parameter specifies whether the destination point code is considered a Home SCP when performing SCCP processing for messages with no Global Title Address Digits (Global Title Indicator (GTI) is set to zero).

This parameter can only be set to "yes" for full DPCs.

**Range:****yes**

the DPC is considered a Home SCP

**no**

the DPC is not considered a Home SCP

**Default:**

No change to the current value

**homesmsc (optional)**

This parameter specifies whether the DPC is considered a Home SMSC when performing SCCP processing for messages with no Global Title Address Digits (GTI is set to zero).

This parameter can only be set to "yes" for full DPCs.

**Range:****yes**

the DPC is considered a Home SMSC

**no**

the DPC is not considered a Home SMSC

**Default:**

No change to the current value

**ncai (optional)**

Nested cluster allowed indicator. Specifies whether the route to the cluster point code can be different for provisioned members of the cluster. A point code is a member of a cluster point code if it has the same network identifier (NI) and network cluster (NC) values as the cluster point code. This parameter can only be specified for cluster point codes. Nested cluster routing is allowed if this parameter is set to yes and the CRMD and NCR features are turned on.

**Range:****yes**

The cluster point code is a nested cluster point code. Point codes that are members of this cluster point code can be assigned to route sets that are different from the route set assigned to the cluster point code.

**no**

The cluster point code is not a nested cluster point code. Point codes that are members of this cluster point code must be assigned to the same route set assigned to the cluster point code.

**Default:**

Current value.

**nprst (optional)**

NM bits reset. This parameter specifies whether the NM bits should be set to 00. This parameter applies only to ITU IAM messages. The `nptype=nm` parameter must be specified (see the `chg-tifopts` command) before this parameter can be specified.

**Range:****off**

Do not set NM Bits to 00 in ITU IAM message if the TIFOPTS `nptype` option value is `nm`

**on**

Set NM Bits to 00 in ITU IAM message if the TIFOPTS `nptype` option value is `nm`

**Default:**

No change to the current value

**prx (optional)**

Proxy point code indicator. This parameter specifies whether a destination point code is used as a proxy point code.

**Range:****yes**

The destination point code is used as a proxy point code.

**no**

The destination point code is not used as a proxy point code.

**Default:**

No change in current value.

**rcause (optional)**

Release cause. The value to be used as the release cause on REL messages. If the TIFOPTS `rlcopc` parameter is specified (see the `chg-tifopts` command), and a value of 0 - 127 is specified for the `rcause` parameter, then the `rcause` parameter value overrides the values specified for the TIFOPTS `rcausenp` and `rcausepfx` parameters.

**Range:***0 - 127, none**none* -use the values specified for the TIFOPTS *rcausenp* and *rcausepfx* parameters**Default:**

No change to the current value

**sccpmsgcnv (optional)**

SCCP UDT(S)/XUDT(S) Message Conversion Indicator. The type of conversion performed on messages for the specified destination.

**Range:*****none***

conversion is not required on messages for the destination

***udt2xudt***

convert all UDT(S) messages for the destination to XUDT(S) messages

***xudt2udt***

convert all non-segmented XUDT(S) messages for the destination to UDT(S) messages

***sxudt2udt***

convert all segmented and non-segmented XUDT(S) messages for the destination to UDT(S) messages

**Default:**

No change to the current value

**spc/spca/spci/spcn/spcn24/spcn16 (optional)**

Secondary point code.

**spc (optional)**ANSI secondary point code with subfields *network indicator-network cluster-network cluster member (ni-nc-ncm)*. The *prefix* subfield indicates a private point code (*prefix-ni-nc-ncm*).**Synonym:***spca***Range:**

Specify a valid value for each subfield of the point code, and separate the subfields with a dash (-).

*p-*, *000-255*, *none**prefix—p-*When *chg-sid:pctype=ansi* is specified, *ni = 000* is not valid.When *chg-sid:pctype=ansi* is specified, *nc = 000* is not valid for *ni = 001-005*.When *chg-sid:pctype=ansi* is specified, *nc = 000* is valid if *ni = 006-255*.Enter *none* to delete the point code.The point code *000-000-000* is not a valid point code.**Default:**

No change to current value

**spci (optional)**

ITU international secondary point code with subfields *zone-area-id*. The *prefix* subfield indicates a spare point code, private point code, or private and spare point code (*prefix-zone-area-id*).

**Range:**

*s-, p-, ps-, 0-255, none*

Specify a valid value for each subfield of the point code, and separate the subfields with a dash (-).

*prefix—s-, p-, ps*

*zone—0-7*

*area—000-255*

*id—0-7*

The point code *0-000-0* is not a valid point code.

Enter *none* to delete the point code.

**Default:**

No change to current value

**spcn (optional)**

ITU national secondary point code in the format of a 5-digit number (*nnnnn*); or 2, 3, or 4 numbers (members) separated by dashes (*m1-m2-m3-m4*) as defined by the `chg-stpopts:npcfmti` flexible point code option. A group code must be specified when the ITUDUPPC feature is turned on (*nnnnn-gc, m1-m2-m3-m4-gc*). The *prefix* subfield indicates a spare point code, private point code, or private and spare point code (*prefix-nnnnn, prefix-nnnnn-gc, prefix-m1-m2-m3-m4, prefix-m1-m2-m3-m4-gc*).

**Range:**

*s-, p-, ps-, 0-16383, aa-zz, none*

Specify a valid value for each subfield of the point code, and separate the subfields with a dash (-).

*prefix—s-, p-, ps*

*nnnnn—0-16383*

*gc—aa-zz*

*m1-m2-m3-m4—0-14* for each member; values must sum to 14

Enter *none* to delete the point code.

**Default:**

No change to current value

**spcn24 (optional)**

24-bit ITU national secondary point code with subfields *main signaling area-sub signaling area-signaling point (msa-ssa-sp)*. The *prefix* subfield indicates a private point code (*prefix-msa-ssa-sp*).

**Range:**

*p-, 000-255, none*

Specify a valid value for each subfield of the point code, and separate the subfields with a dash (-).

*prefix—p*

*msa—000-255*

*ssa—000-255*

*sp—000-255*

Enter *none* to delete the point code.

**Default:**

No change to current value

**spcn16 (optional)**

16-bit ITU national secondary point code with subfields *unit number*, *sub number area*, *main number area* (*un-sna-mna*). The *prefix* subfield indicates a private point code (*prefix-un-sna-mna*).

**Range:***p-*, *000-127*, *none*

Specify a valid value for each subfield of the point code, and separate the subfields with a dash (-).

*prefix---**p**un---**000---**127**sna---**000---**15**mna---**000---**31*Enter *none* to delete the point code.**Default:**

No change to the current value.

**splitiam (optional)**

This parameter specifies when and how to split an ITU IAM message into 1 IAM message + 1 SAM message.

**Note:**

This parameter applies only to ITU IAM messages.

**Range:***15-31*, *none**15 - 31* -Maximum number of CdPN digits allowed in the IAM message before splitting occurs. The remaining digits, up to a total of 32, are encoded in the SAM message.*none* -use the value specified for the TIFOPTS `splitiam` parameter to determine when to split the IAM message**Default:**

No change to the current value

**Example**

To change the CLLI of destination 111-222-111 to RLGHNCA01A:

`chg-dstn:dpc=111-222-111:clli=rlghncxa01a`

To change the exception-list exclusion indicator for cluster 20-2-\* to yes:

`chg-dstn:dpca=20-2-*:elei=yes`

To change an existing destination to contain an SPC:

`chg-dstn:dpc=20-2-2:spc=5-5-5`

To change Nested Cluster Allowed Indicator for cluster 20-2-\* to yes:

`chg-dstn:dpc=20-2-*:ncai=yes`

To change a network destination:

`chg-dstn:dpc=25-*-*:clli=tklc`



To change the BEI parameter value of ITU national destination 8111-aa to yes:

```
chg-dstn:dpcn=8111-aa:bei=yes
```

To change the BEI parameter value of 24-bit ITU-N destination 15-100-10 to yes:

```
chg-dstn:dpcn24=15-100-10:bei=yes
```

To change an existing 24-bit ITU-N destination to contain a 24-bit ITU-N SPC:

```
chg-dstn:dpcn24=12-12-12:spcn24=25-25-25
```

To change ITU-I spare destination point code s-2-100-1 to contain an ITU-I spare secondary point code, ANSI alias, and ITU-N spare alias:

```
chg-  
dstn:dpci=s-2-100-1:spci=s-2-129-9:aliasa=121-120-120:aliasn=s-  
129
```

To prevent a destination point code from being used as a proxy point code:

```
chg-dstn:dpc=11-11-11:prx=no
```

To change ITU-N destination point code 10805-nz to delete its ANSI alias and add both ITU-I spare and non-spare aliases:

```
chg-dstn:dpcn=10805-nz:aliasa=none:aliasi=s-5-80-0,5-80-1
```

To change ITU-I spare destination point code s-5-60-3 to add ITU-N non-spare and spare aliases:

```
chg-dstn:dpci=s-5-60-3:aliasn=10723-gr,s-10723-gr
```

To change ITU-I spare destination point code s-5-60-5 to add ITU-N spare and ITU-I non-spare aliases:

```
chg-dstn:dpci=s-5-60-5:aliasn=s-10725-gr:aliasi=5-60-5
```

To change sccpmsgcnv type to udt2xudt for destination 11:

```
chg-dstn:dpc=11-11-11:sccpmsgcnv=udt2xudt
```

## Dependencies



### Note:

A *full point code* contains numerical values for all three segments of the point code.

At least one optional parameter must be specified.

The specified destination point code value must already be defined in the Destination point code table.

The destination address must be a full point code, a network destination, or a cluster point code.

The ANSI self-ID destination point code for the STP must be defined before ANSI destinations can be changed.

The ITU-I self-ID destination point code for the STP must be defined before ITU-I destinations can be changed.

The ITU-N self-ID destination point code for the STP must be defined before ITU-N destinations can be changed.

The Spare Point Code Support feature must be enabled before the spare point code prefix `s-` can be specified for an ITU-I or ITU-N destination, secondary, or alias point code.

If the `dpcn` or `aliasn` parameter is specified, the format must match the format that was assigned with the `chg-stpopts:npcfmti` parameter.

If the 7000 Routesets or 8000 Routesets feature is enabled, then the total number of provisioned aliases in the system cannot exceed 8000. If the 10,000 Routesets feature is enabled, then the total number of provisioned aliases in the system cannot exceed 10000.

Alias point codes are allowed only for full point code destinations.

Alias point codes for destinations must be full point codes.

A specified alias type cannot already be defined as a destination address.

The `aliasa` and `dpca` parameters cannot be specified together in the command. The `aliasi` and `dpci` parameters and the `aliasn` and `dpcn` parameters cannot be specified together in the command if the `prefix` subfields are the same (both are spare or both are non-spare).

Alias ANSI point codes cannot be members of a cluster or network destination.

The specified alias network type must be different from the destination point code network type.

A 24-bit ITU-N point code cannot have a 14-bit ITU-N alias point code or an ANSI alias point code.

A 24-bit ITU-National point code can have an ITU-I point code alias. This allows conversion of 14-bit ITU-I routing label to 24-bit routing label and vice versa.

A 14-bit ITU-N point code cannot have a 24-bit ITU-N alias point code.

If an ITU-I point code is specified, either the `aliasn` or the `aliasn24` parameter can be specified, but not both.

Cluster destinations are allowed only if the CRMD feature is turned on.

The `ncai` parameter can be specified only for cluster destinations.

The `elei` parameter can be specified only for cluster destinations (for example, `dpc=ni-nc-*`).

The NCR (Nested Cluster Routing) feature must be turned on before the `ncai` parameter can be specified.

Network routing is valid only if the Network Routing (NRT) feature is turned on.

When using network routing, if the destination point code has a value of `*` in the `nc` subfield, the `ncm` subfield must also be `*` (for example, `dpc=21-*-*`).

If a provisioned nested cluster point code is being changed to a non-nested cluster point code (`ncai=no`), previously provisioned members of the cluster must have the same route set.

If a provisioned non-nested cluster point code is being changed to a nested cluster point code (`ncai=yes`), the maximum number of provisioned nested clusters must be no greater than 500.

If specified, the `spc` parameter value must already be configured as a secondary point code in the Secondary Point Code table.

The value specified for the `spc` parameter must be a full point code.

If the `spc` parameter is specified, the `domain=ss7` parameter must be specified.

If the `spc` parameter is specified, then the value specified for the `dpc` parameter must be a full point code.

The network type of the value specified for the `spc` parameter must match the network type of the value specified for the `dpc` parameter.

If a new `CLLI` for the destination point code is specified, it cannot match the `CLLI` of the system.

If the corresponding destination for the specified destination point code is an adjacent signaling point (matched a Far End point code in its linkset entity set), the `CLLI` of the specified destination point code cannot be assigned to any other destination address.

A reserved word cannot be specified for the destination identifier (`CLLI`).

If the destination does *not* use an SPC, the group code of the destination must be the same as the group code of the ITU national true point code. If the destination uses an SPC, then the group code of the destination must match the group code of the SPC.

If an ITU national destination is being changed and the `ITUDUPPC` feature is turned on, this applies depending on whether the destination uses an SPC (secondary point code). For example, if the ITU national true point code has a group code of `ee`, then destinations with group codes of `ee` can be added without using an SPC. Destinations with a group code of `ff` must use an SPC with a group code of `ff`.

The Route table is corrupt or cannot be found.

The STP Self-identity table is corrupt or cannot be found.

The ICNP feature must be enabled and turned on in order to specify the `icnpxlat`, `cgpafmt`, and `cdpafmt` parameters.

Alias point codes cannot already be defined as another destination.

The value specified for the `spc` parameter cannot already be specified as a secondary point code for the destination point code.

The Linkset table is corrupt or cannot be found.

The Proxy Point Code feature must be enabled before the `prx` parameter can be specified.

If the `prx=yes` parameter is specified, then the value of the `dpc` parameter must be a full point code.

If the value of the `dpc` parameter is used as a proxy point code, then the `prx=no` parameter cannot be specified.

The number of proxy destinations cannot exceed the value allowed by the enabled Proxy Point Code quantity feature.

If the `prx=yes` parameter is specified, then the `spc/spca/spci/spcn/spcn24` parameter cannot be specified.

The `prx` parameter must have a value of `yes` or `no`.

If the value specified for the `dpc` parameter is a private point code, then the `prx=yes` parameter cannot be specified.

The total number of proxy destinations cannot exceed the total capacity (100) of the Proxy Point Code feature.

If an IPGW linkset is used, then the `prx=yes` parameter cannot be specified.

The network type of the routeset must be the same as the network type of the destination point code. For example, a destination point code with an ANSI network type cannot use a routeset with an ITU network type.

If the specified destination point code is assigned a proxy point code (PPC) in the DSTN table, then the specified routeset must contain a linkset for the destination point code, and the PPC of the linkset must be equal to the PPC of the destination point code.

The value specified for the `spc` parameter must differ from the secondary point code of the destination/route entry specified by the `dpc` parameter.

The value specified for the `ncai` parameter cannot be same as the NCAI that is already assigned to the destination point code.

If the specified destination point code is a cluster or network destination point code, then the specified routeset cannot contain a route over proxy linksets.

If the destination point code and adjacent point code of the routes in the specified routeset are ITU point codes, then the following conditions must apply.

- If one point code is an ITUI point code, and the other is an ITUN or ITUN24 point code, then the network type of the secondary adjacent point code must match the network type of the destination point code.
- If both point codes have the same network type, then either both must be spare point codes or both must not be spare point codes.
- If the destination point code is an ITUN point code, and the ITUDUPC feature is turned on, then the group code of the destination point code must match the adjacent or the secondary adjacent point code.

A maximum of two aliases can be specified per destination.

If the `dpci` parameter is specified, then a combination of ITUI and ANSI aliases cannot be specified. If the `dpcn` parameter is specified, then a combination of ITUN and ANSI aliases cannot be specified.

Two ITUI or two ITUN aliases can be specified for the same destination point code only if the aliases have different prefixes. One alias must be spare and one non-spare.

The TIF Number Portability feature must be enabled before the `rcause` or `nprst` parameter can be specified.

A TIF feature must be enabled before the `splitiam` parameter can be specified.

The XUDT UDT Conversion feature must be turned on before the `sccpmsgcnv` parameter can be specified.

The J7 Support feature must be enabled before the `aliasn16` parameter can be specified.

If the J7 Support feature is enabled then `aliasa` and `aliasn24` cannot be specified.

Spare point codes for `aliasn 1` and `aliasn 2` must be different, and spare point codes for `aliasi 1` and `aliasi 2` must be different.

### Notes

One of `dpc/dpca/dpci/dpcn/dpcn24/dpcn16` is mandatory and they are mutually exclusive.

Only one of `aliasa/aliasi/aliasn/aliasn24/aliasn16` can be specified as they are mutually exclusive.

Only one of `spc/spca/spci/spcn/spcn24/spcn16` can be specified as they are mutually exclusive.

The `domain` parameter of a destination cannot be changed with this command. To change the `domain` parameter, the destination must be removed with the `dlt-dstn` command and re-entered with the `ent-dstn` command.

In this command, only ITU-international and ITU national point codes and aliases support the spare point code subtype prefix (s-). Only ITU-international and ITU national point codes support the private and spare point code subtype prefix (ps-). All of the point code types support the private (internal) point code subtype prefix (p-). Aliases do not support the private (internal) point code prefix.

The value specified for the DPC parameter must be a full point code in order to be used as a proxy point code. Cluster point codes and private point codes cannot be used as proxy point codes.

Invalid usage of **none** with **aliasi** and **aliasn**:

- `alias=none,none`: parser code expects `none` to be the last argument
- `alias=none,pointcode`: parser code expects `none` to be the last argument
- `alias=,pointcode`: invalid usage of comma separator

### Alias Combination Matrix

**Table 4-5 Alias Combination Matrix**

Destination	specified			result	
	aliasN/ aliasN24	alias1	aliasA/ aliasN16	alias1	alias2
ANSI		none		0	
		pci		pci	
		none			0
		pcn			pcn
		pcn24			pcn24
		none	none	0	0
		none	pci	pci	0
		pcn	none	0	pcn
		pcn24	none	0	pcn24
		pcn	pci	pci	pcn
ITUI	pcn24	pci		pci	pcn24
			none	0a	
			pca	pca	

Table 4-5 (Cont.) Alias Combination Matrix

specified			result	
	none		0i	
	pci		pci	
	none	none	0a, i	
	none	pca	pca	
	pci	none	pci	
	pci	pca	E5074	
none			0n	0
pcn			0n	pcn
pcn, none			0n	pcn
pcn1, pcn2			pcn2	pcn1
pcn24				pcn24
none		none	0a, n	0
none		pca	pca	0
pcn		none	0a, n	pcn
pcn		pca	pca	pcn
pcn, none		none	0a, n	0
pcn, none		pca	0a, n	pcn
pc1, pcn2		none	pcn1	pcn2
pcn1, pcn2		pca	E5001	
pcn24		none	0a	pcn24
pcn24		pca	pca	pcn24
none	none		0i, n	0
none	pci		pci	0
pcn	none		0i, n	pcn
pcn	pci		pci	pcn
pcn1, none	none		0i, n	pcn
pcn1, none	pci		pci	pcn
pcn1, pcn2	none		pcn2	pcn1
pcn1, pcn2	pci		E5001	
pcn24	none		0i	pcn24
pcn24	pci		pci	pcn24
none	none	none	0a, i, n	0
none	none	pca	pca	0
none	pci	none	pci	0
none	pci	pca	E5074	
pcn	none	none	0a,i,n	pcn
pcn	none	pca	pca	pcn
pcn	pci	none	pci	pcn
pcn	pci	pca	E5001	
pcn, none	none	none	0a,i,n	pcn
pcn, none	none	pca	pca	pcn
pcn, none	pci	none	pci	pcn
pcn, none	pci	pca	E5001	

Table 4-5 (Cont.) Alias Combination Matrix

specified		result			
pcn2, pcn1	none	none	pcn2	pcn1	
pcn2, pcn1	none	pca	E5001		
pcn2, pcn1	pci	none	E5001		
pcn2, pcn1	pci	pca	E5001		
pcn24	none	none	0a,i	pcn24	
pcn24	none	pca	pca	pcn	
pcn24	pci	none	pca	pcn	
pcn24	pci	pca	E5001		
		pcn16	pcn16		
	none	pcn16	pcn16		
	pci	pcn16	E2325		
none	pci	pcn16	E2325		
none		pcn16	pcn16		
pcn		pcn16	pnc16	pcn	
pcn	none	pcn16	pcn16	pcn	
pcn, none		pcn16	pcn16	pcn	
pcn1,pcn2		pcn16	E5001		
none	none	pcn16	E5074		
pcn, none	none	pcn16	pcn16	pcn	
pcn2,pcn1	none	pcn16	E5001		
ITUN		none	0a		
		pca	pca		
	none			0	
	pci			pci	
	pci, none		0	pci	
	pci1, pci2		pci2	pci1	
	none	none	0a,i	0	
	none	pca	pca	0	
	pci	none	0,a	pci	
	pci	pca	pca	pci	
	pci, none	none	0,a,i	pci	
	pci, none	pca	pca	pci	
	pci1, pci2	none	pci2	pci1	
	pci1, pci2	pca	E5001		
none			0,n		
pcn			pcn		
pcn24			pcn24		
none		none	0,a,n		
none		pca	pca		
pcn		none	pcn		
pcn		pca	E5074		
pcn24		none	pcn24		
pcn24		pca	E5074		

Table 4-5 (Cont.) Alias Combination Matrix

specified			result	
none	none		0,i,n	0
none	pci		0,i,n	pci
none	pci, none		0,i,n	pci
none	pci1, pci2		pci2	pci1
pcn	none		pcn	0
pcn	pci		pcn	pci
pcn	pci, none		pcn	pci
pcn	pci1, pci2		E5001	
pcn24	none		pcn24	0
pcn24	pci		pcn24	pci
pcn24	pci	none	pcn24	pci
pcn24	pci1, pci2	E5001		
none	none	none	0a,i,n	0
none	none	pca	pca	0
none	pci	none	0a,i,n	pci
none	pci	pca	pca	pci
none	pci, none	none	0a,i,n	0
none	pci, none	pca	pca	pci
none	pci1, pci2	none	pci2	pci1
none	pci1, pci2	pca	E5001	
pcn	none	none	pcn	0
pcn	none	pca	E5074	
pcn	pci	none	pcn	pci
pcn	pci	pca	E5001	
pcn	pci, none	none	pcn	pci
pcn	pci, none	pca	E5001	
pcn	pci1, pci2	none	E5001	
pcn	pci1, pci2	pca	E5001	
pcn24	none	none	pcn24	0
pcn24	none	pca	E5074	
pcn24	pci	none	pcn24	pci
pcn24	pci	pca	E5001	
pcn24	pci, none	none	pcn24	pci
pcn24	pci, none	pca	E5001	
pcn24	pci1, pci2	none	E5001	
pcn24	pci1, pci2	pca	E5001	
		pcn16	pcn16	
	none	pcn16	pcn16	
	pci, none	pcn16	pcn16	
	pci	pcn16	pcn16	pci
	pci1,pci2	pcn16	E5001	
none	none	pcn16	pcn16	0
none	pci	pcn16	pcn16	pci



Table 4-5 (Cont.) Alias Combination Matrix

		specified		result	
ITUN24	none	pci, none	pcn16	pcn16	pci
	none	pci1,pci2	pcn16	E5001	
	pcn	pci	pcn16	E2325	
	pcn	none	pcn16	E5074	
	pcn	pci, none	pcn16	E5001	
		none	0		
		pca	pca		
		none		none	
		pci		pci	
		none	none	0	0
ITUN16	none	pca	pca	0	
	pci	none	0	pci	
	pci	pca	pca	pci	
	-	none	-	0	-
	-	pci	-	pci	-
	none		-		0
	pcn		-	-	pcn
	none	pci	-	pci	0
	none	none	-	pci	0
	pcn	none	-	0	pcn
pcn	pci	-	pci	pcn	

**Legend****0**—clear alias if provisioned regardless of its point code type**0A**—clear alias if provisioned and point code is ANSI**0I**—clear alias if provisioned and point code is ITUI**0N**—clear alias if provisioned and point code is ITUN**0A,I**—clear alias if provisioned and point code is ANSI or ITUI**0A,N**—clear alias if provisioned and point code is ANSI or ITUN**0I,N**—clear alias if provisioned and point code is ITUI or ITUN**0A,I,N**—clear alias if provisioned and point code is ANSI or ITUI or ITUN**Output**

This example shows the output when the NCR, NRT, and CRMD features are off and all Routes and Routesets features are off:

```
chg-dstn:dpca=111-222-111:aliasn=321
```

```
rlghncxa03w 04-08-17 15:35:05 EST EAGLE 31.8.0
Destination table is (10 of 2000) 1% full
```

```
Destination table is (10 of 2000) 1% full
Alias table is (8 of 12000) 1% full
CHG-DSTN: MASP A - COMPLTD
;
```

This example shows the output when the NCR, NRT, and CRMD features are off and the 5000 Routes feature is on:

```
chg-dstn:dpca=111-222-111:aliasn=321
```

```
rlghncxa03w 04-08-18 08:29:15 EST EAGLE 31.8.0
Destination table is (10 of 5000) 1% full
Alias table is (8 of 12000) 1% full
CHG-DSTN: MASP A - COMPLTD
;
```

This example shows the output when one or more of the NCR, NRT, or CRMD features and the DSTN5000 (5000 Routes) feature is on:

```
chg-dstn:dpca=111-222-111:aliasn=321
```

```
rlghncxa03w 04-08-18 08:29:15 EST EAGLE 31.8.0
DESTINATION ENTRIES ALLOCATED: 5000
  FULL DPC(s): 9
  NETWORK DPC(s): 0
  CLUSTER DPC(s): 1
  TOTAL DPC(s): 10
  CAPACITY (% FULL): 1%
ALIASES ALLOCATED: 12000
  ALIASES USED: 8
  CAPACITY (% FULL): 1%
X-LIST ENTRIES ALLOCATED: 500
CHG-DSTN: MASP A - COMPLTD
;
```

This example shows the output when the NCR, NRT, and CRMD features are off and the 6000 Routesets feature is on:

```
chg-dstn:dpca=111-222-111:aliasn=321
```

```
rlghncxa03w 04-08-18 08:29:15 EST EAGLE 31.8.0
Destination table is (60 of 6000) 1% full
Alias table is (8 of 12000) 1% full
CHG-DSTN: MASP A - COMPLTD
;
```

This example shows the output when one or more of the NCR, NRT, or CRMD features and the 6000 Routesets feature is on:

```
chg-dstn:dpca=111-222-111:aliasn=321
```

```
rlghncxa03w 04-08-18 08:29:15 EST EAGLE 31.8.0
DESTINATION ENTRIES ALLOCATED: 6000
  FULL DPC(s): 46
  NETWORK DPC(s): 1
  CLUSTER DPC(s): 1
  TOTAL DPC(s): 12
  CAPACITY (% FULL): 1%
ALIASES ALLOCATED: 12000
  ALIASES USED: 8
  CAPACITY (% FULL): 1%
X-LIST ENTRIES ALLOCATED: 500
CHG-DSTN: MASP A - COMPLTD
```

```
;
```

This example shows the output when the NCR, NRT, and CRMD features are off. When the 7000 Routesets quantity feature is on, the Destination table line shows "...of 7000". When the 8000 Routesets quantity feature is on, the Destination table line shows "...of 8000."

```
chg-dstn:dpca=111-222-111:aliasn=321
```

```
rlghncxa03w 04-08-18 08:29:15 EST EAGLE 31.8.0
Destination table is (60 of 7000) 1% full
Alias table is (8 of 8000) 1% full
CHG-DSTN: MASP A - COMPLTD
```

```
;
```

This example shows the output when one or more of the NCR, NRT, or CRMD features is on. When the 7000 Routesets quantity feature is on, the DESTINATION ENTRIES ALLOCATED line shows "8000". When the 7000 Routesets quantity feature is on, the DESTINATION ENTRIES ALLOCATED line shows "7000."

```
chg-dstn:dpca=111-222-111:aliasn=321
```

```
rlghncxa03w 04-08-18 08:29:15 EST EAGLE 31.8.0
DESTINATION ENTRIES ALLOCATED: 8000
  FULL DPC(s): 9
  NETWORK DPC(s): 0
  CLUSTER DPC(s): 1
  TOTAL DPC(s): 10
  CAPACITY (% FULL): 1%
ALIASES ALLOCATED: 8000
  ALIASES USED: 8
  CAPACITY (% FULL): 1%
X-LIST ENTRIES ALLOCATED: 500
CHG-DSTN: MASP A - COMPLTD
```

```
;
```

This example shows the output when one or more of the NCR, NRT, or CRMD features is on. In this example, a destination is defined as a proxy point code:

```
chg-dstn:dpc=1-1-1:prx=yes
```

```
tekelecstp 07-03-05 17:34:18 EST EAGLE 37.5.0
DESTINATION ENTRIES ALLOCATED: 2000
  FULL DPC(s): 27
  EXCEPTION DPC(s): 0
  NETWORK DPC(s): 1
  CLUSTER DPC(s): 1
  PROXY DPC(s): 1
  TOTAL DPC(s): 30
  CAPACITY (% FULL): 2%
ALIASES ALLOCATED: 12000
  ALIASES USED: 0
  CAPACITY (% FULL): 0%
X-LIST ENTRIES ALLOCATED: 500
CHG-DSTN: MASP A - COMPLTD
;
```

This example shows the output when the secondary point code is changed:

```
chg-dstn:dpc=1-1-1:spc-144-23-48
```

```
tekelecstp 07-03-05 17:34:18 EST EAGLE 37.5.0
CAUTION: Dstn's SPC has changed - verify remote node's route.
DESTINATION ENTRIES ALLOCATED: 2000
  FULL DPC(s): 27
  EXCEPTION DPC(s): 0
  NETWORK DPC(s): 1
  CLUSTER DPC(s): 1
  PROXY DPC(s): 1
  TOTAL DPC(s): 30
  CAPACITY (% FULL): 2%
ALIASES ALLOCATED: 12000
  ALIASES USED: 0
  CAPACITY (% FULL): 0%
X-LIST ENTRIES ALLOCATED: 500
CHG-DSTN: MASP A - COMPLTD
;
```

This example shows the output when the NCR, NRT, and CRMD features are off and the 10,000 Routesets feature is on:

```
chg-dstn:dpca=11-22-11:aliasn=321
```

```
rlghncxa03w 10-08-17 08:29:15 EST EAGLE 43.0.0
Destination table is (10 of 10000) 1% full
Alias table is (8 of 10000) 1% full
```

```
CHG-DSTN: MASP A - COMPLTD  
;
```

This example shows the output when one or more of the NCR, NRT, or CRMD features and the 10,000 Routesets feature is on:

```
chg-dstn:dpca=11-22-11:aliasn=321
```

```
rlghncxa03w 10-08-17 08:29:15 EST EAGLE 43.0.0  
DESTINATION ENTRIES ALLOCATED: 10000  
  FULL DPC(s): 9  
  NETWORK DPC(s): 0  
  CLUSTER DPC(s): 1  
  TOTAL DPC(s): 10  
  CAPACITY (% FULL): 1%  
ALIASES ALLOCATED: 10000  
  ALIASES USED: 8  
  CAPACITY (% FULL): 1%  
X-LIST ENTRIES ALLOCATED: 500  
CHG-DSTN: MASP A - COMPLTD  
;
```

This command shows the output when J7 Support feature is enabled.

```
chg-dstn:dpcn16=1-1-1:aliasi=2-2-4
```

```
tekelecstp 13-02-27 14:39:25 EST 45.0.0-64.56.0  
chg-dstn:dpcn16=1-1-1:aliasi=2-2-4  
Command entered at terminal #4.  
Destination table is (2 of 2000) 1% full  
Alias table is (1 of 12000) 1% full  
  
CHG-DSTN: MASP A - COMPLTD  
;
```

### Related Topics

- [chg-rte](#)
- [dlt-dstn](#)
- [dlt-rte](#)
- [ent-dstn](#)
- [ent-rte](#)
- [rept-stat-dstn](#)
- [rept-stat-rte](#)
- [rtrv-dstn](#)
- [rtrv-rte](#)

## chg-e1

Use this command to change an interface for an E1 card in the system. An E1 card can consist of an E5-E1T1-B card used as an E1 or SE-HSL card.

### Parameters

#### **e1port (mandatory)**

E1 port number. The value must be an E1 port that has already been configured with an E1 interface on the specified E1 card.

##### **Range:**

*1 - 8*

Any 2 of the 8 ports on an E5-E1T1-B card can be specified when the card is used as an SE-HSL card.

Any 1 of the 8 ports on card can be specified when the card is used as an SE-HSL card.

#### **loc (mandatory)**

The card location as stenciled on the shelf of the system.

##### **Range:**

*1101 - 1108, 1111 - 1112, 1201 - 1208, 1211 - 1218, 1301 - 1308, 1311 - 1318, 2101 - 2108, 2111 - 2118, 2201 - 2208, 2211 - 2218, 2301 - 2308, 2311 - 2318, 3101 - 3108, 3111 - 3118, 3201 - 3208, 3211 - 3218, 3301 - 3308, 3311 - 3318, 4101 - 4108, 4111 - 4118, 4201 - 4208, 4211 - 4218, 4301 - 4308, 4311 - 4318, 5101 - 5108, 5111 - 5118, 5201 - 5208, 5211 - 5218, 5301 - 5308, 5311 - 5318, 6101 - 6108, 6111 - 6118*

#### **crc4 (optional)**

CRC4 enable or disable indicator.

##### **Range:**

*on*

*off*

##### **Default:**

No change in current value

#### **encode (optional)**

Indicator for use of HDB3 or AMI encoding/decoding.

##### **Range:**

*hdb3*

*ami*

AMI encoding is supported for cards used as E1 cards (not as SE-HSL cards).

##### **Default:**

No change to the current value

**minsurate (optional)**

Minimum signal unit rate. The minimum number of SUs present on a link that are uniformly distributed.

**Range:**

500 - 2000

**Default:**

No change to the current value

**si (optional)**

Value of two Spare International bits of NFAS data.

**Range:**

0 - 3

**Default:**

No change in current value

**sn (optional)**

Value of five Spare International bits of NFAS data.

**Range:**

0 - 31

**Default:**

No change in current value

**e1tsel (optional)**

Timing source.

**Range:**

*line - slave timing source*

*external - master timing source*

**Default:**

No change in current value

**Example**

```
chg-e1:loc=1205:elport=1:crc4=off:cas=on:encode=hdb3:si=2:sn=12
```

```
chg-e1:loc=1205:elport=2:encode=ami
```

```
chg-e1:loc=1205:elport=1:minsurate=1000
```

```
chg-e1:loc=1201:elport=2:e1tsel=external
```

**Dependencies**

At least one optional parameter must be specified.

The specified card location (`loc` parameter) must be equipped.

The card specified by the `loc` parameter must be a LIME1 card type.

The port specified by the `elport` parameter must already be equipped with an E1 interface.

If the value specified for the `loc` parameter indicates an E1 card, then all signaling links that are serviced by the card must be deactivated (see the `dlt-slk` command) before the values for the `crc4`, `cas`, `encode`, and `e1tsel` parameters can be changed.

The `encode=ami` parameter is supported only for cards used as E1 cards (not as SE-HSL cards).

The `linkclass=unchan` parameter must be specified before the `minsurate` parameter can be specified.

The E1/T1 table must be accessible.

The Card table must be accessible.

HIPR2 cards must be equipped in card locations `xy09` and `xy10` ( $x$  is the frame,  $y$  is the shelf) on each EAGLE shelf that contains one or more E5-E1T1-B cards.

The Shelf FAN bit must be turned ON for the shelf on which an E5-E1T1-B card is being used as an E1 or SE-HSL card.

Card locations 1113 - 1118 (E5-MASP and E5-MDAL cards) cannot be specified as values for the `loc` parameter.

Locations `xy09` and `xy10`, where  $x$  is the frame and  $y$  is the shelf, cannot be specified as values for the `loc` parameter.

### Notes

External timing is derived from the EAGLE High-Speed Master Clock (1.544 MHz for T1 or 2.048 MHz for E1); therefore, the Master Timing feature is required. Line timing is derived from its received data stream, if present.

### Output

```
chg-e1:loc=1205:e1port=2:encode=ami
```

```
rlghncxa03w 04-01-20 09:07:58 EST EAGLE 31.3.0  
CHG-E1: MASP A - COMPLTD
```

```
;
```

### Related Topics

- [dlt-e1](#)
- [ent-e1](#)
- [rtv-e1](#)
- [tst-e1](#)

## chg-eisopts

Use this command to enable and disable the copy functions that are associated with the EAGLE 5 Integrated Monitoring Support (E5IS) feature.



## Parameters

### **eiscopy (optional)**

System-wide control for MSU, alarm, and event copy to the ESP.

#### **Range:**

*on*

*off*

#### **Default:**

No change to the current value

#### **System Default:**

*off*

### **fcgp1 (optional)**

This parameter applies the functionality specified by the `fcmode` parameter to cards running the specified Fast Copy GPL.

#### **Range:**

*all*

apply functionality to cards running the IPSG GPL

*ipsg*

apply functionality to cards running the IPSG GPL

#### **Default:**

No change to the current value

#### **System Default:**

*all*

### **fcmode (optional)**

This parameter specifies a system-wide control to enable or disable monitoring on FC-capable cards.

#### **Range:**

*fcopy*

FC monitoring is performed on FC-capable cards

*off*

Monitoring is not performed on FC-capable cards

*stc*

STC monitoring is performed on FC-capable cards

#### **Default:**

No change to the current value

#### **System Default:**

*stc*

If Integrated Monitoring is turned on for the first time, and the `eiscopy=on` parameter has been specified, then the system default for the `fcmode` parameter is `stc`. If the `eiscopy=off` parameter has been specified, then the system default value is `off`.

### Example

```
chg-eisopts:eiscopy=on  
chg-eisopts:fcmode=fcopy:fcgpl=all
```

### Dependencies

At least one parameter must be specified.

The E5IS feature must be turned on before this command can be entered

The NETOPTS table must be accessible.

Before the E5IS copy function can be enabled, at least 2 STC cards must be installed and in the IS-NR state in the system.

The `eiscopy=on` parameter must be specified before a value of `stc` or `fcopy` can be specified for the `fcmode` parameter.

The `fcmode=off` parameter must be specified before the `eiscopy=off` parameter can be specified and before the value of the `fcmode` parameter can be changed between `stc` and `fcopy`.

At least one card must be running the IPSPG GPL and must be in the IS-NR state before a value of `ipsg` or `all` can be specified for the `fcgpl` parameter.

If the `fcgpl` parameter is specified, then the `fcmode` parameter must be specified.

The host portion of the PVN network address must be 0 based on the PVN subnet mask (see the `chg-netopts` command) before the `eiscopy=on` parameter can be specified.

The destination of a static IP route (see the `ent-ip-rte` command) and the local interface network address of an IP card (see the `ent-ip-host` command) must be different from the PVN, FCNA, and FCNB network addresses (see the `chg-ip-lnk` command) before the `eiscopy=on` parameter can be specified.

The FCMODE cannot be changed to FCOPY due to Signaling Link(s) provisioned on Port C or Port D.

If the same value is specified for the PVN, FCNA, or FCNB network addresses (see the `chg-netopts` command), then the `eiscopy=on` parameter cannot be specified.

### Notes

#### Fast Copy Cards

E5-ENET-B cards running the IPSPG GPL are considered to be *FC-capable*. An *FC-capable* card is considered *FC-enabled* when Fast Copy monitoring is enabled for the respective GPL.

## Output

```
chg-eisopts:fcmode=fcopy:fcgpl=all
```

```
rlghncxa03w 10-02-02 09:08:58 EST EAGLE 42.0.0  
CHG-EISOPTS: MASP A - COMPLTD
```

## Related Topics

- [rtrv-eisopts](#)

# chg-enumopts

Use this command to provision ENUM-specific data. This command updates the ENUMOPTS table.

## Parameters

### **cngntfy (optional)**

Congestion Notification Flag

#### **Range:**

Yes

Notify congestion to the sender

No

Silently discard the message

#### **System Default:**

*no*

### **cngrcode (optional)**

RCODE values in ENUM error response message to be sent due to congestion on ENUM card.

#### **Range:**

6

ENUM\_TOO\_BUSY

7

ENUM\_RESOURCES\_EXCEEDED

#### **System Default:**

6

ENUM\_TOO\_BUSY

### **conglv11 (optional)**

ENUM application card congestion threshold level 1.

**Range:**

0-100

**System Default:**

40

**cong1v12 (optional)**

ENUM application card congestion threshold level 2.

**Range:**

0-100

**System Default:**

80

**excludesp (optional)**

SP Entity Id validity flag.

**Range:**

Yes

SP Entity Id is invalid as key for lookup in ENUM profile selection Table.

No

SP Entity Id is valid as key for lookup in ENUM profile selection Table.

**System Default:**

no

**maxdndigs (optional)**

Max number of DN digits from an incoming ENUM query.

**Range:**

5-15

**System Default:**

15

**rncontext (optional)**

Flag for RNCONTEXT Parameter in ENUM TEL URI.

**Range:**

Yes

Include the RNCONTEXT parameter in ENUM TEL URI.

No

Do not include the RNCONTEXT parameter in ENUM TEL URI.

**System Default:**

no

**incprefix (optional)**

Flag to determine if PREFIX Parameter in ENUM PROFILE entries is to be used as RN in regex response for NAPTR queries for service type PSTN-SIP.

**Range:**

Yes

Include the PREFIX parameter as RN in NAPTR regex response.

No

Do not include the PREFIX parameter as RN in NAPTR regex response.

**System Default:**

No

**Example**

```
chg-enumopts:maxdndigs=10
chg-enumopts:conglvl1=50
chg-enumopts:conglvl2=10
chg-enumopts:cngntfy=yes
chg-enumopts:cngrcode=6
chg-enumopts:excludesp=yes
chg-enumopts:rncontext=yes
chg-enumopts:incprefix=yes
```

**Dependencies**

The ENUMOPTS table should be accessible.

Congestion level 1 must be less than congestion level 2.

**Output**This example displays output when `maxdndigs` is specified:

```
>chg-enumopts:maxdndigs=10

tekelecstp 14-05-28 15:04:28 EST EAGLE 46.1.0
  chg-enumopts:maxdndigs=10
  Command entered at terminal #4.
  CHG-ENUMOPTS: MASP A - COMPLTD
;
```

This example displays output when `conglvl1` is specified:

```
>chg-enumopts:conglvl1=50

tekelecstp 14-05-28 15:04:28 EST EAGLE 46.1.0
  chg-enumopts:conglvl1=50
  Command entered at terminal #4.
```

```
CHG-ENUMOPTS: MASP A - COMPLTD  
;
```

This example displays output when `conglvl2` is specified:

```
>chg-enumopts:conglvl2=90  
  
tekelecstp 14-05-28 15:04:28 EST EAGLE 46.1.0  
  chg-enumopts:conglvl2=90  
  Command entered at terminal #4.  
  CHG-ENUMOPTS: MASP A - COMPLTD  
;
```

This example displays output when `cngntfy` is specified:

```
>chg-enumopts:cngntfy=yes  
  
tekelecstp 14-05-28 15:04:28 EST EAGLE 46.1.0  
  chg-enumopts:cngntfy=yes  
  Command entered at terminal #4.  
  CHG-ENUMOPTS: MASP A - COMPLTD  
;
```

This example displays output when `cngrcode` is specified:

```
>chg-enumopts:cngrcode=6  
  
tekelecstp 14-05-28 15:04:28 EST EAGLE 46.1.0  
  chg-enumopts:cngrcode=6  
  Command entered at terminal #4.  
  CHG-ENUMOPTS: MASP A - COMPLTD  
;
```

This example displays output when `excludesp` is specified:

```
>chg-enumopts:excludesp=yes  
  
tekelecstp 14-05-28 15:04:28 EST EAGLE 46.5.0  
  chg-enumopts:excludesp=yes  
  Command entered at terminal #4.  
  CHG-ENUMOPTS: MASP A - COMPLTD  
;
```

This example displays output when `rncontext` is specified:

```
>chg-enumopts:rncontext=yes
```

```
tekelecstp 14-05-28 15:04:28 EST EAGLE 46.5.0
  chg-enumopts:rncontext=yes
  Command entered at terminal #4.
  CHG-ENUMOPTS: MASP A - COMPLTD
;
```

This example displays output when incprefix is specified:

```
> chg-enumopts:incprefix=yes
Command Accepted - Processing
  tekelecstp 19-05-03 16:53:17 MST  EAGLE 46.8.0.0.0-75.18.14
  chg-enumopts:incprefix=yes
  Command entered at terminal #4.
  tekelecstp 19-05-03 16:53:17 MST  EAGLE 46.8.0.0.0-75.18.14
  CHG-ENUMOPTS: MASP A - COMPLTD
;
```

### Related Topics

- [rtrv-enumopts](#)

## chg-enum-prof

Use this command to change the existing profile entry which has data to generate the ENUM response for three supported resource record formats such as NAPTR, NS and CNAME. The ENUMPROF table stores the profile entry.

### Parameters

#### **prn (mandatory)**

Profile name. This parameter specifies the unique logical name assigned to the profile entry used to generate the ENUM response.

#### **Range:**

*ZZZZZZZZZZ*

A string of alphanumeric characters, beginning with a letter and up to 10 characters in length. Valid values are a..z, A..Z, 0..9.

#### **pref (optional)**

Preferred Response. This parameter will decide the values for the Order and Preference fields to be encoded for each NAPTR resource record. The values of these fields are only applicable when there are two NAPTR resource records in the ENUM response. This parameter is only valid for the NAPTR response type.

#### **Range:**

*yes*

*no*

#### **Default:**

No change to the current value





**System Default:***pstntel***prefix (optional)**

This parameter specifies the prefix digits to be appended as routed number (RN) in NAPTR regex response. This parameter is only valid for NAPTR response type.

**Range:***0 - ffff*

Upto 5 hexa-decimal digits allowed.

**Default:**

No change to the current value

**System Default:**

None

**Example**

```
chg-enum-prof:prn=pr1:rrdomain=abc.oracle.com
```

```
chg-enum-prof:prn=pr2:rrdomain=abc1.oracle.com:pref=yes
```

```
chg-enum-prof:prn=pr3:rpdomain=def.oracle.com
```

```
chg-enum-prof:prn=pr4:rpdomain=cname.123
```

```
chg-enum-prof:prn=pr5:prefix=007
```

**Dependencies**

The ENUM Profile Table should be accessible.

The SPARM, PREF and RRDOMAIN parameters cannot be specified with a profile name having a response type of NAPTR.

The RRDOMAIN parameter is valid for the SPARM=SIP or SPARM=PSTNSIP value.

The profile name must be present in the ENUM Profile Table.

RRDOMAIN must be specified for the NAPTR response type.

For the RTYPE=NS or RTYPE=CNAME parameter, the replacement domain name (RPDOMAIN) must be specified.

RTYPE can only be changed for the default profile.

SPARM=SIP or SPARM=PSTNSIP is not supported for the default profile.

**Notes**

The requirement of using PREFIX in the regular expression is only for PSTN-SIP (NAPTR query). As such, PREFIX will not be applied for PSTN-TEL and SIP (NAPTR queries).

PREFIX can be configured for PSTN-TEL and SIP profiles, but it will not be used.

## Output

```
> chg-enum-prof:prn=pr1:rrdomain=abc.oracle.com
tekelecstp 18-05-29 03:35:20 MST EST EAGLE 46.1.0
chg-enum-prof:prn=pr1:rrdomain=abc.oracle.com
Command entered at terminal #19.
;

Command Accepted - Processing
tekelecstp 18-05-29 03:35:20 MST EST EAGLE 46.1.0
CHG-ENUM-PROF: MASP B - COMPLTD
;

> chg-enum-prof:prn=pr2:rrdomain=abc.oracle.com:pref=yes
tekelecstp 18-05-29 03:38:20 MST EST EAGLE 46.1.0
chg-enum-prof:prn=pr2:rrdomain=abc.oracle.com:pref=yes
Command entered at terminal #19.
;

Command Accepted - Processing
tekelecstp 18-05-29 03:38:20 MST EST EAGLE 46.1.0
CHG-ENUM-PROF: MASP B - COMPLTD
;

> chg-enum-prof:prn=pr3:rpdomain=def.oracle.com
tekelecstp 18-05-29 03:40:20 MST EST EAGLE 46.1.0
chg-enum-prof:prn=pr3:rpdomain=def.oracle.com
Command entered at terminal #19.
;

Command Accepted - Processing
tekelecstp 18-05-29 03:40:20 MST EST EAGLE 46.1.0
CHG-ENUM-PROF: MASP B - COMPLTD
;

> chg-enum-prof:prn=default:rtype=naptr:prefix=1159

Command Accepted - Processing

tekelecstp 19-02-01 12:39:44 EST EAGLE 46.8.0.0-75.18.11
chg-enum-prof:prn=default:rtype=naptr:prefix=1159
Command entered at terminal #2.
;

tekelecstp 19-02-01 12:39:45 EST EAGLE 46.8.0.0-75.18.11
CHG-ENUM-PROF: MASP B - COMPLTD
```

## Related Topics

- [dlt-enum-prof](#)
- [ent-enum-prof](#)
- [rtrv-enum-prof](#)

## chg-enum-profsel

Use this command to change an entry in the ENUM Profile Selection Table or the ENUM DN Block Table. The ENUM Profile Selection Table supports the provisioning information related to mapping of Entity Id to Profile Id. The ENUM DN Block Table supports the provisioning information related to mapping of DN Block to Profile Id.

### Parameters

**edn (optional)**

End Dialed Number

**Range:**

5-15 digits

**entityid (optional)**

Network Entity

**Range:**

1-15 hex-digits (0-9, a-f)

**prn1 (optional)**

Profile Name

**Range:**

*zzzzzzzzzz*

A string of alphanumeric characters, beginning with a letter and up to 10 characters in length. Valid values are a..z, A..Z, 0..9.

*none---* deletes the current value of the parameter

**Note:**

Response type of specified profile must be NS

**prn2 (optional)**

Profile Name

**Range:**

*zzzzzzzzzz*

A string of alphanumeric characters, beginning with a letter and up to 10 characters in length. Valid values are a..z, A..Z, 0..9.

*none---* deletes the current value of the parameter

**Note:**

Response type of specified profile must be CNAME

**prn3 (optional)**

Profile Name

**Range:**

*ZZZZZZZZZZ*

A string of alphanumeric characters, beginning with a letter and up to 10 characters in length. Valid values are a..z, A..Z, 0..9.

*none---* deletes the current value of the parameter

**Note:**

Response type of specified profile must be NAPTR

**prn4 (optional)**

Profile Name

**Range:**

*ZZZZZZZZZZ*

A string of alphanumeric characters, beginning with a letter and up to 10 characters in length. Valid values are a..z, A..Z, 0..9.

*none---* deletes the current value of the parameter

**Note:**

Response type of specified profile must be NAPTR

**sdn (optional)**

Start Dialed Number

**Range:**

5-15 digits

**Example**

```
chg-enum-profsel:entityid=12345:prn1=ns2:prn2=cname1
```

```
chg-enum-profsel:sdn=12345:edn=12400:prn3=naptr1:prn4=none
```

**Dependencies**

The ENUM Profile Selection Table should be accessible.

The ENUM DN Block Table should be accessible.

The ENUM Profile Table should be accessible.

ENTITY ID or SDN or EDN must be specified.

At least one profile must be specified.

The profile name specified by the prnX (x=1, 2, 3, 4) parameter must be provisioned in the ENUM Profile Table.

The response type specified by profile name prn1, prn2, prn3 and prn4 should be NS, CNAME, NAPTR and NAPTR respectively.

The last profile name for a particular entry cannot be none.

NAPTR profile names must be unique.

The default profile cannot be associated with any profile selection entry.

Entity Id cannot be specified with SDN or EDN.

### Notes

Response type specified by profile name prn1, prn2, prn3 and prn4 should be NS, CNAME, NAPTR and NAPTR respectively.

### Output

This example displays output when ENTITYID is specified:

```
chg-enum-
profsel:entityid=1234:prn1=ns1:prn2=cname1:prn3=naptr1:prn4=naptr2

tekelecstp 14-05-28 15:04:28 EST EAGLE 46.1.0
  chg-enum-
profsel:entityid=1234:prn1=ns1:prn2=cname1:prn3=naptr1:prn4=naptr2
  Command entered at terminal #4.
  CHG-ENUM-PROFSEL: MASP A - COMPLTD
;
```

This example displays output when SDN is specified:

```
chg-enum-profsel:sdn=1234:prn1=ns1:prn2=cname1:prn3=naptr1:prn4=naptr2

tekelecstp 14-05-28 15:04:28 EST EAGLE 46.1.0
  chg-enum-
profsel:sdn=1234:prn1=ns1:prn2=cname1:prn3=naptr1:prn4=naptr2
  Command entered at terminal #4.
  CHG-ENUM-PROFSEL: MASP A - COMPLTD
;
```

This example displays output when EDN is specified:

```
chg-enum-prosel:edn=2345:prn1=ns1:prn2=cname1:prn3=naptr1:prn4=naptr2
```

```
tekelecstp 14-05-28 15:04:28 EST EAGLE 46.1.0
  chg-enum-profsel:edn=1234:prn1=ns1:prn2=cname1:prn3=naptr1:prn4=naptr2
  Command entered at terminal #4.
  CHG-ENUM-PROFSEL: MASP A - COMPLTD
;
```

### Related Topics

- [dlt-enum-profsel](#)
- [ent-enum-profsel](#)
- [rtrv-enum-profsel](#)

## chg-feat

Use this command to activate the optional features available on the system.

Some optional features must be purchased before you turn the feature on. If you are not sure whether you are entitled to turn a feature on, contact your Oracle Sales Representative or Account Representative.

### Caution:

The features are off when the system is installed. A feature that is turned on with this command cannot be turned off.

### Parameters

#### **cncf** (optional)

This parameter turns on the Calling Name Conversion Facility (CNCF) feature.

#### Range:

*on*

#### System Default:

*off*

#### **crmd** (optional)

This parameter turns on the Cluster Routing and Management Diversity (CRMD) feature.

#### Range:

*on*

#### System Default:

*off*

#### **dstn5000** (optional)

This parameter turns on the 5000 Routes feature.

**Range:**

*on*

**System Default:**

*off*

**e5is (optional)**

This parameter turns on the EAGLE 5 Integrated Monitoring Support (E5IS) feature.

**Range:**

*on*

**System Default:**

*off*

**egt (optional)**

This parameter turns on the Enhanced Global Title Translation (EGTT) feature.

**Range:**

*on*

**System Default:**

*off*

**fan (optional)**

This parameter turns on the cooling fan feature.

**Range:**

*on*

**System Default:**

*off*

**gtt (optional)**

This parameter turns on the Global Title Translation (GTT) feature.

**Range:**

*on*

**System Default:**

*off*

**gws (optional)**

This parameter turns on the Gateway Screening (GWS) feature.

**Range:**

*on*

**System Default:**

*off*

**ipisup (optional)**

This parameter turns on the ISUP Routing Over IP (IPISUP) feature.

**Range:**

*on*

**System Default:**

*off*

**ituduppc (optional)**

This parameter turns on the ITU National Duplicate Point Code (ITUDUPPC) feature.

**Range:**

*on*

**System Default:**

*off*

**itumtprrs (optional)**

This parameter turns on the ITU MTP Restart feature.

**Range:**

*on*

**System Default:**

*off*

**lan (optional)**

This parameter turns on the STP LAN feature.

**Range:**

*on*

**System Default:**

*off*

**lfs (optional)**

This parameter turns on the Link Fault Sectionalization (LFS) feature.

**Range:**

*on*

**System Default:**

*off*

**measplat (optional)**

This parameter turns on the Measurements Platform feature. The `chg-measopts:platformenable=on` command must be entered to enable the Measurement Platform collection function (which cannot be disabled after it is enabled in the system).



**Range:**

*on*

**System Default:**

*off*

**mpc (optional)**

This parameter turns on the Multiple Point Code (MPC) feature.

**Range:**

*on*

**System Default:**

*off*

**mtprs (optional)**

This parameter turns on the ANSI MTP Restart feature.

**Range:**

*on*

**System Default:**

*off*

**ncr (optional)**

This parameter turns on the Nested Cluster Routing (NCR) feature.

**Range:**

*on*

**System Default:**

*off*

**nrt (optional)**

This parameter turns on the Network Routing feature.

**▲ Caution:**

When using this feature, limited network management is provided for point codes not covered by full point code routing, Cluster Routing, or Nested Cluster Routing.

**Range:**

*on*

**System Default:**

*off*

**p1np (optional)**

This parameter turns on the PCS (Personal Communication Service) 1900 Number Portability feature.

**Range:**

*on*

**System Default:**

*off*

**sccpcnv (optional)**

This parameter turns on the SCCP Conversion feature.

**Range:**

*on*

**System Default:**

*off*

**s1sob (optional)**

This parameter turns on the Other CIC (Circuit Identification Code) Bit Used feature.

**Range:**

*on*

**System Default:**

*off*

**tcapcnv (optional)**

This parameter turns on the TCAP Conversion feature.

**Range:**

*on*

**System Default:**

*off*

**t1np (optional)**

This parameter turns on the Triggerless Local Number Portability (TLNP) feature.

**Range:**

*on*

**System Default:**

*off*

**tscsync (optional)**

This parameter turns on the Time Slot Counter Synchronization (TSC) feature that is used with GSPM-II cards. This feature is required, along with use of STC cards, for the EAGLE 5 Integrated Monitoring Support feature ( *e5is=on* ).

**Range:**

*on*

**System Default:**

*off*

**vgtt (optional)**

This parameter turns on the Variable Length GTT (VGTT) feature.

**Range:**

*on*

**System Default:**

*off*

**wnp (optional)**

This parameter turns on the Wireless Number Portability (WNP) feature.

**Range:**

*on*

**System Default:**

*off*

**Example**

```
chg-feat:gtt=on
chg-feat:gws=on:cncf=on
chg-feat:sccpcnv=on:tcapcnv=on
chg-feat:tscsync=on:e5is=on
```

**Dependencies** **Note:**

The "LNP feature" is turned on when the LNP ported TNs quantity appears in the `rtrv-ctrl-feat` command output. An LNP quantity feature access key has been enabled and turned on. See the `enable-ctrl-feat` and `chg-ctrl-feat` commands for more information about turning on the LNP feature.

At least one optional parameter must be specified.

The Gateway Screening feature must be turned on before the STP LAN or CNCF feature can be turned on.

The SCCP Conversion feature must be turned on before the TCAP Conversion feature can be turned on.

The LNP feature must be turned on before the Wireless Number Portability or PCS 1900 LNP features can be turned on.

The LNP and Gateway Screening features must be turned on before the Triggerless LNP feature can be turned on.

The Cluster Routing and Management Diversity feature must be turned on before the Nested Cluster Routing feature can be turned on.

The Global Title Translation feature must be turned on before the Enhanced Global Title Translation feature can be turned on.

The Multiple Point Code feature must be turned on before the ITU National Duplicate Point Code feature can be turned on.

The Global Title Translation feature must be turned on before the Variable Length GTT feature can be turned on.

The Time Slot Counter Synchronization feature must be turned on before the EAGLE 5 Integrated Monitoring Support feature can be turned on. These parameters can be specified together in the command to turn them both on at the same time.

If the ANSI/ITU SCCP Conversion feature is enabled, then the SCCP and TCAP conversion features cannot be turned on.

The Gateway Screening feature must be turned on before the Calling Number Conversion Facility feature can be turned on.

The Global Title Translation feature must be turned on before the Padded Variable Length Global Title Translation feature can be turned on.

The Global Title Translation feature must be turned on before the Prefix Deletion of GT feature can be turned on.

The Global Title Translation feature must be turned on before Global System for Mobile Screening feature can be enabled.

The current hardware configuration cannot be determined.

The MAS configuration table must be accessible.

A null pointer was sent into the command handler.

The IMT table must be accessible.

## Notes

This command is not allowed in upgrade mode.

After a feature bit is turned on, it cannot be turned off. Take care in turning on features that are not used in the network configuration.

The Calling Name Conversion Facility (CNCN) feature provides a conversion of ISUP IAM messages. The facility uses the following two versions of calling name identification presentation (CNIP) for calling name information delivery:

- The nonstandard, proprietary ISUP party information (PIP) parameter.
- The ANSI standard ISUP generic name (GN) parameter.

The conversion either replaces the PIP parameter with the GN parameter or the GN parameter with the PIP parameter in the ISUP IAM message. The user can set up GWS screens to apply the CNCN feature on a per-point-code or range-of-point-code basis.

The CRMD feature allows the system to configure one route set to an entire cluster of destinations, thus enabling the system to manage and switch traffic to more end nodes.

The GTT feature allows the system to provide translation of the global title digits located in the called party address of an SCCP message. The translation consists of a point code and subsystem number. This feature requires Service Module cards loaded with the VSCCP application.

The EGTT feature provides enhancements to the way the system performs GTT for both ITU and ANSI messages. The feature allows the combination of domain (ANSI or ITU), global title indicator (GTI), translation type (TT), numbering plan (NP), and nature of address indicator (NAI) selectors to be used to select a translation table when the system receives a message requiring EGTT. The feature also allows inclusion of the translated subsystem number (SSN) in the called party address (CDPA) and inclusion of the originating point code (OPC) in the calling party address (CGPA). The feature also provides deletion capability of the GT (global title) in the CDPA.

The GWS feature allows the system to screen specific message types with selected parameters from entering the network through this STP. This feature requires E5-OAM cards.

The STP LAN feature allows selected SS7 messages to be copied and sent to a remote host over an Ethernet LAN using the TCP/IP protocol. This feature requires up to 32 cards running the STPLAN application, and requires the GWS feature.

The TLNP feature gives service providers a method to route calls to ported numbers without having to upgrade their signaling switch (end office or mobile switching center) software. This feature uses the gateway screening stop action TLNP to intercept through-switched ISUP messages on the LIM.

The LFS feature allows the system to perform a series of far end loopback tests that identify faulty segments of an SS7 transmission path up to and including the remote network element.

The MTPRS feature provides an orderly process for bringing signaling links back into service after the system has been isolated and restarted. A greater preference is given to restoring the STP to network service in an orderly fashion than to the speed of recovery. The time required is system dependent as shown:

- Up to 64 LIMs—62 seconds (Link Alignment Delay)
- 64 - 127 LIMs—97 seconds
- 128-191 LIMs—132 seconds
- More than 191 LIMs—167 seconds

The ITUMTPRS feature provides MTP restart support for ITU networks and extends the system's ANSI MTP restart support to mixed ITU and ANSI networks. The performance of ITU MTP Restart is comparable to the performance of ANSI MTP Restart.

The SCCPCNV and TCAPCNV features allow the system to convert MTP-routed SCCP and TCAP messages from ANSI to ITU format and to convert ITU formatted messages to ANSI.

The PLNP feature provides for LNP query/response in a PCS wireless environment using the LRN method to support Service Provider Number Portability.

The NCR feature allows the system to support full point code entries on different routes within a cluster.

The Other CIC Bit Used feature is one of two methods provided as ITU SLS enhancements for distributing the load across links in a combined and single linkset. The Other CIC Bit Used feature lets the system derive the LSB (Least Significant Bit) from bits 2 through 4 of the CIC to serve as the three lower bits of the SLS (Signaling Link Selection) and one other bit of the CIC to serve as the MSB (Most Significant Bit) of the SLS. The SLSOCB feature applies only to ITU-ISUP messages. The other method of distributing the load is rotation of the four bits of the SLS to change the LSB of the SLS. For additional information on bit rotation, see the `ent-ls` command.

The NR feature allows provisioning of a single routeset to be used for all MSUs destined to members of that network.

The DSTN5000 feature provides the ability to administer up to 5000 routes on the system. If `dstn5000=on`, the values of the `mtpdpcq` (destination point code) and `mtpxlq` (exception list entries) parameters of the `chg-stpopts` command can total 5500. Otherwise, the sum total for `mtpdpcq` and `mtpxlq` cannot exceed 2500. The Cluster Routing and Management Diversity (CRMD) feature must be turned on before the `mtpxlq` parameter can be specified.

The MPC feature enables the user to use SPCs (secondary point codes) in addition to the true point codes that the EAGLE uses. The SPCs are used for provisioning and routing as if they were the true point code of the EAGLE. SPCs can be provisioned in any of the three domains (ANSI, ITU-N, and ITU-I). SPCs are supported for any type of link.

The ITUDUPPC feature allows an EAGLE mated pair to route traffic for two or more countries that may have overlapping point code values.

The VGTT feature provides the ability to provision global title entries of varying lengths to a single translation type or GTT set. Users are able to assign global title entries of up to 10 different lengths to a single translation type or GTT set.

The TSCSYNC feature allows the system's A (Active) and B (Standby) internal clocks to be synchronized by the GPSM-II card that is running the standby OAM .

The E5IS feature provides an Ethernet interface between the EAGLE and the Integrated Message Feeder (IMF), to eliminate the need for cabling between each SS7 link and IMF to monitor SS7 traffic.

The Measurements Platform feature provides a dedicated processor for collecting and reporting STP, LNP, INP, G-Flex, and G-Port Measurements data, with support for EAGLE growth to more than 700 links.

## Output

```
chg-feat:gtt=on
```

```
rlghncxa03w 04-01-11 11:34:04 EST EAGLE 31.3.0  
CHG-FEAT: MASP A - COMPLD
```

```
;
```

## Related Topics

- [rtrv-feat](#)

## chg-frm-pwr

Use this command to change the power threshold value in the Frame Power Threshold table for a specified frame.

The entries in the Frame Power Threshold table contain a Frame ID and the corresponding power threshold value.

Use the following commands to display the threshold and calculated maximum power consumption for the frames in the system.

- The `rtrv-frm-pwr` command displays the current provisioned frame power threshold for each provisioned frame.
- The `rtrv-stp:display=power` command displays the provisioned frame power threshold for each provisioned frame, and displays the maximum calculated power consumption for each frame, based on card population.
- The `rtrv-stp:display=power:frm=xxxx` command displays the provisioned frame power threshold for the specified frame, the maximum calculated power consumption for the frame based on card population, and the maximum power consumption for each card in the frame and for a fan assembly for each shelf.



### Note:

The frame-level power threshold value needs to be determined from the capacity in Amps of the fuse alarm panel (FAP) for the frame. Contact your site engineer to determine the FAP capacity.

### Parameters

#### **frm** (mandatory)

Frame ID

#### Range:

##### **cf00**

Control frame

##### **ef00**

First extension frame

##### **ef01**

Second extension frame

##### **ef02**

Third extension frame

##### **ef03**

Fourth extension frame

##### **ef04**

Fifth extension frame

**thrshld (mandatory)**

Threshold. This parameter specifies the frame-level power threshold, in Amps. This value is compared with the current calculated maximum power consumption for the frame (use the `rtrv-stp:display=power:frm=` command to obtain the maximum power consumption value), and the appropriate alarms are raised if that power consumption exceeds the threshold limit.

The value of the *thrshld* parameter needs to be determined from the capacity of the fuse alarm panel (FAP) for the frame. Contact your site engineer to determine the frame FAP capacity.

**Range:**

30 - 65

**Default:**

30

**Example**

Change the frame power threshold value for the first extension frame.

```
chg-frm-pwr:frm=ef00:thrshld=58
```

**Dependencies**

The following values are valid for the `frm` parameter: *cf00*, *ef00*, *ef01*, *ef02*, *ef03*, *ef04*.

The valid range of values for the `thrshld` parameter is 30-65 Amps.

A power threshold value must already be provisioned for the specified frame.

The Frame Power Threshold table must be accessible.

**Notes**

The maximum calculated power for a frame is based on the cards that are populated in the system, and includes a fan tray assembly for every shelf (the system cannot detect the presence or absence of a fan tray, and assumes presence for the calculation). These values are typically much higher than the actual power being drawn; the values cannot be used as a gauge of the actual power consumption of the EAGLE.

**Output**

```
chg-frm-pwr:frm=ef00:thrshld=58
```

```
tekelecstp 06-06-01 15:18:41 EST EAGLE 35.0.0
FRAME POWER THRESHOLD table is (4 of 10) 40% full
CHG-FRM-PWR: MASP A - COMPLTD
;
```

**Related Topics**

- [dlt-frm-pwr](#)
- [ent-frm-pwr](#)
- [rtrv-frm-pwr](#)
- [rtrv-stp](#)



## chg-ftp-serv

Use this command to change an entry for an FTP server in the FTP Server table.

### **Caution:**

Contact the Customer Care Center before specifying the user parameter value. The FTP-based Table Retrieve Application (FTRA) sends the necessary FTP Server information to the system, and the system overwrites any entry that is already in the FTP Server table for that server.

### Parameters

#### **app (mandatory)**

Application. This parameter specifies the FTP Client application that interfaces with the FTP server.

#### **Range:**

##### ***db***

Database Backup\Restore application

##### ***dist***

EAGLE Software Release Distribution application

##### ***meas***

Measurements Platform application

##### ***sflog***

SS7 Firewall Logging application

##### ***user***

FTP-based Table Retrieve Application (FTRA)

#### **ipaddr (mandatory)**

IP Address of the FTP Server.

#### ***meas***

Measurements Platform application

#### **Range:**

#### **login (optional)**

FTP Server Username (A prompt for entering a password appears on a separate line.)

#### **Range:**

*ZZZZZZZZZZZZZZZZ*

1 to 15 alphanumeric characters; mixed-case is allowed

#### **path (optional)**

FTP path used to locate the file that will be sent.



An entry for the specified application ID at the specified priority cannot already exist.

The FTP server entry to be changed with this command must already exist in the FTP Server table for the specified IP address and application.

The `security` parameter cannot be set to OFF with application (`app = sflog`).

### Notes

The same FTP server can be defined more than once, but the specified application must be different for each entry.

The FTP connection will be secure when the `security` parameter is ON. The secure FTP connection (SFTP) uses port 22, which must be opened in the customer's network.

### Output

```
chg-ftp-serv:app=meas:ipaddr=1.255.0.102:path="-ftpmeas1"
```

```
rlghncxa03w 04-01-20 09:07:58 EST EAGLE 31.3.0  
CHG-FTP-SERV: MASP A - COMPLTD
```

```
;
```

```
chg-ftp-serv:app=meas:ipaddr=1.255.0.102:login=ftpmeas1
```

```
rlghncxa03w 04-01-20 09:07:58 EST EAGLE 31.3.0  
Enter Password:*****  
CHG-FTP-SERV: MASP A - COMPLTD
```

```
;
```

```
chg-ftp-serv:app=user:ipaddr=1.22.10.2:prio=3
```

```
rlghncxa03w 04-01-20 09:07:58 EST EAGLE 31.3.0  
CHG-FTP-SERV: MASP A - COMPLTD
```

```
;
```

```
chg-ftp-serv:ipaddr=10.248.13.9:app=meas:security=on
```

```
tekelecstp 12-09-19 15:12:54 EST 45.0.0-64.42.0  
chg-ftp-serv:ipaddr=10.248.13.9:app=meas:security=on  
Command entered at terminal #4.  
CHG-FTP-SERV: MASP A-COMPLTD.
```

```
;
```

```
chg-ftp-serv:app=sflog:ipaddr=10.248.13.9:prio=2
```

```
tekelecstp 15-05-27 15:43:58 EST Eagle 46.3.0  
chg-ftp-serv:app=sflog:ipaddr=10.248.13.9:prio=2
```

```

Command entered at terminal #4.
CHG-FTP-SERV: MASP A - COMPLTD
;

```

### Related Topics

- [dlt-ftp-serv](#)
- [ent-ftp-serv](#)
- [rtrv-ftp-serv](#)

## chg-gpl

Use this command to copy a generic program load from the system removable drive to the destination active and standby system disks as a "trial" version. The system release identification file is uploaded from the system removable drive to the active and standby fixed drives along with each GPL. This command also provides a parameter to turn GPL auditing "on" and "off".

### Parameters

#### **audit** (optional)

This parameter specifies whether the active MASP system release running version is to be audited every 90 seconds. The audit state is preserved through a system restart or power up.



#### **Note:**

When audit is turned off, the system release audit process is stopped. The detection, marking, and reporting of corrupt GPLs is continuous and not affected by turning audit off.

#### **Range:**

*on*

*off*

#### **Default:**

*on*

#### **gp1** (optional)

Generic program load. The name of the GPL identifier to be copied from the system removable drive to the active and standby system disks.

#### **Range:**

*xyyyyyyy*

1 alphabetic character followed by up to 7 alphanumeric characters. Valid GPLs are:  
*atmhc*—Used by E5-ATM-B cards to allow the card to support up to 3 signaling links  
*bldc32*—Flash GPL containing a tar image with all code required on E5-MCAP cards to support VxWorks6.9 32-bit application, as in OAMHC69.

*bldc64*—Flash GPL containing a tar image with all code required on E5-SM8G-B cards for SCCP64, ENUM64, SIP64 and DEIR64 applications.

*blmcap*—Flash GPL containing a tar image with all code required on E5-MCAP, E5-E1T1-B, E5-MCPM-B, E5-ATM-B, E5-ENET-B, and E5-SM8G-B cards

*blslc32*—Flash GPL containing a tar image with all code required on SLIC cards for 32-bit application i.e. MCPHC, IPSHC etc.

*blslc64*—Flash GPL containing a tar image with all code required on SLIC cards for 64-bit application i.e. SCCP64, ENUM64, SIP64 and DEIR64.

*blsl932*—Flash GPL containing a tar image with all code required on SLIC cards for 32-bit application on VxWorks6.9, as in IPSHC69 and MCPHC69.

*deirhc*—Used by E5-SM8G-B cards to support the S13/S13' EIR feature

*enumhc*—Used by E5-SM8G-B cards to support the ENUM Mobile Number Portability and Tier One Address Resolution application

*erthc*—Used by E5-ENET-B cards for EAGLE 5 Integrated Monitoring Support functions

*hipr2*—Communication software used on the High Speed IMT Packet Router (HIPR2) card

*ipsg*—Used by E5-ENET-B cards to support the combined functionality of IPLIMx M2PA and IPGWx M3UA

*ipsg32*—Used by SLIC cards to support IPSG application with 64-bit addressing either with GTT functionality or without it.

*ipshc*—Used by E5-ENET-B and SLIC cards to support the IPS application

*ipshc69*—Used by E5-ENET-B and SLIC cards to support the IPS application when running on VxWorks69.

*mcp hc*—Used by E5-MCPM-B cards for the Measurements Platform feature

*mcp hc69*—Used by E5-MCPM-B and SLIC cards for the Measurements Platform feature when running on VxWorks69.

*oamhc*—Used by E5-MCAP cards for enhanced OAM functions

*oamhc69*—Used by E5-MCAP cards for enhanced OAM functions, when running on VxWorks 69.

*sccphc*—Used by E5-SM8G-B cards to support EPAP-based features and the LNP ELAP Configuration feature. If no EPAP-based or LNP ELAP Configuration feature is turned on, and an E5-SM8G-B card is present, then the GPL processes normal GTT traffic.

*sfapp*—Used by SLIC cards to support the Stateful Firewall Application.

*siphc*—Used by E5-SM8G-B Cards to support the SIP application.

*ss7hc*—Application GPL used by E5-E1T1-B and SLIC cards to support **E1** and **T1** signaling links.

**src (optional)**

Source drive. The identification of the disk containing the GPL to be copied

**Range:*****remove***

Removable drive

***usb***

Argument to be used by Oracle personnel only.

**ver (optional)**

Version number of the GPL, in the form of *major-minor-fix*.

**Range:**

*major-minor-fix*—Specify a valid value for each component of the version number, in the range 0-255

**Example**

```
chg-gpl:audit=on
chg-gpl:gpl=atmhc:ver=138-19-0
chg-gpl:gpl=siphc:ver=134-35-0
chg-gpl:gpl=enumhc:ver=135-20-0
chg-gpl:gpl=ipsg32:ver=140-20-0
chg-gpl:gpl=sfapp:ver=141-012-1
```

**Dependencies**

No other activate, change, copy, or retrieve GPL command can be in progress when this command is entered.

If the `ver` or `gpl` parameter is specified, then both parameters must be specified.

The `audit` parameter, the `ver` and `gpl` parameters, or the `audit` and `ver` and `gpl` parameters must be specified.

A system removable drive must be inserted in the Active OAM.

A valid value must be specified for the `gpl` parameter.

**Notes**

If there is a failure changing the active system, the operation is stopped. If there is a failure changing the standby system, the active system is still updated.

A system removable drive must be inserted into the latched USB port, initialized, and formatted as a system disk.

Use the `rtrv-gpl` command to determine the version number and audit state of a GPL.

The `ver` and `gpl` parameters are mandatory if a generic program load is being uploaded from a system removable drive.

The `audit` parameter is required only when turning GPL auditing on or off and the `ver` and `gpl` parameters are optional.

When the `audit=off` parameter is specified, the system release audit process is stopped. The detection, marking, and reporting of corrupt GPLs is continuous and not affected by turning audit off.

**Output**

This example shows the output for a successful command execution:

```
chg-gpl:gpl=ss7hc:ver=125-1-0
```

```
rlghncxa03w 09-03-01 11:43:04 EST EAGLE 40.1.0
SS7HC upload to 1114 completed
```

```
SS7HC upload to 1116 completed
System Release ID table upload to 1116 completed
System Release ID table upload to 1114 completed
;
```

```
chg-gpl:gpl=siphc:ver=134-35-0
```

```
tekelecstp 12-07-09 19:08:39 EST EAGLE 45.0.0
SIPHC upload to 1114 completed
SIPHC upload to 1116 completed
System Release ID table upload to 1116 completed
System Release ID table upload to 1114 completed
;
```

```
chg-gpl:gpl=enumhc:ver=135-20-0
```

```
tekelecstp 14-05-20 15:19:30 EST EAGLE 46.1.0
ENUMHC upload to 1114 completed
ENUMHC upload to 1116 completed
System Release ID table upload to 1116 completed
System Release ID table upload to 1114 completed
;
```

```
chg-gpl:gpl=ipsg32:ver=140-20-0
```

```
tekelecstp 14-05-20 15:19:30 EST EAGLE 46.1.0
IPSG32 upload to 1114 completed
IPSG32 upload to 1116 completed
System Release ID table upload to 1116 completed
System Release ID table upload to 1114 completed
;
```

```
chg-gpl:gpl=sfapp:ver= 141-012-1
```

```
tekelecstp 17-11-29 16:18:04 MST EAGLE 46.5.1.5.0-73.2.0
SFAPP activate to 1114 completed
SFAPP activate to 1116 completed
;
```

### Related Topics

- [act-gpl](#)
- [alw-card](#)
- [copy-gpl](#)
- [init-card](#)
- [init-sys](#)
- [rept-stat-gpl](#)

- [rtrv-gpl](#)

## chg-gsm-msg

Use this command to provision GSM test messages. These messages are used by the MO SMS NPP Test Tool to test MO-based GSM SMS message processing by the NPP.

### Parameters

#### **msgn (mandatory)**

Message number. The GSM message number to be changed.

**Range:**

*1 - 10*

#### **active (optional)**

This parameter specifies whether the GSM test message is sent to the network card for processing.

**Range:**

**yes**

The message is sent to the network card.

**no**

The message is not sent to the network card.

**Default:**

No change to the current value

**System Default:**

*no*

#### **cdpadgts (optional)**

Called party address digits. The SCCP CdPA digits for the GSM test message.

**Range:**

1-15 digits

1 - 15 hexadecimal digits. Valid digits are *0-9, a-f, A-F*.

**Default:**

No change to the current value

**System Default:**

*0123456789abcde*

#### **cdpagti (optional)**

Called party address global title indicator. The SCCP CdPA GT for the GSM test message.

**Range:**

*0 - 15*

**Default:**

No change to the current value



**System Default:**

4

**cdpagtnai (optional)**

Called party address global title nature of address indicator. The SCCP CdPA GT NAI for the GSM test message.

**Range:**

0 - 127

**Default:**

No change to the current value

**System Default:**

4

**cdpndgts (optional)**

Called party number digits. The TCAP CdPN (*SM-RP-UI TP-DA*) digits for the GSM test message.

**Range:**

1 - 20 digits

**Default:**

No change to the current value

**System Default:**

01234567890abcde

**cdpnnai (optional)**

Called party number nature of address indicator. The TCAP CdPN (*SM-RP-UI TP-DA*) NAI for the GSM test message.

**Range:**

0 - 7

**Default:**

No change to the current value

**System Default:**

1

**cdpnp (optional)**

Called party numbering plan. The TCAP CdPN (*SM-RP-UI TP-DA*) NP for the GSM test message.

**Range:**

0 - 15

**Default:**

No change to the current value

**System Default:**

1

**cgpadgts (optional)**

Calling party address digits. The SCCP CgPA digits for the GSM test message.

**Range:**

1 -15 digits

1 - 15 hexadecimal digits. Valid digits are 0-9, a-f, A-F.

**Default:**

No change to the current value

**System Default:**

0123456789abcde

**cgpagt*i* (optional)**

Calling party address global title indicator. The SCCP CgPA GT for the GSM test message.

**Range:**

0 - 15

**Default:**

No change to the current value.

**System Default:**

4

**cgpagtnai (optional)**

Calling party address global title nature of address indicator. The SCCP CgPA GT NAI for the GSM test message.

**Range:**

0 - 127

**Default:**

No change to the current value

**System Default:**

4

**cgpndgts (optional)**

Calling party number digits. The TCAP CgPN (*SM-RP-OA MSISDN*) for the GSM test message.

**Range:**

1 - 21 digits, *none*

*none* -deletes the current digits

**Default:**

No change to the current value

**System Default:**

01234567890abcde

**cgpnnai (optional)**

Calling party number nature of address indicator. The TCAP CgPN (*SM-RP-OA MSISDN*) NAI for the GSM test message.

**Range:**

0 - 7

**Default:**  
No change to the current value

**System Default:**  
1

**cgpnnp (optional)**

Calling party numbering plan. The TCAP CgPN (*SM-RP-OA MSISDN*) NP for the GSM test message.

**Range:**  
0 - 15

**Default:**  
No change to the current value

**System Default:**  
1

**reset (optional)**

This parameter resets all of the parameters to their system default values.

**Range:**  
**yes**  
Message parameters are reset to their default values

**Example**

```
chg-gsm-  
msg:msgn=1:cdpnnai=4:cdpadgts=12457896abcd:cgpnnai=2:cgpndgts=9  
19818541560  
  
chg-gsm-msg:msgn=1:reset=yes
```

**Dependencies**

The TSTMSG table is corrupt or cannot be found.

If the `reset` parameter is specified, then no other parameter can be specified.

At least one optional parameter must be specified.

**Output**

```
chg-gsm-msg:msgn=1:cdpnnai=4:cdpndgts=987654321:cgpnnai=4
```

```
tekelecstp 09-03-02 10:46:51 EST EAGLE 40.1.0  
CHG-GSM-MSG: MASP A - COMPLTD  
;
```

**Related Topics**

- [rtrv-gsm-msg](#)
- [tst-msg](#)

## chg-gsmmap-scrn

Use this command to change the attributes of GSM Map Screening CgPA and CdPA entries that are used to filter out or allow SCCP messages containing Map Op-Codes, CgPA GTA+NPV+NAIV, CdPA GTA+NPV+NAIV, and forbidden parameters.

### Parameters



#### Note:

See [Point Code Formats and Conversion](#) for a detailed description of point code formats, rules for specification, and examples.

#### **cgsr (mandatory)**

CgPA Screening Reference.

##### Range:

*ayyy*

1 alphabetic character followed by up to 3 optional alphanumeric characters

#### **opname (mandatory)**

The user-defined name for the operation code. The *opname* value references the operation code (*opcode*) defined with the *ent-gsms-opcode* command. GSM MAP Screening is performed on the specified address or addresses for the referenced operation code.

##### Range:

*ayyyyyyy*

1 alphabetic character followed by up to 7 alphanumeric characters

#### **cdsr (optional)**

CdPA Screening Reference.

##### Range:

*ayyy*

1 alphabetic character followed by up to 3 alphanumeric characters

#### **force (optional)**

Check Mated Application Override. This parameter must be used to complete command execution if the *npc/npcn/npci/npcn* and *nssn* parameter combination specified in the command is not already defined in the SCCP Application entity set (Remote Point Code/ Mated Application Table).

##### Range:

*yes*

*no*

##### Default:

*no*

**naction (optional)**

The new screening action to take if a message is forbidden as defined by the `forbid` parameter.

**Range:**

***atierr***

Do not route the MSU. An ATI (Any Time Interrogation) reject message is generated to the originator. This value is valid only for ATI MAP operation codes.

***discard***

Do not route the MSU. The MSU is discarded (thrown away) and an appropriate UIM is issued.

***dupdisc***

Route the original message to the duplicate node. The original message will not be sent to the original node. If, however, the duplicate node is not available for routing, the MSU is discarded.

***duplicate***

Route the message as normal to the original destination and route a copy of the original message to the duplicate node. If the MSU fails to route to the duplicate node, a UIM is generated indicating the duplicate routing failure.

***forward***

Route the original message to the forward node. The original message will not be sent to the original node. If, however, the forward node is not available for routing, the MSU is routed to the original node.

***pass***

Route the message as normal to the destination; a UIM will be issued. This is intended to be a test mode and is recommended when setting up GSM Map Screening during the initial phase to assure that no MSUs will be inadvertently thrown away.

***route***

Route the message as normal to the original destination node; no UIM will be generated. The original destination is the node to which normal GTT would be sent if no GSM MAP actions are taken.

**Default:**

No change to current value

**ncdsr (optional)**

The new CDPA Screening Reference.

**Range:**

*ayyy*

1 alphabetic character followed by up to 3 optional alphanumeric characters

**ncgsr (optional)**

The new CGPA Screening Reference.

**Range:***ayyy*

1 alphabetic character followed by up to 3 optional alphanumeric characters

**nforbid (optional)**

The new forbidden parameter value. Indicates a forbidden parameter for the specified entry. If a forbidden parameter is detected, the message is handled with the action defined by the `action/naction` parameter.

**Range:*****all***

All parameters are forbidden. Take the specified screening action defined by the `naction` parameter for messages arriving at the system.

***none***

None of the parameters are forbidden. Route the message to its destination.

***state***

Take the specified screening action defined by the `naction` parameter for messages arriving at the system that contain `state` as the forbidden parameter for the entered address/operation code combination.

 **Note:**

The `state` parameter is valid only for GSM ATI messages.

***location***

Take the specified screening action defined by the `naction` parameter for messages arriving at the system that contain `location` as the forbidden parameter for the entered address/operation code combination.

 **Note:**

This value is valid only for GSM ATI messages.

**Default:**

No change to current value

**nmapset (optional)**

The new MAP set ID.

**Range:***1 - 36000, dflt**dflt*—Default MAP set**Default:**

No change to the MAP set value.

**npc (optional)**

New ANSI point code with subfields *network indicator-network cluster-network cluster member (ni-nc-ncm)*.

**Synonym:**

*npca*

**Range:****npc/npca/npci/npcn/npcn24 (optional)**

New point code. The *npc/npca/ npci/npcn /npcn24* and *nssn* parameters are used when the new screening action (*naction*) is *forward*, *duplicate*, or *dupdisc* (duplicate and discard). These parameters allow the user to change the defined node to which the input message will be routed.

**npci (optional)**

New ITU international destination point code with subfields *zone-area-id*. The *prefix* subfield indicates a spare point code (*prefix-zone-area-id*).

**Range:**

*s-*, 0-255

Specify a valid value for each subfield of the point code, and separate the subfields with a dash (-).

*prefix—s*

*zone—0-7*

*area—000-255*

*id—0-7*

The point code *0-000-0* is not a valid point code.

**npcn (optional)**

New ITU national destination point code in the format of a 5-digit number (*nnnnn*); or 2, 3, or 4 numbers (members) separated by dashes (*m1-m2-m3-m4*) as defined by the *chg-stpopts:npcfmti* flexible point code option. A group code must be specified when the ITUDUPPC feature is turned on (*nnnnn-gc,m1-m2-m3-m4-gc*). The *prefix* subfield indicates a spare point code (*prefix-nnnnn*, *prefix-nnnnn-gc*, *prefix-m1-m2-m3-m4*, *prefix-m1-m2-m3-m4-gc*).

**Range:**

*s-*, 0-16383, *aa-zz*

Specify a valid value for each subfield of the point code, and separate the subfields with a dash (-).

*prefix—s-*

*nnnnn—0-16383*

*gc—aa-zz*

*m1-m2-m3-m4—0-14* for each member; values must sum to 14

**npcn24 (optional)**

New 24-bit ITU national point code with subfields *main signaling area-sub signaling area-signaling point (msa-ssa-sp)*.

**Range:**

000-255

Specify a valid value for each subfield of the point code, and separate the subfields with a dash (-).

*msa—000–255*  
*ssa—000–255*  
*sp—000–255*

**nri (optional)**

New routing indicator. This parameter specifies whether a subsequent global title translation is required.

**Range:**

*gt*

*ssn*

**nssn (optional)**

New Subsystem Number.

**Range:**

*002 - 255, none*

**Default:**

No change to the existing value

**ntt (optional)**

New translation type. The value the CdPA TT is set to as the result of Enhanced GSM Map Screening.

**Range:**

*0 - 255*

**Default:**

No change to the existing value

**Example**

```
chg-gsmmap-scrn:opname=xyz:cgsr=fela:naction=pass
```

```
chg-gsmmap-scrn:opname=xyz:cgsr=fela:cdsr=fall:naction=discard
```

```
chg-gsmmap-scrn:opname=test2:cgsr=pcn1:npcn=s-333:nssn=254
```

```
chg-gsmmap-  
scrn:opname=test1:naction=forward:npc=2-2-2:nssn=20:nmapset=12
```

```
chg-gsmmap-  
scrn:opname=test2:naction=duplicate:npc=1-1-2:nssn=20:cgsr=cg1:nmaps  
et=df1t
```

```
chg-gsmmap-scrn:opname=test3:cgsr=ad:nri=ssn
```

```
chg-gsmmap-scrn:opname=test4:cgsr=ksl:ntt=12
```

**Dependencies**

At least one optional parameter must be specified.

If the `cdsr` parameter is specified, at least one additional optional parameter must be specified.

If the `ncdsr` parameter is specified, then the `cdsr` parameter must be specified.



If the `cdsr` parameter is specified, then the `ncgsr` parameter cannot be specified.

The `ncgsr` parameter and the `ncdsr` parameter cannot be specified together in the same command.

The specified `cgsr` parameter value must exist in the database.

The specified `cdsr` parameter value must exist in the database.

The specified `ncgsr` parameter value cannot already exist in the database.

The specified `ncdsr` parameter value cannot already exist in the database.

The GSM Map Screening feature must be turned on before this command can be entered.

The Enhanced GSM Map Screening (EGMS) feature must be turned on before the `cdsr`, `ncdsr`, `pc`, and `pca` parameters can be specified.

The specified `opname` parameter value must exist in the GSM Map Op-Code table.

A value of *state* or *location* cannot be specified for the `nforbid` parameter unless the operation code (`opcode`) referenced by the `opname` parameter is 71. The `opcode=71` parameter signifies an ATI MAP operation code.

A value of *atierr* cannot be specified for the `naction` parameter unless the operation code (OPCODE) referenced by `opname` is 71.

If specified, the `npc/npca/npci/ npcn/npcn24` parameter must be a full point code.

If the `naction` parameter is specified, and its value is *forward*, *duplicate*, or *dupdisc*, then the `npc/npca/npci/npcn/npcn24` parameter and the `nssn` parameter must be specified.

The `npc/npca/npci/npcn/npcn24` and `nssn` parameters must be specified before the `force` parameter can be specified.

If the `npc/npca/npci/npcn/npcn24` parameter and the `nssn` parameter are specified, and the `force` parameter is not specified as *yes*, the PC-SSN must be populated in the SCCP Application entity set (Remote Point Code / Mated Application Table).

The GSM Map screening table must be accessible.

The GSM Map Op-Code table must be accessible.

The Route table must be accessible.

If specified, the `npc/npca/npci/npcn/npcn24` parameter value must exist as a destination in the Ordered Route entity set (ANSI only), or must reside in a cluster that exists as a destination in the Ordered Route entity set (for global title routing).

The `npc/npca/npci/npcn/npcn24` and `nssn` parameters can be specified only if the `naction` parameter is specified and its value is *forward*, *duplicate*, or *dupdisc*.

The `opname` parameter must be entered.

The `cgsr` parameter must be entered.

The `opname` parameter must be alphanumeric.

The `(n) cgsr` and `(n) cdsr` parameters must begin with an alphabetic character.

The `(n) cgsr` and `(n) cdsr` parameters must have 1-4 alphanumeric characters each.

If the value of the `naction` parameter is *forward*, *duplicate*, or *dupdisc*, then the `nmapset` parameter must be specified.

The `naction` parameter must have a value of *forward*, *duplicate*, or *dupdisc* before the `npc/npca/npci/npcn/npcn24`, `nssn`, `nri`, `ntt`, or `naction` parameters can be specified.

If the `naction` parameter has a value of *forward*, *duplicate*, or *dupdisc*, then the `npc/npca/npci/npcn/npcn24` parameter and the `nssn` parameter must be specified.

The Flexible GTT Load Sharing feature must be enabled before the `nmapset` parameter can be specified.

The specified new MAP set must exist in the MAP table.

If the value of the `nmapset` parameter is not *dflt*, or if the `nmapset=dflt` parameter is specified, but the value of the `force` parameter is not *yes*, then the values for the `npc` and `nssn` parameters must exist in the new MAP set.

If the `nmapset`, `nri`, or `ntt` parameter is specified, and the `naction` parameter is not specified, then the `action` parameter (see the `ent-gsmmap-scrn` command) must have a value of *forward*, *duplicate*, or *dupdisc*.

The MAP table must be accessible.

The `force` parameter can be specified only if the `nmapset` parameter is specified.

If the value of the `naction` parameter is *forward*, *duplicate*, or *dupdisc*, then the value specified for the `npc/npca/npci/npcn/npcn24` parameter cannot be associated with a proxy point code.

If the `nri=ssn` parameter is specified, then the `nssn=none` parameter cannot be specified.

If the `nforbid=none` parameter is specified, then the `naction` parameter must have a value of *pass*.

If the Flexible GTT Load Sharing feature is enabled, and the new or previously provisioned subsystem number has a value of *none*, then MAP set and point code combination must already exist in the MAP table.

If the Flexible GTT Load Sharing feature is not enabled, and the new or previously provisioned subsystem number has a value of *none*, then the point code must already exist in the MAP table.

## Notes

Unlike GTT (Global Title Translation) entries, the GSM MAP Screening commands do not support splits of ranges during deletion or changes of entries.

In this command, only ITU-international and ITU national point codes support the spare point code subtype prefix (s-).

## Output

```
chg-gsmmap-scrn:opname=test4:cgsr=ksl:ntt=12
```

```
tekelecstp 08-08-20 19:13:01 EST EAGLE 39.2.0  
GSM MAP Screening Table (1 of 4000) is 1% full  
CHG-GSM MAP-SCRN: MASP A - COMPLTD  
;
```

## Related Topics

- [dlt-gsmmap-scrn](#)
- [ent-gsmmap-scrn](#)
- [rtrv-gsmmap-scrn](#)

# chg-gsmopts

Use this command to enter GSM (Global System for Mobile Telecommunications) system options in the database. This command updates the GSMOPTS Table.

## Parameters



### Note:

See [Point Code Formats and Conversion](#) for a detailed description of point code formats, rules for specification, and examples.



### Note:

The options for the `on`, `off`, `maplyrrtgon`, and `maplyrrtgoff` parameters are described in the Notes section.

### **ccnc (optional)**

E214 country code and network code.

#### **Range:**

2-8 digits

#### **Default:**

No change to the current value

### **crptt (optional)**

Circular Route Prevention Translation Type.

#### **Range:**

0 - 255, none

**System Default:***none***defmapvr (optional)**

Default MAP version.

**Range:***1 - 3***Default:**

No change to the current value

**System Default:***1***defmcc (optional)**

E212 default mobile country code.

**Range:**3 digits, *none*Valid digits are *0-9, a-f, A-F**none* —Deletes the current value for the `defmcc` parameter**Default:**

No change to the current value

**System Default:***none***defmnc (optional)**

E212 default mobile network code.

**Range:**1-4 digits, *none*Valid digits are *0-9, a-f, A-F*.*none* —Deletes the current value for the `defmnc` parameter**Default:**

No change to the current value

**System Default:***none***df1trn (optional)**Default routing number. The digits to use as the routing number portion of the `msrndig` parameter when an SRI is processed by the SRI Query for Prepaid feature, an RTDB match is found for an own-network subscriber, and Service Portability is not applied.**Range:**1-15 digits, *none***Default:**

No change to the current value

**System Default:***none*

**eirdfltimsilkup (optional)**

Equipment Identity Register (EIR) default IMSI lookup status. This parameter specifies the order of the IMEI table lookup for default IMSI screening. This parameter is analogous to the P1 parameter in the IMSIPFX CSL list but is used only when there is no matching IMSI prefix in the IMSIPFX CSL.

**Range:**

*both*

Perform lookup on Individual IMEI table first & if not found then lookup Range IMEI table

*individual*

Perform lookup on Individual IMEI table only

*none*

Don't perform any lookup. Just return the default IMEI status.

*range*

Perform lookup on Range IMEI table only

**Default:**

No change to the current value.

**System Default:**

*range*

**eirdfltimsiresp (optional)**

Equipment Identity Register (EIR) default IMSI response. This parameter specifies the default IMEI status for default IMSI screening. This parameter is analogous to the P2 parameter in the IMSIPFX CSL list but is used only when there is no matching IMSI prefix in the IMSIPFX CSL.

**Range:**

*blacklist*

The IMEI is "invalid". Registration should not be allowed for this handset

*graylist*

The IMEI is "questionable."

*unknown*

The IMEI is not in the White, Gray, or Black list. Registration should not be allowed for this handset.+

*whitelist*

The IMEI is "valid". Registration should be allowed for the handset.

**Default:**

No change to the current value.

**System Default:**

*whitelist*

**eirgrsp (optional)**

Equipment Identity Register (EIR) Global Response status.

**Range:**

***off***

EIR Global Response is not used

***whitelst***

The IMEI is "valid". Registration should be allowed for the handset.

***graylst***

The IMEI is "questionable." Registration should be allowed, but the event is logged in the EIR log and a special measurement peg is incremented.

***blklst***

The IMEI is "invalid". Registration should not be allowed for this handset.

***unknown***

The IMEI is not in the White, Gray, or Black list. Registration should not be allowed for this handset.

**Default:**

No change to the current value

**System Default:**

*off*

**eirimsichk (optional)**

Equipment Identity Register (EIR) IMSI Check status. This parameter is not valid for IMEI ranges.

**Range:**

***on***

***off***

**Default:**

No change to the current value

**System Default:**

*off*

**eirrsptype (optional)**

Equipment Identity Register (EIR) Response Type.

**Range:**

***type1***

***type2***

**type3**

Table 4-6 contains information to help select the value for this parameter.

Presence in List			EIR Response Type		
White	Gray	Black	Type 1	Type 2	Type 3
X			white list	white list	white list
X	X		gray list	gray list	gray list
X	X	X	black list	black list	black list
X		X	black list	black list	black list
	X		gray list	gray list	unknown
	X	X	black list	black list	unknown
		X	black list	black list	unknown
			white list*	unknown*	unknown*

\*Indicates no match was found for the IMEI in an incoming message within the database.

**Default:**

No change to the current value

**System Default:**

*type1*

**gflexmaplayerrrtg (optional)**

G-Flex MAP layer routing. The message parameter used in the database lookup performed during G-Flex MAP layer routing.

The `gflexmaplayerrrtg` parameter applies G-Flex MLR to the following MAP operations:

- `updateLocation`
- `sendParameters`
- `sendAuthenticationInfo`
- `updateGPRSLocation`
- `AnyTimeInterrogation`

Use the `maplyrrtgon` and `maplyrrtgooff` parameters to apply G-Flex MLR to additional MAP operations.

**Range:*****imsi***

use the IMSI parameter for database lookup

***none***

MLR is not performed

***msisdn***

use the MSISDN parameter for database lookup

**all**

use the IMSI or MSISDN parameter for database lookup based on the operation code of the message

**Default:**

No change to the current value

**System Default:**

*none*

**gsm2is41 (optional)**

GSM to IS41 migration prefix.

**Range:**

1-15 digits, *none*

Valid digits are 0-9, a-f, A-F

*none* —Deletes the current value of the `gsm2is41` parameter.

**Default:**

No change to the current value

**System Default:**

*none*

**is412gsm (optional)**

IS41 to GSM migration prefix.

**Range:**

1-15 digits, *none*

Valid digits are 0-9, a-f, A-F

*none* —Deletes the current value of the `is412gsm` parameter.

**Default:**

No change to the current value

**System Default:**

*none*

**maplyrrtgoff (optional)**

MAP Layer Routing Off. This parameter turns off G-Flex MLR for a comma-separated list of MAP operations. Up to 10 operations can be specified in the list.

**Range:**

*regss, actss, dactss, intss, authfailrpt, rstdata, procunstrqt, rdyform, purgmobss, sriloc, all*

*all* —Turns off G-Flex MLR for all MAP operations supported by the `maplyrrtgoff` parameter.

 **Note:**

If the *all* MAP operation is specified, then no other MAP operations can be specified in the same command.



**Default:**

No change to the current value

**maplyrrtgon (optional)**

MAP Layer Routing On. This parameter turns on G-Flex MLR for a comma-separated list of MAP operations. Up to 10 operations can be specified in the list.

**Range:**

*regss, actss, dactss, intss, authfailrpt, rstdata, procunstrqt, rdyform, purgmobss, sriloc, all*  
*all* —Turns on G-Flex MLR for all MAP operations supported by the `maplyrrtgon` parameter.

**Note:**

If the *all* MAP operation is specified, then no other MAP operations can be specified in the same command.

**Default:**

No change to the current value

**mccmnc (optional)**

E212 mobile country code and mobile network code.

**Range:**

4-7 digits, *none*  
Valid digits are 0-9, a-f, A-F.  
*none* —Deletes the current `mccmnc` and `ccnc` parameter combination entry.

**Default:**

No change to current value

**migrpfx (optional)**

Migration prefix. This parameter specifies whether the database routing number (RN) or the GSM to IS-41 Migration prefix is used as the source for the prefix in the SRI Ack response message for a migrated subscriber.

**Range:*****single***

The RN from the RTDB lookup is not used as the prefix in the SRI Ack. If the `gsm2is41` parameter has a value other than *none*, then that value is used as the prefix in the SRI Ack Response.

***multiple***

The RN from the database lookup is used as the prefix in the SRI Ack response.

**Default:**

No change to the current value

**System Default:**

*single*

A value of *single* is the system default value for a new system, or for a system that upgraded to 36.0 without the IGM feature being turned on. If the IGM feature was turned on before upgrade to 36.0, then a value of *multiple* is hardcoded as the system default value.

**msisdntrunc (optional)**

MS ISDN truncation digits. The number of digits to delete from the beginning of the National MSISDN (MSISDN without Country Code) before formulating the MSRN parameter of the SRI Ack response.

**Range:**

0 - 5

**Default:**

No change to current value

**System Default:**

0

**msrndig (optional)**

The routing number to be used as is or concatenated with the MSISDN.

**Range:*****rn***

Routing number

***rdn***

Routing number prefix and the international DN (dialed/directory number)

***ccrdn***

Country code, routing number, and national directory number

***rnccd***

Routing number, country code and directory number

***rnasd***

Routing number and additional subscriber data

***asdrn***

Additional subscriber data and routing number

***rnasddn***

Routing number, additional subscriber data, and directory number

***asdrndn***

Additional subscriber data, routing number, and directory number

***ccrnasddn***

Country code, routing number, additional subscriber data, and directory number

***ccasdrndn***

Country code, additional subscriber data, routing number and directory number

***rnasdccd***

Routing number, additional subscriber data, country code, and directory number

***asdrncdn***

Additional subscriber data, routing number, country code, and directory number

***rngrn***

Routing number and generic routing number

***grnrn***

Generic routing number and routing number

***rngrndn***

Routing number, generic routing number, and directory number

***grnrndn***

Generic routing number, routing number, and directory number

***ccrngrndn***

Country code, routing number, generic routing number, and directory number

***ccgrnrndn***

Country code, generic routing number, routing number, and directory number

***rngrncdn***

Routing number, generic routing number, country code, and directory number

***grnrncdn***

Generic routing number, routing number, country code, and directory number

**Default:**

No change to the current value

**System Default:**

*m*

***msrnlcn* (optional)**

The number of digits in the MAP Routing Info portion of the returned SRI\_ACK message.

**Range:**

1 - 30

**Default:**

No change to the current value

**System Default:**

30

***msrnnai* (optional)**

The nature of address indicator value for the MSRN.

**Range:**

0 - 7

**0**

Unknown Nature of Address

- 1**  
International Number
- 2**  
National Significant Number
- 3**  
Network Specific Number
- 4**  
Subscriber Number
- 5**  
Reserved for national use
- 6**  
Abbreviated Number
- 7**  
Reserved for extension

**Default:**  
No change to current value

**msrnp (optional)**  
The numbering plan value for the MSRN.



**Note:**

This parameter is mandatory if the `msrnnai` parameter is specified.

**Range:**  
0 - 15

**Default:**  
No change to current value

**multcc (optional)**  
Multiple country code.

**Range:**  
1-3 digits  
Valid digits are 0-9, a-f, A-F

**Default:**  
No change to current value

**nmultcc (optional)**  
New multiple country code.

**Range:**  
1-3 digits, none  
Valid digits are 0-9, a-f, A-F.  
none —Deletes the specified `multcc` value from the multiple country code list.

**Default:**

No change to current value

**off (optional)**

This parameter turns off the specified options. Up to 8 comma-separated unique options can be specified.

**Range:**

*eirdfltimsiscrn*  
*eirimsichk*  
*eirimsiscrn*  
*eirlogwl*  
*encdnpsdnnofound*  
*encdnpsptnone*  
*encodecug*  
*encodenps*  
*srismgttrtg*

**on (optional)**

This parameter turns on the specified options. Up to 8 comma-separated unique options can be specified.

**Range:**

*eirdfltimsiscrn*  
*eirimsichk*  
*eirimsiscrn*  
*eirlogwl*  
*encdnpsdnnofound*  
*encdnpsptnone*  
*encodecug*  
*encodenps*  
*srismgttrtg*

**serverpfx (optional)**

Server SRI prefix.

**Range:**

1-4 digits, *none*  
Valid digits are 0-9, a-f, A-F  
*none* —No Server SRI prefix is provisioned

**Default:**  
No change to current value

**System Default:**  
*none*

**sporttype (optional)**

Service Portability type. This parameter specifies whether Service Portability applies to SRI Query for Prepaid messages for own-network subscribers.

 **Note:**

If Service Portability is performed, then the Service Portability prefix (RTDB 'GRN'entity id) is applied.

 **Note:**

The S-Port feature must be turned on before any change to the parameter will impact the G-Port SRI Query for Prepaid feature.

**Range:**

***gsm***

Apply Service Portability prefix for own-network GSM subscribers

***is41***

Apply Service Portability prefix for own-network IS41 subscribers

***all***

Apply Service Portability prefix for all own-network (IS41 and GSM) subscribers

***none***

Service Portability is not performed for this feature

**Default:**  
No change to the current value

**System Default:**  
*none*

**srfaddr (optional)**

Entity address of the MNP\_SRF node.

**Range:**

1-15 digits, *none*

Valid digits are 0-9, a-f, A-F

*none* —Deletes the current value for the `srfaddr` parameter.

**Default:**  
No change to current value

**System Default:**

*none*

**srfnai (optional)**

The nature of address indicator value of the MNP\_SRF.

**Range:**

*0 - 127*

**Default:**

No change to current value

**srfnp (optional)**

The numbering plan value of the MNP\_SRF.

**Range:**

*0 - 15*

**Default:**

No change to current value

**sridn (optional)**

The Send Routing Information Dialed Number location.

**Range:**

*tcap*

*sccp*

**Default:**

No change to current value

**System Default:**

*tcap*

**sridnnotfound (optional)**

The processing used when G-Port encounters an RTDB query result that indicates that the specified directory number is not known.

**Range:**

*gtt*

GTT is performed on the message for routing to an HLR

*srinack*

an SRI negative acknowledgement is generated and returned to the calling party

**Default:**

No change to the current value

**System Default:**

*gtt*

**srirdctent (optional)**

This indicates whether existing SRI REDIRECT feature (SP) or Intra Network Number Portability feature (GRN) is to be used.

**Range:*****grn***

Vendor type of GRN should be considered to be matched against Vendor type of CGPA GTA.

***sp***

Vendor type of SP should be considered to be matched against Vendor type of CGPA GTA.

**Default:**

No change to the current value

**System Default:**

*sp*

**ownnetworksetname (optional)**

This indicates the GTTSet (of Set Type CDGTA) to be used to screen and determine if the GT belongs to own network or not.

**Range:*****ayyyyyyyy, none***

Valid characters are 1 alphabetic character followed by up to 8 alphanumeric characters.

**Default:**

No change to the current value

**System Default:**

*none*

**Example**

```
chg-gsmopts:msisdntrunc=1:srfaddr=123456789abcdef:srfnai=0:srfnp=0
chg-gsmopts:msrnnai=1:msrnp=1:msrndig=ccrndn:dfmapvr=2
chg-gsmopts:sridn=sccp
chg-gsmopts:is412gsm=1234:gsm2is41=1234
chg-gsmopts:serverpfx=1000
chg-gsmopts:multcc=011
chg-gsmopts:multcc=011:nmultcc=11
chg-gsmopts:ccnc=33322123:mccmnc=21434
chg-gsmopts:eirimsichk=on:eirrsptype=type2:eigrsp=blk1st
chg-gsmopts:migrpfx=multiple
chg-gsmopts:sridnnotfound=srinack
chg-gsmopts:dfmcc=214:dfmnc=34
```



```
chg-gsmopts:msrndig=rnasd

chg-
gsmopts:on=eirimsichk,eirimsiscrn,eirlogwl,eirdfltimsiscrn:eirr
sptype=type2:

eirgrsp=blk1st

chg-
gsmopts:on=encodecug,encodenps,srismgrnrtg:off=eirimsichk,eirim
siscrn,eirlogwl,

eirdfltimsiscrn:crptt=50

chg-gsmopts:on=encdnpsptnone,encdnpsdnotfound

chg-
gsmopts:maplyrrtgon=regss,actss,sriloc:maplyrrtgooff=dactss,rstd
ata

chg-gsmopts:eirdfltimsilkup=range

chg-gsmopts:eirdfltimsiresp=whitelist

chg-gsmopts:srirdctent=grn

chg-gsmopts:ownnetworksetname=cdgta1
```

### Dependencies

At least one parameter must be specified.

The G-Flex feature must be turned on before the `defmnc`, `ccnc`, or `mccmnc` parameter can be specified.

The G-Port or IGM feature must be enabled before the `srfaddr`, `msrndig`, `msrnnai`, `sridn`, `msisdntrunc`, `migrpfx`, `gsm2is41`, or `serverpfx` parameter can be specified and before a value of `encodecug`, `encodenps`, `srismgrnrtg`, `encdnpsptnone`, or `encdnpsdnotfound` can be specified for the `on` or `off` parameter.

An `is412gsm` parameter value must exist in the database before the `serverpfx` parameter can be specified.

The `serverpfx=none` parameter must be specified before the `is412gsm=none` parameter can be specified.

The EIR feature must be turned on before the `eirgrsp`, `eirrstype`, `eirimsichk`, `eirdfltimsilkup`, or `eirdfltimsiresp` parameters can be specified and before the `eirimsichk`, `eirimsiscrn`, `eirlogwl` or `eirdfltimsiscrn` options can be specified for the `on` or `off` parameter.

The `ccnc` and `mccmnc` parameter values must be specified together in the command.

A maximum of 10 `ccnc` records can exist in the database.

The value specified for the `ccnc` parameter cannot already exist in the database unless the `mccmnc=none` parameter is specified.

The `srfaddr`, `srfnai`, and `srfnp` parameters must be specified together in the command.

The `msrnnai` and `msrnnp` parameters must be specified together in the command.

The value specified for the `ccnc` parameter must already exist in the database if the `mccmnc=none` parameter is specified.

A maximum of 10 entries can be defined in the multiple country code list (in addition to the STP options `defcc` value).

A multiple country code cannot be entered when the STP options `defcc` value is none. A `defcc` value must first be defined before the first multiple country code can be entered. See the `chg-stpopts` command.

The value specified for the `nmultcc` parameter cannot already exist in the multiple country code list.

If the `multcc` and `nmultcc` parameters are specified to change the `multcc` value to the `nmultcc` value, then the `multcc` value must already exist in the multiple country code list.

The specified `multcc` and `nmultcc` values cannot already be defined as the STP options `defcc` parameter value.

The STP Options table is corrupt or cannot be found.

The IGM feature must be enabled before the `is412gsm`, `gsm2is41`, or `migrpfx` parameter can be specified.

The G-Port, IGM, MO SMS ASD, MO SMS B-Party Routing, MO SMS GRN, MO SMS IS41-to-GSM Migration, MO-based GSM SMS NP, or Prepaid SMS Intercept Ph1 feature must be enabled, or the G-Flex, EIR, or V-Flex feature must be turned on before this command can be entered.

The G-Port or IGM feature must be enabled or the V-Flex feature must be turned on before the `multcc` and `nmultcc` parameters can be specified.

The G-Flex MAP Layer Routing feature must be enabled and turned on before the `gflexmaplayerrtg`, `maplyrrtgon`, or `maplyrrtgoff` parameter can be specified.

The G-Flex or G-Port feature must be turned on or the MT-Based GSM SMS NP or IGM feature must be enabled before the `defm` or `cc` parameter can be specified.

If the MT-Based GSM SMS NP feature is turned on, then the `defmcc=none` parameter cannot be specified.

The `nmultcc` and `multcc` parameters must be specified together in the command.

If the `multcc` parameter is specified to enter a new value in the multiple country list, then the specified value cannot already exist in the list.

The IGM or MO SMS IS41-to-GSM Migration feature must be enabled before the `is412gsm` parameter can be specified.

The G-Port feature must be enabled before the `sridnnotfound` parameter can be specified.

The G-Port feature must be turned on before the `migrpfx=multiple` parameter can be specified.

The EGLEOPTS table is corrupt or cannot be found.

The G-Port, IGM, MO SMS ASD, MO SMS B-Party Routing, MO SMS GRN, MO-based GSM SMS NP, or Prepaid SMS Intercept Ph1 feature must be enabled before the `defmapvr` parameter can be specified.

The G-Port SRI Query for Prepaid feature must be enabled before the `dfltrn` parameter can be specified.

The S-Port and G-Port SRI Query for Prepaid features must be enabled before the `sporttype` parameter can be specified.

The G-Flex feature must be turned on or the G-Port or IGM feature must be enabled before the `ccnc` and `mccmnc` parameters can be specified.

The G-Flex feature must be turned on or the G-Port or IGM feature must be enabled before the `ccnc` and `mccmnc` parameters can be specified.

The MNP Circular Route Prevention feature must be turned on before the `crptt` parameter can be specified.

The `eirimsichk` parameter and the `on` or `off` parameter cannot be specified together in the command.

The same value cannot be specified for the `on` and `off` parameters.

The same MAP operation cannot be specified by the `maplyrrtgon` and `maplyrrtgoff` parameters in the same command.

If the `all` MAP operation is specified for the `maplyrrtgon` or `maplyrrtgoff` parameter, then no other operation can be specified for these parameters in the same command.

If the `maplyrrtgon=all` parameter is specified, then the `maplyrrtgoff` parameter cannot be specified in the same command.

If the `maplyrrtgoff=all` parameter is specified, then the `maplyrrtgon` parameter cannot be specified in the same command.

The GSM MAP SRI Redirect feature must be enabled before the `srirdctent` parameter can be set to `grn` or `sp`.

## Notes

The `sriddn` parameter can be used with the G-Port feature only or with the G-Port feature and the MNP Circular Route Prevention feature. Refer to *G-Port User's Guide* for more information.

If the IGM feature was turned on prior to upgrade to Release 36.0, then the migration prefix is hard-coded to a value of *multiple*. After upgrade, if the `chg-gsmopts:migrpfx=single` command is used to change the migration prefix to *single*, then the G-Port feature must be turned on before the migration prefix can be changed back to *multiple* (`chg-gsmopts:migrpfx=multiple`).

In 39.2.4, the `gflexmaplayerrtg` values changed from *off/on* to *none/imsi/msisdnl/all*. The value *off* was changed to *none*. The value *on* was changed to *imsi*. The message processing did not change, just the text description that is displayed to the user. The numeric values did not change, so no upgrade is necessary.

SRIRDCTENT is a system-wide option that can be set to use either the Intra Network Number Portability feature or the GSM MAP SRI Redirect feature.

**on/off options**

- *eirimsichk* —Specifies the use of the Equipment Identity Register (EIR) IMSI Check status. This option is not valid for IMEI ranges. This option has a default of OFF.
- *encodecug* —Specifies whether the Closed User Group (CUG) Checkinfo from the SRI message is included in the SRI Ack message. This option has a default of OFF.
- *enodenps* — Specifies whether the Number Portability Status Indicator (NPSI) is included in SRI Ack messages when the portability type (PT) has a value of 0, 1, 2 or 36. This option has a default of ON.
- *srismgtrtg* —Specifies whether the SRI\_SM routing feature is on. This option has a default of OFF.
- *encdnpsptnone* —Specifies whether the NPSI is included in SRI Ack messages when the PT has a value of *none* (255). This option has a default of OFF.
- *encdnpsdnotfound* —Specifies whether the NPSI is included in SRI Ack messages when the DN is not found. This option has a default of OFF.
- *eirimsiscrn* ---- Specifies the use of Equipment Identity Register (EIR) IMSI screening status. This option specifies whether the IMSI Screening shall be done before the IMEI check. This option has a default of OFF.
- *eirlogwl* ---- Specifies the use of Equipment Identity Register (EIR) white list logging status. This option specifies whether the white list logging for EIR shall be on. This option has a default of OFF.
- *eirdflimsiscrn* ---- Specifies the use of Equipment Identity Register (EIR) default IMSI screening status. This option specifies whether the default IMSI screening shall be on. This option has a default of OFF.

**MAP Operations Supported by the maplyrrtgon and maplyrrtgooff Parameters**

The `maplyrrtgon` and `maplyrrtgooff` parameters are used to turn G-Flex MLR on and off, respectively, for the following MAP operations:

- *regss* : *registerSS* —Register Supplementary Service
- *actss* : *activateSS* —Activate Supplementary Service
- *dactss* : *deactivateSS* —Deactivate Supplementary Service
- *intss* : *interrogateSS* —Interrogate Supplementary Service
- *authfailrpt* : *authenticationFailureReport* —Authentication Failure Report
- *rstdata* : *restoreData* —Restore Data
- *procunstrqt* : *processUnstructuredSS-Request* —Process Unstructured SS Request
- *rdyforism* : *readyForSM* —Ready For Short Message
- *purgmobss* : *purgeMS* —Purge Mobile Subscriber
- *sriloc* : *sendRoutingInfoForLCS* —Send Routing Information for Location Service

**Output**

```
chg-gsmopts:msrnnai=1:msrnp=1:msrndig=ccrngrndn:defmapvr=2
```

```
tekelecstp 09-05-05 12:28:07 EST EAGLE 41.1.0
```

```
CHG-GSMOPTS: MASP A - COMPLTD
;

chg-gsmopts:srirdctent=grn

tekelecstp 14-05-30 16:39:41 EST EAGLE 46.1.0
CHG-GSMOPTS: MASP A - COMPLTD
;
```

### Related Topics

- [chg-gsmsmsopts](#)
- [rtrv-gsmopts](#)
- [rtrv-gsmsmsopts](#)

## chg-gsms-opcode

Use this command to change the attributes of the GSM (Global System for Mobile Telecommunication) MAP (mobile application part) screening operation codes. The command allows you to change the default screening action and the operation-code name for a specific operation code.

### Parameters



#### Note:

See [Point Code Formats and Conversion](#) for a detailed description of point code formats, rules for specification, and examples.

#### **opname (mandatory)**

Operation code name. The user-defined name for the operation code.

#### **Range:**

*ayyyyyyy*

1 alphabetic character followed by up to 7 alphanumeric characters

#### **force (optional)**

Check Mated Application Override. This parameter is used to complete command execution if the *npc/npca/npci/npcn/npcn24* and *nssn* parameter combination specified in the command is not already defined in the SCCP Application entity set (Remote Point Code/Mated Application Table).

#### **Range:**

*yes*

*no*

#### **Default:**

*no*

**ndfltact (optional)**

New default screening action.

**Range:*****pass***

Route the message as normal to the destination; a UIM will be issued. This is intended to be a test mode and is recommended when setting up GSM Map Screening during the initial phase to assure that no MSUs will be inadvertently thrown away.

***discard***

Do not route the MSU. The MSU is discarded (thrown away) and an appropriate UIM is issued.

***atierr***

Do not route the MSU. An ATI (Any Time Interrogation) reject message is generated to the originator. This value is valid only for ATI MAP operation codes.

***route***

Route the message as normal to the original destination node; no UIM will be generated. The original destination is the node to which normal GTT would be sent if no GSM MAP actions are taken.

***forward***

Route the original message to the forward node. The original message will not be sent to the original node. If, however, the forward node is not available for routing, the MSU is routed to the original node.

***duplicate***

Route the message as normal to the original destination and route a copy of the original message to the duplicate node. If the MSU fails to route to the duplicate node, a UIM is generated indicating the duplicate routing failure.

***dupdisc***

Route the original message to the duplicate node. The original message will not be sent to the original node. If, however, the duplicate node is not available for routing, the MSU is discarded.

**Default:**

No change to the current value

**nmapset (optional)**

New MAP set ID.

**Range:**

1 - 36000, *dflt*  
*dflt* —Default MAP set

**nopname (optional)**

New operation code name.

**Range:**

*ayyyyyyy*  
1 alphabetic character followed by up to 7 alphanumeric characters

**Default:**

No change to current value

**npc (optional)**

ANSI point code with subfields *network indicator-network cluster-network cluster member (ni-nc-ncm)*.

**Synonym:**

*npca*

**Range:**

000-255

Specify a valid value for each subfield of the point code, and separate the subfields with a dash (-).

When *chg-sid:pctype=ansi* is specified, *ni = 000* is not valid.

When *chg-sid:pctype=ansi* is specified, *nc = 000* is not valid if *ni = 001–005*.

When *chg-sid:pctype=ansi* is specified, *nc = 000* is valid if *ni = 006–255*.

The point code *000-000-000* is not a valid point code.

**npc/npca/npci/npcn/npcn24 (optional)**

New point code. The *npc/npca/npci /npcn/npcn24* and *nssn* parameters are used when the default screening action (*dflttact*) is *forward*, *duplicate*, or *dupdisc* (duplicate and discard). These parameters allow the user to change the defined node to which the input message will be routed.

**npci (optional)**

New ITU international point code with subfields *zone-area-id*. The *prefix* subfield indicates a spare point code (*prefix-zone-area-id*).

**Range:**

*s-*, 0-255

Specify a valid value for each subfield of the point code, and separate the subfields with a dash (-).

*prefix—s*

*zone—0-7*

*area—000-255*

*id—0-7*

The point code *0-000-0* is not a valid point code.

**npcn (optional)**

New ITU national destination point code in the format of a 5-digit number (*nnnnn*); or 2, 3, or 4 numbers (members) separated by dashes (*m1-m2-m3-m4*) as defined by the *chg-stpopts:npcfmti* flexible point code option. A group code must be specified when the ITUDUPPC feature is turned on (*nnnnn-gc*, *m1-m2-m3-m4-gc*). The *prefix* subfield indicates a spare point code (*prefix-nnnnn*, *prefix-nnnnn-gc*, *prefix-m1-m2-m3-m4*, *prefix-m1-m2-m3-m4-gc*).

**Range:**

*s-*, 0-16383, *aa-zz*

Specify a valid value for each subfield of the point code, and separate the subfields with a dash (-).

*prefix—s-*

*nnnnn—0-16383*

*gc—aa-zz*

*m1-m2-m3-m4—0-14* for each member; values must sum to 14

**npcn24 (optional)**

New 24-bit ITU national point code with subfields *main signaling area-sub signaling area-signaling point* (*msa-ssa-sp*).

**Range:**

000-255

Specify a valid value for each subfield of the point code, and separate the subfields with a dash (-).

*msa—000–255*

*ssa—000–255*

*sp—000–255*

**nri (optional)**

New routing indicator. This parameter specifies whether a subsequent global title translation is required.

**Range:**

*gt*

*ssn*

**nssn (optional)**

New Subsystem Number.

**Range:**

2 - 255

**Default:**

No change to the existing value

**ntt (optional)**

New translation type. This parameter specifies the value that the CdPA TT is set to as the result of Enhanced GSM Map Screening.

**Range:**

0 - 255

**Default:**

No change to the existing value

**Example**

```
chg-gsms-opcode:opname=ati:ndfltact=atierr
```

```
chg-gsms-  
opcode:opname=ati:ndfltact=forward:npci=1-1-1:nssn=5:force=yes
```

```
chg-gsms-opcode:opname=xyz:npca=9-9-9:nssn=3
```

```
chg-gsms-opcode:opname=test2:npci=s-1-1-1
```

```
chg-gsms-  
opcode:opname=test2:ndfltact=dupdisc:npci=1-1-1:nssn=5:nmapset=8
```

```
chg-gsms-  
opcode:opname=ts4:ndfltact=forward:npc=1-1-2:nssn=5:nmapset=df1t
```

```
chg-gsms-opcode:opname=test:nri=ssn
```



```
chg-gsms-opcode:opname=test4:ntt=12
```

### Dependencies

At least one optional parameter must be specified.

If the `ndfltact` parameter is specified, one of the following values must be specified: *pass*, *discard*, *atierr*, *route*, *forward*, *duplicate*, or *dupdisc*.

If the `ndfltact` parameter is specified and its value is *forward*, *duplicate*, or *dupdisc*, the `npc/npca/npci /npcn/npcn24` and `nssn` parameters must be specified.

The word *none* cannot be specified as a value for the `opname` or `nopname` parameter.

If the `npc/npca/npcinpcn/npcn24` and `nssn` parameters are specified with the `ndfltact` parameter, the `ndflact` parameter must have a value of *forward*, *duplicate*, or *dupdisc*.

The `npc/npca/npci/npcn/npcn24` and `nssn` parameters must be specified before the `force` parameter can be specified.

The value specified for the `opname` parameter must already exist in the GSM Map Op-Code table.

The GSM Map Screening feature must be turned on before this command can be entered.

The EGMS feature must be enabled and turned on before the `npc` or `npca` parameters can be specified.

The `ndfltact=atierr` parameter cannot be specified unless the value of the operation code referenced by the `opcode` parameter is 71. The *atierr* option is valid only for ATI MAP operation codes, and the `opcode=71` parameter signifies an ATI MAP operation code.

The value specified for the `npc/npca/npci/npcn /npcn24` parameter must be a full point code.

The GSM Map Op-Code table must be accessible.

The Route table must be accessible.

If the `npc/npca/npci/npcn/npcn24` parameter and the `nssn` parameter are specified, and the `force` parameter is not specified as *yes*, the PC-SSN must be populated in the SCCP Application entity set (Remote Point Code / Mated Application Table).

If specified, the `npc/npca/npci/npcn/npcn24` parameter value must exist as a destination in the Ordered Route entity set or reside in a cluster (ANSI only) that exists as a destination in the Ordered Route entity set (for global title routing).

If the `opname` parameter is specified, the value must be alphanumeric.

The `opname` parameter value and the `nopname` parameter value must be no more than 8 characters long.

The `nmapset` parameter must be specified if the value of the `ndfltact` parameter is *forward*, *duplicate*, or *dupdisc*.

If the `ndfltact` parameter is specified with the `nmapset`, `nri`, `ntt`, `pc`, or `ssn` parameter, then the `ndfltact` parameter must have a value of *forward*, *duplicate*, or *dupdisc*.

The `nmapset` parameter must be specified before the `force` parameter can be specified.

The Flexible GTT Load Sharing feature must be enabled before the `nmapset` parameter can be specified.

The specified new MAP set must exist.

If the `nmapset=dfmt` parameter is not specified, or the `nmapset=dfmt` parameter is specified, but the `force=yes` parameter is not specified, then the new PC and new SSN must exist in the new MAP set.

If the `nmapset`, `nri`, or `ntt` parameter is specified, and the `ndfltact` parameter is not specified, then the `dfltact` parameter must have a previously provisioned value of *forward*, *duplicate*, or *dupdisc*.

The MAP table must be accessible.

If the value of the `ndfltact` parameter is *forward*, *duplicate*, or *dupdisc*, then the value specified for the `npc/npca/npci/npcn/npcn24` parameter cannot be associated with a proxy point code.

If the `nri=ssn` parameter is specified, then the `ssn=none` parameter cannot be specified.

If the Flexible GTT Load Sharing feature is enabled, and the new or previously provisioned subsystem number has a value of *none*, then the new or previously provisioned MAP set and point code combination must already exist in the MAP table.

If the Flexible GTT Load Sharing feature is not enabled, and the new or previously provisioned subsystem number has a value of *none* (the `nssn=none` parameter is specified in this command, or the `ssn=none` parameter was specified in the `ent-gsms-opcode` command), then the point code must already exist in the MAP table.

## Notes

In this command, only ITU-international and ITU national point codes support the spare point code subtype prefix (s-).

## Output

```
chg-gsms-opcode:opname=test4:ntt=12
```

```
tekelecstp 08-08-20 19:13:01 EST EAGLE 39.2.0
CHG-GSM-OPCODE: MASP A - COMPLTD
;
```

## Related Topics

- [dlt-gsms-opcode](#)
- [ent-gsms-opcode](#)
- [rtv-gsms-opcode](#)

## chg-gsmsmsopts

Use this command to enter GSM SMS system options in the database. This command updates the GSMSMSOPTS table.

### Parameters

#### **bpartygttsn (optional)**

MO SMS B-Party Routing GTT Set name. The GTT set where Global Title Translation lookup on B-Party digits is performed.

**Range:**

ayyyyyyy

1 alphabetic character followed by up to 8 alphanumeric characters.

**Default:**

No change to the current value

**System Default:**

none

#### **defis41smc (optional)**

Default IS41 short message service center. The default SMSC where an SRI\_SM message received for an own network IS41 subscriber is relayed.

**Range:**

1-15 digits, *none*

**Default:**

No change to the current value

**System Default:**

*none*

#### **defrn (optional)**

Default routing number. A default routing number used for own-network subscribers.

**Range:**

1-15 digits, *none*

Valid digits are 0-9, a-f, A-F

**Default:**

No change to the current value

**System Default:**

*none*

#### **igsmsrelay (optional)**

IGM - based SMS relay. This parameter specifies whether IGM relays an SRI\_SM message that is received for an own network IS41 subscriber to a default SMSC or sends an SRI\_SM-NACK error message.

**Range:****yes**

IGM relays the message to the default SMSC

**no**

IGM sends an SRI\_SM-NACK

**Default:**

No change to the current value

**System Default:**

*no*

**is41smscgtsn (optional)**

IS41 SMSC GTT Set name. The GTT set where Global Title Translation lookup on default IS41 SMSC digits is performed.

**Range:**

*ayyyyyyy*

1 leading alphabetic and up to 8 following alphanumeric characters.

**Default:**

No change to the current value

**mosmsaclen (optional)**

The number of the digits that are taken from the MO SMS CgPA and used as the Area Code in the MO SMS CdPA.

**Range:**

*0 - 8*

**Default:**

No change to the current value

**System Default:**

*0*

**mosmsdigmat (optional)**

MO-based SMS Home SMSC match. The method used by the Portability Check for MO SMS or the MO-based GSM SMS NP feature to find a Home SMSC match.

**Range:****exact**

The system searches for an exact match of digits in the HomeSMSC Table.

**bestfit**

The system searches for a match on the leading digits of an incoming message with any provisioned entry in HomeSMSC table if an exact match is not found.

**Default:**

No change to the current value

**System Default:**

*exact*

**mosmsfwd (optional)**

MO-based SMS forward. This parameter specifies whether the value of the SCCP CDPA in the MO-based SMS message is modified to the GTA value that is specified by the `mosmsgta` parameter.

**Range:****yes**

The SCCP CDPA value is modified.

**no**

The SCCP CDPA value is not modified.

This parameter must be specified before the `mosmsfwd=yes` parameter can be specified.

**Default:**

No change to the current value

**System Default:**

*no*

**mosmsgta (optional)**

MO-based SMS GTA. The GTA value that is used to replace the SCCP CDPA value in the MO-based SMS message.

**Range:**

5-21 digits, *none*

**Default:**

No change to the current value

**System Default:**

*none*

**mosmsgttdig (optional)**

MO SMS B-Party Routing GTT digits. The digits used for Global Title Translation.

**Range:****sccpcdpa**

The SCCP CdPA is used for GTT

**mapbparty**

The MAP B-Party number is used for GTT

**Default:**

No change to the current value

**System Default:**

*sccpcdpa*

**mosmsnai (optional)**

MO-based SMS NAI. The number conditioning performed on the SMS message destination address before lookup in the number portability database is performed.

**Range:*****intl***

Number is treated as INTL (1) for number conditioning

***nai***

The NAI from the SMS message is used to perform number conditioning

***nat***

Number is treated as NATL (2) for number conditioning

***unknown***

Number is treated as UNKNOWN (0) for number conditioning

A value of *nai* must be specified before the *intl*, *natl*, *nai1*, *nai2*, *nai3*, and *unkn* parameters in the *chg-npp-serv* command can be changed to non-default values for the MOSMSGCDPN service.

**Default:**

No change to the current value

**System Default:**

*intl*

**mosmssa (optional)**

MO-based SMS sub-address. This parameter specifies whether the sub-address is searched in the SMS called party (destination address).

**Range:*****yes***

Sub-address is searched in the SMS called party.

***no***

Sub-address is not searched in the SMS called party.

**Default:**

No change to the current value

**System Default:**

*no*

**mosmstcapseg (optional)**

MO-based SMS TCAP Segmentation for GSM. This parameter specifies whether Mobile-Originated segmented TCAP messages are supported.

**Range:*****on***

Segmented messages are supported.

***off***

Segmented messages are not supported.

**Default:**

No change to the current value

**System Default:***off***mosmstype (optional)**

MO-based SMS type. The value of the entity type that indicates that a successful lookup occurred in the number portability database.

**Range:*****sp***

signaling point

***rn***

routing number

***sprn***Lookup is successful if the value of the entity type is *sp* or *rn*.***all***Lookup is successful if the value of the entity type is *sp* or *rn*, or if no entity type is found.**Default:**

No change to the current value

**System Default:***sprn***mtmmsackn (optional)**

MT-Based MMS acknowledgement. The message that is generated in response to a successful number portability database lookup for an SRI\_SM message from a Home MMSC.

**Range:*****ack***

SRI\_SM\_ACK message

***nack***

SRI\_SM\_NACK (Return Error) message

**Default:**

No change to the current value

**System Default:***ack***mtmmsentylen (optional)**

MT-Based MMS Entity length. The maximum number of digits used from the entity value of a returned RN, SP, or SRFIMSI entity for Multimedia Service (MMS) processing.

**Range:***1 - 15, none**none* —all digits from the entity value are used

**Default:**  
No change to the current value

**System Default:**  
*none*

**mtmmsgta (optional)**

MT-Based MMS GTA. The GTA that is compared with the SCCP CgPA GTA of an SRI\_SM message to determine whether the originator of the message is a Home MMSC.

**Range:**  
5-21 digits, *none*  
Valid digits are 0-9, a-f, A-F  
*none* —Deletes the current value of the `mtmmsgta` parameter.

**Default:**  
No change to the current value

**System Default:**  
*none*

**mtmmslen (optional)**

MT-Based MMS Length. The maximum number of digits used in the returned IMSI and/or NNI fields for MMS processing.

**Range:**  
1 - 24, *none*  
*none* —all digits from the fields are used

**Default:**  
No change to the current value

**System Default:**  
*none*

**mtmmstype (optional)**

MT-Based MMS type. The value of the entity type that indicates that a successful lookup occurred in the number portability database.

**Range:**

- sp**  
signaling point
- rn**  
routing number
- sprn**  
**sporn**
- all**  
**sp, rn,** or DN with no entity
- nonsp**  
**rn** or DN with no entity



**Default:**

No change to the current value

**System Default:**

*m*

**mtsmsackn (optional)**

MT-Based SMS acknowledgement. The message generated in response to a successful number portability database lookup for an SRI\_SM message from a Home SMSC.

**Range:*****ack***

SRI\_SM\_ACK message

***nack***

SRI\_SM\_NACK (Return Error) message

**Default:**

No change to the current value

**System Default:**

*ack*

**mtsmschksrc (optional)**

MT-Based SMS check source. This parameter specifies whether the SCCP CgPA GTA of a SRI\_SM message is validated to determine if the source of the message is a Home SMSC.

**Range:*****yes***

The SCCP CgPA GTA of an SRI\_SM message is validated

***no***

The SCCP CgPA GTA of an SRI\_SM message is not validated

If the `mtsmschksrc=yes` parameter is specified, and if the incoming SRI\_SM message has SCCP CgPA GTA, then the SCCP CgPA GTA must be found in the Home SMSC list for the source of the message to be considered a Home SMSC. If the message is not found in the Home SMSC list, then the MT-Based GSM SMS NP feature does not process the message.

If the `mtsmschksrc=no` parameter is specified, or if SCCP CgPA GTA does not exist in the incoming message, then the source of the message is considered to be a Home SMSC, and the MT-Based GSM SMS NP feature considers the message for processing.

**Default:**

No change to the current value

**System Default:**

*no*

**mtsmsdltr (optional)**

MT-Based SMS delimiter. This parameter specifies whether to insert a delimiter digit string before or after the routing number (RN) if the RN is used in the outbound digit format.

**Note:**

The delimiter string that is inserted is determined by the `mtsmsdltrv` parameter.

**Range:*****no***

A delimiter digit string is not inserted

***prern***

A delimiter digit string is inserted before the RN

***postrn***

A delimiter digit string is inserted after the RN

**Default:**

No change to the current value

**System Default:**

*no*

**mtsmsdltrv (optional)**

MT-Based SMS delimiter value. The delimiter digit string that is inserted before or after the RN when the RN is used in the outbound digit format.

**Range:**

1-5 digits, *none*

Valid digits are *0-9, a-f, A-F*

**Default:**

No change to the current value

**System Default:**

*none*

**mtsmsimsi (optional)**

MT-Based SMS IMSI. The required format of digits that are encoded in the "IMSI" parameter of the SRI\_SM response message.

**Range:*****rn***

routing number

***rndn***

routing number and the international dialed or directory number

***ccrndn***

country code, routing number, and national directory or dialed number

**dn**  
directory or dialed number

**srfimsi**  
IMSI is encoded as the “SRFIMSI” parameter from the number portability database

**mccrndn**  
mobile country code, routing number, and directory or dialed number

**Default:**  
No change to the current value

**System Default:**  
*mccrndn*

**mtsmsnakerr (optional)**  
MT-Based SMS negative acknowledgement error. The TCAP error choice code used in the NACK response message generated for SRI\_SM messages.

**Range:**  
0 - 255

**Default:**  
No change to the current value

**System Default:**  
1

**mtsmsnni (optional)**  
MT-Based SMS network node indicator. The required format of digits that are encoded in the “Network Node Number” parameter of the SRI\_SM response message.

**Range:**

**rn**  
routing number

**rndn**  
routing number and the international dialed or directory number

**ccrndn**  
country code, routing number, and national directory or dialed number

**dn**  
Directory or Dialed Number

**srfimsi**  
IMSI is encoded as the “SRFIMSI” parameter from the number portability database

**mccrndn**  
mobile country code, routing number, and directory or dialed number

**none**

The Network Node Number parameter is not encoded in the response message

**Default:**

No change to the current value

**System Default:**

*rn*

**mtsmstype (optional)**

MT-Based SMS type. The value of the entity type that indicates that a successful lookup occurred in the number portability database for messages that are modified by the MT-Based GSM SMS NP feature.

**Range:*****sp***

signaling point

***rn***

routing number

***sprn***

***sporn***

***all***

***sp, rn***, or DN with no entity

***nonsp***

***rn*** or DN with no entity

**Default:**

No change to the current value

**System Default:**

*rn*

**spfill (optional)**

This parameter specifies whether the Numbering Plan Processor (NPP) can populate SP and RN entities for own network subscribers at the same time.

**Range:*****off***

Do not populate the RN and SP entities at the same time

***on***

Allow population of the RN and SP entities at the same time

**Default:**

No change to the current value

**System Default:**

*off*

**sporttype (optional)**

Service Portability type. This parameter specifies whether Service Portability is performed for the associated feature.

The S-Port feature must be enabled before this parameter can be specified. The S-Port feature must be turned on before any change to the parameter will impact the associated feature.

If Service Portability is performed, then the Service Portability prefix (RTDB 'GRN'entity id) is applied.

**Range:*****gsm***

apply Service Portability prefix for own-network GSM subscribers

***is41***

apply Service Portability prefix for own-network IS41 subscribers

***all***

apply Service Portability prefix for all own-network (IS41 and GSM) subscribers

***none***

Service Portability is not performed

**Default:**

No change to the current value

**System Default:**

*none*

**srismdn (optional)**

SRI\_SM DN location. This parameter specifies whether the MT-Based GSM SMS NP feature selects the MSISDN from the TCAP or SCCP CdPA section of the SRI\_SM message.

**Range:*****sccp***

select the MSISDN from the SCCP CDPA section

***tcap***

select the MSISDN from the TCAP section

**Default:**

*sccp*

**Example**

```
chg-gsmsmsopts:mosmsnai=intl:mosmstype=sp:mosmssa=no
```

```
chg-gsmsmsopts:mosmsfwd=no:mosmsgta=987654321
```

```
chg-gsmsmsopts:srismdn=tcap
```

```
chg-gsmsmsopts:mtsmsackn=nack:mtsmsdltr=no:mtsmsdltrv=125:mtsmschksrc=no
```

```
chg-  
gsmsmsopts:mtmsgta=51111:mtmstype=sp:mtmsackn=nack:mtmmsentlen=7  
:mtmmslen=10  
  
chg-gsmsmsopts:mosmsdigmat=bestfit  
  
chg-gsmsmsopts:bpartygttsn=setint001:mosmsgtttdig=mapbparty  
  
chg-gsmsmsopts:mosmsaclen=4  
  
chg-gsmsmsopts:mosmstcapseg=on
```

### Dependencies

At least one parameter must be specified.

The Hex Digit Support for GTT feature must be enabled before a hexadecimal value for the `mosmsgta` parameter can be specified.

The `mosmsgta` parameter must be specified before the `mosmsfwd=yes` parameter can be specified.

The `mtsmsdltrv` parameter must be provisioned before a value of `prern` or `postrn` can be specified for the `mtsmsdltr` parameter.

The value specified for the `bpartygttsn` or `is41smscgtsn` parameter must match the name of an existing GTT Set.

The `mosmsgtttdig=scpcdpa` parameter must be specified before the `bpartygttsn=none` parameter can be specified.

The GTT set specified for the `bpartygttsn` or `is41smscgtsn` parameter must have `settype=cdgta` (see the `ent-gttset` command).

If the `bpartygttsn=none` parameter is specified, then the `mosmsgtttdig=mapbparty` parameter cannot be specified.

The GTT Set table is corrupt or cannot be found.

The EGLEOPTS table is corrupt or cannot be found.

The MO-based GSM SMS NP, MO SMS ASD, or MO SMS GRN feature must be enabled before the `mosmsfwd` or `mosmsgta` parameter can be specified.

The Portability Check for MO SMS feature or the MO-based GSM SMS NP feature must be turned on before the `mosmsdigmat` or `mosmstcapseg` parameter can be specified.

The MT-Based GSM SMS NP feature must be enabled before the `mtsmsimsi`, `mtsmsnni`, `mtsmstype`, `mtsmsackn`, `mtsmsdltr`, `mtsmsdltrv`, `mtsmsnakerr`, `mtsmschksrc`, or `srismdn` parameter can be specified.

The MT-Based GSM MMS NP feature must be enabled before the `mtmsgta`, `mtmstype`, `mtmsackn`, `mtmmsentlen`, or `mtmmslen` parameter can be specified.

The MO SMS B-Party Routing feature must be enabled before the `bpartygttsn` or `mosmsgtttdig` parameter can be specified.

The MO-based GSM SMS NP feature must be enabled before the `mosmstype`, `defrn`, or `spfill` parameter can be specified.

The MO SMS ASD, MO SMS GRN, MO-based GSM SMS NP, or Prepaid SMS Intercept Phase 1 feature must be enabled before the `mosmsaclen`, `mosmsnai`, or `mosmssa` parameter can be specified.

If a digit string value has already been specified for the `mosmsgta` or `mtsmsdltrv` parameter, then a value of *none* cannot be specified subsequently for that parameter.

The IS41 GSM Migration feature must be turned on before the `igmsmsrelay`, `is41smscgttsn`, or `defis41smssc` parameter can be specified.

If the `defis41smssc=none` parameter is specified, then the `igmsmsrelay=yes` parameter cannot be specified.

If the `defis41smssc` parameter has a value other than *none*, then the `is41smscgttsn=none` parameter cannot be specified.

The S-Port feature must be enabled before the `sporttype` parameter can be specified.

The EGTT feature must be turned on before the `is41smscgttsn` parameter can be specified.

### Notes

The `mosmstcapseg` parameter is turned off automatically if the Portability Check for MO SMS feature is turned off or the temporary FAK for the feature expires, and the MO-based GSM SMS NP feature is not enabled.

### Output

```
chg-
gsmmssopts:is41smscgttsn=set1:defis41smssc=1234:igmsmsrelay=yes
```

```
tekelecstp 09-06-08 18:52:54 EST EAGLE 41.1.0
CHG-GSMSMSOPTS: MASP A - COMPLTD
```

```
;
```

### Related Topics

- [chg-gsmopts](#)
- [rtrv-gsmopts](#)
- [rtrv-gsmmssopts](#)

## chg-gta

Use this command to change the global title address information (GTA) for applicable global title selectors required to specify a global title entry.

This command changes the routing objects for messages requiring global title translations. The specified point code, subsystem number, MRN set ID, and routing indicator overwrite the existing data values.

When the Intermediate GTT Load Sharing feature and the Flexible GTT Load Sharing feature are both on, multiple relationships can be defined among a set of destination point codes in the existing MRN table. The relationship used in a particular translation

is based on the GTA digits used for translation. The MRN Set ID and the post-translation PC create a key that is used to perform a lookup in the MRN table. This lookup results in a set of alternate PCs from which a PC is selected, based on relative cost, to route the MSU in most cost-effective way.

 **Note:**

If the EGTT feature is turned on, then the GTT Selector (`ent/chg/dlt/rtrvgtttsel`), GTT Set (`ent/dlt/rtrv-gttset`), and GTA (`ent/chg/dlt/rtrvgta`) commands replace the Translation Type (`ent/dlt/rtrv-tt`) and Global Title Translation (`ent/chg/dlt/rtrv-gtt`) commands. It is not recommended to run `ent/dlt/rtrv-tt & ent/chg/dlt/rtrv-gtt` commands as it may cause the advance GTA fields of GTT entry to be reset to the default values.

## Parameters

 **Note:**

See [Point Code Formats and Conversion](#) for a detailed description of point code formats, rules for specification, and examples.

### **gttsn (mandatory)**

GTT set name. A GTT set is an entity to which global title addresses and selectors are assigned.

**Range:**

*ayyyyyyy*

1 leading alphabetic character followed by up to 8 following alphanumeric characters

### **acn (optional)**

Application context name. The ITU TCAP ACN field in the incoming MSU.

**Range:**

*0 - 255, \*, none*

The ACN supports up to 7 subfields separated by a dash (e.g.,

*1-202-33-104-54-26-007*).

*\** —any valid value in the ITU TCAP ACN field in the incoming MSU

*none* —there is no ITU TCAP ACN field in the incoming MSU

**Default:**

No change to the current value

### **actsn (optional)**

GTT Action Set Name.

**Range:**

*ayyyyyyy*

1 leading alphabetic character followed by up to 8 alphanumeric characters

*none* -Action set name does not point to any action set



**ccgt (optional)**

Cancel called global title indicator.

**Range:**

*yes*

*no*

**Default:**

No change to the current value

**cdselid (optional)**

CdPA selector ID.

**Range:**

*0 - 65534, none*

*none* —deletes the current value of the *CDSELID* field

**Default:**

No change to the current value

**cdssn (optional)**

Starting CdPA subsystem number.

**Range:**

*0 - 255*

**cgcnvsn (optional)**

Calling party conversion set name.

**Range:**

*ayyyyyyy*

1 leading alphabetic character and up to 8 following alphanumeric characters.

*none* —deletes the current value of the parameter

**cggtmod (optional)**

Calling party GT modification indicator. This parameter specifies whether calling party global title modification is required.

**Range:**

*yes*

*no*

**Default:**

*no*

**cgpc (optional)**

ANSI CgPA point code with subfields *network indicator-network cluster-network cluster member (ni-nc-ncm)*.

**Synonym:**

*cgpca*

**Range:**

0-255, \*

Specify a valid value for each subfield of the point code, and separate the subfields with a dash (-).

The asterisk (\*) value is not valid for the *ni* subfield.

When `chg-sid:pctype=ansi` is specified, *ni=000* is not valid.

When `chg-sid:pctype=ansi` is specified, *nc = 000* is not valid if *ni=001-005*.

When `chg-sid:pctype=ansi` is specified, *nc=000* is valid if *ni=006-255*.

When `chg-sid:pctype=ansi` is specified, *ni-\*-\** is valid if *ni =006-255*.

The point code *000-000-000* is not a valid point code.

**cgpcaction (optional)**

This parameter is used to provide the required abilities, indicating what any particular translation needs to do with CgPA PC.

**Range:***dfit*

protocol will be allowed to perform all the required processing/conversion with CGPC.

*ignore*

CGPC will be left as it was in incoming MSU.

*remove*

CGPC will be removed from outgoing MSU.

**Default:***dfit***cgpci (optional)**

ITU international CgPA point code with subfields *zone-area-id*. The *prefix* subfield indicates a spare point code (*prefix-zone-area-id*).

**Range:***s-, 0-255*

Specify a valid value for each subfield of the point code, and separate the subfields with a dash (-).

*prefix—s**zone—0-7**area—000-255**id—0-7*

The point code *0-000-0* is not a valid point code.

**cgpcn (optional)**

ITU national CgPA point code in the format of a 5-digit number (*nnnnn*); or 2, 3, or 4 numbers (members) separated by dashes (*m1-m2-m3-m4*) as defined by the `chg-stpopts:npcfmti` flexible point code option. A group code must be specified when the ITUDUPPC feature is turned on (*nnnnn-gc*, *m1-m2-m3-m4-gc*). The *prefix* subfield indicates a spare point code (*prefix-nnnnn*, *prefix-nnnnn-gc*, *prefix-m1-m2-m3-m4*, *prefix-m1-m2-m3-m4-gc*).

**Range:***s*-, 0-16383, *aa-zz*

Specify a valid value for each subfield of the point code, and separate the subfields with a dash (-).

*prefix*—*s*-*nnnnn*—0-16383*gc*—*aa-zz**m1-m2-m3-m4*—0-14 for each member; values must sum to 14**cgpcn16 (optional)**16-bit ITU national CgPA point code with subfields *unit number-sub number area-main number area* (*un-sna-mna*).**Range:**

000---127

Specify a valid value for each subfield of the point code, and separate the subfields with a dash (-).

*un*---000---127*sna*--000---15*mna*---000---31**cgpcn24 (optional)**24-bit ITU national CgPA point code with subfields *main signaling area-sub signaling area-signaling point* (*msa-ssa-sp*).**Range:**

000-255

Specify a valid value for each subfield of the point code, and separate the subfields with a dash (-).

*msa*—000–255*ssa*—000–255*sp*—000–255**cgselid (optional)**

Calling party selector ID.

**Range:**0 - 65534, *none**none* —deletes the current value of the *CGSELID* field**Default:**

No change to the current value

**cgssn (optional)**

The subsystem number of the starting CgPA.

**Range:**

0 - 255

**defmapvr (optional)**

Default MAP version for a MAP message. This parameter is used to provide the default MAP version for a MAP message if ACN (Application Context Name) is not present in an incoming MAP message.

**Range:**

v1

v2

v3

**Default**

No change to the current value

**dpc (optional)**

ANSI destination point code with subfields *network indicator-network cluster-network cluster member (ni-nc-ncm)*.

**Synonym:**

dpca

**Range:**

0--255, \*

Specify a valid value for each subfield of the point code, and separate the subfields with dash (-).

The asterisk (\*) value is not valid for the *n* subfield.

When `chg-sid:pctype=ansi` is specified, `ni=000` is not valid.

When `chg-sid:pctype=ansi` is specified, `nc=000` is not valid if `ni=001--005`.

When `chg-sid:pctype=ansi` is specified, `nc=000` is valid if `ni=006--255`.

When `chg-sid:pctype=ansi` is specified, `ni--*--` is valid if `ni=006--225`.

The point code `000---000---000` is not a valid point code.

**dpc/dpca/dpci/dpcn/dpcn24/dpcn16 (optional)**

Point Code.

**dpci (optional)**

ITU international destination point code with subfields *zone-area-id*. The *prefix* subfield indicates a spare point code (*prefix-zone-area-id*).

**Range:**

s-, 0-255

Specify a valid value for each subfield of the point code, and separate the subfields with a dash (-).

prefix—s

zone—0-7

area—000-255

id—0-7

The point code `0-000-0` is not a valid point code.

**dpcn (optional)**

ITU destination point code in the format of a 5-digit number (*nnnnn*); or 2, 3, or 4 numbers (members) separated by dashes (*m1-m2-m3-m4*) as defined by the `chg-stpopts:npcfmti` flexible point code option. A group code must be specified when the ITUDUPPC feature is turned on (*nnnnn-gc*, *m1-m2-m3-m4-gc*). The *prefix* subfield indicates a spare point code (*prefix-nnnnn*, *prefix-nnnnn-gc*, *prefix-m1-m2-m3-m4*, *prefix-m1-m2-m3-m4-gc*).

**Range:**

*s*-, 0-16383, *aa-zz*

Specify a valid value for each subfield of the point code, and separate the subfields with a dash (-).

*prefix*—*s*-

*nnnnn*—0-16383

*gc*—*aa-zz*

*m1-m2-m3-m4*—0-14 for each member; values must sum to 14

**dpcn16 (optional)**

16-bit ITU national destination point code with subfields *unit number-sub number area-main number area* (*un-sna-mna*).

**Range:**

000---127

Specify a valid value for each subfield of the point code, and separate the subfields with a dash (-).

*un*---000---127

*sna*---000---15

*mna*---000---31

**dpcn24 (optional)**

24-bit ITU national destination point code with subfields *main signaling area-sub signaling area-signaling point* (*msa-ssa-sp*).

**Range:**

000-255

Specify a valid value for each subfield of the point code, and separate the subfields with a dash (-).

*msa*—000–255

*ssa*—000–255

*sp*—000–255

**eaddr (optional)**

End Address (Similar to EGTA). This parameter specifies the end of a range of MAP digits (IMEI/IMSI/MSISDN/VLRNB/SMRPOA/SMRPDA).

**Range:**

1--21 digits

If the Hex Digit Support for GTT feature is not enabled, the range is 1 - 21 decimal digits; valid digits are 0-9.

If the Hex Digit Support for GTT feature is enabled and on, the range is 1 - 21 hexadecimal digits; valid digits are 0-9, a-f, A-F.

**Default**

Same as the specified SADDR value

**ecdssn (optional)**

Subsystem number of the ending called party.

**Range:**

0 - 255

**ecgssn (optional)**

Subsystem number of the ending CgPA.

**Range:**

0 - 255

**egta (optional)**

End global title address. The end of a range of global title digits.

**Range:**

1 - 21 digits

If the Hex Digit Support for GTT feature is not enabled, the range is 1-21 decimal digits; valid digits are 0-9.

If the Hex Digit Support for GTT feature is enabled and on, the range is 1 - 21 hexadecimal digits; valid digits are 0-9, a-f, A-F.

**Default:**

Same as the specified *gta* value

**fallback (optional)**

Fallback option. The action that is taken if the last translation doesn't match when performing GTT using a FLOBR-specific GTT mode.

**Range:****yes**

GTT is performed based on the last matched entry

**no**

GTT fails and the MSU is discarded

**sysdfit**

The system-wide default fallback option in the SCCPOPTS table is used.

**Default:**

No change to the current value

**family (optional)**

The ANSI TCAP *FAMILY* field in the incoming MSU.

**Range:**

0 - 255, \*, *none*

\* —any valid value in the ANSI TCAP *FAMILY* field in the incoming MSU

*none* —there is no value in the ANSI TCAP *FAMILY* field in the incoming MSU

**System Default:**

*none*

**force (optional)**

Check mated application override.

**Range:**

*yes*

*no*

**Default:**

*no*

**gta (optional)**

Global title address. The beginning of a range of global title digits.

**Range:**

1 - 21 digits

If the Hex Digit Support for GTT feature is not enabled, the range is 1-21 decimal digits; valid digits are 0-9.

If the Hex Digit Support for GTT feature is enabled and on, the range is 1 - 21 hexadecimal digits; valid digits are 0-9, a-f, A-F.

**gtmodid (optional)**

Global title modification identifier.

**Range:**

*aaaaaaaa*

1 leading alphabetic character followed by up to 8 alphanumeric characters

*none* —removes the association between the translation and the GTMODID

**Default:**

No change to the current value

**loopset (optional)**

SCCP loopset name. This parameter associates a translation set with a loopset.

**Range:**

*aaaaaaaa*

One leading alphabetic character and up to 7 following alphanumeric characters.

*none* —Disassociates the translation set from all loopsets.

**mapset (optional)**

MAP set ID. The Mated Application set ID.

**Range:**

1 - 36000, *dflt*

*dflt* —Default MAP set

**mrnset (optional)**

MRN set ID. The Mated Relay Node set ID.

**Range:**

1 - 3000, *dflt*, *none*

*dflt* —Default MRN set

*none* —The GTA translation does not participate in any load sharing.

**opc (optional)**

ANSI originating point code with subfields *network indicator-network cluster-network cluster member (ni-nc-ncm)*.

**Synonym:**

*opca*

**Range:**

0-255, \*

Specify a valid value for each subfield of the point code, and separate the subfields with a dash (-).

The asterisk (\*) value is not valid for the *ni* subfield.

When *chg-sid:pctype=ansi* is specified, *ni=000* is not valid.

When *chg-sid:pctype=ansi* is specified, *nc = 000* is not valid if *ni=001–005*.

When *chg-sid:pctype=ansi* is specified, *nc=000* is valid if *ni=006–255*.

When *chg-sid:pctype=ansi* is specified, *ni-\*-\** is valid if *ni =006–255*.

The point code *000-000-000* is not a valid point code.

**opci (optional)**

ITU international originating point code with subfields *zone-area-id*. The *prefix* subfield indicates a spare point code (*prefix-zone-area-id*).

**Range:**

*s-*, 0-255

Specify a valid value for each subfield of the point code, and separate the subfields with a dash (-).

*prefix—s*

*zone—0-7*

*area—000-255*

*id—0-7*

The point code *0-000-0* is not a valid point code.

**opc n (optional)**

ITU national originating point code in the format of a 5-digit number (*nnnnn*); or 2, 3, or 4 numbers (members) separated by dashes (*m1-m2-m3-m4*) as defined by the *chg-stpopts:npcfmti* flexible point code option. A group code must be specified when the ITUDUPPC feature is turned on (*nnnnn-gc*, *m1-m2-m3-m4-gc*). The *prefix* subfield indicates a spare point code (*prefix-nnnnn*, *prefix-nnnnn-gc*, *prefix-m1-m2-m3-m4*, *prefix-m1-m2-m3-m4-gc*).

**Range:**

*s-*, 0-16383, *aa-zz*

Specify a valid value for each subfield of the point code, and separate the subfields with a dash (-).

*prefix—s-*

*nnnnn—0-16383*

*gc—aa-zz*

*m1-m2-m3-m4—0-14* for each member; values must sum to 14

**opc n16 (optional)**

16-bit ITU national originating point code with subfields *unit number-sub number area-main number area (un-sna-mna)*.



**Range:**

000---127

Specify a valid value for each subfield of the point code, and separate the subfields with a dash (-).

un---000---127

sna---000---15

mna---000---31

**opc24 (optional)**

24-bit ITU national originating point code with subfields *main signaling area-sub signaling area-signaling point (msa-ssa-sp)*.

**Range:**

000-255

Specify a valid value for each subfield of the point code, and separate the subfields with a dash (-).

msa—000–255

ssa—000–255

sp—000–255

**opcode (optional)**

The TCAP *opcode* field in the incoming MSU.

**Range: 0 - 255, \*, none**

\* —any valid value in the TCAP *OPCODE* field in the incoming MSU.

*none* —there is no value in the TCAP *OPCODE* field in the incoming MSU.

**opcsn (optional)**

The new OPC GTT set name.

**Range:**

ayyyyyyy

1 leading alphabetic character and up to 8 following alphanumeric characters.

**optsn (optional)**

Optional GTT set name.

**Range:**

ayyyyyyy

1 leading alphabetic character and up to 8 following alphanumeric characters.

*none* —deletes the current value of the parameter

**pc (optional)**

ANSI point code with subfields *network indicator-network cluster-network cluster member (ni-nc-ncm)*. The *prefix* subfield indicates a private point code (*prefix-ni-nc-ncm*).

**Synonym:**

pca

**Range:***p-*, 000-255

Specify a valid value for each subfield of the point code, and separate the subfields with a dash (-).

*prefix—p-*When `chg-sid:pctype=ansi` is specified, *ni = 000* is not valid.When `chg-sid:pctype=ansi` is specified, *nc = 000* is not valid if *ni = 001-005*.When `chg-sid:pctype=ansi` is specified, *nc = 000* is valid if *ni = 006-255*.The point code *000-000-000* is not a valid point code.**pci (optional)**ITU international point code with subfields *zone-area-id*. The *prefix* subfield indicates a spare point code, private point code, or private and spare point code (*prefix-zone-area-id*).**Range:***s-*, *p-*, *ps-*, 0-255

Specify a valid value for each subfield of the point code, and separate the subfields with a dash (-).

*prefix—s-*, *p-*, *ps**zone—0-7**area—000-255**id—0-7*The point code *0-000-0* is not a valid point code.**pcn (optional)**ITU national destination point code in the format of a 5-digit number (*nnnnn*); or 2, 3, or 4 numbers (members) separated by dashes (*m1-m2-m3-m4*) as defined by the `chg-stpopts:npcfmti` flexible point code option. A group code must be specified when the ITUDUPPC feature is turned on (*nnnnn-gc*, *m1-m2-m3-m4-gc*). The *prefix* subfield indicates a spare point code, private point code, or private and spare point code (*prefix-nnnnn*, *prefix-nnnnn-gc*, *prefix-m1-m2-m3-m4*, *prefix-m1-m2-m3-m4-gc*).**Range:***s-*, *p-*, *ps-*, 0-16383, *aa-zz*

Specify a valid value for each subfield of the point code, and separate the subfields with a dash (-).

*prefix—s-*, *p-*, *ps**nnnnn—0-16383**gc—aa-zz**m1-m2-m3-m4—0-14* for each member; values must sum to 14**pcn16 (optional)**16-bit ITU national point code with subfields *unit number-sub number area-main number area* (*un-sna-mna*). The *prefix* subfield indicates a private point code (*prefix-un-sna-mna*).**Range:***p-*, 000---127

Specify a valid value for each subfield of the point code, and separate the subfields with a dash (-).

*prefix---p**un---000---127*

*sna---000---15*

*mna---000---31*

**pcn24 (optional)**

24-bit ITU national point code with subfields *main signaling area-sub signaling area-signaling point (msa-ssa-sp)*. The *prefix* subfield indicates a private point code (*prefix-msa-ssa-sp*).

**Range:**

*p-*, 000-255

Specify a valid value for each subfield of the point code, and separate the subfields with a dash (-).

*prefix—p*

*msa—000—255*

*ssa—000—255*

*sp—000—255*

**pkgtype (optional)**

The ANSI and ITU TCAP package type.

**Range:**

***ansiuni***

ANSI unidirectional

***ansiabort***

ANSI abort

***any***

Wildcard value

***bgn***

Begin

***cnt***

Continue

***cwp***

Conversation with Permission

***cwop***

Conversation without Permission

***end***

End

***ituabort***

ITU abort

***ituuni***

ITU unidirectional

***resp***

Response

**qwp**  
Query with Permission

**qwop**  
Query without Permission

**ANSI TCAP Package Types**  
*ansiuni, qwp, qwop, resp, cwp, cwop, ansiabort, any*

**ITU TCAP Package Types**  
*bgn, ituabort, ituuni, any, end, cnt*

**ppmeasreqd (optional)**

Per Path Measurement required. This parameter specifies whether to perform per path measurements.

**Range:**

**yes**  
perform Per Path Measurements

**no**  
do not perform Per Path Measurements

**Default:**

No change to the current value

**prio (optional)**

This parameter assigns priority to an OPCODE GTTSET based translation.

**Range:**

*1 - 1024*  
1 is the highest priority and 1024 the lowest

**Default:**

*1024*

**ri (optional)**

Routing indicator.

**Range:**

**gt**

**ssn**

**Default:**

No change to current value.

**saddr (optional)**

Start Address (Similar to GTA). The beginning of a range of MAP digits (IMEI/IMSI/MSISDN/VLRNB/SMRPOA/SMRPDA).

**Range:**

*1--21 digits*

If the Hex Digit Support for GTT feature is not enabled, the range is 1 - 21 decimal digits; valid digits are 0-9.

If the Hex Digit Support for GTT feature is enabled and on, the range is 1 - 21 hexadecimal digits; valid digits are 0-9, a-f, A-F.

**Default**

Same as the specified SADDR value

**split (optional)**

Split or change an existing GTA range.

**Range:****yes**

Splits the existing GTA range.

**no**

Changes the existing GTA range.

**Default:**

yes

**ssn (optional)**

Subsystem number.

**Range:**

002 - 255

**Default:**

If the `xlat` parameter is not changed to `dpcngt` —No change to current value

If the `xlat` parameter is changed to `dpcngt` —The `ssn` parameter value is removed.

**testmode (optional)**

This parameter invokes a Test Tool that is used to debug the FLOBR/TOBR rules.

 **Caution:**

If the `testmode=on` parameter is specified, then the rule is used only by test messages and is ignored by live traffic. If the `testmode=off` parameter is specified, then both test and live messages use the rule. Changing from `testmode=off` to `testmode=on` is equivalent to deleting the rule for live traffic.

**Range:****on**

process the translation rules defined in the test message

**off**

perform standard GTT behavior

**Default:**

off

**transmeasrqd (optional)**

Per GTT Translation Measurement required. This parameter specifies whether to perform per GTT Translation measurements.

**Range:****yes**

perform per GTT Translation Measurements

**no**

do not perform per GTT Translation Measurements

**Default:***no***xlat (optional)**

Translate indicator. This parameter is used to specify translation actions and routing actions.

**Range:****dpc****dpcngt****dpcssn****none****Default:**

No change to the current value

**Example**

```
chg-
gta:gttsn=lidb:gta=9195554321:xlat=dpcssn:ri=ssn:pc=001-255-252:ssn=
254
```

```
chg-
gta:gttsn=test:gta=100000:egta=199999:pca=1-1-1:xlat=dpcngt:ri=gt:gt
modid=set1
```

```
chg-gta:gttsn=setnat003:gta=987658321198765432102:pcn=s-129
```

```
chg-gta:gttsn=itui1:gta=987658321198765432112:pci=s-1-210-1
```

```
chg-gta:gttsn=setnat003:gta=987658321198765432122:pcn=s-128-aa
```

```
chg-
gta:gttsn=setmap:gta=2345678911:egta=3456789022:ri=ssn:pc=2-2-2:ssn=
221:mapset=df1t
```

```
chg-
gta:gttsn=setopcode:pci=3-3-2:opcode=*:pkgtype=bgn:acn=*:prio=1024
```

In this example, the database contains a GTA range [5556000-5558000], but no part of the GTA range [5558001-5559000] exists. The command deletes the GTA range [5556000-5558000] from the database and adds two new GTA ranges [5556000-5556799] and [5556800-5559000].

```
chg-gta:gttsn=tst1:gta=5556800:egta=5559000:split=yes
```

This example deletes the GTA range [5556000-5556799] from the database and adds a new GTA range [5556200-5556500] to the database. All the parameters for the GTA range [5556200-5556500] have the same values as that of the deleted [5556000-5556799] GTA range, except the `pc` parameter that is has a value of 1.

```
chg-gta:gttsn=tst1:gta=5556200:egta=5556500:pc=1-1-2:split=no
```

This example deletes the GTA range [5556200-5556500] from the database and adds two new GTA ranges [5556200-5556400] and [5556401-5556500] to the database.

```
chg-gta:gttsn=tst1:gta=5556401:egta=5556500
```

This example specifies the default MRN set.

```
chg-gta:gttsn=setmrn:gta=1234567880:pc=1-1-2:mrnset=df1t
```

This example removes the MRN set ID.

```
chg-
```

```
gta:gttsn=setmrn:gta=1234567890:egta=2234567890:pc=1-1-2:mrnset=none
```

```
chg-
```

```
gta:gttsn=setcdgta:gta=123456789012345678901:egta=223456789012345678901:optsn=cggtal:opcsn=opc1
```

```
chg-
```

```
gta:gttsn=setcdgta:gta=123456789012345678901:egta=223456789012345678901:cgselid=1024:opcsn=opc1
```

```
chg-
```

```
gta:gttsn=setcdgta:gta=123456789012345678901:egta=223456789012345678901:optsn=none
```

```
chg-gta:gttsn=setopc:opca=002-001-001:xlat=dpcssn:ri=ssn:pca=001-001-001:ssn=20:optsn=setcgssn
```

```
chg-gta:gttsn=setcgpc:cgpca=001-001-001:xlat=dpcssn:ri=ssn:pca=001-001-001:ssn=20:optsn=setcgssn
```

```
chg-gta:gttsn=setcgssn:cgssn=100:ecgssn=200:xlat=dpcssn:ri=ssn:pca=001-001-001:ssn=20
```

```
chg-
```

```
gta:gttsn=set1:gta=2543:egta=2943:actsn=actdisc1:ppmeasreqd=yes
```

```
chg-gta:gttsn=set2:cgpc=1-2-*:actsn=actudts1
```

```
chg-gta:gttsn=set3:opc=2543:actsn=actudts1
```

```
chg-
```

```
gta:gttsn=set4:cgssn=25:ecgssn=29:actsn=actdup1:xlat=dpc:ri=gt:pc=1-1-1
```

This example specifies hexadecimal digits for the `gta` and `egta` parameters.

```
chg-gta:gttsn=set1:gta=abcd:egta=abce
```

```
chg-
```

```
gta:gttsn=setmap:gta=2345678901:egta=3456789012:ri=ssn:pc=1-1-3:ssn=225:mapset=2:loopset=raleigh1
```

This example specifies that calling party GT modification is required.

```
chg-gta:gttsn=setans004:cggtmod=yes:gta=981234
```

This example changes the GTA translations when the FLOBR feature is turned on.

```
chg-gta:gttsn=setcdgta:gta=1234567890:egta=2234567890:
xlat=dpcssn:ri=ssn:pca=001-001-001:ssn=100:fallback=no:testmode=on
```

This example changes the GTA translations when the OBSR feature is enabled and the FLOBR feature is turned on.

```
chg-gta:gttsn=setcdgta:gta=1234567890:egta=2234567890:
xlat=dpcssn:ri=ssn:pc=2-2-2:ssn=100:fallback=yes:optsn=setcgta:test
mode=on
```

This example changes the GTA translations when the FLOBR feature is turned on.

```
chg-gta:gttsn=setcdssn:cdssn=15:ecdssn=29:xlat=dpc:pc=1-1-1:ri=gt
```

This example changes the GTA translations when the TOBR and OBSR features are turned on.

```
chg-
gta:gttsn=setopcode:pkgtype=qwop:opcode=none:family=*:xlat=dpc:ri=gt
: pc=2-2-2:opcsn=setopc:optsn=setcdgta
```

```
chg-
gta:gttsn=setopcode:pkgtype=bgn:opcode=none:acn=1-22-123-43-54-65-76
: xlat=dpc:ri=gt:pc=2-2-2:opcsn=setopc:optsn=setcdgta
```

```
chg-
gta:gttsn=setopcode:pkgtype=bgn:opcode=none:family=*:xlat=dpc:ri=gt:
pc=2-2-2:optsn=imsi1:defmapvr=v3
```

```
chg-gta:saddr=1234567890:eaddr=2234567890:gttsn=setmsisdn
```

This example changes the GTA translation for a DPC GTT set when the FLOBR feature is turned on.

```
chg-gta:gttsn=setdpc:dpc=1-1-1:optsn=setc1
```

```
chg-gta:gttsn=setcdgta:gta=78901234:xlat=dpc:gtmodid=none
```

```
chg-
gta:gttsn=setcdgta:gta=123456789012345678901:xlat=none:gtmodid=gttsn
1
```

```
chg-
gta:gttsn=setopcode:pkgtype=bgn:opcode=none:acn=1-2-3-4-5-6-7:xlat=none:mapset=1
```

```
chg-gta:gttsn=setcdgta:gta=123456:xlat=none:mapset=1:mrnset=2
```

Example for 16 bit PC and CGPCACTION param.

```
chg-
gta:gttsn=gttl1:xlat=dpc:ri=ssn:pcn16=1-14-0:cgpcn16=45-1-0:mapset=df
lt:
```

```
cgpcaction=remove
```

```
chg-
gta:gttsn=imeil:saddr=98765432112:xlat=dpc:ri=gt:pci=1-210-1:transme
asrqd=yes
```

### Dependencies

The EGTT feature must be turned on before this command can be entered.



The ANSI/ITU SCCP Conversion feature must be enabled before a translated point code that is of a different domain than the GTT set specified by the `gttsn` parameter can be specified.

At least one optional parameter must be specified.

The `gttsn=none` parameter cannot be specified.

The point code specified for the `pc` parameter must be a full point code.

The values of the `gta/saddr` and `egta/eaddr` parameters must be the same length.

If the specified or previously provisioned translated point code is of type ANSI, then the `ngti` value of the referred GT Modification Identifier (see the `ent-gtmod` command) must be 2.

The length of the specified `gta/saddr` parameter must match the number of digits provisioned for the specified GTT set when the VGTT feature is turned off. If the VGTT feature is turned on, then up to 10 GTA/SADDR lengths can exist per GTT set. If the Support for 16 GTT Lengths in VGTT feature is turned on, then up to 16 GTA/SADDR lengths can exist per GTT set.

The specified `gta/egta` or `saddr/eaddr` range must exist for the specified GTT set in the STP active database. While an exact match is not required, an overlap with another range cannot be specified. If the range overlaps, an error is generated that displays a list of overlapped global title addresses. An example follows that shows what happens when the user attempts to enter a range (such as 8005550000 to 8005559999) that overlaps an existing range. The overlapping links must match. If they do not, error message E2401 is generated displaying the list of overlapped global title addresses:

```
The following GTA ranges overlap the input GTA range START GTA END GTA
8005550000 8005551999 8005552000 8005553999 8005554000 8005555999 CHG-
GTA: MASP A - Command Aborted
```

If a new or existing `xlat=dpcngt` parameter is specified, a new or existing `ri=gt` parameter must be specified.

If the `ssn` parameter is specified, a new or existing `xlat=dpcssn` parameter must be specified.

If the `xlat=dpcssn` parameter is specified, the `ssn` parameter must be specified.

If the `pc/pca/pci /pcn/pcn24/pcn16` parameter is specified, and the point code is the STP true point code, then the value of the new or existing `xlat` parameter must be `dpcssn`, and the new or existing value of the `ri` parameter must be `ssn`.

If the `pc/pca/pci/pcn/pcn24/pcn16` parameter, `ssn` parameter, or both, are specified, and the point code is the STP true point code, the `ssn` value must exist in the SS-APPL table.

If the `pc/pca/pci/pcn/pcn24/pcn16` parameter is specified, then it must exist as a destination in the Route table or reside in a cluster that exists as a destination in the Route table (for global routing) unless the point code is the STP's true point code.

If new or existing `ri=ssn` and `xlat=dpc` parameters are specified, and the `pc/pca/pci/pcn/pcn24/pcn16` parameter is not specified, then the existing PC must exist in the Remote Point Code/MAP table, unless the `force=yes` parameter is specified.

If new or existing `ri=ssn`, `xlat=dpc`, and `pc/pca/pci/pcn/pcn24/pcn16` parameters are specified, the new point code must exist in the Remote Point Code/MAP table, unless the `force=yes` parameter is specified.

If a new or existing `ccgt=yes` parameter is specified, a new or existing `ri=ssn` parameter must be specified.

If the new or existing `pc/pca/pci/pcn/pcn24/pcn16` parameter is an the STP point code or capability point code, then the `ccgt=no` parameter must be specified.

If new or existing `ri=ssn` and `xlat=dpcssn` parameters are specified, a new or existing `xlat=dpcssn` parameter must exist in the Remote Point Code/MAP table, unless the `force=yes` parameter is specified.

The GTT table cannot be full.

If the `ri=gt` parameter is specified, the `mrnset` parameter must be specified. If the `ri=gt` parameter is not specified, the `mrnset` parameter cannot be specified

If the Flexible GTT Load Sharing feature is enabled, the specified PC must already exist in the specified MRN set.

The specified MRN set must already exist in the MRN table.

If the Flexible GTT Load Sharing feature is enabled, the specified PC must exist in the MRN set.

The Flexible GTT Load Sharing feature must be enabled before the `mrnset` parameter can be specified.

If the `ri=gt` parameter is specified, the `mrnset` parameter must be specified. If the `ri=ssn` parameter is specified, the `mrnset` parameter cannot be specified.

The SEAS command can operate only on the default MRN set or the default MAP set.

The MRN table is corrupt or cannot be found.

If the `ri=ssn` parameter is specified, the `mapset` parameter must be specified. If the `ri=gt` parameter is specified, the `mapset` parameter cannot be specified.

Note: The `mapset` parameter can only be specified if the Flexible GTT Load Sharing feature is enabled.

The Flexible GTT Load Sharing feature must be enabled before the `mapset` parameter can be specified.

The specified MAP set must exist in the database.

The specified or previously provisioned PC/SSN must exist in the specified or previously provisioned MAP set.

The SEAS command cannot operate on any MAP set other than the default MAP set.

If the `xlat=dpc` parameter is specified, and the value of the `force` parameter is not yes, then the point code and MAP set must exist in the MAP table.

The MAP table is corrupt or cannot be found.

The specified GTA/SADDR must occur within an existing GTA range in the specified GTT Set.

The `gta`, `cgpc/cgpca/cgpci/cgpcn/cgpcn24/cgpcn16`, `opc/opca/opci/opcn/opcn24/opcn16`, `cgssn/cdssn`, `opcode/acn/pkgtype`, `opcode/family/pkgtype`, `dpc/dpca/dpci/dpcn/dpcn24/dpcn16`, or `saddr` parameter must be specified.

The FLOBR feature must be turned on before the `cgssn`, `opcsn`, `optsn`, and `cgselid` parameters can be specified in the same command.

The `pc/pca/pci/pcn/pcn24/pcn16`, `cgpc/cgpca/cgpci/cgpcn/cgpcn24/cgpcn16`, `opc/opca/opci/opcn/opcn24/opcn16`, and `dpc/dpca/dpci/dpcn/dpcn24/dpcn16` parameters must have values within the valid range for each subfield.

The value specified for the `ecgssn/ecdssn` parameter must be greater than the value specified for the `cgssn/cdssn` parameter.

The specified GTT set must have a set type of `opcode` (see the `ent-gttset` command) before the `opcode/acn/pkgtype` or `opcode/family/pkgtype` parameters can be specified. The specified GTT set must have a set type of `cdssn`, `cgssn`, `cdgta/cgta`, `opc`, or `cgpc` before the `cdssn`, `cgssn`, `gta`, `opc`, or `cgpc` parameter, respectively, can be specified.

The OBSR feature must be enabled before the `opcsn`, `cgpc/cgpca/cgpci/cgpcn/cgpcn24/cgpcn16`, `opc/opca/opci/opcn/opcn24/opcn16`, or `(e)cgssn` parameters can be specified.

If the GTT set specified by the `gttsn` parameter (GTTSN set) has a set type of `cdgta` (see the `ent-gttset` command), then the `optsn` parameter cannot specify a GTT set (OPTSN set) with a set type of `cgssn`. The OPTSN set must have a set type of `cggta` or `cgpc`.

The FLOBR feature must be turned on before a GTTSN set with a set type of `cgpc`, `cggta`, or `opc` can be specified with an OPTSN with a set type other than `cgssn`.

If the FLOBR feature is turned on, and the GTTSN set has a set type of `cdgta` or `cdssn`, then the OPTSN set cannot have a set type of `opc`.

If the TOBR feature is turned on, and the GTTSN set has a set type of `opcode`, then the OPTSN set cannot have a set type of `opc`.

If the GTTSN set has a set type of MBR (`imei/imsi/vlrnb/msisdn/smrpda/smrpoa`), then the OPTSN set type cannot have the same set type as GTTSN.

If the OPTSN set has a set type of MBR (`imei/imsi/vlrnb/msisdn/smrpda/smrpoa`), then the GTTSET must have a set type of MBR (`imei/imsi/vlrnb/msisdn/smrpda/smrpoa`) or `opcode`.

The `cdselid`, `cgselid`, and `optsn` parameters cannot be specified together in the command. If the GTTSN has a set type of `cdgta`, `cdssn`, or `opcode` (see the `ent-gttset` command) then the `opcsn` parameter can be specified if one of the other exclusive parameters is specified.

The `gta` parameter must be specified if the GTTSN set type has a value of `cdgta` or `cggta`. The `gta` parameter cannot be specified for other set types.

The `cgpc/cgpca/cgpci/cgpcn/cgpcn24/cgpcn16` parameter must be specified if the GTTSN set type has a value of `cgpc`. The `cgpc/cgpca/cgpci/cgpcn/cgpcn24/cgpcn16` parameter cannot be specified for other set types.

The `opc/opca/opci/opcn/opcn24/opcn16` parameter must be specified if the GTTSN set type has a value of `opc`. The `opc/opca/opci/opcn/opcn24/opcn16` cannot be specified for other set types.

The `cgssn` parameter must be specified if the GTTSN set type is `cgssn`. The `cgssn` parameter cannot be specified for other set types.

The range specified by the `cgssn/ecgssn` and `cdssn/ecdssn` parameters cannot overlap a currently existing range for the specified GTT set.

The GTT set specified by the `opcsn` parameter must have a set type of `opc` (see the `ent-gttset` command).

If the specified GTT set is an ANSI set, the `cgpc/cgpca`, `opc/opca`, and `dpc/dpca` parameters must be valid ANSI point codes. If the specified GTT set is an ITU set, the `cgpci/cgpcn/cgpcn24/cgpcn16`, `opci/opcn/opcn24/opcn16`, and `dpci/dpcn/dpcn24/dpcn16` parameters must be valid ITU point codes.

The set domain of the `opcsn` parameter must be the same as the set domain of the `gttsn` parameter. For example, if the set domain of the `gttsn` parameter is ANSI, then the set domain of the `opcsn` parameter must be ANSI. If the set domain of the `gttsn` parameter is ITU, then the set domain of the `opcsn` parameter must be ITU.

The range specified by the `cgssn/ecgssn` and `cdssn/ecdssn` parameters must exist for the specified GTT set in the STP active data base. An exact match is not required.

The translation entry associated with the specified point code (`dpc/dpca/dpci/dpcn/dpcn24/dpcn16`, `pc/pca/pci/pcn/pcn24/pcn16`, or `opc/opca/opci/opcn/opcn24/opcn16`) or `opcode` must already exist.

The `cgpc`, `cgssn`, `gta`, `opc`, `cdssn`, `opcode` and `saddr` parameters cannot be specified in the same command.

If the `cgssn` and `cdssn` parameters are both specified in the same command (in any order), then only the value for the last of the two parameters specified is used during processing.

The Hex Digit Support for GTT feature must be turned on before hexadecimal digits can be specified for the `gta/saddr` or `egta/eaddr` parameters.

The SCCP Loop Detection feature must be enabled before the `loopset` parameter can be specified.

The value of the `loopset` parameter must already exist in the database.

The Loopset table is corrupt or cannot be found.

The value specified for the `egta/eaddr` parameter must be greater than value specified for the `gta/saddr` parameter.

The value specified for the `pc` parameter cannot be associated with a proxy point code.

The AMGTT feature or the AMGTT CgPA Upgrade feature must be turned on before the `cggmod` parameter can be specified.

The FLOBR feature must be turned on before the `fallback`, `cdselid`, `(e)cdssn`, or `dpc` parameter can be specified.

The FLOBR feature must be turned on before the `gttsn` parameter can specify a GTT set with a set type other than `cdgta` (see the `ent-gttset` command) in the same command with the `cgselid` parameter.

The OBSR feature must be enabled or the FLOBR feature must be turned on before the `cgselid` parameter can be specified.

The same value cannot be specified for the `gttsn` and `optsn` parameters.

The ANSI/ITU SCCP Conversion feature must be enabled before the GTT set specified by the `optsn` parameter can have a different domain than the GTT set specified by the `gttsn` parameter.

A TOBR quantity feature must be turned on before the `opcode`, `pkgtype`, `acn`, `family`, `saddr`, `eaddr` or `defmapvr` parameter can be specified.

The `opcode`, `pkgtype`, and `family` parameters must be specified together for ANSI TCAP translations. The `opcode`, `pkgtype`, and `acn` parameters must be specified together for ITU TCAP translations.

If the GTT set specified by the `gttsn` parameter has a set type of `opcode` (see the `ent-gttset` command), then the `opcode/acn/pkgtype` or `opcode/family/pkgtype` parameters must be specified. These parameters cannot be specified if the GTT set has of any other set type.

If the GTT set specified by the `gttsn` parameter has a set type of `cdssn` (see the `ent-gttset` command), then the `cdssn` parameter must be specified. This parameter cannot be specified if the GTT set has any other set type.

The `opcsn` parameter can be specified only if the GTT set specified by the `gttsn` parameter has a set type of `cdgta`, `opcode`, or `cdssn` (see the `ent-gttset` command).

The value specified for the `gttsn` parameter must match the name of an existing GTT Set.

A value of *none* must be specified for the `optsn`, `cgselid`, or `cdselid` parameter before the parameter can be changed to another value.

The ANSI/ITU SCCP Conversion feature must be enabled and the FLOBR feature must be turned on before the `cgcnvsn` parameter can be specified.

The GTT set specified by the `gttsn` parameter must have a set type of `cdgta` or `cggta` (see the `ent-gttset` command), before the `cgcnvsn` parameter can be specified.

The value specified for the `gttsn` parameter cannot be the same as the value specified for the `cgcnvsn` parameter.

If the `family` parameter is specified, then the `pkgtype` parameter must have a value of *ansiuni*, *qwp*, *qwop*, *resp*, *cwp*, *cwop*, *ansiabort*, or *any*.

If the `acn` parameter is specified, then the `pkgtype` parameter must have a value of *bgn*, *ituabort*, *ituuni*, *any*, *end*, or *cnt*.

The `gttsn` parameter must be specified and must match an existing GTT set.

The GTT set name specified in the `optsn`, `opcsn`, or `cgcnvsn` parameters must match an existing GTT set name.

If the `pkgtype=ituabort` parameter is specified, then a value of *none* must be specified for the `acn` and `opcode` parameters.

If the `pkgtype=ansiabort` parameter is specified then a value of *none* must be specified for the `family` and `opcode` parameters.

The OBSR feature must be enabled or the FLOBR feature must be turned on before the `optsn` parameter can be specified.

The GTT Action Set specified by the `actsn` parameter must already exist in the database.

If the GTT set specified by the `gttsn` parameter has a set type of *dpc* (see the `ent-gttset` command), then the `dpc/dpca/dpci/dpcn/dpcn24/dpcn16` parameter must be specified. If the GTT set has a set type other than *dpc*, then the `dpc/dpca/dpci/dpcn/dpcn24/dpcn16` parameter cannot be specified.

The value specified for the `gtmodid` parameter must already exist in the GTMOD table (see the `ent-gtmod` command).

The GTMOD table is corrupt or cannot be found.

The values specified for the `gta` and `egta` parameters must be an exact match to the GTA values referred in GTT Action Path table (see the `ent-gttapath` command).

If the FGTTLS feature is enabled, and the `xlat=none` parameter is specified, then the `mrnset` or `mapset` parameter must be specified.

If the `xlat=none` parameter is specified, then the `ri`, `pc/pca/pci/pcn/pcn24/pcn16`, `force`, `ssn`, and `ccgt` parameters cannot be specified.

The `acn` and `family` parameters cannot be specified together in the command.

If the `cgssn` parameter is specified, then the `(e)cdssn` parameter cannot be specified. If the `cdssn` parameter is specified, then the `(e)cgssn` parameter cannot be specified.

If the `opc` or `dpc` parameter is specified, then the `(e)gta`, `(e)cgssn`, `(e)cdssn`, and `opcode` parameters cannot be specified.

The J7 Support feature must be enabled before the `cgpcn16/opcn16/dpcn16` parameters can be specified.

The J7 Support feature must not be enabled before the `cgpcn24/opcn24/dpcn24/cgpca/opca/dpca` parameters can be specified.

The `SADDR` parameter must be specified if the GTT set specified by the `gttsn` parameter is of MBR type (IMEI/IMSI/MSISDN/VLRNB/SMRPOA/SMRPDA).

If the GTT set specified by the `optsn` parameter is of MBR type (IMEI/IMSI/MSISDN/VLRNB/SMRPOA/SMRPDA) in the GTA command for an ITU opcode entry, then the package type specified via the `pkgtype` parameter must be ITU BGN/CNT/END.

The `defmapvr` parameter can be specified in the GTA command for an ITU opcode entry if the GTT set specified by the `optsn` parameter is of MBR type (IMEI/IMSI/MSISDN/VLRNB/SMRPOA/SMRPDA).

`PRIO` parameter can be specified with `OPCODE` GTT set types only.

`PRIO` value should lie between 1-1024 (both inclusive)

If the `saddr` parameter is specified, then the `ecgssn/ecdssn` parameters cannot be specified.

### Notes

The maximum length of the resulting GTA string must not exceed 21 digits when translation is complete.

If a GTT is being deleted or changed and the point code (DPC or RTE) is not found in the route table (unless the point code is the STP's true point code), then the following message is displayed in the terminal scroll area:

```
NOTICE: No DPC and/or RTE found for GTT being deleted or changed.
```

The above situation may occur if the reference count rules were not enforced and a DPC and/or RTE were deleted while being referenced by a GTT entry. This indicates a software error; contact My Oracle Support (MOS).

In this command, only ITU-international and ITU national point codes support the spare point code subtype prefix (s-) and the private and spare point code subtype prefix (ps-). All of the point code types support the private (internal) point code subtype prefix (p-).

When the Flexible GTT Load Sharing feature and the Intermediate GTT Load Sharing feature are on, multiple relationships can be defined among a set of destination point codes in the existing MRN table. The relationship used in a particular translation is based on the GTA digits used for translation. The `mrnset` parameter and the post-translation PC create a key that is used to perform a lookup in the MRN table. This lookup results in a set of alternate PCs, from which a PC is selected, based on relative cost, to route the MSU in most cost-effective way.

When the Flexible GTT Load Sharing feature is turned on, multiple relationships can be defined among a set of PC/SSN pairs in the existing MAP table. The relationship used in a particular translation is based on the GTA digits used for translation.

When the Origin-based SCCP Routing feature is enabled, the CdPA GTA entry can be provisioned in addition to the CgPA GTA, CgPA PC, CgPA SSN, and OPC entries. When provisioning, the Advanced CdPA GTA entry can associate with the CgPA GTA set or the CgPA PC set, the SELID and/or OPC set; the CgPA GTA, CgPA PC, or OPC can associate with the CgPA SSN set; the CgPA SSN cannot associate with any other GTT set. The Advanced CdPA GTA entry may contain the selector ID along with CgPA information present in the MSU to search the Selector table again for the CgPA GTA or CgPA PC Set.

A loopset consists of a set of point codes that form a routing loop in the network. If the SCCP Loop Detection feature is enabled, then the loopset can be associated with or disassociated from specified translation entries. Loopsets that are associated with translation entries are checked during intermediate and final GTT traffic routing. If a loop exists, then the system can be notified with or without discarding the associated traffic.

If the range specified by the `gta` and `egta` parameters does not exactly match the existing range, then the existing range is split. All addresses in the existing range that are outside the range specified by the `gta/egta` parameters retain the original `xlat`, `ri`, `pc` and `ssn` parameters. A new range is created that is bounded by the `gta/egta` parameters. The new range contains new values for the `xlat`, `ri`, `pc` and



ssn parameters that are present in the command, while retaining parameter values from the previous range that do not have corresponding new values in the command.

If the FLOBR GTT hierarchy is provisioned on a linkset, then translations do not have to be searched in a predetermined manner. If a translation points to another GTTSET/SELID, then database searches continue. The number of searches is limited by the following conditions:

- The same GTT set name cannot be referred more than once.
- Up to 7 database searches can be performed.
- For MBR, the same GTT settype (IMEI/IMSI/MSISDN/VLRNB/SMRPOA/SMRPDA) cannot be referred more than once.

If the FLOBR feature is turned on, then any translation can point to any GTTSETS other than that specified by the GTTSN. The CdPA GTA and CdPA SSN translations can also point to an OPCS. For CdPA GTA and CdPA SSN translations, if an OPTSN GTTSET/SELID is provisioned apart from an OPCS, then the OPTSN GTTSET/SELID takes precedence over the OPCS.

The MBR GTT set types translation entries (IMEI/IMSI/MSISDN/VLRNB/SMRPOA/SMRPDA) can be configured only when the TOBR feature is turned ON. The GTTsets of the types mentioned above are allowed to be provisioned ONLY in GTA entries from a GTTSet of the type OPCODE or one of the other GTT Set types supported by this feature (SS7 Firewall).

Translations associated with the TOBR feature:

- ANSI Opcode—ANSI opcode specifier, ANSI TCAP Package type, and Family
- ITU Opcode—ITU opcode, ITU TCAP Package Type, and ACN

Translations associated with the FLOBR feature:

- CdPA SSN Translations—Can be configured with routing and flexible routing data. The provisioning rules for CdPA SSN translations are the same as CgPA SSN translations in OBSR.
- DPC Translations—The provisioning rules for DPC translations are the same as OPC translations except that OPCS parameter cannot be configured for DPC translations.

## Output

```
chg-gta:gttsn=set2:xlat=dpcssn:ri=ssn:pc=3-3-3:ssn=10:cgpc=1-2-
*:actsn=actudts1:ppmeasreqd=yes
```

```
tekelecstp 10-02-15 17:29:06 EST EAGLE 42.0.0
CHG-GTA: MASP A - COMPLTD
;
```

```
chg-
gta:gttsn=imsi1:xlat=dpc:ri=gt:pc=1-1-1:saddr=1234567890:eaddr=22345
67890
```

```
tekelecstp 15-05-24 12:09:18 EST EAGLE 46.3.0
ENT-GTA: MASP A - COMPLTD
;
```



```

chg-gta:gttsn=setopcode:pci=3-3-2:opcode=*:pkgtype=bgn:acn=*:
prio=1024

tekelecstp 16-11-07 14:13:13 MST EAGLE 46.5.0.0-70.5.0
    CHG-GTA: MASP A - COMPLTD
;

chg-
gta:gttsn=imei1:saddr=98765432112:xlat=dpc:ri=gt:pci=1-210-1:tr
ansmeasrqd=yes

tekelecstp 17-05-11 15:20:06 EST EAGLE 46.6.0
    CHG-GTA: MASP A - COMPLTD
;

```

### Related Topics

- [dlt-gta](#)
- [ent-gta](#)
- [rtrv-gta](#)

## chg-gtcnv

Use this command to change entries in the Default Global Title Conversion table. A table entry is identified by the direction and the `tta` or `tti` parameter, or the `tti/np/nai` parameter combination. The Notes section for this command describes rules for changing entry information.

### Parameters

#### **dir** (mandatory)

Direction of conversion.

#### **Range:**

***atoi***  
ANSI to ITU conversion

***itoa***  
ITU to ANSI conversion

***both***  
Conversion in both directions

#### **nai** (optional)

Nature of address indicator. This parameter is mandatory when `gtixlat=24` is specified, and cannot be specified when `gtixlat=22` is specified.

**Range:**  
0 - 63, \*

**Default:**  
No change to current value

**np (optional)**

Numbering plan. This parameter is mandatory when `gtixlat=24` is specified, and cannot be specified when `gtixlat=22` is specified.

**Range:**

0 - 15, \*

**Default:**

No change to current value

**npdd (optional)**

New prefix digits to be deleted. The number of new prefix digits to be deleted. These digits will be replaced with the new prefix digits string (`npds`).

**Range:**

0 - 21

**Default:**

No change to current value

**npds (optional)**

New prefix digits string. The new prefix digits string that will replace the received prefix digits.

**Range:**

1 - 21 digits

If the Hex Digit Support for GTT feature is not enabled and on, the range is 1 - 21 decimal digits; valid digits are 0-9.

If the Hex Digit Support for GTT feature is enabled and on, the range is 1 - 21 hexadecimal digits; valid digits are 0-9, a-f, A-F.

**Default:**

No change to current value

**nsdd (optional)**

New suffix digits to be deleted. The number of new suffix digits to be deleted. These digits will be replaced with the new suffix digits string (`nsds`).

**Range:**

0 - 21

**Default:**

No change to current value

**nsds (optional)**

New suffix digits string. The new suffix digits string that will replace the received suffix digits.

**Range:**

1 - 21 digits

If the Hex Digit Support for GTT feature is not enabled and on, the range is 1 - 21 decimal digits; valid digits are 0-9.

If the Hex Digit Support for GTT feature is enabled and on, the range is 1 - 21 hexadecimal digits; valid digits are 0-9, a-f, A-F.

**Default:**

No change to current value

**rdmod (optional)**

Reset digit modifiers (npdd/npds or nsdd/nsds) values to "no digit modification."

**Range:****yes**

Reset the npdd/npds or nsdd/nsds parameter values

**no**

Do not reset the npdd/npds or nsdd/nsds parameter values.

**Default:**

No change to current value

**tta (optional)**

ANSI translation type. This parameter is mandatory when dir=atoi or dir=both is specified.

**Range:**

0 - 255, \*

**Default:**

No change to current value

**tti (optional)**

ITU translation type. This parameter is mandatory when dir=atoi is specified.

**Range:**

0 - 255, \*

**Default:**

No change to current value

**Example**

This example changes a dir=atoi entry's current tti value to 5:

```
chg-gtcnv:dir=atoi:tta=10:tti=5
```

This example changes a dir=atoi entry's current tti, nai, and np values to 7, 8, and 6 respectively, and changes or adds NSDD and NSDS values:

```
chg-gtcnv:dir=atoi:tta=11:tti=7:nai=8:np=6:nsdd=3:nsds=123
```

This example changes a dir=itoe entry's current TTA value to 11, and changes or adds NPDD and NPDS values:

```
chg-gtcnv:dir=itoe:tta=11:tti=7:npdd=3:npds=123
```

This example changes a dir=itoe entry's TTA value to 12, and changes or adds NSDD and NSDS values:

```
chg-gtcnv:dir=itoe:tta=12:tti=7:nai=8:np=6:nsdd=5:nsds=45667
```

This example adds or changes a dir=both entry's NSDD and NSDS values:

```
chg-gtcnv:dir=both:tta=12:tti=33:nsdd=3:nsds=456
```

This example changes a default dir=atoi entry's current TTI value to 9, and changes or adds NSDD and NSDS values:

```
chg-gtcnv:dir=atoi:tta=*:tti=9:nsdd=1:nsds=9
```

This example changes a default `dir=atoi` entry's current TTI, NAI, and NP value to 4, 6, and 5 respectively:

```
chg-gtcnv:dir=atoi:tta=*:tti=4:nai=6:np=5
```

This example changes a default `dir=ittoa` entry's current TTI value to 17, and changes or adds NPDD and NPDS values:

```
chg-gtcnv:dir=ittoa:tta=17:tti=*:nai=*:np=*:npdd=3:npds=123
```

This example resets existing NPDD/NPDS or NSDD/NSDS values to "no digit modification":

```
chg-gtcnv:dir=both:tta=12:tti=11:rdmod=yes
```

This example specifies hexadecimal digits for NSDS:

```
chg-gtcnv:dir=atoi:tta=*:tti=4:npdd=3:npds=abc1234fed
```

### Dependencies

The ANSI/ITU SCCP Conversion feature must be enabled before this command can be entered.

If the `dir=atoi` parameter is specified, then the `tta` parameter must be specified.

If the `dir=both` parameter is specified, then the `tta` and `tti` parameters must be specified.

If the `dir=both` parameter is specified, then a wildcard value (\*) cannot be specified for any of the other parameters.

If the `dir=atoi` parameter is specified, then a value of \* can be specified only for the `tta` parameter.

If the `dir=ittoa` parameter is specified, then a value of \* must be specified for the `tti`, `np`, and `nai` parameters.

If the `dir=ittoa` and `gtixlat=22` parameters are specified, then a value of \* cannot be specified.

The specified `dir`, `tta`, `tti`, `np`, and `nai` parameter combination cannot already exist in the database.

The `nsdd/nsds` and the `npdd/npds` parameters cannot be specified together in the command.

The Hex Digit Support for GTT feature must be enabled and on before hexadecimal digits can be specified for the `npds` and `nsds` parameters.

### Notes

The use of asterisks (wildcards) is allowed only once for each direction of ANSI to ITU and ITU to ANSI. This provides a configurable default.

In the conversion direction of ANSI to ITU, an asterisk can be specified only for the ANSI `tta` parameter.

In the conversion direction of ITU to ANSI, the asterisk value must be specified for the `itu`, `tti`, `np`, and `nai` parameters.

Asterisks are not allowed when conversion is in both directions (`dir=both`).

The suffix digit manipulation parameters `nsdd` and `nsds` cannot be specified in the same command with the prefix digit manipulation parameters (`npdd` and `npds`). The `npdd` and

`nsdd` parameters specify how many digits to delete, if any, from the beginning or end respectively of the Global Title address digits. The `npds` and `nsds` parameters specify what digits, if any, to append to the beginning or end respectively of the Global Title address digits.

The `gtixlat` parameter is expressed in the form of the ANSI GTI and the ITU GTI. The `gtixlat` parameter is used to indicate the conversion of the Global Title Indicator between the ANSI and ITU standards. For example: A `gtixlat` value of 24 converts an incoming ANSI GTI2 to an outgoing ITU GTI 4 or an incoming ITU GTI 4 to an outgoing ANSI GTI2.

### Output

```
chg-gtcnv:dir=atoi:gtixlat=22:ttta=10:tti=5
```

```
rlghncxa03w 03-11-07 11:43:07 EST EAGLE 31.3.0
CHG-GTCNV: MASP A - COMPLTD
;
```

### Related Topics

- [dlt-gtcnv](#)
- [ent-gtcnv](#)
- [rtrv-gtcnv](#)

## chg-gtmod

Use this command to change GT Modification (GTMOD) entry data. The GTMOD entry consists of a GTMOD ID and GTMOD specific data.

### Parameters



#### Note:

Definitions for the feature options specified by the `on` and `off` parameters are located in the Notes section.

#### **gtmodid (mandatory)**

GT Modification Identifier.

#### **Range:**

ayyyyyyy

1 alphabetic character followed by up to 8 alphanumeric characters

#### **cgpassn (optional)**

Calling party subsystem number. This parameter specifies the calling party subsystem address that receives the message.

#### **Range:**

2 - 255, none

**Default:**

No change to the current value

**ngti (optional)**

New Global Title Indicator. This parameter specifies whether a new GTI translation format is type 2 or type 4.

**Range:**

**2**

**4**

**none**

**Default:**

No change to the current value

**ngtmodid (optional)**

New GT Modification Identifier.

**Range:**

*ayyyyyyy*

1 alphabetic character followed by up to 8 alphanumeric characters

**nnai (optional)**

New nature of address indicator. This parameter specifies the value that is used to replace the received NNAI.

**Range:**

*0 - 127, none*

**Default:**

*none*-if the `ngti=2` parameter is specified. Otherwise, no change to the current value.

**ntp (optional)**

New numbering plan. The value used to replace the received numbering plan.

**Range:**

*0 - 15, none*

**Default:**

*none*-if the `ngti=2` parameter is specified. Otherwise, no change to the current value.

**npdd (optional)**

Number of prefix digits to be deleted. The number of digits to be deleted from the prefix of the received GT address.

**Range:**

*1 - 21, none*

**Default:**

No change to the current value

**npds (optional)**

New prefix digits string. The digits to be prefixed to the received GT address.

**Range:**1-21 digits, *none*

If the Hex Digit Support for GTT feature is not enabled, the range is 1 - 21 decimal digits; valid digits are 0-9.

If the Hex Digit Support for GTT feature is on, the range is 1 - 21 hexadecimal digits; valid digits are 0-9, a-f, A-F.

**Default:**

No change to the current value

**nsdd (optional)**

Number of suffix digits to be deleted. The number of digits to be deleted from the suffix of the received GT address.

**Range:**1 - 21, *none***Default:**

No change to the current value

**nsds (optional)**

New suffix digits string. The digits to be suffixed to the received GT address.

**Range:**1-21 digits, *none*

If the Hex Digit Support for GTT feature is not enabled, the range is 1 - 21 decimal digits; valid digits are 0-9.

If the Hex Digit Support for GTT feature is enabled and on, the range is 1 - 21 hexadecimal digits; valid digits are 0-9, a-f, A-F.

**Default:**

No change to the current value

**ntt (optional)**

New Translation Type. The value that replaces the received Translation Type.

**Range:**0 - 255, *none***Default:**

No change to the current value

**off (optional)**

Turns off the specified feature options. A comma-separated list of feature options that are requested to be turned off. Up to 8 feature options can be specified in the list.

**Range:***gtOfill***on (optional)**

Turns on the specified feature options. A comma-separated list of feature options that are requested to be turned on. Up to 8 feature options can be specified in the list.

**Range:**  
*gtOfill*

**precd (optional)**

Precedence. This parameter specifies whether the prefix or suffix takes precedence during modification of the received GT address.

**Range:**

*pfx*

*sfx*

**Default:**

*pfx*-if the *npdd* and *npds* parameters are specified

*sfx*-if the *nsdd* and *nsds* parameters are specified

**Example**

```
chg-
gtmod:gtmodid=set2:ngti=4:nnp=4:nnai=2:off=gtOfill:npds=2:precd=sfx:
nsds=1
```

```
chg-gtmod:gtmodid=set3:on=gtOfill:nnp=7:nnai=100:nsdd=2:ntt=none
```

**Dependencies**

If the *ngti=4* parameter is specified, then the *nnp* and *nnai* parameters must be specified.

If the *ngti=2* parameter is specified, then the *nnp* and *nnai* parameters cannot be specified.

The ANSI/ITU SCCP Conversion feature must be enabled before the *ngti* parameter can be specified.

The Hex Digit Support for GTT feature must be turned on before hexadecimal digits can be specified for the *npds* or *nsds* parameter.

The GTMOD table is corrupt or cannot be found.

At least one optional parameter must be specified.

The AMGTT, AMGTT CdPA Only, or AMGTT CgPA Upgrade feature must be turned on before any parameter except the *ntt* parameter can be specified.

The value specified for the *gtmodid* parameter must already exist in the GTMOD table.

If the *npdd/npds* and *nsdd/nsds* parameters are specified or were previously provisioned, then the *precd* parameter must be specified.

The combined digit length of the values for the specified or previously provisioned *npds* and *nsds* parameters cannot be greater than 21.

The (n) *gtmodid=none* parameter cannot be specified.

If the *ngti=4* parameter is specified, then the referred translated point code cannot be ANSI. For ANSI point codes, the *ngti* value must be 2.

If the *ngti=4* parameter is specified or was previously provisioned, then a value of *none* cannot be specified for the *nnp* and *nnai* parameters.



If the `ngti=none` parameter is specified, then the `on=gt0fill` parameter cannot be specified.

If the `on=gt0fill` parameter is specified, then the `ngti` parameter must be specified.

The value specified for the `ngtmodid` parameter cannot already exist in the database.

The same value cannot be specified for the `on` and `off` parameters.

## Notes

### on/off options

- *gt0fill* —GT zero fill. Specifies whether the last 0 of the GTA is a treated as a valid digit (OFF) or as filler (ON) during GT Modification for the `gti(x)=2` to `gti(x)=4` scenario.

## Output

```
chg-gtmod:gtmodid=gtmodid2:ngti=4:nnp=4:nnai=2:off=gt0fill
```

```
tekelecstp 10-03-18 14:43:31 EST EAGLE 42.0.0
Command entered at terminal #4
```

```
GTMOD table is (2 of 50000) 1% full
```

```
CHG-GTMOD: MASP A - COMPLTD
```

```
;
```

## Related Topics

- [dlt-gtmod](#)
- [ent-gtmod](#)
- [rtrv-gtmod](#)

# chg-gtt

Use this command to change the routing objects for messages requiring global title translation. The global title addresses remain unchanged.

### Note:

If the EGTT feature is turned on, then the GTT Selector (`ent/chg/dlt/rtrvgttssel`), GTT Set (`ent/dlt/rtrv-gttset`), and GTA (`ent/chg/dlt/rtrvgta`) commands replace the Translation Type (`ent/dlt/rtrv-tt`) and Global Title Translation (`ent/chg/dlt/rtrv-gtt`) commands. It is not recommended to run `ent/dlt/rtrv-tt & ent/chg/dlt/rtrv-gtt` commands as it may cause the advance GTA fields of GTT entry to be reset to the default values.

## Parameters



### Note:

See [Point Code Formats and Conversion](#) for a detailed description of point code formats, rules for specification, and examples.

### **gta (mandatory)**

Global title address. The beginning of a range of global title digits.

#### **Range:**

1-21 digits

If the Hex Digit Support for GTT feature is not enabled, the range is 1 - 21 decimal digits; valid digits are 0-9.

If the Hex Digit Support for GTT feature is enabled and on, the range is 1 - 21 hexadecimal digits; valid digits are 0-9, a-f, A-F.

### **cggtmod (optional)**

Calling party GT modification indicator. This parameter specifies whether calling party global title modification is required.

#### **Range:**

*yes*

*no*

#### **Default:**

*no*

### **egta (optional)**

End global title address. The end of a range of global title digits.

#### **Range:**

1-21 digits

If the Hex Digit Support for GTT feature is not enabled, the range is 1 - 21 decimal digits; valid digits are 0-9.

If the Hex Digit Support for GTT feature is enabled and on, the range is 1 - 21 hexadecimal digits; valid digits are 0-9, a-f, A-F.

#### **Default:**

*egta* same as *gta*

### **gtmodid (optional)**

Global title modification identifier.

#### **Range:**

*ayyyyyyy*

1 alphabetic followed by up to 8 alphanumeric characters

#### **Default:**

No change to the current value

**loopset (optional)**

SCCP loopset name. This parameter associates a translation set with a loopset.

**Range:**

ayyyyyyy

1 alphabetic character followed by up to 7 alphanumeric characters.

*none* —Disassociates the translation set from all loopsets.

**mapset (optional)**

MAP set ID. The Mated Application set ID.

**Range:**

1 - 36000, *dflt*

*dflt* —Default MAP set

**mrnset (optional)**

MRN set ID. The Mated Relay Node set ID.

**Range:**

1 - 3000, *dflt*, *none*

*dflt* -Default MRN set

*none* -The GTT translation does not participate in any load sharing

**pc (optional)**

ANSI point code with subfields *network indicator-network cluster-network cluster member (ni-nc-ncm)*. The *prefix* subfield indicates a private point code (*prefix-ni-nc-ncm*).

**Synonym:**

*pca*

**Range:**

*p-*, 000-255

Specify a valid value for each subfield of the point code, and separate the subfields with a dash (-).

*prefix—p-*

When *chg-sid:pctype=ansi* is specified, *ni = 000* is not valid.

When *chg-sid:pctype=ansi* is specified, *nc = 000* is not valid if *ni = 001-005*.

When *chg-sid:pctype=ansi* is specified, *nc = 000* is valid if *ni = 006-255*.

The point code *000-000-000* is not a valid point code.

**pc/pca/pci/pcn/pcn24 (optional)**

Point code.

**pci (optional)**

ITU international point code with subfields *zone-area-id*. The *prefix* subfield indicates a spare point code, private point code, or private and spare point code (*prefix-zone-area-id*).

**Range:**

*s-*, *p-*, *ps-*, 0-255

Specify a valid value for each subfield of the point code, and separate the subfields with a dash (-).

*prefix—s-, p-, ps*

zone—0-7  
area—000-255  
id—0-7

The point code 0-000-0 is not a valid point code.

#### **pcn (optional)**

ITU national point code in the format of a 5-digit number (*nnnnn*); or 2, 3, or 4 numbers (members) separated by dashes (*m1-m2-m3-m4*) as defined by the `chg-stpopts:npcfmti` flexible point code option. A group code must be specified when the ITUDUPPC feature is turned on (*nnnnn-gc*, *m1-m2-m3-m4-gc*). The *prefix* subfield indicates a spare point code, private point code, or private and spare point code (*prefix-nnnnn*, *prefix-nnnnn-gc*, *prefix-m1-m2-m3-m4*, *prefix-m1-m2-m3-m4-gc*).

#### **Range:**

*s-*, *p-*, *ps-*, 0-16383, *aa-zz*

Specify a valid value for each subfield of the point code, and separate the subfields with a dash (-).

*prefix*—*s-*, *p-*, *ps*

*nnnnn*—0-16383

*gc*—*aa-zz*

*m1-m2-m3-m4*—0-14 for each member; values must sum to 14

#### **pcn24 (optional)**

24-bit ITU national point code with subfields *main signaling area-sub signaling area-signaling point* (*msa-ssa-sp*). The *prefix* subfield indicates a private point code (*prefix-msa-ssa-sp*).

#### **Range:**

*p-*, 000-255

Specify a valid value for each subfield of the point code, and separate the subfields with a dash (-).

*prefix*—*p*

*msa*—000-255

*ssa*—000-255

*sp*—000-255

#### **ri (optional)**

Routing Indicator. This parameter provides routing instructions to the receiving signaling point. In gateway screening, messages may be screened based on the value of the routing indicator.

#### **Range:**

##### **gt**

Allow a called party address with a routing indicator value of *global title*.

##### **ssn**

Allow a called party address with a routing indicator value of *dpc/ssn*.

#### **Default:**

No change in current value.

#### **split (optional)**

Split or change an existing GTA range.

**Range:****yes**

Split the existing GTA range.

**no**

Change the existing GTA range.

**Default:**

yes

**ssn (optional)**

Subsystem number.

**Range:**

002 - 255

**Default:**

If the `xlat=dpcngt` parameter is specified, there is no change to the current value.

If the `xlat=dpcngt` parameter is not specified, the `ssn` parameter is removed.

**ttn (optional)**

Translation type name.

**Range:**

ayyyyyyy

1 alphabetic character followed by up to 8 alphanumeric characters

**Default:**

No translation name is given

**type/typea/typei/typen/typen24/typeis/typens (optional)**

Translation type. The translation type and network type. This parameter is the decimal representation of the 1-byte field used in SS7.

The `type` and `typea` parameters specify an ANSI network.

The `typei` parameter specifies an ITU-international network.

The `typen` parameter specifies an ITU-national network.

The `typen24` parameter specifies a 24-bit ITU-national network.

The `typeis` parameter specifies an ITU-international spare network.

The `typens` parameter specifies an ITU-national spare network.

A translation type numeric value may be entered as an ANSI type (`type` or `typea`) and as an ITU type (`typei/typen/typen24/typeis/typens`). However, they are separate entities.

The point code domain translation types for GTT are handled by the EAGLE protocol processing as either ANSI or ITU; therefore, ITU applies to ITU-I, ITU-I spare, ITU-N, ITU-N spare, and ITU-N24.

**Range:**

0 - 255

**Default:**

No translation type is specified

**xlat (optional)**

Translate indicator. Translation actions and routing actions.

**Range:***dpc**dpcssn**dpcngt***Default:**

No change in current value.

**Example**

```
chg-gtt:type=5:gta=9195551212:egta=9195551999:xlat=dpcssn:ri=ssn:
pc=255-002-001:ssn=255
```

```
chg-gtt:ttn=lidb2:gta=9197771212:egta=9197771999:xlat=dpcngt:ri=gt:
pc=255-002-001
```

```
chg-gtt:ttn=lidb6:gta=910777:pc=255-002-002
```

```
chg-gtt: type=10:gta=8005553232:egta=8005554000:gtmodid=sn1
```

```
chg-gtt:type=11:gta=8005553232:egta=8005554000:gtmodid=none
```

```
chg-gtt:gta=123456:pci=s-1-129-7:typei=41
```

```
chg-gtt:gta=223456:pcn=s-128-aa:typen=3
```

```
chg-
gtt:ttn=setmrn:gta=1234567890:egta=2234567890:pc=1-1-2:mrnset=none
```

```
chg-
gtt:ttn=setmrn:gta=2234567891:egta=2234567892:pc=1-1-2:mrnset=df1t
```

```
chg-gtt:ttn=setmrn:gta=2345678901:egta=3456789012:pc=1-1-3:mrnset=2
```

```
chg-
gtt:ttn=setmap:gta=2345678911:egta=3456789022:ri=ssn:pc=2-2-2:ssn=6:
mapset=df1t
```

The database contains a GTA range [5556000-5558000], but no part of the GTA range [5558001-5559000] exists. This example deletes the GTA range [5556000-5558000] from the database and adds a new GTA range [5556800-5559000] to the database.

```
chg-gtt:ttn=tst1:gta=5556800:egta=5559000:split=no
```

This example deletes the GTA range [5556800-5559000] from the database and adds three new GTA ranges [5556800-5556899], [5556900-5557000] and [5557001-5559000] to the database.

```
chg-gtt:ttn=tst1:gta=5556900:egta=5557000
```

This example specifies hexadecimal digits for the *gta*, *egta*, and *nsds* parameters.

```
chg-
gtt:type=1:xlat=dpcssn:ri=ssn:ssn=10:pc=1-1-1:gta=df3456789012345678
906:egta=df345678901234567890a
```

```
chg-
gtt:ttn=setmap:gta=2345678901:egta=3456789012:ri=ssn:pc=1-1-3:ssn=10
:mapset=2:loopset=none:gtmodid=set6
```

This example specifies that calling party GT modification is required.

```
chg-gtt:gta=981234:type=4:cggmod=yes
```

```
chg-
```

```
gtt:typeis=5:gta=123456:egta=129999:xlata=dpc:ri=gt:pci=s-1-1-4
```

```
chg-
```

```
gtt:typens=5:gta=123456:egta=129999:xlata=dpc:ri=gt:pcn=s-111
```

## Dependencies

If the `pcn` parameter is specified, its format must match the format that was assigned with `chg-stpopts:npcfmti`.

The value specified for the `tt` parameter must correspond to the value specified for the `type/typea/typeei/typen/typen24/typeis/typens` parameter.

The value of the `tt` parameter must exist in the Translation Type table.

The ANSI/ITU SCCP Conversion feature must be enabled before a translated point code and a translation type in different network types can be specified.

If the `xlata=dpc`, `ri=ssn`, and `pc/pca/pci/pcn` parameters are specified, then the point code must exist in the MAP table.

If the new or existing `xlata` parameter value is `dpc`, the new or existing `ri` parameter value is `ssn`, and the `pc/pca/pci/pcn` parameter is not specified, a point code must exist in the Remote Point Code/MAP table.

If the `xlata` parameter value is changed from `dpcssn` to `dpc` or `dpcngt`, a new `ssn` parameter value cannot be specified, and the current `ssn` parameter value must be removed.

If the new `xlata` parameter value is `dpcssn`, and the current `ssn` parameter value has been removed, a new `ssn` parameter value must be specified.

The start GTA length must equal the number of digits specified by the translation type. If the VGTT (variable length GTT) feature is turned on, then up to 10 GTA lengths per translation type are allowed. When the `ent-gtt` command is entered to create entries, the software keeps track of the lengths and allows only ten different lengths. The global title address specified for the translation type must then have the same number of digits as an existing GTA.

If the specified or previously provisioned translated point code is of type ANSI, then the `ngti` value of the referred GT Modification Identifier (see the `ent-gtmod` command) must be 2.

If the `egta` parameter is specified, the length must equal the length of the start GTA.

If the `egta` parameter is specified, the value must be greater than the value specified for the `gta` parameter.

The range of global title addresses to be changed, as specified by the start and end global title addresses, must match exactly or be contained within an existing range in the global title translation data for the specified translation type.

The new `gta - egta` range cannot include the GTA or EGTA of an existing range. However, the new GTA range can completely fall within an existing GTA range. If the range overlaps, an error is generated that displays a list of overlapped GTAs. An example follows that shows what happens when the user attempts to enter a global

title address range (such as 8005550000 to 8005559999) that overlaps an existing range. The overlapping links must match. If they do not, the error message displays the list of overlapped global title addresses:

```
The following GTA ranges overlap the input GTA range
START GTA END GTA 8005550000 8005551999 8005552000 8005553999 8005554000
8005555999
CHG-GTT: MASP A - Command Aborted
```

The `tt` parameter cannot be specified with a value that has been defined as an alias for another translation type.

Either the `type` or the `ttn` parameter must be specified.

Point code entries must be full point codes. Partial point codes are not allowed.

[Table 4-7](#) shows the valid combinations for the `xlat`, `ri`, and `ssn` parameters. All other combinations are rejected.

**Table 4-7 Valid Parameter Combinations for chg-gtt Routing Parameters**

New or Existing XLAT Value	New or Existing RI Value	Routing Action	SSN Value
DPC	GT	Translate DPC only and route on GT	Cannot be specified. The current database entry is removed.
DPC	SSN	Translate DPC only and route on SSN	Cannot be specified. The current database entry is removed.
DPCSSN	GT	Translate DPC and SSN and route on GT	Must be specified
DPCSSN	SSN	Translate DPC and SSN and route on SSN	Must be specified
DPCNGT	GT	Translate DPC only and route on GT	Cannot be specified. The current database entry is removed.

To enter this command, the Remote Point Code table cannot be full.

To enter this command, the subsystem table for primary remote point codes cannot be full.

If the `ri=ssn` parameter is specified, the `mrnset` parameter cannot be specified.

If the Flexible GTT Load Sharing feature is enabled, the point code must already exist in the specified MRN set.

The specified MRN set must already exist in the MRN table.

The Flexible GTT Load-Sharing feature must be enabled before the `mrnset` parameter can be specified.



The SEAS command is not allowed to operate on any other MRN set except the default MRN set.

The MRN table is corrupt or cannot be found.

The `mapset` parameter can only be specified if the Flexible GTT Load Sharing feature is enabled, and the `ri=ssn` parameter is specified. If the `ri=ssn` parameter is specified, the `mapset` parameter must be specified. If the `ri=gt` parameter is specified, the `mapset` parameter cannot be specified.

If the Flexible GTT Load Sharing feature is not enabled, the `mapset` parameter cannot be specified.

At least one entry must be provisioned in the specified MAP set in the MAP table.

The MAP table is corrupt or cannot be found.

The specified or previously provisioned point code and subsystem number must exist in the specified or previously provisioned MAP set.

The SEAS command cannot operate on any MAP set other than the default MAP set.

The specified GTA must lie within an existing GTA range in the specified GTT Set.

The specified GTA range must not overlap with any other existing GTA range in the specified GTT Set.

If the Flexible GTT Load Sharing feature is enabled, then the specified PC must exist in the MRN set.

If the `ri=gt` parameter is specified, the `mapset` parameter cannot be specified.

The Hex Digit Support for GTT feature must be turned on before hexadecimal digits can be specified for the `gta` or `egta` parameter.

The Loopset table is corrupt or cannot be found.

The SCCP Loop Detection feature must be enabled before the `loopset` parameter can be specified.

The value of the `loopset` parameter must exist in the Loopset table.

The site identification table is corrupt or cannot be found.

The Route table is corrupt or cannot be found.

The database is corrupt or cannot be found. Severe database failure.

The Loopset table is corrupt or cannot be found.

If the `ri=gt` parameter is specified, the `mrnset` parameter must be specified.

The GTT table cannot be full.

If the value of the `pc/pca/pci/pcn/pcn24` parameter is the True Point Code, then the `xlat=dpcssn` parameter and the `ri=ssn` parameter must be specified.

If the `ssn` parameter is specified, and if the value of the `pc/pca/pci/pcn/pcn24` parameter is the True Point Code, then the value of the `ssn` parameter must exist in the SS-APPL table.

The value of the `pc/pca/pci/pcn/pcn24` parameter must exist as a destination in the ordered route entity set or must reside in a cluster (ANSI only) that exists as a destination in the ordered route entity set.

If the `xlat=dpcssn` and `ri=gt` parameters are specified, then the `ssn` parameter must be specified.

The `xlat=dpcssn` parameter must be specified before the `ssn` parameter can be specified.

If the `xlat=dpcngt` parameter is specified, then the `ri=gt` parameter must be specified.

The `gta` length is not defined for the specified translation type entity.

If the `tt` parameter is not specified, then the value of the `ttn` parameter must match the value of a `tt` parameter in the STP database.

The value of the `pc/pca/pci/pcn/pcn24` parameter cannot be out of range.

At least one optional parameter must be specified.

The value specified for the `pc` parameter cannot be associated with a proxy point code.

The AMGTT feature or the AMGTT CgPA Upgrade feature must be turned on before the `cggtmod` parameter can be specified.

The GTT set associated with the translation type specified by the `ttn` parameter must have a set type of `cdgta` (see the `ent-gttset` command).

The value specified by the `gtmodid` parameter must already exist in the GTMOD table (see the `ent-gtmod` command).

The GTMOD table is corrupt or cannot be found.

The `ttn=none` parameter cannot be specified.

The network domain of the translation type specified by the `ttn` parameter cannot be CROSS (see the `ent-gttset` command).

The `xlat=none` parameter cannot be specified.

The values specified for the `gta` and `egta` parameters must match the GTA values referred in the GTT Action Path table (see the `ent-gttapath` command).

## Notes

The specified DPC, SSN, relative cost, and routing indicator will overwrite the existing data values in the table.

When the Intermediate GTT Load Sharing feature and the Flexible GTT Load Sharing feature are on, multiple relationships can be defined among a set of destination point codes in the existing MRN table. The relationship used in a particular translation is based on the GTA digits used for translation. The MRN Set and the post-translation PC formulate a key used as a lookup in the MRN table. The MRN table lookup results in a set of alternate PCs, one of which is selected (based on relative cost) to route the MSU in the most cost effective way.

When the Flexible GTT Load Sharing feature is turned on, multiple relationships among a set of PCs and SSNs in the existing MAP table are supported. The relationship used in a particular translation is based on the GTA digits used for translation. The MAP set ID and PC/SSN formulate a key that is used to perform lookup tasks in the MAP table. The lookup

results in a set of mate PC/SSNs, one of which is selected to route the MSU in the most cost effective way.

If the AMGTT feature is turned off, then the Default GT Conversion table is used for conversion.

AMGTT feature: The digit manipulation parameters NSDD, NSDS are enabled with the AMGTT feature. NSDD and NSDS (suffix digit manipulation parameters) are mutually exclusive of the NPDD and NPDS (prefix digit manipulations parameters).

Spare Point Code feature (53120): The point code parameters PCI and PCN supports the Spare Point Code subtype prefix (s-). The Point Code domain translation types for GTT are handled by the system protocol processing as ANSI or ITU. ITU applies to ITU-I, ITU-I Spare, ITU-N, and ITU-N Spare. ITU-I includes ITU-I Spare, and ITU-N includes ITU-N Spare.

Flexible GTT Load Sharing feature (74382): The Flexible GTT Load Sharing feature allows a PC or PC/SSN combination to be provisioned in multiple load-sharing relationships for post-GTT load sharing of intermediate and final GTT traffic.

Load sharing for intermediate GTT traffic requires the Intermediate GTT Load Sharing feature, which can be run in conjunction with the Flexible GTT Load Sharing feature. Intermediate GTT load sharing is performed through the MRN table, and the GTT destination is a PC. If both the Intermediate and Flexible GTT Load Sharing features are on, different load-sharing relationships can be defined between the same set of PCs, and different sets of destinations can contain the same PCs.

Load sharing for final GTT traffic is performed through the MAP table, and the GTT destination is a PC/SSN combination. If the Flexible GTT Load Sharing feature is on, different load-sharing relationships can be defined between the same set of PC/SSNs, and different sets of destinations can contain the same PC/SSN combinations.

A loopset consists of a set of point codes that form a routing loop in the network. If the SCCP Loop Detection feature is enabled, then the loopset can be associated with or disassociated from specified translation entries. Loopsets that are associated with translation entries are checked during intermediate and final GTT traffic routing. If a loop exists, then the system can be notified with or without discarding the associated traffic.

The maximum length of the resulting GTA string must not exceed 21 digits when translation is complete.

If the range specified by the `gta` and `egta` parameters does not exactly match the existing range, then the existing range is split. All addresses in the existing range that are outside the range specified by the `gta` and `egta` parameters retain the original `xlat`, `ri`, `pc`, and `ssn` parameters.

A new range is created that is bounded by the `gta` and `egta` parameters. The new range contains new values for the `xlat`, `ri`, `pc`, and `ssn` parameters that are present in the command, while retaining parameter values from the previous range that do not have corresponding new values in the command.

If the EGTT feature is turned on, then the following occurs for the `chg-gtt` command:

- For ANSI, if a GTT selector is deleted using the `dlt-gttsel` command, then the corresponding GTT entry cannot be updated.

- For ITU, if a true GTT selector entry (GTI=2 or GTI=4) is deleted using the `dlt-gttset` command, or if the GTT set name of an entry is changed using the `chg-gttset` command, then the corresponding GTT entry cannot be updated.

### Output

```
chg-gtt:gta=981234:type=4:cggtmod=yes:gtmodid=set3
```

```
tekelecstp 10-03-09 17:29:06 EST EAGLE 42.0.0
CHG-GTT: MASP A - COMPLTD
;
```

### Related Topics

- [dlt-gtt](#)
- [ent-gtt](#)
- [rtrv-gtt](#)

## chg-gttact

Use this command to change a Global Title Translation (GTT) Action entry. A GTT Action entry consists of an Action ID, an action, and action specific data. The action specified in the entry determines the process that is performed on the MSU during translation.

### Parameters



#### Note:

Definitions for the feature options specified by the `on` and `off` parameters are located in the Notes section.

#### **actid (mandatory)**

GTT Action ID. The Action ID associated with the GTT Action entry.

#### **Range:**

ayyyyyyy

1 leading alphabetic character and up to 8 following alphanumeric characters

#### **act (optional)**

Action. The GTT Action that is applied to the message.

#### **Range:**

#### ***disc***

discard message with no return error

#### ***dup***

route a copy of the message to a specified duplicate node

***fwd***

route the original message to a specified forward node instead of the destination indicated by the GTT/ DB data

***scpval***

perform the SCCP MAP validation on MO/MT-FSM messages

***sflog***

send a copy of original message to SFLOG card

***sfthrot***

discard message if threshold is exceeded

***svvc***

apply service (GPORT/GFLEX/SMSMR) on the message

***tcaperr***

discard message that has a specified TCAP error

***udts***

discard message and send UDTS/XUDTS

**atcaperr (optional)**

ANSI TCAP error cause. The reason for discarding a message that contains the ANSI TCAP portion associated with the *tcaperr* GTT Action.

**Range:**

0 - 255

**Default:**

No change to the current value

**atirescgmodid (optional)**

Calling party global title modification identifier for ATI. The GTMOD ID to be associated with the calling party of a SFAPP GTT Action entry.

**Range:**

ayyyyyyy

1 leading alphabetic character followed by up to 8 alphanumeric characters

**Default:**

None

**bursts (optional)**

The number of previous 30 second windows from where the unused capacity can be carried over to the current window.

**Range:**

0 - 2

**Default:**

0

**cdgtmodid (optional)**

Called party global title modification identifier.

**Range:**

ayyyyyyy

1 alphabetic followed by up to 8 alphanumeric characters

*none* —removes the association between the GTT Action entry and the CdPGT modification identifier**Default:**

No change to the current value

**cggtmodid (optional)**

Calling party global title modification identifier.

**Range:**

ayyyyyyy

1 alphabetic character followed by up to 8 alphanumeric characters

*none* —removes the association between the GTT Action entry and the CgPGT modification identifier**Default:**

No change to the current value

**cgpc (optional)**ANSI CgPA point code with subfields *network indicator-network cluster-network cluster member (ni-nc-ncm)*. The *prefix* subfield indicates a private point code (*prefix-ni-nc-ncm*).**Synonym:**

cgpca

**Range:**

p-, 000-255

Specify a valid value for each subfield of the point code, and separate the subfields with a dash (-).

*prefix—p-*When *chg-sid:pctype=ansi* is specified, *ni = 000* is not valid.When *chg-sid:pctype=ansi* is specified, *nc = 000* is not valid if *ni = 001-005*.When *chg-sid:pctype=ansi* is specified, *nc = 000* is valid if *ni = 006-255*.The point code *000-000-000* is not a valid point code.**cgpci (optional)**ITU international CgPA point code with subfields *zone-area-id*. The *prefix* subfield indicates a spare point code, private point code, or private and spare point code (*prefix-zone-area-id*).**Range:**

s-, p-, ps-, 0-255

Specify a valid value for each subfield of the point code, and separate the subfields with a dash (-).

*prefix—s-, p-, ps**zone—0-7**area—000-255**id—0-7*The point code *0-000-0* is not a valid point code.**cgpcn (optional)**ITU national CgPA point code in the format of a 5-digit number (*nnnnn*); or 2, 3, or 4 numbers (members) separated by dashes (*m1-m2-m3-m4*) as defined by the *chg-*

`stpopts:npcfmti` flexible point code option. A group code must be specified when the ITUDUPPC feature is turned on (*nnnnn-gc*, *m1-m2-m3-m4-gc*). The *prefix* subfield indicates a spare point code, private point code, or private and spare point code (*prefix-nnnnn*, *prefix-nnnnn-gc*, *prefix-m1-m2-m3-m4*, *prefix-m1-m2-m3-m4-gc*).

**Range:**

*s-*, *p-*, *ps-*, *0-16383*, *aa-zz*

Specify a valid value for each subfield of the point code, and separate the subfields with a dash (-).

*prefix*—*s-*, *p-*, *ps*

*nnnnn*—*0-16383*

*gc*—*aa-zz*

*m1-m2-m3-m4*—*0-14* for each member; values must sum to 14

**cgpcn16 (optional)**

16-bit ITU national CgPA point code with subfields *unit number-sub number area-main number area* (*un-sna-mna*). The *prefix* subfield indicates a private point code (*prefix-un-sna-mna*).

**Range:**

*p--*, *000--127*

Specify a valid value for each subfield of the point code, and separate the subfields with a dash (-).

*prefix--p*

*un---000---127*

*sna ---000---15*

*mna---000---31*

**cgpcn24 (optional)**

24-bit ITU national CgPA point code with subfields *main signaling area-sub signaling area-signaling point* (*msa-ssa-sp*). The *prefix* subfield indicates a private point code (*prefix-msa-ssa-sp*).

**Range:**

*p-*, *000-255*

Specify a valid value for each subfield of the point code, and separate the subfields with a dash (-).

*prefix*—*p*

*msa*—*000–255*

*ssa*—*000–255*

*sp*—*000–255*

**cgpcogmsg (optional)**

The data used as the Calling Party Point Code in the outgoing message.

**Range:**

*dflt*

Default. The standard Global Title Translation process supplies the CgPA PC.

**cgpcicmsg**

CgPA PC data from the incoming MSU

**opcicmsg**

OPC data from the incoming MSU

**provcgpc**

provisioned CGPC/CGPCA/CGPCI/CGPCN/CGPCN24/CGPCN16 data in the GTT Action

**remove**

CGPC will be removed from outgoing MSU

**Default:**

No change to the current value

**defactid (optional)**

Default Action ID. The default action that is performed when the  *fwd*  GTT Action fails to route the MSU or when  *sfthrot*  or  *scpval*  GTT Action fails.

**Range:**

ayyyyyyy

1 leading alphabetic character followed by 8 alphanumeric characters

The  *defactid*  parameter can take one of the following values:

- GTT Action ID with a GTT Action of  *disc* ,  *udts* , or  *tcaperr*  (see the  *act*  parameter). This value must already be defined in the GTT Action table.
- *fallback*  —The MSU is routed using routing data in the translated MSU when action is  *fwd* . When action is set to  *scpval/sfthrot* , the MSU is discarded.

**itcaperr (optional)**

ITU TCAP error cause. The reason for discarding the message that contains the ITU TCAP portion associated with the  *tcaperr*  GTT Action.

**Range:**

0 - 255

**Default:**

No change to the current value

**loopset (optional)**

SCCP loopset name. This parameter associates a GTT Action with a loopset.

**Range:**

ayyyyyyy

One leading alphabetic character and up to 7 following alphanumeric characters.

*none*  —disassociates the GTT Action from all loopsets

**Default:**

No change to the current value

**mapset (optional)**

MAP Set ID. The Mated Application Set ID.



**Range:**

1 - 36000, *dflt*  
*dflt* —Default MAP set

**Default:**

No change to the current value

**mrnset (optional)**

MRN Set ID. The Mated Relay Node Set ID.

**Range:**

1 - 3000, *dflt*, *none*  
*dflt* —Default MRN Set ID  
*none* —The GTT Action does not participate in any loadsharing.

**Default:**

No change to the current value

**nactid (optional)**

New GTT Action ID.

**Range:**

*ayyyyyyy*  
1 leading alphabetic character and up to 8 following alphanumeric characters

**ndgt (optional)**

Number of digits to be matched. This parameter is used to specify the number of digits that needs to be matched between the SCCP and MAP parameters.

**Range:**

1-21, *all*

*all* - All the digits present in the SCCP and MAP parameters are matched.

**Default:**

*all*

**off (optional)**

Disables or turns off the specified feature options. A comma-separated list of feature options that are requested to be turned off. Up to 8 feature options can be specified in the list.

**Range:**

*uimreqd*

*useicmsg*

*handlresp*

**on (optional)**

Enables or turns on the specified feature options. A comma-separated list of feature options that are requested to be turned on. Up to 8 feature options can be specified in the list.

**Range:***uimreqd**useicmsg**handlresp***pc (optional)**

ANSI point code with subfields *network indicator-network cluster-network cluster member (ni-nc-ncm)*. The *prefix* subfield indicates a private point code (*prefix-ni-nc-ncm*).

**Synonym:***pca***Range:***p-*, 000-255

Specify a valid value for each subfield of the point code, and separate the subfields with a dash (-).

*prefix—p-*

When *chg-sid:pctype=ansi* is specified, *ni = 000* is not valid.

When *chg-sid:pctype=ansi* is specified, *nc = 000* is not valid if *ni = 001-005*.

When *chg-sid:pctype=ansi* is specified, *nc = 000* is valid if *ni = 006-255*.

The point code *000-000-000* is not a valid point code.

**pci (optional)**

ITU international destination point code with subfields *zone-area-id*. The *prefix* subfield indicates a spare point code, private point code, or private and spare point code (*prefix-zone-area-id*).

**Range:***s-*, *p-*, *ps-*, 0-255

Specify a valid value for each subfield of the point code, and separate the subfields with a dash (-).

*prefix—s-*, *p-*, *ps**zone—0-7**area—000-255**id—0-7*

The point code *0-000-0* is not a valid point code.

**pcn (optional)**

ITU national point code in the format of a 5-digit number (*nnnnn*); or 2, 3, or 4 numbers (members) separated by dashes (*m1-m2-m3-m4*) as defined by the *chg-stpopts:npcfnti* flexible point code option. A group code must be specified when the ITUDUPPC feature is turned on (*nnnnn-gc*, *m1-m2-m3-m4-gc*). The *prefix* subfield indicates a spare point code, private point code, or private and spare point code (*prefix-nnnnn*, *prefix-nnnnn-gc*, *prefix-m1-m2-m3-m4*, *prefix-m1-m2-m3-m4-gc*).

**Range:***s-*, *p-*, *ps-*, 0-16383, *aa-zz*

Specify a valid value for each subfield of the point code, and separate the subfields with a dash (-).

*prefix—s-*, *p-*, *ps**nnnnn—0-16383*

*gc—aa-zz*  
*m1-m2-m3-m4—0-14* for each member; values must sum to 14

**pcn24 (optional)**

24-bit ITU national point code with subfields *main signaling area-sub signaling area-signaling point (msa-ssa-sp)*. The *prefix* subfield indicates a private point code (*prefix-msa-ssa-sp*).

**Range:**

*p-*, 000-255

Specify a valid value for each subfield of the point code, and separate the subfields with a dash (-).

*prefix—p*

*msa—000—255*

*ssa—000—255*

*sp—000—255*

**pcn16 (optional)**

16-bit ITU national point code with subfields *unit number-sub number area-main number area (un-sna-mna)*. The *prefix* subfield indicates a private point code (*prefix-un-sna-mna*).

**Range:**

*p--*, 000--127

Specify a valid value for each subfield of the point code, and separate the subfields with a dash (-).

*prefix--p*

*un---000---127*

*sna ---000---15*

*mna---000---31*

**psirescgmodid (optional)**

Calling party global title modification identifier for PSI. The GTMOD ID to be associated with the calling party of a SFAPP GTT Action entry.

**Range:**

*ayyyyyyy*

1 leading alphabetic character followed by up to 8 alphanumeric characters

**Default:**

None

**ri (optional)**

Routing indicator. The routing indicator in the SCCP called party address of the MSU being processed.

**Range:**

*gt*

route by the global title digits

**ssn**

route by the subsystem number

**snai (optional)**

The service nature of address indicator.

**Range:**

*Sub* -- Subscriber number

*Natl* -- National significant number

*intl* -- International number

*rnidn* -- Routing number prefix and international dialed/directory number

*rnndn* -- Routing number prefix and national dialed/directory number

*rnsdn* -- Routing number prefix and subscriber dialed/directory number

*ccrndn* -- Country code, routing number, and national directory number

**snp (optional)**

The service numbering plan.

**Range:**

*e164* ---- E.164 numbering plan

*e212* ---- E.212 numbering plan

*e214* ---- E.214 numbering plan

**sprm (optional)**

SCCP Parameter. This parameter is used to decide whether the SCCP GTA, NP and NAI (if GTI=4 and NP/NAI is present) will be picked up from CDPA or CGPA and used for comparison.

**Range:**

*CDPA* --- SCCP CDPA GTA, NP and NAI (if GTI=4 and NP/NAI is present) is used for comparison.

*CGPA* --- SCCP CGPA GTA, NP and NAI (if GTI=4 and NP/NAI is present) is used for comparison.

**Default:**

*CDPA*

**svccerr (optional)**

The action to be performed when the Service triggered by GTT Action Services fails. The MSU can be processed by either applying the results of the pre-Service GTT, or continue with the specific Service error.

**Range:**

*SRVC* --- Continue with specific service error

*GTT* --- Apply the result of pre-GTT service

**Default:**  
*SRVC*

**srvcname (optional)**

Service to be applied on the MSU when *act* is set to *srvc*.

**Range:**  
*GFLEX, GPORT, SMSMR*

**ssn (optional)**

Subsystem number. The value used for the SSN in the SCCP called party address of the MSU.

**Range:**  
*2 - 255, none*  
*none* —an SSN is not used

**threshold (optional)**

Throttling threshold. The MSU is discarded if the number of MSUs serviced by the SFTHROT action exceeds this value in a 30 second period.

**Range:**  
*1-42949676295*

**Default:**  
*1*

**tprm (optional)**

TCAP Parameter. This parameter is used to decide whether the MAP digits, NP and NON (if NP and NON are present) will be picked up from SMRPDA or SMRPOA and used for comparison.

**Range:**  
*SMRPDA* --- MAP digits, NP and NON (if NP and NON are present) from SMRPDA are used for comparison

*SMRPOA* --- MAP digits, NP and NON (if NP and NON are present) from SMRPOA are used for comparison

**Default:**  
*SMRPDA*

**udtserr (optional)**

UDTS error cause. The reason associated with the UDTS GTT Action for discarding the message.

**Range:**  
*0 - 255*

**Default:**  
No change to the current value

**Example**

```
chg-gttact:actid=dup1:act=dup:ssn=40
```

Changing the Action Id of the already provisioned GTT Action entry:

```
chg-gttact:actid=dup1:act=dup:nactid=dup2
```

```

chg-gttact:actid=discl:act=tcaperr:atcaperr=10

chg-gttact:actid=actfwd1:act=fwd:pc=2-2-2:ri=gt:defactid=none

chg-gttact:act=dup:actid=dup2:cdgtmodid=set1:cggtmodid=none

chg-gttact:act=dup:actid=dup5:cggtmodid=set4

chg-
gttact:actid=actfwd2:act=fwd:pc=2-2-2:ri=gt:defactid=fallback:on=use
icmsg

chg-gttact:actid=actfwd3:act=fwd:pc=2-2-2:ri=gt:cgpcogmsg=opcicmsg

chg-
gttact:actid=actdup3:act=dup:pc=2-2-2:ri=gt:cgpc=1-1-1:cgpcogmsg=pro
vcgpc

chg-
gttact:act=fwd:actid=actfwd5:pcn16=1-14-0:ri=gt:mrnset=dflt:cgpcogms
g=remove

chg-gttact:actid=gflex1:act=GPORT

chg-gttact:actid=actsrvcl:snp=e164:snai=rnndn:svcerr=gtt

chg-gttact:actid=actsfthrot:threshold=2000:bursts=1

chg-gttact:actid=sflog1:nactid=sflogid1

chg-gttact:actid=scpval1:act=scpval:sprm=cgpa:ndgt=20

chg-gttact:actid=sfapp8:failactid=fallback

chg-gttact:actid=sfapp8:hlraddr=tcapparm:tt=26

chg-gttact:actid=sfapp9:hlraddr=usecdpa

chg-gttact:actid=sfapp10:act=sfapp:atirescgmodid=set1

chg-gttact:actid=sfapp10:psirescgmodid=set5

chg-gttact:actid=sfapp10:on=handlresp

```

### Dependencies

A value of *dup* or *fwd* must be specified for the *act* parameter before the *pc/pca/pci/pcn/pcn24/pcn16*, *cgpc/cgpc/cgpci/cgpcn/cgpcn24/cgpcn16*, *cgpcogmsg*, *cdgtmodid*, *cggtmodid*, *ssn*, *ri*, *mrnset*, *mapset*, or *loopset* parameter can be specified and before a value of *useicmsg* can be specified for the *on* or *off* parameter.

The *act=tcaperr* parameter must be specified before the *atcaperr* and *itcaperr* parameters can be specified.

The *act=udts* parameter must be specified before the *udtserr* parameter can be specified.

The *act=fwd/sfthrot/scpval* parameter must be specified before the *defactid* parameter can be specified.

The Service Numbering Plan (*snp*), Service Nature of Address Indicator (*sna*), Service Name (*svcname*) and Service Error Cause (*svcerr*) parameters can only be specified when *act* is set to *srvc*.

The *srvc/sflog/sfthrot/scpval* GTT Action cannot be changed to any other GTT Action (Duplicate/forward/TCAP Error/Discard/UDTS Error) and vice versa.

The parameters *threshold* and *bursts* can only be specified when *action* is set to *sfthrot*.

The *sfthrot* GTT Action cannot be changed to any other GTT Action (Duplicate/Forward/TCAP Error/Discard/UDTS Error/SRVC/SCPVAL) and vice versa.

The *scpval* GTT Action cannot be changed to any other GTT Action (Duplicate/Forward/TCAP Error/Discard/UDTS Error/SRVC/SFTHROT) and vice versa.

The *sflog* GTT Action cannot be changed to any other GTT Action (Duplicate/Forward/TCAP Error/Discard/UDTS Error/SRVC/SFTHROT/SCPVAL) and vice versa.

The SCCP Parameter (*sprm*), TCAP Parameter (*tprm*) can only be specified when *act* is set to *scpval* and *valtype* is set to *scptotcap*.

The Number of digits to match (*ndgt*) parameters can only be specified when *act* is set to *scpval*.

A value of *disc*, *udts*, *tcaperr* or *scpval* must be specified for the *act* parameter before a value of *uimreqd* can be specified for the *on* or *off* parameter.

The GTT Action table is corrupt or cannot be found.

The GTT Action entry specified by the *actid* parameter must already exist in the database.

The value specified for the *nactid* parameter cannot already exist in the database.

A value of *none* or *fallback* cannot be specified for the *actid* or *nactid* parameter.

If a value of *dup* or *fwd* is specified for the *act* parameter then the *pc/pca/pci/pcn/pcn24/pcn16* parameter must be specified.

If the *cgpcogmsg=provcgpc* parameter is specified, then the *cgpc/cgpcacgpci/cgpcn/cgpcn24/pcn16* parameter must be specified.

The GTT Action - DISCARD feature must be enabled before a value of *disc*, *udts*, or *tcaperr* can be specified for the *act* parameter.

The GTT Action - DUPLICATE feature must be enabled before the *act=dup* parameter can be specified.

The specified PC/SSN must already exist in the specified MAP set.

If the *ri=ssn* parameter is specified, then the *mrnset* parameter cannot be specified.

The Flexible GTT Load Sharing feature must be enabled before the *mrnset* parameter can be specified.

If the *ri=gt* parameter is specified, then the *mapset* parameter cannot be specified.

The Flexible GTT Load Sharing feature must be enabled before the *mapset* parameter can be specified.

The specified MAP set must already exist in the database.

The specified MRN set must already exist in the MRN table.

If the Flexible GTT Load Sharing feature is enabled, then the specified PC must already exist in the specified MRN set.

The point code specified for the `pc/pca/pci/pcn/pcn24/pcn16` parameter must be a full point code.

The value specified for the `pc/pca/pci/pcn/pcn24/pcn16` parameter must already exist as a destination in the Route table.

If the value specified for the `pc/pca/pci/pcn/pcn24/pcn16` parameter is the STP true point code, then the value specified for the `ssn` parameter must already exist in the SS-APPL table.

The value specified for the `pc` parameter cannot be associated with a proxy point code.

The MAP table is corrupt or cannot be found.

If the `pc/pca/pci/pcn/pcn24/pcn16`, `ri=ssn` and `ssn` parameters are specified, then the PC/SSN must be populated in the Remote Point Code and MAP tables.

The point code specified for the `pc/pca/pci/pcn/pcn24/pcn16` and `cgpc/cgpca/cgpci/cgpcn/cgpcn24/cgpcn16` parameters must be within the range specified by the parameter definition.

A value of `disc`, `utds`, or `tcaperr` must be specified for the `defactid` parameter.

The Route table is corrupt or cannot be found.

The STP Self-identity table is corrupt or cannot be found.

The SS-APPL table is corrupt or cannot be found.

The MRN table is corrupt or cannot be found.

The `ri=ssn` and the `ssn=none` parameters cannot be specified together in the command.

The SCCP Loop Detection feature must be enabled before the `loopset` parameter can be specified.

The value specified for the `loopset` parameter must already exist in the database.

The Loopset table is corrupt or cannot be found.

Failure while reading the GTT Action Set Table.

The GTT Action - FORWARD feature must be enabled before the `act=fwd` parameter can be specified.

The GTMOD table is corrupt or cannot be found.

The point code specified by the `pc/pca/pci/pcn/pcn24/pcn16` parameter must be associated with a valid route.

If the value specified for the `pc/pca/pci/pcn/pcn24/pcn16` parameter is the STP true point code, then the `ri=ssn` parameter must be specified.

The values specified for the `cdgtmodid` and `cggtmodid` parameters must already exist in the GTMOD table.



The AMGTT or AMGTT CgPA Upgrade feature must be turned on before the `cggmodid` parameter can be specified.

The GTT Action ID specified by the `defactid` parameter must already exist.

The `pc/pca/pci/pcn/pcn24/pcn16` and `cgpc/cgpca/cgpci/cgpcn/cgpcn24/cgpcn16` parameters must have the same domain.

One of the optional parameters must be specified.

The value specified by the `act` parameter cannot be changed until the associated Action ID is referenced by an Action Set or by any `forward/scpval/sfthrot/sflog` action. The value can only be changed from `disc/udts/tcaperr` to `disc/udts/tcaperr`.

The `defactid=none` parameter cannot be specified.

The same value(s) cannot be specified for the `on` and `off` parameters.

The GFLEX feature must be activated if the GFLEX service is entered with the `SRVCNAME` parameter.

The GPORT feature must be activated if the GPORT service is entered with the `SRVCNAME` parameter.

The Portability Check for Mobile Originated SMS feature/PPSMS feature must be turned ON, or the MO SMS ASD/MO SMS B-Party Routing/MO SMS GRN/MO SMS IS41-to-GSM Migration/MO-based GSM SMS NP/MO-based IS41 SMS NP feature must be ENABLED before the SMSMR Service is entered with `SRVCNAME` parameter.

If the value specified for the `SRVCNAME` parameter is GFLEX, then the `snai=sub`, `natl` or `intl` parameter must be specified.

If the value specified for the `SRVCNAME` parameter is GPORT/SMSMR, then the `snai= rnidn`, `rnndn`, `rnsdn` or `ccrndn` parameter must be specified.

If the value specified for the `SRVCNAME` parameter is GPORT/SMSMR, then the `snp=e164` parameter must be specified.

If the value specified for the `SRVCNAME` parameter is GFLEX, then the `snp=e164`, `e212` or `e214` parameter must be specified.

The GTT destination must exist in the DSTN table.

A value of `fwd`, `dup` or `scpval` must be specified for the `act` parameter before a value of `useicmsg` can be specified for the `on` or `off` parameter.

The value specified for the `atirescgmodid` and `psirescgmodid` parameters must already exist in the GTMOD table.

AMGTT feature must be enabled, if `atirescgmodid` or `psirescgmodid` is specified.

## Notes

### on/off options

- `uimreqd` —UIM required. Specifies whether a UIM should be generated.

- *useicmsg* —Use Incoming Message. Specifies whether to apply GTT Action data to the message as the message was received (OFF) or after any EPAP or GTT translation/ modification data has been applied (ON).
- *handlresp* — Handle response message. Specifies whether to apply GTT Action data to the message as the message is a response message to an Eagle-generated ATI or PSI.

GTT Actions *svrc*, *scpval*, *sflog* and *sfthrot* cannot be changed to any other GTT Action (Duplicate/Forward/TCAP Error/Discard/UDTS Error/*svrc*/*scpval*/*sflog*/*sfthrot*) and vice versa. A *svrc* GTT Action representing one service can be changed to another service.

GTI, TT and NPDS must be provisioned in GTMOD table to associate gtmoid with ATIRESCGMODID or PSIRESCGMODID.

## Output

```
chg-gttact:actid=dup1:ssn=40
```

```
tekelecstp 10-02-04 18:29:41 EST EAGLE 42.0.0
chg-gttact:actid=dup1:ssn=40
Command entered at terminal #4
```

```
GTT Action table is (2 of 2000) 1% full
```

```
CHG-GTTACT: MASP A - COMPLTD
```

```
;
```

```
chg-gttact:actid=gflex1:act=GPORT
```

```
tekelecstp 13-12-07 13:41:11 EST EAGLE 46.0.0
chg-gttact:actid=gflex1:act=GPORT
Command entered at terminal #1
GTT Action table is (5 of 2000) 1% full
CHG-GTTACT: MASP A - COMPLTD
```

```
;
```

```
chg-gttact:actid=sfthrot1:threshold=2000:bursts=1
```

```
tekelecstp 15-05-27 15:43:59 EST Eagle 46.3.0
chg-gttact:actid=sfthrot1:threshold=2000:bursts=1
Command entered at terminal #1
GTT Action table is (5 of 2000) 1% full
CHG-GTTACT: MASP A - COMPLTD
```

```
;
```

```
chg-gttact:actid=scpval1:act=scpval:sprm=cgpa:ndgt=20
```

```
tekelecstp 15-05-28 10:27:42 EST EAGLE 46.3.0
chg-gttact:actid=scpval1:act=scpval:sprm=cgpa:ndgt=20
Command entered at terminal #1
GTT Action table is (20 of 2000) 1% full
```

```

CHG-GTTACT: MASP A - COMPLTD
;

chg-gttact:actid=sfapp3:act=sfapp:atirescgmodid=set5

tekelecstp 18-05-07 10:13:26 EST  EAGLE 46.7.0.0-74.5.0
chg-gttact:actid=sfapp3:act=sfapp:atirescgmodid=set5
Command entered at terminal #4.
GTT-ACT table is (3 of 2000) 1% full.
CHG-GTTACT: MASP A - COMPLTD
;

```

### Related Topics

- [dlt-gttact](#)
- [ent-gttact](#)
- [rtrv-gttact](#)

## chg-gttapath

Use this command to change a GTT Action path entry. A GTT Action path consists of pairs of "setname + value" for Opcode/CgGTA/CdGTA. Each "setname + value" pair must already be defined in the GTT translation table.

### Parameters

#### **gttpn (mandatory)**

GTT Path name.

##### **Range:**

*ayyyy*

1 leading alphabetic character and up to 4 following alphanumeric characters.

#### **acn (optional)**

Application context name. The ITU TCAP ACN field in the incoming MSU.

##### **Range:**

*0 - 255, \* none*

*none*—there is no ITU TCAP ACN field in the incoming MSU

#### **cdgta (optional)**

Called Party Global Title Address.

##### **Range:**

1-21 digits

If the Hex Digit Support for GTT feature is not enabled, the range is 1 - 21 decimal digits; valid digits are 0-9.

If the Hex Digit Support for GTT feature is enabled and on, the range is 1 - 21 hexadecimal digits; valid digits are 0-9, *a-f*, *A-F*.

#### **cdgttsn (optional)**

GTT set name (CDPA type).

**Range:**

ayyyyyyy

1 leading alphabetic and up to 8 following alphanumeric characters.

**cggta (optional)**

Calling Party Global Title Address.

**Range:**

1-21 digits

If the Hex Digit Support for GTT feature is not enabled, the range is 1 - 21 decimal digits; valid digits are 0-9.

If the Hex Digit Support for GTT feature is enabled and on, the range is 1 - 21 hexadecimal digits; valid digits are 0-9, a-f, A-F.

**cggtsn (optional)**

GTT set name (CGPA type).

**Range:**

ayyyyyyy

1 leading alphabetic and up to 8 following alphanumeric characters.

**family (optional)**

The ANSI TCAPFAMILY field in the incoming MSU.

**Range:**

0 - 255, \*, none

none —there is no value in the ANSI TCAP FAMILY field in the incoming MSU

**ngttn (optional)**

GTT Path name. The new GTT path name.

**Range:**

ayyyy

1 leading alphabetic character and up to 4 following alphanumeric characters.

**opcode (optional)**

The TCAP OPCODE field in the incoming MSU.

**Range:**

0 - 255, \*, none

none —there is no value in the TCAP OPCODE field in the incoming MSU

**opgtsn (optional)**

GTT set name (Opcode type).

**Range:**

ayyyyyyy

1 leading alphabetic and up to 8 following alphanumeric characters.

**pkgtype (optional)**

The ANSI and ITU TCAP package type.

**Range:*****ituuni***

ITU unidirectional

***qwp***

Query with Permission

***qwop***

Query without Permission

***resp***

Response

***cwp***

Conversation with Permission

***cwop***

Conversation without Permission

***any***

Wildcard value

***bgn***

Begin

***end***

End

***cnt***

Continue

***ituabort***

ITU abort

***ansiabort***

ANSI abort

***ansiuni***

ANSI unidirectional

**ANSI TCAP Package Types:***ansiuni, qwp, qwop, resp, cwp, cwop, ansiabort, any***ITU TCAP Package Types:***bgn, ituabort, ituuni, any, end, cnt***Example**

```
chg-  
gttapath:gttpn=path1:opgttsn=opsn2:acn=1-1-1-1-1-1-1:opcode=123  
:pkgtype=ituuni
```

```
chg-gttapath:gttpn=path1:cggtsn=cgsn2:cggta=45673
```

```
chg-gttapath:gttpn=path1:ngttn=path2
```

## Dependencies

If the `family` parameter is specified, then a value of `ansiuni`, `qwp`, `qwop`, `resp`, `cwp`, `cwop`, `ansiabort`, or `any` must be specified for the `pkgtype` parameter.

If the `acn` parameter is specified, then a value of `bgn`, `ituabort`, `ituuni`, `any`, `end`, or `cnt` must be specified for the `pkgtype` parameter.

If the `pkgtype=ituabort` parameter is specified, then a value of `none` must be specified for the `acn` and `opcode` parameters.

If the `pkgtype=ansiabort` parameter is specified then a value of `none` must be specified for the `family` and `opcode` parameters.

The `opcode`, `pkgtype`, and `family` parameters must be specified together for ANSI TCAP translations. The `opcode`, `pkgtype`, and `acn` parameters must be specified together for ITU TCAP translations.

If the `family` and `opcode` parameters are specified, then either both parameters must have a value of `none` or neither parameter can have a value of `none`.

The GTA table is corrupt or cannot be found.

The GTT DBMM table is corrupt or cannot be found.

A value of `none` cannot be specified for the `opgttsn`, `cggttsn`, and `cdgttsn` parameter(s).

The GTT Action Path table is corrupt or cannot be found.

The specified path cannot already exist in the GTT Action Path table.

The `acn` and `family` parameters cannot be specified together in the command.

The GTT Action - DISCARD, GTT Action - FORWARD, or GTT Action - DUPLICATE feature must be enabled before this command can be entered.

A translation entry corresponding to the specified `(opgttsn + opcode + pkgtype + acn/family)/(cggttsn + cggtta)/(cdgttsn + cdgta)` parameters must exist.

At least one GTT set-value combination must be specified.

The GTT set name specified by the `opgttsn`, `cggttsn`, or `cdgttsn` parameter must match an existing GTT set name.

The GTT set name specified by the `opgttsn`, `cggttsn`, and `cdgttsn` parameters must have set types of `opcode`, `cggtta`, and `cdgta`, respectively.

The GTT Set table must be accessible.

The GTA value specified by the `cggtta` or `cdgta` parameter must be the start GTA in the translation entry.

The GTT path name specified by the `gttprn` parameter must already exist in the database.

A GTT set-value combination(s) cannot be associated with a GTT path that is already associated to another combination. The value specified for the path name must be different from the existing path name.

The GTT path name specified by the `ngttn` parameter cannot already exist in the database.

The value specified for the `gtn` and `ngttn` parameters cannot be a reserved word.

At least one optional parameter must be specified.

### Output

```
chg-gttapath:gtn=path2:cgttsn=cgsn2:cgta=45673
```

```
tekelecstp 10-02-04 18:29:41 EST EAGLE 42.0.0
chg-gttapath:gtn=path2:cgttsn=cgsn2:cgta=45673
Command entered at terminal #4.
```

```
GTT Action Path table is (1 of 10000) 1% full
```

```
CHG-GTTAPATH: MASP A - COMPLTD
```

```
;
```

### Related Topics

- [dlt-gttapath](#)
- [ent-gttapath](#)
- [rtv-gttapath](#)

## chg-gttaset

Use this command to change Global Title Translation (GTT) Action Set data. A GTT Action Set consists of an Action Set name and a set of Action IDs. The specified Action IDs determine the actions that are applied to the MSU during translation. Action IDs are configured using the `ent/chg/dlt-gttact` commands.

### Parameters



#### Note:

Definitions for the feature options specified by the `on` and `off` parameters are located in the Notes section.

#### **actsn (mandatory)**

GTT Action Set Name.

#### **Range:**

ayyyyyyy

1 leading alphabetic character and up to 8 following alphanumeric characters

#### **actid1 (optional)**

GTT Action ID 1. The first Action ID associated with the GTT Action Set.

**Range:***ayyyyyyy*

1 leading alphabetic character and up to 8 following alphanumeric characters  
*none*—removes the Action ID from the GTT Action Set

**actid2 (optional)**

GTT Action ID 2. The second Action ID associated with the GTT Action Set.

**Range:***ayyyyyyy*

1 leading alphabetic character and up to 8 following alphanumeric characters  
*none*—removes the Action ID from the GTT Action Set

**actid3 (optional)**

GTT Action ID 3. The third Action ID associated with the GTT Action Set.

**Range:***ayyyyyyy*

1 leading alphabetic character and up to 8 following alphanumeric characters  
*none*—removes the Action ID from the GTT Action Set

**actid4 (optional)**

GTT Action ID 4. The fourth Action ID associated with the GTT Action set.

**Range:***ayyyyyyy*

1 leading alphabetic character and up to 8 following alphanumeric characters  
*none*—removes the Action ID from the GTT Action Set

**actid5 (optional)**

GTT Action ID 5. The fifth action ID associated with the GTT Action set.

**Range:***ayyyyyyy*

1 leading alphabetic character and up to 8 following alphanumeric characters  
*none*—removes the Action ID from the GTT Action Set

**actid6 (optional)**

GTT Action ID 6. The sixth Action ID associated with the GTT Action Set.

**Range:***ayyyyyyy*

1 leading alphabetic character and up to 8 following alphanumeric characters  
*none*—removes the Action ID from the GTT Action Set

**nactsn (optional)**

New GTT Action Set Name.

**Range:***ayyyyyyy*

1 leading alphabetic character and up to 8 following alphanumeric characters

**off (optional)**

Disables or turns off the specified feature options. A comma-separated list of feature options that are requested to be turned off. Up to 8 feature options can be specified in the list.



**Range:**  
*testmode*

**on (optional)**

Enables or turns on the specified feature options. A comma-separated list of feature options that are requested to be turned on. Up to 8 feature options can be specified in the list.

**Range:**  
*testmode*

**Example**

Changing the GTT Action Set name:

```
chg-gttaset:actsn=asetdisc1:nactsn=asetdisc2
```

Removing Action ID1 and ID3 from an Action Set and changing ID2 to another ID in the GTT Action Set table:

```
chg-  
gttaset:actsn=asetdup1:actid1=none:actid2=disc1:actid3=none:off  
=testmode
```

```
chg-  
gttaset:actsn=asetfwd1:actid1=actfwd1:actid2=actdup1:on=testmod  
e
```

```
chg-gttaset:actsn=asetsrvc1:actid1=actdup2:actid2=actsrvc2
```

**Dependencies**

The GTT Action table is corrupt or cannot be found.

The GTT Action Set table is corrupt or cannot be found.

The Action ID specified by the `actid(X)` parameter(s) must already exist in the GTT Action table.

The value specified for the `nactsn` parameter cannot already exist in the database.

The GTT Action Set name specified by the `actsn` parameter must already exist in the GTT Action Set table.

A value of *none* cannot be specified for the `(n)actsn` parameter.

At least one Action ID in the Action Set must be associated with an action other than *none* or *fallback*.

Only one Action ID in an Action Set can be associated with an action of type *disc*, *udts*, *tcaperr* or *svrc*.

If an Action ID with an action of *fwd* is specified, then no other Action ID in the Action Set can be associated with an act of *disc*, *udts*, *tcaperr*, *svrc*, or *fwd*.

If an Action ID with an action of *svrc* is specified, then no other Action ID in the same Action Set can be associated with an act of *fwd*, *disc*, *udts*, *tcaperr*, or *svrc*.

If the Action Set contains five Action IDs with an action of *dup* then the remaining Action ID cannot have an action of *dup*.

Action IDs associated with an action of *disc*, *udts*, *tcaperr*, *svvc*, or *fwd* must be the last actions in an Action Set.

Action IDs associated with an action of *sftthrot* must be the first action in an Action Set.

If the Action Set contains two Action IDs associated with an action of *scpval*, then the remaining action ID cannot be associated with an action of *scpval*.

One of the optional parameters must be specified.

The *actid1/actid2/actid3/actid4/actid5/actid6* parameters must each specify a unique Action ID in the command.

The EGTT feature must be turned on before this command can be entered.

The same option(s) cannot be specified for the *on* and *off* parameters.

A maximum of two SCPVAL GTT actions are allowed in an action set. Both action sets should have a different combination of SPRM and TPRM.

## Notes

### on/off options

- *testmode*—invokes a field-safe Test Tool used to debug the GTT Action Set rules

### Output

```
chg-gttaset:actsn=asetdup1:actid1=dup2:on=testmode
```

```
tekelecstp 10-02-04 18:29:41 EST EAGLE 42.0.0
chg-gttaset:actsn=asetdup1:actid1=dup2:on=testmode
Command entered at terminal #4.
```

```
GTT Action Set table is (2 of 20000) 1% full
```

```
CHG-GTTASET: MASP A - COMPLTD
```

```
;
```

### Related Topics

- [dlt-gttaset](#)
- [ent-gttaset](#)
- [rtrv-gttaset](#)

## chg-gttset

Use this command to change the global title translation (GTT) set linked with an existing *gti(x)*, *tt*, *np/npv*, *nai/naiv*, *lsn*, *selid*, *eaglegen*, and *cgssn* combination.

 **Note:**

If the EGTT feature is turned on, then the GTT Selector (`ent/chg/dlt/rtrvgttset`), GTT Set (`ent/dlt/rtrv-gttset`), and GTA (`ent/chg/dlt/rtrvgta`) commands replace the Translation Type (`ent/dlt/rtrv-tt`) and Global Title Translation (`ent/chg/dlt/rtrv-gtt`) commands. It is not recommended to run `ent/dlt/rtrv-tt & ent/chg/dlt/rtrv-gtt` commands as it may cause the advance GTA fields of GTT entry to be reset to the default values.

**Parameters** **Note:**

The nature of address indicator parameters (`naiv` or `nai`) and the numbering plan parameters (`npv` or `np`) can be specified using either a mnemonic or an explicit value. Both values cannot be specified at the same time for the same parameter. [NAIV/NAI Mapping](#) shows the mapping between the `naiv` and `nai` values. [NPV/NP Mapping](#) shows the mapping between the `npv` and `np` values.

**gti/gtia/gtii/gtin/gtin24/gtiis/gtins /gtin16 (mandatory)**

Global title indicator.

For all EGTT selector commands, the domain is defined as GTI and GTIA (ANSI), GTII (ITU international), GTIN (ITU national), GTIN24 (24-bit ITU national), GTIIS (ITU international spare), GTINS (ITU national spare) and GTIN16 (16-bit ITU National). For the selector commands, GTI and GTIA are equivalent. GTT selectors can be provisioned for the same translation type (TT) with different ITU domains. GTT selectors are provisioned independently for each domain.

**Range:**

0, 2, 4

Supported value for ANSI: `gti=0, 2` and `gtia=0, 2`

Supported values for ITU: `gtii/gtin/gtin24/gtiis/gtins/gtin16=0, 2, 4`

**cdgtasn (optional)**

CdPA GTA GTT set name.

**Range:**

ayyyyyyy

1 leading alphabetic character and up to 8 following alphanumeric characters.

*none* —Set names do not point to the CdGTA set.

*none* —Set names do not point to the CdGTA set.

**cdgttsn (optional)**

CdPA GTT set name.

**Range:**

ayyyyyyy

1 leading alphabetic and up to 8 following alphanumeric characters.

*none* —Set names do not point to the CdPA GTT set.

**cggtasn (optional)**

CgPA GTA GTT set name.

**Range:**

ayyyyyyy

1 leading alphabetic character and up to 8 following alphanumeric characters.

*none* —Set names do not point to the CgGTA set.

**cggttsn (optional)**

CgPA GTT set name.

**Range:**

ayyyyyyy

1 leading alphabetic and up to 8 following alphanumeric characters.

*none* —Set names do not point to the CgPA GTT set.

**cgpcsn (optional)**

CgPA PC GTT set name.

**Range:**

ayyyyyyy

1 leading alphabetic character and up to 8 following alphanumeric characters.

*none* —Set names do not point to the CgPC set.

**cgssn (optional)**

CgPA subsystem number.

**Range:**

0 - 255

**eag1egen (optional)**

This parameter specifies whether the selector is used by system-generated messages.

**Range:**

**yes**

used by a system MSU

**gttsn (optional)**

GTT set name. A GTT set is an entity to which global title addresses and selectors are assigned.

**Range:**

ayyyyyyy

1 leading alphabetic character and up to 8 following alphanumeric characters.

**l1sn (optional)**

Linkset name. The linkset used in GTT routing.

**Range:**

ayyyyyyy

1 leading alphabetic character followed by up to 9 alphanumeric characters

**msgtype (optional)**

SCCP message type.

Allow one or more SCCP message types (UDT/UDTS/XUDT/XUDTS) for every GTT Selector entry. This will help in screening different message types differently.

**Range:**

*sub*

*u*

*us*

*x*

*xs*

*all*

**Default**

*all*

**nai (optional)**

Nature of Address indicator.

**Range:**

*sub*

*rsvd*

*natl*

*intl*

*dflt*

**naiv (optional)**

Nature of Address indicator value.

**Range:**

*0 - 127*

**np (optional)**

Numbering Plan.

**Range:**

*e164*

*generic*

*x121*

*f69*

*e210*

**e212****e214****private****dflt****npv (optional)**

Numbering Plan value.

**Range:**

0 - 15

**selid (optional)**

Selector ID.

**Range:**

0 - 65534

**tt (optional)**

Translation type.

**Range:**

0 - 255

**Example**

```
chg-
gttsel:gtii=2:tt=40:cdgtasn=setcggtta:cgpcsn=none:cgssn=10:selid=12
chg-gttset:gtia=2:tt=253:gttsn=newansi
chg-gttset:gtin=4:tt=0:np=dflt:nai=dflt:gttsn=setint000
```

This example changes the selectors linked with GTTSN ANSI1 so that the selectors are linked with ANSI2 (if ANSI2 is an existing GTT set in the database):

```
chg-gttset:gtii=4:tt=5:npv=1:naiv=2:gttsn=ansi2
chg-
gttsel:gtin=4:tt=60:npv=5:naiv=5:cgpcsn=setcgpc:selid=100:cgssn=10
chg-
gttsel:gtia=2:tt=21:cdgttsn=setcgpc:cdgttsn=setcdgta:cgssn=20:selid=
1:lsn=ls10
chg-gttset:gtia=2:tt=2:cdgttsn=setcdgta:lsn=ls1010
chg-gttset:gtia=2:tt=2:cdgttsn=setcdgta:eaglegen=yes
chg-gttset:gtins=4:cdgttsn=setitu004:tt=4:np=e164:nai=intl
chg-gttset:gti=0:cdgttsn=setansi0
chg-gttset:gtin16=2:tt=10:cgpcsn=abc
chg-gttset:gtii=2:tt=17:msgtype=u:cdgttsn=cdset1
chg-gttset:gtii=2:tt=17:msgtype=x,xs:cdgttsn=cdset3
```

## Dependencies

The EGTT feature must be turned on before this command can be entered.

The `np` and `npv` parameters cannot be specified together in the same command.

The `nai` and `naiv` parameters cannot be specified together in the same command.

The `gti/gtia=4`, `gti(x)=`, and `gti(x)=3` parameters cannot be specified.

If the `gti/gtia/gtii/gtin/gtin24/gtiis/gtins/gtin16=2` parameter is specified, then the `np/npv` and `nai/naiv` parameter combinations cannot be specified.

If the `gtii/gtin/gtin24/gtiis/gtins/gtin16=4` parameter is specified, an `np(v)/nai(v)` parameter combination must be specified. These parameters can be specified in any combination.

The network domain (ANSI or ITU) must match that of the GTT Set entry specified by the `cdgttsn`, `cdgtasn`, or `gttsn` parameter.

The GTT set specified by the `cdgtasn`, `cdgttsn`, or `gttsn` parameter must already exist in the GTT Set table.

A value of *none* cannot be specified for the `gttsn`, `cdgtasn`, `cdgttsn`, `cggttsn`, `cggtasn`, or `cgpcsn` parameter.

The OBSR feature must be enabled before the `cdgtasn`, `cggtasn`, `cgpcsn`, or `cgssn` parameter can be specified.

The GTT set specified by the `cggttsn`, `cggtasn`, or `cgpcsn` parameter must already exist in the GTT Set table.

The network domain of the CgPA GTT Set specified by the `cggttsn`, `cggtasn`, or `cgpcsn` parameter must match the domain indicated by the `gti(x)` parameter.

The set type specified by the `cggtasn` or `cgpcsn` parameter must match the set type of the corresponding entry in the GTT set table. For example, the `cggtasn` parameter should have a set type of *cggt*, and the `cgpcsn` parameter should have a set type of *cgpc*.

The SSNSELID table must be accessible.

A value of *none* cannot be specified for the `cdgtasn` parameter if the `gttsn` parameter specifies the only GTTSET associated with that selector.

If the FLOBR feature is turned on, then the `cdgtasn`, `cggtasn`, and `cgpcsn` parameters cannot be specified.

An entry must already exist that matches the `msgtype`, `gti(x)`, `tt`, and `np(v)/nai(v)` combination of parameters.

If the OBSR feature is enabled or the FLOBR feature is turned on, then the `gttsn` parameter cannot be specified.

The `np` and `nai` parameters must both have a value of *dflt* or neither can have a value of *dflt*.

The FLOBR feature must be turned on before the `lsn`, `eaglegen`, `cdgttsn`, and `cggttsn` parameters can be specified.

At least one GTT set name parameter must be specified. These parameters include:

- `cdgtasn`, `cggtasn`, or `cgpcsn` if the OBSR feature is enabled
- `cdgttsn` or `cggttsn` if the FLOBR feature is turned on
- `gttsn` if the OBSR feature is not enabled and the FLOBR feature is not turned on

The GTT Set specified by the `cdgtasn` or `gttsn` parameter must have a set type of `cdgta` (see the `ent-gttset` command).

The GTT Set table is corrupt or cannot be found.

The GTT Selector table is corrupt or cannot be found.

The GTTDBMM table is corrupt or cannot be found.

The linkset specified by the `lsn` parameter must already exist in the Linkset table.

A database error occurred while trying to access the SSNSELID table.

The SSNSELID Table cannot contain more than 100,000 entries.

The GTTDBMM Table cannot contain more than 42,502 entries.

The Linkset table is corrupt or cannot be found.

If the `lsn` parameter is specified, then the `cdgttsn` or `cggttsn` parameter must be specified.

The `cggtasn`, `cgpcsn`, and `cggttsn` parameters cannot be specified together in the command.

The `gttsn`, `cdgtasn`, and `cdgttsn` parameters cannot be specified together in the command.

If the `gttsn`, `cdgttsn`, or `cdgtasn` parameter is specified, then the `cgssn` parameter cannot be specified. If the `cggtasn`, `cgpcsn`, or `cggttsn` parameter is specified, then the `cgssn` parameter must be specified.

If the `eaglegen=yes` parameter is specified, then the `msgtype`, `lsn`, `selid`, `gttsn`, `cdgtasn`, `cgssn`, `cggttsn`, `cggtasn`, and `cgpcsn` parameters cannot be specified.

If the `np=dflt` or `nai=dflt` parameter is specified, then the `cggtasn`, `cggttsn`, `cgpcsn`, `cgssn`, `eaglegen`, `lsn`, and `selid` parameters cannot be specified.

If the `gti(x)=0` parameter is specified, then the `eaglegen`, `tt`, `np/npv`, and `nai/naiv` parameters cannot be specified.

If a value of 2 or 4 is specified for the `gti(x)` parameter, then the `tt` parameter must be specified.

The MBR - supported GTT set types (IMEI/IMSI/MSISDN/VLRNB/SMRPDA/SMRPOA) cannot be referenced by GTT selectors.

## Notes

The entry that matches the specified parameter combination is assigned to the specified `gttsn`.



When the Origin-based SCCP Routing feature is enabled, two GTT sets, either the `cdgtasn/cggtasn` or the `cdgtasn/cgpcsn`, can be assigned to a GTT selector. The `cggtasn` and `cgpcsn` GTT sets are mutually exclusive and cannot be assigned to the same GTT selector.

When the value of the `cggtasn/cgpcsn` GTT set is specified as `none`, that combination (`domain`, `tt`, `gti`, `np/npi`, `na/nai`, `cgssn`, and `selid`) are deleted from the database. At any point of time, each provisioned selector must have at least one GTT set.

There is no J7 FAK dependency on the `GTIA/GTIN16/GTIN24` parameters. The command can be entered successfully whether the J7 FAK is enabled or not enabled.

GTT Selector entries configured using `GTIN24/GTIN16` parameters shall be treated as `ITU-N24` entries if the J7 FAK is disabled and shall be treated as `ITU-N16` entries if the J7 FAK is enabled.

The command will change `CgPA/CdPA` GTTSet for the EXACT match of the `GTTSet` parameters. For example, a given selector is provisioned with `msgtype=u,us`. To change the `CdPA` GTTSet associated with that selector, only the below command can be used:

- `chg-gtttsel:gtii=2:tt=17:msgtype=u,us:cdgttsn=cdset1`

Similarly, to change associated GTTSet of a given selector provisioned with `msgtype=all`, only the below command can be used:

- `chg-gtttsel:gtii=2:tt=32:msgtype=all:cdgttsn=cdset1`

## Output

```
chg-gtttsel:gti=0:cdgttsn=setansi0
```

```
tekelecstp 10-04-28 13:02:49 EST Eagle 42.0.0
chg-gtttsel:gti=0:cdgttsn=setansi0
Command entered at terminal #4.
CHG-GTTSEL: MASP A - COMPLTD
```

```
;
```

```
chg-gtttsel:gttsn=cd1:msgtype=u:gtii=0
```

```
tekelecstp 17-07-14 15:22:49 EST Eagle 46.6
chg-gtttsel:gttsn=cd1:msgtype=u:gtii=0
Command entered at terminal #4.
CHG-GTTSEL: MASP A - COMPLTD
```

```
;
```

```
chg-gtttsel:gttsn=u,us,xs:msgtype=u:gtii=0
```

```
tekelecstp 17-07-14 15:22:49 EST Eagle 46.6
chg-gtttsel:gttsn=cd1:msgtype= u,us,xs:gtii=0
Command entered at terminal #4.
CHG-GTTSEL: MASP A - COMPLTD
```

```
;
```

**Related Topics**

- [dlt-gttset](#)
- [ent-gttset](#)
- [rtrv-gttset](#)

## chg-gttset

Use this command to specify the attributes to change for an existing set of global title translations.

**Parameters****gttsn (mandatory)**

GTT set name. A GTT set is an entity to which global title addresses and selectors are assigned.

**Range:**

ayyyyyyy

1 alphabetic character followed by up to 8 alphanumeric characters.

**checkmulcomp (optional)**

This option indicates whether or not to find translation for multiple components (up to 3 components, if present) of a TCAP message.

**Range:**

*on*

Perform lookup for translation for multiple components.

*off*

Perform lookup for translation for first component only.

**Default:**

No change to the current value

**gttsetmeasrqd (optional)**

GTTSET Measurement required. This parameter specifies whether to perform per GTTSET measurements.

**Range:**

*yes*

perform per GTTSET Measurements

*no*

do not perform per GTTSET Measurements

*pertrans*

perform per GTT Translation Measurements

**Default:**

No change to the current value

**ndgt (optional)**

Number of digits. The number of digits required for GTAs associated with this GTT set.

**Range:**

1 - 21

**netdom (optional)**

Network domain. This command does not distinguish between ITU national or ITU international because the Enhanced Global Title Translation (EGTT) feature does not discriminate between the ITU-I and ITU-N translations.

 **Note:**

The `netdom` parameter refers to the incoming message network domain.

**Range:**

*cross*

*ansi*

*itu*

**ngttsn (optional)**

New GTT set name. The GTT set name that will replace the existing GTT set name.

**Range:**

*ayyyyyyy*

1 alphabetic character followed by up to 8 alphanumeric characters.

**npsn (optional)**

GTT set name (Not present Set Name). This Parameter can have IMEI/IMSI/MSISDN/VLRNB/SMRPOA/SMRPDA GTT set types.

**Range:**

*Ayyyyyyy, none*

1 leading alphabetic character and up to 8 following alphanumeric characters

**sxudt (optional)**

Segmented XUDT. This parameter specifies whether TOBR will support the processing of segmented XUDT message.

**Range:**

*yes*

perform decoding of segmented XUDT message

*no*

do not perform decoding of segmented XUDT message

**Default:**

*no*

### Example

```
chg-gttset:gttsn=lidb:netdom=cross
chg-gttset:gttsn=setxyz:netdom=cross:ndgt=10
chg-gttset:gttsn=acdgt:ngttsn=acdgtal
chg-gttset:gttsn=imsi1:npsn=imsi
chg-gttset:gttsn=setopcode:checkmulcomp=on
chg-gttset:gttsn=setabc:gttsetmeasrqd=pertrans
chg-gttset:gttsn=opcode1:sxudt=no
```

### Dependencies

The (n) `gttsn=none` parameter cannot be specified.

The specified `netdom` parameter value must be *cross*. This command cannot be used to change the `netdom` setting from *cross* to *ansi* or *itu*.

If the `settype` parameter has a value of *cdssn*, *cgpc*, *cgssn*, *opc*, *opcode*, or *dpc*, then the `ndgt` parameter cannot be specified.

The EGTT feature must be turned on prior to using this command.

The value specified for the `gttsn` parameter must match the name of an existing GTT Set.

If the VGTT feature is turned on, the `ndgt` parameter cannot be specified.

The ANSI/ITU SCCP Conversion feature must be enabled before the `netdom` parameter can be specified.

If GTAs are assigned to the GTT set, the `ndgt` parameter cannot be specified.

The `netdom=cross` parameter can be specified if the `settype=cdgta/imei/imsi/msisdn/vlrnb/smrpoa/smrpda` parameter is specified.

The GTTSET table must be accessible.

The GTT DBMM table must be accessible.

The NPSN parameter will be specified with IMEI/IMSI/MSISDN/VLRNB/SMRPOA/SMRPDA GTT set types.

The NPSN parameter can be of MBR set type only.

The value specified for the `npsn` parameter must match the name of an existing GTT Set of IMEI/IMSI/MSISDN/VLRNB/SMRPOA/SMRPDA types.

The GTT set type of GTT set entry referred by the NPSN parameter should be different from the GTT set type referred by the GTTSN parameter.

The GTT set specified by the `gttsn` parameter must not be associated with the GTT set referred by the NPSN parameter.

The GTTSET domain and the associated NPSN set domain must match, when the SCCP conversion feature is not ON.

CHECKMULCOMP parameter can be specified with OPCODE GTT set types only.

The SXUDT parameter must be specified with the OPCODE GTT set type only.

### Output

```
chg-gttset:gttsn=acdgta:ngttsn=acdgtal
```

```
tekelecstp 10-04-28 17:58:38 EST Eagle 42.0.0  
GTT-SET table is (1 of 2000) 1% full.
```

```
CHG-GTTSET: MASP A - COMPLTD
```

```
;
```

```
chg-gttset:gttsn=msisdn:npsn=smrpoal
```

```
tekelecstp 15-05-28 17:58:38 EST Eagle 46.3.0  
GTT-SET table is (1 of 2000) 1% full.
```

```
CHG-GTTSET: MASP A - COMPLTD
```

```
;
```

```
chg-gttset:gttsn=setopcode:checkmulcomp=on
```

```
tekelecstp 16-10-10 13:54:11 MST EAGLE 46.5.0.0.0-70.5.0  
CHG-GTTSET: MASP A - COMPLTD
```

```
;
```

```
chg-gttset:gttsn=imeil2:gttsetmeasrqd=yes
```

```
tekelecstp 17-05-11 15:30:38 EST Eagle 46.6.0  
GTT-SET table is (1 of 10000) 1% full.
```

```
CHG-GTTSET: MASP A - COMPLTD
```

```
;
```

```
chg-gttset:gttsn=opcode1:sxudt=yes
```

```
tekelecstp 17-07-15 14:28:38 EST Eagle 46.6.0  
GTT-SET table is (3 of 10000) 1% full.
```

```
CHG-GTTSET: MASP A - COMPLTD
```

```
;
```

### Related Topics

- [dlt-gttset](#)
- [ent-gttset](#)
- [rtrv-gttset](#)

## chg-gtw-stp

Use this command to modify the level 3 ANSI transfer control status (TFCSTAT) when converted from ITU to ANSI.

### Parameters

#### **tfcstat (mandatory)**

The desired level 3 control status on a TFC message received from an ITU node destined for an ANSI node.

#### **Range:**

1 - 3

### Example

```
chg-gtw-stp:tfcstat=1
```

### Dependencies

None

### Notes

None

### Output

```
chg-gtw-stp:tfcstat=1
```

```
rlghncxa03w 04-01-11 11:34:04 EST EAGLE 31.3.0  
CHG-GTW-STP: MASP A - COMPLTD
```

```
;
```

### Related Topics

- [rtrv-gtw-stp](#)

## chg-gws-actset

Use this command to configure the gateway screening (GWS) stop action sets in the system database. Stop action sets are used to define the actions performed on the Message Sending Units (MSUs) that pass the gateway screening process. The GWS Stop Action table contains a maximum of 16 stop action sets, with each stop action set containing a maximum of 10 stop actions. The first three GWS stop action sets (`actid=1`, `actid=2`, and `actid=3`) are already defined with the existing GWS stop actions shown in [Gateway Screening Stop Action Definitions](#).

Table 4-8 Gateway Screening Stop Action Definitions

Gateway Screening Stop Action ID	Gateway Screening Stop Action Set Name	Stop Action 1	Stop Action 2	Action Performed by the system
1	copy	copy	—	Copy the MSU for the STP LAN feature.
2	rdct	rdct	—	Redirect the MSU for the DTA feature.
3	cr	copy	rdct	Copy the MSU for the STP LAN feature and redirect the MSU for the DTA feature.

 **Caution:**

Even though gateway screening is in the screen test mode, as defined by the `gwsa=off` and `gws=on` parameters in the `chg-ls` command, the GWS action in the stop action set will be performed at the end of the screening process.

### Parameters

 **Note:**

The TIF, TIF2, and TIF3 stop actions each represent a specific TIF service. The services are provisioned using the `chg-npp-serv` command.

 **Note:**

Definitions of the values for the `act1` - `act10` parameters are located in the *Notes* section.

 **Note:**

GWS Stop Actions DUP and STRIP can be provisioned only in the GWS Action Set.

#### **actid (mandatory)**

The identification number of the GWS stop action set.

**Range:**  
4 - 16

**act1 (optional)**  
Stop action 1.

**Range:**

*cncf*

*copy*

*dup*

*none*

*rdct*

*sccp*

*strip*

*tif*

*tif2*

*tif3*

*tinp*

*tlnp*

**Default:**  
No change to the current value

**act2 (optional)**  
Stop action 2.

**Range:**

*cncf*

*copy*

*dup*

*none*

*rdct*

*sccp*

*strip*

*tif*

*tif2*



*tif3*

*tinp*

*tlnp*

**Default:**

No change to the current value

**act3 (optional)**

Stop action 3.

**Range:**

*cncf*

*copy*

*dup*

*none*

*rdct*

*sccp*

*strip*

*tif*

*tif2*

*tif3*

*tinp*

*tlnp*

**Default:**

No change to the current value

**act4 (optional)**

Stop action 4.

**Range:**

*cncf*

*copy*

*dup*

*none*

*rdct*

*sccp*

*strip*

*tif*

*tif2*

*tif3*

*tinp*

*tlnp*

**Default:**

No change to the current value

**act5 (optional)**

Stop action 5.

**Range:**

*cncf*

*copy*

*dup*

*none*

*rdct*

*sccp*

*strip*

*tif*

*tif2*

*tif3*

*tinp*

*tlnp*

**Default:**

No change to the current value

**act6 (optional)**

Stop action 6.

**Range:**

*cncf*

*copy*

*dup*

*none*

*rdct*

*sccp*

*strip*

*tif*

*tif2*

*tif3*

*tinp*

*tlnp*

**Default:**

No change to the current value

**act7 (optional)**

Stop action 7.

**Range:**

*cncf*

*copy*

*dup*

*none*

*rdct*

*sccp*

*strip*

*tif*

*tif2*

*tif3*

*tinp*

*tlnp*

**Default:**

No change to the current value

**act8 (optional)**

Stop action 8.

**Range:**

*cncf*

*copy*

*dup*

*none*

*rdct*

*sccp*

*strip*

*tif*

*tif2*

*tif3*

*tinp*

*tlnp*

**Default:**

No change to the current value

**act9 (optional)**

Stop action 9.

**Range:**

*cncf*

*copy*

*dup*

*none*

*rdct*

*sccp*

*strip*

*tif*

*tif2*

*tif3*

*tinp*

*tlnp*

**Default:**  
No change to the current value

**act10 (optional)**  
Stop action 10.

**Range:**

*cncf*

*copy*

*dup*

*none*

*rdct*

*sccp*

*strip*

*tif*

*tif2*

*tif3*

*tinp*

*tlnp*

**Default:**  
No change to the current value

**actname (optional)**  
The name of the GWS stop action set.

**Range:**  
*ayyyy*  
One alphabetic character followed by up to five alphanumeric characters.

**Default:**  
No change to the current value

**a11 (optional)**  
Clears all of the actions in the specified stop action set and deletes the stop action set.

**Range:**  
*none*

**Default:**  
Undefined

**force (optional)**  
Use this parameter when erasing the action set or changing the action name.

**Range:**

yes

**Example**

```
chg-gws-actset:actid=4:actname=cncf:act1=cncf
```

```
chg-gws-actset:actid=5:actname=dup:act1=dup
```

**Dependencies**

At least one optional parameter must be specified.

If the `all=none` parameter is specified, then no other optional parameters can be specified.

The `actname=none` parameter cannot be specified.

The `force=yes` parameter must be specified to change an existing stop action.

The Calling Name Conversion Feature must be turned on before the CNCF stop action can be specified.

The TLNP feature must be turned on or the ISUP NP with EPAP feature must be enabled before the TLNP stop action can be specified.

The TLNP feature must be turned on before the TLNP stop action can be specified.

A specific stop action can be specified for one and only one stop action parameter for each stop action set.

The value specified for the `actname` parameter cannot already exist in the database.

A value of `copy` can be specified for only the `act1` parameter.

If the RDCT stop action is specified with other stop actions, then it must be specified with the last stop action parameter specified for the command.

The TLNP stop action cannot be specified in the same action set with the CNCF stop action.

The TINP gateway screening stop action cannot be specified in the same action set with the CNCF gateway screening stop action.

The TINP feature must have been enabled before upgrading to Release 39.2 or later before the TINP stop action can be specified.

At least one TIF feature must be enabled before the TIF, TIF2, or TIF3 stop action can be specified.

Only one of the TIF, TIF2, TIF3, TLNP, TINP, RDCT, and SCCP stop actions can be specified in the command.

If specified, the TIF, TIF2, TIF3, TLNP, TINP, RDCT, or SCCP stop action must be the last stop action in the command.

The SCCP stop action cannot be specified in the same Action Set with the CNCF stop action.

The MTP Routed GWS Stop Action feature must be enabled before the SCCP stop action can be specified.

The GWS STRIP stop action cannot be specified with other stop actions in the same Action Set.

The GWS DUP point code (GDPC) must be configured in the STPOPTS table before the GWS DUP stop action can be specified.

### Notes

The GWS stop action 1 (*act1*) is the first stop action to be performed, and GWS stop action 10 (*act10*) is the last stop action to be performed on the MSU. These parameters can have the following values:

- *cncf*—Convert the PIP parameter with the GN parameter or the GN parameter with the PIP parameter in the ISUP IAM message for the Calling Name Conversion Facility feature
- *copy*—Copy the MSU for the STP LAN feature
- *dup*--- MSUs that pass gateway screening are duplicated towards a point code configured in STPOPTS:GDPC.
- *none*—No action is performed on the MSU
- *rdct*—Redirect the MSU for the DTA feature
- *sccp*—SCCP messages that pass gateway screening are forwarded to the SCCP card for service processing. This GWS stop action applies only to MTP routed UDT/UDTS and XUDT/XUDTS messages.
- *strip*--- De-encapsulate the MSUs encapsulated by GWS REDIRECT stop action and then send to MTP3 layer for further processing.
- *tif*—Apply TIF processing to MSU
- *tif2*—Apply TIF processing to MSU
- *tif3*—Apply TIF processing to MSU
- *tinp*—ISUP IAMs that pass gateway screening are intercepted by the Triggerless ISUP NP equipped EAGLE and converted to include the RN if the call is to a ported number. This GWS stop action applies only to the Triggerless ISUP NP feature.
- *tlnp*—ISUP IAMs that pass gateway screening are intercepted by the Triggerless LNP equipped EAGLE and converted to include the LRN if the call is to a ported number. This GWS stop action applies only to the Triggerless LNP feature.

### Output

```
chg-gws-actset:actid=4:actname=cncf:act1=cncf
```

```
rlghncxa03w 04-01-10 11:43:04 EST EAGLE 31.3.0
CAUTION: GWS action set may be referenced by one or more GWS rules
CHG-GWS-ACTSET: MASP A - COMPLTD
;
```

```
chg-gws-actset:actid=5:actname=dup:act1=dup
```

```
tklclstp 13-10-10 11:43:04 EST EAGLE 46.0
CAUTION: GWS action set may be referenced by one or more GWS rules
```

```
CHG-GWS-ACTSET: MASP A - COMPLTD
;
```

### Related Topics

- [rtrv-gws-actset](#)

## chg-gws-redirect

Use this command to change the provisioning data for the redirect function. The values that are specified for this command are stored in the Redirect table, and they are used to set the variable fields of the MSUs being redirected. For example, if the `ri=gt` parameter is specified, the value `gt` is set for the routing indicator in the called party address (CDPA) of the MSU being redirected.

### Parameters

#### Note:

See [Point Code Formats and Conversion](#) for a detailed description of point code formats, rules for specification, and examples.

#### **dpc (optional)**

Specifies the value used to set the ANSI destination point code field in the routing label of the MSU that is being redirected. The point code has subfields *network indicator-network cluster-network cluster member (ni-nc-ncm)*.

##### **Synonym:**

*dpca*

##### **Range:**

000-255

Specify a valid value for each subfield of the point code, and separate the subfields with a dash (-).

When `chg-sid:pctype=ansi` is specified, `ni = 000` is not valid.

When `chg-sid:pctype=ansi` is specified, `nc = 000` is not valid if `ni = 001-005`.

When `chg-sid:pctype=ansi` is specified, `nc = 000` is valid if `ni = 006-255`.

The point code `000-000-000` is not a valid point code.

##### **Default:**

Current value.

#### **dpca/dpci/dpcn/dpcn24/dpcn16 (optional)**

Destination point code.

#### **dpci (optional)**

Specifies the value used to set the ITU international destination point code field in the routing label of the MSU that is being redirected. The point code has subfields *zone-area-id*.

##### **Range:**

0-255



Specify a valid value for each subfield of the point code, and separate the subfields with a dash (-).

*zone—0-7*

*area—000-255*

*id—0-7*

The point code *0-000-0* is not a valid point code.

**Default:**

Current value.

**dpcn (optional)**

Specifies the value used to set the ITU national destination point code field in the routing label of the MSU that is being redirected. The point code is in the format of a 5-digit number (*nnnnn*); or 2, 3, or 4 numbers (members) separated by dashes (*m1-m2-m3-m4*) when the `chg-stpopts:npcfmti` flexible point code option is on. A group code (*gc*) must be specified when the ITUDUPPC feature is on (*nnnnn-gc*, *m1-m2-m3-m4-gc*).

**Range:**

*0-16383, aa-zz*

Specify a valid value for each subfield of the point code, and separate the subfields with a dash (-).

*nnnnn—0-16383*

*gc—aa-zz*

*m1-m2-m3-m4—0-14* for each member; values must sum to 14

**Default:**

Current value.

**dpcn24 (optional)**

Specifies the value used to set the 24-bit ITU national destination point code field in the routing label of the MSU that is being redirected. The point code has subfields *main signaling area-sub signaling area-signaling point (msa-ssa-sp)*.

**Range:**

*000-255*

Specify a valid value for each subfield of the point code, and separate the subfields with a dash (-).

*msa—000-255*

*ssa—000-255*

*sp—000-255*

**Default:**

Current value.

**dpcn16 (optional)**

Specifies the value used to set the 16-bit ITU national destination point code field in the routing label of the MSU that is being redirected. The point code has subfields *unit number-sub number area-main number area (un-sna-mna)*.

**Range:**

*000---127*

Specify a valid value for each subfield of the point code, and separate the subfields with a dash (-).

*un---000---127*

*sna---000---15*

*mna---000---31*

**Default:**

Current value.

**enabled (optional)**

This parameter specifies whether MSUs that have passed gateway screening are redirected or routed as normal.

**Range:**

***on***

redirect the MSU

***off***

route the MSU as normal

**Default:**

No change to the current value

**gta (optional)**

The value used to set the global title address (dialed digits) in the SCCP called party address of the MSU being redirected.

**Range:**

1-21 digits

**ri (optional)**

The value used to set the routing indicator in the SCCP called party address of the MSU being redirected.

**Range:**

***gt***

route by global title digits

***ssn***

route by subsystem number

**Default:**

No change to the current value

**ssn (optional)**

The value used to set the subsystem number (SSN) in the SCCP called party address of the MSU being redirected. This number is the SSN of the SCP to which all MSUs meeting the redirect criteria are to be redirected.

**Range:**

0 - 255

**Default:**  
No change to the current value

**tt (optional)**

The type of the global title translation (GTT). It is the decimal representation of the 1-byte field used in SS7. This value is used to set the type of the GTT in the SCCP called party address of the MSU being redirected.

**Range:**  
0 - 255

**Default:**  
No change to the current value

**Example**

```
chg-gws-  
redirect:dpc=111-222-111:ri=gt:ssn=10:tt=1:gta=180833:enabled=on  
  
chg-gws-redirect:enabled=off  
  
chg-gws-  
redirect:dpcn16=1-14-0:ri=gt:ssn=10:tt=10:gta=1:enabled=off
```

**Dependencies**

At least one optional parameter must be specified.

The `dpc/dpca/dpci/dpcn/dpcn24/dpcn16` parameter must be defined in the Destination table or defined as the STP site point code.

If the `dpc/dpca/dpci/dpcn/dpcn24/dpcn16` parameter is defined as a destination, at least one route must be defined.

The redirect function data must exist in the database before it can be changed with this command.

**Notes**

None

**Output**

```
chg-gws-  
redirect:dpc=111-222-111:ri=gt:ssn=10:tt=1:gta=180833:enabled=on  
  
rlghncxa03w 04-07-10 11:43:04 EST EAGLE 31.6.0  
CHG-GWS-REDIRECT: MASP A - COMPLTD  
;
```

**Related Topics**

- [dlt-gws-redirect](#)
- [ent-gws-redirect](#)

- [rtrv-gws-redirect](#)

## chg-inpopts

Use this command to provision INP-specific data. This command updates the INPOPTS table.

### Parameters



#### Note:

The options in the on and off parameters are described in the Notes section.

#### **cdpnnai (optional)**

Called Party Number Nature of Address indicator.

**Range:**

0 - 127

The following parameter values are valid: 1 (Subscriber), 2 (Unknown), 3 (National), and 4 (International)

**Default:**

No change to the current value

#### **cdpnprfx (optional)**

Called Party Number Prefix.

**Range:**

1-15 digits

Valid digits are 0-9, A-F, a-f

**Default:**

No change to the current value

#### **defrn (optional)**

Default routing number. A default routing number that is used for own-network subscribers.

**Range:**

1-15 digits, *none*

Valid digits are 0-9, a-f, A-F

**Default:**

No change to the current value

**System Default:**

*none*

#### **d1tprfx (optional)**

Delete prefix.

**Range:***yes**no***Default:***no***dra (optional)**

Destination routing address. This parameter specifies the routing address format supported in INP "Connect" response messages.

**Range:*****rndn***

RN + [CDPNPFX] + DN

***rn***

Routing Number

***ccrndn***

[CDPNPFX] + CC + RN + DN

***rnecdn***

RN+ [CDPNPFX]+ NEC+ DN

***homerndn***

Home Routing Number

***rnasd***

RN + ASD

***asdrn***

ASD + RN

***rnasddn***

Supports RN +ASD+ [CDPNPFX] + DN in the INP "CONNECT" response messages.

***asdrndn***

Supports ASD+ RN + [CDPNPFX] + DN in the INP "CONNECT" response messages.

***ccrnasddn***

Supports [CDPNPFX] +CC + RN + ASD+DN in the INP "CONNECT" response messages.

***asdrnccdn***

Supports ASD+ RN+ [CDPNPFX]+ CC+ DN in the INP "CONNECT" response messages.

***ccasdrndn***

Supports [CDPNPFX] +CC + ASD + RN+DN in the INP "CONNECT" response messages.

***rnsdccdn***

Supports RN + ASD + [CDPNPFX] +CC + DN in the INP "CONNECT" response messages.

***rnsdnecdn***

RN + ASD + [CDPNPFX] + NEC + DN

***asdrnecdn***

ASD + RN+ [CDPNPFX]+ NEC+ DN

***rngrn***

RN + GRN

***grnrn***

GRN + RN

***rngrndn***

RN + GRN + [CDPNPFX] + DN

***grnrndn***

GRN + RN + [CDPNPFX] + DN

***ccngrndn***

[CDPNPFX] + CC + RN + GRN + DN

***ccgrnrndn***

[CDPNPFX] + CC + GRN + RN + DN

***grnrnccdn***

GRN + RN + [CDPNPFX] + CC + DN

***rngrnccdn***

RN + GRN + [CDPNPFX] + CC + DN

***rngrnecdn***

RN + GRN + [CDPNPFX] + NEC + DN

***grnrnecdn***

GRN + RN + [CDPNPFX] + NEC + DN

***grn***

GRN

***grndn***

GRN + [CDPNPFX] + DN

***ccgrndn***

[CDPNPFX] + CC + GRN + DN

**Default:**

No change to the current value

**System Default:**

*rndn*

**dranai (optional)**

Nature of Address indicator.

**Range:**

*sub*

*unknown*

*natl*

*intl*

*ntwk*

**Default:**

No change to the current value

**dranaiv (optional)**

Nature of Address indicator value.

**Range:**

*0 - 127*

**dranp (optional)**

Numbering plan.

**Range:**

*e164*

*x121*

*f69*

**Default:**

Current value

**dranpv (optional)**

Numbering plan value.

**Range:**

*0 - 7*

**Default:**

No change to the current value

**ncdnpfx (optional)**

New Called Party Number Prefix.

**Range:**

1-15 digits, *none*

Valid digits are *0-9, a-f, A-F*

**nec (optional)**

National Escape Code.

**Range:**

1-5 digits, *none*

Valid digits are *0-9, a-f, A-F*

**Default:***none***off (optional)**

This parameter turns off the specified options. Up to 8 comma-separated unique options can be specified.

**Range:***cutnpaste***on (optional)**

This parameter turns on the specified options. Up to 8 comma-separated unique options can be specified.

**Range:***cutnpaste***relcause (optional)**

Release cause. The reason for releasing the call when an INP Circular Route is detected.

**Range:***1 - 127***Default:***31 -normal, unspecified***snai (optional)**

Service Nature of Address indicator.

**Range:***sub**natl**intl**none**unknown***Default:**

No change to the current value

**sporttype (optional)**

Service Portability type. This parameter specifies whether Service Portability is performed for the associated feature.

**Note:**

The S-Port feature must be turned on before any change to the parameter will impact the associated feature.



 **Note:**

If Service Portability is performed, then the Service Portability prefix (RTDB 'GRN'entity id ) is applied.

**Range:*****gsm***

Apply Service Portability prefix for own-network GSM subscribers

***is41***

Apply Service Portability prefix for own-network IS41 subscribers

***all***

Apply Service Portability prefix for all own-network (IS41 and GSM) subscribers

***none***

Service Portability is not performed for the feature.

**Default:**

No change to the current value

**System Default:**

*none*

**sprestype (optional)**

INP option that indicates the type of message the EAGLE is to send when an IDP message is received for INP service, the DN digits match, and the HLR ID is present.

**Range:*****connect***

send a CONNECT message

***continue***

send a CONTINUE message

**Default:**

*continue*

**Example**

```
chg-inpopts:dra=rn:dranp=e164:dranai=intl
```

```
chg-inpopts:dranp=f69:dranai=sub:dra=rndn
```

```
chg-  
inpopts:dra=rn:dranp=e164:dranai=intl:cdpnpfx=fac:dltprfx=yes
```

```
chg-inpopts:dranp=f69:dranai=sub:dra=rndn:cdpnpfx=200
```

```
chg-  
inpopts:dranp=f69:dranai=sub:dra=rndn:cdpnpfx=200:ncdpnpfx=3abc  
def:dltprfx=yes
```

```
chg-
inopts:dranp=f69:dranai=sub:dra=rndn:cdpnpfx=3abcdef:ncdpnpfx=none

chg-inopts:dranp=f69:dranai=sub:dra=rndn:cdpnpfx=fed123:dltprfx=no

chg-
inopts:dra=rn:dranp=e164:dranai=intl:cdpnpfx=fac:dltprfx=no:cdpnnai=
1 :snai=none

chg-inopts:sprestype=connect

chg-inopts:dra=rnecdn:nec=abcd1

chg-
inopts:dra=asdrnccdn:dranp=e164:dranai=intl:cdpnpfx=fac:dltprfx=yes

chg-inopts:relcause=30

chg-inopts:dra=grnrndn:dranp=e164:dranai=intl

chg-inopts:dranp=e164:dranaiv=10:dra=rn

chg-inopts:dranai=sub:dranpv=3

chg-inopts:dranpv=4:dranaiv=20

chg-inopts:cdpnpfx=2a3b4c5d6e7f

chg-inopts:cdpnnai=1:snai=sub

chg-inopts:on=cutnpaste

chg-inopts:dra=ccgrndn:dranp=e164:dranai=intl
```

### Dependencies

At least one optional parameter must be specified.

The `dranp` and `dranpv` parameters cannot be specified together in the command.

The `dranai` and `dranaiv` parameters cannot be specified together in the command.

If the `ncdpnpfx` or `dltprfx` parameter is specified, the `cdpnpfx` parameter must be specified.

A value of *none* cannot be specified for the `cdpnpfx` parameter.

If the `ncdpnpfx=none` parameter is specified, then the `dltprfx` parameter cannot be specified.

The value specified for the `cdpnpfx` parameter must already exist in the INPOPTS table.

The value specified for the `ncdpnpfx` parameter cannot already exist in the INPOPTS table.

A maximum of 5 Called Party Number Nature of Address values is allowed.

The `cdpnnai` and `snai` parameters must be specified together in the command.

If this command is entered to delete a CdPN Nature of Address value from the INPOPTS table, then the value specified for the `cdpnnai` parameter must already exist in the INPOPTS table.

A valid value must be specified for the `nec` parameter.

A maximum of 40 Called Party Number Prefix values can be provisioned.

If the `nec=none` parameter is specified, then values of `asdrnecdn`, `rnsdrnecdn`, `rnecdn`, `rngrnecdn`, and `grnrnecdn` cannot be specified for the `dra` parameter.

The INP CRP feature must be enabled before the `relcause` parameter can be specified.

The S-Port feature must be enabled before the `sporttype` parameter can be specified.

The INP feature must be enabled before this command can be entered.

The same option cannot be specified for the `on` and `off` parameters.

## Notes

### on/off options

- `cutnpaste` —Specifies whether the CutAndPaste parameter is included in an INP CONNECT response message. The value for the CutAndPaste parameter is the length of the incoming DN in the IDP query. If the `cutnpaste` option is provisioned, then this value is cut from the CdPN. The remaining digits are pasted to the end of the DRA digits sent by the STP in the CONNECT response to form the new routing digits. This option has a default of OFF.

## Output

```
chg-inpopts:dra=rngrn:nec=0
```

```
tekelecstp 09-05-05 12:20:32 EST EAGLE 41.1.0
CHG-INPOPTS: MASP A - COMPLTD
;
```

## Related Topics

- [rtv-inpopts](#)

# chg-ip-card

Use this command to provision IP networking parameters for a given card.

## Parameters

### loc (mandatory)

Card location. The unique identifier of a specific application subsystem located in the STP.

#### Range:

1101 - 1108, 1111 - 1112, 1201 - 1208, 1211 - 1218, 1301 - 1308, 1311 - 1318,  
2101 - 2108, 2111 - 2118, 2201 - 2208, 2211 - 2218, 2301 - 2308, 2311 - 2318,  
3101 - 3108, 3111 - 3118, 3201 - 3208, 3211 - 3218, 3301 - 3308, 3311 - 3318,  
4101 - 4108, 4111 - 4118, 4201 - 4208, 4211 - 4218, 4301 - 4308, 4311 - 4318,

5101 - 5108, 5111 - 5118, 5201 - 5208, 5211 - 5218, 5301 - 5308, 5311 - 5318, 6101 - 6108, 6111 - 6118, 1113, 1115

**bpipaddr (optional)**

Bonded Port IPv4 address. This parameter specifies an IPv4 address for the card in the specified location.

**Range:**

4 numbers separated by dots, with each number in the range of 0-255.

A value of 0.0.0.0 removes the IP address from the parameter.

**Default:**

No change to the current value

**bpsubmask (optional)**

Bonded Port IPv4 submask.

**Range:**

The value must be valid for the class of the entered IP address.

**Valid for Class A Networks**

- 255.0.0
- 255.192.0
- 255.224.0
- 255.240.0
- 255.248.0
- 255.252.0
- 255.254.0
- 255.255.128.0

**Valid for Class A or B Networks**

- 255.255.0.0
- 255.255.192.0
- 255.255.224.0
- 255.255.240.0
- 255.255.248.0
- 255.255.252.0
- 255.255.254.0
- 255.255.255.128

**Valid for Class A, B, or C Networks**

- 255.255.255.0
- 255.255.255.192

- 255.255.255.224
- 255.255.255.240
- 255.255.255.248
- 255.255.255.252

**defrouter (optional)**

Default router IP address. This is a TCP/IP address expressed in standard dot notation. IP addresses consist of the system's network number and the machine's unique host number. An example IP address is 192.126.100.5, where 192.126.100 is the network number and 5 is the machine's host number.

**Range:**

4 numbers separated by dots, with each number in the range of 0-255. A value of 0.0.0.0 removes the IP address from the parameter.

**Default:**

No change to the current value

**System Default:**

0.0.0.0

**dnsa (optional)**

IP address for Domain Name Server A. TCP/IP address expressed in standard dot notation. IP addresses consist of the system's network number and the machine's unique host number. An example IP address is 192.126.100.5, where 192.126.100 is the network number and 5 is the machine's host number.

**Range:**

4 numbers separated by dots, with each number in the range of 0-255. A value of 0.0.0.0 removes the IP address from the parameter.

**Default:**

No change to the current value

**System Default:**

0.0.0.0

**dnσα6 (optional)**

The IPv6 address for Domain Name Server A. dnσα6 address should be enclosed in double quotes (" ").

**Range:**

x: x: x: x: x: x: x: x, where the 'x's are one to four hexadecimal digits of the eight 16-bit pieces of the address.

**Default:**

No change to the current value

**System Default:**

0:0:0:0:0:0:0:0

**dnσb (optional)**

IP address for Domain Name Server B. TCP/IP address expressed in standard dot notation. IP addresses consist of the system's network number and the machine's

unique host number. An example IP address is 192.126.100.5, where 192.126.100 is the network number and 5 is the machine's host number.

**Range:**

4 numbers separated by dots, with each number in the range of 0-255.

A value of 0.0.0.0 removes the IP address from the parameter.

**Default:**

No change to the current value

**System Default:**

0.0.0.0

**domain (optional)**

Domain name of the Domain server.

**Range:**

Any string of characters beginning with a letter and comprising up to 120 characters in length.

Valid characters are 0-9, a-z, A-Z, - (dash), . (period).

**Default:**

No change to the current value

**System Default:**

Null

**dsctp (optional)**

This parameter specifies the dsctp value that shall be set for outbound messages for SIGTRAN cards.

**Range:**

0-63

**Default:**

No change to the current value

**System Default:**

0

**rstdomain (optional)**

Reset Domain Name. This parameter is used to reset the Domain Name to a NULL value.

**Range:****yes**

reset Domain Name to a NULL value

**no**

Domain Name does not change

**Default:**

no

**sctpcsum (optional)**

SCTP checksum algorithm. This parameter specifies the configured SCTP checksum algorithm for a specific card.

The system-wide setting for the SCTP checksum algorithm type (see the `chg-sg-opts` command) takes precedence over the setting for an individual card. The `chg-sg-opts:sctpcsum=percard` command must be entered before the `chg-ip-card:sctpcsum=` command can be entered.

**Range:**

*adler32*

*crc32c*

**System Default:**

*crc32c*

**srchordr (optional)**

Host table search order

**Range:*****local***

Local host table is searched first

***svr***

Domain Server is searched first

***svronly***

Only the Domain Server is searched

**Default:**

No change to the current value

**System Default:**

No search

**Example**

```
chg-ip-card:loc=1211:dnsa=150.1.1.1:domain=nc.tekelec.com:defrouter=150.1.1.105
```

```
chg-ip-card:loc=1107:sctpcsum=adler32
```

```
chg-ip-card:dscp=4
```

**Dependencies**

At least one optional parameter must be specified.

The value specified for the `loc` parameter must correspond to the location of a card that can run an IP application (other than the `eroute` application, which is not supported by this command). For a list of the cards and their associated applications, see [Valid Card Applications and Types](#).

The card in the location specified by the `loc` parameter must be inhibited before this command can be entered.

If the `domain` parameter is specified, the `rstdomain` parameter cannot be specified.

The default router IP address cannot be an existing IP link address.

The default router IP address must be local to one of the card's Ethernet network(s).

If the card in the location specified by the `loc` parameter is not an E5-SM4G or E5-SM8G-B card then the `bpipaddr` and `bpsubmask` parameters cannot be specified.

The IP address specified by the `bpipaddr` and `bpsubmask` parameters must be unique.

The `bpipaddr` parameter must be specified before the `bpsubmask` parameter can be specified.

A valid value must be specified for the `bpsubmask` parameter.

If the `bpipaddr` parameter is specified, then the `bpsubmask` parameter must be specified.

The `chg-sg-opts:sctpsum=percard` command must be entered before the `sctpsum` parameter can be specified in the `chg-ip-card` command.

A valid value must be specified for the `domain` parameter. If the value contains a hyphen, then the host name must be enclosed within quotation marks.

### Notes

The Domain Name has a 120 character limitation.

**Table 4-9 Standard DSCP Values**

DSCP Class	DSCP (bin)	DSCP (hex)	DSCP (dec)
NONE	000000	0x00	0
CS1	001000	0x08	8
AF11	001010	0x0A	10
AF12	001100	0x0C	12
AF13	001110	0x0E	14
CS2	010000	0x10	16
AF21	010010	0x12	18
AF22	010100	0x14	20
AF23	010110	0x16	22
CS3	011000	0x18	24
AF31	011010	0x1A	26
AF32	011100	0x1C	28
AF33	011110	0x1E	30
CS4	100000	0x20	32
AF41	100010	0x22	34
AF42	100100	0x24	36
AF43	100110	0x26	38
CS5	101000	0x28	40
EF	101110	0x2E	46
CS6	110000	0x30	48
CS7	111000	0x38	56



## Output

```
chg-ip-  
card:loc=1211:dnsa=150.1.1.1:domain=nc.tekelec.com:defrouter=15  
0.1.1.105: sctpcsum=adler32
```

```
rlghncxa03w 08-02-22 15:35:05 EST EAGLE 38.0.0  
CHG-IP-CARD: MASP A - COMPLTD
```

```
;
```

```
chg-ip-card:dscp=10
```

```
rlghncxa03w 13-09-24 16:56:31 EST EAGLE 46.0.0  
CHG-IP-CARD: MASP A - COMPLTD
```

```
;
```

## Related Topics

- [chg-sg-opts](#)
- [rtrv-ip-card](#)

# chg-ip-conn

Use this command to enable or disable a particular SIP/ENUM/SCCP/SFAPP/IPS with SFLOG connection to receive SIP/ENUM/SCCP/SFAPP/IPS with SFLOG traffic respectively. The IPCONN table supports the provisioning information related to the SIP/ENUM/SCCP/SFAPP/IPS with SFLOG connections.

## Parameters

### **cname (mandatory)**

Connection name. This parameter specifies the unique logical name assigned to each SIP/ENUM/SCCP/SFAPP/IPS with SFLOG connection.

#### **Range:**

*ZZZZZZZZZZZZZZZZ*

A string of alphanumeric characters, beginning with a letter and up to 15 characters in length. Valid values are a..z, A..Z, 0..9.

### **open (mandatory)**

The parameter specifies whether the connection manager should allow or disallow the SIP/ENUM/SCCP/SFAPP/IPS with SFLOG connection to receive SIP/ENUM/SCCP/SFAPP/IPS with SFLOG traffic.

#### **Range:**

yes

allow the SIP/ENUM/SCCP/SFAPP/IPS with SFLOG connection to receive SIP/ENUM/SCCP/SFAPP/IPS with SFLOG traffic respectively.

*no*

prohibit the SIP/ENUM/SCCP/SFAPP/IPS with SFLOG connection to receive SIP/ENUM/SCCP/SFAPP/IPS with SFLOG traffic respectively.

**Default:**

No change to the current value

**System Default:**

*no*

**Example**

```
chg-ip-conn:cname=conn1101a:open=yes
```

```
chg-ip-conn:cname=conn1101a:open=no
```

**Dependencies**

SIPNP Feature must be enabled before enabling or disabling any SIP connection.

At least one ENUM card must be provisioned before entering any ENUM connection information.

At least one IPS card with SFLOG=yes must be provisioned before entering any TCP connection information on IPS

At least one SCCP/SFAPP card must be provisioned before entering any Visualization connection information

IPCONN table should be accessible.

The value specified for the CNAME parameter must already exist in the IPCONN table.

**Notes**

None

**Output**

```
chg-ip-conn:cname=conn1101a:open=yes
```

```
tekelecstp 12-06-25 15:44:10 EST EAGLE 45.0.0
  chg-ip-conn:cname=conn1101a:open=yes
  Command entered at terminal #4.
  CHG-IP-CONN: MASP A - COMPLTD
;
```

**Related Topics**

- [dlt-ip-conn](#)
- [rtrv-ip-conn](#)
- [ent-ip-conn](#)

## chg-ip-lnk

Use this command to provision the IP link table.

## Parameters

### **loc (mandatory)**

Card location. The unique identifier of a specific application subsystem located in the system.

#### **Range:**

1101 - 1108, 1111 - 1112, 1201 - 1208, 1211 - 1218, 1301 - 1308, 1311 - 1318,  
2101 - 2108, 2111 - 2118, 2201 - 2208, 2211 - 2218, 2301 - 2308, 2311 - 2318,  
3101 - 3108, 3111 - 3118, 3201 - 3208, 3211 - 3218, 3301 - 3308, 3311 - 3318,  
4101 - 4108, 4111 - 4118, 4201 - 4208, 4211 - 4218, 4301 - 4308, 4311 - 4318,  
5101 - 5108, 5111 - 5118, 5201 - 5208, 5211 - 5218, 5301 - 5308, 5311 - 5318,  
6101 - 6108, 6111 - 6118, 1113, 1115

### **port (mandatory)**

Ethernet interface Port ID.

#### **Range:**

*a, b, c, d*

Port *b* is not valid for the OAMHC application.

Ports *c* and *d* are valid with DEIR/SIP/ENUM/IPSG on SLIC card.

### **auto (optional)**

Tells hardware whether to automatically determine duplex and speed.

#### **Note:**

Always specify "auto=yes" for ports that connected to an ELAP. The corresponding ports on ExAP LAN switches should be configured accordingly to achieve the operational speed and duplex of 1Gbps and Full Duplex.

#### **Range:**

##### **yes**

Automatically determine duplex and speed

##### **no**

Do not automatically determine duplex and speed

#### **Default:**

No change to the current value

#### **System Default:**

*no*

### **duplex (optional)**

This is the mode of operation of the interface.

**Range:**

***half***  
Half duplex

***full***  
Full duplex

**Default:**

No change to the parameter value

**System Default:**

*full*

**ipaddr (optional)**

The IP address for the specified port. This is a TCP/IP address expressed in standard dot notation. IP addresses consist of the system's network number and the machine's unique host number. An example IP address is 192.126.100.5, where 192.126.100 is the network number and 5 is the machine's host number.

**Range:**

4 numbers separated by dots, with each number in the range of 0-255.  
A value of 0.0.0.0 removes the IP address from the parameter.

**Default:**

No change to the parameter value.

**System Default:**

*0.0.0.0*

**mactype (optional)**

The Media Access Control Type of the interface.

**Range:**

***802.3***  
The IEEE standard number 802.3 for Ethernet 1

***dix***  
The Digital/Inter/Xerox *de facto* standard for Ethernet 2

**Default:**

No change to the parameter value

**System Default:**

*dix*

**mcast (optional)**

Multicast Control. This parameter enables or disables multicast support for the interface. This parameter is necessary for INP, G-Port, and G-Flex to establish the connection from the Service Module card to the MPS system.

**Range:****yes**

Multicasting is enabled on the interface and the sending and receiving of multicast frames is allowed.

**no**

All multicast frames are silently dropped.

**System Default:**

*no*

**speed (optional)**

The bandwidth for the interface in megabits per second

**Range:**

**10**

**100**

**1000**

**Default:**

No change to the parameter value

**System Default:**

*100*

**submask (optional)**

The subnet mask of the IP interface in the form of an IP address with a restricted range of values.

This parameter is mandatory when the *ipaddr* parameter is specified.

**Range:**

The value must be valid for the class of the entered IP address.

**Valid for Class A Networks**

- 255.0.0
- 255.192.0
- 255.224.0
- 255.240.0
- 255.248.0
- 255.252.0
- 255.254.0
- 255.255.128.0

**Valid for Class A or B Networks**

- 255.255.0.0

- 255.255.192.0
- 255.255.224.0
- 255.255.240.0
- 255.255.248.0
- 255.255.252.0
- 255.255.254.0
- 255.255.255.128

#### Valid for Class A, B, or C Networks

- 255.255.255.0
- 255.255.255.192
- 255.255.255.224
- 255.255.255.240
- 255.255.255.248
- 255.255.255.252

#### Default:

If the `ipaddr` parameter is not specified, there is no change to the parameter value. If a host's IP address is known, the default subnet mask should be chosen according to [Default Subnet Mask Values](#).

Network Class	IP Network Address Range	Default Subnet Mask
A	1.0.0.0 to 127.0.0.0	255.0.0.0
B	128.0.0.0 to 191.255.0.0	255.255.0.0
C	192.0.0.0 to 223.255.255.0	255.255.255.0

#### System Default:

0.0.0.0

#### Example

```
chg-ip-lnk:loc=1102:port=a:auto=yes
```

#### Dependencies

The value specified for the `ipaddr` parameter must already exist in the Host table.

The IP addresses for interface A, B, C, and D must be unique (a card cannot have two interfaces on the same network).

At least one optional parameter must be specified.

If `auto=yes` is specified, then the duplex and speed parameters cannot be specified.

The value specified for the `loc` parameter must correspond to the location of a card that can run an IP application (other than the EROUTE application, which is not supported by this command). For a list of the cards and their associated applications, see [Table A-7](#).

The card in the location (other than OAM locations) specified by the `loc` parameter must be inhibited before this command can be entered.

If the location specified by the `loc` parameter is an OAM card location, then the command can be entered while the card is in IN-SR status (as DB modifications are not allowed while the OAM is inhibited). However, the card needs to be re-initialized after the command in order for the changes to take effect.

Sockets cannot be assigned to the B interface for all cards except for those configured as IPSPG.

The local `ipaddr` and `submask` values of either the A or B network cannot be changed to an address that represents a different network if a default router and/or other gateway routers are assigned to the current local network (display with `rtrv-ip-card` and `rtrv-ip-rte`).

The local IP address cannot be changed if the current or new local host has open sockets or associations (the `open` parameter set to `yes` with the `ent/chg-assoc` command).

The IP address of an existing IP link entry in the IP Link table cannot be changed if it exists in the IP Host table.

An IP link entry must be provisioned in the IP Link table before an IP host entry can be provisioned with a corresponding IP address in the IP Host table.

The IP host entry must be deleted from the IP Host table before an IP link entry can be deleted from the IP Link table.

An existing IP link entry in the IP Link table cannot be deleted (`ipaddr=0.0.0.0`) if it exists in the IP Host table.

The IP network address specified by the `ipaddr` and `submask` parameters must be different from the PVN and fast copy network addresses specified by the `pvn/pvnmask`, `fcna/fcnamask`, and `fcnb/fcnbmask` parameters (see the `chg-netopts` command).

The card in the location specified by the `loc` parameter must support the port specified by the `port` parameter.

The `ipaddr` and `submask` parameters must be specified together in the command.

The local IP address cannot be changed if the local host associated with a diameter connection has open connections (the `open` parameter set to `yes` with the `chg-assoc` command and that association is associated with a diameter connection in the DCONN table).

An IP address cannot be configured for the card if the card is provisioned as a GTT card.

Each IP address in the IP link table must be unique.

Speed = 1000 (1 Gbps link) can be specified only for ExAP port on the card.

Each IP address entered into the IP Link table must be unique.

If the `submask` parameter is specified, the value given must be a valid subnet mask.

## Notes

Interface A/D is used for ExAP connectivity and interface B/C is used for the signaling network on the SLIC card running the DEIR/EIR/SIP application.

When the `chg-ip-lnk` command is executed for an OAM card location, the following message is displayed:

```
CAUTION: MCAP IP INFO HAS BEEN CHANGED, MANUAL RE-INITIALIZATION IS NEEDED
```

## Output

```
chg-ip-lnk:loc=1102:port=a:auto=yes
```

```
      chg-ip-lnk:loc=1102:port=a:auto=yes  
      Command entered at terminal #3.
```

```
;
```

```
tekelecstp 14-06-05 11:17:48 MST  EAGLE5 46.0.0-65.20.0  
      CHG-IP-LINK: MASP B - COMPLTD
```

```
;
```

```
chg-ip-  
lnk:loc=1103:port=c:ipaddr=10.248.13.59:submask=255.255.255.0:auto=y  
es
```

```
chg-ip-lnk:loc=1103:port=c:ipaddr=10.248.13.59:submask=255.255.255.0:auto=yes  
      Command entered at terminal #18.
```

```
;
```

```
tekelecstp 16-05-25 11:51:03 MST  EAGLE 46.4.0.0-69.1.0  
      CHG-IP-LINK: MASP B - COMPLTD
```

```
;
```

## Related Topics

- [rtrv-ip-lnk](#)

# chg-is41-msg

Use this command to provision IS41 test messages. These messages are used by the MO SMS NPP Test Tool to test MO-based IS41 SMS message processing by the NPP.



## Parameters

### **msgn (mandatory)**

Message number. The test message number that will be changed.

**Range:**

*1 - 10*

### **active (optional)**

This parameter specifies whether the IS41 MOSMS message can be sent to the network card for processing.

**Range:**

**yes**

The message is sent to the network card.

**no**

The message is not sent to the network card.

**Default:**

No change to the current value

**System Default:**

*no*

### **cdpadgts (optional)**

Called party address digits. The SCCP CdPA digits for the IS41 test message.

**Range:**

1-15 digits

1 - 15 hexadecimal digits. Valid digits are 0-9, a-f, A-F .

**Default:**

No change to the current value

**System Default:**

*0123456789abcde*

### **cdpagti (optional)**

Called party address global title indicator. The SCCP CdPA GT for the IS41 test message.

**Range:**

*0 - 15*

**Default:**

No change to the current value

**System Default:**

*4*

### **cdpagtnai (optional)**

Called party address global title nature of address indicator. The SCCP CdPA GT NAI for the IS41 test message.

**Range:**

*0 - 127*

**Default:**

No change to the current value

**System Default:**

*4*

**cdpndgts (optional)**

Called party number digits. The TCAP CdPN (*SMS\_DA / SMS\_ODA*) digits for the IS41 test message.

**Range:**

*1-21 digits*

**Default:**

No change to the current value

**System Default:**

*01234567890abcde*

**cdpnes (optional)**

Called party number encoding scheme. The TCAP CdPN (*SMS\_DA / SMS\_ODA*) encoding scheme for the IS41 test message

**Range:**

*0 - 15*

**Default:**

No change to the current value

**System Default:**

*1*

**cdpnnai (optional)**

Called party number nature of address indicator. The TCAP CdPN (*SMS\_DA / SMS\_ODA*) NAI for the IS41 test message.

**Range:**

*0 - 1*

**Default:**

No change to the current value

**System Default:**

*1*

**cdpnp (optional)**

Called party numbering plan. The TCAP CdPN (*SMS\_DA / SMS\_ODA*) NP for the IS41 test message.

**Range:**

*0 - 15*

**Default:**

No change to the current value

**System Default:**

2

**cgpadgts (optional)**

Calling party address digits. The SCCP CgPA digits for the IS41 MOSMS message.

**Range:**

1-15 digits

1 - 15 hexadecimal digits. Valid digits are 0-9, a-f, A-F .

**Default:**

No change to the current value

**System Default:**

0123456789abcde

**cgpagti (optional)**

Calling party address global title indicator. The SCCP CgPA GT for the IS41 test message.

**Range:**

0 - 15

**Default:**

No change to the current value

**System Default:**

4

**cgpagtnai (optional)**

Calling party address global title nature of address indicator. The SCCP CgPA GT NAI for the IS41 test message.

**Range:**

0 - 127

**Default:**

No change to the current value

**System Default:**

4

**cgpndgts (optional)**

Calling party number digits. The TCAP CgPN (SMS\_OOA) digits for the IS41 test message.

**Range:**

1-21 digits, *none*

*none* -deletes the current digits

**Default:**

No change to the current value

**System Default:**

01234567890abcde

**cgpnes (optional)**

Calling party number encoding scheme. The TCAP CgPN (SMS\_OOA) encoding scheme for the IS41 test message

**Range:**

0 - 15

**Default:**

No change to the current value

**System Default:**

1

**cgpnnai (optional)**

Calling party number nature of address indicator. The TCAP CgPN (SMS\_OOA) NAI for the IS41 test message.

**Range:**

0 - 1

**Default:**

No change to the current value

**System Default:**

1

**cgpnp (optional)**

Calling party numbering plan. The TCAP CgPN (SMS\_OOA) NP for the IS41 test message.

**Range:**

0 - 15

**Default:**

No change in the current value

**System Default:**

2

**reset (optional)**

This parameter resets all of the parameters to their default values.

**Range:****yes**

All of the message parameters are reset to their default values.

**no**

None of the message parameters are reset.

**Default:**

No change to the current value

**Example**

```
chg-is41-msg:msgn=1:cdpnnai=1:cdpadgts=12457896abcd:cgpnnai=1
```

```
chg-is41-msg:msgn=1:cdpnnai=1:cdpndgts=981123456
```

### Dependencies

The TSTMSG table is corrupt or cannot be found.

If the `reset` parameter is specified, then no other parameters can be specified.

At least one optional parameter must be specified.

### Output

```
chg-is41-msg:msgn=1:cdpnnai=1:cdpndgts=987654321:cgpnnai=1
```

```
tekelecstp 09-03-02 10:46:51 EST EAGLE 40.1.0
CHG-IS41-MSG: MASP A - COMPLTD
;
```

### Related Topics

- [rtv-is41-msg](#)
- [tst-msg](#)

## chg-is41opts

Use this command to change the values of one or more of the IS41 option indicators maintained in the IS41 Options (IS41OPTS) table.

### Parameters



#### Note:

The options for the `on` and `off` parameters are described in the Notes section.

#### **df1trn (optional)**

Default routing number. The routing digits if Service Portability is not applicable.

##### **Range:**

1-15 digits

1 - 15 hexadecimal digits. Valid digits are 0-9, a-f, A-F.

#### **esnmfg (optional)**

ESN manufacturer code. The value that will be encoded in the manufacturer code section of the `esn` parameter for a LOCREQ response message.

##### **Range:**

0 - 255

##### **Default:**

0

**esnsn (optional)**

ESN serial number. The value that will be encoded in the serial number section of the `esn` parameter for a LOCREQ response message.

**Range:**

0 - 16777215

**Default:**

0

**iec (optional)**

International escape code. The international escape code that a received LOCREQ message can contain and have lookup performed.

**Range:**

1-5 digits, *none*

*none* —Removes the IEC from a received LOCREQ message before lookup.

**Default:**

*none*

**locreqdn (optional)**

This parameter specifies whether to obtain the Called Party, used for database lookup, from the SCCP or TCAP layer of a received LOCREQ message.

**Range:*****tcap***

Obtains the Called Party from the TCAP layer.

***sccp***

Obtains the Called Party from the SCCP layer.

**Default:**

*sccp*

**locreqrmhrn (optional)**

LOCREQ remove HomeRN. This parameter specifies whether to remove the HomeRN from the TCAP Outgoing Called Party for a relayed LOCREQ message.

**Range:*****yes***

Remove HomeRN.

***no***

Do not remove HomeRN.

**Default:**

*no*

**mscmktid (optional)**

MSCID market ID. The value that will be encoded in the Market ID section of the `mscid` parameter for a response LOCREQ message.

**Range:** 0 - 65535

**Default:**

0

**mscswitch (optional)**

MSCID market ID switch. The value that will be encoded in the Market ID Switch section of the `mscid` parameter for a response LOCREQ message.

**Range:**

0 - 255

**Default:**

0

**mtplocreqlen (optional)**

The number of terminating called party digits to extract from the LOCREQ message.

**Range:**

5 - 15

**Default:**

15

**System Default:**

0

**mtplocreqnai (optional)**

MTP-routed LOCREQ nature of address indicator. This parameter specifies how the Called Party from the TCAP layer of a received MTP-routed LOCREQ message will be interpreted.

**Range:*****ccrndn***

Country code, routing number, and national directory number

***frmsg***

Incoming message value.

***intl***

International number

***natl***

National number

***rnidn***

Routing number prefix and international dialed/directory number

***rnndn***

Routing number prefix and national dialed/directory number

***rnsdn***

Routing number prefix and subscriber dialed/directory number

***sub***

Subscriber number

**locreqlen**

Number of terminating called party digits specified by the `locreqlen` parameter

**Default:**

*frmsg*

**nec (optional)**

National escape code. The national escape code that a received LOCREQ message can contain and have lookup performed.

**Range:**

1-5 digits, *none*

*none* —Removes the NEC from the received LOCREQ message before database lookup.

**Default:**

*none*

**off (optional)**

This parameter turns off the specified options. Up to 8 comma-separated options can be specified.

**Range:**

*smsreqbypass*

*locreqrmhrn*

*locreqrspnd*

**on (optional)**

This parameter turns on the specified options. Up to 8 comma-separated options can be specified.

**Range:**

*smsreqbypass*

*locreqrmhrn*

*locreqrspnd*

**rspcdpapcp (optional)**

Response called party point code present. The point code present bit that will encode the SCCP CdPA GTA of a LOCREQ response message.

**Range:****off**

The response will not contain a point code present bit.

**on**

The point code in the SCCP CgPA of the received LOCREQ message will be used. If no point code is present, the originating point code in the MTP Routing Label will be used.



**frmsg**

The point code present bit from the received message will be used. Override does not occur.

**Default:**

*off*

**rspcdpari (optional)**

Response called party routing indicator. The value of the routing indicator bit that will encode the SCCP CdPA GTA of a LOCREQ response message.

**Range:****frmsg**

The received message routing indicator bit will be used. Override does not occur.

**gt**

The GTA digits in the SCCP CgPA GTA of the received message will be used. If no GTA digits are present in the SCCP CgPA GTA, override will occur according to the `cdpari=ssn` parameter.

**ssn**

The SCCP CgPA of the received message will be used.

**Default:**

*frmsg*

**rspcgpanai (optional)**

Response calling party nature of address indicator. The nature of address (NAI) that will encode the SCCP CgPA GTA of a LOCREQ response message.

**Range:**

*0 - 127, none*

*none* —The NAI value in the SCCP CdPA of the received message will be used. Override does not occur.

**Default:**

*none*

**rspcgpanp (optional)**

Response calling party numbering plan. The numbering plan (NP) that will encode the SCCP CgPA GTA of a LOCREQ response message.

**Range:**

*0 - 15, none*

*none* —The NP in SCCP CdPA of the received message will be used. Override does not occur.

**Default:**

*none*

**rspcgpapcp (optional)**

Response calling party point code present. This parameter specifies the point code present bit that will encode the SCCP CgPA GTA of a LOCREQ response message.

**Range:*****frmsg***

The point code present bit from the received message will be used.

***on***

The point code in the SCCP CdPA of the incoming LOCREQ message will be used. If no point code is present, the destination point code in the MTP Routing Label will be used.

***off***

The response message will not contain a point code present bit.

**Default:**

*frmsg*

***rspcgpari* (optional)**

Response calling party routing indicator. The routing indicator bit that will encode the SCCP CgPA GTA of a LOCREQ response message.

**Range:*****frmsg***

The value from the received message will be used. Override does not occur.

***gt***

The GTA digits in the SCCP CdPA GTA of the received message will be used. If no GTA digits are present, override occurs according to the *cgpari=ssn* parameter.

***ssn***

The SCCP CdPA of the received message will be used.

**Default:**

*frmsg*

***rspcgpatt* (optional)**

Response calling party translation type. The translation type (TT) that will encode the SCCP CgPA GTA of a LOCREQ response message.

**Range: 0 - 255, none**

*none* —The TT in the SCCP CdPA of the received message will be used. Override does not occur.

**Default:**

*none*

***rspdig* (optional)**

Routing number. The digit encoding format of the TCAP Outgoing Called Party parameter for a LOCREQ response message.

The routing number will be used as is or concatenated with the Called Party Number. The routing number format will be used on a per EAGLE node basis.

**Range:*****ccrndn***

Country Code + RN + DN

**hrnrndn**

HomeRN + RN + DN

**rn****rndn**

RN + DN

**Default:***rn***rspdigtype (optional)**

Response digit type. The value that will encode the Digit Type field in the TCAP Outgoing Called Party parameter of a LOCREQ response message.

**Range:**

0 - 255

**Default:**

6

**rspmin (optional)**

Response LOCREQ MIN parameter encoding. This parameter specifies how the `min` parameter of a LOCREQ response message will be encoded.

**Range:****homern**

The exact number of digits, with home RN prefix, as encoded in the Called Party of the received LOCREQ message.

**nothomern**

The exact number of digits, without home RN prefix, as encoded in the Called Party of the received LOCREQ message.

**tendelhomern**

The leading 10 digits of the Called Party of the received LOCREQ message after deleting the home RN prefix, if it exists.

**tenhomern**

The leading 10 digits the Called Party of the received LOCREQ message without deletion of the home RN prefix.

**tenzero**

10 digits filled with 0.

**Default:***homern***rspnon (optional)**

MSRN nature of number. The nature of number value that will encode the TCAP Outgoing Called Party parameter of a LOCREQ response message.

**Range:**

0 - 255, none

*none* —The NAI value in the Digits[Dialed] parameter of a received LOCREQ message is used.

**Default:***none***rspnp (optional)**

MSRN numbering plan. This parameter specifies the numbering plan that will encode the TCAP Outgoing Called Party parameter of the LOCREQ response message.

**Range:***0 - 15, none**2* —Telephony Numbering**Default:***2***rspparm (optional)**

Response parameter. The TCAP parameter that will encode the RN and/or DN information for a LOCREQ response message.

This value encodes the DigitType field of the TerminationList, RoutingDigits, or Digits[Destination] on a per EAGLE node basis.

**Range:*****ddigit****Digits[Destination].****rdigit****Routingdigits****tlist****Termination list (Default)***Default:***tlist***smsreqbypass (optional)**

This parameter specifies whether a received SMSREQ message that passes the MNP Service Selector ( *serv=mnps* parameter in the *chg-sccp-serv* command) will undergo A-Port message processing.

**Range:*****yes****Bypass A-Port.****no****Do not bypass A-Port.***Default:***no***sporttype (optional)**

Service Portability Type. The application of Service Portability that is applied to the associated feature.

The S-Port feature must be enabled before this parameter can be specified. The S-Port feature must be turned on before any change to the parameter will impact the associated feature.

 **Note:**

If Service Portability is performed, then the Service Portability prefix (RTDB 'GRN'entity id ) is applied.

**Range:*****none***

Service Portability is not performed for the feature.

***gsm***

apply Service Portability prefix for own-network GSM subscribers

***is41***

apply Service Portability prefix for own-network IS41 subscribers

***all***

apply Service Portability prefix for all own-network (IS41 and GSM) subscribers

**Default:**

No change to the current value

**System Default:**

*none*

**tcapsnai (optional)**

This parameter specifies how the Called Party from the TCAP layer of a received LOCREQ message will be interpreted.

**Range:*****ccrndn***

Country code, routing number, and national directory number

***frmsg***

Incoming message value

***intl***

International number

***natl***

National number

***rnidn***

Routing number prefix and international dialed/directory number

***rnndn***

Routing number prefix and national dialed/directory number

***rnsdn***

Routing number prefix and subscriber dialed/directory number

**sub**  
Subscriber number

**Default:**  
*frmsg*

### Example

```
chg-is41opts:iec=12345:nec=12345:rspcgpari=gt:rspcdpari=gt
chg-is41opts:rspnon=1:tcapsnai=sub:mscmktid=78
chg-
is41opts:locreqdn=tcap:rspcgpapcp=frmsg:rspnp=14:rspmin=tendelhomern
chg-is41opts:smsreqbypass=yes:rspcdpapcp=off
chg-is41opts:rspcgpanai=120:rspcgpanp=5:rspcgpatt=25
chg-is41opts:mtplocreqnai=intl:rspparm=tlist:rspdig=rn
chg-is41opts:rspnon=25:mscmktid=535:mscswitch=55
chg-is41opts:esnmfg=159:esnsn=7215:rspdigtype=67:locreqrmhrn=yes
chg-is41opts:sporttype=gsm:dfltrn=48607:on=smsreqbypass,locreqrspnd
```

### Dependencies

The A-Port or IS41 GSM Migration (IGM) feature must be enabled before this command can be entered.

The EGLEOPTS table is corrupt or cannot be found.

The Service Portability and LOCREQ Query Response features must be enabled before the *sporttype* parameter can be specified.

The *smsreqbypass* and *locreqrmhrn* parameters and the *on* or *off* parameter cannot be specified in the same command.

The LOCREQ Query Response feature must be enabled before the *dfltrn* parameter can be specified.

The LOCREQ Query Response feature must be turned on before the *locreqrspnd* option can be specified for the *on* or *off* parameter.

The same option cannot be specified for the *on* and *off* parameters.

### Notes

#### on/off options

- *smsreqbypass* —Specifies whether a received SMSREQ message that passes the MNP Service Selector (see the *chg-sccp-serv* command) undergoes A-Port message processing. This option has a default of OFF.
- *locreqrmhrn* —LOCREQ remove HomeRN. Specifies whether to remove the HomeRN from the TCAP Outgoing Called Party for a relayed LOCREQ message. This option has a default of OFF.

- *locreqrspnd*—Specifies whether the system should always respond to a LOCREQ query. This option has a default of OFF.

### Output

```
chg-is41opts:smsreqbypass=yes
```

```
tekelecstp 06-09-11 15:13:20 EST EAGLE 36.0.0
Command entered at terminal #4.
CHG-IS41OPTS: MASP A - COMPLTD
;
```

### Related Topics

- [chg-is41smsopts](#)
- [rtrv-is41opts](#)
- [rtrv-is41smsopts](#)

## chg-is41smsopts

Use this command to enter IS41 SMS system options in the database. This command updates the IS41SMSOPTS table.

### Parameters

#### **bpartygttsn (optional)**

MO SMS B-Party Routing GTT Set name. The GTT set where Global Title Translation lookup on B-Party digits is performed.

**Range:**

*ayyyyyyy*

1 leading alphabetic and up to 8 following alphanumeric characters

**Default:**

No change to the current value

**System Default:**

*none*

#### **defrn (optional)**

Default routing number. A default routing number that is used for own-network subscribers.

**Range:**

1-15 digits, *none*

Valid digits are 0-9, a-f, A-F.

**Default:**

No change to the current value

**System Default:**

*none*

**modaparam (optional)**

This parameter specifies whether the SMS\_DestinationAddress or SMS\_OriginalDestinationAddress parameter from the IS41 SMDPP message is used for conditioning, lookup, and modification for the MO-based IS41 SMS NP and MO SMS IS41-to-GSM Migration features.

**Range:**

**da**  
Destination Address

**oda**  
Original Destination Address

**Default:**

No change to the current value

**System Default:**

*da*

**moigmpfx (optional)**

MO SMS IS41-to-GSM migration prefix. This parameter specifies whether the MO SMS IS41-to-GSM Migration feature uses digits from the RTDB network entity (NE) associated with the B number or the *is412gsm* parameter (see the *chg-gsmopts* command) as a prefix to modify the destination address in the outgoing SMDPP.

**Range:**

**ne**  
The RTDB NE data associated with the B number is used for prefixing.

**is412gsm**  
The provisioned IS412GSM migration prefix is used for prefixing.

**Default:**

No change to the current value

**System Default:**

*ne*

**mosmsaclen (optional)**

The number of the digits that are taken from the MO SMS CgPA and used as the Area Code in the MO SMS CdPA.

**Range:**

*0 - 8*

**Default:**

No change to the current value

**System Default:**

*0*

**mosmsdigmat (optional)**

This parameter specifies that the “HomeSMSC Match with Digits” search option can be used with the MO-based IS41 SMS NP and MO SMS IS41-to-GSM Migration features.



**Range:**

***exact***

The system searches for an exact match of digits in the HomeSMSC Table.

***bestfit***

The system searches for a match on the leading digits of an incoming message with any provisioned entry in HomeSMSC table if an exact match is not found.

***bypass***

The HomeSMSC search is not performed.

**Default:**

No change to the current value

**System Default:**

*exact*

**mosmsgttdig (optional)**

MO SMS B-Party Routing GTT digit. The digits that are used for Global Title Translation.

**Range:**

***sccpcdpa***

The SCCP CdPA is used for GTT.

***mapbparty***

The MAP B-Party number is used for GTT.

**Default:**

No change to the current value

**System Default:**

*sccpcdpa*

**mosmsnai (optional)**

MO-based SMS Nature Address Indicator. The number conditioning that is performed on the SMS\_DestinationAddress digits in the SMDPP message before lookup in the number portability database is performed.

**Range:**

***intl***

Number is treated as INTL (1) for number conditioning.

***nai***

The NAI from the SMS\_DestinationAddress parameter in the SMDPP message is used to perform number conditioning

***nat***

Number is treated as NATL (0) for number conditioning.

**unknown**

Number is treated as UNKNOWN (2) for number conditioning.

A value of *nai* must be specified before the *intl*, *natl*, *nai1*, *nai2*, *nai3*, and *unkn* parameters in the `chg-npp-serv` command can be changed to non-default values for the MOSMSICDPN service.

**Default:**

No change to the current value

**System Default:**

*intl*

**mosmstype (optional)**

MO-based SMS type. The value of the entity type that indicates that a successful lookup occurred in the number portability database.

**Range:*****sp***

signaling point

***rn***

routing number

***sprn***

Lookup is successful if the value of the entity type is *sp* or *rn*.

***all***

Lookup is successful if the value of the entity type is *sp* or *rn*, or if no entity type is found.

**Default:**

No change to the current value

**System Default:**

*sprn*

**mtsmsackn (optional)**

MT-Based SMS acknowledgement. The message generated in response to a successful number portability database lookup for an SMSREQ message from a Home SMSC.

**Range:*****ack***

SMSREQ\_ACK message

***nack***

SMSREQ\_NACK (Return Error) message

**Default:**

No change to current value.

**System Default:**

*ack*

**mtsmschksrc (optional)**

MT-Based SMS check source. This parameter specifies whether the SCCP CgPA GTA of a SMSREQ message is validated to determine whether the source of the message is a Home SMSC.

**Range:****yes**

The SCCP CgPA GTA of an SMSREQ message is validated.

**no**

The SCCP CgPA GTA of an SMSREQ message is not validated.

If the `mtsmschksrc=yes` parameter is specified, and if the incoming SMSREQ message has SCCP CgPA GTA, then the SCCP CgPA GTA must be found in the Home SMSC list for the source of the message to be considered a Home SMSC. If the message is not found in the Home SMSC list, then the MT-Based IS41 SMS NP feature does not process the message.

If the `mtsmschksrc=no` parameter is specified, or if SCCP CgPA GTA does not exist in the incoming message, then the source of the message is considered to be a Home SMSC, and the MT-Based IS41 SMS NP feature considers the message for processing.

**Default:**

No change to current value

**System Default:**

*no*

**mtsmsdigtype (optional)**

MT-Based SMS digit type. The value that is used to encode the "Type of digits" field in the SMS\_Address parameter of an SMSREQ ACK message.

**Range:**

0 - 255

**Default:**

No change to the current value

**System Default:**

6

**mtsmsdltr (optional)**

MT-Based SMS delimiter. This parameter specifies whether to insert a delimiter string before or after the routing number (RN) when the RN is used in the `mtsmsdnfmt` digits.

**Note:**

The delimiter string that is inserted is determined by the `mtsmsdltrv` parameter.

**Range:**

***no***

A delimiter string is not inserted.

***prern***

A delimiter digit string is inserted before the RN.

***postrn***

A delimiter digit string is inserted after the RN.

**Default:**

No change to the current value

**System Default:**

*no*

**mtsmsdltrv (optional)**

MT-Based SMS delimiter value. The delimiter digit string inserted before or after the RN when the RN is used in the mtsmsdnfmt digits.

**Range:**

1-5 digits, *none*

Valid digit *none*s are 0-9, a-f, A-F.

**Default:**

No change to the current value

**System Default:**

*none*

**mtsmsdnfmt (optional)**

MT-Based SMS DN format. The required format of digits to be encoded in the "SMS\_Address" parameter of the SMSREQ response.

**Range:**

***rn***

routing number

***rndn***

routing number and the international dialed/directory number

***ccrndn***

country code, routing number, and national directory/dialed number

***dn***

directory or dialed number

***srfimsi***

IMSI is encoded as the "SRFIMSI" parameter from the number portability database.

**Default:**

No change to the current value

**System Default:**

*rndn*

**mtsmsesn (optional)**

MT-Based SMS electronic serial number. This parameter specifies whether to encode the ESN parameter while generating the SMSREQ response message.

**Range:*****no***

The ESN parameter is not encoded.

***yes***

The ESN parameter is encoded.

**Default:**

No change to the current value

**System Default:**

*no*

**mtsmsnakerr (optional)**

MT-Based SMS negative acknowledgement error. The TCAP access denied reason to be included in the NACK response message that is generated for SMSREQ messages.

**Range:**

*0 - 255*

**Default:**

No change to the current value.

**System Default:**

*5*

**mtsmsparm (optional)**

MT-Based SMS parameter. The format used to encode the "SMS\_Address" parameter of an SMSREQ response message.

**Range:*****digit***

DIGIT format

***pcssn***

PCSSN format

**Default:**

No change to the current value

**System Default:**

*digit*

**mtsmsssn (optional)**

MT-Based SMS subsystem number. The SSN that is encoded in "SMS\_Address" field, if the `mtsmsparm=pcssn` parameter is specified, and the SSN entry is not found in the entity.

**Range:**

*2 - 255*

**Default:**

No change to the current value

**System Default:**

6

**mtsmstype (optional)**

MT-Based SMS type. The entity type that indicates a successful lookup occurred in the number portability database.

**Range:**

**sp**

signaling point

**rn**

routing number

**sprn**

sporn

**all**

sp,rn, or DN with no entity

**nonsp**

rnor DN with no entity

**Default:**

No change to the current value

**System Default:**

rn

**spfill (optional)**

This parameter specifies whether the Numbering Plan Processor (NPP) can populate SP and RN entities for own network subscribers at the same time.

**Range:**

**off**

Do not populate both RN and SP entities at the same time

**on**

Allow population of the RN and SP entities at the same time

**Default:**

No change to the current value

**System Default:**

off

**sporttype (optional)**

Service Portability type. This parameter specifies whether Service Portability is performed for the associated feature.

 **Note:**

If Service Portability is performed, then the Service Portability prefix (RTDB GRN entity id) is applied.

**Range:*****gsm***

Apply Service Portability prefix for own-network GSM subscribers

***is41***

Apply Service Portability prefix for own-network IS41 subscribers

***all***

Apply Service Portability prefix for all own-network (IS41 and GSM) subscribers

***none***

Service Portability is not performed for the feature.

**Default:**

No change to the current value

**System Default:**

*none*

**Example**

This example sets the IS41 SMS options when MO SMS ASD or MO SMS GRN feature is enabled:

```
chg-is41smsopts:modaparam=da:mosmsnai=intl:mosmsaclen=3
```

This example sets the IS41 SMS options when the MT-based IS41 SMS NP feature is enabled:

```
chg-is41smsopts:mtsmsdltr=no:mtsmsparm=digit
```

```
chg-is41smsopts:mtsmsdltrv=9854:mtsmsackn=nack:mtsmsesn=no
```

```
chg-is41smsopts:mtsmsssn=2:mtsmsnakerr=55:mtsmsdigtype=25
```

```
chg-is41smsopts:mtsmschksrc=no
```

This example sets the IS41 SMS options when the MO SMS B-Party Routing feature is enabled:

```
chg-is41smsopts:bpartygttsn=setint001:mosmsgttddig=mapbparty
```

```
chg-is41smsopts:mtsmsdnfmt=dn:mtsmsstype=sp
```

This example sets the IS41 SMS options when the MO-based IS41 SMS NP feature is enabled:

```
chg-is41smsopts:mosmstype=sp:mosmsnai=intl:mosmsdigmat=exact:
modaparam=da:mosmsaclen=3
```

This example sets the IS41 SMS options when the MO SMS IS41-to-GSM Migration feature is enabled.

```
chg-is41smsopts:mosmsdigmat=exact:moigmpfx=is412gsm:modaparam=da:  
mosmsnai=intl:mosmsaclen=3
```

This example sets the Area Code Length, when MO-based IS41 SMS NP, MO SMS IS41-to-GSM Migr, MO SMS ASD or MO SMS GRN feature is enabled:

```
chg-is41smsopts:mosmsaclen=5
```

### Dependencies

At least one parameter must be specified.

The `mtsmsdltrv` parameter must be specified before a value of `prern` or `postrn` can be specified for the `mtsmsdltr` parameter.

The value specified for the `bpartygttsn` parameter must match the name of an existing GTT Set.

The `mosmsgttdig=sccpcdpa` parameter must be specified before the `bpartygttsn=none` parameter can be specified.

The GTT set specified for the `bpartygttsn` parameter must have `settype=cdgta` (see the `ent-gttset` command).

If the `bpartygttsn=none` parameter is specified, then the `mosmsgttdig=mapbparty` parameter cannot be specified.

The GTT Set table is corrupt or cannot be found.

The EGLEOPTS table is corrupt or cannot be found.

The MT-Based IS41 SMS NP feature must be enabled before the `mtsmsdnfmt`, `mtsmsstype`, `mtsmsparm`, `mtsmsdltr`, `mtsmsdltrv`, `mtsmsackn`, `mtsmsesn`, `mtsmsssn`, `mtsmsnakerr`, `mtsmsdigtype`, or `mtsmschksrc` parameters can be specified.

The MO SMS IS41-to-GSM Migration feature must be enabled before the `moigmpfx` parameter can be specified.

The MO SMS B-Party Routing feature must be enabled before the `bpartygttsn` or `mosmsgttdig` parameter can be specified.

The MO-based IS41 SMS NP or MO SMS IS41-to-GSM Migration feature must be enabled before the `mosmsdigmat` parameter can be specified.

The MO-based IS41 SMS NP feature must be enabled before the `mosmstype`, `defrn`, and `spfill` parameters can be specified.

The MO-based IS41 SMS NP, MO SMS IS41-to-GSM Migration, MO SMS ASD, or MO SMS GRN feature must be enabled before the `modaparam`, `mosmsnai`, or `mosmsaclen` parameter can be specified. The `modaparam` parameter can also be specified if the MO SMS B-Party Routing feature is enabled.

The S-Port feature must be enabled before the `sporttype` parameter can be specified.



## Output

```
chg-is41smsopts:mtsmsackn=ack
```

```
tekelecstp 08-05-11 13:11:27 EST EAGLE 39.0.0  
CHG-IS41SMSOPTS: MASP A - COMPLTD  
;
```

## Related Topics

- [chg-is41opts](#)
- [rtrv-is41opts](#)
- [rtrv-is41smsopts](#)

# chg-isup-msg

Use this command to enter or change specific parameters of an ISUP test message in the TESTMSG table. The TIF Test Tool processes ISUP test messages to verify the TIF and NPP provisioned configuration in the system.

## Parameters

### **msgn (mandatory)**

Test message number. The ISUP test message number for which parameters are being changed in the TESTMSG table.

**Range:**

*1 - 10*

### **active (optional)**

Active. This parameter sets the *Active* field of the specified ISUP test message.

**Range:**

***no***

Do not send the message to the network card for processing.

***yes***

Send the message to the network card for processing.

**Default:**

*no*

### **cdpndgts (optional)**

Called Party Number digits. The value for the CdPN digits in the specified ISUP test message.

**Range:**

1-32 digits

1 - 32 hexadecimal digits. Valid digits are *0-9, a-f, A-F*.

**System Default:**

1234567890abcdef

**Default:**

No change to the current value

**cdpnnai (optional)**

Called Party Number Nature of Address Indicator. The value for the CdPN NAI in the specified ISUP test message.

**Range:**

0 - 127

**Default:**

No change to the current value

**System Default:**

4

**cgpncat (optional)**

Calling Party Number Category. The value of the CgPN Category in the specified ISUP test message.

**Range:**

0 - 255

**Default:**

0

**cgpndgts (optional)**

Calling Party Number digits. The value for the CgPN digits in the specified ISUP test message.

**Range:**

1-32 digits, *none*

1 - 32 hexadecimal digits. Valid digits are 0-9, a-f, A-F .

**Default:**

No change to the current value

**System Default:**

1234567890abcdef

**cgpnnai (optional)**

Calling Party Number Nature of Address Indicator. The value of the CgPN NAI in the specified ISUP test message.

**Range:**

0 - 127

**Default:**

No change to the current value

**nmbits (optional)**

NM Bits. The value of the NM bits in the specified ISUP test message. NM bits are used to determine whether a number portability lookup has already been performed in the network.

**Range:**

0 - 3

**0-1**

Portability has not been performed.

**2**

The number is not ported.

**3**

The number is ported.

**Default:**

0

**Example**

```
chg-isup-  
msg:msgn=1:active=yes:nmbits=1:cgpndgts=987654321:cdpndgts=9234  
87:cdpnnai=125
```

```
chg-isup-msg:msgn=6:cgpncat=200:cdpnnai=23
```

**Dependencies**

At least one of the optional parameters must be specified.

At least one TIF feature must be enabled before this command can be entered.

The TSTMSG table is corrupt or cannot be found.

**Output**

```
chg-isup-msg:msgn=10:active=yes:nmbits=1
```

```
tekelecstp 08-07-24 10:37:20 EST EAGLE 39.2.0  
CHG-ISUP-MSG: MASP A - COMPLTD  
;
```

**Related Topics**

- [rtv-isup-msg](#)
- [tst-msg](#)

## chg-j1

Use this command to change an interface for a J1 card in the system. J1 interface can be provisioned on E5-E1T1-B.

**Parameters****loc (mandatory)**

The card location as stenciled on the shelf of the system.

**Range:**

1101 - 1108, 1111 - 1112, 1201 - 1208, 1211 - 1218, 1301 - 1308, 1311 - 1318, 2101 - 2108, 2111 - 2118, 2201 - 2208, 2211 - 2218, 2301 - 2308, 2311 - 2318, 3101 - 3108, 3111 - 3118, 3201 - 3208, 3211 - 3218, 3301 - 3308, 3311 - 3318, 4101 - 4108, 4111 - 4118, 4201 - 4208, 4211 - 4218, 4301 - 4308, 4311 - 4318, 5101 - 5108, 5111 - 5118, 5201 - 5208, 5211 - 5218, 5301 - 5308, 5311 - 5318, 6101 - 6108, 6111 - 6118

**j1port (mandatory)**

J1 port number

The value must be a J1 port that has already been configured with a J1 interface on the specified T1 card with application as CCS7ITU.

**Range:**

1-8

**encode (optional)**

Indicator for use of B8ZS or AMI encoding/decoding.

**Range:**

*b8zs*

*ami*

**Default:**

No change to the current value.

**l1 (optional)**

T1 cable length in feet between the EAGLE and the connecting node.

**Range:**

0-655

**Default:**

No change to the current value.

**j1tsel (optional)**

Timing source for a J1 card.

**Range:**

*line*

slave timing source

*external*

master timing source

**Default:**

No change to the current value.

**Example**

```
chg-j1:loc=1101:j1port=1:encode=ami:j1tsel=external
```

```
chg-j1:loc=1102:j1port=2:encode=b8zs:l1=250
```

## Dependencies

At least one optional parameter must be specified.

The card location specified by the loc parameter must be equipped.

The J1 table must be accessible.

The Card (IMT) table must be accessible.

The card specified by the loc parameter must be a LIMT1 card type and application must be CCS7ITU.

The port specified by the j1port parameter must have already been configured with a J1 interface on the specified J1 card with application as CCS7ITU.

All signaling links that are serviced by the specified J1 card with application as CCS7ITU must be deactivated before the values for the encode, j1tsel, and ll parameters can be changed.

Card locations 1113 - 1118 (OAM, TDM, MDAL cards) cannot be specified as values for the loc parameter.

j1port must be in range from 1 to 8.

## Notes

External timing is derived from the EAGLE High-Speed Master Clock (1.544 MHz for T1 or 2.048 MHz for E1): therefore, the Master Timing feature is required. Line timing is derived from its received data stream, if present.

## Output

```
chg-j1:loc=1101:j1port=1:encode=ami
```

```
tekelecstp 13-12-20 12:33:39 EST 46.0.0-65.3.0
chg-j1:loc=1101:j1port=1:encode=ami
Command entered at terminal #4.
CHG-J1: MASP A - COMPLTD
;
```

## Related Topics

- [dlt-j1](#)
- [ent-j1](#)
- [rtrv-j1](#)
- [tst-j1](#)

# chg-l2t

Use this command to change the values of the SS7 MTP level 2 timers. The timers are organized in 40 timer sets of which sets 1-35 have 9 timer values and sets 36-40 have 10 timer values. The timer sets are grouped and system default values are initialized by specification (ANSI, ITU, High Speed for China, High Speed for Q.703 Annex A, JT

Q703, and High Speed for Unchannelized T1). Each timer set is administered individually by this command. The `ent-slk` command is used to assign an SS7 signaling link to any of the timer sets. Each assigned link is associated with a timer set.

### Parameters

#### **l2tset (mandatory)**

Level 2 timer set. This parameter specifies the Level 2 timer set identifier or timer set number. Up to 40 different timer sets can be defined. A signaling link can be assigned to any of the timer sets.

**Range:**

1 - 40

**1-10**

ANSI links

**11-20**

low-speed ITU links

**21-25**

China high speed links

**26-30**

Q.703 Annex A high speed links

**31-35**

Unchannelized T1 high speed links

**36-40**

Japan ITU low speed links

#### **nodata (optional)**

This parameter specifies a value for the NODATA timer.

 **Note:**

The NODATA timer measures the amount of time, in milliseconds, that must pass with no transmissions on a link before the EAGLE interprets the condition as a link failure or terminal equipment failure and initiates changeover procedures.

The NODATA timer is not applicable for HSLs. It is valid for low speed links only.

The NODATA timer is configurable only for low speed SS7 links running BASIC Error Correction Method (ECM).

The NODATA timer is not configurable for low speed SS7 links running PCR ECM. The NODATA timer value is calculated as  $T2 (L2 \text{ timer } 2 \text{ value})/3$  for low speed SS7 links running PCR ECM.

**Range:**

100 - 500

**Default:**

No change to the current value

**System Default:**

100

**τ1 (optional)**

Timer 1—Aligned/ready

**Range:**

5000 - 350000 (milliseconds)

ANSI timer sets 1–10—5000–20000

ITU timer sets 11–20—40000–50000

China timer sets 21–25—25000–350000

Q.703 Annex A timer sets 26–30—25000–350000

Unchannelized T1 timer sets 31–35—16000–151000

Japan timer sets 36--40--- 15000

**Default:**

No change to the current value

**System Default:**

ANSI timer sets 1–10—13000

ITU timer sets 11–20—40000

China timer sets 21–25—150000

Q.703 Annex A timer sets 26–30—300000

Unchannelized T1 timer sets 31–35—151000

Japan timer sets 36--40--- 15000

**τ2 (optional)**

Timer 2—Not aligned

**Range:**

5000 - 480000 (milliseconds)

ANSI timer sets 1–10—5000–30000

ITU timer sets 11–20—5000–150000

China timer sets 21–25—5000–150000

Q.703 Annex A timer sets 26–30—5000–150000

Unchannelized T1 timer sets 31–35—5000–14000

Japan timer sets 36--40---5000--480000

**Default:**

No change to the current value

**System Default:**

ANSI timer sets 1–10—11500

ITU timer sets 11–20—30000

China timer sets 21–25—130000

Q.703 Annex A timer sets 26–30—130000

Unchannelized T1 timer sets 31–35—14000

Japan timer sets 36--40--5000

**τ3 (optional)**

Timer 3—Aligned

**Range:**

1000 - 20000 (milliseconds)

ANSI timer sets 1–10—5000–20000

ITU timer sets 11–20—1000–2000  
Q.703 Annex A timer sets 26–30—1000–2000  
China timer sets 21–25—1000–2000  
Unchannelized T1 timer sets 31–35—5000–14000  
Japan timer sets 36--40---3000

**Default:**

No change to the current value

**System Default:**

ANSI timer sets 1–10—11500  
ITU timer sets 11–20—2000  
China timer sets 21–25—1000  
Q.703 Annex A timer sets 26–30—1000  
Unchannelized T1 timer sets 31–35—14000  
Japan ITU low speed links 36--40---3000

**t4epp (optional)**

Timer 4—Proving period Emergency

**Range:**

200 - 10000 (milliseconds)  
ANSI timer sets 1–10—200–1000  
ITU timer sets 11–20— 400–600  
China timer sets 21–25—400–600  
Q.703 Annex A timer sets 26–30—400–600  
Unchannelized T1 timer sets 31–35—3000–10000  
Japan timer sets 36--40--3000

**Default:**

No change to the current value

**System Default:**

ANSI timer sets 1–10—600  
ITU timer sets 11–20—500  
China timer sets 21–25—500  
Q.703 Annex A timer sets 26–30—500  
Unchannelized T1 timer sets 31–35—3000  
Japan timer sets 36--40--3000

**t4npp (optional)**

Timer 4— Proving period normal

**Range:**

500 - 70000 (milliseconds)  
ANSI timer sets 1–10—500–5000  
ITU timer sets 11–20—7500–9500  
China timer sets 21–25—3000–70000  
Q.703 Annex A timer sets 26–30—3000–70000  
Unchannelized T1 timer sets 31–35—3000–30000  
Japan timer sets 36--40-- Not applicable

**Default:**

No change to the current value



**System Default:**

ANSI timer sets 1–10—2300  
ITU timer sets 11–20—8200  
China timer sets 21–25—30000  
Q.703 Annex A timer sets 26–30—30000  
Unchannelized T1 timer sets 31–35—30000

**t5 (optional)**

Timer 5—Sending SIB

**Range:**

40 - 500 (milliseconds)  
ANSI timer sets 1–10—40–500  
ITU timer sets 11–20—80–120  
China timer sets 21–25—80–120  
Q.703 Annex A timer sets 26–30—80–120  
Unchannelized T1 timer sets 31–35—80–120  
Japan timer sets 36--40--200

**Default:**

No change to the current value

**System Default:**

ANSI timer sets 1–10—100  
ITU timer sets 11–20—100  
China timer sets 21–25—100  
Q.703 Annex A timer sets 26–30—100  
Unchannelized T1 timer sets 31–35—80  
Japan timer sets 36--40--200

**t6 (optional)**

Timer 6—Remote congestion

**Range:**

1000 - 10000 (milliseconds)  
ANSI timer sets 1–10—1000 - 10000  
ITU timer sets 11–20—3000 - 6000  
China timer sets 21–24—3000 - 6000  
Q.703 timer sets 26–30—3000 - 6000  
Unchannelized T1 sets 31–35—3000 - 6000  
Japan timer sets 36--40--5000

**Default:**

No change to the current value

**System Default:**

ANSI timer sets 1–10—4000  
ITU timer sets 11–20—4000  
China timer sets 21–25—5000  
Q.703 Annex A timer sets 26–30—5000  
Unchannelized T1 timer sets 31–35—5000  
Japan timer sets 36--40--5000

**t7 (optional)**

Timer 7—Excessive delay of acknowledgment

**Range:**

200 - 3000 (milliseconds)

For ANSI timer sets 1–10—200–3000

ITU timer sets 11–20—500–2000

China timer sets 21–25—500–2000

Q.703 Annex A timer sets 26–30—500–2000

Unchannelized T1 timer sets 31–35—500–2000

Japan ITU low speed links 36--40---2000--3000

**Default:**

No change to the current value

**System Default:**

ANSI timer sets 1–10—1500

For ITU timer sets 11–20—1500

For China timer sets 21–25—800

For Q.703 Annex A timer sets 26–30—800

For Unchannelized T1 timer sets 31–35—500

Japan ITU low speed links 36--40--2000

**Example**

```
chg-l2t:l2tset=1:t1=5400
```

```
chg-l2t:l2tset=21:t4epp=600:t5=90:t6=3500:t7=1900
```

```
chg-l2t:l2tset=1:nodata=200
```

```
chg-l2t:l2tset=36:t2=6000
```

**Dependencies**

At least one optional parameter must be specified.

Failed reading level 2 timer set table.

The value specified for the timer must be within the range for that domain.

The value specified for the timer must be in the allowed range.

For l2tset greater than 35, timers t1, t3, t4epp, t5, and t6 are not allowed to change.

**Notes**

ANSI timer defaults are within the Telcordia recommended ranges.

ITU timer defaults are within ITU Q.703 white book recommended ranges.

J1 timer defaults are within JT Q.703 white book recommended ranges.

If the value specified for the `nodata` parameter is greater than 200 milliseconds, then the following message appears:

**▲ Caution:**

WARNING: If NODATA timer value is greater than 200ms, links could go into congestion before link failure is declared

**Output**

```
chg-l2t:l2tset=21:t4epp=600:t5=90:t6=3500:t7=1900
```

```
rlghncxa03w 05-02-07 11:11:28 EST EAGLE5 34.0.0
CHG-L2T: MASP A - COMPLTD
```

```
;
```

```
chg-l2t:l2tset=1:nodata=200
```

```
tekelecstp 08-05-02 16:36:09 EST EAGLE 39.0.0
CHG-L2T: MASP A - COMPLTD
```

**Related Topics**

- [ent-slk](#)
- [rtrv-l2t](#)
- [rtrv-slk](#)

## chg-l3t

Use this command to change the SS7 MTP level 3 timers. The SS7 MTP level 3 timers are organized in a timer set of 21 values each. Only one timer set is administered by this command. Each linkset is associated with the SS7 MTP level 3 Timer set. The linkset and timer set association is assigned with the link administration commands.

**Parameters** **Note:**

All timer values are entered in milliseconds. The `rtrv-l3t` command displays output in seconds.

 **Note:**

All `it(x)` parameters can be specified for ITU networks only. All `t(x)` parameters can be specified for ANSI or ITU networks. `Tc` parameter can be specified for J7 (Japan ITU-N) networks only.

**l3tset (mandatory)**

Timer set table. Only one timer set table exists. All SS7 signaling links use the SS7 MTP level 3 timer set table.

**Range:**

1

**it18 (optional)**

Timer 18—Timer within a signaling point whose MTP restarts to supervise the receipt of routing information and the activation of the link and link set.

**Range:**

*19000 - 50000*

**Default:**

No change to the current value.

**System Default:**

*50000*

**it19 (optional)**

Timer 19—Supervision timer during MTP restart to avoid ping-pong of TFP, TFR1, and TRA messages.

**Range:**

*67000 - 69000*

**Default:**

No change to the current value

**System Default:**

*67000*

**it20 (optional)**

Timer 20—Overall MTP restart timer at the signaling point whose MTP restarts.

**Range:**

*59000 - 61000*

**Default:**

No change to the current value.

**System Default:**

*59000*

**it21 (optional)**

Timer 21—Overall MTP restart timer at a signaling point adjacent to one whose MTP restarts.

**Range:**

*63000 - 65000*

**Default:**

No change to the current value.

**System Default:**

*63000*

**it22 (optional)**

Timer 22—Waiting to repeat local inhibit test.

**Range:**

*180000 - 360000*

**Default:**  
No change to the current value

**System Default:**  
*90000*

**it23 (optional)**

Timer 23—Waiting to repeat remote inhibit test.

**Range:**  
*180000 - 360000*

**Default:**  
No change to the current value

**System Default:**  
*90000*

**t1 (optional)**

Timer 1—Changeover delay. Also used as isolation timer for ITU MTP Restart.

**Range:**  
*100 - 2000*

**Default:**  
No change to the current value

**System Default:**  
*800*

**t10 (optional)**

Timer 10—Wait to repeat signaling route set test (SRST) message.

**Range:**  
*20000 - 90000*

**Default:**  
No change to the current value

**System Default:**  
*30000*

**t11 (optional)**

Timer 11—Transfer restricted; in milliseconds.

**Range:**  
*1000 - 90000*

**Default:**  
No change to the current value System

**System Default:**  
*30000*

**t12 (optional)**

Timer 12—Wait for uninhibit acknowledgment.

**Range:**

*100 - 2000*

**Default:**

No change to the current value

**System Default:**

*800*

**τ13 (optional)**

Timer 13—Wait for force uninhibit.

**Range:**

*100 - 2000*

**Default:**

No change to the current value.

**System Default:**

*800*

**τ14 (optional)**

Timer 14—Wait for inhibit acknowledgment.

**Range:**

*200 - 4000*

**Default:**

No change to the current value

**System Default:**

*2000*

**τ15 (optional)**

Timer 15—Wait for repeat route set congestion test (RSCT).

**Range:**

*200 - 4000*

**Default:**

No change to the current value

**System Default:**

*3000*

**τ16 (optional)**

Timer 16—Wait for route set congestion test (RSCT) updates.

**Range:**

*200 - 3000*

**Default:**

No change to the current value

**System Default:**

*1400*

**τ17 (optional)**

Timer 17—Delay to avoid oscillation of initial alignment failure; in milliseconds.

**Range:**

*500 - 2000*

**Default:**

No change to the current value

**System Default:**

*800*

**τ18 (optional)**

Timer 18—Repeat transfer restricted (TFR) once by response method.

**Range:**

*2000 - 20000*

**Default:**

No change to the current value

**System Default:**

*10000*

**τ19 (optional)**

Timer 19—Failed link craft referral timer.

**Range:**

*30000 - 600000*

**Default:**

No change to the current value.

**System Default:**

*480000*

**τ2 (optional)**

Timer 2—Wait for changeover acknowledge (COA).

**Range:**

*100 - 3000*

**Default:**

No change to the current value

**System Default:**

*1400*

**τ20 (optional)**

Timer 20—Repeat local inhibit test; in milliseconds.

**Range:**

*90000 - 120000*

**Default:**

No change to the current value

**System Default:**

*90000*

**t21 (optional)**

Timer 21—Repeat remote inhibit test; in milliseconds.

**Range:**

*90000 - 120000*

**Default:**

No change to the current value

**System Default:**

*90000*

**t22 (optional)**

Timer 22—Timer at restarting STP, waiting for signaling links to become available; in milliseconds.

**Range:**

*10000 - 60000*

**Default:**

No change to the current value.

**System Default:**

*10000*

**t23 (optional)**

Timer 23—Timer at restarting STP, started after T22, waiting to receive all TRA messages; in milliseconds.

**Range:**

*9000 - 100000*

**Default:**

No change to the current value.

**System Default:**

*10000*

**t24 (optional)**

Timer 24—Timer at restarting STP with transfer function, started after T23, waiting to broadcast all TRA messages.

**Range:**

*9000 - 60000*

**Default:**

No change to the current value.

**System Default:**

*10000*

**t25 (optional)**

Timer 25—Timer at adjacent STP and restarting STP, waiting for TRA message; may be started at level 2.



**Range:**  
*30000 - 35000*

**Default:**  
No change to the current value

**System Default:**  
*30000*

**τ26 (optional)**

Timer 26—Timer at restarting STP, waiting to repeat TRW message.

**Range:**  
*12000 - 15000*

**Default:**  
No change to the current value.

**System Default:**  
*12000*

**τ28 (optional)**

Timer 28—Timer at STP adjacent to restarting STP, waiting for TRW message.

**Range:**  
*3000 - 35000*

**Default:**  
No change to the current value

**System Default:**  
*3000*

**τ29 (optional)**

Timer 29—Timer started when a TRA is sent in response to an unexpected TRA or TRW; also, started when traffic resumed without receipt of TRA.

**Range:**  
*60000 - 65000*

**Default:**  
No change to the current value

**System Default:**  
*60000*

**τ3 (optional)**

Timer 3—Time controlled diversion on changeback.

**Range:**  
*100 - 2000*

**Default:**  
No change to the current value

**System Default:**  
*800*

**τ30 (optional)**

Timer 30—Timer to limit sending of TFPs/TFRs in response to an unexpected TRA or TRW.

**Range:**

*30000 - 35000*

**Default:**

No change to the current value

**System Default:**

*30000*

**τ31 (optional)**

Timer 31—False link congestion detection.

**Range:**

*10000 - 120000*

**Default:**

No change to the current value.

**System Default:**

*60000*

**τ32 (optional)**

Timer 32—Link oscillation timer – Procedure A.

**Range:**

*1000 - 120000*

**Default:**

No change to the current value.

**System Default:**

*60000*

**τ4 (optional)**

Timer 4—Wait for changeback acknowledge (CBA) #1.

**Range:**

*100 - 2000*

**Default:**

No change to the current value

**System Default:**

*800*

**τ5 (optional)**

Timer 5—Wait for changeback acknowledge (CBA) #2.

**Range:**

*100 - 2000*

**Default:**

No change to the current value

**System Default:**  
800

**t6 (optional)**

Timer 6—Controlled reroute.

**Range:**  
100 - 2000

**Default:**  
No change to the current value

**System Default:**  
800

**t7 (optional)**

Timer 7—Signaling data link connection (SDLC) acknowledge.

**Range:**  
100 - 3000

**Default:**  
No change to the current value.

**System Default:**  
1000

**t8 (optional)**

Timer 8—Transfer prohibited (TFP) inhibit.

**Range:**  
500 - 2000

**Default:**  
No change to the current value.

**System Default:**  
800

**tc (optional)**

Timer C- Release transfer congestion status timer in J7 network.

**Range:**  
3000 - 60000

**Default:**  
No change to the current value.

**System Default:**  
3000

**Example**

```
chg-l3t:l3tset=1:t1=800
```

```
chg-l3t:l3tset=1:t5=800:t6=800:t32=70000
```

## Dependencies

The minimum parameter requirement is the table number and at least one timer specified.

Do not specify T20 and IT22 pairs of timers together because one value overrides the other.

Do not specify T21 and IT23 pairs of timers together because one value overrides the other.

The Level 3 timer table must be accessible.

The STP options table must be accessible.

## Notes

The command line allows 157 characters. Some SS7 MTP level 3 timer changes may exceed this limit. Multiple entries of this command may be required in such cases.

Timer 9 is not currently supported in the SS7 protocol, and has been omitted from this manual. The command will support this timer when it has been defined in the protocol.

The default values are within the Telcordia recommended ranges.

tc timer is only supported in J7 network.

## Output

```
chg-l3t:l3tset=1:t1=800
```

```
rlghncxa03w 04-01-07 08:40:50 EST EAGLE 31.3.0
CHG-L3T: MASP A - COMPLTD
;
```

## Related Topics

- [chg-l2t](#)
- [rtrv-l2t](#)
- [rtrv-l3t](#)

# chg-lbp

Use this command to change a far-end loopback point's attribute values maintained in the link fault sectionalization table.

## Parameters

### lbp (mandatory)

Loopback point ID. This parameter identifies a far-end loopback point that lies along an SS7 signaling link path between the STP and the target device (up to *and including* the target device).

#### Range:

1 - 32

**link (mandatory)**

SS7 signaling links. The SS7 signaling link to be tested.

**Synonym:**

*port*

**Range:**

*a, b, a1 - a31, b1 - b31*

Not all card types support all `link` parameter values.

See [Table A-1](#) for valid link parameter range values for each type of card that can have assigned signaling links.

**loc (mandatory)**

Card location. The unique identifier of a specific application subsystem located in the STP.

**Range:**

*1101 - 1108, 1111 - 1112, 1201 - 1208, 1211 - 1218, 1301 - 1308, 1311 - 1318,  
2101 - 2108, 2111 - 2118, 2201 - 2208, 2211 - 2218, 2301 - 2308, 2311 - 2318,  
3101 - 3108, 3111 - 3118, 3201 - 3208, 3211 - 3218, 3301 - 3308, 3311 - 3318,  
4101 - 4108, 4111 - 4118, 4201 - 4208, 4211 - 4218, 4301 - 4308, 4311 - 4318,  
5101 - 5108, 5111 - 5118, 5201 - 5208, 5211 - 5218, 5301 - 5308, 5311 - 5318,  
6101 - 6108, 6111 - 6118*

**clli (optional)**

Common Language Location Identifier (CLLI) code. This parameter specifies the CLLI or other mnemonic identifier used to refer to the given loopback point.

**Range:**

*ayyyyyyyyy*

1 alphabetic character followed by up to 23 alphanumeric characters

**Default:**

No change to the current value

**lfst (optional)**

Link fault sectionalization test. The type of link fault sectionalization loopback test to be performed.

**Range:**

*lft*

latching loopback test

*nlt*

nonlatching loopback test

**rep (optional)**

Repetition count. The number of link elements of the same type (not including the target device) that lie between the STP and the link element to be tested.

**Range:**

*0 - 31*

**Default:**

No change unless:

0—The link element to be looped back for testing is NEI (*rle=nei* is specified)

0—The type of link fault sectionalization test is NLT (*lfst=nlt* is specified)

0—The new remote link element is the first loopback point of the link to be tested

1–30—Next sequential number for subsequent loopback points of the link to be tested

**rle (optional)**

Remote link element. The link element to be looped back for testing.

**Range:**

*ds0*

*ocu*

*csu*

*dsu*

*nei*

**Default:**

No change to the rle value

**Example**

```
chg-lbp:loc=1101:link=a:lbp=1:rle=ds0:lfst=11t
```

**Dependencies**

The Link Fault Sectionalization (LFS) feature must be on before using this command.

At least one optional parameter must be specified.

The card location specified in the *loc* parameter cannot be reserved by the system.

The card location (*loc* parameter) must identify a provisioned E5-E1T1-B card, provisioned with the LIMT1 card type, configured with either the SS7ANSI or CCS7ITU application.

The CLLI cannot be a reserved word.

The *rep* parameter value that is specified for this loopback point (LBP) must be greater than the *rep* parameter value of any previously defined LBP and less than the *rep* parameter value of any subsequently defined LBP.

The *rep* parameter must be specified if the default value is a duplicate of the *rep* parameter value of any previously defined loopback point.

The LBP must have been previously defined.

The *rep* parameter can be specified only if the *lfst=11t* parameter is specified.

If the *rle=nei* parameter is specified, the *rep=0* parameter must be specified.

The *rle=ds0* or the *rle=nei* parameter cannot be specified if the *lfst=nlt* parameter is specified. The DS0 and Network Element Interface (NEI) link elements do not support non-latching loopbacks.

For each SS7 signaling link, you can define only one loopback point with `rle=nei` specified; and that loopback point must be the terminating SS7 signaling link component.

For each SS7 signaling link, the loopback point with `rle=nei` specified must be the terminating SS7 signaling link component.

The card location specified in the `loc` parameter must be equipped.

The Link Fault Sectionalization database Loopback Point (LBP) table is not accessible.

### Notes

None

### Output

```
chg-lbp:loc=1101:port=a:lbp=1:rle=ds0:lfst=llt
```

```
rlghncxa03w 05-01-17 15:35:05 EST EAGLE5 33.0.0
CHG-LBP: MASP A - COMPLTD
```

```
;
```

### Related Topics

- [act-lbp](#)
- [dact-lbp](#)
- [dlt-lbp](#)
- [ent-lbp](#)
- [rtrv-lbp](#)

## chg-lg-card

Use this command to change the group of an LG card.

The command class is `TKLC_INTERNAL` inheriting properties of `DEBUG` class. The Load Generator is supported on `IPSG`, `IPLHC`, `IPGHC` and `SS7HC` GPLs.

### Parameters

#### **grp (mandatory)**

##### **Range:**

`aaaaaaaa`

Up to 10 alphanumeric characters; the first character must be a letter.

#### **loc (mandatory)**

The card location as stenciled on the shelf of the system.

##### **Range:**

`1101 - 1108`, `1111 - 1112`, `1201 - 1208`, `1211 - 1218`, `1301 - 1308`, `1311 - 1318`,  
`2101 - 2108`, `2111 - 2118`, `2201 - 2208`, `2211 - 2218`, `2301 - 2308`, `2311 - 2318`,

3101 - 3108, 3111 - 3118, 3201 - 3208, 3211 - 3218, 3301 - 3308, 3311 - 3318, 4101 - 4108, 4111 - 4118, 4201 - 4208, 4211 - 4218, 4301 - 4308, 4311 - 4318, 5101 - 5108, 5111 - 5118, 5201 - 5208, 5211 - 5218, 5301 - 5308, 5311 - 5318, 6101 - 6108, 6111 - 6118

### Example

```
chg-lg-card:loc=1304:grp=lgroup1
```

### Dependencies

The specified `grp` parameter value must exist in the database.

The card location must not be 1113-1118, or `xy09` and `xy10` where `x` is the frame and `y` is the shelf.

The LG Card table is corrupt or cannot be found.

The card location specified in the `loc` parameter must be of a provisioned LG card.

The LG Group table is corrupt or cannot be found.

The `loc` and `grp` parameters are mandatory

Changing the group of an LG card to which it is already a part of has no effect.

### Output

#### Related Topics

- [act-lg-card](#)
- [dact-lg-card](#)
- [dlt-lg-card](#)
- [ent-lg-card](#)
- [rept-stat-lg](#)
- [rtrv-lg-card](#)

## chg-lg-engine

Use this command to modify an LG engine. The command class is `TKLC_INTERNAL` inheriting properties of `DEBUG` class. The Load Generator is supported on `IPSG`, `IPLHC`, `IPGHC` and `SS7HC` GPLs.

### Parameters

#### **engine (mandatory)**

##### **Range:**

aaaaaaaaaa

Up to 10 alphanumeric characters; the first character must be a letter.

#### **action (optional)**

This parameter specifies the transmitting and receiving actions of a LG Engine.



**Range:**

***snk***

Rx Action: Sink Mode

***ret***

Rx Action: Return Mode

***cap***

Rx Action: Capture Mode

***pbk***

Tx Action: Playback mode

***retl2***

Rx Action: Return by L2

***cong***

Rx Action: Congestion.

**event (optional)**

**Range:**

*aaaaaaaaaa*

Up to 10 alphanumeric characters; the first character must be a letter

**port (optional)**

The signaling link on the card specified in the `loc` parameter.

**Synonym:**

*link*

**Range:**

*a, b, a1 - a31, b1 - b31*

Not all card types support all `link` parameter values.

See [Table A-1](#) for valid `link` parameter range values for each type of card that can have a location specified in the `loc` parameter.

**rxengine (optional)**

Receiving LG Engine.

**Range:**

*aaaaaaaaaa*

Up to 10 alphanumeric characters; the first character must be a letter.

**txrate (optional)**

Transmission rate of a LG Engine.

**Range:**

*0 - 10000*

**Example**

```
chg-lg-engine:engine=txengine1:txrate=100
```

```
chg-lg-engine:engine=txengine1:port=b
```

## Dependencies

The engine name specified must pre-exist in the LG Engine table.

The LG Engine table is corrupt or cannot be found.

The number of events associated with a engine should not exceed the max limit.

The `txrate` parameter cannot be specified with the `event` parameter of Rx type.

The `action=pbk` parameter can only be assigned to Tx event direction.

The `action` parameter of type `snk`, `ret`, `retl2`, `cong`, or `cap` can only be assigned to RX event direction.

The port specified in the command must be provisioned.

The `rxengine` parameter can only be specified with the `action=pbk` parameter.

The LG Card and Event specified in the command must belong to same network

SIF Size > 272 not supported on ss7hc

The Rx Event can not be associated to more than one Engine on the same LG card

Event dir and Action cannot be changed if engine is of Rx type and associated with the Tx engine.

The LG Event name specified in the command must exist in the table

The specified Rx `engine` parameter value must be associated with the card.

The `port` parameter cannot be specified with the `event` parameter of Rx type.

Engine specified in RxEngine parameter must of Rx Type.

The Rxengine specified must pre-exist in the LG Engine table.

## Output

### Related Topics

- [act-lg-engine](#)
- [dact-lg-engine](#)
- [dlt-lg-engine](#)
- [rept-stat-lg](#)
- [rtrv-lg-engine](#)

## chg-lg-event

Use this command to change an LG event's characteristics. The command class is TKLC\_INTERNAL inheriting properties of DEBUG class. The Load Generator is supported on IPGS, IPLHC, IPGHC and SS7HC GPLs.

## Parameters

### event (mandatory)

**Range:**

ayyyyyyyy

Up to 10 alphanumeric characters; the first character must be a letter

### cause (optional)

Cause Code for UPUs

**Range:**

0 - 15

### cnglv1 (optional)

Congestion Level for TFCs

**Range:**

0 - 3

### cpc (optional)

ANSI capability point code with subfields *network indicator-network cluster-network cluster member (ni-nc-ncm)*.

**Synonym:**

*cpc*

**Range:**

000-255

Specify a valid value for each subfield of the point code, and separate the subfields with a dash (-).

When *chg-sid:pctype=ansi* is specified, *ni = 000* is not valid.

When *chg-sid:pctype=ansi* is specified, *nc = 000* is not valid if *ni = 001-005*.

When *chg-sid:pctype=ansi* is specified, *nc = 000* is valid if *ni = 006-255*.

The point code *000-000-000* is not a valid point code.

### cpc/cpca/cpci/cpcn/cpcn24 (optional)

Capability point code. The code used by the SS7 protocol to identify a group of functionally related STPs in the signaling network to which the STP belongs.

### cpci (optional)

**Range:**

s-, 0-255

Specify a valid value for each subfield of the point code, and separate the subfields with a dash (-).

*prefix—s*

*zone—0-7*

*area—000-255*

*id—0-7*

The point code *0-000-0* is not a valid point code.

### cpcn (optional)

ITU national point code in the format of a 5-digit number (*nnnnn*); or 2, 3, or 4 numbers (members) separated by dashes (*m1-m2-m3-m4*) as defined by the *chg-*

`stpopts:npcfmti` flexible point code option. A group code must be specified when the ITUDUPPC feature is turned on (*nnnnn-gc,m1-m2-m3-m4-gc*). The *prefix* subfield indicates a spare point code (*prefix-nnnnn*, *prefix-nnnnn-gc*, *prefix-m1-m2-m3-m4*, *prefix-m1-m2-m3-m4-gc*).

**Range:**

*s*-, 0-16383, *aa-zz*

Specify a valid value for each subfield of the point code, and separate the subfields with a dash (-).

*prefix*—*s*-

*nnnnn*—0-16383

*gc*—*aa-zz*

*m1-m2-m3-m4*—0-14 for each member; values must sum to 14

**Default:**

No change to existing point code value.

**cpcn24 (optional)**

24-bit ITU national point code with subfields *main signaling area-sub signaling area-signaling point* (*msa-ssa-sp*).

**Range:**

000-255

Specify a valid value for each subfield of the point code, and separate the subfields with a dash (-).

*msa*—000–255

*ssa*—000–255

*sp*—000–255

**Default:**

No change to existing point code value.

**dpc (optional)**

ANSI destination point code with subfields *network indicator-network cluster-network cluster member* (*ni-nc-ncm*). The *prefix* subfield indicates a private point code (*prefix-ni-nc-ncm*).

**Synonym:**

*dpca*

**Range:**

*p*-, 000-255, \*

Specify a valid value for each subfield of the point code, and separate the subfields with a dash (-).

*prefix*—*p*-

The asterisk value (\*) is not valid for the *ni* subfield.

When `chg-sid:pctype=ansi` is specified, *ni* = 000 is not valid.

When `chg-sid:pctype=ansi` is specified, *nc* = 000 is not valid if *ni* = 001–005.

When `chg-sid:pctype=ansi` is specified, *nc* = 000 is valid if *ni* = 006–255.

The point code 000-000-000 is not a valid point code.

**dpc/dpca/dpci/dpcn/dpcn24 (optional)**

Destination point code

**dpci (optional)**

ITU international destination point code with subfields *zone-area-id*. The *prefix* subfield indicates a spare point code, private point code, or private and spare point code (*prefix-zone-area-id*).

**Range:**

*s-, p-, ps-, 0-255*

Specify a valid value for each subfield of the point code, and separate the subfields with a dash (-).

*prefix—s-, p-, ps*

*zone—0-7*

*area—000-255*

*id—0-7*

The point code *0-000-0* is not a valid point code.

**dpcn (optional)**

ITU national destination point code in the format of a 5-digit number (*nnnnn*); or 2, 3, or 4 numbers (members) separated by dashes (*m1-m2-m3-m4*) as defined by the `chg-stpopts:npcfnti` flexible point code option. A group code must be specified when the ITUDUPPC feature is turned on (*nnnnn-gc, m1-m2-m3-m4-gc*). The *prefix* subfield indicates a spare point code, private point code, or private and spare point code (*prefix-nnnnn, prefix-nnnnn-gc, prefix-m1-m2-m3-m4, prefix-m1-m2-m3-m4-gc*).

**Range:**

*s-, p-, ps-, 0-16383, aa-zz*

Specify a valid value for each subfield of the point code, and separate the subfields with a dash (-).

*prefix—s-, p-, ps*

*nnnnn—0-16383*

*gc—aa-zz*

*m1-m2-m3-m4—0-14* for each member; values must sum to 14

**dpcn24 (optional)**

24-bit ITU national point code with subfields *main signaling area-sub signaling area-signaling point* (*msa-ssa-sp*). The *prefix* indicates a private point code (*prefix-msa-ssa-sp*).

**Range:****Range:**

*p-, 000-255*

Specify a valid value for each subfield of the point code, and separate the subfields with a dash (-).

*prefix—p*

*msa—000-255*

*ssa—000-255*

*sp—000-255*

**egta (optional)**

End global title address. The end of a range of global title digits.

**Range:**

*1 - 21*

**h0h1 (optional)**

SNM Type

**Range:**

*tfa*

*tfp*

*tfc*

*tfr*

*rct*

*upu*

**maxcic (optional)**

Maximum CIC Selector

**Range:**

0 - 4294967295

**maxsize (optional)**

Maximum Service Message SIF Size

**Range:**

0 - 4095

**maxs1s (optional)**

Maximum SLS selector

**Range:**

0-255 -ANSI

0-15 -ITU

**mincic (optional)**

Minimum CIC Selector

**Range:**

0 - 4294967295

**minsize (optional)**

Minimum Service Message SIF Size

**Range:**

0 - 4095

**Default:**

60 -SCCP MSUs

40 -other MSUs

**mins1s (optional)**

Minimum SLS Selector

**Range:**

0-255 -ANSI  
0-15 -ITU

**opc (optional)**

ANSI originating point code with subfields *network indicator-network cluster-network cluster member (ni-nc-ncm)*.

**Range:**

*p-*, 000-255, \*

Specify a valid value for each subfield of the point code, and separate the subfields with a dash (-).

*prefix—p-*

The asterisk value (\*) is not valid for the *ni* subfield.

When *chg-sid:pctype=ansi* is specified, *ni = 000* is not valid.

When *chg-sid:pctype=ansi* is specified, *nc = 000* is not valid if *ni = 001–005*.

When *chg-sid:pctype=ansi* is specified, *nc = 000* is valid if *ni = 006–255*.

The point code *000-000-000* is not a valid point code.

**opc/opca/opci/opcn/opcn24 (optional)**

Originating Point Code

**opci (optional)**

ITU international originating point code with subfields *zone-area-id*. The *prefix* subfield indicates a spare point code (*prefix-zone-area-id*).

**Range:**

*s-*, *p-*, *ps-*, 0-255

Specify a valid value for each subfield of the point code, and separate the subfields with a dash (-).

*prefix—s-*, *p-*, *ps*

*zone—0-7*

*area—000-255*

*id—0-7*

The point code *0-000-0* is not a valid point code.

**opcn (optional)**

ITU national originating point code in the format of a 5-digit number (*nnnnn*); or 2, 3, or 4 numbers (members) separated by dashes (*m1-m2-m3-m4*) as defined by the *chg-stpopts:npcfmti* flexible point code option. A group code must be specified when the ITUDUPPC feature is turned on (*nnnnn-gc*, *m1-m2-m3-m4-gc*). The *prefix* subfield indicates a spare point code (*prefix-nnnnn*, *prefix-nnnnn-gc*, *prefix-m1-m2-m3-m4*, *prefix-m1-m2-m3-m4-gc*).

**Range:**

*s-*, *p-*, *ps-*, 0-16383, *aa-zz*

Specify a valid value for each subfield of the point code, and separate the subfields with a dash (-).

*prefix—s-*, *p-*, *ps*

*nnnnn—0-16383*

*gc—aa-zz*

*m1-m2-m3-m4—0-14* for each member; values must sum to 14

**opc24 (optional)**

24-bit ITU national originating point code with subfields *main signaling area-sub signaling area-signaling point (msa-ssa-sp)*.

**Range:**

*p*-, 000-255

Specify a valid value for each subfield of the point code, and separate the subfields with a dash (-).

*prefix—p*

*msa—000—255*

*ssa—000—255*

*sp—000—255*

**priority (optional)**

Service Message Priority

**Range:**

0 - 3

**ri (optional)**

GTT or SSN

**Range:**

*gtt*

*ssn*

**sc1ass (optional)**

Class of service

**Range:**

0 - 1

**sgta (optional)**

Start of global title address. This parameter specifies the beginning of a range of global title digits.

**Range:**

1 - 21

**ssn (optional)**

Subsystem number. The application's subsystem number. This attribute is composed of the decimal representation of the 1-byte field used in the SS7 protocol.

**Range:**

2 - 255

**Default:**

5

**System Default:**

0

**tt (optional)**

Translation type.



**Range:**

0 - 255

**usrid (optional)**

User ID for UPUs

**Range:**

0 - 15

**Default:**

5

**System Default:**

0

**Example**

```
chg-lg-event:event=txisup1:dpc=3-3-3
```

```
chg-lg-event:event=txisup1:dpc=2-2-2:opc=1-1-1
```

```
chg-lg-event:event=rxisup1:dpc=4-4-4
```

**Dependencies**

If the `h0h1/cnglv1/cause/usrid/cpc` parameter is specified, then the `si` parameter must have a value of 0 (snm).

If the `mincic/maxcic` parameter is specified, then the `si` must have a value of 4 (tup), 5 (isup), or 13 (bicc)

If the `tt/ssn/sgta/egta` parameter is specified, the `si` must be 3 (sccp)

Failed to read LG Event table.

The LG Event name specified in the command must exist in the table

The `event` parameter is mandatory

The value specified for the `mincic` parameter must be less than the value specified for the `maxcic` parameter.

The `minsize` specified must be less than `maxsize`.

The value specified for the `minsls` parameter must be less than the value specified for the `maxsls` parameter.

ITU SLS must be less than 15

The OPC/DPC network type must match the provisioned OPC/DPC network type.

The value specified for the SIF size must be valid for the SI type.

The same DPC cannot be assigned to more than one Event of Rx type.

The value specified for the event name cannot be an EAGLE reserved name.

At least one optional parameter must be specified

SI-specific parameters cannot be specified together in the command.

Optional parameters except **dpc** cannot be specified with Rx event

The lengths of the values specified for the `sgta` and `egta` parameters must match

The `sgta` and `egta` parameters must be specified together in the command.

The value specified for the `egta` parameter must be greater than or equal to the value specified for the `sgta` parameter.

If the `ri=gt` parameter is specified, then the `sgta/egta` parameters must be specified.

If the lengths of the values specified for the `sgta/egta` parameters do not match the provisioned length of the `sgta` parameter, then the `minsize` parameter must be specified.

## Output

### Related Topics

- [dlt-lg-event](#)
- [ent-lg-event](#)
- [rept-stat-lg](#)
- [rtrv-lg-event](#)

## chg-lnp-serv

Use this command to change an existing LNP service.

### Parameters



#### Note:

All alias translation types must be removed before the service can be moved to another translation type.

### **ndfltact (optional)**

New default action associated with an LNP TT Service entry.

#### **Range:**

*ayyyyyyy*

1 leading alphabetic character followed by up to 8 alphanumeric characters

The `ndfltact` parameter must have one of the following values:

- a GTT Action ID that already exists in the GTT Action table with an associated action of *disc/udts/tcaperr*
- *fallback* —Fallback to the relay data for MSUs relayed by LNP using relay data from the LNP database provided by the LNP Message Relay service. For an LNP Query message, the MSU is sent to the LNP local subsystem.
- *falltogtt* —Fallback to GTT. The GTT selector search is performed again, using `gttselid=none`.

#### **Default:**

No change to the current value

**ndv (optional)**

New digits valid.

**Range:**

*sccp*

*tcap*

**Default:**

No change to the current value

**ngttselid (optional)**

New GTT Selector ID.

**Range:**

*0 - 65534, none*

*none* —deletes the current value of the GTTSELID field

**Default:**

No change to the current value

**nrqdtb1nop (optional)**

The action performed with a message that arrives at an SCCP card that does not have the necessary LNP table, and the current message routing is subsystem.

**Range:**

*udts*

generate UDTs for the processed MSU

*disc*

discard the processed MSU

**Default:**

No change to the current value

**nserv (optional)**

New reserved service type name.

**Range:**

*ain*

*in*

*pcs*

*wnp*

*class*

*lidx*

*cnam*

*isvm*

*lnpqs*

*wsmisc*

*udf1*

*udf2*

*udf3*

*udf4*

*lnnqt*

**Default:**

No change to the current value

**ntt (optional)**

New translation type.

**Range:**

0 - 255

**Default:**

No change to the current value

**nttn (optional)**

New User defined LNP Translation type name.

**Range:**

*ayyyyyyy*, *none*

1 alphabetic character followed by up to 7 alphanumeric characters

*none* —defaults the name to the reserved service type name

**Default:**

If *none* is specified, the default value is the reserved service type name ( *serv* parameter).

If *none* is not specified, no change to current value.

**off (optional)**

Disables or turns off the specified feature options. This parameter specifies a comma-separated list of feature options that are requested to be turned off. Up to 10 feature options can be specified in the list.

**Range:**

*gttrqd*

**on (optional)**

Enables or turns on the specified feature options. This parameter specifies a comma-separated list of feature options that are requested to be turned on. Up to 10 feature options can be specified in the list.

**Range:**

*gttrqd*

**serv (optional)**

Reserved service type name.

**Range:**

*ain*

*in*

*pcs*

*wnp*

*class*

*lidb*

*cnam*

*isvm*

*lnpqs*

*wmsmc*

*udf1*

*udf2*

*udf3*

*udf4*

*lrnqt*

**Default:**

No change to the current value

**tt (optional)**

Translation type.

**Range:**

0 - 255

**Default:**

No change to the current value

**Example**

```
chg-lnp-serv:tt=10:ndfltact=fallback:on=gttrqd:ngttselid=none
```

```
chg-lnp-serv:serv=lidb:ntt=22:ndv=tcap:nttn=mrlidb
```

```
chg-lnp-serv:tt=239:nserv=lrnqt
```

**Dependencies**

The same value cannot be specified for the `on` and `off` parameters.

The `ndfltact=none` parameter cannot be specified.

The EGTT feature must be turned on before the `ngttselid`, `ndfltact`, or `on/off=gttrqd` parameter can be specified.

If a GTT Action ID is specified as the value for the `ndfltact` parameter, then the Action ID must already exist in the GTT Action table.

If a GTT Action ID is specified as a value for the `ndfltact` parameter, then the GTT Action ID must have an associated action of `disc`, `udts`, or `tcaperr`.

The LNP feature must be turned on before this command can be entered.

The LNP SMS feature must be turned on before the `nserve=wsmc` parameter can be specified.

The PCS 1900 LNP (PLNP) feature must be turned on before the `nserve=pcs` parameter can be specified.

The WNP feature must be turned on before the `nserve=wnp` parameter can be specified.

The value of the `ntt` parameter cannot already exist in the LNP database.

The value of the `nttn` parameter cannot already exist in the LNP database.

The value of the `serv` parameter must already exist in the LNP database.

The `serv` or `tt` parameter and one other optional parameter must be specified.

The same value cannot be specified for the `ndv` and `dv` parameters.

An LNP alias cannot be specified as the value for the `ntt` parameter.

All LNP aliases for the existing service must be removed from the LNP database before the `nserve` or `ntt` parameter can be specified.

A reserved service type name can be specified as a value for the `nttn` parameter only if the name matches the existing service (the value specified for the `serv` parameter).

The LNP TT SERV table is corrupt or cannot be found.

If a value of `wsmc`, `udf1`, `udf2`, `udf3`, or `udf4` is specified for the `serv` parameter, then the `ndv=sccp` parameter must be specified.

If a value of `lnpqs`, `ain`, `in`, `pcs`, `wnp`, or `lrnqt` is specified for the `serv` parameter, then the `ndv=tcap` parameter must be specified.

The LRNQT feature must be turned on before the `(n)serve=lrnqt` parameter can be specified.

The GTT Action table is corrupt or cannot be found.

The value specified for the `nserve` parameter cannot already exist in the LNP database.

If the value specified for the `tt` parameter is an alias, then the `ntt`, `nserve`, `nttn`, and `ndv` parameters cannot be specified.

If the value specified for the `(n)serve` parameter is already associated with the `class`, `lidb`, `cnam`, `isvm`, `wsmc`, `udf1`, `udf2`, `udf3`, or `udf4` service, then a value of `lnpqs`, `lrnqt`, `ain`, `in`, `wnp`, or `pcs` cannot be specified for the `(n)serve` parameter.

The `ndfltact`, `ngttselid`, and `on/off=gttrqd` parameters cannot be specified with the `udf1`, `udf2`, `udf3`, and `udf4` LNP Services.

The `nrqdtblnop` parameter requires that the Dual ExAP Config feature be enabled.

### Notes

#### on/off options

**gttrqd**—GTT required. Specifies whether GTT is performed after the successful completion of an LNP Message Relay service and before initiation of an LNP Query service. This option has a default of OFF.

### Output

```
chg-lnp-serv:tt=3:on=gttrqd:ngttselid=10:ndfltact=falltogtt
```

```
rlghncxa03w 10-11-08 08:50:12 EST EAGLE 43.0.0
CHG-LNP-SERV: MASP A - COMPLTD
;
```

### Related Topics

- [dlt-lnp-serv](#)
- [ent-lnp-serv](#)
- [rtrv-lnp-serv](#)

## chg-lnpopts

Use this command to enter LNP-specific system options in the database. This command updates the LNPOPTS table.

### Parameters

#### Note:

As of Release 43.0, the `dra`, `lrndgts`, `naiv`, and `tn dgts` parameters are obsolete for this command.

#### **admhipri (optional)**

Give LNP database administration the highest administrative priority in the system.

#### **Range:**

*yes*

*no*

#### **Default:**

No change to the current value

#### **amactype (optional)**

AMA call type.

**Range:**

3 digits

**Default:**

No change to the current value

**amafeatid (optional)**

AMA feature ID.

**Range:**

3 digits

**Default:**

No change to the current value

**amaslipid (optional)**

AMA slip ID.

**Range:**

9 digits

**Default:**

No change to the current value

**System Default:**

none

**ccp (optional)**

Copy charge parameters. When this parameter has a value of *yes*, the system copies the Charge Number and Charge Party Station type from an LNP AIN query (if present) to the LNP AIN Response message.

**Range:**

*yes*

*no*

**Default:**

No change to the current value

**cic (optional)**

Carrier identification code.

**Range:**

3-4 digits

**Default:**

No change to the current value

**gtwystp (optional)**

Indicates that the LNP system is also configured as a Gateway STP.

**Range:**

*yes*



***no***

**Default:**

No change to the current value

**incslp (optional)**

Include AMA slip ID in the response.

**Range:**

***yes***

***no***

**Default:**

No change to the current value

**jipdigits (optional)**

Jurisdictional Information Parameter value.

**Range:**

6 digits

**Default:**

No change to the current value

**jipprv (optional)**

Determines whether a Jurisdictional Information Parameter value is to be added to the IAM.

**Range:**

***yes***

***no***

**Default:**

No change to the current value

**servport (optional)**

Service portability.

**Range:**

***yes***

allows splitting services between TN and LRN override records. This setting allows the LNP user to update LRN overrides for message relay services that are to be supported in the network. The TN gateway point code (NPAC subscription data) is used for message relay services the CLEC wants to provide.

***no***

If no LRN override services are provisioned, then the TN's gateway point codes (NPAC subscription data) are used to route queries out of the network. If one or more LRN override services are provisioned, the TN is considered to

be ported into the network. In this case, if an LRN override service is requested and the LRN has other services administered, but the requested service is not provisioned, then a UDTs response for the service is provided.

**Default:**

No change to the current value

**sp (optional)**

Service provider ID.

**Range:**

*xyyy*

4 alphanumeric characters

**Default:**

No change to the current value

**wqredrct (optional)**

Wireless queries directed to default GTT.

**Range:*****on***

allows GTT functionality to treat any wireless LNP (WNP and PCS) queries that require GT as a normal GTT

***off***

routes all wireless LNP queries (WNP and PCS) that require GT directly to the local subsystem

**Default:**

No change to the current value

**tndgts (optional)**

SCCP GTA digit length indicator for 10 or 11 digits.

**Range:*****yes***

The system verifies that either 10 or 11 digits are present in the CDPA GTA. If 11 digits are present, the first digit is stripped to derive 10 digits for LNP SMS translation. If 10 digits are present, all 10 digits are used for LNP SMS translation.

***no***

The system verifies that 11 digits (plus a padded 0 digit) are present in the CDPA GTA. If 11 digits are present, the system strips the first digit and considers only 10 digits for LNP SMS translation.

**Default:**

No change to the current value

**Example**

```
chg-lnpopts:amaslpid=123456789
```

```
chg-lnpopts:amactype=003
```

```
chg-lnpopts:amafeatid=010
```

```
chg-lnpopts:incslp=yes
chg-lnpopts:cic=1369
chg-lnpopts:sp=1234
chg-lnpopts:jipdigits=919460
chg-lnpopts:jipprv=yes
chg-lnpopts:frcsmplx=yes
chg-lnpopts:admhipri=yes
chg-lnpopts:gtwystp=yes
chg-lnpopts:ccp=yes
chg-lnpopts:servport=yes
chg-lnpopts:wqredrct=off
chg-lnpopts:wsmc10dig=yes
```

### Dependencies

At least one optional parameter must be specified.

The LNP and Triggerless LNP (TLNP) features must be turned on before this command can be entered.

The LNP database must be accessible.

The Triggerless LNP feature must be turned on before the `jipprv` and `jipdigits` parameters can be specified.

The LNP SMS feature must be turned on before the `wsmc10dig` parameter can be specified.

The LNP options table must be accessible.

The LNP feature or AINPQ feature must be turned on before this command can be entered.

The WNP or PCS feature must be turned on before the `wqredrct` parameter can be specified.

### Notes

If the `admhipri=yes` parameter is specified, LNP database administration can starve out normal STP updates during LNP administration of 2 TNs per second. If the parameter is set to *no*, then STP and LNP updates receive the same priority. Depending on the system activity level, the performance of LNP updates may be reduced.

If the `gtwystp=yes` parameter is specified, the LNP system is also configured as a gateway STP. The NPAC sends down capability point codes without routes. In this configuration, the system does not output a warning (UIM 1176) about capability point codes or true point codes without routes.

MTT rule E3524 has been deleted in Release 43.0 under PR 168138.

AINPQ feature dependency is required to get AIN queries processed by INPQ subsystem.

### Output

```
chg-lnpopts:amaslpid=123456789

      rlgncxa03w 04-01-07 00:57:31 EST  EAGLE 31.3.0
      CHG-LNPOPTS: MASP A - COMPLTD
;
```

### Related Topics

- [rtrv-lnpopts](#)

## chg-loopset

Use this command to change the loopset data in the database. This command updates the Loopset Table. A single instance of this command can be used to append up to 6 point codes to the loopset (a loopset can contain a total of 12 point codes), replace all data in the loopset, or change one or two point codes in the loopset.

### Parameters

#### **name (mandatory)**

Loopset name. Sn entry in the Loopset table.  
The `name=none` parameter cannot be specified.

#### **Range:**

`ayyyyyyy`  
1 alphabetic and up to 7 alphanumeric characters.

#### **apc1 (optional)**

ANSI appending point code list with subfields *network indicator-network cluster-network cluster member (ni-nc-ncm)*. The *prefix* subfield indicates a private point code (*prefix-ni-nc-ncm*). This parameter allows up to 6 comma-delimited entries in the point code list.

#### **Synonym:**

`apcla`

#### **Range:**

`p-, 000-255`  
Specify a valid value for each subfield of the point code, and separate the subfields with a dash (-).  
`prefix—p-`  
When `chg-sid:pctype=ansi` is specified, `ni = 000` is not valid.  
When `chg-sid:pctype=ansi` is specified, `nc = 000` is not valid if `ni = 001-005`.  
When `chg-sid:pctype=ansi` is specified, `nc = 000` is valid if `ni = 006-255`.  
The point code `000-000-000` is not a valid point code.

#### **apcli (optional)**

ITU international appending point code list with subfields *zone-area-id*. The *prefix* subfield indicates a spare point code, private point code, or private and spare point code (*prefix-zone-area-id*). This parameter allows up to 6 comma delimited entries in the point code list.

**Range:***s-, p-, ps-, 0-255*

Specify a valid value for each subfield of the point code, and separate the subfields with a dash (-).

*prefix—s-, p-, ps**zone—0-7**area—000-255**id—0-7*The point code *0-000-0* is not a valid point code.**apc1n (optional)**

ITU national appending point code list in the format of a 5-digit number (*nnnnn*); or 2, 3, or 4 numbers (members) separated by dashes (*m1-m2-m3-m4*) as defined by the **chg-stpopts:npcfmti** flexible point code option. A group code must be specified when the ITUDUPPC feature is turned on (*nnnnn-gc, m1-m2-m3-m4-gc*). The *prefix* subfield indicates a spare point code (*prefix-nnnnn, prefix-nnnnn-gc, prefix-m1-m2-m3-m4, prefix-m1-m2-m3-m4-gc*). This parameter allows up to 6 comma-delimited entries in the point code list.

**Range:***s-, p-, ps-, 0-16383, aa-zz*

Specify a valid value for each subfield of the point code, and separate the subfields with a dash (-).

*prefix—s-, p-, ps**nnnnn—0-16383**gc—aa-zz**m1-m2-m3-m4—0-14* for each member; values must sum to 14**apc1n24 (optional)**

24-bit ITU national appending point code list with subfields *main signaling area-sub signaling area-signaling point (msa-ssa-sp)*. This parameter allows up to 6 comma-delimited entries in the point code list.

**Range:***p-, 000-255*

Specify a valid value for each subfield of the point code, and separate the subfields with a dash (-).

*prefix—p**msa—000-255**ssa—000-255**sp—000-255***apc1n16 (optional)**

16-bit ITU national point code with subfields *unit number-sub number area-main number area (un-sna-mna)*. This parameter allows up to 6 comma-delimited entries in the point code list.

**Range:***p--, 000--127*

Specify a valid value for each subfield of the point code, and separate the subfields with a dash (-).

*prefix--p*

*un--000--127*

*sna--000--15*

*mna---000--31*

**force (optional)**

This parameter must be specified to modify a loopset that is being used by GTT.

**Range:**

*yes*

**mode (optional)**

Mode of operation. This parameter specifies whether the message is discarded when an SCCP loop is detected.

**Range:*****notify***

Generates a UIM without discarding the message.

***discard***

Generates a UIM and discards the message.

**npc1 (optional)**

ANSI new point code 1 with subfields *network indicator-network cluster-network cluster member (ni-nc-ncm)*. The *prefix* subfield indicates a private point code (*prefix-ni-nc-ncm*).

**Synonym:**

*npc1a*

**Range:**

*p-, 000-255*

Specify a valid value for each subfield of the point code, and separate the subfields with a dash (-).

*prefix—p-*

When *chg-sid:pctype=ansi* is specified, *ni = 000* is not valid.

When *chg-sid:pctype=ansi* is specified, *nc = 000* is not valid if *ni = 001-005*.

When *chg-sid:pctype=ansi* is specified, *nc = 000* is valid if *ni = 006-255*.

The point code *000-000-000* is not a valid point code.

**npc1i (optional)**

ITU international new point code 1 with subfields *zone-area-id*. The *prefix* subfield indicates a spare point code, private point code, or private and spare point code (*prefix-zone-area-id*).

**Range:**

*s-, p-, ps-, 0-255*

Specify a valid value for each subfield of the point code, and separate the subfields with a dash (-).

*prefix—s-, p-, ps*

*zone—0-7*

*area—000-255*

*id—0-7*

The point code *0-000-0* is not a valid point code.

**npc1n (optional)**

ITU national new point code 1 in the format of a 5-digit number (*nnnnn*); or 2, 3, or 4 numbers (members) separated by dashes (*m1-m2-m3-m4*) as defined by the **chg-stpopts:npcfmti** flexible point code option. A group code must be specified when the ITUDUPPC feature is turned on (*nnnnn-gc*, *m1-m2-m3-m4-gc*). The *prefix* subfield indicates a spare point code (*prefix-nnnnn*, *prefix-nnnnn-gc*, *prefix-m1-m2-m3-m4*, *prefix-m1-m2-m3-m4-gc*).

**Range:**

*s-*, *p-*, *ps-*, *0-16383*, *aa-zz*

Specify a valid value for each subfield of the point code, and separate the subfields with a dash (-).

*prefix*—*s-*, *p-*, *ps*

*nnnnn*—*0-16383*

*gc*—*aa-zz*

*m1-m2-m3-m4*—*0-14* for each member; values must sum to 14

**npc1n24 (optional)**

24-bit ITU national new point code 1 with subfields *main signaling area-sub signaling area-signaling point* (*msa-ssa-sp*).

**Range:**

*p-*, *000-255*

Specify a valid value for each subfield of the point code, and separate the subfields with a dash (-).

*prefix*—*p*

*msa*—*000-255*

*ssa*—*000-255*

*sp*—*000-255*

**npc1n16 (optional)**

16-bit ITU national point code with subfields *unit number-sub number area-main number area* (*un-sna-mna*). This parameter allows up to 6 comma-delimited entries in the point code list.

**Range:**

*p--*, *000--127*

Specify a valid value for each subfield of the point code, and separate the subfields with a dash (-).

*prefix--p*

*un--000--127*

*sna--000--15*

*mna--000--31*

**npc2 (optional)**

ANSI new point code 2 with subfields *network indicator-network cluster-network cluster member* (*ni-nc-ncm*). The *prefix* subfield indicates a private point code (*prefix-ni-nc-ncm*).

**Synonym:***npc2a***Range:***p-*, 000-255

Specify a valid value for each subfield of the point code, and separate the subfields with a dash (-).

*prefix—p-*When *chg-sid:pctype=ansi* is specified, *ni = 000* is not valid.When *chg-sid:pctype=ansi* is specified, *nc = 000* is not valid if *ni = 001-005*.When *chg-sid:pctype=ansi* is specified, *nc = 000* is valid if *ni = 006-255*.The point code *000-000-000* is not a valid point code.**npc2i (optional)**ITU international new point code 2 with subfields *zone-area-id*. The *prefix* subfield indicates a spare point code, private point code, or private and spare point code (*prefix-zone-area-id*).**Range:***s-*, *p-*, *ps-*, 0-255

Specify a valid value for each subfield of the point code, and separate the subfields with a dash (-).

*prefix—s-*, *p-*, *ps**zone—0-7**area—000-255**id—0-7*The point code *0-000-0* is not a valid point code.**npc2n (optional)**ITU national new point code 2 in the format of a 5-digit number (*nnnnn*); or 2, 3, or 4 numbers (members) separated by dashes (*m1-m2-m3-m4*) as defined by the *chg-stpopts:npcfmti* flexible point code option. A group code must be specified when the ITUDUPPC feature is turned on (*nnnnn-gc*, *m1-m2-m3-m4-gc*). The *prefix* subfield indicates a spare point code (*prefix-nnnnn*, *prefix-nnnnn-gc*, *prefix-m1-m2-m3-m4*, *prefix-m1-m2-m3-m4-gc*).**Range:***s-*, *p-*, *ps-*, 0-16383, *aa-zz*

Specify a valid value for each subfield of the point code, and separate the subfields with a dash (-).

*prefix—s-*, *p-*, *ps**nnnnn—0-16383**gc—aa-zz**m1-m2-m3-m4—0-14* for each member; values must sum to 14**npc2n24 (optional)**24-bit ITU national new point code 2 with subfields *main signaling area-sub signaling area-signaling point* (*msa-ssa-sp*).**Range:***p-*, 000-255

Specify a valid value for each subfield of the point code, and separate the subfields with a dash (-).

*prefix—p**msa—000-255*



ssa—000–255  
sp—000–255

**npc2n16 (optional)**

16-bit ITU national point code with subfields *unit number-sub number area-main number area (un-sna-mna)*. This parameter allows up to 6 comma-delimited entries in the point code list.

**Range:**

*p--*, 000--127

Specify a valid value for each subfield of the point code, and separate the subfields with a dash (-).

*prefix--p*

*un--000--127*

*sna--000--15*

*mna--000--31*

**pc1 (optional)**

ANSI point code 1 with subfields *network indicator-network cluster-network cluster member (ni-nc-ncm)*. The *prefix* subfield indicates a private point code (*prefix-ni-nc-ncm*).

**Synonym:**

*pc1a*

**Range:**

*p-*, 000-255

Specify a valid value for each subfield of the point code, and separate the subfields with a dash (-).

*prefix—p-*

When *chg-sid:pctype=ansi* is specified, *ni = 000* is not valid.

When *chg-sid:pctype=ansi* is specified, *nc = 000* is not valid if *ni = 001-005*.

When *chg-sid:pctype=ansi* is specified, *nc = 000* is valid if *ni = 006-255*.

The point code *000-000-000* is not a valid point code.

**pc1i (optional)**

ITU international point code 1 with subfields *zone-area-id*. The *prefix* subfield indicates a spare point code, private point code, or private and spare point code (*prefix-zone-area-id*).

**Range:**

*s-*, *p-*, *ps-*, 0-255

Specify a valid value for each subfield of the point code, and separate the subfields with a dash (-).

*prefix—s-*, *p-*, *ps*

*zone—0-7*

*area—000-255*

*id—0-7*

The point code *0-000-0* is not a valid point code.

**pc1n (optional)**

ITU national point code 1 in the format of a 5-digit number (*nnnnn*); or 2, 3, or 4 numbers (members) separated by dashes (*m1-m2-m3-m4*) as defined by the `chg-stpopts:npcfmti` flexible point code option. A group code must be specified when the ITUDUPPC feature is turned on (*nnnnn-gc*, *m1-m2-m3-m4-gc*). The *prefix* subfield indicates a spare point code (*prefix-nnnnn*, *prefix-nnnnn-gc*, *prefix-m1-m2-m3-m4*, *prefix-m1-m2-m3-m4-gc*).

**Range:**

*s-*, *p-*, *ps-*, *0-16383*, *aa-zz*

Specify a valid value for each subfield of the point code, and separate the subfields with a dash (-).

*prefix—s-*, *p-*, *ps*

*nnnnn—0-16383*

*gc—aa-zz*

*m1-m2-m3-m4—0-14* for each member; values must sum to 14

**pc1n24 (optional)**

24-bit ITU national point code 1 with subfields *main signaling area-sub signaling area-signaling point* (*msa-ssa-sp*).

**Range:**

*p-*, *000-255*

Specify a valid value for each subfield of the point code, and separate the subfields with a dash (-).

*prefix—p*

*msa—000-255*

*ssa—000-255*

*sp—000-255*

**pc1n16 (optional)**

16-bit ITU national point code with subfields *unit number-sub number area-main number area* (*un-sna-mna*). This parameter allows up to 6 comma-delimited entries in the point code list.

**Range:**

*p--*, *000--127*

Specify a valid value for each subfield of the point code, and separate the subfields with a dash (-).

*prefix--p*

*un--000--127*

*sna--000--15*

*mna--000--31*

**pc2 (optional)**

ANSI point code 2 with subfields *network indicator-network cluster-network cluster member* (*ni-nc-ncm*). The *prefix* subfield indicates a private point code (*prefix-ni-nc-ncm*).

**Synonym:**

*pc2a*

**Range:***p-*, 000-255

Specify a valid value for each subfield of the point code, and separate the subfields with a dash (-).

*prefix—p-*When `chg-sid:pctype=ansi` is specified, *ni = 000* is not valid.When `chg-sid:pctype=ansi` is specified, *nc = 000* is not valid if *ni = 001-005*.When `chg-sid:pctype=ansi` is specified, *nc = 000* is valid if *ni = 006-255*.The point code *000-000-000* is not a valid point code.**pc2i (optional)**ITU international point code 2 with subfields *zone-area-id*. The *prefix* subfield indicates a spare point code, private point code, or private and spare point code (*prefix-zone-area-id*).**Range:***s-*, *p-*, *ps-*, 0-255

Specify a valid value for each subfield of the point code, and separate the subfields with a dash (-).

*prefix—s-*, *p-*, *ps**zone—0-7**area—000-255**id—0-7*The point code *0-000-0* is not a valid point code.**pc2n (optional)**ITU national point code 2 in the format of a 5-digit number (*nnnnn*); or 2, 3, or 4 numbers (members) separated by dashes (*m1-m2-m3-m4*) as defined by the `chg-stpopts:npcfmti` flexible point code option. A group code must be specified when the ITUDUPPC feature is turned on (*nnnnn-gc*, *m1-m2-m3-m4-gc*). The *prefix* subfield indicates a spare point code (*prefix-nnnnn*, *prefix-nnnnn-gc*, *prefix-m1-m2-m3-m4*, *prefix-m1-m2-m3-m4-gc*).**Range:***s-*, *p-*, *ps-*, 0-16383, *aa-zz*

Specify a valid value for each subfield of the point code, and separate the subfields with a dash (-).

*prefix—s-*, *p-*, *ps**nnnnn—0-16383**gc—aa-zz**m1-m2-m3-m4—0-14* for each member; values must sum to 14**pc2n24 (optional)**24-bit ITU national point code 2 with subfields *main signaling area-sub signaling area-signaling point* (*msa-ssa-sp*).**Range:***p-*, 000-255

Specify a valid value for each subfield of the point code, and separate the subfields with a dash (-).

*prefix—p**msa—000-255**ssa—000-255**sp—000-255*

**pc2n16 (optional)**

16-bit ITU national point code with subfields *unit number-sub number area-main number area* (*un-sna-mna*). This parameter allows up to 6 comma-delimited entries in the point code list.

**Range:**

*p--*, *000--127*

Specify a valid value for each subfield of the point code, and separate the subfields with a dash (-).

*prefix--p*

*un--000--127*

*sna--000--15*

*mna--000--31*

**rpc1 (optional)**

ANSI replacing point code list with subfields *network indicator-network cluster-network cluster member* (*ni-nc-ncm*). The prefix subfield indicates a private point code (*prefix-ni-nc-ncm*). This parameter allows up to 6 comma-delimited entries in the point code list.

**Synonym:**

*rpcla*

**Range:**

*p-*, *000-255*

Specify a valid value for each subfield of the point code, and separate the subfields with a dash (-).

*prefix—p-*

When *chg-sid:pctype=ansi* is specified, *ni = 000* is not valid.

When *chg-sid:pctype=ansi* is specified, *nc = 000* is not valid if *ni = 001-005*.

When *chg-sid:pctype=ansi* is specified, *nc = 000* is valid if *ni = 006-255*.

The point code *000-000-000* is not a valid point code.

**rpc1i (optional)**

ITU international replacing point code list with subfields *zone-area-id*. The *prefix* subfield indicates a spare point code, private point code, or private and spare point code (*prefix-zone-area-id*). This parameter allows up to 6 comma-delimited entries in the point code list.

**Range:**

*s-*, *p-*, *ps-*, *0-255*

Specify a valid value for each subfield of the point code, and separate the subfields with a dash (-).

*prefix—s-*, *p-*, *ps*

*zone—0-7*

*area—000-255*

*id—0-7*

The point code *0-000-0* is not a valid point code.

**rpc1n (optional)**

ITU national replacing point code list in the format of a 5-digit number (*nnnnn*); or 2, 3, or 4 numbers (members) separated by dashes (*m1-m2-m3-m4*) as defined by the *chg-*

`stpopts:npcfmti` flexible point code option. A group code must be specified when the ITUDUPPC feature is turned on (*nnnnn-gc*, *m1-m2-m3-m4-gc*). The *prefix* subfield indicates a spare point code (*prefix-nnnnn*, *prefix-nnnnn-gc*, *prefix-m1-m2-m3-m4*, *prefix-m1-m2-m3-m4-gc*). This parameter allows up to 6 comma-delimited entries in the point code list.

**Range:**

*s-*, *p-*, *ps-*, *0-16383*, *aa-zz*

Specify a valid value for each subfield of the point code, and separate the subfields with a dash (-).

*prefix*—*s-*, *p-*, *ps*

*nnnnn*—*0-16383*

*gc*—*aa-zz*

*m1-m2-m3-m4*—*0-14* for each member; values must sum to 14

**rpc1n24 (optional)**

24-bit ITU national replacing point code list with subfields *main signaling area-sub signaling area-signaling point* (*msa-ssa-sp*). This parameter allows up to 6 comma-delimited entries in the point code list.

**Range:**

*p-*, *000-255*

Specify a valid value for each subfield of the point code, and separate the subfields with a dash (-).

*prefix*—*p*

*msa*—*000-255*

*ssa*—*000-255*

*sp*—*000-255*

**rpc1n16 (optional)**

16-bit ITU national point code with subfields *unit number-sub number area-main number area* (*un-sna-mna*). This parameter allows up to 6 comma-delimited entries in the point code list.

**Range:**

*p--*, *000--127*

Specify a valid value for each subfield of the point code, and separate the subfields with a dash (-).

*prefix--p*

*un--000--127*

*sna--000--15*

*mna--000--31*

**Example**

This example sets the mode to discard and appends the listed point codes to the loopset RTP1 if the set is not being used by GTT.

```
chg-loopset:name=rtp1:mode=discard:apcl=3-7-3,5-7-5,7-4-7,5-4-5
```

This example replaces the point codes in the set with the listed point codes for the loopset RTP1 if the set is not being used by GTT.

```
chg-loopset:name=rtp2:rpc1=3-2-3,5-7-8,7-8-7,3-5-3
```

This example sets the mode to DISCARD in the loopset RTP2 if the set is not being used by GTT.

```
chg-loopset:name=rtp2:mode=discard
```

This example replaces PC1 with NPC1 in the loopset RTP1 if the set is not being used by GTT.

```
chg-loopset:name=rtp1:pc1=3-3-3:npc1=3-3-9
```

This example replaces PC1 and PC2 with NPC1 and NPC2 in the loopset RTP2 if the set is not being used by GTT.

```
chg-loopset:name=rtp2:pc1=3-2-3:npc1=3-3-9:pc2=7-8-7:npc2=7-7-9
```

This example sets the mode to NOTIFY in the loopset RTP2 even if the set is being used by GTT.

```
chg-loopset:name=rtp2:mode=notify:force=yes
```

```
chg-
```

```
loopset:name=rtpn16:pc1n16=3-2-3:npc1n16=3-3-9:pc2n16=7-8-7:npc2n16=7-7-9
```

### Dependencies

If the loopset is being used by GTT, and the `rpcl`, `pc1/pc2/npc1/npc2`, or `mode` parameter is specified, then the `force=yes` parameter must be specified.

If the `pc2` parameter is specified, then the `pc1` parameter must be specified.

If the `npc1` or `npc2` parameter is specified, then the corresponding `pc1` or `pc2` parameter must be specified.

The command requires at least one optional parameter.

The `rpcl` and `apcl` parameters cannot be specified together in the command.

If the `pc1` or `pc2` parameter is specified, then the `apcl` and `rpcl` parameters cannot be specified.

The value of the `name` parameter must already exist in the database.

The SCCP Loop Detection feature must be enabled before this command can be entered.

The GTT feature must be turned on before this command can be entered.

A maximum of 6 point codes can be added using this command with the `apcl` parameter. The Loopset entry can contain a maximum of 12 point codes.

The Loopset table can hold a maximum of 1,000 loopset entries, with each entry containing up to 12 point codes. Additional loopset entries and point codes cannot be added when the table is full.

The Loopset table must be accessible.

The values for the `apcl` and `rpcl` parameters cannot consist of any invalid point codes. The valid point codes must be consecutively specified and separated by commas.

The `name=none` parameter cannot be specified.

At least one valid point code must be specified as a value for the `apcl` and `rpcl` parameters.

The values specified for the `apcl` and `rpcl` parameters must be unique.

If the `npc1/pc1` or `npc2/pc2` parameters are specified together, then the value of the `npc` parameter cannot equal the value of the `pc` parameter.

A valid point code must be specified for the `pc1`, `pc2`, `npc1` or `npc2` parameter.

Equal values cannot be specified for the `pc1` and `pc2` parameters.

Equal values cannot be specified for the `npc1` and `npc2` parameters.

The GTT table must be accessible.

When adding point codes using the `apcl` parameter, or changing point codes using the `pc1/npc1` or `pc2/npc2` parameters, the new point code type must match the point code type of the loopset where the point codes are being added or changed.

The value of the `apcl` parameter cannot already exist in the loopset.

The value of the `pc1` or `pc2` parameter must already exist in the loopset.

### Notes

There is no J7 FAK dependency on the `apcln16/rpcln16/pc1n16/npc1n16/pc2n16/npc2n16` parameters. The command can be entered successfully when the J7 FAK is not enabled.

There is no J7 FAK dependency on the `apcln24/rpcln24/pc1n24/npc1n24/pc2n24/npc2n24` parameters. The command can be entered successfully when the J7 FAK is enabled.

There is no J7 FAK dependency on the `apcl/apcla/rpcla/pc1a/npc1a/pc2a/npc2a` parameters. The command can be entered successfully when the J7 FAK is enabled.

### Output

This example replaces the existing point codes with new point codes in loopset RTP2 when that set is not being used by GTT:

```
chg-loopset:name=rtp2:pc1=3-2-3:npc1=3-3-9:pc2=7-8-7:npc2=7-7-9
```

```
rlghncxa03w 07-02-10 08:41:17 EST EAGLE Rel 35.6.0
LOOPSET table is (12 of 1000) 1% full
CHG-LOOPSET: MASP A - COMPLTD
```

```
;
```

### Related Topics

- [dlt-loopset](#)
- [ent-loopset](#)
- [rtrv-loopset](#)

## chg-ls

Use this command to change the attributes for a specified linkset in the system database. The new values overwrite the existing values. All parameters required for

MTP distribution will be used whether they are explicitly specified or obtain from existing provisioning.

## Parameters



### Note:

See [Point Code Formats and Conversion](#) for a detailed description of point code formats, rules for specification, and examples.

### **lsn (mandatory)**

Linkset name. Each linkset name must be unique in the system.

#### **Range:**

*ayyyyyyyy*

1 alphabetic character followed by up to 9 alphanumeric characters

### **action (optional)**

This parameter adds or deletes the SAPC, mate IPGWx linkset name, or the value specified for the `rcontext` parameter.

#### **Range:**

*add*

*delete*

#### **Default:**

No change to the current value

#### **System Default:**

*add*

### **adapter (optional)**

Adapter layer for links provisioned in an IPSG linkset.

#### **Range:**

*m3ua*

*m2pa*

#### **Default:**

No change to the current value

#### **System Default:**

*m2pa*

### **apc (optional)**

ANSI point code with subfields *network indicator-network cluster-network cluster member (ni-nc-ncm)*. The *prefix* subfield indicates a private point code (*prefix-ni-nc-ncm*).

#### **Synonym:**

*apca*



**Range:***p-*, 000-255

Specify a valid value for each subfield of the point code, and separate the subfields with a dash (-).

*prefix—p-*When `chg-sid:pctype=ansi` is specified, *ni = 000* is not valid.When `chg-sid:pctype=ansi` is specified, *nc = 000* is not valid if *ni = 001-005*.When `chg-sid:pctype=ansi` is specified, *nc = 000* is valid if *ni = 006-255*.The point code *000-000-000* is not a valid point code.**apc/apca/apci/apcn/apcn24/apcn16 (optional)**

Adjacent point code.

**apci (optional)**ITU international point code with subfields *zone-area-id*. The *prefix* subfield indicates a spare point code, private point code, or private and spare point code (*prefix-zone-area-id*).**Range:***s-*, *p-*, *ps-*, 0-255

Specify a valid value for each subfield of the point code, and separate the subfields with a dash (-).

*prefix—s-*, *p-*, *ps**zone—0-7**area—000-255**id—0-7*The point code *0-000-0* is not a valid point code.**apcn (optional)**ITU national point code in the format of a 5-digit number (*nnnnn*); or 2, 3, or 4 numbers (members) separated by dashes (*m1-m2-m3-m4*) as defined by the `chg-stpopts:npcfmti` flexible point code option. A group code must be specified when the ITUDUPPC feature is turned on (*nnnnn-gc*, *m1-m2-m3-m4-gc*). The *prefix* subfield indicates a spare point code, private point code, or private and spare point code (*prefix-nnnnn*, *prefix-nnnnn-gc*, *prefix-m1-m2-m3-m4*, *prefix-m1-m2-m3-m4-gc*).**Range:***s-*, *p-*, *ps-*, 0-16383, *aa-zz*

Specify a valid value for each subfield of the point code, and separate the subfields with a dash (-).

*prefix—s-*, *p-*, *ps**nnnnn—0-16383**gc—aa-zz**m1-m2-m3-m4—0-14* for each member; values must sum to 14**apcn24 (optional)**24-bit ITU national point code with subfields *main signaling area-sub signaling area-signaling point* (*msa-ssa-sp*). The *prefix* indicates a private point code (*prefix-msa-ssa-sp*).**Range:***p-*, 000-255

Specify a valid value for each subfield of the point code, and separate the subfields with a dash (-).

*prefix—p*  
*msa—000–255*  
*ssa—000–255*  
*sp—000–255*

**apcn16 (optional)**

16-bit ITU national point code with subfields *unit number-sub number area-main number area (un-sna-mna)*. The *prefix* indicates a private point code (*prefix-un-sna-mna*).

**Range:**

*p--*, *000-127*

Specify a valid value for each subfield of the point code, and separate the subfields with a dash (-)

*prefix---p*

*un---000---127*

*sna--000--15*

*mna--000--31*

**apcntype (optional)**

ITU-N Adjacent Point Code Type. The format used for changeover and changeover acknowledgement messages.

**Range:**

*itun*

ITU National Adjacent Point Code type

*itunchina*

ITU National China Adjacent Point Code type

**Default:**

*itun*

**as18 (optional)**

Adjacent SLS 8-bit indicator. This parameter specifies whether the adjacent node is sending MSUs with 8-bit SLSs.

**Range:**

*yes*

*no*

**Default:**

No change to the current value

**asnotif (optional)**

AS notification. This parameter specifies whether AS notifications are sent for an IPSPG linkset.

**Range:**

*yes*

*no*

**Default:**

*yes*

If the `adapter=m2pa` parameter is specified, the default value is *no*.

If the `adapter=m3ua` parameter is specified, the default value is *yes*.

**bei (optional)**

Broadcast exception indicator. This parameter specifies whether TFP (transfer prohibited) messages are allowed to be broadcast on the linkset.

**Range:**

*yes*

TFPs are not broadcast

*no*

TFPs are broadcast

**Default:**

No change to the current value

**cggmod (optional)**

Calling party GT modification indicator. This parameter specifies whether calling party global title modification is required for the specified linkset.

**Range:**

*yes*

*no*

**Default:**

No change to the current value

**cgpnb1set (optional)**

Calling party blacklist set.

**Range:**

*1-255, none*

**System Default:**

*none*

**chgntp3opc (optional)**

Change MTP3 OPC. This parameter specifies whether to change MTP3 OPC with SPC or not.

**Range**

*on*

*off*

**Default**

No change to the current value

**clli (optional)**

Far-end Common Language Location Identifier (CLLI). The CLLI assigned to the linkset.

**Range:**

*ayyyyyyyyy*

1 alphabetic character followed by up to 10 alphanumeric characters

**Default:**

No change to the current value

**gnameset (optional)**

Generic Name Set type. The new settype for an IPSP-M3UA linkset.

**Range:**

*seta*

*setb*

*both*

**System Default:**

*both*

**gsmscrn (optional)**

GSM MAP screening. This parameter specifies whether GSM MAP screening is allowed.

**Range:**

*on*

GSM map screening is allowed

*off*

GSM map screening is not allowed

**Default:**

No change to the current value

**gttmode (optional)**

Global Title Translation Mode. This parameter specifies a GTT Mode hierarchy for each link set.

**Range:**

*cd*

CdPA GTT only

*cg*

CgPA GTT only

*acdcd*

Advanced CdPA GTT, CdPA GTT

***acdcgcd***

Advanced CdPA GTT, CgPA GTT, CdPA GTT

***acdcdcg***

Advanced CdPA GTT, CdPA GTT, CgPA GTT

***cgacdcd***

CgPA GTT, Advanced CdPA GTT, CdPA GTT

***cgcd***

CgPA GTT, CdPA GTT

***cdcg***

CdPA GTT, CgPA GTT

***fcd***

FLOBR CdPA only

***fcg***

FLOBR CgPA only

***fcgxcd***

FLOBR CgPA, FLOBR CdPA

***xcdfcg***

FLOBR CdPA, FLOBR CgPA

***sysdfit***

System wide default value

**Default:**

No change to current value.

***gwsa* (optional)**

Gateway screening action. This parameter specifies whether gateway screening (GWS) is on or off for the specified linkset.

**Range:**

*on*

*off*

**Default:**

No change to the current value

***gwsd* (optional)**

Gateway screening MSU discard. This parameter specifies whether the discarding of MSUs that bypass the gateway screening function due to load-shedding is on or off. This parameter is also used with the redirect function; MSUs that cannot be screened are discarded if *gwsd=on* is specified.

**Range:**

*on*

**off**

**Default:**

*off*

**gwsn (optional)**

Gateway screening messaging. This parameter specifies whether messages are generated for each message screened by gateway screening.

**Range:**

*on*

*off*

**Default:**

No change to the current value

**ipsg (optional)**

IP signaling gateway adjacent point code. This parameter specifies whether a linkset is entered for an IP SG card. The specified adjacent point code is an IP gateway adjacent point code.

**Range:**

*yes*

*no*

**Default:**

*no*

**islsrsb (optional)**

Incoming rotated signaling link selection (SLS) bit. The bit (1-4) for ITU and (1-8) for ANSI link sets to rotate as the new SLS LSB (Least Significant Bit) of the incoming linkset. The SLS is not modified in the outgoing message.

[Table 4-32](#) shows how the rotation affects the four bits of the ITU SLS during linkset selection.

[Table 4-33](#) shows how the rotation affects the four bits of the ANSI SLS during linkset selection.

This parameter is used for ITU or ANSI messages on a per-linkset basis.

**Range:**

*1 - 8*

ITU linkset— *1 - 4*

ANSI linkset— *1 - 8*

The `rsls8=yes` parameter must be specified (see the `chg-lsopts` command) before a value greater than 5 can be specified.

**Default:**

No change to the current value

**System Default:**

*1*

**itutfr (optional)**

ITU TFR (Transfer Restricted) procedure indicator. This parameter specifies whether the TFR procedure is on or off on a per-linkset basis. This parameter is valid for ITU national linksets only.

**Range:**

*on*

*off*

**Default:**

No change to the current value

**l3tset (optional)**

Link timer set. This parameter is defined with the `chg-l3t` command.

**Range:**

*1*

**Default:**

No change to the current value

**lst (optional)**

Linkset type of the specified linkset. This parameter specifies whether the specified link is an access link, bridge link, cross link, diagonal link, or extended link, as defined in Telcordia GR-246-CORE, T1.111.5.

**Range:**

*a*

Access links

*b*

Bridge links

*c*

Cross links

*d*

Diagonal links

*e*

Extended links

**Default:**

No change to the current value

**lsusealm (optional)**

IPTPS linkset alarm threshold percent. The percent of the linkset TPS (`iptps`) at which an alarm is generated to indicate that the actual linkset TPS is approaching the configured `iptps` value for the linkset.

**Range:**

*10 - 100*

**Default:**

No change to the current value

**System Default:**

100

**mate1sn (optional)**

Mate linkset name.

**Range:**

ayyyyyyyyy

1 alphabetic character followed by up to 9 alphanumeric characters

**Default:**

No change to the current value

**maxslktps (optional)**

Maximum per signaling link TPS. The maximum capacity a link is permitted when sufficient unused capacity is present on the host card.

 **Note:**

This parameter cannot be specified for links in non-IPSG linksets. If the HIPR2 High Rate Mode feature is turned off, then the sum of the TPS values assigned to all linksets in the system must be less than or equal to 500,000. If the HIPR2 High Rate Mode feature is turned on, then the sum of the TPS values assigned to all linksets in the system must be less than or equal to 750,000. If the HIPR2 High Rate Mode and 1M System TPS features are turned on, then the sum of the TPS values assigned to all linksets in the system must be less than or equal to 1,000,000.

**Range:**

25 - 12,000

 **Note:**

The maximum value that can be specified for this parameter depends on the type of IPSG card that is used:

- E5-ENET-B card when the E5-ENET-B IPSG High Throughput feature is turned off-6500 TPS
- E5-ENET-B card when the E5-ENET-B IPSG High Throughput feature is turned on-9500 TPS
- SLIC card - 12,000 TPS

**Default:**

No change to the current value

**System Default:**

6500



**mtp<sub>rs</sub>e (optional)**

ANSI or ITU MTP Restart equipped. This parameter specifies whether the node adjacent to the linkset is equipped with MTP Restart.

**Range:**

**yes**  
equipped

**no**  
not equipped

**Default:**

No change to the current value

**mult<sub>gc</sub> (optional)**

Multiple group codes. The parameter specifies whether multiple group codes can be specified.

**Range:**

**yes**

**no**

**nis (optional)**

Network Indicator Spare. This parameter specifies whether the Network Indicator Spare option is on or off for the specified linkset. When this option is enabled, the Network Spare value for network indicator for both ANSI and ITU-National (ITU-N) links is supported by the system.

**Range:**

**on**

**off**

**Default:**

*off*

**nlsn (optional)**

New linkset name.

**Range:**

*aaaaaaaaaa*

Up to 10 alphanumeric characters; the first character must be a letter

**Default:**

No change to the current value

**rands<sub>ls</sub> (optional)**

Random SLS (signaling link selection). This parameter is used to apply random SLS generation on a per linkset basis.

Specifying this parameter enables random SLS generation on a per linkset basis only if the `randsls=perls` parameter has been specified in the `chg-stpopts` command. For more details, refer to *Database Administration - SS7 User's Guide, Per-Linkset Random SLS*.

**Range:****off**

disables random SLS generation on a specified linkset

**class0**

enables random SLS generation for Class0 SCCP traffic on a specified linkset

**all**

enables random SLS generation for Class0 and Class1 SCCP traffic on a specified ITU linkset and for Class0 and ISUP traffic on a specified ANSI linkset

**Default:**

No change to the current value

**rcontext (optional)**

Routing Context. The new routing context for an IPSG-M3UA linkset.

**Range:**

0 - 4294967295

**Default:**

No change to the current value

**sapci (optional)**

ITU international secondary adjacent point code with subfields *zone-area-id*. The *prefix* subfield indicates a spare point code, private point code, or private and spare point code (*prefix-zone-area-id*).

**Range:**

*s-*, *p-*, *ps-*, 0-255

Specify a valid value for each subfield of the point code, and separate the subfields with a dash (-).

*prefix*—*s-*, *p-*, *ps*

*zone*—0-7

*area*—000-255

*id*—0-7

The point code 0-000-0 is not a valid point code.

**sapci/sapcn/sapcn24/spcn16 (optional)**

Secondary adjacent point code.

**sapcn (optional)**

ITU national secondary adjacent point code in the format of a 5-digit number (*nnnnn*); or 2, 3, or 4 numbers (members) separated by dashes (*m1-m2-m3-m4*) as defined by the `chg-stpopts:npcfmti` flexible point code option. A group code must be specified when the ITUDUPPC feature is turned on (*nnnnn-gc*, *m1-m2-m3-m4-gc*). The *prefix* subfield indicates a spare point code, private point code, or private and spare point code (*prefix-nnnnn*, *prefix-nnnnn-gc*, *prefix-m1-m2-m3-m4*, *prefix-m1-m2-m3-m4-gc*).

**Range:**

*s-*, *p-*, *ps-*, 0-16383, *aa-zz*

Specify a valid value for each subfield of the point code, and separate the subfields with a dash (-).

*prefix*—*s-*, *p-*, *ps*

*nnnnn*—0-16383  
*gc*—aa-zz  
*m1-m2-m3-m4*—0-14 for each member; values must sum to 14

**sapcn24 (optional)**

24-bit ITU national secondary adjacent point code with subfields *main signaling area-sub signaling area-signaling point (msa-ssa-sp)*. The *prefix* indicates a private point code (*prefix-msa-ssa-sp*).

**Range:**

*p*-, 000-255

Specify a valid value for each subfield of the point code, and separate the subfields with a dash (-).

*prefix*—*p*

*msa*—000–255

*ssa*—000–255

*sp*—000–255

**scrn (optional)**

Gateway screening screen set. The gateway screening screen set assigned to this linkset.

When using this parameter to change Gateway Screening from an old screenset name with Gateway Screening Allowed Mode *gwsa=off* to a new screenset name with *gwsa=on*, the command must first be entered to assign the screenset name to NONE (*scrn=none*). This assignment prevents any rules from the old screenset from being applied during the interim period that it takes for the new screenset to load.

**Range:**

*ayyy*

1 alphabetic character followed by up to 3 alphanumeric characters

*none* -deletes the screen set association

**Default:**

No change to the current value

**s1ktps (optional)**

Reserved per signaling link TPS for IPSP Linkset. The capacity guaranteed for each link in the linkset.

 **Note:**

This parameter is required for each link in an IPSP linkset and cannot be specified for links in non-IPSP linksets.

 **Note:**

The sum of guaranteed capacities for the links hosted by an IPSP card cannot exceed the IPSP card capacity.

 **Note:**

If the HIPR2 High Rate Mode feature is turned off, then the sum of the TPS values assigned to all linksets in the system must be less than or equal to 500,000. If the HIPR2 High Rate Mode feature is turned on, then the sum of the TPS values assigned to all linksets in the system must be less than or equal to 750,000. If the HIPR2 High Rate Mode and 1M System TPS features are turned on, then the sum of the TPS values assigned to all linksets in the system must be less than or equal to 1,000,000.

**Synonym:***rsvdslktps***Range:***0 - 12,000* **Note:**

The maximum value that can be specified for this parameter depends on the type of IPSP card that is used:

- E5-ENET-B card when the E5-ENET-B IPSP High Throughput feature is turned off-6500 TPS
- E5-ENET-B card when the E5-ENET-B IPSP High Throughput feature is turned on-9500 TPS
- SLIC card - 12,000 TPS

**Default:**

No change to the current value

**s1kusealm (optional)**

IPTPS signaling link alarm threshold percent. The percent of the link TPS at which an alarm is generated to indicate that the actual link TPS is approaching the alarmed IPTPS (*s1ktps/rsvdslktps* or *maxs1ktps*) configured for the link.

**Range:***10 - 100***Default:**

No change to the current value

**System Default:***80***s1sci (optional)**

5-bit to 8-bit SLS conversion indicator. This parameter specifies whether the 5-bit to 8-bit SLS conversion feature is used to select links for outgoing messages direct to the given linkset. When enabled, the system replaces any 5-bit SLS values contained in received messages, with a random 8-bit value before the 5-bit SLS values are used by the STP to select the outgoing link in that linkset.

**Range:****yes**  
enabled**no**  
disabled**Default:**

No change to the current value

**s1socbit (optional)**

Other CIC (Circuit Identification Code) Bit. If the SLSOCB feature is turned on, this parameter specifies whether the Other CIC Bit option is to be used during link selection. If the option is to be used, specify which bit (5– 16) of the CIC is to be used as the other CIC bit. During link selection, the specified bit acts as the most significant bit of the new SLS and bits 2 through 4 of the received CIC become the least significant bits of the new SLS. This parameter is used for ITU-ISUP messages. The SLS is not modified in the outgoing message. [Table 4-11](#) shows a received CIC where bit 9 is the other CIC bit (`s1socbit=9`). The new SLS is 0100:

	16	15	14	13	12	11	10	9	8	7	6	5	4	3	2	1
	0	0	0	0	1	0	0	0	1	0	0	1	1	0	0	1
New SLS								0					1	0	0	

**Range:**

5 - 16

**Default:**

No change to the current value

**s1srsb (optional)**

Rotated SLS (Signaling Link Selection) Bit. The bit (1–4) to rotate as the new SLS LSB (Least Significant Bit). The SLS is not modified in the outgoing message. [Table 4-35](#) shows how the rotation affects the SLS during linkset selection. This parameter is used for ITU messages on a per-linkset basis.

**Range:**

1 - 4

**Default:**

No change to the current value

**s1tset (optional)**

SLTM record. The SLTM record to be associated with the linkset.

**Range:**

1 - 20

0 –sets the linkset to SLT reflect mode

**Default:**

No change to the current value

**spc (optional)**

ANSI secondary point code with subfields *network indicator-network cluster-network cluster member (ni-nc-ncm)*.

**Synonym:***spca***Range:**

Specify a valid value for each subfield of the point code, and separate the subfields with a dash (-).

*p-*, 000-255, *none**prefix—p-*

When *chg-sid:pctype=ansi* is specified, *ni = 000* is not valid.

When *chg-sid:pctype=ansi* is specified, *nc = 000* is not valid for *ni = 001-005*.

When *chg-sid:pctype=ansi* is specified, *nc = 000* is valid if *ni = 006-255*.

Enter *none* to delete the point code.

The point code *000-000-000* is not a valid point code.

**spc/spca/spci/spcn/spcn24/spcn16 (optional)**

Secondary point code.

**spci (optional)**

ITU international secondary point code with subfields *zone-area-id*. The *prefix* subfield indicates a spare point code (*prefix-zone-area-id*).

**Range:***s-*, 0-255, *none*

Specify a valid value for each subfield of the point code, and separate the subfields with a dash (-).

*prefix—s**zone—0-7**area—000-255**id—0-7*

Enter *none* to delete the point code.

The point code *0-000-0* is not a valid point code.

**spcn (optional)**

ITU national secondary point code in the format of a 5-digit number (*nnnnn*); or 2, 3, or 4 numbers (members) separated by dashes (*m1-m2-m3-m4*) as defined by the *chg-stpopts:npcfmti* flexible point code option. A group code must be specified when the ITUDUPPC feature is turned on (*nnnnn-gc*, *m1-m2-m3-m4-gc*). The *prefix* subfield indicates a spare point code (*prefix-nnnnn*, *prefix-nnnnn-gc*, *prefix-m1-m2-m3-m4*, *prefix-m1-m2-m3-m4-gc*).

**Range:***s-*, 0-16383, *aa-zz*, *none*

Specify a valid value for each subfield of the point code, and separate the subfields with a dash (-).

*prefix—s**nnnnn—0-16383**gc—aa-zz*

*m1-m2-m3-m4—0-14* for each member; values must sum to 14

Enter *none* to delete the point code.

**spcn24 (optional)**

24-bit ITU national secondary point code with subfields *main signaling area-sub signaling area-signaling point* (*msa-ssa-sp*).

**Range:***000-255, none*

Specify a valid value for each subfield of the point code, and separate the subfields with a dash (-).

*msa—000-255**ssa—000-255**sp—000-255*

Enter *none* to delete the point code.

**spcn16 (optional)**

16-bit ITU national point code with subfields *unit number sub number area main number area (un-sna-mna)*.

**Range:***000--127, none*

Specify a valid value for each subfield of the point code, and separate the subfields with a dash (-)

*un---000--127**sna--000--15**mna--000--31*

Enter *none* to delete the point code.

**tfatcabmlq (optional)**

TFA/TCA broadcast minimum link quantity. The minimum number of links in the given linkset, or in the combined linkset in which the linkset resides, that must be available to user-part messages traffic. This parameter value is used by the STP to consider the first-choice ordered routes using that linkset as Allowed rather than Restricted. If this parameter's provisioned or default value is 0, then the TFA/TCA broadcast minimum link quantity is calculated by the system to be either 1 for linksets containing 2 or fewer links, or half (rounded-up) of the number of links configured in the linkset for linksets containing more than 2 links.

If this parameter value is set to a specific value greater than 0, then the system does not calculate a TFA/TCA broadcast minimum link quantity. The specified value is used.

**Range:***0, 1 - 16***Default:**

No change to current value.

**System Default:***0***tpsalmtype (optional)**

IPSG IPTPS threshold alarm type. The IPTPS threshold that can be alarmed.

**Range:*****rsvdslktps***

the SLKTPS/RSVDSLKTPS threshold is alarmed

***maxslktps***

the MAXSLKTPS threshold is alarmed

**Default:**

No change to the current value

**System Default:***rsvdslktps***visualizedata (optional)**

Linkset based Visualization option.

**Range:*****off***

Visualization is off on this linkset

***risky***

Only risky opcodes (based on FS11) will be visualize on this linkset

***all***

All opcodes will be visualize on this linkset

**System Default:***off***Example**

Changes linkset WY644368 to use APC 144-202-5:

```
chg-ls:lsn=wy644368:apc=144-202-005
```

Changes link set WY644368 to Link Set Type A:

```
chg-ls:lsn=wy644368:lst=a
```

Adds an SAPC to a linkset:

```
chg-ls:lsn=linkset:sapcn=1234-fr:action=add
```

```
chg-ls:lsn=c002:gwsm=on:nis=on
```

```
chg-ls:lsn=nc003:sltm=reg:lst=b
```

Adds a 24-bit ITU-N SAPC to a linkset:

```
chg-ls:lsn=ls1:sapcn24=5-5-5
```

Deletes a 24-bit ITU-N SAPC from a linkset:

```
chg-ls:lsn=ls1:sapcn24=5-5-5:action=delete
```

Assigns a mate linkset to a linkset:

```
chg-ls:lsn=linkset:matelsn=matelinkset
```

Changes an ITUN24 linkset to an APCNTYPE for China:



```
chg-ls:lsn=ls2:apcntype=itunchina
```

```
chg-ls:lsn=nc003:slsci=yes:tfatcabmlq=2
```

```
chg-ls:lsn=lsitu1:gmscrn=off
```

```
chg-ls:apca=p-011-2-3:lsn=lsa1:lst=a
```

```
chg-ls:lsn=ls1:randsls=all
```

Indicates that calling party GT modification is required:

```
chg-ls:lsn=ls1:apc=1-1-1:cggmod=yes
```

Changes the linkset's SPC value:

```
chg-ls:lsn=ls1:spc=100-23-48
```

Changes the adapter of a specified IPSP linkset:

```
chg-ls:lsn=ls2:adapter=m2pa
```

Changes the AS notification status and routing context value for an IPSP-M3UA linkset:

```
chg-ls:lsn=m3ua33:rcontext=9999:action=add
```

Converts the linkset to IPSP:

```
chg-ls:lsn=m2pa33:ipsp=yes
```

This command changes the Incoming SLS Bit Rotation value to 6 for ANSI link sets:

```
chg-ls:lsn=ls1:islsrsb=6
```

Changes the GTTMODE value to FLOBR CdPA when the FLOBR feature is turned on:

```
chg-ls:lsn=ls3:gttmode=fcd
```

Converts the linkset to SLT reflect mode:

```
chg-ls:lsn=ls1:sltset=0
```

Change adapter type of a 16-bit ITU national linkset type:

```
chg-ls:lsn=ls1:apcn16=121-5-15:adapter=m3ua
```

Change linkset chgmtp3opc parameter:

```
chg-ls:lsn=ls112:chgmtp3opc=off
```

Change linkset gnameset parameter:

```
chg-ls:lsn=ls112:gnameset=setb
```

Change linkset cgpnblset parameter:

```
chg-ls:lsn=ls112:cgpnblset=3
```

### Dependencies

A valid screenset name must be associated with the linkset, or the `scrn` parameter must be specified with a valid screenset name before the `gwsa`, `gwsn`, and `gwsd` parameters can be specified.

The `gwsa=on` parameter must be specified before the `gwsd=on` parameter can be specified.

At least one optional parameter must be specified.

If the `lsrestrict=off` parameter is specified (see the `chg-ss7opts` command), the `tfatcabmlq` database value for C linksets cannot be changed from the system default of 0. If the `lsrestrict=on` parameter is specified, the `tfatcabmlq` value for C linksets (`lst=c`) can be set to 1 - 16. If the `tfatcabmlq` value for one or more C linksets in the system is changed, the `lsrestrict` parameter cannot be changed from `on` to `off` until all of the changed C linkset `tfatcabmlq` values are set back to 0. C linksets are never the primary route (except to reach the STP's mate).

The `tfatcabmlq` parameter value cannot exceed the total number of assigned links in the linkset.

The linkset name must be in the database.

The screen set name specified by the `scrn` parameter must be valid and must be in the database.

Adjacent point codes must be full point codes.

The adjacent point code must be defined as a destination point code.

The adjacent point code cannot match the site point code.

The domain of the new adjacent point code must be the same as the previous adjacent point code unless there are no links in the linkset.

Only one linkset can be defined for an adjacent point code.

An SAPC cannot be deleted when routes exist for its SS7 domain.

If the `gwsa=off` and `gwsm=off` parameters are specified, all MSUs are passed. If the `gwsa=off` and `gwsm=off` parameters are specified for all linksets, gateway screening and the GWS redirect function for the DTA feature are disabled.

If the `gwsa=on` and `gwsm=off` parameters are specified, MSUs are screened but messages are not generated.

#### **Caution:**

Even though gateway screening is in the screen test mode, as defined by the parameters `gwsa=off` and `gwsm=on`, the gateway screening action in the stop action set specified by the `actname` parameter of the screen set is performed at the end of the screening process.

The `mtprse` parameter can be specified only if the MTP restart feature, MTPRS (for ANSI), or ITUMTPRS (for ITU), is turned on. The `rtrv-feat` command can be used to verify whether the feature is turned on (MTPRS=YES or ITUMTPRS=YES in the output).

If the `ipgwapc=yes` or `ipsg=yes` parameter is specified, then the `mtprse=yes` parameter cannot be specified.

The `clli` and `apc/apca/apci/apcn/apcn24/apcn16` parameters must be specified together in the command.

The value of the `clli` parameter must match the `clli` of the current site.

The `asl8=yes` parameter can be assigned only to an SS7 linkset (a linkset containing an adjacent point code in the SS7 domain).

The `apcn` parameter format must match the format assigned with the `chg-stpopts:npcfmti` parameter.

An SAPC parameter can be specified only for ITU-N and ITU-N24 linksets.

The `slsobit` parameter is valid only for ITU linksets.

The `slsrsb` parameter is valid only for ITU linksets.

The GSM Map Screening feature must be turned on before the `gmscrn` parameter can be specified.

The Enhanced GSM Map Screening feature must be turned on before the `gmscrn=on` parameter can be specified for an ANSI linkset.

The `itutfr` parameter is valid only for ITU national linksets.

The group code of DPC(s) must match the group code of the APC/SAPC when the `multgc=no` parameter is specified.

If the adjacent point code's group code is changed, the `multgc=yes` parameter must be specified, or there must be no routes using the linkset.

The `multgc` parameter value can be changed to *no* only if there are no routes with group codes different from the adjacent point code's group code.

Only one ITU-N APC/SAPC is allowed with the `multgc=no` parameter.

Only one ITU-I or 24-bit ITU-N APC/SAPC is allowed per linkset.

The `apcntype` parameter can be specified only for ITU-N and ITU-N24 linksets.

A linkset cannot have both a 14-bit ITU-N and a 24-bit ITU-N APC/SAPC unless it contains only IPGWI links. These links support 14-bit ITU-N and 24-bit ITU-N traffic simultaneously.

A linkset with the `ipgwapc=no` parameter cannot have both a 14-bit ITU-N and a 24-bit ITU-N APC/SAPC if no links are provisioned.

The SAPC cannot be a 24-bit ITU-N point code if the linkset contains E1 ATM links, which do not support 24-bit ITU-N traffic.

The `ipgwapc=yes` or `ipsg=yes` parameter must be specified before the `lsusealm` parameter can be specified.

The `ipgwapc=yes` or `ipsg=yes` parameter must be specified before the `slkusealm` parameter can be specified.

The same value cannot be specified for the `lsn` and `matelsn` parameters.

If the `action=add` parameter is specified, the specified mate linkset cannot already be assigned as the mate of the specified linkset.

When the `action=add` parameter is specified, the specified mate linkset cannot already be the mate of another linkset.

The specified mate linkset must be an existing linkset in the database.

A mated linkset can have only one assigned link.

Mated linksets can contain only SS7IPGW or IPGWI links.

Mated linksets must have APCs of the same network type.

The card that has the link assigned to the specified linkset must be inhibited before the `action=add` parameter can be specified to assign the specified mate linkset to the specified linkset.

The card that has a link in the mate linkset must be inhibited before the `action=delete` parameter can be specified to delete the mate linkset assignment.

If the `action=delete` parameter is specified to delete a mate linkset assignment, the specified mate linkset must be the mate of the specified linkset in the database.

If the `action=delete` parameter is specified, then the `sapc`, `matelsn`, or `rconext` parameter must be specified. The parameters cannot be specified together in the command.

The `mtprse` parameter can be specified only if the MTP restart feature ITUMTPRS (for ITU) is turned on. The `rtv-feat` command can be used to verify whether the feature is turned on (ITUMTPRS=YES in the output).

The `slocbit` parameter is valid only if the SLSOCB feature is turned on.

The adjacent point code cannot match the capability point code.

The STP Site ID table is corrupt or cannot be found.

The Linkset table is corrupt or cannot be found.

The Route table is corrupt or cannot be found.

An APC cannot be changed to a point code that has exception routes provisioned.

The Route Exception table is corrupt or cannot be found.

The Origin-based SCCP Routing feature must be turned on before the `gtmode` parameter can have a value of `acdcd`, `cgacdcd`, `acdcgcd`, `acdcdcg`, `cgcd`, `cdcg`, or `cg`.

All links assigned to the linkset must be removed before changing the `apcntype` parameter value from `apcn` to `apcn24` or from `apcn24` to `apcn`.

If one or more of the links in the specified linkset are in service, then the `apc/apca/apci/apcn/apcn24/apcn16` parameter cannot be specified.

If `apcn` is specified for the Adjacent Point Code then the format of `apcn` must match the format dictated by the `npcfmti` parameter via the `chg-stpopts` command.

Gateway linksets must be configured from a SEAS terminal.

If the system is configured for ANSI formatted point code, the network indicator value of the foreign point code parameter must be 6 or greater when the cluster value is 0.

The value of the `apc/apca/apci/apcn/apcn24/apcn16` or `sapc/sapca/sapci/sapcn/sapcn24` parameter cannot be assigned to more than one linkset.

The new `apc/apca/apci/apcn/apcn24/apcn16` parameter must have the same point code type as the `apc/apca/apci/apcn/apcn24/apcn16` parameter currently specified for the linkset.

The value of the `apc/apca/apci/apcn/apcn24/apcn16` parameter must exist in the Point Code table.

The `lst` parameter must have a value of `b`, `c`, or `d` if a network or cluster route is configured through the linkset.

If the `multgc=yes` parameter is specified, then an IPGWI or IPLIMI link must be specified.

If the ITUDUPPC feature is off, then the `multgc=yes` parameter cannot be specified.

If the `multgc=yes` parameter is specified, then the `apci`, `apcn`, `apcn16`, or `apcn24` parameter must be specified.

The value of the `sapc/sapca/sapci/sapcn/sapcn24` parameter must exist in the Destination Point Code table.

The `apc/apca/apci/apcn/apcn24` or `sapc/sapca/sapci/sapcn/sapcn24` parameter can be defined only once per linkset.

The maximum number of `sapc/sapca/sapci/sapcn/sapcn24` entries is 1000.

The value of the specified `lsn` parameter cannot already exist in the database.

The specified `matelsn` parameter must already be equipped in the linkset database.

If the linkset is not mated to the linkset specified by the `matelsn` parameter, then the `action=delete` parameter cannot be specified.

The value specified for the `spc` parameter must be a valid full point code.

The values specified for the `spc` and `apc` parameters must have the same network type.

If the `sapc`, `matelsn`, `rcontext`, or `action` parameter is specified, then those four parameters are the only optional parameters that can be specified. If the `action` parameter is specified, then the `sapc` or `rcontext` or `matelsn` parameter must be specified. If the `ipsg` parameter is specified, then no other optional parameters can be specified.

The Multiple Linksets to Single Adjacent PC (MLS) feature must be turned on before the `spc` parameter can be specified.

The value specified for the `spc` parameter must already exist in the SPC table.

The SPC table must be accessible.

The point code type of the value specified for the `spc` parameter must be the same as the point code type of the value of the existing `spc` parameter.

The value specified for the `spc` parameter cannot already be specified as a secondary point code for an adjacent destination point code.

The value specified for the `apc` parameter must differ from the adjacent point code of the linkset specified by the `lsn` parameter.

The value specified for the `spc` parameter must differ from the secondary point code of the linkset specified by the `lsn` parameter.

If a proxy linkset is used, then the `apc`, `sapc`, `action`, and `lst` parameters cannot be specified.

The specified combination of the `apc` and `spc` parameters must be unique for each linkset.

The specified combination of the `apc` and `sapc` parameters must be unique for each linkset.

The AMGTT feature or the AMGTT CgPA Upgrade feature must be turned on before the `cggmod` parameter can be specified.

The `ipsg=yes` parameter must be specified before the `adapter` parameter can be specified.

The `ipsg=yes` and `adapter=m3ua` parameters must be specified before the `asnotif` parameter can be specified.

The `ipsg=yes` and `adapter=m3ua` parameters must be specified before the `rcontext` parameter can be specified.

If the IPSEG linkset contains links, then the `adapter` parameter cannot be specified.

The `ipsg=yes` parameter must be specified before the `slktps/rsvdslktps` or `maxslktps` parameter can be specified.

If the `ipsg=yes` and `adapter=m3ua` parameters are specified, then the `lst=a` parameter must be specified.

A maximum of 1 IPGW linkset or a maximum of 6 of any other linksets are allowed between any APC and the EAGLE.

If the HIPR2 High Rate Mode feature is turned off, then the sum of the TPS values assigned to all linksets in the system must be less than or equal to 500,000. If the HIPR2 High Rate Mode feature is turned on, then the sum of the TPS values assigned to all linksets in the system must be less than or equal to 750,000. If the HIPR2 High Rate Mode and 1M System TPS features are turned on, then the sum of the TPS values assigned to all linksets in the system must be less than or equal to 1,000,000.

The value specified for the `slktps/rsvdslktps` parameter cannot cause the card to exceed the total maximum capacity of the card.

If the `ipsg=yes` and `adapter=m3ua` parameters are specified, then the `multgc=yes` parameter cannot be specified.

If the `ipsg=yes` and `adapter=m3ua` parameters are specified, then the `tfatcabmlq` parameter cannot be specified.

If the `action=delete` parameter is specified to delete the routing context, then the value specified for the `rcontext` parameter must be the value used by the specified linkset in the database.

The link must be equipped.

The Link table is corrupt or cannot be found.

If the linkset already contains IPSEG links, then the `ipsg=no` parameter cannot be specified.

If the `ipsg=yes` and `adapter=m3ua` parameters are specified, then a secondary adjacent point code cannot be specified for the linkset.

If one or more links in a specified linkset are in service, then the `rcontext` parameter cannot be specified.

Multiple signaling links in a single linkset cannot share the same association.

If multiple linksets share an association, then the `rcontext` parameter cannot be specified for only one linkset.

The value specified for the `rcontext` parameter must already exist in the database.

If a linkset shares an association with another linkset, then a unique value for the `rcontext` parameter must be specified for each linkset.

If the `ipsg=yes` parameter is specified, then the `slktps/rsvdslktps` parameter must be specified.

If the `multgc=yes` parameter is specified, then all links assigned to the linkset must be of the same type.

If any of the links are not in the OOS state, then the `rcontext` parameter cannot be specified.

The ISLSBR feature must be enabled before the `islsrsb` parameter can be specified.

The FLOBR feature must be turned on before the `gttmode` parameter can have a value of `fcd`, `fcg`, `fcgfcfcd`, or `fcdfcg`.

The SAPC table is corrupt or cannot be found.

The `rsls8=yes` parameter (see the `chg-lsopts` command) must be specified for an ANSI linkset before a value greater than 5 can be specified for the `islsrsb` parameter.

If an ITU linkset is used, then a value of 1 – 4 must be specified for the `islsrsb` parameter.

The value specified for the `slktps/rsvdslktps` parameter must be less than or equal to the value specified for the `maxslktps` parameter.

The `sltset=0` parameter can be specified only for a type A linkset (`lst=a`).

The value specified for the `slktps/rsvdslktps` and `maxslktps` parameters must be within the allowed range.

The ITUTFR (command `ent/chg-ls`) cannot be specified for a linkset to be configured for APCN16.

The NIS (command `ent/chg-ls`) cannot be specified for a linkset to be configured for APCN16.

The PPC specified must not be a private point code.

The MTP Restart Equipped (MTPRSE) parameter is only valid for adjacent ANSI nodes in the SS7 domain.

The adapter type specified must be either `m3ua` or `m2pa`.

The GTT destination must exist in the DSTN table.

## Notes

Any optional parameter that is not specified is not changed.

The links that directly connect the system with a distant node are grouped into one or more linksets. A linkset can contain up to 8 (international standards) or 16 (national

standard) signaling links, depending on how the system attributes were defined when the network was created.

Signaling link test acknowledgments (SLTA) are the same type of maintenance message as the SLTMs received on the link.

MTP restart provides an orderly process for bringing signaling links back into service after the system has been isolated and restarted. A greater preference is given to restoring the STP to network service in an orderly fashion than to the speed of recovery. The time required is system dependent as shown:

- up to 64 LIMs—62 seconds (Link Alignment Delay)
- 64 - 127 LIMs—97 seconds
- 128 - 191 LIMs—132 seconds
- more than 191 LIMs—167 seconds

When two linksets are used as a combined linkset, each linkset should have the same `slsci` and `asl8` values and the same `slsobit` and `islsrsb/slrsrb` values.

 **Caution:**

**This is not enforced in the system and there is no warning mechanism if the values of these parameters are not the same for each linkset.**

The `slrsrb` parameter alone does not provide an even distribution of ITU-ISUP messages across all links within a linkset. The system uses all four bits of the SLS to determine the actual link to route messages. Because the static bit is simply rotated within the SLS, all possible values of the SLS field will still not be realized. The `slsobit` parameter must also be used to provide an even distribution across all links within the linkset. If both parameters are used for a given linkset, the SLS field is processed in the following order:

- The SLS is modified using the Other CIC Bit option.
- The modified SLS is modified again using the Rotated SLS Bit option.
- The modified SLS is used by the existing linkset and link selection algorithms to select a link.
- The ISUP message is sent out of the link containing the original, unmodified SLS field.

To modify a secondary adjacent point code, `sapc` has to be first deleted, then added again.

A 24-bit ITU-N point code can be provisioned as an SAPC only if the APC is not already a 24-bit ITU-N point code.

Only one 24-bit ITU-N point code is allowed to be provisioned as an SAPC.

For a linkset containing either low speed CCS7ITU links if the APC is a 14-bit ITU-N point code, then a 24-bit ITU-N point code cannot be provisioned as an SAPC.

For a linkset containing either low speed CCS7ITU links, if the APC is a 24-bit ITU-N point code, then a 14-bit ITU-N point code cannot be provisioned as a SAPC.

For a linkset containing either low speed CCS7ITU links, if the APC is an ITU-I point code, then either a 24-bit ITU-N point code or a 14-bit ITU-N point code can be provisioned as an SAPC, but not both.



In this command, only ITU-international and ITU national point codes support the spare point code subtype prefix (s-) and the private and spare point code subtype prefix (ps-). All of the point code types support the private (internal) point code subtype prefix (p-).

The ITU National and ITU National China Adjacent Point Code types indicate the format that is used for changeover and changeover acknowledgement messages. China specifies a 16-bit field for data in changeover messages. The FSN occupies the first 12 bits. The trailing 4 bits are spare and are coded as 0. ITU uses a 24-bit field for data in the extended changeover/changeover acknowledgement messages. The FSN is encoded in the first 12 bits. The last 12 bits of the field are spare and are coded as zero.

The `randsls` parameter value applies to SCCP ITU-T messages and Class0 and ISUP ANSI messages when random SLS generation is set to occur on a per linkset basis (the `randsls=perls` parameter is specified in the `chg-stpopts` command).

If the `randsls=perls` parameter is specified, it is recommended that the linksets in a combined linkset be provisioned with the same `randsls` value to avoid undesired SLS distribution.

The `tfatcabmlq=0` parameter specifies that the system broadcasts TFAs or TCAs only when half the links in the given linkset, or in the combined linkset in which it resides, become available.

A gateway linkset can be configured only from a SEAS terminal and not from a system terminal.

If the `gwsa=off` and `gwsm=on` parameters are specified, then all MSUs pass. Error messages are generated if an MSU matches a screening condition.

If the `gwsa=on` and `gwsm=off` parameters are specified, then MSUs are screened but messages are not generated.

If the `gwsa=off` and `gwsm=on` parameters are specified, then gateway screening is defined to be in the screen test mode. The gateway screening action in the stop action set specified by the `actname` parameter of the screen set is performed at the end of the screening process.

If the `asl8=yes` and the `lst=a` (a linkset containing access signaling links) parameters are specified, then the originator of the MSUs is generating 8-bit SLSs. For other linkset types, the `asl8=yes` parameter indicates that the adjacent STP is converting 5-bit SLSs to 8-bit SLSs. The SLS in MSUs received by the system on a linkset that has the `asl8=yes` parameter assigned is not converted. These MSUs are assumed to contain 8-bit SLSs.

If the `gwsa=on`, `gwsm=on`, and `gwsd=off` parameters are specified, then MSUs are screened, and error messages are generated if an MSU is passed when it should have been screened.

The `chgntp3opc` parameter is applied on the outgoing linkset.

The `chgntp3opc` parameter will be nullified if the `sccpopts:mtprgntt` option is set to `fullgntt`.

### Incoming SLS Bit Rotation

If the ISLSBR feature is turned on, and Incoming SLS Bit Rotation is applied to an MSU, then the outgoing SLS bit rotation is not applied for that MSU. If the ISLSBR

feature is turned off, or Incoming SLS Bit Rotation is not applied to an MSU, then the outgoing SLS bit rotation is applied for that MSU.

The valid ISLSRSB values are 1 – 4 for ITU linksets and 1 – 8 for ANSI linksets.

The `randsls` parameter is applied on incoming linksets for ANSI messages and on outgoing linksets for ITU messages.

### Output

This example shows the output when the secondary point code is changed:

```
chg-ls:lsn=ls1:spc=100-23-48
```

```
rlghncxa03w 07-07-18 08:16:14 EST EAGLE 37.5.0
CAUTION: Linkset SPC has changed - verify remote node's route.
Link set table is (114 of 1024) 1% full
```

```
CHG-LS: MASP A - COMPLTD
```

This example shows the output when GTT mode is changed to FLOBR CdPA:

```
chg-ls:lsn=ls3:gttmode=fcd
```

```
tekelecstp 09-04-12 13:34:33 EST EAGLE 41.0.0
Link set table is (5 of 1024) 1% full.
```

```
CHG-LS: MASP A - COMPLTD
```

```
;
```

### Related Topics

- [chg-lsopts](#)
- [chg-slt](#)
- [chg-ss7opts](#)
- [dlt-ls](#)
- [ent-ls](#)
- [rtrv-ls](#)

## chg-lsopts

Use this command to administer the thresholds for IPSPG-M3UA linksets and to set SLS bit rotation for ANSI linksets.

### Parameters

#### **lsn (mandatory)**

Linkset name. The name of the linkset. Each linkset name must be unique in the system.

**Range:***ayyyyyyyyy*

1 alphabetic character followed by up to 9 alphanumeric characters

**icnimap (optional)**

Incoming NI Map. The NI mapping for incoming MSUs on a linkset. The NI value in the incoming MSU is changed to the value specified by this parameter before processing the message.

**Range:***itui2ituis*

Map ITU International to ITU International Spare

*ituis2itui*

Map ITU International Spare to ITU International

*itun2ituns*

Map ITU National to ITU National Spare

*ituns2itun*

Map ITU National Spare to ITU National

*none*

NI mapping is not performed on the specified linkset.

**Default:**

No change to the current value

**System Default:***none***numslkalw (optional)**

Number of signaling links allowed. The IS-NR link count threshold required for an IPSPG-M3UA linkset to transition from the Restricted or Prohibited state to the Allowed state.

 **Note:**

When the number of IS-NR links in an IPSPG-M3UA linkset transitions from a value less than `numslkalw` to a value equal to or greater than `numslkalw`, the linkset transitions to the allowed state.

**Range:***0 - 16*

0—The IS-NR link count threshold value for an IPSPG-M3UA linkset is considered to be half of the number of links configured in the linkset.

**Default:**

No change to the current value

**System Default:***1*

**numslkproh (optional)**

Number of signaling links required to prohibit a linkset. The IS-NR link count threshold required for an IPSP-M3UA linkset to transition from the Restricted or Allowed state to the Prohibited state.

 **Note:**

When the number of IS-NR links in an IPSP-M3UA linkset transitions from a value equal to or greater than `numslkproh` to a value less than `numslkproh`, the linkset transitions to the Prohibited state.

**Range:**

0 - 16

 **Note:**

0 —The IS-NR link count threshold value for an IPSP-M3UA linkset is considered to be half of the number of links configured in the linkset.

**Default:**

No change to current value

**System Default:**

1

**numslkrstr (optional)**

Number of signaling links required to restrict a linkset. The IS-NR link count threshold required for an IPSP-M3UA linkset to transition from the Allowed state to the Restricted state.

When the number of IS-NR links in an IPSP-M3UA linkset transitions from a value equal to or greater than `numslkrstr` to a value less than `numslkrstr` and greater than `numslkproh`, the linkset transitions from the Allowed state to the Restricted state. Transition from the Prohibited state to the Restricted state is not supported.

**Range:**

0 - 16

0 —The IS-NR link count threshold value for an IPSP-M3UA linkset is considered to be half of the number of links configured in the linkset.

**Default:**

No change to current value

**System Default:**

1

**ognimap (optional)**

Outgoing NI Map. The NI mapping for outgoing MSUs on a linkset. The NI value in the processed MSU is changed to the value specified by the `ognimap` parameter for that linkset before routing the message to the intended destination.

**Range:**

***itui2ituis***

Map ITU International to ITU International Spare

***ituis2itui***

Map ITU International Spare to ITU International

***itun2ituns***

Map ITU National to ITU National Spare

***ituns2itun***

Map ITU National Spare to ITU National.

***none***

NI mapping is not performed on the specified linkset.

**Default:**

No change to the current value

**System Default:**

*none*

**pct (optional)**

Point Code and CIC Translation. This option specifies whether to apply PCT to the specified linkset.

**Range:**

***off***

do not apply PCT to the linkset

***on***

apply PCT to the linkset

**Default:**

*off*

**rs1s8 (optional)**

Rotate SLS by 5 or 8 bits. This parameter specifies whether the signaling link selector (SLS) of the incoming ANSI linkset is rotated by 5 or 8 bits.

**Range:**

***yes***

8 bit SLS of the incoming linkset is considered for bit rotation

***no***

5 bit SLS of the incoming linkset is considered for bit rotation

**Default:**

No change to the current value

**System Default:**

*no*

### Example

The following example changes the threshold value of the `numslkproh` parameter to 3 for an IPSG-M3UA linkset.

```
chg-lsopts:lsn=lsm3ual:numslkproh=3
```

The following example sets the incoming and outgoing NI Mapping for a linkset.

```
chg-lsopts:lsn=lsnimap1:icnimap=itun2ituns:ognimap=ituns2itun
```

The following example sets 8 bit incoming bit rotation for an ANSI link set

```
chg-lsopts:lsn=ls1:rsls8=yes
```

```
chg-lsopts:lsn=ls111:pct=on
```

### Dependencies

The value specified for the `numslkproh` parameter cannot be greater than the value specified for the `numslkrstr` parameter.

The value specified for the `numslkrstr` parameter cannot be greater than the value specified for the `numslkalw` parameter.

The value specified for the `lsn` parameter must indicate an IPSG-M3UA linkset before the `numslkalw`, `numslkproh`, and `numslkrstr` parameters can be specified.

The value specified for the `numslkalw`, `numslkproh`, or `numslkrstr` parameter cannot be greater than the number of links configured in the IPSG-M3UA linkset.

The ITU National and International Spare Point Code Support feature must be enabled before the `icnimap` and `ognimap` parameters can be specified.

The `icnimap` and `ognimap` parameters must be specified together in the command.

The NI mapping for incoming messages in a linkset must be compatible with the NI mapping for the outgoing messages.

Values for the `icnimap` and `ognimap` parameters other than *none* can be specified only for ITU-I and ITU-N APCs of the linkset.

An ANSI linkset must be specified by the `lsn` parameter before the `rsls8=yes` parameter can be specified.

The ISLSBR feature must be enabled before the `rsls8` parameter can be specified.

A PCT quantity feature must be enabled before the `pct` parameter can be specified.

### Notes

#### NI Mapping Parameter Compliance Rules

The values specified for the `icnimap` and `ognimap` parameters for a linkset must be compatible. [Table 4-12](#) shows the relationship between the parameters for a linkset.

**Table 4-12 NI Mapping Rules**

ICNIMAP	OGNIMAP
ITUI2ITUIS	ITUIS2ITUI

**Table 4-12 (Cont.) NI Mapping Rules**

ICNIMAP	OGNIMAP
ITUIS2ITUI	ITUI2ITUIS
ITUN2ITUNS	ITUNS2ITUN
ITUNS2ITUN	ITUN2ITUNS
NONE	NONE

If the `rsls8=yes` parameter is specified, then 8 bits of the Incoming ANSI SLS are used for the ISLSBR feature. If the `rsls8=no` parameter is specified, then 5 bits are used.

[Table 4-13](#) summarizes the cases in which rotation is done on the Incoming ANSI SLS bits:

**Table 4-13 Incoming SLS Bit Rotation for ANSI Linksets**

Number of Incoming SLS Bits	RSLS8	Valid range of values of ISLSRSB	SLSCNV/SLSCI	If Incoming SLS bits are rotated or not
5	No	1-5	No	Yes
5	No	1-5	Yes	Yes ( Lower 5 bits)
5	Yes	1-8	No	No
5	Yes	1-8	Yes	Yes
8	No	1-5	Yes/No	Yes (Lower 5 bits)
8	Yes	1-8	Yes/No	Yes

### Output

```
chg-lsopts:lsn=ls1:rsls8=yes
```

```
tekelecstp 09-03-03 10:52:55 EST EAGLE 41.0.0
Command entered at terminal #4.
Link set table is (7 of 1024) 1% full.
CHG-LSOPTS: MASP A - COMPLTD
```

### Related Topics

- [chg-ls](#)
- [rtrv-ls](#)

## chg-m2pa-tset

Use this command to change M2PA timers in an M2PA timer set. The `srcset` and `tset` parameters can be used to copy from one timer set to another.

 **Note:**

The M2PA RFC feature introduces 20 new timer sets. M2PA timer sets created prior to this feature become M2PA Draft 6 timer sets, which are used by the M2PA Draft 6 associations. M2PA RFC associations use the RFC timer sets.

**Parameters** **Note:**

All values specified for the timer parameters ( $t(x)$ ) are in milliseconds.

**tset (mandatory)**

Timer set. The name of the M2PA timer set.

**Range:**

1 - 20

**srctset (optional)**

The timer set to be copied into the timer set specified by the `tset` parameter. If this parameter is specified, no other timer values can be specified.

**Range:**

1 - 20

**t1 (optional)**

T1 timer. Alignment timer. The amount of time M2PA waits to receive a Link Status Alignment message from the peer.

**Range:**

1000 - 350000

**Default:**

D6- 10000

RFC- 35000

**t2 (optional)**

T2 timer. M2PA RFC timer.

 **Note:**

This timer is not used in M2PA Draft 6 timer sets.

**Range:**

5000 - 150000

**Default:**

20000



**t3 (optional)**

T3 timer. Ready timer. The amount of time after proving that M2PA waits to receive a Link Status Ready message from the peer.

**Range:**

1000 - 60000

**Default:**

10000 D6

2000 RFC

**t4e (optional)**

T4E timer. Emergency proving timer. The amount of time M2PA generates Link Status Proving messages during emergency proving.

**Range:**

400 - 5000

**Default:**

500

**t4n (optional)**

T4N timer. Normal proving timer. The amount of time M2PA generates Link Status Proving messages during normal proving.

**Range:**

1000 - 70000

**Default:**

D6- 10000

RFC- 30000

**t5 (optional)**

T5 timer. Busy rate timer. The amount of time between sending Link Status Busy messages while the link is in service.

**Range:**

80 - 10000

**Default:**

1000 D6

100 RFC

**t6 (optional)**

T6 timer. Remote congestion timer. The amount of time that a congested link will remain in service.

**Range:**

1000 - 6000

**Default:**

3000

**t7 (optional)**

T7 timer. Excessive acknowledgement delay timer. The maximum amount of time that can pass between transmission of a user data message and receipt of an

acknowledgement for that message from the peer. If this timer expires, the link is taken out of service.

**Range:**  
*200 - 2000*

**Default:**  
*1200*

**t16 (optional)**

T16 timer. Proving rate timer. The amount of time between sending Link Status Proving messages while T2N or T2E is running.



**Note:**

The T16 value is given in microseconds.

**Range:**  
*100 - 500000*

**Default:**  
*200000*

**t17 (optional)**

T17 timer. Ready rate timer. The amount of time between sending Link Status Ready messages while T3 is running.

**Range:**  
*100 - 500*

**Default:**  
*250*

**t18 (optional)**

T18 timer. Processor outage rate timer. The amount of time between sending Link Status Processor Outage messages while the link is in service.

**Range:**  
*100 - 10000*

**Default:**  
*1000*

**ver (optional)**

Version. The M2PA version used by the association.

**Range:**

*d6*

*rfc*

**Example**

```
chg-m2pa-tset:tset=1:t1=20000
```

```
chg-m2pa-tset:tset=1:t1=20000:ver=d6
chg-m2pa-tset:srctset=1:tset=2:ver=rfc
```

### Dependencies

At least one optional parameter must be specified.

The `srctset` parameter and the `tset` parameter cannot specify the same timer set name.

The specified timer must be supported for the Draft 6 version of M2PA.

Either a timer value or the `srctset` parameter must be specified.

Timer value parameters and the `SRCTSET` parameter cannot be specified together.

### Notes

None

### Output

```
chg-m2pa-tset:tset=1:t1=20000:ver=d6
```

```
rlghncxa03w 06-01-18 08:16:14 EST EAGLE 34.3.0
CHG-M2PA-TSET: MASP A - COMPLTD
;
```

### Related Topics

- [rtrv-m2pa-tset](#)

## chg-map

Use this command to add or modify an entry in the Mated Application Part (MAP) table. A MAP table entry consists of a mate PC/SSN, its attributes, and an Alternate Routing Indicator Mate MRN Set and MRN point code.

#### Note:

A mate point code defines an adjacent signaling point, which is considered the mated signal transfer point (STP) to the system. See the *Notes* section for additional information on multiplicity modes.

#### Note:

The GTT Load Sharing with Alternate Routing Indicator (GTT LS ARI) feature must be enabled before an Alternate RI Mate for a MAP Set can be provisioned.

## Parameters



### Note:

See [Point Code Formats and Conversion](#) for a detailed description of point code formats, rules for specification, and examples.



### Note:

The `mrnset` and `mrnpc` parameters indicate whether an Alternate RI Mate search is performed in the MRN table if all of the point code/subsystem number combinations provisioned in a given MAP Set are unavailable or congested.

### **pc (mandatory)**

ANSI point code with subfields *network indicator-network cluster-network cluster member (ni-nc-ncm)*.

#### **Synonym:**

*pca*

#### **Range:**

*000-255*

Specify a valid value for each subfield of the point code, and separate the subfields with a dash (-).

When `chg-sid:pctype=ansi` is specified, *ni = 000* is not valid.

When `chg-sid:pctype=ansi` is specified, *nc = 000* is not valid if *ni = 001-005*.

When `chg-sid:pctype=ansi` is specified, *nc = 000* is valid if *ni = 006-255*.

The point code *000-000-000* is not a valid point code.

### **pc/pca/pci/pcn/pcn24 /pcn16 (mandatory)**

Primary remote point code.

### **pci (mandatory)**

ITU international point code with subfields *zone-area-id*. The *prefix* subfield indicates a spare point code (*prefix-zone-area-id*).

#### **Range:**

*s-, 0-255*

Specify a valid value for each subfield of the point code, and separate the subfields with a dash (-).

*prefix—s*

*zone—0-7*

*area—000-255*

*id—0-7*

The point code *0-000-0* is not a valid point code.

### **pcn (mandatory)**

ITU national point code in the format of a 5-digit number (*nnnnn*); or 2, 3, or 4 numbers (members) separated by dashes (*m1-m2-m3-m4*) as defined by the `chg-`

`stpopts:npcfmti` flexible point code option. A group code must be specified when the

ITUDUPPC feature is turned on (*nnnnn-gc, m1-m2-m3-m4-gc*). The *prefix* subfield indicates a spare point code (*prefix-nnnnn, prefix-nnnnn-gc, prefix-m1-m2-m3-m4, prefix-m1-m2-m3-m4-gc*).

**Range:**

*s-*, 0-16383, *aa-zz*

Specify a valid value for each subfield of the point code, and separate the subfields with a dash (-).

*prefix—s-*

*nnnnn—0-16383*

*gc—aa-zz*

*m1-m2-m3-m4—0-14* for each member; values must sum to 14

**pcn24 (mandatory)**

24-bit ITU national point code with subfields *main signaling area-sub signaling area-signaling point* (*msa-ssa-sp*).

**Range:**

000-255

Specify a valid value for each subfield of the point code, and separate the subfields with a dash (-).

*msa—000–255*

*ssa—000–255*

*sp—000–255*

**pcn16 (mandatory)**

16-bit ITU national point code with subfields *unit number-sub number area-main number area* (*un-sna-mna*).

**Range:**

000---127

Specify a valid value for each subfield of the point code, and separate the subfields with a dash (-).

*un---000---127*

*sna---000---15*

*mna---000---31*

**ssn (mandatory)**

Subsystem number.

**Range:**

2 - 255

**eswt (optional)**

Entity set weight. The weight assigned to each PC/SSN in a weighted entity set.

 **Note:**

This parameter cannot be specified when adding PC/SSNs to a weighted entity set or when modifying RC or weight values for an individual PC/SSN.

**Range:**

1 - 99, none

none —Changes a weighted entity set to a non-weighted entity set.

**force (optional)**

This parameter must be specified to modify the `rc` parameter and the `srm`, `mrc`, or `wt` parameter in the same command.

Modification of the `srm`, `mrc`, or `wt` parameter depends on the parameter's current multiplicity state, which depends on the RC value. Changing the `rc` parameter value can change the multiplicity state, which can cause the `srm`, `mrc`, or `wt` parameter value to become invalid.

**Range:**

yes

**grp (optional)**

The concerned point code broadcast list (CSPC) group name. The CSPC is a group of point codes that should be notified of the subsystem status. A different CSPC group can be assigned to each mated PC/SSN. For ANSI, the EAGLE broadcasts SSP or SSA to the mate subsystem only if the mate's point code is provisioned as part of the CSPC group to receive an SSP or SSA.

**Range:**

ayyyyyyy

1 alphabetic character followed by up to 7 alphanumeric characters

none —Disassociates a concerned point code broadcast list group from the given mate application

**Default:**

Current value.

**grpwt (optional)**

Group weight. The weight assigned to each PC/SSN in a weighted RC group.

 **Note:**

This parameter cannot be specified when adding PC/SSNs to a weighted entity set or when modifying RC or weight values for an individual PC/SSN.

**Range:**

1 - 99

**mapset (optional)**

MAP set ID.

**Range:**

1 - 36000, *dflt*  
*dflt* —Default MAP set

**Default:**

*dflt* -if the Flexible GTT Load Sharing feature is not enabled  
 No change to current value—if the Flexible GTT Load Sharing feature is enabled

**materc (optional)**

Mate relative cost. The RC assigned to the mate PC/SSN that is being added to the entity set. The system determines the multiplicity mode based on the RC values (*rc* and *materc* parameters) of the subsystem.

**Range:**

0 - 99

**Default:**

Current value.

**mpc (optional)**

ANSI point code with subfields *network indicator-network cluster-network cluster member (ni-nc-ncm)*.

**Synonym:**

*mpca*

**Range:**

000-255

Specify a valid value for each subfield of the point code, and separate the subfields with a dash (-).

When *chg-sid:pctype=ansi* is specified, *ni = 000* is not valid.

When *chg-sid:pctype=ansi* is specified, *nc = 000* is not valid if *ni = 001–005*.

When *chg-sid:pctype=ansi* is specified, *nc = 000* is valid if *ni = 006–255*.

The point code *000-000-000* is not a valid point code.

**Default:**

000

**mpc/mpca/mpci/mpcn/mpcn24/mpcn16 (optional)**

Mate remote point code.

**mpci (optional)**

ITU international point code with subfields *zone-area-id*. The *prefix* subfield indicates a spare point code (*prefix-zone-area-id*).

**Range:**

*s-*, 0-255

Specify a valid value for each subfield of the point code, and separate the subfields with a dash (-).

*prefix*—*s*

*zone*—0-7

*area*—000-255

*id*—0-7

The point code *0-000-0* is not a valid point code.

**Default:**  
000

**mpcn (optional)**

ITU national point code in the format of a 5-digit ITU number (*nnnnn*). The *prefix* subfield indicates a spare point code (*prefix-nnnnn*).

**Range:**

*s-*, 0-16383, *aa-zz*

Specify a valid value for each subfield of the point code, and separate the subfields with a dash (-).

*prefix*—*s-*

*nnnnn*—0-16383

*gc*—*aa-zz*

*m1-m2-m3-m4*—0-14 for each member; values must sum to 14

**Default:**

00000

**mpcn24 (optional)**

24-bit ITU national point code with subfields *main signaling area-sub signaling area-signaling point* (*msa-ssa-sp*).

**Range:**

000-255

Specify a valid value for each subfield of the point code, and separate the subfields with a dash (-).

*msa*—000-255

*ssa*—000-255

*sp*—000-255

**Default:**

000

**mpcn16 (optional)**

16-bit ITU national point code with subfields *unit number-sub number area-main number area* (*un-sna-mna*).

**Range:**

000---127

Specify a valid value for each subfield of the point code, and separate the subfields with a dash (-).

*un*---000---127

*sna*---000---15

*mna*---000---31

**Default:**

000



**mrc (optional)**

Message routing under congestion. This parameter specifies whether Class 0 messages to the specified PC/SSN are routed to the next preferred mode/subsystem when that PC/SSN is congested.

**Range:**

*yes*

*no*

**Default:**

No change to the current value

**mrnpc (optional)**

ANSI point code with subfields *network indicator-network cluster-network cluster member (ni-nc-ncm)*.

**Synonym:**

*mrnpca*

**Default:**

*000*

**mrnpc/mrnpca/mrnpci/mrnpn/mrnpn24/mrnpn16 (optional)**

Alternate RI Mate point code.

**mrnpai (optional)**

ITU international point code with subfields *zone-area-id*. The *prefix* subfield indicates a spare point code (*prefix-zone-area-id*).

**Default:**

*0-000-0*

**mrnpn (optional)**

ITU national point code in the format of a 5-digit number (*nnnnn*); or 2, 3, or 4 numbers (members) separated by dashes (*m1-m2-m3-m4*) as defined by the `chg-stpopts:npcfmti` flexible point code option. A group code must be specified when the ITUDUPPC feature is turned on (*nnnnn-gc*, *m1-m2-m3-m4-gc*). The *prefix* subfield indicates a spare point code (*prefix-nnnnn*, *prefix-nnnnn-gc*, *prefix-m1-m2-m3-m4*, *prefix-m1-m2-m3-m4-gc*).

**Default:**

*00000*

**mrnpn24 (optional)**

24-bit ITU national point code with subfields *main signaling area-sub signaling area-signaling point (msa-ssa-sp)*.

**Default:**

*000*

**mrnpn16 (optional)**

16-bit ITU national point code with subfields *unit number-sub number area-main number area (un-sna-mna)*.

**Range:**  
*000--127*

Specify a valid value for each subfield of the point code, and separate the subfields with a dash (-).

*un--000--127*

*sna--000--15*

*mna--000--31*

**Default:**  
*000*

**mrnset (optional)**

Alternate RI Mate MRN Set ID. The MRN Set where the Alternate RI Mate search is performed.

**Range:**  
*1 - 3000, dflt*  
*dflt* —default MRN Set

 **Note:**

If the `mrnpc` parameter is specified, and the `mrnset` parameter is not specified, then the value for the `mrnset` parameter is automatically set to *dflt*.

**Default:**  
No change to the current value

**mssn (optional)**

Mated subsystem number. The SSN that acts as a backup if the SSN fails.

**Range:**  
*2 - 255*

**Default:**  
Current value.

**mwt (optional)**

Mate point code weight. The weight assigned to the PC/SSN that is being added to a weighted entity set.

**Range:**  
*1 - 99*

**rc (optional)**

Relative cost. The RC assigned to a specified PC/SSN. The EAGLE determines the multiplicity mode based on the relative costs (the `rc` and `materc` parameters) of the subsystem.

**Range:**  
*0 - 99*

**Default:**  
Current value.

**srm (optional)**

Subsystem routing messages. This parameter specifies whether subsystem routing messages (SBR, SNR) are transmitted between the mated applications. This value can be provisioned in any of the multiplicity modes, but its value only affects traffic if the multiplicity mode is *DOM* or *COM*. See the *Notes* section for more information on multiplicity modes.

**Range:**

*yes*

*no*

**Default:**  
Current value.

**sso (optional)**

Subsystem status option. This parameter specifies whether the PC/SSN initiates a subsystem test when a RESUME is received for the PC.

**Range:**

*on*  
prohibited

*off*  
allowed

**Default:**  
Primary—no change  
Mate, if entered— *off*

**thr (optional)**

Threshold. The in-service threshold assigned to each PC/SSN in a weighted entity set or RC group.

This parameter cannot be specified when adding PC/SSNs to a weighted entity set or RC group or when modifying RC or weight values for an individual PC/SSN.

If this parameter is not specified, a value of 1% is assigned to each weighted PC/SSN.

**Range:**  
*1 - 100*

**wt (optional)**

Weight. The new weight assigned to the primary PC/SSN.

**Range:**  
*1 - 99*

**Example**

This example enters 1 into the MAP table and adds it to the same group as 1. Because 1 already exists in the MAP table, the *rc* parameter is not used.

```
chg-map:pc=1-1-0:ssn=10:mpc=1-1-3:mssn=10:materc=40
```

This example enters 1 into the MAP table, and adds it to the same group as 1. Because 1 has a lower relative cost than 1, it is placed into the group in relative cost order.

```
chg-map:pc=1-1-0:ssn=10:mpc=1-1-2:mssn=10:materc=30
```

This example changes the relative cost for the specified PC/SSN pair:

```
chg-map:pc=1-1-0:ssn=10:rc=20
```

This example changes the concerned PC broadcast list group name for the specified PC/SSN pair:

```
chg-map:pc=1-1-0:ssn=10:grp=abc
```

This example changes the ITU-I spare point code entry s-1-12-2 and adds the spare mate point code entry s-2-23-3 in the map table:

```
chg-map:pci=s-1-12-2:ssn=10:rc=10:mpci=s-2-23-3:mssn=20:materc=10
```

This example turns ON the SSO option for PC 1-1-0 and SSN 10.

```
chg-map:pc=1-1-0:ssn=10:sso=on
```

This example turns OFF the SSO option for PC 1-1-0 and SSN 10.

```
chg-map:pc=1-1-0:ssn=10:sso=off
```

This example does not change the current value of the SSO option for the primary or the mate.

```
chg-map:pc=1-1-0:ssn=10:rc=10
```

This example turns ON the SSO option for primary and mate.

```
chg-map:pc=1-1-0:ssn=10:mpc=3-3-3:mssn=2:sso=on
```

This example turns OFF the `sso` option for primary and mate.

```
chg-map:pc=1-1-0:ssn=10:mpc=4-4-4:mssn=2:sso=off
```

This example does not change the current value for the SSO option for the primary. The SSO option is turned OFF for the mate, because the mate is specified but the `sso` parameter is not specified (the default is OFF for the mate when the mate is specified).

```
chg-map:pc=1-1-0:ssn=10:mpc=5-5-5:mssn=2
```

This example changes the ITU-I spare s-1-12-2 entry and adds the spare mate point code s-2-23-3 entry in the map table.

```
chg-map:pci=s-1-12-2:ssn=10:rc=10:mpci=s-2-23-3:mssn=20:materc=10
```

This example adds a new PC/SSN 1 in the existing MAP set 362.

```
chg-map:pc=1-1-1:ssn=10:mpc=1-1-3:mssn=10:materc=40:mapset=362
```

This example adds a new PC/SSN 1-1-3/15 to the same load-sharing group in the default MAP set to which 1-1-1/15 belongs.

```
chg-map:pc=1-1-1:ssn=15:mpc=1-1-3:mssn=15:materc=40:mapset=df1t
```

This example changes the RC of 1-1-1/10 in existing MAP set 362 to 20.

```
chg-map:pc=1-1-1:ssn=10:rc=20:mapset=362
```

This example changes a non-weighted shared or non-weighted combined entity set to a weighted shared or weighted combined entity set.

```
chg-map:pc=1-1-1:ssn=10:eswt=30
```

This example changes a non-weighted shared or non-weighted combined entity set to a weighted shared or weighted combined entity set. The example also sets a threshold value and changes the weights of all of the PC/SSNs in the entity set.

```
chg-map:pc=1-1-1:ssn=10:eswt=30:thr=50
```

This example changes a weighted shared or weighted combined entity set to a non-weighted shared or non-weighted combined entity set.

```
chg-map:pc=1-1-1:ssn=10:eswt=none
```

This example assigns a weight value to each PC/SSN in an RC group within a weighted entity set.

```
chg-map:pc=1-1-1:ssn=10:grpwt=20
```

This example assigns a threshold value to each PC/SSN in an RC group within a weighted entity set.

```
chg-map:pc=1-1-1:ssn=10:thr=70
```

This example assigns weight and threshold values to each PC/SSN in an RC group within a weighted entity set.

```
chg-map:pc=1-1-1:ssn=10:grpwt=20:thr=70
```

This example changes the weight of an existing PC/SSN in a weighted entity set.

```
chg-map:pc=1-1-1:ssn=10:wt=20
```

This example changes the weight of PC/SSN 1 and adds PC/SSN 1-2-1/10 to an existing weighted entity set.

```
chg-  
map:pc=1-1-1:ssn=10:wt=50:mpc=1-2-1:mssn=10:materc=20:mwt=30
```

This example adds PC/SSN 1-3-2/10 to an existing non-weighted entity set.

```
chg-map:pc=1-1-1:ssn=10:mpc=1-3-2:mssn=10:materc=20:mwt=10
```

This example changes the RC value and turns on MRC of an existing PC/SSN in a weighted entity set.

```
chg-map:pc=1-1-1:ssn=10:rc=30:mrc=yes:force=yes
```

This example changes the RC value and turns on SRM of an existing PC/SSN in a weighted entity set.

```
chg-map:pc=1-1-1:ssn=10:rc=30:srm=yes:force=yes
```

This example changes the RC value and the weight of an existing PC/SSN in a weighted entity set.

```
chg-map:pc=1-1-1:ssn=10:rc=30:wt=20:force=yes
```

This example changes the Alternate RI Mate (MRNSET and MRNPC) in an existing MAP set.

```
chg-map:mapset=362:pc=1-1-1:ssn=10:mrnset=1:mrnpc=1-1-2
```

**Example for 16 bit PC:**

```
chg-  
map:pcn16=1-1-1:ssn=10:rc=20:wt=30:mpcn16=1-2-3:mssn=10:materc=  
20:mwt=20:thr=40
```

## Dependencies

At least one optional parameter must be specified.

The specified remote PC must exist in the MAP table.

The Spare Point Code Support feature must be enabled before an ITU-I or ITU-N spare point code can be specified.

The specified SSN must exist for the specified remote PC.

If a subsystem is configured for a subsystem number (SSN) value in the SS-APPL table, then the specified MAP table entry for that subsystem must be a valid point code type for that subsystem. The following point code types are not valid for the indicated subsystems:

- For the INP subsystem, the True Point code cannot be an ITU-I point code.
- For the AIQ, ATINPQ, VFLEX, and EIR subsystems, the True Point code cannot be an ITU-N24 point code.

The mate PC/SSN cannot be the same as the primary PC/SSN.

If the PC value is an ITU type (`pci/pcn/pcn24/pcn16`), the `srm=yes` parameter cannot be specified.

The `apca` and `pcn24/pcn16` parameters cannot be specified for the same MAP set. The `pci` and `pcn` parameters cannot be specified for the same MAP set if the MAP set contains a true point code.

The ANSI/ITU SCCP Conversion feature must be enabled before the network type of the CPC broadcast group can be different from the network type of the point code.

The mated PC/SSN must not already exist in the MAP table.

The DPCs of the primary subsystem and the mate subsystem must be full PCs.

The Route table must be accessible.

The format of the `pcn` or `mpcn` parameter must match the format assigned with the `npcfmt1` parameter of the `chg-stpopts` command.

If the `mpc` parameter is specified, the `mssn` and `materc` parameters must be specified.

A maximum of 128 mated applications is allowed per MAP set.

The `sso` parameter cannot be specified with a PC that is the system true PC.

A true PC can have only one mate.

A true PC cannot be routed to itself.

The RPC3 table must be accessible.

The Site Identification table must be accessible.

If the `mssn` or `materc` parameter is specified, the `mpc` parameter must be specified.

The PC must already exist in the CPC group.

The specified CSPC broadcast list group name must already exist.

If the `mpc` parameter is specified, then the `mssn` parameter must be specified.

The number of MPC Subsystem entries must not exceed the table capacity.

A maximum of 1024 unique remote point codes are allowed.

If a remote MPC is specified, then the remote MPC must exist in the Routing table.

If the Flexible GTT Load Sharing feature is not enabled, then the `mapset` parameter must not be specified. If the Flexible GTT Load Sharing feature is enabled, then the `mapset` parameter must be specified.

The specified MAP set must exist in the database.

The specified PC/SSN/MAP set must already be provisioned in the MAP table.

The EAGLE true PC can be provisioned only in the default MAP set.

The MAP table must be accessible.

The Weighted GTT Loadsharing feature must be turned on before the `wt`, `mwt`, `eswt`, `grpwt`, or `thr` parameters can be specified.

If the `eswt`, `grpwt`, or `thr` parameter is specified, the `mpc` parameter cannot be specified.

If the `eswt`, `grpwt`, and `thr` parameters are specified, the `rc`, `wt`, `mrc`, `srm`, `sso`, and `grp` parameters cannot be specified.

The `eswt` and `grpwt` parameters cannot be specified together in the command.

If the `eswt=none` parameter is specified, the `thr` parameter cannot be specified.

If the `mwt` parameter is specified, the `mpc` parameter must be specified.

The `mpc` parameter value must be a full point code.

If the `mpc` parameter is specified for a weighted entity set, the `mwt` parameter must be specified.

If the `mpc` parameter is specified for a non-weighted entity set, the `mwt` parameter cannot be specified.

The `eswt=none` parameter cannot be specified for a non-weighted entity set.

The `grpwt` and `thr` parameters cannot be specified for a non-weighted entity set.

If the `chg-sid:pctype=ansi` command is entered, a value of `ni=000` cannot be specified.

If the `chg-sid:pctype=ansi` command is entered, and a value of `ni=001 – 005` is specified, a value of `nc=000` cannot be specified.

The mate point code in the command cannot exceed the maximum number of entries in the MAP table.

The MAP table contains the maximum number of possible entries for the specified True Point Code. Maximum entries for the ANSI, ITU-I, and ITU-N point codes are:

- ANSI—2 (ANSI41 AIQ and LNP), 4 (ANSI41 AIQ, ATINPQ, INP, and V-FLEX)
- ITU-I—4 (ANSI41 AIQ, ATINPQ, EIR, and V-FLEX)
- ITU-N—5 (ANSI41 AIQ, ATINPQ, EIR, INP, and V-FLEX)

 **Note:**

LNP is mutually exclusive with ATINPQ and V-FLEX, unless the Dual ExAP Config feature is enabled.

The true point code in the entity set must be the primary PC/SSN for that entity set. The `rc` parameter value for the specified point code cannot be changed, and a new point code cannot be added that causes the true point code to no longer be the primary PC/SSN.

If the `pc` parameter value is a true point code, the subsystem must have a lower RC than all other mated subsystems in the RC group.

If the `mpc` parameter value is a true point code, the subsystem must have a lower RC than all other mated subsystems in the RC group.

The `eswt`, `grpwt`, and `thr` parameters cannot be specified for solitary or dominant entity sets.

The AINPQ, EIR, INP, or V-Flex feature must be turned on or the ANSI41 AIQ or ATINP feature must be enabled before the value specified for the `mpcn` parameter can be a true point code.

The `force=yes` parameter must be specified before the `rc` parameter can be specified in the same command with the `srn`, `mrc`, or `wt` parameter.

The `force` parameter can be used only to specify the `rc` parameter and the `srn`, `mrc`, or `wt` parameter in the same command.

If the `pcn` or `mpcn` parameter is specified, then the format of the parameter must match the format dictated by the `chg-stpopts:npcfnti` command.

The values specified for the `pc` and `mpc` parameters cannot be associated with proxy point codes.

The EIR or V-Flex feature must be turned on or the ANSI41 AIQ or ATINP feature must be enabled before the value specified for the `mpci` parameter can be a true point code.

The LNP, V-Flex, EIR, or INP feature must be turned on or the ANSI41 AIQ or ATINP feature must be enabled before the value specified for the `mpca` parameter can be a true point code. The GTT LS ARI feature must be enabled before the `mrnset` and `mrnpc` parameters can be specified.

The value specified for the `mrnpc` parameter must be a full point code.

The value specified for the `mrnset` parameter must already exist in the MRN table.

The MRN table is corrupt or cannot be found.

The point codes and alternate RI Mate point codes must have compatible network types as shown:

- ITUI, ITU-N, ITU-I spare, ITU-N-spare—ITUI, ITU-N, ITU-I spare, ITU-N-spare
- ANSI—ANSI
- ITUN-24—ITUN-24
- ITUN-16---ITUN-16



The value specified for the `mrnpc` parameter must already exist in the specified MRN Set.

If the `mrnset` parameter is specified, then the `mrnpc/mrnPCA/mrnPCi/mrnPCn/mrnPCn24/mrnPCn16` parameter must be specified.

If the `eswt`, `grpwt`, or `thr` parameter is specified, then the `mrnpc` parameter cannot be specified.

The `mrnset` parameter cannot be specified if the MAP Set specified by the `mapset` parameter contains a True Point Code.

The `chg-map` command will reject provisioning of local subsystem for ITUN16 SID, so that ITUN16 MSUs will not be forwarded to Local Subsystems.

## Notes

When the ANSI/ITU SCCP Conversion feature is enabled, the Concerned Point Code (CSPC) Group's network type can be of a different network than the mated application's network type. For example, the mated application's network type could be ANSI and the CSPC Group could be ITU or mixed with ANSI, ITU, and ITUN concerned point codes.

## Multiplicity Modes

For the `-map` commands, an entity set consists of a group of PC/SSNs that are used for traffic distribution, and an RC group consists of PC/SSNs within an entity set that have the same RC. In *loadsharing* mode, an entity set contains 1 RC group. In *combined loadsharing/dominant* mode, an entity set can contain multiple loadsharing groups.



### Note:

For *dominant* and *combined loadsharing/dominant* modes, the PC/SSN in the MAP table where traffic distribution initializes is determined by the result of GTT translation and is referred to as the preferred PC/SSN. The preferred PC/SSN may not be the lowest cost entry.

The EAGLE supports the following multiplicity modes for nodes/subsystems:

- When a PC/SSN pair is not replicated, the pair is in *solitary* (SOL) mode. The subsystem acts as the only application, with no backup. If this subsystem fails, messages routed to it are discarded and SCCP management returns "Subsystem Unavailable" messages to the originator.
- A group of replicated PC/SSN pairs are in *dominant* (DOM) mode if each PC/SSN pair in the group has a unique RC. The preferred PC/SSN acts as the primary subsystem while the higher cost systems act as backups.
- A group of replicated PC/SSN pairs are in *load sharing* (SHR) mode if each PC/SSN pair in the group has the same RC. All messages are evenly distributed at the SCCP level to all nodes/subsystems in the group. If failure occurs, the non-affected subsystem assumes the load of its failed mate.
- The *combined load sharing/dominant* (COM) mode supports a combination of load sharing and dominant mode. A group of PC/SSN pairs are in COM mode when at

least two of the PC/SSN pairs have the same RC and another node subsystem in the group has a different RC.

The `SSO` parameter changes the initialization of the subsystem status (“prohibited” or “allowed”) for PC/SSN MAP entries. The system previously marked the subsystem status “allowed” (OFF) for each PC/SSN entry. The `SSO` option marks the subsystem status “prohibited” for each entry that has `SSO=ON`. This causes the EAGLE to generate an SST to the remote PC when an MTP-RESUME is received. Upon reception of an SSA, the subsystem status is marked “allowed”.

In this command, only ITU-international and ITU national point codes support the spare point code subtype prefix (S-).

When the Flexible GTT Load Sharing feature is turned on, MAP Load-Sharing Sets are supported. Each MAP set is identified by a new `mapset` parameter.

When the Weighted GTT Loadsharing feature is turned on, weighted entity sets and RC groups are supported, and threshold values can be assigned to each PC/SSN in a weighted entity set.

### Output

```
chg-map:pc=1-1-0:ssn=10:mpc=1-1-3:mssn=10:materc=40:mapset=362
```

```
tekelecstp 11-03-22 12:29:22 EST EAGLE 44.0.0
chg-map:pc=1-1-0:ssn=10:mpc=1-1-3:mssn=10:materc=40:mapset=362
Command entered at terminal #4.
CHG-MAP: MASP A - MESSAGE: EXTENDED PROCESSING REQUIRED
CHG-MAP: MASP A - COMPLTD
```

```
;
```

```
chg-map:pc=1-1-1:ssn=100:mrc=no:srm=no
```

```
tekelecstp 11-03-22 12:29:22 EST EAGLE 44.0.0
chg-map:pc=1-1-1:ssn=100:mrc=no:srm=no
Command entered at terminal #4.
CHG-MAP: MASP A - MESSAGE: EXTENDED PROCESSING REQUIRED
CAUTION: THE VALUE OF SRM IS EFFECTIVE WHEN MULT IS COM OR DOM AND
THE VALUE OF MRC IS EFFECTIVE WHEN MULT IS DOM.
CHG-MAP: MASP A - COMPLTD
```

```
;
```

### Related Topics

- [dlt-map](#)
- [ent-map](#)
- [rtrv-map](#)

## chg-mate-stp

Use this command to enter mate or self PC (point code) into the database.

 **Note:**

This command is used to populate the mate STP table, and is used to route responses to queries generated by the EAGLE for SFAPP UC #3/4 back to the originating EAGLE if a member of a set of EAGLEs is forming a gateway. For messages to be routed properly, the table in each of the members of the set must have the same entries.

**Parameters****pc (mandatory)**

ANSI point code with subfields *network indicator-network cluster-network cluster member (ni-nc-ncm)*.

**Synonym:**

*pca*

**Range:**

000-255 The point code 000-000-000 is not a valid point code.

**pc/pca/pci/pcn/pcn24/pcn16 (mandatory)**

Point code.

 **Note:**

See [Point Code Formats and Conversion](#) for a detailed description of point code formats, rules for specification, and examples.

**pci (mandatory)**

ITU international point code with subfields *zone-area-id*. The *prefix* subfield indicates a spare point code (*prefix-zone-area-id*)

**Range:**

*s-*, 0-255

Specify a valid value for each subfield of the point code, and separate the subfields with a dash (-).

*prefix-s*

*zone-0-7*

*area-000-255*

*id-0-7*

The point code 000-000-000 is not a valid point code.

**pcn (mandatory)**

ITU international point code with subfields *zone-area-id*. The *prefix* subfield indicates a spare point code (*prefix-zone-area-id*)

**Range:**

*s*-, 0-16383, *aa-zz*

Specify a valid value for each subfield of the point code, and separate the subfields with a dash (-).

*prefix-s*

*nnnnn-0-16383*

*gc-aa-zz*

*m1-m2-m3-m4-0-14* for each member; values must sum to 14

**pcn24 (mandatory)**

24-bit ITU national point code with subfields *main signaling area-sub signaling area-signaling point (msa-ssa-sp)*.

**Range:**

000-255

Specify a valid value for each subfield of the point code, and separate the subfields with a dash (-).

*msa-000-255*

*ssa-000-255*

*sp-000-255*

**pcn16 (mandatory)**

16-bit ITU national point code with subfields *main signaling area-sub signaling area-signaling point (msa-ssa-sp)*.

**Range:**

000---127

Specify a valid value for each subfield of the point code, and separate the subfields with a dash (-).

*un---000---127*

*sna---000---15*

*mna---000---31*

**Example**

This example adds a point code:

```
chg-mate-stp:pc=10-20-30
```

This example adds a 24-bit ITU-N secondary point code:

```
chg-mate-stp:pcn24=99-99-99
```

This example adds a spare ITU-N secondary point code:

```
chg-mate-stp:pcn=s-12345
```

This example adds a 16-bit ITU-N secondary point code:

```
chg-mate-stp:pcn16=121-5-10
```

### Dependencies

Mate STP point code must be present in either destination table or SID table.

Point code already exist in mate STP table.

Point code entered must be in same network as other existing point codes.

Mate stp table is full.

### Notes

- The command is rejected when the point code is in invalid format.
- The command is rejected when point code is of a different network than the existing point codes/code's network.
- The command is rejected when the stp\_table is full, as in, there are 16 point codes in the table already.
- The command is rejected when the point code specified already exists in the table.
- The command is rejected when no DPC (destination point code) exists for the specified point code. To add a new point code in the STP table, either it should be in the SID table or it should exist in the destination point code table.

### Output

```
chg-mate-stp:pci=3-3-1
```

```
Searching destination table on disk - please wait...
```

```
Searching route table on disk - please wait...
```

```
Command Accepted - Processing
```

```
tekelecstp 18-05-28 17:24:37 MST EAGLE 46.6.2.0.0-73.19.0
```

```
chg-mate-stp:pci=3-3-1
```

```
Command entered at terminal #2.
```

```
;
```

```
tekelecstp 18-05-28 17:24:38 MST EAGLE 46.6.2.0.0-73.19.0
```

```
CHG-MATE-STP: MASP B - COMPLTD
```

## chg-meas

Use this command to change both the report and collecting status of the OAM based measurement subsystem.

### Note:

After the Measurements Platform collection function has been enabled, the `collect=on/off` parameter controls only the output of reports to the UI. The parameter has no effect on enabling and disabling collection and report generation for the Measurements Platform. Report generation for the Measurements Platform is controlled by the `rept-ftp-meas` and `chg-measopts` commands.

## Parameters

### **collect (optional)**

Activates or deactivates the reporting of scheduled measurements to the UI when the E5-OAM Integrated Measurements feature is on. This parameter does not affect measurements collection and generation for the Measurements Platform. It only activates or deactivates the reporting of scheduled measurements to the UI for the Measurements Platform.

#### **Range:**

*on*

*off*

#### **Default:**

No change to value

#### **System Default:**

*off*

### **complink (optional)**

Activates or deactivates scheduled measurement report for links.

#### **Range:**

*on*

*off*

#### **Default:**

Current value

### **complnkset (optional)**

Activates or deactivates scheduled measurement report for linksets.

#### **Range:**

*on*

*off*

#### **Default:**

Current value

### **gtwylnkset (optional)**

Activates or deactivates the scheduled GTWY measurement report for the linkset.

#### **Range:**

*on*

*off*

#### **Default:**

Current value

**gtwylsfltr (optional)**

Filters the linksets included in the GTWY report.

**Range:*****both***

Only gateway linksets are included in the report to the terminal and SEAS.

***stp***

Only gateway linksets are included in the report to the terminal. All defined linksets are included in the report to SEAS.

***seas***

All defined linksets are included in the report to the terminal. Only gateway linksets are included in the report to SEAS.

***none***

All defined linksets are included in the report to the terminal and SEAS

**gtwystp (optional)**

Activates or deactivates the scheduled GTWY measurement report for the STP.

**Range:**

*on*

*off*

**Default:**

Current value

**systotstp (optional)**

Activates or deactivates scheduled measurement report for STP system totals.

**Range:**

*on*

*off*

**Default:**

Current value

**systottt (optional)**

Activates or deactivates scheduled measurement report for translation type system totals.

**Range:**

*on*

*off*

**Default:**

Current value

**Example**

```
chg-meas:collect=on
```

```
chg-  
meas:complink=on:complnkset=on:systotst=off:systotstp=off:collect=on  
  
chg-meas:gtwylsfltr=both
```

### Dependencies

At least one optional parameter must be specified.

If the 15 Minute Measurements and Measurements Platform collection functions are provisioned (see the `chg-measopts` command), then the `collect=on` parameter cannot be specified.

At least one SLK or SIP/DEIR connection must be configured before the `collect=on` parameter is specified.

If the Integrated Measurements feature is turned on and the link count exceeds 700 links, then the `systotst=on`, `systotst=on`, `complnkset=on`, `complink=on`, `gtwystp=on`, or `gtwylnkset=on` parameter cannot be specified.

Beginning with Release 46.3, basic OAM measurements are not supported. To turn `collect=on`, either MCPM or integrated measurements should be enabled.

### Notes

Activated scheduled reports print at serial ports configured for traffic-related unsolicited messages (the `traf=yes` parameter of the `chg-trm` command).

When the Measurements Platform is not enabled, the daily maintenance scheduled reports are always allowed and cannot be inhibited.

*Maintenance Guide* provides detailed information on measurements and measurement reports.

### Output

```
chg-  
meas:complink=on:complnkset=on:systotst=off:systotstp=off:collect=on  
  
rlghncxa03w 04-01-18 17:02:57 EST EAGLE 31.3.0  
CHG-MEAS: MASP A - COMPLTD  
;
```

### Related Topics

- [copy-meas](#)
- [rept-ftp-meas](#)
- [rept-meas](#)
- [rtrv-meas-sched](#)

## chg-measopts

Use this command to:

- turn on the collection function for Integrated Measurements and Measurements Platform,



- turn the collection function for 15 Minute Measurements on or off
- turn on and off the unchannelized link label for high-speed MTP2 links
- turn the CLLI-based file name option for measurements reports files on or off
- activate or de-activate automatic generation and FTP transfer of scheduled measurements reports to the FTP server

 **Note:**

After the Measurements Platform or Integrated Measurements collection function has been enabled, it cannot be disabled with this command.

 **Caution:**

Do not execute the `chg-measopts:platformenable=on` or `chg-measopts:oamhcmeas=on` command near a collection starting boundary. The best times for executing these commands are xx07, xx17, xx37 and xx47, where xx is any hour, from 00-23.

## Parameters

 **Note:**

As of Release 45.0, the `all`, `avldlink`, `avllink`, `avlstplan`, `cllibasedname`, `collect15min`, `complink`, `complnkset`, `compsctpasc`, `compsctpcard`, `compua`, `gtwylnkset`, `gtwylsdestni`, `gtwylsonismt`, `gtwylsorigni`, `gtwyorigni`, `gtwyorigninc`, `gtwystp`, `nmlink`, `nmlnkset`, `nmstp`, `systotstp`, `systotstplan`, `systotstt`, `systotsip` and `systotsfthrot` parameters can be set using the individual parameters or as options for the on and off parameters.

 **Note:**

The options for the on and off parameters are described in the Notes section.

### **a11 (optional)**

Activates or deactivates the automatic generation and FTP transfer of all scheduled measurements reports.

 **Note:**

The `all` parameter does not change the setting of the `platformenable`, `cllibasedname`, `collect15min`, `unchlinklabel`, and `oamhcmeas` parameters.

**Range:**

*on*

*off*

**Default:**

No change to the current value

**avldlink (optional)**

Activates or deactivates the automatic generation and FTP transfer of the scheduled daily availability measurement report for links.

**Range:**

*on*

*off*

**Default:**

No change to the current value

**System Default:**

*off*

**avllink (optional)**

Activates or deactivates the automatic generation and FTP transfer of the scheduled hourly availability measurement report for links.

**Range:**

*on*

*off*

**Default:**

No change to the current value

**System Default:**

*off*

**cllibasedname (optional)**

Enable or disable CLLI-based measurements report file name option.

**Range:**

*on*

*off*

**Default:**  
No change to the current value

**System Default:**  
*off*

**collect15min (optional)**

Turns on or off the 15 Minute Measurements collection function.

**Range:**

*on*

*off*

**Default:**  
No change to the current value

**System Default:**  
*off*

**complink (optional)**

Activates or deactivates the automatic generation and FTP transfer of the scheduled component measurement report for links.

**Range:**

*on*

*off*

**Default:**  
No change to the current value

**System Default:**  
*off*

**complinkset (optional)**

Activates or deactivates the automatic generation and FTP transfer of the scheduled component measurement report for linksets.

**Range:**

*on*

*off*

**Default:**  
No change to the current value

**System Default:**  
*off*

**compsctpasoc (optional)**

Activates or deactivates the automatic generation and FTP transfer of the scheduled component measurement report for per association SCTP data.

**Range:**

*on*

*off*

**Default:**

No change to the current value

**compctpcard (optional)**

Activates or deactivates the automatic generation and FTP transfer of the scheduled component measurement report for per card SCTP data.

**Range:**

*on*

*off*

**Default:**

No change to the current value

**compua (optional)**

Activates or deactivates the automatic generation and FTP transfer of the scheduled component measurement report for M3UA and SUA application server/association pairs.

**Range:**

*on*

*off*

**Default:**

No change to the current value

**gtwylnkset (optional)**

Activates or deactivates the automatic generation and FTP transfer of scheduled GTWY measurement report for linksets.

**Range:**

*on*

*off*

**Default:**

No change to the current value

**System Default:**

*off*

**gtwylsdestni (optional)**

Activates or deactivates the automatic generation and FTP transfer of scheduled GTWY link set measurement report for destination NI

**Range:**

*on*

*off*

**Default:**

No change to the current value

**System Default:**

*off*

**gtwylsonismt (optional)**

Activates or deactivates the automatic generation and FTP transfer of scheduled GTWY linkset measurement report for ISUP message type per linkset per originating NI

**Range:**

*on*

*off*

**Default:**

No change to the current value

**System Default:**

*off*

**gtwylsorigni (optional)**

Activates or deactivates the automatic generation and FTP transfer of scheduled GTWY link set measurement report for originating NI

**Range:**

*on*

*off*

**Default:**

No change to the current value

**System Default:**

*off*

**gtwyorigni (optional)**

Activates or deactivates the automatic generation and FTP transfer of scheduled GTWY link measurement report for originating NI.

**Range:**

*on*

*off*

**Default:**

No change to the current value

**System Default:**

*off*

**gtworigininc (optional)**

Activates or deactivates the automatic generation and FTP transfer of scheduled GTWY link measurement report for originating NI and NC.

**Range:**

*on*

*off*

**Default:**

No change to the current value

**System Default:**

*off*

**gtwystp (optional)**

Activates or deactivates the automatic generation and FTP transfer of scheduled GTWY measurement report for STP.

**Range:**

*on*

*off*

**Default:**

No change to the current value

**System Default:**

*off*

**nm1ink (optional)**

Activates or deactivates automatic generation and FTP transfer of the scheduled network management measurement report for links.

**Range:**

*on*

*off*

**Default:**

No change to the current value

**System Default:**

*off*

**nm1nkset (optional)**

Activates or deactivates automatic generation and FTP transfer of the scheduled network management measurement report for link sets.

**Range:**

*on*

*off*

**Default:**

No change to the current value

**System Default:**

*off*

**nms<sub>tp</sub> (optional)**

Activates or deactivates automatic generation and FTP transfer of scheduled network management measurement report for STP.

**Range:**

*on*

*off*

**Default:**

No change to the current value

**System Default:**

*off*

**oamhcmeas (optional)**

Turns on the Integrated Measurements collection function on the E5-OAM card. This function cannot be turned off after it has been turned on.

**Range:**

*on*

**Default:**

No change to the current value.

**System Default:**

*off*

**o<sub>off</sub> (optional)**

This parameter turns off the specified options. Up to 8 comma-separated unique options can be specified.

**Range:**

*all*

*avldlink*

*avllink*

*avlstplan*

*cllibasedname*

*collect15min*

*complink*

*complnkset*

*compsctpasoc*

*compsctpcard*

*compua*

*gtwylnkset*

*gtwylsdestni*

*gtwylsonismt*

*gtwylsorigni*

*gtwyorigni*

*gtwyorigninc*

*gtwystp*

*nmlink*

*nmlnkset*

*nmstp*

*systotidpr*

*systotsfthrot*

*systotsip*

*systotstp*

*systotstplan*

*systottt*

*unclinklabel*

**on (optional)**

This parameter turns on the specified options. Up to 8 comma-separated unique options can be specified.

**Range:**

*all*

*avldlink*

*avllink*



*avlstplan*  
*cllibasedname*  
*collect15min*  
*complink*  
*complnkset*  
*compsctpasoc*  
*compsctpcard*  
*compua*  
*gtwylnkset*  
*gtwylsdestni*  
*gtwylsonismt*  
*gtwylsorigni*  
*gtwyorigni*  
*gtwyorigninc*  
*gtwystp*  
*nmlink*  
*nmlnkset*  
*nmstp*  
*oamhcmeas*  
*platformenable*  
*systotidpr*  
*systotsfthrot*  
*systotsip*  
*systotstp*  
*systotstplan*  
*systottt*  
*unlinklabel*

**platformenable (optional)**

Turns on the Measurements Platform collection function.  
This parameter cannot be turned off after it has been turned on.

**Range:**

*on*

**Default:**

No change to the current value

**System Default:**

*off*

**sysoftsfthrot (optional)**

Activates or deactivates automatic generation and FTP transfer of scheduled measurement report for GTT SFTHROT Action.

**Range:**

*on*

*off*

**Default:**

No change to the current value

**System Default:**

*off*

**sysoftsip (optional)**

Activates or deactivates automatic generation and FTP transfer of scheduled measurement report for SIP system totals.

**Range:**

*on*

*off*

**Default:**

No change to the current value

**System Default:**

*off*

**sysoftstp (optional)**

Activates or deactivates automatic generation and FTP transfer of scheduled measurement report for STP system totals.

**Range:**

*on*

*off*

**Default:**

No change to the current value

**System Default:**

*off*

**systottt (optional)**

Activates or deactivates automatic generation and FTP transfer of scheduled measurement report for translation type system totals.

**Range:**

*on*

*off*

**Default:**

No change to the current value

**System Default:**

*off*

**unchlinklabel**

Turns on a link label that identifies unchannelized (high speed) MTP2 links.

**Range:**

*on*

*off*

**Example**

```
chg-measopts:platformenable=on
```

```
chg-measopts:platformenable=on:complink=on:  
complnkset=on:systottt=off:systotstp=off
```

```
chg-measopts:on=complink,complnkset,systottt,systotidpr:  
off=gtwylsonismt,compua,nmlink,nmstp
```

```
chg-measopts:systotsip=on
```

```
chg-measopts:systotsfthrot=on
```

**Dependencies**

The Measurements Platform feature must be turned on before the `platformenable=on` parameter can be specified.

An MCPM card must be in the IS-ANR Restrict state before the Measurements Platform collection option can be enabled.

The 15 Minute Measurements feature must be enabled and turned on before the 15 Minute Measurements collection option can be turned on.

The `platformenable=on` or `oamhcmcas=on` parameter must be specified before the `cllibasedname=on` parameter can be specified.

This command is not allowed while in upgrade mode.

Half-hour collection and report processing cannot be in progress when `collect15min=on` is specified.

Quarter-hour collection and report processing cannot be in progress when `collect15min=off` is specified.

At least one SLK or SIP/DEIR connection must be configured, before the `platformenable=on` or `oamhcmeas=on` parameter is specified.

The `oamhcmeas` or `platformenable` parameter cannot be specified if an OAM/OAMHC to MCP or MCP to OAMHC transition is in progress.

The Integrated Measurements feature must be turned on before the `oamhcmeas=on` parameter can be specified.

The Integrated Measurements or Measurements Platform feature must be turned on before this command can be entered.

The `platformenable` and `oamhcmeas` parameters cannot be specified together in the command.

The same option cannot be specified for the `on` and `off` parameters in the same command.

Parameters cannot be specified individually and as options for the `on` or `off` parameter in the same command.

At least one GTT Action - SFTHROT must be provisioned before the `systotsfthrot=on` parameter is specified.

## Notes

Activated scheduled reports are generated and transferred to the customer's FTP server.

The `rept-ftp-meas` command can be used to manually generate and transfer one report at a time as needed.

The primary application of the `set-time` command is for Daylight Savings Time changes, setting the time forward or backward 1 hour. To reduce effects of `set-time` changes on measurements, the time change should be done within the first 15 minutes of any hour.

The *Maintenance Guide* provides detailed information on measurements and measurement reports.

### **CLLI-Based Measurements Report File Name**

When the CLLI-based file name option (`cllibasedname`) is turned on, the CLLI is added to the measurements report file name, and the year is removed from the file name to ensure that the file name is equal to or fewer than 39 characters.

### **15 Minute Measurements**

When the SEAS feature is turned on and 15 Minute Measurements collection is turned from off to on with the `collect15min=on` parameter, the message "Disabling SEAS Measurements..." is displayed at the UI.

When the SEAS feature is turned on and 15 Minute Measurements collection is running (`collect15min=on`), EAGLE measurements output to the SEAS interface is disabled.

When the SEAS feature is turned on and 15 Minute Measurements collection is turned from on to off with the `collect15min=off` parameter, EAGLE measurements output to the SEAS interface is enabled again.

 **Note:**

If SEAS reporting is turned on, for the 24 hours after the 15 Minute Measurements option is turned from on to off, 30-minute demand SEAS reports for time periods prior to the option status change will contain only 15 minutes of data, and SEAS will not support reporting at the xx15 and xx45 times.

Some quarter-hour measurements data might not be available for 24 hours after turning 15 Minute Measurements collection on. This condition exists for quarter-hour intervals for which 15 Minute Measurements collection has not yet occurred. Data that was collected on a 30-minute basis is available for reporting for up to 24 hours after it is collected. After the 15 Minute Measurements collection option is turned on, this data remains available on a half-hour basis (xx00 and xx30) but is not available on a quarter-hour basis (xx15 and xx45) because no data was collected on the quarter hours. After the 15 Minute Measurements collection option has been turned on for 24 hours, all 15-minute measurements data is available on a quarter-hour basis (xx00, xx15, xx30, and xx45).

In addition, full 30-minute data coverage will not be available until 24 hours after turning off the 15 Minute Measurements collection option. Reports for specific periods will always contain the amount of data collected for that period.

The action of turning 15-minute measurements feature control status on using the `chg-ctrl-feat` command also has an impact on the generation of measurements reports for `period=active`. Specifically, if the feature control status of 15-minute measurements is turned on and a report is requested for the active interval prior to the next scheduled measurements collection (based on the current 15-minute measurements status), the starting time for the period shown in the report will be incorrect. As soon as the next scheduled collection occurs, active reports will show the correct starting time. For example, if 15-minute feature control status is turned on with the `chg-ctrl-feat` command at 13:03, and the 15-minute measurements collection option is turned on using the `chg-measopts` command at 13:05, and a `comp-link` report for `period=active` is requested at 13:10, that report will contain an incorrect interval start time. If the same report is requested at 13:20, the start time shown in the report will be correct, because a collection occurred at 13:15.

A similar limitation exists for `period=last`. If the feature control status of 15-minute measurements is turned on and a report is requested for the last interval prior to the next scheduled measurements collection (based on the current 15-minute measurements status), the start and end times for the period shown in the report will be incorrect. The data presented in the report will correspond to the start and end times. As soon as the next scheduled collection occurs, then `period=last` reports will show the correct start and end times and the corresponding data for that interval. To generate measurements from the last collected interval before the first collection with feature control status on, a `period=specific` report will need to be entered. In the example given in the previous paragraph, the first report requested at 13:10 would not give the last interval, but the data given would correspond to the interval shown in the report. The second report requested at 13:20 would show correct start and end times and the data would correspond to the interval.

If the 15 Minute Measurements collection option is turned from on to off in the first 15 minutes of a half-hour (xx00-xx15 or xx30-xx45) and a demand report is requested in the second 15 minutes of a half-hour (xx15-xx30 or xx45-xx60) for `period=last` or

`period` not specified, the report that is displayed will be the last 15-minute interval (xx00-xx15 or xx30-xx45), not the last collected 15-minute interval (xx45-xx00 or xx15-xx30). Collection did not occur during this 15-minute period, and the message “Measurements data not current” will be displayed. To report the last collected 15-minute interval, `period=specific` must be specified in the command with the correct `qh/hh` value.

The time interval in each measurements report shows which collection option was on when the measurements were collected. (This might not be the option that is currently on if the option was changed in the last 24 hours).

- `xx00-xx15`—None. 15 minutes of data will be collected for the quarter-hour `xx15`.
- `xx15-xx30`—The `xx15` interval will contain no data. The `xx30` interval will contain 30 minutes of data.
- `xx30-xx45`—None. 15 minutes of data will be collected for the quarter-hour `xx15`.
- `xx45-xx00`—The `xx45` interval will contain no data. The `xx00` interval will contain 30 minutes of data.

### on/off options

- `all` —Allows automatic generation and FTP transfer of all scheduled measurements reports. If the 15 Minute Measurements feature is turned on and the `collect15min` parameter is specified, then scheduled reports on FTP can be generated every 15 minutes. This parameter does not change the setting of the `platformenable`, `cllibasedname`, `collect15min`, `unchlinklabel`, and `oamhcmeas` parameters. This option has a default of OFF
- `avldlink` —Allows automatic generation and FTP transfer of the scheduled daily availability measurement report for links. If the 15 Minute Measurements feature is turned on and the `collect15min` parameter is specified, then scheduled reports on FTP can be generated every 15 minutes. This option has a default of OFF.
- `avllink` —Allows automatic generation and FTP transfer of the scheduled hourly availability measurement report for links. If the 15 Minute Measurements feature is turned on and the `collect15min` parameter is specified, then scheduled reports on FTP can be generated every 15 minutes. This option has a default of OFF.
- `avlstplan` —Allows automatic generation and FTP transfer of the scheduled hourly availability measurement report for STPLAN. If the 15 Minute Measurements feature is turned on and the `collect15min` parameter is specified, then scheduled reports on FTP can be generated every 15 minutes. This option has a default of OFF.
- `cllibasedname` —CLLI-based measurements report file name option. This option has a default of OFF.
- `collect15min` —15 Minute Measurements collection function. This option has a default of OFF.
- `complink` —Allows automatic generation and FTP transfer of the scheduled component measurement report for links. If the 15 Minute Measurements feature is turned on and the `collect15min` parameter is specified, then scheduled reports on FTP can be generated every 15 minutes. This option has a default of OFF.
- `complinkset` —Allows automatic generation and FTP transfer of the scheduled component measurement report for linksets. If the 15 Minute Measurements feature is turned on and the `collect15min` parameter is specified, then scheduled reports on FTP can be generated every 15 minutes. This option has a default of OFF.

- *compsctpasoc* —Allows automatic generation and FTP transfer of the scheduled component measurement report for per association SCTP data. If the 15 Minute Measurements feature is turned on and the `collect15min` parameter is specified, then scheduled reports on FTP can be generated every 15 minutes. This option has a default of OFF.
- *compsctpcard* —Allows automatic generation and FTP transfer of the scheduled component measurement report for per card SCTP data. If the 15 Minute Measurements feature is turned on and the `collect15min` parameter is specified, then scheduled reports on FTP can be generated every 15 minutes. This option has a default of OFF.
- *compua* —Allows automatic generation and FTP transfer of the scheduled component measurement report for M3UA and SUA application server/association pairs. If the 15 Minute Measurements feature is turned on and the `collect15min` parameter is specified, then scheduled reports on FTP can be generated every 15 minutes. This option has a default of OFF.
- *gtwylnkset* —Allows automatic generation and FTP transfer of scheduled GTWY measurement report for linksets. If the 15 Minute Measurements feature is turned on and the `collect15min` parameter is specified, then scheduled reports on FTP can be generated every 15 minutes. This option has a default of OFF.
- *gtwylsdestni* —Allows automatic generation and FTP transfer of scheduled GTWY link set measurement report for destination NI. If the 15 Minute Measurements feature is turned on and the `collect15min` parameter is specified, then scheduled reports on FTP can be generated every 15 minutes. This option has a default of OFF.
- *gtwylsonismt* —Allows automatic generation and FTP transfer of scheduled GTWY linkset measurement report for ISUP message type per linkset per originating NI. If the 15 Minute Measurements feature is turned on and the `collect15min` parameter is specified, then scheduled reports on FTP can be generated every 15 minutes. This option has a default of OFF.
- *gtwylsorigni* —Allows automatic generation and FTP transfer of scheduled GTWY link set measurement report for originating NI. If the 15 Minute Measurements feature is turned on and the `collect15min` parameter is specified, then scheduled reports on FTP can be generated every 15 minutes. This option has a default of OFF.
- *gtwylorigni* —Allows automatic generation and FTP transfer of scheduled GTWY link measurement report for originating NI. If the 15 Minute Measurements feature is turned on and the `collect15min` parameter is specified, then scheduled reports on FTP can be generated every 15 minutes. This option has a default of OFF.
- *gtwylorigninc* —Allows automatic generation and FTP transfer of scheduled GTWY link measurement report for originating NI and NC. If the 15 Minute Measurements feature is turned on and the `collect15min` parameter is specified, then scheduled reports on FTP can be generated every 15 minutes. This option has a default of OFF.
- *gtwystp* —Allows automatic generation and FTP transfer of scheduled GTWY measurement report for STP. If the 15 Minute Measurements feature is turned on and the `collect15min` parameter is specified, then scheduled reports on FTP can be generated every 15 minutes. This option has a default of OFF.

- *nmlink* —Allows automatic generation and FTP transfer of the scheduled network management measurement report for links. This option has a default of OFF.
- *nmlinkset* —Allows automatic generation and FTP transfer of the scheduled network management measurement report for link sets. This option has a default of OFF.
- *nmstp* —Allows automatic generation and FTP transfer of scheduled network management measurement report for STP. This option has a default of OFF.
- *oamhcmeas* —Turns ON the Integrated Measurements collection function on the E5-OAM card. This option cannot be turned OFF.
- *platformenable* —Turns ON the Measurements Platform collection function. This option cannot be turned OFF.
- *systotidpr* —Allows scheduled reports for IDPR Measurement Pegs on FTP to be generated every 30 minutes. If the 15 Minute Measurements feature is turned on and the `collect15min` parameter is specified, then scheduled reports on FTP can be generated every 15 minutes. This option has a default of OFF.
- *systotsfthrot* — Allows automatic generation and FTP transfer of scheduled measurement report for GTT SFTHROT actions system totals. If the 15 Minute Measurements feature is turned on and the `collect15min` parameter is specified, then scheduled reports on FTP can be generated every 15 minutes. This option has a default of OFF.
- *systotsip* — Allows automatic generation and FTP transfer of scheduled measurement report for SIP system totals. If the 15 Minute Measurements feature is turned on and the `collect 15min` parameter is specified, then scheduled reports on FTP can be generated every 15 minutes. This option has a default of OFF.
- *systotstp* —Allows automatic generation and FTP transfer of scheduled measurement report for STP system totals. If the 15 Minute Measurements feature is turned on and the `collect15min` parameter is specified, then scheduled reports on FTP can be generated every 15 minutes. This option has a default of OFF.
- *systotstplan* —Allows automatic generation and FTP transfer of the scheduled measurement report for the STPLAN feature system totals. If the 15 Minute Measurements feature is turned on and the `collect15min` parameter is specified, then scheduled reports on FTP can be generated every 15 minutes. This option has a default of OFF.
- *systottt* —Allows automatic generation and FTP transfer of scheduled measurement report for translation type system totals. If the 15 Minute Measurements feature is turned on and the `collect15min` parameter is specified, then scheduled reports on FTP can be generated every 15 minutes. This option has a default of OFF.
- *unchnlinklabel* —Turns ON/OFF a link label that identifies unchannelized (high-speed) MTP2 links. This option has a default of OFF.

### Output

```
chg-
measopts:platformenable=on:complink=on:complnkset=on:systottt=off:sy
stotstp=off
```

```
tekelecstp 08-06-01 14:31:25 EST EAGLE 44.0.0
CHG-MEASOPTS: MASP A - COMPLTD
```

```
;
```



```
chg-  
measopts:on=systotidpr,systottdt,complnkset,complink:off=avldlin  
k,avllink,avlstplan
```

```
tekelecstp 10-12-01 12:15:25 EST EAGLE 44.0.0  
CHG-MEASOPTS: MASP A - COMPLTD
```

```
;
```

```
chg-measopts:systotsip=on
```

```
tekelecstp 12-07-26 14:41:09 EST EAGLE 45.0.0  
chg-measopts:systotsip=on  
Command entered at terminal #4.  
CHG-MEASOPTS: MASP A - COMPLTD
```

```
;
```

```
chg-measopts:systotsfthrot=on
```

```
tekelecstp 15-08-26 14:41:09 EST EAGLE 46.3.0  
chg-measopts:systotsfthrot=on  
Command entered at terminal #4.  
CHG-MEASOPTS: MASP A - COMPLTD
```

```
;
```

### Related Topics

- [chg-ftp-serv](#)
- [chg-meas](#)
- [chg-mtc-measopts](#)
- [chg-netopts](#)
- [dlt-ftp-serv](#)
- [ent-ftp-serv](#)
- [rept-ftp-meas](#)
- [rept-meas](#)
- [rept-stat-meas](#)
- [rtrv-ftp-serv](#)
- [rtrv-measopts](#)
- [rtrv-mtc-measopts](#)
- [rtrv-netopts](#)

## chg-mrn

Use this command to add new point codes, modify existing point codes and relative costs, and add or modify Alternate RI Mate data in the Mated Relay Node (MRN) table. The Intermediate GTT Load-Sharing (IGTTLS) feature must be on to enter this

command. The GTT Load Sharing with Alternate Routing Indicator Feature (GTT LS ARI) must be enabled to provision an Alternate RI Mate.

If the IGTTLS feature is on, and the Flexible GTT Load Sharing feature (FGTTLS) is enabled, then entries are added to or changed in existing MRN sets in the MRN table.

If the IGTTLS feature is on, and the FGTTLS feature is not enabled, then the MRN table can contain a maximum of 3000 entries. If both the IGTTLS and FGTTLS features are on, then the MRN table can contain a maximum of 6000 entries.

### **Caution:**

If any entries are provisioned in the SCCP-SERV table, the maximum number of entries that the MRN table can contain is reduced by that amount. Enter the `rttrv-sccp-serv` command to see if entries exist in the SCCP-SERV table. See the Notes section for additional information on multiplicity modes.

## Parameters

### **Note:**

See [Point Code Formats and Conversion](#) for a detailed description of point code formats, rules for specification, and examples.

### **Note:**

The `mapset`, `mappc`, and `mapssn` parameters indicate whether an Alternate RI Mate search is performed in the MAP table if all PCs provisioned in a given MRN Set are unavailable or congested.

### **pc (mandatory)**

ANSI point code with subfields *network indicator-network cluster-network cluster member (ni-nc-ncm)*.

#### **Synonym:**

*pca*

#### **Range:**

*000-255*

Specify a valid value for each subfield of the point code, and separate the subfields with a dash (-).

When `chg-sid:pctype=ansi` is specified, *ni = 000* is not valid.

When `chg-sid:pctype=ansi` is specified, *nc = 000* is not valid if *ni = 001-005*.

When `chg-sid:pctype=ansi` is specified, *nc = 000* is valid if *ni = 006-255*.

The point code *000-000-000* is not a valid point code.

### **pc/pca/pci/pcn/pcn24/pcn16 (mandatory)**

Post-GTT-translated point code.

**pci (mandatory)**

ITU international point code with subfields *zone-area-id*. The *prefix* subfield indicates a spare point code (*prefix-zone-area-id*).

**Range:**

*s-*, 0-255

Specify a valid value for each subfield of the point code, and separate the subfields with a dash (-).

*prefix*—*s*

*zone*—0-7

*area*—000-255

*id*—0-7

The point code 0-000-0 is not a valid point code.

**pcn (mandatory)**

ITU national point code in the format of a 5-digit number (*nnnnn*); or 2, 3, or 4 numbers (members) separated by dashes (*m1-m2-m3-m4*) as defined by the `chg-stpopts:npcfmti` flexible point code option. A group code must be specified when the ITUDUPPC feature is turned on (*nnnnn-gc*, *m1-m2-m3-m4-gc*). The *prefix* subfield indicates a spare point code (*prefix-nnnnn*, *prefix-nnnnn-gc*, *prefix-m1-m2-m3-m4*, *prefix-m1-m2-m3-m4-gc*).

**Range:**

*s-*, 0-16383, *aa-zz*

Specify a valid value for each subfield of the point code, and separate the subfields with a dash (-).

*prefix*—*s-*

*nnnnn*—0-16383

*gc*—*aa-zz*

*m1-m2-m3-m4*—0-14 for each member; values must sum to 14

**pcn24 (mandatory)**

24-bit ITU national point code with subfields *main signaling area-sub signaling area-signaling point* (*msa-ssa-sp*).

**Range:**

000-255

Specify a valid value for each subfield of the point code, and separate the subfields with a dash (-).

*msa*—000-255

*ssa*—000-255

*sp*—000-255

**pcn16 (mandatory)**

16-bit ITU national point code with subfields *unit number-sub number area-main number area* (*un-sna-mna*).

**Range:**

000--127

Specify a valid value for each subfield of the point code, and separate the subfields with a dash (-).

*un--000--127*

*sna--000--15*

*mna--000--31*

**eswt (optional)**

Entity set weight. The weight assigned to each PC in a weighted entity set.

 **Note:**

This parameter cannot be specified when adding PCs to a weighted entity set or when modifying RC or weight values for an individual PC.

**Range:**

*1 - 99, none*

*none* —Changes a weighted entity set to a non-weighted entity set.

**force (optional)**

This parameter must be specified to modify the *rc*, *rc1*, *rc2*, *rc3*, or *rc4* parameter and the *wt*, *wt1*, *wt2*, *wt3*, or *wt4* parameter in the same command.

Modification of the *wt*, *wt1*, *wt2*, *wt3*, or *wt4* parameters depends on the parameter's current multiplicity state, which depends on the RC value. Changing the *rc* parameter value can change the multiplicity state, which can then cause any of the weight parameter values to become invalid.

**Range:**

*yes*

**grpwt (optional)**

Group weight. The weight assigned to each PC in a weighted RC group.

 **Note:**

This parameter cannot be specified when adding PCs to a weighted entity set or when modifying RC or weight values for an individual PC.

**Range:**

*1 - 99*

**mappc (optional)**

ANSI point code with subfields *network indicator-network cluster-network cluster member (ni-nc-ncm)*.

**Synonym:**

*mappca*

**Range:**

*000-255*

Specify a valid value for each subfield of the point code, and separate the subfields with a dash (-).

When `chg-sid:pctype=ansi` is specified, `ni = 000` is not valid.  
 When `chg-sid:pctype=ansi` is specified, `nc = 000` is not valid if `ni = 001–005`.  
 When `chg-sid:pctype=ansi` is specified, `nc = 000` is valid if `ni = 006–255`.  
 The point code `000-000-000` is not a valid point code.

**Default:**  
`000`

**mappc/mappca/mappci/mappcn/mappcn24/mappcn16 (optional)**

Alternate RI Mate point code.

**mappci (optional)**

ITU international point code with subfields *zone-area-id*. The *prefix* subfield indicates a spare point code (*prefix-zone-area-id*).

**Range:**

*s-*, 0-255

Specify a valid value for each subfield of the point code, and separate the subfields with a dash (-).

*prefix—s*

*zone—0-7*

*area—000-255*

*id—0-7*

The point code `0-000-0` is not a valid point code.

**Default:**

`0-000-0`

**mappcn (optional)**

ITU national point code in the format of a 5-digit number (*nnnnn*); or 2, 3, or 4 numbers (members) separated by dashes (*m1-m2-m3-m4*) as defined by the `chg-stpopts:npcfmti` flexible point code option. A group code must be specified when the ITUDUPPC feature is turned on (*nnnnn-gc*, *m1-m2-m3-m4-gc*). The *prefix* subfield indicates a spare point code (*prefix-nnnnn*, *prefix-nnnnn-gc*, *prefix-m1-m2-m3-m4*, *prefix-m1-m2-m3-m4-gc*).

**Range:**

*s-*, 0-16383, *aa-zz*

Specify a valid value for each subfield of the point code, and separate the subfields with a dash (-).

*prefix—s-*

*nnnnn—0-16383*

*gc—aa-zz*

*m1-m2-m3-m4—0-14* for each member; values must sum to 14

**Default:**

`00000`

**mappcn24 (optional)**

24-bit ITU national point code with subfields *main signaling area-sub signaling area-signaling point* (*msa-ssa-sp*).

**Range:**

`000-255`

Specify a valid value for each subfield of the point code, and separate the subfields with a dash (-).

*msa—000—255*

*ssa—000—255*

*sp—000—255*

**Default:**

*000*

**mapcn16 (optional)**

16-bit ITU national point code with subfields *unit number-sub number area-main number area (un-sna-mna)*.

**Range:**

*000--127*

Specify a valid value for each subfield of the point code, and separate the subfields with a dash (-).

*un---000---127*

*sna---000---15*

*mna---000---31*

**Default:**

*000*

**mapset (optional)**

Alternate RI Mate MAP Set ID. The MAP set where Alternate Routing Indicator searches are performed.

**Range:**

*1 - 36000, dflt*

*dflt*—Default MAP Set

If the `mappc` and `mapssn` parameters are specified, and the `mapset` parameter is not specified, then the `mapset` parameter is automatically set to a value of *dflt*.

**Default:**

No change to the current value

**mapssn (optional)**

Alternate RI Mate Subsystem Number. The subsystem number used for the Alternate Routing Indicator search.

**Range:**

*2 - 255, \*, none*

If the `mapssn=*` parameter is specified, then the values specified for the `mapset` and `mappc` parameters must already exist in the MAP table.

**Default:**

No change to the current value

**mrnset (optional)**

MRN set ID.

**Range:**

1 - 3000, *dflt*  
*dflt* -default MRN set

**pc1 (optional)**

ANSI point code with subfields *network indicator-network cluster-network cluster member (ni-nc-ncm)*.

**Synonym:**

*pca1*

**Range:**

000-255

Specify a valid value for each subfield of the point code, and separate the subfields with a dash (-).

When *chg-sid:pctype=ansi* is specified, *ni = 000* is not valid.

When *chg-sid:pctype=ansi* is specified, *nc = 000* is not valid if *ni = 001-005*.

When *chg-sid:pctype=ansi* is specified, *nc = 000* is valid if *ni = 006-255*.

The point code *000-000-000* is not a valid point code.

**pc1/pca1/pci1/pcn1/pcn241/pcn161 (optional)**

Alternate post-GTT-translated point code.

**pc2 (optional)**

ANSI point code with subfields *network indicator-network cluster-network cluster member (ni-nc-ncm)*.

**Synonym:**

*pca2*

**Range:**

000-255

Specify a valid value for each subfield of the point code, and separate the subfields with a dash (-).

When *chg-sid:pctype=ansi* is specified, *ni = 000* is not valid.

When *chg-sid:pctype=ansi* is specified, *nc = 000* is not valid if *ni = 001-005*.

When *chg-sid:pctype=ansi* is specified, *nc = 000* is valid if *ni = 006-255*.

The point code *000-000-000* is not a valid point code.

**pc2/pca2/pci2/pcn2/pcn242/pcn162 (optional)**

Alternate post-GTT-translated point code.

**pc3 (optional)**

ANSI point code with subfields *network indicator-network cluster-network cluster member (ni-nc-ncm)*.

**Synonym:**

*pca3*

**Range:**

000-255

Specify a valid value for each subfield of the point code, and separate the subfields with a dash (-).

When *chg-sid:pctype=ansi* is specified, *ni = 000* is not valid.

When `chg-sid:pctype=ansi` is specified, `nc = 000` is not valid if `ni = 001–005`.

When `chg-sid:pctype=ansi` is specified, `nc = 000` is valid if `ni = 006–255`.

The point code `000-000-000` is not a valid point code.

#### **pc3/pca3/pci3/pcn3/pcn243/pcn163 (optional)**

Alternate post-GTT-translated point code.

#### **pc4 (optional)**

ANSI point code with subfields *network indicator-network cluster-network cluster member (ni-nc-ncm)*.

##### **Synonym:**

*pca4*

##### **Range:**

*000-255*

Specify a valid value for each subfield of the point code, and separate the subfields with a dash (-).

When `chg-sid:pctype=ansi` is specified, `ni = 000` is not valid.

When `chg-sid:pctype=ansi` is specified, `nc = 000` is not valid if `ni = 001–005`.

When `chg-sid:pctype=ansi` is specified, `nc = 000` is valid if `ni = 006–255`.

The point code `000-000-000` is not a valid point code.

#### **pc4/pca4/pci4/pcn4/pcn244/pcn164 (optional)**

Alternate post-GTT-translated point code.

#### **pci1 (optional)**

ITU international point code with subfields *zone-area-id*. The *prefix* subfield indicates a spare point code (*prefix-zone-area-id*).

##### **Range:**

*s-, 0-255*

Specify a valid value for each subfield of the point code, and separate the subfields with a dash (-).

*prefix—s*

*zone—0-7*

*area—000-255*

*id—0-7*

The point code `0-000-0` is not a valid point code.

#### **pci2 (optional)**

ITU international point code with subfields *zone-area-id*. The *prefix* subfield indicates a spare point code (*prefix-zone-area-id*).

##### **Range:**

*s-, 0-255*

Specify a valid value for each subfield of the point code, and separate the subfields with a dash (-).

*prefix—s*

*zone—0-7*

*area—000-255*

*id—0-7*

The point code `0-000-0` is not a valid point code.



**pci3 (optional)**

ITU international point code with subfields *zone-area-id*. The *prefix* subfield indicates a spare point code (*prefix-zone-area-id*).

**Range:**

*s-*, 0-255

Specify a valid value for each subfield of the point code, and separate the subfields with a dash (-).

*prefix—s*

*zone—0-7*

*area—000-255*

*id—0-7*

The point code *0-000-0* is not a valid point code.

**pci4 (optional)**

ITU international point code with subfields *zone-area-id*. The *prefix* subfield indicates a spare point code (*prefix-zone-area-id*).

**Range:**

*s-*, 0-255

Specify a valid value for each subfield of the point code, and separate the subfields with a dash (-).

*prefix—s*

*zone—0-7*

*area—000-255*

*id—0-7*

The point code *0-000-0* is not a valid point code.

**pcn161 (optional)**

16-bit ITU national point code with subfields *unit number-sub number area-main number area* (*un-sna-mna*).

**Range:**

*000--127*

Specify a valid value for each subfield of the point code, and separate the subfields with a dash (-).

*un---000---127*

*sna---000---15*

*mna---000---31*

**pcn162 (optional)**

16-bit ITU national point code with subfields *unit number-sub number area-main number area* (*un-sna-mna*).

**Range:**

*000--127*

Specify a valid value for each subfield of the point code, and separate the subfields with a dash (-).

*un---000---127*

*sna---000---15*

*mna---000---31*

**pcn163 (optional)**

16-bit ITU national point code with subfields *unit number-sub number area-main number area (un-sna-mna)*.

**Range:**

*000--127*

Specify a valid value for each subfield of the point code, and separate the subfields with a dash (-).

*un---000---127*

*sna---000---15*

*mna---000---31*

**pcn164 (optional)**

16-bit ITU national point code with subfields *unit number-sub number area-main number area (un-sna-mna)*.

**Range:**

*000--127*

Specify a valid value for each subfield of the point code, and separate the subfields with a dash (-).

*un---000---127*

*sna---000---15*

*mna---000---31*

**pcn1 (optional)**

ITU national point code in the format of a 5-digit number (*nnnnn*); or 2, 3, or 4 numbers (members) separated by dashes (*m1-m2-m3-m4*) as defined by the `chg-stpopts:npcfmti` flexible point code option. A group code must be specified when the ITUDUPPC feature is turned on (*nnnnn-gc*, *m1-m2-m3-m4-gc*). The *prefix* subfield indicates a spare point code (*prefix-nnnnn*, *prefix-nnnnn-gc*, *prefix-m1-m2-m3-m4*, *prefix-m1-m2-m3-m4-gc*).

**Range:**

*s-*, *0-16383*, *aa-zz*

Specify a valid value for each subfield of the point code, and separate the subfields with a dash (-).

*prefix—s-*

*nnnnn—0-16383*

*gc—aa-zz*

*m1-m2-m3-m4—0-14* for each member; values must sum to 14

**pcn2 (optional)**

ITU national point code in the format of a 5-digit number (*nnnnn*); or 2, 3, or 4 numbers (members) separated by dashes (*m1-m2-m3-m4*) as defined by the `chg-`

`stpopts:npcfmti` flexible point code option. A group code must be specified when the ITUDUPPC feature is turned on (*nnnnn-gc,m1-m2-m3-m4-gc*). The *prefix* subfield indicates a spare point code (*prefix-nnnnn*, *prefix-nnnnn-gc*, *prefix-m1-m2-m3-m4*, *prefix-m1-m2-m3-m4-gc*).

**Range:**

*s-*, 0-16383, *aa-zz*

Specify a valid value for each subfield of the point code, and separate the subfields with a dash (-).

*prefix—s-*

*nnnnn—0-16383*

*gc—aa-zz*

*m1-m2-m3-m4—0-14* for each member; values must sum to 14

**pcn241 (optional)**

24-bit ITU national point code with subfields *main signaling area-sub signaling area-signaling point* (*msa-ssa-sp*).

**Range:**

000-255

Specify a valid value for each subfield of the point code, and separate the subfields with a dash (-).

*msa—000–255*

*ssa—000–255*

*sp—000–255*

**pcn242 (optional)**

24-bit ITU national point code with subfields *main signaling area-sub signaling area-signaling point* (*msa-ssa-sp*).

**Range:**

000-255

Specify a valid value for each subfield of the point code, and separate the subfields with a dash (-).

*msa—000–255*

*ssa—000–255*

*sp—000–255*

**pcn243 (optional)**

24-bit ITU national point code with subfields *main signaling area-sub signaling area-signaling point* (*msa-ssa-sp*).

**Range:**

000-255

Specify a valid value for each subfield of the point code, and separate the subfields with a dash (-).

*msa—000–255*

*ssa—000–255*

*sp—000–255*

**pcn244 (optional)**

24-bit ITU national point code with subfields *main signaling area-sub signaling area-signaling point* (*msa-ssa-sp*).

**Range:***000-255*

Specify a valid value for each subfield of the point code, and separate the subfields with a dash (-).

*msa—000—255**ssa—000—255**sp—000—255***pcn3 (optional)**

ITU national point code in the format of a 5-digit number (*nnnnn*); or 2, 3, or 4 numbers (members) separated by dashes (*m1-m2-m3-m4*) as defined by the `chg-stpopts:npcfmti` flexible point code option. A group code must be specified when the ITUDUPPC feature is turned on (*nnnnn-gc,m1-m2-m3-m4-gc*). The *prefix* subfield indicates a spare point code (*prefix-nnnnn, prefix-nnnnn-gc, prefix-m1-m2-m3-m4, prefix-m1-m2-m3-m4-gc*).

**Range:***s-, 0-16383, aa-zz*

Specify a valid value for each subfield of the point code, and separate the subfields with a dash (-).

*prefix—s-**nnnnn—0-16383**gc—aa-zz**m1-m2-m3-m4—0-14* for each member; values must sum to 14**pcn4 (optional)**

ITU national point code in the format of a 5-digit number (*nnnnn*); or 2, 3, or 4 numbers (members) separated by dashes (*m1-m2-m3-m4*) as defined by the `chg-stpopts:npcfmti` flexible point code option. A group code must be specified when the ITUDUPPC feature is turned on (*nnnnn-gc, m1-m2-m3-m4-gc*). The *prefix* subfield indicates a spare point code (*prefix-nnnnn, prefix-nnnnn-gc, prefix-m1-m2-m3-m4, prefix-m1-m2-m3-m4-gc*).

**Range:***s-, 0-16383, aa-zz*

Specify a valid value for each subfield of the point code, and separate the subfields with a dash (-).

*prefix—s-**nnnnn—0-16383**gc—aa-zz**m1-m2-m3-m4—0-14* for each member; values must sum to 14**rc (optional)**

Relative cost. The relative cost of the route for the primary PC.

**Range:***0 - 99***rc1 (optional)**

Relative cost 1. The relative cost of the route for mate PC 1.

**Range:***0 - 99*

**rc2 (optional)**

Relative cost 2. The relative cost of the route for mate PC 2.

**Range:**

0 - 99

**rc3 (optional)**

Relative cost 3. The relative cost of the route for mate PC 3.

**Range:**

0 - 99

**rc4 (optional)**

Relative cost 4. The relative cost of the route for mate PC 4.

**Range:**

0 - 99

**thr (optional)**

Threshold. The in-service threshold of all PCs in a weighted entity set or RC group. This parameter cannot be specified when adding PCs to a weighted entity set or RC group or when modifying RC or weight values for an individual PC. If this parameter is not specified, a value of 1% is assigned to each weighted PC.

**Range:**

1 - 100

**wt (optional)**

Weight. The new weight assigned to the primary PC.

**Note:**

This parameter cannot be specified when adding PCs to a weighted entity set.

**Range:**

1 - 99

**wt1 (optional)**

Weight 1. The weight assigned to the mate PC 1 that is being added to the weighted entity set.

**Range:**

1 - 99

**wt2 (optional)**

Weight 2. The weight assigned to the mate PC 2 that is being added to the weighted entity set.

**Range:**

1 - 99

**wt3 (optional)**

Weight 3. The weight assigned to the mate PC 3 that is being added to the weighted entity set.

**Range:**

1 - 99

**wt4 (optional)**

Weight 4. The weight assigned to the mate PC 4 that is being added to the weighted entity set.

**Range:**

1 - 99

**Example**

In this example, the system searches the MRN table for a point code of 1-1-0. If the point code is found, its relative cost is set to 40.

```
chg-mrn:pc=1-1-0:rc=40
```

In this example, the system searches the MRN table for point code 1-1-0. Having found it, the system searches the entity set for 1-1-10. If 1-1-10 is not in the entity set, the command adds point code 1-1-10 is added to the entity set and assigned a relative cost of 30.

```
chg-mrn:pc=1-1-0:pc1=1-1-10:rc1=30
```

In this example, the system searches the MRN table for a point code of 1-1-0. Having found it, the system searches for each of the specified associated point codes in the entity set. If neither associated point code is found, the specified point codes and their relative costs are inserted into the entity set in the MRN table.

```
chg-mrn:pc=1-1-0:pc1=1-1-1:rc1=10:pc2=1-1-10:rc2=20
```

These examples include spare point codes.

```
chg-mrn:pcn=s-1-1-1-123-aa:rc=1:pcn1=s-1-1-1-235-aa:rc1=2:pcn2=s-1-1-1-235-aa:rc2=3
```

```
chg-mrn:pci=s-2-2-1:rc=20:pci1=s-2-2-2:rc1=21:pci2=s-2-100-1:rc2=22
```

```
chg-mrn:pc=1-1-1:rc=30:mrnset=df1t
```

```
chg-mrn:pc=1-1-1:rc=20:pc1=2-2-2:rc1=20:mrnset=111
```

```
chg-mrn:pc=1-1-1:pc1=3-3-3:rc1=30:mrnset=111
```

This example changes a non-weighted entity set to a weighted entity set.

```
chg-mrn:pc=1-1-1:eswt=30
```

```
chg-mrn:pc=1-1-1:eswt=30:thr=50
```

This example changes a weighted entity set to a non-weighted entity set.

```
chg-mrn:pc=1-1-1:eswt=none
```

This example assigns a weight value to each PC in a weighted RC group within a weighted entity set.

```
chg-mrn:pc=1-1-1:grpwt=20
```

This example assigns a threshold value to each PC in the RC group within a weighted entity set.

```
chg-mrn:pc=1-1-1:thr=70
```

This example assigns a weight and threshold to each PC in an RC group within a weighted entity set.

```
chg-mrn:pc=1-1-1:grpwt=20:thr=70
```

This example assigns PC 1 a weight of 30.

```
chg-mrn:pc=1-1-1:wt=30
```

This example adds PC 1 to the weighted entity set containing PC 1 and assigns PC 1 an RC of 30 and a weight of 20.

```
chg-mrn:pc=1-1-0:pc1=1-1-10:rc1=30:wt1=20
```

This example assigns specified PCs and their associated RCs and weights to the weighted entity set that contains the point code 1.

```
chg-  
mrn:pc=1-1-0:pc1=1-1-1:rc1=10:wt1=35:pc2=1-1-10:rc2=20:wt2=20
```

This example modifies both RC values and weights for PCs in an existing weighted entity set.

```
chg-  
mrn:pc=1-1-0:rc=30:wt=10:pc1=1-1-10:rc1=20:pc2=1-1-2:wt2=5:force=yes
```

This example modifies only weights for PCs in an existing weighted entity set.

```
chg-mrn:pc=1-1-0:wt=10:pc1=1-1-10:wt1=20:pc2=1-1-2:wt2=5  
chg-mrn:pc=1-1-1:mrnset=111:mapset=df1t:mappc=2-1-1:mapssn=10
```

```
chg-mrn:pc=1-1-1:mrnset=111:mapssn=*
```

```
chg-mrn:pc=1-1-1:mrnset=111:mapset=1:mappc=2-1-2:mapssn=12
```

```
chg-mrn:pci=1-002-1:mrnset=10:mapset=2:mappcn=00126:mapssn=12
```

Example for 16 bit PC entry:

```
chg-  
mrn:pcn16=1-14-0:rc=10:wt=30:pcn161=45-1-0:rc1=10:wt1=10:mrnset=df1t
```

## Dependencies

The Intermediate Global Title Translation Load Sharing feature must be turned on before this command can be entered.

The `apca` and `pcn24/pcn16` parameters cannot be specified for the same MRN set.

When a new point code is specified, its relative cost (`rc`) must be specified; a new point code and its relative cost must be entered together in the command.

A new point code that is specified in the command must not already exist in the MRN table.

The point codes cannot have the same value as the EAGLE SID.

The same point code value cannot be entered more than once in the MRN table.

Each point code group can contain a maximum of 128 point codes.

ITU-N point codes must be in the format set by the `npcfmti` parameter of the `chg-stpopts` command. (Use the `rtrv-stpopts` command to display the STP option settings).

Mate remote point codes must already exist as destinations in the Ordered Route entity set or reside in a cluster destination for which ordered routes are specified.

To change the relative cost for a point code, the point code must already exist in the MRN table.

The Flexible GTT Loadsharing feature must be enabled before the `mrnset` parameter can be specified.

If the Flexible GTT Loadsharing feature is enabled, the specified PC must already exist in the specified MRN set.

The specified MRN set must already exist in the MRN table.

If the IGTTLS feature is on, and the FGTTLS feature is not enabled, then the MRN table can contain a maximum of 3000 entries. If both the IGTTLS and FGTTLS features are on, then the MRN table can contain a maximum of 6000 entries.

The Weighted GTT Loadsharing feature must be turned on before the `wt/wt1/wt2/wt3/wt4`, `eswt`, `grpwt`, or `thr` parameter can be specified.

If the `rc` parameter is not specified, the `wt` parameter cannot be specified.

The `eswt` and `grpwt` parameters cannot be specified together in the command.

If the `eswt=none` parameter is specified, the `thr` parameter cannot be specified.

If the `eswt`, `grpwt`, or `thr` parameters are specified, the `rc/rc1/rc2/rc3/rc4` and `wt/wt1/wt2/wt3/wt4` parameters cannot be specified.

If the Weighted GTT Loadsharing feature is enabled, and individual PCs are being modified, the `wt` or `rc` parameter must be specified for each PC.

Alternate point codes cannot be specified when modifying an entity set or RC group.

If the `pc1/pc2/pc3/pc4` parameter is specified for a weighted entity set, a corresponding `wt1/wt2/wt3/wt4` parameter must be specified.

If the `pc1/pc2/pc3/pc4` parameter is specified for a non-weighted entity set, the `wt1/wt2/wt3/wt4` parameter cannot be specified.

The `eswt=none` parameter cannot be specified for non-weighted entity sets.

The `grpwt` and `thr` parameters cannot be specified for non-weighted entity sets.

At least one additional point code must be specified.

If the `wt/wt1/wt2/wt3/wt4` parameter is specified, the corresponding `pc/pc1/pc2/pc3/pc4` parameter must be specified.

The `pc/pc1/pc2/pc3/pc4` parameter values must be full point codes.

The SID table is corrupt or cannot be found by the system.

The Route table is corrupt or cannot be found by the system.

At least one optional parameter must be specified.



If the Weighted GTT Loadsharing feature is not enabled, and individual PCs are being modified, the `rc` parameter must be specified for each PC.

The `eswt`, `grpwt`, and `thr` parameters cannot be specified for solitary or dominant entity sets.

If the `chg-sid:pctype=ansi` command is entered, a value of `ni=000` cannot be specified.

If the `chg-sid:pctype=ansi` command is entered, and a value of `ni=001 – 005` is specified, a value of `nc=000` cannot be specified.

The `force=yes` parameter must be specified before the `rc`, `rc1`, `rc2`, `rc3`, or `rc4` parameter can be specified in the same command with the `wt`, `wt1`, `wt2`, `wt3`, or `wt4` parameter.

The `force` parameter can be used only to specify the `rc`, `rc1`, `rc2`, `rc3`, or `rc4` parameter and the `wt`, `wt1`, `wt2`, `wt3`, or `wt4` parameter in the same command.

The value specified for the `pc/pc1/pc2/pc3/pc4` parameter cannot be associated with a proxy point code.

The GTT LS ARI feature must be enabled before the `mapset`, `mappc`, or `mapssn` parameter can be specified.

The value specified for the `mappc` parameter must be a full point code.

The point codes and alternate RI Mate point codes must have compatible network types as shown:

- ITUI, ITU-N, ITU-I spare, ITU-N-spare—ITUI, ITU-N, ITU-I spare, ITU-N-spare
- ANSI—ANSI
- ITUN-24—ITUN-24
- ITUN-16---ITUN-16

The MAP table is corrupt or cannot be found.

The value specified for the `mapset` parameter must already exist in the MAP table.

The values specified for the `mappc` and `mapssn` parameters must already exist in the specified MAP Set.

The values specified for the `mapset` and `mappc` parameters must already exist in the MAP table.

The value specified for the `mappc` parameter cannot match an existing STP point code.

The `mappc` and `mapssn` parameters must be specified together in the command.

## Notes

For MRN commands, an entity set consists of a group of PCs that are used for traffic distribution, and an RC group consists of PCs within an entity set that have the same RC. In loadsharing mode, an entity set contains 1 RC group. In combined/dominant loadsharing mode, an entity set can contain multiple loadsharing groups.

All of the point codes that are specified in one command must exist in the same point code group in the MRN table.

In this command, only ITU-international and ITU national point codes support the spare point code subtype prefix (s-).

The EAGLE supports the following multiplicity modes for nodes/subsystems.

- A group of replicated PCs are in *dominant* mode if each PC in the group has a unique RC. The specified subsystem with the lowest RC acts as the primary subsystem, while the mate subsystem acts as a backup. In the event of congestion, messages route to the mate subsystem. When the congestion subsides, messages are again routed to the primary (dominant) subsystem.
- A group of replicated PCs are in *load sharing* mode if each PC in the group has the same RC. All messages are evenly distributed at the SCCP level to all nodes/subsystems in the group. In the event of congestion or failure, the non-affected subsystem assumes the load of its failed or congested mate.
- The *combined load sharing/dominant* mode supports a combination of load sharing and dominant mode. A group of PCs are in combined load sharing/dominant mode when at least two of the PCs have the same RC and another node subsystem in the group has a different RC. A combination of node accessibility and RC determines the preferred PC.

When the Weighted GTT Loadsharing feature is turned on, weighted entity sets and RC groups are supported, and threshold values can be assigned to each PC.

When the GTT LS ARI feature is enabled, the Alternate RI Mate for an MRN Set can be provisioned.

### Output

```
chg-mrn:pci=1-1-2:mrnset=111:mapset=10:mappc=1-1-1:mapssn=*
```

```
tekelecstp 11-03-22 15:43:00 EST EAGLE 44.0.0
chg-mrn:pci=1-1-2:mrnset=111:mapset=10:mappc=1-1-1:mapssn=*
Command entered at terminal #4.
CHG-MRN: MASP A - MESSAGE: EXTENDED PROCESSING REQUIRED
CHG-MRN: MASP A - COMPLTD
;
```

### Related Topics

- [dlt-mrn](#)
- [ent-mrn](#)
- [rtrv-mrn](#)

## chg-mtc-measopts

Use this command to enable or disable the automatic generation and FTP transfer of scheduled maintenance measurements reports to the FTP server.

## Parameters

 **Note:**

As of Release 46.6, the `mtcdaiq`, `mtcdatinpq`, `mtcdeir`, `mtcdgttpath`, `mtcdgttset`, `mtcdlink`, `mtcdlnkset`, `mtcdlnp`, `mtcdmap`, `mtcdnp`, `mtcdsctpasoc`, `mtcdsctpcard`, `mtcdsip`, `mtcdstp`, `mtcdstplan`, `mtcdua`, `mtcdvflex`, `mtchaiq`, `mtchatinpq`, `mtcheir`, `mtchgttpath`, `mtchgttset`, `mtchlnp`, `mtchmap`, `mtchnp`, `mtchvflex`, `mtcddeir`, `mtchdeir` and `mtcdsfthrot` parameters can be specified individually or as options for the `on` and `off` parameters.

 **Note:**

The options for the `on` and `off` parameters are specified in the Notes section.

### **mtcdaiq (optional)**

Activates or deactivates the automatic generation and FTP transfer of the scheduled daily maintenance measurement report for ANSI41 AnalyzedInformation Query (ANSI41 AIQ).

**Range:**

*on*

*off*

**Default:**

No change to the current value.

**System Default:**

*off*

### **mtcdatinpq (optional)**

Activates or deactivates the automatic generation and FTP transfer of the scheduled daily maintenance measurement report for ATI Number Portability Query (ATINP).

**Range:**

*on*

*off*

**Default:**

No change to the current value

**System Default:**

*off*

**mtcdeir (optional)**

Activates or deactivates the automatic generation and FTP transfer of the daily maintenance measurement reports for Equipment Identity Register (EIR).

**Range:**

*on*

*off*

**Default:**

No change to the current value

**System Default:**

*off*

**mtcdenum (optional)**

Activates or deactivates the automatic generation and FTP transfer of the daily ENUM NP maintenance measurement reports.

**Range:**

*on*

*off*

**Default:**

No change to the current value

**System Default:**

*off*

**mtcdgttpath (optional)**

Activates or deactivates the automatic generation and FTP transfer of the scheduled daily maintenance measurement report for GTT Action per path measurements.

**Range:**

*on*

*off*

**Default:**

No change to the current value

**System Default:**

*off*

**mtcdgttset (optional)**

Activates or deactivates the automatic generation and FTP transfer of the scheduled daily per GTTSET maintenance measurement report.

**Range:**

*on*

*off*

**Default:**  
No change to the current value

**System Default:**  
*off*

**mtcdlink (optional)**

Activates or deactivates the automatic generation and FTP transfer of the daily maintenance measurement report for links.

**Range:**

*on*

*off*

**Default:**  
No change to the current value

**System Default:**  
*off*

**mtcdlinkset (optional)**

Activates or deactivates the automatic generation and FTP transfer of the daily maintenance measurement report for link sets.

**Range:**

*on*

*off*

**Default:**  
No change to the current value

**System Default:**  
*off*

**mtcdlnp (optional)**

Activates or deactivates the automatic generation and FTP transfer of the scheduled daily maintenance measurement report for LNP.

**Range:**

*on*

*off*

**Default:**  
No change to the current value

**System Default:**  
*off*

**mtcdmap (optional)**

Activates or deactivates the automatic generation and FTP transfer of the scheduled daily maintenance measurement report per GSM MAP Screening server entry.

**Range:**

*on*

*off*

**Default:**

No change to the current value

**System Default:**

*off*

**mtcdnp (optional)**

Activates or deactivates the automatic generation and FTP transfer of the scheduled daily maintenance measurement report for INP.

**Range:**

*on*

*off*

**Default:**

No change to the current value

**System Default:**

*off*

**mtcdsctpasoc (optional)**

Activates or deactivates the automatic generation and FTP transfer of the scheduled daily maintenance measurement report for per association SCTP data.

**Range:**

*on*

*off*

**Default:**

No change to the current value

**mtcdsctpcard (optional)**

Activates or deactivates the automatic generation and FTP transfer of the scheduled daily maintenance measurement report for per card SCTP data.

**Range:**

*on*

*off*

**Default:**

No change to the current value

**mtcdsfthrot (optional)**

Activates or deactivates the automatic generation and FTP transfer of the scheduled daily maintenance measurement report for GTT SFTHROT Action measurements.

**Range:**

*on*

*off*

**Default:**

No change to the current value

**System Default:**

*off*

**mtcdsip (optional)**

Activates or deactivates the automatic generation and FTP transfer of the daily maintenance measurement report for SIP.

**Range:**

*on*

*off*

**Default:**

No change to the current value

**System Default:**

*off*

**mtcdstp (optional)**

Activates or deactivates the automatic generation and FTP transfer of the daily maintenance measurement report for STP.

**Range:**

*on*

*off*

**Default:**

No change to the current value

**System Default:**

*off*

**mtcdua (optional)**

Activates or deactivates the automatic generation and FTP transfer of the scheduled daily maintenance measurement report for M3UA and SUA application server/ association pairs.

**Range:**

*on*

*off*

**Default:**

No change to the current value

**System Default:**

*off*

**mtcdvflex (optional)**

Activates or deactivates the automatic generation and FTP transfer of the daily maintenance measurement report for V-Flex (Voice Mail Router).

**Range:**

*on*

*off*

**Default:**

No change to the current value

**System Default:**

*off*

**mtchaiq (optional)**

Activates or deactivates the automatic generation and FTP transfer of the scheduled hourly maintenance measurement report of ANSI41 AnalyzedInformation Query (ANSI41 AIQ).

**Range:**

*on*

*off*

**Default:**

No change to the current value.

**System Default:**

*off*

**mtchatinpq (optional)**

Activates or deactivates the automatic generation and FTP transfer of the scheduled hourly maintenance measurement report of Any Time Interrogation (ATI) Number Portability (NP) Queries.

**Range:**

*on*

*off*

**Default:**

No change to the current value

**System Default:**

*off*

**mtchdeir (optional)**

Activates or deactivates the automatic generation and FTP transfer of the hourly S13 EIR maintenance measurement reports.



**Range:**

*on*

*off*

**Default:**

No change to the current value

**System Default:**

*off*

**mtcheir (optional)**

Activates or deactivates the automatic generation and FTP transfer of the scheduled hourly maintenance measurement report for Equipment Identity Register (EIR).

**Range:**

*on*

*off*

**Default:**

No change to the current value

**System Default:**

*off*

**mtchenum (optional)**

Activates or deactivates the automatic generation and FTP transfer of the hourly ENUM NP maintenance measurement reports.

**Range:**

*on*

*off*

**Default:**

No change to the current value

**System Default:**

*off*

**mtchgttpath (optional)**

Activates or deactivates the automatic generation and FTP transfer of the scheduled hourly maintenance measurement report for GTT Action per path measurements.

**Range:**

*on*

*off*

**Default:**

No change to the current value

**System Default:**

*off*

**mtchgttset (optional)**

Activates or deactivates the automatic generation and FTP transfer of the scheduled hourly per GTTSET maintenance measurement report.

**Range:**

*on*

*off*

**Default:**

No change to the current value

**System Default:**

*off*

**mtchlmp (optional)**

Activates or deactivates the automatic generation and FTP transfer of the scheduled hourly maintenance measurement report for LNP.

**Range:**

*on*

*off*

**Default:**

No change to the current value

**System Default:**

*off*

**mtchmap (optional)**

Activates or deactivates the automatic generation and FTP transfer of scheduled hourly maintenance measurement report per GSM MAP Screening server entry.

**Range:**

*on*

*off*

**Default:**

No change to the current value

**System Default:**

*off*

**mtchnp (optional)**

Activates or deactivates the automatic generation and FTP transfer of the scheduled hourly maintenance measurement report for INP.

**Range:**

*on*

*off*

**Default:**

No change to the current value

**System Default:**

*off*

**mtchvflex (optional)**

Activates or deactivates the automatic generation and FTP transfer of the scheduled hourly maintenance measurement report for V-Flex (Voice Mail Router).

**Range:**

*on*

*off*

**Default:**

No change to the current value

**System Default:**

*off*

**off (optional)**

This parameter turns off the specified options. Up to 8 comma-separated unique options can be specified.

**Range:**

*mtcdaiq*

*mtcdatinpq*

*mtcddeir*

*mtcdeir*

*mtcdenum*

*mtcdgttpath*

*mtcdgttpset*

*mtcdlink*

*mtcdlnkset*

*mtcdlnp*

*mtcdmap*

*mtcdnp*

*mtcdsctpasoc*

*mtcdsctpcard*

*mtcdsfthrot*

*mtcdsip*

*mtcdstp*

*mtcdstplan*

*mtcdua*

*mtcdvflex*

*mtchaiq*

*mtchatinpq*

*mtchdeir*

*mtcheir*

*mtchenum*

*mtchgttpath*

*mtchgttpset*

*mtchlnp*

*mtchmap*

*mtchnp*

*mtchvflex*

**on (optional)**

This parameter turns on the specified options. Up to 8 comma-separated unique options can be specified.

**Range:**

*mtcdaiq*

*mtcdatinpq*

*mtcddeir*

*mtcdeir*

*mtcdenum*

*mtcdgttpath*

*mtcdgttpset*

*mtcdlink*

*mtcdlnkset*

*mtcdlnp*

*mtcdmap*  
*mtcdnp*  
*mtcdsctpasoc*  
*mtcdsctpcard*  
*mtcdsfthrot*  
*mtcdsip*  
*mtcdstp*  
*mtcdstplan*  
*mtcdua*  
*mtcdvflex*  
*mtchaiq*  
*mtchatinpq*  
*mtchdeir*  
*mtcheir*  
*mtchenum*  
*mtchgttpath*  
*mtchgttpset*  
*mtchlnp*  
*mtchmap*  
*mtchnp*  
*mtchvflex*

#### Example

```
chg-mtc-measopts:mtcdeir=off:mtcheir=on  
chg-mtc-measopts:mtchvflex=on:mtcdvflex=on  
chg-mtc-measopts:mtchaiq=on:mtcdaiq=on  
chg-mtc-measopts:on=mtcdaiq,mtcdatinpq,mtcdeir,  
mtcdgttpath,mtcdlink,mtcdlnkset,mtcdlnp,mtcdmap  
chg-mtc-measopts:off=mtcdsctpcard,mtcdstp,mtcdstplan,  
mtcdua,mtcdvflex,mtchaiq:on=mtchlnp,mtchmap  
chg-mtc-measopts:mtcdsip=on  
chg-mtc-measopts:on=mtchdeir,mtcddeir
```

```
chg-mtc-measopts:mtchdeir=on:mtcddeir=on  
chg-mtc-measopts:on=mtcdenum,mtchenum  
chg-mtc-measopts:mtchenum=on:mtcdenum=off  
chg-mtc-measopts:mtcdsfthrot=on  
chg-mtc-measopts:mtchgttset=on:mtcdgttset=on
```

### Dependencies

The LNP feature must be turned on before the `mtchlnp=on` or `mtcdlnp=on` parameter can be specified.

The GSM Map Screening (GSMSCR) feature must be turned on before the `mtcdmap=on` parameter or the `mtchmap=on` parameter can be specified.

The Equipment Identity Register (EIR) feature must be turned on before the `mtcheir=on` parameter or the `mtcdeir=on` parameter can be specified.

This command is not allowed while in upgrade mode.

The V-Flex feature must be turned on before the `mtchvflex=on` parameter or the `mtcdvflex=on` parameter can be specified.

The ATINP feature must be enabled before the `mtchatinpq=on` parameter or the `mtcdatinpq=on` parameter can be specified.

The A-Port, G-Port, IS41 GSM Migration, MO SMS IS41-to-GSM Migration, MO-based GSM SMS NP, MO-based IS41 SMS NP, Prepaid SMS Intercept Ph1, TIF ASD, TIF GRN, TIF Number Portability, or TIF Simple Number Substitution feature must be enabled, or the INP feature must be turned on before the `mtchnp=on` parameter or the `mtcdnp=on` parameter can be specified.

The ANSI41 AIQ feature must be enabled before the `mtchaiq=on` or `mtcdaiq=on` parameter can be specified.

The Integrated Measurements or Measurements Platform feature must be turned on before this command can be entered.

The GTT Action - DISCARD, GTT Action - FORWARD, or GTT Action - DUPLICATE feature must be enabled before the `mtchgttpath=on` or `mtcdgttpath=on` parameter can be specified.

At least one GTT Action - SFTHROT must be provisioned before the `mtcdsfthrot=on` parameter is specified.

The same option cannot be specified for the `on` and `off` parameters in the same command.

Parameters cannot be specified individually and as options for the `on` or `off` parameter in the same command.

The Diameter S13/S13' Interface for EIR feature (DEIR) must be turned on before the `mtchdeir=on` parameter or the `mtcddeir=on` parameter can be specified.

At least one ENUM card must be provisioned before the `mtchenum=on` or `mtcdenum=on` parameter can be specified.

The EGTT feature must be turned ON before `mtchggttset=on` or `mtcdggttset=on` parameter can be specified.

## Notes

Activated scheduled reports are generated and transferred to the customer's FTP server

The `rept-ftp-meas` command can be used to manually generate and transfer one report at a time as needed.

*Maintenance Guide* provides detailed information on measurements and measurement reports.

## on/off options

### ***mtcdaiq***

Allows automatic generation and FTP transfer of the scheduled daily maintenance measurement report for ANSI41 Analyzed Information Query (ANSI41 AIQ). The option has a default of OFF.

### ***mtcdatinpq***

Allows automatic generation and FTP transfer of the scheduled daily maintenance measurement report for ATI Number Portability Query (ATINP). The option has a default of OFF.

### ***mtcddeir***

Allows automatic generation and FTP transfer of the scheduled daily maintenance measurement report for S13 EIR. The option has a default of OFF.

### ***mtcdeir***

Allows automatic generation and FTP transfer of the daily maintenance measurement report for Equipment Identity Register (EIR). The option has a default of OFF.

### ***mtcdenum***

Allows automatic generation and FTP transfer of the scheduled daily maintenance measurement report for ENUM NP. The option has a default of OFF.

### ***mtcdgttapath***

Allows automatic generation and FTP transfer of the scheduled daily maintenance measurement report for GTT Action per path measurements. The option has a default of OFF.

### ***mtcdgttset***

Allows automatic generation and FTP transfer of the scheduled daily maintenance measurement report per GTTSET. The option has a default of OFF.

### ***mtcdlink***

Allows automatic generation and FTP transfer of the daily maintenance measurement report for links. The option has a default of OFF.

### ***mtcdlnkset***

Allows automatic generation and FTP transfer of the daily maintenance measurement report for link sets. The option has a default of OFF.

### ***mtcdlnp***

Allows automatic generation and FTP transfer of the scheduled daily maintenance measurement report for LNP. The option has a default of OFF.

***mtcdmap***

Allows automatic generation and FTP transfer of the scheduled daily maintenance measurement report per GSM MAP Screening server entry. The option has a default of OFF.

***mtcdnp***

Allows automatic generation and FTP transfer of the scheduled daily maintenance measurement report for INP. The option has a default of OFF.

***mtcdsctpasoc***

Allows automatic generation and FTP transfer of the scheduled daily maintenance measurement report for per association SCTP data. The option has a default of OFF.

***mtcdsctpcard***

Allows automatic generation and FTP transfer of the scheduled daily maintenance measurement report for per card SCTP data. The option has a default of OFF.

***mtcdsfthrot***

Allows automatic generation and FTP transfer of the scheduled daily maintenance measurement report for GTT SFTHROT Action measurements. The option has a default of OFF.

***mtcdsip***

Allows automatic generation and FTP transfer of the daily maintenance measurement report for SIP. The option has a default of OFF.

***mtcdstp***

Allows automatic generation and FTP transfer of the daily maintenance measurement report for STP. The option has a default of OFF.

***mtcdstplan***

Allows automatic generation and FTP transfer of the daily maintenance measurement report for STPLAN. The option has a default of OFF.

***mtcdua***

Allows automatic generation and FTP transfer of the scheduled daily maintenance measurement report for M3UA and SUA application server/association pairs. The option has a default of OFF.

***mtcdvflex***

Allows automatic generation and FTP transfer of the daily maintenance measurement report for V-Flex (Voice Mail Router). The option has a default of OFF.

***mtchaiq***

Allows automatic generation and FTP transfer of the scheduled hourly maintenance measurement report of ANSI41 Analyzed Information Query (ANSI41 AIQ). The option has a default of OFF.

***mtchatinpq***

Allows automatic generation and FTP transfer of the scheduled hourly maintenance measurement report of Any Time Interrogation (ATI) Number Portability (NP) Queries. The option has a default of OFF.

***mtchdeir***

Allows automatic generation and FTP transfer of the scheduled hourly maintenance measurement report for S13 EIR. The option has a default of OFF.



**mtcheir**

Allows automatic generation and FTP transfer of the scheduled hourly maintenance measurement report for Equipment Identity Register (EIR). The option has a default of OFF.

**mtchenum**

Allows automatic generation and FTP transfer of the scheduled hourly maintenance measurement report for ENUM NP. The option has a default of OFF.

**mtchgttpath**

Allows automatic generation and FTP transfer of the scheduled hourly maintenance measurement report for GTT Action per path measurements. The option has a default of OFF.

**mtchgttset**

Allows automatic generation and FTP transfer of the scheduled hourly maintenance measurement report per GTTSET. The option has a default of OFF.

**mtchlnp**

Allows automatic generation and FTP transfer of the scheduled hourly maintenance measurement report for LNP. The option has a default of OFF.

**mtchmap**

Allows automatic generation and FTP transfer of scheduled hourly maintenance measurement report per GSM MAP Screening server entry. The option has a default of OFF.

**mtchnp**

Allows automatic generation and FTP transfer of the scheduled hourly maintenance measurement report for INP. The option has a default of OFF.

**mtchvflex**

Allows automatic generation and FTP transfer of the scheduled hourly maintenance measurement report for V-Flex (Voice Mail Router). The option has a default of OFF.

**Output**

```
chg-mtc-measopts:mtchgttpath=on:mtcdgttpath=on
```

```
tekelecstp 10-02-11 14:31:25 EST EAGLE 44.0.0  
CHG-MTC-MEASOPTS: MASP A - COMPLTD
```

```
;
```

```
chg-mtc-measopts:on=mtcdaiq,mtcdatinpq,mtcdeir,  
mtcdgttpath,mtcdlink:off=mtcheir,mtchgttpath,mtchlnp
```

```
tekelecstp 10-02-11 14:31:25 EST EAGLE 44.0.0  
CHG-MTC-MEASOPTS: MASP A - COMPLTD
```

```
;
```

```
chg-mtc-measopts:mtcdsip=on
```

```
tekelecstp 12-07-26 14:55:58 EST EAGLE 45.0.0
chg-mtc-measopts:mtcdsip=on
Command entered at terminal #4.
CHG-MTC-MEASOPTS: MASP A - COMPLTD.
```

```
;
```

```
chg-mtc-measopts:mtchdeir=on:mtcddeir=on
```

```
tekelecstp 13-03-15 14:55:58 EST EAGLE 45.1.0
chg-mtc-measopts:mtchdeir=on:mtcddeir=on
Command entered at terminal #4.
CHG-MTC-MEASOPTS: MASP A - COMPLTD
```

```
;
```

```
chg-mtc-measopts:mtchenum=on:mtcdenum=off
```

```
tekelecstp 14-05-18 14:55:58 EST EAGLE 46.1.0
chg-mtc-measopts:mtchenum=on:mtcdenum=off
Command entered at terminal #4.
CHG-MTC-MEASOPTS: MASP A - COMPLTD
```

```
;
```

```
chg-mtc-measopts:mtcdsfthrot=on
```

```
tekelecstp 15-03-15 14:55:58 EST EAGLE 46.3.0
chg-mtc-measopts:mtcdsfthrot=on
Command entered at terminal #4.
CHG-MTC-MEASOPTS: MASP A - COMPLTD
```

```
;
```

```
chg-mtc-measopts:mtchgttset=on:mtcdgttset=on
```

```
tekelecstp 17-05-11 15:55:48 EST EAGLE 46.6.0
chg-mtc-measopts:mtchgttset=on:mtcdgttset=on
Command entered at terminal #4.
CHG-MTC-MEASOPTS: MASP A - COMPLTD
```

```
;
```

### Related Topics

- [chg-ftp-serv](#)
- [chg-meas](#)
- [chg-measopts](#)
- [chg-netopts](#)
- [dlt-ftp-serv](#)

- [ent-ftp-serv](#)
- [rept-ftp-meas](#)
- [rept-meas](#)
- [rept-stat-meas](#)
- [rtrv-ftp-serv](#)
- [rtrv-measopts](#)
- [rtrv-mtc-measopts](#)
- [rtrv-netopts](#)

## chg-netopts

Use this command to change the Private Virtual Network (PVN) address and PVN subnet mask values for the IP networks and the network address and subnet mask values for the Fast Copy networks used by the system.

### **Caution:**

Ensure that the configured addresses do not conflict with the DHCP IP addresses leased to STC cards (see the `mode=full` report generated by the `rept-stat-card` command). Conflicting IP addresses can adversely affect the EAGLE 5 Integrated Monitoring Support feature.

### Parameters

#### **fcna (optional)**

Fast Copy Network A. The network address for the Fast Copy A network.

### **Note:**

This parameter consists of a classless Inter Domain Routing (Supernet) address with a network prefix of up to 23 bits.

#### **Range:**

*0.0.2.0-255.255.253.0*

The last 9 bits are zero (0) and are reserved for the Host ID.

#### **Default:**

No change to the current value

#### **System Default:**

*172.21.48.00*

#### **fcnb (optional)**

Fast Copy Network B. The network address for the Fast Copy B network.

 **Note:**

This parameter consists of a classless Inter Domain Routing (Supernet) address with a network prefix of up to 23 bits.

**Range:**

*0.0.2.0-255.255.253.0*

The last 9 bits are zero (0) and are reserved for the Host ID.

**Default:**

No change to the current value

**System Default:**

*172.22.48.00*

**pvn (optional)**

Private Virtual Network address for the EAGLE. The value must be valid for a Class B network IP address. The host portion of the PVN address must be 0 based on the PVNMASK.

**Range:**

*128.0.0.0-191.255.255.0*

4 numbers separated by dots in the range 128.0.0.0 - 191.255.255.0

**Default:**

No change to the current value

**System Default:**

*172.20.48.00*

**pvnmask (optional)**

A subnet mask for the EAGLE PVN.

**Range:**

The value must be valid for a Class B network IP address

- 255.255.0.0
- 255.255.128.0
- 255.255.192.0
- 255.255.224.0
- 255.255.240.0
- 255.255.248.0
- 255.255.252.0
- 255.255.254.0
- 255.255.255.0

**Default:**

No change to the current value

**System Default:**  
255.255.252.00

### Example

```
chg-netopts:pvn=170.120.50.1:pvnmask=255.255.252.0
```

```
chg-netopts:fcna=170.120.50.0
```

```
chg-netopts:fcnb=172.121.50.0
```

### Dependencies

At least one pair of optional parameters must be specified in the command (i.e. `pvn` and `pvnmask` or `fcna` and `fcnb`).

The `pvn` and `pvnmask` IP addresses cannot have the same value.

The NETOPTS table is corrupt or cannot be found.

The `pvn` and `pvnmask` parameters must be specified together in the command.

The IP network address specified by the `pvn/pvnmask` or `fcna/fcnb` parameters cannot be the same as, overlap, or include any IP network or host addresses assigned to any Ethernet interface for any IP card.

The IP Network address specified by the `pvn` and `pvnmask` parameters or the `fcna` and `fcnb` parameters cannot have an existing route in the IP Route table.

The E5IS feature must be turned on before this command can be specified.

The value specified for the `fcna` parameter must be a classless Inter Domain Routing (Supernet) address with a 23-bit network prefix.

The value specified for the `fcnb` parameter must be a classless Inter Domain Routing (Supernet) address with a 23-bit network prefix.

If the `fcmode=fcopy` parameter is specified (see the `chg-eisopts` command) for an IPSPG or IPGHC GPL, then the `fcna` and `fcnb` parameters cannot be specified.

The `eiscopy=off` parameter must be specified (see the `chg-eisopts` command) before the `pvn` or `pvnmask` parameter can be specified.

The same value cannot be specified for the `pvn`, `fcna`, and `fcnb` parameters.

The same value cannot be specified for the `fcna` and `fcnamask` parameters.

The same value cannot be specified for the `fcnb` and `fcnbmask` parameters.

The value specified for the `pvn` parameter must be a valid Class B network IP address.

The host portion of the value specified for the `pvn` parameter must be 0.0.0.0 based on the value specified for the `pvnmask` parameter.

The value specified for the `pvnmask` parameter must be a valid subnet IP address.

### Notes

#### Fast Copy Cards

E5-ENET-B cards running the IPSP or IPGHC GPL are considered to be *FC-capable*. A card running the IPGHC GPL must be in the IS-NR State before the card can be considered *FC-capable*. This restriction does not apply to cards running the IPSP GPL. An *FC-capable* card is considered *FC-enabled* when Fast Copy monitoring is enabled for the respective GPL.

### Output

```
chg-netopts:fcna=170.120.50.0
```

```
tekelecstp 10-12-09 16:00:29 EST EAGLE 43.0.0
chg-netopts:fcna=170.120.50.0
Command entered at terminal #4.
CAUTION: Ensure that configured PVN/FCNA/FCNB addresses do not conflict
with the DHCP IP addresses leased to STC cards.
```

```
CHG-NETOPTS: MASP A - COMPLTD
```

```
;
```

### Related Topics

- [rtv-netopts](#)

## chg-npp-as

Use this command to change a Numbering Plan Processor (NPP) Action Set (AS). An AS is used by the NPP to assist with digit string filtering, conditioning, and encoding for selected EAGLE applications. An AS is a collection of NPP Conditioning Actions (CAs), Service Actions (SAs), and Formatting Actions (FAs).

### Parameters



#### Note:

CAs and FAs are processed in the order that they are specified in the comma-separated list.



#### Note:

SAs are processed in order of high-to-low precedence and must be specified in high-to-low precedence order in the comma-separated list. The SAs cannot be duplicated in the list. If multiple SAs have the same precedence, then the SAs are processed in the order in which they appear in the list.



#### Note:

CAs and FAs are processed in consecutive order. The CAs and FAs are processed in the order that they are specified in the comma separated list.

 **Note:**

SAs are processed in order of high-to-low precedence. The SAs must be specified in high-to-low precedence order in the list, and cannot be duplicated in the comma separated list. If multiple SAs have the same precedence, then the SAs are processed in the order in which they appear in the list.

 **Note:**

The `ac*`, `dn*`, `sn*`, and `cc*` values refer to all CAs that begin with `ac`, `dn`, `sn`, or `cc`, respectively.

 **Note:**

To change the value of a single CA, FA, or SA within an AS, all of the associated parameters that were specified for that CA, FA, or SA for the AS must be entered.

 **Note:**

Refer to *Numbering Plan Processor (NPP) User's Guide* and to the Feature Manual for the feature of interest for more information on provisioning Action Sets and for definitions for the CA, FA, and SA values.

 **Note:**

The `sa(X)dgts` parameters are currently not supported by any feature.

 **Note:**

The `sa(X)val` parameters are used by the TIF Range CgPN Blacklist, TIF Subscriber CgPN Blacklist, and TIF Selective Screening features. Up to 2 numerical values can be specified in each list.

 **Note:**

If an `sa(X)` value is changed or removed, then any associated `sa(X)val` and `sa(X)dgts` parameters are set to *none* unless a new value is specified in the command.

 **Note:**

Support of a numerical values list (`sa (X) val` parameter) is specific to the Service and Service Action.

**asn (mandatory)**

Action set name. This parameter specifies the name of the AS.

**Range:**

*ayyyyyyyyy*

1 alphabetic character followed by up to 9 alphanumeric characters

**ca (optional)**

Conditioning Action list. A comma-separated CA list that can be applied to an incoming digit string. Up to 12 CAs can be specified in the list. The CAs are processed in the order they are specified in the list.

**Range:**

*ac1, ac2, ac3, ac4, ac5, ac6, ac7, ac8, accgpn, accgpn1, accgpn2, accgpn3, accgpn4, accgpn5, accgpn6, accgpn7, accgpn8, acdef, aclac, cc1, cc2, cc3, ccdef, cccgpn, dn1, dn2, dn3, dn4, dn5, dn6, dn7, dn8, dn9, dn11, dn12, dn13, dn14, dn15, dnx, fpx, ign1, ign2, ign3, ign4, ign5, ign6, ign7, ign8, ign9, ign10, pfxa1, pfxa2, pfxa3, pfxa4, pfxa5, pfxa6, pfxa7, pfxa8, pfxb1, pfxb2, pfxb3, pfxb4, pfxb5, pfxb6, pfxb7, pfxb8, pfxc1, pfxc2, pfxc3, pfxc4, pfxc5, pfxc6, pfxc7, pfxc8, pfxd1, pfxd2, pfxd3, pfxd4, pfxd5, pfxd6, pfxd7, pfxd8, pfxe1, pfxe2, pfxe3, pfxe4, pfxe5, pfxe6, pfxe7, pfxe8, pfxf1, pfxf2, pfxf3, pfxf4, pfxf5, pfxf6, pfxf7, pfxf8, sn1, sn2, sn3, sn4, sn5, sn6, sn7, sn8, sn9, sn10, sn11, sn12, sn13, sn14, sn15, snx, znx*

**fa (optional)**

Formatting Action list. A comma-separated FA list that can be applied to the outgoing digit string. Up to 12 FAs can be specified in the list. The FAs are processed in the order they are specified in the list and cannot be duplicated.

**Range:**

*ac, asd, asdothor, cc, dlma, dlmb, dlmc, dlmd, dlme, dlmf, dlmg, dlmh, dlmi, dlmj, dlmk, dlml, dlmm, dlmn, dlmo, dlmp, dn, fpx, grn, grnothor, orig, pfxa, pfxb, pfxc, pfxd, pfxe, pfxf, rn, rnospodn, rnosposn, rnospozsn, sn, sp, sfrimsi, vmid, zn, none*  
*none*-deletes all FAs from the specified FA list

**fatype (optional)**

Formatting Action List Type. The Formatting Action list used to format digits in response messages on a per message basis. The lists are updated by values specified for the `fa` parameter.

**Range:*****dfft***

digits are formatted using the TTROPTS:CDDRA and TTROPTS:CGDRA parameters

***fane***

Formatting Action list to format digits when neither the SP nor the RN network entity is associated with the DN in the RTDB



***fanf***

Formatting Action list to format digits when the DN is not present in the RTDB

***farn***

Formatting Action list to format digits when the RN network entity is associated with the DN in the RTDB

***fasp***

Formatting Action list to format digits when the SP network entity is associated with the DN in the RTDB

***fascrcd***

Formatting Action list to format ISUP CdPN digits when CdPN is Screened by SELSCR SA and SA(X)VAL is none.

***fascrcg***

Formatting Action list to format ISUP CgPN digits when CdPN is Screened by SELSCR SA and SA(X)VAL is none.

**ofnai (optional)**

Outgoing filter nature of address indicator. The filter nature of address indicator (FNAI) class of the outgoing digit string.

**Range:*****intl***

*intl* value provisioned in the `chg-npp-serv` command

***natl***

*natl* value provisioned in the `chg-npp-serv` command

***nai1***

*nai1* value provisioned in the `chg-npp-serv` command

***nai2***

*nai2* value provisioned in the `chg-npp-serv` command

***nai3***

*nai3* value provisioned in the `chg-npp-serv` command

***unkn***

*unkn* value provisioned in the `chg-npp-serv` command

***inc***

NAI of the incoming digit string

**sa (optional)**

Service Action list. A comma-separated SA list that can be applied to an incoming digit string. Up to 8 SAs can be specified in the list. The SAs must be specified in high-to-low precedence order in the list, and cannot be duplicated in the list.

**Range:**

*asdlkup*, *blk1stqry*, *blk1strly*, *blnfndrls*, *blrls*, *cdial*, *ccncchk*, *cdpnnp*, *cgpnasdrqd*, *cgpngnrnqd*, *cgpnnp*, *cgpnrtg*, *cgpnsvcrqd*, *crp*, *fpfxrls*, *fraudchk*, *fwdscs*, *grnlkup*,

*inprtg, lacck, migrate, nocgpnrls, npnrls, nprelay, nprls, nscgpn, nscdpn, pprelay, rtdbtrn, rtdbtsp, rtdbtrnsp, skgtartg, snsccgpn, tifgnbl, tiflsbl, tifrdnbl*  
*none*—Deletes ALL SAs from the Action Set.

**sa1dgts (optional)**

Service Action 1 digit string. A digit string that can be used with the first SA.

**Range:**

1-8 hexadecimal digits. Valid digits are *0-9, a-f, A-F*.

*none*—Deletes digit string for this SA

**sa1va1 (optional)**

Service Action 1 numerical values list. A comma-separated numerical values list that can be used with the first SA.

**Range:**

*0 - 65534, none*

*none*—Deletes all numerical values for this SA from list

**sa2dgts (optional)**

Service Action 2 digit string. A digit string that can be used with the second SA.

**Range:**

1-8 hexadecimal digits. Valid digits are *0-9, a-f, A-F*

*none*—Deletes digit string for this SA

**sa2va1 (optional)**

Service action 2 numerical values list. A comma-separated numerical values list that can be used with the second SA.

**Range:**

*0 - 65534, none*

*none*—Deletes all numerical values for this SA from list

**sa3dgts (optional)**

Service Action 3 digit string. A digit string that can be used with the third SA.

**Range:**

1-8 hexadecimal digits. Valid digits are *0-9, a-f, A-F*

*none*—Deletes digit string for this SA

**sa3va1 (optional)**

Service Action 3 numerical values list. A comma-separated numerical values list that can be used with the third SA.

**Range:**

*0 - 65534, none*

*none*—Deletes all numerical values for this SA from list

**sa4dgts (optional)**

Service Action 4 digit string. A digit string that can be used with the fourth SA.

**Range:**

1-8 hexadecimal digits, *none*

Valid digits are *0-9, a-f, A-F*

*none*—Deletes digit string for this SA

**sa4va1 (optional)**

Service Action 4 numerical values list. A comma-separated numerical values list that can be used with the fourth SA.

**Range:**

0 - 65534, *none*

*none*—Deletes all numerical values for this SA from list

**sa5dgt5 (optional)**

Service Action 5 digit string. A digit string that can be used with the fifth SA.

**Range:**

1-8 hexadecimal digits, *none*

Valid digits are 0-9, a-f, A-F

*none*—Deletes digit string for this SA

**sa5va1 (optional)**

Service Action 5 numerical values list. A comma-separated numerical values list that can be used with the fifth SA.

**Range:**

0 - 65534, *none*

*none* —Deletes all numerical values for this SA from list

**sa6dgt6 (optional)**

Service Action 6 digit string. A digit string that can be used with the sixth SA.

**Range:**

1-8 hexadecimal digits, *none*

Valid digits are 0-9, a-f, A-F

*none*—Deletes digit string for this SA

**sa6va1 (optional)**

Service Action 6 numerical values list. A comma-separated numerical values list that can be used with the sixth SA.

**Range:**

0 - 65534, *none*

*none*—Deletes all numerical values for this SA from list

**sa7dgt7 (optional)**

Service Action 7 digit string. A digit string that can be used with the seventh SA.

**Range:**

1-8 hexadecimal digits, *none*.

Valid digits are 0-9, a-f, A-F

*none*—Deletes digit string for this SA

**sa7va1 (optional)**

Service Action 7 numerical values list. A comma-separated numerical values list that can be used with the seventh SA.

**Range:**

0 - 65534, *none*

*none*—Deletes all numerical values for this SA from list

**sa8dgt8 (optional)**

Service Action 8 digit string. A digit string that can be used with the eighth SA.

**Range:**

1-8 hexadecimal digits, *none*.

Valid digits are 0-9, a-f, A-F

*none*—Deletes digit string for this SA

**sa8val1 (optional)**

Service Action 8 numerical values list. A comma-separated numerical values list that can be used with the eighth SA.

**Range:**

0 - 65534, *none*

*none*—Deletes all numerical values for this SA from list

**Example**

```
chg-npp-as:asn=asn7:ca=ign1,ac1,cc3,sn2:fa=cc,sn,ac
chg-npp-as:asn=asn7:ca=cc1,dn1:fa=cc,dn
chg-npp-as:asn=asn1:ca=znx:fa=asd:sa=cgpnasdrqd
chg-npp-as:asn=asn8:ca=cc2,dnx:fa=cc,rnospodn
chg-npp-as:asn=asn9:sa=migrate,asdlkup
chg-npp-as:asn=asn6:ca=znx:fa=zn:sa=nscdpn,nscgpn
chg-npp-
as:asn=set10:sa=blrls,blnfndrls,nscgpn:salval=101,102:sa2val=77,88
chg-npp-as:asn=asn9:ca=znx:sa=inprtgskgstartg
chg-npp-as:asn=set32:ca=ccdef,accgpn2,snx
chg-npp-as:asn=asn1:fa=cc,ac,grn,sn:fatype=fane
chg-npp-as:asn=asn1:fa=none:fatype=fasp
chg-npp-as:asn=tif5557:fa=dlma,zn:fatype=fascrd
chg-npp-
as:asn=tif1:fa=dlma,zn:salval=10,none:saldgt=ff:fatype=fascrd
chg-npp-as:asn=set1:ca=znx:sa=tifgnbl
```

**Dependencies**

One of the following combinations of Conditioning Actions must be specified:

- znx
- cc\*, dn\*
- cc\*, ac\*, sn\*

The existing or new Formatting Actions specified for the AS must contain the corresponding Formatting Action that a Conditioning Action will populate or load.

The AS must contain a CA that can load or populate all the Formatting Action lists configured in the AS.

The CAs within an AS cannot condition more than 32 digits.

The AS cannot contain CAs that load or populate the same FA.

Conditioning Actions must be specified for inclusion in an individual Action Set using valid number conditioning rules:

- If the ZNX Conditioning Action is specified, then the CC\*, AC\*, SN\*, DN\*, and DNX Conditioning Actions cannot be specified.
- If the CC\* AND DN\* or DNX Conditioning Actions are specified, then the AC\*, SN\*, SNX, and ZNX Conditioning Actions cannot be specified.
- If the CC\*, AC\*, AND SN\* or SNX Conditioning Actions are specified, then the DN\*, DNX, and ZNX Conditioning Actions cannot be specified.

The AS cannot contain the following combinations of FAs:

- If the DN Formatting Action is specified, then the AC, SN, and ZN Formatting Actions cannot be specified.
- If the ZN Formatting Action is specified, then the AC, CC, SN, and DN Formatting Actions cannot be specified.
- If the SN Formatting Action is specified, then the ZN and DN Formatting Actions cannot be specified.
- If the RNOSPODN, RNOSPOSN, or RNOSPOZN Formatting Action is specified, then the RN, SP, SN, DN, and ZN Formatting Actions cannot be specified.
- The RNOSPODN, RNOSPOSN, and RNOSPOZN Formatting Actions cannot be specified together.

 **Note:**

This rule is applicable for FA lists FANE, FANF, FARN, and FASP as well.

If specified, the FPFX CA must be the first value (*fpx*) in the *ca* value list.

If specified, the ZNX, SNX, or DNX CA must be the final value (*znx*, *snx*, or *dnx*) in the *ca* value list.

If rules that reference an AS exist, then the AS cannot be changed.

The *ca* and *caX*, *fa* and *faX*, and *sa* and *saX* parameters cannot be specified together in the command.

The *fa* parameter must be specified before the *fatype* parameter can be specified.

The AS specified by the *asn* parameter must already exist.

If no Service Actions are provisioned, then only a value of *none* can be specified for the *sa1val* parameter.

If less than 2 Service Actions are provisioned, then only a value of *none* can be specified for the *sa2val* parameter.

If less than 3 Service Actions are provisioned, then only a value of *none* can be specified for the `sa3val` parameter.

If less than 4 Service Actions are provisioned, then only a value of *none* can be specified for the `sa4val` parameter.

If less than 5 Service Actions are provisioned, then only a value of *none* can be specified for the `sa5val` parameter.

If less than 6 Service Actions are provisioned, then only a value of *none* can be specified for the `sa6val` parameter.

If less than 7 Service Actions are provisioned, then only a value of *none* can be specified for the `sa7val` parameter.

If less than 8 Service Actions are provisioned, then only a value of *none* can be specified for the `sa8val` parameter.

If no Service Actions are provisioned, then only a value of *none* can be specified for the `sa1dgts` parameter.

If less than 2 Service Actions are provisioned, then only a value of *none* can be specified for the `sa2dgts` parameter.

If less than 3 Service Actions are provisioned, then only a value of *none* can be specified for the `sa3dgts` parameter.

If less than 4 Service Actions are provisioned, then only a value of *none* can be specified for the `sa4dgts` parameter.

If less than 5 Service Actions are provisioned, then only a value of *none* can be specified for the `sa5dgts` parameter.

If less than 6 Service Actions are provisioned, then only a value of *none* can be specified for the `sa6dgts` parameter.

If less than 7 Service Actions are provisioned, then only a value of *none* can be specified for the `sa7dgts` parameter.

If less than 8 Service Actions are provisioned, then only a value of *none* can be specified for the `sa8dgts` parameter.

## Notes

None.

## Output

```
chg-npp-as:asn=asn7:ca=cc1,dn1:fa=cc,dn
```

```
tekelecstp 09-08-18 13:57:06 EST EAGLE 41.1.0  
NPP-AS table is (5 of 1024) 1% full.
```

```
CHG-NPP-AS: MASP A - COMPLTD
```

```
;
```

**Related Topics**

- [ent-npp-as](#)
- [dlt-npp-as](#)
- [rtrv-npp-as](#)

## chg-npp-serv

Use this command to change a Numbering Plan Processor (NPP) service entry. An NPP service is any EAGLE feature that uses the NPP to assist with the processing of digit strings.

 **Note:**

This command can be used to enter values for the `dlma - dlmc` parameters. However, if these parameters have a value other than *none* in the `tifopts:dlma - dlmc` or `ttropts:dlma - dlmc` commands, then those values will overwrite the values that were entered for the parameters using the `chg-npp-serv` command for the TIF and IDPR services, respectively.

 **Note:**

- The `intl`, `nat1`, `nai1`, `nai2`, `nai3`, and `unkn` parameters are used to change the FNAI class to NAI mappings for a service.
- A value of *incoming* must be specified for the `ttropts:snai` parameter before the `intl`, `nat1`, `nai1`, `nai2`, `nai3`, and `unkn` parameters can be changed to non-default values for the IDPRCDPN(X) service.
- A value of *incoming* must be specified for the `ttropts:cgsnai` parameter before the `intl`, `nat1`, `nai1`, `nai2`, `nai3`, and `unkn` parameters can be changed to non-default values for the IDPRCGPN service.
- A value of *nai* must be specified for the `is41smsopts:mosmsnai` parameter before the `intl`, `nat1`, `nai1`, `nai2`, `nai3`, and `unkn` parameters can be changed to non-default values for the MOSMSICDPN service.
- A value of *nai* must be specified for the `gsmsmsopts:mosmsnai` parameter before the `intl`, `nat1`, `nai1`, `nai2`, `nai3`, and `unkn` parameters can be changed to non-default values for the MOSMSGCDPN service.

**Parameters****srvn (mandatory)**

Service name. The name of the NPP Service.

**Range:**

***nppt***  
NPP Test Service

***idprcdpn***  
IDPRCDPN Service

***idprcgpn***  
IDPRCGPN Service

***tif***  
TIF Service

***tif2***  
TIF2 Service

***tif3***  
TIF3 Service

***mosmsicgpn***  
MOSMSICGPN Service

***mosmsicdpn***  
MOSMSICDPN Service

***mosmsgcgpn***  
MOSMSGCGPN Service

***mosmsgcdpn***  
MOSMSGCDPN Service

***iarcdpn***  
IARCDPN Service

***iarcgpn***  
IARCGPN Service

***idprcdpn2***  
IDPRCDPN2 Service

***idprcdpn3***  
IDPRCDPN3 Service

***idprcdpn4***  
IDPRCDPN4 Service

***tifcgpn***  
TIFCGPN Service

***tifcgpn2***  
TIFCGPN2 Service

***tifcgpn3***  
TIFCGPN3 Service



**d1ma (optional)**

A delimiter that is used to format the outgoing dialed number.

**Range:**

1-16 digits, *none*

1-16 hexadecimal digits. Valid digits are 0-9, a-f, A-F

*none*—deletes the current value of the delimiter

**Default:**

*none*

**d1mb (optional)**

A delimiter that is used to format the outgoing dialed number.

**Range:**

1-16 digits, *none*

1-16 hexadecimal digits. Valid digits are 0-9, a-f, A-F

*none*—deletes the current value of the delimiter

**Default:**

*none*

**d1mc (optional)**

A delimiter that is used to format the outgoing dialed number.

**Range:**

1-16 digits, *none*

1-16 hexadecimal digits. Valid digits are 0-9, a-f, A-F

*none*—deletes the current value of the delimiter

**Default:**

*none*

**d1md (optional)**

A delimiter that is used to format the outgoing dialed number.

**Range:**

1-16 digits, *none*

1-16 hexadecimal digits. Valid digits are 0-9, a-f, A-F

*none* —deletes the current value of the delimiter

**Default:**

*none*

**d1me (optional)**

This parameter specifies a delimiter that is used to format the outgoing dialed number.

**Range:**

1-16 digits, *none*

1-16 hexadecimal digits. Valid digits are 0-9, a-f, A-F

*none*—deletes the current value of the delimiter

**Default:**

*none*

**d1mf (optional)**

A delimiter used to format the outgoing dialed number.

**Range:**

1-16 digits, *none*

1-16 hexadecimal digits. Valid digits are 0-9, a-f, A-F  
*none*—deletes the current value of the delimiter

**Default:**

*none*

**d1mg (optional)**

A delimiter used to format the outgoing dialed number.

**Range:**

1-16 digits, *none*

1-16 hexadecimal digits. Valid digits are 0-9, a-f, A-F  
*none*—deletes the current value of the delimiter

**Default:**

*none*

**d1mh (optional)**

A delimiter used to format the outgoing dialed number.

**Range:**

1-16 digits, *none*

1-16 hexadecimal digits. Valid digits are 0-9, a-f, A-F  
*none*—deletes the current value of the delimiter

**Default:**

*none*

**d1mi (optional)**

A delimiter used to format the outgoing dialed number.

**Range:**

1-16 digits, *none*

1-16 hexadecimal digits. Valid digits are 0-9, a-f, A-F  
*none*—deletes the current value of the delimiter

**Default:**

*none*

**d1mj (optional)**

A delimiter used to format the outgoing dialed number.

**Range:**

1-16 digits, *none*

1-16 hexadecimal digits. Valid digits are 0-9, a-f, A-F  
*none* —deletes the current value of the delimiter

**Default:**

*none*

**d1mk (optional)**

A delimiter used to format the outgoing dialed number.

**Range:**

1 - 16, *none*

1-16 hexadecimal digits. Valid digits are 0-9, a-f, A-F  
*none* —deletes the current value of the delimiter

**Default:**

*none*

**d1m1 (optional)**

A delimiter used to format the outgoing dialed number.

**Range:**

1-16 digits, *none*

1-16 hexadecimal digits. Valid digits are 0-9, a-f, A-F  
*none* —deletes the current value of the delimiter

**Default:**

*none*

**d1mm (optional)**

A delimiter used to format the outgoing dialed number.

**Range:**

1-16 digits, *none*

1-16 hexadecimal digits. Valid digits are 0-9, a-f, A-F  
*none* —deletes the current value of the delimiter

**Default:**

*none*

**d1mn (optional)**

A delimiter used to format the outgoing dialed number.

**Range:**

1-16 digits, *none*

1-16 hexadecimal digits. Valid digits are 0-9, a-f, A-F  
*none*—deletes the current value of the delimiter

**Default:**

*none*

**d1mo (optional)**

A delimiter used to format the outgoing dialed number.

**Range:**

1-16 digits, *none*

1-16 hexadecimal digits. Valid digits are 0-9, a-f, A-F  
*none*—deletes the current value of the delimiter

**Default:**

*none*

**d1mp (optional)**

A delimiter used to format the outgoing dialed number.

**Range:**

1-16 digits, *none*

1-16 hexadecimal digits. Valid digits are 0-9, a-f, A-F  
*none* —deletes the current value of the delimiter

**Default:**

*none*

**intl (optional)**

International. This parameter maps an International FNAI class to the NAI of the incoming digit string.

**Range:**

0 - 255, *none*

*none*—A rule with an FNAI or OFNAI of *intl* cannot be provisioned

**Default:**

No change to the current value

**System Default:**

1 —IARCDPN, IARCGPN services and all MOSMS services

4 —NPPT, TIF, TIF2, TIF3, IDPRCDPN, IDPRCDPN2, IDPRCDPN3, IDPRCDPN4 and IDPRCGPN services

**nai1 (optional)**

This parameter maps an NAI-1 FNAI class to the NAI of the incoming digit string.

**Range:**

0 - 255, *none*

*none*—A rule with an FNAI or OFNAI of *nai1* cannot be provisioned

**Default:**

No change to the current value

**System Default:**

*none*

**nai2 (optional)**

This parameter maps an NAI-2 FNAI class to the NAI of the incoming digit string.

**Range:**

0 - 255, *none*

*none*—A rule with an FNAI or OFNAI of *nai2* cannot be provisioned

**Default:**

No change to the current value

**System Default:**

*none*

**nai3 (optional)**

This parameter maps an NAI-3 FNAI class to the NAI of the incoming digit string.

**Range:**

0 - 255, none

none—A rule with an FNAI or OFNAI of *nai3* cannot be provisioned

**Default:**

No change to the current value

**System Default:**

none

**nat1 (optional)**

This parameter maps a National FNAI class to the NAI of the incoming digit string.

**Range:**

0 - 255, none

none—A rule with an FNAI or OFNAI of *nat1* cannot be provisioned

**Default:**

No change to the current value

**System Default:**

0

IARCDPN, IARCGPN, MOSMSICDPN and MOSMSICGPN services

**System Default:**

2—MOSMSGCDPN and MOSMSGCGPN services

3—NPPT, TIF, TIF2, TIF3, IDPRCDPN, IDPRCDPN2, IDPRCDPN3, IDPRCDPN4, and IDPRCGPN services

**status (optional)**

This parameter specifies whether the service can be processed by the NPP.

**Range:**

**off**

The service cannot be processed by the NPP.

**on**

The service can be processed by the NPP.

The `status=on` parameter must be specified before a service can be processed by the NPP.

**Default:**

off

**unkn (optional)**

This parameter maps an Unknown FNAI class to the NAI of the incoming digit string.

**Range:**

0 - 255

**Default:**

No change to the current value

**System Default:**

0—NPPT, TIF, TIF2, TIF3, IDPRCDPN, IDPRCDPN2, IDPRCDPN3, IDPRCDPN4, IDPRCGPN, MOSMSGCDPN and MOSMSGCGPN services  
 2—IARCDPN, IARCGPN, MOSMSICDPN and MOSMSICGPN services

**Example**

```
chg-npp-serv:svrn=nppt:status=on
chg-npp-serv:svrn=nppt:status=on:nai3=6:intl=15:natl=50
chg-npp-serv:svrn=nppt:status=on:nai3=6:intl=15
chg-npp-serv:svrn=tif:dlma=1234567890abcdef:
dlmb=aaaaabbbbcccccd:dlmc=102030405
```

**Dependencies**

The service specified by the `svrn` parameter must have associated rules before the `status=on` parameter can be specified.

If the service specified by the `svrn` parameter references any NPP rules, then the `intl`, `natl`, `nai1`, `nai2`, and `nai3` parameters cannot have a value of *none*.

**Output**

```
chg-npp-serv:svrn=nppt:status=on:nai3=6:intl=15:natl=50
```

```
tekelecstp 08-05-17 15:55:35 EAGLE 39.0.0
chg-npp-serv:svrn=nppt:status=on:nai3=6:intl=15:natl=50
CHG-NPP-SERV: MASP A - COMPLTD
;
```

**Related Topics**

- [chg-npp-srs](#)
- [dlt-npp-srs](#)
- [ent-npp-srs](#)
- [rtrv-npp-serv](#)
- [rtrv-npp-srs](#)

## chg-npp-srs

Use this command to change the Action Set (AS) that is associated with a Numbering Plan Processor (NPP) Rule. An NPP Rule is an association between a single NPP filter and an AS.

**Note:**

The contents of the AS are configured using the `ent/chg-npp-as` commands.

## Parameters

### **f<sub>d</sub>l (mandatory)**

Filter digit length. The number of digits on the incoming digit string that is filtered by the NPP.

#### **Range:**

1 - 32, \*

\*—multiple lengths of digit strings can be filtered

### **f<sub>nai</sub> (mandatory)**

Filter nature of address indicator. The filter Nature of Address Indicator (NAI) class.

#### **Range:**

##### ***intl***

filter messages with NAI=INTL

##### ***natl***

filter messages with NAI=NATL

##### ***nai1***

filter messages with NAI=NAI1

##### ***nai2***

filter messages with NAI=NAI2

##### ***nai3***

filter messages with NAI=NAI3

##### ***unkn***

filter messages with NAI=UNKN



#### **Note:**

The `chg-npp-serv` command is used to assign values to the various FNAI classes.

### **f<sub>p</sub>f<sub>x</sub> (mandatory)**

Filter prefix. The prefix used to filter incoming digit strings.

#### **Range:**

1 - 16, \*, ?

1 - 16 hexadecimal digits inclusive of single digit wildcard (?); or wildcard (\*) matching the entire digit string; valid digits are ?, \*, 0-9, a-f, A-F.

### **srvn (mandatory)**

The name of the NPP Service.

**Range:**

***nppt***  
NPP Test Service

***idprcdpn***  
IDPRCDPN Service

***idprcgpn***  
IDPRCGPN Service

***tif***  
TIF Service

***tif2***  
TIF2 Service

***tif3***  
TIF3 Service

***mosmsicgpn***  
MOSMSICGPN Service

***mosmsicdpn***  
MOSMSICDPN Service

***mosmsgcgpn***  
MOSMSGCGPN Service

***mosmsgcdpn***  
MOSMSGCDPN Service

***iarcdpn***  
IARCDPN Service

***iarcgpn***  
IARCGPN Service

***idprcdpn2***  
IDPRCDPN2 Service

***idprcdpn3***  
IDPRCDPN3 Service

***idprcdpn4***  
IDPRCDPN4 Service

***tifcgpn***  
TIFCGPN Service

***tifcgpn2***  
TIFCGPN2 Service

***tifcgpn3***  
TIFCGPN3 Service



**asn (optional)**

Action set name.

**Range:**

ayyyyyyyyy

1 alphabetic character followed by up to 9 alphanumeric characters

**Default:**

No change to the current value

**invkserv (optional)**

Invoke service name. The name of the NPP service to be invoked.



**Note:**

As of Release 44.0, only the *tifcgpn*, *tifcgpn2*, *tifcgpn3*, and *none* values are supported.

**Range:**

***nppt***

NPP Test Service

***idprcdpn***

IDPRCDPN Service

***idprcgpn***

IDPRCGPN Service

***tif***

TIF Service

***tif2***

TIF2 Service

***tif3***

TIF3 Service

***mosmsicgpn***

MOSMSICGPN Service

***mosmsicdpn***

MOSMSICDPN Service

***mosmsgcgpn***

MOSMSGCGPN Service

***mosmsgcdpn***

MOSMSGCDPN Service

***iarcdpn***

IARCDPN Service

***iarcgpn***  
IARCGPN Service

***idprcdpn2***  
IDPRCDPN2 Service

***idprcdpn3***  
IDPRCDPN3 Service

***idprcdpn4***  
IDPRCDPN4

***tifcgn***  
TIFCGPN

***tifcgn2***  
TIFCGPN2

***tifcgn3***  
TIFCGPN3

***none***  
no additional NPP services are invoked

**Default:**  
No change to the current value

**System Default:**  
*none*

### Example

```
chg-npp-srs:svn=nppt:fpfx=a:fdl=16:fnai=intl:asn=asn3
chg-npp-
srs:svn=tif:fnai=intl:fpfx=9090:fdl=*:asn=set1:invkserv=tifcgn
chg-npp-srs:svn=idprcdpn4:fpfx=91:fnai=intl:asn=asn9:fdl=12
```

### Dependencies

The AS specified by the `asn` parameter must already exist in the NPP AS table.

The AS specified by the `asn` parameter cannot contain Conditioning Actions that are not supported by the service specified by the `svn` parameter.

The AS specified by the `asn` parameter cannot contain Service Actions that are not supported by the service specified by the `svn` parameter.

The AS specified by the `asn` parameter cannot contain Formatting Actions that are not supported by the service specified by the `svn` parameter.

The AS specified by the `asn` parameter cannot contain Service Actions that do not conform to the precedence order that is supported by the service specified by the `svn` parameter.

The Conditioning Actions in the AS specified by the `asn` parameter cannot condition more digits than allowed by the `fdl` parameter.

If the `fdl=*` parameter is specified, then the AS specified by the `asn` parameter must contain Conditioning Actions that support variable digit string conditioning.

The NPP Rule that is specified by the `fdl`, `fnai`, `fpfx`, and `srvn` parameters must already exist in the NPP Rule table.

All of the features associated with the Service Actions in the AS specified by the `asn` parameter must be turned on before the AS can be used.

The Service Actions in the AS specified by the `asn` parameter cannot violate mutual exclusivity rules defined by the service specified by the `srvn` parameter. Refer to the Feature Manual for the feature of interest for additional information.

The AS specified by the `asn` parameter cannot contain an OFNAI class with a value of *none*.

At least one TIF feature must be turned on before an AS containing the CDIAL Service Action can be specified as a value for the `asn` parameter.

The TIF SCS Forwarding feature must be turned on before an AS containing the FWDSCS Service Action can be specified as a value for the `asn` parameter.

The TIF Simple Number Substitution feature must be turned on before an AS containing the SNSCGPN Service Action can be specified as a value for the `asn` parameter.

The TIF Number Portability feature must be turned on before an AS containing the CRP, NPNRLS, CGPNNPRQD, NPRELAY, or NPRLS Service Action can be specified as a value for the `asn` parameter.

The IDPR ASD feature must be enabled before an AS containing the ASDLKUP or CGPNASDRQD Service Action can be specified as a value for the `asn` parameter with the IDPRCDPN(X) or IDPRCGPN service.

The IDPR GRN feature must be enabled before an AS containing the GRNLKUP or CGPNGRNRQD Service Action can be specified as a value for the `asn` parameter with the IDPRCDPN(X) or IDPRCGPN service.

An AS containing the ASDLKUP and CGPNASDRQD Service Actions cannot be specified as a value for the `asn` parameter.

An AS containing the GRNLKUP and CGPNGRNRQD Service Actions cannot be specified as a value for the `asn` parameter.

If a value of *tif*, *tif2*, or *tif3* is specified for the `srvn` parameter, then the TIF ASD feature must be enabled before an AS containing the ASDLKUP or CGPNASDRQD Service Action can be specified as value for the `asn` parameter.

The TIF GRN feature must be enabled before an AS containing the GRNLKUP or CGPNGRNRQD Service Actions can be specified as a value for the `asn` parameter with the TIF services.

If a value of *mosmsgcdpn*, *mosmsgcgpn*, *mosmsicdpn*, or *mosmsicgpn* is specified for the `srvn` parameter, then the MO SMS ASD feature must be enabled before an AS containing the ASDLKUP or CGPNASDRQD Service Action can be specified as a value for the `asn` parameter.

If a value of *mosmsgcdpn*, *mosmsgcgpn*, *mosmsicdpn*, or *mosmsicgpn* is specified for the `srvn` parameter, then the MO SMS GRN feature must be enabled before an AS

containing the CGPNGRNRQD or GRNLKUP Service Action can be specified as a value for the `asn` parameter.

If a rule contains an FPFX with a wildcard value, then the rule cannot also contain an AS where the FPFX Conditioning Action is specified.

The TIF Number Substitution feature must be enabled before an AS containing the NSCGPN or NSCDPN Service Action can be specified as a value for the `asn` parameter.

The AS specified by the `asn` parameter cannot contain both the NSCGPN and SNSCGPN Service Actions.

If a value of `mosmsgcdpn` or `mosmsgcgpn` is specified for the `servn` parameter, then the Prepaid SMS Intercept Ph1 feature must be enabled before an AS containing the PPRELAY Service Action can be specified as a value for the `asn` parameter.

If the `servn=mosmsgcgpn` parameter is specified, then the Portability Check for MO SMS feature must be enabled before an AS containing the FRAUDCHK Service Action can be specified as a value for the `asn` parameter.

If the `servn=mosmsicdpn` parameter is specified, then the MO SMS IS41-to-GSM Migration feature must be enabled before an AS containing the MIGRATE Service Action can be specified as a value for the `asn` parameter.

If the `servn=mosmsicdpn` parameter is specified, then the MO-based IS41 SMS NP feature must be enabled before an AS containing the CDPNNP Service Action can be specified as a value for the `asn` parameter.

If the `servn=mosmsgcdpn` parameter is specified, then the MO-based GSM SMS NP feature must be enabled before an AS containing the CDPNNP Service Action can be specified as a value for the `asn` parameter.

The IDP A-Party Routing feature must be enabled before the AS specified by the `asn` parameter can contain the CGPNRTG Service Action.

The IDP A-Party Blacklist feature must be enabled before the AS specified by the `asn` parameter can contain the BLKLSTQRY or BLKLSTRLY Service Action.

If the AS specified by the `asn` parameter contains the BLKLSTQRY Service Action, then the AS cannot contain any other Service Actions.

If the `srvn=idprcdpn(X)` parameter is specified, then the Action Set specified by the `asn` parameter cannot contain both the ACCGPN\* and CCCGPN Conditioning Actions.

If a value of `iarcdpn` or `iarcgpn` is specified for the `servn` parameter, then the IAR Base feature must be enabled before an AS containing the CCNCCHK, CDIAL, or CPGNSRVRQQD Service Action can be specified as a value for the `asn` parameter.

If a value of `iarcdpn` or `iarcgpn` is specified for the `servn` parameter, then the IAR NP feature must be enabled before an AS containing the CDPNNP or CGPNNP Service Action can be specified as a value for the `asn` parameter.

If a value of `iarcdpn` or `iarcgpn` is specified for the `servn` parameter, then the IAR ASD feature must be enabled before an AS containing the ASDLKUP or CGPNASDRQD Service Action can be specified as a value for the `asn` parameter.

If a value of `iarcdpn` or `iarcgpn` is specified for the `servn` parameter, then the IAR GRN feature must be enabled before an AS containing the GRNLKUP or CGPNGRNRQD Service Action can be specified as a value for the `asn` parameter.

If the NPP Service specified by the `srvn` parameter does not support invoking another NPP Service, then only a value of *none* can be specified for the `invkserv` parameter.

If the NPP Service specified by the `srvn` parameter can invoke the TIFCGPN NPP Service, then only a value of *tifcgn* or *none* can be specified for the `invkserv` parameter.

If the NPP Service specified by the `srvn` parameter can invoke the TIFCGPN3 NPP Service, then only a value of *tifcgn3* or *none* can be specified for the `invkserv` parameter.

If the AS specified by the `asn` parameter contains the ASDOTHER or GRNOTHER Formatting Action, then the `invkserv=none` parameter cannot be specified.

If the AS specified by the `asn` parameter contains the CGPNASDRQD, CGPNGRNQD, CGPNSVCRQD, NSCGPN, or SNSCGPN Service Action, then only a value of *none* can be specified for the `invkserv` parameter.

The TIF Range CgPN Blacklist feature must be enabled before:

- an AS containing the NOCGPNRLS Service Action can be specified as a value for the `asn` parameter and a value of *tif*, *tif2*, or *tif3* can be specified for the `srvn` parameter
- an AS containing the FPFXRLS Service Action can be specified as a value for the `asn` parameter and a value of *tifcgn*, *tifcgn2*, or *tifcgn3* can be specified for the `srvn` parameter

If the AS specified by the `asn` parameter contains the FPFXRLS Service Action, then no other Service Action can be specified in the AS.

If the AS specified by the `asn` parameter contains the FPFXRLS Service Action, then the AS must also contain a numerical values list with 2 numerical values.

If the AS specified by the `asn` parameter contains the FPFXRLS Service Action, then the 2 numerical values specified by the numerical values list must each be between 0-127.

If the AS specified by the `asn` parameter contains the NOCGPNRLS Service Action, then the AS must also contain a numerical values list with 2 numerical values.

If the AS specified by the `asn` parameter contains the NOCGPNRLS Service Action, then the 2 numerical values specified by the numerical values list must each be between 0-127.

The TIF Subscr CgPN Blacklist feature must be enabled before an AS containing the BLRLS or BLNFNDRLS Service Action can be specified as a value for the `asn` parameter, and a value of *tifcgn*, *tifcgn2*, or *tifcgn3* can be specified as a value for the `srvn` parameter.

If the AS specified by the `asn` parameter contains the BLRLS Service Action, then the AS must also contain a numerical values list with 2 numerical values.

If the AS specified by the `asn` parameter contains the BLRLS Service Action, then the 2 numerical values specified by the numerical values list must each be between 0-127.

If the AS specified by the `asn` parameter contains the BLNFNDRLS Service Action, then the AS must also contain a numerical values list with 2 numerical values.

If the AS specified by the `asn` parameter contains the BLNFNDRLS Service Action, then the 2 numerical values specified by the numerical values list must each be between 0-127.

If the Service specified by the `srvn` parameter does not support a numerical value list for the first Service Action in the AS specified by the `asn` parameter, then the `sa1val` parameter in the AS can only have a value of *none*.

If the Service specified by the `srvn` parameter does not support a numerical value list for the second Service Action in the AS specified by the `asn` parameter, then the `sa2val` parameter in the AS can only have a value of *none*.

If the Service specified by the `srvn` parameter does not support a numerical value list for the third Service Action in the AS specified by the `asn` parameter, then the `sa3val` parameter in the AS can only have a value of *none*.

If the Service specified by the `srvn` parameter does not support a numerical value list for the fourth Service Action in the AS specified by the `asn` parameter, then the `sa4val` parameter in the AS can only have a value of *none*.

If the Service specified by the `srvn` parameter does not support a numerical value list for the fifth Service Action in the AS specified by the `asn` parameter, then the `sa5val` parameter in the AS can only have a value of *none*.

If the Service specified by the `srvn` parameter does not support a numerical value list for the sixth Service Action in the AS specified by the `asn` parameter, then the `sa6val` parameter in the AS can only have a value of *none*.

If the Service specified by the `srvn` parameter does not support a numerical value list for the seventh Service Action in the AS specified by the `asn` parameter, then the `sa7val` parameter in the AS can only have a value of *none*.

If the Service specified by the `srvn` parameter does not support a numerical value list for the eighth Service Action in the AS specified by the `asn` parameter, then the `sa8val` parameter in the AS can only have a value of *none*.

If the Service specified by the `srvn` parameter does not support a digit string for the first Service Action in the AS specified by the `asn` parameter, then the `sa1dgts` parameter in the AS can only have a value of *none*.

If the Service specified by the `srvn` parameter does not support a digit string for the second Service Action in the AS specified by the `asn` parameter, then the `sa2dgts` parameter in the AS can only have a value of *none*.

If the Service specified by the `srvn` parameter does not support a digit string for the third Service Action in the AS specified by the `asn` parameter, then the `sa3dgts` parameter in the AS can only have a value of *none*.

If the Service specified by the `srvn` parameter does not support a digit string for the fourth Service Action in the AS specified by the `asn` parameter, then the `sa4dgts` parameter in the AS can only have a value of *none*.

If the Service specified by the `srvn` parameter does not support a digit string for the fifth Service Action in the AS specified by the `asn` parameter, then the `sa5dgts` parameter in the AS can only have a value of *none*.

If the Service specified by the `srvn` parameter does not support a digit string for the sixth Service Action in the AS specified by the `asn` parameter, then the `sa6dgt`s parameter in the AS can only have a value of *none*.

If the Service specified by the `srvn` parameter does not support a digit string for the seventh Service Action in the AS specified by the `asn` parameter, then the `sa7dgt`s parameter in the AS can only have a value of *none*.

If the NPP Service specified by the `srvn` parameter can invoke the TIFCGPN2 NPP Service, then only a value of *tifcgn2* or *none* can be specified for the `invkserv` parameter.

If the Service specified by the `srvn` parameter does not support a digit string for the eighth Service Action in the AS specified by the `asn` parameter, then the `sa8dgt`s parameter in the AS can only have a value of *none*.

At least one optional parameter must be specified.

A new value must be specified for the `asn` or `invkserv` parameter.

The TIF Selective Screening feature must be enabled before an AS containing the SELSCR, FPFURLS, BLURLS, or BLNFNDRLS Service Action can be specified as a value for the `asn` parameter, and a value of *tif*, *tif2*, or *tif3* can be specified as a value for the `srvn` parameter.

If the AS specified by the `asn` parameter contains the SELSCR Service Action, then no TIF Number Substitution (NSCGPN or NSCDPN) Service Action can be specified in the AS.

If the AS specified by the `asn` parameter contains the SELSCR Service Action, then the 2 numerical values specified by the numerical values list must each be between 0-127 or *none*.

Only one call type can be specified for the SELSCR Service Action in the TIF NPP service rule. If the AS specified by the `asn` parameter contains the SELSCR Service Action, the corresponding SA Digit String specified must be between *none* or 1-FF.

The CGPNSVCRQD and NPNRLS Service Actions cannot exist within the same Action Set.

SUBCDPN must be configured in TIFOPTS in order to apply TIFRDNBL SA.

ASD related SAs cannot be configured in same srs.

## Notes

None.

## Output

```
chg-npp-srs:srvn=tif:fnai=intl:fpfx=9090:fdl=*:asn=set1
```

```
tekelecstp 09-04-05 15:45:28 EST EAGLE 41.0.0
NPP-SRS table is (1 of 8192) 1% full.
CHG-NPP-SRS: MASP A - COMPLTD
```

```
;
```

**Related Topics**

- [chg-npp-as](#)
- [dlt-npp-srs](#)
- [ent-npp-as](#)
- [ent-npp-srs](#)
- [rtrv-npp-as](#)
- [rtrv-npp-srs](#)

## chg-pid

Use this command to change your password.

When this command is executed, you are prompted to enter your current password. This prevents anyone but you from changing your password.

**Parameters**

This command has no parameters.

**Example**

```
chg-pid
```

**Dependencies**

This command cannot be entered from a terminal that is configured as an OAP terminal.

The password can contain up to 12 characters.

The password must contain at least the number of characters specified by the `minlen` parameter in the `chg-secu-dflt` command.

The password must contain at least the number of alphabetic characters specified by the `alpha` parameter in the `chg-secu-dflt` command.

The password must contain at least the number of numeric characters specified by the `num` parameter in the `chg-secu-dflt` command.

The password must contain at least the number of punctuation characters specified by the `punc` parameter in the `chg-secu-dflt` command.

The password cannot contain the associated User ID.

The number of days specified by the `minintrvl` parameter in the `chg-secu-dflt` command must pass between password changes.

The password must contain fewer duplicate characters from the existing password than the number specified by the `pchreuse` parameter in the `chg-secu-dflt` command.

The password cannot be the same as a previous password if the limit in the password history, specified by the `preuse` parameter of the `chg-secu-dflt` command, has been reached.

The current password cannot be entered as the new password.



The OA&M IP Security Enhancements feature must be turned on before passwords can be created or modified from a telnet terminal (terminal IDs 17-40).

The value entered for password verification must match the value entered for the password.

### Notes

When a new system is shipped, both the user ID and password are set to the system. Change these immediately to ensure system security.

MTT 2889 was deleted for 42.0, PR 158511.

### Output

chg-pid

```
rlghncxa03w 10-03-07 09:10:41 EST EAGLE 42.0.0
CHG-PID: MASP A - COMPLTD
```

;

```
Enter Old Password : <old password> Enter New Password : <new
password>
```

If secu-dflt parameter preuse is non zero and pchreuse is non zero:

New password must contain:

- between 8 and 12 characters
- at least 1 alphabetic character(s) ('a'-'z')
- at least 1 numeric character(s) ('0'-'9')
- at least 1 punctuation character(s) (e.g. \$%@#)

New password must:

- be unique from the old password
- be unique from the last 2 historical password(s)
- not reuse more than 4 character(s) from the old password

If secu-dflt parameter preuse is non zero and pchreuse is zero:

New password must contain:

- between 8 and 12 characters
- at least 1 alphabetic character(s) ('a'-'z')
- at least 1 numeric character(s) ('0'-'9')
- at least 1 punctuation character(s) (e.g. \$%@#)

New password must:

- be unique from the old password
- be unique from the last 2 historical password(s)

If secu-dflt parameter preuse is zero and pchreuse is non zero:

New password must contain:

- between 8 and 12 characters
- at least 1 alphabetic character(s) ('a'-'z')
- at least 1 numeric character(s) ('0'-'9')
- at least 1 punctuation character(s) (e.g. \$%@#)

New password must:

- be unique from the old password
- not reuse more than 4 character(s) from the old password

If secu-dflt parameter preuse is zero and pchreuse is zero:

New password must contain:

- between 8 and 12 characters
- at least 1 alphabetic character(s) ('a'-'z')
- at least 1 numeric character(s) ('0'-'9')
- at least 1 punctuation character(s) (e.g. \$%@#)

New password must:

- be unique from the old password

### Related Topics

- [act-user](#)
- [chg-secu-dflt](#)
- [chg-user](#)
- [dact-user](#)
- [dlt-user](#)
- [ent-user](#)
- [login](#)
- [logout](#)
- [rept-stat-user](#)
- [rtrv-secu-dflt](#)
- [rtrv-secu-user](#)
- [rtrv-user](#)

## chg-ppsopts

Use this command to enter Prepaid Short Message Service options (PPSOPTS) in the database. This command updates the PPSOPTS Table with entries that correspond to Intelligent Network (IN) platforms.

### Parameters



#### Note:

See [Point Code Formats and Conversion](#) for a detailed description of point code formats, rules for specification, and examples.



#### Note:

If the CgPA GTA matches the value of the `gta`, `gta1`, `gta2`, or `gta3` parameter during message screening, then the message falls through to GTT instead of receiving PPSMS screening.

**bpartychk (optional)**

MO SMS B-Party PPSMS Check. This parameter specifies whether a prepaid check on the B-Party is performed on an incoming MO SMS message.

**Range:****off**

Prepaid Check on B-Party is not performed

**on**

Prepaid Check on B-Party is performed

**Default:**

No change to current value

**System Default:**

*off*

**gta (optional)**

Global title address. The entity address for an IN platform. Determines whether an incoming message receives PPSMS screening.

**Range:**

1-15 digits

Valid digits are *0-9, A-F, a-f*.

**Default:**

No change to current value

**gta1 (optional)**

Global title address. The entity address for an IN platform. Determines whether an incoming message receives PPSMS screening.

**Range:**

1-15 digits

Valid digits are *0-9, A-F, a-f*

**Default:**

No change to current value.

**gta2 (optional)**

Global title address. The entity address for an IN platform. Determines whether an incoming message receives PPSMS screening.

**Range:**

1-15 digits

Valid digits are *0-9, A-F, a-f*

**Default:**

No change to current value.

**gta3 (optional)**

Global title address. This parameter specifies the entity address for an IN platform. Determines whether an incoming message receives PPSMS screening.

**Range:**

1-15 digits  
Valid digits are 0-9, A-F, a-f

**Default:**

No change to current value.

**ngta (optional)**

New global title address. An entity address that replaces an existing entity address for an IN platform.

**Range:1-15 digits, none**

Valid digits are 0-9, A-F, a-f  
*none* —Deletes the current value

**Default:**

No change to current value.

**pc (optional)**

ANSI point code with subfields *network indicator-network cluster-network cluster member (ni-nc-ncm)*. The *prefix* subfield indicates a private point code (*prefix-ni-nc-ncm*).

**Synonym:**

*pca*

**Range:**

Specify a valid value for each subfield of the point code, and separate the subfields with a dash (-).

*p-*, 000-255, *none*

*prefix—p-*

When *chg-sid:pctype=ansi* is specified, *ni = 000* is not valid.

When *chg-sid:pctype=ansi* is specified, *nc = 000* is not valid for *ni = 001-005*.

When *chg-sid:pctype=ansi* is specified, *nc = 000* is valid if *ni = 006-255*.

Enter *none* to delete the point code.

The point code 000-000-000 is not a valid point code.

**Default:**

No change to current value.

**pci (optional)**

ITU international point code with subfields *zone-area-id*. The *prefix* subfield indicates a spare point code (*prefix-zone-area-id*).

**Range:**

*s-*, 0-255, *none*

Specify a valid value for each subfield of the point code, and separate the subfields with a dash (-).

*prefix—s*

*zone—0-7*

*area—000-255*

*id—0-7*

Enter *none* to delete the point code.

The point code 0-000-0 is not a valid point code.

**Default:**

No change to current value.

**pcn (optional)**

ITU national point code in the format of a 5-digit number (*nnnnn*); or 2, 3, or 4 numbers (members) separated by dashes (*m1-m2-m3-m4*) as defined by the `chg-stpopts:npcfmti` flexible point code option. A group code must be specified when the ITUDUPPC feature is turned on (*nnnnn-gc*, *m1-m2-m3-m4-gc*). The *prefix* subfield indicates a spare point code (*prefix-nnnnn*, *prefix-nnnnn-gc*, *prefix-m1-m2-m3-m4*, *prefix-m1-m2-m3-m4-gc*).

**Range:**

*s*-, *0-16383*, *aa-zz*, *none*

Specify a valid value for each subfield of the point code, and separate the subfields with a dash (-).

*prefix*—*s*

*nnnnn*—*0-16383*

*gc*—*aa-zz*

*m1-m2-m3-m4*—*0-14* for each member; values must sum to 14

Enter *none* to delete the point code.

**Default:**

No change to current value.

**ppt (optional)**

Prepaid portability type. The IN platform where the incoming message is sent.

**Range:**

*1 - 32*

**ri (optional)**

Routing indicator. The IN platform routing indicator.

**Range:**

**gt**

Routes on the GT value.

**ssn**

Routes on the SSN value.

**Default:**

No change to current value.

**setid (optional)**

Set ID. The MAP set ID (if the `ri=ssn` parameter is specified) or the MRN set ID (if the `ri=gt` parameter is specified) that is used by a loadsharing IN platform.

**Note:**

If the FGTTLS feature is not enabled, lookup is performed in the default set of the MAP table or MRN table.

**Range:**

*1 - 36000*, *none*, *dflt*

*1 - 36000, none, dflt* —MAP table  
*1 - 3000* —MRN table  
*none* —Lookup is not performed. This value applies only to the MRN table.  
*dflt* —Lookup is performed in the default MAP set or MRN set.

**Default:**  
No change to current value.

**ssn (optional)**  
Subsystem number

**Range:**  
*2 - 255*

**Default:**  
*none*

### Example

This command provisions a single GTA in the PPSOPTS table.  
`chg-ppsopts:gta=1234`

This command provisions four GTAs in the PPSOPTS table.  
`chg-ppsopts:gta=1101:gta1=1102:gta2=1103:gta3=1104`

This command replaces an existing GTA with a new GTA.  
`chg-ppsopts:gta=1101:ngta=4567`

This command deletes a specified GTA from the PPSOPTS table.  
`chg-ppsopts:gta=1102:ngta=none`

This command deletes the *pc*, *ri*, and *setid* values for a specified IN platform.  
`chg-ppsopts:ppt=1:pci=none`

This example provisions a loadsharing set for a specified IN platform.  
`chg-ppsopts:ppt=2:setid=2`

This example provisions point code, routing indicator, and set ID values for a specified IN platform and loadsharing set.  
`chg-ppsopts:ppt=1:pci=1-1-1:ri=gt:setid=1`

This example provisions the prepaid check on B-Party.  
`chg-ppsopts:bpartychk=on`

This example provisions ANSI point code, routing indicator, and set ID values for a specified IN platform and loadsharing set.  
`chg-ppsopts:ppt=2:pca=2-2-1:ri=ssn:setid=4`

### Dependencies

At least one parameter must be specified.

The PPSMS, IDP A-Party Routing, or IDP Service Key Routing feature must be enabled and turned on before this command can be entered.

If the `ngta` parameter is specified, then the `gta` parameter must be specified.

The `gta`, `gta1`, `gta2`, and `gta3` parameters cannot have a value of *none*.

If the `ngta` parameter is specified, the `gta` parameter value must already exist in the database.

The `ngta` parameter value cannot already exist in the database.

The value specified for the `pc/pca/pci/pcn` parameter cannot be the same as the STP True Point Code.

The value specified for the `pc/pca/pci/pcn` parameter cannot be the same as the STP Capability Point Code.

If the `pc`, `ri`, `ssn`, or `setid` parameter is specified, then the `ppt` parameter must be specified.

If the `gta1`, `gta2`, or `gta3` parameter is specified, then the `ngta` parameter cannot be specified.

The Flexible GTT Load Sharing (FGTTLS) feature must be enabled before the `setid` parameter can be specified.

If the `ri=gt` parameter is specified, then the value of the `setid` parameter cannot exceed the value of the maximum MRN set ID.

The Site Identification table is corrupt or cannot be found.

The value specified for the `pc/pca/pci/pcn` parameter must already exist in the Routing Indicator table.

The Prepaid SMS options (PPSOPTS) table is corrupt or cannot be found.

The value of the `gta`, `gta1`, `gta2`, or `gta3` parameter cannot already exist in the database unless the `ngta` parameter is specified.

The `pc/pca/pci/pcn` parameter and the `ri` parameter must be specified together in the command, or a value of `none` must be specified for the `pc/pca/pci/pcn` parameter.

The `gta`, `gta1`, `gta2`, and `gta3` parameters cannot have the same value.

A maximum of 32 GTA values (for 32 IN platforms) can be defined in the database.

If the Flexible GTT Load Sharing (FGTTLS) feature is enabled, and if the `ri=ssn` parameter is specified, then the values specified for the `pc/pca/pci/pcn` and `ssn` parameters must exist in the MAP table in the MAP set specified by the `setid` parameter, or in the default MAP set if the `setid` parameter is not specified.

If the `ri=gt` parameter is specified, then the value specified for the `pc/pca/pci/pcn` parameter must exist in the MRN table.

If the `ri=ssn` parameter is specified, then the `setid=none` parameter cannot be specified.

The `pc/pca/pci/pcn`, `ri`, `setid`, and `ssn` parameters must be specified before the `ppt` parameter can be specified.

The `pc/pca/pci/pcn` parameter must be provisioned for the prepaid type specified by the `ppt` parameter before the `setid` parameter can be specified.

If a value of `none` is specified for the `pc/pca/pci/pcn` parameter, then the `ri` or `setid` parameter cannot be specified.





Part or all of the feature name can be entered. If part of the feature name is specified, the entry must start with the first letter of the name, and must contain enough of the name to uniquely identify the feature. For example, there are two feature names that begin with "GSM MAP." Enough additional characters to identify which GSM MAP feature is being entered (at least "GSM MAP SR" to identify the "GSM MAP SRI Redirect" feature). This command supports the following controlled features:

- GSM MAP SRI Redirect
- ISUP NP for EPAP

**prefix (mandatory)**

Prefix Value. Prefix table entries for the GSM MAP SRI Redirect and ISUP NP with EPAP features.

**Range:**

1-15 hexadecimal digits. Valid digits are 0-9, a-f, A-F

**Default:**

Current value

**prefixnum (mandatory)**

Prefix Number. The prefix value to use for the specified feature name.

**Range:**

1 - 7

1 - 128 for GSM MAP SRI Redirect feature prefix values

1-5 for ISUP NP with EPAP feature prefix values

6 for the ISUP NP with EPAP feature Insertion Country Code

7 for the ISUP NP with EPAP feature Deletion Condition value

**Default:**

No change to the current value

**Example**

Define a prefix with prefix number 1 for the ISUP NP with EPAP feature.

```
chg-prefix:feature="isup np with epap":prefix=1004:prefixnum=1
```

Define a prefix with prefix number 2 and specify part of the GSM MAP SRI Redirect feature name.

```
chg-prefix:feature="GSM MAP SRI":prefix=104:prefixnum=2
```

Define a prefix with prefix number 6 and specify part of the GSM MAP SRI Redirect feature name.

```
chg-prefix:feature="GSM MAP SRI  
Redirect":prefix=1006:prefixnum=6
```

**Dependencies**

The specified feature name value (`feature` parameter) must be enclosed in double quotation marks

(" ").

The GSM MAP SRI Redirect feature must be enabled before a GSM MAP SRI Redirect prefix can be defined.

The ISUP NP with EPAP feature must be enabled before an ISUP NP with EPAP prefix can be defined.

The specified prefix value must contain a number of digits that is equal to or less than the maximum number of digits required by the specified feature.

The specified prefix number (`prefixnum`) must be valid for the specified feature.

The specified feature name must be the name of an enabled controlled feature as it is displayed in the `rtrv-ctrl-feat` command output. The specified feature must be the GSM MAP SRI Redirect or ISUP NP for EPAP feature.

The FEATPFX table is corrupt or cannot be found by the system.

The FEATPFX table cannot be full when a new entry is added.

### Notes

The Prefix table contains different groups of entries based on the features that are turned on. For the GSM MAP SRI Redirect for Serving HLR feature, the entries are referenced by the VendID table, based on a Vendor Number matching a Prefix Number. For the ISUP NP with EPAP feature, the entries are referenced by the SubnetID table, based on a Subnet Number matching a Prefix Number. The Prefix table for the ISUP NP with EPAP feature also reserves Prefix Number 6 for the Insertion Country Code value, and reserves Prefix Number 7 for the Deletion Condition value. [Figure 4-7](#) illustrates the references to the Prefix table.

**Figure 4-7 Prefix Table References**

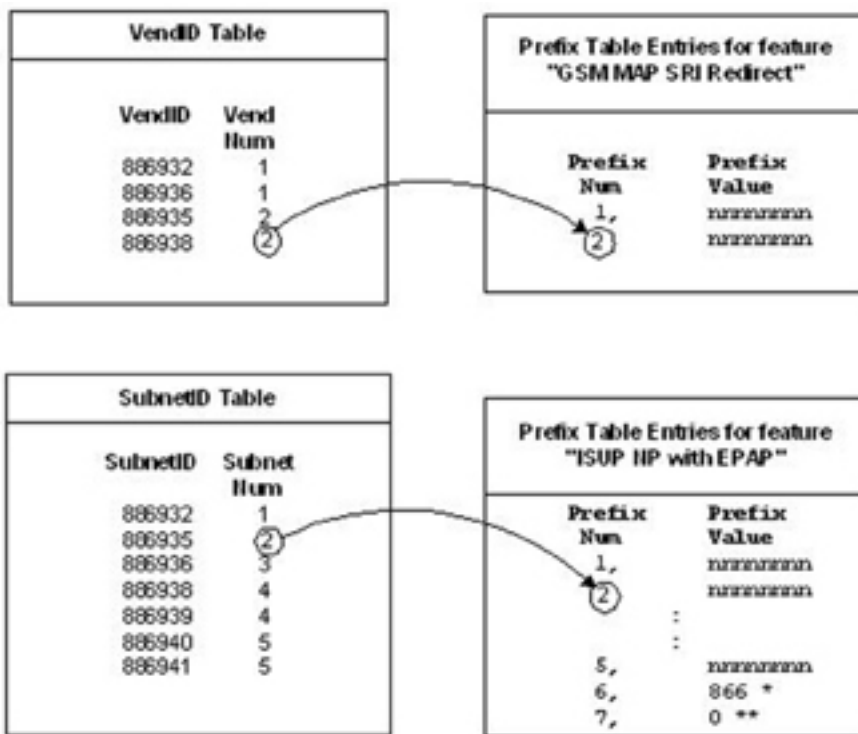

\* Reserved for the ISUP NP with EPAP feature Insertion Country Code value

\*\* Reserved for the ISUP NP with EPAP feature Deletion Condition value

For the ISUP NP with EPAP feature:

- When the Insertion Country Code (prefix number 6) is defined, the following information message appears:  
ISUP NP with EPAP, Insertion Country Code value is now defined
- When the Deletion Condition (prefix number 7) is defined, the following information message appears:  
ISUP NP with EPAP, Deletion Condition value is now defined

The maximum number of prefixes that can be defined is:

- 128 for the GSM MAP SRI Redirect feature
- 5 values, 1 Insertion Country Code, and 1 Deletion Condition for the ISUP NP with EPAP feature

### Output

```
chg-prefix:feature="isup np with epap":prefix=1004:prefixnum=1
```

```

rlghncxa03w 04-09-20 09:04:14 EST  EAGLE 31.11.0
CHG-PREFIX: MASP A - COMPLTD
;

```

```
chg-prefix:feature="gsm map sri
redirect":prefix=1205:prefixnum=18
```

```

tekelecstp 14-05-30 16:44:50 EST  EAGLE 46.1.0
CHG-PREFIX: MASP A - COMPLTD
;

```

### Related Topics

- [dlt-prefix](#)
- [rtrv-ctrl-feat](#)
- [rtrv-prefix](#)

## chg-rte

Use this command to change the “cost,” or priority of a route. The cost is based on whether this route is first choice, second choice, and so on. Prioritize routes in such a way that the most direct route (fewest intermediate signaling points) is highest priority.

## Parameters

 **Note:**

See [Point Code Formats and Conversion](#) for a detailed description of point code formats, rules for specification, and examples.

**lsn (mandatory)**

Linkset name. The name of the linkset associated with the route.

 **Note:**

The linkset name must be unique.

**Range:**

ayyyyyyyyy

1 alphabetic character followed by 9 alphanumeric characters

**dpc (optional)**

ANSI destination point code with subfields *network indicator-network cluster-network cluster member (ni-nc-ncm)*. The *prefix* subfield indicates a private point code (*prefix-ni-nc-ncm*).

**Synonym:**

*dpca*

**Range:**

*p-*, 000-255, \*

Specify a valid value for each subfield of the point code, and separate the subfields with a dash (-).

*prefix—p-*

The asterisk value (\*) is not valid for the *ni* subfield.

When *chg-sid:pctype=ansi* is specified, *ni = 000* is not valid.

When *chg-sid:pctype=ansi* is specified, *nc = 000* is not valid if *ni = 001–005*.

When *chg-sid:pctype=ansi* is specified, *nc = 000* is valid if *ni = 006–255*.

The point code *000-000-000* is not a valid point code.

**dpc/dpca/dpci/dpcn/dpcn24/dpcn16 (optional)**

Destination point code.

**dpci (optional)**

ITU international destination point code with subfields *zone-area-id*. The *prefix* subfield indicates a spare point code, private point code, or private and spare point code (*prefix-zone-area-id*).

**Range:**

*s-*, *p-*, *ps-*, 0-255

Specify a valid value for each subfield of the point code, and separate the subfields with a dash (-).

*prefix—s-*, *p-*, *ps*

zone—0-7  
 area—000-255  
 id—0-7

The point code 0-000-0 is not a valid point code.

#### **dpcn (optional)**

ITU national point code in the format of a 5-digit number (*nnnnn*); or 2, 3, or 4 numbers (members) separated by dashes (*m1-m2-m3-m4*) as defined by the `chg-stpopts:npcfmti` flexible point code option. A group code must be specified when the ITUDUPPC feature is turned on (*nnnnn-gc*, *m1-m2-m3-m4-gc*). The *prefix* subfield indicates a spare point code, private point code, or private and spare point code (*prefix-nnnnn*, *prefix-nnnnn-gc*, *prefix-m1-m2-m3-m4*, *prefix-m1-m2-m3-m4-gc*).

#### **Range:**

*s-*, *p-*, *ps-*, 0-16383, *aa-zz*

Specify a valid value for each subfield of the point code, and separate the subfields with a dash (-).

*prefix*—*s-*, *p-*, *ps*

*nnnnn*—0-16383

*gc*—*aa-zz*

*m1-m2-m3-m4*—0-14 for each member; values must sum to 14

#### **dpcn24 (optional)**

24-bit ITU national destination point code with subfields *main signaling area-sub signaling area-signaling point* (*msa-ssa-sp*). The *prefix* subfield indicates a private point code.

#### **Range:**

*p-*, 000-255

Specify a valid value for each subfield of the point code, and separate the subfields with a dash (-).

*prefix*—*p*

*msa*—000–255

*ssa*—000–255

*sp*—000–255

#### **dpcn16 (optional)**

16-bit ITU national point code with subfields *unit number sub number area main number area* (*un-sna-mna*). The *prefix* subfield indicates a private point code.

#### **Range:**

*p-*, 000-127

Specify a valid value for each subfields of the point code, and separate the subfields with a dash (-).

*prefix*--*p*

*un*--000--127

*sna*--000--15

*mna*--000--31

**force (optional)**

This parameter allows the NLSN to be same as the ILSN in the exception routes of the destination or allows APC to be same as OPC in the exception routes of the destination.

**Range:**

yes

**nlsn (optional)**

New linkset name. The new linkset name associated with the route.

**Range:**

ayyyyyyyy

1 alphabetic character followed by 9 alphanumeric characters

**Default:**

The current value

**rc (optional)**

Relative cost (priority) for the route. Zero (0) is the highest priority, 99 the lowest.

**Range:**

0 - 99

**Default:**

The current value

**Example**

```
chg-rte:lsn=rlgh03:rc=0:dpc=244-003-001
```

```
chg-rte:dpc=25-*-*:lsn=myls:rc=10
```

This example changes route for DPCN 4084-aa using linkset E1M2ITUN to relative cost of 30:

```
chg-rte:dpcn=4085-aa:lsn=e1m2itun:rc=30
```

This example changes route for DPCN24, 10-100-14 using linkset WE123624 to a relative cost of 2:

```
chg-rte:dpcn24=10-100-14:lsn=we123624:rc=25
```

This example changes route for private point code DPC p-1-1-1 using linkset WE123642 to relative cost of 50:

```
chg-rte:dpc=p-1-1-1:lsn=we123642:rc=50
```

This example changes route for spare point code DPCN s-4085-aa using linkset E1M2ITUN to relative cost of 30:

```
chg-rte:dpc=s-4085-aa:lsn=e1m2itun:rc=30
```

This example changes route for private point code DPCN24 p-1-100-1 using linkset WE123624 to relative cost of 25:

```
chg-rte:dpcn24=p-1-100-1:lsn=we123624:rc=25
```

This example changes route for private and spare point code DPCI ps-1-104-1 using linkset E1M2ITUI to relative cost of 30:

```
chg-rte:dpci=ps-1-104-1:lsn=e1m2itui:rc=30
```

This example changes route for DPCN16, 121-10-15 using linkset WE123624 to a relative cost of 10:

```
chg-rte:dpcn16=10-100-14:lsn=we123624:rc=10
```

### Dependencies

The 6-Way Loadsharing on Routesets feature must be turned on before more than 2 routes can be provisioned with the same relative cost.

If the `ipgwapc=yes` parameter is specified, then the associated `dpc/dpca/dpci/dpcn/dpcn24/dpcn16` parameter cannot have a cluster route assigned.

If the identity of a route is being changed because of a change in the linkset name, the database must not already contain the new linkset name and destination address.

If the `nlsn` parameter is specified, the link set must already exist in the database and at least one link must be assigned to the link set.

If a new linkset name (`nlsn` parameter) is specified for an existing destination network address (`ni-*-*`), or destination network cluster address (`ni-nc-*`), the linkset type used in the route (see the `chg-ls` command) must be *b*, *c*, or *d*.

If the specified destination address is a full point code address (`ni-nc-ncm`) and is a member of a provisioned cluster (`ni-nc-*`), whether the attributes of the ordered routes assigned to the cluster can be changed is determined by the destination address's NCAI (Nested Cluster Allowed Indicator). The NCAI is set with the `ncai` parameter of the `ent/chg-dstn` commands.

- If the `ncai=no` parameter is specified, the cluster point code is not a nested cluster point code and the attributes of the ordered routes assigned to the cluster cannot be changed.
- If the `ncai=yes` parameter is specified, the specified destination address is a member of a provisioned nested cluster where the attributes of the ordered routes assigned to the cluster can be changed.

If the specified destination address is a network cluster address (`ni-nc-*`), how the attributes of the specified ordered route are changed is determined by the setting of the destination address's NCAI.

- If the `ncai=no` parameter is specified, the attributes of the specified ordered route are changed for each signaling point code having the same network identifier (*ni*) and network cluster (*nc*) codes.
- If the `ncai=yes` parameter is specified, the specified destination address is a nested cluster where changing the attributes of the ordered routes for the cluster does not affect the attributes of the ordered routes of the provisioned members.

The route destination's type must match the route's linkset adjacent point code or the route's linkset secondary adjacent point code type.

Only IPGW routes are allowed for private point codes.

If the `dpcn` parameter is specified, its format must match the format that was assigned with the `chg-stpopts:npcfmti` parameter.

Network routing is valid only if the NRT feature is on.

When using network routing, if the destination point code has a value of \* in the *nc* field, the *ncm* field must also be \* (for example, *dpc=21-\*-\**).

The Route table is corrupt or cannot be found.

The Linkset table is corrupt or cannot be found.

The *nda*, *nz*, *nlsn*, or *nrc* parameter must be specified.

The current destination address must be a full or a cluster point code.

All linksets that are currently assigned to a route set must still be equipped.

The linkset specified by the *lsn* parameter must exist in the routeset of the destination table entry.

If a new link set (*nlsn* parameter) is specified in the command, that link set name must exist in the active LINK SET entity.

The specified DPC must be in the database.

Only a single route is allowed for an APC or SAPC for an IPGWx linkset. The changed route must include the APC or SAPC's IPGWx linkset with the destination equal to the APC or SAPC.

If a proxy linkset is used, then the *nlsn* parameter cannot be specified.

If a proxy linkset is used, then the value specified for the *dpc* parameter cannot be a network cluster address (*ni-nc-\**) or network address (*ni-\*.\**).

The network type of the routeset must be same as the network type of the destination point code.

The value specified for the *rc* parameter must differ from the original routing cost of the associated linkset.

If the value specified for the *dpc* parameter refers to a Proxy Point Code in the Destination table, then the *nlsn* parameter cannot be specified.

The SAPC table is corrupt or cannot be found.

## Notes

In this command, only ITU-international and ITU national point codes support the spare point code subtype prefix (s-) and the private and spare point code subtype prefix (ps-). All of the point code types support the private (internal) point code subtype prefix (p-).

## Output

```
chg-rte:lsn=rlgh03:rc=0:dpc=244-003-001
```

```
rlghncxa03w 04-01-07 11:43:04 EST EAGLE 31.3.0
CHG-RTE: MASP A - COMPLTD
;
```

## Related Topics

- [chg-dstn](#)



- dlt-dstn
- dlt-rte
- ent-dstn
- ent-rte
- rept-stat-dstn
- rept-stat-rte
- rtrv-dstn
- rtrv-rte

## chg-rtx

Use this command to change an exception route entry in the Routing table.

### Parameters

At least one of the following optional parameters must be specified: *opc*, *ilsn*, *si*, or *cic*.

#### **dpc (mandatory)**

ANSI destination point code with subfields *network indicator-network cluster-network cluster member (ni-nc-ncm)*. The *prefix* subfield indicates a private point code (*prefix-ni-nc-ncm*).

##### **Synonym:**

*dpca*

##### **Range:**

*p-*, 000-255

Specify a valid value for each subfield of the point code, and separate the subfields with a dash (-).

*prefix—p-*

When *chg-sid:pctype=ansi* is specified, *ni = 000* is not valid.

When *chg-sid:pctype=ansi* is specified, *nc = 000* is not valid if *ni = 001-005*.

When *chg-sid:pctype=ansi* is specified, *nc = 000* is valid if *ni = 006-255*.

The point code *000-000-000* is not a valid point code.

#### **dpc/dpca/dpci/dpcn/dpcn24/dpcn16 (mandatory)**

Destination point code.

#### **dpci (mandatory)**

Destination Point Code. ITU international point code with subfields *zone-area-id*. The *prefix* subfield indicates a spare point code, private point code, or private and spare point code (*prefix-zone-area-id*).

##### **Range:**

*s-*, *p-*, *ps-*, 0-255

Specify a valid value for each subfield of the point code, and separate the subfields with a dash (-).

*prefix—s-*, *p-*, *ps*

*zone—0-7*

*area—000-255*

*id—0-7*

The point code *0-000-0* is not a valid point code.

**dpcn (mandatory)**

Destination Point Code. ITU national point code in the format of a 5-digit number (*nnnnn*); or 2, 3, or 4 numbers (members) separated by dashes (*m1-m2-m3-m4*) as defined by the `chg-stpopts:npcfmti` flexible point code option. A group code must be specified when the ITUPUPPC feature is turned on (*nnnnn-gc*, *m1-m2-m3-m4-gc*). The prefix subfield indicates a spare point code, private point code or private and spare point code (*prefix-nnnnn*, *prefix-nnnnn-gc*, *prefix-m1-m2-m3-m4*, *prefix-m1-m2-m3-m4-gc*).

**Range:**

*s-*, *p-*, *ps-*, *0-16383*, *aa-zz*

Specify a valid value for each subfield of the point code, and separate the subfields with a dash (-).

*prefix—s-*, *p-*, *ps*

*nnnnn—0-16383*

*gc—aa-zz*

*m1-m2-m3-m4—0-14* for each member; values must sum to 14

**dpcn24 (mandatory)**

Destination Point Code. 24-bit ITU national point code with subfields *main signaling area-sub signaling area-signaling point* (*msa-ssa-sp*). The *prefix* subfield indicates a private point code (*prefix-msa-ssa-sp*).

**Range:**

*p-*, *000-255*

Specify a valid value for each subfield of the point code, and separate the subfields with a dash (-).

*prefix—p*

*msa—000-255*

*ssa—000-255*

*sp—000-255*

**dpcn16 (mandatory)**

Destination Point Code. 16-bit ITU national point code with subfields *unit number-sub number area-main number area* (*un-sna-mna*). The *prefix* subfield indicates a private point code (*prefix-un-sna-mna*).

**Range:**

*p--*, *000-127*

Specify a valid value for each subfield of the point code, and separate the subfields with a dash (-).

*prefix--p*

*un---000---127*

*sna---000---15*

*mna---000---31*

**l<sub>sn</sub> (mandatory)**

The name of the linkset associated with the specified exception route.

**Range:**

ayyyyyyyyy

1 alphabetic character followed by up to 9 alphanumeric characters.

**c<sub>ic</sub> (optional)**

Starting Circuit Identification Code. This parameter is used alone or with the `ecic` parameter as exception routing criteria for the specified exception route.

**Range:**

1 - 16383

**ec<sub>ic</sub> (optional)**

Ending Circuit Identification Code. This parameter and the `cic` parameter define the CIC range that is used as exception routing criteria for the specified exception route.

**Range:**

0 - 16383

**force (optional)**

This parameter must be specified when the `ilsn` parameter value is the same as the `nlsn` parameter value.

**Range:**

yes

**i<sub>l<sub>sn</sub></sub> (optional)**

The name of the incoming/originating linkset. This parameter is used as part of the exception routing criteria for the specified exception route.

**Range:**

ayyyyyyyyy

1 alphabetic character followed by up to 9 alphanumeric characters

**n<sub>l<sub>sn</sub></sub> (optional)**

The new linkset name that replaces the linkset name associated with the specified exception route.

**Range:**

ayyyyyyyyy

1 alphabetic character followed by up to 9 alphanumeric characters

**opc (optional)**

ANSI origination point code with subfields *network indicator-network cluster-network cluster member (ni-nc-ncm)*. The *prefix* subfield indicates a private point code (*prefix-ni-nc-ncm*).

**Range:**

p-, 000-255

Specify a valid value for each subfield of the point code, and separate the subfields with a dash (-).

prefix—p-

When `chg-sid:pctype=ansi` is specified, `ni = 000` is not valid.

When `chg-sid:pctype=ansi` is specified, `nc = 000` is not valid if `ni = 001-005`.

When `chg-sid:pctype=ansi` is specified, `nc = 000` is valid if `ni = 006-255`.

The point code `000-000-000` is not a valid point code.

### **opc/opca/opci/opcn/opcn24/opcn16 (optional)**

Originating Point Code

#### **opci (optional)**

ITU international point code with subfields *zone-area-id*. The *prefix* subfield indicates a spare point code, private point code, or private and spare point code (*prefix-zone-area-id*).

#### **Range:**

*s-, p-, ps-, 0-255*

Specify a valid value for each subfield of the point code, and separate the subfields with a dash (-).

*prefix—s-, p-, ps*

*zone—0-7*

*area—000-255*

*id—0-7*

The point code `0-000-0` is not a valid point code.

#### **opcn (optional)**

ITU national point code in the format of a 5-digit number (*nnnnn*); or 2, 3, or 4 numbers

(members) separated by dashes (*m1-m2-m3-m4*) as defined by the `chg-`

`stpopts:npcfmti` flexible point code option. A group code must be specified when the

ITUPUPPC feature is turned on (*nnnnn-gc, m1-m2-m3-m4-gc*). The *prefix* subfield indicates

a spare point code, private point code or private and spare point code (*prefix-nnnnn, prefix-nnnnn-gc, prefix-m1-m2-m3-m4, prefix-m1-m2-m3-m4-gc*).

#### **Range:**

*s-, p-, ps-, 0-16383, aa-zz*

Specify a valid value for each subfield of the point code, and separate the subfields with a dash (-).

*prefix—s-, p-, ps*

*nnnnn—0-16383*

*gc—aa-zz*

*m1-m2-m3-m4—0-14* for each member; values must sum to 14

#### **opcn24 (optional)**

24-bit ITU national point code with subfields *main signaling area-sub signaling area-signaling point* (*msa-ssa-sp*). The *prefix* subfield indicates a private point code (*prefix-msa-ssa-sp*).

#### **Range:**

*p-, 000-255*

Specify a valid value for each subfield of the point code, and separate the subfields with a dash (-).

*prefix—p*

*msa—000-255*

*ssa—000-255*

*sp—000-255*

#### **opcn16 (optional)**

16-bit ITU national point code with subfields *unit number-sub number area-main number*

*area* (*un-sna-mna*). The *prefix* subfield indicates a private point code (*prefix-un-sna-mna*).

**Range:***p--*, *000--127*

Specify a valid value for each subfield of the point code, and separate the subfields with a dash (-).

*prefix--p**un---000---127**sna---000---15**mna---000---31***rc (optional)**

The relative cost associated with the specified exception route.

**Range:**

0 - 99

**si (optional)**

Service indicator. This parameter is used as part of the exception routing criteria for the specified exception route.

**Range:**

3 - 15

**Example**

This example changes the relative cost of an existing exception route.

```
chg-rtx:dpca=1-1-1:opca=2-3-3:lsn=1set1:rc=30
```

This example changes the linkset associated with the exception route.

```
chg-rtx:dpca=1-2-1:si=3:lsn=1set2:nlsn=1set3
```

This example changes the linkset and relative cost of the exception route.

```
chg-rtx:dpca=1-3-1:ilsn=1set2:lsn=1set3:nlsn=1set4:rc=20
```

```
chg-rtx:dpci=2-100-1:ilsn=1set2:lsn=1set4:rc=10
```

```
chg-rtx:dpci=2-100-1:si=5:lsn=1set5:rc=50
```

```
chg-rtx:dpcn16=121-10-15:si=5:lsn=1set5:rc=50
```

**Dependencies**

Only one of the `opc`, `ilsn`, `cic`, or `si` parameters can be specified for an exception route entry.

If the `ecic` parameter is specified, the `cic` parameter must be specified.

The `ecic` parameter value cannot be less than the `cic` parameter value.

The `opc/opca/opci/opcn/opcn24/opcn16` parameter value cannot be the same as the `dpc` parameter value.

The Origin-Based MTP Routing feature must be turned on before this command can be entered.

The specified combination of exception route parameter conditions must already exist.

The linkset name, as defined by the `ilsn`, `lsn`, or `nlsn` parameter, must exist.

The 6-Way Loadsharing on Routesets feature must be turned on before more than 2 routes can be provisioned with the same relative cost for a given exception route criteria.

The network domain of the adjacent point code in the linkset or in the routes in the specified routeset must be the same as the network domain of the specified destination point code or its alias.

The APC/SAPC type and group code in the linkset specified by the `lsn` parameter must match the value specified by the `dpc/dpca/dpci/dpcn/dpcn24/dpcn16` parameter.

The Linkset table is corrupt or cannot be found.

The Route table is corrupt or cannot be found.

The Route Exception table is corrupt or cannot be found.

The `nlsn` parameter value cannot be the same as the `lsn` parameter value.

Either the `nlsn` parameter, the `rc` parameter, or both parameters must be specified.

The value specified for the destination point code must be a full point code and not a cluster or network point code.

The point code specified by the `dpc/dpca/dpci/dpcn/dpcn24/dpcn16` parameter must exist in the destination table.

If the `ilsn` and `lsn` parameter have the same value, or if the value specified for the `opc/opca/opci/opcn/opcn24/opcn16` parameter is the same as the APC of the linkset specified by the `lsn` parameter, then the `force=yes` parameter must be specified.

The route cost specified by the `rc` parameter must differ from the existing route cost for the linkset specified by the `lsn` parameter.

The route associated with the linkset specified by the `lsn` parameter must already exist in the specified exception route.

The route associated with the linkset specified by the `nlsn` parameter cannot already exist in the specified exception route.

The value specified for the `opc/opca/opci/opcn/opcn24/opcn16` parameters cannot be the same as the adjacent point code of the linkset specified by the `lsn` parameter.

The J7 Support feature must be enabled before the `dpcn16/opcn16` parameter can be specified.

## Output

```
chg-rtx:dpca=1-1-1:opc=2-3-3:lsn=lset1:rc=30
```

```
stdcfg2b 06-05-19 18:20:11 EST EAGLE 35.0.0  
CHG-RTX: MASP A - COMPLTD
```

## Related Topics

- [dlt-rtx](#)

- [ent-rtx](#)
- [rept-stat-rtx](#)
- [rtrv-rtx](#)

## chg-sccp-msg

Use this command to revise an SCCP message.

### Parameters



#### Note:

The nature of address indicator, numbering plan, and TCAP package indicator can be specified by mnemonic or numeric values (*cdnai/cdnaiv*, *cdnp/cdnpv*, and *tcappkg/tcappkgv* respectively).

#### **msgn (mandatory)**

Message number. The number of the SCCP message.

##### **Range:**

*1 - 10*

#### **active (optional)**

This parameter specifies whether the SCCP message should be sent to the network card for processing.

##### **Range:**

##### **yes**

The message is sent to the network card.

##### **no**

The message is not sent to the network card.

##### **Default:**

*yes*

#### **cdgta (optional)**

CdPA GTA. The Called Party Address for the SCCP message.

##### **Range:**

*1 - 15 hexadecimal digits. Valid digits are 0-9, a-f, A-F*

##### **Default:**

*1234567890*

#### **cdgti (optional)**

CdPA GTI. The Called Party Global Title Indicator for the SCCP message.

##### **Range:**

*0 - 4*

**cdnai (optional)**

CdPA NAI. The Called Party Nature of Address Indicator for the SCCP message.

**Range:**

*sub*

*rsvd*

*natl*

*intl*

**Default:**

*sub*

**cdnaiv (optional)**

CdPA NAIV. The Called Party Nature of Address Indicator Value for the SCCP message.

**Range:**

*0 - 127*

**Default:**

*1*

**cdnp (optional)**

CdPA NP. The Called Party Numbering Plan for the SCCP message.

**Range:**

*e164*

*generic*

*x121*

*f69*

*e210*

*e212*

*e214*

*private*

**Default:**

*e164*

**cdnpv (optional)**

CdPA NPV. The Called Party Numbering Plan Value for the SCCP message.

**Range:**

*0 - 15*

**Default:**

*1*



**cdpc (optional)**

ANSI Called Party point code with subfields *network indicator-network cluster-network cluster member (ni-nc-ncm)*.

**Range:**

*p-*, 000-255

Specify a valid value for each subfield of the point code, and separate the subfields with a dash (-).

*prefix—p-*

When *chg-sid:pctype=ansi* is specified, *ni = 000* is not valid.

When *chg-sid:pctype=ansi* is specified, *nc = 000* is not valid if *ni = 001-005*.

When *chg-sid:pctype=ansi* is specified, *nc = 000* is valid if *ni = 006-255*.

The point code *000-000-000* is not a valid point code.

**Default:**

10

ANSI 10-10-10

**cdpci (optional)**

ITU international destination point code with subfields *zone-area-id*. The *prefix* subfield indicates a spare point code, private point code, or private and spare point code (*prefix-zone-area-id*).

**Range:**

*s-*, *p-*, *ps-*, 0-255

Specify a valid value for each subfield of the point code, and separate the subfields with a dash (-).

*prefix—s-*, *p-*, *ps*

*zone—0-7*

*area—000-255*

*id—0-7*

The point code *0-000-0* is not a valid point code.

**cdpcn (optional)**

ITU national point code in the format of a 5-digit number (*nnnnn*); or 2, 3, or 4 numbers (members) separated by dashes (*m1-m2-m3-m4*) as defined by the *chg-stpopts:npcfmti* flexible point code option. A group code must be specified when the ITUDUPPC feature is turned on (*nnnnn-gc*, *m1-m2-m3-m4-gc*). The *prefix* subfield indicates a spare point code, private point code, or private and spare point code (*prefix-nnnnn*, *prefix-nnnnn-gc*, *prefix-m1-m2-m3-m4*, *prefix-m1-m2-m3-m4-gc*).

**Range:**

*s-*, *p-*, *ps-*, 0-16383, *aa-zz*

Specify a valid value for each subfield of the point code, and separate the subfields with a dash (-).

*prefix—s-*, *p-*, *ps*

*nnnnn—0-16383*

*gc—aa-zz*

*m1-m2-m3-m4—0-14* for each member; values must sum to 14

**cdpcn24 (optional)**

24-bit ITU national CdPA point code with subfields *main signaling area-sub signaling area-signaling point (msa-ssa-sp)*.

**Range:**

*p*-, 000-255

Specify a valid value for each subfield of the point code, and separate the subfields with a dash (-).

*prefix*-*p*

*msa*-000-255

*ssa*-000-255

*sp*-000-255

**cdpcn16 (optional)**

16-bit ITU national CdPA point code with subfields *unit number-sub number area-main number area (un-sna-mna)*.

**Range:**

*p*-, 000-127

Specify a valid value for each subfield of the point code, and separate the subfields with a dash (-).

*prefix*-*p*

*un* -000-127

*sna* -000-15

*mna* -000-31

**cdssn (optional)**

CdPA SSN. The Called Party Subsystem Number for the SCCP message.

**Range:**

0 - 255

**Default:**

6

**cdtt (optional)**

CdPA TT. The Called Party Translation Type for the SCCP message.

**Range:**

0 - 255

**Default:**

0

**cggtta (optional)**

CgPA GTA. The Calling Party Address for the SCCP message.

**Range:**

1 - 15 hexadecimal digits. Valid digits are 0-9, a-f, A-F

**Default:**

1234567890

**cggti (optional)**

CgPA GTI. The Calling Party Global Title Indicator for the SCCP message.

**Range:**

0 - 4

**cgna*i*** (optional)

CgPA NAI. The Calling Party Nature of Address Indicator for the SCCP message.

**Range:**

*sub*

*rsvd*

*natl*

*intl*

**cgna*iv*** (optional)

CgPA NAIV. The Calling Party Nature of Address Indicator Value for the SCCP message.

**Range:**

*0 - 127*

**Default:**

*1*

**cgnp** (optional)

CgPA NP. The Calling Party Numbering Plan for the SCCP message.

**Range:**

*e164*

*generic*

*x121*

*f69*

*e210*

*e212*

*e214*

*private*

**cgnpv** (optional)

CgPA NPV. The Calling Party Numbering Plan Value for the SCCP message.

**Range:**

*0 - 15*

**Default:**

*1*

**cgpc** (optional)

ANSI CGPA point code with subfields *network indicator-network cluster-network cluster member (ni-nc-ncm)*.

**Range:***p-*, 000-255

Specify a valid value for each subfield of the point code, and separate the subfields with a dash (-).

*prefix—p-*When *chg-sid:pctype=ansi* is specified, *ni = 000* is not valid.When *chg-sid:pctype=ansi* is specified, *nc = 000* is not valid if *ni = 001-005*.When *chg-sid:pctype=ansi* is specified, *nc = 000* is valid if *ni = 006-255*.The point code *000-000-000* is not a valid point code.**Default:**

20

ANSI 20-20-20

**cgpci (optional)**ITU international CgPA point code with subfields *zone-area-id*. The *prefix* subfield indicates a spare point code (*prefix-zone-area-id*).**Range:***s-*, *p-*, *ps-*, 0-255

Specify a valid value for each subfield of the point code, and separate the subfields with a dash (-).

*prefix—s-*, *p-*, *ps**zone—0-7**area—000-255**id—0-7*The point code *0-000-0* is not a valid point code.**cgpcn (optional)**ITU national CgPA point code in the format of a 5-digit number (*nnnnn*); or 2, 3, or 4 numbers (members) separated by dashes (*m1-m2-m3-m4*) as defined by the *chg-stpopts:npcfmti* flexible point code option. A group code must be specified when the ITUDUPPC feature is turned on (*nnnnn-gc*, *m1-m2-m3-m4-gc*). The *prefix* subfield indicates a spare point code (*prefix-nnnnn*, *prefix-nnnnn-gc*, *prefix-m1-m2-m3-m4*, *prefix-m1-m2-m3-m4-gc*).**Range:***s-*, *p-*, *ps-*, 0-16383, *aa-zz*

Specify a valid value for each subfield of the point code, and separate the subfields with a dash (-).

*prefix—s-*, *p-*, *ps**nnnnn—0-16383**gc—aa-zz**m1-m2-m3-m4—0-14* for each member; values must sum to 14**cgpcn24 (optional)**24-bit ITU national CgPA point code with subfields *main signaling area-sub signaling area-signaling point* (*msa-ssa-sp*).**Range:***p-*, 000-255

Specify a valid value for each subfield of the point code, and separate the subfields with a dash (-).

*prefix—p*  
*msa—000–255*  
*ssa—000–255*  
*sp—000–255*

**cgpcn16 (optional)**

16-bit ITU national CgPA point code with subfields *unit number-sub number area-main number area (un-sna-mna)*.

**Range:**

*p-*, 000-127

Specify a valid value for each subfield of the point code, and separate the subfields with a dash (-).

*prefix-p*  
*un -000-127*  
*sna -000-15*  
*mna -000-31*

**cgssn (optional)**

CgPA SSN. The Calling Party Subsystem Number for the SCCP message.

**Range:**

0 - 255

**Default:**

8

**cgtt (optional)**

CgPA TT. The Calling Party Translation Type for the SCCP message.

**Range:**

0 - 255

**Default:**

0

**dpcc (optional)**

ANSI destination point code with subfields *network indicator-network cluster-network cluster member (ni-nc-ncm)*.

**Synonym:**

*dpca*

**Range:**

*p-*, 000-255

Specify a valid value for each subfield of the point code, and separate the subfields with a dash (-).

*prefix—p-*

When *chg-sid:pctype=ansi* is specified, *ni = 000* is not valid.

When *chg-sid:pctype=ansi* is specified, *nc = 000* is not valid if *ni = 001-005*.

When *chg-sid:pctype=ansi* is specified, *nc = 000* is valid if *ni = 006-255*.

The point code *000-000-000* is not a valid point code.

**Default:**

20

## ANSI 20-20-20

**dpc/dpca/dpci/dpcn/dpcn24/dpcn16 (optional)**

Point Code.

**dpci (optional)**ITU international destination point code with subfields *zone-area-id*. The *prefix* subfield indicates a spare point code (*prefix-zone-area-id*).**Range:***s-, p-, ps-, 0-255*

Specify a valid value for each subfield of the point code, and separate the subfields with a dash (-).

*prefix—s-, p-, ps**zone—0-7**area—000-255**id—0-7*The point code *0-000-0* is not a valid point code.**dpcn (optional)**ITU national destination point code in the format of a 5-digit number (*nnnnn*); or 2, 3, or 4 numbers (members) separated by dashes (*m1-m2-m3-m4*) as defined by the `chg-stpopts:npcfmti` flexible point code option. A group code must be specified when the ITUDUPPC feature is turned on (*nnnnn-gc, m1-m2-m3-m4-gc*). The *prefix* subfield indicates a spare point code (*prefix-nnnnn, prefix-nnnnn-gc, prefix-m1-m2-m3-m4, prefix-m1-m2-m3-m4-gc*).**Range:***s-, p-, ps-, 0-16383, aa-zz*

Specify a valid value for each subfield of the point code, and separate the subfields with a dash (-).

*prefix—s-, p-, ps**nnnnn—0-16383**gc—aa-zz**m1-m2-m3-m4—0-14* for each member; values must sum to 14**dpcn24 (optional)**24-bit ITU national destination point code with subfields *main signaling area-sub signaling area-signaling point* (*msa-ssa-sp*).**Range:***p-, 000-255*

Specify a valid value for each subfield of the point code, and separate the subfields with a dash (-).

*prefix—p**msa—000-255**ssa—000-255**sp—000-255***dpcn16 (optional)**16-bit ITU national destination point code with subfields *unit number-sub number area-main number area* (*un-sna-mna*).

**Range:**

*p--*, *000--127*

Specify a valid value for each subfield of the point code, and separate the subfields with a dash (-).

*prefix-p*

*un -000-127*

*sna -000-15*

*mna -000-31*

**eaglegen (optional)**

This parameter specifies whether the message is an EAGLE-generated message.

**Range:**

**no**

the message is not an EAGLE-generated message

**yes**

the message is an EAGLE-generated message

**imeidgts (optional)**

IMEI Digits. This specifies the IMEI digits present in the TCAP portion of the incoming MSU.

**Range:**

*1 - 15 hexadecimal digits*

Valid digits are *0-9, a-f, A-F*

**Default:**

*1234567890*

**imsidgts (optional)**

IMSI Digits. This specifies the IMSI digits present in the TCAP portion of the incoming MSU.

**Range:**

*1 - 15 hexadecimal digits*

Valid digits are *0-9, a-f, A-F*

**Default:**

*1234567890*

**lsn (optional)**

Linkset name. The incoming linkset name for the SCCP message.

**Range:**

*ayyyyyyyy*

1 alphabetic character followed by up to 9 alphanumeric characters

**mapparam (optional)**

MAP Parameters. The parameter defines the MAP parameters (IMEI/IMSI/MSISDN/VLR/SMRPOA/SMRPDA) present in the incoming MSU.

**Range:**

*none*

*imei*

*imsi*

*msisdn*

*vlr*

*smrpoa*

*smrpda*

*imsimsisdn*

*imsivlr*

*msisdnlvr*

*smrpoada*

*smrpoadaimsi*

*imeiimsi*

*imeiimsidn*

*imeivlr*

*smrpoaimsi*

*smrpdaimsi*

**Default:**

*none*- None of the above specified parameters is present in the incoming MSU.

**msisdndgts (optional)**

MSISDN Digits. This specifies the MSISDN digits present in the TCAP portion of the incoming MSU.

**Range:**

*1 - 15 hexadecimal digits*

Valid digits are *0-9, a-f, A-F*

**Default:**

*1234567890*

**msisdnp (optional)**

MSISDN NP. The Numbering Plan of the MSISDN digits.

**Range:**

*e164*



*x121*

*f69*

*e212*

*e129*

*private*

*reserved*

*none*

**Default:**

*none*- NP is missing for the MSISDN in the incoming MSU

**opc (optional)**

ANSI originating point code with subfields *network indicator-network cluster-network cluster member (ni-nc-ncm)*.

**Range:**

*p*-, 000-255

Specify a valid value for each subfield of the point code, and separate the subfields with a dash (-).

*prefix—p*-

When *chg-sid:pctype=ansi* is specified, *ni = 000* is not valid.

When *chg-sid:pctype=ansi* is specified, *nc = 000* is not valid if *ni = 001-005*.

When *chg-sid:pctype=ansi* is specified, *nc = 000* is valid if *ni = 006-255*.

The point code *000-000-000* is not a valid point code.

**Default:**

*10*

ANSI 10-10-10

**opci (optional)**

ITU international originating point code with subfields *zone-area-id*. The *prefix* subfield indicates a spare point code (*prefix-zone-area-id*).

**Range:**

*s*-, *p*-, *ps*-, 0-255

Specify a valid value for each subfield of the point code, and separate the subfields with a dash (-).

*prefix—s*-, *p*-, *ps*

*zone—0-7*

*area—000-255*

*id—0-7*

The point code *0-000-0* is not a valid point code.

**opcn (optional)**

ITU national originating point code in the format of a 5-digit number (*nnnnn*); or 2, 3, or 4 numbers (members) separated by dashes (*m1-m2-m3-m4*) as defined by the *chg-stpopts:npcfmti* flexible point code option. A group code must be specified when the ITUDUPPC feature is turned on (*nnnnn-gc*, *m1-m2-m3-m4-gc*). The *prefix*

subfield indicates a spare point code (*prefix-nnnnn*, *prefix-nnnnn-gc*, *prefix-m1-m2-m3-m4*, *prefix-m1-m2-m3-m4-gc*).

**Range:**

*s*-, *p*-, *ps*-, 0-16383, *aa-zz*

Specify a valid value for each subfield of the point code, and separate the subfields with a dash (-).

*prefix*—*s*-, *p*-, *ps*

*nnnnn*—0-16383

*gc*—*aa-zz*

*m1-m2-m3-m4*—0-14 for each member; values must sum to 14

**opcn24 (optional)**

24-bit ITU national originating point code with subfields *main signaling area-sub signaling area-signaling point* (*msa-ssa-sp*).

**Range:**

Specify a valid value for each subfield of the point code, and separate the subfields with a dash (-).

*p*-, 000-255, *none*

*prefix*—*p*-

When *chg-sid:pctype=ansi* is specified, *ni = 000* is not valid.

When *chg-sid:pctype=ansi* is specified, *nc = 000* is not valid for *ni = 001-005*.

When *chg-sid:pctype=ansi* is specified, *nc = 000* is valid if *ni = 006-255*.

Enter *none* to delete the point code.

The point code *000-000-000* is not a valid point code.

**opcn16 (optional)**

16-bit ITU national originating point code with subfields *unit number-sub number area-main number area* (*un-sna-mna*).

**Range:**

000-127

Specify a valid value for each subfield of the point code, and separate the subfields with a dash (-).

*un* -000-127

*sna* -000-15

*mna* -000-31

Enter *none* to delete the point code.

The point code *000-000-000* is not a valid point code.

**selid (optional)**

Selector ID. The Selector ID used in the first GTT selector search.

**Range:**

0 - 65534

**smrpdadgts (optional)**

SMRPDA Digits. The digits present in the SMRPDA parameter of the incoming MSU.

**Range:**

1 - 15 hexadecimal digits

Valid digits are 0-9, a-f, A-F

**Default:**  
*1234567890*

**smrpdanp (optional)**

SMRPDA NP. The Numbering Plan of the SMRPDA digits.

**Range:**  
*e164*

*x121*

*f69*

*e212*

*e129*

*private*

*reserved*

*none*

**Default:**

*none*- NP is missing for the SMRPDA in the incoming MSU

**smrpoadgts (optional)**

SMRPOA Digits. The digits present in the SMRPOA parameter of the incoming MSU.

**Range:**  
*1 - 15 hexadecimal digits*  
Valid digits are *0-9, a-f, A-F*

**Default:**  
*1234567890*

**smrpoanp (optional)**

SMRPOA NP. The Numbering Plan of the SMRPOA digits.

**Range:**  
*e164*

*x121*

*f69*

*e212*

*e129*

*private*

*reserved*

*none*

**Default:**

*none*- NP is missing for the SMRPOA in the incoming MSU

**tcapacn (optional)**

TCAP application context name. The ITU TCAP *acn* field in the incoming MSU.

**Range:**

0 - 255, *none*

The *acn* field supports up to 7 subfields separated by a dash (e.g., 1-202-33-104-54-26-007).

*none* —there is no ITU TCAP *acn* field in the incoming MSU

**tcapfamily (optional)**

The ANSI TCAP *family* field in the incoming MSU.

**Range:**

0 - 255, *none*

*none* —there is no ANSI TCAP *family* field in the incoming MSU

**tcapfamily2 (optional)**

The ANSI TCAP *family2* field in the incoming MSU.

**Range:**

0 - 255, *none*

*none* —there is no ANSI TCAP *family2* field in the incoming MSU

**tcapfamily3 (optional)**

The ANSI TCAP *family3* field in the incoming MSU.

**Range:**

0 - 255, *none*

*none* —there is no ANSI TCAP *family3* field in the incoming MSU

**tcapopcode (optional)**

The first TCAP *opcode* field in the incoming MSU.

**Range:**

0 - 255, *none*, *notpresent*

*none* —the first component is present but there is no *opcode* in it

*notpresent*—the first component is not present

**Default:**

*notpresent*

**tcapopcode2 (optional)**

The second TCAP *opcode* field in the incoming MSU.

**Range:**

0 - 255, *none*, *notpresent*

*none* —the second component is present but there is no *opcode* in it

*notpresent*—the second component is not present

**Default:**

*notpresent*

**tcapopcode3 (optional)**

The third TCAP *opcode* field in the incoming MSU.

**Range:**

*0 - 255, none, notpresent*

*none* —the third component is present but there is no *opcode* in it

*notpresent*—the third component is not present

**Default:**

*notpresent*

**tcappkg (optional)**

TCAP package. The ANSI TCAP and ITU TCAP package type.

**Range:**

***ituuni***

ITU unidirectional

***qwp***

Query with Permission

***qwop***

Query without Permission

***resp***

Response

***cwp***

Conversation with Permission

***cwop***

Conversation without Permission

***bgn***

Begin

***end***

End

***cnt***

Continue

***ituabort***

ITU abort

***ansiabort***

ANSI abort

***ansiuni***

ANSI unidirectional

**ANSI TCAP Package Types—**

*ansiuni, qwp, qwop, resp, cwp, cwop, ansiabort*

**ITU TCAP Package Types—***bgn, ituabort, ituuni, end, cnt***tcappkgv (optional)**

TCAP package value. The TCAP package type value.

**Range: 0 - 255****v1rldgts (optional)**

VLR Digits. This specifies the VLR digits present in the TCAP portion of the incoming MSU.

**Range:***1 - 15 hexadecimal digits*Valid digits are *0-9, a-f, A-F***Default:***1234567890***Example**

```

chg-sccp-msg:msgn=1:cgtt=4:cdnp=generic:eaglegen=yes:cdpc=2-2-2
chg-sccp-msg:msgn=3:cdgta=324ab12:cdtt=6:cdnaiv=3:cgnai=rsvd
chg-sccp-msg:msgn=5:cdtt=10:opc=4-5-6:cgpcn=1234
chg-sccp-msg:msgn=1:tcappkg=bgn:tcapopcode=34
chg-sccp-msg:msgn=1:cdtt=12:dpci=1-101-1:cgpci=1-101-2
chg-sccp-msg:msgn=5:cdtt=10:opc16=2-14-0:cgpcn16=2-14-1
chg-sccp-msg:msgn=1:smrpoadgts=654789:smrpdanp=e164:smrpoanp=x121:
imsidgts=123456
chg-sccp-msg:msgn=1:tcapopcode=34:tcapopcode2=35:tcapopcode3=100

```

**Dependencies**

The TSTMSG table is corrupt or cannot be found.

At least one optional parameter must be specified.

The `cdnp` and `cdnpv` parameters and the `cgnp` and `cgnpv` parameters cannot be specified together in the command.The `cdnai` and `cdnaiv` parameters and the `cgnai` and `cgnaiv` parameters cannot be specified together in the command.A TOBR quantity feature must be turned on before the `tcapacn`, `tcappkg`, `tcappkgv`, `tcapopcode`, `tcapopcode2`, `tcapopcode3`, `tcapfamily`, `tcapfamily2`, `tcapfamily3`, `mapparam`, `imsidgts`, `imeidgts`, `msisdndgts`, `v1rldgts`, `smrpoadgts`, `smrpdadgts`, `msisdnp`, `smrpoanp` or `smrpdanp` parameter can be specified.The `tcappkg` and `tcappkgv` parameters cannot be specified together in the command.The values 1 and 3 cannot be specified for the `cdgti` and `cggti` parameters.

The GTT feature must be turned on before this command can be entered.

The J7 Support feature must be enabled before the `cgpcn16/cdpcn16/opcn16/dpcn16` parameters can be specified.

`Tcapopcode2` cannot be 0-255 or none if `tcapopcode = notpresent`, and `tcapopcode3` cannot be 0-255 or none if `tapopcode2 = notpresent`.

### Notes

There is no J7 FAK dependency on ANSI/N24 point code parameters, i.e., `cgpcn24/cdpcn24/opcn24/dpcn24/cgppca/cdppca/opca/dpca`. The command can be entered successfully whether or not the J7 Support feature is enabled.

### Output

```
chg-sccp-msg:msgn=1:tcapacn=7-8-9-0
```

```
tekelecstp 09-03-02 16:07:33 EST EAGLE 41.0.0
Command entered at terminal #4.
CHG-SCCP-MSG: MASP A - COMPLTD
```

```
;
```

```
chg-sccp-
msg:msgn=1:smrpoadgts=654789:smrpdanp=e164:smrpoanp=x121:imsidg
ts=123456
```

```
tekelecstp 15-06-01 16:07:33 EST EAGLE 46.3.0
Command entered at terminal #4.
CHG-SCCP-MSG: MASP A - COMPLTD
```

```
;
```

```
chg-sccp-
msg:msgn=1:tcapopcode=34:tcapopcode2=35:tcapopcode3=100
```

```
tekelecstp 16-10-03 14:18:10 MST EAGLE 46.5.0.0.0
Command entered at terminal #17.
CHG-SCCP-MSG: MASP A - COMPLTD
```

```
;
```

```
chg-sccp-msg:msgn=1:imeidgts=98715123450
```

```
tekelecstp 17-05-11 15:09:18 EST EAGLE 46.6.0
Command entered at terminal #4.
CHG-SCCP-MSG: MASP A - COMPLTD
```

```
;
```

### Related Topics

- [rtrv-sccp-msg](#)
- [tst-msg](#)

## chg-sccp-serv

Use this command to:

- Change the state of G-Flex and G-Port services to online or offline. Taking a service offline shifts the processing load to designated nodes.
- Add PCs to an existing service group for service re-route assignment, or change the relative cost (RC) of existing point codes in a group.

### Parameters



#### Note:

See [Point Code Formats and Conversion](#) for a detailed description of point code formats, rules for specification, and examples.

#### **serv (mandatory)**

Service. The name of the service.

##### Range:

###### **gflex**

G-Flex (GSM Flexible Numbering)

###### **gport**

G-Port (GSM Mobile Number Portability)

###### **mnp**

Mobile Number Portability

#### **gtt (optional)**

GTT option indicator. This parameter specifies whether to use GTT as part of the re-routing procedure when the service is offline, and alternate PCs are not defined or not available.

##### Range:

###### **no**

Do not use GTT as part of the re-routing procedure.

###### **yes**

Use GTT as part of the re-routing procedure.

##### Default:

yes

#### **pc1 (optional)**

ANSI point code with subfields *network indicator-network cluster-network cluster member (ni-nc-ncm)*.

##### Synonym:

*pca1*



**Range:**

000-255

Specify a valid value for each subfield of the point code, and separate the subfields with a dash (-).

When `chg-sid:pctype=ansi` is specified, `ni = 000` is not valid.

When `chg-sid:pctype=ansi` is specified, `nc = 000` is not valid if `ni = 001–005`.

When `chg-sid:pctype=ansi` is specified, `nc = 000` is valid if `ni = 006–255`.

The point code `000-000-000` is not a valid point code.

**pc1/pca1/pci1/pcn1/pcn241 (optional)**

Alternate post-GTT-translated point code.

**pc2 (optional)**

ANSI point code with subfields *network indicator-network cluster-network cluster member (ni-nc-ncm)*.

**Synonym:**

*pca2*

**Range:**

000-255

Specify a valid value for each subfield of the point code, and separate the subfields with a dash (-).

When `chg-sid:pctype=ansi` is specified, `ni = 000` is not valid.

When `chg-sid:pctype=ansi` is specified, `nc = 000` is not valid if `ni = 001–005`.

When `chg-sid:pctype=ansi` is specified, `nc = 000` is valid if `ni = 006–255`.

The point code `000-000-000` is not a valid point code.

**pc2/pca2/pci2/pcn2/pcn242 (optional)**

Alternate post-GTT-translated point code.

**pc3 (optional)**

ANSI point code with subfields *network indicator-network cluster-network cluster member (ni-nc-ncm)*.

**Synonym:**

*pca3*

**Range:**

000-255

Specify a valid value for each subfield of the point code, and separate the subfields with a dash (-).

When `chg-sid:pctype=ansi` is specified, `ni = 000` is not valid.

When `chg-sid:pctype=ansi` is specified, `nc = 000` is not valid if `ni = 001–005`.

When `chg-sid:pctype=ansi` is specified, `nc = 000` is valid if `ni = 006–255`.

The point code `000-000-000` is not a valid point code.

**pc3/pca3/pci3/pcn3/pcn243 (optional)**

Alternate post-GTT-translated point code.

**pc4 (optional)**

ANSI point code with subfields *network indicator-network cluster-network cluster member (ni-nc-ncm)*.

**Synonym:***pca4***Range:***000-255*

Specify a valid value for each subfield of the point code, and separate the subfields with a dash (-).

When *chg-sid:pctype=ansi* is specified, *ni = 000* is not valid.

When *chg-sid:pctype=ansi* is specified, *nc = 000* is not valid if *ni = 001-005*.

When *chg-sid:pctype=ansi* is specified, *nc = 000* is valid if *ni = 006-255*.

The point code *000-000-000* is not a valid point code.

**pci4/pca4/pci4/pcn4/pcn244 (optional)**

Alternate post-GTT-translated point code.

**pci1 (optional)**

ITU international point code with subfields *zone-area-id*. The *prefix* subfield indicates a spare point code (*prefix-zone-area-id*).

**Range:***s-, 0-255*

Specify a valid value for each subfield of the point code, and separate the subfields with a dash (-).

*prefix—s**zone—0-7**area—000-255**id—0-7*

The point code *0-000-0* is not a valid point code.

**pci2 (optional)**

ITU international point code with subfields *zone-area-id*. The *prefix* subfield indicates a spare point code (*prefix-zone-area-id*).

**Range:***s-, 0-255*

Specify a valid value for each subfield of the point code, and separate the subfields with a dash (-).

*prefix—s**zone—0-7**area—000-255**id—0-7*

The point code *0-000-0* is not a valid point code.

**pci3 (optional)**

ITU international point code with subfields *zone-area-id*. The *prefix* subfield indicates a spare point code (*prefix-zone-area-id*).

**Range:***s-, 0-255*

Specify a valid value for each subfield of the point code, and separate the subfields with a dash (-).

*prefix—s**zone—0-7**area—000-255*

*id—0-7*

The point code *0-000-0* is not a valid point code.

**pci4 (optional)**

ITU international point code with subfields *zone-area-id*. The *prefix* subfield indicates a spare point code (*prefix-zone-area-id*).

**Range:**

*s-*, *0-255*

Specify a valid value for each subfield of the point code, and separate the subfields with a dash (-).

*prefix—s*

*zone—0-7*

*area—000-255*

*id—0-7*

The point code *0-000-0* is not a valid point code.

**pcn1 (optional)**

ITU national point code in the format of a 5-digit number (*nnnnn*); or 2, 3, or 4 numbers (members) separated by dashes (*m1-m2-m3-m4*) as defined by the `chg-stpopts:npcfmti` flexible point code option. A group code must be specified when the ITUDUPPC feature is turned on (*nnnnn-gc,m1-m2-m3-m4-gc*). The *prefix* subfield indicates a spare point code (*prefix-nnnnn*, *prefix-nnnnn-gc*, *prefix-m1-m2-m3-m4*, *prefix-m1-m2-m3-m4-gc*).

**Range:**

*s-*, *0-16383*, *aa-zz*

Specify a valid value for each subfield of the point code, and separate the subfields with a dash (-).

*prefix—s-*

*nnnnn—0-16383*

*gc—aa-zz*

*m1-m2-m3-m4—0-14* for each member; values must sum to 14

**pcn2 (optional)**

ITU national point code in the format of a 5-digit number (*nnnnn*); or 2, 3, or 4 numbers (members) separated by dashes (*m1-m2-m3-m4*) as defined by the `chg-stpopts:npcfmti` flexible point code option. A group code must be specified when the ITUDUPPC feature is turned on (*nnnnn-gc, m1-m2-m3-m4-gc*). The *prefix* subfield indicates a spare point code (*prefix-nnnnn*, *prefix-nnnnn-gc*, *prefix-m1-m2-m3-m4*, *prefix-m1-m2-m3-m4-gc*).

**Range:**

*s-*, *0-16383*, *aa-zz*

Specify a valid value for each subfield of the point code, and separate the subfields with a dash (-).

*prefix—s-*

*nnnnn—0-16383*

*gc—aa-zz*

*m1-m2-m3-m4—0-14* for each member; values must sum to 14

**pcn241 (optional)**

24-bit ITU national point code with subfields *main signaling area-sub signaling area-signaling point* (*msa-ssa-sp*).

**Range:**

000-255

Specify a valid value for each subfield of the point code, and separate the subfields with a dash (-).

*msa—000—255**ssa—000—255**sp—000—255***pcn242 (optional)**

24-bit ITU national point code with subfields *main signaling area-sub signaling area-signaling point (msa-ssa-sp)*.

**Range:**

000-255

Specify a valid value for each subfield of the point code, and separate the subfields with a dash (-).

*msa—000—255**ssa—000—255**sp—000—255***pcn243 (optional)**

24-bit ITU national point code with subfields *main signaling area-sub signaling area-signaling point (msa-ssa-sp)*.

**Range:**

000-255

Specify a valid value for each subfield of the point code, and separate the subfields with a dash (-).

*msa—000—255**ssa—000—255**sp—000—255***pcn244 (optional)**

24-bit ITU national point code with subfields *main signaling area-sub signaling area-signaling point (msa-ssa-sp)*.

**Range:**

000-255

Specify a valid value for each subfield of the point code, and separate the subfields with a dash (-).

*msa—000—255**ssa—000—255**sp—000—255***pcn3 (optional)**

ITU national point code in the format of a 5-digit number (*nnnnn*); or 2, 3, or 4 numbers (members) separated by dashes (*m1-m2-m3-m4*) as defined by the `chg-stpopts:npcfmti` flexible point code option. A group code must be specified when the ITUDUPPC feature is turned on (*nnnnn-gc,m1-m2-m3-m4-gc*). The *prefix* subfield indicates a spare point code (*prefix-nnnnn, prefix-nnnnn-gc, prefix-m1-m2-m3-m4, prefix-m1-m2-m3-m4-gc*).

**Range:***s-, 0-16383, aa-zz*

Specify a valid value for each subfield of the point code, and separate the subfields with a dash (-).

*prefix*—*s*-

*nnnnn*—*0-16383*

*gc*—*aa-zz*

*m1-m2-m3-m4*—*0-14* for each member; values must sum to 14

#### **pcn4 (optional)**

ITU national point code in the format of a 5-digit number (*nnnnn*); or 2, 3, or 4 numbers (members) separated by dashes (*m1-m2-m3-m4*) as defined by the `chg-stpopts:npcfmti` flexible point code option. A group code must be specified when the ITUDUPPC feature is turned on (*nnnnn-gc*, *m1-m2-m3-m4-gc*). The *prefix* subfield indicates a spare point code (*prefix-nnnnn*, *prefix-nnnnn-gc*, *prefix-m1-m2-m3-m4*, *prefix-m1-m2-m3-m4-gc*).

#### **Range:**

*s*-, *0-16383*, *aa-zz*

Specify a valid value for each subfield of the point code, and separate the subfields with a dash (-).

*prefix*—*s*-

*nnnnn*—*0-16383*

*gc*—*aa-zz*

*m1-m2-m3-m4*—*0-14* for each member; values must sum to 14

#### **rc1 (optional)**

Relative cost 1. The relative cost of the route for alternate post-GTT-translated point code 1.

#### **Range:**

*0 - 99*

#### **rc2 (optional)**

Relative cost 2. The relative cost of the route for alternate post-GTT-translated point code 2.

#### **Range:**

*0 - 99*

#### **rc3 (optional)**

Relative cost 3. The relative cost of the route for alternate post-GTT-translated point code 3.

#### **Range:**

*0 - 99*

#### **rc4 (optional)**

Relative cost 4. The relative cost of the route for alternate post-GTT-translated point code 4.

#### **Range:**

*0 - 99*

#### **state (optional)**

The state of the service.

**Note:**

Re-routing is performed when the service state is *offline*.

**Range:**

*offline*

*online*

**Default:**

*offline*

**Example**

```
chg-sccp-serv:serv=gport:state=online

chg-sccp-serv:serv=gport:pca1=1-1-1:rc1=10:
pca2=2-2-2:rc2=20:pca3=3-3-3:rc3=30:pca4=4-4-4:rc4=40

chg-sccp-serv:serv=gport:pci1=2-2-2:rc1=10:pci2=3-3-3:rc2=10

chg-sccp-serv:serv=gport:state=online:gtt=yes
```

**Dependencies**

The specified point code network type must match an existing point code network type.

The point code and relative cost parameter values must be specified together as a pair in the command.

The point code cannot match the existing site identification true point code.

The mate remote point code must already exist as destination in the Ordered Route entity set or reside in a cluster destination for which ordered routes are specified.

The SCCP Service table cannot be full when the command is entered. For each supported service (G-Port and G-Flex), up to 7 point codes can be specified for each network type (ANSI, ITU-I, S-ITU-I, ITU-N, S-ITU-N, and ITU-N24).

A maximum of 7 point codes can be allocated to a group or SCCP Service set.

The Route table is corrupt or cannot be found by the system.

The Site Identification table is corrupt or cannot be found by the system.

The MRN table is corrupt or cannot be found by the system.

The SCCP Service table is corrupt or cannot be found by the system.

The A-Port or IGM feature, G-Flex feature, and G-Port feature must be enabled before the `serv=mnps`, `serv=gflex`, and `serv=gport` parameter can be specified, respectively.

If the A-Port or IS41 GSM Migration (IGM) feature is enabled, the `serv=gport` parameter cannot be specified.

The A-Port or IGM feature must be enabled before the `serv=mnps` parameter can be specified.

At least one optional parameter must be specified.

At least one PC/RC pair (for example, the `pc1` and `rc1` parameters) must be specified.

The mated point code must be a full point code.

Each new point code (specified by the `pc1`, `pc2`, `pc3`, or `pc4` parameter) must already exist in the destination table. See the `ent-dstn` command.

The same point code value cannot be entered more than once in the SCCP-SERV table.

New and existing point codes cannot be entered together in the same command.

The specified MRN set must already exist in the MRN table for the SCCP-SERV table.

If the Flexible GTT Loadsharing feature is enabled, the specified point code must already exist in the specified SCCP-SERV set in the MRN table.

### Notes

The SCCP Service table is part of the MRN table.

When using this command to modify relative cost values, all of the point codes that are specified in one command must exist in the same group in the SCCP-SERV table.

In this command, only ITU-international and ITU national point codes support the spare point code subtype prefix (s-).

This command supports the assignment of point codes to SCCP Service point code groups used for service re-route assignment. It is used to add point codes to a service group or to change the relative cost (RC) of existing point codes in a service group.

SCCP Service groups are organized by service (G-Flex or G-Port) and PC network type (ANSI, ITU-I, Spare ITU-I, ITU-N, Spare ITU-N, or ITUN-24). Up to 7 point codes can be in a network type grouping for service re-route load sharing. Up to 4 point codes can be added or modified in one command.

The `-sccp-serv` commands differ from the `-mrn` commands in that the service name (`serv` parameter) is required instead of an existing PC in the set serving as the key.

When using this command to add new point codes, none of the point codes that are specified in one command can exist in the group in the SCCP-SERV table and must all be added to the same SCCP-SERV group.

### Output

The following example changes the SCCP service for G-Port to provision the point code and relative cost values: `chg-sccp-`

```
serv:serv=gport:pcal=1-1-1:rc1=10:pc2=1-1-2:rc2=20
```

```
tekelecstp 05-12-20 08:35:15 EST 35.0.0
CHG-SCCP-SRV : MASP A - COMPLTD
;
```

### Related Topics

- [dlt-sccp-serv](#)

- [rtrv-sccp-serv](#)

## chg-sccpopts

Use this command to change the values of one or more of the SCCP option indicators maintained in the STP options table.

### Parameters

#### **ac1en (optional)**

Area code length. The length of the area code.

 **Note:**

This parameter is used with the CgPN.

**Range:**

0 - 8

**Default:**

No change to the current value

**System Default:**

0 - If the `ac1en` parameter was provisioned in the `chg-tifopts` command, then the value from the `chg-tifopts` command is used as the initial value for the `ac1en` parameter in the `chg-sccpopts` command.

#### **cc1en (optional)**

Country code length. The length of the country code.

 **Note:**

This parameter is used with the CgPN.

**Range:**

0 - 3

**Default:**

No change to the current value

**System Default:**

0

#### **class1seq (optional)**

This parameter enables or disables Class 1 message sequencing.



**Range:**

***on***

Enabled; Class 1 messages are guaranteed to be sequenced, but the messages are not load shared.

***off***

Disabled; Class 1 message sequencing is not guaranteed, but the messages might be load shared (if appropriate configuration exists).

**Default:**

Current value

**System Default:**

*off*

**cnvainat (optional)**

The value of the called party/calling party address Reserved for National Use bit when the message is routed to the ITU national network.

When SCCP Conversion is performed on a LIM card, this option is applied only in cases of domain crossing.

When message processing is done on an SCCP card, this option is applied always, regardless of whether there was domain crossing or not.

**Range:**

***0***

The Reserved for National Use bit is not reserved for national use.

***1***

The Reserved for National Use bit is reserved for national use.

**Default:**

No change to the current value

**System Default:**

*1*

**cnvclgitu (optional)**

This parameter enables or disables the CgPA conversion for ITU-I/ITU-I Spare/ITU-N/ITU-N Spare domain crossing during SCCP conversion.

**Range:**

***on***

convert CgPA

***off***

do not convert CgPA

**Default:**

*on*

*No change to the current value*

**System Default:**

*off*

**delccprefix (optional)**

This parameter specifies how to apply the DELCCPREFIX digit action to a Called Party Global Title Address (CdPA GTA).

**Default:**

*on*

*No change to the current value*

**Range:*****pxwcc***

Apply the DELCCPREFIX digit action to the CdPA GTA only when the address has a International format. If this option is selected, then the Country Code is deleted and the GTA is prefixed with the Entity Id.

***px4all***

Apply the DELCCPREFIX digit action to the CdPA GTA in all cases. If this option is selected, then for an International format, the Country Code is deleted and the GTA is prefixed with the Entity Id. For a National format, the GTA is prefixed with the Entity ID.

**df1tfallback (optional)**

Default fallback option. This parameter specifies the action that is taken if the last translation doesn't match when performing GTT using a FLOBR-specific GTT mode.

**Range:*****no***

GTT fails and the MSU is discarded

***yes***

GTT is performed based on the last matched entry

**Default:**

No change to the current value

**System Default:**

*no*

**df1tgttmode (optional)**

Default GTT mode. The system default value of the GTT mode hierarchy used by the EAGLE when performing GTT.

**Range:*****acdcd***

Advanced CdPA GTT, CdPA GTT

***acdgcgd***

Advanced CdPA GTT, CgPA GTT, CdPA GTT

***acdcdcg***

Advanced CdPA GTT, CdPA GTT, CgPA GTT

**cd**

CdPA GTT only

**cdcg**

CdPA GTT, CgPA GTT

**cg**

CgPA GTT only

**cgcd**

CgPA GTT, CdPA GTT

**cgacdcd**

CgPA GTT, Advanced CdPA GTT, CdPA GTT

**fcd**

FLOBR CdPA only

**fcg**

FLOBR CgPA only

**fcgfd**

FLOBR CgPA, FLOBR CdPA

**fcdfcg**

FLOBR CdPA, FLOBR CgPA

**gmstcapce (optional)**

This parameter enables and disables the processing of GSM Map Screening for TCAP\_Continue and TCAP\_End messages.

**Range:**

*on*

Enables GSM Map Screening for TCAP\_Continue and TCAP\_End messages

*off*

Disables GSM Map Screening for TCAP\_Continue and TCAP\_End messages

**gttddist (optional)**

This parameter specifies the type of card on which the GTT traffic will be distributed.

**Range:**

*all*

Distribute GTT traffic among SCCP cards irrespective of their data types

*gtt*

Distribute GTT traffic among SCCP cards of data type GTT

*dn*

Distribute GTT traffic among SCCP cards of data type DN

*imsi*

Distribute GTT traffic among SCCP cards of data type IMSI

*epap*

Distribute GTT traffic among SCCP cards of data type DN, IMSI or EPAP

*elap*

Distribute GTT traffic among SCCP cards of data type ELAP

**System Default Value:**

*all*

**intlunknai (optional)**

This parameter specifies whether International NAIs (*nai=intl*) are included in Unknown NAIs (*nai=unkn*) and should be considered for country code CgPN (*cccgpn*) conditioning.

**Range:**

*no*

*yes*

**Default:**

No change to the current value

**System Default:**

*no*

**itun16scmg (optional)**

This parameter specifies whether sccp scmg messages will be processed or not.

**Range:**

*on*

sccp scmg messages will be processed.

*off*

sccp scmg messages will not be processed.

**Default:**

No change to the current value

**System Default:**

*off*

**mobrscpopc (optional)**

The OPC that is derived from the SCCP message that is used as an exception class.

**Range:****sccp**

The OPC exception class uses the point code within the CGPA, if the CGPA portion of the message is "route-on-dpcsn". If the option is "route-on-gt", the *sccp* option is not used and defaults to the *mtp* option.

**mtp**

The OPC exception class uses the original MTP OPC value as its criteria.

**tpc**

The OPC exception class uses the EAGLE true point code for the criteria.

**mtprggtt (optional)**

This parameter specifies whether GTT is performed on an MTP-routed MSU and the routing that is performed on the MSU after GTT.

**Range:****off**

GTT is not performed

**usemtpc**

GTT is performed and the MSU is then routed to the original DPC

**fullgtt**

GTT is performed and the MSU is then routed to a translated DPC

**Default:**

No change to the current value

**System Default:**

*off*

**mtprgttfa11bk (optional)**

This parameter specifies whether an MTP-routed MSU is MTP-routed after GTT failure.

**Range:****mtproute**

perform MTP routing on the MSU if a failure occurs during GTT

**gttfail**

discard the MSU if a failure occurs during GTT. Send UDTS if required."

**Default:**

No change to the current value

**System Default:**

*mtproute*

**subdfn (optional)**

This parameter specifies whether S-Port Subscriber Differentiation is performed.

**Range:*****on***

perform S-Port Subscriber Differentiation

***off***

do not perform S-Port Subscriber Differentiation

**Default:**

No change to the current value

**System Default:***off***tgtt0 (optional)**

This parameter enables or disables transaction-based GTT loadsharing for SCCP Class0 UDT, Class0 XUDT, UDTS, and XUDTS messages.

**Range:*****udt***

Enables transaction-based GTT loadsharing for UDTS and Class0 UDT messages.

***xudt***

Enables transaction-based GTT loadsharing for XUDTS and Class0 XUDT messages.

***both***

Enables transaction-based GTT loadsharing for UDTS, XUDTS, Class0 UDT, and Class0 XUDT messages.

***none***

—Disables transaction-based GTT loadsharing for UDTS, XUDTS, Class0 UDT, and Class0 XUDT messages.

**Default:**

No change to current value

**System Default:***none***tgtt1 (optional)**

This parameter enables or disables transaction-based GTT loadsharing for SCCP Class1 UDT, Class1 XUDT, UDTS, and XUDTS messages.

**Range:*****udt***

Enables transaction-based GTT loadsharing for UDTS and Class1 UDT messages.

***xudt***

Enables transaction-based GTT loadsharing for XUDTS and Class1 XUDT messages.

***both***

Enables transaction-based GTT loadsharing for UDTs, XUDTs, Class1 UDT, and Class1 XUDT messages.

***none***

Disables transaction-based GTT loadsharing for UDTs, XUDTs, Class1 UDT, and Class1 XUDT messages.

**Default:**

No change to current value

**System Default:**

*none*

**tgttudtkey (optional)**

The transaction parameter for incoming UDT(S) messages. Messages with this parameter are routed to the same load-shared PC within a MAPGROUP or MRNGROUP.

**Range:**

***mtp***

Transaction-based GTT loadsharing is performed using the mtp algorithm

***tcap***

Transaction-based GTT loadsharing is performed using the tcap algorithm

***sccp***

Transaction-based GTT loadsharing is performed using the sccp algorithm

***enhmtp***

Transaction-based GTT loadsharing is performed using the enhanced mtp algorithm

**Default:**

No change to current value

**System Default:**

*mtp*

**tgtxudtkey (optional)**

The transaction parameter for incoming XUDT(S) messages. Messages with this parameter are routed to the same load-shared PC within a MAPGROUP or MRNGROUP.

**Range:**

***mtp***

Transaction-based GTT loadsharing is performed using the mtp algorithm

***sccp***

Transaction-based GTT loadsharing is performed using the sccp algorithm

***enhmtp***

Transaction-based GTT loadsharing is performed using the enhanced mtp algorithm

**Default:**  
No change to current value

**System Default:**  
*mtp*

**unqgttse1 (optional)**

This parameter specifies whether a GTT Selector search is performed on overlapped selectors.

**Range:**

***bestmatch***  
search overlapped GTT selectors if non-overlapped GTT selectors are not found

***exactmatch***  
search only non-overlapped GTT selectors

**Example**

```
chg-sccpopts:class1seq=on
chg-sccpopts:mobrscpopc=sccp
chg-sccpopts:tgtt0=udt
chg-sccpopts:tgtt1=xudt
chg-sccpopts:tgttudtkey=mtp
chg-sccpopts:tgtxudtkey=sccp
chg-sccpopts:cclen=1:aclen=3
chg-sccpopts:dfltfallback=yes
chg-sccpopts:dfltgttmode=fcd
chg-sccpopts:mtprgttfallback=gttfail
chg-sccpopts:unqgttse1=exactmatch
chg-sccpopts:gttidist=dn
chg-sccpopts:gttidist=epap
chg-sccpopts:itun16scmg=on
```

**Dependencies**

At least one optional parameter must be specified.

The STP Options table must be accessible.

The Origin-based MTP Routing feature must be turned on before the `mobrscpopc` parameter can be specified.

The Origin-based SCCP Routing feature must be turned on before the `dfltgttmode` parameter can have a value of `acdc`, `cgacdc`, `acdcgdc`, `acdcgdcg`, `cgcd`, `cdcg`, or `cg`.

The GTTSET table must be accessible.



The Transaction-based GTT Loadsharing feature must be enabled before the `tgtt0`, `tgtt1`, `tgttudtkey`, or `tgttxudkey` parameters can be specified.

The GSM Map Screening feature must be turned on before the `gmstcapce` parameter can be specified.

The ANSI/ITU SCCP Conversion feature must be enabled before the `cnvainat` or `cnvclgitu` parameter can be specified.

The FLOBR feature must be turned on before the `dfltgttmode` parameter can have a value of `fcd`, `fcg`, `fcgfcf`, or `fcdfcg` and before the `dfltfallback` parameter can be specified.

The MTP routed messages for SCCP Applications feature or the GWS Stop Action SCCP feature must be enabled before the `mtprggt` or `mtprggtfallback` parameter can be specified.

The S-Port Subscriber Differentiation feature must be enabled and turned on before the `subdfn` parameter can be specified.

The ANSI/ITU SCCP Conversion feature must be ON before the `cnvclgitu` parameter can be specified.

The EPAP Data Split feature must be enabled before `GTTDIST=DN/IMSI` parameter can be specified.

The Dual ExAP Config feature or EPAP Data Split feature must be enabled before `GTTDIST = EPAP` parameter can be specified.

The Dual ExAP Config feature must be enabled before `GTTDIST=EPAP/ELAP` parameter can be specified.

Either Dual ExAP Config or EPAP Data Split feature should be enabled before `GTTDIST=GTT` parameter can be specified.

The J7 Support feature must be enabled before the `ITUN16SCMG` parameter can be specified.

## Notes

None.

## Output

```
chg-sccpopts:mtprggt=usemtppc
```

```
tekelecstp 10-02-10 20:09:11 EST EAGLE 42.0.0
chg-sccpopts:mtprggt=usemtppc
Command entered at terminal #4.
CHG-SCCPOPTS: MASP A - COMPLTD
;
```

```
chg-sccpopts:gttldist=elap
```

```
tekelecstp 12-07-11 14:47:02 EST EAGLE 45.0.0
chg-sccpopts:gttldist=elap
Command entered at terminal #4.
```

```
CHG-SCCPOPTS: MASP A - COMPLTD  
;
```

### Related Topics

- [rtvr-sccpopts](#)

## chg-scr-aftpc

Use this command to change the attributes of a specific screening reference in the allowed affected point code category. Attributes that can be changed are the point code and the subsystem number.

### Parameters

 **Note:**

See [Point Code Formats and Conversion](#) for a detailed description of point code formats, rules for specification, and examples.

#### **sr (mandatory)**

Screening reference. The point code's unique screening reference name.

**Range:**

*ayyy*

1 alphabetic character followed by up to 3 alphanumeric characters

#### **ssn (mandatory)**

Subsystem number.

**Range:**

*0 - 255, \**

\* —the full range of values from 0–255

#### **actname (optional)**

Action name. The name of the gateway screening stop action set. Stop actions must be administered using this parameter in conjunction with the gateway screening stop action table (see the `chg-gws-actset` and `rtvr-gws-actset` commands).

**Range:**

*ayyyyy*

1 alphabetic character followed by up to 5 alphanumeric characters.

*none* —Remove an existing gateway screening stop action set from a gateway screening rule.

#### **area (optional)**

ITU international area. The *area* in the point code represented by *zone-area-id*.

**Range: 0 - 255, \***

\* —the full range of values from 0–255

**force (optional)**

When there are more than 200 affected screensets, this parameter will decide whether to execute the command successfully or not.

**Range:**

*yes*

*no*

**Default:**

*no*

**id (optional)**

ITU international ID. The *ID* in the point code represented by *zone-area-id*.

**Range: 0 - 7, \***

\*—the full range of values from 0–7

**mna (optional)**

16-bit ITU national main number area. The *mna* in the point code represented by *un-sna-mna*.

**Range:**

*0--31, \**

\*—the full range of values from 0--31

**msa (optional)**

24-bit ITU-national main signaling area value. The *msa* of the point code represented by *msa-ssa-sp*.

**Range: 0 - 255, \***

\*—the full range of values from 000–255

**narea (optional)**

New ITU-international area value.

**Range: 0 - 255, \***

\*—the full range of values from 0–255

**Default:**

No change to the current value

**nc (optional)**

Network cluster value. Specifies one or more *nc* values for the network indicator and network cluster member values specified by the *ni* and *ncm* parameters. It specifies the *nc* of the point code represented by *ni-nc-ncm*.

**Range:**

*0 - 255, \**

\*—the full range of values from 0–255

**ncm (optional)**

Network cluster member value. Specifies one or more *ncm* values for the network indicator and network cluster values identified in the *ni* and *nc* parameters. It specifies the *ncm* of the point code represented by *ni-nc-ncm*.

**Range:**

0 - 255, \*

\* —the full range of values from 0–255

**ni (optional)**

Network indicator value. Specifies one or more *ni* values for the network cluster and network cluster member values identified in the *nc* and *ncm* parameters. It specifies the *ni* of the point code represented by *ni-nc-ncm*.

**Range:**

0 - 255, \*

\* —the full range of values from 0–255

**nid (optional)**

New ITU-international ID value

**Range:**

0 - 7, \*

\* —the full range of values from 0–7

**Default:**

No change to the current value

**nmna (optional)**

New 16-bit ITU national main number area. The new *mna* in the point code represented by *un-sna-mna*.

**Range:**

0--31, \*

\*—the full range of values from 0--31

**nmsa (optional)**

New 24-bit ITU-national main signaling area value. The new *msa* of the point code represented by *msa-ssa-sp*.

**Range:**

0 - 255, \*

\* —the full range of values from 0–255

**nnc (optional)**

New network cluster. Specifies one or more *nnc* values for the screening reference specified in the *sr* parameter. It specifies the new *nc* of the point code represented by *ni-nc-ncm*.

**Range:**

0 - 255, \*

\* —the full range of values from 0–255

**Default:**

No change to the current value

**nncm (optional)**

New network cluster member. Specifies one or more *ncm* values for the screening reference specified in the *sr* parameter. It specifies the new *ncm* of the point code represented by *ni-nc-ncm*.

**Range:**

0 - 255, \*

\* —the full range of values from 0–255

**Default:**

No change to the current value

**nni (optional)**

New network identifier. Specifies one or more *nni* values for the screening reference specified in the *sr* parameter. It specifies the new *ni* of the point code represented by *ni-nc-ncm*.

**Range:**

0 - 255, \*

\* —the full range of values from 0–255

**Default:**

No change to the current value

**nnpc (optional)**

New ITU-national point code.

 **Note:**

Gateway screening allows the ITU national point code to be displayed and entered in the database only as a single number. If you use multiple-part ITU national point codes, see [Converting ITU National Point Code Formats](#) in Appendix A for information on converting the point code format.

**Range:**

0 - 16383, \*

\* —the full range of values from 0–16383

**Default:**

No change to the current value

**npc (optional)**

ITU national point code.

**Range:**

0 - 16383, \*

\* —the full range of values from 0–16383

**npcst (optional)**

New point code subtype. This parameter indicates whether the specified new ITU international or ITU national point code has no subtype prefix or has the spare point code prefix (s-).

**Range:***none**s*

**Default:***none***nsfi (optional)**

The next screening category used in the gateway screening process. This parameter halts the gateway screening process, and the message then proceeds through normal routing.

**Range:***stop***Default:**

No change to the current value

**nsna (optional)**

New 16-bit ITU national sub number area. The new *sna* in the point code represented by *un-sna-mna*.

**Range:***0--15,\**

\*—the full range of values from 0--15

**nsp (optional)**

New 24-bit ITU national signaling point. The new *sp* of the point code represented by *msa-ssa-sp*.

**Range:***0 - 255,\**

\* —the full range of values from 0–255

**nsr (optional)**

Next screening reference. This parameter specifies which screening reference in the specified screening category (*nsfi*) is to be used in the screening process.

**Range:***ayyy*

1 alphabetic character followed by up to 3 alphanumeric characters

**Default:**

No change to the current value

**nssa (optional)**

New 24-bit ITU national sub signaling area. The new *ssa* of the point code represented by *msa-ssa-sp*.

**Range:***0 - 255,\**

\* —the full range of values from 0–255

**nssn (optional)**

New subsystem number.

**Range:***0 - 255,\**

\* —the full range of values from 0–255

**Default:**

No change to the current value

**nun (optional)**

New 16-bit ITU national unit number. The new *un* in the point code represented by *un-sna-mna*.

**Range:**

0--127,\*

\*—the full range of values from 0--127

**nzone (optional)**

New ITU-international zone. The new *zone* for the point code represented by *zone-area-id*.

**Range:**

0 - 7, \*

\*—the full range of values from 0–7

**Default:**

No change to the current value

**pcst (optional)**

Point code subtype. This parameter indicates whether the specified ITU international or ITU national point code has no subtype prefix or has the spare point code prefix (S-).

**Range:**

*none*

*s*

**Default:**

*none*

**sna (optional)**

16-bit ITU-national sub number area. The *sna* of the point code represented by *un-sna-mna*.

**Range:**

0--15,\*

\*—the full range of values from 0-15

**sp (optional)**

24-bit ITU national signaling point. The *sp* in the point code represented by *msa-ssa-sp*.

**Range:**

0 - 255, \*

\*—the full range of values from 0–255

**ssa (optional)**

24-bit ITU national sub signaling area. The *ssa* in the point code represented by the format *msa-ssa-sp*.

**Range:**

0 - 255, \*

\* —the full range of values from 0–255

**un (optional)**16-bit ITU-national unit number. The *un* of the point code represented by *un-sna-mna*.**Range:**

0--127,\*

\*—the full range of values from 0-127

**zone (optional)**ITU international zone. The *zone* in the point code represented by *zone-area-id*.**Range:**

0 - 7, \*

\* —the full range of values from 0–255

**Example**

```
chg-scr-
aftpc:sr=iec:ni=240:nc=010:ncm=010:ssn=254:nni=240:nnc=003:nncm=030
:nssn=253
```

```
chg-scr-
aftpc:sr=iec:ni=240:nc=008:ncm=203:nssn=253:nsfi=stop:actname=copy
```

```
chg-scr-
aftpc:sr=aft1:zone=1:area=2:id=3:nsfi=stop:ssn=1:pcst=s:npcst=none
```

```
chg-scr-
aftpc:sr=aft2:un=1:sna=2:mna=1:nsfi=stop:ssn=1:nun=2:nsna=3:nmna=2
```

**Dependencies****▲ Caution:**

Even though gateway screening is in the screen test mode, as defined by the parameters `gwsa=off` and `gwsn=on`, the gateway screening action in the stop action set specified by the `actname` parameter of the screen set will be performed at the end of the screening process.

A complete point code must be specified, and must be one and only one, of the five point code parameter combinations: *ni-nc-ncm*, *zone-area-id*, *msa-ssa-sp*, *un-sna-mna*, or *npc*.

ANSI point code value 000-000-000 and ITU-International point code value 0-000-0 are not allowed.

At least one optional parameter must be specified.

The new affected point code and subsystem number to be changed cannot already exist in the affected point code entity set.

The `actname` parameter value must already be defined in the Gateway Screening Stop Action table with the `chg-gws-actset` command. These values are shown in the *ACT NAME* field of the `rtrv-gws-actset` command output.



If the `zone=*` parameter is specified, the `area=*` and `id=*` parameters must be specified.

If the `area=*` parameter is specified, the `id=*` parameter must be specified.

If the `msa=*` parameter is specified, the `ssa=*` and `sp=*` parameters must be specified.

If the `ssa=*` parameter is specified, the `sp=*` parameter must be specified.

If the `un=*` parameter is specified, the `sna=*` and `mna=*` parameters must be specified.

If the `sna=*` parameter is specified, the `mna=*` parameter must be specified.

If the `nc` parameter is specified as a range, the `ncm` parameter must be specified as an asterisk or as the full range 0–255.

If the `nc` parameter is specified as a single value or a range, a single value must be specified for the `ni` parameter.

If the `nc=*` parameter is specified, the `ncm` parameter must be specified as an asterisk or as the full range 0–255.

If the `ncm` parameter is specified as a single value, or a range other than the full range of 0–255, the `ni` and `nc` parameters must be specified with a single value.

If the `ni` parameter is specified as an asterisk (`ni=*`) or as a range, the `nc` and `ncm` parameters must be specified as an asterisk or as the full range 0–255.

If the `nsfi` parameter is specified, the parameter value must be `stop`.

If the `nsfi=stop` parameter is specified, the `nsr` parameter cannot be specified.

The character `c` cannot be specified for the `ni`, `nc`, `ncm`, `zone`, `area`, `id`, `msa`, `ssa`, `sp`, `un`, `sna`, `mna`, and `npcst` parameters.

The Gateway Screening Rules table can contain a maximum of 372,600 rules.

The specified screening reference (`sr`) must already exist in the database.

The Spare Point Code Support feature must be enabled before the `pcst` parameter can be specified.

The spare point code subtype prefix (`s-`) is not supported for ANSI point codes (parameters `ni`, `nc`, `ncm`) or for 24-bit ITU national point codes (parameters `msa`, `ssa`, `sp`) or for 16-bit ITU national point codes (parameters `un`, `sna`, `mna`). The `pcst` and `npcst` parameters cannot be specified for ANSI, ITU-N24 or ITU-N16 point codes.

The Gateway Screening Stop Action table must be accessible.

The affected point code and subsystem number to be changed must already exist in the affected point code entity set.

The J7 support feature must be enabled before the `un`, `sna`, `mna`, `nun`, `nsna`, or `nmna` parameters are specified.

The J7 support feature must not be enabled before the `msa`, `ssa`, `sp`, `nmsa`, `nssa`, or `nsp` parameters are specified.

The GWSOA parameter combination should be known and valid.

### Notes

A range of values is specified by separating the values that define the range by two ampersands (&&); for example, `ni=025&&100` specifies all network indicators for ANSI point codes from 25 - 100.

An asterisk cannot be specified for a parameter value in this command unless an asterisk was specified for the parameter value in the original `ent-scr-aftpc` command.

If the screen set reaches 100% capacity (indicated by the "100% full" message), the system will allow subsequent entries. An error will occur, however, when downloading the screen set to the card. Screen sets should not exceed 100% capacity. Remove screen set entries until the capacity is below 100%.

A screening reference is assigned to screen sets using the `ent-scrset` command. A screening reference can belong to multiple screen sets.

The spare point code subtype prefix `s-` is supported only for ITU international and ITU national point codes. The `pcst` parameter indicates whether the specified point code has no subtype prefix or has the spare point code prefix.

There is no feature dependency on ANSI point code parameters i.e., `ni`, `nc`, `ncm`, `nni`, `nnc` or `nncm`. The command can be entered successfully whether the J7 feature is enabled or not enabled.

If there are more than 200 affected screensets and the force parameter is set to **yes**, then the following warning message is displayed: "WARNING: Command may take up to 30 minutes" and the command proceeds successfully.

If there are more than 200 affected screensets and the force parameter is set to **no**, then the following notice is displayed: "Notice: Force parameter is required for affected screensets greater than 200" and the command is aborted.

### Output

```
chg-scr-
aftpc:sr=iec:ni=240:nc=010:ncm=010:ssn=254:nni=240:nnc=003:nncm=030
:nssn=253
```

```
rlghncxa03w 04-01-07 11:43:04 EST EAGLE 31.3.0
CHG-SCR-AFTPC: SCREEN SET AFFECTED - IEC 25% FULL
CHG-SCR-AFTPC: MASP A - COMPLTD
```

```
;
```

When there are more than 200 affected screensets and the force parameter is **no**:

```
chg-scr-
aftpc:sr=iec:ni=240:nc=010:ncm=010:ssn=254:nni=240:nnc=003:nncm=030
:nssn=253:force=no
```

Command entered at terminal #17.

```
;
```

```
tekelecstp 15-07-15 12:19:42 MST EAGLE5 46.3.0.0.0-66.10.0
```

```

CHG-SCR-AFTPC: MASP A - Cannot access standby fixed disk.
CHG-SCR-AFTPC: MASP A - Simplex database update.
Notice: Force parameter is required for affected screensets
greater than 200
CHG-SCR-AFTPC: MASP A - Command Aborted

```

When there are more than 200 affected screensets and the force parameter is **yes**:

```

chg-scr-
aftpc:sr=iec:ni=240:nc=010:ncm=010:ssn=254:nni=240:nnc=003:nncm
=030 :nssn=253:force=yes

```

Command entered at terminal #17.

```
;
```

```

tekelecstp 15-07-15 14:10:31 MST EAGLE5 46.3.0.0.0-66.10.0
CHG-SCR-AFTPC: MASP A - Cannot access standby fixed disk.
CHG-SCR-AFTPC: MASP A - Simplex database update.

```

```

WARNING: Command may take upto 30 minutes.
-----

```

```
;
```

Command Accepted - Processing

```

tekelecstp 15-07-15 14:10:31 MST EAGLE5 46.3.0.0.0-66.10.0
Notice: The number of screensets affected is 201.
CHG-SCR-AFTPC: SCREEN SET AFFECTED - s1      1% FULL
CHG-SCR-AFTPC: SCREEN SET AFFECTED - s10     1% FULL
CHG-SCR-AFTPC: SCREEN SET AFFECTED - s100    1% FULL
CHG-SCR-AFTPC: SCREEN SET AFFECTED - s101    1% FULL
CHG-SCR-AFTPC: SCREEN SET AFFECTED - s102    1% FULL
-----
-----

```

(List of affected screensets)

### Related Topics

- [dlt-scr-aftpc](#)
- [ent-scr-aftpc](#)
- [rtrv-scr-aftpc](#)

## chg-scr-blkdpc

Use this command to change the attributes of a specific screening reference in the blocked DPC category. Attributes that can be changed are the blocked destination point code, next screening function identifier, and the next screening reference.

## Parameters

 **Note:**

See [Point Code Formats and Conversion](#) for a detailed description of point code formats, rules for specification, and examples.

**sr (mandatory)**

Screening reference. The point code's unique screening reference name.

**Range:**

*ayyy*

1 alphabetic character followed by up to 3 alphanumeric characters

**actname (optional)**

Action name. The name of the gateway screening stop action set. Stop actions must be administered using this parameter in conjunction with the gateway screening stop action table (see `chg-gws-actset` and `rtrv-gws-actset`).

**Range:**

*ayyyyy*

1 alphabetic character followed by up to 5 alphanumeric characters.

*none* —Remove an existing gateway screening stop action set from a gateway screening rule.

**area (optional)**

ITU international area. The *area* in the point code represented by *zone-area-id*.

**Range:**

*0 - 255, \*, C*

*\** —the full range of values from 0–255

*C* —continue

**force (optional)**

When there are more than 200 affected screensets, this parameter will decide whether to execute the command successfully or not.

**Range:**

*yes*

*no*

**Default:**

*no*

**id (optional)**

ITU international ID. The *ID* in the point code represented by *zone-area-id*.

**Range:**

*0 - 7, \*, C*

*\** —the full range of values from 0–7

*C* —continue

**mna (optional)**

16-bit ITU national main number area. The *mna* in the point code represented by *un-sna-mna*.

**Range:**

0 - 31, \*, C

\*--- the full range of values from 0--31

C--continue

**msa (optional)**

24-bit ITU-national main signaling area value. The *msa* of the point code represented by *msa-ssa-sp*.

**Range:**

0 - 255, \*, C

\*—the full range of values from 0–255

C—continue

**narea (optional)**

New ITU-international area value.

**Range:**

0 - 255, \*, C

\*—the full range of values from 0–255

C—continue

**Default:**

No change to the current value

**nc (optional)**

Network cluster value. This parameter specifies one or more *nc* values for the network indicator and network cluster member values specified in the *ni* and *ncm* parameters. It specifies the *nc* of the point code represented by *ni-nc-ncm*.

**Range:**

0 - 255, \*, C

\*—the full range of values from 0–255

C—continue

**ncm (optional)**

Network cluster member value. This parameter specifies one or more *ncm* values for the network indicator and network cluster values identified in the *ni* and *nc* parameters. It specifies the *ncm* of the point code represented by *ni-nc-ncm*.

**Range:**

0 - 255, \*, C

\*—the full range of values from 0–255

C—continue

**ni (optional)**

Network indicator value. This parameter specifies one or more *ni* values for the network cluster and network cluster member values identified in the *nc* and *ncm* parameters. It specifies the *ni* of the point code represented by *ni-nc-ncm*.

**Range:**

0 - 255, \*, C

\* —the full range of values from 0–255

C —continue

**nid (optional)**

New ITU-international ID value.

**Range:**

0 - 7, \*, C

\* —the full range of values from 0–7

C —continue

**Default:**

No change to the current value

**nmna (optional)**New 16-bit ITU national main number area. The new *mna* in the point code represented by *un-sna-mna*.**Range:**

0 - 31, \*, C

\*--- the full range of values from 0--31

C--continue

**nmsa (optional)**New 24-bit ITU-national main signaling area value. The new *msa* of the point code represented by *msa-ssa-sp*.**Range:**

0 - 255, \*, C

\* —the full range of values from 0–255

C —continue

**nnc (optional)**New network cluster. This parameter specifies one or more *nnc* values for the screening reference specified in the *sr* parameter. It specifies the *nc* of the point code represented by *ni-nc-ncm*.**Range:**

0 - 255, \*, C

\* —the full range of values from 0–255

C —continue

**Default:**

No change to the current value

**nncm (optional)**New network cluster member. This parameter specifies one or more *ncm* values for the screening reference specified in the *sr* parameter. It specifies the new *ncm* of the point code represented by *ni-nc-ncm*.**Range:**

0 - 255, \*, C

\* —the full range of values from 0–255

C —continue

**Default:**

No change to the current value

**nni (optional)**

New network identifier. This parameter specifies one or more nni values for the screening reference specified in the `sr` parameter. It specifies the new *ni* of the point code represented by *ni-nc-ncm*.

**Range:**

0 - 255, \*, C

\*—the full range of values from 0–255

C—continue

**Default:**

No change to the current value

**nnpc (optional)**

New ITU-national point code.

**Note:**

Gateway screening allows the ITU national point code to be displayed and entered in the database only as a single number. If you use multiple-part ITU national point codes, see [Converting ITU National Point Code Formats](#) in Appendix A for information on converting the point code format.

**Range:**

0 - 16383, \*, C

\*—the full range of values from 0–16383

C—continue

**Default:**

No change to the current value

**npc (optional)**

ITU national point code.

**Range:**

0 - 16383, \*, C

\*—the full range of values from 0–16383

C—continue

**npcst (optional)**

New point code subtype. Indicates whether the specified new ITU international or ITU national point code has no subtype prefix or has the spare point code prefix (s-).

**Range:**

*none*

*s*

**Default:**

*none*

**nsfi (optional)**

This parameter specifies the next screening category that is used in the gateway screening process, or it indicates that the gateway screening process should stop.

**Range:*****cgpa***

Allowed CGPA is the next screening category

***fail***

Discard the received message

***destfld***

Allowed destination field (DESTFLD) is the next screening category

***isup***

ISUP message type (ISUP) is the next screening category

***stop***

The gateway screening process ends and the message proceeds through normal routing

**Default:**

No change to the current value

**nsna (optional)**

New 16-bit ITU national sub number area. The new *sna* in the point code represented by *un-sna-mna*.

**Range:**

0 - 15, \*, C

\*-- the full range of values from 0--15

C--continue

**nsp (optional)**

New 24-bit ITU national signaling point. The new *sp* of the point code represented by *msa-ssa-sp*.

**Range:**

0 - 255, \*, C

\*—the full range of values from 0–16383

C—continue

**nsr (optional)**

Next screening reference. Indicates which screening reference in the specified screening category (*nsfi*) is to be used in the screening process.

**Range:**

*ayyy*

1 alphabetic character followed by up to 3 alphanumeric characters

**Default:**

No change to the current value



**nssa (optional)**

New 24-bit ITU national sub signaling area. The new *ssa* of the point code represented by *msa-ssa-sp*.

**Range:**

0 - 255, \*, C

\*—the full range of values from 0–255

C—continue

**nun (optional)**

New 16-bit ITU national unit number. The new *un* in the point code represented by *un-sna-mna*.

**Range:**

0 - 127, \*, C

\*-- the full range of values from 0--127

C--continue

**nzone (optional)**

New ITU-international zone. The new *zone* for the point code represented by *zone-area-id*.

**Range:**

0 - 7, \*, C

\*—the full range of values from 0–7

C—continue

**Default:**

No change to the current value

**pcst (optional)**

Point code subtype. *z* indicates whether the specified ITU international or ITU national point code has no subtype prefix or has the spare point code prefix (s-).

**Range:**

*none*

*s*

**Default:**

*none*

**sna (optional)**

16-bit ITU national sub number area. The *sna* in the point code represented by *un-sna-mna*.

**Range:**

0 - 15, \*, C

\*-- the full range of values from 0--15

C--continue

**sp (optional)**

24-bit ITU national signaling point. The *sp* in the point code represented by *msa-ssa-sp*.

**Range:**

0 - 255, \*, C

\*—the full range of values from 0–255

C—continue

**ssa (optional)**24-bit ITU national sub signaling area. The *ssa* in the point code represented by the format *msa-ssa-sp*.**Range:**

0 - 255, \*, C

\*—the full range of values from 0–255

C—continue

**un (optional)**16-bit ITU-national unit number. The *un* in the point code represented by *un-sna-mna*.**Range:**

0 - 127, \*, C

\*--- the full range of values from 0--127

C--continue

**zone (optional)**ITU international zone. The *zone* in the point code represented by *zone-area-id*.**Range:**

0 - 7, \*, C

\*—the full range of values from 0–255

C—continue

**Example**

```
chg-scr-blkdpc:sr=iec:ni=240:nc=010:ncm=010:nni=240:nnc=003:nncm=030
```

```
chg-scr-blkdpc:sr=iec:ni=c:nc=c:ncm=c:nsfi=cgpa:nsr=wr2
```

```
chg-scr-blkdpc:sr=iec:ni=240:nc=010:ncm=010:nsfi=stop:actname=cr
```

```
chg-scr-blkdpc:sr=bdp1:npc=128:nsfi=fail:pcst=s:npcst=none
```

```
chg-scr-blkdpc:sr=iec:un=121:sna=10:mna=15:nun=50:nsna=5:nmna=10
```

**Dependencies****▲ Caution:**

Even though gateway screening is in the screen test mode, as defined by the parameters `gwsa=off` and `gws=on`, the gateway screening action in the stop action set specified by the `actname` parameter of the screen set will be performed at the end of the screening process.

The Gateway Screening Rules table can contain a maximum of 360,600 rules.

A complete point code must be specified, using the `ni-nc-ncm`, `zone-area-id`, `msa-ssa-sp`, `un-sna-mna`, or `npc` combination unless a value of `c` is specified.

A new point code entry must be specified by one and only one, of the five point code parameter combinations: `nni-nc-ncm`, `nzone-narea-nid`, `nun-nsna-nmna`, `nmsa-nssa-nsp`, or `npc`. If the new point code entry is a different point code type than the existing point code entry, all subfields of the new point code type must be specified.

ANSI point code value 000-000-000 and ITU-International point code value 0-000-0 are not allowed.

At least one optional parameter must be specified.

The blocked DPC specified by `ni-nc-ncm`, `zone-area-id`, `msa-ssa-sp`, `un-sna-mna` or `npc` must already exist in the screening reference or within an existing range of DPCs.

The new blocked DPC or DPC range defined by `ni-nc-ncm`, `zone-area-id`, `msa-ssa-sp`, `un-sna-mna` or `npc` cannot already exist in the screening reference or within an existing range of DPCs.

If an asterisk (\*) is specified for the new blocked DPC, nothing that matches the specified range of DPCs can already exist in the DPC screening table for the screening reference.

If the `actname` parameter is specified, the `nsfi=stop` parameter must be specified.

If the `actname` parameter is specified, the `nsr` parameter cannot be specified.

The value of the `actname` parameter must already be defined in the Gateway Screening Stop Action table.

If the `area=*` parameter is specified, then the `id=*` parameter must be specified.

If the `msa=*` parameter is specified, then the `ssa=*` and `sp=*` parameters must be specified.

If the `un=*` parameter is specified, then the `sna=*` and `mna=*` parameters must be specified.

If the `msa=c` parameter is specified, then the `ssa` and `sp` parameters must have a value of `c` or must not be specified. If the `msa=c` parameter is specified, and the `ssa` and `sp` parameters are not specified, then the `ssa` and `sp` parameters default to a value of `c`.

If the `un=c` parameter is specified, then the `sna` and `mna` parameters must have a value of `c` or must not be specified. If the `un=c` parameter is specified, and the `sna` and `mna` parameters are not specified, then the `sna` and `mna` parameters default to a value of `c`.

If the `nc` parameter is specified as a range, the `ncm` parameter must be specified as an asterisk or as the full range (0–255)

If the `nc` parameter is specified as a single value or a range, a single value must be specified for the `ni` parameter.

If the `nc` parameter is specified as an asterisk, the `ncm` parameter must be specified as an asterisk or as the full range (0–255).

If the `ncm` parameter is specified as a single value, or a range other than the full range of 0–255, the `ni` and `nc` parameters must be specified with a single value.

If the `ni` parameter is specified as an asterisk (`ni=*`) or as a range, the `nc` and `ncm` parameters must be specified as an asterisk or as the full range (0–255).

If the `ni=c` parameter is specified, then the `nc` and `ncm` parameters must have a value of `c` or must not be specified. If the `ni=c` parameter is specified, and the `nc` and `ncm` parameters are not specified, then the `nc` and `ncm` parameters default to a value of `c`.

If the specified `ni-nc-ncm`, `zone-area-id`, `un-sna-mna`, or `msa-ssa-sp` is not equal to `c-c-c`, or if the `npc=c` parameter is not specified, then the `nsfi=fail` parameter must be specified, and the `nsr` parameter cannot be specified.

If the `nnc` parameter is specified as a range, the `nncm` parameter must be specified as an asterisk or as the full range (0–255).

If the `nnc` parameter is specified as a single value or a range, a single value must be specified for the `nni` parameter.

If the `nnc` parameter is specified as an asterisk, the `nnm` parameter must be specified as an asterisk or as the full range (0–255).

If the `nncm` parameter is specified as a single value, or a range other than the full range of 0–255, the `nni` and `nnc` parameters must be specified with a single value.

If the `nni` parameter is specified as an asterisk or as a range, the `nnc` and `nncm` parameters must be specified as an asterisk or as the full range (0–255).

If the value of the `nsfi` parameter is not `stop` or `fail`, then the `nsr` parameter must be specified.

If the `nsfi=fail` parameter is specified, then the `nni`, `nc`, `nncm`, `narea`, `nzone`, `nid`, `nmsa`, `nssa`, `nsp`, `npc`, `nun`, `nsna`, and `nmna` parameters cannot have a value of `c`.

The specified screening reference (`sr`) must already exist in the database.

The Spare Point Code Support feature must be enabled before the `pcst` parameter can be specified.

The `pcst` and `npcst` parameters cannot be specified with `c` for a blocked screen reference (`sr`).

The spare point code subtype prefix (`s-`) is not supported for ANSI point codes (parameters `ni`, `nc`, `ncm`) for 24-bit ITU national point codes (parameters `msa`, `ssa`, `sp`) or for 16-bit ITU National point codes (parameters `un`, `sna`, `mna`). The `pcst` and `npcst` parameters cannot be specified for ANSI, ITU-N16 or ITU-N24 point codes.

If the `ssa=*` parameter is specified, then the `sp=*` parameter must be specified.

If the `sna=*` parameter is specified, then the `mna=*` parameter must be specified.

If the `zone=*` parameter is specified, then the `area=*` and `id=*` parameters must be specified.

If the `zone=c` parameter is specified, then the `area` and `id` parameters must have a value of `c` or must not be specified. If the `zone=c` parameter is specified, and the `area` and `id` parameters are not specified, then the `area` and `id` parameters default to a value of `c`.

The `nsfi=fail` parameter cannot be specified when changing a continue entry.

The `nsfi` and `nsr` parameters cannot be specified when changing a screening entry that is other than the continue entry (`c-c-c`).

The value of the `nsfi` parameter must be valid for the BLKDPC entity type.

The Gateway Screening Stop Action table is corrupt or cannot be found.

If the specified `ni-nc-ncm`, `zone-area-id`, `msa-ssa-sp`, or `un-sna-mna` is equal to `c-c-c` or if the `npc=c` parameter is specified, the `nsfi=fail` parameter cannot be specified, and the `nni`, `nnc`, `nncm`, `nzone`, `narea`, `nid`, `nmsa`, `nssa`, `nsp`, `nun`, `nsna`, `nmna`, and `nnpc` parameters cannot be specified. Point code `c-c-c` and `npc=c` cannot be changed to a numbered point code.

The `nsfi` and `nsr` parameters must point to an existing screen, or the `nsfi=stop` parameter must be specified, and the `nsr` parameter cannot be specified.

The J7 support feature must be enabled before the `un/sna/mna/nun/nsna/nmna` parameters are specified.

The J7 support feature must not be enabled before the `msa`, `ssa`, `sp`, `nmsa`, `nssa`, or `nsp` parameters are specified.

The GWSOA parameter combination should be known and valid.

## Notes

When a blocked DPC screening reference is created, the first entry for a point code must be `c-c-c` or `npc=c` parameter. Subsequent entries must be specific point codes.

The character `c` is used in the blocked DPC screens to allow the screening process to continue for messages with point codes that do not match any point codes in the blocked DPC screens. When screening for a blocked DPC and the point code being screened does not match any of the point codes in the blocked DPC screens, the message is not rejected and the screening process continues.

There must be an entry in the blocked DPC screens to allow the screening process to continue. This entry consists of a screening reference, point code, `nsfi`, and `nsr`. The point code is `npc=c` or subfields equal to `c-c-c`. When the character `c` is specified, the `nsfi` and `nsr` parameters must be specified.

If the character `c` is specified for the parameters `ni-nc-ncm`, `zone-area-id`, `un-sna-mna`, or `msa-ssa-sp`, the character `c` is the only value that can be specified for all three parameters. No other values can be used. For example, a point code `c-c-255` is not allowed. The point code must be `c-c-c`. The asterisk (\*) value cannot be used with the character `c` (for example, a point code `c-c-*` is not allowed).

When the point code does not match any entries in the blocked DPC screens, the screening process is directed to the screening reference with the point code `c-c-c` or `npc=c`. The `nsfi` and `nsr` in this entry are examined to determine the next step in the screening process.

If the current `ni-nc-ncm`, `zone-area-id`, `un-sna-mna`, or `msa-ssa-sp` is equal to `c-c-c` or `npc=c`, only the `nsfi` and `nsr` can be changed. Otherwise, only the blocked DPC can be changed.

A range of values is specified by separating the values that define the range by two ampersands (&&); for example, `ni=025&&100` specifies all network indicators for ANSI point codes from 25 - 100.

An asterisk cannot be specified for a parameter value in this command unless an asterisk was specified for the parameter value in the `ent-scr-blkdpc` command.

If the screen set reaches 100% capacity (indicated by the 100% Full message), the system allows subsequent entries. An error occurs, however, when downloading the screen set to an LIM. Ensure that screen sets do not exceed 100% capacity. Remove screen set entries until the capacity is below 100%.

The spare point code subtype prefix (s-) is supported only for ITU international and ITU national point codes. The `pcst` and `npcst` parameters indicate whether the specified point code has no subtype prefix or has the spare point code prefix.

There is no feature dependency on ANSI point code parameters i.e., `ni`, `nc`, `ncm`, `nni`, `nnc`, or `nncm`. The command can be entered successfully whether the J7 feature is enabled or not enabled.

If there are more than 200 affected screensets and the force parameter is set to **yes**, then the following warning message is displayed: "WARNING: Command may take up to 30 minutes" and the command proceeds successfully.

If there are more than 200 affected screensets and the force parameter is set to **no**, then the following notice is displayed: "Notice: Force parameter is required for affected screensets greater than 200" and the command is aborted.

## Output

```
chg-scr-
blkdpc:sr=ss01:ni=240:nc=010:ncm=010:nni=240:nnc=003:nncm=030
```

```
rlghncxa03w 04-01-07 11:43:04 EST EAGLE 31.3.0
CHG-SCR-BLKDPC: SCREEN SET AFFECTED - SS01 25% FULL
CHG-SCR-BLKDPC: MASP A - COMPLTD
```

```
;
```

When there are more than 200 affected screensets and the force parameter is **no**:

```
chg-scr-
blkdpc:sr=ss01:ni=240:nc=010:ncm=010:nni=240:nnc=003:nncm=030:force=
no
```

Command entered at terminal #17.

```
;
```

```
tekelecstp 15-07-15 12:19:42 MST EAGLE5 46.3.0.0.0-66.10.0
CHG-SCR-BLKDPC: MASP A - Cannot access standby fixed disk.
CHG-SCR-BLKDPC: MASP A - Simplex database update.
Notice: Force parameter is required for affected screensets greater than
200
CHG-SCR-BLKDPC: MASP A - Command Aborted
```

When there are more than 200 affected screensets and the force parameter is **yes**:

```
chg-scr-
blkdpc:sr=ss01:ni=240:nc=010:ncm=010:nni=240:nnc=003:nncm=030:force= yes
```

Command entered at terminal #17.

```
;

tekelecstp 15-07-15 14:10:31 MST EAGLE5 46.3.0.0.0-66.10.0
CHG-SCR-BLKDPC: MASP A - Cannot access standby fixed disk.
CHG-SCR-BLKDPC: MASP A - Simplex database update.
WARNING: Command may take upto 30 minutes.
-----
```

```
;
Command Accepted - Processing
tekelecstp 15-07-15 14:10:31 MST EAGLE5 46.3.0.0.0-66.10.0
Notice: The number of screensets affected is 201.
CHG-SCR-BLKDPC: SCREEN SET AFFECTED - s1      1% FULL
CHG-SCR-BLKDPC: SCREEN SET AFFECTED - s10     1% FULL
CHG-SCR-BLKDPC: SCREEN SET AFFECTED - s100    1% FULL
CHG-SCR-BLKDPC: SCREEN SET AFFECTED - s101    1% FULL
CHG-SCR-BLKDPC: SCREEN SET AFFECTED - s102    1% FULL
-----
```

(List of affected screensets)

### Related Topics

- [dlt-scr-blkdpc](#)
- [ent-scr-blkdpc](#)
- [rtrv-scr-blkdpc](#)

## chg-scr-blkopc

Use this command to change the attributes associated with a screening reference in the blocked OPC category. Attributes that can be changed are the point code, next screening function identifier, and next screening reference.

### Parameters

#### **sr (mandatory)**

Screening reference. The point code's unique screening reference name.

#### **Range:**

*ayyy*

1 alphabetic character followed by up to 3 alphanumeric characters

#### **actname (optional)**

Name of the gateway screening stop action set. Stop actions must be administered using this parameter in conjunction with the gateway screening stop action table (see [chg-gws-actset](#) and [rtrv-gws-actset](#) ).

**Range:***ayyyy*

1 alphabetic character followed by up to 5 alphanumeric characters.

*none* —Remove an existing gateway screening stop action set from a gateway screening rule**area (optional)**ITU international area. The *area* in the point code represented by *zone-area-id*.**Range:***0 - 255, \*, C**\** —the full range of values from 0–255*C* —continue**force (optional)**

When there are more than 200 affected screensets, this parameter will decide whether to execute the command successfully or not.

**Range:***yes**no***Default:***no***id (optional)**ITU international ID. The *ID* in the point code represented by *zone-area-id*.**Range:***0 - 255, \*, C**\** —the full range of values from 0–7*C* —continue**mna (optional)**16-bit ITU national main number area. The *mna* in the point code represented by *un-sna-mna*.**Range:***0 - 31, \*, C**\*--* the full range of values from 0--31*C--*continue**msa (optional)**24-bit ITU-national main signaling area value. The *msa* of the point code represented by *msa-ssa-sp*.**Range:***0 - 255, \*, C**\** —the full range of values from 0–7*C* —continue**narea (optional)**

New ITU-international area value.



**Range:**

0 - 255, \*, C

\*—the full range of values from 0–255

C—continue

**Default:**

No change to the current value

**nc (optional)**

Network cluster value. This parameter specifies one or more *nc* values for the network indicator and network cluster member values specified in the *ni* and *ncm* parameters. It specifies the *nc* of the point code represented by *ni-nc-ncm*.

**Range:**

0 - 255, \*, C

\*—the full range of values from 0–255

C—continue

**ncm (optional)**

Network cluster member value. This parameter specifies one or more *ncm* values for the network indicator and network cluster values identified in the *ni* and *nc* parameters. It specifies the *ncm* of the point code represented by *ni-nc-ncm*.

**Range:**

0 - 255, \*, C

\*—the full range of values from 0–255

C—continue

**ni (optional)**

Network indicator value. This parameter specifies one or more *ni* values for the network cluster and network cluster member values identified in the *nc* and *ncm* parameters. It specifies the *ni* of the point code represented by *ni-nc-ncm*.

**Range:**

0 - 255, \*, C

\*—the full range of values from 0–255

C—continue

**nid (optional)**

New ITU-international ID value.

**Range:**

0 - 7, \*, C

\*—the full range of values from 0–7

C—continue

**Default:**

No change to the current value

**nmna (optional)**

New 16-bit ITU national main number area. The new *mna* in the point code represented by *un-sna-mna*.

**Range:**

0 - 31, \*, C

\*--- the full range of values from 0--31  
C--continue

**nmsa (optional)**

New 24-bit ITU-national main signaling area value. The new *msa* of the point code represented by *msa-ssa-sp*.

**Range:**

0 - 255, \*, C

\*—the full range of values from 0–255

C—continue

**nnc (optional)**

New network cluster. This parameter specifies one or more *nnc* values for the screening reference specified in the *sr* parameter. It specifies the new *nc* of the point code represented by *ni-nc-ncm*.

**Range:**

0 - 255, \*, C

\*—the full range of values from 0–255

C—continue

**Default:**

No change to the current value

**nncm (optional)**

New network cluster member. This parameter specifies one or more *ncm* values for the screening reference specified in the *sr* parameter. It specifies the new *ncm* of the point code represented by *ni-nc-ncm*.

**Range:**

0 - 255, \*, C

\*—the full range of values from 0–255

C—continue

**Default:**

No change to the current value

**nni (optional)**

New network identifier. This parameter specifies one or more *nni* values for the screening reference specified in the *sr* parameter. It specifies the new *ni* of the point code represented by *ni-nc-ncm*.

**Range:**

0 - 255, \*, C

\*—the full range of values from 0–255

C—continue

**Default:**

No change to the current value

**nnpc (optional)**

New ITU-national point code.

 **Note:**

Gateway screening allows the ITU national point code to be displayed and entered in the database only as a single number. If you use multiple-part ITU national point codes, see [Converting ITU National Point Code Formats](#) in Appendix A for information on converting the point code format.

**Range:**

0 - 16383, \*, C

\*—the full range of values from 0–16383

C—continue

**Default:**

No change to the current value

**npc (optional)**

ITU national point code.

**Range:**

0 - 16383, \*, C

\*—the full range of values from 0–16383

C—continue

**npcst (optional)**

New point code subtype. Indicates whether the specified new ITU international or ITU national point code has no subtype prefix or has the spare point code prefix (s-).

**Range:**

*none*

*s*

**Default:**

*none*

**nsfi (optional)**

This parameter specifies the next screening category that is used in the gateway screening process, or it indicates that the gateway screening process should stop.

**Range:**

*cgpa*

Allowed CGPA

*fail*

Discard the received message.

*stop*

The gateway screening process ends and the message proceeds through normal routing.

*sio*

Allowed SIO

**dpc**  
Allowed DPC

**blkdpc**  
Blocked DPC

**Default:**  
No change to the current value

**nsna (optional)**  
New 16-bit ITU national sub number area. The new *sna* in the point code represented by *un-sna-mna*.

**Range:**  
0 - 15, \*, C  
\*--- the full range of values from 0--15  
C--continue

**nsp (optional)**  
New 24-bit ITU national signaling point. This parameter specifies the new *sp* of the point code represented by *msa-ssa-sp*.

**Range:**  
0 - 255, \*, C  
\*—the full range of values from 0–255  
C—continue

**nsr (optional)**  
Next screening reference. The parameter indicates which screening reference in the specified screening category (*nsfi*) is to be used in the screening process.

**Range:**  
*ayyy*  
1 alphabetic character followed by up to 3 alphanumeric characters

**Default:**  
No change to the current value

**nssa (optional)**  
New 24-bit ITU national sub signaling area. The new *ssa* of the point code represented by *msa-ssa-sp*.

**Range:**  
0 - 255, \*, C  
\*—the full range of values from 0–255  
C—continue

**nun (optional)**  
New 16-bit ITU national unit number. The new *un* in the point code represented by *un-sna-mna*.

**Range:**  
0 - 127, \*, C  
\*--- the full range of values from 0--127  
C--continue

**nzone (optional)**

New ITU-international zone. The new zone for the point code represented by *zone-area-id*.

**Range:**

0 - 7, \*, C

\*—the full range of values from 0–7

C—continue

**Default:**

No change to the current value

**pcst (optional)**

Point code subtype. This parameter indicates whether the specified ITU international or ITU national point code has no subtype prefix or has the spare point code prefix (S-).

**Range:**

*none*

*s*

**Default:**

*none*

**sna (optional)**

16-bit ITU national sub number area. The *sna* in the point code represented by *un-sna-mna*.

**Range:**

0 - 15, \*, C

\*-- the full range of values from 0--15

C--continue

**sp (optional)**

24-bit ITU national signaling point. The *sp* in the point code represented by *msa-ssa-sp*.

**Range:**

0 - 255, \*, C

\*—the full range of values from 0–255

C—continue

**ssa (optional)**

24-bit ITU national sub signaling area. The *ssa* in the point code represented by *msa-ssa-sp*.

**Range:**

0 - 255, \*, C

\*—the full range of values from 0–255

C—continue

**un (optional)**

16-bit ITU-national unit number. The *un* in the point code represented by *un-sna-mna*.

**Range:**

0 - 127, \*, C

\*--- the full range of values from 0--127

C--continue

**zone (optional)**ITU international zone. The *zone* in the point code represented by *zone-area-id*.**Range:**

0 - 7, \*, C

\*—the full range of values from 0–7

C—continue

**Example**

```
chg-scr-blkopc:sr=iec:ni=240:nc=010:ncm=010:nni=240:nnc=010:nncm=020
```

```
chg-scr-blkopc:sr=iec:ni=c:nc=c:ncm=c:nsfi=dpc:nsr=wrld1
```

```
chg-scr-blkopc:sr=iec:ni=c:nc=c:ncm=c:nsfi=stop:actname=none
```

```
chg-scr-blkopc:sr=bop1:npc=128:nsfi=fail:pcst=s:npcst=none
```

```
chg-scr-blkopc:sr=iec:un=121:sna=10:mna=15:nun=50:nsna=5:nmna=10
```

**Dependencies****▲ Caution:**

Even though gateway screening is in the screen test mode, as defined by the parameters `gwsa=off` and `gws=on`, the gateway screening action in the stop action set specified by the `actname` parameter of the screen set will be performed at the end of the screening process.

A complete point code must be specified, using the `ni-nc-ncm`, `zone-area-id`, `msa-ssa-sp`, `un-sna-mna`, or `npc` combination unless a value of `c` is specified.

A new point code entry must be specified by one, and only one of the five point code parameter combinations: `nni-nnc-nncm`, `nzone-narea-nid`, `nmsa-nssa-nsp`, `nun-nsna-nmna` or `nnpc`. If the new point code entry is a different point code type than the existing point code entry, all subfields of the new point code type must be specified.

ANSI point code value 000-000-000 and ITU-International point code value 0-000-0 are not allowed.

At least one optional parameter must be specified.

The blocked OPC specified by the `ni-nc-ncm`, `zone-area-id`, `msa-ssa-sp`, `un-sna-mna`, or `npc` parameter must already exist in the screening reference or within an existing range of OPCs.

The new blocked OPC or OPC range defined by the `ni-nc-ncm`, `zone-area-id`, `msa-ssa-sp`, `un-sna-mna`, or `npc` parameter must not already exist in the screening reference or within an existing range of OPCs.

If the `actname` parameter is specified, the `nsr` parameter cannot be specified.

The `actname` parameter value must already be defined in the Gateway Screening Stop Action table with the `chg-gws-actset` command.

If the `area=*` parameter is specified, then the `id=*` parameter must be specified.

If the `msa=*` parameter is specified, then the `ssa=*` and `sp=*` parameters must be specified.

If the `un=*` parameter is specified, then the `sna=*` and `mna=*` parameters must be specified.

If the `msa=c` parameter is specified, then the `ssa` and `sp` parameters must have a value of `c` or must not be specified. If the `msa=c` parameter is specified, and the `ssa` and `sp` parameters are not specified, then the `ssa` and `sp` parameters default to a value of `c`.

If the `un=c` parameter is specified, then the `sna` and `mna` parameters must have a value of `cor` or must not be specified. If the `un=c` parameter is specified, and the `sna` and `sp` parameters are not specified, then the `sna` and `mna` parameters default to a value of `c`.

The `nsfi` and `nsr` parameters must point to an existing screen, or the `nsfi=stop` parameter must be specified, and the `nsr` parameter cannot be specified.

If the `nc` parameter is specified as a range, the `ncm` parameter must be specified as an asterisk or as the full range.

If the `nc` parameter is specified as a single value or a range, a single value must be specified for the `ni` parameter.

If the `nc=*` parameter is specified, the `ncm` parameter must be specified as an asterisk or as the full range 0–255.

If the `ncm` parameter is specified as a single value, or a range other than the full range, the `ni` and `nc` parameters must be specified with a single value.

If the `ni` parameter is specified as an asterisk or as a range, the `nc` and `ncm` parameters must be specified as an asterisk or as the full range.

If the `ni=c` parameter is specified, then the `nc` and the `ncm` parameters must have a value of `c` or must not be specified. If the `ni=c` parameter is specified, and the `nc` and the `ncm` parameters are not specified, then the `nc` and `ncm` parameters default to a value of `c`.

If the `nnc` parameter is specified as a range, the `nncm` parameter must be specified as an asterisk or as the full range.

If the `nnc` parameter is specified as a single value or a range, a single value must be specified for the `nni` parameter.

If the `nnc=*` parameter is specified, the `nncm` parameter must be specified as an asterisk or as the full range.

If the `nncm` parameter is specified as a single value, or a range other than the full range of 0–255, the `nni` and `nnc` parameters must be specified with a single value.

If the `nni` parameter is specified as an asterisk or as a range, the `nnc` and `nncm` parameters must be specified as an asterisk or as the full range.

If the `nsfi=fail` parameter is specified, then the `nni`, `nc`, `nncm`, `narea`, `nzone`, `nid`, `nmsa`, `nssa`, `nsp`, `nun`, `nsna`, `nmna`, and `npc` parameters cannot have a value of `c`.

When changing a screening entry, and the `nsfi=fail` parameter is specified, the `nni`, `nnc`, `nncm`, `narea`, `nzone`, `nid`, `nmsa`, `nssa`, `nsp`, `nun`, `nsna`, `nmna`, and `npc` parameters cannot have a value of `c`.

If the specified `ni-nc-ncm`, `zone-area-id`, `msa-ssa-sp`, or `un-sna-mna` is equal to `c-c-c` or if the `npc=c` parameter is specified, the `nsfi=fail` parameter cannot be specified, and the `nni`, `nnc`, `nncm`, `nzone`, `narea`, `nid`, `nmsa`, `nssa`, `nsp`, `nun`, `nsna`, `nmna`, and `npc` parameters cannot be specified. Point code `c-c-c` and `npc=c` cannot be changed to a numbered point code.

If the specified `ni-nc-ncm`, `zone-area-id`, `un-sna-mna`, or `msa-ssa-sp` is not equal to `c-c-c`, or the `npc=c` parameter is not specified, the `nsfi=fail` parameter must be specified, and the `nsr` parameter cannot be specified.

If the `ssa=*` parameter is specified, then the `sp=*` parameter must be specified.

If the `sna=*` parameter is specified, then the `mna=*` parameter must be specified.

The specified screening reference must already exist in the database.

The Spare Point Code Support feature must be enabled before the `pcst` and `npcst` parameters can be specified.

The `pcst` and `npcst` parameters cannot be specified if the `sr=c` parameter is specified.

The spare point code subtype prefix (s-) is not supported for ANSI point codes (parameters `ni`, `nc`, `nncm`) or for 24-bit ITU national point codes (parameters `msa`, `ssa`, `sp`) or for 16-bit ITU national point codes (parameters `un`, `sna`, `mna`). The `pcst` and `npcst` parameters cannot be specified for ANSI, ITU-N24 or ITU-N16 point codes.

If the `zone=*` parameter is specified, then the `area=*` and `id=*` parameters must be specified.

If the `zone=c` parameter is specified, then the `area` and `id` parameters must have a value of `c` or must not be specified. If the `zone=c` parameter is specified, and the `area` and the `id` parameters are not specified, then the `area` and `id` parameters default to a value of `c`.

If the `actname` parameter is specified, then the `nsfi=stop` parameter must be specified.

The value of the `nsfi` parameter must be valid for the BLKOPC entity type.

The `nsr` parameter cannot be specified if a stop action is specified.

If the specified `ni-nc-ncm`, `zone-area-id`, `un-sna-mna`, or `msa-ssa-sp` equals `c-c-c`, then the `nsfi=fail` parameter cannot be specified.

If the specified `ni-nc-ncm`, `zone-area-id`, `un-sna-mna` or `msa-ssa-sp` is not equal to `c-c-c`, or if the `npc=c` parameter is not specified, then the `nsfi=fail` parameter must be specified, and the `nsr` parameter cannot be specified.

The `nsfi` and `nsr` parameters cannot be specified when changing a screening entry that is other than `c-c-c`.

The `nsr` parameter must be specified when the next screening function identifier (`nsfi`) is not equal to `stop` or `fail`.



The Gateway Screening Stop Action table is corrupt or cannot be found.

The J7 Support feature must be enabled before the `un/sna/mna/nun/nsna/nmna` parameters are specified.

The J7 support feature must not be enabled before the `msa`, `ssa`, `sp`, `nmsa`, `nssa`, or `nsp` parameters are specified.

The GWSOA parameter combination should be known and valid.

## Notes

When a blocked OPC screening reference is created, the first entry for a point code must be `c-c-c` or `c` for the `npc` parameter. Subsequent entries must be specific point codes.

The character `c` is used in the blocked OPC screens to allow the screening process to continue for messages with point codes that do not match any point codes in the blocked OPC screens. When screening for a blocked OPC and the point code being screened does not match any of the point codes in the blocked OPC screens, the message is not rejected and the screening process continues. There must be an entry in the blocked OPC screens to allow the screening process to continue.

This entry consists of a screening reference, point code, `nsfi`, and `nsr`. The point code is `npc=c` or subfields equal to `c`. When the character `c` is specified, the `nsfi` and `nsr` parameters must be specified.

If the character `c` is specified for the parameters `ni-nc-ncm`, `zone-area-id`, `un-sna-mna` or `msa-ssa-sp`, the character `c` is the only value that can be specified for all three parameters. No other values can be used. For example, a point code `c-c-255` is not allowed. The point code must be `c-c-c`. The asterisk (\*) value cannot be used with the character `c` (for example, a point code `c-c-*` is not allowed).

When the point code does not match any entries in the blocked OPC screens, the screening process is directed to the screening reference with the point code `c-c-c` or `npc=c`. The `nsfi` and `nsr` in this entry are examined to determine the next step in the screening process.

If the current `ni-nc-ncm`, `zone-area-id`, `un-sna-mna` or `msa-ssa-sp` is equal to `c-c-c` or `npc=c`, only the `nsfi` and `nsr` can be changed. Otherwise, only the blocked OPC can be changed.

A range of values is specified by separating the values that define the range by two ampersands (&&); for example, `ni=025&&100` specifies all network indicators for ANSI point codes from 25 - 100.

An asterisk cannot not be specified for a parameter value in this command unless an asterisk was specified for the parameter value in the original `ent-scr-blkopc` command.

If the screen set reaches 100% capacity (indicated by the "100% full" message), the system will allow subsequent entries. An error will occur, however, when downloading the screen set to the card. Screen sets should not exceed 100% capacity. Remove screen set entries until the capacity is below 100%.

The spare point code subtype prefix (s-) is supported only for ITU international and ITU national point codes. The `pcst` and `npcst` parameters indicate whether the specified point code has no subtype prefix or has the spare point code prefix.

There is no feature dependency on ANSI point code parameters i.e., `ni`, `nc`, `ncm`, `nni`, `nnc`, or `nncm`. The command can be entered successfully whether the J7 Support feature is enabled or not enabled.

If there are more than 200 affected screensets and the force parameter is set to **yes**, then the following warning message is displayed: "WARNING: Command may take up to 30 minutes" and the command proceeds successfully.

If there are more than 200 affected screensets and the force parameter is set to **no**, then the following notice is displayed: "Notice: Force parameter is required for affected screensets greater than 200" and the command is aborted.

## Output

```
chg-scr-blkopc:sr=iec:ni=240:nc=010:ncm=010:nni=240:nnc=010:nncm=020
```

```
rlghncxa03w 04-01-07 11:43:04 EST EAGLE 31.3.0
CHG-SCR-BLKOPC: SCREEN SET AFFECTED - IEC 25% FULL
CHG-SCR-BLKOPC: MASP A - COMPLTD
;
```

When there are more than 200 affected screensets and the force parameter is **no**:

```
chg-scr-blkopc:sr=bo1:nsfi=sio:nsr=sr2:nc=c:ncm=c:ni=c:force=no
```

Command entered at terminal #17.

```
;
tekelecstp 15-07-15 12:19:42 MST EAGLE5 46.3.0.0.0-66.10.0
CHG-SCR-BLKOPC: MASP A - Cannot access standby fixed disk.
CHG-SCR-BLKOPC: MASP A - Simplex database update.
Notice: Force parameter is required for affected screensets greater than
200
CHG-SCR-BLKOPC: MASP A - Command Aborted
```

When there are more than 200 affected screensets and the force parameter is **yes**:

```
chg-scr-blkopc:sr=bo1:nsfi=sio:nsr=sr2:nc=c:ncm=c:ni=c:force=yes
```

Command entered at terminal #17.

```
;
tekelecstp 15-07-15 14:10:31 MST EAGLE5 46.3.0.0.0-66.10.0
CHG-SCR-BLKOPC: MASP A - Cannot access standby fixed disk.
CHG-SCR-BLKOPC: MASP A - Simplex database update.

WARNING: Command may take upto 30 minutes.
-----
;
Command Accepted - Processing
tekelecstp 15-07-15 14:10:31 MST EAGLE5 46.3.0.0.0-66.10.0
Notice: The number of screensets affected is 201.
CHG-SCR-BLKOPC: SCREEN SET AFFECTED - s1 1% FULL
```

```

CHG-SCR-BLKOPC: SCREEN SET AFFECTED - s10      1% FULL
CHG-SCR-BLKOPC: SCREEN SET AFFECTED - s100     1% FULL
CHG-SCR-BLKOPC: SCREEN SET AFFECTED - s101     1% FULL
CHG-SCR-BLKOPC: SCREEN SET AFFECTED - s102     1% FULL
-----

```

(List of affected screensets)

### Related Topics

- [dlt-scr-blkopc](#)
- [ent-scr-blkopc](#)
- [rtrv-scr-blkopc](#)

## chg-scr-cdpa

Use this command to change the attributes associated with a specific screening reference in the allowed called party address category. Attributes that can be changed are the point code, subsystem number, next screening function identifier, and next screening reference.

### Parameters

#### **sr (mandatory)**

Screening reference. The point code's unique screening reference name.

#### **Range:**

ayyy

1 alphabetic character followed by up to 3 alphanumeric characters

#### **ssn (mandatory)**

Subsystem number.

#### **Range:**

0 - 255, \*

\* —the full range of values from 0–255

#### **actname (optional)**

Action name. The name of the gateway screening stop action set. Stop actions must be administered using this parameter in conjunction with the gateway screening stop action table (see `chg-gws-actset` and `rtrv-gws-actset`).

#### **Range:**

ayyyyy

1 alphabetic character followed by up to 5 alphanumeric characters.

*none* —Remove an existing gateway screening stop action set from a gateway screening rule.

#### **area (optional)**

ITU international area. The *area* in the point code represented by *zone-area-id*.

**Range:**

0 - 255, \*

\* —the full range of values from 0–255

**force (optional)**

When there are more than 200 affected screensets, this parameter will decide whether to execute the command successfully or not.

**Range:**

yes

no

**Default:**

no

**id (optional)**

ITU international ID. The *ID* in the point code represented by *zone-area-id*.

**Range:**

0 - 7, \*

\* —the full range of values from 0–7

**mna (optional)**

16-bit ITU national main number area. The *mna* in the point code represented by *un-sna-mna*.

**Range:**

0 - 31, \*

\*--- the full range of values from 0--31, \*

**msa (optional)**

24-bit ITU-national main signaling area value. The *msa* of the point code represented by *msa-ssa-sp*.

**Range:**

0 - 255, \*

\* —the full range of values from 0–255

**narea (optional)**

New ITU-international area value. A

**Range:**

0 - 255, \*

\* —the full range of values from 0–255

**Default:**

No change to the current value

**nc (optional)**

Network cluster value. This parameter specifies one or more *nc* values for the network indicator and network cluster member values specified in the *ni* and *ncm* parameters. It specifies the *nc* of the point code represented by *ni-nc-ncm*.

**Range:**

0 - 255, \*

\* —the full range of values from 0–255

**ncm (optional)**

Network cluster member value. This parameter specifies one or more *ncm* values for the network cluster indicator and network cluster values identified in the *ni* and *nc* parameters. It specifies the *ncm* of the point code represented by *ni-nc-ncm*.

**Range:**

0 - 255, \*

\* —the full range of values from 0–255

**ni (optional)**

Network indicator value. This parameter specifies one or more *ni* values for the network cluster and network cluster member values identified in the *nc* and *ncm* parameters. It specifies the *ni* of the point code represented by *ni-nc-ncm*.

**Range:**

0 - 255, \*

\* —the full range of values from 0–255

**nid (optional)**

New ITU-international ID value.

**Range:**

0 - 7, \*

\* —the full range of values from 0–7

**Default:**

No change to the current value

**nmna (optional)**

New 16-bit ITU national main number area. The new *mna* in the point code represented by *un-sna-mna*.

**Range:**

0 - 31, \*

\*--- the full range of values from 0--31, \*

**nmsa (optional)**

New 24-bit ITU-national main signaling area value. The new *msa* of the point code represented by *msa-ssa-sp*.

**Range:**

0 - 255, \*

\* —the full range of values from 0–255

**nnc (optional)**

New network cluster. This parameter specifies one or more *nnc* values for the screening reference specified in the *sr* parameter. It specifies the new *nc* of the point code represented by *ni-nc-ncm*.

**Range:**

0 - 255, \*

\* —the full range of values from 0–255

**Default:**  
No change to the current value

**nncm (optional)**

New network cluster member. This parameter specifies one or more *nncm* values for the screening reference specified in the *sr* parameter. It specifies the new *nncm* of the point code represented by *ni-nc-nncm*.

**Range:**  
0 - 255, \*  
\* —the full range of values from 0–255

**Default:**  
No change to the current value

**nni (optional)**

New network identifier. This parameter specifies one or more *nni* values for the screening reference specified in the *sr* parameter. It specifies the new *nni* of the point code represented by *ni-nc-nncm*.

**Range:**  
0 - 255, \*  
\* —the full range of values from 0–255

**Default:**  
No change to the current value

**nnpc (optional)**

New ITU-national point code.

 **Note:**

Gateway screening allows the ITU national point code to be displayed and entered in the database only as a single number. If you use multiple-part ITU national point codes, see [Converting ITU National Point Code Formats](#) in Appendix A for information on converting the point code format.

**Range:**  
0 - 16383, \*  
\* —the full range of values from 0–16383

**Default:**  
No change to the current value

**npc (optional)**

ITU national point code.

**Range:**  
0 - 16383, \*  
\* —the full range of values from 0–16383

**npcst (optional)**

New point code subtype. Indicates whether the specified new ITU international or ITU national point code has no subtype prefix or has the spare point code prefix (s-).

**Range:**

*none*

*s*

**Default:**

*none*

**nscmgfid (optional)**

New SCMG format ID

**Range:**

*1 - 255, \**

\* —the full range of values from 0–255

**Default:**

No change to the current value

**nsfi (optional)**

This parameter specifies the next screening category that is used in the gateway screening process, or it indicates that the gateway screening process should stop.

**Range:**

*aftpc*

Allowed affected point code is the next screening category

*stop*

The gateway screening process ends and the message proceeds through normal routing.

**Default:**

No change to the current value

**nsna (optional)**

New 16-bit ITU national sub number area. The new *sna* in the point code represented by *un-sna-mna*.

**Range:**

*0 - 15, \**

\*--- the full range of values from 0--15, \*

**nsp (optional)**

New 24-bit ITU national signaling point. The new *sp* of the point code represented by *msa-ssa-sp*.

**Range:**

*0 - 255, \**

\* —the full range of values from 0–255

**nsr (optional)**

Next screening reference. This parameter indicates which screening reference in the specified screening category (*nsfi*) is to be used in the screening process.

**Range:***ayyy*

1 alphabetic character followed by up to 3 alphanumeric characters

**Default:**

No change to the current value

**nssa (optional)**New 24-bit ITU national sub signaling area. The new ssa of the point code represented by *msa-ssa-sp*.**Range:***0 - 255, \**

\* —the full range of values from 0–255

**nssn (optional)**

New subsystem number

**Range:***0 - 255, \**

\* —the full range of values from 0–255

**Default:**

No change to the current value

**nun (optional)**New 16-bit ITU national unit number. The new *un* in the point code represented by *un-sna-mna*.**Range:***0 - 127, \**

\*--- the full range of values from 0--127, \*

**nzone (optional)**New ITU-international zone. The new *zone* for the point code represented by *zone-area-id*.**Range:***0 - 7, \**

\* —the full range of values from 0–255

**Default:**

No change to the current value

**pcst (optional)**

Point code subtype. This parameter indicates whether the specified ITU international or ITU national point code has no subtype prefix or has the spare point code prefix (s-).

**Range:***none**s***Default:***none*



**scmgfid (optional)**

SCCP management format ID. This parameter consists of a one-octet field and uniquely defines the function and format of each SCMG message. The following SCCP message types are screened against the Allowed CDPA table and all others are passed: UDT, UDTS, XU DT, XU DTS.

**Range:**

1 - 255, \*

\*—the full range of values from 1–255

**sna (optional)**

16-bit ITU national sub number area. The *sna* in the point code represented by *un-sna-mna*.

**Range:**

0 - 15, \*

\*--- the full range of values from 0--15, \*

**sp (optional)**

24-bit ITU national signaling point. The *sp* in the point code represented by *msa-ssa-sp*.

**Range:**

0 - 255, \*

\*—the full range of values from 0–255

**ssa (optional)**

24-bit ITU national sub signaling area. The *ssa* in the point code represented by *msa-ssa-sp*.

**Range:**

0 - 255

\*—the full range of values from 0–255

**un (optional)**

16-bit ITU-national unit number. The *un* in the point code represented by *un-sna-mna*.

**Range:**

0 - 127, \*

\*--- the full range of values from 0--127, \*

**zone (optional)**

ITU international zone. The *zone* in the point code represented by *zone-area-id*.

**Range:**

0 - 7

\*—the full range of values from 0–255

**Example**

```
chg-scr-
cdpa:sr=cdp1:ni=5:nc=5:ncm=5:ssn=1:scmgfid=4:nsfi=stop:nni=6:nn
cm=3 :nssn=*
```

```
chg-scr-
cdpa:sr=cdp1:ni=c:nc=c:ncm=c:ssn=1:scmgfid=3:nsfi=stop:actname=
copy
```

```
chg-scr-  
cgpa:sr=cgpa:zone=1:area=2:id=3:ssn=1:sccpmt=9:ri=*:nsfi=stop:pcst=s  
:npcst=none
```

```
chg-scr-  
cdpa:sr=cdp1:un=1:sna=2:mna=1:ssn=1:nun=2:nsna=3:nmna=2:nsfi=stop
```

## Dependencies

### ▲ Caution:

Even though gateway screening is in the screen test mode, as defined by the parameters `gwsa=off` and `gwsn=on`, the gateway screening action in the stop action set specified by the `actname` parameter of the screen set will be performed at the end of the screening process.

A complete point code must be specified, and must be one and only one of the five point code parameter combinations: `ni-nc-ncm`, `zone-area-id`, `msa-ssa-sp`, `un-sna-mna` or `npc`, except in the special case of entering `c` for "continue."

ANSI point code value 000-000-000 and ITU-International point code value 0-000-0 are not allowed.

At least one optional parameter must be specified.

The CDPA point code, `scmgfid`, and `ssn` to be changed must already exist in the CDPA entity set.

The new CDPA point code, `scmgfid`, and `ssn` cannot already exist in the CDPA entity set.

If the `actname` parameter is specified, the `nsfi=stop` parameter must be specified.

If the `actname` parameter is specified, the `nsr` parameter cannot be specified.

The `actname` parameter value must already be defined in the Gateway Screening Stop Action table with the `chg-gws-actset` command.

If the `nc` parameter is specified as a range, the `ncm` parameter must be specified as an asterisk or as the full range.

If the `nc` parameter is specified as a single value or a range, a single value must be specified for the `ni` parameter.

If the `nc=*` parameter is specified, the `ncm` parameter must be specified as an asterisk or as the full range.

If the `ncm` parameter is specified as a single value, or a range other than the full range of 0–255, the `ni` and `nc` parameters must be specified with a single value.

If the `ni` parameter is specified as an asterisk or as a range, the `nc` and `ncm` parameters must be specified as an asterisk or as the full range.

If the `nnc` parameter is specified as a range, the `nncm` parameter must be specified as an asterisk or as the full range.

If the `nnc` parameter is specified as a single value or a range, a single value must be specified for the `nni` parameter.

If the `nnc=*` parameter is specified, the `nnm` parameter must be specified as an asterisk or as the full range.

If the `nncm` parameter is specified as a single value, or a range other than the full range of 0–255, the `nni` and the `nnc` parameters must be specified with a single value.

If the `nni` parameter is specified as an asterisk or as a range, the `nnc` and `nncm` parameters must be specified as an asterisk or as the full range.

If the `nsfi=aftpc` parameter is specified, the `ssn=1` parameter must be specified.

If the `nsfi=stop` parameter is specified, the `nsr` parameter cannot be specified.

If the `nsfi` parameter is specified with a value other than `stop`, the `nsr` parameter must be specified.

The next screening function identifier (`nsfi`) and the next screening reference (`nsr`) must point to an existing screen, or the `nsfi` must be equal to `stop` and the `nsr` must not be specified.

The specified screening reference must already exist in the database.

The Spare Point Code Support feature must be enabled before the `pcst` parameter can be specified.

The spare point code subtype prefix (s-) is not supported for ANSI point codes (parameters `ni`, `nc`, `ncm`) or for 24-bit ITU national point codes (parameters `msa`, `ssa`, `sp`) or for 16-bit ITU national point codes (parameters `un`, `sna`, `mna`). The `pcst` and `npcst` parameters cannot be specified for ANSI, ITU-N24, or ITU-N16 point codes.

If the `ssn` parameter is specified with a value other than 1, the `scmgfid` parameter cannot be specified.

If the `ssn=1` parameter is specified, the `scmgfid` parameter must be specified.

The specified value for the `nsfi` parameter is not valid for `cdpa` screen.

The Gateway Screening Stop Action table is corrupt or cannot be found.

The J7 Support feature must be enabled before the `un`, `sna`, `mna`, `nun`, `nsna`, or `nmna` parameters are specified.

The J7 Support feature must not be enabled before the `msa`, `ssa`, `sp`, `nmsa`, `nssa`, or `nsp` parameters are specified.

The GWSOA parameter combination should be known and valid.

## Notes

A range of values is specified by separating the values that define the range by two ampersands (&&); for example, `ni=025&&100` specifies all network indicators for ANSI point codes from 25 - 100.

If the screen set reaches 100% capacity (indicated by the 100% Full message), the system will allow subsequent entries. An error will occur, however, when downloading

the screen set to a LIM. Screen sets should not exceed 100% capacity. Remove screen set entries until the capacity is below 100%.

An asterisk can be specified for a parameter value in the `chg/dlt-scr-cdpa` commands only if that parameter value was specified as an asterisk in the `ent-scr-cdpa` command to define the parameter value.

The Spare Point Code Support feature must be enabled before the `pcst` parameter can be specified.

The spare point code subtype prefix (s-) is supported only for ITU international and ITU national point codes. The `pcst` parameter indicates whether the specified point code has no subtype prefix or has the spare point code prefix.

There is no feature dependency on ANSI point code parameters i.e., `ni`, `nc`, `ncm`, `nni`, `nnc`, or `nncm`. The command can be entered successfully whether the J7 Support feature is enabled or not enabled.

If there are more than 200 affected screensets and the `force` parameter is set to **yes**, then the following warning message is displayed: "WARNING: Command may take up to 30 minutes" and the command proceeds successfully.

If there are more than 200 affected screensets and the `force` parameter is set to **no**, then the following notice is displayed: "Notice: Force parameter is required for affected screensets greater than 200" and the command is aborted.

## Output

```
chg-scr-
cdpa:sr=cdp1:ni=5:nc=5:ncm=5:ssn=1:scmgfid=4:nsfi=stop:nni=6:nncm=3
:nssn=*
```

```
rlghncxa03w 04-01-14 15:35:30 EST EAGLE 31.3.0
CHG-SCR-CDPA: MASP A - COMPLTD
```

```
;
```

When there are more than 200 affected screensets and the `force` parameter is **no**:

```
chg-scr-
cdpa:sr=cd1:nsfi=aftpc:nsr=af2:ni=4:nc=1:ncm=1:ssn=1:scmgfid=1:force
=no
```

Command entered at terminal #17.

```
;
```

```
tekelecstp 15-07-15 12:19:42 MST EAGLE5 46.3.0.0.0-66.10.0
CHG-SCR-CDPA: MASP A - Cannot access standby fixed disk.
CHG-SCR-CDPA: MASP A - Simplex database update.
Notice: Force parameter is required for affected screensets greater than
200
CHG-SCR-CDPA: MASP A - Command Aborted
```

When there are more than 200 affected screensets and the `force` parameter is **yes**:

```
chg-scr-  
cdpa:sr=cd1:nsfi=aftpc:nsr=af2:ni=4:nc=1:ncm=1:ssn=1:scmgfid=1:  
force=yes
```

Command entered at terminal #17.

```
;
```

```
tekelecstp 15-07-15 14:10:31 MST EAGLE5 46.3.0.0.0-66.10.0  
CHG-SCR-CDPA: MASP A - Cannot access standby fixed disk.  
CHG-SCR-CDPA: MASP A - Simplex database update.
```

```
WARNING: Command may take upto 30 minutes.  
-----
```

```
;
```

Command Accepted - Processing

```
tekelecstp 15-07-15 14:10:31 MST EAGLE5 46.3.0.0.0-66.10.0  
Notice: The number of screensets affected is 201.  
CHG-SCR-CDPA: SCREEN SET AFFECTED - s1      1% FULL  
CHG-SCR-CDPA: SCREEN SET AFFECTED - s10     1% FULL  
CHG-SCR-CDPA: SCREEN SET AFFECTED - s100    1% FULL  
CHG-SCR-CDPA: SCREEN SET AFFECTED - s101    1% FULL  
CHG-SCR-CDPA: SCREEN SET AFFECTED - s102    1% FULL  
-----
```

```
(List of affected screensets)
```

### Related Topics

- [dlt-scr-cdpa](#)
- [ent-scr-cdpa](#)
- [rtrv-scr-cdpa](#)

## chg-scr-cgpa

Use this command to change the attributes associated with a specific screening reference in the allowed calling party address category. Attributes that can be changed are the point code, subsystem number, routing indicator, next screening function identifier, and next screening reference.

### Parameters

#### **ri (mandatory)**

Routing indicator. This parameter specifies routing instructions to the receiving signaling point. In gateway screening, messages may be screened based on the value of the routing indicator.

#### **Range:**

##### ***dpc***

Allow a called party address with a routing indicator value of "DPC/SSN."

**gt**

Screening stops and gateway screening is bypassed as a forced pass.

\*

Allow both routing indicator values.

**sccpmt (mandatory)**

SCCP message type.

**Range:**

**9**

UDT

**10**

UDTS

**17**

XUDT

**18**

XUDTS

\*

full range of values

**sr (mandatory)**

Screening reference. The point code's unique screening reference name.

**Range:**

*ayyy*

1 alphabetic character followed by up to 3 alphanumeric characters

**ssn (mandatory)**

Subsystem number

**Range:**

*1 - 255, \**

\* —the full range of values from 1–255

**actname (optional)**

Action name. The name of the gateway screening stop action set. Stop actions must be administered using this parameter in conjunction with the gateway screening stop action table (see `chg-gws-actset` and `rtrv-gws-actset`).

**Range:**

*ayyyyy*

1 alphabetic character followed by up to 5 alphanumeric characters.

*none* —remove an existing gateway screening stop action set from a gateway screening rule

**area (optional)**

ITU international area. The *area* in the point code represented by *zone-area-id*.

**Range:**

*0 - 255, \**

\* —the full range of values from 0–255

**force (optional)**

When there are more than 200 affected screensets, this parameter will decide whether to execute the command successfully or not.

**Range:**

yes

no

**Default:**

no

**id (optional)**

ITU international ID. The *ID* in the point code represented by *zone-area-id*.

**Range:**

0 - 7, \*

\* —the full range of values from 0–7

**mna (optional)**

16-bit ITU national main number area. The *mna* in the point code represented by *un-sna-mna*.

**Range:**

0 - 31, \*

\*--- the full range of values from 0--31, \*

**msa (optional)**

24-bit ITU-national main signaling area value. The *msa* of the point code represented by *msa-ssa-sp*.

**Range:**

0 - 255, \*

\* —the full range of values from 0–255

**narea (optional)**

New ITU-international area value

**Range:**

0 - 255, \*

\* —the full range of values from 0–255

**Default:**

No change to the current value

**nc (optional)**

Network cluster value. This parameter specifies one or more *nc* values for the network indicator and network cluster member values specified in the *ni* and *ncm* parameters. It specifies the *nc* of the point code represented by *ni-nc-ncm*.

**Range:**

0 - 255, \*

\* —the full range of values from 0–255

**ncm (optional)**

Network cluster member value. This parameter specifies one or more *ncm* values for the network indicator and network cluster values identified in the *ni* and *nc* parameters. It specifies the *ncm* of the point code represented by *ni-nc-ncm*.

**Range:**

0 - 255, \*

\*—the full range of values from 0–255

**ni (optional)**

Network indicator value. This parameter specifies one or more *ni* values for the network cluster and network cluster member values identified in the *nc* and *ncm* parameters. It specifies the *ni* of the point code represented by *ni-nc-ncm*.

**Range:**

0 - 255, \*

\*—the full range of values from 0–255

**nid (optional)**

New ITU-international ID value.

**Range:**

0 - 7, \*

\*—the full range of values from 0–7

**Default:**

No change to the current value

**nmna (optional)**

New 16-bit ITU national main number area. The new *mna* in the point code represented by *un-sna-mna*.

**Range:**

0 - 31, \*

\*--- the full range of values from 0--31, \*

**nmsa (optional)**

New 24-bit ITU-national main signaling area value. The new *msa* of the point code represented by *msa-ssa-sp*.

**Range:**

0 - 255, \*

\*—the full range of values from 0–255

**nnc (optional)**

New network cluster. This parameter specifies one or more *nnc* values for the screening reference specified in the *srx* parameter. It specifies the new *nc* of the point code represented by *ni-nc-ncm*.

**Range:**

0 - 255, \*

\*—the full range of values from 0–255

**Default:**

No change to the current value



**nncm (optional)**

New network cluster member. This parameter specifies one or more *nncm* values for the screening reference specified in the *sr* parameter. It specifies the new *nncm* of the point code represented by *ni-nc-nncm*.

**Range:**

0 - 255, \*

\* —the full range of values from 0–255

**Default:**

No change to the current value

**nni (optional)**

New network identifier. This parameter specifies one or more *nni* values for the screening reference specified in the *sr* parameter. It specifies the new *nni* of the point code represented by *ni-nc-nncm*.

**Range:**

0 - 255, \*

\* —the full range of values from 0–255

**Default:**

No change to the current value

**npc (optional)**

New ITU-national point code.

 **Note:**

Gateway screening allows the ITU national point code to be displayed and entered in the database only as a single number. If you use multiple-part ITU national point codes, see [Converting ITU National Point Code Formats](#) for information on converting the point code format.

**Range:**

0 - 16383, \*

\* —the full range of values from 0–16383

**Default:**

No change to the current value

**npc (optional)**

ITU national point code.

**Range:**

0 - 16383, \*

\* —the full range of values from 0–16383

**npcst (optional)**

New point code subtype. This parameter indicates whether the specified new ITU international or ITU national point code has no subtype prefix or has the spare point code prefix (s-).

**Range:**

*none*

*s*

**Default:**

*none*

**nri (optional)**

New routing indicator that provides routing instructions to the receiving signaling point. In gateway screening, messages may be screened based on the value of the routing indicator.

**Range:**

*dpc*

Allow a called party address with a routing indicator value of "DPC/SSN."

*gt*

Screening stops and gateway screening is bypassed as a forced pass.

\*

both the *gt* and *dpc* values are accepted in the gateway screening process

**Default:**

No change to the current value

**nsccpmt (optional)**

New SCCP message type.

**Range:**

*9*

*10*

*17*

*18*

\*

full range of values

**Default:**

No change to the current value

**nsfi (optional)**

This parameter specifies the next screening category used in the gateway screening process, or it indicates that the gateway screening process should stop.

**Range:**

*cdpa*

Allowed called party address is the next screening category

**stop**

The gateway screening process ends and the message proceeds through normal routing

**tt**

Allowed translation type is the next screening category

**Default:**

No change to the current value

**nsna (optional)**

New 16-bit ITU national sub number area. The new *sna* in the point code represented by *un-sna-mna*.

**Range:**

0 - 15, \*

\*--- the full range of values from 0--15, \*

**nsp (optional)**

New 24-bit ITU national signaling point. The new *sp* of the point code represented by *msa-ssa-sp*.

**Range:**

0 - 255, \*

\* —the full range of values from 0–255

**nsr (optional)**

Next screening reference. This parameter specifies which screening reference in the specified screening category (*nsfi*) is to be used in the screening process.

**Range:**

*ayyy*

1 alphabetic character followed by up to 3 alphanumeric characters

**Default:**

No change to the current value

**nssa (optional)**

New 24-bit ITU national sub signaling area. The new *ssa* of the point code represented by *msa-ssa-sp*.

**Range:**

0 - 255, \*

\* —the full range of values from 0–255

**nssn (optional)**

New subsystem number

**Range:**

0 - 255, \*

\* —the full range of values from 0–255

**Default:**

No change to the current value

**nun (optional)**

New 16-bit ITU national unit number. The new *un* in the point code represented by *un-sna-mna*.

**Range:**

0 - 127, \*

\*--- the full range of values from 0--127, \*

**nzone (optional)**

New ITU-international zone. The new *zone* for the point code represented by *zone-area-id*.

**Range:**

0 - 7, \*

\* —the full range of values from 0–7

**Default:**

No change to the current value

**pcst (optional)**

Point code subtype. This parameter indicates whether the specified ITU international or ITU national point code has no subtype prefix or has the spare point code prefix (s-).

**Range:**

*none*

*s*

**Default:**

*none*

**sna (optional)**

16-bit ITU national sub number area. The *sna* in the point code represented by *un-sna-mna*.

**Range:**

0 - 15, \*

\*--- the full range of values from 0--15, \*

**sp (optional)**

24-bit ITU national signaling point. The *sp* in the point code represented by *msa-ssa-sp*.

**Range:**

0 - 255, \*

\* —the full range of values from 0–255

**ssa (optional)**

24-bit ITU national sub signaling area. The *ssa* in the point code represented by the format *msa-ssa-sp*.

**Range:**

0 - 255, \*

\* —the full range of values from 0–255

**un (optional)**

16-bit ITU-national unit number. The *un* in the point code represented by *un-sna-mna*.

**Range:**

0 - 127, \*

\*--- the full range of values from 0--127, \*

**zone (optional)**ITU international zone. The *zone* in the point code represented by *zone-area-id*.**Range:**

0 - 7, \*

\*—the full range of values from 0–7

**Example**

```
chg-scr-cgpa:sr=iec:ni=240:nc=010:ncm=010:ssn=3:ri=dpc
```

```
chg-scr-
cgpa:sr=iec:ni=240:nc=010:ncm=010:ssn=3:ri=dpc:nsfi=stop:actnam
e=copy
```

```
chg-scr-
cgpa:sr=cdp1:ni=5:nc=5:ncm=5:ssn=1:ri=dpc:sccpmt=009:nsfi=sdpa:
nsr=cdp1
```

```
chg-scr-
cgpa:sr=cgpa:zone=1:area=2:id=3:ssn=1:sccpmt=9:ri=*:nsfi=stop:p
cst=s :npcst=none
```

```
chg-scr-
cgpa:sr=cgp1:un=1:sna=2:mna=1:ssn=1:sccpmt=9:nun=2:nsna=3:nmna=
2:nsfi=stop:ri=*
```

**Dependencies** **Caution:**

Even though gateway screening is in the screen test mode, as defined by the `gwsa=off` and `gwsn=on` parameters, the gateway screening action in the stop action set specified by the `actname` parameter of the screen set will be performed at the end of the screening process.

A complete point code must be specified, and must be one, and only one of the five point code parameter combinations: `ni-nc-ncm`, `zone-area-id`, `msa-ssa-sp`, `un-sna-mna`, or `npc`.

ANSI point code value 000-000-000 and ITU-International point code value 0-000-0 are not allowed.

At least one optional parameter must be specified.

The CGPA point code or range of point codes, `ri`, `sccpmt`, and subsystem number or numbers to be changed must exist in the CGPA entity set.

The new CGPA point code and subsystem number cannot already exist in the CGPA entity set.

If the `actname` parameter is specified, the `nsfi=stop` parameter must be specified.

If the `actname` parameter is specified, the `nsr` parameter cannot be specified.

The value of the `actname` parameter must already be defined in the Gateway Screening Stop Action table with the `chg-gws-actset` command.

The next screening function identifier (`nsfi`) and the next screening reference (`nsr`) must point to an existing screen, or the `nsfi` must be equal to `stop` and the `nsr` must not be specified.

If the `nc` parameter is specified as a range, the `ncm` parameter must be specified as an asterisk or as the full range.

If the `nc` parameter is specified as a single value or a range, a single value must be specified for the `ni` parameter.

If the `nc` parameter is specified as an asterisk, the `ncm` parameter must be specified as an asterisk or as the full range.

If the `ncm` parameter is specified as a single value, or a range other than the full range of 0–255, the `ni` and `nc` parameters must be specified with a single value.

If the `ni` parameter is specified as an asterisk or as a range, the `nc` and `ncm` parameters must be specified as an asterisk or as the full range.

If the `nnc` parameter is specified as a range, the `nncm` parameter must be specified as an asterisk or as the full range.

If the `nnc` parameter is specified as a single value or a range, a single value must be specified for the `nni` parameter.

If the `nnc` parameter is specified as an asterisk, the `nnm` parameter must be specified as an asterisk or as the full range.

If the `nncm` parameter is specified as a single value, or a range other than the full range of 0–255, the `nni` and `nnc` parameters must be specified with a single value.

If the `nni` parameter is specified as an asterisk or as a range, the `nnc` and `nncm` parameters must be specified as an asterisk or as the full range.

The `nsfi=cdpa` parameter can be specified only when the `ri=*` or the `ri=dpc` parameter is specified.

The `nsfi=tt` parameter can be specified only when the `ri=*` or the `ri=gt` parameter is specified.

If the `nsfi=stop` parameter is specified, the `nsr` parameter cannot be specified.

If the `nsfi` parameter has a value other than `stop`, the `nsr` parameter must be specified.

The specified screening reference (`sr`) must already exist in the database.

The Spare Point Code Support feature must be enabled before the `pcst` parameter can be specified.

The spare point code subtype prefix (s-) is not supported for ANSI point codes (parameters `ni`, `nc`, `ncm`) or for 24-bit ITU national point codes (parameters `msa`, `ssa`, `sp`) or for 16-bit ITU national point codes (parameters `un`, `sna`, `mna`). The `pcst` and `npcst` parameters cannot be specified for ANSI, ITU-N24 or ITU-N16 point codes.

Valid values must be specified for the `nsccpmt` and `sccpmt` parameters.

The Gateway Screening Stop Action table must be accessible.

The specified value for the `nsfi` parameter is not valid for `cgpa` screen.

The new CGPA point code, `ri`, `sccpmt`, and `ssn` to be added can not already exist in the CGPA entity set.

The J7 Support feature must be enabled before the `un`, `sna`, `mna`, `nun`, `nsna`, or `nmna` parameters are specified.

The J7 Support feature must not be enabled before the `msa`, `ssa`, `sp`, `nmsa`, `nssa`, or `nsp` parameters are specified.

The GWSOA parameter combination should be known and valid.

## Notes

A range of values is specified by separating the values that define the range by two ampersands (&&); for example, `ni=025&&100` specifies all network indicators for ANSI point codes from 25 - 100.

If the screen set reaches 100% capacity (indicated by the 100% Full message), the system will allow subsequent entries. An error will occur, however, when downloading the screen set to a LIM. Screen sets should not exceed 100% capacity. Remove screen set entries until the capacity is below 100%.

An asterisk can be specified for a parameter value in the `chg/dlt-scr-cgpa` commands only if that parameter value was specified as an asterisk in the `ent-scr-cgpa` command to define the parameter value.

The spare point code subtype prefix (s-) is supported only for ITU international and ITU national point codes. The `pcst` parameter indicates whether the specified point code has no subtype prefix or has the spare point code prefix.

There is no feature dependency on ANSI point code parameters i.e., `ni`, `nc`, `ncm`, `nni`, `nnc`, or `nncm`. The command can be entered successfully whether the J7 Support feature is enabled or not enabled.

If there are more than 200 affected screensets and the `force` parameter is set to **yes**, then the following warning message is displayed: "WARNING: Command may take up to 30 minutes" and the command proceeds successfully.

If there are more than 200 affected screensets and the `force` parameter is set to **no**, then the following notice is displayed: "Notice: Force parameter is required for affected screensets greater than 200" and the command is aborted.

## Output

```
chg-scr-cgpa:sr=iec:ni=240:nc=010:ncm=010:ssn=3:ri=dpc
```

```
rlghncxa03w 04-01-07 11:43:04 EST EAGLE 31.3.0
CHG-SCR-CGPA: SCREEN SET AFFECTED - IEC 25% FULL
CHG-SCR-CGPA: MASP A - COMPLTD
;
```

When there are more than 200 affected screensets and the `force` parameter is **no**:

```
chg-scr-cgpa:sr=iec:ni=240:nc=010:ncm=010:ssn=3:ri=dpc:force=no
```

```
Command entered at terminal #17.
```

```
;
```

```
tekelecstp 15-07-15 12:19:42 MST EAGLE5 46.3.0.0.0-66.10.0
CHG-SCR-CGPA: MASP A - Cannot access standby fixed disk.
CHG-SCR-CGPA: MASP A - Simplex database update.
Notice: Force parameter is required for affected screensets greater than
200
CHG-SCR-CGPA: MASP A - Command Aborted
```

When there are more than 200 affected screensets and the `force` parameter is **yes**:

```
chg-scr-cgpa:sr=iec:ni=240:nc=010:ncm=010:ssn=3:ri=dpc:force=yes
```

```
Command entered at terminal #17.
```

```
;
```

```
tekelecstp 15-07-15 14:10:31 MST EAGLE5 46.3.0.0.0-66.10.0
CHG-SCR-CGPA: MASP A - Cannot access standby fixed disk.
CHG-SCR-CGPA: MASP A - Simplex database update.
WARNING: Command may take upto 30 minutes.
-----
;
Command Accepted - Processing
tekelecstp 15-07-15 14:10:31 MST EAGLE5 46.3.0.0.0-66.10.0
Notice: The number of screensets affected is 201.
CHG-SCR-CGPA: SCREEN SET AFFECTED - s1      1% FULL
CHG-SCR-CGPA: SCREEN SET AFFECTED - s10     1% FULL
CHG-SCR-CGPA: SCREEN SET AFFECTED - s100    1% FULL
CHG-SCR-CGPA: SCREEN SET AFFECTED - s101    1% FULL
CHG-SCR-CGPA: SCREEN SET AFFECTED - s102    1% FULL
-----
-----
(List of affected screensets)
```

### Related Topics

- [dlt-scr-cgpa](#)
- [ent-scr-cgpa](#)
- [rtrv-scr-cgpa](#)

## chg-scr-destfld

Use this command to change the attributes of a specific screening reference in the allowed affected destination field (DESTFLD) category. Attributes that can be changed are the allowed affected destination point codes.



## Parameters

### **sr (mandatory)**

Screening reference. The point code's unique screening reference name.

#### **Range:**

*ayyy*

1 alphabetic character followed by up to 3 alphanumeric characters

### **actname (optional)**

Action name. The name of the gateway screening stop action set. Stop actions must be administered using this parameter in conjunction with the gateway screening stop action table (see `chg-gws-actset` and `rtrv-gws-actset` ).

#### **Range:**

*ayyyyy*

1 alphabetic character followed by up to 5 alphanumeric characters.

*none* —remove an existing gateway screening stop action set from a gateway screening rule.

### **area (optional)**

ITU international area. The *area* in the point code represented by *zone-area-id*.

#### **Range:**

*0 - 255, \**

\*—the full range of values from 0–255

### **force (optional)**

When there are more than 200 affected screensets, this parameter will decide whether to execute the command successfully or not.

#### **Range:**

*yes*

*no*

#### **Default:**

*no*

### **id (optional)**

ITU international ID. The *ID* in the point code represented by *zone-area-id*.

#### **Range:**

*0 - 7, \**

\*—the full range of values from 0–7

### **mna (optional)**

16-bit ITU national main number area. The *mna* in the point code represented by *un-sna-mna*.

#### **Range:**

*0 - 31, \**

\*--- the full range of values from 0--31

**msa (optional)**

24-bit ITU-national main signaling area value. The *msa* of the point code represented by *msa-ssa-sp*.

**Range:**

0 - 255, \*

\*—the full range of values from 0–255

**narea (optional)**

New ITU-international area value

**Range:**

0 - 255, \*

\*—the full range of values from 0–255

**Default:**

No change to the current value

**nc (optional)**

Network cluster value. This parameter specifies one or more *nc* values for the network indicator and network cluster member values specified in the *ni* and *ncm* parameters. It specifies the *nc* of the point code represented by *ni-nc-ncm*.

**Range:**

0 - 255, \*

\*—the full range of values from 0–255

**ncm (optional)**

Network cluster member value. This parameter specifies one or more *ncm* values for the network indicator and network cluster values identified in the *ni* and *nc* parameters. It specifies the *ncm* of the point code represented by *ni-nc-ncm*.

**Range:**

0 - 255, \*

\*—the full range of values from 0–255

**ni (optional)**

Network indicator value. This parameter specifies one or more *ni* values for the network cluster and network cluster member values identified in the *nc* and *ncm* parameters. It specifies the *ni* of the point code represented by *ni-nc-ncm*.

**Range:**

0 - 255, \*

\*—the full range of values from 0–255

**nid (optional)**

New ITU-international ID value.

**Range:**

0 - 7, \*

\*—the full range of values from 0–7

**Default:**

No change to the current value

**nmna (optional)**

New 16-bit ITU national main number area. The new *mna* in the point code represented by *un-sna-mna*.

**Range:**

0 - 31, \*

\*--- the full range of values from 0--31

**nmsa (optional)**

New 24-bit ITU-national main signaling area value. The new *msa* of the point code represented by *msa-ssa-sp*.

**Range:**

0 - 255, \*

\*—the full range of values from 0–255

**nnc (optional)**

New network cluster. This parameter specifies one or more *nnc* values for the screening reference specified in the *sr* parameter. It specifies the new *nc* of the point code represented by *ni-nc-ncm*.

**Range:**

0 - 255, \*

\*—the full range of values from 0–255

**Default:**

No change to the current value

**nncm (optional)**

New network cluster member. This parameter specifies one or more *ncm* values for the screening reference specified in the *sr* parameter. It specifies the new *ncm* of the point code represented by *ni-nc-ncm*.

**Range:**

0 - 255, \*

\*—the full range of values from 0–255

**Default:**

No change to the current value

**nni (optional)**

New network identifier. This parameter specifies one or more *nni* values for the screening reference specified in the *sr* parameter. It specifies the new *ni* of the point code represented by *ni-nc-ncm*.

**Range:**

0 - 255, \*

\*—the full range of values from 0–255

**Default:**

No change to the current value

**nnpc (optional)**

New ITU-national point code

 **Note:**

Gateway screening allows the ITU national point code to be displayed and entered in the database only as a single number. If you use multiple-part ITU national point codes, see [Converting ITU National Point Code Formats](#) in Appendix A for information on converting the point code format.

**Range:**

0 - 16383, \*

\*—the full range of values from 0–16383

**Default:**

No change to the current value

**npc (optional)**

ITU national point code.

**Range:**

0 - 16383

\*—the full range of values from 0–16383

**npcst (optional)**

New point code subtype. This parameter indicates whether the specified new ITU international or ITU national point code has no subtype prefix or has the spare point code prefix (s-).

**Range:**

*none*

*s*

**Default:**

*none*

**nsfi (optional)**

This parameter specifies the next screening category that is used in the gateway screening process.

**Range: stop ,**

*stop* —The gateway screening process ends and the message proceeds through normal routing.

**Default:**

No change to the current value

**nsna (optional)**

New 16-bit ITU national sub number area. The new *sna* in the point code represented by *un-sna-mna*.

**Range:**

0 - 15, \*

\*--- the full range of values from 0--15

**nsp (optional)**

New 24-bit ITU national signaling point. The new *sp* of the point code represented by *msa-ssa-sp*. A

**Range:**

0 - 255, \*

\*—the full range of values from 0–255

**nsr (optional)**

Next screening reference. This parameter specifies the point code's unique screening reference name.

**Range:**

*ayyy*

1 alphabetic character followed by up to 3 alphanumeric characters

**nssa (optional)**

New 24-bit ITU national sub signaling area. The new *ssa* of the point code represented by *msa-ssa-sp*.

**Range:**

0 - 255, \*

\*—the full range of values from 0–255

**nun (optional)**

New 16-bit ITU national unit number. The new *un* in the point code represented by *un-sna-mna*.

**Range:**

0 - 127, \*

\*--- the full range of values from 0--127

**nzone (optional)**

New ITU-international zone. The new *zone* for the point code represented by *zone-area-id*.

**Range:**

0 - 7, \*

\*—the full range of values from 0–255

**Default:**

No change to the current value

**pcst (optional)**

Point code subtype. This parameter indicates whether the specified ITU international or ITU national point code has no subtype prefix or has the spare point code prefix (s-).

**Range:**

*none*

*s*

**Default:**

*none*

**sna (optional)**

16-bit ITU national sub number area. The *sna* in the point code represented by *un-sna-mna*.

**Range:**

0 - 15, \*

\*--- the full range of values from 0--15

**sp (optional)**

24-bit ITU national signaling point. The *sp* in the point code represented by *msa-ssa-sp*.

**Range:**

0 - 255, \*

\*—the full range of values from 0–255

**ssa (optional)**

24-bit ITU national sub signaling area. The *ssa* in the point code represented by *msa-ssa-sp*.

**Range:**

0 - 255, \*

\*—the full range of values from 0–255

**un (optional)**

16-bit ITU-national unit number. The *un* in the point code represented by *un-sna-mna*.

**Range:**

0 - 127, \*

\*--- the full range of values from 0--127

**zone (optional)**

ITU international zone. The *zone* in the point code represented by *zone-area-id*.

**Range:**

0 - 7, \*

\*—the full range of values from 0–7

**Example**

```
chg-scr-destfld:sr=iec:ni=240:nc=010:ncm=019&&020:nncm=021
```

```
chg-scr-destfld:sr=iec:ni=240:nc=010:ncm=019&&020:nsfi=stop:actname=none
```

```
chg-scr-destfld:sr=dst1:zone=1:area=2:id=3:nsfi=stop:pcst=s:npcst=none
```

```
chg-scr-destfld:sr=ds01:un=1:sna=2:mna=3:nun=4:nsna=5:nmna=6
```

**Dependencies****▲ Caution:**

Even though gateway screening is in the screen test mode, as defined by the `gwsa=off` and `gwsn=on` parameters, the gateway screening action in the stop action set specified by the `actname` parameter of the screen set will be performed at the end of the screening process.

A complete point code must be specified, using the `ni-nc-ncm`, `zone-area-id`, `msa-ssa-sp`, `un-sna-mna` or `npc` combination unless a value of `c` is specified.

A new point code entry must be specified by one, and only one of the five point code parameter combinations: `nnc-nnc-ncm`, `nzone-narea-nid`, `nmsa-nssa-nsp`, `nun-nsna-nmna` or `nnpc`. If the new point code entry is a different point code type than the existing point code entry, all subfields of the new point code type must be specified.

ANSI point code value 000-000-000 and ITU-International point code value 0-000-0 are not allowed.

At least one optional parameter must be specified.

The new DESTFLD defined by `ni-nc-ncm`, `zone-area-id`, `msa-ssa-sp`, `un-sna-mna`, or the `npc` parameter must not already exist in the screening reference.

If the `actname` parameter is specified, the `nsfi=stop` parameter must be specified.

If the `actname` parameter is specified, the `nsr` parameter cannot be specified.

The value of the `actname` parameter must already be defined in the Gateway Screening Stop Action table with the `chg-gws-actset` command.

If the `zone=*`  parameter is specified, then the `area=*`  and the `id=*`  parameters must be specified.

If the `area=*`  parameter is specified, then the `id=*`  parameter must be specified.

If the `msa=*`  parameter is specified, then the `ssa=*`  and the `sp=*`  parameters must be specified.

If the `un=*`  parameter is specified, then the `sna=*`  and the `mna=*`  parameters must be specified.

If the `ssa=*`  parameter is specified, then the `sp=*`  parameter must be specified.

If the `sna=*`  parameter is specified, then the `mna=*`  parameter must be specified.

If the `nsfi=stop` parameter is specified, then the `nsr` parameter cannot be specified.

If the `nc` parameter is specified as a range, the `ncm` parameter must be specified as an asterisk or as the full range 000–255 .

If the `nc` parameter is specified as a single value or a range, a single value must be specified for the `ni` parameter.

If the `nc=*`  parameter is specified, the `ncm` parameter must be specified as an asterisk or as the full range.

If the `ncm` parameter is specified as a single value, or a range other than the full range of 0–255, the `ni` and `nc` parameters must be specified with a single value.

If the `ni` parameter is specified as an asterisk or as a range, the `nc` and `ncm` parameters must be specified as an asterisk or as the full range.

If the `nnc` parameter is specified as a range, the `nncm` parameter must be specified as an asterisk or as the full range.

If the `nnc` parameter is specified as a single value or a range, a single value must be specified for the `nni` parameter.

If the `nnc` parameter is specified as an asterisk, the `nnm` parameter must be specified as an asterisk or as the full range.

If the `nncm` parameter is specified as a single value, or a range other than the full range of 0–255, the `nni` and `nnc` parameters must be specified with a single value.

If the `nni` parameter is specified as an asterisk or as a range, the `nnc` and `nncm` parameters must be specified as an asterisk or as the full range.

The `nsfi=stop` parameter must be specified in the command

The entry specified by `ni-nc-ncm`, `zone-area-id`, `msa-ssa-sp`, `un-sna-mna`, or the `npc` parameter must already exist in the screening reference.

The specified screening reference must already exist in the database.

The Spare Point Code Support feature must be enabled before the `pcst` parameter can be specified.

The spare point code subtype prefix (s-) is not supported for ANSI point codes (parameters `ni`, `nc`, `nncm`) or for 24-bit ITU national point codes (parameters `msa`, `ssa`, `sp`) or for 16-bit ITU national point codes (parameters `un`, `sna`, `mna`). The `pcst` and `npcst` parameters cannot be specified for ANSI, ITU-N24 or ITU-N16 point codes.

If the `nsfi=fail` parameter is specified, then the `nni`, `nc`, `nncm`, `narea`, `nzone`, `nid`, `nmsa`, `nssa`, `nsp`, `nun`, `nsna`, `nmna`, and `npc` parameters cannot have a value of `c`.

The Gateway Screening Stop Action table must be accessible.

The J7 support feature must be enabled before the `un`, `sna`, `mna`, `nun`, `nsna`, or `nmna` parameters are specified.

The J7 support feature must not be enabled before the `msa`, `ssa`, `sp`, `nmsa`, `nssa`, or `nsp` parameters are specified.

The GWSOA parameter combination should be known and valid.

## Notes

A range of values is specified by separating the values that define the range by two ampersands (`&&`); for example, `ni=025&&100` specifies all network indicators for ANSI point codes from 25 - 100.

An asterisk can be specified for a parameter value in the `chg/dlt-scr-destfld` commands only if that parameter value was specified as an asterisk in the `ent-scr-destfld` command to define the parameter value.

The spare point code subtype prefix (s-) is supported only for ITU international and ITU national point codes. The `pcst` and `npcst` parameters indicate whether the specified point code has no subtype prefix or has the spare point code prefix.

There is no feature dependency on ANSI point code parameters i.e., `ni`, `nc`, `nncm`, `nni`, `nnc` or `nncm`. The command can be entered successfully whether the J7 feature is enabled or not enabled.



If there are more than 200 affected screensets and the force parameter is set to **yes**, then the following warning message is displayed: "WARNING: Command may take up to 30 minutes" and the command proceeds successfully.

If there are more than 200 affected screensets and the force parameter is set to **no**, then the following notice is displayed: "Notice: Force parameter is required for affected screensets greater than 200" and the command is aborted.

## Output

```
chg-scr-destfld:sr=iec:ni=240:nc=010:ncm=019&&020:nncm=021
```

```
rlghncxa03w 04-01-13 11:49:47 EST EAGLE 31.3.0
CHG-SCR-DESTFLD: SCREEN SET AFFECTED - SS01 25% FULL
CHG-SCR-DESTFLD: MASP A - COMPLTD
```

```
;
```

When there are more than 200 affected screensets and the force parameter is **no**:

```
chg-scr-
destfld:sr=iec:ni=240:nc=010:ncm=019&&020:nncm=021:force=no
```

Command entered at terminal #17.

```
;
```

```
tekelecstp 15-07-15 12:19:42 MST EAGLE5 46.3.0.0.0-66.10.0
CHG-SCR-DESTFLD: MASP A - Cannot access standby fixed disk.
CHG-SCR-DESTFLD: MASP A - Simplex database update.
Notice: Force parameter is required for affected screensets
greater than 200
CHG-SCR-DESTFLD: MASP A - Command Aborted
```

When there are more than 200 affected screensets and the force parameter is **yes**:

```
chg-scr-
destfld:sr=iec:ni=240:nc=010:ncm=019&&020:nncm=021:force=yes
```

Command entered at terminal #17.

```
;
```

```
tekelecstp 15-07-15 14:10:31 MST EAGLE5 46.3.0.0.0-66.10.0
CHG-SCR-DESTFLD: MASP A - Cannot access standby fixed disk.
CHG-SCR-DESTFLD: MASP A - Simplex database update.
WARNING: Command may take upto 30 minutes.
-----
```

```
;
```

Command Accepted - Processing

```
tekelecstp 15-07-15 14:10:31 MST EAGLE5 46.3.0.0.0-66.10.0
Notice: The number of screensets affected is 201.
CHG-SCR-DESTFLD: SCREEN SET AFFECTED - s1 1% FULL
CHG-SCR-DESTFLD: SCREEN SET AFFECTED - s10 1% FULL
CHG-SCR-DESTFLD: SCREEN SET AFFECTED - s100 1% FULL
```

```

CHG-SCR-DESTFLD: SCREEN SET AFFECTED - s101    1% FULL
CHG-SCR-DESTFLD: SCREEN SET AFFECTED - s102    1% FULL
-----
-----
(List of affected screensets)

```

### Related Topics

- [dlt-scr-destfld](#)
- [ent-scr-destfld](#)
- [rtrv-scr-destfld](#)

## chg-scr-dpc

Use this command to change the attributes of a specific screening reference in the allowed DPC category. Attributes that may be changed are the point code, next screening function identifier, and the next screening reference.

### Parameters

#### **sr (mandatory)**

Screening reference. The point code's unique screening reference name.

##### **Range:**

*ayyy*

1 alphabetic character followed by up to 3 alphanumeric characters

#### **actname (optional)**

Action name. The name of the gateway screening stop action set. Stop actions must be administered using this parameter in conjunction with the gateway screening stop action table (see `chg-gws-actset` and `rtrv-gws-actset` ).

##### **Range:**

*ayyyyy*

1 alphabetic character followed by up to 5 alphanumeric characters.

*none* —remove an existing gateway screening stop action set from a gateway screening rule.

#### **area (optional)**

ITU international area. The *area* in the point code represented by *zone-area-id*.

##### **Range:**

*0 - 255, \**

\*—the full range of values from 0–255

#### **force (optional)**

When there are more than 200 affected screensets, this parameter will decide whether to execute the command successfully or not.

**Range:**

yes

no

**Default:**

no

**id (optional)**

ITU international ID. The *ID* in the point code represented by *zone-area-id*.

**Range:**

0 - 7, \*

\*—the full range of values from 0–7

**mna (optional)**

16-bit ITU national main number area. The *mna* in the point code represented by *un-sna-mna*.

**Range:**

0 - 31, \*

\*--- the full range of values from 0--31

**msa (optional)**

24-bit ITU-national main signaling area value. The *msa* of the point code represented by *msa-ssa-sp*.

**Range:**

0 - 255, \*

\*—the full range of values from 0–255

**narea (optional)**

New ITU-international area value.

**Range:**

0 - 255, \*

\*—the full range of values from 0–255

**Default:**

No change to the current value

**nc (optional)**

Network cluster value. This parameter specifies one or more *nc* values for the network indicator and network cluster member values specified in the *ni* and *ncm* parameters. It specifies the *nc* of the point code represented by *ni-nc-ncm*.

**Range:**

0 - 255, \*

\*—the full range of values from 0–255

**ncm (optional)**

Network cluster member value. This parameter specifies one or more *ncm* values for the network indicator and network cluster values identified in the *ni* and *nc* parameters. It specifies the *ncm* of the point code represented by *ni-nc-ncm*.

**Range:**

0 - 255, \*

\*—the full range of values from 0–255

**ni (optional)**

Network indicator value. This parameter specifies one or more *ni* values for the network cluster and network cluster member values identified in the *nc* and *ncm* parameters. It specifies the *ni* of the point code represented by *ni-nc-ncm*.

**Range:**

0 - 255, \*

\*—the full range of values from 0–255

**nid (optional)**

New ITU-international ID value.

**Range:**

0 - 7, \*

\*—the full range of values from 0–7

**Default:**

No change to the current value

**nmna (optional)**

New 16-bit ITU national main number area. The new *mna* in the point code represented by *un-sna-mna*.

**Range:**

0 - 31, \*

\*--- the full range of values from 0--31

**nmsa (optional)**

New 24-bit ITU-national main signaling area value. The new *msa* of the point code represented by *msa-ssa-sp*.

**Range:**

0 - 255, \*

\*—the full range of values from 0–255

**nnc (optional)**

New network cluster. This parameter specifies one or more *nnc* values for the screening reference specified in the *sr* parameter. It specifies the new *nc* of the point code represented by *ni-nc-ncm*.

**Range:**

0 - 255, \*

\*—the full range of values from 0–255

**Default:**

No change to the current value

**nncm (optional)**

New network cluster member. This parameter specifies one or more *ncm* values for the screening reference specified in the *sr* parameter. It specifies the new *ncm* of the point code represented by *ni-nc-ncm*.

**Range:**

0 - 255, \*

\*—the full range of values from 0–255

**Default:**

No change to the current value

**nni (optional)**

New network identifier. This parameter specifies one or more *nni* values for the screening reference specified in the *sr* parameter. It specifies the new *ni* of the point code represented by *ni-nc-ncm*.

**Range:**

0 - 255, \*

\*—the full range of values from 0–255

**Default:**

No change to the current value

**nnpc (optional)**

New ITU-national point code.

 **Note:**

Gateway screening allows the ITU national point code to be displayed and entered in the database only as a single number. If you use multiple-part ITU national point codes, see [Converting ITU National Point Code Formats](#) in Appendix A for information on converting the point code format.

**Range:**

0 - 16383, \*

\*—the full range of values from 0–16383

**Default:**

No change to the current value

**npc (optional)**

ITU national point code.

**Range:**

0 - 16383

\*—the full range of values from 0–16383

**npcst (optional)**

New point code subtype. This parameter indicates whether the specified new ITU international or ITU national point code has no subtype prefix or has the spare point code prefix (s-).

**Range:***none**s*

**Default:***none***nsfi (optional)**

This parameter specifies the next screening category that is used in the gateway screening process, or it indicates that the gateway screening process should stop.

**Range:*****blkdpc***

Blocked DPC is the next screening category.

***cgpa***

Allowed CGPA is the next screening category.

***cgpa***

Allowed CGPA is the next screening category.

***cgpa***

Allowed CGPA is the next screening category.

***isup***

ISUP message type (ISUP) is the next screening category.

***stop***

The gateway screening process ends and the message proceeds through normal routing.

**Default:**

No change to the current value

**nsna (optional)**

New 16-bit ITU national sub number area. The new *sna* in the point code represented by *un-sna-mna*.

**Range:**

0 - 15, \*

\*-- the full range of values from 0--15

**nsp (optional)**

New 24-bit ITU national signaling point. The new *sp* of the point code represented by *msa-ssa-sp*.

**Range:**

0 - 255, \*

\*—the full range of values from 0–255

**nsr (optional)**

Next screening reference. This parameter specifies which screening reference in the specified screening category (*nsfi*) is to be used in the screening process.

**Range:**

*ayyy*

1 alphabetic character followed by up to 3 alphanumeric characters

**Default:**

No change to the current value

**nssa (optional)**

New 24-bit ITU national sub signaling area. The new *ssa* of the point code represented by *msa-ssa-sp*.

**Range:**

0 - 255, \*

\*—the full range of values from 0–255

**nun (optional)**

New 16-bit ITU national unit number. The new *un* in the point code represented by *un-sna-mna*.

**Range:**

0 - 127, \*

\*--- the full range of values from 0--127

**nzone (optional)**

New ITU-international zone. The new *zone* for the point code represented by *zone-area-id*.

**Range:**

0 - 7, \*

\*—the full range of values from 0–7

**Default:**

No change to the current value

**pcst (optional)**

Point code subtype. This parameter indicates whether the specified ITU international or ITU national point code has no subtype prefix or has the spare point code prefix (S-).

**Range:**

*none*

*s*

**Default:**

*none*

**sna (optional)**

16-bit ITU national sub number area. The *sna* in the point code represented by *un-sna-mna*.

**Range:**

0 - 15, \*

\*--- the full range of values from 0--15

**sp (optional)**

24-bit ITU national signaling point. The *sp* in the point code represented by *msa-ssa-sp*.

**Range:**

0 - 255, \*

\*—the full range of values from 0–255

**ssa (optional)**

24-bit ITU national sub signaling area. The *ssa* in the point code represented by *msa-ssa-sp*.

**Range:**

0 - 255, \*

\*—the full range of values from 0–255

**un (optional)**

16-bit ITU-national unit number. The *un* in the point code represented by *un-sna-mna*.

**Range:**

0 - 127, \*

\*--- the full range of values from 0--127

**zone (optional)**

ITU international zone. The *zone* in the point code represented by *zone-area-id*. A

**Range:**

0 - 7, \*

\*—the full range of values from 0–7

**Example**

```
chg-scr-dpc:sr=iec:ni=240:nc=010:ncm=010:nni=240:nnc=003:nncm=030
```

```
chg-scr-
```

```
dpc:sr=iec:ni=240:nc=010:ncm=010:nni=240:nnc=003:nncm=030:nsfi=stop
:actname=none
```

```
chg-scr-dpc:sr=dpc1:npc=128:nsfi=fail:pcst=s:npcst=none
```

```
chg-scr-dpc:sr=dpc2:un=1:sna=2:mna=1:nun=2:nsna=3:nmna=2:nsfi=stop
```

**Dependencies****▲ Caution:**

Even though gateway screening is in the screen test mode, as defined by the `gwsa=off` and `gwsn=on` parameters, the gateway screening action in the stop action set specified by the `actname` parameter of the screen set will be performed at the end of the screening process.

A complete point code must be specified, using the `ni-nc-ncm`, `zone-area-id`, `msa-ssa-sp`, `un-sna-mna` or `npc` combination unless a value of `c` is specified.

A new point code entry must be specified by one, and only one of the four point code parameter combinations: `nni-nnc-nncm`, `nzone-narea-nid`, `nmsa-nssa-nsp`, `nun-nsna-nmna` or `nnpc` . If the new point code entry is a different point code type than the existing point code entry, all subfields of the new point code type must be specified.

ANSI point code value 000-000-000 and ITU-International point code value 0-000-0 are not allowed.

At least one optional parameter must be specified.



The DPC specified by `ni-nc-ncm`, `zone-area-id`, `msa-ssa-sp`, `un-sna-mna`, or the `npc` parameter must already exist in the screening reference or within an existing range of DPCs.

The new DPC or DPC range defined by `ni-nc-ncm`, `zone-area-id`, `msa-ssa-sp`, `un-sna-mna`, or the `npc` parameter must not already exist in the screening reference or within an existing range of DPCs.

If the `actname` parameter is specified, then the `nsfi=stop` parameter must be specified.

If the `actname` parameter is specified, the `nsr` parameter cannot be specified.

The `actname` parameter value must already be defined in the Gateway Screening Stop Action table with the `chg-gws-actset` command. These values are shown in the `ACT NAME` field of the `rtrv-gws-actset` command output.

If the `zone=*`  parameter is specified, then the `area=*`  and `id=*`  parameters must be specified.

If the `area=*`  parameter is specified, then the `id=*`  parameter must be specified.

If the `msa=*`  parameter is specified, then the `ssa=*`  and `sp=*`  parameters must be specified.

If the `ssa=*`  parameter is specified, then the `sp=*`  parameter must be specified.

If the `un=*`  parameter is specified, then the `sna=*`  and `mna=*`  parameters must be specified.

If the `sna=*`  parameter is specified, then the `mna=*`  parameter must be specified.

The `nsfi` and `nsr` parameters must point to an existing screen, or the `nsfi=stop` parameter must be specified, and the `nsr` parameter cannot be specified.

If the `nc` parameter is specified as a range, the `ncm` parameter must be specified as an asterisk or as the full range.

If the `nc` parameter is specified as a single value or a range, a single value must be specified for the `ni` parameter.

If the `nc=*`  parameter is specified, the `ncm` parameter must be specified as an asterisk or as the full range.

If the `ncm` parameter is specified as a single value, or a range other than the full range of 0–255, the `ni` and `nc` parameters must be specified with a single value.

If the `ni` parameter is specified as an asterisk or as a range, the `nc` and `ncm` parameters must be specified as an asterisk or as the full range.

If the `nnc` parameter is specified as a range, the `nncm` parameter must be specified as an asterisk or as the full range.

If the `nnc` parameter is specified as a single value or a range, a single value must be specified for the `nni` parameter.

If the `nnc=*`  parameter is specified, the `nnm` parameter must be specified as an asterisk or as the full range.

If the `nncm` parameter is specified as a single value, or a range other than the full range of 0–255, the `nni` and `nnc` parameters must be specified with a single value.

If the `nni` parameter is specified as an asterisk or as a range, the `nnc` and `nncm` parameters must be specified as an asterisk or as the full range.

If the `nsfi=stop` parameter is not specified, then the `nsr` parameter must be specified.

The value of the `sr` parameter must already exist in the BLKDPC entity set.

The Spare Point Code Support feature must be enabled before the `pcst` parameter can be specified.

The spare point code subtype prefix (s-) is not supported for ANSI point codes (parameters `ni`, `nc`, `nncm`) or for 24-bit ITU national point codes (parameters `msa`, `ssa`, `sp`) or for 16-bit ITU national point codes (parameters `un`, `sna`, `mna`). The `pcst` and `npcst` parameters cannot be specified for ANSI, ITU-N24, or ITU-N16 point codes.

If the `nsfi=fail` parameter is specified, then the `nni`, `nc`, `nncm`, `narea`, `nzone`, `nid`, `nmsa`, `nssa`, `nsp`, `nun`, `nsna`, `nmna`, and `npc` parameters cannot have a value of `c`.

The Gateway Screening Stop Action table is corrupt or cannot be found.

The J7 support feature must be enabled before the `un`, `sna`, `mna`, `nun`, `nsna` or `nmna` parameters are specified.

The J7 support feature must not be enabled before the `msa`, `ssa`, `sp`, `nmsa`, `nssa` or `nsp` parameters are specified.

The GWSOA parameter combination should be known and valid.

## Notes

A range of values is specified by separating the values that define the range by two ampersands (&&); for example, `ni=025&&100` specifies all network indicators for ANSI point codes from 25 - 100.

An asterisk cannot not be specified for a parameter value in this command unless an asterisk was specified for the parameter value in the original `ent-scr-dpc` command.

If the screen set reaches 100% capacity (indicated by the "100% full" message), the system will allow subsequent entries. An error will occur, however, when downloading the screen set to the card. Screen sets should not exceed 100% capacity. Remove screen set entries until the capacity is below 100%.

The spare point code subtype prefix (s-) is supported only for ITU international and ITU national point codes. The `pcst` and `npcst` parameters indicate whether the specified point code has no subtype prefix or has the spare point code prefix.

There is no feature dependency on ANSI point code parameters i.e., `ni`, `nc`, `nncm`, `nni`, `nnc` or `nncm`. The command can be entered successfully whether the J7 feature is enabled or not enabled.

If there are more than 200 affected screensets and the force parameter is set to **yes**, then the following warning message is displayed: "WARNING: Command may take up to 30 minutes" and the command proceeds successfully.

If there are more than 200 affected screensets and the force parameter is set to **no**, then the following notice is displayed: "Notice: Force parameter is required for affected screensets greater than 200" and the command is aborted.

### Output

```
chg-scr-
dpc:sr=iec:ni=240:nc=010:ncm=010:nni=240:nnc=003:nncm=030
```

```
rlghncxa03w 04-01-07 11:43:04 EST EAGLE 31.3.0
CHG-SCR-DPC: SCREEN SET AFFECTED - IEC 25% FULL
CHG-SCR-DPC: MASP A - COMPLTD
```

```
;
```

When there are more than 200 affected screensets and the force parameter is **no**:

```
chg-scr-dpc:sr=dp1:nsfi=cgpa:nsr=cg1:ni=2:nc=1:ncm=1:force=no
```

Command entered at terminal #17.

```
;
```

```
tekelecstp 15-07-15 12:19:42 MST EAGLE5 46.3.0.0.0-66.10.0
CHG-SCR-DPC: MASP A - Cannot access standby fixed disk.
CHG-SCR-DPC: MASP A - Simplex database update.
Notice: Force parameter is required for affected screensets
greater than 200
CHG-SCR-DPC: MASP A - Command Aborted
```

When there are more than 200 affected screensets and the force parameter is **yes**:

```
chg-scr-dpc:sr=dp1:nsfi=cgpa:nsr=cg1:ni=2:nc=1:ncm=1:force=yes
```

Command entered at terminal #17.

```
;
```

```
tekelecstp 15-07-15 14:10:31 MST EAGLE5 46.3.0.0.0-66.10.0
CHG-SCR-DPC: MASP A - Cannot access standby fixed disk.
CHG-SCR-DPC: MASP A - Simplex database update.
```

```
WARNING: Command may take upto 30 minutes.
-----
```

```
;
```

Command Accepted - Processing

```
tekelecstp 15-07-15 14:10:31 MST EAGLE5 46.3.0.0.0-66.10.0
Notice: The number of screensets affected is 201.
CHG-SCR-DPC: SCREEN SET AFFECTED - s1 1% FULL
CHG-SCR-DPC: SCREEN SET AFFECTED - s10 1% FULL
CHG-SCR-DPC: SCREEN SET AFFECTED - s100 1% FULL
CHG-SCR-DPC: SCREEN SET AFFECTED - s101 1% FULL
CHG-SCR-DPC: SCREEN SET AFFECTED - s102 1% FULL
-----
-----
```

(List of affected screensets)

### Related Topics

- [dlt-scr-dpc](#)
- [ent-scr-dpc](#)
- [rtrv-scr-dpc](#)

## chg-scr-isup

Use this command to change the attributes associated with a specific allowed ISUP screening reference in the Allowed ISUP entity set.

### Parameters

#### **isupmt/tupmt (mandatory)**

ISUP or TUP message type.

##### **Range:**

0 - 255, \*

\*—the full range of values from 0–255

#### **sr (mandatory)**

Screening reference. The point code's unique screening reference name.

##### **Range:**

ayyy

1 alphabetic character followed by up to 3 alphanumeric characters

#### **actname (optional)**

Action name. The stop action set name.

##### **Range:**

ayyyy

1 alphabetic character followed by up to 5 alphanumeric characters.

##### **Default:**

No change to the current value

#### **force (optional)**

When there are more than 200 affected screensets, this parameter will decide whether to execute the command successfully or not.

##### **Range:**

yes

no

##### **Default:**

no

#### **nisupmt/ntupmt (optional)**

New ISUP or new TUP message type.

**Range:**

0 - 255, \*

\*—the full range of values from 0–255

**nsfi (optional)**

The next screening category that is used in the gateway screening process.

**Range:***stop* —The gateway screening process ends and the message proceeds through normal routing.**Default:**

No change to the current value

**nsr (optional)**Next screening reference. The parameter specifies which screening reference in the specified screening category (*nsfi*) is to be used in the screening process.**Range:***ayyy*

1 alphabetic character followed by up to 3 alphanumeric characters

**Default:**

No change to the current value

**Example**

```
chg-scr-isup:sr=iec:isupmt=1:nisupmt=1&&2
```

```
chg-scr-isup:tupmt=20:ntupmt=1:sr=tu01
```

**Dependencies**

At least one optional parameter must be specified.

If the *actname* parameter is specified, the *nsfi=stop* parameter must be specified.The value of the *actname* parameter must already be defined in the Gateway Screening Stop Action table with the *chg-gws-actset* command.The value specified for the *isupmt* or *tupmt* parameter must already exist in the screening reference specified by the *sr* parameter.The specified *nisupmt* or *ntupmt* parameter value cannot already exist in the specified *sr*.If the *nsfi* parameter is specified, the parameter value must be *stop*.If the *nsfi=stop* parameter is specified, the *nsr* parameter cannot be specified.For SEAS commands with the *nisupmt* parameter specified, the *nsfi* parameter must be specified.

The GWSOA parameter combination should be known and valid.

The ISUPMT (ISUP Message Type) parameter must be specified for a SEAS command.

## Notes

An asterisk can be specified for a parameter value in the `chg/dlt-scr-isup` and `ent-scr-isup` commands only if that parameter value was specified as an asterisk in the `ent-scr-isup` command to define the parameter value.

A range of values can be specified for the `isupmt` or `tupmt` parameter, by separating the values that define the range by two ampersands (&&); for example, `isupmt=025&&100` specifies all ISUP message types from 25 - 100. The value to the left of the && must be less than the value to the right of the && in the range.

TUP does not apply to SEAS. ISUP Message Type is the default.

To use TUP message type screening, an SIO screening reference with `si=04` (TUP) must exist in the SIO table. The TUP screening reference specifies the SIO screening reference as the next screening reference parameter (`nsr`) value.

To use ISUP message type screening, an SIO screening reference with `si=05` (ISUP) must exist in the SIO table. The ISUP screening reference specifies the ISUP SIO screening reference as the `nsr` value.

To screen for TUP and ISUP message types using a combined ISUP/TUP screen set, the SIO screening reference with `si=4` and the SIO screening reference with `si=5` must be two different screening references. The TUP screening reference specifies the SIO screening reference as the `nsr` value, and the ISUP screening reference specifies the SIO ISUP screening reference as the `nsr` value.

If there are more than 200 affected screensets and the force parameter is set to **yes**, then the following warning message is displayed: "WARNING: Command may take up to 30 minutes" and the command proceeds successfully.

If there are more than 200 affected screensets and the force parameter is set to **no**, then the following notice is displayed: "Notice: Force parameter is required for affected screensets greater than 200" and the command is aborted.

## Output

When a screening reference is specified that is not yet associated with a screen set, the following output appears:

```
chg-scr-isup:sr=is01:isupmt=2:nsfi=stop:nisupmt=4
```

```
rlghncxa03w 04-01-14 16:45:50 EST EAGLE 31.3.0
CHG-SCR-ISUP: MASP A - COMPLTD
```

```
;
```

When there are more than 200 affected screensets and the force parameter is **no**:

```
chg-scr-isup:sr=is02:isupmt=9:nsfi=stop:nisupmt=8:force=no
```

```
Command entered at terminal #17.
```

```
;
```

```
tekelecstp 15-07-15 12:19:42 MST EAGLE5 46.3.0.0.0-66.10.0
CHG-SCR-ISUP: MASP A - Cannot access standby fixed disk.
```

```

CHG-SCR-ISUP: MASP A - Simplex database update.
Notice: Force parameter is required for affected screensets
greater than 200
CHG-SCR-ISUP: MASP A - Command Aborted

```

When there are more than 200 affected screensets and the force parameter is **yes**:

```
chg-scr-isup:sr=is02:isupmt=9:nsfi=stop:nisupmt=8:force=yes
```

Command entered at terminal #17.

```
;
```

```

tekelecstp 15-07-15 14:10:31 MST EAGLE5 46.3.0.0.0-66.10.0
CHG-SCR-ISUP: MASP A - Cannot access standby fixed disk.
CHG-SCR-ISUP: MASP A - Simplex database update.
WARNING: Command may take upto 30 minutes.
-----

```

```
;
```

Command Accepted - Processing

```

tekelecstp 15-07-15 14:10:31 MST EAGLE5 46.3.0.0.0-66.10.0
Notice: The number of screensets affected is 201.
CHG-SCR-ISUP: SCREEN SET AFFECTED - s1      1% FULL
CHG-SCR-ISUP: SCREEN SET AFFECTED - s10     1% FULL
CHG-SCR-ISUP: SCREEN SET AFFECTED - s100    1% FULL
CHG-SCR-ISUP: SCREEN SET AFFECTED - s101    1% FULL
CHG-SCR-ISUP: SCREEN SET AFFECTED - s102    1% FULL
-----
-----

```

(List of affected screensets)

### Related Topics

- [dlt-scr-isup](#)
- [ent-scr-isup](#)
- [rtrv-scr-isup](#)

## chg-scr-opc

Use this command to change the attributes associated with a specific screening reference in the allowed OPC category. Attributes that can be changed are the point code, next screening function identifier and, next screening reference.

### Parameters

#### **sr** (mandatory)

Screening reference. The point code's unique screening reference name.

#### **Range:**

*ayyy*

1 alphabetic character followed by up to 3 alphanumeric characters

**actname (optional)**

Action name. The name of the gateway screening stop action set. Stop actions must be administered using this parameter in conjunction with the gateway screening stop action table (see `chg-gws-actset` and `rtrv-gws-actset` ).

**Range:**

*ayyyyy*

1 alphabetic character followed by up to 5 alphanumeric characters.

*none* —Remove an existing gateway screening stop action set from a gateway screening rule.

**area (optional)**

ITU international area. The *area* in the point code represented by *zone-area-id*.

**Range:**

*0 - 255, \**

\*—the full range of values from 0–255

**force (optional)**

When there are more than 200 affected screensets, this parameter will decide whether to execute the command successfully or not.

**Range:**

*yes*

*no*

**Default:**

*no*

**id (optional)**

ITU international ID. The *ID* in the point code represented by *zone-area-id*.

**Range:**

*0 - 7, \**

\*—the full range of values from 0–7

**mna (optional)**

16-bit ITU national main number area. The *mna* in the point code represented by *un-sna-mna*.

**Range:**

*0 - 31, \**

\*--- the full range of values from 0--31

**msa (optional)**

24-bit ITU-national main signaling area value. The *msa* of the point code represented by *msa-ssa-sp*.

**Range:**

*0 - 255, \**

\*—the full range of values from 0–255

**narea (optional)**

New ITU-international area value



**Range:**

0 - 255, \*

\*—the full range of values from 0–255

**Default:**

No change to the current value

**nc (optional)**

Network cluster value. This parameter specifies one or more *nc* values for the network indicator and network cluster member values specified in the *ni* and *ncm* parameters. It specifies the *nc* of the point code represented by *ni-nc-ncm*.

**Range:**

0 - 255, \*

\*—the full range of values from 0–255

**ncm (optional)**

Network cluster member value. This parameter specifies one or more *ncm* values for the network indicator and network cluster values identified in the *ni* and *nc* parameters. It specifies the *ncm* of the point code represented by *ni-nc-ncm*.

**Range:**

0 - 255, \*

\*—the full range of values from 0–255

**ni (optional)**

Network indicator value. This parameter specifies one or more *ni* values for the network cluster and network cluster member values identified in the *nc* and *ncm* parameters. It specifies the *ni* of the point code represented by *ni-nc-ncm*.

**Range:**

0 - 255, \*

\*—the full range of values from 0–255

**nid (optional)**

New ITU-international ID value.

**Range:**

0 - 7, \*

\*—the full range of values from 0–7

**Default:**

No change to the current value

**nmna (optional)**

New 16-bit ITU national main number area. The new *mna* in the point code represented by *un-sna-mna*.

**Range:**

0 - 31, \*

\*--- the full range of values from 0--31

**nmsa (optional)**

New 24-bit ITU-national main signaling area value. The new *msa* of the point code represented by *msa-ssa-sp*.

**Range:**

0 - 255, \*

\*—the full range of values from 0–255

**nnc (optional)**

New network cluster. This parameter specifies one or more *nnc* values for the screening reference specified in the *sr* parameter. It specifies the new *nc* of the point code represented by *ni-nc-ncm*.

**Range:**

0 - 255, \*

\*—the full range of values from 0–255

**Default:**

No change to the current value

**nncm (optional)**

New network cluster member. This parameter specifies one or more *ncm* values for the screening reference specified in the *sr* parameter. It specifies the new *ncm* of the point code represented by *ni-nc-ncm*.

**Range:**

0 - 255, \*

\*—the full range of values from 0–255

**Default:**

No change to the current value

**nni (optional)**

New network identifier. This parameter specifies one or more *nni* values for the screening reference specified in the *sr* parameter. It specifies the new *ni* of the point code represented by *ni-nc-ncm*.

**Range:**

0 - 255, \*

\*—the full range of values from 0–255

**Default:**

No change to the current value

**npoc (optional)**

New ITU-national point code.

 **Note:**

Gateway screening allows the ITU national point code to be displayed and entered in the database only as a single number. If you use multiple-part ITU national point codes, see [Converting ITU National Point Code Formats](#) in Appendix A for information on converting the point code format.

**Range:**

0 - 16383, \*

\*—the full range of values from 0–16383

**Default:**  
No change to the current value

**npc (optional)**  
ITU national point code

**Range:**  
*0 - 16383, \**  
\*—the full range of values from 0–16383

**npcst (optional)**  
New point code subtype. This parameter indicates whether the specified new ITU international or ITU national point code has no subtype prefix or has the spare point code prefix (s-).

**Range:**  
*none*

*s*

**Default:**  
*none*

**nsfi (optional)**  
This parameter specifies the next screening category that is used in the gateway screening process, or it indicates that the gateway screening process should stop.

**Range:**

***blkdpc***  
Blocked DPC is the next screening category.

***blkopc***  
Blocked OPC is the next screening category.

***cgpa***  
Allowed CGPA is the next screening category.

***dpc***  
Allowed DPC is the next screening category.

***sio***  
Allowed SIO is the next screening category.

***stop***  
The gateway screening process ends and the message proceeds through normal routing.

**Default:**  
No change to the current value

**nsna (optional)**  
New 16-bit ITU national sub number area. The new *sna* in the point code represented by *un-sna-mna*.

**Range:**

0 - 15, \*

\*--- the full range of values from 0--15

**nsp (optional)**

New 24-bit ITU national signaling point. The new *sp* of the point code represented by *msa-ssa-sp*.

**Range:**

0 - 255, \*

\*—the full range of values from 0–255

**nsr (optional)**

Next screening reference. This parameter indicates which screening reference in the specified screening category (*nsfi*) is to be used in the screening process.

**Range:**

ayyy

1 alphabetic character followed by up to 3 alphanumeric characters

**Default:**

No change to the current value

**nssa (optional)**

New 24-bit ITU national sub signaling area. The new *ssa* of the point code represented by *msa-ssa-sp*.

**Range:**

0 - 255, \*

\*—the full range of values from 0–255

**nun (optional)**

New 16-bit ITU national unit number. The new *un* in the point code represented by *un-sna-mna*.

**Range:**

0 - 127, \*

\*--- the full range of values from 0--127

**nzone (optional)**

New ITU-international zone. The new *zone* for the point code represented by *zone-area-id*.

**Range:**

0 - 7, \*

\*—the full range of values from 0–7

**Default:**

No change to the current value

**pcst (optional)**

Point code subtype. This parameter indicates whether the specified ITU international or ITU national point code has no subtype prefix or has the spare point code prefix (s-).

**Range:***none**s***Default:***none***sna (optional)**

16-bit ITU national sub number area. The *sna* in the point code represented by *un-sna-mna*.

**Range:***0 - 15, \**

\*--- the full range of values from 0--15

**sp (optional)**

24-bit ITU national signaling point. The *sp* in the point code represented by *msa-ssa-sp*.

**Range:***0 - 255, \**

\*—the full range of values from 0–255

**ssa (optional)**

24-bit ITU national sub signaling area. The *ssa* in the point code represented by *msa-ssa-sp*.

**Range:***0 - 255, \**

\*—the full range of values from 0–255

**un (optional)**

16-bit ITU-national unit number. The *un* in the point code represented by *un-sna-mna*.

**Range:***0 - 127, \**

\*--- the full range of values from 0--127

**zone (optional)**

ITU international zone. The *zone* in the point code represented by *zone-area-id*.

**Range:***0 - 7, \**

\*—the full range of values from 0–7

**Example**

```
chg-scr-
opc:sr=iec:ni=240:nc=010:ncm=010:nni=240:nnc=010:nncm=020
```

```
chg-scr-
opc:sr=iec:ni=240:nc=010:ncm=010:nni=240:nnc=010:nncm=020:nsfi=
stop :actname=cncf
```

```
chg-scr-opc:sr=iec:nsfi=dpc:nsr=wr2
```

```
chg-scr-opc:sr=opc1:npc=128:nsfi=fail:pcst=s:npcst=none
```

```
chg-scr-opc:sr=opc2:un=1:sna=2:mna=1:nun=2:nsna=3:nmna=2:nsfi=stop
```

## Dependencies

### ▲ Caution:

Even though gateway screening is in the screen test mode, as defined by the `gwsa=off` and `gwsn=on` parameters, the gateway screening action in the stop action set specified by the `actname` parameter of the screen set will be performed at the end of the screening process.

A complete point code must be specified, using the `ni-nc-ncm`, `zone-area-id`, `msa-ssa-sp`, `un-sna-mna` or `npc` combination unless a value of `c` for “continue” is specified.

A new point code entry must be specified by one, and only one of the four point code parameter combinations: `nni-nnc-nncm`, `nzone-narea-nid`, `nmsa-nssa-nsp`, `nun-nsna-nmna` or `npc`. If the new point code entry is a different point code type than the existing point code entry, all subfields of the new point code type must be specified.

ANSI point code value 000-000-000 and ITU-International point code value 0-000-0 are not allowed.

At least one optional parameter must be specified.

The current OPC specified by `ni-nc-ncm`, `zone-area-id`, `msa-ssa-sp`, `un-sna-mna` or the `npc` parameter must already exist in the screening reference or within an existing range of OPCs.

The new OPC or OPC range defined by `ni-nc-ncm`, `zone-area-id`, `msa-ssa-sp`, `un-sna-mna` or the `npc` parameter must not already exist in the screening reference or within an existing range of OPCs.

If the `actname` parameter is specified, then the `nsfi=stop` parameter must be specified.

If the `nsr` parameter is specified, then the `actname` parameter cannot be specified.

The `actname` parameter value must already be defined in the Gateway Screening Stop Action table with the `chg-gws-actset` command.

If `zone=*` is specified, `area=*` and `id=*` must be specified.

If the `area=*` parameter is specified, the `id=*` parameter must be specified.

If the `msa=*` parameter is specified, the `ssa=*` and `sp=*` parameters must be specified.

If the `ssa=*` parameter is specified, the `sp=*` parameter must be specified.

If the `un=*` parameter is specified, then the `sna=*` and `mna=*` parameters must be specified.

If the `sna=*` parameter is specified, then the `mna=*` parameter must be specified.

The `nsfi` and `nsr` parameters must point to an existing screen, or the `nsfi=stop` parameter must be specified, and the `nsr` parameter cannot be specified.

If the `nc` parameter is specified as a range, the `ncm` parameter must be specified as an asterisk or as the full range.

If the `nc` parameter is specified as a single value or a range, a single value must be specified for the `ni` parameter.

If the `nc=*` parameter is specified, the `ncm` parameter must be specified as an asterisk or as the full range .

If the `ncm` parameter is specified as a single value, or a range other than the full range of 0–255, the `ni` and the `nc` parameters must be specified with a single value.

If the `ni` parameter is specified as an asterisk or as a range, the `nc` and `ncm` parameters must be specified as an asterisk or as the full range.

If the `nnc` parameter is specified as a range, the `nncm` parameter must be specified as an asterisk or as the full range.

If the `nnc` parameter is specified as a single value or a range, a single value must be specified for the `nncm` parameter.

If the `nc=*` parameter is specified, the `nncm` parameter must be specified as an asterisk or as the full range.

If the `nncm` parameter is specified as a single value, or a range other than the full range of 0–255, the `nnc` and the `nncm` parameters must be specified with a single value.

If the `nncm` parameter is specified as an asterisk or as a range, the `nnc` and `nncm` parameters must be specified as an asterisk or as the full range.

If the `nsfi=stop` parameter is not specified, then the `nsr` parameter must be specified.

The value of the `sr` parameter must already exist in the BLKOPC entity set.

The Spare Point Code Support feature must be enabled before the `pcst` parameter can be specified.

The spare point code subtype prefix (s-) is not supported for ANSI point codes (parameters `ni`, `nc`, `ncm`) or for 24-bit ITU national point codes (parameters `msa`, `ssa`, `sp`) or for 16-bit ITU national point codes (parameters `un`, `sna`, `mna`). The `pcst` parameter cannot be specified for ANSI, ITU-N24 or ITU-N16 point codes.

The Gateway Screening Stop Action table is corrupt or cannot be found.

The J7 support feature must be enabled before the `un`, `sna`, `mna`, `nun`, `nsna`, or `nmna` parameters are specified.

The J7 support feature must not be enabled before the `msa`, `ssa`, `sp`, `nmsa`, `nssa`, or `nsp` parameters are specified.

The GWSOA parameter combination should be known and valid.

## Notes

A range of values is specified by separating the values that define the range by two ampersands (&&); for example, `ni=025&&100` specifies all network indicators for ANSI point codes from 25 - 100.

An asterisk cannot not be specified for a parameter value in this command unless an asterisk was specified for the parameter value in the original `ent-scr-opc` command.

If the screen set reaches 100% capacity (indicated by the "100% full" message), the system will allow subsequent entries. An error will occur, however, when downloading the screen set to the card. Screen sets should not exceed 100% capacity. Remove screen set entries until the capacity is below 100%.

The spare point code subtype prefix (s-) is supported only for ITU international and ITU national point codes. The `pcst` and `npcst` parameters indicate whether the specified point code has no subtype prefix or has the spare point code prefix.

There is no feature dependency on ANSI point code parameters i.e., `ni`, `nc`, `ncm`, `nni`, `nnc`, or `nncm`. The command can be entered successfully whether the J7 feature is enabled or not enabled.

If there are more than 200 affected screensets and the force parameter is set to **yes**, then the following warning message is displayed: "WARNING: Command may take up to 30 minutes" and the command proceeds successfully.

If there are more than 200 affected screensets and the force parameter is set to **no**, then the following notice is displayed: "Notice: Force parameter is required for affected screensets greater than 200" and the command is aborted.

## Output

```
chg-scr-opc:sr=iec:ni=240:nc=010:ncm=010:nni=240:nnc=010:nncm=020
```

```
rlghncxa03w 04-01-07 12:05:33 EST EAGLE 31.3.0
CHG-SCR-OPC: SCREEN SET AFFECTED - IEC 25% FULL
CHG-SCR-OPC: MASP A - COMPLTD
```

```
;
```

When there are more than 200 affected screensets and the force parameter is **no**:

```
chg-scr-opc:sr=op1:nsfi=blkopc:nsr=bo1:ni=1:nc=1:ncm=1:force=no
```

```
Command entered at terminal #17.
```

```
;
```

```
tekelecstp 15-07-15 12:19:42 MST EAGLE5 46.3.0.0.0-66.10.0
CHG-SCR-OPC: MASP A - Cannot access standby fixed disk.
CHG-SCR-OPC: MASP A - Simplex database update.
Notice: Force parameter is required for affected screensets greater than
200
CHG-SCR-OPC: MASP A - Command Aborted
```

When there are more than 200 affected screensets and the force parameter is **yes**:

```
chg-scr-opc:sr=op1:nsfi=blkopc:nsr=bo1:ni=1:nc=1:ncm=1:force=yes
```

```
Command entered at terminal #17.
```

```
;
```



```

tekelecstp 15-07-15 14:10:31 MST EAGLE5 46.3.0.0.0-66.10.0
CHG-SCR-OPC: MASP A - Cannot access standby fixed disk.
CHG-SCR-OPC: MASP A - Simplex database update.
WARNING: Command may take upto 30 minutes.
-----
;
Command Accepted - Processing
tekelecstp 15-07-15 14:10:31 MST EAGLE5 46.3.0.0.0-66.10.0
Notice: The number of screensets affected is 201.
CHG-SCR-OPC: SCREEN SET AFFECTED - s1      1% FULL
CHG-SCR-OPC: SCREEN SET AFFECTED - s10     1% FULL
CHG-SCR-OPC: SCREEN SET AFFECTED - s100    1% FULL
CHG-SCR-OPC: SCREEN SET AFFECTED - s101    1% FULL
CHG-SCR-OPC: SCREEN SET AFFECTED - s102    1% FULL
-----
(List of affected screensets)

```

### Related Topics

- [dlt-scr-opc](#)
- [ent-scr-opc](#)
- [rtrv-scr-opc](#)

## chg-scr-sio

Use this command to change a specific screening reference in the allowed service indicator octet category. Attributes that may be changed are the network indicator, service indicator, message priority, heading codes, next screening function identifier, and next screening reference.

### Note:

To use TUP message type screening, an SIO screening reference with `si=04` (TUP) must be defined in the SIO table. This SIO screening reference is specified as the next screening reference (`nsr`) value in an ISUP screening reference for screening TUP message types.

### Parameters

#### **nic (mandatory)**

Network indicator code. This parameter specifies whether the message originated from an international (0) or national (2) network.

#### **Range:**

0 - 3, \*

\*—the full range of values from 0–3

#### **pri (mandatory)**

Message priority. The new message priority in the SIO.

**Range:**

0 - 3, \*

\*—the full range of values from 0–3

**Default:**

No change to the current value

**si (mandatory)**

Service indicator. The type of message. The values are defined in Telcordia TR-NWT-000246.

**Range:**

00 - 15

**sr (mandatory)**

Screening reference. The point code's unique screening reference name.

**Range:**

ayyy

1 alphabetic character followed by up to 3 alphanumeric characters

**actname (optional)**

Action name. The name of the gateway screening stop action set. Stop actions must be administered using this parameter in conjunction with the gateway screening stop action table (see `chg-gws-actset` and `rtrv-gws-actset` ).

**Range:**

ayyyyy

1 alphabetic character followed by up to 5 alphanumeric characters.

*none* —remove an existing gateway screening stop action set from a gateway screening rule.

**force (optional)**

When there are more than 200 affected screensets, this parameter will decide whether to execute the command successfully or not.

**Range:**

yes

*no***Default:***no***h0 (optional)**

This parameter is mandatory if the `si` value is 00, 01, 02, or 03. Otherwise, the `h0` parameter is undefined.

**Range:**

0 - 15, \*

\*—the full range of values from 0–15

**Default:**

Current value or undefined

**h1 (optional)**

This parameter is mandatory if the *si* value is 00, 01, 02, or 03. Otherwise, the *h1* parameter is undefined.

**Range:**

0 - 15, \*

\*—the full range of values from 0–15

**Default:**

Current value or undefined

**nh0 (optional)**

New H0 heading code. The new H0 heading code for the screening reference specified in the *sr* parameter.

**Range:**

0 - 15, \*

\*—the full range of values from 0–15

**Default:**

No change to the current value

**nh1 (optional)**

New H1 heading code. The new H1 heading code for the screening reference specified in the *sr* parameter.

**Range:**

0 - 15, \*

\*—the full range of values from 0–15

**Default:**

No change to the current value

**nnic (optional)**

New network indicator code. The new *nic* for the screening reference specified.

**Range:**

0 - 3

\*—the full range of values from 0–3

**Default:**

No change to the current value

**npri (optional)**

New message priority. The new message priority in the SIO.

**Range:**

0 - 3, \*

\*—the full range of values from 0–3

**Default:**

No change to the current value

**nsfi (optional)**

This parameter specifies the next screening category that is used in the gateway screening process, or it indicates that the gateway screening process should stop.

**Range:**

***blkdpc***  
Blocked DPC

***cdpa***  
Allowed CDPA

***cgpa***  
Allowed CGPA

***destfld***  
Allowed destination field (DESTFLD)

***isup***  
ISUP message type (ISUP)

***stop***  
The gateway screening process ends and the message proceeds through normal routing.

***dpc***  
Allowed DPC

**Default:**

No change to the current value

**nsi (optional)**

New service indicator. The type of message for the specified screening reference. The values are defined in Telcordia TR-NWT-000246.

**Range:**  
0 - 15

**Default:**  
No change to the current value

**nsr (optional)**

Next screening reference. This parameter specifies which screening reference in the specified screening category (*nsfi*) is to be used in the screening process.

**Range:**  
*ayyy*  
1 alphabetic character followed by up to 3 alphanumeric characters

**Default:**  
No change to the current value

**Example**

```
chg-scr-sio:sr=iec:nic=1:si=1:h0=02:h1=03:pri=*:nh0=03&&04
```

```
chg-scr-sio:sr=iec:nic=1:si=3:pri=2:npri=1
```

```
chg-scr-sio:sr=iec:nic=1:si=3:pri=3:nnic=2:nsfi=stop:actname=copy
```

**Dependencies**

**▲ Caution:**

Even though gateway screening is in the screen test mode, as defined by the `gwsa=off` and `gwsn=on` parameters, the gateway screening action in the stop action set specified by the `actname` parameter of the screen set will be performed at the end of the screening process.

At least one attribute must be changed.

If asterisk values or ranges are specified for the new heading codes, nothing that matches the entire combination of `nic/nnic`, `si/nsi`, and the specified new heading codes and priorities can already exist in the allowed SIO category for the screening reference.

An asterisk cannot be specified for a parameter value in this command unless an asterisk was specified for the parameter value in the original `ent-scr-sio` command.

If the `actname` parameter is specified, then the `nsfi=stop` parameter must be specified.

If the `actname` parameter is specified, the `nsr` parameter cannot be specified.

The `actname` parameter value must already be defined in the Gateway Screening Stop Action table with the `chg-gws-actset` command. These values are shown in the *ACT NAME* field of the `rtrv-gws-actset` command output.

The `nsfi` and `nsr` parameters must point to an existing screen, or the `nsfi=stop` parameter must be specified, and the `nsr` parameter cannot be specified.

The values specified for the `nsfi` and `si` parameters must meet the mapping requirements as shown:

- `nsfi=destfld — si=00`
- `nsfi=cdpa — si=03`
- `nsfi=cgpa — si=03`
- `nsfi=isup — si=05`

If the `si` parameter value is greater than 2, and the `nsi` parameter value is greater than 3, the `nh0` and `nh1` parameters are used to enter the required `h0` and `h1` parameter values.

Valid combinations for the `h0/h1` and `nh0/nh1` parameters are:

- `h0 (nh0)` is a single value—`h1 (nh1)` can be a single value, range, or asterisk
- `h0 (nh0)` is a range—`h1 (nh1)` can be an asterisk
- `h0 (nh0)` is an asterisk—`h1 (nh1)` can be an asterisk

If the value specified for the `nsi` parameter is greater than 2, then the `nh0` and `nh1` parameters cannot be specified.

Use [Table 4-14](#) to determine additional acceptable combinations of specified parameter values

**Table 4-14 Supported chg-scr-sio Parameter Combinations**

<b>si value:</b>	<b>nic value</b>	<b>pri value</b>	<b>h0 value:</b>	<b>h1 value:</b>
0	s, *	s, *, r	s	s, *, r
0	s, *	s, *, r	*, r	*
1, 2	s, *	s, *, r	s	s, *, r
1, 2	s, *	s, *, r	*, r	*
3-15	s, *	s, *, r	u	u
<b>Legend</b>				
• s = single value				
• r = range				
• * = asterisk				
• u = unspecified				

If the `nh0` or `nh1` parameters are specified, the parameter values must be valid with the `h0` or `h1` values currently in the database.

The `h0`, `h1`, `nh0`, and `nh1` parameters cannot be specified if the `si` parameter is not equal to 00, 01, or 02, and the `nsi` parameter is not specified.

The `nnic`, `nsi`, `pri`, and `nh0/nh1` parameters must not already exist in the allowed SIO category.

The `sr`, `nic`, `si`, `pri`, and `h0/h1` parameters for which attributes are to be changed must be in the allowed SIO category.

If the `nsfi=stop` parameter is specified, the `nsr` parameter cannot be specified.

If the `nsfi=stop` parameter is not specified, then the `nsr` parameter must be specified.

The Gateway Screening Stop Action table must be accessible.

If the `si` parameter is equal to 00, 01, or 02, the `h0` and `h1` parameters must be specified. Otherwise, the `h0` parameter cannot be specified.

The specified screening reference must already exist in the database.

The GWSOA parameter combination should be known and valid.

For SEAS command commands, the `pri` parameter specified must be in the range 0-3, \*."

For SEAS command commands, the `h0` parameter specified must be in the range 0-15, \*."

For SEAS command commands, the `h1` parameter specified must be in the range 0-15, \*."

### Notes

If the screen set reaches 100% capacity (indicated by the "100% full" message), the system allows subsequent entries. An error occurs, however, when downloading the screen set to the card. Ensure that screen sets do not exceed 100% capacity. Remove screen set entries until the capacity is below 100%.

To use TUP message type screening, an SIO screening reference with `si=04` (TUP) must be defined in the SIO table. To use ISUP message type screening, a rule with `si=05` (ISUP) must be defined in the SIO table. To use a combined ISUP/TUP screen set for TUP and ISUP

message screening, the SIO screening reference with `si=4` and the SIO screening reference with `si=5` must be two different screening references.

A network indicator value of 1 or 3 can be used in private networks.

A network indicator value of 3 can be used in some national networks to broaden the identity of a national network, but is usually spare.

If there are more than 200 affected screensets and the force parameter is set to **yes**, then the following warning message is displayed: "WARNING: Command may take up to 30 minutes" and the command proceeds successfully.

If there are more than 200 affected screensets and the force parameter is set to **no**, then the following notice is displayed: "Notice: Force parameter is required for affected screensets greater than 200" and the command is aborted.

### Output

```
chg-scr-sio:sr=iec:nic=1:si=3:pri=2:npri=1
```

```
rlghncxa03w 04-01-14 16:45:50 EST EAGLE 31.3.0
CHG-SCR-SIO: SCREEN SET AFFECTED - SS01 25% FULL
CHG-SCR-SIO: SCREEN SET AFFECTED - SS04 35% FULL
CHG-SCR-SIO: MASP A - COMPLTD
```

```
;
```

When there are more than 200 affected screensets and the force parameter is **no**:

```
chg-scr-sio:sr=iec:nic=1:si=3:pri=2:npri=1:force=no
```

```
Command entered at terminal #17.
```

```
;
```

```
tekelecstp 15-07-15 12:19:42 MST EAGLE5 46.3.0.0.0-66.10.0
CHG-SCR-SIO: MASP A - Cannot access standby fixed disk.
CHG-SCR-SIO: MASP A - Simplex database update.
Notice: Force parameter is required for affected screensets
greater than 200
CHG-SCR-SIO: MASP A - Command Aborted
```

When there are more than 200 affected screensets and the force parameter is **yes**:

```
chg-scr-sio:sr=iec:nic=1:si=3:pri=2:npri=1:force=yes
```

```
Command entered at terminal #17.
```

```
;
```

```
tekelecstp 15-07-15 14:10:31 MST EAGLE5 46.3.0.0.0-66.10.0
CHG-SCR-SIO: MASP A - Cannot access standby fixed disk.
CHG-SCR-SIO: MASP A - Simplex database update.
WARNING: Command may take upto 30 minutes.
-----
```

```
;
```

```
Command Accepted - Processing
```

```

tekelecstp 15-07-15 14:10:31 MST EAGLE5 46.3.0.0-66.10.0
Notice: The number of screensets affected is 201.
CHG-SCR-SIO: SCREEN SET AFFECTED - s1      1% FULL
CHG-SCR-SIO: SCREEN SET AFFECTED - s10     1% FULL
CHG-SCR-SIO: SCREEN SET AFFECTED - s100    1% FULL
CHG-SCR-SIO: SCREEN SET AFFECTED - s101    1% FULL
CHG-SCR-SIO: SCREEN SET AFFECTED - s102    1% FULL
-----
(List of affected screensets)

```

### Related Topics

- [dlt-scr-sio](#)
- [ent-scr-sio](#)
- [rtrv-scr-sio](#)

## chg-scr-tt

Use this command to change the attributes of a specific screening reference in the allowed translation type category. Attributes that can be changed are the translation type, next screening function identifier and next screening reference.

### Parameters

#### **sr (mandatory)**

Screening reference. The point code's unique screening reference name.

#### **Range:**

ayyy

1 alphabetic character followed by up to 3 alphanumeric characters

#### **type (mandatory)**

Translation type. The GTT type value in the CdPA.

#### **Range:**

0 - 255, \*

\*—the full range of values from 0–255

#### **actname (optional)**

Action name. The name of the gateway screening stop action set. Stop actions must be administered using this parameter in conjunction with the gateway screening stop action table (see `chg-gws-actset` and `rtrv-gws-actset` ).

#### **Range:**

ayyyy

1 alphabetic character followed by up to 5 alphanumeric characters.

*none* —remove an existing gateway screening stop action set from a gateway screening rule.



**force (optional)**

When there are more than 200 affected screensets, this parameter will decide whether to execute the command successfully or not.

**Range:**

*yes*

*no*

**Default:**

*no*

**nsfi (optional)**

This parameter specifies the next screening category that is used in the gateway screening process, or it indicates that the gateway screening process should stop.

**Range: *cdpa, stop******cdpa***

Allowed called party address is the next screening category.

***stop***

The gateway screening process ends and the message proceeds through normal routing.

**Default:**

No change to the current value

**nsr (optional)**

Next screening reference. This parameter specifies which screening reference in the specified screening category (*nsfi*) is to be used in the screening process.

**Range:**

*ayyy*

1 alphabetic character followed by up to 3 alphanumeric characters

**Default:**

No change to the current value

**ntype (optional)**

New translation type. The GTT type value in the CdPA. A single value or a range of values can be specified.

**Range:**

*0 - 255, \**

\*—the full range of values from 0–255

**Default:**

No change to the current value

**Example**

```
chg-scr-tt:sr=iec:type=012:ntype=014
```

```
chg-scr-tt:sr=iec:type=012:ntype=014:nsfi=stop:actname=none
```

## Dependencies

### ▲ Caution:

Even though gateway screening is in the screen test mode, as defined by the `gwsa=off` and `gws=on` parameters, the gateway screening action in the stop action set specified by the `actname` parameter of the screen set will be performed at the end of the screening process.

At least one attribute must be changed.

The new translation type cannot already exist.

If an asterisk is specified for the new allowed `type`, no other translation types can exist in the screening table.

If the `actname` parameter is specified, the `nsfi=stop` parameter must be specified.

If the `actname` parameter is specified, the `nsr` parameter cannot be specified.

The `actname` parameter value must already be defined in the Gateway Screening Stop Action table with the `chg-gws-actset` command. These values are shown in the *ACT NAME* field of the `rtrv-gws-actset` command output.

The next screening function identifier and the next screening to be added must point to one or more existing screening references.

If the `nsfi=stop` parameter is specified, the `nsr` parameter cannot be specified.

If the `nsfi` parameter has a value other than `stop`, the `nsr` parameter must be specified.

If the screening reference exists, the single value or range specified for the allowed `type` to be added to the TT screen for the allowed TT screening reference must not already exist in that TT screen.

The screening reference and translation type for which the attributes are to be changed must exist.

The current translation type must already exist.

The Gateway Screening Stop Action table must be accessible.

The value specified for the `type` parameter must be within the allowed range.

The GWSOA parameter combination should be known and valid.

### Notes

If the screen set reaches 100% capacity (indicated by the “100% full” message), the system allows subsequent entries. An error occurs, however, when downloading the screen set to the card. Ensure that screen sets do not exceed 100% capacity. Remove screen set entries until the capacity is below 100%.

An asterisk can be specified for a parameter value in the `chg/dlt-scr-tt` commands only if that parameter value was specified as an asterisk in the `ent-scr-tt` command to define the parameter value.

If there are more than 200 affected screensets and the force parameter is set to **yes**, then the following warning message is displayed: "WARNING: Command may take up to 30 minutes" and the command proceeds successfully.

If there are more than 200 affected screensets and the force parameter is set to **no**, then the following notice is displayed: "Notice: Force parameter is required for affected screensets greater than 200" and the command is aborted.

## Output

```
chg-scr-tt:sr=iec:type=012:ntype=014
```

```
rlghncxa03w 04-01-07 12:05:33 EST EAGLE 31.3.0
CHG-SCR-TT: SCREEN SET AFFECTED - IEC 25% FULL
CHG-SCR-TT: MASP A - COMPLTD
;
```

When there are more than 200 affected screensets and the force parameter is **no**:

```
chg-scr-tt:sr=ttl:nsfi=cdpa:nsr=cd1:type=0:force=no
```

Command entered at terminal #17.

```
;
tekelecstp 15-07-15 12:19:42 MST EAGLE5 46.3.0.0.0-66.10.0
CHG-SCR-TT: MASP A - Cannot access standby fixed disk.
CHG-SCR-TT: MASP A - Simplex database update.
Notice: Force parameter is required for affected screensets
greater than 200
CHG-SCR-TT: MASP A - Command Aborted
```

When there are more than 200 affected screensets and the force parameter is **yes**:

```
chg-scr-tt:sr=ttl:nsfi=cdpa:nsr=cd1:type=0:force=yes
```

Command entered at terminal #17.

```
;
tekelecstp 15-07-15 14:10:31 MST EAGLE5 46.3.0.0.0-66.10.0
CHG-SCR-TT: MASP A - Cannot access standby fixed disk.
CHG-SCR-TT: MASP A - Simplex database update.

WARNING: Command may take upto 30 minutes.
-----
;
Command Accepted - Processing
tekelecstp 15-07-15 14:10:31 MST EAGLE5 46.3.0.0.0-66.10.0
Notice: The number of screensets affected is 201.
CHG-SCR-TT: SCREEN SET AFFECTED - s1 1% FULL
CHG-SCR-TT: SCREEN SET AFFECTED - s10 1% FULL
CHG-SCR-TT: SCREEN SET AFFECTED - s100 1% FULL
CHG-SCR-TT: SCREEN SET AFFECTED - s101 1% FULL
CHG-SCR-TT: SCREEN SET AFFECTED - s102 1% FULL
```

```
-----
-----
(List of affected screensets)
```

### Related Topics

- [dlt-scr-tt](#)
- [ent-scr-tt](#)
- [rtrv-scr-tt](#)

## chg-scrset

Use this command to change the attributes of a screen set. A screen set is a group of screening references that can be assigned to a linkset. It is defined by a name and a pointer to the first screening reference of a screen set.

### Parameters

The `nscrn`, `nsfi`, or `nsr` parameter must be specified.

#### **scrn (mandatory)**

Screen set name. Each screening reference must have a unique name.

#### **Range:**

*ayyy*

1 alphabetic character followed by up to 3 alphanumeric characters

#### **actname (optional)**

Action name. This parameter specifies the name of the gateway screening stop action set. Stop actions must be administered using this parameter in conjunction with the gateway screening stop action table (see `chg-gws-actset` and `rtrv-gws-actset`).

#### **Range:**

*ayyyy*

1 alphabetic character followed by up to 5 alphanumeric characters.

*none*—remove an existing gateway screening stop action set from a gateway screening rule.

#### **destfld (optional)**

This parameter turns on and off the automatic allowed affected destination screening for network management messages against the routing table, self point codes, and capability point codes. When this parameter is on, the automatic screening is applied at the end of the provisioned screen set.

#### **Range:**

*yes*

*no*

#### **Default:**

Current value

**nscrn (optional)**

New screen set name.

**Range:**

ayyy 1 alphabetic character followed by up to 3 alphanumeric characters

**Default:**

Current value

**nsfi (optional)**

This parameter specifies the next screening category that is used in the gateway screening process, or it indicates that the gateway screening process should stop.

**Range:*****blkdpc***

Blocked DPC is the next screening category.

***blkopc***

Blocked OPC is the next screening category.

***dpc***

Allowed DPC is the next screening category.

***opc***

Allowed OPC is the next screening category.

***sio***

Allowed SIO is the next screening category.

***stop***

The gateway screening process ends and the message proceeds through normal routing.

**Default:**

Current value

**nsr (optional)**

Next screening reference. The parameter indicates which screening reference in the specified screening category (*nsfi*) is to be used in the screening process. If *nsfi=stop*, the *nsr* parameter cannot be specified.

**Range:**

ayyy

1 alphabetic character followed by up to 3 alphanumeric characters

**Default:**

Current value

**Example**

```
chg-scrset:scrn=ss01:nsfi=opc:nsr=iec
```

```
chg-scrset:scrn=ss02:nsfi=stop:nscrn=ss03
```

```
chg-scrset:scrn=ss02:nscrn=ss03:nsfi=stop:actname=copy
```

```
chg-scrset:scrn=ss02:nsfi=stop:nscrn=ss03:destfld=no
```

## Dependencies

The value of the `nscrn` parameter cannot be assigned to another screen set.

If the `actname` parameter is specified, the `nsfi=stop` parameter must be specified.

If the `actname` parameter is specified, the `nsr` parameter cannot be specified.

The `actname` parameter value must already be defined in the Gateway Screening Stop Action table with the `chg-gws-actset` command. These values are shown in the *ACT NAME* field of the `rtrv-gws-actset` command output.

The `nsfi` and `nsr` parameters must point to one or more existing entities in another entity set, or the `nsfi=stop` parameter must be specified, and the `nsr` parameter cannot be specified.

If the `nsfi=stop` parameter is not specified, then the `nsr` parameter must be specified.

An existing screen set must be removed from all linksets before it can be changed.

If the `nscrn` parameter is specified, the `scrn` parameter value cannot be referenced by a linkset.

The Gateway Screening (GSW) Stop Action table must be accessible.

If the next screening function identifier (`nsfi`) and the next screening reference (`nsr`) does not point to an existing screen, the `nsfi` must be equal to `stop` and the `nsr` parameter must not be specified.

The `nsfi` parameter must be valid for the SCRSET entity.

At least one optional parameter must be specified.

The GWSOA parameter combination should be known and valid.

The value for the `scrn` and `nscrn` parameters must be different.

When the screen sets are provisioned at maximum capacity (1023 screen sets), no screen sets can be changed.

## Notes

If the screen set reaches 100% capacity (indicated by the "100% full" message), the system allows subsequent entries. An error occurs, however, when downloading the screen set to the card. Screen sets should not exceed 100% capacity. Remove screen set entries until the capacity is below 100%.

The system validates the command to verify that the specified screen set name is in use.

## Output

```
chg-scrset:scrn=ss01:nsfi=opc:nsr=iec
```

```
rlghncxa03w 04-01-07 09:35:10 EST EAGLE 31.3.0
CHG-SCRSET: SCREEN SET AFFECTED - SS01 25% FULL
CHG-SCRSET: MASP A - COMPLTD
;
```

**Related Topics**

- [dlt-scrset](#)
- [ent-scrset](#)
- [rtrv-scrset](#)

## chg-seas-config

Use this command to configure information for the CCS Message Router (CCS MR) in the EAGLE database. The CCS MR is a stand-alone, self-contained system that provides a centralized mechanism for routing CCS network operations traffic between STPs/SCPs and existing and new OSS.

**Parameters****authmode (optional)**

Authentication mode. The authentication mode for the EAGLE.

**Note:**

Password-based authentication is the only authentication mode that is supported currently.

**Range:**

*password*

**conn (optional)**

Connection. The CCS MR where the SEAS terminal is connected.

**Range:**

*ipmr1*

*ipmr2*

**hname (optional)**

Host name. This parameter specifies the name of the remote host machine.

**Range:**

*ZZZZZZZZZZZZZZZZ*

1-15 alphanumeric characters. Quotation marks (") can be entered as part of the value. If quotation marks are used, then a hyphen ( ) can also be used.

**ipaddr (optional)**

IP address. The IP address of the CCS MR.

**Range:**

4 numbers separated by dots, with each number in the range of 0-255.

**login (optional)**

The login name used to create an SSH connection between the CCS MR and the EAGLE.

**Range:**

ZZZZZZZZZZZZZZ

1-15 alphanumeric characters.

**port (optional)**

The port number of the CCS MR.

**Range:**

1024 - 5000

**seasc11i (optional)**

The SEASCLLI portion of the EAGLE node name that is sent in SR-5129 messages.

**Note:**

This value is different from the EAGLE CLLI value that is configured with the `chg-sid` command.

The corresponding SEASCLLI name must be configured on the CCS MR. Refer to Telecordia Configuration Specification "Telcordia Technologies System Documentation", *BD-SNAM-ADMIN-4 Issue 14, November 2006*.

**Range:**

axxxxxxxxxx

1 alphabetic character followed by up to 10 alphanumeric characters

**Example**

```
chg-seas-config:seasc11i=eaglestp001:conn=ipmr1:  
ipaddr=198.168.25.10:port=1500
```

```
chg-seas-config:conn=ipmr2:port=3000
```

```
chg-seas-config:conn=ipmr2:ipaddr=10.203.63.23
```

**Dependencies**

The SEAS Over IP feature must be enabled before this command can be entered.

The SEAS terminal must be inhibited before the `seasc11i`, `ipaddr`, `port`, `login`, `hname`, or `authmode` parameters can be specified.

The `conn` parameter must be specified before the `port`, `ipaddr`, `login`, or `hname` parameters can be specified.

The SEASCFG Table must be accessible.

The value of the password requested by the `login` parameter must be from 1 - 15 alphanumeric characters in length.

The values of the `login` and `hname` parameters must be between 1-15 characters in length.

The `port` and `ipaddr` parameters must have unique values for each CCS MR.



## Output

```
chg-seas-  
config:seasccli=eaglestp001:conn=ipmr1:ipaddr=198.168.25.10:por  
t=1500
```

```
tekelecstp 07-06-16 22:34:11 IST EAGLE 37.5.0  
CHG-SEAS-CONFIG: MASP A - COMPLTD  
;
```

## Related Topics

- [rtrv-seas-config](#)

# chg-secu-dflt

Use this command to change various system-wide, security-related defaults, such as:

- The default password aging interval
- The default user ID aging interval
- Whether to allow or prohibit multiple simultaneous logins with the same user ID
- Control of the password security algorithm
- Login warning message text
- Clear the warning message text displayed during login to the EAGLE
- Password expiring notification interval
- Password expired grace period
- Control of the Telnet terminal security

## Parameters

### **alpha (optional)**

Minimum number of alphabetic characters (a–z) required in a new password.

**Range:**

0 - 12

**Default:**

Current value

**System Default:**

1

### **clrwrntx (optional)**

Clear warning text. This parameter deletes warning message text.

**Range:**

*no*

Does not delete any warning message text.

*yes*

Deletes warning message text for the line specified by the *wrnln* parameter.

*all*

Deletes warning message text for all lines.

**Default:**

No change to current value.

**minintrvl (optional)**

Minimum number of days before a password can be changed again.

**Range:**

0 - 30

**Default:**

No change to the current value

**System Default:**

1

**minlen (optional)**

Minimum number of characters that must be in a user password.

**Range:**

1 - 12

**Default:**

Current value

**System Default:**

8

**multlog (optional)**

This parameter specifies whether multiple simultaneous logins can be performed with a user ID.

**Range:**

*yes*

A user ID can be logged in to more than one terminal at the same time.

*no*

A user ID can be logged in to only one terminal at a time.

**Default:**

Current value

**System Default:**

*no*

**num (optional)**

Minimum number of numeric characters required in a new password.

**Range:**

0 - 12

**Default:**

Current value

**System Default:**

1

**page (optional)**

Default password aging interval for newly created user IDs. If the `page` parameter is specified in the `ent-user` command, the system uses that value; otherwise, the system uses the value specified here.

**Range:**

0 - 999

**Default:**

Current value

**System Default:**

90

**pchreuse (optional)**

Number of characters that cannot be reused from the existing password when setting a new password.

**Range:**

0 - 10

**Default:**

No change to the current value

**System Default:**

4

**pgrace (optional)**

Number of days after password expiration during which the user can login without changing their password.

**Range:**

0 - 7

**Default:**

No change to the current value

**System Default:**

3

**pnotify (optional)**

Number of days before password expiration that the user is notified about the expiration.

**Range:**

0 - 30

**Default:**

No change to the current value

**System Default:**

7

**preuse (optional)**

Number of passwords in the password history that must be unique.

**Range:**

0 - 12

**Default:**

No change to the current value

**punc (optional)**

Minimum number of punctuation characters required in a new password. A punctuation character is any character that is not an alphabetic or numeric character, including spaces.

**Range:**

0 - 12

**Default:**

Current value

**System Default:**

1

**ssh (optional)**

This parameter specifies whether the telnet connections are secure or not.

**Range:**

*on*

The telnet connections are secure.

*off*

The telnet connections are unsecure.

**System Default:**

*on*

**uout (optional)**

Number of successive days a user ID can go unused (no successful login) before the system denies login. If the `uout` parameter is specified in the `ent-user` command, the system uses that value; otherwise, the system uses the value specified here.

**Range:**

0 - 999

**Default:**

Current value



```
chg-secu-dflt:wrnln=10:wrntx=" " (set to 1 space to insert a blank
line)
chg-secu-dflt:wrnln=10:clrwrntx=yes
chg-secu-dflt:clrwrntx=all
chg-secu-dflt:clrwrntx=no:multilog=yes
chg-secu-dflt:ssh=on
```

### Dependencies

At least one optional parameter must be specified.

The sum of the values specified for the `alpha`, `num`, and `punc` parameters must not be greater than 12.

The `wrnln` and `wrntx` parameters must be specified together in this command.

If the `clrwrntx=yes` parameter is specified, then the `wrnln` parameter must be specified.

If the `clrwrntx=all` parameter is specified, then the `wrnln` and `wrntx` parameters cannot be specified.

If the `wrnln` parameter is specified, then the `wrntx` parameter or the `clrwrntx=yes` parameter must be specified.

Inhibit the IPSM cards before changing the value of parameter SSH.

### Notes

The warning message lines are displayed in the scroll area in order after a successful login; that is, line 1, line 2, and so on.

Any warning message line deleted with `clrwrntx=yes` parameter is not displayed in the scroll area during login.

The following message is the default message delivered with every system:

```
NOTICE: This is a private computer system.
```

```
Unauthorized access or use may lead to prosecution.
```

Even though the minimum number of characters allowed in a password is specified using the `minlen` parameter, the password also must satisfy the minimum value requirements specified on the `alpha`, `num`, and `punc` parameters. The actual minimum password length is the greater of either the value specified on the `minlen` parameter or the total number of characters specified on the `alpha`, `num`, and `punc` parameters.

For example, if `chg-secu-dflt:minlen=5:alpha=2:num=2:punc=2` is entered, the minimum number of password characters specified on the `minlen` parameter is 5. But the total number of characters specified in the `alpha`, `num`, and `punc` parameters is 6 (`alpha+num+punc`). The effective minimum number of characters is actually 6 rather than the 5 specified on the `minlen` parameter.

If the `clrwrntx=yes` parameter is specified, then at least one line number must be specified.

The Telnet connections will be secure when the value of the `ssh` parameter is ON. If the `ssh` parameter is OFF, the Telnet connections will not be secure.

### Output

The following commands create the warning message that is shown in the output after the commands. The notes that are not bold in parentheses after some commands explain the displayed output. The warning message is displayed after the user enters the `login` command and a password. The output example shows the command output, a `login` command and password prompt, and the warning message that was created with these commands. See the Notes section for this command for additional information about entering this command.

```
chg-secu-
dflt:wrnln=1:wrntx="*****
*****"

chg-secu-dflt:wrnln=2:wrntx="* NOTICE: This is a private
computer system. *"

chg-secu-dflt:wrnln=3:wrntx="* Unauthorized Access or use may
lead to *"

chg-secu-dflt:wrnln=4:wrntx="* prosecution. *"

chg-secu-dflt:wrnln=5:wrntx="* 08/03/01 Notice!!! Eagle will be
upgraded between `*"

chg-secu-dflt:wrnln=6:wrntx="*                               the hours of
2am-3am on 08/03/15. *"

chg-secu-dflt:wrnln=7:wrntx="*  *"

chg-secu-dflt:wrnln=8:wrntx="* Today's happy message: Go with
Oracle!!          *"

chg-secu-
dflt:wrnln=9:wrntx="*****
*****"

chg-secu-dflt:wrnln=10:wrntx=" " (set to 1 space to cause blank line before
login history is displayed)

chg-secu-dflt:wrnln=11:clrwrntx=yes
chg-secu-dflt:wrnln=12:clrwrntx=yes
chg-secu-dflt:wrnln=13:clrwrntx=yes
chg-secu-dflt:wrnln=14:clrwrntx=yes (remaining lines are provisioned to
cause
chg-secu-dflt:wrnln=15:clrwrntx=yes them not to display as part of the
message
chg-secu-dflt:wrnln=16:clrwrntx=yes after successful login)
chg-secu-dflt:wrnln=17:clrwrntx=yes
```

```

chg-secu-dflt:wrnln=18:clrwrntx=yes
chg-secu-dflt:wrnln=19:clrwrntx=yes
chg-secu-dflt:wrnln=20:clrwrntx=yes

rlghncxa03w 08-03-10 11:43:04 EST  EAGLE 38.0.0
CHG-SECU-DFLT: MASP A - COMPLTD
;
LOGIN:UID=eagle
PASSWORD:<password is not displayed>

*****
* NOTICE: This is a private computer system.      *
* Unauthorized Access or use may lead to          *
* prosecution.                                     *
* 08/03/01 Notice!!! Eagle will be upgraded between *
*           the hours of 2am-3am on 08/03/15.      *
*                                                   *
* Today's happy message: Go with Oracle!!         *
*****

0 LOGIN failures since last successful LOGIN
Last successful LOGIN was on port 3 on 08-03-09 @ 12:12:35
;

```

The following command clears all of the warning messages.

```

chg-secu-dflt:clrwrntx=all

tekelecstp 08-03-02 17:53:13 EST  EAGLE 38.0.0
CHG-SECU-DFLT: MASP A - COMPLTD
;
LOGIN:UID=eagle
PASSWORD:<password is not displayed>

0 LOGIN failures since last successful LOGIN
Last successful LOGIN was on port 3 on 08-02-26 @ 12:12:35
;

```

The following commands set the warning message text that is shown in the output. The parameter `clrwrntx=no` has no impact on the command output.

```

chg-secu-
dflt:wrnln=1:wrntx="*****":clrwrntx=no

chg-secu-dflt:wrnln=2:wrntx="* NOTICE: This is a private computer system.
*****":clrwrntx=no

```



```

chg-secu-
dflt:wrnln=3:wrntx="*****
*****":clrwrntx=no

tekelecstp 08-03-02 17:53:31 EST EAGLE 38.0.0
CHG-SECU-DFLT: MASP A - COMPLTD
;
LOGIN:UID=eagle
PASSWORD:<password is not displayed>

*****
* NOTICE: This is a private computer system. *
*****

0 LOGIN failures since last successful LOGIN
Last successful LOGIN was on port 3 on 08-02-26 @ 17:12:35
;

```

The following command sets the `ssh` parameter to allow secure terminals.

```

chg-secu-dflt:ssh=on

tekelecstp 12-09-18 10:11:43 EST 45.0.0-64.42.0
chg-secu-dflt:ssh=on
Command entered at terminal #4.
CHG-SECU-DFLT: MASP A - COMPLTD
;

```

### Related Topics

- [ent-user](#)
- [login](#)
- [rtrv-secu-dflt](#)

## chg-secu-trm

Use this command to configure the access rights for a terminal. Only a user with system security administration authority can change a terminal's access rights. Access rights determine whether a terminal or port has command access to the system for the different command classes.

### Parameters

#### **trm** (mandatory)

Terminal ID. The port to be configured.

#### **Range:**

1 - 16

**a11 (optional)**

All non-configurable command classes. This parameter specifies whether to configure all of the command classes.

**Range:**

*yes*

*no*

**Default:**

No change to the current value

**System Default:**

*no*

**cc1 (optional)**

Configurable command class name specifying whether the command class is allowed for the specified terminal.

**Range:**

*ayy-yes, ayy-no*

1 alphabetic character followed by 2 alphanumeric characters, a dash, and the indicator value

*-no* —The command is not allowed for the specified terminal.

*-yes* —The command is allowed for the specified terminal.

**cc2 (optional)**

Configurable command class name specifying whether the command class is allowed for the specified terminal.

**Range:**

*ayy-yes, ayy-no*

1 alphabetic character followed by 2 alphanumeric characters, a dash, and the indicator value

*-no* —The command is not allowed for the specified terminal.

*-yes* —The command is allowed for the specified terminal.

**cc3 (optional)**

Configurable command class name specifying whether the command class is allowed for the specified terminal.

**Range:**

*ayy-yes, ayy-no*

1 alphabetic character followed by 2 alphanumeric characters, a dash, and the indicator value

*-no* —The command is not allowed for the specified terminal.

*-yes* —The command is allowed for the specified terminal.

**cc4 (optional)**

Configurable command class name specifying whether the command class is allowed for the specified terminal.

**Range:**

*ayy-yes, ayy-no*

1 alphabetic character followed by 2 alphanumeric characters, a dash and the indicator value

*-no* —The command is not allowed for the specified terminal.

*-yes* —The command is allowed for the specified terminal.

#### **cc5 (optional)**

Configurable command class name, specifying whether the command class is allowed for the specified terminal.

##### **Range:**

*ayy-yes, ayy-no*

1 alphabetic character followed by 2 alphanumeric characters, a dash, and the indicator value

*-no* —The command is not allowed for the specified terminal.

*-yes* —The command is allowed for the specified terminal.

#### **cc6 (optional)**

Configurable command class name specifying whether the command class is allowed for the specified terminal.

##### **Range:**

*ayy-yes, ayy-no*

1 alphabetic character followed by 2 alphanumeric characters, a dash, and the indicator value.

*-no* —The command is not allowed for the specified terminal.

*-yes* —The command is allowed for the specified terminal.

#### **cc7 (optional)**

Configurable command class name specifying whether the command class is allowed for the specified terminal.

##### **Range:**

*ayy-yes, ayy-no*

1 alphabetic character followed by 2 alphanumeric characters, a dash and the indicator value

*-no* —The command is not allowed for the specified terminal.

*-yes* —The command is allowed for the specified terminal.

#### **cc8 (optional)**

Configurable command class name specifying whether the command class is allowed for the specified terminal.

##### **Range:**

*ayy-yes, ayy-no*

1 alphabetic character followed by 2 alphanumeric characters, a dash and the indicator value

*-no* —The command is not allowed for the specified terminal.

*-yes* —The command is allowed for the specified terminal.

#### **db (optional)**

Database Administration class. This parameter specifies whether the Database Administration class of commands is allowed.

**Range:**

*yes*

*no*

**Default:**

No change to the current value

**System Default:**

*no*

**dbg (optional)**

Debug class. This parameter specifies whether the Debug class of commands is allowed.

**Range:**

*yes*

*no*

**Default:**

No change to the current value

**System Default:**

*no*

**link (optional)**

Link Maintenance class. This parameter specifies whether the Link Maintenance class of commands is allowed.

**Range:**

*yes*

*no*

**Default:**

No change to the current value

**System Default:**

*no*

**pu (optional)**

Program Update class. This parameter specifies whether the Program Update class of commands is allowed.

**Range:**

*yes*

*no*

**Default:**

No change to the current value

**System Default:**

*no*

**sa (optional)**

Security Administration class. This parameter specifies whether the Security Administration class of commands is allowed.

**Range:**

*yes*

*no*

**Default:**

No change to the current value

**System Default:**

*no*

**sys (optional)**

System Maintenance class. This parameter specifies whether the System Maintenance class of commands is allowed.

**Range:**

*yes*

*no*

**Default:**

No change to the current value

**System Default:**

*no*

**Example**

```
chg-secu-trm:trm=3:all=yes
```

```
chg-secu-trm:trm=3:sys=yes:cc1=u04-no:cc3=u11=yes
```

**Dependencies**

This command is not supported on telnet terminals (terminal IDs 17-40).

At least one optional parameter must be specified.

Access rights for a terminal cannot be changed while a user is logged on to that terminal.

At least two terminal ports must be configured to have security administration authority.

The Command Class Management feature must be enabled before any of the configurable command class name parameters ( `cc (X)` ) can be specified.

The value specified for a configurable command class name must be a default or provisioned command class name in the CCNAMES table.

The CCCNAMES table is corrupt or cannot be found.

The Terminal table is corrupt or cannot be found.

If the `all` parameter is specified and any of the individual command classes are also specified, the individual command classes take precedence.

### Notes

Up to 8 configurable command class name parameters can be entered in one command. Additional commands can be entered to change access rights for more than 8 names. To change access rights for all 32 available configurable command class names, four commands could be entered with 8 names specified in each command.

Security Administration ports whose terminal port type has been configured with a value of *none* or *printer* do not allow commands to be entered. Because commands cannot be entered from terminals attached to these ports, they are not considered as ports configured for security administration authority.

### Output

```
chg-secu-trm:trm=3:all=yes
```

```
rlghncxa03w 04-01-15 12:30:04 EST EAGLE 31.3.0  
Command entered at terminal #13.
```

```
rlghncxa03w 04-01-15 12:30:07 EST EAGLE 31.3.0  
CHG-SECU-TRM: MASP A - COMPLTD
```

```
;
```

### Related Topics

- [rtrv-secu-trm](#)

## chg-sfappopts

Use this command to change SFAPP configuration. This command updates the SFAPPOPTS table.

### Parameters

#### **agetime (optional)**

This parameter defines value for ageing.

##### **Range:**

1-65535

##### **Default:**

No change to the current value

##### **System Default:**

*None* - Indicates '0' value.

#### **failth (optional)**

This parameter defines the failed validation threshold. The difference between failure and success counts of a dynamically learned VLR must cross this threshold in order for the VLR to become Blacklisted.

**Range:**  
1-65535

**Default:**  
No change to the current value

**System Default:**  
*None - Indicates '0' value.*

**mode (optional)**

Provides the option to turn off dynamic learning, test the learning algorithm, and move the system in operation using various modes

**Range:**  
*off*  
Provides option to turn off dynamic whitelist learning.

*learn*  
New learning possible in this mode. No validation performed.

*test*  
New learning possible in this mode. Challenges can also be performed. However, learned VLRs remain Greylisted

*active*  
No new learning in this mode are performed. Status of dynamically learned VLRs are changed to Whitelisted or Blacklisted if they meet criteria.

**Default:**  
No change to the current value

**System Default:**  
*off*

**succth (optional)**

This parameter defines the successful validation threshold. The difference between success and failure counts of a dynamically learned VLR must cross this threshold in order for the VLR to become Whitelisted.

**Range:**  
1-65535

**Default:**  
No change to the current value

**System Default:**  
*None - Indicates '0' value.*

**velth (optional)**

This parameter defines the number of velocity check attempts needed for a dynamic roaming entry to be marked as Learning Complete.

**Range:**  
1-65535

**Default:**

No change to the current value

**System Default:**

*None - Indicates '0' value.*

**vlrimeichallenge (optional)**

This parameter enables the VLR IMEI challenge to be performed by SFAPP Card by sending a PSI to query IMEI from the visited-VLR.

**Range:**

*yes*

Enabled

*no*

Disabled

**Default:**

No change to the current value

**System Default:**

*no*

**Example**

```
chg-sfappopts:vlrimeichallenge=yes
chg-sfappopts:mode=off
chg-sfappopts:mode=learn
chg-sfappopts:mode=test
chg-sfappopts:mode=active
chg-sfappopts:succth=3
chg-sfappopts:failth=5
chg-sfappopts:succth=5:failth=3:velth=8:mode=learn
```

**Dependencies**

When SFAPP(P) to OAM sync (copy-table) is in progress do not switch the mode to OFF or LEARN as these mode performs copy table from SFAPP(P) to OAM.

Multiple copy table at same time may cause table corruption

The SFAPP table should be accessible.

When there is NO Active SFAPP cards on EAGLE, User will not be able to switch the mode

**Output**

```
chg-sfappopts:mode=learn

tekelecstp 18-09-13 11:04:35 EST  EAGLE 46.7.0.0-75.10.0
  chg-sfappopts:mode=learn
  Command entered at terminal #17.
;
```



```

tekelecstp 18-09-13 11:04:35 EST EAGLE 46.7.0.0-75.10.0

WARNING: Re-Switch the mode after TWO Minute as this mode needs
time to sync with OAM
;
Command Accepted - Processing
tekelecstp 18-09-13 11:04:35 EST EAGLE 46.7.0.0-75.10.0
CHG-SFAPPOPTS: MASP A - COMPLTD
;
Command Executed

```

### Legend

- **VLRIMEICHALLENGE** - Enables/Disables the VLR IMEI challenge for CAT3.2 messages
- **MODE**- Provides option to turn off dynamic learning, test the learning algorithm, and move the system in operation using various modes
  - *OFF*- Turn off the dynamic whitelist learning. Delete all the dynamic VLR profile and dynamic VLR roaming entries.
  - *LEARN* - Only learn about new VLRs, no challenges are performed (newly learned VLRs are considered as Whitelisted). Delete dynamic entries without parent in static when switch from ACTIVE or TEST mode
  - *ACTIVE* - Challenges are performed. Status of dynamically learned VLRs are changed to Whitelisted or Blacklisted if they meet criteria
  - *TEST* - Challenges are performed. However, learned VLRs remain Grey listed
- **SUCCTH** If system-wide success threshold is 0 i.e., None, then do not transition any VLR to whitelist
- **VELTH** - In case VELTH is set to None, all dynamic VLR roaming entries will always be in LEARNING phase and will never be used for VLR validation
- **AGETIME** - In case agetime is set to None, ageing will not perform

### Related Topics

- [rtrv-sfappopts](#)

## chg-sg-opts

Use this command to change the IP7 Secure Gateway protocol options.

### Parameters

#### **dscp (optional)**

This parameter specifies the `dscp` value that shall be set for outbound messages for SIGTRAN cards.

**Range:**  
0-63







## Dependencies

At least one optional parameter must be specified.

The number of static entries in the Routing Key table cannot exceed the value specified for the `srkq` parameter.

The `srkq` parameter value must be greater than or equal to the current number of static routing key entries. Attempts to decrease the value below the actual current number of static routing key entries are not allowed.

The total number of the `srkq` value cannot exceed 2500 for E5-ENET-B cards running the SS7IPGW or IPGWI application.

The total number of actual routing keys cannot not exceed 2500 per system.

This command generated an unexpected response message.

There was a processor timeout error during the period when this command was entered.

## Notes

### SCTP Checksum Algorithm

The SCTP checksum algorithm affects the IPLIMx, IPGWx, and IPSG cards under the following conditions:

- All associations on the card are in the **open=no** state.
- No associations are provisioned on the card

If neither condition is true, the card raises minor alarm (UAM 298) under the following scenarios:

- The system-wide SCTP checksum algorithm is configured to a different value than the active SCTP checksum algorithm on the card.
- The system-wide SCTP checksum algorithm is set to *percard*, and the per-card setting is different than the active SCTP checksum algorithm on the card.

The alarm is cleared (UAM 299), and the SCTP checksum algorithm takes effect when all associations on the card are set to `open=no` or when the card is reset.

**Table 4-15 Standard DSCP Values**

DSCP Class	DSCP (bin)	DSCP (hex)	DSCP (dec)
NONE	000000	0x00	0
CS1	001000	0x08	8
AF11	001010	0x0A	10
AF12	001100	0x0C	12
AF13	001110	0x0E	14
CS2	010000	0x10	16
AF21	010010	0x12	18
AF22	010100	0x14	20
AF23	010110	0x16	22
CS3	011000	0x18	24

**Table 4-15 (Cont.) Standard DSCP Values**

DSCP Class	DSCP (bin)	DSCP (hex)	DSCP (dec)
AF31	011010	0x1A	26
AF32	011100	0x1C	28
AF33	011110	0x1E	30
CS4	100000	0x20	32
AF41	100010	0x22	34
AF42	100100	0x34	36
AF43	100110	0x26	38
CS5	101000	0x28	40
EF	101110	0x2E	46
CS6	110000	0x30	48
CS7	111000	0x38	56

**Output**

```
chg-sg-opts:sctpcsum=percard
```

```
tekelecstp 08-02-22 17:56:31 EST EAGLE 38.0.0
CHG-SG-OPTS: MASP A - COMPLTD
```

```
;
```

```
chg-sg-opts:dscp=8
```

```
tekelecstp 13-09-24 16:56:31 EST EAGLE 46.0.0
CHG-SG-OPTS: MASP A - COMPLTD
```

```
;
```

**Related Topics**

- [rtrv-sg-opts](#)

## chg-shlf

Use this command to change the Shelf FAN bit for an equipment shelf in the database, based on whether the shelf is equipped with a FAN unit or not.

**Parameters****loc (mandatory)**

The location of the shelf.

**Range:**

1200, 1300, 2100, 2200, 2300, 3100, 3200, 3300, 4100, 4200, 4300, 5100, 5200, 5300, 6100, 6200, 6300

**fan (optional)**

This parameter turns ON/OFF the FAN bit. If it is turned ON, the FAN power for this shelf will be added to the Frame Power Budget.

**Range:**

*off* - Shelf is not equipped with a FAN unit

*on* - Shelf is currently equipped with a FAN unit

**Example**

```
chg-shlf:loc=1200:fan=on
```

```
chg-shlf:loc=1200:fan=off
```

**Dependencies**

The frame and shelf values of the shelf location parameter (loc) must be within the valid range (xyzz, where x=frame and y=shelf; zz is always 00 for this command).

The specified shelf location must have been configured previously.

A shelf cannot be provisioned at location 1100. This location is reserved for the control shelf.

The Shelf FAN bit cannot be turned OFF if EPMB, SLIC or E5-APP-B card(s) are provisioned in the shelf.

**Notes**

None

**Output**

```
chg-shlf:loc=1200:fan=on
```

```
tekelecstp 03-09-12 11:11:28 EST EAGLE 45.0.0  
ENT-SHLF: MASP A - COMPLTD
```

```
;
```

```
chg-shlf:loc=1200:fan=off
```

```
tekelecstp 03-09-12 11:11:28 EST EAGLE 45.0.0  
ENT-SHLF: MASP A - COMPLTD
```

```
;
```

**Related Topics**

- [dlt-shlf](#)
- [rtrv-shlf](#)

## chg-sid

Use this command to change the self-identification of the system. The self-identification identifies the system to the other signaling points in the network.

 **Caution:**

Use this command only during periods of low traffic. If you use the `chg-sid` command to change the point code, then the change does not become enabled until you initialize (`init-sys`) the system.

 **Note:**

If you use the `chg-sid` command to change the capability point code, then you do not need to initialize the system for the change to become enabled.

 **Caution:**

Changing a SID impacts all adjacent nodes that reference the SID. Both sides must be changed at the same time, or the signaling link test messaging will fail, and the links will go down.

**Parameters** **Note:**

See [Point Code Formats and Conversion](#) for a detailed description of point code formats, rules for specification, and examples.

 **Caution:**

If there are STC cards in the system for the EAGLE 5 Integrated Monitoring Support (E5IS) feature, you must turn off the EIS copy function (see the `chg-eisopts` command) before you change the system CLLI. When the CLLI change is complete, use the `chg-eisopts` command to turn on the EIS copy function again.

**c11i (optional)**

Common language location identifier. This parameter, which must be unique, identifies the system in terms of its physical location:

- The first four characters identify the city, town, or locality.
- The fifth and sixth characters identify state or province.
- The seventh and eighth characters identify the building.
- The last three characters identify the traffic unit.

**Range:**

ayyyyyyyyy

1 alphabetic character followed by up to 10 alphanumeric characters

The value *none* is invalid for the CLLI.



**Default:**

No change to the current value

**cpc (optional)**

ANSI capability point code with subfields *network indicator-network cluster-network cluster member (ni-nc-ncm)*.

**Synonym:**

*cpc*

**Range:**

000-255

Specify a valid value for each subfield of the point code, and separate the subfields with a dash (-).

When *chg-sid:pctype=ansi* is specified, *ni = 000* is not valid.

When *chg-sid:pctype=ansi* is specified, *nc = 000* is not valid if *ni = 001–005*.

When *chg-sid:pctype=ansi* is specified, *nc = 000* is valid if *ni = 006–255*.

The point code *000-000-000* is not a valid point code.

**cpc/cpca/cpci/cpcn/cpcn24/cpcn16 (optional)**

Capability point code. The code used by the SS7 protocol to identify a group of functionally related STPs in the signaling network to which the STP belongs.

**cpci (optional)**

ITU international point code with subfields *zone-area-id*. The *prefix* subfield indicates a spare point code (*prefix-zone-area-id*).

**Range:**

*s-*, 0-255

Specify a valid value for each subfield of the point code, and separate the subfields with a dash (-).

*prefix—s*

*zone—0-7*

*area—000-255*

*id—0-7*

The point code *0-000-0* is not a valid point code.

**cpcn (optional)**

ITU national point code in the format of a 5-digit number (*nnnnn*); or 2, 3, or 4 numbers (members) separated by dashes (*m1-m2-m3-m4*) as defined by the *chg-stpopts:npcfmti* flexible point code option. A group code must be specified when the ITUDUPPC feature is turned on (*nnnnn-gc,m1-m2-m3-m4-gc*). The *prefix* subfield indicates a spare point code (*prefix-nnnnn*, *prefix-nnnnn-gc*, *prefix-m1-m2-m3-m4*, *prefix-m1-m2-m3-m4-gc*).

**Range:**

*s-*, 0-16383, *aa-zz*

Specify a valid value for each subfield of the point code, and separate the subfields with a dash (-).

*prefix—s-*

*nnnnn—0-16383*

*gc—aa-zz*

*m1-m2-m3-m4—0-14* for each member; values must sum to 14

**cpcn24 (optional)**

24-bit ITU national point code with subfields *main signaling area-sub signaling area-signaling point (msa-ssa-sp)*.

**Range:**

000-255

Specify a valid value for each subfield of the point code, and separate the subfields with a dash (-).

*msa—000–255*

*ssa—000–255*

*sp—000–255*

**cpcn16 (optional)**

16-bit ITU national point code with subfields *unit number sub number area main number area (un-sna-mna)*.

**Range:**

000--127

Specify a valid value for each subfield of the point code, and separate the subfields with a dash (-).

*un---000---127*

*sna---000---15*

*mna---000---31*

**cpctype (optional)**

Capability point code type. This parameter specifies whether the capability point code is for the STP or for a particular service.

This parameter cannot be changed after it is assigned.

**Range:**

***lnp***

Local Number Portability

***stp***

EAGLE

***inp***

INAP-based Number Portability

***eir***

Equipment Identity Register

***gport***

G-Port (GSM Mobile Number Portability)

***gflex***

G-Flex (GSM Flexible Numbering)

***mnp***

Mobile Number Portability

**atinq**

ATI Number Portability Query

**vflex**

Voice Mail Router

**aiq**

ANSI41 Analyzed Information Query

**Default:**

stp

**ncpc (optional)**New ANSI capability point code with subfields *network indicator-network cluster-network cluster member (ni-nc-ncm)*.**Synonym:**

ncpca

**Range:**

000-255, none

Specify a valid value for each subfield of the point code, and separate the subfields with a dash (-).

When `chg-sid:pctype=ansi` is specified, `ni = 000` is not valid.When `chg-sid:pctype=ansi` is specified, `nc = 000` is not valid if `ni = 001-005`.When `chg-sid:pctype=ansi` is specified, `nc = 000` is valid if `ni = 006-255`.Enter *none* to delete the point code.The point code `000-000-000` is not a valid point code.**ncpc/ncpca/ncpci/ncpcn/ncpcn24/ncpcn16 (optional)**

New capability point code. Use new CPCs to replace or delete existing CPCs.

**ncpci (optional)**ITU international point code with subfields *zone-area-id*. The *prefix* subfield indicates a spare point code (*prefix-zone-area-id*).**Range:**

s-, 0-255, none

Specify a valid value for each subfield of the point code, and separate the subfields with a dash (-).

*prefix*—s*zone*—0-7*area*—000-255*id*—0-7Enter *none* to delete the point code.The point code `0-000-0` is not a valid point code.**ncpcn (optional)**New ITU national point code in the format of a 5-digit number (*nnnnn*); or 2, 3, or 4 numbers (members) separated by dashes (*m1-m2-m3-m4*) as defined by the `chg-stpopts:npcfmti` flexible point code option. A group code must be specified when the ITUDUPPC feature is turned on (*nnnnn-gc*, *m1-m2-m3-m4-gc*). The *prefix* subfield indicates a spare point code (*prefix-nnnnn*, *prefix-nnnnn-gc*, *prefix-m1-m2-m3-m4*, *prefix-m1-m2-m3-m4-gc*).

**Range:***s*-, 0-16383, *aa-zz*, *none*

Specify a valid value for each subfield of the point code, and separate the subfields with a dash (-).

*prefix*—*s**nnnnn*—0-16383*gc*—*aa-zz**m1-m2-m3-m4*—0-14 for each member; values must sum to 14Enter *none* to delete the point code.**Default:**

No change to existing point code value.

**ncpcn24 (optional)**New 24-bit ITU national point code with subfields *main signaling area-sub signaling area-signaling point* (*msa-ssa-sp*).**Range:**000-255, *none*

Specify a valid value for each subfield of the point code, and separate the subfields with a dash (-).

*msa*—000-255*ssa*—000-255*sp*—000-255Enter *none* to delete the point code.**ncpcn16 (optional)**16-bit ITU national point code with subfields *unit number sub number area main number area* (*un-sna-mna*).**Range:**000--127, *none*

Specify a valid value for each subfield of the point code, and separate the subfields with a dash (-).

*un*---000---127*sna*---000---15*mna*---000---31Enter *none* to delete the point code.**npc (optional)**New ANSI STP point code with subfields *network indicator-network cluster-network cluster member* (*ni-nc-ncm*).**Synonym:***npca***Range:**000-255, *none*

Specify a valid value for each subfield of the point code, and separate the subfields with a dash (-).

When `chg-sid:pctype=ansi` is specified, `ni = 000` is not valid.

When `chg-sid:pctype=ansi` is specified, `nc = 000` is not valid if `ni = 001-005`.

When `chg-sid:pctype=ansi` is specified, `nc = 000` is valid if `ni = 006-255`.

Enter `none` to delete the point code.

The point code `000-000-000` is not a valid point code.

### **npci (optional)**

New STP ITU international point code with subfields `zone-area-id`. The `prefix` subfield indicates a spare point code (`prefix-zone-area-id`).

#### **Range:**

`s-`, `0-255`, `none`

Specify a valid value for each subfield of the point code, and separate the subfields with a dash (-).

`prefix—s`

`zone—0-7`

`area—000-255`

`id—0-7`

Enter `none` to delete the point code.

The point code `0-000-0` is not a valid point code.

### **npci/npcn (optional)**

New STP ITU national or international point code.

### **npcn (optional)**

New STP ITU national point code in the format of a 5-digit number (`nnnnn`); or 2, 3, or 4 numbers (members) separated by dashes (`m1-m2-m3-m4`) as defined by the `chg-stpopts:npcfmti` flexible point code option. A group code must be specified when the ITUDUPPC feature is turned on (`nnnnn-gc`, `m1-m2-m3-m4-gc`). The `prefix` subfield indicates a spare point code (`prefix-nnnnn`, `prefix-nnnnn-gc`, `prefix-m1-m2-m3-m4`, `prefix-m1-m2-m3-m4-gc`).

#### **Range:**

`s-`, `0-16383`, `aa-zz`, `none`

Specify a valid value for each subfield of the point code, and separate the subfields with a dash (-).

`prefix—s`

`nnnnn—0-16383`

`gc—aa-zz`

`m1-m2-m3-m4—0-14` for each member; values must sum to 14

Enter `none` to delete the point code.

### **pc (optional)**

ANSI STP point code with subfields `network indicator-network cluster-network cluster member` (`ni-nc-ncm`).

#### **Synonym:**

`pca`

#### **Range:**

`000-255`

Specify a valid value for each subfield of the point code, and separate the subfields with a dash (-).

When `chg-sid:pctype=ansi` is specified, `ni = 000` is not valid.

When `chg-sid:pctype=ansi` is specified, `nc = 000` is not valid if `ni = 001–005`.

When `chg-sid:pctype=ansi` is specified, `nc = 000` is valid if `ni = 006–255`.

The point code `000-000-000` is not a valid point code.

#### **pc/pca/pci/pcn/pcn24/pcn16 (optional)**

STP point code.

#### **pci (optional)**

ITU international point code with subfields *zone-area-id*. The *prefix* subfield indicates a spare point code (*prefix-zone-area-id*).

##### **Range:**

*s*-, 0-255

Specify a valid value for each subfield of the point code, and separate the subfields with a dash (-).

*prefix*—*s*

*zone*—0-7

*area*—000-255

*id*—0-7

The point code `0-000-0` is not a valid point code.

#### **pcn (optional)**

ITU national point code in the format of a 5-digit number (*nnnnn*); or 2, 3, or 4 numbers (members) separated by dashes (*m1-m2-m3-m4*) as defined by the `chg-stpopts:npcfmti` flexible point code option. A group code must be specified when the ITUDUPPC feature is turned on (*nnnnn-gc,m1-m2-m3-m4-gc*). The *prefix* subfield indicates a spare point code (*prefix-nnnnn*, *prefix-nnnnn-gc*, *prefix-m1-m2-m3-m4*, *prefix-m1-m2-m3-m4-gc*).

##### **Range:**

*s*-, 0-16383, *aa-zz*

Specify a valid value for each subfield of the point code, and separate the subfields with a dash (-).

*prefix*—*s*-

*nnnnn*—0-16383

*gc*—*aa-zz*

*m1-m2-m3-m4*—0-14 for each member; values must sum to 14

#### **pcn24 (optional)**

24-bit ITU national point code with subfields *main signaling area-sub signaling area-signaling point* (*msa-ssa-sp*).

##### **Range:**

000-255

Specify a valid value for each subfield of the point code, and separate the subfields with a dash (-).

*msa*—000–255

*ssa*—000–255

*sp*—000–255

#### **pcn16 (optional)**

16-bit ITU national point code with subfields *unit number sub number area main number area* (*un-sna-mna*).

**Range:**  
000--127

Specify a valid value for each subfield of the point code, and separate the subfields with a dash (-).

*un---000---127*

*sna---000---15*

*mna---000---31*

**pctype (optional)**

Point code type. This parameter does not affect ITU destinations.

**Range:** *ansi, other*

*ansi* —Supports point codes that meet the ANSI standard

*other* —Supports point codes that do not meet the ANSI standard.

**Default:**

The point code type is not changed.

**Example**

To change the site identification PCTYPE to ANSI:

```
chg-sid:pctype=ANSI
```

To change the site identification CLLI to *rlghncxa03w* :

```
chg-sid:clli=rlghncxa03w
```

To add a new ANSI capability point code:

```
chg-sid:cpc=002-002-002
```

To delete an ITU-I capability point code:

```
chg-sid:cpci=2-003-4:ncpci=none
```

To change an existing ITU-N capability point code, *01234*, to *02092* : (The existing CPC is replaced with the new CPC)

```
chg-sid:cpcn=01234:ncpcn=02092
```

To add a new ANSI LNP CPC:

```
chg-sid:cpc=002-002-002:cpctype=lnp
```

To change an existing ITU-N capability point code with a group code of *01234-aa* to *02092-si* : (The existing CPC is replaced with the new CPC)

```
chg-sid:cpcn=01234-aa:ncpcn=02092-si:cpctype=stp
```

To change the ITU-N 24-bit site identification STP Point Code when no previous ITU-N site identification STP point code exists:

```
chg-sid:pcn24=1-101-1
```

To change the ITU-N site identification STP Point Code when a previous ITU-N site identification STP point code exists:

```
chg-sid:pcn=11111:npcn=none
```

To add a new ITU-N 24-bit Capability Point Code:

```
chg-sid:cpcn24=22-22-22
```

To change an existing 24-bit ITN-N Capability Point Code 22 to 33:

```
chg-sid:cpcn24=22-22-22:ncpcn24=33-33-33
```

To add a new EIR-type Capability Point Code:

```
chg-sid:cpctype=eir:cpci=2-30-1
```

To delete an existing ITUI Capability Spare Point Code:

```
chg-sid:cpci=s-2-003-4:ncpci=none
```

To change an existing node ITU-I spare true point code from an assigned point code value to *none*:

```
chg-sid:pci=s-1-234-5:npci=none
```

To change an existing ITU-N spare capability point code from *s-01234* to *s-02092*. The existing CPC is replaced with the new CPC:

```
chg-sid:cpcn=s-01234:ncpcn=s-02092:cpctype=stp
```

To change or add new node true point codes simultaneously, for ITU-I spare and ITU-N spare point code types:

```
chg-sid:pci=s-1-234-5:pcn=s-12345
```

To change an existing node ITU-N spare true point code from an assigned point code value to *none*:

```
chg-sid:pcn=s-12345:npcn=none
```

To change the CPC list to include an ANSI CPC for the G-Port service:

```
chg-sid:cpc=1-2-3:cpctype=gport
```

To change the CPC list to include an ITU-I CPC for the G-Flex service:

```
chg-sid:cpci=2-3-4:cpctype=gflex
```

To change the ITU-N site identification STP Point Code when a previous ITU-N site identification STP point code does not exist:

```
chg-sid:pcn=11112
```

To change the CPC list to include an ANSI CPC for the ATINPQ service:

```
chg-sid:cpc=3-4-6:cpctype=atinpq
```

To change the CPC list to include an ANSI CPC for the AIQ service:

```
chg-sid:cpc=2-3-5:cpctype=aiq
```

To change the CPC list to include an ANSI CPC for the INP service:

```
chg-sid:cpc=1-1-1:cpctype=inp
```

To add a new ITU-N 16-bit Capability Point Code:

```
chg-sid:cpcn16=125-10-25
```

To change an existing 16-bit ITU-N Capability Point Code from 10 to 15:



```
chg-sid:cpcn16=125-10-25:ncpcn16=125-15-25
```

To change the ITU-N16 site identification STP Point Code:

```
chg-sid:pcn16=123-10-25
```

### Dependencies

At least one optional parameter must be specified.

The Spare Point Code Support feature must be enabled before a spare point code (s-) can be specified in the command.

The value specified for the `pcn`, `cpcn`, or `npcn` parameter must be a full point code.

The STP destination and capability point codes can be specified only as full point codes or *none*.

If the `ncpc/ncpca/ncpci/ncpcn/ncpcn24/ncpcn16` parameter is specified, a corresponding existing `cpc/cpca/cpci/cpcn/cpcn24/cpcn16` parameter must be specified.

If the `ncpci` or `npcn` parameter is specified, a corresponding existing `pci` parameter or `pcn` parameter must be specified.

If the `cpctype` parameter is specified, the `cpc/cpca/cpci/cpcn/cpcn24/cpcn16` parameter must be specified.

If the `cpctype` parameter is specified, an `ncpc/ncpca/ncpci/ncpcn/ncpcn24/ncpcn16` parameter cannot be specified in the command.

The values of the `pc/pca/pci/pcn/pcn24/pcn16`, `cpc/cpca/cpci/cpcn/cpcn24/cpcn16`, and `ncpc/ncpca/ncpci/ncpcn/ncpcn24/ncpcn16` parameters cannot be equal.

The STP capability point code type (domain) must match the new STP capability point code type (domain).

If the `cpctype=lnp` parameter is specified, then the `cpc/cpca` parameter must be specified with an ANSI point code value.

If the `cpctype=inp` parameter is specified, the `cpc` parameter and the `cpca` parameter cannot be specified for the point code. An ANSI point code cannot be specified.

The LNP feature must be turned on before the `cpctype=lnp` parameter can be specified.

The INP feature must be on before the `cpctype=inp` parameter can be specified.

The EIR feature must be on before the `cpctype=eir` parameter can be specified.

Only the `pcn` parameter or the `pcn24` parameter can be specified; however, both parameters cannot be specified in the same command.

If a 14-bit ITU-N site ID exists, then a 24-bit ITU-N site ID cannot be assigned. If a 24-bit ITU-N site ID exists, then a 14-bit ITU-N site ID cannot be assigned.

Only one of the `ncpc/ncpca/ncpci/ncpcn/ncpcn24/ncpcn16` parameters can be specified.

If the `pcn`, `npcn`, `cpcn`, or `ncpcn` parameter is specified, the format must match the format that was assigned with the `chg-stpopts:npcfmti` parameter.

The site CLLI code that is specified in the command cannot be the same as an existing route destination CLLI code.

The STP capability point code that is specified in the command cannot be the same as an existing STP capability point code.

The new STP capability point code that is specified in the command cannot be the same as an existing STP capability point code.

If the system is configured for ANSI format point codes, the specified network indicator value (*ni*) of the `pc`, `cpc`, or `ncpc` parameter must be 6 or greater when the specified cluster value (*nc*) is 0.

The true point code and capability point codes cannot be the same as existing secondary point codes.

The existing true point code cannot be changed if it is in the MAP table.

The maximum number of capability point codes that can be provisioned is 96.

If the existing spare ITU-I or spare ITU-N point code is an STP destination point code, then the `npci=none` or `npcn=none` parameter (respectively) cannot be specified.

A value of none cannot be specified for the `cpc/cpca/cpci/cpcn/cpcn24/cpcn16` parameters.

The STP destination point code that is specified in the command cannot be the same as an existing route `dpc` or `cpc`.

The new STP capability point code that is specified in the command cannot be the same as the STP destination point code.

The specified `pci` or `pcn` parameter value must already exist as an STP destination point code.

The STP Site ID Table is corrupt or cannot be found.

The MAS Configuration Table is corrupt or cannot be found.

The Route Table is corrupt or cannot be found.

The Redirect Table is corrupt or cannot be found.

The SPC Table is corrupt or cannot be found.

The G-Flex feature must be turned on to change the capability point code if the `cpctype=gflex` parameter is specified.

The G-Port feature must be enabled before the `cpctype=gport` parameter can be specified.

If the A-Port or the IS41 GSM Migration (IGM) feature is not enabled, the `cpctype=mnpc` parameter cannot be specified.

If the A-Port or IGM feature is enabled, the `cpctype=gport` parameter cannot be specified.

Could not add or change the (new) capability point code to the list due to software error.

The ATINP feature must be enabled before the `cpctype=atinpq` parameter can be specified.

If a value of `aiq`, `atinpq`, or `eir` is specified for the `cpctype` parameter, then the `pcn24` parameter cannot be specified.

The V-Flex feature must be turned on before the `cpctype=vflex` parameter can be specified.

The ANSI41 AIQ feature must be enabled before the `cpctype=aiq` parameter can be specified.

The values specified for the `cpc/cpca/cpci/pcn`, `ncpc/ncpca/ncpci/npcn`, `npc/npca/npci/npcn`, and `pc/pca/pci/pcn` parameters cannot be the same as any Emulated Point Code value in the PCT table.

ANSI or ITUN-24 SID cannot be provisioned if the J7 feature is enabled.

### Notes

If one of the `pc/pca/pci/pcn/pcn24/pcn16` parameters is specified to change the point code, the following message is displayed:

```
CAUTION: SYSTEM SITE ID HAS BEEN CHANGED, MANUAL RE-INITIALIZATION IS  
NEEDED
```

If the redirect function refers to any of the `pc/pca` or `cpc/cpca` parameters, the following message is displayed:

```
CAUTION: SYSTEM SITE ID WAS REFERENCED BY THE REDIRECT FUNCTION'S DPC
```

In order for the change to be fully implemented, you must enter the `init-sys` command. This initializes the entire system, and reloads all LIMs with the new self ID.

Only one ITU-N Site ID point code can be defined at one time (PCN or PCN24). To change from one to the other, the current Site ID must be disabled before the new one can be defined.

When the `cpctype=lnp` parameter is specified, it associates a specific service or capability (for example, local number portability query response and message relay service) with one or more of the capability point codes.

After the CPCTYPE is defined, it cannot be changed.

For initial installation of a system, the self point code must be entered before any destination is entered.

In this command, only ITU-international and ITU national point codes support the spare point code subtype prefix (s-).

When the Site ID is changed, manual initialization is required because an MSU can be in transition between a link card and an SCCP card at the time the SID table is changed. In that case, it is possible for the Destination True Point Code to no longer

appear to belong to the STP node, and SCCP would not know what to do with it. The following message is displayed:

```
CAUTION: SYSTEM SITE ID HAS BEEN CHANGED, MANUAL RE-INITIALIZATION IS NEEDED
```

Introduced for Feature 90773 GFlex Reroute  
Parameter CPCType has new values added for the services GPORT and GFLEX.  
The CPC parameter is used to support incoming messages (DPC = CPC) which are routed via Final GTT (rt-ssn) to the Eagles internal LNP, EIR, and/or INP Subsystems.  
The CPC parameter is also used to support incoming messages which are routed via Intermediate GTT (rt-gt) to the Eagle (with DPC = CPC) for G-FLEX and/or G-PORT Services and Subsystems on HLR's and/or Nodes which are external to the Eagle.

Spare Point Code support is introduced for Feature 53120.

EAGLE documentation uses the terminology "STP Point Code (PC)" in place of the Bellcore terminology "Destination Point Code (DPC)".

The `chg-sid` command is used to identify the STP in the signaling network. STP identity is determined by the Common Language (CLLI) code and the SS7 Destination/True Point Code (DPC). For MTP message discrimination, the STP can also be identified by one or more optional capability codes representing service-related SCCP capabilities resident at the STP.

The CLLI and DPC are used as paired key fields in SEAS to uniquely identify the STP and all SEAS interactions with that STP. This command is viewed as the first command to be used in provisioning a newly commissioned STP or an STP that is being reactivated in a new location or at a new network address.

The `chg-sid` command can also be used to add capability codes to the existing set for that STP after the CLLI and DPC have been initialized. Alternatively, the STP CLLI and DPC can be provisioned locally during installation, and the command used only to add new capability codes. The STP's own CLLI must be provisioned before SEAS-STP communication, in order to support UAL-level interactions.

If the `chg-sid` command is used to change only the capability point code, then the system does not need to be initialized to enable the change.

The `cpctype=vflex` parameter is used to support incoming messages (DPC = CPC) that are routed through Final GTT to the EAGLE V-Flex subsystem.

If the CLLI of the system is entered or changed with the `chg-sid` command, and the SEAS Over IP feature is turned on, then the CCS MR configuration must be changed to include the new EAGLE CLLI value. The following warning message appears:

```
CAUTION: System CLLI has changed, CCSMR re-configuration required
```

The `cpctype=aiq` parameter is used to support incoming messages (DPC = CPC) that are routed through Final GTT to the EAGLE AIQ subsystem.



**Range:***ZZZZZZZZZZZZZZZZ*

A string of 1 to 15 characters. Valid values are hex digits (0-9, A-F), +, \*, -, #.

**npds (optional)**

New prefix digits to be substituted to digit string after deleting the NPDD.

**Range:***ZZZZZZZZZZZZZZZZ*

A string of 1 to 15 characters. Valid values are hex digits (0-9, A-F), and NONE.

**Default:**

No change to the current value

**System Default:***none***npdd (optional)**

Number of prefix digits to be deleted from the incoming digit string.

**Range:***ZZZZZZZZZZZZZZZZ*

An integer in the range of 0 to 15.

**Default:**

No change to the current value.

**System Default:***0***Example**

```
chg-sip-npp:phctxt=abc.com:px=131:npdd=2
```

```
chg-sip-npp:phctxt=xyz.com:px=131:npds=3a
```

```
chg-sip-npp:phctxt=abc.com:px=1:npdd=1:npds=af91
```

```
chg-sip-npp:phctxt=user@xyz.com:px=91*:npdd=1:npds=af91
```

**Dependencies**

SIPNP Feature must be enabled before changing any number normalization rules.

SIP Phone Context table (SIPPHCXT) should be accessible.

SIP Prefix table (SIPNNPFX) should be accessible.

SIP DBMM 2 table should be accessible.

At least one optional parameter must be specified.

The SIP Prefix entry must already exist in the SIPNNPFX table.

The SIP Phone Context entry must already exist in the SIPPHCXT table.

At least one NPDD or NPDS must be specified with non-default (other than 0, NONE) value.

**Notes**

None

**Output**

This example displays the output when all the parameters are specified:

```
chg-sip-npp:phctxt=abc.com:px=1:npdd=1:npds=af91
```

```
tekelecstp 12-07-09 19:12:14 EST EAGLE 45.0.0
chg-sip-npp:phctxt=abc.com:px=1:npdd=1:npds=af91
Command entered at terminal #4.
```

```
PHCTXTID table is (2 of 101) 2% full.
```

```
CHG-SIP-NPP: MASP A - COMPLTD
```

```
;
```

**Related Topics**

- [dlt-sip-npp](#)
- [rtrv-sip-npp](#)
- [ent-sip-npp](#)

## chg-sipopts

Use this command to change SIP configuration. This command updates the SIPOPTS table.

**Parameters****np1kupfail (optional)**

This parameter indicates whether 302 or 404 response is sent, when DN is not found in RTDB lookup.

**Range:**

302

Redirection response.

404

This parameter indicates that RTDB lookup was unsuccessful and DN was not found.

**Default:**

No change to the current value

**System Default:**

404

**nprspfmt (optional)**

This parameter defines format of URI in Contact header, when INCLUDERN is OFF.

**Range:**

*rn*

Routing Number

*rndn*

RN+DN

*ccrndn*

CC+RN+DN

*masddn*

RN+ASD+DN

*masd*

RN+ASD

*grnasd*

GRN+ASD

*rngrndn*

RN+GRN+DN

**Default:**

No change to the current value.

**System Default:**

*rndn*

**off (optional)**

This parameter turns off the specified options.

**Range:**

*includenpdi*

This option indicates to exclude "npdi" parameter in the response in cases where the RTDB dip is successfully performed.

*includern*

This option indicates to exclude "rn" parameter in the response in cases where the RTDB dip is successfully performed.

**on (optional)**

This parameter turns on the specified options.





```
chg-sipopts:rnfmt=rnasd:nplkupfail=302:rncontext=abc.com
```

### Dependencies

SIPNP Feature must be enabled before changing any SIP configuration.

SIPOPTS table should be accessible.

At least one optional parameter must be specified.

The same option cannot be specified for the on and off parameters in the same command.

Only the defined values must be given for the parameters nplkupfail, rnfmt, on, off and nprspfnt.

### Output

```
chg-sipopts:on=includenpdi
```

```
tekelecstp 12-06-22 17:25:00 EST EAGLE 45.0.0
chg-sipopts:on=includenpdi
Command entered at terminal #4.
CHG-SIPOPTS: MASP A - COMPLTD
```

```
;
```

### Related Topics

- [rtrv-sipopts](#)

## chg-slt

Use this command to change the fields of a signaling link test message (SLTM) record in the SLTM table.

### Parameters

#### **sltset (mandatory)**

Signaling link test message record number in the SLTM table.

#### **Range:**

*1 - 20*

#### **enabled (optional)**

Enables the signaling link test message.

#### **Range:**

*on*

*off*

#### **Default:**

No change to the current value

**mode (optional)**

SLTM mode to be used when sending test messages.

**Range:*****special***

All SLTMs generated by the links in the linkset associated with this SLTM record are designated “special” maintenance messages.

***regular***

All SLTMs generated by the links in the linkset associated with this SLTM record are designated “regular” maintenance messages.

**Default:**

No change to the current value

**pattern (optional)**

Test pattern to be sent with a signaling link test message.

**Range:**

aayyyyyyyyyyyyyyyyyyyyyyyyyyyyyyy

2 to 30 alphanumeric characters; valid characters are 0-9, a-f, A-F

An even number of characters must be used in the pattern. The first two characters of the pattern must be letters.

**Default:**

No change to the current value

**t1 (optional)**

Timer 1. The amount of time, in milliseconds, to wait after an SLTM test fails before running the SLTM test again.

**Range:**

4000 - 12000

**Default:**

No change to the current value

**t2 (optional)**

Timer 2. The amount of time, in milliseconds, that should pass between running SLTM tests for a normally functioning signaling link.

**Range:**

30000 - 90000

**Default:**

No change to the current value

**Example**

```
chg-slt:sltset=1:t1=4000:t2=39000:enabled=off:pattern=aabbccdd
```

**Dependencies**

The value of t1 should be greater than the level 3 timer t6 . The level 3 timer t6 can be 100 - 2000 milliseconds. Enter the `rtrv-13t` command to verify the value of the level 3 timer t6.



If the string contains characters other than alphanumeric characters, the entire string must be enclosed in double quotes (" ").  
The string can be entered in upper and lower case; however, the system converts upper case alphabetic characters to lower case.

**Default:**

No change to the parameter value

**System Default:**

*public*

**cmdport (optional)**

SNMP interface command port ID.

**Range:**

*161, 1024..65535*

This is the port that the SNMP agent will monitor for commands such as GET and SET.

**Default:**

No change to the parameter value

**System Default:**

*161*

**trapport (optional)**

SNMP interface trap port ID.

**Range:**

*162, 1024..65535*

This is the port through which the SNMP agent will transmit traps to the Manager.

**Default:**

No change to the parameter value

**System Default:**

*162*

**hb (optional)**

Heartbeat notification interval

**Range**

*0, 60, 120, 300, 600, 900, 1800, 3600, 5400, 7200*

**Default:**

No change to the parameter value

**System Default:**

*60*

**Example**

```
chg-snmp-host:host=snmpmgr:hb=300:trapcomm="newpwd"
```

```
chg-snmp-  
host:ipaddr=10.25.60.99:hb=300:trapcomm="password":cmdport=2000
```

### Dependencies

The specified HOST or IPADDR must exist in the SNMP Host table.

The specified heartbeat value must be within the range for the HB parameter.

The SNMP feature must be enabled before an SNMP Host can be configured.

To locate a table entry, either the HOST or IPADDR parameters must be specified, but both cannot be used in the same command.

The specified CMDPORT and TRAPPORT values must be within the allowed range.

### Notes

None.

### Output

```
chg-snmp-host:ipaddr=10.25.55.25:cmdport=2015:hb=60
```

```
tekelecstp 12-06-13 10:58:26 EST 45.0.0-64.66.0
chg-snmp-host:ipaddr=10.25.55.25:cmdport=2015:hb=60
Command entered at terminal #4.
CHG-SNMP-HOST: MASP A-COMPLTD
;
```

### Related Topics

- [ent-snmp-host](#)
- [dlt-snmp-host](#)
- [rtrv-snmp-host](#)

## chg-snmpopts

Use this command to change the system-wide SNMP Options.

### Parameters

#### **on (optional)**

This parameter turns on the specified options. Up to 8 comma-separated unique options can be specified.

**Range:**

*snmpuim*

#### **off (optional)**

This parameter turns off the specified options. Up to 8 comma-separated unique options can be specified.

**Range:**

*snmpuim*



**Related Topics**

- [rtrv-snmppopts](#)

## chg-srvsel

Use this command to assign the applicable service selectors required to change a service entry for DSM services.

**Parameters** **Note:**

Definitions for the feature options specified by the `on` and `off` parameters are located in the Notes section.

 **Note:**

The nature of address indicator parameters (`naiv` or `nai`) and the numbering plan parameters (`npv` or `np`) can be specified using a mnemonic or an explicit value. The mnemonic or the explicit value can be specified; however, both values cannot be specified at the same time for the same parameter. [NAIV/NAI Mapping](#) shows the mapping between the `naiv` and `nai` values. [Table A-6](#) shows the mapping between the `npv` and `np` values.

**gti/gtia/gtii/gtin/gtin24 (mandatory)**

Global title indicator. For all service selector commands, the domain is defined as GTI and GTIA (ANSI), GTII (ITU international), GTIN (ITU national) and GTIN24 (24-bit ITU national). For the service selector commands, GTI and GTIA are equivalent.

**Range:**

Supported value for ANSI: `gti/gtia=2`

Supported values for ITU: `gtii/gtin/gtin24=2, 4`

**ssn (mandatory)**

Subsystem number.

**Range:**

`0 - 255, *`

**tt (mandatory)**

Translation type.

**Range:**

`0 - 255`

**nai (optional)**

Nature of address indicator.



**Range:***sub**rsvd**natl**intl***Default:**

No change to the current value

**naiv (optional)**

Nature of address indicator value.

**Range:**

0 - 127

**Default:**

No change to the current value

**ndfl1tact (optional)**

New default action ID associated with the service selector entry.

**Range:***ayyyyyyy*

1 leading alphabetic character followed by up to 8 alphanumeric characters

This parameter must have one of the following values:

- a valid GTT Action ID that exists in the GTT Action table and has a GTT Action of *disc/udts/tcaperr*
- *fallback* — Fallback to the relay data. The relayed MSU is routed using routing data provided by the service.
- *falltogtt* — Fallback to GTT. If the *gttselid* parameter has a value other than *none*, and the GTT selector search fails, then the GTT selector search is performed again using *gttselid=none*.

**Default:**

No change to the current value

**ngttselid (optional)**

New GTT Selector ID. The new ID used to perform GTT on the message relayed by the service.

**Range:**0 - 65534, *none**none* — deletes the current value of the GTTSELID field**Default:**

No change to the current value

**np (optional)**

Numbering plan.

**Range:***e164**generic**x121**f69**e210**e212**e214**private***Default:**

No change to the current value

**npv (optional)**

Numbering plan value.

**Range:**

0 - 15

**Default:**

No change to the current value

**nrqdtb1nop**

The action performed if a message arrives at an SCCP card that does not have the necessary RTDB table, and the current message routing is GT.

**Range:***udts*

generate UDTS for the processed MSU

*gtt*

fall through to GTT for the processed MSU

*disc*

discard the processed MSU

**nserv (optional)**

New DSM service.

**Note:**

The GPORT service cannot be used for the Prepaid SMS Intercept Phase 1 (PPSMS) or the Portability Check for Mobile Originated SMS feature; use the SMSMR service. The MNP service includes the G-Port, A-Port, and IS41-to-GSM Migration services.

**Range:**

***eir***  
Equipment Identity Register

***gflex***  
GSM flexible numbering

***gport***  
GSM number portability

***inpq***  
INP query

***inpmr***  
INP message relay

***smsmr***  
Prepaid SMS Intercept Phase 1, Portability Check for Mobile Originated SMS, MO-based GSM SMS NP, MO-based IS41 SMS NP, MO SMS IS41-to-GSM Migration, MO SMS ASD, MO SMS GRN, MO SMS B-Party Routing.

***idpr***  
Prepaid IDP Query Relay

***idps***  
IDP Screening for Prepaid

***mnp***  
Mobile Number Portability

***vflex***  
V-Flex

***atinp***  
ATI Number Portability Query (ATINP)

***ttr***  
Triggerless TCAP Relay

***aiq***  
ANSI41 Analyzed Information Query

**Default:**  
No change to the current value

**nsnai (optional)**  
New service nature of address indicator.

**Range:**

***sub***  
Subscriber number

***natl***  
National significant number

**intl**  
International number

**rnidn**  
Routing number prefix and international dialed/directory number

**rnndn**  
Routing number prefix and national dialed/directory number

**rnsdn**  
Routing number prefix and subscriber dialed/directory number

**none**  
The *nsnai* is not associated with the new DSM service.

**ccrndn**  
Country code, routing number, and national directory number

**Default:**  
No change to the current value

**nsnp (optional)**  
New service numbering plan.

**Range:**

**e164**  
E.164 numbering plan

**e212**  
E.212 numbering plan

**e214**  
E.214 numbering plan

**none**  
The NSNP value is not associated with the new DSM service.

**Default:**  
No change to the current value

**off (optional)**  
Disables or turns off the specified feature options. A comma-separated list of feature options that are requested to be turned off. Up to 10 feature options can be specified in the list.

**Range:**

*gttrqd*

**on (optional)**  
Enables or turns on the specified feature options. A comma separated list of feature options that are requested to be turned on. Up to 10 feature options can be specified in the list.

**Range:**

*gttrqd*

**Example**

```

chg-srvsel:gti=2:tt=10:ssn=250:nserv=gflex

chg-
srvsel:gtin=4:tt=0:ssn=100:np=e164:nai=intl:nsnp=e164:nsnai=rni
dn

chg-srvsel:gtin24=4:tt=4:np=e164:ssn=50:nai=intl:nsnai=rnidn

chg-srvsel:gtii=4:tt=4:np=e164:nai=intl:ssn=10:nserv=eir

chg-
srvsel:gtii=4:tt=4:np=e164:nai=intl:ssn=12:nserv=gport:on=gttrq
d:ngttselid=4:ndfltact=act1

chg-srvsel:gti=2:tt=10:ssn=250:nserv=gflex:nrqdtblnop=gtt

```

**Dependencies**

The G-Flex feature must be turned on before the `nserv=gflex` parameter can be specified.

The INP feature must be turned on before the `nserv=inpnr` or `nserv=inpq` parameter can be specified.

The G-Port feature must be turned on before the `nserv=gport` parameter can be specified.

The Equipment Identity Register (EIR) feature must be turned on before the `nserv=eir` parameter can be specified.

The `nsnp`, `nsnai`, `nserv`, `ndfltact`, `ngttselid`, `on`, or `off` parameter must be specified.

Values 1 and 3 are not valid for the `gti/gtia/gtii/gtin/gtin24` parameters.

Value 4 is not valid for the `gtia` parameter.

If the `gti/gtia/gtii/gtin/gtin24=2` parameter is specified, then the `np(v)` and `nai(v)` parameter combinations cannot be specified.

If the `gtii/gtin/gtin24=4` parameter is specified, then an `np(v)` and `nai(v)` parameter combination must be specified. The parameters can be specified in these combinations: `np/naiv`, `npv/nai`, `np/nai`, or `npv/naiv`.

The `np` and `npv` parameters cannot be specified together in the command.

The `nai` and `naiv` parameters cannot be specified together in the command.

If the `nserv` parameter has a value of `inpnr`, `gport`, or `eir` then the `gtia` and `gti` parameters cannot be specified.

If the `nserv=inpnr` parameter is specified, then the `nsnp=e164` parameter must be specified.

If the value specified for the `nsnai` parameter is `rnidn`, `rnndn`, or `rnsdn`, then the value specified for the `nserv` parameter must be `inpnr`, `gport`, or `smsmr`.

If the `nserv=inpq` parameter is specified, then the `gtii` parameter cannot be specified.

If a value of `aiq`, `atinp`, `eir`, `idpr`, `idps`, `inpq`, `ttr`, or `vflex` is specified for the `nserv` parameter, then only a value of `none` can be specified for the `nsnai` or `nsnp` parameter.

If the `nserv=gflex` parameter is specified, then the `nsnai=none` and `nsnp=none` parameters cannot be specified.

If the `nserv=inpnr` parameter is specified, then the `nsnai` parameter must be specified.

An entry must already exist that exactly matches the `gti/gtii/gtin/gtin24`, `tt`, `ssn`, `np(v)`, and `nai(v)` combination of parameters.

If the `nsnai=ccrndn` parameter is specified, then the value specified for the `nserv` parameter must be `gport` or `smsmr`.

If the value specified for the `nserv` parameter is `inpnr`, `smsmr`, or `gport`, then the `nsnp=e164` parameter must be specified.

If the value specified for the `nserv` parameter is `gflex`, `gport`, `inpnr` or `smsmr`, then the `nsnai` and `nsnp` parameters must be specified.

The `nsnai=none` parameter can be specified only if the value specified for the `nserv` parameter is `atinp`, `eir`, `idps`, `inpq`, `idpr`, `ttr`, or `vflex`.

If the `ansigflex` STP option is enabled (see the `chg-stpotps` command), then an ITU Service Selector cannot be entered.

The Prepaid IDP Query Relay feature must be turned on or the IAR Base feature must be enabled before the `nserv=ttr` parameter can be specified.

If a value of `idpr` or `ttr` is specified for the `nserv` parameter, then the only valid mandatory service parameters are `gtii`, `gtin`, `ssn`, and `tt`, and the only valid optional parameters are `np` and `nai`.

The IDP Screening for Prepaid feature must be turned on before the `nserv=idps` parameter can be specified.

When the `nserv=idps` parameter is specified, the only valid optional service parameters are `np` and `nai`.

If the `nserv=idps` parameter is specified, then the only valid mandatory service parameters are `tt`, `serv`, `ssn`, `gtin`, and `gtii`.

The V-Flex feature must be turned on before the `nserv=vflex` parameter can be specified.

The PPSMS or Portability Check for MO SMS feature must be turned on, or the MO SMS ASD, MO SMS GRN, MO SMS IS41-to-GSM Migration, MO SMS B-party Routing, MO-based GSM SMS NP, or MO-based IS41 SMS NP feature must be enabled before the `nserv=smsmr` parameter can be specified.

The ATINP feature must be enabled before the `nserv=atinp` parameter can be specified.

If a value of `aiq`, `atinp`, or `eir` is specified for the `nserv` parameter, then the `gtin24` parameter cannot be specified.

If the A-Port or IGM feature is enabled, then the `nserv=gport` parameter cannot be specified.

The Prepaid IDP Query Relay feature must be turned on before the `nserv=idpr` parameter can be specified.

The ANSI41 AIQ feature must be enabled before the `nserv=aiq` parameter can be specified.

The A-Port or IGM feature must be turned on, or the A-Port or IGM feature must be enabled and the G-Port feature must be turned on before the `nserv=mnp` parameter can be specified.

If a DSM4G card is active in the system, then the `on=gttrqd` parameter cannot be specified.

The `ndfltact`, `ngttselid`, `on=gttrqd`, and `off=gttrqd` parameters are supported for the IDPR, TTR, MNP, GPORT, SMSMR, GFLEX, and INPMR services.

The GTT Action table is corrupt or cannot be found.

If a GTT Action ID is specified as the value for the `ndfltact` parameter, then the Action ID must already exist in the GTT Action table.

The value specified for the `ndfltact` parameter must be *fallback*, *falltogtt*, or a valid GTT Action ID with an associated GTT Action of *disc/udts/tcaperr*.

The EGTT feature must be turned on before the `ngttselid` or `ndfltact` parameter can be specified.

The same values cannot be specified for the `on` and `off` parameters.

The `ndfltact=none` parameter cannot be specified.

The EPAP Data Split feature or the Dual ExAP Config feature must be ON before the `nrqdtblnop` parameter can be specified.

The `nrqdtblnop=gtt` parameter cannot be specified if:

- an existing service record for the INPQ, VFLEX, ATI NP, or EIR service is being changed
- a value of *inpq*, *vflex*, *atinp*, or *eir* is specified for the `nserv` parameter

The `nrqdtblnop` parameter cannot be specified if:

- an existing AIQ or IDPS service record is being changed
- a value of *aiq* or *idps* is specified for the `nserv` parameter

If the `serv=inpq` parameter is specified, then the `gtti` parameter cannot be specified.

If the value specified for the `serv` parameter is *gport* or *smsmr*, then the `snp=e164` parameter must be specified.

The requested service selector entry must exist in the database.

The GSM DBMM table must be accessible.

## Notes

### on/off options

- *gttrqd* —GTT required. Specifies whether GTT is required after service execution is complete and the message is relayed by the service. This option is supported for the IDPR, MNP, TTR, GPORT, SMSMR, GFLEX, and INPMR services.

### Output

```
chg-srvsel:gti=2:tt=10:ssn=25:nserv=aiq

      tekelecstp 09-12-03 16:40:40 EST  EAGLE 42.0.0
      Service Selector table is (115 of 1024) 11% full
      CHG-SRVSEL: MASP A - COMPLTD
;
```

### Related Topics

- [dlt-srvsel](#)
- [ent-srvsel](#)
- [rtv-srvsel](#)

## chg-ss-appl

Use this command to change the application status in the database.

### Parameters

#### **app1 (mandatory)**

Application type.

#### **Range:**

*Inp*

*inp*

*eir*

*vflex*

*atinpq*

*aiq*

#### **nstat (mandatory)**

Status.

#### **Range:**

*offline*

*online*

#### **nrqdtblnop**

The action performed with a message that arrives at an SCCP card that does not have the necessary RTDB table, and the current message routing is subsystem.



**Range:****udts**

generate UDTs for the processed MSU

**disc**

discard the processed MSU

**Example**

```
chg-ss-appl:appl=lnp:nstat=offline
```

```
chg-ss-appl:appl=atinpq:nstat=online
```

```
chg-ss-appl:appl=inp:nstat=offline:nrqdtblnop=disc
```

**Dependencies**

The LNP feature must be turned on before the `appl=lnp` parameter can be specified.

The INP feature must be turned on before the `chg-ss-appl:appl=inp` command can be entered.

The Equipment Identity Register (EIR) feature must be turned on before the `chg-ss-appl:appl=eir` command can be entered.

The application type (`appl` parameter) must already exist in the SS-APPL table.

The LNP database is corrupt or cannot be found.

The subsystem must be in the opposite state of the requested change.

The subsystem must be inhibited before `status=offline` can be specified.

Application type must exist in the LNP database

Application type not in SS-APPL table

The SSAPPL table must be accessible (non-DBS 1.0 systems only).

The SSAPPL table must be accessible (DBS 1.0 systems only)

The V-Flex feature must be turned on before the `appl=vflex` parameter can be specified.

The ATINP feature must be enabled before the `appl=atinpq` parameter can be specified.

The ANSI41 AIQ feature must be enabled before the `appl=aiq` parameter can be specified.

The EPAP Data Split feature OR Dual ExAP Config feature must be turned on before the `nrqdtblnop` parameter can be specified.

If the `appl=aiq` parameter is specified, then the `nrqdtblnop` parameter cannot be specified.

## Notes

After the LNP subsystem is inhibited before performing an LNP ELAP bulk download, `chg-ss-appl:appl=lnp:nstat=offline` must be entered to ensure that the subsystem remains down through Service Module card replacements and reloads.

## Output

```
chg-ss-appl:appl=aiq:nstat=offline
```

```
tekelecstp 09-12-03 13:35:40 EST  EAGLE 42.0.0
CHG-SS-APPL: MASP A - COMPLTD
;
```

## Related Topics

- [dlt-ss-appl](#)
- [ent-ss-appl](#)
- [rtrv-ss-appl](#)

# chg-ss7opts

Use this command to update (change by simple replacement) the values of one or more of the SS7 option indicators maintained in the STP Options table. SS7 options can modify normal handling of SS7 traffic.

## Parameters

### **ddbaudtimer (optional)**

Dynamic database audit timer. The amount of time, in minutes, between the end of an automatic dynamic database audit and the beginning of the next automatic dynamic database audit.

#### **Range:**

*5 - 1440, none*

*none* —disables the automatic dynamic database audit

#### **Default:**

No change to the current value

#### **System Default:**

*10*

### **discardtfc (optional)**

This parameter enables and disables the handling of TFC traffic from ITU-I networks. If enabled, TFC traffic from ITU-I networks will be discarded.

**Range:**

**on**  
Discard TFC ITU-I traffic

**off**  
Do not discard TFC ITU-I traffic

**System Default:**

*off*

**discardtfcn (optional)**

This parameter enables and disables the handling of TFC traffic from ITU-N networks. If enabled, TFC traffic from ITU-N networks will be discarded.

**Range:**

**on**  
Discard TFC ITU-N traffic

**off**  
Do not discard TFC ITU-N traffic

**System Default:**

*off*

**lsrestrict (optional)**

Use the restricted linkset routing determination algorithm. This parameter enables and disables the restricted linkset routing determination algorithm on a system-wide basis.

**Range:**

**on**  
Restrictive linkset routing enabled; route traffic on the least restrictive available route with the lowest cost.

**off**  
Restrictive linkset routing disabled; route traffic on the lowest cost route.

**Default:**

No change to the current value

**System Default:**

*off*

**msgpri2itui (optional)**

Message Priority to ITUI. The priority for messages that cross to an ITUI network.

**Range:**

*0 - 3, dflt*

*0-3* —The priority for any MSU crossing to an ITUI network is set to the provisioned value. MSUs crossing to ANSI networks are not affected.

*dflt* —Messages retain their original functionality

**Default:**

No change to the current value

**System Default:***dflt***msgpri2itun (optional)**

Message Priority to ITUN. The priority for messages that cross to an ITUN or ITUN-24 network.

**Range:***0 - 3, dflt*

*0- 3* —The priority for any MSU crossing to an ITUN or ITUN-24 network is set to the provisioned value. MSUs crossing to ANSI networks are not affected.

*dflt* —Messages retain their original functionality

**Default:**

No change to the current value

**System Default:***dflt***s1ancporgopc (optional)**

This parameter specifies whether to copy the originating point code (OPC) from the incoming MSU to the STPLAN application.

**Range:*****on***

Copy the OPC from the incoming MSU to the STPLAN application.

***off***

Do not copy the OPC from the incoming MSU to the STPLAN application.

**System Default:***off***s1an1sn (optional)**

SLAN linkset name. This parameter specifies whether to copy the incoming and outgoing linkset names into the STPLAN message format.

**Range:*****on***

Copy the incoming and outgoing linkset names into the STPLAN message format.

***off***

Do not copy the incoming and outgoing linkset names into the STPLAN message format.

**Default:**

No change to the current value

**System Default:***off***s1sreplace (optional)**

Signaling link selector replace. This parameter enables the EAGLE to replace the SLS for an ANSI message with a random generated SLS value by Random SLS feature .

 **Note:**

The `randsls=perls` parameter must be specified in the `chg-stpopts` command and a `randsls` parameter value other than `off` must be specified on the individual ANSI incoming linkset before the SLS can be replaced. The size of the SLS in the outgoing message is based on the `STPOPTS:SLSREPLACE` parameter, ingress linkset ASL8 parameter and 5->8 bit conversion option. Please refer to *Database Administration - SS7 User's Guide, Per-Linkset Random SLS* for more details.

**Range:****no**

Do not replace the SLS in an outgoing message with a randomly generated SLS.

**yes**

Replace the SLS in an outgoing message with a randomly generated SLS.

**Default:**

No change to the current value.

**System Default:**

*no*

**Example**

```
chg-ss7opts:lsrestrict=on
chg-ss7opts:slanporgopc=on
chg-ss7opts:slsreplace=yes
chg-ss7opts:ddbbaudtimer=5
chg-ss7opts:ddbbaudtimer=none
chg-ss7opts:slanlsn=on
```

**Dependencies**

At least one optional parameter must be specified.

When the `lsrestrict=on` parameter is specified, the `tfatcabmlq` parameter value for C linksets can be changed to a non-zero value (see the `chg-ls` command). If the `tfatcabmlq` parameter in any C linkset has been changed to a non-zero value, the `tfatcabmlq` value must be set back to 0 for all C linksets before the `lsrestrict` parameter can be turned off.

The STP Options Table is corrupt or cannot be found by the system.

The STP LAN feature must be turned on before the `slanporgopc` or `slanlsn` parameter can be specified.

**Notes**

None

## Output

```
chg-ss7opts:slancporgopc=on

tekelecstp 08-09-26 15:22:38 EST EAGLE 39.2.0
CHG-SS7OPTS: MASP B - COMPLTD
;
```

## Related Topics

- [rtrv-ss7opts](#)

# chg-stpopts

Use this command to change the values of one or more of the STP node level processing option indicators maintained in the STP's options table. All values are assigned initially to system defaults at STP installation time, and they may be updated subsequently using this command.

### Note:

For those STP option attributes supporting STP event message throttling, the values for the indicated parameters shall become effective in the next event-message output interval following their activation. All other updates shall be effective immediately, as of the time of activation.

## Parameters

### Note:

If the *cnvcgda*, *cnvcgdi*, *cnvcgdn*, or *cnvcgdn24* parameter has a value of *no* (or a value of *cnvcgda*, *cnvcgdi*, *cnvcgdn*, or *cnvcgdn24* is specified for the *off* parameter), and the CGPA cannot be converted during processing, then the MSU is discarded.

### **ansigflex (optional)**

This parameter enables ANSI G-Flex to execute at 1700 TPS per DSM card.

#### Range:

**yes**  
Enabled

**no**  
Disabled

#### Default:

No change to the current value

**System Default:***no***archbldid (optional)**

Archive build ID. This parameter specifies whether the database archive file name contains the EAGLE build number instead of the release number.

**Range:*****on***

The file name contains the build number.

***off***

The file name contains the release number.

**Default:**

No change to the current value

**System Default:***off***cnvcgda (optional)**

This parameter enables discarding of the CGPA point code in SCCP messages if the destination network type is ANSI, and the point code or alias point code of the destination network type is not defined.

**Range:*****yes***

Enabled

***no***

Disabled

**Default:**

No change to the current value

**System Default:***no***cnvcgdi (optional)**

This parameter enables discarding of the CGPA point code in SCCP messages if the destination network type is ITU-I, and the point code or alias point code of the destination network type is not defined.

**Range:*****yes***

Enabled

***no***

Disabled

**Default:**

No change to the current value

**System Default:***no***cnvcgdn (optional)**

This parameter enables discarding of the CGPA point code in SCCP messages if the destination network type is ITU-N, and the point code or alias point code of the destination network type is not defined.

**Range:****yes**

Enabled

**no**

Disabled

**Default:**

No change to the current value

**System Default:***no***cnvcgdn24 (optional)**

This parameter enables discarding of the CGPA point code in SCCP messages if the destination network type is ITU-N24, and the point code or alias point code of the destination network type is not defined.

**Range:****yes**

Enabled

**no**

Disabled

**Default:**

No change to the current value

**System Default:***no***cnvcgdn16 (optional)**

This parameter enables discarding of the CGPA point code in SCCP messages if the destination network type is ITU-N16, and the point code or alias point code of the destination network type is not defined.

**Range:****yes**

Enabled

**no**

Disabled

**Default:**

No change to the current value



**System Default:***no***criticalinh (optional)**

Critical alarm inhibit. This parameter enables inhibiting of critical alarms.

**Range:****yes**

Enabled

**no**

Disabled

**Default:**

No change to the current value

**System Default:***no***defcc (optional)**

Default country code.

**Range:**1-3 digits, *none*.

Valid digits are 0-9, A-F, a-f

*none* —Deletes the current value.**Default:**

No change to the current value

**defndc (optional)**

Default network destination code.

**Range:**1-5 digits, *none*

Valid digits are 0-9, a-f, A-F

*none* —Deletes the current value.**Default:**

No change to the current value

**dispactalms (optional)**

Display active alarms. This parameter displays active or total alarms in the alarm status area of the VT320 screen (see [Figure 2-1](#)). The alarm status area comprises four boxes to show counts for critical, major, minor, and inhibited alarms. When total alarms are displayed (`dispactalms=no`), the counts for critical, major, and minor alarms include any temporarily or permanently inhibited alarms. The alarm status area is labeled *Total Alarm Status*. When active alarms are displayed (`dispactalms=yes`), the counts for critical, major, and minor alarms do not include any temporarily or permanently inhibited alarms. The alarm status area is labeled *Active Alarm Status*. This parameter does not affect the count displayed in the inhibited box; the number of inhibited alarms is always displayed.

**Range:****yes**

Enabled; active alarm status is displayed

**no**

Disabled; total alarm status is displayed

**Default:**

No change to the current value

**System Default:***no***dsmaud (optional)**

Service Module card audit running state.

**Range:****on**

Running

**off**

Not running

**ccc**

Running with Corruption Cross Correction enabled. EAGLE LNP, G-Flex, G-Port, INP, or V-Flex systems contain  $n+1$  Service Module cards (maximum 32) running the VSCCP application. Each Service Module card contains a full image of the RTDB database. If a record within the RTDB database on any card should become corrupted, a mate Service Module card can supply the corrected data. The `dsmaud=ccc` parameter enables the Corruption Cross Correction function used by the system to obtain the correct data from a mate Service Module card.

**Default:**

No change to the current value

**System Default:***off***gdpc (optional)**

Specifies the value used to set the ANSI destination point code field in the routing label of the MSU that is being duplicated. The point code has subfields *network indicator-network cluster-network cluster member* (*ni-nc-ncm*).

**Synonym:**

gdPCA

**Range:**

000---255, none

Specify a valid value for each subfield of the point code, and separate the subfields with a dash (-).

When `chg-sid:pctype=ansi` is specified, `ni = 000` is not valid.

When `chg-sid:pctype=ansi` is specified, `nc = 000` is not valid if `ni = 001-005`.

When `chg-sid:pctype=ansi` is specified, `nc = 000` is valid if `ni = 006-255`.

Enter *none* to delete the point code.

The point code *000-000-000* is not a valid point code.

**Default:**

Current value

**gdpc/gdpca/gdpci/gdpcn24/gdpcn16 (optional)**

Destination point code.

**gdpci (optional)**

Specifies the value used to set the ITU international destination point code field in the routing label of the MSU that is being duplicated. The point code has subfields *zone-area-id*.

**Range:**

*0---255, none*

Specify a valid value for each subfield of the point code, and separate the subfields with a dash (-).

The point code *0---000---0* is not a valid point code.

*zone---0---7*

*area---000---255*

*id---0---7*

Enter *none* to delete the point code.

**Default:**

Current value.

**gdpcn (optional)**

Specifies the value used to set the ITU national destination point code field in the routing label of the MSU that is being duplicated. The point code is in the format of a 5-digit number (*nnnnn*); or 2, 3, or 4 numbers (members) separated by dashes (*m1-m2-m3-m4*) when the `chg-stpopts:npcfmt1` flexible point code option is on. A group code (*gc*) must be specified when the ITUDUPPC feature is on (*nnnnn-gc, m1-m2-m3-m4-gc*).

**Range:**

*0---16383, aa---zz, none*

Specify a valid value for each subfield of the point code, and separate the subfields with a dash (-).

*nnnnn---0---16383*

*gc---aa---zz*

*m1--m2--m3--m4---0--14* for each member; values must sum to 14.

Enter *none* to delete the point code.

**Default:**

Current value.

**gdpcn24 (optional)**

Specifies the value used to set the 24-bit ITU national destination point code field in the routing label of the MSU that is being duplicated. The point code has subfields *main signaling area-sub signaling area-signaling point (msa-ssa-sp)*.

**Range:**

*000--255, none*

Specify a valid value for each subfield of the point code, and separate the subfields with a dash (-).

*msa---000---255*

*ssa---000---255*

*sp---000---255*

Enter *none* to delete the point code.

**Default:**

Current value.

**gdpcn16 (optional)**

Specifies the value used to set the 16-bit ITU national destination point code with subfields *unit number, sub number area, main number area (un-sna-mna)*.

**Range:**

*000--127, none*

Specify a valid value for each subfield of the point code, and separate the subfields with a dash (-).

*un---000---127*

*sna---000---15*

*mna--000---31*

Enter *none* to delete the point code.

**Default:**

Current value.

**gsmdecerr (optional)**

GSM MAP screening decode error action.

**Range:***pass**discard***Default:**

No change to the current value

**System Default:***pass***gsmdflt (optional)**

GSM MAP screening default action.

**Range:***pass**discard***Default:**

No change to the current value

**System Default:***pass***gtcnvdf1t (optional)**

This parameter enables routing of SCCP messages using system defaults when an appropriate entry is not found in the Default GT Conversion Table.

**Range:***yes*

Enabled

*no*

Disabled

**Default:**

Current value

**System Default:***no***mtpdpcq (optional)**MTP destination point code quantity. The maximum number of DPCs that can be provisioned from the STP. The value of this parameter depends on the number of x-list entries that can be provisioned using the `mtpx1q` parameter. If the number of destinations that can be provisioned is increased, the number of x-list entries that can be maintained is decreased.**Range:***500 - 10000**500-2000* —if the DSTN5000 feature is not turned on*500-5000* —if the DSTN5000 feature is turned on

500–6000 —if the 6000 Routesets feature is enabled  
500–7000 —if the 7000 Routesets feature is enabled  
500–8000 —if the 8000 Routesets feature is enabled  
500–10000 —if the 10,000 Routesets feature is enabled

**Default:**

No change to the current value

**System Default:**

2000

**mtplprst (optional)**

MTP low priority route set test. This parameter specifies whether low priority route set polling is enabled or disabled at the STP.

**Range:**

**yes**

Enabled

**no**

Disabled

**Default:**

Current value

**System Default:**

yes

**mtpltcctdpcq (optional)**

MTP loop test congestion trigger DPC quantity. The number of most frequently occurring DPCs to which the MTP loop test messages are to be sent when the MTP loop test is triggered by congestion.

**Range:**

3 - 10

**Default:**

No change to the current value

**System Default:**

3

**mtplti (optional)**

MTP loop test indicator. This parameter specifies whether the MTP loop detection procedures are enabled or disabled at the STP.

**Range:**

**yes**

Enabled

**no**

Diabled

**Default:**

Current value

**System Default:**

yes

**mtp1tst (optional)**

MTP loop test supervision timer. The amount of time, in milliseconds, that the MTP loop test detection procedures run when started.

**Range:**

10000 - 20000

**Default:**

Current value

**System Default:**

10000

**mtparsi (optional)**

MTP Restart indicator. This parameter specifies whether ANSI and ITU MTP Restart procedures are enabled at the STP.

**Range:****yes**

enable restart procedures

**no**

do not enable restart procedures

**Default:**

Current value

**System Default:**

no

**mtprsit (optional)**

ANSI MTP Restart isolation timer. The minimum duration of node isolation, in milliseconds, before the ANSI MTP Restart procedure is deemed necessary.

**Range:**

2000 - 900000

**Default:**

No change to the current value

**System Default:**

5000

**mtp10alt (optional)**

MTP T10 alternate timer, in milliseconds. The interval at which the STP performs a route set test on low priority routes. The value of this parameter must be equal to or greater than the value of the level 3 T10 timer.

**Range:**

20000 - 10000000

**Default:**

No change to the current value

**System Default:**  
30000

**mtpt31ctl (optional)**

MTP T31 congestion trigger level. The signaling link congestion level at which the system starts the level 3 t31 timer. When the level 3 t31 timer expires, the associated signaling link is removed from service for realignment.

**Range:**  
1 - 2

**Default:**  
No change to the current value

**System Default:**  
1

**mtpx1et (optional)**

MTP x-list expiration time. The maximum amount of time the system maintains an unreferenced dynamic status exception list (x-list) entry. This parameter must be specified in one of the following formats: *mm*, *hmm*, or *hhmm*, where *m* is minutes and *h* is hours. For example, 43 is 43 minutes, 138 is 1 hour 38 minutes, and 2400 is 24 hours.

**Range:**  
0020 - 2400

**Default:**  
No change to the current value

**System Default:**  
0100

**mtpx1ot (optional)**

MTP x-list occupancy threshold. The dynamic status exception list (x-list) occupancy threshold at which the system raises a minor alarm. The threshold is expressed as a percentage of space available.

**Range:**  
0 - 100

**Default:**  
No change to the current value

**System Default:**  
90

**mtpx1q (optional)**

MTP x-list quantity. The number of dynamic status exception list (x-list) entries the system maintains. The value of this parameter is dependent directly on the number of destinations that are provisioned using the `mtpdpcq` parameter.

**Range:**  
500 - 10000  
500-2000 —if the DSTN5000 feature bit is not turned on  
500–5000 —if the DSTN5000 feature bit is turned on



500–6000 —if the 6000, 7000, or 8000 Routesets feature is enabled  
500–10000 —if the 10,000 Routesets feature is enabled

**Default:**

Current value

**System Default:**

500

**npcfmt*i* (optional)**

ITU National Point Code Format Identifier. This parameter specifies how the ITU national point code is entered into the database and how it is displayed in any outputs from the system. The ITU national point code is a 14-bit integer. The point codes can be a single number up to five digits, or two, three, or four numbers separated by dashes. This parameter specifies the number of bits to allow in each position of the four members.

**Range:**

*m1-m2-m3-m4*: Four members where each member represents the number of bits allowed in the corresponding position for a flexible ITU national point code. The range of each member (*m1–m4*) is from 0 - 14.

Each member must be specified no matter how many numbers the point code format contains, and the sum of *m1+m2+m3+m4* must equal 14 (for example, *npcfmti=7-7-0-0* or *npcfmti=0-6-8-0*).

[Table 4-16](#) defines the values of the parts of the ITU national point code.

Number of Bits in Point Code Section								
Bit	0	1	2	3	4	5	6	7
Range of Values	Not used	0-1	0-3	0-7	0-15	0-31	0-63	0-127
Bit	8	9	10	11	12	13	14	
Range of Values	0-255	0-511	0-1023	0-2047	0-4095	0-8191	0-16383	
NPCFMTI Value		Range of Point Code Values						
7-7-0-0		0-0 to 127-127						
0-6-8-0		0-0 to 63-255						
0-0-4-10		0-0 to 15-1023						
3-8-3-0		0-0-0 to 7-255-7						
2-9-2-1		0-0-0-0 to 3-511-3-1						
4-4-4-2		0-0-0-0 to 15-15-15-3						
14-0-0-0		00000 to 16385						

**Default:**

No change to the current value

**System Default:**

14-0-0-0

**off (optional)**

Disables or turns off the specified feature options. A comma-separated list of feature options that are requested to be turned off. Up to 8 feature options can be specified in the list.

**Range:***ansigflex**archblidid**cnvcgda**cnvcgdi**cnvcgdn**cnvcgdn24**critalminh**dispactalms**gbsusnminm**gtcnvdfilt**mtplprst**mtplti**mtprsi**rptlnpmrss**rstrdev**uimrd***on (optional)**

Enables or turns on the specified feature options. A comma-separated list of feature options that are requested to be turned on. Up to 8 feature options can be specified in the list.

**Range:***ansigflex**archblidid**cnvcgda**cnvcgdi**cnvcgdn**cnvcgdn24*

*critalminh*  
*dispactalms*  
*epap240m*  
*epapx*  
*gbsusnminm*  
*gtcnvdfit*  
*mtplprst*  
*mtplti*  
*mtprsi*  
*rptlnpmrss*  
*rstrdev*  
*uimrd*

**pcn16fmt (optional)**

PCN16 point code can be provisioned in two formats: first format is 745 (un-sna-mna) and second format is 547 (mna-sna-un).

**Range:**

**745**  
un-sna-mna

**547**  
mna-sna-un

**Default:**

No changes to the current value

**System Default:**

745

**pct (optional)**

The method used to apply PCT to MSUs.

**Range:**

**off**  
do not apply PCT to any MSU

**on**  
apply PCT to all MSUs

**lset**  
apply PCT to MSUs that are coming in or going out on a link that belongs to a linkset where PCT is provisioned (see the `chg-lsopts` command)

**Default:***off***randsls (optional)**

Random SLS (signaling link selection) option. This parameter enables the system to ignore the incoming SLS value and randomly generate a new SLS value to select an outgoing linkset and a link. This parameter is implemented independently of the SLS Enhancement feature settings for individual linksets, which are defined by the `slsobit` and `slsrsb` parameters of the `ent/chg-ls` commands. For ITU the value specified for the `randsls` parameter in the `chg-stpopts` command will override the value specified for the `randsls` parameter for each individual linkset. To use the `randsls` with ANSI, the value for `randsls` must be specified as `perls`.

To enable random SLS generation per linkset, the `randsls=perls` parameter must be specified. When this parameter is specified, the SLS Bit Rotation capability (set with the `slsrsb` parameter of the `ent/chg-ls` command) is overridden, and cannot be used on individual linksets. The `ent/chg-ls` commands do not prevent the user from provisioning with the parameter and also enables the user to restrict Random SLS generation to Class 0 messages only.

This parameter is implemented independently of the SLS Enhancement feature settings for individual linksets. These settings are specified by the `slsobit` (Use of the Other CIC BIT capability) and `slsrsb` (SLS Bit Rotation capability) parameters of the `ent/chg-ls` commands. When the SLS Enhancement is turned on with the `randsls=all` or `randsls=class0` parameters, the SLS Bit Rotation capability (set with the `slsrsb` parameter of the `ent/chg-ls` command) is overridden, and cannot be used on individual linksets. The `ent/chg-ls` commands do not prevent the user from provisioning with the `slsrsb` parameter.

When `randsls=perls` is specified, the `randsls` parameter needs to be individually enabled on outgoing linksets for ITU traffic and on incoming linksets for ANSI traffic, to get the feature working for the particular traffic.

**Range:*****class0***

Enables random SLS generation for ITU Class0 SCCP traffic. (Not compatible with ANSI)

***all***

Enables random SLS generation for both ITU Class0 & Class1 SCCP traffic. (Not compatible with ANSI)

***off***

Disables random SLS generation for both ITU and ANSI traffic

***perls***

Enables random SLS generation on a per-linkset basis for ITU Traffic (SCCP Class0 or both SCCP Class0 & Class1 instead of a system-wide basis) and for ANSI traffic (SCCP Class0 or both SCCP Class0 & ISUP).

**Default:**

No change to the current value

**System Default:***off*

**rptlnpmrssl (optional)**

Report LNP MR SS unequipped. This parameter specifies whether to generate UIM 1049 for LNP message relay (MR) messages with missing subsystems. If no MAP entry is found from a GTT done on an LNP MR message, the UIM is either displayed (`rptlnpmrssl=yes`) or suppressed (`rptlnpmrssl=no`). This setting applies only to LNP MR messages. All other messages display UIM 1049 when no MAP entry is found, regardless of this setting.

**Range:****yes**

Display UIM 1049 for all messages.

**no**

Do not display UIM 1049 for LNP MR with missing subsystems.

**Default:**

No change to the current value

**System Default:**

yes

**rstrdev (optional)**

Restore device state. This parameter enables restoration of device states when the `init-sys` command is executed and when an OAM role change occurs and maintains the inhibited state of terminals, links, and cards.

 **Caution:**

An `init-sys` command causes the system to go down.

**Range:****on****off****Default:**

No change to the current value

**System Default:**

off

**secmtpmate (optional)**

This parameter enables security screening for MTP messages received by an STP on a non-C-Link, with an OPC equal to the SID (True, Adjacent, or Capability) point code of its mate.

**Range:****off**

Screening is disabled; message is processed normally

**notify**

Screening is enabled; UIM is generated and message is discarded

**silent**

Screening is enabled; message is discarded. No UIM is generated

**test**

Screening is enabled; UIM is generated and message is processed normally

**Default:**

No change to the current value

**System Default:**

*off*

**secmtpsid (optional)**

This parameter enables security screening for MTP messages received at MTP3 containing an OPC equal to its own SID (OPC that is the True, Secondary, or Capability point code entered in the `chg-sid` command) that is not a route-set-congestion-message. The system should not receive a message with its own OPC unless the message is a result of a circular route test or is an SLTM when the far end is in loopback. (SLTM messages are not checked.)

**Range:****off**

Screening is disabled; message is processed normally.

**notify**

Screening is enabled; UIM is generated and message is discarded.

**silent**

Screening is enabled; message is discarded. No UIM is generated.

**test**

Screening is enabled; UIM is generated and message is processed normally.

**Default:**

Current value

**System Default:**

*off*

**secmtpsnm (optional)**

This parameter enables security screening for MTP SNM messages. The system should not receive an MTP network management message unless:

- The OPC is an adjacent point code. (For all link types, this rule does not apply to UPU, TFC, and RCT messages.)
- The system has a route to the OPC of the MTP network management message on the linkset which the message was received.
- The system has a route to the destination field in the message (if applicable to the concerned message) on the linkset which the message was received. (For all link types, this rule does not apply to RST messages.)

**Range:*****off***

Screening is disabled; message is processed normally

***notify***

Screening is enabled; UIM is generated and message is discarded

***silent***

Screening is enabled; message is discarded. No UIM is generated

***test***

Screening is enabled; UIM is generated and message is processed normally

**Default:**

No change to the current value

**System Default:**

*off*

**secsccpscmsg (optional)**

This parameter enables security screening for SCCP SCMG messages. The system should not receive an SCCP network management message unless:

- The system has a route to the OPC of the SCMG message on the linkset on which the message was received.
- The system has a route to the Affected Point Code (Concerned Point Code) in the message on the linkset on which the message was received.

This parameter applies only to SSP and SOR messages. SSA, SST, SOG, SBR, SNR and SRT messages are not affected.

**Range:*****off***

Screening is disabled; message is processed normally.

***notify***

Screening is enabled; UIM is generated and message is discarded.

***silent***

Screening is enabled; message is discarded. No UIM is generated.

***test***

Screening is enabled; UIM is generated and message is processed normally.

**Default:**

No change to the current value

**System Default:**

*off*

**s1scnv (optional)**

Per node SLS conversion indicator.

**Range:*****on***

SLS conversion is enabled on all linksets

***off***

SLS conversion is disabled on all linksets

***perls***

SLS conversion is enabled on a per linkset basis

**Default:**

No change to the current value

**System Default:***off***tfatfrpr (optional)**

TFA/TFR pacing rate. The amount of time, in milliseconds, between partial broadcasts of up to 20 percent increments of the number of TFAs/TCAs or TFRs/TCRs to be broadcast by the STP when an affected destination becomes accessible using its primary route rather than an alternate route. The STP uses this pacing to prevent congestion on the newly recovered linksets.

**Range:***0 - 1000*

Set in increments of 100

**Default:**

No change to the current value

**System Default:***1000***uimrd (optional)**

Unsolicited Information Message (UIM) redirect indicator. This parameter specifies whether the UIMs are to be routed to the specified output group.

**Range:*****yes***

Enabled

***no***

Disabled

**Default:**

No change to the current value

**System Default:***no***uithrottle (optional)**

UI pacing rate. This parameter specifies the speed at which UI output is sent to the terminals. Zero represents the most throttling, or the slowest output. Nine represents the least throttling, or the fastest output.



**▲ Caution:**

Before changing the `uithrottle` value from the default, the terminals must be set to the 115200 baud rate. If the `uithrottle` value is changed without updating the terminals, output could be lost.

**Range:**

0--9

**Default:**

No change to the current value

**System Default:**

0

**visualization (optional)**

System wide visualization option. This parameter specify whether the visualization is disable or specific visualization is enable as per below options.

**Range:**

*off* : Visualization feature is disable

*uim* : Only UIM visualization is enable

*msg* : Only message visualization is enable

*All*: Both UIM and MSG visualization is enable.

**Default:**

No change to the current value

**System Default:**

*off*

**Example**

```
chg-stpopts:mtpt31ctl=2:uimrd=yes
chg-stpopts:mtpxlq=1000:mtpxlet=0200:mtpxlot=75
chg-stpopts:npcfmti=4-4-4-2
chg-stpopts:rptlnpmrss=no
chg-stpopts:rstrdev=on
chg-stpopts:hsclksrc=t1framed
chg-stpopts:hsclksrc=e1unframed:force=yes
chg-stpopts:hsclkl1=shorthaul
chg-stpopts:cnvcgda=yes
chg-stpopts:randsls=perls
chg-stpopts:pct=on
```

```
chg-stpopts:mtpdpcq=10000
chg-stpopts:cnvcgdn16=on
chg-stpopts:pcn16fmt=547
chg-stpopts:gdpca=2-2-2
chg-stpopts:epapx=on
```

### Dependencies

The values of the `mtpdpcq` and `mtpxlq` parameters are interdependent; that is, to increase the number of DPCs that can be provisioned, the number of x-list entries that the STP is to maintain must be decreased. Conversely, to increase the number of x-list entries that the STP maintains, the number of DPCs that can be provisioned must be decreased.

At least one optional parameter must be specified.

The ANSI/ITU SCCP Conversion feature must be enabled before the `cnvcgda`, `cnvcgdi`, `cnvcgdn`, `cnvcgdn24`, or `gtcnvdf1t` parameters can be specified.

To allow ANSI GFLEX and other EPAP-based features to co-exist, the E5-SM4G Throughput Cap quantity key for 6800 must be enabled.

The `ansigflex` option cannot be enabled if a DSM is equipped in the system AND one or more of the following features are Enabled:

- 1100 TPS/DSM for ITU NP
- A-Port
- AINPQ
- ATINP
- EIR
- G-Flex MAP Layer Routing
- G-Port
- Info Analyzed Relay Base
- INP
- IS41 GSM Migration
- Prepaid Short Message Intercept Phase 1 (PPSMS)
- MO SMS ASD
- MO SMS GRN
- MO SMS IS41-to-GSM Migration
- MO-based GSM SMS NP
- MO-based IS41 SMS NP
- Portability Check for MO SMS
- TIF Number Portability
- TIF Number Substitution
- TIF Selective Screening

- TIF Subscr CgPN Blacklist
- V-Flex

The G-Flex feature must be on before the `ansigflex` option can be enabled.

The `ansigflex` option cannot be enabled when Service Selector table contains an ITU entry. (See the `chg-srvsel` command.)

When the `mtpxlet` parameter is specified, the value for minutes (*mm*) must be in the range 00-59.

The DSTN5000 (5000 Routes) feature must be turned on before the `mtpdpcq` parameter value can be increased to more than 2000.

When the number of x-list entries (`mtpxlq` parameter) is specified, the total number of DPCs (`mtpdpcq` parameter) and x-list entries provisioned cannot exceed the space available in the Route table.

When the number of DPCs (`mtpdpcq` parameter) is specified, the total number of DPCs and x-list entries (`mtpxlq` parameter) provisioned cannot exceed the space available in the Route table.

The number of DPCs provisioned (`mtpdpcq` parameter) cannot be increased if space allocated for maintaining x-list entries becomes full.

The value for the `mtpdpcq` parameter cannot be less than the number of DPCs provisioned.

The Cluster Routing and Management Diversity (CRMD) feature must be turned on before the `mtpxlq`, `mtpxlet`, and `mtpxlot` parameters can be specified.

The ANSI MTP restart (MTPRS) feature must be turned on before the `mtprsit` parameter can be specified.

The ANSI MTP restart (MTPRS) or ITU MTP restart (ITUMTPRS) feature must be turned on before the `mtparsi` parameter can be specified.

The value for the `tfatfrpr` parameter must be specified in increments of 100 milliseconds (0.1 seconds).

The System Options table is corrupt or cannot be found.

Cluster x-list maintenance data must be accessible.

The level 3 Timer table is corrupt or cannot be found.

If critical alarms are inhibited in the system, then the `critalminh=no` parameter cannot be specified.

If the `npcfmti` parameter is specified, the sum of the values specified for *m1* + *m2* + *m3* + *m4* must be equal to 14.

The `defcc` parameter value cannot already exist as an entry in the GSM Options Multiple Country Code (the `multcc` parameter) list.

If a GSM Options Multiple Country Code (`multcc` parameter) has been defined, the `defcc=none` parameter cannot be specified.

The GSM Map Screening feature must be turned on before the `gsmdflt` or `gsmsdecerr` parameter can be specified.

The Network Security Enhancements feature must be turned on before the `secmtpmate`, `secmtpsid`, `secmtpsnm`, and `secscpcscmg` parameters can be specified.

The MAS Configuration table is corrupt or cannot be found.

If the Origin-based MTP Routing feature is enabled, then the `mtplprst=no` parameter cannot be specified.

The AINPQ, EIR, G-Flex, G-PORT, INP, LNP ELAP Configuration, Prepaid SMS Intercept Ph1, SIP NP or V-Flex feature must be turned on before the `dsmaud` parameter can be specified.

The value specified for `mtpt10alt` parameter cannot be less than the Level3-T10 timer value.

The GSM Options table is corrupt or cannot be found.

If the MT-Based GSM SMS NP feature is turned on, then the `defcc=none` parameter cannot be specified.

If the MT-Based IS41 SMS NP feature is turned on, then the `defcc=none` parameter cannot be specified.

If the ATINP feature is turned on, then the `defcc=none` parameter cannot be specified.

If the TN quantity key is above 228M, or if ELAP version 8.0 or above is provisioned, then the `dsmaud=ccc` parameter cannot be specified.

If the Prepaid IDP Relay feature is turned on or the IAR Base feature is enabled, then the `defcc=none` parameter cannot be specified.

If the `on` or `off` parameter is specified, then the `ansigflex`, `archbldid`, `cnvcgda`, `cnvcgdi`, `cnvcgdn`, `cnvcgdn24`, `gtnvdfilt`, `critalminh`, `dispactalms`, `mtplprst`, `mtplti`, `mtprsi`, `rptlnpmrssi`, `rstrdev`, and `uimrd` parameters cannot be specified.

Contact My Oracle Support (MOS) for assistance in turning off the GBSUSNMINM parameter.

The same option cannot be specified by both the `on` and `off` parameters.

A PCT quantity feature must be enabled before the `pct` parameter can be specified.

Contact My Oracle Support (MOS) for assistance in turning off the PCT Feature.

If the SIPNP feature is turned on, then the `defcc=none` parameter cannot be specified.

EPAP240M or EPAPX can only be turned on if at least one EPAP-related feature is ON.

EPAP240M can not be turned on if an EPAP-based E5-SM4G card is present in the system.

GBSUSNMINM cannot be turned on if an A-class card is present in the system.

EPAPX cannot be turned on if 32-bit SM8G/SLIC EPAP based SCCP cards is present in the system.

If EPAPX is turned ON then EPAP240M cannot be turned ON.

This command cannot be entered when CAT2 syncing is in progress.

## Notes

If the database contains ITU national point codes of a particular format, and the format is changed with the `npcfmti` parameter, the format of the ITU national point codes in the database will be changed to the new format.

The format defined by the `npcfmti` parameter applies to all database entities that use ITU national point codes except gateway screening. Gateway screening allows the ITU national point code to be displayed and entered in the database only as a single number. If the system is using a format for the ITU national point code other than a single number, the point code will have to be converted from its current format to a single number in order to be used by gateway screening. The conversion is explained in "Converting ITU National Point Code Formats".

For the STP option attributes supporting STP event message throttling, the values for the indicated parameters become effective in the next event-message output interval following their activation. All other updates become effective at the time of activation (immediately).

When the `slscnv=on` parameter is specified, the node acts as if the 5-bit to 8-bit SLS conversion is being performed on every linkset in the database, including linksets where the `slsci=no` parameter has been specified.

When the `slscnv=off` parameter is specified, the node acts as if the 5-bit to 8-bit SLS conversion has been turned off for every linkset in the database, including linksets where the `slsci=yes` parameter has been specified.

When the `slscnv=perls` parameter is specified, the 5-bit to 8-bit SLS conversion is performed only on the linksets where the `slsci=yes` parameter has been specified.

When the value of the `dispactalms` parameter is changed, there could be a delay of up to five seconds as the VT320 screen refreshes to the selected display.

The maximum allowed number of destination point codes can be changed by the `mtpdpcq` parameter.

If the Cluster Routing and Management Diversity feature is turned on, the maximum number of destination point codes contained in the exception list can be changed by the `mtpxlq` parameter.

The sum of the values of the `mtpdpcq` and `mtpxlq` parameters can be increased beyond 2500 only if one or more of the following features are turned on:

- If the DSTN5000 feature is turned on, the parameters cannot exceed 5500.
- If the 6000 Routesets feature is enabled, the parameters cannot exceed 6500.
- If the 7000 Routesets feature is enabled, the parameters cannot exceed 7500.
- If the 8000 Routesets feature is enabled, the parameters cannot exceed 8500.
- If the 10,000 Routesets feature is enabled, the parameters cannot exceed 10500.

To enter seconds (instead of milliseconds) for the timer values, the timer value must contain at least one decimal place, and can contain up to three decimal places. If no decimal places are entered, the system accepts the value as milliseconds. The `rtrv-stpopts` command always displays the output in milliseconds, not seconds.

There will be only one Network Point Code in the STPOPTS table for GWS DUP action- either "a" (ANSI), "I" (ITU-I), "n" (ITU-N), "n24" (ITU-N24) or "n16" (ITU-N16).

**on/off options**

- *ansigflex* —Enables/Disables ANSI G-Flex to execute at 1700 TPS per DSM card
- *archblidid* —Archive build ID Enables/Disables specifying that the database archive file name contains the EAGLE build number/release number, respectively.
- *cnvcgda* —Enables/Disables discarding of the CGPA point code in SCCP messages if the destination network type is ANSI, and the point code or alias point code of the destination network type is not defined
- *cnvcgdi* —Enables/Disables discarding of the CGPA point code in SCCP messages if the destination network type is ITU-I, and the point code or alias point code of the destination network type is not defined
- *cnvcgdn* —Enables/Disables discarding of the CGPA point code in SCCP messages if the destination network type is ITU-N, and the point code or alias point code of the destination network type is not defined
- *cnvcgdn24* —Enables/Disables discarding of the CGPA point code in SCCP messages if the destination network type is ITU-N24, and the point code or alias point code of the destination network type is not defined
- *criticalinh* —Critical alarm inhibit. This enables/disables inhibiting of critical alarms.
- *dispactalms* —Enables/Disables the display of active alarms in the alarm status area of the VT320 screen (see [Figure 2-1](#)). The alarm status area comprises four boxes to show counts for critical, major, minor, and inhibited alarms. The counts for critical, major, and minor alarms do not include any temporarily or permanently inhibited alarms. The alarm status area is labeled *Active Alarm Status*. This parameter does not affect the count displayed in the inhibited box; the number of inhibited alarms is always displayed.
- *epap240m* - Enables the option to download the 240M DN/IMSI RTDB data on EPAP-based E5-SM8G-B card. It cannot be turned ON once *epapx* is turned ON.

 **Note:**

This feature has a dependency on 64-bit GPLs. The SM cards must be running 64-bit GPLs in order to support the larger RTDB data from the EPAP. If the SM cards are not already running 64-bit GPLs, then the flash GPLs on the SM cards need to be manually converted to 64-bit. See the `init-flash` command for more information.

- *epapx* - Enables the option to download the 480M DN & 600M IMSI/600M IMEI RTDB data on EPAP-based SLIC SCCP cards. Enabling *epapx* will automatically turn OFF *epap240m*.

 **Note:**

- This feature has a dependency on 64-bit GPLs. The SLIC cards must be running 64-bit GPLs in order to support the larger RTDB data from the EPAP. If the SLIC cards are not already running 64-bit GPLs, then the flash GPLs on the SLIC cards need to be manually converted to 64-bit. See the `init-flash` command for more information.
  - The `epapx` parameter should only be turned ON after connecting to EPAP 16.3.
- `gbsusnminm`- Enable/Disable applications to send SNM/INM Group Broadcast message. The default value is off.

 **Note:**

- The `gbsusnminm` parameter cannot be turned on if an A-class card is present in the system.
  - Customers cannot disable (off) this option once enabled. Debug method is required for turning off `gbsusnminm`. Customers need to contact MOS if it is required to turn off the `gbsusnminm`.
- `gdpc` --- MSU duplicated by GWS DUP Stop Action will be routed to the point code configured in GDPC..
  - `gtcnvdfit` —Enables/Disables routing of SCCP messages using system defaults when an appropriate entry is not found in the Default GT Conversion Table.
  - `mtplprst` —Enables/Disables MTP low priority route set testing via polling the STP.
  - `mtplti` —Enables/Disables MTP loop detection procedures on the STP .
  - `mtprsi` —Enables/Disables the MTP Restart procedures (both ANSI and ITU) on the STP .
  - `rptlnpmrssi` —Enables/Disables the generation of UIM 1049 for LNP message relay (MR) messages with missing subsystems if no MAP entry is found from a GTT done on an LNP MR message.
  - `rstrdev` —Enables/Disables restoration of device states when the `init-sys` command is executed and when an OAM role change occurs and maintains the inhibited state of terminals, links, and cards through an `init-sys` execution, OAM role change, and card reload. An `init-sys` command causes the system to go down.
  - `uimrd` —Enables/Disables UIMs (Unsolicited Information Messages) to be routed to the specified output group.
- EPM-B based cards refer to E5-ENET-B, E5-E1T1-B, E5-ATM-B, and E5-MCPM-B cards.

## Output

```
chg-stpopts:randsls=all
```

```
tekelecstp 06-07-26 12:03:28 EST EAGLE 36.0.0
CHG-STPOPTS: MASP A - COMPLTD
;
```

## Related Topics

- [rtrv-stpopts](#)

# chg-t1

Use this command to change an interface for a T1 card in the system. T1 cards consist of /E5-E1T1-B cards used as T1 or ST-HSL-A cards.

## Parameters

### **loc (mandatory)**

The card location as stenciled on the shelf of the system.

#### **Range:**

1101 - 1108, 1111 - 1112, 1201 - 1208, 1211 - 1218, 1301 - 1308, 1311 - 1318, 2101 - 2108, 2111 - 2118, 2201 - 2208, 2211 - 2218, 2301 - 2308, 2311 - 2318, 3101 - 3108, 3111 - 3118, 3201 - 3208, 3211 - 3218, 3301 - 3308, 3311 - 3318, 4101 - 4108, 4111 - 4118, 4201 - 4208, 4211 - 4218, 4301 - 4308, 4311 - 4318, 5101 - 5108, 5111 - 5118, 5201 - 5208, 5211 - 5218, 5301 - 5308, 5311 - 5318, 6101 - 6108, 6111 - 6118

### **t1port (mandatory)**

T1 port number

The value must be a T1 port that has already been configured with a T1 interface on the specified T1 card.

#### **Range:**

1 - 8

Any 2 of the 8 ports on an E5-E1T1-B card can be specified when the card is used as an ST-HSL-A card.

Any 1 of the 8 ports on a card can be specified when the card is used as an ST-HSL-A card.

### **encode (optional)**

Indicator for use of B8ZS or AMI encoding/decoding.

#### **Range:**

*b8zs*

*ami*

#### **Default:**

No change to the current value



**framing (optional)**

Indicator for framing format. *esfperf* is the framing format with performance monitoring.

**Range:**

*sf, esf, esfperf*

**Default:**

No change to the current value

**l1 (optional)**

T1 cable length in feet between the EAGLE and the connecting node.

**Range:**

*0 - 655*

**Default:**

No change to the current value

**minsurate (optional)**

Minimum signal unit rate. The minimum number of SUs present on a link that are uniformly distributed.

**Range:**

*400 - 1600*

**Default:**

No change to the current value

**t1tsel (optional)**

This parameter specifies the timing source for a T1 card.

**Range:**

*line - slave timing source*

*external - master timing source*

**Default:**

No change to the current value

**Example**

```
chg-t1:loc=1205:t1port=1:encode=ami
chg-t1:loc=1205:t1port=2:encode=b8z:l1=250s
chg-t1:loc=1205:t1port=1:minsrate=1000
chg-t1:loc=1205:t1port=1:encode=ami:t1tsel=external
```

**Dependencies**

At least one optional parameter must be specified.

The card location specified by the `loc` parameter must be equipped.

The E1/T1 table must be accessible.

The Card (IMT) table must be accessible.

The card specified by the `loc` parameter must be a LIMT1 card type.

The port specified by the `t1port` parameter must have already been configured with a T1 interface on the specified T1 card.

All signaling links that are serviced by the specified T1 card must be deactivated before the values for the `encode`, `t1tsel`, `ll`, and `framing` parameters can be changed.

The shelf FAN bit must be turned ON for the shelf on which an E5-E1T1-B card is provisioned and present. The system checks the shelf FAN bit when an E5-E1T1-B card is present in the specified odd card location (`loc` parameter) and the `chanbrdg=on` parameter is specified.

HIPR2 cards must be equipped in card locations `xy09` and `xy10` ( $x$  is the frame,  $y$  is the shelf) on each EAGLE shelf that contains one or more /E5-E1T1-B cards. The system checks for HIPR2 cards when the `chanbrdg=on` parameter is specified for /E5-E1T1-B cards.

The following card locations cannot be specified in the `loc` parameter: 1113 - 1118 (E5-MASP and E5-MDAL cards), or `xy09` and `xy10` where  $x$  is the frame and  $y$  is the shelf (MUX cards).

The `linkclass=unchan` parameter must be specified (see the `ent-t1` command) before the `minsurate` parameter can be specified.

The ST-HSL-A feature must be turned on before the `framing=esfperf` parameter can be specified.

### Notes

External timing is derived from the EAGLE High-Speed Master Clock (1.544 MHz for T1 or 2.048 MHz for E1): therefore, the Master Timing feature is required. Line timing is derived from its received data stream, if present.

### Output

```
chg-t1:loc=1205:t1port=1:encode=ami
```

```
rlghncxa03w 04-01-20 09:07:58 EST EAGLE 31.3.0  
CHG-T1: MASP A - COMPLTD
```

```
;
```

### Related Topics

- [dlt-t1](#)
- [ent-t1](#)
- [rtrv-t1](#)
- [tst-t1](#)

## chg-tatr-msg

Use this command to revise a Triggerless ANSI TCAP Relay message.

## Parameters

### **msgn (mandatory)**

Message number. The number of the TATR message.

**Range:**

*1 - 10*

### **active (optional)**

This parameter specifies whether the TATR message is sent to the network card for processing.

**Range:**

**yes**

The message is sent to the network card.

**no**

The message is not sent to the network card.

**Default:**

No change to the current value

**System Default:**

*no*

### **cdpadgts (optional)**

Called party address digits. This parameter specifies the SCCP CdPA digits for the IAR message.

**Range:**

*1 - 15 hexadecimal digits. Valid digits are 0-9, a-f, A-F*

**Default:**

No change to the current value

### **cdpagt (optional)**

Called party address global title. The SCCP CdPA GT for the IAR message.

**Range:**

*0 - 15*

**Default:**

No change to the current value

### **cdpagtnai (optional)**

Called party address global title nature of address indicator. The SCCP CdPA GT NAI for the IAR message.

**Range:**

*0 - 127*

**Default:**

No change to the current value

**cdpndgts (optional)**

Called party number digits. The TCAP CdPN digits for the IAR message.

**Range:**

1 - 32 hexadecimal digits. Valid digits are 0-9, a-f, A-F

**Default:**

No change to the current value

**cdpnnai (optional)**

Called party number Nature of Address Indicator. The value for TCAP CdPN NAI value for the IAR message.

**Range:**

0 - 255

**Default:**

No change to the current value

**cgpndgts (optional)**

Calling party address digits. The SCCP CgPA digits for the IAR message.

**Range:**

1 - 15 hexadecimal digits. Valid digits are 0-9, a-f, A-F

**Default:**

No change to the current value

**cgpagt (optional)**

Calling party address global title. The SCCP CgPA GT for the IAR message.

**Range:**

0 - 15

**Default:**

No change to the current value

**cgpagtnai (optional)**

Calling party address global title nature of address indicator. The SCCP CgPA GT NAI for the IAR message.

**Range:**

0 - 127

**Default:**

No change to the current value

**cgpndgts (optional)**

Calling party number digits. The TCAP CgPN digits in the IAR message.

**Range:**

1- 32 hexadecimal digits. Valid digits are 0-9, a-f, A-F

**Default:**

No change to the current value

**cgpnnai (optional)**

Calling party number nature of address indicator. The TCAP CgPN NAI in the IAR message.

**Range:**

0 - 255

**Default:**

No change to the current value

**reset (optional)**

This parameter resets all of the parameters to their default values.

**Range:**

**yes**

Resets all message parameters to their default values

**Default:**

No change to the current value

**trigtype (optional)**

Trigger Type. The value for the *TrigType* field of the IAR message.

**Range:**

0 - 255

The value for this parameter can be entered as a decimal value ( 0-255 ) or as 2 hexadecimal digits. Valid digits are 0-9, a-f, A-F.

If hexadecimal digits are used, then the digits must be preceded by *h'*. [Table 4-23](#) lists valid hexadecimal values.

**Default:**

No change to the current value

**Example**

```
chg-tatr-  
msg:msgn=1:trigtype=h'26:cdpnnai=4:cdpadgts=12457896abcd:cgpnnai=4
```

```
chg-tatr-  
msg:msgn=1:trigtype=12:cdpnnai=2:cdpndgts=981123456:active=yes
```

**Dependencies**

The IAR Base feature must be enabled before this command can be entered.

The TSTMSG table is corrupt or cannot be found.

If the `reset` parameter is specified, then no other parameters can be specified.

At least one optional parameter must be specified.

## Output

```
chg-tatr-  
msg:msgn=1:trigtype=37:cdpnnai=4:cdpndgts=987654321:cgpnnai=4
```

```
tekelecstp 09-07-07 15:58:08 EST EAGLE 41.1.0  
CHG-TATR-MSG: MASP A - COMPLTD  
;
```

## Related Topics

- [rtrv-tatr-msg](#)
- [tst-msg](#)

# chg-tatropts

Use this command to enter Triggerless ANSI TCAP Relay (TATR)-specific options in the database. This command updates the TATROPTS table.

## Parameters

### **cdnptype (optional)**

Entity type for CdPN RTDB lookup. The entity type that is considered a success when used for RTDB lookup.

#### **Range:**

**sp**  
Service provider

**rn**  
Routing number

**rns**  
*rn* or *sp*

**anymatch**  
*rn*, *sp*, or no match with any entity

**always**  
Lookup is always considered successful

**rnsdn**  
*rn*, *sp*, or *dn*

If the `cdnptype=anymatch` parameter is specified, then the value is also used as the RN for the outgoing CdPN.

**Default:**  
No change to the current value

**System Default:**  
*rns*

**cgnptype (optional)**

CgPN database lookup type. The entity type that is considered a success when used for RTDB lookup.

**Range:**

**sp**  
Service Provider

**rn**  
Routing Number

**rns**  
*rn* or *sp*

**anymatch**  
*rn*, *sp*, or no match with any entity

**always**  
Lookup is always considered successful

**rnsdn**  
*rn*, *sp*, or *dn*

If the `cgnptype=anymatch` parameter is specified, then the value is also used as the RN for the outgoing CgPN.

**Default:**

No change to the current value

**System Default:**

*rns*

**cgpaccck (optional)**

CgPA country code check. This parameter specifies whether a DEFCC check is performed on the incoming CgPA.

**Range:**

**always**  
The DEFCC check is always performed.

**nonintl**  
The DEFCC check is performed if the CdPN NAI is not 'International'.

**off**  
The DEFCC check is not performed.

**Default:**

No change to the current value

**System Default:**

*nonintl*

**df1trn (optional)**

Default routing number. The default RN used when a value of *sp* or *rnsp* is specified for the *cdnptype* or *cgnptype* parameter, and the CdPN or CgPN RTDB lookup returns entity type SP.

**Range:**

1 - 15 digits, *none*

1-15 hexadecimal digits. Valid digits are 0-9, a-f, A-F.

*none* —a default RN is not used

**Default:**

No change to the current value

**System Default:**

*none*

**sporttype (optional)**

Service Portability type. This parameter specifies whether Service Portability is performed for the Info Analyzed Relay (IAR) NP feature.

 **Note:**

The S-Port feature must be turned on before any change to the parameter will impact the associated feature.

 **Note:**

If Service Portability is performed, then the Service Portability prefix (RTDB 'GRN'entity id) is applied.

**Range:*****gsm***

Apply Service Portability prefix for own-network GSM subscribers

***is41***

Apply Service Portability prefix for own-network IS41 subscribers

***all***

Apply Service Portability prefix for all own-network (IS41 and GSM) subscribers

***none***

Service Portability is not performed for the feature.

**Default:**

No change to the current value

**System Default:**

*none*

**Example**

```
chg-tatropts:cdnptype=always:sporttype=is41
```



```
chg-tatropts:cgntype=sp
chg-tatropts:cgpaccck=always
chg-tatropts:dfltrn=123456789012345
```

### Dependencies

At least one optional parameter must be specified.

The IAR Base feature must be enabled before this command can be entered.

The EGLEOPTS table is corrupt or cannot be found.

The IAR Number Portability and the Service Portability features must be enabled before the `sporttype` parameter can be specified.

### Output

```
chg-tatropts:cdnptype=sp
```

```
tekelecstp 09-07-05 13:34:22 EST EAGLE 41.1.0
CHG-TATROPTS: MASP A - COMPLTD
;
```

### Related Topics

- [rtv-tatropts](#)

## chg-th-alm

Use this command to change the alarm thresholds and associated values.

### Parameters

#### **deircong1v11 (optional)**

The percentage of S13 card level 1 alarm threshold settings.

**Range:**

*1 - 100*

**Default:**

*40*

#### **deircong1v12 (optional)**

The percentage of S13 card level 2 alarm threshold settings.

**Range:**

*1 - 100*

 **Note:**

This value must be greater than the value specified for the `deirconglv11` parameter

**Default:**  
*80*

**gttservlv1 (optional)**

The percentage for the SCCP GTT Service error ratio level 1 (lower) Threshold Alarm.

**Range:**  
*1 - 100*

**Default:**  
*10*

**gttservlv2 (optional)**

The percentage for the SCCP GTT Service error ratio level 2 (upper) Threshold Alarm.

**Range:**  
*1 - 100*

**Default:**  
*20*

**imtbusut1lv11 (optional)**

The percentage for the IMT Bus Combined utilization level 1 Threshold Alarm (reported on IMT System).

**Range:**  
*35 - 70*

**Default:**  
*70*

**imtbusut1lv12 (optional)**

The percentage for the IMT Bus Combined utilization level 2 Threshold Alarm (reported on IMT System).

**Range:**  
*40 - 80*

**Default:**  
*80*

**imtcongestlv11 (optional)**

The percentage for the IMT Bus Congestion level 1 Threshold Alarm (reported on HIPR2 card).

**Range:**  
*35 - 70*

**Default:**

70

**imtcongestlv12 (optional)**

The percentage for the IMT Bus Congestion level 2 Threshold Alarm (reported on HIPR2 card).

**Range:**

40 - 80

**Note:**

This value must be greater than the value specified for the `imtcongestlv11` parameter.

**Default:**

80

**lnptndb1v1 (optional)**

The percentage for the TN Database provisioned level 1 (lower) Capacity Threshold Alarm.

**Range:**

1 - 100

**Default:**

80

**lnptndb1v2 (optional)**

The percentage for the LNP TN Database provisioned level 2 (upper) Capacity Threshold Alarm.

**Range:**

1 - 100

**Note:**

This value must be greater than the `lnptndb1v1` parameter value.

**Default:**

95

**nongttserv1v1 (optional)**

The percentage for the SCCP Non-GTT Service (AIQ, ATINPQ, GPORT, GFLEX, EIR, INPMR, INPQS, LNPQR, LNPQS, LRNQT, PLNPQS, TLNP, V-Flex, WNPQS) error ratio level 1 (lower) Threshold Alarm.

**Range:**

1 - 100

**Default:**

10

**nongttservlv2 (optional)**

The percentage for the SCCP Non-GTT Service (AIQ, ATINPQ, GPORT, GFLEX, EIR, INPMR, INPQS, LNPMR, LNPQS, LRNQT, PLNPQS, TLNP, V-Flex, WNPQS) error ratio level 2 (upper) Threshold Alarm.

**Range:**

1 - 100

**Default:**

20

**sccpcalcmtld (optional)**

Calculation method used to determine whether the TPS Threshold Alarm levels have been exceeded.

**Range:**

*n*

use all In Service Normal cards in the calculation

*nplus1*

use all In Service Normal cards minus 1 card in TPS calculation

**Default:**

*n*

**sccpthlv1intvl (optional)**

Number of minutes during which the SCCP threshold level 1 alarm cannot be raised more than once.

**Range:**

0 - 1440

**Default:**

0

**sccpthlv2intvl (optional)**

Number of minutes during which the SCCP threshold level 2 alarm cannot be raised more than once.

**Range:**

0 - 1440

**Default:**

0

**sccptpscap (optional)**

The percentage for the SCCP Load Capacity Threshold Alarm.

**Range:**

0 - 100

**Default:**

80

**sfappcalcmtld (optional)**

SFAPP Calculation Method.

**Range:**  
*{n, nplus1}*

**Default:**  
*n*

**sfappconglv11 (optional)**  
SFAPP Congestion Alarm Level 1

**Range:**  
*1 - 100*

**Default:**  
*40*

**sfappconglv12 (optional)**  
SFAPP Congestion Alarm Level 2

**Range:**  
*1 - 100*

**Default:**  
*80*

**sfappservlv1 (optional)**  
The percentage for the SFAPP Service error ratio level 1 (lower)

**Range:**  
*1 - 100*

**Default:**  
*10*

**sfappservlv2 (optional)**  
The percentage for the SFAPP Service error ratio level 2 (upper)

**Range:**  
*1 - 100*

**Default:**  
*20*

**sfappthlv11intv1 (optional)**  
Interval in minutes during which SFAPP Service Alarm Level 1 cannot be raised more.

**Range:**  
*0-1440*

**Default:**  
*0*

**sfappthlv12intv1 (optional)**  
Interval in minutes during which SFAPP Service Alarm Level 2 cannot be raised more.

**Range:**  
*0-1440*

**Default:**  
0

**sfapptpscap (optional)**

The percentage for the SFAPP Load Capacity Threshold Alarm.

**Range:**  
0 - 100

**Default:**  
80

**sfthrotthresh (optional)**

The percentage for the Throttling Action Threshold Alarm.

**Range:**  
1 - 100

**Default:**  
80

**sipconglv11 (optional)**

The percentage of SIP card level 1 alarm threshold settings.

**Range:**  
1 - 100

**Default:**  
40

**sipconglv12 (optional)**

The percentage of SIP card level 2 alarm threshold settings.

**Range:**  
1 - 100



**Note:**

This value must be greater than the value specified for the `sipconglv11` parameter.

**Default:**  
80

**therma1lv1 (optional)**

Thermal Alarm Level 1 as a percentage of a card's thermal limit.

**Range:**  
73 - 92

**therma1lv2 (optional)**

Thermal Alarm Level 2 as a percentage of a card's thermal limit.

**Range:**  
74 - 100

### Example

```
chg-th-alm:lnptndblvl=85
chg-th-alm:sccptpscap=85
chg-th-alm:sccpcalcmtld=nplus1
chg-th-alm:gttserlvl1=25:gttserlvl2=28
chg-th-alm:sccpthlvl1intvl=20:sccpthlvl2intvl=50
chg-th-alm:nongttserlvl1=30:nongttserlvl2=60
chg-th-alm:deirconglvl1=50:deirconglvl2=80
chg-th-alm:sipconglvl1=50:sipconglvl2=80
chg-th-alm:sfthrotthresh=70
chg-th-alm:sfappcalcmtld=nplus1
chg-th-alm:sfapptpscap=85
chg-th-alm:sfappthlvl1intvl=20:sfappthlvl2intvl=50
chg-th-alm:sfappserlvl1=30:sfappserlvl2=60
chg-th-alm:sfappconglvl1=50:sfappconglvl2=80
```

### Dependencies

Each Level 1 parameter value must be less than its corresponding Level 2 parameter value.

### Notes

To display the currently configured values for the Thermal Alarm Levels, use the `rtrv-th-alm` command.

EPM based E5-ENET, E5-IPSM, and E5-TSM cards have a thermal operating limit of 95 degrees Celsius. E5-SM4G and EPM-B based cards have a thermal operating limit of 90 degrees Celsius. `thermallvl1` and `thermallvl2` are applicable to both EPM and EPM-B based cards.

The thermal threshold values represent a percentage of the thermal operating limit of a card.

EPM-B based cards refer to E5-ATM-B, E5-ENET-B, E5-E1T1-B, and E5-MCPM-B cards.

### Output

```
chg-th-alm:thermallvl1=85
```

```
rlghncxa03w 06-05-07 11:43:04 EST EAGLE 35.0.0
```

```
CHG-TH-ALM: MASP A - COMPLTD
;

chg-th-alm:deirconglvl1=50:deirconglvl2=80

tekelecstp 13-03-19 11:43:04 EST EAGLE 45.1.0
CHG-TH-ALM: MASP A - COMPLTD
;

chg-th-alm:sipconglvl1=50:sipconglvl2=80

tekelecstp 15-04-22 13:06:06 MST EAGLE5 46.3.0
CHG-TH-ALM: MASP A - COMPLTD
;

chg-th-alm:sfthrotthresh=70

tekelecstp 15-03-19 11:43:04 EST EAGLE 46.3.0
CHG-TH-ALM: MASP A - COMPLTD
;

chg-th-alm:sfappconglvl1=50:sfappconglvl2=80

tekelecstp 13-03-19 11:43:04 EST EAGLE 46.5.1.5
CHG-TH-ALM: MASP A - COMPLTD
;

chg-th-alm:sfappcalcmthd=nplus1

tekelecstp 15-04-22 13:06:06 MST EAGLE5 46.5.1.5
CHG-TH-ALM: MASP A - COMPLTD
;

chg-th-alm:sfappservlv1=30:sfappservlv2=60

tekelecstp 15-03-19 11:43:04 EST EAGLE 46.5.1.5
CHG-TH-ALM: MASP A - COMPLTD
;
```

### Related Topics

- [rept-stat-sccp](#)
- [rtrv-th-alm](#)

## chg-tifopts

Use this command to update the TIF Options table.



 **Note:**

Values other than *none* that are entered for the `dlma`, `dlmb`, or `dlmc` parameters for the TIF services (TIF, TIF2, TIF3) using this command will overwrite values entered for those parameters using the `chg-npp-serv` command.

**Parameters****condcgpn (optional)**

The preconditioning required when a CgPN lookup is needed.

**Range:**

***addcc***

add the country code

***none***

**Default:**

*none*

**crpre1 (optional)**

The ISUP Release cause for a message that is determined to be circular routed.

**Range:**

*0 - 255*

**Default:**

*31 -normal, unspecified*

**df1trn (optional)**

Default routing number. This parameter provides a set of digits to substitute for a signaling point.

This parameter is used with both calling party and called party numbers.

**Range:**

1-15 hexadecimal digits, *none*

Valid digits are *0-9, a-f, A-F*

**Default:**

*none*

**dlma (optional)**

Delimiter A. The digits used for Delimiter A in an NPP Formatting Action.

**Range:**

1-16 hexadecimal digits, *none*

Valid digits are *0-9, a-f, A-F*

**Default:**

*none*

**d1mb (optional)**

Delimiter B. The digits used for Delimiter B in an NPP Formatting Action.

**Range:**

1-16 hexadecimal digits, *none*  
Valid digits are 0-9, a-f, A-F

**Default:**

*none*

**d1mc (optional)**

Delimiter C. The digits used for Delimiter C in an NPP Formatting Action.

**Range:**

1-16 hexadecimal digits, *none*  
Valid digits are 0-9, a-f, A-F

**Default:**

*none*

**iamcgpn (optional)**

The format of the outgoing CgPN digits.

**Range:*****rn***

Replaces the CgPN with the RN.

***rndn***

Adds the RN as a prefix to the CgPN.

***dn***

Replaces the CgPN with the DN.

**Default:**

*dn*

**matchseq (optional)**

The DN lookup mechanism.

**Range:*****dn***

search the range database if the DN is not found during subscriber lookup

***nptype***

search the range database if the DN is not found during subscriber lookup or if the located DN does not match the value specified for the *nptype* or *nptypecgpn* parameter

**Default:**

*dn*

**npflag (optional)**

This parameter specifies whether the *nm* parameter is modified in the IAM message to show that NP lookup has been performed.

The *nm* parameter exists only in incoming and outgoing IAM messages.

**Range:**

***nm***  
modifies the `nm` parameter

***none***  
does not modify the `nm` parameter

**Default:**

*none*

**nptypecgpn (optional)**

NP entity type for the CgPN. The entity type of the DN that is used to indicate that a successful NP lookup occurred.

**Range:**

***sp***  
signaling point

***rn***  
routing number

***sprn***  
Lookup is successful if the value of the entity type is *sp* or *rn*

***all***  
Lookup is always considered successful.

***rnspsdn***  
Lookup is successful if the value of the entity type is *rn*, *sp*, or *dn*

***any***  
Lookup is successful if the value of the entity type is *rn*, *sp*, or no match with any entity.

**Default:**

*sprn*

**nptyperls (optional)**

The entity type of the DN that is used to indicate that a successful NP lookup occurred for the NPRLS and NPNRLS Service Actions.

**Range:**

***sp***  
signaling point

***rn***  
routing number

***sprn***  
Lookup is successful if the value of the entity type is *sp* or *rn*.

***all***  
Lookup is always considered successful.

***rnspsdn***

Lookup is successful if the value of the entity type is *rn*, *sp*, or *dn*.

***any***

Lookup is successful if the value of the entity type is *rn*, *sp*, or no match with any entity.

**Default:**

No change to the current value

**System Default:**

*sprn*

**nptyperly (optional)**

The entity type of the DN that is used to indicate that a successful NP lookup occurred for the NPRELAY Service Action.

**Range:**

***sp***

signaling point

***rn***

routing number

***sprn***

Lookup is successful if the value of the entity type is *sp* or *rn*.

***all***

Lookup is always considered successful.

***rnspsdn***

Lookup is successful if the value of the entity type is *rn*, *sp*, or *dn*.

***any***

Lookup is successful if the value of the entity type is *rn*, *sp*, or no match with any entity.

**Default:**

No change to the current value

**System Default:**

*sprn*

**nsaddldata (optional)**

This parameter specifies whether the incoming IAM Calling Party Category should be compared with the value for the `nspublic` parameter before performing Calling Party number substitution.

**Range:**

***yes***

Compare the Calling Party Category in the message with the `nspublic` parameter value.

**no**

Do not compare the Calling Party Category in the message with the `nspublic` parameter value.

**Default:**

*no*

**nspublic (optional)**

The value of the Calling Party Category that indicates that the Calling Party number is public.

**Range:**

0 - 255

**Default:**

0

**rcausenp (optional)**

The value used for the release cause in an REL message when number portability occurs.

**Range:**

0 - 127

**Default:**

0

**rcausepfx (optional)**

The value used for the release cause in an REL message when number portability does not occur.

**Range:**

0 - 127

**Default:**

0

**r1copc (optional)**

This parameter specifies whether the value specified for the `rcause` parameter (see the `ent/chg-dstn` commands) overrides the values specified for the `rcausenp` and `rcausepfx` parameters.

**Range:****off**

Use the values specified for the TIFOPTS `rcausenp` and `rcausepfx` parameters as the release cause in REL messages.

**on**

Use the value specified for the `rcause` parameter as the release cause in REL messages.

**Default:**

*off*

**rnrgd (optional)**

This parameter specifies whether the redirection number is included in the release message when release handling is indicated.

**Range:**

*yes*

*no*

**Default:**

*yes*

**snsccpndflt (optional)**

The digits to be used in calling number simple number substitution.

**Range:**

1-32 hexadecimal digits, *none*  
Valid digits are 0-9, a-f, A-F

**Default:**

*none*

**spfill (optional)**

This parameter specifies whether the *sp* entity type is populated if the value specified for the *defltn* or *grn* parameter is used for NPP processing.

**Range:**

*off*

do not populate the *sp* entity type

*on*

populate the *sp* entity type

**Default:**

No change to the current value

**System Default:**

*off*

**splitiam (optional)**

This parameter specifies when to split the IAM into IAM + 1 SAM.

**Range:**

15 - 31, *none*

**Default:**

*none*

**sportrelay (optional)**

The Service Portability configuration option for the NPRELAY Service Action.

**Range:**

***none***

Service Portability is not performed for this Service Action

***gsm***

Apply Service Portability prefix (RTDB 'GRN' entity id) for own-network GSM subscribers

***is41***

Apply Service Portability prefix (RTDB 'GRN' entity id) for own-network IS41 subscribers

***all***

Apply Service Portability prefix ('GRN' from RTDB entity) for all own-network (IS41 and GSM) subscribers

**Default:**

No change to the current value

**System Default:**

*none*

**spportr1s (optional)**

The Service Portability configuration option for the NPRLS Service Action.

**Range:**

***none***

Service Portability is not performed for this Service Action

***gsm***

Apply Service Portability prefix (RTDB 'GRN'entity id ) for own-network GSM subscribers

***is41***

Apply Service Portability prefix (RTDB 'GRN' entity id) for own-network IS41 subscribers

***all***

Apply Service Portability prefix ('GRN' from RTDB entity) for all own-network (IS41 and GSM) subscribers

**Default:**

No change to the current value

**System Default:**

*none*

**subcdpn (optional)**

Configuration option for the combination of TIFRDNBL Service Action (SA) and Formatting Action (FA) ASD.

**Range:*****none***

TIFRDNBL SA cannot be configured. 1-10 hexadecimal digits, none. Valid digits are 0-9, a-f, A-F.

**Default:**

No change to the current value

**System Default:**

*none*

**Example**

```
chg-tifopts:dlma=1234567890
chg-tifopts:dfltrn=123456789012345
chg-tifopts:nptype=all
chg-tifopts:nsaddldata=yes:nspublic=5
chg-tifopts:subcdpn=1234567890
```

**Dependencies**

At least one optional parameter must be specified.

At least one of the following features must be enabled before this command can be entered.

- TIF Additional Subscriber Data
- TIF Generic Routing Number
- TIF Number Portability
- TIF Number Substitution
- TIF Range CgPN Blacklist
- TIF SCS Forwarding
- TIF Simple Number Substitution
- TIF Subscriber CgPN Blacklist
- TIF Selective Screening

The Eagle Options table is corrupt or cannot be found.

If the TIF ASD feature is turned on, then the `matchseq=nptype` parameter cannot be specified.

If the TIF GRN feature is turned on, then the `matchseq=nptype` parameter cannot be specified.

The TIF Number Portability feature must be enabled before the `matchseq=nptype` parameter can be specified.

If the TIF Number Substitution feature is enabled, then the `matchseq=nptype` parameter cannot be specified.

The TIF Number Substitution feature must be enabled before the `nsaddldata` parameter or the `nspublic` parameter can be specified.



If the `matchseq=nptype` parameter is specified, then the only value that can be specified for the `sportrelay` or `sportrls` parameter is *none*. If the `sportrelay` or `sportrls` parameter has a value other than *none*, then the `matchseq=nptype` parameter cannot be specified.

The S-Port feature must be enabled before the `sportrelay` or `sportrls` parameter can be specified.

When `npp-srs` table has `TIFRDNBL` configured as an SA corresponding to the ASN in `npp-as` table `SUBCDPN` cannot be set to *none*.

### Notes

None

### Output

```
chg-tifopts:nsaddldata=yes:nspublic=5
```

```
tekelecstp 09-03-05 09:36:03 EST EAGLE 41.0.0
CHG-TIFOPTS: MASP A - COMPLTD
;
```

### Related Topics

- [rtrv-tifopts](#)

## chg-trm

Use the change terminal command to configure the operational characteristics of each of the 40 terminal ports used to connect modems, printers, and terminals to the system.

### Parameters

#### **trm (mandatory)**

Terminal. The ID number of the terminal whose characteristics are to be changed.

#### **Range:**

1 - 40

#### **a11 (optional)**

This parameter specifies whether to display unsolicited messages of all types (TRAF, LINK, SA, DB, SYS, PU, UIMRD, APPSERV, APPSS, CARD, CLK, DBG, GTT, GWS, MEAS, MON, MPS, SEAS, SLAN) in the scroll area.

#### **Range:**

**yes**

receive all

**no**

receive none

**Default:**

*yes*—If `type=emsalm` is specified

Current value—if `type` parameter value is not *emsalm*

**appserv (optional)**

Application server. This parameter specifies whether to display UAMs and UIMs assigned to the Application Server output group in the scroll area.

**Range:****yes**

receive all

**no**

receive none

**Default:**

If `all` is specified—current `all` value

If `all` is not specified—current `appserv` value.

If `type=emsalm` is specified—*yes*

**System Default:**

*no*

**appss (optional)**

Application subsystem. This parameter specifies whether to display UAMs and UIMs assigned to the Application Subsystem output group in the scroll area

**Range:****yes**

receive all

**no**

receive none

**Default:**

If `all` is specified—current `all` value

If `all` is not specified—current `appss` value.

If `type=emsalm` is specified—*yes*

**System Default:**

*no*

**baud (optional)**

The line speed (baud rate) for this terminal's serial port connection.

**Range:**

*2400, 4800, 9600, 19200, 38400, 57600, 115200*

**Note:**

Values 38400, 57600, and 115200 are only valid when the OAMHC is used.

**Default:**

No change to the current value

**System Default:**

9600

**card (optional)**

This parameter specifies whether to display UAMs and UIMs assigned to the Card output group in the scroll area.

**Range:****yes**

receive all

**no**

receive none

**Default:**

If `all` is specified—current `all` value

If `all` is not specified—current `card` value.

If `type=emsalm` is specified—`yes`

**System Default:**

`no`

**clk (optional)**

Clock. This parameter specifies whether to display UAMs and UIMs assigned to the Clock output group in the scroll area.

**Range:****yes**

receive all

**no**

receive none

**Default:**

If `all` is specified—current `all` value

If `all` is not specified—current `clk` value.

If `type=emsalm` is specified—`yes`

**db (optional)**

Database. This parameter specifies whether to display database-related unsolicited messages in the scroll area.

**Range:**

**yes**  
receive all

**no**  
receive none

**Default:**

If `all` is specified—current `all` value  
If `all` is not specified—current `db` value.  
If `type=emsalm` is specified—yes

**System Default:**

`no`

**dbg (optional)**

Debug. This parameter specifies whether to display UAMs and UIMs assigned to the Debug output group in the scroll area.

**Range:**

**yes**  
receive all

**no**  
receive none

**Default:**

If `all` is specified—current `all` value  
If `all` is not specified—current `dbg` value.  
If `type=emsalm` is specified—yes

**System Default:**

`no`

**dura1 (optional)**

Terminal lockout time. The length of time the terminal is disabled after each failed login/unlock attempt in excess of the threshold configured on the `mxinv` parameter. The value can be specified as seconds (`ss`); minutes and seconds (`mmss`); or hours, minutes, and seconds (`hhmmss`).

**Range:**

`0 - 999999`  
`0-59 (ss)`  
`0-5959 (mmss)`  
`0-995959 (hhmmss)`  
`999999`

**Default:**

No change to the current value

**System Default:**

`100`

1 minute, 0 seconds

**fc (optional)**

Flow control. The type of flow control used to regulate the flow of data between the system and an RS-232 connected device, so that no characters are lost (especially at high baud rates). The control setting of the system and the connected device must match.

**Range:**

**sw**  
software flow control

**none**  
neither hardware nor software flow control

**Default:**

No change to the current value

**System Default:**

sw

**gtt (optional)**

This parameter specifies whether to display UAMs and UIMs assigned to the GTT output group in the scroll area.

**Range:**

**yes**  
receive all

**no**  
receive none

**Default:**

If `all` is specified—current `all` value

If `all` is not specified—current `gtt` value.

If `type=emsa1m` is specified—yes

**gws (optional)**

This parameter specifies whether to display UAMs and UIMs assigned to the GWS output group in the scroll area.

**Range:**

**yes**  
receive all

**no**  
receive none

**Default:**

If `all` is specified—current `all` value

If `all` is not specified—current `gws` value.

If `type=emsa1m` is specified—yes

**System Default:**

no

**link (optional)**

This parameter specifies whether to display link maintenance-related unsolicited messages in the scroll area.

**Range:****yes**

receive all

**no**

receive none

**Default:**

If `all` is specified—current `all` value

If `all` is not specified—current `link` value.

If `type=emsalm` is specified—yes

**logintmr (optional)**

Login timer. The amount of time, in seconds, allowed for a user to log into a Telnet terminal after selecting the terminal.

 **Note:**

This parameter applies to Telnet terminals.

**Range:**

3 - 600, none

none—Login can occur at any time after selecting the terminal.

**Default:**

No change to the current value

**System Default:**

none

**logouttmr (optional)**

Logout timer. The amount of time, in seconds, before the Telnet session closes after the user manually or automatically logs out.

 **Note:**

This parameter applies to Telnet terminals.

**Range:**

0 - 1200, none

none—The Telnet session does not close after logout.

**Default:**

No change to the current value

**System Default:**

none

**meas (optional)**

Measurement. This parameter specifies whether to display UAMs and UIMs assigned to the Measurements Maintenance output group in the scroll area.

**Range:****yes**

receive all

**no**

receive none

**Default:**

If `all` is specified—current `all` value

If `all` is not specified—current `meas` value.

If `type=emsalm` is specified—`yes`

**System Default:**

`no`

**mon (optional)**

Monitor. This parameter specifies whether to display UAMs and UIMs assigned to the Monitor output group in the scroll area.

**Range:****yes**

receive all

**no**

receive none

**Default:**

If `all` is specified—current `all` value

If `all` is not specified—current `mon` value.

If `type=emsalm` is specified—`yes`

**mps (optional)**

This parameter specifies whether to display UAMs and UIMs assigned to the MPS output group in the scroll area.

**Range:****yes**

receive all

**no**

receive none

**Default:**

If `all` is specified—current `all` value

If `all` is not specified—current `mps` value.

If `type=emsalm` is specified—`yes`

**mxinv (optional)**

Login/unlock failure threshold. When a login or unlock failure occurs on a terminal, a counter of successive login failures is incremented by one. After the increment, if the counter is greater than or equal to the mxinv parameter value, the system sends an information message to all system administrator ports and locks out the port temporarily. The port is locked out for an interval that is specified in the dural parameter.

To disable the info message and temporary lockout function for the terminal, specify

`mxinv=0`.

**Range:**

0 - 9

**Default:**

No change to the current value

**System Default:**

5

successive failed login/unlock attempts

**pngfailcnt (optional)**

Ping fail count. The number of consecutive ping fails that must occur before the Telnet connection is dropped.

 **Note:**

This parameter applies to Telnet terminals or to EMSALM terminals that have Telnet connections.

**Range:**

1 - 10

**Default:**

No change to the current value

**System Default:**

1

**pngtimeint (optional)**

Ping time out. The amount of time, in milliseconds, that must pass before the IPSM card initiates a new ping cycle.

 **Note:**

This parameter applies to Telnet terminals or to EMSALM terminals that have Telnet connections.

**Range:**

100 - 1200000, none

none—Pinging does not occur.



**Default:**  
No change to the current value

**System Default:**  
*none*

**prty (optional)**

Parity. The parity for this terminal's serial port connection.

**Range:**

*none*

*even*

*odd*

**Default:**  
No change to the current value

**System Default:**  
*even*

**pu (optional)**

Program update. This parameter specifies whether to display program update-related unsolicited messages in the scroll area.

**Range:**

*yes*  
receive all

*no*  
receive none

**Default:**  
If *all* is specified—current *all* value  
If *all* is not specified—current *pu* value.  
If *type=emsa1m* is specified—*yes*

**sa (optional)**

Security administration. This parameter specifies whether to display security administration-related unsolicited messages in the scroll area.

**Range:**

*yes*  
receive all

*no*  
receive none

*yes*—Receive all.

*no*—Receive none.

**Default:**

If `all` is specified—current `all` value  
If `all` is not specified—current `sa` value.  
If `type=emsalm` is specified—yes

**sb (optional)**

Stop bit. The number of stop bits used in communications with the terminal.

**Range:**

1 - 2

**Default:**

No change to the current value

**System Default:**

1

**seas (optional)**

This parameter specifies whether to display UAMs and UIMs assigned to the SEAS Maintenance output group in the scroll area.

**Range:**

**yes**  
receive all

**no**  
receive none

**Default:**

If `all` is specified—current `all` value  
If `all` is not specified—current `seas` value.  
If `type=emsalm` is specified—yes

**s1an (optional)**

This parameter specifies whether to display UAMs and UIMs assigned to the SLAN Maintenance output group in the scroll area.

**Range:**

**yes**  
receive all

**no**  
receive none

**Default:**

If `all` is specified—current `all` value  
If `all` is not specified—current `s1an` value.  
If `type=emsalm` is specified—yes

**System Default:**

no

**sys (optional)**

System. This parameter specifies whether to display system maintenance-related unsolicited messages in the scroll area.

**Range:****yes**

receive all

**no**

receive none

**Default:**

If `all` is specified—current `all` value

If `all` is not specified—current `sys` value.

If `type=emsalm` is specified—yes

**tmout (optional)**

Maximum channel idle time. The maximum amount of time in minutes that a login session can remain idle (no user input) on a terminal before being automatically logged off. To disable idle time monitoring for a terminal, specify `tmout=0`.

**Range:**

0 - 99

**Default:**

No change to the current value

**System Default:**

30

minutes

**traf (optional)**

Traffic. This parameter specifies whether to display traffic-related unsolicited messages displayed in the scroll area.

**Range:****yes**

receive all

**no**

receive none

**Default:**

If `all` is specified—current `all` value

If `all` is not specified—current `traf` value

If `type=emsalm` is specified—yes

**System Default:**

no

**type (optional)**

The type of device being connected to this terminal.

**Range:**

*vt320*, *ksr*, *printer*, *sccs*, *mgmt*, *telnet*, *emsalm*, *none*, *seas*

The *emsalm* value is valid for terminals 1-40.

The *telnet*, *emsalm*, *seas*, and *none* are valid values for terminals 17 - 40.

**Default:**

Current value.

**System Default:**

*vt320* -terminals 1-16

*telnet*-terminals 17-40

**uimrd (optional)**

Unsolicited messages. This parameter specifies whether to display the unsolicited messages assigned to this group.

**Range:**

**yes**

receive all

**no**

receive none

**Default:**

If *all* is specified—current *all* value

If *all* is not specified—current *uimrd* value.

If *type=emsalm* is specified—*yes*

**System Default:**

*no*

**Example**

```
chg-trm:trm=13:type=ksr:baud=9600:uimrd=yes
```

```
chg-trm:trm=1:link=yes:sys=yes:db=yes
```

```
chg-trm:trm=17:all=yes
```

```
chg-trm:trm=22:type=none
```

```
chg-trm:trm=10:link=yes:card=yes:clk=yes
```

```
chg-trm:trm=1:type=ksr:gtt=yes
```

```
chg-
```

```
trm:trm=2:appserv=no:appss=yes:card=yes:clk=no:dbg=no:gtt=yes:gws=no  
:meas=yes:mon=no:mps=yes:seas=no:slan=yes
```

```
chg-trm:trm=17:logintmr=50
```

```
chg-trm:trm=17:pngtimeint=1000
```

```
chg-trm:trm=17:pngfailcnt=5
```

**Dependencies**

At least one optional parameter must be specified.

The system requires that at least two terminals be configured as security administration terminals. If only two security administration terminals are configured, the value of the `type` parameter cannot be changed to a value that would make the terminal unusable (*printer* or *none*) because only one security administration terminal would remain.

The combined total line speed (baud rate) for all active terminal ports cannot exceed 168,000. This value allows for 16 terminal to be configured at 9600 bps each.

If the `prty=none` parameter is specified, then the `type=vt320` parameter cannot be specified. A VT320 terminal does not support 7-bit data bytes and no parity. The number of data bits cannot be changed.

If the `prty=none` parameter is specified, then the `type=sccs` parameter cannot be specified.

For terminals 1 – 16, the `type=telnet` parameter cannot be specified.

For terminals 17 - 40, the value of the `type` parameter must be *telnet*, *seas*, *emsalm*, or *none*.

If the `type=telnet` parameter is specified, then the `baud`, `prty`, `sb`, and `fc` parameters cannot be specified.

If the value of the `type` parameter is *telnet*, *seas*, or *emsalm*, and if the value of the `trm` parameter is 17-40, then an IPSM card must be equipped in the system. Parameters for these terminals cannot be changed unless an IPSM card has been added for the target terminal.

 **Note:**

For one IPSM card, telnet terminals 17-24 are available. For two IPSM cards, telnet terminal IDs 17-32 are available. For three IPSM cards, telnet terminal IDs 17-40 are available. If an installed IPSM card is removed, the eight terminal IDs that were assigned to that card are no longer available. For example, if three IPSM cards are installed, and the second card that was installed is then removed, telnet terminal IDs 17-24 and 33-40 are available. To make the IDs consecutive again, the third card that was previously installed must be removed and re-installed. Then, its available terminal IDs change from 33-40 to 25-32. Use the `rtrv-trm` command to display the available telnet terminal IDs.

The terminal port must be inhibited (see the `inh-trm` command) before the `type`, `baud`, `prty`, `sb`, and `fc` parameters can be changed.

The `all`, `traf`, `link`, `sa`, `db`, `sys`, `uimrd`, and `pu` parameters can be changed on any terminal, including the one in use, regardless of the port status (inhibited or allowed).

The port cannot be removed from service (`rmv-trm`) when the `type`, `baud`, `prty`, `sb`, and `fc` parameters are being changed.

The `dural` parameter must be specified in the range of 0–995959 or with a value of 999999.

The hours portion of the `dural` parameter must be in the range 0–99.

The seconds portion of the `dural` parameter must be in the range 0–59.

The Terminal table is corrupt or cannot be found.

The IP User Interface (Telnet) feature must be enabled and turned on before the `type=telnet` parameter (IDs 17-40) or the `type=emsaln` parameter (IDs 1-40) can be specified.

The minutes portion of the `dural` parameter must be in the range 0–59.

A valid value must be specified or the `baud` parameter. Baud rates 38400, 57600, and 115200 are only valid when the OAMHC is used.

The terminal state requested must be answered.

The parity (`prty`) parameter must have a valid value assigned.

The flow control (`fc`) parameter if specified must have a valid value assigned.

The specified terminal must be inhibited before the `type=seas` parameter can be specified.

If the specified terminal is a SEAS Terminal, then the SEAS output group cannot be turned off.

If the SEAS Over IP feature is turned on, then an IPSM card must be provisioned at the location corresponding to the specified SEAS terminal.

The SEAS Over IP feature must be enabled before the `type=seas` parameter can be specified.

The `type=seas` parameter cannot be specified if:

- The value of the `trm` parameter is 1 - 16.
- Specifying the parameter results in more than one SEAS terminal on an IPSM card.
- Specifying the parameter results in more than two SEAS terminals in the EAGLE.
- An IPSM card is not physically present in the corresponding location.
- An available (unconfigured) SEAS terminal does not exist in the SEASCFG table.

The IP User Interface feature must be turned on before the value of the `type` parameter can be `telnet`, `seas`, `emsaln`, or `none`.

The IPTERM table is corrupt or could not be found.

The `type=telnet` parameter must be specified before the `logintmr` and `logouttmr` parameters can be specified.

If the value specified for the `type` parameter is `seas` or `none`, then the `pngtimeint` and `pngfailcnt` parameters cannot be specified.

The terminal must be in the Inhibited state before the `logintmr`, `logouttmr`, `pngtimeint`, and `pngfailcnt` parameters can be specified.

## Notes

Refer to *Maintenance Guide* for a list of unsolicited output messages that you might see for each output group.

This command cannot be entered when an upgrade is in progress.

If your terminal has the auto-wrap feature, you must disable the feature to use the terminal on the system.

To disable the informational message and temporary port lockout feature for a terminal, specify the `mxinv=0` parameter.

To prevent a terminal from being disabled, specify the `dural=0` parameter.

To make the lockout period for a terminal indefinite, specify the `dural=999999` parameter. When disabled, a terminal remains disabled until the port is inhibited (`inh-trm` command) and then allowed (`alw-trm` command).

Terminal idle time monitoring and auto-logout applies only if the terminal type is `vt320`, `ksr`, or `sccs`. The `chg-trm` command can be entered with a `tmout` parameter value for other terminal types, but it has no effect.

Using the terminal type of `none` conveys to the terminal processor that a particular port is not connected or is no longer in use. The terminal processor does not service output queues for a terminal port that is configured as `type=none`.

When the terminal type for a terminal is changed to `type=emsalm`, the value for all output group parameters is set to `yes`.

When the terminal type for a terminal is changed from `type=emsalm` to another type, the current value for all output groups is not changed. A command must be entered to change one or more output group values to another value.

 **Note:**

Though the output groups are set to `yes`, terminals of type `emsalm` do not display any reports or any UIMs except "UIM 1083 system alive".

The number of data bits cannot be changed; it is set to 7.

Software flow control (XON and XOFF pacing), involves sending control codes between the system and the connected device.

Software flow control is recommended if the connected device is a printer. Software flow control is highly recommended if the connected device is a modem.

To connect a modem, specify the `type=vt320` parameter.

The `all` parameter cannot be specified in the command with the other message status parameters (`traf`, `link`, `sa`, `db`, `sys`, or `pu`). If the `all` parameter and other message status parameters are specified together in the command, the terminal is assigned the other specified message status parameters and the `all` parameter is ignored.

If a SEAS terminal is being removed, then a warning that states "Invalidating the Terminal data in SEASCFG table" appears.

If the SEAS output group is turned off for a SEAS terminal, then a message "SEAS Output Group is SET for SEAS Terminal *trm number*" appears.

## Output

```
chg-trm:trm=2:all=yes
```

```
rlghncxa03w 04-05-07 11:11:28 EST EAGLE 31.5.0  
CHG-TRM: MASP A - COMPLTD  
;
```

## Related Topics

- [act-echo](#)
- [canc-echo](#)
- [chg-trm](#)
- [dact-echo](#)
- [inh-trm](#)
- [rept-stat-trm](#)
- [rmv-trm](#)
- [rst-trm](#)
- [rtrv-trm](#)

# chg-ttmap

Use this command to change a mapped SS7 message translation type (TT) for a given gateway linkset name. With this command you can change the identification of the type of allowed global title translation in the SS7 message before and after translation type mapping. For example, suppose you are mapping the translation type 001 (before TT mapping) to 238 (after TT mapping). You can use this command to change that mapping to 001 (before) to 254 (after).

## Parameters

### **ett (mandatory)**

Translation type before mapping. The identification of the type of global title translation in the SS7 message before translation type mapping. This attribute is the decimal representation of the 1-octet binary field used by the SS7 protocol to identify the translation type.

**Range:**

0 - 255

### **io (mandatory)**

Incoming or outgoing. This parameter indicates whether the translation type mapping data provisioned for the gateway linkset is for SS7 messages received or sent on the linkset.

**Range:**

*i*  
incoming



**o**  
outgoing

**lsn (mandatory)**

Linkset name. The unique network identifier for the gateway linkset.

**Range:**

ayyyyyyyy

1 alphabetic character followed by 9 alphanumeric characters

**mtt (mandatory)**

Mapped translation type. The identification of the type of global title translation in the SS7 message after translation type mapping. This attribute is the decimal representation of the 1-octet binary field used by the SS7 protocol to identify the translation type.

**Range:**

0 - 255

**Example**

```
chg-ttmap:lsn=nc001:io=o:ett=128:mtt=55
```

**Dependencies**

The Translation Type mapping table must be accessible.

The linkset table must be accessible.

The linkset must be defined.

**Notes**

None

**Output**

```
chg-ttmap:lsn=nc001:io=o:ett=128:mtt=55
```

```
rlghncxa03w 04-01-22 10:37:07 EST EAGLE 31.3.0  
CHG-TTMAP: MASP A - COMPLTD
```

```
TTMAP table for nc001 is (2 of 64) 3% full
```

```
;
```

**Related Topics**

- [dlt-ttmap](#)
- [ent-ttmap](#)
- [rtrv-ttmap](#)

## chg-ttr-msg

Use this command to revise a Triggerless TCAP Relay message.

## Parameters

### **msgn (mandatory)**

Message number. The number of the TTR message.

**Range:**

1 - 10

### **active (optional)**

This parameter specifies whether the TTR message is sent to the network card for processing.

**Range:**

**yes**

The message is sent to the network card.

**no**

The message is not sent to the network card.

**Default:**

no

### **bcsn (optional)**

Basic call state model. The value for the *EventTypeBCSM* field of the TTR message.

**Range:**

2 hexadecimal digits. Valid digits are 0-9, a-f, A-F

**Default:**

No change to the current value

### **cdpadgts (optional)**

Called party address digits. The SCCP CdPA digits for the IDP message.

**Range:**

1 - 15 hexadecimal digits. Valid digits are 0-9, a-f, A-F

**Default:**

No change to the current value

### **cdpagt (optional)**

Called party address global title. The SCCP CdPA GT for the IDP message.

**Range:**

0 - 15

**Default:**

No change to the current value

### **cdpagtnai (optional)**

Called party address global title nature of address indicator. The SCCP CdPA GT NAI for the IDP message.

**Range:**

0 - 127

**Default:**

No change to the current value

**cdpndgts (optional)**

Called party number digits. The TCAP CdPN digits for the IDP message.

**Range:**

1 - 32 hexadecimal digits. Valid digits are *0-9, a-f, A-F*

**Default:**

No change to the current value

**cdpnnai (optional)**

Called Party Number Nature of Address Indicator. The value for TCAP CdPN NAI value for the IDP message.

**Range:**

*0 - 127*

**Default:**

No change to the current value

**cgpndgts (optional)**

Calling party address digits. The SCCP CgPA digits for the IDP message.

**Range:**

1 - 15 hexadecimal digits. Valid digits are *0-9, a-f, A-F*

**Default:**

No change to the current value

**cgpagt (optional)**

Calling party address global title. The SCCP CgPA GT for the IDP message.

**Range:**

*0 - 15*

**Default:**

No change to the current value

**cgpagnai (optional)**

Calling party address global title nature of address indicator. The SCCP CgPA GT NAI for the IDP message.

**Range:**

*0 - 127*

**Default:**

No change to the current value

**cgpndgts (optional)**

Calling party number digits. The TCAP CgPN digits in the IDP message.

**Range:**

1- 32 hexadecimal digits, *none* .  
Valid digits are *0-9, a-f, A-F*  
*none* -deletes the current digits

**Default:**  
No change to the current value

**cgpnnai (optional)**  
Calling party number nature of address indicator. The TCAP CgPN NAI in the IDP message.

**Range:**  
*0 - 127*

**Default:**  
No change to the current value

**lacdgt5 (optional)**  
Location area code digits. The area code if the value is not provided in the CdPN.

**Range:**  
1 - 6 hexadecimal digits. Valid digits are *0-9, a-f, A-F*

**Default:**  
No change to the current value

**reset (optional)**  
This parameter resets all of the parameters to their default values.

**Range:**  
**yes**  
Resets all message parameters to their default values

**Default:**  
No change to the current value

**sk (optional)**  
Service key. The service key for the IDP message.

**Range:**  
8 hexadecimal digits. Valid digits are *0-9, a-f, A-F*

**Default:**  
No change to the current value

**tcaptype (optional)**  
This parameter specifies whether the IDP message is Intelligent Network Application Protocol-based (INAP) or Camel Application Protocol-based (CAP).

**Range:**  
**inap**  
INAP-based  
**cap**  
CAP-based

**Default:**  
No change to the current value

**Example**

```
chg-ttr-
msg:msgn=1:tcaptype=INAP:cdpnnai=4:cdpadgts=12457896abcd:cgpnna
i=4
```

```
chg-ttr-
msg:msgn=1:cdpnnai=2:cdpndgts=981123456:sk=00006b00:bcsn=02
```

**Dependencies**

The Prepaid IDP Query Relay feature must be enabled before this command can be entered.

If the `tcaptype` parameter is specified, then the `cdpnnai` and the `cgpnna` parameters must be specified.

The TSTMSG table is corrupt or cannot be found.

If the `reset` parameter is specified, then no other parameters can be specified.

At least one optional parameter must be specified.

**Notes**

None.

**Output**

```
chg-ttr-
msg:msgn=1:tcaptype=CAP:cdpnnai=4:cdpndgts=987654321:cgpnna=4
```

```
tekelecstp 08-05-05 15:58:08 EST EAGLE 39.0.0
CHG-TTR-MSG: MASP A - COMPLTD
```

```
;
```

**Related Topics**

- [rtv-ttr-msg](#)
- [tst-msg](#)

## chg-ttropts

Use this command to enter Triggerless TCAP Relay (TTR)-specific options in the database. This command updates the TTROPTS table.

**Note:**

Values other than *none* that are entered for the `dlma`, `dlmb`, or `dlmc` parameters for the IDP Relay services (IDPRCDPN(X), IDPRCGPN) using this command will overwrite values entered for those parameters using the `chg-npp-serv` command.

## Parameters



### Note:

The options for the `on` and `off` parameters are described in the Notes section.

### **cddnotfndrsp (optional)**

The system response for an IDP message processed by the IDPR/TTR service when the Called Party Number (CdPN) is not found in the RTDB.

#### Range:

**relay**

relay the message

**connect**

send a CONNECT message

**continue**

send a CONTINUE message

**release**

send a RELEASECALL message

#### Default:

*release*

### **cddra (optional)**

The destination routing address (DRA) used in the CONNECT message generated by the INPRTG Service Action based on the CdPN RTDB lookup.

#### Range:

**rdn**

RN + DN

**rn**

RN

**grn**

GRN

**rnasd**

RN + ASD

**asdrn**

ASD + RN

**rngrn**

RN + GRN

**grnrn**

GRN + RN

***ccrndn***

CC + RN + DN

***rnasddn***

RN + ASD + DN

***asdrndn***

ASD + RN + DN

***ccrnasddn***

CC + RN + ASD + DN

***ccasdrndn***

CC + ASD + RN + DN

***asdrnccdn***

ASD + RN + CC + DN

***rnasdccdn***

RN + ASD + CC + DN

***rngrndn***

RN + GRN + DN

***grnrndn***

GRN + RN + DN

***ccrngrndn***

CC + RN + GRN + DN

***ccgrnrndn***

CC + GRN + RN + DN

***grnrnccdn***

GRN + RN + CC + DN

***rngrnccdn***

RN + GRN + CC + DN

***grndn***

GRN + DN

***ccgrndn***

CC + GRN + DN

**Default:**

*rndn*

**cddranai (optional)**

The DRA nature of address indicator used in the CONNECT response generated by the INPRTG Service Action based on the CdPN RTDB lookup.

**Range:**

*sub*

*unknown*

*natl*

*intl*

*ntwk*

**Default:**

*natl*

**cd dranp (optional)**

The DRA numbering plan used in the CONNECT response generated by the INPRTG Service Action based on the CdPN RTDB lookup.

**Range:**

*e164*

*x121*

*f69*

**Default:**

*e164*

**cdnoentityrsp (optional)**

The system response for an IDP message processed by the IDPR/TTR service when neither the RN nor SP entity is found in the CdPN RTDB.

**Range:**

*relay*

relay the message

*connect*

send a CONNECT message

*continue*

send a CONTINUE message

*release*

send a RELEASECALL message

**Default:**

*continue*

**cdrelcause (optional)**

The *cause* parameter value for the RELEASECALL message generated by the INPRTG Service Action based on the CdPN RTDB lookup.

**Range:**

*1 - 127*

**Default:**

*31*



(not defined)

**cdnrnrsp (optional)**

The system response for an IDP message processed by the IDPR/TTR service when the CdPN is associated with an RN entity.

**Range:*****relay***

relay the message

***connect***

send a CONNECT message

***continue***

send a CONTINUE message

***release***

send a RELEASECALL message

**Default:**

*connect*

**cdsprrsp (optional)**

The system response for an IDP message processed by the IDPR/TTR service when the CdPN is associated with an SP entity.

**Range:*****relay***

relay the message

***connect***

send a CONNECT message

***continue***

send a CONTINUE message

***release***

send a RELEASECALL message

**Default:**

*relay*

**cgdnnotfndrsp (optional)**

The system response for an IDP message processed by the IDPR/TTR service when the Calling Party Number (CgPN) is not found in the RTDB.

**Range:*****relay***

relay the message

***connect***

send a CONNECT message

**continue**

send a CONTINUE message

**release**

send a RELEASECALL message

**Default:***release***cgdra (optional)**

The DRA used in the CONNECT response generated by the INPRTG Service Action based on the CGPN RTDB lookup.

**Range:*****rndn***

RN + DN

***rn***

RN

***grn***

GRN

***rnasd***

RN + ASD

***asdrn***

ASD + RN

***rngrn***

RN + GRN

***grnrn***

GRN + RN

***ccrndn***

CC + RN + DN

***rnasddn***

RN + ASD + DN

***asdrndn***

ASD + RN + DN

***ccrnasddn***

CC + RN + ASD + DN

***ccasdrndn***

CC + ASD + RN + DN

***asdrnccdn***

ASD + RN + CC + DN

***rnasdccdn***

RN + ASD + CC + DN

***rngrndn***  
RN + GRN + DN

***grnrndn***  
GRN + RN + DN

***ccrngrndn***  
CC + RN + GRN + DN

***ccgrnrndn***  
CC + GRN + RN + DN

***grnrccdn***  
GRN + RN + CC + DN

***rngrccdn***  
RN + GRN + CC + DN

***grndn***  
GRN + DN

***ccgrnrndn***  
CC + GRN + DN

**Default:**  
*rndn*

**cgdranai (optional)**

The NAI option used in the CONNECT response generated by the INPRTG Service Action based on the CgPN lookup.

**Range:**

***sub***

***unknown***

***natl***

***intl***

***ntwk***

**Default:**  
*natl*

**cgdranp (optional)**

The DRA NP used in the CONNECT response generated by the INPRTG Service Action based on the CgPN lookup.

**Range:**

***e164***

***x121***

***f69***

**Default:***e164***cgnoentityrsp (optional)**

The system response for an IDP message processed by the IDPR/TTR service when neither the RN nor SP entity is found in the CgPN RTDB.

**Range:*****relay***

relay the message

***connect***

send a CONNECT message

***continue***

send a CONTINUE message

***release***

send a RELEASECALL message

**Default:***continue***cgnpdtype (optional)**

CgPN database lookup type. The entity type that is considered a success when used for RTDB lookup.

**Range:*****sp***

Service Provider

***rn***

Routing Number

***rns****rn* or *sp****anymatch****rn*, *sp*, or no match with any entity***always***

Lookup is always considered successful

***rnsdn****rn*, *sp*, or *dn*

If the `cgnpdtype=anymatch` parameter is specified, then the value is also used as the RN for the outgoing CgPN.

**Default:***rns***cgpacck (optional)**

CgPA country code check. This parameter specifies whether a DEFCC check is performed on the incoming CgPA.

**Range:**

***always***

The DEFCC check is always performed.

***nonintl***

The DEFCC check is performed if the CdPN NAI is not 'International'.

***off***

The DEFCC check is not performed.

**Default:**

*nonintl*

**cgpnskrtrtg (optional)**

This parameter specifies whether SK routing occurs if IDP A-Party routing fails.

**Range:**

***no***

SK routing does not execute if IDP A-Party Routing fails.

***yes***

SK routing executes if IDP A-Party Routing fails.

**Default:**

No change to the current value

**System Default:**

*no*

**cgre1cause (optional)**

The *cause* parameter value in the RELEASECALL message generated by an INPRTG Service Action based on the CgPN RTDB lookup.

**Range:**

*1 - 127*

**Default:**

*31* (not defined)

**cgrnrsp (optional)**

The system response for an IDP message processed by the IDPR/TTR service when the CgPN is associated with an RN entity.

**Range:**

***relay***

relay the message

***connect***

send a CONNECT message

***continue***

send a CONTINUE message

**release**  
send a RELEASECALL message

**Default:**  
*connect*

**cgsnai (optional)**

Calling party number nature of address indicator. The CgPN NAI that is used during number conditioning.

**Range:**

**incoming**  
The incoming CgPN NAI is used.

**intl**  
The CgPN NAI is set to 'International' (4).

**natl**  
The CgPN NAI is set to 'National' (3).

**unkn**  
The CgPN NAI is set to 'Unknown' (0).

A value of *incoming* must be specified before the *intl*, *natl*, *nai1*, *nai2*, *nai3*, and *unkn* parameters in the *chg-npp-serv* command can be changed to non-default values for the IDPRCGPN service.

**Default:**  
*incoming*

**cgsprsp (optional)**

The system response sent for an IDP message processed by the IDPR/TTR service when the CgPN is associated with an SP entity.

**Range:**

**relay**  
relay the message

**connect**  
send a CONNECT message

**continue**  
send a CONTINUE message

**release**  
send a RELEASECALL message

**Default:**  
*relay*

**df1trn (optional)**

Default routing number. The default RN used when a value of *sp* or *rns* is specified for the *nptype* parameter, and the CdPN RTDB lookup returns entity type SP.

**Range:**

1-15 hexadecimal digits, *none*.  
Valid digits are 0-9, a-f, A-F.  
*none* —a default RN is not used

**Default:**

*none*

**d1ma (optional)**

Delimiter A. The first delimiter used to format the outgoing TCAP dialed number.

**Range:**

1-16 hexadecimal digits, *none*.  
Valid digits are 0-9, a-f, A-F.

**Default:**

*none*

**d1mb (optional)**

Delimiter B. The second delimiter used to format the outgoing TCAP dialed number.

**Range:**

1-16 hexadecimal digits, *none*.  
Valid digits are 0-9, a-f, A-F.

**d1mc (optional)**

Delimiter C. The third delimiter used to format the outgoing TCAP DN.

**Range:**

1-16 hexadecimal digits, *none*.  
Valid digits are 0-9, a-f, A-F.

**drafmt (optional)**

DRA digit format. The format of the DRA digits.

**Range:*****grn***

The format is GRN.

***grndn***

The format is GRN+DN.

***dngrn***

The format is DN+GRN.

***ccgrndn***

The format is CC+GRN+DN.

***grnccdn***

The format is GRN+CC+DN.

**Default:**

No change to the current value

**System Default:**

*grn*

**dranai (optional)**

DRA nature of address indicator. The DRA NAI that is used during number conditioning.

**Range:**

1 - 127

**Default:**

No change to the current value

**System Default:**

3 - NATL

**map (optional)**

Mapping direction. The mapping direction between the Type of Number (TON) and the Nature Of Address Indicator (NAI).

**Range:*****nai2ton***

NAI mapping to TON

***ton2nai***

TON mapping to NAI

**Default:**

See the *Notes* section.

**nai (optional)**

Nature of Address Indicator. The NAI used in mapping.

**Range:**

0 - 127

**Default:**

See the *Notes* section.

**nptype (optional)**

Entity type for CdPN RTDB lookup. The entity type that is considered a success when used for RTDB lookup.

**Range:*****sp***

Service provider

***rn***

Routing number

***rnsp***

*rn* or *sp*

***anymatch***

*m*, *sp*, or no match with any entity

***always***

Lookup is always considered successful



***rnspsdn***  
*rn, sp, or dn*

If the `nptype=anymatch` parameter is specified, then the value is also used as the RN for the outgoing CdPN.

**Default:**

*rnsps*

Use RN or SP as entity type for RTDB lookup

**off (optional)**

This parameter turns off the specified options. Up to 8 comma-separated unique options can be specified.

**Range:**

***cdcnp***

***cgcnp***

**on (optional)**

This parameter turns on the specified options. Up to 8 comma-separated unique options can be specified.

**Range:**

***cdcnp***

***cgcnp***

**rnspsfill (optional)**

This parameter specifies whether the RN and SP entities are set to the value of the RN or SP digits from the RTDB when certain conditions are met.

**Range:**

***off***

If the `nptype` parameter has a value of *rnsps*, *anymatch*, or *always*, and the `dfltrn=none` parameter is specified, then the RN entity is NOT set to the value of the SP digits from the RTDB. If the `nptype` parameter has a value of *rnsps*, *anymatch*, or *always*, then the SP entity is NOT set to the value of the RN digits from the RTDB.

***on***

If the `nptype` parameter has a value of *rnsps*, *any*, or *all*, and the `dfltrn` parameter has a value of *none*, then the RN entity is set to the value of the SP digits from the RTDB. If the `nptype` parameter has a value of *rnsps*, *anymatch*, or *always*, and the `spsfill=on` parameter is specified, then the SP entity is set to the value of the RN digits from the RTDB.

**Default:**

No change to the current value

**System Default:**

*off*

**snai (optional)**

CdPN nature of address indicator. The CdPN NAI used during number conditioning.

**Range:*****incoming***

The incoming CdPN NAI is used.

***intl***

A CdPN NAI of 'International' (4) is used.

***natl***

A CdPN NAI of 'National' (3) is used.

***unkn***

A CdPN NAI of 'Unknown' (0) is used.

A value of *incoming* must be specified before the *intl*, *natl*, *nai1*, *nai2*, *nai3*, and *unkn* parameters in the `chg-npp-serv` command can be changed to non-default values for the IDPRCDPN(X) service.

**Default:**

*incoming*

**spfill (optional)**

This parameter specifies whether the SP entity type is populated if the value specified for the *dfltrn* or *grn* parameter is used for NPP processing.

**Range:*****off***

do not populate the SP entity type

***on***

populate the SP entity type

**Default:**

No change to the current value

**System Default:**

*off*

**sporttype (optional)**

Service Portability type. This parameter specifies whether Service Portability is performed for the associated feature.

The S-Port feature must be turned on before any change to the parameter will impact the associated feature. If Service Portability is performed, then the Service Portability prefix (RTDB 'GRN'entity id) is applied.

**Range:*****gsm***

apply Service Portability prefix for own-network GSM subscribers

***is41***

apply Service Portability prefix for own-network IS41 subscribers

**all**

apply Service Portability prefix for all own-network (IS41 and GSM) subscribers

**none**

Service Portability is not performed for the feature.

**Default:**

No change to the current value

**System Default:**

*none*

**ton (optional)**

Type of Number. The Type of Number used in mapping.

**Range:**

0 - 7

**Default:**

See the *Notes* section.

**Example**

```
chg-ttropts:nptype=always
chg-ttropts:snai=intl
chg-ttropts:cgnptype=sp
chg-ttropts:cgsnai=natl
chg-ttropts:dlma=1234567890
chg-ttropts:dlmb=1234567890123456
chg-ttropts:dlmc=1234567890abcdef
chg-ttropts:cgpaccck=always
chg-ttropts:dfltrn=123456789012345
chg-
ttropts:cddra=rn:cdrelcause=10:cgdranp=e164:cdnrsp=continue
chg-ttropts:cddra=grndn:on=cdcnp:off=cgcnp
chg-ttropts:nai=12:ton=7:map=nai2ton
```

**Dependencies**

At least one optional parameter must be specified.

The Prepaid IDP Query Relay feature must be enabled before this command can be entered.

The EGLEOPTS table is corrupt or cannot be found.

The IDP A-Party Routing feature and the IDP SK Routing feature must be enabled before the `cgpnskrty` parameter can be specified.

If the new or existing value specified for the `drafrmt` parameter contains a country code (e.g., `ccgrndn`), then only a value of 4 can be specified for the `dranai` parameter. If the `dranai` parameter has a new or existing value that is not equal to 4, then the value that is specified for the `drafrmt` parameter cannot contain a country code.

The S-Port feature must be enabled before the `sporttype` parameter can be specified.

The same option cannot be specified for the `on` and `off` parameters.

The `nai`, `ton`, and `map` parameters must be specified together in the command.

## Notes

### Definitions for the on/off options

- *cdcnp* —Specifies whether the *CutAndPaste* parameter is included in the CONNECT message generated by the INPRTG Service Action based on the CdPN RTDB lookup. The value for the *CutAndPaste* parameter is the length of the incoming DN in the IDP query if the DRA formatting option has a DN. If the option does not have a DN, the value is 0. The option has a default of OFF.
- *cgcnp* —Specifies whether the *CutAndPaste* parameter is included in the CONNECT message generated by the INPRTG Service Action based on the CgPN RTDB lookup. The value for the *CutAndPaste* parameter is the length of the incoming DN in the IDP query if the DRA formatting option has a DN. If the option does not have a DN, the value is 0. The option has a default of OFF.

### IDPR TON Mapping Default Values

If the `map`, `nai`, and `ton` parameters are not specified, then the TON and NAI values are associated as follows:

**Table 4-18 TON2NAI Mapping Default Values**

TON	NAI	
1	4	INTL
2	3	NATL
0	2	UNKN
All other values	2	-

**Table 4-19 NAI2TON Mapping Default Values**

NAI	TON	
4	1	INTL
3	2	NATL
2	0	UNKN
All other values	0	-

## Output

```
chg-ttropts:nptype=sp
```

```
tekelecstp 08-05-05 13:34:22 EST EAGLE 39.0.0  
CHG-TTROPTS: MASP A - COMPLTD
```

```
;
```

```
chg-
```

```
ttropts:cgdra=rn:cdrelcause=10:cgdranp=e164:cdnrsp=continue
```

```
tekelecstp 10-10-20 16:01:35 EST EAGLE 43.0.0  
Command entered at terminal #4.  
CHG-TTROPTS: MASP A - COMPLTD
```

```
;
```

## Related Topics

- [rtrv-ttropts](#)

# chg-uaps

Use this command to change the UA parameter set.

## Parameters

### **set (mandatory)**

UA parameter set to be changed.

#### **Range:**

1 - 9

#### **Default:**

No change to the current value

### **parm (optional)**

Parameter number.

#### **Range:**

1 - 10

1—ASP SNM Options

2—ASP/AS Notification Options

3—UA Serviceability Options

4-10—Unused

#### **Default:**

No change to the current value

**pvalue (optional)**

If the `parm` parameter is specified, then this parameter specifies the numerical value that the `parm` parameter will be set to. Each parameter value is 32 bits (decimal 4294967295); not all 32 bits are used for each parameter. Only the values of the used bits are evaluated to determine the parameter value.

If the default setting for one bit is ON and you want to turn ON another bit in addition, specify the value that turns both bits ON. To turn OFF a bit that is ON and leave other bits ON, specify the value that turns ON just the bits that you want to be on. See the Notes section for this command for an explanation of the meanings of the bit settings.

**Range:**

0 - 4294967295

Enter a valid decimal or hexadecimal value shown in [Table 4-20](#) for the `pvalue` parameter to be used for the specified `parm` parameter.

Parameter (parm)	To Turn On Only Bit(s)	Decimal pvalue	Hexadecimal pvalue	System Default
1. ASP SNM Options	0	1	h'1	
Bit 0=	1	2	h'2	
Broadcast	6	64	h'40	Off
Bit 1=	0, 1	3	h'3	On
Response Method	0, 6	65	h'41	
Bit 6 =	1, 6	66	h'42	
Broadcast	0, 1, 6	67	h'43	
Congestion Status Change				
Bits 2-5 and 7-31=	Unused			
2. ASP/AS Notification Options	1	h'1		
Bit 0= ASP	1	2	h'2	
ACTIVE	2	4	h'4	
Notifications	0, 1	3	h'3	
Bit 1= ASP	0, 2	5	h'5	
INACTIVE	1, 2	6	h'6	
Notifications	0, 1, 2	7	h'7	Off
Bit 2 = ASP				
AS State Query				
Bits 3-31 =	Unused			

Parameter (parm)	To Turn On Only Bit(s)	Decimal pvalue	Hexadecimal pvalue	System Default
3. <i>UA Serviceability Options</i>	0	1	h'1	Off
Bit 0 = UA Heartbeats	1	2	h'2	Off
Bit 1 = UA Graceful Shutdown	0,1	3	h'3	Off
Bits 2-31 = Unused				
4. <i>SCTP Payload Protocol Indicator Option</i>	0	1	h'1	Off
Bit 0 = SCTP Payload Protocol Indicator				
Bits 1-31 = Unused				

**Default:**

No change to the current value

**srcset (optional)**

When specified, this source UAPS will be copied into the specified UAPS (set).

**Range:**

1 - 10

**Default:**

Empty

**timer (optional)**

Timer number within the UA parameter set.

**Range:**

1 - 10

1—Unused

2—False IP Connection Congestion Timer

3—UA Heartbeat Period Timer

4—UA Heartbeat Received Timer

5-10—Unused

**Default:**

No change to the current value

**tvalue (optional)**

The value given to a timer in milliseconds. Each timer value is 32 bits (decimal 4294967295).

**Range:**

0 - 60000

Timer 2—0-30000

Timer 3—100-60000

Timer 4—100-10000

If the value specified is greater than the maximum range of the timer, then the maximum value of the timer is used.

**Default:**

No change to the current value

**System Default:**

Timer 2 -3000

Timer 3 -10000

Timer 4 -5000

**Example**

The following example copies UA parameter set 1 into UA parameter set 2.

```
chg-uaps:set=2:srcset=1
```

The following example sets the Timer 2 value to 30 milliseconds.

```
chg-uaps:set=1:timer=2:tvalue=30
```

The following example sets the UA parameter set 2 value to hexadecimal 7, which turns on bits 0, 1, and 2.

```
chg-uaps:set=1:parm=2:pvalue=h'7
```

The following example sets the Timer 2 value to 30 milliseconds, and sets the value for UA parameter set 1 to decimal 64, which turns OFF bits 0 and 1 and turns ON only bit 6.

```
chg-uaps:set=2:timer=2:tvalue=30:parm=1:pvalue=64
```

**Dependencies**

The `srcset` and `set` parameter values cannot be the same.

At least one of the `timer`, `parm`, and `srcset` optional parameters must be entered.

If the `srcset` parameter is specified, no other optional parameters can be entered in the command.

If the `parm` parameter is specified, the `pvalue` parameter must be specified.

If the `timer` parameter is specified, the `tvalue` parameter must be specified.

**Notes**

There are 10 UA parameter sets. Each UA parameter set has 10 timers and 10 optional bit-mapped parameters. The bit-mapped parameter values control SNM and extended UA notification message behavior.

**Timer 2** is the False IP Connection Congestion Timer, which controls the maximum amount of time (in milliseconds) that an association is allowed to remain congested before failing due



to false connection congestion. This timer value is limited to 0-30,000 milliseconds by the IPGWx application. The default value is 3000 milliseconds. This timer is not supported on the IPSP application.

**Timer 3** is the UA Heartbeat Period Timer, which controls the time (in milliseconds) between sending of BEAT messages by the NE. This timer value is limited to 100-60,000 milliseconds by the IPSP and IPGWx applications. The default value is 10,000 milliseconds.

**Timer 4** is the UA Heartbeat Received Timer, which controls the timeout period for response BEAT ACK messages by the NE. This timer value is limited to 100-10,000 milliseconds by the IPSP and IPGWx applications. The default value is 5000 milliseconds.

The bit-mapped parameters contain the following flags, which are set by using the *pvalue* parameter to turn the bits on or off in each bit map:

- *Broadcast* —Controls broadcast phase SNM TFPs, TFRs and TFAs sent when a destination's status changes. If this flag is on (set to 1), SNM TFPs, TFRs, and TFAs will be broadcast to all associations and sockets assigned to routing keys associated with the destination's network and group code. The default is to enable all broadcast phase messages.
- *Response Method* —Sending a SNM TFC/UPU as a reply to a message received on an association or a socket for an unavailable destination. If this bit is on (set to 1), the SNM response message is sent. The default is to allow the response to be sent.
- *Broadcast Congestion Status Change* —Controls sending unsolicited congestion status changes. If this flag is on (set to 1) for an ASP, unsolicited congestion status messages are sent by the ASP when a destination's congestion status changes. This flag is applicable only if, *ipgwabate* has been turned on with the *chg-sg-opts* command. The default is do not generate unsolicited congestion status changes.
- *ASP ACTIVE Notifications*—Controls sending ASP-Active notifications. If this flag is on (set to 1), the Secure Gateway will, when an ASP transitions to Active, send a Notify message to all inactive and active ASPs in the AS of status type "Other" and a newly defined status ID of "ASP Activation". The ASP Activation notification message will include the ASP ID of the ASP that activated, and is transmitted only if the ASP ID is present. This notification is an extension to RFC3332 and not implemented for M3UA Version 8 adapters. The default is do not send ASP Active Notifications.
- *ASP INACTIVE Notifications*—Controls sending ASP-Inactive notifications. If this flag is on (set to 1), the Secure Gateway will, when an ASP transitions to Inactive, send a Notify message to all inactive and active ASPs in the AS of status type "Other" and a newly defined status ID of "ASP Inactivation". The ASP Inactivation notification message will include the ASP ID of the ASP that inactivated and is transmitted only if the ASP ID is present. This notification is an extension to RFC3332 and not implemented for M3UA Version 8 adapters. The default is do not send ASP Inactive Notifications.
- *ASP AS State Query*—Controls sending ASP/AS State Notifications on request by ASP. If this flag is on (set to 1), the Secure Gateway will respond with ASP and AS state notifications if 1) the remote ASP sends ASP-UP or ASP-INACTIVE while the local ASP is in the ASP-INACTIVE state, or 2) the remote ASP sends ASP-ACTIVE while the local ASP is in the ASP-ACTIVE state. The default is do not send state notifications.

- *UA Heartbeats*—Controls sending UA Heartbeats on request by a connection. If this flag is on (set to 1), Heartbeat messages are transmitted in the ASP-DOWN, ASP-ACTIVE and ASP-INACTIVE States on connections from the Secure Gateway to the far end.
- *UA Graceful Shutdown*—Controls whether an association should be shutdown gracefully or not. If this flag is on (set to 1), then a graceful shutdown will occur when OPEN=NO is executed on the server side. Otherwise, the association will abort when OPEN=NO is executed.
- *SCTP Payload Protocol Indicator byte order option*—Indicates whether the SCTP Payload Protocol Indicator (PPI) in received/transmitted messages is in big endian or little endian byte format. If this flag is on (set to 1), then the PPI in received/transmitted messages is little endian. Otherwise, the PPI is in big endian byte format. This flag is implemented only on IPSG M2PA associations; all other association types ignore the flag.

### Output

```
chg-uaps:set=2:srcset=1
```

```
rlghncxa03w 02-03-07 11:11:28 EST EAGLE 30.0.0
CHG-UAPS: MASP A - COMPLTD
;
```

### Related Topics

- [rtrv-uaps](#)

## chg-user

Use this command to change user access to commands, change user ID's, and change passwords.

### Parameters



#### Note:

All `cc (X)` parameters consist of a configurable command class name (`ayy`), and indicator (`-yes` or `-no`) to specify whether the command class is allowed. A value of `fayy-yes` indicates that the value is allowed. A value of `fayy-no` indicates that the value is not allowed.

#### **uid (mandatory)**

User ID

#### **Range:**

`azzzzzzzzzzzzzzz`

1 alphabetic character followed by up to 15 alphanumeric characters

#### **a11 (optional)**

Specifies whether or not the user ID is assigned all non-configurable command classes (LINK, SA, SYS, PU, DB, DBG, LNP).

**Range:**

*yes*

*no*

**Default:**

No change to the current value

**cc1 (optional)**

Configurable command class name and an indicator to specify whether the User ID can enter commands assigned to the specified command class.

**Range:**

*ayy*

Specify the parameter value in the format *ayy-no* or *ayy-yes* .

**cc2 (optional)**

Configurable command class name and an indicator to specify whether the User ID can enter commands assigned to the specified command class.

**Range:**

*ayy*

Specify the parameter value in the format *ayy-no* or *ayy-yes* .

**cc3 (optional)**

Configurable command class name and an indicator to specify whether the User ID can enter commands assigned to the specified command class.

**Range:**

*ayy*

Specify the parameter value in the format *ayy-no* or *ayy-yes* .

**cc4 (optional)**

Configurable command class name and an indicator to specify whether the User ID can enter commands assigned to the specified command class.

**Range:**

*ayy*

Specify the parameter value in the format *ayy-no* or *ayy-yes* .

**cc5 (optional)**

Configurable command class name and an indicator to specify whether the User ID can enter commands assigned to the specified command class.

**Range:**

*ayy*

Specify the parameter value in the format *ayy-no* or *ayy-yes* .

**cc6 (optional)**

Configurable command class name and an indicator to specify whether the User ID can enter commands assigned to the specified command class.

**Range:**

*ayy*

Specify the parameter value in the format *ayy-no* or *ayy-yes* .

**cc7 (optional)**

Configurable command class name and an indicator to specify whether the User ID can enter commands assigned to the specified command class.

**Range:**

*ayy*

Specify the parameter value in the format *ayy-no* or *ayy-yes* .

**cc8 (optional)**

Configurable command class name and an indicator to specify whether the User ID can enter commands assigned to the specified command class.

**Range:**

*ayy*

Specify the parameter value in the format *ayy-no* or *ayy-yes* .

**db (optional)**

Access to all commands in command class Database Administration.

**Range:**

**yes**

**no**

**Default:**

No change to the current value

**dbg (optional)**

Access to all commands in command class Debug.

**Range:**

**yes**

**no**

**Default:**

No change to the current value

**link (optional)**

Access to all commands in command class Link Maintenance.

**Range:**

**yes**

**no**

**Default:**

No change to the current value

**nuid (optional)**

New user ID

**Range:**

*azzzzzzzzzzzzzzzzz* 1 alphabetic character followed by up to 15 alphanumeric characters

**Default:**

No change to the current value

**page (optional)**

The maximum age of the password, in days. The STP automatically prompts the user for a new password at login if the user's password is older than the value specified for the `page` parameter.

**Range:**

0 - 999

**Default:**

No change to the current value

**pid (optional)**

Password ID. Required only if changing the password of a user.

**Range:**

*yes*

*no*

**Default:**

No change to the current value

**pu (optional)**

Access to all commands in command class Program Update.

**Range:**

*yes*

*no*

**Default:**

No change to the current value

**revoke (optional)**

Revoke the user ID. The system rejects login attempts for a revoked user ID.

**Range:**

*yes*

*no*

**Default:**

No change to the current value

**rstls1 (optional)**

Reset the user ID. Use this command to reset the last successful login date, for this user ID, to the current date. If the user ID has been prevented login for non-use, use the `rstls1=yes` parameter to allow the user ID access again.

**Range:**

*yes*

*no*

**Default:**

No change to the current value

**sa (optional)**

Access to all commands in command class Security Administration.

**Range:**

*yes*

*no*

**Default:**

No change to the current value

**sys (optional)**

Access to all commands in command class System Maintenance.

**Range:**

*yes*

*no*

**Default:**

No change to the current value

**uout (optional)**

User ID aging interval. The number of successive days a user ID can go unused (that is, no successful login) before the system denies login of that user ID.

**Range:**

0 - 999

**Default:**

The value specified for the `uout` parameter on the `chg-secu-dflt` command

**Example**

```
chg-user:uid=john:nuid=johnmayer
```

```
chg-user:uid=john:nuid=john*mayer
```

```
chg-user:uid=john:db=yes
```

```
chg-user:uid=user123:cc1=dab-no:cc2=krb=yes
```

**Dependencies**

Passwords cannot be created or modified from a telnet terminal (terminal IDs 17-40) unless the OA&M IP Security Enhancements feature is turned on.

Changes to a user ID cannot be made while that user is logged on the system.

The `revoke=yes` parameter cannot be specified for a user ID with system administration authorization.

The Command Class Management feature must be enabled before a configurable command class name can be specified in the `cc1 - cc8` parameters.

The UserID table must be accessible.

The Password table must be accessible.

The CCCNAMES table must be accessible.

The values specified in the `cc1 - cc8` parameters must be valid default ( `u01 - u32` ) or provisioned configurable command class names.

### Notes

When the `pid=yes` parameter is specified, the system issues a separate prompt for this password and disables character echo at the terminal so that the entered password is not displayed on the screen. After the password has been entered, the system issues a second prompt, and the password must be entered again. This feature ensures that no typing mistakes were made on the first entry. The password must adhere to all password provisioning rules as established by the `chg-secu-dflt` command. These rules are displayed on the screen when the password prompt is presented.

The current password is not required when assigning a new password.

Use the following rules for changing passwords:

- A new password cannot contain more than 12 characters.
- A new password must contain at least the number of characters that is specified in the `minlen` parameter of the `chg-secu-dflt` command.
- A new password must contain at least the number of alphabetic, numeric, and punctuation characters specified in the `chg-secu-dflt` command.

A new password cannot contain the associated user ID.

As a default, the command class Basic is assigned to all users. If no other command class is assigned, the user still has access to commands in the Basic class.

Up to 8 configurable command class name parameters can be specified in one command. Additional commands can be entered to assign user access for more than 8 names. To assign user access for all 32 available configurable command class names, you could enter four commands with 8 names specified in each command.

### Output

```
chg-user:uid=john:nuid=johnmayer

      rlgncxa03w 04-01-07 11:11:28 EST  EAGLE 31.3.0
      CHG-USER: MASP A - COMPLTD
;
```

### Related Topics

- [act-user](#)

- [chg-pid](#)
- [dact-user](#)
- [dlt-user](#)
- [ent-user](#)
- [login](#)
- [logout](#)
- [rept-stat-user](#)
- [rtv-secu-user](#)
- [rtv-user](#)

## chg-vflx-cd

Use this command to revise the call decision criteria. This command updates the Call Decision table. The V-Flex feature must be enabled before this command can be entered.

### Parameters

#### **cdn (mandatory)**

Call decision name. The name of an entry in the Call Decision table.

##### **Range:**

*ayyy*

1 alphabetic character followed by 3 alphanumeric characters

#### **ncdn (optional)**

New call decision name. A new name for an entry in the Call Decision table.

##### **Range:**

*ayyy*

1 alphabetic character followed by 3 alphanumeric characters

##### **Default:**

No change to the current value

#### **nrndx (optional)**

New routing number index. A new routing number index associated with a call decision entry.

##### **Range:**

*0 - 9*

##### **Default:**

No change to the current value

#### **nvmdig (optional)**

New voice mail number or voice mail prefix digits. A new voice mail number or voice mail digits associated with a call decision entry.

##### **Range:**

1 - 15 hexadecimal digits. Valid digits are *0-9, A-F, a-f*



**Default:**

No change to the current value

**Example**

The following command specifies a new routing number index.

```
chg-vflx-cd:cdn=cdn1:nrnidx=7
```

The following command specifies a new call decision entry name and new routing number index.

```
chg-vflx-cd:cdn=cdn1:ncdn=cdn3:nrnidx=3
```

The following command specifies a new call decision entry name.

```
chg-vflx-cd:cdn=cdn3:ncdn=cdn5
```

The following command specifies a new voice mail number or voice mail prefix digits.

```
chg-vflx-cd:cdn=cdn1:nvmdig=123456
```

**Dependencies**

The value specified for the `cdn` parameter cannot be a reserved word, such as `none`.

At least one parameter value must be different from the values provisioned for the table entry.

The Call Decision table is corrupt or cannot be found.

The value specified for the `cdn` parameter must already exist in the Call Decision table.

The `ncdn`, `nrnidx`, or `nvmdig` parameter must be specified.

The V-Flex feature must be enabled before this command can be entered.

The value specified for the `ncdn` parameter cannot already exist in the Call Decision table.

The value specified for the `nvmdig` parameter cannot already exist in the Call Decision table with the same `dnstat`, `rdi`, and `bcap` values.

The value specified for the `nvmdig` parameter cannot differ from a value that already exists in the Call Decision table by only the value of the `dnstat` parameter. The values specified for the `rdi` and `bcap` parameters must also differ.

**Output**

```
chg-vflx-cd:cdn=cdn1:ncdn=cdn3:nrnidx=3
```

```
rlghncxa03w 08-05-07 11:11:28 EST EAGLE 39.0.0
CHG-VFLX-CD: MASP A - COMPLTD
;
```

**Related Topics**

- [dlt-vflx-cd](#)
- [ent-vflx-cd](#)
- [rtrv-vflx-cd](#)

## chg-vflx-opts

Use this command to provision the data that is used to condition the DN in an incoming MSU. This command updates the VFLXOPTS table. The V-Flex feature must be enabled before this command can be entered.

### Parameters

 **Note:**

The nature of address indicator parameters (`dranaiv` or `drnai`) can be specified using a mnemonic or an explicit value. Either the mnemonic or the explicit value can be specified; however, both values cannot be specified at the same time for the same parameter. [Table A-3](#) shows the mapping between the `dranaiv` and `drnai` parameter values.

 **Note:**

The numbering plan parameters (`dranpv` or `dranp`) can be specified using a mnemonic or an explicit value. Either the mnemonic or the explicit value can be specified; however, both values cannot be specified at the same time for the same parameter. [Table A-4](#) shows the mapping between the `dranaiv` and the `drnai` parameter values.

### **dra** (optional)

Destination routing address. This parameter specifies the destination routing address in the "CONNECT" response.

#### Range:

*rn*  
Routing number

*rndn*  
RN + DN

*ccrndn*  
CC + RN + DN

**Default:**  
No change to current value.

**System Default:**  
*rn*

### **dranai** (optional)

Nature of address indicator. The nature of address indicator for the destination routing address.

**Range:**

*sub*

*unknown*

*natl*

*intl*

*ntwk*

**Default:**

Current value

**dranai v (optional)**

The nature of address indicator value for the destination routing address.

**Range:**

0 - 127

**dranp (optional)**

The numbering plan for the destination routing address.

**Range:**

*e164*

*x121*

*f69*

**Default:**

No change to the current value

**dranpv (optional)**

This parameter specifies the numbering plan value for the destination routing address.

**Range:**

0 - 7

**Default:**

No change to the current value

**nequeryonly (optional)**

This parameter specifies whether the Call Decision table is searched after RTDB lookup.

**Range:**

*off*

The table is not searched.

*on*

The table is searched.

**Default:**

No change to the current value.

**netype (optional)**

This parameter specifies the network entity type that is used for RTDB lookup.

**Range:**

**vmsid**  
voice mail server ID

**sprn**  
signaling point routing number

**grn**  
generic routing number

**Default:**

No change to the current value.

**System Default:**

*vmsid*

**Example**

This example specifies a new numbering plan and nature of address indicator:

```
chg-vflx-opts:dranai=sub:dranp=e164
```

This example searches the Call Decision and VMSID tables and uses the *vmsid* network entity before RTDB lookup:

```
chg-vflx-opts:nequeryonly=on:netype=vmsid
```

This example specifies a new destination routing address:

```
chg-vflx-opts:dra=rn
```

**Dependencies**

At least one optional parameter must be specified.

The *dranp* and *dranpv* parameters cannot be specified together in the command.

The *dranai* and *dranaiv* parameters cannot be specified together in the command.

The V-Flex Options table is corrupt or cannot be found by the system.

The V-Flex feature must be enabled before this command can be entered.

The *nequeryonly=on* parameter must be specified before the *netype* parameter can be specified.

**Output**

```
chg-vflx-opts:dra=rn:dranp=e164:dranai=intl
```

```
tekelecstp 08-05-11 11:34:04 EST EAGLE 39.0.0  
CHG-VFLX-OPTS: MASP A - COMPLTD
```

```
;
```

**Related Topics**

- [rtrv-vflx-opts](#)

## chg-vflx-rn

Use this command to revise the voice mail routing numbers. This command updates the Routing Number table. The V-Flex feature must be enabled before this command can be entered.

**Parameters****rnname (mandatory)**

Routing number name. The name associated with a voice mail routing number.

**Range:**

*ayyyyyyy*

1 alphabetic character followed by 7 alphanumeric characters

**nrn (optional)**

New routing number. A new voice mail routing number.

**Range:**

1-15 digits. Valid digits are *0-9, A-F, a-f*

**Default:**

No change to the current value

**nrnname (optional)**

New routing number name. The new name associated with a voice mail routing number.

**Range:**

*ayyyyyyy*

1 alphabetic character followed by 7 alphanumeric characters.

**Default:**

No change to the current value

**Example**

This example changes the name of the routing number.

```
chg-vflx-rn:rnname=rn01:nrnname=rn04
```

This example changes the routing number digits for a specified routing number name.

```
chg-vflx-rn:rnname=rn01:nrn=122345BC8
```

This example changes the routing number digits and the routing number name.

```
chg-vflx-rn:rnname=rn01:nrn=1223EAB68:nrnname=rn03
```

**Dependencies**

The Routing Number table is corrupt or cannot be found by the system.

The value specified for the `rnname` parameter must already exist in the Routing Number table.

The value specified for the `nrn` parameter cannot already exist in the Routing Number table.

The V-Flex feature must be enabled before this command can be entered.

The value specified for the `nrnname` parameter cannot already exist in the Routing Number table.

The `nrn` or `nrnname` parameter must be specified in the command.

The value specified for the `nrnname` parameter cannot be a reserved word, such as `none`.

At least one parameter value must be different from the values provisioned for the table entry.

### Output

```
chg-vflx-rn:rnname=rn01:nrn=122345CE8:nrnname=rn02
```

```
rlghncxa03w 08-05-07 11:43:04 EST EAGLE 39.0.0
CHG-VFLX-RN: MASP A - COMPLTD
;
```

### Related Topics

- [dlt-vflx-rn](#)
- [ent-vflx-rn](#)
- [rtrv-vflx-rn](#)

## chg-vflx-vmsid

Use this command to revise the routing numbers that are associated with a VMS ID. This command updates the VMSID table. The V-Flex feature must be enabled before this command can be entered.

### Parameters

#### **id (mandatory)**

The identification of the voice mail server.

#### **Range:**

1 - 15 digits, *dflt*

Valid digits are 0-9, A-F, a-f.

*dflt*—default set of routing numbers that is used when a query is received with an invalid MSISDN or an MSISDN that is not found in the RTDB.

#### **nid $\times$ 0 (optional)**

A new routing number name for VMRN index 0.

#### **Range:**

*ayyyyyyy*

1 alphabetic character followed by up to 7 alphanumeric characters

*none*—deletes the routing number name associated with an index

#### **Default:**

No change to the current value

**nidx1 (optional)**

A new routing number name for VMRN index 1.

**Range:**

*ayyyyyyy*

1 alphabetic character followed by up to 7 alphanumeric characters

*none*—deletes the routing number name associated with an index

**Default:**

No change to the current value

**nidx2 (optional)**

A new routing number name for VMRN index 2.

**Range:**

*ayyyyyyy*

1 alphabetic character followed by up to 7 alphanumeric characters

*none*—deletes the routing number name associated with an index

**Default:**

No change to the current value

**nidx3 (optional)**

A new routing number name for VMRN index 3.

**Range:**

*ayyyyyyy*

1 alphabetic character followed by up to 7 alphanumeric characters

*none*—deletes the routing number name associated with the index

**Default:**

No change to the current value

**nidx4 (optional)**

A new routing number name for VMRN index 4.

**Range:**

*ayyyyyyy*

1 alphabetic character followed by up to 7 alphanumeric characters

*none*—deletes the routing number name associated with the index

**Default:**

No change to the current value

**nidx5 (optional)**

A new routing number name for VMRN index 5.

**Range:**

*ayyyyyyy*

1 alphabetic character followed by up to 7 alphanumeric characters

*none*—deletes the routing number name associated with the index

**Default:**

No change to the current value

**nidx6 (optional)**

A new routing number name for VMRN index 6.

**Range:**

ayyyyyyy

1 alphabetic character followed by up to 7 alphanumeric characters

*none*—deletes the routing number name associated with the index

**Default:**

No change to the current value

**nidx7 (optional)**

A new routing number name for VMRN index 7.

**Range:**

ayyyyyyy

1 alphabetic character followed by up to 7 alphanumeric characters

*none*—deletes the routing number name associated with an index

**Default:**

No change to the current value

**nidx8 (optional)**

A new routing number name for VMRN index 8.

**Range:**

ayyyyyyy

1 alphabetic character followed by up to 7 alphanumeric characters

*none*—deletes the routing number name associated with an index

**Default:**

No change to the current value

**nidx9 (optional)**

A new routing number name for VMRN index 9.

**Range:**

ayyyyyyy

1 alphabetic character followed by up to 7 alphanumeric characters

*none*—deletes the routing number name associated with an index

**Default:**

No change to the current value

**Example**

The following example updates the specified VMS ID with a new routing number name for index 5. It also removes the routing number name associated with index 1.

```
chg-vflx-vmsid:id=1234ae5:nidx1=none:nidx5=rname1
```

**Dependencies**

The V-Flex feature must be enabled before this command can be entered.

The value specified for the `id` parameter must already exist in the VMSID table.



The routing number name of the entry specified by the `id` parameter must already exist in the Routing Number table.

At least one of the optional parameters must be specified.

The VMSID table is corrupt or cannot be found by the system.

The Routing Number table is corrupt or cannot be found by the system.

The GTT DBMM table is corrupt or cannot be found by the system.

At least one parameter value must be different from the values provisioned for the table entry.

The value specified for the `rname` parameter must already exist in the Routing Number table.

### Output

```
chg-vflx-vmsid:id=1234ae5:nidx1=none:nidx5=rname1
```

```
rlghncxa03w 08-05-07 11:43:04 EST EAGLE 39.0.0  
CHG-VFLX-VMSID: MASP A - COMPLTD
```

```
;
```

### Related Topics

- [dlt-vflx-vmsid](#)
- [ent-vflx-vmsid](#)
- [rtrv-vflx-vmsid](#)

## chg-vlr-prof

Use this command to change a Visitor Location Register (VLR) Profile for a mobile subscriber. A VLR-Profile entry helps in getting information required to locate the user while roaming and is subsequently used in VLR-ROAM table.

### Parameters

#### **vlr** (mandatory)

VLR Number: Hexadecimal digit GT Number with variable length (1 to 16).

#### **Range:**

Hexadecimal digit string 1 to 16 digits

#### **filter** (optional)

Determines the category in which the number falls into.

#### **Range:**

*whitelist*

*blacklist*

*graylist*

**Default:**  
*graylist*

**ageofloc (optional)**

Determines whether the duration at which the location was last updated must be taken into consideration.

**Range:**  
*yes*

*no*

**Default:**  
*no*

**lastact (optional)**

Determines whether last user activity must be taken into consideration.

**Range:**  
*yes*

*no*

**Default:**  
*no*

**imeirtrv (optional)**

Determines whether the VLR challenge by the IMEI is enabled for the given profile entry's last user activity has to be taken into consideration.

**Range:**  
*yes*

*no*

**Default:**  
*no*

**Example**

```
chg-vlr-prof:vlr=4234:filter=blacklist
chg-vlr-prof:vlr=4234:ageofloc=no:lastact=yes
chg-vlr-prof:vlr=4234:imeirtrv=yes
```

**Dependencies**

VLR\_PROF table must be accessible.

VLR\_DBMM table must be accessible.

OLDVLR and NEWVLR parameter length must be in the range 1 to 5 digits as per current restriction.

OLDVLR or NEWVLR parameter must be existing in VLR-PROF table

At least one of the optional parameter is mandatory to be specified.

If an entry is referenced in VLR-ROAMING table, then it cannot be updated.

## Output

```
chg-vlr-prof:vlr=9234:ageofloc=no:lastact=yes

tekelecstp 17-11-23 14:08:49 MST  EAGLE 46.5.1.5.0-73.2.0
  chg-vlr-prof:vlr=9234:ageofloc=no:lastact=yes
  Command entered at terminal #17.
;

tekelecstp 17-11-23 14:08:49 MST  EAGLE 46.5.1.5.0-73.2.0
CHG-VLR-PROF: MASP A - Cannot access standby fixed disk.
CHG-VLR-PROF: MASP A - Simplex database update.
Command Accepted - Processing

VLR-PROF table is (4 of 500) 1% full.

;
tekelecstp 17-11-23 14:08:49 MST  EAGLE 46.5.1.5.0-73.2.0
CHG-VLR-PROF: MASP A - COMPLTD
;
Command Executed
```

The following example explains E3609:

```
chg-vlr-prof:vlr=124:filter=blacklist
```

E3609 Cmd Rej: A reference of this entry exists in VLR roaming tbl

```
tekelecstp 17-11-27 13:36:07 MST  EAGLE 46.5.1.5.0-73.2.0
  chg-vlr-prof:vlr=124:filter=blacklist
  Command entered at terminal #2.
;

tekelecstp 17-11-27 13:36:07 MST  EAGLE 46.5.1.5.0-73.2.0
CHG-VLR-PROF: MASP A - Cannot access standby fixed disk.
CHG-VLR-PROF: MASP A - Simplex database update.
CHG-VLR-PROF: MASP A - Command Aborted
;
```

## Related Topics

- [dlt-vlr-prof](#)
- [ent-vlr-prof](#)
- [rtrv-vlr-prof](#)

# chg-vlr-roaming

Use this command to change a Visitor Location Register (VLR) roaming entry for a mobile subscriber. A VLR-Roaming entry uses existing entries for both new as well as old entries from vlr-prof table.

## Parameters

### **oldv1r (mandatory)**

VLR Number from which mobile subscriber has moved, hexadecimal digit GT number with variable length (1 to 16).

#### **Range:**

Hexadecimal digit string 1 to 16 digits

### **newv1r (mandatory)**

VLR Number to which mobile subscriber has moved, hexadecimal digit GT number with variable length (1 to 16).

#### **Range:**

Hexadecimal digit string 1 to 16 digits

### **time (mandatory)**

Duration for which the roaming must occur. Time is in minutes.

#### **Range:**

1-1440

## Example

```
chg-vlr-roaming:oldv1r=1234:newv1r=56545:time=20
```

## Dependencies

VLR\_PROF table must be accessible.

VLR\_DBMM table must be accessible.

VLR\_ROAM table must be accessible.

OLDVLR and NEWVLR parameter length must be in the range 1 to 5 digits as per current restriction.

OLDVLR or NEWVLR parameter must be existing in VLR-PROF table

The entry should be existing in VLR\_ROAM table

## Output

```
chg-vlr-roaming:oldv1r=1234:newv1r=56545:time=20
```

```
tekelecstp 17-11-23 16:23:44 MST EAGLE 46.5.1.5.0-73.2.0
```

```
  chg-vlr-roaming:oldv1r=1234:newv1r=56545:time=20
```

```
  Command entered at terminal #17.
```

```
;
```

```
tekelecstp 17-11-23 16:23:44 MST EAGLE 46.5.1.5.0-73.2.0
```

```
CHG-VLR-ROAMING: MASP A - Cannot access standby fixed disk.
```

```
CHG-VLR-ROAMING: MASP A - Simplex database update.
```

```
Command Accepted - Processing
```

```
VLR-ROAMING table is (1 of 1000) 1% full.
```

```
;
tekelecstp 17-11-23 16:23:44 MST EAGLE 46.5.1.5.0-73.2.0
CHG-VLR-ROAMING: MASP A - COMPLTD
;
```

### Related Topics

- [dlt-vlr-roaming](#)
- [ent-vlr-roaming](#)
- [rtrv-vlr-roaming](#)

## chk-unref-ent

Use this command to check for unreferenced entities in the STP gateway screening entity sets. Unreferenced entities are those entities not referenced by another entity using the next screening function identifier and next screening reference combination, or using the linkset screening reference.

### Parameters

#### **aftpc (optional)**

This parameter specifies whether to audit the affected PC/SSN entity set.

##### **Range:**

*yes*

*no*

##### **Default:**

*no*

#### **a11 (optional)**

This parameter specifies whether to audit all of the entity sets.

##### **Range:**

*yes*

*no*

##### **Default:**

*no*

#### **blkdpc (optional)**

This parameter specifies whether to audit the blocked DPC entity set.

##### **Range:**

*yes*

*no*

##### **Default:**

*no*

**blkopc (optional)**

This parameter specifies whether to audit the blocked OPC entity set.

**Range:**

*yes*

*no*

**Default:**

*no*

**cdpa (optional)**

This parameter specifies whether to audit the allowed CDPA entity set.

**Range:**

*yes*

*no*

**Default:**

*no*

**cgpa (optional)**

This parameter specifies whether to audit the allowed CGPA entity set.

**Range:**

*yes*

*no*

**Default:**

*no*

**destfld (optional)**

This parameter specifies whether to audit the affected DESTFLD entity set.

**Range:**

*yes*

*no*

**Default:**

*no*

**dpc (optional)**

This parameter specifies whether to audit the allowed DPC entity set.

**Range:**

*yes*

*no*

**Default:**

*no*

**isup (optional)**

This parameter specifies whether to audit the ISUP message type entity set.

**Range:**

*yes*

*no*

**Default:**

*no*

**opc (optional)**

This parameter specifies whether to audit the allowed OPC entity set.

**Range:**

*yes*

*no*

**Default:**

*no*

**sio (optional)**

This parameter specifies whether to audit the allowed SIO entity set.

**Range:**

*yes*

*no*

**Default:**

*no*

**tt (optional)**

This parameter specifies whether to audit the allowed TT entity set.

**Range:**

*yes*

*no*

**Default:**

*no*

**Example**

```
chk-unref-ent:opc=yes:dpc=yes:sio=yes
```

```
chk-unref-ent:all=yes
```

```
chk-unref-ent:all=yes:blkopc=no:blkdpc=no
```

**Dependencies**

At least one entity set name must be specified.

The Gateway Screening (GWS) database must be accessible.

**Notes**

None

**Output**

```
chk-unref-ent:opc=yes:dpc=yes:sio=yes
```

```

rlghncxa03w 04-01-18 08:29:15 EST  EAGLE 31.3.0
ENTITY          UNREFERENCED
TYPE            ENTITIES
-----
OPC             <NONE>
DPC             DPC1
DPC             DPC2
SIO             <NONE>
;

```

```
chk-unref-ent:all=yes
```

```

rlghncxa03w 04-01-18 08:29:15 EST  EAGLE 31.3.0
ENTITY          UNREFERENCED
TYPE            ENTITIES
-----
OPC             <NONE>
DPC             dpc1
                dpc2
BLKOPC          <NONE>
BLKDPC          <NONE>
SIO             <NONE>
CGPA            <NONE>
CDPA            <NONE>
TT              tt0-1
                tt-05
DESTFLD        <NONE>
AFTPC           <NONE>
ISUP            <NONE>
;

```

```
chk-unref-ent:all=yes:blkopc=no:blkdpc=no
```

```

rlghncxa03w 04-01-18 08:29:15 EST  EAGLE 31.3.0
ENTITY          UNREFERENCED
TYPE            ENTITIES
-----

```



OPC	<NONE>
DPC	dpc1 dpc2
SIO	<NONE>
CGPA	<NONE>
CDPA	<NONE>
TT	tt01 tt05
AFTPC	<NONE>

;

### Legend

- **ENTITY TYPE**—This field displays which entity type is being checked.
- **UNREFERENCED ENTITIES**—This field displays whether the entity type listed is referenced by another entity.

### Related Topics

- [aud-data](#)
- [chg-scr-aftpc](#)
- [chg-scr-blkdpc](#)
- [chg-scr-blkopc](#)
- [chg-scr-cdpa](#)
- [chg-scr-cgpa](#)
- [chg-scr-destfld](#)
- [chg-scr-dpc](#)
- [chg-scr-opc](#)
- [chg-scr-sio](#)
- [chg-scr-tt](#)
- [chg-scrset](#)
- [dlt-scr-aftpc](#)
- [dlt-scr-blkdpc](#)
- [dlt-scr-blkopc](#)
- [dlt-scr-cdpa](#)
- [dlt-scr-cgpa](#)
- [dlt-scr-destfld](#)
- [dlt-scr-dpc](#)
- [dlt-scr-opc](#)
- [dlt-scr-sio](#)
- [dlt-scr-tt](#)
- [dlt-scrset](#)
- [ent-scr-aftpc](#)

- ent-scr-blkdpc
- ent-scr-blkopc
- ent-scr-cdpa
- ent-scr-cgpa
- ent-scr-destfld
- ent-scr-dpc
- ent-scr-opc
- ent-scr-sio
- ent-scr-tt
- ent-scrset

## clr-imt-stats

Every card in the system has a card location identifier (stenciled on the shelf and provided in all output) and an IMT address. Use this command to clear the following statistics:

- IMT level 1 and level 2 statistics for specified IMT addresses and hourly time period statistics for IMT errors
- Card error and hourly time period statistics for the MUX cards
- All IMT and MUX error and hourly time period statistics. When hourly time period statistics for the errors are cleared, the current hourly time period number is reset to 0 (zero) on all cards.

### Parameters

#### **a11 (optional)**

Clear all IMT and MUX statistics.

#### **Range:**

**yes**

**no**

#### **Default:**

*no*

#### **e (optional)**

End address. The IMT address of the last card in the range.

#### **Range:**

*0 - 251*

(See the *Installation Guide* for an illustration with IMT addresses).

#### **e10c (optional)**

End location. The card location of the last card in the range.

**Range:**

1101 - 1113, 1115, 1201 - 1218, 1301 - 1318, 2101 - 2118, 2201 - 2218, 2301 - 2318, 3101 - 3118, 3201 - 3218, 3301 - 3318, 4101 - 4118, 4201 - 4218, 4301 - 4318, 5101 - 5118, 5201 - 5218, 5301 - 5318, 6101 - 6118

**Default:**

If `sloc` is specified—current `sloc` value

If `sloc` is not specified—1115 which corresponds to IMT address 251 (`e=251`)

**eshelf (optional)**

End shelf location for MUX statistics. The shelf location of the last shelf in the range. (MUX statistics will be cleared if they exist in the range between and including the `sshelf` and `eshelf` locations).

**Range:**

1100, 1200 - 6100

**Default:**

If `sshelf` is specified—current `sshelf` value

If `sshelf` is not specified— 6100

**s (optional)**

Start address. The IMT address of the first (or only) card in the range.

**Range:**

0 - 251

See the *Installation Guide* of your current documentation set for an illustration with IMT addresses.

**sloc (optional)**

Start location. Specifies the card location of the first card in the range.

**Range:**

1101 - 1113, 1115, 1201 - 1218, 1301 - 1318, 2101 - 2118, 2201 - 2218, 2301 - 2318, 3101 - 3118, 3201 - 3218, 3301 - 3318, 4101 - 4118, 4201 - 4218, 4301 - 4318, 5101 - 5118, 5201 - 5218, 5301 - 5318, 6101 - 6118

**Default:**

If `eloc` is specified—current `eloc` value

If `eloc` is not specified— 1201 which corresponds to IMT address 0 (`s=0`).

**sshelf (optional)**

Start shelf location for MUX statistics. This parameter specifies the shelf location of the first shelf in the range. (MUX statistics will be cleared if they exist in the range between and including the `sshelf` and `eshelf` locations).

**Range:**

1100, 1200 - 6100

**Default:**

If `eshelf` is specified—current `eshelf` value

If `eshelf` is not specified— 1100

**Example**

```
clr-imt-stats:s=00
```

## Dependencies

The command cannot be entered if the `rept-imt-info`, `rept-imt-lvl1`, `rept-imt-lvl2`, or `tst-imt` command is running.

The `s` and `e` parameters and the `sloc` and `eloc` parameters cannot be specified in the same command.

This command cannot be entered during IMT statistics collection following an hourly boundary.

The `s`, `sloc`, or `shelf` parameter must be specified.

This command cannot be entered during an Extended Bit Error Rate Test (BERT).

## Notes

The `sloc` and `eloc` parameters allow individual MUX cards to be cleared.

The `s` and `e` parameters will not clear MUX cards.

The `sshelf` and `eshelf` parameters clear MUX cards on bus A and bus B.

## Output

```
clr-imt-stats:all=yes
```

```
rlghncxa03w 04-01-07 11:02:30 EST EAGLE 35.0.0
Clear IMT Statistics command(s) issued...
Command Completed.
;
```

## Related Topics

- [conn-imt](#)
- [disc-imt](#)
- [rept-imt-info](#)
- [rept-imt-lvl1](#)
- [rept-imt-lvl2](#)
- [rmv-imt](#)
- [rst-imt](#)
- [tst-imt](#)

# conn-imt

Use this command to connect a manually disconnected card to the specified IMT bus. The card must have been manually disconnected from the bus previously by the `disc-imt` command. If the card was disconnected from the bus for other reasons, this command has no effect.

## Parameters

### **bus (mandatory)**

IMT bus to which the specified card is to be connected.

#### **Range:**

*a*

*b*

### **loc (mandatory)**

The card location as stenciled on the shelf of the system.

#### **Range:**

*1101 - 1108, 1111 - 1112, 1201 - 1208, 1211 - 1218, 1301 - 1308, 1311 - 1318,  
2101 - 2108, 2111 - 2118, 2201 - 2208, 2211 - 2218, 2301 - 2308, 2311 - 2318,  
3101 - 3108, 3111 - 3118, 3201 - 3208, 3211 - 3218, 3301 - 3308, 3311 - 3318,  
4101 - 4108, 4111 - 4118, 4201 - 4208, 4211 - 4218, 4301 - 4308, 4311 - 4318,  
5101 - 5108, 5111 - 5118, 5201 - 5208, 5211 - 5218, 5301 - 5308, 5311 - 5318,  
6101 - 6108, 6111 - 6118*

## Example

```
conn-imt:loc=1201:bus=a
```

## Dependencies

The card being reconnected must first be disconnected manually from the bus by using the `disc-imt` command.

This command cannot be entered during an IMT Fault Isolation Test or an Extended Bit Error Rate Test (BERT).

The card location, frame, shelf, or slot must be within the allowed range.

Valid IMT bus entries are "A" or "B".

## Notes

This command has no effect if the card was disconnected from the IMT bus in any way other than manually using the `disc-imt` command.

## Output

```
conn-imt:loc=1201:bus=a
```

```
rlghncxa03w 04-01-07 11:02:30 EST EAGLE 31.3.0  
Connect IMT Bus A command issued to card 1201
```

```
rlghncxa03w 04-01-07 11:02:30 EST EAGLE 31.3.0  
0100.0006 IMT Bus A Card connected to IMT
```

```
rlghncxa03w 04-01-07 11:02:30 EST EAGLE 31.3.0  
3112.0006 CARD 1201 CCS7ITU Card connected to IMT
```

```
;
```

**Related Topics**

- [clr-imt-stats](#)
- [disc-imt](#)
- [rept-imt-lvl1](#)
- [rept-imt-lvl2](#)
- [rept-stat-imt](#)
- [rmv-imt](#)
- [rst-imt](#)

## copy-disk

Use this command to copy a mirror image of the active fixed disk to the standby fixed disk. When the fixed disk requires replacement, or needs to be repaired or updated, this command formats the standby fixed disk and copies the contents of the active fixed disk to the standby fixed disk.

**▲ Caution:**

Before entering this command, contact the Customer Care Center.

**▲ Caution:**

If this command fails and the standby E5-TDM boots continuously, insert a removable disk with the same release as the fixed disks in the latched USB port of the standby E5-MCAP. The standby E5-MASP should successfully boot off the removable disk. After the E5-MASP has booted completely, re-enter the command.

**Parameters****dloc (mandatory)**

The location of the standby fixed disk. This is the destination drive for this function.

**Range:**

*1114, 1116*

(TDM)

**force (optional)**

This parameter provides some protection against data loss from copying over a fixed disk. If the target medium is recognized as a valid system medium, the `force=yes` parameter must be specified.

**Range:**

*yes*

*no*

**Default:***no***format (optional)**

This parameter specifies whether to format the standby fixed disk before executing the copy. If a format is not necessary, specifying *no* can save a significant amount of time.

**Range:***yes**no***Default:***yes***sloc (optional)**

The location of the active fixed disk. This will be the source drive for this function.

**Range:***1114, 1116*  
(TDM)**Default:**

The location of the active fixed disk

**Example**

```
copy-disk:sloc=1114:dloc=1116:force=yes
```

**Dependencies** **Caution:**

Do not turn off measurements at midnight because doing so can cause the loss of an entire day of measurements. Do not turn off measurements during the 30 minute measurements processing period, because this can result in the loss of the measurements for the 30 minute period being processed.

Measurements collection must be turned off before this command can be executed. Do not issue the `chg-meas` command while the `copy-disk` command is in progress. This results in read and write errors, because the standby fixed disk is not accessible and the active fixed disk only allows read-only access.

OAM Measurements collection cannot be in progress when this command is entered. Retry the command after a period of waiting for the measurements collection to complete.

The `copy-disk` command reserves both the active and standby disks, preventing database updates for the duration of the command. Access is allowed for read-only; writing to the disk is prohibited.

All commands that affect the database are not allowed for the duration of the command. Attempts to use such commands are rejected, and an error message is

displayed indicating that the command has been rejected because the `copy-disk` command is in use.

The OAMHC GPL version that is running in the active OAM card location must be the same GPL version that is running in the standby OAM card location.

The `sloc` and `dloc` fixed disks must be available and compatible.

The `sloc` fixed disk must be coherent.

The `dloc` parameter must specify the standby fixed disk.

The `sloc` parameter must specify the active fixed disk.

The standby fixed disk cannot be initialized while un-uploaded security log entries exist.

The `force=yes` parameter is required if the destination medium is recognized as a system medium. This parameter is optional if the destination medium is not a system medium. Only media that contain the **dms.cfg** file are recognized as system media.

If the `force=yes` parameter is specified, the disk should not require low-level formatting, and the `format=no` parameter should also be specified.

This command cannot be entered when CAT2 IPSM to OAM syncing is in progress.

N/A N/A

### Notes

If this command is initiated and the standby OAM initialization is not complete, command processing will be delayed. If standby initialization fails, the command proceeds to allow the standby TDM to recover from a previous `format-disk` or `copy-disk` failure. In such cases, the following messages appear:

```
Standby MASP has not finished initializing - please wait...
```

```
Standby MASP initialization timed out - continuing...
```

Specify the `format=no` parameter when upgrading a spare TDM. Specify the `format=yes` parameter when there is a suspected hardware problem.

When the active command is processing, the system cannot log other commands to the security log because the active fixed disk is set to read-only. During this time, commands that would alter the database fail when entered.

The performance time required to copy a fixed disk to another fixed disk varies depending on database size and system activity. This operation should typically take no longer than 2.5 hours. (If the low-level format (`format=no`) is not being performed, the operation should take no longer than an hour.) If the `copy-disk` operation exceeds three hours, or if the operation without the low-level format exceeds 1.5 hours, contact My Oracle Support. See the "My Oracle Support" section in Chapter 1 of this manual.



## Output

```
copy-disk:sloc=1114:dloc=1116:force=yes
```

```
rlghncxa03w 04-01-07 11:02:30 EST EAGLE 31.3.0
copy-disk:sloc=1114:dloc=1116:force=yes
Command entered at terminal #3.
Copy-disk (fixed): from active (1114) to standby (1116) started.
Extended processing required, please wait.
Copy-disk (fixed): from active (1114) to standby (1116) completed.
Measurements collection may be turned on now if desired.
```

## Related Topics

- [chg-db](#)
- [copy-gpl](#)
- [copy-meas](#)
- [disp-disk-dir](#)
- [format-disk](#)
- [rept-stat-db](#)

# copy-ext-stats

Use this command to copy the HIPR2 Extended Statistics information from the HIPR2 cards to the EXTSTATS.SYS file.

## Parameters

### **bus (optional)**

The IMT bus containing the HIPR2 cards with the extended statistics to be copied.

### **Range:**

**a**  
HIPR2 cards on the A bus

**b**  
HIPR2 cards on the B bus

**both**  
HIPR2 cards on both buses

### **Default:**

*both*

### **e1oc (optional)**

The ending card location for a range of HIPR2 cards that contain extended statistics to be copied.

 **Note:**

Statistics are copied from only valid In-Service Normal HIPR2 cards within the range.

**Range:**

*1109, 1110, 1209, 1210, 1309, 1310, 2109, 2110, 2209, 2210, 2309, 2310, 3109, 3110, 3209, 3210, 3309, 3310, 4109, 4110, 4209, 4210, 4309, 4310, 5109, 5110, 5209, 5210, 5309, 5310, 6109, 6110*

**Default:**

*6110*

**loc (optional)**

The location of a single HIPR2 card that contains extended statistics to be copied.

**Range:**

*1109, 1110, 1209, 1210, 1309, 1310, 2109, 2110, 2209, 2210, 2309, 2310, 3109, 3110, 3209, 3210, 3309, 3310, 4109, 4110, 4209, 4210, 4309, 4310, 5109, 5110, 5209, 5210, 5309, 5310, 6109, 6110*

**Default:**

all HIPR2 cards within the range specified by the `sloc` and `eloc` parameters

**mode (optional)**

A bitmask where the numeric value entered is converted to its binary value. Each bit represents a unique set of data to retrieve.

 **Note:**

This parameter is currently unused.

**Range: 0 - 65535****Default:**

*0*

**sloc (optional)**

The starting card location of a range of HIPR2 cards that contain extended statistics to be copied.

 **Note:**

Statistics are copied from only valid In-Service Normal HIPR2 cards within the range.

**Range:**

1109, 1110, 1209, 1210, 1309, 1310, 2109, 2110, 2209, 2210, 2309, 2310, 3109, 3110, 3209, 3210, 3309, 3310, 4109, 4110, 4209, 4210, 4309, 4310, 5109, 5110, 5209, 5210, 5309, 5310, 6109, 6110

**Default:**

1109

**Example**

```
copy-ext-stats
copy-ext-stats:loc=1110
copy-ext-stats:mode=1:loc=1109
copy-ext-stats:sloc=1101:eloc=6118:b=a
copy-ext-stats:sloc=1209:eloc=1210
```

**Dependencies**

Numeric values must be specified for the `loc`, `sloc`, and `eloc` parameters. These values must indicate valid card locations. See the associated parameter definitions for lists of valid values.

The value specified for the `mode` parameter must be from 0 - 65535.

A value of `a`, `b`, or `both` must be specified for the `bus` parameter.

No other `init/copy-ext-stats` command can be in progress when this command is entered.

The `loc` parameter cannot be specified in the same command with the `sloc` and `eloc` or `bus` parameters.

The value specified for the `loc` parameter must be a valid MUX card location.

The range specified by the `sloc` and `eloc` parameters must include an MUX card location.

**Output**

```
copy-exts-stats

e5oam 10-02-10 23:07:15 EST EAGLE 42.0.0
copy-ext-stats
Command entered at terminal #6.

;
e5oam 10-02-10 23:07:15 EST EAGLE 42.0.0
COPY-EXT-STATS: Data retrieval starting for MUX card 1209

;

e5oam 10-02-10 23:07:15 EST EAGLE 42.0.0
COPY-EXT-STATS: Data retrieval completed for MUX card 1209
```

```
;

e5oam 10-02-10 23:07:15 EST EAGLE 42.0.0
COPY-EXT-STATS: Data retrieval starting for MUX card 1210

;

e5oam 10-02-10 23:07:35 EST EAGLE 42.0.0
COPY-EXT-STATS: Data retrieval completed for MUX card 1210

;

e5oam 10-02-10 23:07:35 EST EAGLE 42.0.0
COPY-EXT-STATS: Data retrieval starting for MUX card 1109

;

e5oam 10-02-10 23:07:36 EST EAGLE 42.0.0
COPY-EXT-STATS: Data retrieval completed for MUX card 1109

;

e5oam 10-02-10 23:07:36 EST EAGLE 42.0.0
COPY-EXT-STATS: Data retrieval starting for MUX card 1110

;

e5oam 10-02-10 23:07:36 EST EAGLE 42.0.0
COPY-EXT-STATS: Data retrieval completed for MUX card 1110

;

e5oam 10-02-10 23:07:36 EST EAGLE 42.0.0
COPY-EXT-STATS: Data retrieved from the following MUX cards:
    CARD Location: 1209 : PASSED
    CARD Location: 1210 : PASSED
    CARD Location: 1109 : PASSED
    CARD Location: 1110 : PASSED

;

e5oam 10-02-10 23:07:36 EST EAGLE 42.0.0
Command Completed.

;
```

### Related Topics

- [init-ext-stats](#)

## copy-fts

Use this command to copy tables into or from the file transfer area (FTA).

### Parameters

#### **dloc** (mandatory)

The card location of the destination or table.



**Example**

```
copy-fta:sloc=1114:dloc=1114:stbl=2:dfile="F1_name.OUT"
```

```
copy-fta:sfile=dms.cfg:dtbl=0:sloc=1114:dloc=1116
```

**Dependencies**

A destination table must be specified when a source file is specified.

A destination file must be specified when a source table is specified.

A source and a destination must be specified.

Only one source parameter and one destination parameter can be specified.

This command cannot be entered to modify the security log.

File name formats are limited to 8 + 3 DOS-compatible characters.

When using DOS file names, if the file name contains a special character such as an underscore ( `_` ) or begins with a numeric, the file name must be in quotes ( " " ), for example, "92\_name.ext".

Only one file transfer can be active at a time.

The 1113 and 1115 locations are used by E5-MCAP cards. The 1114 and 1116 locations are used by E5-TDM cards.

Legacy TDM, GPSM-II, and MDAL cards cannot be installed in the same system as E5-TDM, E5-MCAP, and E5-MDAL cards.

The source file and destination file combination is not allowed.

The source table and destination table combination is not allowed.

The removable drive must have a File Transfer Area to be used as the source or destination.

**Notes**

This command is used to copy into the file transfer area or out of the file transfer area. The `stbl`, `dfile`, `sfile`, and `dtbl` parameters are used to describe the nature of the copy. A copy from a DMS table into the file transfer area would use the `stbl` (source table) and `dfile` (destination file) parameters. Thus, data would move from a table into a transfer area file. To copy from the file transfer area to a DMS table, use the `sfile` (source file) and `dtbl` (destination table) parameters. Any other combination of these 4 parameters is invalid.

**Output**

```
copy-fta:stbl=1:dfile="2F1.OUT":sloc=1114:dloc=1114
```

```
rlghncxa03w 15-01-05 14:59:10 EST EAGLE 46.2.0
```

```
copy-fta:stbl=1:dfile="2F1.OUT":sloc=1114:dloc=1114
```

```
Command entered at terminal #1.
```

```
;
```

```
rlghncxa03w 15-01-05 14:59:26 EST EAGLE 46.2.0
```

```
Copied Table 1 successfully from FIXED to 2F1.OUT in FTA.
```

```
;
```

```
rlghncxa03w 15-01-05 15:00:49 EST EAGLE 46.2.0
copy-fta:sfile=dms.cfg:dtbl=0:sloc=1114:dloc=1113
Command entered at terminal #1.
;
rlghncxa03w 15-01-05 15:01:12 EST EAGLE 46.2.0
Copied DMS.CFG successfully from FTA to Table 0 on REMOVABLE.
;
```

### Related Topics

- [act-file-trns](#)
- [disp-fta-dir](#)
- [dlt-fta](#)

## copy-gpl

Use this command to copy all approved GPLs from one drive to another. The GPLs can be copied only from the fixed disk on the active TDM to the removable drive, or from the removable drive to the fixed disk on the standby TDM.

### Parameters

#### **ddrv** (optional)

Destination drive. The identification of the disk to which the GPL is copied.

#### **Range:**

##### ***fixed***

The fixed disk

##### ***remove***

The removable drive

##### ***usb***

Argument to be used by Oracle personnel only.

#### **dloc** (optional)

The destination location of the GPLs to be copied.

#### **Range:**

##### ***1114***

The TDM

##### ***1116***

The TDM

##### ***1113***

The latched USB port

##### ***1115***

The latched USB port

**Default:***none***sdrv (optional)**

Source drive. The identification of the disk from which the GPL is copied.

**Range:*****fixed***

The fixed disk

***remove***

The removable media drive

***usb***

Argument to be used by Oracle personnel only.

**sloc (optional)**

The source location of the GPLs to be copied.

**Range:*****1114***

The TDM

***1116***

The TDM

***1113***

The latched USB port

***1115***

The latched USB port

**Default:**

The location of the active TDM

**Example**

```
copy-gpl
```

```
copy-gpl:sloc=1115:dloc=1116
```

```
copy-gpl:sloc=1116
```

**Dependencies**

While this command is executing, the `act/chg-gpl` commands cannot be entered.

The standby fixed disk could not be accessed. There could be a hardware problem.

The active fixed disk could not be accessed. There could be a hardware problem.

The source and destination disks are not compatible. There could be a hardware problem

The system cannot determine the capacity of the disk that is being formatted.

The removable disk must be accessible.



The GPLs can be copied only from the fixed disk on the active TDM (sloc=1114 or sloc=1116) to the removable drive (dloc=1113 or dloc=1115), or from the removable drive (sloc=1113 or sloc=1115) to the fixed disk on the standby TDM (dloc=1114 or dloc=1116).

The source drive must be coherent when the command is executed.

The 1113 and 1115 locations are used by E5-MCAP cards. The 1114 and 1116 locations are used by E5-TDM cards.

The plug-in flash drive must be accessible in the Active OAM's flush-mounted USB port.

The specified disk type must match the specified location.

This command cannot be entered when CAT2 IPISM to OAM syncing is in progress.

### Notes

This command has no effect on the GPLs stored on other cards (for example, SCCP).

### Output

Copying the GPLs from the fixed disk on the active TDM (card location 1114) to the removable drive (card location 1113).

```
copy-gpl:sloc=1114:dloc=1113
```

```
rlghncxa03w 09-01-07 00:57:31 EST EAGLE 40.1.0
COPY GPL: MASP A - COPY STARTS ON ACTIVE MASP
COPY GPL: MASP A - COPY TO REMOVABLE MEDIA COMPLETE
```

```
;
```

Copying the GPLs from the removable drive (card location 1115) to the fixed disk on the standby TDM (card location 1116).

```
copy-gpl:sloc=1115:dloc=1116
```

```
rlghncxa03w 09-01-07 00:57:31 EST EAGLE 40.1.0
COPY GPL: MASP B - COPY STARTS ON REMOVABLE DRIVE
```

```
;
```

```
rlghncxa03w 09-01-07 01:01:27 EST EAGLE 40.1.0
COPY GPL: MASP B - COPY TO STANDBY MASP COMPLETE
```

```
;
```

Copying the GPLs from the fixed disk on the active USB drive.

```
copy-gpl:sloc=1114:ddrv=usb
```

```
e5oam 09-01-09 05:14:23 MST EAGLE 40.1.0
COPY GPL: MASP A - COPY STARTS ON ACTIVE MASP
```

```
;
```

```
e5oam 09-01-09 05:22:30 MST EAGLE 40.1.0  
COPY GPL: MASP A - COPY TO USB DRIVE COMPLETE
```

### Related Topics

- [act-gpl](#)
- [alw-card](#)
- [chg-gpl](#)
- [init-card](#)
- [init-sys](#)
- [rept-stat-gpl](#)
- [rtrv-gpl](#)

## copy-meas

Use this command to copy all measurements tables on the active fixed disk to a measurements removable drive. Do this when you need to perform off-line analysis of the raw measurements data.



### Note:

This command is not supported on the Measurements Platform feature.

### Parameters

None

### Example

```
copy-meas
```

### Dependencies

The removable drive:

- must be inserted
- must be initialized
- must be a MEAS disk
- cannot be a SYSTEM disk

This command cannot be entered when CAT2 IPSM to OAM syncing is in progress.

### Notes

To execute this command, measurement collection must be turned off. If measurement collection is on, enter the `chg-meas:collect=off` command to turn off measurement collection.

The *Maintenance Guide* provides a description of all measurement report parameters.



**Default:***act***slog (optional)**

Source log indicator. The log that is to be copied to the FTA.

**Range:*****act***

Copies the log on the active fixed disk

***stb***

Copies the log on the standby fixed disk

**Default:***act***Example**

```
copy-seculog
copy-seculog:dfile="somename.log"
copy-seculog:slog=stb
copy-seculog:slog=act
copy-seculog:slog=act:dloc=stb
```

**Dependencies**

No other security log command can be in progress when this command is entered.

No `copy-fta` command can be in progress when this command is entered.

GPSM-II and E5-MCAP cards cannot be provisioned in the system at the same time.

The source log and destination file combination is not allowed.

The removable drive must have a File Transfer Area to be used as the destination.

**Notes**

For the `dfile` parameter, if the file name is not accepted by the system because it contains special characters such as blanks, colons, dashes, ampersands, or others; or because it does not start with an alphabetic character, enclose the file name in double quotes as in this example: "seculog-1.ext".

Any scroll area failure message that can be produced by the `copy-fta` command can be produced also by the `copy-seculog` command.

**Output**

This example shows that the log on the active fixed disk is copied to the FTA on the active fixed disk and given the default name (note the *a* in the log name).

```
copy-seculog
```

```
rlghncxa03w 04-01-04 15:59:06 EST EAGLE 31.3.0
Security log on TDM 1114 copied to file 040104a.log on TDM 1114
```

This example shows that the log on the active fixed disk is copied to the FTA on the active fixed disk and given a user-specified name.

```
copy-seculog:dfile="somename.log"
```

```
rlghncxa03w 04-01-04 15:59:06 EST EAGLE 31.3.0
Security log on TDM 1116 copied to file somename.log on TDM 1114
```

This example shows that the log on the standby fixed disk is copied to the FTA on the active fixed disk and given the default name (note the s in the log name).

```
copy-seculog:slog=stb
```

```
rlghncxa03w 04-01-04 15:59:06 EST EAGLE 31.3.0
Security log on TDM 1114 copied to file 040104s.log on TDM 1116
```

This example shows that the copy of the log fails because a file already exists in the FTA with the same name.

```
copy-seculog:slog=act
```

```
rlghncxa03w 04-01-04 15:59:06 EST EAGLE 31.3.0
Command Failed - Destination File already exists in the File
Transfer Area
```

This example shows that the copy fails because there is not enough room in the FTA to contain the copy.

```
copy-seculog:slog=act:dloc=stb
```

```
rlghncxa03w 04-01-04 15:59:06 EST EAGLE 31.3.0
Command Failed - Not enough room exists in the File Transfer Area
```

### Related Topics

- [act-file-trns](#)
- [copy-tbl](#)
- [disp-fta-dir](#)
- [dlt-fta](#)

## dact-alm-trns

Use this command to return all audible alarm indications to the local office.

### Parameters

This command has no parameters.

### Example

```
dact-alm-trns
```

### Dependencies

None

### Notes

After you enter `dact-alm-trns`, enter `rept-stat-alm` to verify the status of the alarms.

### Output

```
dact-alm-trns
```

```
rlghncxa03w 04-01-07 11:11:28 EST EAGLE 31.3.0  
Alarms returned to Local Maintenance Center
```

```
;
```

### Related Topics

- [act-alm-trns](#)
- [rept-stat-clk](#)
- [rept-stat-trbl](#)
- [rls-alm](#)
- [rtrv-obit](#)
- [rtrv-trbl](#)

## dact-cdl

Use this command to deactivate a previously initiated command driven loopback for testing a signaling link, if the test is active. If it is not active, the command will attempt to clear both near-end and far-end latched loopback points

### Parameters

#### **link (mandatory)**

SS7 signaling ports. The signaling port to which the SS7 signaling link being tested is assigned.

**Synonym:***port***Range:***a, b, a1 - a31, b1 - b31*

Not all card types support all link parameter values.

See [Table A-1](#) for valid `link` parameter range values for each type of card that can have assigned signaling links.**loc (mandatory)**

The card location as stenciled on the shelf of the system.

**Range:**

1101 - 1108, 1111 - 1112, 1201 - 1208, 1211 - 1218, 1301 - 1308, 1311 - 1318,  
 2101 - 2108, 2111 - 2118, 2201 - 2208, 2211 - 2218, 2301 - 2308, 2311 - 2318,  
 3101 - 3108, 3111 - 3118, 3201 - 3208, 3211 - 3218, 3301 - 3308, 3311 - 3318,  
 4101 - 4108, 4111 - 4118, 4201 - 4208, 4211 - 4218, 4301 - 4308, 4311 - 4318,  
 5101 - 5108, 5111 - 5118, 5201 - 5208, 5211 - 5218, 5301 - 5308, 5311 - 5318,  
 6101 - 6108, 6111 - 6118

**Example**`dact-cdl:loc=1205:link=b`**Dependencies**The card location specified in the `loc` parameter must be equipped.The signaling link specified in the `link` parameter must be equipped.

Link Fault Sectionalization (LFS) must not be running on the specified signaling link when this command is entered.

Command Driven Loopback testing is not available during upgrade.

A link diagnostic test is in progress on the signaling link specified in the `link` parameter, but it is not a Command Driven Loopback.The card location specified in the `loc` parameter must be in service.The signaling link specified in the `link` parameter must not be active.The card location specified in the `loc` parameter cannot be reserved by the system.**Notes**

None

**Output**`dact-cdl:loc=1205:link=b`

```
tekelecstp 05-01-21 17:00:36 EST  EAGLE5 33.0.0
Command Accepted: Stop Command Driven Loopback message is sent.
```

;

```
tekelecstp 05-01-21 17:00:36 EST  EAGLE5 33.0.0
```

```
Command Completed.  
;
```

### Related Topics

- [act-cdl](#)
- [act-lbp](#)
- [dact-lbp](#)
- [rept-stat-cdl](#)
- [tst-slk](#)

## dact-echo

Use this command to halt the echoing of command responses from the user's terminal to other terminals or printers.

### Parameters

#### **trm (optional)**

The ID number of the terminal for which the echo is being canceled.

#### **Range:**

1 - 16

#### **Default:**

Cancels all active echoes

### Example

```
dact-echo
```

### Dependencies

The echo to the same terminal from which the `dact-echo` command is issued cannot be cancelled.

There must be an active echo (`act-echo`) to the terminal specified.

### Notes

Only the echoing of command output responses can be halted by this command. To halt the printing of alarm and network messages, use the `chg-trm` command.

### Output

```
dact-echo
```

```
rlghncxa03w 04-01-07 11:11:28 EST EAGLE 31.3.0  
Command entered at terminal #6.  
Scroll Area Output echo disabled to all terminals.  
;
```



```
dact-echo:trm=7
```

```
rlghncxa03w 04-01-07 11:11:28 EST EAGLE 31.3.0  
Command entered at terminal #1.  
Scroll Area Output echo disabled for terminal 7.
```

```
;
```

### Related Topics

- [act-echo](#)
- [alw-trm](#)
- [canc-echo](#)
- [chg-trm](#)
- [inh-trm](#)
- [rept-stat-trm](#)
- [rmv-trm](#)
- [rst-trm](#)
- [rtrv-trm](#)

## dact-lbp

Use this command to deactivate a previously activated loopback point test, if a test is active. If no test is active, the command attempts to clear both near-end and far-end latched loopback points.

### Parameters

#### **link (mandatory)**

SS7 signaling link. The signaling link for which the loopback point test is being deactivated.

#### **Synonym:**

*port*

#### **Range:**

*a, b, a1 - a31, b1 - b31*

Not all card types support all `link` parameter values.

See [Table A-1](#) for valid `link` parameter range values for each type of card that can have a location specified in the `loc` parameter.

#### **loc (mandatory)**

Card location. The unique identifier of the card containing the signaling link on which loopback point testing is to be deactivated.

#### **Range:**

*1101 - 1108, 1111 - 1112, 1201 - 1208, 1211 - 1218, 1301 - 1308, 1311 - 1318,  
2101 - 2108, 2111 - 2118, 2201 - 2208, 2211 - 2218, 2301 - 2308, 2311 - 2318,  
3101 - 3108, 3111 - 3118, 3201 - 3208, 3211 - 3218, 3301 - 3308, 3311 - 3318,*

4101 - 4108, 4111 - 4118, 4201 - 4208, 4211 - 4218, 4301 - 4308, 4311 - 4318, 5101 - 5108, 5111 - 5118, 5201 - 5208, 5211 - 5218, 5301 - 5308, 5311 - 5318, 6101 - 6108, 6111 - 6118

### Example

```
dact-lbp:loc=1205:link=b
```

### Dependencies

The specified signaling link must be equipped.

For clearing a remotely initiated loopback or LFS test stop, the card location (`loc` parameter) must be an or E5-E1T1-B card, provisioned with the LIMT1 card type, configured with either the SS7ANSI or CCS7ITU application.

This command cannot be entered until any previously issued `act-lbp` or `dact-lbp` command is accepted.

If an LFS test is about to complete, a new `dact-lbp` command cannot be entered until the test completes.

This command cannot be entered to cancel a signaling link test (a `tst-slk` test).

This command cannot be entered to cancel a Command Driven Loopback test.

The specified link must exist, and the maximum number of allowed LFS or signaling link tests must not already be in progress. At least one active LFS or signaling link test must be completed before this command can be entered again.

This command cannot be entered during upgrade.

The specified signaling link must not be active.

For clearing a remotely initiated loopback, the card location specified in the `loc` parameter must be equipped.

For clearing a remotely initiated loopback, the card location specified in the `loc` parameter must be in service (**IS-NR**).

For clearing a remotely initiated loopback, the card location specified in the `loc` parameter cannot be reserved by the system.

### Notes

After the deactivation of loopback point testing has started, you cannot cancel the process.

If an LFS test is aborted by a card reset, it could leave the remote far-end loop-back condition active. Use the `dact-lbp` command to cancel LFS tests.

### Output

The following example output is generated only when a latched loopback is cleared and when there were no active loopback tests in progress.



#### Note:

This situation could occur even if there were no latched loopbacks to be cleared.

```
dact-lbp:loc=1205:link=b

rlghncxa03w 04-02-17 16:02:05 EST EAGLE5 33.0.0
LOC = 1205 LINK = B
CLEAR STATUS = PASS, loopback was cleared.
;
```

The following example output is generated only when a latched loopback could not be cleared when there were no active loopback tests in progress.

```
dact-lbp:loc=1205:link=b

rlghncxa03w 04-02-17 16:02:05 EST EAGLE5 33.0.0
LOC = 1205 LINK = B
CLEAR STATUS = ERROR, loopback could not be cleared.
;
```

### Related Topics

- [act-lbp](#)
- [chg-lbp](#)
- [dlt-lbp](#)
- [ent-lbp](#)
- [rept-stat-lfs](#)
- [rtrv-lbp](#)

## dact-lg-card

Use this command to deactivate all LG event generation/reception for a given LG card. The command class is TKLC\_INTERNAL inheriting properties of DEBUG class. The Load Generator is supported on IPSPG, IPLHC, IPGHC and SS7HC GPLs.

### Parameters

#### **loc (mandatory)**

The card location as stenciled on the shelf of the system.

#### **Range:**

*1101 - 1108, 1111 - 1112, 1201 - 1208, 1211 - 1218, 1301 - 1308, 1311 - 1318,  
2101 - 2108, 2111 - 2118, 2201 - 2208, 2211 - 2218, 2301 - 2308, 2311 - 2318,  
3101 - 3108, 3111 - 3118, 3201 - 3208, 3211 - 3218, 3301 - 3308, 3311 - 3318,  
4101 - 4108, 4111 - 4118, 4201 - 4208, 4211 - 4218, 4301 - 4308, 4311 - 4318,  
5101 - 5108, 5111 - 5118, 5201 - 5208, 5211 - 5218, 5301 - 5308, 5311 - 5318,  
6101 - 6108, 6111 - 6118*

#### **dir (optional)**

The direction in which the event generation or reception is to be deactivated.

**Range:**

***Tx***  
Transmit Event

***Rx***  
Receive Event

***all***  
Both in Tx and Rx directions

**Default:**

*all*

**Example**

```
dact-lg-card:loc=1302  
dact-lg-card:loc=1302:dir=tx
```

**Dependencies**

The card location must not be 1113-1118, or xy09 and xy10 where x is the frame and y is the shelf.

The LG Card table is corrupt or cannot be found.

The card location specified in the `loc` parameter must be of a provisioned LG card.

Loc is mandatory

Activating the state of an LG object that is already activated or deactivating the state of an LG object that is already deactivated has no effect.

**Output****Related Topics**

- [act-lg-card](#)
- [chg-lg-card](#)
- [dlt-lg-card](#)
- [ent-lg-card](#)
- [rept-stat-lg](#)
- [rtrv-lg-card](#)

## dact-lg-engine

Use this command to deactivate LG event generation/reception for a given engine on a LG engine. The command class is TKLC\_INTERNAL inheriting properties of DEBUG class. The Load Generator is supported on IPSTG, IPLHC, IPGHC and SS7HC GPLs.

**Parameters**

**dir (optional)**  
Traffic Direction.

**Range:**

**Rx**  
Receive Direction

**Tx**  
Transmit Direction

**All**  
Both in Tx and Rx directions

**Default:**

*All*

**engine (optional)****Range: ayyyyyyyyy**

Up to 10 alphanumeric characters; the first character must be a letter.

**loc (optional)**

The card location as stenciled on the shelf of the system.

**Range:**

1101 - 1108, 1111 - 1112, 1201 - 1208, 1211 - 1218, 1301 - 1308, 1311 - 1318,  
2101 - 2108, 2111 - 2118, 2201 - 2208, 2211 - 2218, 2301 - 2308, 2311 - 2318,  
3101 - 3108, 3111 - 3118, 3201 - 3208, 3211 - 3218, 3301 - 3308, 3311 - 3318,  
4101 - 4108, 4111 - 4118, 4201 - 4208, 4211 - 4218, 4301 - 4308, 4311 - 4318,  
5101 - 5108, 5111 - 5118, 5201 - 5208, 5211 - 5218, 5301 - 5308, 5311 - 5318,  
6101 - 6108, 6111 - 6118

**Example**

```
dact-lg-engine:loc=1301
dact-lg-engine:loc=1301:dir=tx
dact-lg-engine:engine=txengine1
```

**Dependencies**

The engine name specified must pre-exist in the LG Engine table.

The `loc` and `engine` parameters cannot be specified together in the command.

The card location specified in the `loc` parameter must be of a provisioned LG card.

The `loc` parameter must be specified before the `dir` parameter can be specified.

Activating the state of an LG object that is already activated or deactivating the state of an LG object that is already deactivated has no effect.

**Output****Related Topics**

- [act-lg-engine](#)
- [chg-lg-engine](#)
- [dlt-lg-engine](#)

- [ent-lg-engine](#)
- [rept-stat-lg](#)
- [rtrv-lg-engine](#)

## dact-lg-grp

Use this command to deactivate event generation/reception for a LG group. The command class is TKLC\_INTERNAL inheriting properties of DEBUG class. The Load Generator is supported on IPSG, IPLHC, IPGHC and SS7HC GPLs.

### Parameters

#### **grp (mandatory)**

**Range:**

*aaaaaaaaaa*

Up to 10 alphanumeric characters; the first character must be a letter

#### **dir (optional)**

The direction in which the event generation or reception is to be deactivated

**Range:**

***Rx***

Receive Direction

***Tx***

Transmit Direction

***All***

Both in Tx and Rx directions

**Default:**

*All*

### Example

```
dact-lg-grp:grp=lgroup1:dir=tx
```

```
dact-lg-grp:grp=lgroup2
```

### Dependencies

The value specified for the `grp` parameter must already exist in the LG Group table.

The LG Group table is corrupt or cannot be found.

The `grp` parameter must be specified.

Activating the state of an LG object that is already activated or deactivating the state of an LG object that is already deactivated has no effect.

### Output

### Related Topics

- [act-lg-grp](#)

- [dlt-lg-grp](#)
- [ent-lg-grp](#)
- [rept-stat-lg](#)
- [rtrv-lg-grp](#)

## dact-lg-sys

Use this command to deactivate the LG event generation/reception on all LG cards configured in the system.

The command class is TKLC\_INTERNAL inheriting properties of DEBUG class. The Load Generator is supported on IPSPG, IPLHC, IPGHC and SS7HC GPLs.

### Parameters

#### **dir** (mandatory)

The direction in which the event generation or reception is to be deactivated

#### **Range:**

##### ***Rx***

Receive Direction

##### ***Tx***

Transmit Direction

##### ***All***

Both in Tx and Rx Directions

#### **Default:**

*all*

### Example

```
dact-lg-sys:dir=tx
```

```
dact-lg-sys:dir=rx
```

```
dact-lg-sys:dir=all
```

### Dependencies

The LG System table is corrupt or cannot be found.

The `dir` parameter must be specified.

Activating the state of an LG object that is already activated or deactivating the state of an LG object that is already deactivated has no effect.

### Output

#### **Related Topics**

- [act-lg-sys](#)
- [rept-stat-lg](#)
- [rtrv-lg-sys](#)

## dact-rstst

Use this command to request deactivation of the routeset test being performed by the LIMs running the *ss7ansi* application. The system verifies that the point code and the linkset exist, and that the specified linkset is in the routeset of the specified point code. If it is, then a request to stop routeset testing procedures for the specified destination-linkset combination is sent to the LIM.

### Parameters

#### **dpc (mandatory)**

The ANSI destination point code of the destination, x-list entry, or cluster whose routeset testing is to be stopped, with subfields *network indicator-network cluster-network cluster member (ni-nc-ncm)*.

#### **Synonym:**

*dpca*

#### **Range:**

*000-255*

Specify a valid value for each subfield of the point code, and separate the subfields with a dash (-).

When *chg-sid:pctype=ansi* is specified, *ni = 000* is not valid.

When *chg-sid:pctype=ansi* is specified, *nc = 000* is not valid if *ni = 001-005*.

When *chg-sid:pctype=ansi* is specified, *nc = 000* is valid if *ni = 006-255*.

The point code *000-000-000* is not a valid point code.

#### **lsn (mandatory)**

The name of the linkset associated with the destination point code that is to have routeset testing stopped.

#### **Range:**

*ayyyyyyyy*

1 alphabetic character followed by 9 alphanumeric characters

### Example

```
dact-rstst:dpc=1-2-*:lsn=lsn1a
```

```
dact-rstst:dpc=1-2-33:lsn=lsn1b
```

### Dependencies

The specified DPC must be either provisioned or an x-list entry.

The specified linkset must be in the DPC's routeset.

The destination address must be a full point code or a cluster point code specified as *ni-nc-\**. A DPC cannot be specified as *ni-nc-\*\** or *ni-nc-\*\*\** for the this command.

The specified linkset must exist in the linkset table.

### Notes

None



## Output

```
dact-rstst:dpc=1-2-*:lsn=lsn1a

rlghncxa03w 04-01-05 16:40:40 EST  EAGLE 31.3.0
Stop routeset testing request sent to SNM (scroll area)

rlghncxa03w 04-01-05 16:40:40 EST  EAGLE 31.3.0
Command Completed.
;
```

## dact-slk

Use this command to change the state of the specified link to OOS-MT-DSBLD (out-of-service maintenance-disabled).

### Caution:

This command impacts network performance, and should be used only during periods of low traffic.

## Parameters

### link (mandatory)

Signaling link on the card specified in the `loc` parameter. The signaling links can be specified in any sequence or pattern.

#### Synonym:

*port*

#### Range:

*a, b, a1 - a63, b1 - b63*

Not all card types support all `link` parameter values.

See [Table A-1](#) for valid `link` parameter range values for each type of card that can have a location specified in the `loc` parameter.

### loc (mandatory)

The card location as stenciled on the shelf of the system.

#### Range:

*1101 - 1108, 1111 - 1112, 1201 - 1208, 1211 - 1218, 1301 - 1308, 1311 - 1318,  
2101 - 2108, 2111 - 2118, 2201 - 2208, 2211 - 2218, 2301 - 2308, 2311 - 2318,  
3101 - 3108, 3111 - 3118, 3201 - 3208, 3211 - 3218, 3301 - 3308, 3311 - 3318,  
4101 - 4108, 4111 - 4118, 4201 - 4208, 4211 - 4218, 4301 - 4308, 4311 - 4318,  
5101 - 5108, 5111 - 5118, 5201 - 5208, 5211 - 5218, 5301 - 5308, 5311 - 5318,  
6101 - 6108, 6111 - 6118*

## Example

```
dact-slk:loc=1301:link=a
```

## Dependencies

Valid IMT bus entries are "A" or "B".

A card location must be specified that is valid and defined in the database.

No other action command can be in progress when this command is entered.

The value specified for the `loc` parameter must refer to one of the following cards, and the referenced card must be equipped:

- E5-E1T1-B, or HC MIM card running the SS7ANSI or CCS7ITU application
- E5-ATM-B card running the ATMANSI or ATMITU application
- E5-ENET-B card running the IPGWI, IPLIMI, IPSG, or SS7IPGW application
- SLIC card running the IPSG application

The card must contain signaling links.

The signaling link must be equipped in the database.

The card must be equipped in the specified card location.

An appropriate value must be specified for the `link` parameter when an ATM card is used:

- `a-a1, b`—E5-ATM-B card running the ATMANSI or ATMITU application

This command is not valid for IPSG-M3UA signaling links.

## Notes

*Installation Guide* provides an illustration of card locations.

After the `dact-slk` command is entered, verify the cancellation by issuing the `rept-stat-slk` command.

## Output

```
dact-slk:loc=1301:link=a
```

```
rlghncxa03w 04-01-07 11:11:28 EST EAGLE5 33.0.0
Deactivate Link message sent to card
;
```

## Related Topics

- [act-slk](#)
- [blk-slk](#)
- [dlt-slk](#)
- [ent-slk](#)
- [inh-slk](#)
- [rept-stat-slk](#)
- [rtrv-slk](#)
- [tst-slk](#)

- [ublk-slk](#)
- [unhb-slk](#)

## dact-user

Use this command to end a user session. The `logout` command has the same affect as the `dact-user` command.

### Parameters

This command has no parameters.

### Example

```
dact-user
```

### Dependencies

None

### Notes

The `logout` or `canc-user` commands can be used in place of `dact-user`.

### Output

Not applicable.

### Related Topics

- [act-user](#)
- [chg-pid](#)
- [chg-user](#)
- [dlt-user](#)
- [ent-user](#)
- [login](#)
- [logout](#)
- [rept-stat-user](#)
- [rtrv-secu-user](#)
- [rtrv-user](#)

## disc-imt

The interprocessor message transport bus (IMT bus) is the main communications artery between all subsystems in the system. Use this command to disconnect a card from the specified IMT bus.

 **Note:**

When a card is disconnected from the IMT Bus, it may take several seconds for the card IMT Status to be updated. If an `init-mux` or `disc-imt` command is entered for the alternate IMT Bus before the card IMT Status is updated, then the card may reboot. After disconnecting the card from the IMT bus, use the `rept-stat-imt` or `rept-stat-card` command to determine whether the card IMT status is updated. Do not issue the `disc-imt` or `init-mux` command for the alternate IMT bus until the card status is updated.

**Parameters****bus (mandatory)**

IMT bus to be disconnected from.

**Range:**

*a, b*

**loc (mandatory)**

The card location as stenciled on the shelf of the system.

**Range:**

*1101 - 1108, 1111 - 1112, 1201 - 1208, 1211 - 1218, 1301 - 1308, 1311 - 1318, 2101 - 2108, 2111 - 2118, 2201 - 2208, 2211 - 2218, 2301 - 2308, 2311 - 2318, 3101 - 3108, 3111 - 3118, 3201 - 3208, 3211 - 3218, 3301 - 3308, 3311 - 3318, 4101 - 4108, 4111 - 4118, 4201 - 4208, 4211 - 4218, 4301 - 4308, 4311 - 4318, 5101 - 5108, 5111 - 5118, 5201 - 5208, 5211 - 5218, 5301 - 5308, 5311 - 5318, 6101 - 6108, 6111 - 6118*

**Example**

```
disc-imt:loc=1213:bus=b
```

**Dependencies**

Valid IMT bus entries are "A" or "B".

This command cannot be entered during an IMT Fault Isolation Test. The card cannot be isolated from both IMT busses.

When disconnecting a card from one IMT bus, the other (alternate) IMT bus must be in a known, good (IS-NR) state.

The card location, frame, shelf, or slot must be within the allowed range.

This command cannot be entered if an IMT Rate Change sequence is in progress.

This command cannot be entered during an IMT Fault Isolation Test or an Extended Bit Error Rate Test (BERT).

**Notes**

The card can be reconnected by issuing the `conn-imt` command, or by re-inserting the card. A software reset does not affect connect status. (The `init-card` command performs a software reset.)

## Output

```
disc-imt:loc=1213:bus=b
```

```
rlghncxa03w 04-01-07 11:02:30 EST EAGLE 31.3.0  
Disconnect IMT Bus B command issued to card 1213  
;
```

## Related Topics

- [clr-imt-stats](#)
- [conn-imt](#)
- [rept-imt-lvl1](#)
- [rept-imt-lvl2](#)
- [rept-stat-imt](#)
- [rmv-imt](#)
- [rst-imt](#)

# disp-fta-dir

Use this command to display the files that are in the file transfer area (FTA) the layout of FTA, and the amount of free space in the FTA.

## Parameters

### loc (optional)

The location of the fixed disk whose FTA is to be displayed.

#### Range:

*1114, 1116*  
(TDMs)

#### Default:

The active TDM location

## Example

```
disp-fta-dir:loc=1114
```

## Dependencies

This command must display the files (along with deleted files and free slots) in the order in which they appear in the file transfer area.

The `loc` parameter must specify a TDM card.

Only one file transfer can be active at a time.

TDM and E5-TDM cards cannot co-exist in the system.

**Notes**

None

**Output**

disp-fta-dir:loc=1114

```
rlghncxa03w 05-07-01 16:21:12 EST EAGLE 31.3.0
File Transfer Area Directory of fixed disk 1114:
```

FILENAME	LENGTH	LAST MODIFIED	LBA
oam.elf	1048576	05-07-01 16:51	40960
<deleted>	65536	-----	43008
sccp.elf	1048576	05-07-01 18:30	43136
<deleted>	1048576	-----	46704
tbl213.out	640000	05-07-01 06:39	48752
5 File(s) 21584896 bytes free			

;

**Related Topics**

- [act-file-trns](#)
- [copy-fta](#)
- [dlt-fta](#)

## dlt-acg-mic

Use this command to delete ACG controls that apply to certain queries. The control can apply to all queries or to specific query services and called party digits. A particular control is selected to be deleted by either specifying that it is the `type=all` control or specifying its service and digits.

**Parameters****dgts (optional)**

Digits

**Range:**

000 - 999, 000000 - 9999999999  
Specify 3 digits or 6-10 digits.

**serv (optional)**

Query service

**Range:***ain**in*

**type (optional)**

Type of control

**Range:***all**sd***Default:***sd***Example**

```
dlt-acg-mic:type=all
```

```
dlt-acg-mic:serv=ain:dgts=9194602132
```

**Dependencies**

If the `type=all` parameter is specified, then the `serv` and `dgts` parameters cannot be specified.

If the `type=sd` parameter is specified, then the `serv` and `dgts` parameters must be specified.

If the `type=all` parameter is specified, a MIC with `type=all` must exist.

If the `type=sd` parameter is specified, a MIC with the same service and digits must exist.

The LNP feature must be turned on before this command can be entered.

The `dgts` parameter value must be 3 digits or 6-10 digits in length.

**Notes**

None

**Output**

```
dlt-acg-mic:type=all
```

```
rlghncxa03w 04-02-28 08:50:12 EST EAGLE 31.3.0
ACG MIC table is (10 of 256) 4% full of type SD
DLT-ACG-MIC: MASP A - COMPLTD
;
```

**Related Topics**

- [chg-acg-mic](#)
- [ent-acg-mic](#)
- [rept-stat-lnp](#)
- [rtrv-acg-mic](#)

## dlt-acg-noc

Use this command to delete the definition of a node overload level. The definition is comprised of the threshold LNP query rates for node overload levels and the values for the Automatic Call Gappings (ACG) to be sent when at the level. If a level is not defined, it is not used. Level 10 cannot be deleted.

### Parameters

#### lvl (mandatory)

Overload level.

#### Range:

1 - 9

### Example

```
dlt-acg-noc:lvl=3
```

### Dependencies

The specified overload level must be defined.

The ACG NOC table must be accessible.

The LNP feature must be turned on before this command can be entered.

### Notes

None

### Output

```
dlt-acg-noc:lvl=3
```

```
rlghncxa03w 04-02-28 08:50:12 EST EAGLE 31.3.0  
DLT-ACG-NOC: MASP A - COMPLTD
```

```
;
```

### Related Topics

- [chg-acg-noc](#)
- [ent-acg-noc](#)
- [rept-stat-lnp](#)
- [rtrv-acg-noc](#)

## dlt-appl-rtkey

Use this command to delete static entries from the Routing Key table. These entries are used to associate a routing key with a socket name. A static entry is created using the `ent-appl-rtkey` command.



There are three types of routing keys, as follows:

- DPC, SI, SSN routing keys, which are used to route SCCP messages
- DPC, SI routing keys, which are used to route non-SCCP and non-ISUP messages
- DPC, SI, CIC routing keys, which are used to route ISUP messages

### Parameters



#### Note:

See [Point Code Formats and Conversion](#) for a detailed description of point code formats, rules for specification, and examples.

#### **asname (optional)**

Application Server (AS) name; AS assigned to this routing key.

##### Range:

aaaaaaaaaaaaaaaa

Up to 15 alphanumeric characters; the first character must be a letter

#### **cice (optional)**

The end range of circuit identification codes assigned to the routing key. The `cice` and `cics` parameters identify the routing key to be changed. Valid only and required if a value of 4, 5, or 13 is specified for the `si` parameter.

##### Range:

0 - 4294967295

See [Table A-2](#) for valid CIC values for specified SI and MSU types.

#### **cics (optional)**

The end range of circuit identification codes assigned to the routing key. The `cice` and `cics` parameters identify the routing key to be changed. Valid only and required if a value of 4, 5, or 13 is specified for the `si` parameter.

##### Range:

0 - 4294967295

See [Table A-2](#) for valid CIC values for specified SI and MSU types.

#### **dpc (optional)**

ANSI destination point code with subfields *network indicator-network cluster-network cluster member* (*ni-nc-ncm*).

##### Synonym:

*dpca*

##### Range:

000-255

Specify a valid value for each subfield of the point code, and separate the subfields with a dash (-).

When `chg-sid:pctype=ansi` is specified, *ni = 000* is not valid.

When `chg-sid:pctype=ansi` is specified, `nc = 000` is not valid if `ni = 001–005`.

When `chg-sid:pctype=ansi` is specified, `nc = 000` is valid if `ni = 006–255`.

The point code `000-000-000` is not a valid point code.

#### **dpc/dpca/dpci/dpcn/dpcn24/dpcn16 (optional)**

Destination point code.

#### **dpci (optional)**

ITU international destination point code with subfields *zone-area-id*. The *prefix* subfield indicates a spare point code (*prefix-zone-area-id*).

##### **Range:**

*s*-, 0-255

Specify a valid value for each subfield of the point code, and separate the subfields with a dash (-).

*prefix*—*s*

*zone*—0-7

*area*—000-255

*id*—0-7

The point code `0-000-0` is not a valid point code.

#### **dpcn (optional)**

ITU national destination point code in the format of a 5-digit number (*nnnnn*); or 2, 3, or 4 numbers (members) separated by dashes (*m1-m2-m3-m4*) as defined by the `chg-stpopts:npcfmti` flexible point code option. A group code must be specified when the ITUDUPPC feature is turned on (*nnnnn-gc*, *m1-m2-m3-m4-gc*). The *prefix* subfield indicates a spare point code (*prefix-nnnnn*, *prefix-nnnnn-gc*, *prefix-m1-m2-m3-m4*, *prefix-m1-m2-m3-m4-gc*).

##### **Range:**

*s*-, 0-16383, *aa-zz*

Specify a valid value for each subfield of the point code, and separate the subfields with a dash (-).

*prefix*—*s*-

*nnnnn*—0-16383

*gc*—*aa-zz*

*m1-m2-m3-m4*—0-14 for each member; values must sum to 14

#### **dpcn24 (optional)**

24-bit ITU national destination point code with subfields *main signaling area-sub signaling area-signaling point* (*msa-ssa-sp*).

##### **Range:**

000-255

Specify a valid value for each subfield of the point code, and separate the subfields with a dash (-).

*msa*—000–255

*ssa*—000–255

*sp*—000–255

#### **dpcn16 (optional)**

16-bit ITU national point code with subfields *unit number-sub number area-main number area* (*un-sna-mna*).

**Range:***000---127*

Specify a valid value for each subfield of the point code, and separate the subfields with a dash (-).

*un-000-127**sna-000-15**mna-000-31***opc (optional)**

ANSI originating point code with subfields *network indicator-network cluster-network cluster member (ni-nc-ncm)*.

**Synonym:***opca***Range:***000-255*

Specify a valid value for each subfield of the point code, and separate the subfields with a dash (-).

When *chg-sid:pctype=ansi* is specified, *ni = 000* is not valid.

When *chg-sid:pctype=ansi* is specified, *nc = 000* is not valid if *ni = 001-005*.

When *chg-sid:pctype=ansi* is specified, *nc = 000* is valid if *ni = 006-255*.

The point code *000-000-000* is not a valid point code.

**opc/opca/opci/opcn/opcn24/opcn16 (optional)**

Originating point code. Valid only and required if the *si* parameter has a value of 4, 5, or 13.

**opci (optional)**

ITU international originating point code with subfields *zone-area-id*. The *prefix* subfield indicates a spare point code (*prefix-zone-area-id*)

**Range:***s-, 0-255*

Specify a valid value for each subfield of the point code, and separate the subfields with a dash (-).

*prefix—s**zone—0-7**area—000-255**id—0-7*

The point code *0-000-0* is not a valid point code.

**opcn (optional)**

ITU national originating point code in the format of a 5-digit number (*nnnnn*); or 2, 3, or 4 numbers (members) separated by dashes (*m1-m2-m3-m4*) as defined by the *chg-stpopts:npcfmti* flexible point code option. A group code must be specified when the ITUDUPPC feature is turned on (*nnnnn-gc*, *m1-m2-m3-m4-gc*). The *prefix* subfield indicates a spare point code (*prefix-nnnnn*, *prefix-nnnnn-gc*, *prefix-m1-m2-m3-m4*, *prefix-m1-m2-m3-m4-gc*).

**Range:***s-*, 0-16383, *aa-zz*

Specify a valid value for each subfield of the point code, and separate the subfields with a dash (-).

*prefix—s-**nnnnn—0-16383**gc—aa-zz**m1-m2-m3-m4—0-14* for each member; values must sum to 14**opc24 (optional)**24-bit ITU national originating point code with subfields *main signaling area-sub signaling area-signaling point (msa-ssa-sp)*.**Range:**

000-255

Specify a valid value for each subfield of the point code, and separate the subfields with a dash (-).

*msa—000–255**ssa—000–255**sp—000–255***opc16 (optional)**16-bit ITU national point code with subfields *unit number-sub number area-main number area (un-sna-mna)*.**Range:**

000---127

Specify a valid value for each subfield of the point code, and separate the subfields with a dash (-).

*un-000-127**sna-000-15**mna-000-31***rcontext (optional)**Identify a routing key by its routing context when a routing key needs to be deleted as an optional alternative to entering the *dpc/si/ssn/opc/cics/cice/type* key parameters.**Range:**

0 - 4294967295

**si (optional)**

Service indicator.

**Range:**

0 - 15

0-15 or equivalent text values

**Number = Text—Description**0=*snm*—Signaling network management messages1=*regtest*—Signaling network testing and maintenance regular2=*spltest*—Signaling network testing and maintenance special3=*sccp*—SCCP

4=*tup*—Telephone user part

5= *isup*—ISDN user part

13= *qbicc*

**ssn (optional)**

Subsystem number.

**Range:**

0 - 255

**type (optional)**

Type of routing key that is being changed.

**Range:**

*full*

*partial*

*default*

**Default:**

*full*

**Example**

```
dlt-appl-rtkey:dpc=1-1-1:si=3:asname=as1:ssn=255
```

```
dlt-appl-rtkey:dpci=s-3-11-1:si=5:opci=s-4-11-2:
```

```
cics=1:cice=1000:asname=asitu
```

```
dlt-appl-rtkey:rcontext=100
```

```
dlt-appl-
```

```
rtkey:dpcn16=121-10-5:si=5:opcn16=121-10-6:cics=1:cice=1000:
```

```
asname=asitu
```

**Dependencies**

The SSN is valid and must be specified only when the *si=3* (or *sccp*) parameter is specified. When the *si=3* (or *sccp*) parameter is not specified, the *ssn* parameter must not be specified.

The value entered for the *cics* parameter must be less than or equal to the value entered for the ending circuit identification code *cice* parameter.

A circuit identification code range (*cics* to *cice*) that overlaps an existing routing key cannot be specified.

When the DPC is ANSI and the *si=4* parameter is specified, a DPC/SI routing key must be specified (TUP is used only in an ITU network).

The *opc*, *cics*, and *cice* parameters are required and can be entered only if the *si* parameter value is 4, 5, or 13.

If the *si* parameter has a value of 4, 5, or 13 (*tup*, *isup*), or the *qbicc* parameter is specified, the *opc*, *cics*, and *cice* parameters used to route ISUP messages must

be specified. The `opc`, `cics`, and `cice` parameters can be specified only if the `si` parameter has a value of 4, 5, or 13 (*tup*, *isup*), or if the `qbicc` parameter is specified.

Table A-2 shows valid CIC values for SI types 4, 5, and 13.

The routing key must be in the Routing Key table.

If the `asname` parameter is specified, the AS name must already be defined in the AS table. The AS name and parameters specified for a routing key must use an address format that is valid for the adapter type used by the ASP associations assigned to the AS.

When the `type=full` parameter is specified, the `dpc` and `si` parameters must be specified.

The following types of partial routing keys are supported:

- DPC-SI-OPC (ignore CIC) can be used as a partial match key for CIC- based traffic.
- DPC-SI (ignore all other fields) can be used as a partial match key for CIC- based traffic or SCCP traffic.
- DPC only (ignore all other fields) can be used as a partial match for any type of traffic.
- SI only (ignore all other fields) can be used as a partial match for any type of traffic.

The following card locations are not valid for this command: 1113, 1115, 1117, 1118, and all xy09 and xy10 locations (where *x* is the frame and *y* is the shelf). The card must be equipped and in service.

If the `type=default` parameter is specified, then the `dpc`, `si`, `ssn`, `opc`, `cice`, and `cics` parameters cannot be specified.

The `asname` or the `rcontext` parameter must be specified in the command.

The `opc`, `cics`, and `cice` parameters can be specified with the `si` parameter only if the `si` parameter has a value of 4, 5, or 13 (or *tup*, *isup*, or *qbicc*).

### Notes

A specific routing key/socket name association can be deleted by specifying a fully qualified routing key (`dpc/dpca`, `si`, `ssn`, and `asname`). By default, socket associations in the static key entries are deleted using the `dlt-appl-rtkey` command.

The OPC and DPC cannot specify a cluster route.

Group codes are required for ITU-N point codes (DPCN/OPCN) when the Duplicate Point Code feature is turned on.

In this command, only ITU-international and ITU national point codes support the spare point code subtype prefix (s-).

### Output

```
dlt-appl-rtkey:asname=tekelec:si=3:ssn=255:type=full:dpc=2-2-2
```

```
rlghncxa03w 08-03-17 15:35:05 EST EAGLE 38.0.0
DLT-APPL-RTKEY: MASP A - COMPLTD
;
```

**Related Topics**

- [ent-appl-rtkey](#)
- [rtrv-appl-rtkey](#)

## dlt-as

Use this command to delete an AS.

**Parameters****aname (mandatory)**

Name of the M3UA/SUA SCTP association to be deleted.

**Range:**

aaaaaaaaaaaaaaaa

Up to 15 alphanumeric characters; the first character must be a letter.

**asname (mandatory)**

Application Server assigned to the routing key.

**Range:**

aaaaaaaaaaaaaaaa

Up to 15 alphanumeric characters; the first character must be a letter

**Example**

```
dlt-as:as=asx:aname=asxp1
```

**Dependencies**

An AS that is still assigned to a routing key cannot be deleted.

The connection state for the associations assigned to the AS must be `open=no` before the AS can be deleted.

The AS must be defined in the AS table.

The specified associaton name (`aname`) parameter must be defined in the AS.

**Notes**

None

**Output**

```
dlt-as:as=asx:as=asxp1
```

```
rlghncxa03w 04-02-17 15:35:05 EST EAGLE 31.3.0
DLT-AS: MASP A - COMPLTD
```

```
;
```

**Related Topics**

- [chg-as](#)

- [ent-as](#)
- [rept-stat-as](#)
- [rtrv-as](#)

## dlt-assoc

Use this command to delete the SCTP associations from the IPAPSOCK table.

### Parameters

#### **aname (mandatory)**

Name assigned to the association to be deleted.

#### **Range:**

aaaaaaaaaaaaaaaa

Up to 15 alphanumeric characters; the first character must be a letter

### Example

```
dlt-assoc:aname=tekelec
```

### Dependencies

The value specified for the `aname` parameter must already exist in the IP Socket/Association (IPAPSOCK) table.

An association that exists on any AS cannot be deleted from the IPAPSOCK table.

An AS assigned to a routing key cannot be deleted from the IPAPSOCK table.

The connection state must be `open=no` to delete the association from the IPAPSOCK table.

If the association on an IPSP card is referenced by a signaling link, then the association cannot be deleted.

An association that is already assigned to a diameter connection in the DCONN table cannot be deleted from the IPAPSOCK table.

### Notes

None.

### Output

```
dlt-assoc:aname=tekelec
```

```
rlghncxa03w 04-02-17 15:35:05 EST EAGLE 31.3.0  
DLT-ASSOC: MASP A - COMPLTD
```

```
;
```

### Related Topics

- [chg-assoc](#)
- [ent-assoc](#)



- [rtrv-assoc](#)

## dlt-card

Use this command to remove a card entry from the system database.

### Parameters

#### **loc (mandatory)**

The card location as stenciled on the shelf of the system.

#### **Range:**

*1101 - 1108, 1111 - 1112, 1201 - 1208, 1211 - 1218, 1301 - 1308, 1311 - 1318,  
2101 - 2108, 2111 - 2118, 2201 - 2208, 2211 - 2218, 2301 - 2308, 2311 - 2318,  
3101 - 3108, 3111 - 3118, 3201 - 3208, 3211 - 3218, 3301 - 3308, 3311 - 3318,  
4101 - 4108, 4111 - 4118, 4201 - 4208, 4211 - 4218, 4301 - 4308, 4311 - 4318,  
5101 - 5108, 5111 - 5118, 5201 - 5208, 5211 - 5218, 5301 - 5308, 5311 - 5318,  
6101 - 6108, 6111 - 6118, 6201 - 6208, 6211 - 6218, 6301 - 6308, 6311 - 6318*

### Example

```
dlt-card:loc=1201
```

```
dlt-card:loc=6201
```

### Dependencies

The card location slot must be between 1 - 18, but not 9 or 10.

The card location cannot be 1113–1118.

The shelf location must be 11xx, 12xx, 13xx, 21xx, 22xx, 23xx, 31xx, 32xx, 33xx, 41xx, 42xx, 43xx, 51xx, 52xx, 53xx, 61xx, 62xx, or 63xx.

The shelf and card must be equipped.

Before this command can be entered, all TCP/IP data links assigned to the card must be deleted.

Before an E1 card can be deleted, any E1 interfaces assigned to the card must be deleted.

Before a T1 card can be deleted, any T1 interfaces assigned to the card must be deleted.

After the links are deleted, the card must be inhibited before it can be deleted. Use the `inh-card` command to set the card to the OOS-MT-DSBLD state.

Before this command can be entered, SS7 signaling links assigned to the card must be deleted. E5-APP-B cards do not need to be inhibited first before they can be deleted.

Only one database change, action, backup, or restore can be in progress at a time.

The E1/T1 table must be accessible.

The Shelf table must be accessible.

The Card (IMT) table must be accessible.

The Link table must be accessible.

Before a J1 card can be deleted, any J1 interfaces assigned to the card must be deleted.

Before deleting the SFLOG card, the SFLOG action must be deleted from the GTT Action table.

### Notes

If a SEAS terminal is configured for a location, then entering the `dlt-card` command causes the warning “Invalidating the Terminal data in SEASCFG table” to appear.

### Output

```
dlt-card:loc=1201
```

```
rlghncxa03w 04-01-07 11:11:28 EST EAGLE 31.3.0  
DLT-CARD: MASP A - COMPLTD
```

```
;
```

```
dlt-card:loc=6201
```

```
tekelecstp 13-02-28 12:40:29 EST 45.0.0  
DLT-CARD: MASP A - COMPLTD
```

```
;
```

### Related Topics

- [init-card](#)
- [rept-stat-card](#)
- [rmv-card](#)
- [rtrv-card](#)

## dlt-csl

Use this command to delete an existing entry from the Common Screening List (CSL). The Common Screening List commands are used to tailor certain types of general screening information to specific features.

### Parameters



#### Note:

Either the `ds` parameter or the `pc` parameter must be specified in the command. Both parameters cannot be specified in the same command.

#### **ds (optional)**

Digit string. A unique string of digits that is used by the specified screening feature.



<b>gt</b>	Global Title List
<b>imsipfx</b>	IMSI Screening Prefix List
<b>insl</b>	In Network Subscriber List
<b>npbypass</b>	SIP NPBYPASS List
<b>skbcm</b>	SK+BCSM List
<b>skts</b>	Service Key + Teleservice List
<b>trig</b>	Trigger List
<b>vmplx</b>	Voice Mail Prefix List
<b>opcdpc</b>	OPC + DPC List

The following screening lists are valid for the indicated features:

- *ccnc*, *gt*—Prepaid IDP Query Relay and Info Analyzed Relay Base
- *imsipfx* --- EIR

 **Note:**

If list argument is not specified in this command for EIR feature then list = *imsipfx* by default is taken

- *insl*, *skts*—IDP Screening for Prepaid
- *npbypass* — SIP Number Portability
- *skbcm*—Prepaid IDP Query Relay and IDP Service Key Routing
- *trig*—Info Analyzed Relay Base
- *vmplx*—VFLEX
- *opcdpc*—Prepaid IDP Query Related

The *delpfx* list is not supported at this time. This list should only be used by Oracle personnel.

**pc (optional)**

ANSI point code with subfields *network indicator-network cluster-network cluster member (ni-nc-ncm)*.

**Synonym:***pca***Range:***000-255*

Specify a valid value for each subfield of the point code, and separate the subfields with a dash (-).

When `chg-sid:pctype=ansi` is specified, *ni = 000* is not valid.

When `chg-sid:pctype=ansi` is specified, *nc = 000* is not valid if *ni = 001-005*.

When `chg-sid:pctype=ansi` is specified, *nc = 000* is valid if *ni = 006-255*.

The point code *000-000-000* is not a valid point code.

**Note:**

See [Point Code Formats and Conversion](#) for a detailed description of point code formats, rules for specification, and examples.

**pc/pca/pci/pcn/pcn24 (optional)**

Point code. The `ds` parameter or a point code parameter must be specified.

**pci (optional)**

ITU international point code with subfields *zone-area-id*.

**Range:***0-255*

Specify a valid value for each subfield of the point code, and separate the subfields with a dash (-).

*zone—0-7**area—000-255**id—0-7*

The point code *0-000-0* is not a valid point code.

**pcn (optional)**

ITU national point code in the format of a 5-digit number (*nnnnn*); or 2, 3, or 4 numbers (members) separated by dashes (*m1-m2-m3-m4*) as defined by the `chg-stpopts:npcfmti` flexible point code option. A group code must be specified when the ITUDUPPC feature is turned on (*nnnnn-gc*, *m1-m2-m3-m4-gc*).

**Range:***s-, 0-16383, aa-zz*

Specify a valid value for each subfield of the point code, and separate the subfields with a dash (-).

*prefix—s-**nnnnn—0-16383**gc—aa-zz**m1-m2-m3-m4—0-14* for each member; values must sum to 14**pcn24 (optional)**

24-bit ITU national point code with subfields *main signaling area-sub signaling area-signaling point* (*msa-ssa-sp*).

**Range:**

000-255

Specify a valid value for each subfield of the point code, and separate the subfields with a dash (-).

msa—000–255

ssa—000–255

sp—000–255

**dpc(optional)**

ANSI destination point code with subfields *network indicator-network cluster-network cluster member (ni-nc-ncm)*.

**Synonym:**

dpca

**Range:**

000-255

Specify a valid value for each subfield of the point code, and separate the subfields with a dash (-).

The point code 000-000-000 is not a valid point code.

**dpc/dpca/dpci/dpcn/dpcn24/dpcn16 (optional)**

Destination point code.

**dpci (optional)**

ITU international destination point code with subfields *zone-area-id*. The *prefix* subfield indicates a spare point code (*prefix-zone-area-id*).

**Range:**

s-, 0-255

Specify a valid value for each subfield of the point code, and separate the subfields with a dash (-).

prefix-s

zone-0-7

area-000-255

id-0-7

The point code 0-000-0 is not a valid point code.

**dpcn (optional)**

ITU national destination point code in the format of a 5-digit number (*nnnnn*); or 2, 3, or 4 numbers (members) separated by dashes (*m1-m2-m3-m4*) as defined by the `chg-stopts:npfnti` flexible point code option. A group code must be specified when the ITUDUPPC feature is turned on (*nnnnn-gc,m1-m2-m3-m4-gc*). The *prefix* subfield indicates a spare point code (*prefix-nnnnn, prefix-nnnnn-gc, prefix-m1-m2-m3-m4, prefix-m1-m2-m3-m4-gc*).

**Range:**

s-, 0-16383, aa-zz

Specify a valid value for each subfield of the point code, and separate the subfields with a dash (-).

*prefix-s-*

*nnnnn-0-16383*

*gc-aa-zz*

*m1-m2-m3-m4-0-14* for each member; values must sum to 14

**dpcn24 (optional)**

16-bit ITU national point code with subfields *unit number sub number area main number area (un-sna-mna)*.

**Range:**

*000-255*

Specify a valid value for each subfield of the point code, and separate the subfields with a dash (-).

*msa-000-255*

*ssa-000-255*

*sp-000-255*

**dpcn16 (optional)**

24-bit ITU national destination point code with subfields *main signaling area-sub signaling area-signaling point (msa-ssa-sp)*.

**Range:**

*000-127*

Specify a valid value for each subfield of the point code, and separate the subfields with a dash (-).

*un---000---127*

*sna---000---15*

*mna---000---31*

**opc (optional)**

ANSI originating point code with subfields *network indicator-network cluster-network cluster member (ni-nc-ncm)*.

**Synonym:**

*opca*

**Range:**

*000-255*

Specify a valid value for each subfield of the point code, and separate the subfields with a dash (-).

The point code *000-000-000* is not a valid point code.

**opc/opca/opci/opcn/opcn24/opcn16 (optional)**

Originating point code.

**opci (optional)**

ITU international destination point code with subfields *zone-area-id*. The *prefix* subfield indicates a spare point code (*prefix-zone-area-id*).

**Range:**

*s-*, 0-255

Specify a valid value for each subfield of the point code, and separate the subfields with a dash (-).

*prefix-s*

*zone-0-7*

*area-000-255*

*id-0-7*

The point code *0-000-0* is not a valid point code.

**opcni (optional)**

New ITU national originating point code in the format of a 5-digit number (*nnnnn*); or 2, 3, or 4 numbers (members) separated by dashes (*m1-m2-m3-m4*) as defined by the *chg-stpopts:npfnti* flexible point code option. A group code must be specified when the ITUDUPPC feature is turned on (*nnnnn-gc*, *m1-m2-m3-m4-gc*). The *prefix* subfield indicates a spare point code (*prefix-nnnnn*, *prefix-nnnnn-gc*, *prefix-m1-m2-m3-m4*, *prefix-m1-m2-m3-m4-gc*).

**Range:**

*s-*, 0-16383, *aa-zz*

Specify a valid value for each subfield of the point code, and separate the subfields with a dash (-).

*prefix-s-*

*nnnnn-0-16383*

*gc-aa-zz*

*m1-m2-m3-m4-0-14* for each member; values must sum to 14

**opcni24 (optional)**

24-bit ITU national originating point code with subfields *main signaling area-sub signaling area-signaling point* (*msa-ssa-sp*).

**Range:**

000-255

Specify a valid value for each subfield of the point code, and separate the subfields with a dash (-).

*msa-000-255*

*ssa-000-255*

*sp-000-255*



**opc16 (optional)**

16-bit ITU national point code with subfields *unit number sub number area main number area* (*un-sna-mna*).

**Range:**

000-127

Specify a valid value for each subfield of the point code, and separate the subfields with a dash (-).

*un*---000---127

*sna*---000---15

*mna*---000---31

**pn (optional)**

Part Number. The 9-digit "893xxxxxx" part number of the feature for which the command is entered. The `rtrv-ctrl-feat` command description shows the part number in the command output example.

**Range:**

893000000 - 893999999

The first 3 digits are 893. Do not separate the digits with dashes or spaces. The following part numbers are valid for this command:

- 893012301—EIR
- 893015501—IDP Screening for Prepaid
- 893016001—Prepaid IDP Query Relay
- 893034201—Info Analyzed Relay Base
- 893016701—VFLEX

**Example**

```
dlt-csl:feature="IDP Screening for Prepaid":list=insl:ds=246810
```

```
dlt-csl:pn=893015501:list=skts:ds=36ab
```

```
dlt-csl:feature="VFLEX":list=vmpfx:ds=123456789abcdEF
```

```
dlt-csl:pn=893040601:list=npbypass:ds=0000000056
```

```
dlt-csl:feature="EIR":list=imsipfx:ds=4012312312
```

```
dlt-csl:pn=893016001:list=opcdpc:dpci=4-5-6
```

```
dlt-csl:pn=893016001:list=opcdpc:dpci=4-5-6:opci=2-1-2
```

**Dependencies**

An enabled feature must be specified using a valid part number (`pn` parameter) or feature name (`feature` parameter). The specified feature must use a Common Screening List.

The value specified for the feature parameter must be a valid feature name for a feature that uses a Common Screening List. The feature name must be specified as it appears in the `rtrv-ctrl-feat` command output. Enough of the name must be

specified to make the name unique when two features begin with the same word or acronym.

The feature that is specified in the `feature` parameter must be enabled.

The `list` parameter must be specified for features that use more than one type of screening list.

The value specified for the `list` parameter must be valid for the specified screening feature.

The specified screening list entry must exist in the screening list that is used by the feature.

The following parameters are allowed with the indicated common screening list type:

- `list=gt`— `ds` parameter
- `list=ccnc`—`ds` parameter
- `list=imsipfx`—`ds` parameters
- `list=skbcsm`—`ds` parameter
- `list=skts`—`ds` parameter
- `list=insl`—`ds` parameter
- `list=vmpfx`—`ds` parameter
- `list=trig`—`ds` parameter

The Common Screening List table is corrupt or cannot be found.

The `opc/dpc`, `pc` and `ds` parameters cannot be specified together in the command.

The parameter `p1` or `p2` cannot be specified in the command.

For IDPR service, if list type `opcdpc` given, then `opc/dpc` parameter must be specified.

## Notes

None

## Output

```
dlt-csl:pn=893015501:list=insl:ds=123456789abcdEF
```

```
tekelecstp 05-08-21 15:18:41 EST EAGLE 34.3.0
INSL List table is (5 of 50) 10% full
DLT-CSL: MASP A - COMPLTD
```

```
;
```

```
dlt-csl:pn=893040601:list=npbypass:ds=0000000012
```

```
tekelecstp 12-06-25 15:29:14 EST EAGLE 45.0.0
dlt-csl:pn=893040601:list=npbypass:ds=0000000012
Command entered at terminal #4.
PFX List (2 of 1000) 1%
DLT-CSL: MASP A-COMPLTD
```

```
;
```

**Related Topics**

- [chg-csl](#)
- [ent-csl](#)
- [rtrv-csl](#)
- [rtrv-ctrl-feat](#)

## dlt-cspc

Use this command to remove a CSPC or an entire CSPC group.

**Parameters** **Note:**

See [Point Code Formats and Conversion](#) for a detailed description of point code formats, rules for specification, and examples.  
One, but not both, of these optional parameters must be specified: `all`, `pc/pca/pci/pcn/pcn24`.

**grp (mandatory)**

Group name

**Range:**

`ayyyyyy`

1 alphabetic character followed by up to 7 alphanumeric characters

**a11 (optional)**

Use this parameter to confirm that all entries for this concerned signaling point code group are to be removed.

**Range:**

`yes`

`no`

**Default:**

`no`

**pc (optional)**

ANSI point code with subfields *network indicator-network cluster-network cluster member* (`ni-nc-ncm`).

**Synonym:**

`pca`

**Range:**

`000-255`

Specify a valid value for each subfield of the point code, and separate the subfields with a dash (-).

When `chg-sid:pctype=ansi` is specified, `ni = 000` is not valid.

When `chg-sid:pctype=ansi` is specified, `nc = 000` is not valid if `ni = 001–005`.

When `chg-sid:pctype=ansi` is specified, `nc = 000` is valid if `ni = 006–255`.

The point code `000-000-000` is not a valid point code.

#### **pc/pca/pci/pcn/pcn24/pcn16 (optional)**

Concerned signaling point code.

#### **pci (optional)**

ITU international point code with subfields *zone-area-id*. The *prefix* subfield indicates a spare point code (*prefix-zone-area-id*)

##### **Range:**

*s*-, 0-255

Specify a valid value for each subfield of the point code, and separate the subfields with a dash (-).

*prefix*—*s*

*zone*—0-7

*area*—000-255

*id*—0-7

The point code `0-000-0` is not a valid point code.

#### **pcn (optional)**

ITU national point code in the format of a 5-digit number (*nnnnn*); or 2, 3, or 4 numbers (members) separated by dashes (*m1-m2-m3-m4*) as defined by the `chg-stpopts:npcfmti` flexible point code option. A group code must be specified when the ITUDUPPC feature is turned on (*nnnnn-gc*, *m1-m2-m3-m4-gc*). The *prefix* subfield indicates a spare point code (*prefix-nnnnn*, *prefix-nnnnn-gc*, *prefix-m1-m2-m3-m4*, *prefix-m1-m2-m3-m4-gc*).

##### **Range:**

*s*-, 0-16383, *aa-zz*

Specify a valid value for each subfield of the point code, and separate the subfields with a dash (-).

*prefix*—*s*-

*nnnnn*—0-16383

*gc*—*aa-zz*

*m1-m2-m3-m4*—0-14 for each member; values must sum to 14

#### **pcn24 (optional)**

24-bit ITU national point code with subfields *main signaling area-sub signaling area-signaling point* (*msa-ssa-sp*).

##### **Range:**

*p*-, 000-255

Specify a valid value for each subfield of the point code, and separate the subfields with a dash (-).

*prefix*—*p*

*msa*—000–255

*ssa*—000–255

*sp*—000–255

**pcn16 (optional)**

16-bit ITU national point code with subfields *unit number sub number area main number area* (*un-sna-mna*). The *prefix* subfield indicates a private point code.

**Range:**

*p--*, 000-127

Specify a valid value for each subfield of the point code, and separate the subfields with a dash (-).

*prefix---p*

*un---000---127*

*sna---000---15*

*mna---000---31*

**Example**

```
dlt-cspc:grp=grp01:pc=144-201-001
```

```
dlt-cspc:grp=grp01:pci=s-144-201-001
```

```
dlt-cspc:grp=grp01:all=yes
```

```
dlt-cspc:grp=grp01:pcn16=123-7-20
```

**Dependencies**

A CPC group name must be specified. The specified group name must exist in the database.

The `grp` parameter and the `all=yes` parameter must be entered with no point code parameter, to remove a group and all of its point codes.

If a PC is specified, then the PC network type must match the group network type, and the PC must exist in the specified CPC group. The specified PC is removed from the CPC group.

Either a PC parameter or the `all=yes` parameter must be specified.

The Spare Point Code Support feature must be enabled before the spare PC prefix `s-` can be specified for an ITU-I or ITU-N point code.

The `pc/pca/pci/pcn/pcn24` parameter and the `all` parameter cannot be specified in the same command.

The specified CSPC group must not be referred to by any Mate Application entity.

If the Flexible GTT Load Sharing feature is not enabled, a CAUTION is displayed. When the feature is enabled, the command is rejected with message E4534.

**Notes**

The system issues a warning if a mate application entity could potentially use a group name that is being deleted.

In this command, only ITU-international and ITU national point codes support the spare point code subtype prefix (`s-`).

## Output

```
dlt-cspc:grp=grp01:pci=2-2-2

      tekelecstp 04-04-08 12:42:47 EST  EAGLE 31.3.0
      DLT-CSPC: MASP A - COMPLTD
;
```

## Related Topics

- [ent-cspc](#)
- [rtrv-cspc](#)

# dlt-dconn

Use this command to delete existing Diameter connection information. The DCONN table supports the provisioning information related to the Diameter connections.

## Parameters

### **dcname (mandatory)**

Diameter connection name. This parameter specifies the unique logical name assigned to each diameter connection.

#### **Range:**

aaaaaaaaaaaaaaaa

A string of alphanumeric characters, beginning with a letter and up to 15 characters in length. Valid values are a..z, A..Z, 0..9.

#### **Default:**

No change to the current value

#### **System Default:**

null

## Example

```
dlt-dconn:dcname=conn1
```

## Dependencies

S13 feature must be enabled before deleting any existing diameter connection.

**DCONN** table should be accessible.

The value specified for the **DCNAME** parameter must already exist in the DCONN table.

Any Diameter Connection that is still OPEN to receive traffic cannot be deleted (the open parameter set to yes with the chg-assoc command).

## Notes

None

## Output

```
dlt-dconn:dcname=conn1

tekelecstp 13-03-19 15:29:14 EST EAGLE 45.1.0
dlt-dconn:dcname=conn1
Command entered at terminal #4.
DLT-DCONN: MASP A - COMPLTD
;
```

## Related Topics

- [chg-dconn](#)
- [ent-dconn](#)
- [rtrv-dconn](#)

# dlt-dlk

Use this command to remove a TCP/IP data link from the database. The TCP/IP data link is used for the STP LAN feature, connecting the system to a remote host for message processing.

## Parameters

### **loc (mandatory)**

The card location as stenciled on the shelf of the system.

#### **Range:**

*1101 - 1108, 1111 - 1112, 1201 - 1208, 1211 - 1218, 1301 - 1308, 1311 - 1318,  
2101 - 2108, 2111 - 2118, 2201 - 2208, 2211 - 2218, 2301 - 2308, 2311 - 2318,  
3101 - 3108, 3111 - 3118, 3201 - 3208, 3211 - 3218, 3301 - 3308, 3311 - 3318,  
4101 - 4108, 4111 - 4118, 4201 - 4208, 4211 - 4218, 4301 - 4308, 4311 - 4318,  
5101 - 5108, 5111 - 5118, 5201 - 5208, 5211 - 5218, 5301 - 5308, 5311 - 5318,  
6101 - 6108, 6111 - 6118*

## Example

```
dlt-dlk:loc=1201
```

## Dependencies

The value specified for the `loc` parameter must indicate an STPLAN card.

The shelf and card must be equipped.

The location specified by the `loc` parameter must already have a TCP/IP data link assigned to it.

The specified card and data link must be out-of-service maintenance-disabled (OOS-MT-DSBLD).

**Notes**

None

**Output**

dlt-dlk:loc=1201

```
rlghncxa03w 04-02-10 11:43:02 EST EAGLE 31.3.0
DLT-DLK: MASP A - COMPLTD
;
```

**Related Topics**

- [act-dlk](#)
- [canc-dlk](#)
- [ent-dlk](#)
- [rept-stat-dlk](#)
- [rtrv-dlk](#)
- [tst-dlk](#)

## dlt-dstn

Use this command to delete destinations from the Destination entity set after the STP no longer routes to those destinations.

**Parameters****Note:**

See [Point Code Formats and Conversion](#) for a detailed description of point code formats, rules for specification, and examples.

**dpc/dpca/dpci/dpcn/dpcn24/dpcn16 (mandatory)**

Destination point code.

**dpc (optional)**

ANSI destination point code with subfields *network indicator-network cluster-network cluster member (ni-nc-ncm)*. The *prefix* subfield indicates a private point code (*prefix-ni-nc-ncm*).

**Synonym:**

*dpca*

**Range:**

*p-, 000-255, \**

Specify a valid value for each subfield of the point code, and separate the subfields with a dash (-).



*prefix*—*p*-

The asterisk value (\*) is not valid for the *ni* subfield.

When *chg-sid:pctype=ansi* is specified, *ni = 000* is not valid.

When *chg-sid:pctype=ansi* is specified, *nc = 000* is not valid if *ni = 001–005*.

When *chg-sid:pctype=ansi* is specified, *nc = 000* is valid if *ni = 006–255*.

The point code *000-000-000* is not a valid point code.

#### **dpci (optional)**

ITU international destination point code with subfields *zone-area-id*. The *prefix* subfield indicates a spare point code, private point code, or private and spare point code (*prefix-zone-area-id*).

##### **Range:**

*s*-, *p*-, *ps*-, *0-255*

Specify a valid value for each subfield of the point code, and separate the subfields with a dash (-).

*prefix*—*s*-, *p*-, *ps*

*zone*—*0-7*

*area*—*000-255*

*id*—*0-7*

The point code *0-000-0* is not a valid point code.

#### **dpcn (optional)**

ITU national destination point code in the format of a 5-digit number (*nnnnn*); or 2, 3, or 4 numbers (members) separated by dashes (*m1-m2-m3-m4*) as defined by the *chg-stpopts:npcfmti* flexible point code option. A group code (*gc*) must be specified when the ITUDUPPC feature is turned on. The *prefix* indicates a spare point code, private point code, or private and spare point code.

##### **Range:**

*s*-, *p*-, *ps*-, *0-16383*, *aa-zz*

Specify a valid value for each subfield of the point code, and separate the subfields with a dash (-).

*prefix*—*s*-, *p*-, *ps*

*nnnnn*—*0-16383*

*gc*—*aa-zz*

*m1-m2-m3-m4*—*0-14* for each member; values must sum to 14

#### **dpcn24 (optional)**

24-bit ITU national destination point code with subfields *main signaling area-sub signaling area-signaling point* (*msa-ssa-sp*). The *prefix* subfield indicates a private point code.

##### **Range:**

*p*-, *000-255*

Specify a valid value for each subfield of the point code, and separate the subfields with a dash (-).

*prefix*—*p*

*msa*—*000–255*

*ssa*—*000–255*

*sp*—*000–255*

**dpcn16 (optional)**

16-bit ITU national point code with subfields *unit number sub number area main number area* (un-sna-mna). The *prefix* indicates a private point code (*prefix-un-sna-mna*).

**Range:**

*p--*, 000---127

Specify a valid value for each subfield of the point code, and separate the subfields with a dash (-).

*prefix---p*

*un---000---127*

*sna---000---15*

*mna---000---31*

**Example**

To delete destination 11-222-111:

```
dlt-dstn:dpc=111-222-111
```

To delete a network destination:

```
dlt-dstn:dpc=21-*-*
```

To delete destination 8112-ge:

```
dlt-dstn:dpcn=8112-ge
```

To delete ITU-N 24-bit destination 13-100-10:

```
dlt-dstn:dpcn24=13-100-10
```

To delete destination spare point code s-8112:

```
dlt-dstn:dpcn=s-8112
```

**Dependencies**

The destination address must be either a full point code, a cluster point code, or a network destination point code.

The format of the specified `dpcn` parameter must match the format for ITU national point codes that was assigned with the `chg-stpopts:npcfmti` parameter.

The specified destination point code must already exist in the Destination entity set.

The destination cannot have routes assigned to it.

The specified destination point code cannot already be defined as a remote application internal point code (IPC).

The `dpc` parameter must be defined as a destination point code.

The specified destination point code cannot already be defined as an adjacent point code or a secondary adjacent point code.

The specified destination cannot be referenced by SCCP as a destination point codes in the Mate Application table.

The specified destination cannot be referenced by SCCP as a destination point code in the Mated Relay Node (MRN) table.

Network routing is valid only if the Network Routing (NRT) feature is turned on.

When using network routing, if the destination point code has a value of \* in the *nc* subfield, the *ncm* subfield must also be \* (for example, *dpc=21-\*-\**).

The Route table is corrupt or cannot be found.

The MAS Configuration table is corrupt or cannot be found.

The Linkset table is corrupt or cannot be found.

A destination point code that is used as a proxy point code cannot be deleted.

The SAPC table is corrupt or cannot be found.

If an exception route is associated with a cluster member, then the cluster member cannot be deleted.

### Notes

In this command, only ITU-international and ITU national point codes support the spare point code subtype prefix (s- ) and the private and spare point code subtype prefix (ps-). All of the point code types support the private (internal) point code subtype prefix (p-).

One of *dpc/dpca/dpci/dpcn/dpcn24/dpcn16* is mandatory and they are mutually exclusive.

### Output

This example shows the output with the NCR, NRT, and CRMD features off (disabled) and all Routes and Route sets features off:

```
dlt-dstn:dpc=111-222-111

rlghncxa03w 04-08-17 15:35:05 EST EAGLE 31.8.0
Destination table is (10 of 2000) 1% full
Alias table is (8 of 12000) 1% full
DLT-DSTN: MASP A - COMPLTD
;
```

This example shows the output with the NCR, NRT, and CRMD features off and the DSTN5000 (5000 Routes) feature on:

```
dlt-dstn:dpc=111-222-111

rlghncxa03w 04-08-18 08:29:15 EST EAGLE 31.8.0
Destination table is (10 of 5000) 1% full
Alias table is (8 of 12000) 1% full
```

```
DLT-DSTN: MASP A - COMPLTD
;
```

This example shows the output with one or more of the NCR, NRT, or CRMD features on and the DSTN5000 (5000 Routes) feature on:

```
dlt-dstn:dpc=111-222-111
```

```
rlghncxa03w 04-08-18 08:29:15 EST EAGLE 31.8.0
DESTINATION ENTRIES ALLOCATED: 5000
  FULL DPC(s): 9
  NETWORK DPC(s): 0
  CLUSTER DPC(s): 1
  TOTAL DPC(s): 10
  CAPACITY (% FULL): 1%
ALIASES ALLOCATED: 12000
  ALIASES USED: 8
  CAPACITY (% FULL): 1%
X-LIST ENTRIES ALLOCATED: 500
DLT-DSTN: MASP A - COMPLTD
;
```

This example shows the output with the NCR, NRT, and CRMD features off and the 6000 Routesets feature on:

```
dlt-dstn:dpc=111-222-111
```

```
rlghncxa03w 04-08-18 08:29:15 EST EAGLE 31.8.0
Destination table is (60 of 6000) 1% full
Alias table is (8 of 12000) 1% full
DLT-DSTN: MASP A - COMPLTD
;
```

This example shows the output with one or more of the NCR, NRT, or CRMD features on and the 6000 Routesets feature on:

```
dlt-dstn:dpc=111-222-111
```

```
rlghncxa03w 04-08-18 08:29:15 EST EAGLE 31.8.0
DESTINATION ENTRIES ALLOCATED: 6000
  FULL DPC(s): 46
  NETWORK DPC(s): 1
  CLUSTER DPC(s): 1
  TOTAL DPC(s): 12
  CAPACITY (% FULL): 1%
ALIASES ALLOCATED: 12000
  ALIASES USED: 8
  CAPACITY (% FULL): 1%
X-LIST ENTRIES ALLOCATED: 500
DLT-DSTN: MASP A - COMPLTD
;
```

This example shows the output with the NCR, NRT, and CRMD features off. When the 7000 Routesets quantity feature is on, the Destination table line shows "...of 7000". When the 8000 Routesets quantity feature is on, the Destination table line shows "...of 8000."

```
dlt-dstn:dpc=111-222-111
```

```
rlghncxa03w 04-08-18 08:29:15 EST EAGLE 31.8.0
Destination table is (10 of 7000) 1% full
Alias table is (8 of 8000) 1% full
DLT-DSTN: MASP A - COMPLTD
```

```
;
```

This example shows the output with one or more of the NCR, NRT, or CRMD features on. When the 8000 Routesets quantity feature is on, the DESTINATION ENTRIES ALLOCATED line shows "8000". When the 7000 Routesets quantity feature is on, the DESTINATION ENTRIES ALLOCATED line shows "7000."

```
dlt-dstn:dpc=111-222-111
```

```
rlghncxa03w 04-08-18 08:29:15 EST EAGLE 31.8.0
DESTINATION ENTRIES ALLOCATED: 8000
  FULL DPC(s): 46
  NETWORK DPC(s): 1
  CLUSTER DPC(s): 1
  TOTAL DPC(s): 12
  CAPACITY (% FULL): 1%
ALIASES ALLOCATED: 8000
  ALIASES USED: 8
  CAPACITY (% FULL): 1%
X-LIST ENTRIES ALLOCATED: 500
DLT-DSTN: MASP A - COMPLTD
```

```
;
```

This example shows the output with none of the NCR, NRT, or CRMD features on. A proxy destination is being deleted.

```
dlt-dstn:dpc=11-11-11
```

```
tekelecstp 07-03-07 16:34:32 EST EAGLE 37.5.0
Destination table is (11 of 2000) 1% full
Alias table is (0 of 12000) 0% full
PPC table is (1 of 10) 10% full
DLT-DSTN: MASP A - COMPLTD
```

```
;
```

This example shows the output when the NCR, NRT, and CRMD features are off and the 10,000 Routesets feature is on:

```
dlt-dstn:dpc=11-222-11

rlghncxa03w 10-08-17 08:29:15 EST EAGLE 43.0.0
Destination table is (10 of 10000) 1% full
Alias table is (8 of 10000) 1% full
DLT-DSTN: MASP A - COMPLTD
;
```

This example shows the output with one or more of the NCR, NRT, or CRMD features and the 10,000 Routesets feature on:

```
dlt-dstn:dpc=11-222-11

rlghncxa03w 10-08-17 08:29:15 EST EAGLE 43.0.0
DESTINATION ENTRIES ALLOCATED: 10000
  FULL DPC(s): 9
  NETWORK DPC(s): 0
  CLUSTER DPC(s): 1
  TOTAL DPC(s): 10
  CAPACITY (% FULL): 1%
ALIASES ALLOCATED: 10000
  ALIASES USED: 8
  CAPACITY (% FULL): 1%
X-LIST ENTRIES ALLOCATED: 500
DLT-DSTN: MASP A - COMPLTD
;
```

### Related Topics

- [chg-dstn](#)
- [chg-rte](#)
- [dlt-rte](#)
- [ent-dstn](#)
- [ent-rte](#)
- [rept-stat-dstn](#)
- [rept-stat-rte](#)
- [rtrv-dstn](#)
- [rtrv-rte](#)

## dlt-e1

Use this command to delete an interface for E5-E1T1-B cards used as E1 or SE-HSL cards.

### Parameters

#### **e1port (mandatory)**

E1 port number.

**Range:**

1 - 8

**loc (mandatory)**

The card location as stenciled on the shelf of the system.

**Range:**

1101 - 1108, 1111 - 1112, 1201 - 1208, 1211 - 1218, 1301 - 1308, 1311 - 1318,  
2101 - 2108, 2111 - 2118, 2201 - 2208, 2211 - 2218, 2301 - 2308, 2311 - 2318,  
3101 - 3108, 3111 - 3118, 3201 - 3208, 3211 - 3218, 3301 - 3308, 3311 - 3318,  
4101 - 4108, 4111 - 4118, 4201 - 4208, 4211 - 4218, 4301 - 4308, 4311 - 4318,  
5101 - 5108, 5111 - 5118, 5201 - 5208, 5211 - 5218, 5301 - 5308, 5311 - 5318,  
6101 - 6108, 6111 - 6118

**Example**

```
dlt-e1:loc=1205:elport=1
```

**Dependencies**

The card in the location specified by the `loc` parameter must be equipped.

The card in the location specified by the `loc` parameter must be a LIME1 card type.

The port specified by the `elport` parameter must be already equipped with an E1 interface.

The E1/T1 table must be accessible.

The Card (IMT) table must be accessible.

All signaling links providing timeslots serviced by the specified E1 interface must be deleted before the E1 interface can be deleted. See the `dlt-slk` command to delete the signaling links providing the timeslots.

Card locations 1113 - 1118 (control cards) cannot be specified as values for the `loc` parameter.

**Notes**

None.

**Output**

```
dlt-e1:loc=1205:elport=1
```

```
rlghncxa03w 04-02-20 09:07:58 EST EAGLE 31.3.0  
dlt-E1: MASP A - COMPLTD
```

```
;
```

**Related Topics**

- [chg-e1](#)
- [ent-e1](#)
- [rtrv-e1](#)
- [tst-e1](#)

## dlt-enum-acl

Use this command to delete an entry in the ENUM Access Control List (ACL) Table. The ENUM ACL Table supports the provisioning information related to the allowed IP Addresses for the ENUM application.

### Parameters

#### **ipaddr (mandatory)**

This is a TCP/IP address expressed in standard dot notation. It specifies allowed IP addresses for the ENUM application.

#### **Range:**

Four numbers separated by dots, with each number in the range of 0-255, \*.

#### **Note:**

It also supports wildcard characters as follows:

xxx.xxx.xxx.\*

xxx.xxx.\*.\*

xxx.\*.\*.\*

where xxx can be any number in range of 0-255.

#### **System Default:**

0.0.0.0

### Example

```
dlt-enum-acl:ipaddr=10.248.13.9
```

```
dlt-enum-acl:ipaddr=10.248.13.*
```

```
dlt-enum-acl:ipaddr=10.248.*.*
```

```
dlt-enum-acl:ipaddr=10.*.*.*
```

### Dependencies

The ENUM ACL Table should be accessible.

The IP Address specified by the IPADDR parameter should be provisioned in the ENUM ACL Table.

The IP Address specified by the IPADDR parameter must be a valid IP address.

### Notes

Wildcard IP addresses are allowed to support the ranges of IP addresses.



## Output

```
dlt-enum-acl:ipaddr=10.248.13.*

tekelecstp 14-05-28 15:04:28 EST EAGLE 46.1.0
dlt-enum-acl:ipaddr=10.248.13.*
Command entered at terminal #4.
DLT-ENUM-ACL: MASP A - COMPLTD
;
```

## Related Topics

- [ent-enum-acl](#)
- [rtrv-enum-acl](#)

# dlt-enum-prof

Use this command to delete the existing profile entry which has data used to generate the ENUM response for three supported resource record formats such as NAPTR, NS and CNAME. The ENUM Profile Table is used to configure the profile entry.

## Parameters

### **prn (mandatory)**

Profile name. This parameter specifies the unique logical name assigned to the profile entry used to generate the ENUM response.

#### **Range:**

*ZZZZZZZZZZ*

A string of alphanumeric characters, beginning with a letter and up to 10 characters in length. Valid values are a..z, A..Z, 0..9.

## Example

```
dlt-enum-prof:prn=pr1
```

## Dependencies

The ENUM Profile Table should be accessible.

The profile name must be present in the ENUM Profile Table.

The profile name cannot be referenced in either the ENUM Profile Selection Table or the ENUM DN Block Table.

The default profile cannot be deleted.

## Notes

None.

## Output

```
> dlt-enum-prof:prn=pr1
  tekelecstp 18-05-29 04:35:20 MST  EST EAGLE 46.1.0
  dlt-enum-prof:prn=pr1
  Command entered at terminal #19.
;

Command Accepted - Processing
  tekelecstp 18-05-29 04:35:20 MST  EST EAGLE 46.1.0
  DLT-ENUM-PROF: MASP B - COMPLTD
;
```

## Related Topics

- [chg-enum-prof](#)
- [ent-enum-prof](#)
- [rtrv-enum-prof](#)

# dlt-enum-profsel

Use this command to delete an entry from the ENUM Profile Selection Table or the ENUM DN Block Table. The ENUM Profile Selection Table supports the provisioning information related to the mapping of Entity Id to Profile Id. The ENUM DN Block Table supports the provisioning information related to the mapping of DN Block to Profile Id.

## Parameters

### **edn (optional)**

End Dialed Number

#### **Range:**

5-15 digits

### **entityid (optional)**

Network Entity

#### **Range:**

1-15 hex-digits (0-9, a-f)

### **sdn (optional)**

Start Dialed Number

#### **Range:**

5-15 digits

## Example

```
dlt-enum-profsel:entityid=12345
```

```
dlt-enum-profsel:sdn=11223344
```

```
dlt-enum-profsel:edn=1324566
```

## Dependencies

The ENUM Profile Selection Table should be accessible.

The ENUM DN Block Table should be accessible.

The ENUM Profile Table should be accessible.

At least one optional parameter must be specified.

The Entity Id, SDN or EDN must already exist in the ENUM Profile Selection Table and the ENUM DN Block Table respectively.

ENTITYID cannot be specified with SDN or EDN.

## Output

This example displays output when ENTITYID is specified:

```
dlt-enum-profsel:entityid=1234

tekelecstp 14-05-28 15:04:28 EST EAGLE 46.1.0
  dlt-enum-profsel:entityid=1234
  Command entered at terminal #4.
  DLT-ENUM-PROSEL: MASP A - COMPLTD
;
```

This example displays output when SDN is specified:

```
dlt-enum-profsel:sdn=1234567

tekelecstp 14-05-28 15:04:28 EST EAGLE 46.1.0
  dlt-enum-profsel:sdn=1234567
  Command entered at terminal #4.
  DLT-ENUM-PROFSEL: MASP A - COMPLTD
;
```

This example displays output when EDN is specified:

```
dlt-enum-profsel:edn=11223344

tekelecstp 14-05-28 15:04:28 EST EAGLE 46.1.0
  dlt-enum-profsel:edn=11223344
  Command entered at terminal #4.
  DLT-ENUM-PROFSEL: MASP A - COMPLTD
;
```

## Related Topics

- [chg-enum-profsel](#)
- [ent-enum-profsel](#)

- [rtrv-enum-profsel](#)

## dlt-frm-pwr

Use this command to delete the existing power threshold entry from the Frame Power Threshold table for the specified frame. After the power threshold value is deleted, the default power threshold value of 30 Amps is assumed for the specified frame.

### Parameters

#### **frm (mandatory)**

Frame ID

#### **Range:**

##### **cf00**

Control frame

##### **ef00**

First extension frame

##### **ef01**

Second extension frame

##### **ef02**

Third extension frame

##### **ef03**

Fourth extension frame

##### **ef04**

Fifth extension frame

### Example

Delete the frame power threshold value for the third extension frame.

```
dlt-frm-pwr:frm=ef02
```

```
<Table> = FRAME POWER THRESHOLD
```

```
<Cmd Keyword> = DLT-FRM-PWR
```

### Dependencies

The following values are valid for the `frm` parameter: `cf00`, `ef00`, `ef01`, `ef02`, `ef03`, `ef04`.

A power threshold value must already be provisioned for the specified frame.

The Frame Power Threshold table must be accessible.

### Output

```
dlt-frm-pwr:frm=ef02
```

```
tekelecstp 06-04-11 16:07:11 EST EAGLE 35.0.0
```



**loc (optional)**

The card location of the fixed disk containing the FTA.

**Range:**

1114, 1116  
(TDM)

**Default:**

The location of the active TDM

**Example**

```
dlt-fta:loc=1114:file="CAM.ELF"  
dlt-fta:loc=1114:file="CAM.ELF":force=yes  
dlt-fta:loc=1116:all=yes
```

**Dependencies**

Removing an individual file only frees up that file name for another transfer of that file.

The `all=yes` parameter must be specified when a specific filename is not supplied.

The `all=yes` parameter not only removes all files from the FTA, but frees up the space in the FTA.

When using DOS file names, if the file name contains a special character such as an underscore ( `_` ) or begins with a numeric, the file name must be in quotes ( " " ), for example, "92\_name.ext".

Removing an individual file only frees up that file name for another transfer of that file.

The `force=yes` parameter must be specified to remove the last file in the FTA.

The `loc` parameter must specify a TDM card.

A specific filename and `all=yes` cannot be specified at the same time.

Only one file transfer can be active at a time.

TDM and E5-TDM cards cannot be installed in the same system.

**Notes**

None

**Output**

```
dlt-fta:file=oam.elf:loc=1114  
  
rlghncxa03w 04-02-05 15:31:59 EST EAGLE 31.3.0  
File OAM.ELF deleted from File Transfer Area on fixed disk 1114.  
;
```

```
dlt-fta:all=yes:loc=116
```

```
rlghncxa03w 04-02-05 15:33:32 EST EAGLE 31.3.0  
All files deleted from File Transfer Area on fixed disk 1116.
```

```
;
```

### Related Topics

- [act-file-trns](#)
- [copy-fta](#)
- [disp-disk-dir](#)

## dlt-ftp-serv

Use this command to delete an entry for an FTP server from the FTP Server table.

### Parameters

#### **app (mandatory)**

Application. The FTP Client application at the EAGLE STP that interfaces with the FTP Server.

#### **Range:**

##### ***meas***

Measurements Platform application

##### ***user***

FTP-based Table Retrieve Application (FTRA)

##### ***db***

Database Backup\Restore application

##### ***dist***

EAGLE Software Release distribution application

##### ***sflog***

SS7 Firewall Logging application

#### **ipaddr (mandatory)**

IP Address of the FTP Server.

#### **Range:**

4 numbers separated by dots, with each number in the range of 0-255.

### Example

```
dlt-ftp-serv:app=meas:ipaddr=1.255.0.102
```

```
dlt-ftp-serv:app=sflog:ipaddr=10.248.13.9
```

## Dependencies

Both the `app` and `ipaddr` parameters must be entered in the command to delete an FTP server.

An entry must already exist in the FTP Server table for this application at the specified IP address.

The `app` parameter must specify an application that uses the FTP Support feature.

The `ipaddr` parameter must specify a valid IP address for the FTP server.

## Notes

None

## Output

```
dlt-ftp-serv:app=meas:ipaddr=1.255.0.102
```

```
rlghncxa03w 04-02-20 09:07:58 EST EAGLE 31.3.0
FTP SERV table is (1 of 10) 10% full
DLT-FTP-SERV: MASP A - COMPLTD
```

;

```
dlt-ftp-serv:app=user:ipaddr=1.255.0.102
```

```
rlghncxa03w 04-02-20 09:07:58 EST EAGLE 31.3.0
FTP SERV table is (0 of 10) 0% full
DLT-FTP-SERV: MASP A - COMPLTD
```

;

```
dlt-ftp-serv:app=sflog:ipaddr=10.248.13.9
```

```
tekelecstp 15-05-27 15:50:06 EST Eagle 46.3.0
dlt-ftp-serv:app=sflog:ipaddr=10.248.13.9
Command entered at terminal #4.
FTP SERV table is (0 of 10) 0% full
DLT-FTP-SERV: MASP A - COMPLTD
```

;

## Related Topics

- [chg-ftp-serv](#)
- [ent-ftp-serv](#)
- [rtrv-ftp-serv](#)

# dlt-gserv-data

Use this command to delete translation type, originating point code, or global title address data from the GSERV table. These values are used to determine whether a Send



Routing Information (SRI) request should receive G-Port SRI Query for Prepaid Service or normal G-Port SRI service.

## Parameters



### Note:

See [Point Code Formats and Conversion](#) for a detailed description of point code formats, rules for specification, and examples.

### gta (optional)

Global title address. This parameter specifies a CgPA global title address.

#### Range:

1 - 21

### opc (optional)

ANSI originating point code with subfields *network indicator-network cluster-network cluster member (ni-nc-ncm)*.

#### Synonym:

*opca*

#### Range:

*p-*, 000-255

Specify a valid value for each subfield of the point code, and separate the subfields with a dash (-).

*prefix—p-*

When *chg-sid:pctype=ansi* is specified, *ni = 000* is not valid.

When *chg-sid:pctype=ansi* is specified, *nc = 000* is not valid if *ni = 001-005*.

When *chg-sid:pctype=ansi* is specified, *nc = 000* is valid if *ni = 006-255*.

The point code *000-000-000* is not a valid point code.

### opc/opca/opci/opcn/opcn24 (optional)

Originating point code. Use these parameters to specify message transfer part (MTP) originating point codes.

### opci (optional)

ITU international originating point code with subfields *zone-area-id*.

#### Range:

*s-*, *p-*, *ps-*, 0-255

Specify a valid value for each subfield of the point code, and separate the subfields with a dash (-).

*prefix—s-, p-, ps*

*zone—0-7*

*area—000-255*

*id—0-7*

The point code *0-000-0* is not a valid point code.

### opcn (optional)

ITU national originating point code in the format of a 5-digit number (*nnnnn*); or 2, 3, or 4 numbers (members) separated by dashes (*m1-m2-m3-m4*) as defined by the

`chg-stpopts:npcfmti` flexible point code option. A group code must be specified when the ITUDUPPC feature is turned on (*nnnnn-gc, m1-m2-m3-m4-gc*).

**Range:**

*s-, p-, ps-, 0-16383, aa-zz*

Specify a valid value for each subfield of the point code, and separate the subfields with a dash (-).

*prefix—s-, p-, ps*

*nnnnn—0-16383*

*gc—aa-zz*

*m1-m2-m3-m4—0-14* for each member; values must sum to 14

**opc24 (optional)**

24-bit ITU national originating point code with subfields *main signaling area-sub signaling area-signaling point (msa-ssa-sp)*.

**Range:**

*p-, 000-255*

Specify a valid value for each subfield of the point code, and separate the subfields with a dash (-).

*prefix—p*

*msa—000-255*

*ssa—000-255*

*sp—000-255*

**tt (optional)**

Translation type. This parameter specifies a called party (CdPA) translation type.

**Range: 0 - 255**

**Example**

```
dlt-gserv-data:tt=26
```

```
dlt-gserv-data:opc=1-1-1
```

```
dlt-gserv-data:gta=9194605500
```

**Dependencies**

The `tt`, `opc/opca/opci/opcn/opcn24`, or `gta` parameter must exist in the GSERV table before this command can be entered.

The system is busy, or the GSERV table is corrupted.

The G-Port SRI Query for Prepaid feature must be enabled before this command can be entered.

Only one of the `tt`, `opc`, and `gta` parameters can be specified in the command.

The G-Port feature must be enabled before this command can be entered.

**Output**

```
dlt-gserv-data:tt=26
```

```
mystp 06-07-20 09:04:21 EST EAGLE 35.2.0
```

```
DLT-GSERV-DATA: MASP A - CMLTD  
;
```

### Related Topics

- [ent-gserv-data](#)
- [rtrv-gserv-data](#)

## dlt-gsmmap-scrn

Use this command to delete the GSM Map Screening CgPA and CdPA entries that are used to filter out or allow SCCP messages containing Map Op-Codes, CGPA GTA+NPV+NAIV, CDPA GTA+NPV+NAIV, and forbidden parameters.

### Parameters

#### **cgsr (mandatory)**

CgPA Screening Reference.

##### **Range:**

*ayyy*

1 alphabetic character followed by up to 3 optional alphanumeric characters

#### **opname (mandatory)**

Operation code name. This value references the operation code OPCODE defined with the `ent-gsms-opcode` command.

##### **Range:**

*ayyyyyyy*

Up to 8 alphanumeric characters

#### **cdsr (optional)**

CdPA Screening Reference.

##### **Range:**

*ayyy*

1 alphabetic character followed by up to 3 optional alphanumeric characters

### Example

```
dlt-gsmmap-scrn:opname=xyz:cgsr=fela:cdsr=fall
```

```
dlt-gsmmap-scrn:opname=xyz:cgsr=fela
```

### Dependencies

The GSM Map Screening feature must be enabled before this command can be entered.

The Enhanced GSM Map Screening (EGMS) feature must be enabled before the `cdsr` parameter can be specified.

The specified `cgsr` parameter value must exist in the database.

The specified `cdsr` parameter value must exist in the database.

A `cgpa` entry cannot be deleted if it is referred to by `cdpa` entries.

The GSM MAP Op-Code table is corrupt or cannot be found.

The GSM MAP screening table is corrupt or cannot be found.

The specified `opname` parameter value must exist in the GSM Map Op-Code table.

The `opname` parameter must be an alphanumeric character.

The `cgsr` and `cdsr` parameters must begin with an alphabetic character.

The `cgsr` and `cdsr` parameters must each have 1-4 alphanumeric characters.

The `opname` and `cgsr` parameters must be entered.

The MAP table is corrupt or cannot be found.

### Notes

Unlike GTT (Global Title Translation) entries, the GSM MAP screening commands do not support splits of ranges during deletion or changes of entries.

### Output

```
dlt-gsmmap-scrn:opname=xyz:cgsr=fela:cdsr=fall
```

```
rlghncxa03w 04-02-29 08:51:12 EST EAGLE 31.4.0
GSM Map Screening table is (1 of 4000) 1% full
DLT-GSM MAP-SCRN: MASP A - COMPLTD
;
```

### Related Topics

- [chg-gsmmap-scrn](#)
- [ent-gsmmap-scrn](#)
- [rtv-gsmmap-scrn](#)

## dlt-gsms-opcode

Use this command to delete GSM (Global System for Mobile Telecommunication) MAP (Mobile Application Part) screening operation codes and the default screening action for that operation code.

### Parameters

#### **opname (mandatory)**

Operation code name.

#### **Range:**

ayyyyyyy

Up to 8 alphanumeric characters

### Example

```
dlt-gsms-opcode:opname=ati
```

### Dependencies

The reserved word *none* cannot be specified as a value for the `opname` parameter.

The value specified for the `opname` parameter must exist in the GSM MAP Op-Code table.

The GSM MAP Op-Code table must be accessible.

The `opname` value being deleted cannot be referenced in the GSM MAP Screening table.

The GSM Map Screening feature must be enabled before this command can be entered.

The `opname` parameter must consist of alphanumeric characters.

The `opname` parameter must be no more than 8 characters long.

The MAP table must be accessible.

### Notes

None

### Output

```
dlt-gsms-opcode:opname=ati
```

```
rlghncxa03w 06-02-29 08:50:12 EST EAGLE 35.0.0
DLT-GSMS-OPCODE: MASP A - COMPLTD
;
```

### Related Topics

- [chg-gsms-opcode](#)
- [ent-gsms-opcode](#)
- [rtrv-gsms-opcode](#)

## dlt-gsmssn-scrn

Use this command to delete an SSN (subsystem number) from the GSM (Global System for Mobile Telecommunication) SSN screening table.

### Parameters

#### **ssn (mandatory)**

Subsystem number.

**Range:** 000 - 255

#### **type (mandatory)**

Subsystem type.

**Range:*****orig***

The origination SSN

***dest***

The destination SSN

**Example**

This example deletes a destination subsystem of 255 from the GSM SSN screening table:

```
dlt-gsmssn-scrn:ssn=255:type=dest
```

**Dependencies**

The GSM Map Screening feature must be enabled before this command can be entered.

The GSM SSN screening table is corrupt or cannot be found.

A value for the `ssn/type` parameter combination must be specified that exists in the GSM SSN screening table.

A valid value must be specified for the `ssn` parameter.

A valid value must be specified for the `type` parameter.

**Notes**

None

**Output**

```
dlt-gsmssn-scrn:ssn=255:type=dest
```

```
rlghncxa03w 04-02-20 09:04:21 EST EAGLE 31.3.0  
DLT-GSMSSN-SCRN: MASP A - COMPLTD
```

```
;
```

**Related Topics**

- [ent-gsmssn-scrn](#)
- [rtv-gsmssn-scrn](#)

## dlt-gta

Use this command to delete the GTA (global title address) information applicable to a global title selector combination.

This command deletes the routing of SCCP messages for specified global title addresses from designated destinations and their subsystem numbers.

 **Note:**

If the EGTT feature is turned on, then the GTT Selector (`ent/chg/dlt/rtrvgttssel`), GTT Set (`ent/dlt/rtrv-gttset`), and GTA (`ent/chg/dlt/rtrvgta`) commands replace the Translation Type (`ent/dlt/rtrv-tt`) and Global Title Translation (`ent/chg/dlt/rtrv-gtt`) commands. It is not recommended to run `ent/dlt/rtrv-tt & ent/chg/dlt/rtrv-gtt` commands as it may cause the advance GTA fields of GTT entry to be reset to the default values.

**Parameters****gttsn (mandatory)**

GTT set name. A GTT set is an entity to which global title addresses and selectors are assigned.

**Range:**

ayyyyyyy

1 leading alphabetic and up to 8 following alphanumeric characters.

**acn (optional)**

Application context name. The ITU TCAP ACN field in the incoming MSU.

**Range:**

0 - 255, \*, none

This parameter supports up to 7 subfields separated by a dash (e.g., 1-202-33-104-54-26-007).

\* —any valid value in the ITU TCAP ACN field in the incoming MSU

none —there is no value in the ITU TCAP ACN field in the incoming MSU

**cdssn (optional)**

Starting CdPA subsystem number.

**Range:**

0 - 255

**cgpc (optional)**

ANSI CgPA point code with subfields *network indicator-network cluster-network cluster member* (*ni-nc-ncm*).

**Synonym:**

cgpa

**Range:**

0-255, \*

Specify a valid value for each subfield of the point code, and separate the subfields with a dash (-).

The asterisk (\*) value is not valid for the *ni* subfield.

When `chg-sid:pctype=ansi` is specified, *ni=000* is not valid.

When `chg-sid:pctype=ansi` is specified, *nc = 000* is not valid if *ni=001–005*.

When `chg-sid:pctype=ansi` is specified, *nc=000* is valid if *ni=006–255*.

When `chg-sid:pctype=ansi` is specified, *ni-\*.\** is valid if *ni =006–255*.

The point code *000-000-000* is not a valid point code.

**cgpci (optional)**

ITU international CgPA point code with subfields *zone-area-id*. The *prefix* subfield indicates a spare point code (*prefix-zone-area-id*).

**Range:**

*s*-, 0-255

Specify a valid value for each subfield of the point code, and separate the subfields with a dash (-).

*prefix*—*s*

*zone*—0-7

*area*—000-255

*id*—0-7

The point code 0-000-0 is not a valid point code.

**cgpcn (optional)**

ITU national CgPA point code in the format of a 5-digit number (*nnnnn*); or 2, 3, or 4 numbers (members) separated by dashes (*m1-m2-m3-m4*) as defined by the `chg-stpopts:npcfmti` flexible point code option. A group code must be specified when the ITUDUPPC feature is turned on (*nnnnn-gc*, *m1-m2-m3-m4-gc*). The *prefix* subfield indicates a spare point code (*prefix-nnnnn*, *prefix-nnnnn-gc*, *prefix-m1-m2-m3-m4*, *prefix-m1-m2-m3-m4-gc*).

**Range:**

*s*-, 0-16383, *aa-zz*

Specify a valid value for each subfield of the point code, and separate the subfields with a dash (-).

*prefix*—*s*-

*nnnnn*—0-16383

*gc*—*aa-zz*

*m1-m2-m3-m4*—0-14 for each member; values must sum to 14

**cgpcn24 (optional)**

24-bit ITU national CgPA point code with subfields *main signaling area-sub signaling area-signaling point* (*msa-ssa-sp*).

**Range:**

000-255

Specify a valid value for each subfield of the point code, and separate the subfields with a dash (-).

*msa*—000-255

*ssa*—000-255

*sp*—000-255

**cgpcn16 (optional)**

16-bit ITU national CgPA point code with subfields *unit number-sub number area-main number area* (*un-sna-mna*).

**Range:**

000-127

Specify a valid value for each subfield of the point code, and separate the subfields with a dash (-).

*un---*000---127



*sna---000---15*

*mna---000---31*

**cgssn (optional)**

Starting CgPA subsystem number.

**Range:**

*0 - 255*

**dpc (optional)**

ANSI destination point code with subfields *network indicator-network cluster-network cluster member (ni-nc-ncm)*.

**Synonym:**

*dpca*

**Range:**

*0-255, \**

Specify a valid value for each subfield of the point code, and separate the subfields with a dash (-).

The asterisk (\*) value is not valid for the *ni* subfield.

When *chg-sid:pctype=ansi* is specified, *ni=000* is not valid.

When *chg-sid:pctype=ansi* is specified, *nc = 000* is not valid if *ni=001-005*.

When *chg-sid:pctype=ansi* is specified, *nc=000* is valid if *ni=006-255*.

When *chg-sid:pctype=ansi* is specified, *ni-\*\*-\** is valid if *ni =006-255*.

The point code *000-000-000* is not a valid point code.

**dpc/dpca/dpci/dpcn/dpcn24/dpcn16 (optional)**

Point Code.

**dpci (optional)**

ITU international destination point code with subfields *zone-area-id*. The *prefix* subfield indicates a spare point code (*prefix-zone-area-id*).

**Range:**

*s-, 0-255*

Specify a valid value for each subfield of the point code, and separate the subfields with a dash (-).

*prefix—s*

*zone—0-7*

*area—000-255*

*id—0-7*

The point code *0-000-0* is not a valid point code.

**dpcn (optional)**

ITU destination point code in the format of a 5-digit number (*nnnnn*); or 2, 3, or 4 numbers (members) separated by dashes (*m1-m2-m3-m4*) as defined by the *chg-stpopts:npcfmti* flexible point code option. A group code must be specified when the ITUDUPPC feature is turned on (*nnnnn-gc*, *m1-m2-m3-m4-gc*). The *prefix* subfield indicates a spare point code (*prefix-nnnnn*, *prefix-nnnnn-gc*, *prefix-m1-m2-m3-m4*, *prefix-m1-m2-m3-m4-gc*).

**Range:***s-*, 0-16383, *aa-zz*

Specify a valid value for each subfield of the point code, and separate the subfields with a dash (-).

*prefix—s-**nnnnn—0-16383**gc—aa-zz**m1-m2-m3-m4—0-14* for each member; values must sum to 14**dpcn24 (optional)**24-bit ITU national destination point code with subfields *main signaling area-sub signaling area-signaling point (msa-ssa-sp)*.**Range:**

000-255

Specify a valid value for each subfield of the point code, and separate the subfields with a dash (-).

*msa—000–255**ssa—000–255**sp—000–255***dpcn16 (optional)**16-bit ITU national destination point code with subfields *unit number-sub number area-main number area (un-sna-mna)*.**Range:**

000-127

Specify a valid value for each subfield of the point code, and separate the subfields with a dash (-).

*un---000---127**sna---000---15**mna---000---31***eaddr (optional)**

End Address (Similar to EGTA). This parameter specifies the end of a range of MAP digits (IMEI/IMSI/MSISDN/VLRNB/SMRPOA/SMRPDA).

**Range:**

1 - 21 digits

If the Hex Digit Support for GTT feature is not enabled, the range is 1 - 21 decimal digits; valid digits are 0-9

If the Hex Digit Support for GTT feature is enabled and on, the range is 1 - 21 hexadecimal digits; valid digits are 0-9, a-f, A-F

**Default:**

Same as the specified SADDR value.

**ecdssn (optional)**

Ending CdPA subsystem number.

**Range:**

0 - 255

**ecgssn (optional)**

Ending CgPA subsystem number.

**Range:**

0 - 255

**egta (optional)**

End global title address. This parameter specifies the end of a range of global title digits.

**Range:**

1 - 21 digits

If the Hex Digit Support for GTT feature is not enabled and on, the range is 1 - 21 decimal digits; valid digits are 0-9

If the Hex Digit Support for GTT feature is enabled and on, the range is 1 - 21 hexadecimal digits; valid digits are 0-9, a-f, A-F

**Default:**

Same as the specified gta value

**family (optional)**

This parameter specifies the ANSI TCAP *family* field in the incoming MSU.

**Range:**

0 - 255, \*, none

\*—any valid value in the ANSI TCAP *family* field in the incoming MSU

none—there is no value in the ANSI TCAP *family* field in the incoming MSU

**gta (optional)**

Global title address. The beginning of a range of global title digits.

**Range:**

1 - 21 digits

If the Hex Digit Support for GTT feature is not enabled and on, the range is 1 - 21 decimal digits; valid digits are 0-9 .

If the Hex Digit Support for GTT feature is enabled and on, the range is 1 - 21 hexadecimal digits; valid digits are 0-9, a-f, A-F.

**opc (optional)**

ANSI originating point code with subfields *network indicator-network cluster-network cluster member (ni-nc-ncm)*.

**Synonym:**

*opca*

**Range:**

0-255, \*

Specify a valid value for each subfield of the point code, and separate the subfields with a dash (-).

The asterisk (\*) value is not valid for the *ni* subfield.

When *chg-sid:pctype=ansi* is specified, *ni=000* is not valid.

When *chg-sid:pctype=ansi* is specified, *nc = 000* is not valid if *ni=001–005*.

When *chg-sid:pctype=ansi* is specified, *nc=000* is valid if *ni=006–255*.

When *chg-sid:pctype=ansi* is specified, *ni-\*\*-\** is valid if *ni =006–255*.

The point code *000-000-000* is not a valid point code.

**opci (optional)**

ITU international originating point code with subfields *zone-area-id*. The *prefix* subfield indicates a spare point code (*prefix-zone-area-id*).

**Range:**

*s*-, 0-255

Specify a valid value for each subfield of the point code, and separate the subfields with a dash (-).

*prefix*—*s*

*zone*—0-7

*area*—000-255

*id*—0-7

The point code 0-000-0 is not a valid point code.

**opcN (optional)**

ITU national originating point code in the format of a 5-digit number (*nnnnn*); or 2, 3, or 4 numbers (members) separated by dashes (*m1-m2-m3-m4*) as defined by the `chg-stpopts:npcfmti` flexible point code option. A group code must be specified when the ITUDUPPC feature is turned on (*nnnnn-gc*, *m1-m2-m3-m4-gc*). The *prefix* subfield indicates a spare point code (*prefix-nnnnn*, *prefix-nnnnn-gc*, *prefix-m1-m2-m3-m4*, *prefix-m1-m2-m3-m4-gc*).

**Range:**

*s*-, 0-16383, *aa-zz*

Specify a valid value for each subfield of the point code, and separate the subfields with a dash (-).

*prefix*—*s*-

*nnnnn*—0-16383

*gc*—*aa-zz*

*m1-m2-m3-m4*—0-14 for each member; values must sum to 14

**opcN24 (optional)**

24-bit ITU national originating point code with subfields *main signaling area-sub signaling area-signaling point* (*msa-ssa-sp*).

**Range:**

000-255

Specify a valid value for each subfield of the point code, and separate the subfields with a dash (-).

*msa*—000-255

*ssa*—000-255

*sp*—000-255

**opcN16 (optional)**

16-bit ITU national originating point code with subfields *unit number-sub number area-main number area* (*un-sna-mna*).

**Range:**

000-127

Specify a valid value for each subfield of the point code, and separate the subfields with a dash (-).

*un*---000---127

*sna---000---15*

*mna---000---31*

**opcode (optional)**

This parameter specifies the TCAP *OPCODE* field in the incoming MSU.

**Range:**

*0 - 255, \*, none*

\*—any valid value in the TCAP *opcode* field in the incoming MSU

*none*—there is no value in the TCAP *opcode* field in the incoming MSU

**pkgtype (optional)**

Package type. The ANSI TCAP and ITU TCAP package type.

**Range:**

***ansiuni***

ANSI unidirectional

***qwp***

Query with Permission

***qwop***

Query without Permission

***cwp***

Conversation with Permission

***cwop***

Conversation without Permission

***any***

Wildcard value

***bgn***

Begin

***cnt***

Continue

***ansiabort***

ANSI abort

***end***

End

***ituabort***

ITU abort

***ituuni***

ITU unidirectional

***resp***

Response

**ANSI TCAP PKGTYPE—***ansiuni, qwp, qwop, resp, cwp, cwop, ansiabort, any***ITU TCAP PKGTYPE—***bgn, ituabort, ituuni, any, end, cnt***saddr (optional)**

Start Address (Similar to GTA). This parameter specifies the beginning of a range of MAP digits (IMEI/MSIS/MSISDN/VLRNB/SMRPOA/SMRPDA).

**Range:***1 - 21 digits*

If the Hex Digit Support for GTT feature is not enabled, the range is 1 - 21 decimal digits; valid digits are 0-9

If the Hex Digit Support for GTT feature is enabled and on, the range is 1 - 21 hexadecimal digits; valid digits are 0-9, a-f, A-F

**Example**

```
dlt-
gta:gttsn=setcdgta:gta=123456789012345678901:egta=223456789012345678
901
```

```
dlt-gta:gttsn=t800:gta=919461:egta=919468
```

```
dlt-
gta:gttsn=setcggta:gta=323456789012345678901:egta=423456789012345678
901
```

```
dlt-gta:gttsn=setcgpc:cgpca=001-001-001
```

```
dlt-gta:gttsn=setopc:opca=002-001-001
```

```
dlt-gta:gttsn=setcgssn:cgssn=100:ecgssn=200
```

The following example specifies hexadecimal digits for the GTA and EGTA.

```
dlt-gta:gttsn=setl:gta=abcd:egta=abce
```

The following examples specify the GTA translations when the FLOBR feature is on.

```
dlt-gta:gttsn=setcdssn:cdssn=100:ecdssn=150
```

```
dlt-gta:gttsn=setdpc:dpci=1-101-1
```

```
dlt-gta:gttsn=gttl:cgpcn16=45-1-0
```

```
dlt-gta:gttsn=setimsi:saddr=3234567890:eaddr=4234567890
```

**Dependencies**

The `gttsn` parameter must be specified, cannot have a value of *none*, and must match an existing `gttsn`.

The length of the specified `gta/saddr` parameter must match the number of digits provisioned for the specified GTT set when the VGTT feature is turned off. If the VGTT feature is turned on, then up to 10 GTA/SADDR lengths can exist per GTT set. If the Support for 16 GTT Lengths in VGTT feature is turned on, then up to 16 GTA/SADDR lengths can exist per GTT set.

The specified `gta/egta` or `saddr/eaddr` range must exist for the specified GTT set in the STP active database. While an exact match is not required, you cannot specify an overlap

with another range. If the range overlaps, an error is generated that displays a list of overlapped global title addresses. An example follows that shows what happens when the user attempts to enter a global title address range (such as 8005550000 to 8005559999) that overlaps an existing range. The overlapping links must match. If they do not, the error message displays the list of overlapped global title addresses:

```
The following GTA ranges overlap the input GTA range START GTA END GTA
8005550000 8005551999 8005552000 8005553999 8005554000 8005555999 DLT-
GTA: MASP A - Command Aborted
```

If the `egta/eaddr` parameter is specified, the `gta/saddr` and `egta/eaddr` value must be the same length and the `egta/eaddr` value must be greater than the `gta/saddr` value.

The GTT table cannot be full in case a delete command causes a split requiring more entries to be added.

The `cgpc/cgpca/cgpci/cgpcn/cgpcn24/cgpcn16`, `opc/opca/opci/opcn/opcn24/opcn16`, `cgssn`, `gta`, `cdssn`, `opcode/acn/pkgtype`, `opcode/family/pkgtype`, `dpc/dpca/dpci/dpcn/dpcn24/dpcn16` or `saddr` parameter must be specified.

The `cgpc/cgpca/cgpci/cgpcn/cgpcn24/cgpcn16`, `opc/opca/opci/opcn/opcn24/opcn16` and `dpc/dpca/dpci/dpcn/dpcn24/dpcn16` parameters must have a valid value within the range for each subfield.

If specified, the `ecgssn/ecdssn` parameter must be greater than the `cgssn/cdssn` parameter.

The Origin-based SCCP Routing feature must be enabled when specifying the `cgpc/cgpca/cgpci/cgpcn/cgpcn24/cgpcn16`, `opc/opca/opci/opcn/opcn24/opcn16`, or (e) `cgssn` parameters.

The `gta` parameter must be specified if the GTTSN set type has a value of `cdgta` or `cggta`, and cannot be specified for other set types.

The `cgpc/cgpca/cgpci/cgpcn/cgpcn24/cgpcn16` parameter must be specified if the GTTSN set type has a value of `cgpc`, and cannot be specified for other set types.

The `opc/opca/opci/opcn/opcn24/opcn16` parameter must be specified if the GTTSN set type has a value of `opc`, and cannot be specified for other set types.

The `cgssn` parameter must be specified if the GTTSN set type has a value of `cgssn`, and cannot be specified for other set types.

If the specified GTT Set is an ANSI set, then the `cgpc/cgpca`, `opc/opca`, and `dpc/dpca` parameters must be valid ANSI point codes. If the specified GTT Set is an ITU set, then the `cgpci/cgpcn/cgpcn24/cgpcn16`, `opci/opcn/opcn24/opcn16`, and `dpci/dpcn/dpcn24/dpcn16` parameters must be valid ITU point codes.

The range specified by the `cgssn/ecgssn` and `cdssn/ecdssn` parameters must exist for the specified GTT set.

The translation entry associated with the specified point code (`dpc/dpca/dpci/dpcn/dpcn24/dpcn16`, `pc/pca/pci/pcn/pcn24/pcn16`, or `opc/opca/opci/opcn/opcn24/opcn16` or `opcode` value must already exist.

The range specified by the `cgssn/ecgssn` and `cdssn/ecdssn` parameters cannot overlap an existing range for the specified GTT set.

The `cgpc`, `cgssn`, `gta`, `opc`, `cdssn`, `opcode` and `saddr` parameters cannot be specified together in the command.

If the `cgssn` and `cdssn` parameters are both specified in the same command (in any order), then only the value for the last of the two parameters specified is used during processing.

The Hex Digit Support for GTT feature must be enabled and on before hexadecimal digits can be specified for the `gta/saddr` or `egta/eaddr` parameters.

If the specified GTT set has a set type of `opcode` (see the `ent-gttset` command), then the `opcode/acn/pkgtype` or `opcode/family/pkgtype` parameters must be specified. These parameters cannot be specified for GTT sets with other set types.

If the specified GTT set has a set type of `cdssn` (see the `ent-gttset` command), then the `cdssn` parameter must be specified. The `cdssn` parameter cannot be specified for GTT sets with other set types.

The value specified for the `gttsn` parameter must match the name of an existing GTT Set.

A TOBR quantity feature must be turned on before the `opcode`, `pkgtype`, `acn`, `family`, `saddr`, `eaddr` or `defmapvr` parameter can be specified.

The `opcode`, `pkgtype`, and `family` parameters must be specified together for ANSI TCAP translations. The `opcode`, `pkgtype`, and `acn` parameters must be specified together for ITU TCAP translations.

If the `cgssn` parameter is specified, then the `ecdssn` parameter cannot be specified. If the `cdssn` parameter is specified, then the `ecgssn` parameter cannot be specified.

If the `family` parameter is specified, then the `pkgtype` parameter must have a value of *ansiuni*, *qwp*, *qwop*, *resp*, *cwp*, *cwop*, *ansiabort*, or *any*.

If the `acn` parameter is specified, then the `pkgtype` parameter must have a value of *bgn*, *ituabort*, *ituuni*, *any*, *end*, or *cnt*.

If the `pkgtype=ituabort` parameter is specified, then a value of *none* must be specified for the `acn` and `opcode` parameters.

If the `pkgtype=ansiabort` parameter is specified, then a value of *none* must be specified for the `family` and `opcode` parameters.

The GTT Action Set table is corrupt or cannot be found.

If the GTT set specified by the `gttsn` parameter has a set type of `dpc` (see the `ent-gttset` command), then the `dpc/dpca/dpci/dpcn/dpcn24/dpcn16` parameter must be specified. If the set type has a value other than `dpc`, then the `dpc/dpca/dpci/dpcn/dpcn24/dpcn16` parameter cannot be specified.

The FLOBR feature must be turned on before the `cdssn`, `ecdssn`, or `dpc` parameter can be specified.

If the translation entry is referenced in GTT Action Path table, then the entry cannot be deleted.

The specified GTT set must have a set type of `opcode` (see the `ent-gttset` command) before the `opcode/acn/pkgtype` or `opcode/family/pkgtype` parameters can be



specified. The specified GTT set must have a set type of `cdssn`, `cgssn`, `cdgta`/`cgta`, `opc`, or `cgpc` before the `cdssn`, `cgssn`, `gta`, `opc`, or `cgpc` parameter, respectively, can be specified.

The `acn` and `family` parameters cannot be specified together in the command.

If the `opc` or `dpc` parameter is specified, then the `(e)gta`, `(e)cgssn`, `(e)cdssn`, and `opcode` parameters cannot be specified.

SADDR parameter must be specified if GTT set specified by `gttsn` parameter is of MBR type (IMEI/IMSI/MSISDN/VLRNB/SMRPOA/SMRPDA).

If the `saddr` parameter is specified, then the `ecgssn`/`ecdssn` parameters cannot be specified.

### Notes

If a GTT is being deleted or changed and the point code (DPC or RTE) is not found in the route table (unless the point code is the STP's true point code), the following message is displayed in the terminal scroll area:

```
NOTICE: No DPC and/or RTE found for GTT being deleted or changed.
```

The above situation may occur for the following reasons:

A database was upgraded from a release prior to EAGLE Release 27.1 or IP7 Secure Gateway Release 3.0 when GTT entries were not linked to the route table and the deletion of the DPC was permitted. The GTT referenced a DPC/RTE that was deleted, and the enforce reference counts between the GTT and route tables were not updated.

- A serious problem occurred in which the reference count rules were not enforced and a DPC and/or RTE were deleted while being referenced by a GTT entry. This indicates a software error; notify the Customer Care Center.

The error message E2478 was deleted in release 41.0 for PR 137896.

The error message E5099 was deleted in release 42.0 for PR 137290.

### Output

The following example specifies GTA translations when the FLOBR feature is on.

```
dlt-gta:gttsn=setcdssn:cdssn=100
```

```
rlghncxa03w 10-03-10 09:04:21 EST EAGLE 42.0.0
DLT-GTA: MASP A - CMLPTD
;
```

### Related Topics

- [chg-gta](#)
- [ent-gta](#)
- [rtrv-gta](#)

## dlt-gtcnv

Use this command to delete entries from the Default Global Title Conversion table. The particular entry to be deleted is identified by the direction in conjunction with the TTA or TTI, or with the TTI, NP, and NAI.

### Parameters

#### **dir (mandatory)**

Direction of conversion.

##### **Range:**

###### ***atoi***

ANSI to ITU conversion

###### ***itoa***

ITU to ANSI conversion

###### ***both***

Conversion in both directions

#### **nai (optional)**

Nature of Address Indicator. This parameter is mandatory when `gtixlat=24` is specified, and cannot be specified when `gtixlat=22` is specified.

##### **Range:**

0 - 63, \*

##### **Default:**

No change to current value

#### **np (optional)**

Numbering Plan. This parameter is mandatory when `gtixlat=24` is specified, and cannot be specified when `gtixlat=22` is specified.

##### **Range:**

0 - 15, \*

##### **Default:**

No change to current value

#### **tta (optional)**

ANSI translation type. This parameter is mandatory when `dir=atoi` or `dir=both` is specified.

##### **Range:**

0 - 255, \*

##### **Default:**

No change to current value

#### **tti (optional)**

ITU translation type. This parameter is required when `dir=atoi` is specified.

**Range:**

0 - 255, \*

**Default:**

No change to current value

**Example**

The following example deletes an ANSI-to-ITU entry using the TTA of 10 to identify the entry.

```
dlt-gtcnv:dir=atoi:tta=10
```

The following example deletes an ANSI-to-ITU entry using the TTA of 11 to identify the entry.

```
dlt-gtcnv:dir=atoi:tta=11
```

The following example deletes a ITU-to-ANSI entry using the TTI of 7, NAI of 8, and NP of 6 to identify the entry.

```
dlt-gtcnv:dir=ittoa:tti=7:nai=8:np=6
```

The following example deletes a BOTH (ANSI <-> ITU) entry using the TTI of 9 and TTA of 12 to identify the entry.

```
dlt-gtcnv:dir=both:tta=12:tti=9
```

The following example deletes a BOTH (ANSI <-> ITU) entry using the TTI of 7, NAI of 6, NP of 4, and TTA of 12 to identify the entry.

```
dlt-gtcnv:dir=both:tta=12:tti=7:np=4:nai=6
```

The following example deletes an ANSI-to-ITU default entry using the TTA of \* to identify the entry.

```
dlt-gtcnv:dir=atoi:tta=*
```

The following example deletes an ITU-to-ANSI default entry using the TTI and NAI of \* and NP of \* to identify the entry.

```
dlt-gtcnv:dir=ittoa:tti=*:nai=*:np=*
```

**Dependencies**

The ANSI/ITU SCCP Conversion feature must be enabled before this command can be entered.

The specified `dir`, `tta`, `tti`, `np`, and `nai` parameter combination must already exist in the database.

If the `dir=atoi` parameter is specified, then the `tta` parameter must be specified.

If the `dir=atoi` parameter is specified, then the `tti`, `nai`, and `np` parameters cannot be specified.

If the `dir=ittoa` parameter is specified, then the `tti` parameter must be specified.

If the `dir=ittoa` parameter is specified, then a wildcard value (\*) must be specified for the `tti`, `np`, and `nai` parameters.

If the `dir=both` parameter is specified, then the `tta` and `tti` parameters must be specified.

If the `dir=both` parameter is specified, then a wildcard value (\*) cannot be specified for any of the other parameters.

If specified, the `nai` and `np` parameters must be specified together in the command.

If the `dir=ittoa` and `gtixlat=22` parameters are specified, then wildcard values (\*) cannot be specified. The `dir=ittoa` and `gtixlat=24` parameters must be specified before wildcard values can be specified.

If the `dir=ittoa` parameter is specified, then the `tta` parameter cannot be specified.

### Notes

To delete an ANSI-to-ITU entry, specify the direction (`dir`) and TTA.

To delete an ITU-to-ANSI entry when `gtixlat=22`, specify the direction and TTI.

To delete an ITU-to-ANSI entry when `gtixlat=24`, specify the direction, TTI, NAI, and NP.

To delete a BOTH (ANSI <-> ITU) entry when `gtixlat=22`, specify the direction, TTA and TTI.

To delete a BOTH (ANSI <-> ITU) entry when `gtixlat=24`, specify the direction, TTA, TTI, NP and NAI.

### Output

```
dlt-gtcnv:dir=both:tta=12:tti=9
```

```

    rlgncxa03w 03-03-18 08:50:12 EST  EAGLE 31.3.0
    DLT-GTCNV: MASP A - COMPLTD
;

```

### Related Topics

- [chg-gtcnv](#)
- [ent-gtcnv](#)
- [rtrv-gtcnv](#)

## dlt-gtmod

Use this command to delete an existing GT Modification (GTMOD) entry. The GTMOD entry consists of a GTMOD ID and GTMOD specific data.

### Parameters

#### **gtmodid (mandatory)**

GT Modification Identifier.

#### **Range:**

ayyyyyyy

1 alphabetic character followed by 8 alphanumeric characters

### Example

```
dlt-gtmod:gtmodid=set1
```

### Dependencies

The GTMOD table is corrupt or cannot be found.

If the GTMOD identifier is referenced in the GTT or GTT Action tables, then the identifier cannot be deleted.

The value specified for the `gtmodid` parameter must already exist in the GTMOD table.

The `gtmodid=none` parameter cannot be specified.

### Output

```
dlt-gtmodid:gtmodid=set1

tekelecstp 10-03-08 18:38:05 EST EAGLE 42.0.0

GTMOD table is (2 of 100000) 1% full

DLT-GTMOD: MASP A - COMPLTD

;
```

### Related Topics

- [chg-gtmod](#)
- [ent-gtmod](#)
- [rtrv-gtmod](#)

## dlt-gtt

Use this command to remove the routing of messages for specified global title addresses from designated destinations and their subsystem numbers.

#### Note:

If the EGTT feature is turned on, then the GTT Selector (`ent/chg/dlt/rtrvgttset`), GTT Set (`ent/dlt/rtrv-gttset`), and GTA (`ent/chg/dlt/rtrvgta`) commands replace the Translation Type (`ent/dlt/rtrv-tt`) and Global Title Translation (`ent/chg/dlt/rtrv-gtt`) commands. It is not recommended to run `ent/dlt/rtrv-tt & ent/chg/dlt/rtrv-gtt` commands as it may cause the advance GTA fields of GTT entry to be reset to the default values.

## Parameters

### **gta (mandatory)**

Global title start address. The beginning of a range of global title digits.

#### **Range:**

1-21 digits

If the Hex Digit Support for GTT feature is not enabled and on, the range is 1 - 21 decimal digits; valid digits are 0-9

If the Hex Digit Support for GTT feature is enabled and on, the range is 1 - 21 hexadecimal digits; valid digits are 0-9, a-f, A-F.

### **egta (optional)**

Global title end address. The end of a range of global title digits.

#### **Range:**

1-21 digits

If the Hex Digit Support for GTT feature is not enabled and on, the range is 1 - 21 decimal digits; valid digits are 0-9

If the Hex Digit Support for GTT feature is enabled and on, the range is 1 - 21 hexadecimal digits; valid digits are 0-9, a-f, A-F .

#### **Default:**

value of the `gta` parameter

### **ttn (optional)**

Translation type name.

#### **Range:**

ayyyyyyy

1 alphabetic character followed by up to 8 alphanumeric characters

#### **Default:**

No translation name is given

### **type/typeea/typeei/typen/typen24/typeis/typens (optional)**

Translation type. This parameter identifies the translation type and network type. This parameter is the decimal representation of the 1-byte field used in SS7.

The `type` and `typeea` parameters specify an ANSI network.

The `typei` parameter specifies an ITU-international network.

The `typen` parameter specifies an ITU-national network.

The `typen24` parameter specifies a 24-bit ITU-national network.

The `typeis` parameter specifies an ITU-international spare network.

The `typens` parameter specifies an ITU-national spare network.

A translation type numeric value may be entered as ANSI type (`type` or `typeea`) and as an ITU type (`typei/typen/typen24/typeis/typens`). However, they are separate entities.

The point code domain translation types for GTT are handled by the EAGLE protocol processing as either ANSI or ITU; therefore, ITU applies to ITU-I, ITU-I spare, ITU-N, ITU-N spare, and ITU-N24.

#### **Range:**

0 - 255

**Default:**

No translation type is specified

**Example**

```
dlt-gtt:type=252:ttn=lidb9:gta=408908:egta=408988
dlt-gtt:gta=919833:typen24=4
dlt-gtt:ttn=set1:gta=abcd123456789a:egta=abcE123456789F
dlt-gtt:gta=123456:typeis=5
dlt-gtt:gta=123456:typens=5
```

**Dependencies**

If translation type is specified, it must exist in the database.

If the `ttn` parameter is specified, the name must correspond to a translation type entry.

If both `ttn` and `type` are specified, `ttn` must correspond to the given translation type.

The `type` or `ttn` parameter must be specified.

The `gta` length must equal the number of digits specified by the translation type. If the VGTT (variable length GTT) feature is turned on, you can have up to 10 GTA lengths per translation type. When you enter the `ent-gtt` command to create entries, the software keeps track of the lengths and allows only ten different lengths. The global title address specified for the translation type must then have the same number of digits as an existing GTA.

The global title address range as expressed by the `gta` and `egta` parameters must already exist in the global title translation.

The range, as specified by the GTA and EGTA, must be exactly the same as a current entry or be contained within an existing range in the GTT data for the specified translation type. If the range overlaps, an error is generated that displays a list of overlapped global title addresses. An example follows that shows what happens when the user attempts to delete a global title address range (such as 8005550000 to 8005559999) that overlaps an existing range. The overlapping links must match. If they do not, the error message displays the list of overlapped global title addresses:

```
The following GTA ranges overlap the input GTA range START GTA END GTA
8005550000 8005551999 8005552000 8005553999 8005554000 8005555999 DLT-
GTT: MASP A - Command Aborted
```

If the address range as specified by the start and end global title addresses does not exactly match the existing range, the range is split. All addresses in the existing range that are outside of the specified range are used to create new ranges. The specified range is deleted.

The Hex Digit Support for GTT feature must be enabled and on before hexadecimal digits can be specified for the `gta` or `egta` parameters.

If the `egta` parameter is specified, the value must be greater than the value specified for the `gta` parameter.

The `tt` parameter cannot be specified with a value that has been defined as an alias for another translation type.

The length of the specified GTA must match the number of digits provisioned for the specified Translation Type or the Translation Type referenced by the specified Translation Type Name, unless the PVGTT or VGTT feature is on. In the case the PVGTT feature is on the length of the specified GTA and EGTA can be less than or equal to the number of digits provisioned for the corresponding TT. In the case the VGTT feature is on, up to 10 different lengths can be provisioned per TT.

The `gta` length is not defined for the specified translation type entity.

The GTT table cannot be full.

The MAP table is corrupt or cannot be found.

The GTT set associated with the translation type specified by the `ttn` parameter must have a set type of `cdgta` (see the `ent-gttset` command).

The network domain of the translation type specified by the `ttn` parameter cannot be CROSS (see the `ent-gttset` command).

The `ttn=none` parameter cannot be specified.

The `xlat=none` parameter cannot be specified.

If the translation entry is referenced in GTT Action Path table, then the entry cannot be deleted.

### Notes

If the OBSR or FLOBR feature is turned on, then this command can delete only translation entries that have been provisioned by GTA commands and that have a set type of CdGTA.

### Output

```
dlt-gtt:type=252:ttn=lidb9:gta=408908:egta=408988
```

```
rlghncxa03w 04-01-07 11:43:07 EST EAGLE 31.3.0
DLT-GTT: MASP A - COMPLTD
;
```

### Related Topics

- [chg-gtt](#)
- [ent-gtt](#)
- [rtv-gtt](#)

## dlt-gttact

Use this command to delete an existing Global Title Translations (GTT) Action entry.

### Parameters

#### **actid (mandatory)**

GTT Action ID. The Action ID associated with the GTT Action entry.



**Range:**

ayyyyyyy

1 leading alphabetic character and up to 8 following alphanumeric characters

**Example**

```
dlt-gttact:actid=disc1
```

**Dependencies**

The specified Action ID must already exist in the database.

The GTT Action table is corrupt or cannot be found.

The Action ID specified by the `actid` parameter cannot be referenced by an Action Set or an action entry that is associated an action of `fwd/scpval/sfthrot`.

The Action ID specified by the `actid` parameter cannot be associated with an action of `none` or `fallback`.

The GTT destination must exist in the DSTN table.

**Output**

```
dlt-gttact:actid=disc1
```

```
tekelecstp 10-02-04 18:38:05 EST EAGLE 42.0.0
dlt-gttact:actid=disc1
Command entered at terminal #4.

GTT Action table is (1 of 2000) 1% full

DLT-GTTACT: MASP A - COMPLTD
;
```

**Related Topics**

- [chg-gttact](#)
- [ent-gttact](#)
- [rtrv-gttact](#)

## dlt-gttapath

Use this command to delete a GTT Action Path entry. A GTT Action Path entry consists of pairs of "setname + value" for Opcode/CgGTA/CdGTA. Each of these "setname + value" pairs should already be defined in the GTT translation table.

**Parameters****gttpn (mandatory)**

GTT Path name.

**Range:**

ayyyy

1 leading alphabetic character and up to 4 following alphanumeric characters.

**Example**

```
dlt-gttapath:gttpn=path1
```

**Dependencies**

The GTA table is corrupt or cannot be found.

The GTT Action Path table is corrupt or cannot be found.

The GTT Action - DISCARD, GTT Action - FORWARD, or GTT Action - DUPLICATE feature must be enabled before this command can be entered.

The GTT path name specified by the `gttpn` parameter must already exist in the database.The value specified for the `gttpn` parameter cannot be a reserved word.**Output**

```
dlt-gttapath:gttpn=path1
```

```
tekelecstp 10-02-04 18:29:41 EST EAGLE 42.0.0
```

```
dlt-gttapath:gttpn=path1
```

```
Command entered at terminal #4.
```

```
GTT Action Path table is (2 of 10000) 1% full
```

```
DLT-GTTAPATH: MASP A - COMPLTD
```

```
;
```

**Related Topics**

- [chg-gttapath](#)
- [ent-gttapath](#)
- [rtv-gttapath](#)

## dlt-gttaset

Use this command to delete an existing Global Title Translations (GTT) Action Set.

**Parameters****actsn (mandatory)**

GTT Action Set Name.

**Range:**

ayyyyyyy

1 leading alphabetic and up to 8 following alphanumeric characters.

### Example

```
dlt-gttaset:actsn=asetdisc1
```

### Dependencies

The specified GTT Action Set must already exist in the database.

The GTT Action table is corrupt or cannot be found.

The GTT Action entry cannot be referred by any translation entry.

The `actsn=none` parameter cannot be specified.

The GTT Action Set table is corrupt or cannot be found.

The EGTT feature must be turned on before this command can be entered.

### Output

```
dlt-gttaset:actsn=asetdisc1
```

```
tekelecstp 10-02-04 18:38:05 EST EAGLE 42.0.0
dlt-gttaset:actsn=asetdisc1
Command entered at terminal #4.
```

```
GTT Action Set table is (1 of 20000) 1% full
```

```
DLT-GTTASET: MASP A - COMPLTD
```

```
;
```

### Related Topics

- [chg-gttaset](#)
- [ent-gttaset](#)
- [rtrv-gttaset](#)

## dlt-gttset

Use this command to delete an applicable global title translation (GTT) selector.

### Note:

When the EGTT feature is turned on, the GTT Selector (`ent/chg/dlt/rtrv-gttset`), GTT Set (`ent/dlt/rtrv-gttset`), and GTA (`ent/chg/dlt/rtrv-gta`) commands replace the Translation Type (`ent/dlt/rtrv-tt`) and Global Title Translation (`ent/chg/dlt/rtrv-gtt`) commands. However, the Translation Type and Global Title Translation commands continue to work according to their original functionality when the EGTT feature is turned on.

## Parameters

### Note:

The nature of address indicator parameters (*naiv* or *nai*) can be specified using a mnemonic or an explicit value. Either the mnemonic or the explicit value can be specified; however, both values cannot be specified at the same time for the same parameter. [Table 58: NAIV/NAI Mapping](#) shows the mapping between the *naiv* and *nai* parameter values.

### Note:

The numbering plan parameters (*npv* or *np*) can be specified using a mnemonic or an explicit value. Either the mnemonic or explicit value can be specified; however, both values cannot be specified at the same time for the same parameter. [Table A-6](#) shows the mapping between the *npv* and *np* parameter values.

### **gti/gtia/gtii/gtin/gtin24/gtiis/gtins/gtin16 (mandatory)**

Global title indicator.

For all EGTT selector commands, the domain is defined as **gti** and **gtia** (ANSI), **gtii** (ITU international), **gtin** (ITU national), **gtin24** (24-bit ITU national), **gtiis** (ITU international spare), **gtins** (ITU national spare) and **gtin16** (16-bit ITU national).

For the selector commands, *gti* and *gtia* are equivalent. GTT selectors can be provisioned for the same translation type (TT) with different ITU domains.

#### **Range:**

0, 2, 4

Supported value for ANSI: *gti*=0, 2 and *gtia*=0, 2

Supported values for ITU: *gtii/gtin/gtin24/gtiis/gtins/gtin16*=0, 2, 4

### **cgssn (optional)**

CgPA subsystem number.

#### **Range:**

0 - 255

### **eaglegen (optional)**

This parameter specifies whether the selector is used by EAGLE generated messages.

#### **Range:**

**yes**

used by EAGLE generated messages

### **lsn (optional)**

Linkset name.

**Range:**

*ayyyyyyyyy*

1 alphabetic character followed by up to 9 alphanumeric characters

**msgtype (optional)**

SCCP message type.

Allow one or more SCCP message types (UDT/UDTS/XUDT/XUDTS) for every GTT Selector entry. This will help in screening different message types differently.

**Range:**

*sub*

*u*

*us*

*x*

*xs*

*all*

**Default**

*all*

**nai (optional)**

Nature of Address indicator.

**Range:**

*sub*

*rsvd*

*natl*

*intl*

*dflt*

**naiv (optional)**

Nature of Address indicator value.

**Range:**

*0 - 127*

**np (optional)**

Numbering Plan.

**Range:**

*e164*

*generic*

*x121*

**f69****e210****e212****e214****private****dflt****npv (optional)**

Numbering Plan value.

**Range:**

0 - 15

**selid (optional)**

Selector ID.

**Range:**

0 - 65534

**tt (optional)**

Translation type.

**Range:**

0 - 255

**Example**

```
dlt-gttset:gti=2:tt=10
```

```
dlt-gttset:gtin=4:tt=0:np=dflt:nai=dflt
```

```
dlt-gttset:gtia=2:tt=21:cgssn=20:selid=1:lsn=ls10
```

```
dlt-gttset:gtia=2:tt=2:eaglegen=yes
```

```
dlt-gttset:gti=0:selid=2
```

```
dlt-gttset:gtiis=0
```

```
dlt-gttset:gtins=0
```

```
dlt-gttset:gtin16=2:tt=10
```

```
dlt-gttset:npv=2:naiv=14:msgtype=x,us:gtii=4:TT=245
```

```
dlt-gttset:npv=2:naiv=14:msgtype=xs,us:gtin=4:TT=242:cgssn=10
```

**Dependencies**

The EGTT feature must be turned on before this command can be entered.

The `np` and `npv` parameters cannot be specified together in the same command.

The `nai` and `naiv` parameters cannot be specified together in the same command.

The `gti/gtia=4`, `gti(x)=1`, and `gti(x)=3` parameters cannot be specified.

If the `gti/gtia/gtii/gtin/gtin24/gtiis/gtins/gtin16 =2` parameter is specified, then the `np/npv` and `nai/naiv` parameters cannot be specified.

If the `gtii/gtin/gtin24/gtiis/gtins/gtin16 =4` parameter is specified, then an `np(v)` and `nai(v)` parameter combination must be specified. These parameters can be specified in any combination: `np/naiv`, `npv/nai`, `np/nai`, or `npv/naiv`.

The SSNSELID table must be accessible.

The FLOBR feature must be turned on before the `lsn` or `eaglegen` parameters can be specified.

If the `eaglegen=yes` parameter is specified, then the `msgtype`, `lsn`, `selid`, or `cgssn` parameters cannot be specified.

The GTT selector specified by the `gti(x)`, `tt`, and `np(v)` and `nai(v)` parameters must already exist.

A value of `dflt` must be specified for the `np` and `nai` parameters, or neither parameter can have a value of `dflt`.

A database error occurred while trying to access the SSNSELID table.

The OBSR feature must be enabled before the `cgssn` parameter can be specified.

If a value of `dflt` is specified for the `np` and `nai` parameters, then the `cgssn`, `selid`, `lsn`, or `eaglegen` parameters cannot be specified.

The linkset specified by the `lsn` parameter must already exist.

If the `gti(x)=0` parameter is specified, then the `eaglegen`, `tt`, `np/npv`, and `nai/naiv` parameters cannot be specified.

If a value of 2 or 4 is specified for the `gti(x)` parameter, then the `tt` parameter must be specified.

## Notes

There is no J7 FAK dependency on GTIA/GTIN16/GTIN24 parameters. The command can be entered successfully whether the J7 FAK is enabled or not enabled.

GTT Selector entries configured using GTIN24/GTIN16 parameters shall be treated as ITU-N24 entries if the J7 FAK is disabled and treated as ITU-N16 entries if the J7 FAK is enabled.

In the `msgtype` parameter, the parameter values correspond to SCCP message types as given in the following list:

- 'u' implies SCCP UDT message
- 'us' implies SCCP UDTS message
- 'x' implies SCCP XUDT message
- 'xs' implies to SCCP XUDTS messages, and
- 'all' implies all SCCP messages

This command will delete the EXACT match of the GTTSel parameteric values provided in command. For example, a given selector is provisioned with `msgtype=u,us`. To delete the said selector, only the following command can be used:

```
dlt-gttset:gtii=2:tt=17:msgtype=u,us
```

Similarly, to delete a given selector provisioned with `msgtype=all`, only the following commands can be used:

```
dlt-gttset:gtii=2:tt=32:msgtype=all
```

```
dlt-gttset:gtii=2:tt=32
```

### Output

```
dlt-gttset:gti=0
```

```
tekelecstp 10-02-05 16:35:13 EST Eagle 42.0.0
```

```
dlt-gttset:gti=0
```

```
Command entered at terminal #4.
```

```
DLT-GTTSEL: MASP A - COMPLTD
```

```
;
```

```
dlt-gttset:msgtype=u:gti=2:tt=253
```

```
tekelecstp 17-06-16 02:49:32 EST EAGLE 46.6.0.0.0-71.1.0
```

```
dlt-gttset:msgtype=u:gti=2:tt=253
```

```
Command entered at terminal #4.
```

```
DLT-GTTSEL: MASP A - COMPLTD
```

```
;
```

```
dlt-gttset:msgtype=u,us,x:gti=2:tt=253
```

```
tekelecstp 17-06-16 02:49:32 EST EAGLE 46.6.0.0.0-71.1.0
```

```
dlt-gttset:msgtype=u,us,x:gti=2:tt=253
```

```
Command entered at terminal #4.
```

```
DLT-GTTSEL: MASP A - COMPLTD
```

```
;
```

### Related Topics

- [chg-gttset](#)
- [ent-gttset](#)
- [rtv-gttset](#)

## dlt-gttset

Use this command to delete the specified global title translation set.



 **Note:**

When the EGTT feature is turned on, the GTT Selector (`ent/chg/dlt/rtrv-gttset`), GTT Set (`ent/dlt/rtrv-gttset`), and GTA (`ent/chg/dlt/rtrv-gta`) commands replace the Translation Type (`ent/dlt/rtrv-tt`) and Global Title Translation (`ent/chg/dlt/rtrv-gtt`) commands. However, the Translation Type and Global Title Translation commands continue to work according to their original functionality when the EGTT feature is turned on.

**Parameters****gttsn (mandatory)**

GTT set name. A GTT set is an entity to which global title addresses and selectors are assigned.

**Range:**

ayyyyyyy

1 leading alphabetic and up to 8 following alphanumeric characters

**Example**

```
dlt-gttset:gttsn=t800
```

**Dependencies**

The EGTT feature must be turned on before this command can be entered.

The `gttsn` parameter must be specified, cannot have a value of *none*, and must match an existing GTT set.

The GTT set cannot be deleted if it is referenced in the GTTSEL or GTA tables or if the GTT set is used by the IS41SMSCGTTSN option (see the `ent/chg-gsmsmsopts` command) or BPARTYGTTSN option (see the `ent/chg-is41smsopts` command).

The GTT set cannot be deleted if it is referenced by *npsn*.

If a translation is provisioned in the specified GTT set, or if the GTT set is referred by any translation, then the GTT set cannot be deleted.

The EGLEOPTS table is corrupt or cannot be found.

The value specified for the `gttsn` parameter must match the name of an existing GTT Set.

**Notes**

None

**Output**

```
dlt-gttset:gttsn=t800
```

```
rlghncxa03w 09-08-09 08:20:26 EST EAGLE 41.1.0
DLT-GTTSET: MASP A - CMPLTD
```

```
GTT-SET table is (3 of 2000) 1% full.  
;
```

#### Related Topics

- [chg-gttset](#)
- [ent-gttset](#)
- [rtrv-gttset](#)

## dlt-gws-redirect

Use this command to delete the provisioning of the redirect function and subsequently to disable the gateway screening redirect function. After the gateway screening redirect function is disabled, you must use `ent-gws-redirect` to enable the function again.

#### Parameters

This command has no parameters.

#### Example

```
dlt-gws-redirect
```

#### Dependencies

The redirect function data that will be deleted (removed) with this command must exist in the database.

#### Notes

None

#### Output

```
dlt-gws-redirect
```

```
rlghncxa03w 04-02-10 11:43:04 EST EAGLE 31.3.0  
DLT-GWS-REDIRECT: MASP A - COMPLTD  
;
```

#### Related Topics

- [chg-gws-redirect](#)
- [ent-gws-redirect](#)
- [rtrv-gws-redirect](#)

## dlt-home-smsc

Use this command to delete HOME SMSC specific addresses currently used to identify Short Message Service Centers in the database. This command updates the HOME SMSCADDR table.

## Parameters

### **smsc (mandatory)**

Short Message Service Center address.

#### **Range:**

1-21 digits

1-21 hexadecimal digits

## Example

```
dlt-home-smsc:smsc=552611646
```

## Dependencies

One of the following features must be enabled before this command can be entered.

- MO SMS IS41-to-GSM Migration
- MO-based GSM SMS NP
- MO-based IS41 SMS NP
- MT-Based GSM SMS NP
- MT-Based IS41 SMS NP
- Portability Check for Mobile Originated SMS

The specified HOME SMSC address must exist in the HOME SMSCADDR table.

The HOME SMSCADDR table must be accessible.

The GSM DBMM table must be accessible.

## Notes

None

## Output

```
dlt-home-smsc:smsc=552611646
```

```
rlghncxa03w 04-02-28 08:50:12 EST EAGLE 31.3.0  
DLT-HOME-SMSC: MASP A - COMPLTD
```

;

## Related Topics

- [ent-home-smsc](#)
- [rtrv-home-smsc](#)

# dlt-homern

Use this command to delete a routing number prefix from the HOMERN table.

## Parameters

### **rn (mandatory)**

The home routing number prefix

#### **Range:**

1 - 15 digits

## Example

```
dlt-homern:rn=C441234
```

## Dependencies

The specified routing number must already exist in the HOMERN table.

A value of *none* cannot be specified for the `rn` parameter.

The A-Port, AINPQ, G-Port, INP, or V-Flex feature must be turned on before this command can be entered.

The HOMERN table must be accessible.

## Notes

None

## Output

```
dlt-homern:rn=C441234
```

```
rlghncxa03w 04-02-28 08:50:12 EST EAGLE 31.3.0  
HOMERN table is (1 of 100) 1% full  
DLT-HOMERN: MASP A - COMPLTD
```

```
;
```

## Related Topics

- [ent-homern](#)
- [rtrv-homern](#)

# dlt-ip-conn

Use this command to delete existing SIP/ENUM/SCCP/SFAPP/IPS with SFLOG connection information. The IPCONN table supports the provisioning information related to the SIP/ENUM/SCCP/SFAPP/IPS with SFLOG connections.

## Parameters

### **cname (mandatory)**

Connection name. This parameter specifies the unique logical name assigned to each SIP/ENUM/IPS with SFLOG connection.

**Range:***ZZZZZZZZZZZZZZZZ*

A string of alphanumeric characters, beginning with a letter and upto 15 characters in length. Valid values are a..z, A..Z, 0..9.

**Example**

```
dlt-ip-conn:cname=conn1101a
```

**Dependencies**

SIPNP Feature must be enabled before deleting any existing SIP connection.

At least one ENUM/SCCP/SFAPP/IPS with SFLOG card must be provisioned before entering any ENUM/SCCP/SFAPP/IPS connection information.

IPCONN table should be accessible.

The value specified for the CNAME parameter must already exist in the IPCONN table.

Any Connection that is still OPEN to receive traffic cannot be deleted (the open parameter set to yes with the chg-ip-conn command).

**Notes**

None

**Output**

```
dlt-ip-conn:cname=conn1102a
```

```
tekelecstp 12-06-25 15:29:14 EST EAGLE 45.0.0
dlt-ip-conn:cname=conn1102a
Command entered at terminal #4.
DLT-IP-CONN: MASP A - COMPLTD
```

```
;
```

**Related Topics**

- [ent-ip-conn](#)
- [rtrv-ip-conn](#)
- [chg-ip-conn](#)

## dlt-ip-host

Use this command to delete entries from the IP Host table. The IP Host table defines the local and remote host names and their associated IP addresses.



## Parameters

### **ipaddr (mandatory)**

The node's IP address. This is a TCP/IP address expressed in standard dot notation. IP addresses consist of the system's network number and the machine's unique host number. An example IP address is *192.126.100.5*, where *192.126.100* is the network number and *5* is the machine's host number.

#### **Range:**

*1-223, 0-255*

4 numbers separated by dots

*1-223*—first number

*0-255*—the other three numbers

### **force (optional)**

Whether or not to remove all applications associated with the node, thus removing the entire node from the database.

#### **Range:**

##### **yes**

Delete all connections to node

##### **no**

Delete specified application or connection

#### **Default:**

*no*

### **ipappl (optional)**

The IP application supported by the node.

#### **Range:**

*stplan*

#### **Default:**

*none*

### **ipport (optional)**

The logical IP port that addresses the application on the node.

#### **Range:**

*1024 - 5000*

#### **Default:**

*none*

### **loc (optional)**

The card location as stenciled on the shelf of the system.

#### **Range:**

*1101 - 1108, 1111 - 1112, 1201 - 1208, 1211 - 1218, 1301 - 1308, 1311 - 1318,  
2101 - 2108, 2111 - 2118, 2201 - 2208, 2211 - 2218, 2301 - 2308, 2311 - 2318,  
3101 - 3108, 3111 - 3118, 3201 - 3208, 3211 - 3218, 3301 - 3308, 3311 - 3318,*

4101 - 4108, 4111 - 4118, 4201 - 4208, 4211 - 4218, 4301 - 4308, 4311 - 4318, 5101 - 5108, 5111 - 5118, 5201 - 5208, 5211 - 5218, 5301 - 5308, 5311 - 5318, 6101 - 6108, 6111 - 6118

**Default:**  
none

### Example

To delete the connection for a TCP/IP link associated with an STPLAN on a specified location:

```
dlt-ip-node:ipaddr=193.4.201.50:ipappl=stplan:loc=1201
```

To delete the connection for a TCP/IP link associated with an IPPORT on a specified location:

```
dlt-ip-node:ipaddr=193.4.201.50:ipport=1024:loc=1201
```

To delete all connections for TCP/IP links associated with the STPLAN on all locations:

```
dlt-ip-node:ipaddr=193.4.201.50:ipappl=stplan
```

To delete the connection for TCP/IP links associated with an IPPORT:

```
dlt-ip-node:ipaddr=193.4.201.50:ipport=1024
```

To delete all connections for a TCP/IP link associated with any application on a specified location:

```
dlt-ip-node:ipaddr=193.4.201.50:loc=1201
```

To delete all connections for TCP/IP links associated with any application on any location:

```
dlt-ip-node:ipaddr=193.4.201.50:force=yes
```

### Dependencies

The `ipappl` must be supported by the node.

The `ipport` must exist.

The `ipaddr` must exist.

The `force` parameter must be specified to remove an entire node.

The `ipappl`, `ipport`, `loc`, or `force=yes` parameter must be specified.

If the `force=yes` parameter is specified, the `ipappl`, `ipport`, and `loc` parameters cannot be specified.

The `ipappl` and `ipport` parameters cannot be specified together in the command.

If the `loc` parameter is specified, the shelf and card must be equipped.

If the `loc` parameter is specified, the specified card must have a TCP/IP data link assigned to it.

If the `loc` parameter is specified, the IP port on the node must be assigned to the application for the specified TCP/IP data link.

If the `loc` and `ipaddr` parameters are specified, the specified IP address must match the IP address of the card location's remote IP node.



If the `loc` and `ipport` parameters are specified, the specified IP port must match the card location's remote IP port.

If the `loc` and `ipappl` parameters are specified, the specified IP application must match the card location's remote IP application.

### Notes

A particular application can be specified by giving either the application's name or its IP port on the node.

Only Class A, Class B, and Class C IP addresses are supported by the STP LAN feature.

### Output

```
dlt-ip-node:ipaddr=193.4.201.50:loc=1201
```

```
rlghncxa03w 04-02-10 11:43:04 EST EAGLE 31.3.0
Deleting multiple nodes on disk - please wait...
DLT-IP-NODE: MASP A - COMPLTD
```

```
;
```

### Related Topics

- [ent-ip-node](#)
- [rtrv-ip-node](#)

## dlt-ip-rte

Use this command to delete a static IP route entry from the Static IP Route table (destination IP address, subnet mask, and gateway IP address) for the specified card.

### Caution:

The deletion of static IP routes can adversely affect IP connection oriented transports.

### Parameters

#### **loc (mandatory)**

Card location. The unique identifier of a specific IP card in the system.

#### **Range:**

*1101 - 1108, 1111 - 1112, 1201 - 1208, 1211 - 1218, 1301 - 1308, 1311 - 1318, 2101 - 2108, 2111 - 2118, 2201 - 2208, 2211 - 2218, 2301 - 2308, 2311 - 2318, 3101 - 3108, 3111 - 3118, 3201 - 3208, 3211 - 3218, 3301 - 3308, 3311 - 3318, 4101 - 4108, 4111 - 4118, 4201 - 4208, 4211 - 4218, 4301 - 4308, 4311 - 4318, 5101 - 5108, 5111 - 5118, 5201 - 5208, 5211 - 5218, 5301 - 5308, 5311 - 5318, 6101 - 6108, 6111 - 6118*

**dest (mandatory)**

Destination IP Address. The remote destination host or network destination IP Address that is to be removed.

**Range:**

4 numbers separated by dots, with each number in the range of 0-255.  
The IP address 0.0.0.0 is not valid.

**force (optional)**

A value of yes is required when the card is allowed and this command is to be completed.

**Range:**

**yes**

**no**

**Default:**

*no*

**Example**

```
dlt-ip-rte:loc=1301:dest=128.252.10.5
dlt-ip-rte:loc=1301:dest=128.252.10.5:force=yes
```

**Dependencies**

The specified destination IP address (*dest* parameter):

- Must not be the default route (0.0.0.0)
- Must not correspond to any loopback address (i.e. 127.X.X.X)
- Must not reside on this card's A or B network

The specified destination IP address must exist in the Static IP Route table.

The card in the location specified with the *loc* parameter should typically be inhibited for this command to complete successfully. The *force=yes* parameter is required when the card is allowed and the command is entered.

**Notes**

None

**Output**

```
dlt-ip-rte:loc=1301:dest=128.252.10.5

rlghncxa03w 04-02-17 15:35:05 EST EAGLE 31.3.0
DLT-IP-RTE:  MASP A - COMPLTD
;
```

**Related Topics**

- [rtrv-ip-lnk](#)

## dlt-j1

Use this command to delete J1 interface.

### Parameters

#### **loc (mandatory)**

The card location as stenciled on the shelf of the system.

#### **Range:**

*1101 - 1108, 1111 - 1112, 1201 - 1208, 1211 - 1218, 1301 - 1308, 1311 - 1318,  
2101 - 2108, 2111 - 2118, 2201 - 2208, 2211 - 2218, 2301 - 2308, 2311 - 2318,  
3101 - 3108, 3111 - 3118, 3201 - 3208, 3211 - 3218, 3301 - 3308, 3311 - 3318,  
4101 - 4108, 4111 - 4118, 4201 - 4208, 4211 - 4218, 4301 - 4308, 4311 - 4318,  
5101 - 5108, 5111 - 5118, 5201 - 5208, 5211 - 5218, 5301 - 5308, 5311 - 5318,  
6101 - 6108, 6111 - 6118*

#### **j1port (mandatory)**

The value must be a J1 port that has already been configured with a J1 interface on the specified T1 card with application as CCS7ITU.

#### **Range:**

*1-8*

### Example

```
dlt-j1:loc=1101:j1port=2
```

### Dependencies

The specified card location ( loc parameter) must be equipped.

The card in the specified card location ( loc parameter) must be a LIMT1 card type and application must be CCS7ITU.

The port specified by the j1port parameter must be already equipped with J1 interface.

The J1 table must be accessible.

The Card (IMT) table must be accessible.

All signaling links providing timeslots serviced by the specified J1 interface must be deleted before the J1 interface can be deleted. Use the dlt-slk command to delete the signaling links providing the timeslots.

Card locations 1113 - 1118 (OAM, TDM, MDAL cards) cannot be specified as values for the loc parameter.

J1port must be in range from 1 to 8.

### Notes

None.

**Output**

```
dlt-j1:loc=1101:j1port=1

tekelecstp 13-12-20 12:57:15 EST 46.0.0-65.3.0
dlt-j1:j1port=1:loc=1101
DLT-J1: MASP A - COMPLTD
;
```

**Related Topics**

- [chg-j1](#)
- [ent-j1](#)
- [rtrv-j1](#)
- [tst-j1](#)

## dlt-lbp

Use this command to delete one or all far-end loopback points maintained in the Link Fault Sectionalization table for testing data signaling link elements in a single CCS7 transmission path.

**Parameters****link (mandatory)**

SS7 signaling link. The SS7 signaling link that is to be tested.

**Synonym:**

*port*

**Range:**

*a, b, a1 - a31, b1 - b31*

Not all card types support all `link` parameter values.

See [Table A-1](#) for valid `link` parameter range values for each type of card that can have assigned signaling link ports.

**loc (mandatory)**

Card location. The unique identifier of the card containing the signaling link to be used for loopback point testing.

**Range:**

*1101 - 1108, 1111 - 1112, 1201 - 1208, 1211 - 1218, 1301 - 1308, 1311 - 1318, 2101 - 2108, 2111 - 2118, 2201 - 2208, 2211 - 2218, 2301 - 2308, 2311 - 2318, 3101 - 3108, 3111 - 3118, 3201 - 3208, 3211 - 3218, 3301 - 3308, 3311 - 3318, 4101 - 4108, 4111 - 4118, 4201 - 4208, 4211 - 4218, 4301 - 4308, 4311 - 4318, 5101 - 5108, 5111 - 5118, 5201 - 5208, 5211 - 5218, 5301 - 5308, 5311 - 5318, 6101 - 6108, 6111 - 6118*

**a11 (optional)**

Deletes all loopback points for the specified signaling link or deletes only the link specified on the `lbp` parameter.

**Range:**

*yes*

**lbp (optional)**

Loopback point ID. This parameter identifies a far-end loopback point that lies along an SS7 signaling link path between the STP and the target device (up to and including the target device).

**Range:**

*1 - 32*

**Example**

```
dlt-lbp:loc=1101:link=a:lbp=1
```

```
dlt-lbp:loc=1101:link=a:all=yes
```

**Dependencies**

At least one optional parameter must be specified.

The `lbp` parameter and the `all` parameter cannot be specified together in the command.

The Link Fault Sectionalization (LFS) feature must be on before this command can be entered.

The loopback point (LBP) must have been previously defined.

The card location indicated by the `loc` parameter must indicate an E5-E1T1-B card, provisioned with the LIMT1 card type, with either the SS7ANSI or CCS7ITU application.

The card location specified in the `loc` parameter must be equipped.

The card location specified in the `loc` parameter cannot be reserved by the system.

The Link Fault Sectionalization database Loopback Point (LBP) table is not accessible.

**Notes**

None

**Output**

```
dlt-lbp:loc=1101:link=a:lbp=1
```

```
rlghncxa03w 05-02-17 15:35:05 EST EAGLE5 33.0.0  
DLT-LBP: MASP A - COMPLTD
```

;

**Related Topics**

- [act-lbp](#)
- [chg-lbp](#)
- [dact-lbp](#)

- [ent-lbp](#)
- [rtrv-lbp](#)

## dlt-lg-card

Use this command to delete an LG card.

The command class is TKLC\_INTERNAL inheriting properties of DEBUG class. The Load Generator is supported on IPSG, IPLHC, IPGHC and SS7HC GPLs.

### Parameters

#### loc (mandatory)

The card location as stenciled on the shelf of the system.

#### Range:

*1101 - 1108, 1111 - 1112, 1201 - 1208, 1211 - 1218, 1301 - 1308, 1311 - 1318, 2101 - 2108, 2111 - 2118, 2201 - 2208, 2211 - 2218, 2301 - 2308, 2311 - 2318, 3101 - 3108, 3111 - 3118, 3201 - 3208, 3211 - 3218, 3301 - 3308, 3311 - 3318, 4101 - 4108, 4111 - 4118, 4201 - 4208, 4211 - 4218, 4301 - 4308, 4311 - 4318, 5101 - 5108, 5111 - 5118, 5201 - 5208, 5211 - 5218, 5301 - 5308, 5311 - 5318, 6101 - 6108, 6111 - 6118*

### Example

```
dlt-lg-card:loc=1302
```

### Dependencies

The card location must not be 1113-1118, or xy09 and xy10 where x is the frame and y is the shelf.

All LG engines must be removed or disassociated from the LG card.

Card must be deactivated before it can be deleted.

The card location specified in the loc parameter must be of a provisioned LG card.

The LG Card table is corrupt or cannot be found.

The loc parameter must be specified.

### Output

#### Related Topics

- [act-lg-card](#)
- [chg-lg-card](#)
- [dact-lg-card](#)
- [ent-lg-card](#)
- [rept-stat-lg](#)
- [rtrv-lg-card](#)

## dlt-lg-engine

Use this command to delete an LG engine.

The command class is TKLC\_INTERNAL inheriting properties of DEBUG class. The Load Generator is supported on IPSG, IPLHC, IPGHC and SS7HC GPLs.

### Parameters

#### **engine (mandatory)**

**Range:**

aaaaaaaaaa

Up to 10 alphanumeric characters; the first character must be a letter.

### Example

```
dlt-lg-engine:engine=txengine1
```

### Dependencies

The LG Engine table is corrupt or cannot be found.

The engine name specified must pre-exist in the LG Engine table.

Engine must be deactivated before it can be deleted.

Rx engine must be removed or disassociated from the Tx engine.

### Output

### Related Topics

- [act-lg-engine](#)
- [dact-lg-engine](#)
- [ent-lg-engine](#)
- [rept-stat-lg](#)
- [rtrv-lg-engine](#)

## dlt-lg-event

Use this command to delete an LG event. The command class is TKLC\_INTERNAL inheriting properties of DEBUG class. The Load Generator is supported on IPSG, IPLHC, IPGHC and SS7HC GPLs.

### Parameters

#### **event (mandatory)**

**Range:**

aaaaaaaaaa

Up to 10 alphanumeric characters; the first character must be a letter

**Example**

```
dlt-lg-event:event=txisup1
```

**Dependencies**

When failed to read LG Event table.

The value specified for the `event` parameter must already exist in the table

The LG Event name specified in the command should not be referenced in the LG Engine table.

The `event` parameter must be specified.

**Output****Related Topics**

- [chg-lg-event](#)
- [ent-lg-event](#)
- [rept-stat-lg](#)
- [rept-stat-lg](#)
- [rtrv-lg-event](#)

## dlt-lg-grp

Use this command to delete an LG group. The command class is TKLC\_INTERNAL inheriting properties of DEBUG class. The Load Generator is supported on IPSG, IPLHC, IPGHC and SS7HC GPLs.

**Parameters****grp (mandatory)****Range:**

aaaaaaaa

Up to 10 alphanumeric characters; the first character must be a letter

**Example**

```
dlt-lg-grp:grp=lggroup1
```

**Dependencies**

The value specified for the `grp` parameter must already exist in the LG Group table.

An LG group can be deleted only when no LG cards are associated with that group.

The Group must be deactivated before it can be deleted.

The LG Group table is corrupt or cannot be found.

The `grp` parameter is mandatory



**Output****Related Topics**

- [act-lg-grp](#)
- [dact-lg-grp](#)
- [ent-lg-grp](#)
- [rept-stat-lg](#)
- [rtrv-lg-grp](#)

## dlt-lnp-serv

Use this command to delete from the database an LNP service or an alias translation type associated with an LNP service.

**Parameters****serv (mandatory)**

Reserved service type name.

**Range:**

*ain*

*in*

*pcs*

*wnp*

*class*

*lidb*

*cnam*

*isvm*

*lnpqs*

*wsmc*

*udf1*

*udf2*

*udf3*

*udf4*

*lrnqt*

**alias (optional)**

Alias translation type.

**Range:**  
000 - 255

### Example

```
dlt-lnp-serv: serv=lidb: alias=236
```

```
dlt-lnp-serv: serv=lrnqt
```

### Dependencies

The LNP feature must be turned on before this command can be entered.

The value of the `serv` parameter must already exist in the LNP database.

The service must not be referenced in the LNP database.

The value of the `alias` parameter must be associated with the value of the specified `serv` parameter.

The value specified for the `alias` parameter cannot already exist in the LNP database as a true translation type.

The LNP TT SERV table is corrupt or cannot be found.

All aliases associated with the LNP service must be deleted before the service can be deleted.

The value of the `alias` parameter must exist in the LNP database.

The LNP database is corrupt or cannot be found.

The GTT Action table is corrupt or cannot be found.

### Notes

None

### Output

```
dlt-lnp-serv: serv=cnam: alias=23
```

```
rlghncxa03w 10-11-09 16:40:40 EST EAGLE 43.0.0  
DLT-LNP-SERV: MASP A - COMPLTD  
Command Completed.
```

```
;
```

### Related Topics

- [chg-lnp-serv](#)
- [ent-lnp-serv](#)
- [rtrv-lnp-serv](#)

## dlt-loopset

Use this command to delete loopset and point code data from the database. This command updates the Loopset table.

 **Note:**

A total of 6 point codes can be deleted each time this command is issued. If the command is issued twice, all point codes in a loopset can be deleted, creating an empty loopset.

**Parameters****name (mandatory)**

Loopset name. This parameter specifies an entry in the Loopset table.

**Range:**

ayyyyyyy

1 alphabetic and up to 7 alphanumeric characters

**force (optional)**

The `force=yes` parameter must be specified to delete a single point code entry from a loopset that is being used by GTT.

**Range:**

yes

**pcl (optional)**

ANSI point code list with subfields *network indicator-network cluster-network cluster-member (ni-nc-ncm)*. The *prefix* subfield indicates a private point code(*prefix-ni-nc-ncm*). This parameter allows up to 6 comma-delimited entries in the point code list.

**Synonym:**

pcla

**Range:**

p-, 000-255

Specify a valid value for each subfield of the point code, and separate the subfields with a dash (-).

prefix—p-

When `chg-sid:pctype=ansi` is specified, *ni = 000* is not valid.

When `chg-sid:pctype=ansi` is specified, *nc = 000* is not valid if *ni = 001-005*.

When `chg-sid:pctype=ansi` is specified, *nc = 000* is valid if *ni = 006-255*.

The point code *000-000-000* is not a valid point code.

**pcli (optional)**

ITU international point code list with subfields *zone-area-id*. The *prefix* subfield indicates a spare point code, private point code, or private and spare point code (*prefix-zone-area-id*). This parameter allows up to 6 comma-delimited entries in the point code list.

**Range:**

s-, p-, ps-, 0-255

Specify a valid value for each subfield of the point code, and separate the subfields with a dash (-).

prefix—s-, p-, ps

zone—0-7

*area*—000-255

*id*—0-7

The point code 0-000-0 is not a valid point code.

#### **pc1n (optional)**

ITU national point code list in the format of a 5-digit number (*nnnnn*); or 2, 3, or 4 numbers (members) separated by dashes (*m1-m2-m3-m4*) as defined by the **chg-stpopts:npfcmfti** flexible point code option. A group code must be specified when the ITUDUPPC feature is turned on (*nnnnn-gc*, *m1-m2-m3-m4-gc*). The *prefix* subfield indicates a spare point code (*prefix-nnnnn*, *prefix-nnnnn-gc*, *prefix-m1-m2-m3-m4*, *prefix-m1-m2-m3-m4-gc*). This parameter allows up to 6 comma-delimited entries in the point code list.

#### **Range:**

*s-*, *p-*, *ps-*, 0-16383, *aa-zz*, *none*

Specify a valid value for each subfield of the point code, and separate the subfields with a dash (-).

*prefix*—*s-*, *p-*, *ps*

*nnnnn*—0-16383

*gc*—*aa-zz*

*m1-m2-m3-m4*—0-14 for each member; values must sum to 14

Enter *none* to delete the point code.

#### **pc1n24 (optional)**

24-bit ITU national point code with subfields *main signaling area-sub signaling area-signaling point* (*msa-ssa-sp*). This parameter allows up to 6 comma-delimited entries in the point code list.

#### **Range:**

*p-*, 000-255

Specify a valid value for each subfield of the point code, and separate the subfields with a dash (-).

*prefix*—*p*

*msa*—000-255

*ssa*—000-255

*sp*—000-255

#### **pc1n16 (optional)**

16-bit ITU national point code with subfields *unit number sub number area main number area* (*un-sna-mna*). This parameter allows up to 6 comma-delimited entries in the point code list.

#### **Range:**

*p--*, 000--127

Specify a valid value for each subfield of the point code, and separate the subfields with a dash (-).

*prefix---**p*

*un---*000---127

*sna---*000---15

*mna---*000---31

### Example

This example deletes the entire loopset table entry for the loopset RTP7 when that set is not being used by GTT.

```
dlt-loopset:name=rtp7
```

This example deletes a single point code in the entry for the loopset RTP2 when that set is being used by GTT.

```
dlt-loopset:name=rtp2:pc1=3-3-9:force=yes
```

This example deletes a point code for the loopset RTP1 when the loopset is not being used by GTT.

```
dlt-loopset:name=rtp1:pc1=3-3-9
```

This example deletes a point code for the loopset RTP1 when the loopset is not being used by GTT.

```
dlt-loopset:name=rtp1:pc1n16=3-3-9
```

### Dependencies

The value of the `name` parameter must already exist in the database.

The SCCP Loop Detection feature must be enabled before this command can be entered.

The GTT feature must be turned on before this command can be entered.

A loopset entry cannot be deleted when it is being used by GTT.

If a point code in the Loopset table is being used by GTT, then the `force=yes` parameter must be specified before the `pc1/pc1i/pc1n/pc1n24/pc1n16` parameter can be specified.

The Loopset table must be accessible.

The values for the `pc1` parameter cannot consist of any invalid point codes. The valid point codes must be consecutively specified and separated by commas.

The `name=none` parameter cannot be specified.

At least one valid point code must be specified as a value for the `pc1` parameter.

The values for the `pc1` parameter must be unique.

The GTT table must be accessible.

The value of the `pc1` parameter must exist in the loopset entry in the database.

### Notes

There is no J7 feature dependency on the `pc1n16` parameter. The command can be entered successfully when the J7 feature is not enabled.

There is no J7 feature dependency on the `pc1/pc1a/pc1n2 4` parameters. The command can be entered successfully when the J7 feature is enabled.

## Output

The following example deletes a single point code in the entry for the loopset RTP2 when the set is being used by GTT. `dlt-loopset:name=rtp2:pcl=3-3-9:force=yes`

```
rlghncxa03w 07-02-10 08:48:25 EST EAGLE Rel 35.6.0
LOOPSET table is (11 of 1000) 1% full
DLT-LOOPSET: MASP A - COMPLTD
;
```

## Related Topics

- [chg-loopset](#)
- [ent-loopset](#)
- [rtv-loopset](#)

# dlt-ls

Use this command to remove a linkset from the system database. A linkset is a group of signaling links carrying traffic to the same signaling point.

## Parameters

### **lsn (mandatory)**

Linkset name. This parameter specifies the name of the linkset. Only one linkset name per command can be specified.

#### **Range:**

`ayyyyyyyy`

1 alphabetic character followed by up to 9 alphanumeric characters

## Example

```
dlt-ls:lsn=lsna
```

## Dependencies

The linkset must be in the database.

The linkset can be removed only if all links associated with the linkset have been removed.

If the linkset is referenced by the historic routeset of any destination, then this command cannot be entered.

The specified linkset cannot be deleted if it has or is a mate linkset.

A gateway linkset can be deleted only from a SEAS terminal, and not from a system terminal.

The Linkset table is corrupt or cannot be found.

The Route table is corrupt or cannot be found.

The linkset cannot be deleted if an SAPC entry is present for the linkset.

If the linkset is referenced by the historic routeset of any exception route destination, then this command cannot be entered.

The Route Exception table is corrupt or cannot be found.

SAPC entry present for the linkset.

If multiple linksets are assigned to an adjacent point code, then the proxy linkset must be the final linkset that is deleted.

If the linkset that is specified by the `lsn` parameter is used as an incoming linkset for an exception route entry (see the `rtrv-rtx` command), then this command cannot be entered.

If the linkset is referenced by the GTT selector table, then this command cannot be entered.

The GTT selector table is corrupt or cannot be found.

The SAPC table is corrupt or cannot be found.

The GTT destination must exist in the DSTN table.

### Notes

When a linkset is removed from the system database, the related entries are removed automatically from the translation type mapping table.

Deleted MTT 4848 (MB).

### Output

```
dlt-ls:lsn=lsna
```

```
rlghncxa03w 04-01-07 11:11:28 EST EAGLE 31.3.0
Link set table is (114 of 1024) 11% full
DLT-LS: MASP A - COMPLTD
```

```
;
```

### Related Topics

- [chg-l3t](#)
- [ent-ls](#)
- [rept-stat-ls](#)
- [rtrv-ls](#)

## dlt-map

Use this command to remove mate application entries, groups, or an Alternate RI Mate associated with a MAP Set. This command removes one or more entries from the Remote Point Code Subsystem Number table.

**⚠ Caution:**

If PC/SSNs within a weighted entity set are deleted such that the entity set's multiplicity mode becomes solitary or dominant, the weight values are reset to indicate a non-weighted entity set.

**✎ Note:**

See the "Notes" section for this command for additional information on multiplicity modes.

**✎ Note:**

The GTT LS ARI feature must be enabled before an Alternate RI Mate can be deleted from a MAP Set.

**Parameters****✎ Note:**

At least one of these parameters must be specified: `all`, `ssn`.

**✎ Note:**

See [Point Code Formats and Conversion](#) for a detailed description of point code formats, rules for specification, and examples.

**pc (mandatory)**

ANSI point code with subfields *network indicator-network cluster-network cluster member (ni-nc-ncm)*.

**Synonym:**

*pca*

**Range:**

*000-255*

Specify a valid value for each subfield of the point code, and separate the subfields with a dash (-).

When `chg-sid:pctype=ansi` is specified, *ni = 000* is not valid.

When `chg-sid:pctype=ansi` is specified, *nc = 000* is not valid if *ni = 001-005*.

When `chg-sid:pctype=ansi` is specified, *nc = 000* is valid if *ni = 006-255*.

The point code *000-000-000* is not a valid point code.

**pc/pca/pci/pcn/pcn24/pcn16 (mandatory)**

Post-GTT-translated point code.



**pci (mandatory)**

ITU international point code with subfields *zone-area-id*. The *prefix* subfield indicates a spare point code (*prefix-zone-area-id*)

**Range:**

*s-*, 0-255

Specify a valid value for each subfield of the point code, and separate the subfields with a dash (-).

*prefix*—*s*

*zone*—0-7

*area*—000-255

*id*—0-7

The point code 0-000-0 is not a valid point code.

**pcn (mandatory)**

ITU national point code in the format of a 5-digit number (*nnnnn*); or 2, 3, or 4 numbers (members) separated by dashes (*m1-m2-m3-m4*) as defined by the `chg-stpopts:npcfmti` flexible point code option. A group code must be specified when the ITUDUPPC feature is turned on (*nnnnn-gc,m1-m2-m3-m4-gc*). The *prefix* subfield indicates a spare point code (*prefix-nnnnn*, *prefix-nnnnn-gc*, *prefix-m1-m2-m3-m4*, *prefix-m1-m2-m3-m4-gc*).

**Range:**

*s-*, 0-16383, *aa-zz*

Specify a valid value for each subfield of the point code, and separate the subfields with a dash (-).

*prefix*—*s-*

*nnnnn*—0-16383

*gc*—*aa-zz*

*m1-m2-m3-m4*—0-14 for each member; values must sum to 14

**pcn24 (mandatory)**

24-bit ITU national point code with subfields *main signaling area-sub signaling area-signaling point* (*msa-ssa-sp*).

**Range:**

000-255

Specify a valid value for each subfield of the point code, and separate the subfields with a dash (-).

*msa*—000-255

*ssa*—000-255

*sp*—000-255

**pcn16 (mandatory)**

16-bit ITU national point code with subfields *unit number-sub number area-main number area* (*un-sna-mna*).

**Range:**

000---127

Specify a valid value for each subfield of the point code, and separate the subfields with a dash (-).

*un*---000---127

*sna---000---15*

*mna---000---31*

**a11 (optional)**

This parameter must be specified to remove all subsystem numbers associated with this point code. If this parameter is not specified, only the specified subsystem number is removed.

**Range:**

*yes*

**Default:**

*no*

**mapset (optional)**

The MAP set ID.

**Range:**

*1 - 36000, dflt*

*dflt* —Default MAP set

**Default:**

*dflt* —If the Flexible GTT Load Sharing (FGTTLS) feature is not enabled,

**mrnset (optional)**

Alternate RI Mate MRN Set ID.

**Range:**

*1 - 3000, dflt*

**ssn (optional)**

Subsystem Number.

**Range:**

*2 - 255*

**Default:**

The specified subsystem number is removed for the given point code.

**Example**

This example deletes the single entry PC 1 with an SSN value of 123 from its mated group. If this is the last entry in the group then the PC is also deleted from the MAP tables:

```
dlt-map:pc=1-1-1:ssn=123
```

This example deletes each entry of PC 1-1-1 and all SSNs associated with the PC from each of the PC/SSN mated groups. The PC is also deleted from the MAP tables:

```
dlt-map:pc=1-1-1:all=yes
```

This example deletes subsystem 10 associated with spare PC 1 from the MAP table.

```
dlt-map:pci=s-1-1-0:ssn=10
```

This example deletes subsystem 10 associated with PC 1 in MAP set 362.

```
dlt-map:pc=1-1-1:ssn=10:mapset=362
```

This example deletes PC 1 along with all the subsystems associated with this PC in the default MAP set.

```
dlt-map:pc=1-1-2:all=yes:mapset=df1t
```

This example deletes the Alternate RI Mate associated with MAP Set 362.

```
dlt-map:mapset=362:mrnset=1
```

This example deletes the Alternate RI Mate for the default MAP Set and PC/SSN 1-1-1/10.

```
dlt-map:mapset=df1t:pc=1-1-1:ssn=10:mrnset=1
```

This example deletes the entry from MAP set.

```
dlt-map:mapset=1:pc=1-1-1:ssn=10
```

This example deletes the 16 bit PC entry from MAP set.

```
dlt-map:mapset=1:pcn16=1-1-1:ssn=10
```

### Dependencies

The `all` and `ssn` parameters cannot be specified together in the command.

If the `all=yes` parameter is specified, all SSNs for the given PC are removed.

The DPC of the primary subsystem must be a full PC.

The specified remote PC must exist in the MAP table.

The specified SSN must exist in the MAP table entity set associated with the specified remote PC.

An STP true point code that is assigned to an AIQ, ATINPQ, EIR, INP, LNP, or V-Flex subsystem cannot be deleted.

If the `pcn` parameter is specified, the format of the PC must match the format that was assigned with the `chg-stpopts:npcfmti` parameter.

The Site Identification table is corrupt or cannot be found.

If the FGTTLS feature is not enabled, the `mapset` parameter cannot be specified. If the FGTTLS feature is enabled, the `mapset` parameter must be specified.

The specified MAP set must exist in the database.

The specified PC/SSN/MAP set must already be provisioned in the MAP table.

If the `pc` and `mapset` parameters are specified, and the `all=yes` parameter is specified, then at least one entry for that PC/MAP set must exist in the MAP table.

If the FGTTLS feature is enabled, then a MAP entry cannot be deleted if the entry is referenced in the MRN, GTT, GTA, GTT Action, GSM MAP Opcode, or GSM MAP Screening table using the MAPSET/PC/SSN combination, or if the entry is referenced in the MRN, GTT, GTA, GSM MAP Opcode, GSM MAP Screening, or PPSOPTS table using the MAPSET/PC combination, and the entry is the last entry in that MAP set with the specified point code.

If the FGTTLS feature is not enabled, then a MAP entry cannot be deleted if the entry is referenced in the GTT, GTA, GTT Action, GSM MAP Opcode, or GSM MAP Screening table using the PC/SSN combination or if the entry is referenced in the GTT, GTA, GSM MAP Opcode, GSM MAP Screening, or PPSOPTS table using the point code, and the entry is the last entry in the default MAP set with that point code.

The MAP table is corrupt or cannot be found.

PC "Point code out of range".

If the `pcn` or `mpcn` parameter is specified, then the format of the parameter must match the format dictated by the `chg-stpopts:npcfmti` command.

The GTT LS ARI feature must be enabled before the `mrnset` parameter can be specified.

The value specified for the `mrnset` parameter must already be associated with a MAP Set.

The MRN table is corrupt or cannot be found.

If the `mrnset` parameter is specified, then the `all` parameter cannot be specified.

If a MAP set is referenced in the GTT table without an associated point code and subsystem number, then the MAP set cannot be deleted.

### Notes

For the MAP commands, an entity set consists of a group of PC/SSNs that are used for traffic distribution, and an RC group consists of PC/SSNs within an entity set that have the same RC. In loadsharing mode, an entity set contains 1 RC group. In combined/dominant loadsharing mode, an entity set can contain multiple loadsharing groups.

The EAGLE supports the following modes for nodes/subsystems:

- When a PC/SSN pair is not replicated, the pair is in *solitary* mode. The subsystem acts as the only application, with no backup. If this subsystem fails, messages routed to it are discarded and SCCP management returns "Subsystem Unavailable" messages to the originator.
- A group of replicated PC/SSN pairs are in *dominant* mode if each PC/SSN pair in the group has a unique RC. The specified subsystem with the lowest RC acts as the primary subsystem, while the mate subsystem acts as a backup. In the event of congestion, messages route to the mate subsystem. When the congestion subsides, messages are again routed to the primary (dominant) subsystem.
- A group of replicated PC/SSN pairs are in *load sharing* mode if each PC/SSN pair in the group has the same RC. All messages are evenly distributed at the SCCP level to all nodes/subsystems in the group. In the event of congestion or failure, the non-affected subsystem assumes the load of its failed or congested mate.
- The *combined load sharing/dominant* mode supports a combination of load sharing and dominant mode. A group of PC/SSN pairs are in combined load sharing/dominant mode when at least two of the PC/SSN pairs have the same RC and another node subsystem in the group has a different RC. A combination of node accessibility and RC determines the preferred PC/SSN.

In this command, only ITU-international and ITU national PCs support the spare point code subtype prefix (s-).

When the FGTTLS feature is on, MAP load sharing sets are supported. Each MAP set is identified by a new `mapset` parameter.

When the Weighted GTT Loadsharing feature is turned on, weighted entity sets and RC groups are supported, and threshold values can be assigned to each PC/SSN.

## Output

```
dlt-map:pc=1-1-0:ssn=10:mapset=362
```

```
tekelecstp 08-12-22 12:20:10 EST EAGLE 40.1.0
```

```
DLT-MAP: MASP A - COMPLTD
```

```
;
```

```
dlt-map:mapset=362:mrnset=1
```

```
tekelecstp 08-12-22 12:20:10 EST EAGLE 40.1.0
```

```
DLT-MAP: MASP A - COMPLTD
```

```
;
```

## Related Topics

- [chg-map](#)
- [ent-map](#)
- [rtrv-map](#)

# dlt-mate-stp

Use this command to delete an PC (secondary point code) from the database. Also use this command to change an PC by first removing the PC from the database and then using the ent-mate-stp command to enter the new PC value.

## Parameters



### Note:

See [Point Code Formats and Conversion](#) for a detailed description of point code formats, rules for specification, and examples.

### **pc (mandatory)**

ANSI point code with subfields *network indicator-network cluster-network cluster member (ni-nc-ncm)*.

#### **Synonym:**

*pca*

#### **Range:**

*000-255*

The point code *000-000-000* is not a valid point code.

### **pc/pca/pci/pcn/pcn24/pcn16 (mandatory)**

Secondary point code.

**pci (mandatory)**

ITU international point code with subfields *zone-area-id*. The *prefix* subfield indicates a spare point code (*prefix-zone-area-id*)

**Range:**

*s-*, 0-255

Specify a valid value for each subfield of the point code, and separate the subfields with a dash (-).

*prefix-s*

*zone-0-7*

*area-000-255*

*id-0-7*

The point code *000-000-000* is not a valid point code.

**pcn (mandatory)**

ITU international point code with subfields *zone-area-id*. The *prefix* subfield indicates a spare point code (*prefix-zone-area-id*)

**Range:**

*s-*, 0-16383, *aa-zz*

Specify a valid value for each subfield of the point code, and separate the subfields with a dash (-).

*prefix-s*

*nnnnn-0-16383*

*gc-aa-zz*

*m1-m2-m3-m4-0-14* for each member; values must sum to 14

**pcn24 (mandatory)**

24-bit ITU national point code with subfields *main signaling area-sub signaling area-signaling point (msa-ssa-sp)*.

**Range:**

000-255

Specify a valid value for each subfield of the point code, and separate the subfields with a dash (-).

*msa-000-255*

*ssa-000-255*

*sp-000-255*

**pcn16 (mandatory)**

16-bit ITU national point code with subfields *main signaling area-sub signaling area-signaling point (msa-ssa-sp)*.

**Range:***000---127*

Specify a valid value for each subfield of the point code, and separate the subfields with a dash (-).

*un---000---127**sna---000---15**mna---000---31***Example**`dlt-mate-stp:pc=10-20-30``dlt-mate-stp:pcn24=98-98-98``dlt-mate-stp:pcn=s-12345``dlt-mate-stp:pcn16=121-10-30`**Dependencies**

A point code is not present in Mate STP table.

**Output**`dlt-mate-stp:pci=1-1-1`

```
Command Accepted - Processing
```

```
tekelecstp 18-05-29 11:09:12 MST EAGLE 46.6.2.0.0-73.19.0
```

```
dlt-mate-stp:pci=1-1-1
```

```
Command entered at terminal #2.
```

```
;
```

```
tekelecstp 18-05-29 11:09:13 MST EAGLE 46.6.2.0.0-73.19.0
```

```
DLT-MATE-STP: MASP B - COMPLTD
```

```
;
```

**Related Topics**

- [ent-mate-stp](#)
- [rtrv-mate-stp](#)

## dlt-mrn

Use this command to delete entries or an Alternate RI Mate from the MRN table. A single command can delete one point code from the group, or delete the entire group.

 **Caution:**

If PCs within a weighted entity set are deleted such that the entity set's multiplicity mode becomes dominant, the weight values are reset to indicate a non-weighted entity set.

 **Note:**

See the "Notes" section for this command for additional information on multiplicity modes.

 **Note:**

The GTT LS ARI feature must be enabled before an Alternate RI Mate can be deleted from an MRN Set.

**Parameters** **Note:**

See [Point Code Formats and Conversion](#) for a detailed description of point code formats, rules for specification, and examples.

**pc (mandatory)**

ANSI point code with subfields *network indicator-network cluster-network cluster member (ni-nc-ncm)*.

**Synonym:**

*pca*

**Range:**

*000-255*

Specify a valid value for each subfield of the point code, and separate the subfields with a dash (-).

When *chg-sid:pctype=ansi* is specified, *ni = 000* is not valid.

When *chg-sid:pctype=ansi* is specified, *nc = 000* is not valid if *ni = 001–005*.

When *chg-sid:pctype=ansi* is specified, *nc = 000* is valid if *ni = 006–255*.

The point code *000-000-000* is not a valid point code.

**pc/pca/pci/pcn/pcn24/pcn16 (mandatory)**

Post-GTT-translated point code.

**pci (mandatory)**

ITU international point code with subfields *zone-area-id*. The *prefix* subfield indicates a spare point code (*prefix-zone-area-id*)



**Range:***s*-, 0-255

Specify a valid value for each subfield of the point code, and separate the subfields with a dash (-).

*prefix*—*s**zone*—0-7*area*—000-255*id*—0-7

The point code 0-000-0 is not a valid point code.

**pcn (mandatory)**

ITU national point code in the format of a 5-digit number (*nnnnn*); or 2, 3, or 4 numbers (members) separated by dashes (*m1-m2-m3-m4*) as defined by the `chg-stpopts:npcfmti` flexible point code option. A group code must be specified when the ITUDUPPC feature is turned on (*nnnnn-gc*, *m1-m2-m3-m4-gc*). The *prefix* subfield indicates a spare point code (*prefix-nnnnn*, *prefix-nnnnn-gc*, *prefix-m1-m2-m3-m4*, *prefix-m1-m2-m3-m4-gc*).

**Range:***s*-, 0-16383, *aa-zz*

Specify a valid value for each subfield of the point code, and separate the subfields with a dash (-).

*prefix*—*s*-*nnnnn*—0-16383*gc*—*aa-zz**m1-m2-m3-m4*—0-14 for each member; values must sum to 14**pcn24 (mandatory)**

24-bit ITU national point code with subfields *main signaling area-sub signaling area-signaling point* (*msa-ssa-sp*).

**Range:**

000-255

Specify a valid value for each subfield of the point code, and separate the subfields with a dash (-).

*msa*—000-255*ssa*—000-255*sp*—000-255**pcn16 (mandatory)**

16-bit ITU national point code with subfields *unit number-sub number area-main number area* (*un-sna-mna*).

**Range:**

000---127

Specify a valid value for each subfield of the point code, and separate the subfields with a dash (-).

*un*---000---127*sna*---000---15*mna*---000---31

**a11 (optional)**

This parameter is used to delete the entire group of point codes that contains the specified point code in the MRN table.

**Range:**

*yes*

**mapset (optional)**

Alternate RI Mate MAP Set ID.

**Range:**

*1 - 36000, dflt*

**mrnset (optional)**

The MRN set ID.

**Range:**

*1 - 3000, dflt*

*dflt* —Default MRN set

**pc1 (optional)**

ANSI point code with subfields *network indicator-network cluster-network cluster member (ni-nc-ncm)*.

**Synonym:**

*pca1*

**Range:**

*000-255*

Specify a valid value for each subfield of the point code, and separate the subfields with a dash (-).

When *chg-sid:pctype=ansi* is specified, *ni = 000* is not valid.

When *chg-sid:pctype=ansi* is specified, *nc = 000* is not valid if *ni = 001–005*.

When *chg-sid:pctype=ansi* is specified, *nc = 000* is valid if *ni = 006–255*.

The point code *000-000-000* is not a valid point code.

**pc1/pca1/pci1/pcn1/pcn241/pcn161 (optional)**

Alternate post-GTT-translated point code.

**pc2 (optional)**

ANSI point code with subfields *network indicator-network cluster-network cluster member (ni-nc-ncm)*.

**Synonym:**

*pca2*

**Range:**

*000-255*

Specify a valid value for each subfield of the point code, and separate the subfields with a dash (-).

When *chg-sid:pctype=ansi* is specified, *ni = 000* is not valid.

When *chg-sid:pctype=ansi* is specified, *nc = 000* is not valid if *ni = 001–005*.

When *chg-sid:pctype=ansi* is specified, *nc = 000* is valid if *ni = 006–255*.

The point code *000-000-000* is not a valid point code.

**pc2/pca2/pci2/pcn2/pcn242/pcn162 (optional)**

Alternate post-GTT-translated point code.

**pc3 (optional)**

ANSI point code with subfields *network indicator-network cluster-network cluster member (ni-nc-ncm)*.

**Synonym:**

*pca3*

**Range:**

*000-255*

Specify a valid value for each subfield of the point code, and separate the subfields with a dash (-).

When *chg-sid:pctype=ansi* is specified, *ni = 000* is not valid.

When *chg-sid:pctype=ansi* is specified, *nc = 000* is not valid if *ni = 001-005*.

When *chg-sid:pctype=ansi* is specified, *nc = 000* is valid if *ni = 006-255*.

The point code *000-000-000* is not a valid point code.

**pc3/pca3/pci3/pcn3/pcn243/pcn163 (optional)**

Post-GTT-translated point code.

**pc4 (optional)**

ANSI point code with subfields *network indicator-network cluster-network cluster member (ni-nc-ncm)*.

**Synonym:**

*pca4*

**Range:**

*000-255*

Specify a valid value for each subfield of the point code, and separate the subfields with a dash (-).

When *chg-sid:pctype=ansi* is specified, *ni = 000* is not valid.

When *chg-sid:pctype=ansi* is specified, *nc = 000* is not valid if *ni = 001-005*.

When *chg-sid:pctype=ansi* is specified, *nc = 000* is valid if *ni = 006-255*.

The point code *000-000-000* is not a valid point code.

**pc4/pca4/pci4/pcn4/pcn244/pcn164 (optional)**

Alternate post-GTT-translated point code.

**pci1 (optional)**

ITU international point code with subfields *zone-area-id*. The *prefix* subfield indicates a spare point code (*prefix-zone-area-id*)

**Range:**

*s-, 0-255*

Specify a valid value for each subfield of the point code, and separate the subfields with a dash (-).

*prefix—s*

*zone—0-7*

*area—000-255*

*id—0-7*

The point code *0-000-0* is not a valid point code.

**pci2 (optional)**

ITU international point code with subfields *zone-area-id*. The *prefix* subfield indicates a spare point code (*prefix-zone-area-id*)

**Range:**

*s*-, 0-255

Specify a valid value for each subfield of the point code, and separate the subfields with a dash (-).

*prefix*—*s*

*zone*—0-7

*area*—000-255

*id*—0-7

The point code 0-000-0 is not a valid point code.

**pci3 (optional)**

ITU international point code with subfields *zone-area-id*. The *prefix* subfield indicates a spare point code (*prefix-zone-area-id*)

**Range:**

*s*-, 0-255

Specify a valid value for each subfield of the point code, and separate the subfields with a dash (-).

*prefix*—*s*

*zone*—0-7

*area*—000-255

*id*—0-7

The point code 0-000-0 is not a valid point code.

**pci4 (optional)**

ITU international point code with subfields *zone-area-id*. The *prefix* subfield indicates a spare point code (*prefix-zone-area-id*)

**Range:**

*s*-, 0-255

Specify a valid value for each subfield of the point code, and separate the subfields with a dash (-).

*prefix*—*s*

*zone*—0-7

*area*—000-255

*id*—0-7

The point code 0-000-0 is not a valid point code.

**pcn1 (optional)**

ITU national point code in the format of a 5-digit number (*nnnnn*); or 2, 3, or 4 numbers (members) separated by dashes (*m1-m2-m3-m4*) as defined by the `chg-stpopts:npcfmti` flexible point code option. A group code must be specified when the ITUDUPPC feature is turned on (*nnnnn-gc*, *m1-m2-m3-m4-gc*). The *prefix* subfield indicates a spare point code (*prefix-nnnnn*, *prefix-nnnnn-gc*, *prefix-m1-m2-m3-m4*, *prefix-m1-m2-m3-m4-gc*).

**Range:**

*s*-, 0-16383, *aa-zz*

Specify a valid value for each subfield of the point code, and separate the subfields with a dash (-).

*prefix*—s-  
*nnnnn*—0-16383  
*gc*—aa-zz  
*m1-m2-m3-m4*—0-14 for each member; values must sum to 14

**pcn2 (optional)**

ITU national point code in the format of a 5-digit number (*nnnnn*); or 2, 3, or 4 numbers (members) separated by dashes (*m1-m2-m3-m4*) as defined by the `chg-stpopts:npcfmti` flexible point code option. A group code must be specified when the ITUDUPPC feature is turned on (*nnnnn-gc,m1-m2-m3-m4-gc*). The *prefix* subfield indicates a spare point code (*prefix-nnnnn, prefix-nnnnn-gc, prefix-m1-m2-m3-m4, prefix-m1-m2-m3-m4-gc*).

**Range:**

*s*-, 0-16383, *aa-zz*  
 Specify a valid value for each subfield of the point code, and separate the subfields with a dash (-).

*prefix*—s-  
*nnnnn*—0-16383  
*gc*—aa-zz  
*m1-m2-m3-m4*—0-14 for each member; values must sum to 14

**pcn241 (optional)**

24-bit ITU national point code with subfields *main signaling area-sub signaling area-signaling point* (*msa-ssa-sp*).

**Range:**

000-255  
 Specify a valid value for each subfield of the point code, and separate the subfields with a dash (-).  
*msa*—000–255  
*ssa*—000–255  
*sp*—000–255

**pcn242 (optional)**

24-bit ITU national point code with subfields *main signaling area-sub signaling area-signaling point* (*msa-ssa-sp*).

**Range:**

000-255  
 Specify a valid value for each subfield of the point code, and separate the subfields with a dash (-).  
*msa*—000–255  
*ssa*—000–255  
*sp*—000–255

**pcn243 (optional)**

24-bit ITU national point code with subfields *main signaling area-sub signaling area-signaling point* (*msa-ssa-sp*).

**Range:**

000-255  
 Specify a valid value for each subfield of the point code, and separate the subfields with a dash (-).

*msa—000–255*  
*ssa—000–255*  
*sp—000–255*

**pcn244 (optional)**

24-bit ITU national point code with subfields *main signaling area-sub signaling area-signaling point (msa-ssa-sp)*.

**Range:**

*000-255*

Specify a valid value for each subfield of the point code, and separate the subfields with a dash (-).

*msa—000–255*

*ssa—000–255*

*sp—000–255*

**pcn3 (optional)**

ITU national point code in the format of a 5-digit number (*nnnnn*); or 2, 3, or 4 numbers (members) separated by dashes (*m1-m2-m3-m4*) as defined by the `chg-stpopts:npcfmti` flexible point code option. A group code must be specified when the ITUDUPPC feature is turned on (*nnnnn-gc,m1-m2-m3-m4-gc*). The *prefix* subfield indicates a spare point code (*prefix-nnnnn, prefix-nnnnn-gc, prefix-m1-m2-m3-m4, prefix-m1-m2-m3-m4-gc*).

**Range:**

*s-, 0-16383, aa-zz*

Specify a valid value for each subfield of the point code, and separate the subfields with a dash (-).

*prefix—s-*

*nnnnn—0-16383*

*gc—aa-zz*

*m1-m2-m3-m4—0-14* for each member; values must sum to 14

**pcn4 (optional)**

ITU national point code in the format of a 5-digit number (*nnnnn*); or 2, 3, or 4 numbers (members) separated by dashes (*m1-m2-m3-m4*) as defined by the `chg-stpopts:npcfmti` flexible point code option. A group code must be specified when the ITUDUPPC feature is turned on (*nnnnn-gc, m1-m2-m3-m4-gc*). The *prefix* subfield indicates a spare point code (*prefix-nnnnn, prefix-nnnnn-gc, prefix-m1-m2-m3-m4, prefix-m1-m2-m3-m4-gc*).

**Range:**

*s-, 0-16383, aa-zz*

Specify a valid value for each subfield of the point code, and separate the subfields with a dash (-).

*prefix—s-*

*nnnnn—0-16383*

*gc—aa-zz*

*m1-m2-m3-m4—0-14* for each member; values must sum to 14

**pcn161 (optional)**

16-bit ITU national point code with subfields *unit number-sub number area-main number area (un-sna-mna)*.

**Range:***000---127*

Specify a valid value for each subfield of the point code, and separate the subfields with a dash (-).

*un---000---127**sna---000---15**mna---000---31***pcn162 (optional)**

16-bit ITU national point code with subfields *unit number-sub number area-main number area* (*un-sna-mna*).

**Range:***000---127*

Specify a valid value for each subfield of the point code, and separate the subfields with a dash (-).

*un---000---127**sna---000---15**mna---000---31***pcn163 (optional)**

16-bit ITU national point code with subfields *unit number-sub number area-main number area* (*un-sna-mna*).

**Range:***000---127*

Specify a valid value for each subfield of the point code, and separate the subfields with a dash (-).

*un---000---127**sna---000---15**mna---000---31***pcn164 (optional)**

16-bit ITU national point code with subfields *unit number-sub number area-main number area* (*un-sna-mna*).

**Range:***000---127*

Specify a valid value for each subfield of the point code, and separate the subfields with a dash (-).

*un---000---127*

```
sna---000---15
```

```
mna---000---31
```

### Example

This example deletes the entire entry for the specified point code (the point code plus all of its associated point codes):

```
dlt-mrn:pc=1-1-0
```

This example finds point codes 1-1-0 and 1-1-1, and deletes them from the group that contains them in the MRN table:

```
dlt-mrn:pc=1-1-0:pc1=1-1-1
```

This example deletes the entire group of point codes that contains the specified point code from the MRN table:

```
dlt-mrn:pc=1-1-0:all=yes
```

This examples includes a spare point codes:

```
dlt-mrn:pci=s-2-2-1
```

```
dlt-mrn:pc=1-1-9:mrnset=df1t
```

```
dlt-mrn:pc=1-1-1:pc1=1-1-9:mrnset=111
```

```
dlt-mrn:pc=1-1-9:all=yes:mrnset=111
```

This example deletes the Alternate RI Mate for MRN Set 111:

```
dlt-mrn:mrnset=111:mapset=123
```

This example deletes the Alternate RI Mate for the default MRN Set and PC 1-1-1:

```
dlt-mrn:mrnset=df1t:pc=1-1-1:mapset=123
```

This example deletes the entry from the MRN set:

```
dlt-mrn:mrnset=1:pc=1-1-1
```

Example for 16 bit PC entry:

```
dlt-mrn:pcn16=1-1-0:mrnset=df1t
```

### Dependencies

ITU-N point codes must be the format set by the `npcfmti` parameter of the `chg-stpopts` command. (Use the `rtrv-stpopts` command to display the STP option settings.)

A point code that is specified in the command must already exist in the MRN table.

The PCs in an entity set cannot be deleted if the deletion leaves only one PC in the entity set. If this occurs, the entire entity set must be deleted by specifying the `all=yes` parameter.

The `mrnset` parameter can be specified only when the Flexible GTT Load Sharing (FGTTLS) feature is enabled.

If the FGTTLS feature is enabled, then the specified PC must already exist in the specified MRN set.



The specified MRN set must already exist in the MRN table.

If the FGTTLS feature is enabled, then an MRN entry cannot be deleted if the entry is referenced in the MAP, GTT, GTA, GTT Action, or PPSOPTS table, using the MRNSET/PC combination. If the FGTTLS feature is not enabled, then the entry cannot be deleted if the entry is referenced in the GTT, GTA, GTT Action, or PPSOPTS table, using the point code.

If the `all=yes` parameter is specified, the `pc` parameter must be specified, and the `pc1/pc2/pc3/pc4` parameters cannot be specified.

The same point code value cannot be entered more than once for deletion.

The `pc/pc1/pc2/pc3/pc4` parameter values must be full point codes.

The GTT LS ARI feature must be enabled before the `mapset` parameter can be specified.

The value specified for the `mrnset` parameter must already be associated with a MAP Set.

The MAP table is corrupt or cannot be found.

If the `mapset` parameter is specified, then the `pc1`, `pc2`, `pc3`, `pc4`, and `all` parameters cannot be specified.

An MRN set cannot be deleted if the MRN set is referenced in the GTT table without an associated point code.

## Notes

For the MRN commands, an entity set consists of a group of PCs that are used for traffic distribution, and an RC group consists of PCs within an entity set that have the same RC. In loadsharing mode, an entity set contains 1 RC group. In combined/dominant loadsharing mode, an entity set can contain multiple loadsharing groups.

The EAGLE supports the following modes for nodes/subsystems:

- A group of replicated PCs are in *dominant* mode if each PC in the group has a unique RC. The specified subsystem with the lowest RC acts as the primary subsystem, while the mate subsystem acts as a backup. In the event of congestion, messages route to the mate subsystem. When the congestion subsides, messages are again routed to the primary (dominant) subsystem.
- A group of replicated PCs are in *load sharing* mode if each PC in the group has the same RC. All messages are evenly distributed at the SCCP level to all nodes/subsystems in the group. In the event of congestion or failure, the non-affected subsystem assumes the load of its failed or congested mate.
- The *combined load sharing/dominant* mode supports a combination of load sharing and dominant mode. A group of PC are in combined load sharing/dominant mode when at least two of the PC have the same RC and another node subsystem in the group has a different RC. A combination of node accessibility and RC determines the preferred PC.

In this command, only ITU-international and ITU national point codes support the spare point code subtype prefix (s-).

The Flexible Intermediate GTT Loadsharing feature adds support for loadsharing sets, which are identified by the `mrnset` parameter.

The Flexible GTT Loadsharing feature and the Intermediate GTT Loadsharing feature used together support MRN sets for flexible intermediate GTT loadsharing.

When the Weighted GTT Loadsharing feature is turned on, weighted entity sets and RC groups are supported, and threshold values can be assigned to each PC/SSN.

E3358 was deleted in release 44.0 for PR 168592.

### Output

```
dlt-mrn:pc=1-1-1:mrnset=111
```

```
tekelecstp 08-12-22 12:20:10 EST EAGLE 40.1.0  
DLT-MRN : MASP A - COMPLTD
```

```
;
```

```
dlt-mrn:mrnset=111:mapset=123
```

```
tekelecstp 08-12-22 12:20:10 EST EAGLE 40.1.0  
DLT-MRN : MASP A - COMPLTD
```

```
;
```

### Related Topics

- [chg-mrn](#)
- [ent-mrn](#)
- [rtv-mrn](#)

## dlt-na

Use this command to delete a previously defined network appearance.

### Parameters

#### **na (mandatory)**

Network appearance.

#### **Range:**

0 - 4294967295

#### **type (mandatory)**

Type of the network appearance to be deleted.

#### **Range:**

*ansi*

*itui*

*ituis*

*itun*

*ituns*

*itun24*

*itun16*

**gc (optional)**

Group Code of the network appearance.

**Range:**

*yy*

2 alphabetic characters; valid values are *aa-zz*

**Example**

```
dlt-na:type=ansi:na=10
```

```
dlt-na:type=itui:na=11
```

```
dlt-na:type=itun:na=10
```

```
dlt-na:type=itun:na=11:gc=fr
```

**Dependencies**

If a value of *ansi*, *itui*, *ituis*, *itun16*, or *itun24* is specified for the `type` parameter, then the `gc` parameter cannot be specified.

The specified network appearance must exist in the Network Appearance table

**Notes**

The ITUDUPPC feature must be turned on before a group code can be deleted for an ITU-N network type

**Output**

```
dlt-na:pstncat=5000:pstnid=1:force=yes
```

```
rlghncxa03w 04-02-20 09:07:58 EST EAGLE 31.3.0  
DLT-NA: MASP A - COMPLTD  
;
```

**Related Topics**

- [ent-na](#)
- [rtrv-na](#)

## dlt-npp-as

Use this command to delete an NPP Action Set (AS) entry.

## Parameters

### **asn (mandatory)**

Action set name. This parameter specifies the name of the AS.

#### **Range:**

ayyyyyyyyy

1 alphabetic character followed by up to 9 alphanumeric characters

## Example

```
dlt-npp-as:asn=asn1
```

## Dependencies

The value specified for the `asn` parameter must exist in the NPP AS table.

If the AS is referenced by a NPP Service Rule Set, then this command cannot be entered.

## Output

```
dlt-npp-as:asn=asn1
```

```
tekelecstp 09-02-19 13:57:06 EST EAGLE 40.1.0  
NPP-AS table is (4 of 1024) 1% full.
```

```
DLT-NPP-AS: MASP A - COMPLTD
```

```
;
```

## Related Topics

- [chg-npp-as](#)
- [dlt-npp-srs](#)
- [ent-npp-as](#)
- [rtrv-npp-as](#)

# dlt-npp-srs

Use this command to delete an NPP Service Rule Set (SRS).

## Parameters

### **fdl (mandatory)**

Filter digit length. The number of digits on the incoming digit string that is filtered by the NPP.

#### **Range:**

1 - 32, \*

\*—multiple lengths of messages can be filtered

### **fnai (mandatory)**

Filter Nature of Address Indicator (NAI).

**Range:**

***intl***

filter messages with NAI=INTL

***natl***

filter messages with NAI=NATL

***nai1***

filter messages with NAI=NAI1

***nai2***

filter messages with NAI=NAI2

***nai3***

filter messages with NAI=NAI3

***unkn***

filter messages when the NAI is unknown

**fpfx (mandatory)**

Filter prefix. The prefix used to filter incoming digit strings.

**Range:**

1-16 digits, ?, \*

1 - 16 hexadecimal digits inclusive of single digit wildcard (?); or wildcard (\*)  
matching the entire digit string;

Valid values are 0-9, a-f, A-F, ?, \*

**srvn (mandatory)**

Service name. The name of the NPP Service.

**Range:**

***nppt***

NPP Test Service

***idprcdpn***

IDPRCDPN Service

***idprcgpn***

IDPRCGPN Service

***tif***

TIF Service

***tif2***

TIF2 Service

***tif3***

TIF3 Service

***mosmsicgpn***

MOSMSICGPN Service

***mosmsicdpn***  
MOSMSICDPN Service

***mosmsgcgpn***  
MOSMSGCGPN Service

***mosmsgcdpn***  
MOSMSGCDPN Service

***iarcdpn***  
IARCDPN Service

***iarcgpn***  
IARCGPN Service

***idprcdpn2***  
IDPRCDPN2 Service

***idprcdpn3***  
IDPRCDPN3 Service

***idprcdpn4***  
IDPRCDPN4 Service

***tifcgpn***  
TIFCGPN Service

***tifcgpn2***  
TIFCGPN2 Service

***tifcgpn3***  
TIFCGPN3 Service

### Example

```
dlt-npp-srs:svn=nppt:fpfx=a:fdl=10:fnai=intl  
dlt-npp-srs:svn=idprcdpn4:fnai=intl:fdl=12:fpfx=91
```

### Dependencies

The NPP Rule must exist in the NPP Rule table.

### Notes

MTT 4945 deleted for PR 194868 in rel 43.0

None

### Output

```
dlt-npp-srs:svn=nppt:fpfx=abc:fdl=16:fnai=intl
```

```
tekelecstp 09-02-19 13:57:01 EST EAGLE 40.1.0  
NPP-SRS table is (0 of 8192) 0% full.
```

```
DLT-NPP-SRS: MASP A - COMPLTD
;
```

### Related Topics

- [chg-npp-as](#)
- [chg-npp-srs](#)
- [dlt-npp-srs](#)
- [ent-npp-as](#)
- [rtrv-npp-as](#)
- [rtrv-npp-srs](#)

## dlt-pct

Use this command to delete a Point Code and CIC Translation.

### Parameters

#### **epc (mandatory)**

ANSI point code with subfields *network indicator-network cluster-network cluster member (ni-nc-ncm)*.

#### **Synonym:**

*epca*

#### **Range:**

*000-255*

Specify a valid value for each subfield of the point code, and separate the subfields with a dash (-).

When *chg-sid:pctype=ansi* is specified, *ni = 000* is not valid.

When *chg-sid:pctype=ansi* is specified, *nc = 000* is not valid if *ni = 001-005*.

When *chg-sid:pctype=ansi* is specified, *nc = 000* is valid if *ni = 006-255*.

The point code *000-000-000* is not a valid point code.

#### **epci (mandatory)**

ITU international destination point code with subfields *zone-area-id*.

#### **Range:**

*0-255*

Specify a valid value for each subfield of the point code, and separate the subfields with a dash (-).

*zone—0-7*

*area—000-255*

*id—0-7*

The point code *0-000-0* is not a valid point code.

#### **epcn (mandatory)**

ITU national point code in the format of a 5-digit number (*nnnnn*); or 2, 3, or 4 numbers (members) separated by dashes (*m1-m2-m3-m4*) as defined by the *chg-stpopts:npcfmti* flexible point code option. A group code must be specified when the ITUDUPPC feature is turned on (*nnnnn-gc*, *m1-m2-m3-m4-gc*).

**Range:***0-16383, aa-zz*

Specify a valid value for each subfield of the point code, and separate the subfields with a dash (-).

*nnnnn—0-16383**gc—aa-zz**m1-m2-m3-m4—0-14* for each member; values must sum to 14**realpc (mandatory)**ANSI point code with subfields *network indicator-network cluster-network cluster member (ni-nc-ncm)*.**Synonym:***realpca***Range:***000-255*

Specify a valid value for each subfield of the point code, and separate the subfields with a dash (-).

When *chg-sid:pctype=ansi* is specified, *ni = 000* is not valid.When *chg-sid:pctype=ansi* is specified, *nc = 000* is not valid if *ni = 001–005*.When *chg-sid:pctype=ansi* is specified, *nc = 000* is valid if *ni = 006–255*.The point code *000-000-000* is not a valid point code.**realpci (mandatory)**ITU international destination point code with subfields *zone-area-id*.**Range:***0-255*

Specify a valid value for each subfield of the point code, and separate the subfields with a dash (-).

*zone—0-7**area—000-255**id—0-7*The point code *0-000-0* is not a valid point code.**realpcn (mandatory)**ITU national point code in the format of a 5-digit number (*nnnnn*); or 2, 3, or 4 numbers (members) separated by dashes (*m1-m2-m3-m4*) as defined by the *chg-stpopts:npcfmti* flexible point code option. A group code must be specified when the ITUDUPPC feature is turned on (*nnnnn-gc, m1-m2-m3-m4-gc*).**Range:***0-16383, aa-zz*

Specify a valid value for each subfield of the point code, and separate the subfields with a dash (-).

*nnnnn—0-16383**gc—aa-zz**m1-m2-m3-m4—0-14* for each member; values must sum to 14**ecice (optional)**

The end of the Emulated Circuit Identification Code range.



**Range:**

0 - 16383, 0 - 4095, 0 - 4294967295, \*  
 0-4095—ITU TUP/ISUP  
 0-16383—ANSI ISUP  
 0-4294967295—ANSI Q.BICC

**Default:**

\*

**ecics (optional)**

The start of the Emulated Circuit Identification Code range.

**Range: 0 - 16383, 0 - 4095, 0 - 4294967295, \***

0-4095 —ITU TUP/ISUP  
 0-16383 —ANSI ISUP  
 0-4294967295 —ANSI Q.BICC

**Default:**

\*

**filtpc (optional)**

ANSI point code with subfields *network indicator-network cluster-network cluster member (ni-nc-ncm)*.

**Synonym:**

*filtpca*

**Range:**

0-255, \*

Specify a valid value for each subfield of the point code, and separate the subfields with a dash (-).

The asterisk (\*) value is not valid for the *ni* subfield.

When *chg-sid:pctype=ansi* is specified, *ni=000* is not valid.

When *chg-sid:pctype=ansi* is specified, *nc = 000* is not valid if *ni=001–005*.

When *chg-sid:pctype=ansi* is specified, *nc=000* is valid if *ni=006–255*.

When *chg-sid:pctype=ansi* is specified, *ni-\*.\** is valid if *ni =006–255*.

The point code *000-000-000* is not a valid point code.

**filtpci (optional)**

ITU international destination point code with subfields *zone-area-id*.

**Range:**

0-255, \*

Specify a valid value for each subfield of the point code, and separate the subfields with a dash (-).

*zone—0-7*

*area—000-255*

*id—0-7*

The point code *0-000-0* is not a valid point code.

**filtpcn (optional)**

ITU national point code in the format of a 5-digit number (*nnnnn*); or 2, 3, or 4 numbers (members) separated by dashes (*m1-m2-m3-m4*) as defined by the *chg-stpopts:npcfmti* flexible point code option. A group code must be specified when the ITUDUPPC feature is turned on (*nnnnn-gc, m1-m2-m3-m4-gc*).

**Range:**

16363, aa-zz, \*

Specify a valid value for each subfield of the point code, and separate the subfields with a dash (-).

*nnnnn*—0-16383

*gc*—aa-zz

*m1-m2-m3-m4*—0-14 for each member; values must sum to 14

**rcice (optional)**

The end of the Real Circuit Identification Code range.

**Range:**

0 - 4294967295, \*

0-4095—ITU TUP/ISUP

0-16383 —ANSI ISUP

0-4294967295 —ANSI Q.BICC

**Default:**

\*

**rcics (optional)**

The start of the Real Circuit Identification Code range.

**Range:**

0 - 4294967295, \*

0-4095 —ITU TUP/ISUP

0-16383 —ANSI ISUP

0-4294967295 —ANSI Q.BICC

**Default:**

\*

**si (optional)**

Service Indicator

**Range:**

**0**

NM

**3**

SCCP

**5**

ISUP

**4**

TUP

**13**

ANSI Q. BICC

**Default:**

\*

**ssn (optional)**

SCCP Subsystem number

**Range:**

0 - 255, \*

**Default:**

\*

**Example**

```
dlt-pct:epc=1-1-1:si=3:ssn=10
```

```
dlt-pct:realpc=2-2-2:si=5:ecics=20
```

**Dependencies**

The values specified for the `epc/epca/epci/epcn`, `filtpc/filtpca/filtpci/filtpcn`, and `realpc/realpca/realpci/realpcn` parameters must be within the range specified by the parameter definition.

The value specified for the `ecice` or `rcice` parameter must be equal to or greater than the value specified for the `ecics` or `rcics` parameter, respectively.

A full point code must be specified as the value for the `realpc/realpca/realpci/realpcn` and `epc/epca/epci/epcn` parameters.

A PCT quantity feature must be enabled before this command can be entered.

If the ITUDUPPC feature is on, and ITU-N Point codes are specified, then the values specified for the `epcn`, `realpcn`, and `filtpcn` parameters must have the same group code.

The Point Code and CIC Translation (PCT) table is corrupt or cannot be found.

The values specified for the `epc/epca/epci/epcn`, `filtpc/filtpca/filtpci/filtpcn`, and `realpc/realpca/realpci/realpcn` parameters must have the same domain.

If the `ssn` or `ecics` parameter is specified, then the `si` parameter must be specified.

A spare point code cannot be specified as a value for the `epci/epcn`, `filtpci/filtpcn`, and `realpci/realpcn` parameters.

A PCT translation entry with the specified parameters must exist.

The `si=3` parameter must be specified before the `ssn` parameter can be specified.

If the `ecice` or `rcice` parameter is specified, then the `ecics` or `rcics` parameter must be specified, respectively.

If the `rcics` parameter is specified, then the `ecics` parameter must be specified.

If the `ecics`, `ecice`, and `rcics` parameters are specified, then the `rcice` parameter must be specified.

A value of 4, 5, or 13 must be specified for the `si` parameter before the `ecice/ecics` and `rcice/rcics` parameters can be specified.

The values specified for the `epc/epca/epci/epcn`, `filtpc/filtpca/filtpci/filtpcn`, and `realpc/realpca/realpci/realpcn` parameters cannot be the same as the STP point code.

The values specified for the `epc/epca/epci/epcn`, `filtpc/filtpca/filtpci/filtpcn`, and `realpc/realpca/realpci/realpcn` parameters cannot be the same as the STP capability point code.

The values specified for the `realpc/realpca/realpci/realpcn` and `filtpc/filtpca/filtpci/filtpcn` parameters must already exist in the Route table.

The values specified for the `realpc/realpca/realpci/realpcn` and `filtpc/filtpca/filtpci/filtpcn` parameters must have at least one route for each value defined in the Route table.

The value specified for the `ecics/ecice` and `rcics/rcice` parameters must be within the range specified by the parameter definition.

The difference between the values specified for the `ecice` and `ecics` parameters must be equal to the difference between the values specified for the `rcice` and `rcics` parameters.

The `ssn` and `cic` parameters cannot be specified together in the command.

If the `ecics`, `rcics` and `rcice` parameters are specified, then the `ecice` parameter must be specified.

If the same value is specified for the `epc` and `realpc` parameters, then the values specified for the `ecics/ecice` and `rcics/rcice` parameters cannot indicate the same range.

Only one of the `filtpca`, `filtpci`, and `filtpcn` parameters can be specified in the command.

The value specified for the `epc/epci/epcn` parameter cannot be the same as a secondary point code.

### Output

```
dlt-pct:epc=1-1-1:realpc=5-5-5:si=3:ssn=10
```

```
tekelecstp 10-08-10 18:29:41 EST EAGLE 43.0.0
dlt-pct:epc=1-1-1:realpc=5-5-5:si=3:ssn=10
Command entered at terminal #4.
DLT-PCT: MASP A - COMPLTD
;
```

### Related Topics

- [ent-pct](#)
- [rtrv-pct](#)

## dlt-prefix

Use this command to delete a prefix based on the name of the feature, its prefix, and its prefix number.



**Default:**  
Current value

### Example

Delete a prefix with prefix number 1 for the ISUP NP with EPAP feature.

```
dlt-prefix:feature="isup np with epap":prefix=1004:prefixnum=1
```

Delete a prefix with prefix number 2 and specify part of the GSM MAP SRI Redirect feature name.

```
dlt-prefix:feature="GSM MAP SRI":prefix=104:prefixnum=2
```

### Dependencies

The specified feature name must be the name of an enabled controlled feature as it is displayed in the `rtrv-ctrl-feat` command output. The specified feature must be one of the following features that are supported by this command:

- GSM MAP SRI Redirect
- ISUP NP for EPAP

The specified feature prefix value must already exist in the database.

The specified feature prefix value must not be used by the specified feature in the database.

The FEATPFX table is corrupt or cannot be found by the system.

### Notes

None

### Output

```
dlt-prefix:feature="isup np with epap":prefix=1004:prefixnum=1
```

```
rlghncxa03w 04-09-20 09:04:14 EST EAGLE 31.11.0  
DLT-PREFIX: MASP A - COMPLTD  
;
```

### Related Topics

- [chg-prefix](#)
- [rtrv-ctrl-feat](#)
- [rtrv-prefix](#)

## dlt-rmt-appl

Use this command to remove remote application assignments from the database.

## Parameters

### **ipc (mandatory)**

ANSI point code with subfields *network indicator-network cluster-network cluster member (ni-nc-ncm)*. The *prefix* subfield indicates a private point code (*prefix-ni-nc-ncm*).

#### **Synonym:**

*ipca*

#### **Range:**

*p-*, 000-255

Specify a valid value for each subfield of the point code, and separate the subfields with a dash (-).

*prefix—p-*

When *chg-sid:pctype=ansi* is specified, *ni = 000* is not valid.

When *chg-sid:pctype=ansi* is specified, *nc = 000* is not valid if *ni = 001-005*.

When *chg-sid:pctype=ansi* is specified, *nc = 000* is valid if *ni = 006-255*.

The point code *000-000-000* is not a valid point code.

### **ipc/ipca/ipci/ipcn/ipcn24/ipcn16 (mandatory)**

End node's internal point code.

### **ipci (mandatory)**

ITU international point code with subfields *zone-area-id*. The *prefix* subfield indicates a spare point code, private point code, or private and spare point code (*prefix-zone-area-id*).

#### **Range:**

*s-*, *p-*, *ps-*, 0-255

Specify a valid value for each subfield of the point code, and separate the subfields with a dash (-).

*prefix—s-*, *p-*, *ps*

*zone—0-7*

*area—000-255*

*id—0-7*

The point code *0-000-0* is not a valid point code.

### **ipcn (mandatory)**

ITU national point code in the format of a 5-digit number (*nnnnn*); or 2, 3, or 4 numbers (members) separated by dashes (*m1-m2-m3-m4*) as defined by the *chg-stpopts:npcfmti* flexible point code option. A group code must be specified when the ITUDUPPC feature is turned on (*nnnnn-gc*, *m1-m2-m3-m4-gc*). The *prefix* subfield indicates a spare point code, private point code, or private and spare point code (*prefix-nnnnn*, *prefix-nnnnn-gc*, *prefix-m1-m2-m3-m4*, *prefix-m1-m2-m3-m4-gc*).

#### **Range:**

*s-*, *p-*, *ps-*, 0-16383, *aa-zz*

Specify a valid value for each subfield of the point code, and separate the subfields with a dash (-).

*prefix—s-*, *p-*, *ps*

*nnnnn—0-16383*

*gc—aa-zz*

*m1-m2-m3-m4—0-14* for each member; values must sum to 14

**ipcn24 (mandatory)**

24-bit ITU national point code with subfields *main signaling area-sub signaling area-signaling point (msa-ssa-sp)*. The *prefix* indicates a private point code (*prefix-msa-ssa-sp*).

**Range:**

*p*-, 000-255

Specify a valid value for each subfield of the point code, and separate the subfields with a dash (-).

*prefix—p*

*msa—000—255*

*ssa—000—255*

*sp—000—255*

**ipcn16 (mandatory)**

16-bit ITU national point code with subfields *unit number-sub number area-main number area (un-sna-mna)*. The *prefix* indicates a private point code (*prefix-un-sna-mna*).

**Range:**

*p*-, 000---127

Specify a valid value for each subfield of the point code, and separate the subfields with a dash (-).

*prefix---p*

*un---000---127*

*sna---000---15*

*mna---000---31*

**si (mandatory)**

Service indicator value that designates which user part is assigned to IPC.

**Range:**

3 - 15

**ssn (optional)**

SCCP subsystem number. Valid only if *si*=3. This parameter is the starting value of the range if the *ssne* parameter is specified.

**Range:**

0 - 255

**ssne (optional)**

Specifies the end range of subsystem number.

**Range:**

1 - 255

**Example**

```
dlt-rmt-appl:ipc=0-0-1:si=3:ssn=5
```

```
dlt-rmt-appl:ipc=0-0-1:si=5
```

```
dlt-rmt-appl:ipcn24=1-100-1:si=5
```



```
dlt-rmt-appl:ipci=ps-2-2-2:si=5
```

```
dlt-rmt-appl:ipcn16=1-2-1:si=5
```

### Dependencies

Partial point codes are not allowed.

The `ssn` parameter is required if `si=3`.

The `ssn` and `ssne` parameters are not allowed unless `si=3`.

The `ssne` parameter value must be greater than the `ssn` parameter value.

The specified `ipc` must be previously defined in the Destination table.

The new entry cannot conflict with an existing entry.

The `ipc`, `si`, `ssn`, and `ssne` parameter values must all match a value in the Destination table.

### Notes

To specify a range of subsystem numbers, specify the `ssn` parameter value as the start of the range and the `ssne` parameter value as the end of the range.

In this command, only ITU-international and ITU national point codes support the spare point code subtype prefix (s-) and the private and spare point code subtype prefix (ps-). All of the point code types support the private (internal) point code subtype prefix (p-).

### Output

```
dlt-rmt-appl:ipc=0-0-1:si=3:ssn=5
```

```
rlghncxa03w 04-01-07 11:43:04 EST EAGLE 31.3.0
DLT-RMT-APPL: MASP A - COMPLTD
;
```

### Related Topics

- [ent-rmt-appl](#)
- [rtrv-rmt-appl](#)

## dlt-rte

Use this command to remove either a single route or all routes from the system database.

## Parameters

 **Note:**

See [Point Code Formats and Conversion](#) for a detailed description of point code formats, rules for specification, and examples.

The `dpc/dpca/dpci/dpcn/dpcn24/dpcn16` or `cic` parameter must be specified. If the `dpc/dpca/dpci/dpcn/dpcn24/dpcn16` parameter is specified, then action is taken upon the historic routes of the destination entity only.

### **a11 (optional)**

This parameter removes all destinations from the system database.

**Range:**

`yes`

**Default:**

`no`

### **dpc (optional)**

ANSI destination point code with subfields *network indicator-network cluster-network cluster member (ni-nc-ncm)*. The *prefix* subfield indicates a private point code (*prefix-ni-nc-ncm*).

**Synonym:**

`dpca`

**Range:**

`p-, 000-255, *`

Specify a valid value for each subfield of the point code, and separate the subfields with a dash (-).

*prefix—p-*

The asterisk value (\*) is not valid for the *ni* subfield.

When `chg-sid:pctype=ansi` is specified, *ni = 000* is not valid.

When `chg-sid:pctype=ansi` is specified, *nc = 000* is not valid if *ni = 001–005*.

When `chg-sid:pctype=ansi` is specified, *nc = 000* is valid if *ni = 006–255*.

The point code `000-000-000` is not a valid point code.

### **dpc/dpca/dpci/dpcn/dpcn24/dpcn16 (optional)**

Destination point code.

### **dpci (optional)**

ITU international destination point code with subfields *zone-area-id*. The *prefix* subfield indicates a spare point code, private point code, or private and spare point code (*prefix-zone-area-id*).

**Range:**

`s-, p-, ps-, 0-255`

Specify a valid value for each subfield of the point code, and separate the subfields with a dash (-).

*prefix*—*s*-, *p*-, *ps*  
*zone*—0-7  
*area*—000-255  
*id*—0-7

The point code 0-000-0 is not a valid point code.

#### **dpcn (optional)**

ITU national destination point code in the format of a 5-digit number (*nnnnn*); or 2, 3, or 4 numbers (members) separated by dashes (*m1-m2-m3-m4*) as defined by the `chg-stpopts:npcfmti` flexible point code option. A group code must be specified when the ITUDUPPC feature is turned on (*nnnnn-gc*, *m1-m2-m3-m4-gc*). The *prefix* subfield indicates a spare point code, private point code, or private and spare point code (*prefix-nnnnn*, *prefix-nnnnn-gc*, *prefix-m1-m2-m3-m4*, *prefix-m1-m2-m3-m4-gc*).

#### **Range:**

*s*-, *p*-, *ps*-, 0-16383, *aa-zz*

Specify a valid value for each subfield of the point code, and separate the subfields with a dash (-).

*prefix*—*s*-, *p*-, *ps*

*nnnnn*—0-16383

*gc*—*aa-zz*

*m1-m2-m3-m4*—0-14 for each member; values must sum to 14

#### **dpcn24 (optional)**

24-bit ITU national point code with subfields *main signaling area-sub signaling area-signaling point* (*msa-ssa-sp*). The *prefix* subfield indicates a private point code (*prefix-msa-ssa-sp*).

#### **Range:**

*p*-, 000-255

Specify a valid value for each subfield of the point code, and separate the subfields with a dash (-).

*prefix*—*p*

*msa*—000-255

*ssa*—000-255

*sp*—000-255

#### **dpcn16 (optional)**

16-bit ITU national point code with subfields *unit number sub number area main number area* (*un-sna-mna*). The *prefix* subfield indicates a private point code (*prefix-un-sna-mna*).

#### **Range:**

*p*--, 000--127

Specify a valid value for each subfield of the point code, and separate the subfields with a dash (-).

*prefix*---*p*

*un*---000---127

*sna*---000---15

*mna*---000---31

**lsn (optional)**

The name of the linkset associated with the route.

**Note:**

This parameter must be specified when the `all` parameter is not specified, and cannot be specified when the `all=yes` parameter is specified.

**Range:**

ayyyyyyyy

1 alphabetic character followed by 9 alphanumeric characters

**Default:**

No linkset name is specified

**Example**

Delete route to DPC 1-1-1 using linkset HQ435326:

```
dlt-rte:dpc=1-1-1:lsn=hq435326
```

Delete all routes to DPC 2-2-2:

```
dlt-rte:dpc=2-2-2:all=yes
```

Delete route to DPCN 3-15-15-15-sp using link E1M2ITUN:

```
dlt-rte:dpcn=3-15-15-15-sp:lsn=e1m2itun
```

Delete route for DPCN24 10-100-14 using linkset WE123624:

```
dlt-rte:dpcn24=10-100-14:lsn=we123624:rc=10
```

Delete route to private point code DPC p-1-1-1 using linkset HQ 325426:

```
dlt-rte:dpc=p-1-1-1:lsn=hq325426
```

Delete all routes to private point code DPC p-21-\*-\*:

```
dlt-rte:dpc=p-21-*-*:all=yes
```

Delete route to spare point code DPCI s-1-100-1 using linkset WE123624:

```
dlt-rte:dpci=s-1-100-1:lsn=we123624
```

Delete route to spare point code DPCN16 121-10-15 using linkset WE123624:

```
dlt-rte:dpcn16=121-10-15:lsn=we123624
```

**Dependencies**

The `dpc/dpca/dpci/dpcn/dpcn24/dpcn16` parameter must exist in the Destination Point Code table.

The value of the `lsn` parameter must exist in the Linkset table.

If the `all=yes` parameter is specified, then the `lsn` parameter cannot be specified.

At least one optional parameter must be specified.

The destination point code of a route must be a full point code (*ni-nc-ncm*) or a cluster point code (*ni-nc-\**).

If the specified destination address is a full point code address (*ni-nc-ncm*) and is a member of a provisioned cluster (*ni-nc-\**), then whether the ordered routes can be deleted is determined by the destination address's nested cluster allowed indicator. This value is set with the `ncai` parameter of the `ent/chg-dstn` commands:

- If the `ncai=no` parameter is specified, then the ordered route cannot be deleted.
- If the `ncai=yes` parameter is specified, then the destination address is a member of a provisioned nested cluster where the ordered routes of the provisioned members can be deleted. Deletion of the ordered routes of a provisioned member results in the provisioned member assuming the attributes of its cluster

If the specified destination address is a network cluster address (*ni-nc-\**), then the method used to delete the specified ordered route attributes is determined by the setting of the destination address's nested cluster allowed indicator. This value is set with the `ncai` parameter of the `ent/chg-dstn` commands.

- If the `ncai=no` parameter is specified, then the specified ordered route is deleted for each signaling point code having the same network identifier (*ni*) and network cluster (*nc*) codes.
- If the `ncai=yes` parameter is specified, then the specified destination is a nested cluster where deletion of the cluster route will not delete the ordered route of the provisioned member.

If the `dpcn` parameter is specified, the format of the point code(s) must match the format you assigned with the `chg-stpopts:npcfmti` parameter.

The last route for the specified destination point code being removed cannot be referenced by a mated application, or a concerned signaling point code. If any of the destinations referencing the specified routset exist in the MAP table, then the last route of the routeset cannot be deleted.

If any of the destinations referencing the routset is used by the redirect function, then the last route of the routeset cannot be deleted.

The last route to a destination point code that exists in the MRN table cannot be deleted until the point code is deleted from the MRN table. If any of the destinations referencing the specified routset exists in the MRN table, then the last route of the routeset cannot be deleted.

The last route to a destination point code that still exists in the Concerned Secondary Point Code (CSPC) table cannot be deleted until the point code is deleted from the CSPC table. If any of the destinations referencing the routset exist in the CSPC table, then the last route of the routeset cannot be deleted.

If the destination point codes associated with the routeset are referenced by GTT, then the last route cannot be deleted. If the last route to a destination point code is referenced by a GTT, then the route cannot be deleted until one of the following actions is performed:

- Delete the GTT using the route's destination.
- Change the route used by the GTT to a route using a different destination.
- Add another route using the same destination.

The NRT feature must be turned on before the `dpc/dpca` parameter can be specified.

When using network routing, if the destination point code has a value of \* in the *nc* field, the *ncm* field must also be \* (for example, `dpc=21-*-*`).

If the routeset does not contain routes, then the `all=yes` parameter cannot be specified.

If the destination point code is specified, then the linkset must exist in the historic routeset.

The Route table is corrupt or cannot be found.

The Linkset table is corrupt or cannot be found.

The Redirect table is corrupt or cannot be found.

The last route to a destination that contains exception routes cannot be deleted. If any of the destinations referencing the specified routset contains exception routes, then the last route of the routeset cannot be deleted.

If a cluster point code is provisioned with `ncal=no`, and any cluster member has an associated exception route, then the routeset cannot be deleted using the `all=yes` parameter.

The Route Exception table is corrupt or cannot be found.

The value of the `dpc/dpca/dpci/dpcn/dpcn24/dpcn16` parameter cannot exist in the Application Filter table.

The last route to a destination point code that still exists in the Prepaid SMS Options (PPSOPTS) table cannot be deleted until the point code is deleted from the PPSOPTS table. If any of the destinations referencing the routset exist in the PPSOPTS table, then the last route of the routeset cannot be deleted.

If multiple routes are assigned to a point code, then the route that uses the proxy linkset must be the final route that is deleted.

The network type of the linkset and routeset must match.

The last route to a destination point code that exists in the PCT table cannot be deleted until the Filter Point Code or the Real Point Code is deleted from the table.

The Prepaid SMS Options Table must be available.

## Notes

In this command, only ITU-international and ITU national point codes support the spare point code subtype prefix (s-) and the private and spare point code subtype prefix (ps-). All of the point code types support the private (internal) point code subtype prefix (p-).

## Output

```
dlt-rte:dpc=1-1-1:lsn=1s01

rlghncxa03w 04-01-07 11:43:04 EST  EAGLE 31.3.0
DLT-RTE: MASP A - COMPLTD
;
```

This example shows the output when the GTT feature is turned on:

```
dlt-rte:dpc=2-2-2:all=yes
```

```
rlghncxa03w 10-03-06 11:43:04 EST EAGLE 42.0.0
WARNING - ROUTE MAY BE REFERENCED BY MAP OR CSPC.
DLT-RTE: MASP A - COMPLTD
```

```
;
```

### Related Topics

- [chg-dstn](#)
- [chg-rte](#)
- [dlt-dstn](#)
- [ent-dstn](#)
- [ent-rte](#)
- [rept-stat-dstn](#)
- [rept-stat-rte](#)
- [rtrv-dstn](#)
- [rtrv-rte](#)

## dlt-rtx

Use this command to delete an exception route entry. If only the `dpc` and criteria (`opc/ilsn/cic/si`) parameters are specified, then all exception route entries associated with those parameters are deleted.

### Parameters

#### **dpc (mandatory)**

ANSI destination point code with subfields *network indicator-network-cluster-network cluster member (ni-nc-ncm)*. The *prefix* subfield indicates a private point code (*prefix-ni-nc-ncm*).

#### **Synonym:**

*dpca*

#### **Range:**

*p-*, 000-255

Specify a valid value for each subfield of the point code, and separate the subfields with a dash (-).

*prefix—p-*

When `chg-sid:pctype=ansi` is specified, *ni = 000* is not valid.

When `chg-sid:pctype=ansi` is specified, *nc = 000* is not valid if *ni = 001-005*.

When `chg-sid:pctype=ansi` is specified, *nc = 000* is valid if *ni = 006-255*.

The point code *000-000-000* is not a valid point code.

#### **dpc/dpca/dpci/dpcn/dpcn24/dpcn16 (mandatory)**

Destination point code.

**dpci (mandatory)**

ITU international point code with subfields *zone-area-id*. The *prefix* subfield indicates a spare point code, private point code, or private and spare point code (*prefix-zone-area-id*).

**Range:**

*s-, p-, ps-, 0-255*

Specify a valid value for each subfield of the point code, and separate the subfields with a dash (-).

*prefix—s-, p-, ps*

*zone—0-7*

*area—000-255*

*id—0-7*

The point code *0-000-0* is not a valid point code.

**dpcn (mandatory)**

ITU national point code in the format of a 5-digit number (*nnnnn*); or 2, 3, or 4 numbers (members) separated by dashes (*m1-m2-m3-m4*) as defined by the `chg-stpopts:npcfmti` flexible point code option. A group code must be specified when the ITUDUPPC feature is turned on (*nnnnn-gc, m1-m2-m3-m4-gc*). The *prefix* subfield indicates a spare point code, private point code, or private and spare point code (*prefix-nnnnn, prefix-nnnnn-gc, prefix-m1-m2-m3-m4, prefix-m1-m2-m3-m4-gc*).

**Range:**

*s-, p-, ps-, 0-16383, aa-zz*

Specify a valid value for each subfield of the point code, and separate the subfields with a dash (-).

*prefix—s-, p-, ps*

*nnnnn—0-16383*

*gc—aa-zz*

*m1-m2-m3-m4—0-14* for each member; values must sum to 14

**dpcn24 (mandatory)**

24-bit ITU national point code with subfields *main signaling area-sub signaling area-signaling point* (*msa-ssa-sp*). The *prefix* subfield indicates a private point code (*prefix-msa-ssa-sp*).

**Range:**

*p-, 000-255*

Specify a valid value for each subfield of the point code, and separate the subfields with a dash (-).

*prefix—p*

*msa—000-255*

*ssa—000-255*

*sp—000-255*

**dpcn16 (mandatory)**

16-bit ITU national point code with subfields *unit number sub number area main number area* (*un-sna-mna*). The *prefix* subfield indicates a private point code (*prefix-un-sna-mna*).

**Range:**

*p--, 000---127*

Specify a valid value for each subfield of the point code, and separate the subfields with a dash (-).



*prefix---p*

*un---000---127*

*sna---000---15*

*mna---000---31*

**cic (optional)**

Starting Circuit Identification Code. This parameter is used alone or together with the `ecic` parameter as exception routing criteria for the specified exception route.

**Range:**

*0 - 16383*

**ecic (optional)**

Ending Circuit Identification Code. This parameter and the `cic` parameter define the CIC range that is used as exception routing criteria for the specified exception route.

**Range:**

*16383*

**ilsn (optional)**

Incoming Link Set Name. The name of the originating linkset. This value is used as part of the exception routing criteria for the specified exception route.

**Range:**

*ayyyyyyyyy*

1 alphabetic character followed by up to 9 alphanumeric characters

**lsn (optional)**

Linkset Name. The name of the linkset associated with the specified exception route.

**Range:**

*ayyyyyyyyy*

1 alphabetic character followed by up to 9 alphanumeric characters

**opc (optional)**

ANSI origination point code with subfields *network indicator-network-cluster-network cluster member (ni-nc-ncm)*. The *prefix* subfield indicates a private point code (*prefix-ni-nc-ncm*).

**Range:**

*p-, 000-255*

Specify a valid value for each subfield of the point code, and separate the subfields with a dash (-).

*prefix—p-*

When `chg-sid:pctype=ansi` is specified, *ni = 000* is not valid.

When `chg-sid:pctype=ansi` is specified, *nc = 000* is not valid if *ni = 001-005*.

When `chg-sid:pctype=ansi` is specified, *nc = 000* is valid if *ni = 006-255*.

The point code *000-000-000* is not a valid point code.

**opc/opca/opci/opcn/opcn24/opcn16 (optional)**

Originating Point Code

**opci (optional)**

ITU international point code with subfields *zone-area-id*. The *prefix* subfield indicates a spare point code, private point code, or private and spare point code (*prefix-zone-area-id*).

**Range:**

*s-, p-, ps-, 0-255*

Specify a valid value for each subfield of the point code, and separate the subfields with a dash (-).

*prefix—s-, p-, ps*

*zone—0-7*

*area—000-255*

*id—0-7*

The point code *0-000-0* is not a valid point code.

**opcn (optional)**

ITU national point code in the format of a 5-digit number (*nnnnn*); or 2, 3, or 4 numbers (members) separated by dashes (*m1-m2-m3-m4*) as defined by the `chg-stpopts:npcfmti` flexible point code option. A group code must be specified when the ITUDUPPC feature is turned on (*nnnnn-gc, m1-m2-m3-m4-gc*). The *prefix* subfield indicates a spare point code, private point code, or private and spare point code (*prefix-nnnnn, prefix-nnnnn-gc, prefix-m1-m2-m3-m4, prefix-m1-m2-m3-m4-gc*).

**Range:**

*s-, p-, ps-, 0-16383, aa-zz*

Specify a valid value for each subfield of the point code, and separate the subfields with a dash (-).

*prefix—s-, p-, ps*

*nnnnn—0-16383*

*gc—aa-zz*

*m1-m2-m3-m4—0-14* for each member; values must sum to 14

**opcn24 (optional)**

24-bit ITU national point code with subfields *main signaling area-sub signaling area-signaling point* (*msa-ssa-sp*). The *prefix* subfield indicates a private point code (*prefix-msa-ssa-sp*).

**Range:**

*p-, 000-255*

Specify a valid value for each subfield of the point code, and separate the subfields with a dash (-).

*prefix—p*

*msa—000-255*

*ssa—000-255*

*sp—000-255*

**opcn16 (optional)**

16-bit ITU national point code with subfields *unit number sub number area main number area* (*un-sna-mna*). The *prefix* subfield indicates a private point code (*prefix-un-sna-mna*).

**Range:**

*p--, 000---127*

Specify a valid value for each subfield of the point code, and separate the subfields with a dash (-).

*prefix---p*

*un---000---127*

*sna---000---15*

*mna---000---31*

**si (optional)**

Service Indicator. This parameter is used as part of the exception routing criteria for the specified exception route.

**Range:**

3 - 15

**Example**

```

dlt-rtx:dpca=1-1-1:opc:2-3-3:lsn=1set1
dlt-rtx:dpca=1-2-1:si=3:lsn=1set2
dlt-rtx:dpca=1-3-1:ilsn=1set2:lsn=1set3
dlt-rtx:dpci=2-100-1:si=5:lsn=1set5
dlt-rtx:dpci=2-100-1:si=6
dlt-rtx:dpci=2-100-1:opc=8-**-*
dlt-rtx:dpcn16=121-10-15:opc:121-3-30:lsn=1set1

```

**Dependencies**

Only one of the `opc`, `ilsn`, `cic`, or `si` parameters can be specified for an exception route entry.

If the `ecic` parameter is specified, the `cic` parameter must also be specified.

The `ecic` parameter value cannot be less than the `cic` parameter value.

The Origin-Based MTP Routing feature must be enabled and turned on before this command can be entered.

The linkset name, as defined by the `ilsn` or `lsn` parameter, must exist.

The specified combination of exception route parameter conditions must exist.

The Linkset table is corrupt or cannot be found.

The Route table is corrupt or cannot be found.

The Route Exception table is corrupt or cannot be found.

The value specified for the destination point code must be a full point code and not a cluster or network point code.

The point code specified by the `dpc/dpca/dpci/dpcn/dpcn24/dpcn16` parameter must exist in the destination table.

The route to be deleted cannot be the last route or route set in the RTX table.

## Output

This example deletes a specific exception route:

```
dlt-rtx:dpca=1-3-1:ilsn=1set2:lsn=1set3
```

```
stdcfg2b 06-05-19 18:20:11 EST EAGLE 35.0.0  
DLT-RTX: MASP A - COMPLTD
```

This example deletes all exception routes for a specific exception criteria:

```
dlt-rtx:dpci=2-100-2:opc=8-*-*
```

```
tekelecstp 08-02-25 10:54:07 EST EAGLE 38.0.0  
Command entered at terminal #4.  
DLT-RTX: MASP A - COMPLTD  
;
```

## Related Topics

- [chg-rtx](#)
- [ent-rtx](#)
- [rept-stat-rtx](#)
- [rtrv-rtx](#)

# dlt-sccp-serv

Use this command to remove entries from the SCCP Service table. The command may either remove a PC from a group or remove the entire group.

## Parameters

### **serv (mandatory)**

The name of the service being deleted.

### **Range:**

*gflex*

*gport*

### **a11 (optional)**

Deletes all point codes from a service.

### **Range:**

*yes*

**pc1 (optional)**

ANSI point code with subfields *network indicator-network cluster-network cluster member (ni-nc-ncm)*.

**Range:**

000-255

Specify a valid value for each subfield of the point code, and separate the subfields with a dash (-).

When `chg-sid:pctype=ansi` is specified, *ni = 000* is not valid.

When `chg-sid:pctype=ansi` is specified, *nc = 000* is not valid if *ni = 001–005*.

When `chg-sid:pctype=ansi` is specified, *nc = 000* is valid if *ni = 006–255*.

The point code *000-000-000* is not a valid point code.

**pc1/pca1/pci1/pcn1/pcn241 (optional)**

Post GTT-translated point code 1.

**pc2 (optional)**

ANSI point code with subfields *network indicator-network cluster-network cluster member (ni-nc-ncm)*.

**Synonym:**

*pca2*

**Range:**

000-255

Specify a valid value for each subfield of the point code, and separate the subfields with a dash (-).

When `chg-sid:pctype=ansi` is specified, *ni = 000* is not valid.

When `chg-sid:pctype=ansi` is specified, *nc = 000* is not valid if *ni = 001–005*.

When `chg-sid:pctype=ansi` is specified, *nc = 000* is valid if *ni = 006–255*.

The point code *000-000-000* is not a valid point code.

**pc2/pca2/pci2/pcn2/pcn242 (optional)**

Post GTT-translated point code 2.

**pc3 (optional)**

ANSI point code with subfields *network indicator-network cluster-network cluster member (ni-nc-ncm)*.

**Synonym:**

*pca3*

**Range:**

000-255

Specify a valid value for each subfield of the point code, and separate the subfields with a dash (-).

When `chg-sid:pctype=ansi` is specified, *ni = 000* is not valid.

When `chg-sid:pctype=ansi` is specified, *nc = 000* is not valid if *ni = 001–005*.

When `chg-sid:pctype=ansi` is specified, *nc = 000* is valid if *ni = 006–255*.

The point code *000-000-000* is not a valid point code.

**pc3/pca3/pci3/pcn3/pcn243 (optional)**

Post GTT-translated point code 3.

**pc4 (optional)**

ANSI point code with subfields *network indicator-network cluster-network cluster member (ni-nc-ncm)*.

**Range:**

000-255

Specify a valid value for each subfield of the point code, and separate the subfields with a dash (-).

When `chg-sid:pctype=ansi` is specified, *ni = 000* is not valid.

When `chg-sid:pctype=ansi` is specified, *nc = 000* is not valid if *ni = 001–005*.

When `chg-sid:pctype=ansi` is specified, *nc = 000* is valid if *ni = 006–255*.

The point code *000-000-000* is not a valid point code.

**pc4/pca4/pci4/pcn4/pcn244 (optional)**

Post GTT-translated point code 4.

**pci1 (optional)**

ITU international point code with subfields *zone-area-id*. The *prefix* subfield indicates a spare point code (*prefix-zone-area-id*).

**Range:**

s-, 0-255

Specify a valid value for each subfield of the point code, and separate the subfields with a dash (-).

*prefix—s*

*zone—0-7*

*area—000-255*

*id—0-7*

The point code *0-000-0* is not a valid point code.

**pci2 (optional)**

ITU international point code with subfields *zone-area-id*. The *prefix* subfield indicates a spare point code (*prefix-zone-area-id*).

**Range:**

s-, 0-255

Specify a valid value for each subfield of the point code, and separate the subfields with a dash (-).

*prefix—s*

*zone—0-7*

*area—000-255*

*id—0-7*

The point code *0-000-0* is not a valid point code.

**pci3 (optional)**

ITU international point code with subfields *zone-area-id*. The *prefix* subfield indicates a spare point code (*prefix-zone-area-id*).

**Range:**

s-, 0-255

Specify a valid value for each subfield of the point code, and separate the subfields with a dash (-).

*prefix—s*

*zone—0-7*

*area—000-255*  
*id—0-7*

The point code *0-000-0* is not a valid point code.

#### **pci4 (optional)**

ITU international point code with subfields *zone-area-id*. The *prefix* subfield indicates a spare point code (*prefix-zone-area-id*).

##### **Range:**

*s-*, *0-255*

Specify a valid value for each subfield of the point code, and separate the subfields with a dash (-).

*prefix—s*  
*zone—0-7*  
*area—000-255*  
*id—0-7*

The point code *0-000-0* is not a valid point code.

#### **pcn1 (optional)**

ITU national point code in the format of a 5-digit number (*nnnnn*); or 2, 3, or 4 numbers (members) separated by dashes (*m1-m2-m3-m4*) as defined by the `chg-stpopts:npcfmti` flexible point code option. A group code must be specified when the ITUDUPPC feature is turned on (*nnnnn-gc*, *m1-m2-m3-m4-gc*). The *prefix* subfield indicates a spare point code (*prefix-nnnnn*, *prefix-nnnnn-gc*, *prefix-m1-m2-m3-m4*, *prefix-m1-m2-m3-m4-gc*).

##### **Range:**

*s-*, *0-16383*, *aa-zz*

Specify a valid value for each subfield of the point code, and separate the subfields with a dash (-).

*prefix—s-*  
*nnnnn—0-16383*  
*gc—aa-zz*  
*m1-m2-m3-m4—0-14* for each member; values must sum to 14

#### **pcn2 (optional)**

ITU national point code in the format of a 5-digit number (*nnnnn*); or 2, 3, or 4 numbers (members) separated by dashes (*m1-m2-m3-m4*) as defined by the `chg-stpopts:npcfmti` flexible point code option. A group code must be specified when the ITUDUPPC feature is turned on (*nnnnn-gc*, *m1-m2-m3-m4-gc*). The *prefix* subfield indicates a spare point code (*prefix-nnnnn*, *prefix-nnnnn-gc*, *prefix-m1-m2-m3-m4*, *prefix-m1-m2-m3-m4-gc*).

##### **Range:**

*s-*, *0-16383*, *aa-zz*

Specify a valid value for each subfield of the point code, and separate the subfields with a dash (-).

*prefix—s-*  
*nnnnn—0-16383*  
*gc—aa-zz*  
*m1-m2-m3-m4—0-14* for each member; values must sum to 14

#### **pcn241 (optional)**

24-bit ITU national point code with subfields *main signaling area-sub signaling area-signaling point* (*msa-ssa-sp*).

**Range:**

000-255

Specify a valid value for each subfield of the point code, and separate the subfields with a dash (-).

*msa—000—255**ssa—000—255**sp—000—255***pcn242 (optional)**

24-bit ITU national point code with subfields *main signaling area-sub signaling area-signaling point (msa-ssa-sp)*.

**Range:**

000-255

Specify a valid value for each subfield of the point code, and separate the subfields with a dash (-).

*msa—000—255**ssa—000—255**sp—000—255***pcn243 (optional)**

24-bit ITU national point code with subfields *main signaling area-sub signaling area-signaling point (msa-ssa-sp)*.

**Range:**

000-255

Specify a valid value for each subfield of the point code, and separate the subfields with a dash (-).

*msa—000—255**ssa—000—255**sp—000—255***pcn244 (optional)**

24-bit ITU national point code with subfields *main signaling area-sub signaling area-signaling point (msa-ssa-sp)*.

**Range:**

000-255

Specify a valid value for each subfield of the point code, and separate the subfields with a dash (-).

*msa—000—255**ssa—000—255**sp—000—255***pcn3 (optional)**

ITU national point code in the format of a 5-digit number (*nnnnn*); or 2, 3, or 4 numbers (members) separated by dashes (*m1-m2-m3-m4*) as defined by the `chg-stpopts:npcfmti` flexible point code option. A group code must be specified when the ITUDUPPC feature is turned on (*nnnnn-gc*, *m1-m2-m3-m4-gc*). The *prefix* subfield indicates a spare point code (*prefix-nnnnn*, *prefix-nnnnn-gc*, *prefix-m1-m2-m3-m4*, *prefix-m1-m2-m3-m4-gc*).

**Range:***s-, 0-16383, aa-zz*



Specify a valid value for each subfield of the point code, and separate the subfields with a dash (-).

*prefix—s-*

*nnnnn—0-16383*

*gc—aa-zz*

*m1-m2-m3-m4—0-14* for each member; values must sum to 14

#### **pcn4 (optional)**

ITU national point code in the format of a 5-digit number (*nnnnn*); or 2, 3, or 4 numbers (members) separated by dashes (*m1-m2-m3-m4*) as defined by the `chg-stpopts:npcfnti` flexible point code option. A group code must be specified when the ITUDUPPC feature is turned on (*nnnnn-gc*, *m1-m2-m3-m4-gc*). The *prefix* subfield indicates a spare point code (*prefix-nnnnn*, *prefix-nnnnn-gc*, *prefix-m1-m2-m3-m4*, *prefix-m1-m2-m3-m4-gc*).

#### **Range:**

*s-*, *0-16383*, *aa-zz*

Specify a valid value for each subfield of the point code, and separate the subfields with a dash (-).

*prefix—s-*

*nnnnn—0-16383*

*gc—aa-zz*

*m1-m2-m3-m4—0-14* for each member; values must sum to 14

#### **Example**

To delete a specified PC from the G-Port service:

```
dlt-sccp-serv:serv=gport:pca2=3-3-3
```

To delete all PCs from the G-Port service and to specify a network PC to delete:

```
dlt-sccp-serv:serv=gport:all=yes:pca1=1-1-1
```

#### **Dependencies**

At least one PC must be specified.

The MRN table must be accessible.

The SCCP Service table must be accessible.

The specified PC must already exist in the SCCP Service table.

The same point code cannot be specified more than once.

The specified point code must already exist in the specified MRN set in the SCCP-SERV table.

At least one point code must be specified.

The specified MRN set must already exist in the SCCP-SERV table portion of the MRN table.

#### **Notes**

In this command, only ITU-international and ITU national point codes support the spare point code subtype prefix (s-).

## Output

```
dlt-sccp-serv:serv=gport:pca2=3-3-3
```

```
tekelecstp 05-12-20 08:54:59 EST EAGLE 35.0.0  
DLT-SCCP-SRV: MASP A - COMPLTD  
;
```

## Related Topics

- [chg-sccp-serv](#)
- [rtrv-sccp-serv](#)

# dlt-scr-aftpc

Use this command to remove a specific screening reference in the allowed affected point code category.

## Parameters

### **sr (mandatory)**

Screening reference. The point code's unique screening reference name.

#### **Range:**

*ayyy*

1 alphabetic character followed by up to 3 alphanumeric characters

### **ssn (mandatory)**

Subsystem number.

#### **Range:**

*0 - 255, \**

\*—the full range of values from 0–255

### **area (optional)**

ITU international area. The *area* in the point code represented by *zone-area-id*.

#### **Range:**

*0 - 255, \**

\*—the full range of values from 0–255

### **id (optional)**

ITU international ID. The *ID* in the point code represented by *zone-area-id*.

#### **Range:**

*0 - 7, \**

\*—the full range of values from 0–

7

### **mna (optional)**

16-bit ITU national *main number area*. The *mna* in the point code represented by *un-sna-mna*.

**Range:**

0--31, \*

\*—the full range of values from 0–31

**msa (optional)**24-bit ITU-national main signaling area value. The *msa* of the point code *msa-ssa-sp*.**Range:**

0 - 255, \*

**nc (optional)**Network cluster value. This parameter specifies one or more *nc* values for the network indicator and network cluster member values specified in the *ni* and *ncm* parameters. It specifies the *nc* of the point code represented by *ni-nc-ncm*.**Range:**

0 - 255, \*

\*—the full range of values from 0–255

**ncm (optional)**Network cluster member value. This parameter specifies one or more *ncm* values for the network indicator and network cluster values identified in the *ni* and *nc* parameters. It specifies the *ncm* of the point code represented by *ni-nc-ncm*.**Range:**

0 - 255, \*

\*—the full range of values from 0–255

**ni (optional)**Network indicator value. This parameter specifies one or more *ni* values for the network cluster and network cluster member values identified in the *nc* and *ncm* parameters. It specifies the *ni* of the point code represented by *ni-nc-ncm*.**Range:**

0 - 255, \*

\*—the full range of values from 0–255

**npc (optional)**

ITU national point code.

**Note:**

Gateway screening allows the ITU national point code to be displayed and entered in the database only as a single number. If you are using multiple-part ITU national point codes, see [Converting ITU National Point Code Formats](#) in Appendix A for information on converting the point code format.

**Range:**

0 - 16383, \*

\*—the full range of values from 0–16383

**pcst (optional)**

Point code subtype. This parameter indicates whether the specified ITU international or ITU national point code has no subtype prefix or has the spare point code prefix (s).

**Range:**

*none*

*s*

**Default:**

*none*

**sna (optional)**

16-bit ITU national *sub number area*. The *sna* in the point code represented by *un-sna-mna*.

**Range:**

*0--15,\**

\*—the full range of values from 0–15

**sp (optional)**

24-bit ITU national signaling point. The *sp* in the point code represented by *msa-ssa-sp*.

**Range:**

*0 - 255, \**

\*—the full range of values from 0–255

**ssa (optional)**

24-bit ITU national sub signaling area. The *ssa* in the point code represented by *msa-ssa-sp*.

**Range:**

*0 - 255, \**

**un (optional)**

16-bit ITU-national *unit number*. The *un* of the point code represented by *un-sna-mna*.

**Range:**

*0--127,\**

\*—the full range of values from 0–127

**zone (optional)**

ITU international zone. The *zone* in the point code represented by *zone-area-id*.

**Range:**

*0 - 7, \**

\*—the full range of values from 0–7

**Example**

```
dlt-scr-aftpc:sr=iec:ni=240:nc=010:ncm=010:ssn=012
```

```
dlt-scr-aftpc:sr=aft1:zone=1:area=2:id=3:ssn=1:pcst=s
```

```
dlt-scr-aftpc:sr=aft2:un=1:sna=2:mna=3:ssn=1
```

## Dependencies

A complete point code must be specified, and must be one, and only one of the five point code parameter combinations: `ni-nc-ncm`, `zone-area-id`, `msa-ssa-sp`, `un-sna-mna` or `npc`.

The affected point code or point code range (given by `ni-nc-ncm/ssn`, `zone-area-id`, `msa-ssa-sp`, `un-sna-mna` or `npc`) to be removed from the table must already exist in the screening reference.

ANSI point code value 000-000-000 and ITU-International point code value 0-000-0 are not allowed.

If asterisk values are specified, the range cannot overlap or contain any of the point code ranges that already exist in the allowed affected point code screening category.

If `zone=*` is specified, `area=*` and `id=*` must be specified.

If `area=*` is specified, `id=*` must be specified.

If `ssa=*` is specified, `sp=*` must be specified.

If `msa=*` is specified, `ssa=*` and `sp=*` must be specified.

If `sna=*` is specified, `mna=*` must be specified.

If `un=*` is specified, `sna=*` and `mna=*` must be specified.

If the `nc` parameter is specified as a range, the `ncm` parameter must be specified as an asterisk or as the full range.

If the `nc` parameter is specified as a single value or a range, a single value must be specified for the `ni` parameter.

If the `nc` parameter is specified as an asterisk, the `ncm` parameter must be specified as an asterisk or as the full range.

If the `ncm` parameter is specified as a single value, or a range other than the full range 0-255, the `ni` and the `nc` parameters must be specified with a single value.

If the `ni` parameter is specified as an asterisk or as a range, the `nc` and `ncm` parameters must be specified as an asterisk or as the full range.

The character `c` is not a valid value for the `ni`, `nc`, `ncm`, `zone`, `area`, `id`, `msa`, `ssa`, `sp`, `un`, `sna`, `mna`, and `npc` parameters.

The specified screening reference (`sr`) must already exist in the database.

The Spare Point Code Support feature must be enabled before the `pcst` parameter can be specified.

The spare point code subtype prefix (s-) is not supported for ANSI point codes (parameters `ni`, `nc`, `ncm`) or for 24-bit ITU national point codes (parameters `msa`, `ssa`, `sp`) or for 16-bit ITU national point codes (parameters `un`, `sna`, `mna`). The `pcst` parameter cannot be specified for ANSI, ITU-N24 or ITU-N16 point codes.

No AFTPC screening reference (`sr`) can be deleted that is referenced by an entity in another screening set.

The `sr`, `ni`, `nc`, `ncm`, and `ssn` parameters, or the `zone`, `area`, `id`, and `npc` parameters cannot be deleted if they are the last entry in the screening reference and the screening reference is part of a screen set.

If only one entry exists, the `sr` cannot be referenced by another screening table. If the `sr` is not referenced by another screening table, the entire screening table is deleted.

The GWSOA parameter combination should be known and valid.

### Notes

The asterisk is a parameter value indicating that the gateway screening process is screening all values for that parameter in the MSU. The asterisk parameter value does not mean that multiple entries whose values may be in the range implied by the asterisk will be removed. The only entry that will be removed by this command when the asterisk is specified as a parameter value is the entry that contains an asterisk as that parameter value.

For example, if the `dlt-scr-aftpc:sr=ied:ni=240:nc=010:nccm=":ssn=*` command is entered, the only entry that will be removed from the database is the entry in screening reference `iec` that contains the values `ni=240`, `nc=010`, `ncm=*`, and `ssn=*`. For an entry to be specified in this command with asterisks as parameter values, that entry must be shown in the `rtrv-scr-aftpc` output with asterisks as the same parameter values specified in the `dlt-scr-aftpc` command.

A range of values is specified by separating the values that define the range by two ampersands (&&); for example, `ni=025&&100` specifies all network indicators for ANSI point codes from 25 - 100.

The spare point code subtype prefix (s-) is supported only for ITU international and ITU national point codes. The `pcst` parameter indicates whether the specified point code has no subtype prefix or has the spare point code prefix.

### Output

```
dlt-scr-aftpc:sr=iec:ni=240:nc=010:ncm=010:ssn=012
```

```
rlghncxa03w 04-01-07 11:43:04 EST EAGLE 31.3.0
DLT-SCR-AFTPC: SCREEN SET AFFECTED - IEC 25% FULL
DLT-SCR-AFTPC: MASP A - COMPLTD
;
```

### Related Topics

- [chg-scr-aftpc](#)
- [ent-scr-aftpc](#)
- [rtrv-scr-aftpc](#)

## dlt-scr-blkdpc

Use this command to remove a specific screening reference from the blocked DPC category. Deleting the last point code (c) also deletes the screening reference.

## Parameters

### **sr (mandatory)**

Screening reference. This parameter specifies the point code's unique screening reference name.

#### **Range:**

*ayyy*

1 alphabetic character followed by up to 3 alphanumeric characters

### **area (optional)**

ITU international area. The *area* in the point code represented by *zone-area-id*.

#### **Range:**

*0 - 255, \*, C*

\*—the full range of values from 0–255

*C*—continue

### **id (optional)**

ITU international ID. The *ID* in the point code represented by *zone-area-id*.

#### **Range:**

*0 - 7, \*, C*

\*—the full range of values from 0–7

*C*—continue

### **mna (optional)**

16-bit ITU national main number area. The *mna* in the point code represented by *un-sna-mna*.

#### **Range:**

*0--31, \*, C*

\*—the full range of values from 0–31

*C*—continue

### **msa (optional)**

24-bit ITU-national main signaling area value. The *msa* of the point code represented by *msa-ssa-sp*.

#### **Range:**

*0 - 255, \*, C*

\*—the full range of values from 0–255

*C*—continue

### **nc (optional)**

Network cluster value. This parameter specifies one or more *nc* values for the network indicator and network cluster member values specified in the *ni* and *ncm* parameters. It specifies the *nc* of the point code represented by *ni-nc-ncm*.

#### **Range:**

*0 - 255, \*, C*

\*—the full range of values from 0–255

*C*—continue

**ncm (optional)**

Network cluster member value. This parameter specifies one or more *ncm* values for the network indicator and network cluster values identified in the *ni* and *nc* parameters. It specifies the *ncm* of the point code represented by *ni-nc-ncm*.

**Range:**

0 - 255, \*, C

\*—the full range of values from 0–255

C—continue

**ni (optional)**

Network indicator value. This parameter specifies one or more *ni* values for the network cluster and network cluster member values identified in the *nc* and *ncm* parameters. It specifies the *ni* of the point code represented by *ni-nc-ncm*.

**Range:**

0 - 255, \*, C

\*—the full range of values from 0–255

C—continue

**npc (optional)**

ITU national point code.

**Note:**

Gateway screening allows the ITU national point code to be displayed and entered in the database only as a single number. If you are using multiple-part ITU national point codes, see [Converting ITU National Point Code Formats](#) in Appendix A for information on converting the point code format.

**Range:**

0 - 16383, \*, C

\*—the full range of values from 0–16383

C—continue

**pcst (optional)**

Point code subtype. This parameter indicates whether the specified ITU international or ITU national point code has no subtype prefix or has the spare point code prefix (s-).

**Range:**

*none*

*s*

**Default:**

*none*

**sna (optional)**

16-bit ITU national sub number area. The *sna* in the point code represented by *un-sna-mna*.

**Range:**

0--15, \*, C



\*—the full range of values from 0–15  
C—continue

**sp (optional)**

24-bit ITU national signaling point. The *sp* in the point code represented by *msa-ssa-sp*.

**Range:**

0 - 255, \*, C

\*—the full range of values from 0–255

C—continue

**ssa (optional)**

24-bit ITU national sub signaling area. The *ssa* in the point code represented by *msa-ssa-sp*.

**Range:**

0 - 255, \*, C

\*—the full range of values from 0–255

C—continue

**un (optional)**

16-bit ITU-national unit number. The *un* of the point code represented by *un-sna-mna*.

**Range:**

0--127, \*, C

\*—the full range of values from 0–127

C—continue

**zone (optional)**

ITU international zone. The *zone* in the point code represented by *zone-area-id*.

**Range:**

0 - 7, \*, C

\*—the full range of values from 0–255

C—continue

**Example**

```
dlt-scr-blkdpc:sr=iec:ni=240:nc=010:ncm=010
```

```
dlt-scr-blkdpc:sr=bdp1:npc=128:pcst=s
```

```
dlt-scr-blkdpc:sr=bdp1:un=125:sna=12:mna=17
```

**Dependencies**

At least one optional parameter must be specified.

A complete point code must be specified, using the *ni-nc-ncm*, *zone-area-id*, *msa-ssa-sp*, *un-sna-mna*, or *npc* combination unless a value of *c* is specified.

The blocked DPC or blocked DPC range specified by *ni-nc-ncm*, *zone-area-id*, *msa-ssa-sp*, *un-sna-mna*, or the *npc* parameter must already exist in the specified screening reference.

The point code to delete cannot have the value `c-c-c` if there is another point code in the blocked screening reference. The last screening reference to be deleted must have `ni`, `zone`, `msa`, `un`, or `npc` equal to `c`.

ANSI point code value 000-000-000 and ITU-International point code value 0-000-0 are not allowed.

If `msa=*` is specified, `ssa=*` and `sp=*` must be specified.

If `un=*` is specified, `sna=*` and `mna=*` must be specified.

If the `msa=c` parameter is specified, then the `ssa` and `sp` parameters must have a value of `c` or must not be specified. If the `msa=c` parameter is specified, and the `ssa` and the `sp` parameters are not specified, then the `ssa` and `sp` parameters default to a value of `c`.

If the `un=c` parameter is specified, then the `sna` and `mna` parameters must have a value of `c` or must not be specified. If the `un=c` parameter is specified, and the `sna` and the `mna` parameters are not specified, then the `sna` and `mna` parameters default to a value of `c`.

If the `nc` parameter is specified as a range, the `ncm` parameter must be specified as an asterisk or as the full range.

If the `nc` parameter is specified as a single value or a range, a single value must be specified for the `ni` parameter.

If the `nc` parameter is specified as an asterisk, the `ncm` parameter must be specified as an asterisk or as the full range.

If the `ncm` parameter is specified as a single value, or a range other than the full range of 0–255, the `n` and the `nc` parameters must be specified with a single value.

If the `ni` parameter is specified as an asterisk or as a range, the `nc` and `ncm` parameters must be specified as an asterisk or as the full range.

If the `ni=c` parameter is specified, then the `nc` and the `ncm` parameters must have a value of `c` or must not be specified. If the `ni=c` parameter is specified, and the `nc` and the `ncm` parameters are not specified, then the `nc` and `ncm` parameters default to a value of `c`.

The last screening reference (`sr`) entry cannot be deleted if it is referenced by another screen.

The Spare Point Code Support feature must be enabled before the `pcst` parameter can be specified.

The spare point code subtype prefix (`s-`) is not supported for ANSI point codes (parameters `ni`, `nc`, `ncm`) or for 24-bit ITU national point codes (parameters `msa`, `ssa`, `sp`) or for 16-bit ITU national point codes (parameters `un`, `sna`, `mna`). The `pcst` parameter cannot be specified for ANSI, ITU-N16 or ITU-N24 point codes.

If the `zone=c` parameter is specified, then the `area` and `id` parameters must have a value of `c` or must not be specified. If the `zone=c` parameter is specified, and the `area` and the `id` parameters are not specified, then the `area` and `id` parameters default to a value of `c`.

The GWSOA parameter combination should be known and valid.

## Notes

If the screening reference is not referenced by any other screen, and if all entries are removed, the entire screening reference can be removed using `ni-nc-ncm, zone-area-`

*id*, *un-sna-mna*, or *msa-ssa-sp* equal to *c* or *npc=c*. If more than one entry exists, *ni-nc-ncm*, *zone-area-id*, *msa-ssa-sp*, *un-sna-mna*, or *npc* cannot equal *c*.

The asterisk is a parameter value indicating that the gateway screening process is screening all values for that parameter in the MSU. The asterisk parameter value does not mean that multiple entries whose values may be in the range implied by the asterisk will be removed. The only entry that will be removed by this command when the asterisk is specified as a parameter value is the entry that contains an asterisk as that parameter value.

For example, if the `dlt-scr-blkdpc:sr=ied:ni=240:nc=010:nccm=":ssn=*` command is entered, the only entry that will be removed from the database is the entry in screening reference *iec* that contains the values *ni=240*, *nc=010*, *ncm=\**, and *ssn=\**. For an entry to be specified in this command with asterisks as parameter values, that entry must be shown in the `rtrv-scr-blkdpc` output with asterisks as the same parameter values specified in the `dlt-scr-blkdpc` command.

The asterisk (\*) value cannot be specified with the character *c*. For example, a point code *c-c-c* is not allowed.

A range of values is specified by separating the values that define the range by two ampersands (&&); for example, *ni=025&&100* specifies all network indicators for ANSI point codes from 25 - 100.

The character *c* is used in the blocked DPC screens to allow the screening process to continue for messages with point codes that do not match any point codes in the blocked DPC screens. When screening for a blocked DPC and the point code being screened does not match any of the point codes in the blocked DPC screens, the message is not rejected and the screening process continues.

There must be an entry in each unique blocked DPC screening reference to allow the screening process to continue. This entry consists of a screening reference, point code, *nsfi*, and *nsr*. The point code is in the form of subfields *ni-nc-ncm*, *zone-area-id*, *un-sna-mna* or *msa-ssa-sp* equal to *c-c-c* or *npc=c*. When the character *c* is specified, the *nsfi* and *nsr* parameters must be specified.

When the point code does not match any entries in the blocked DPC screens, the screening process is directed to the screening reference with the point code *c*. The *nsfi* and *nsr* in this entry are examined to determine the next step in the screening process.

The spare point code subtype prefix (s-) is supported only for ITU international and ITU national point codes. The *pcst* parameter indicates whether the specified point code has no subtype prefix or has the spare point code prefix.

## Output

```
dlt-scr-blkdpc:sr=iec:ni=240:nc=010:ncm=010
```

```
rlghncxa03w 04-01-07 11:43:04 EST EAGLE 31.3.0
DLT-SCR-BLKDPC: SCREEN SET AFFECTED - IEC 25% FULL
DLT-SCR-BLKDPC: MASP A - COMPLTD
```

```
;
```

**Related Topics**

- [chg-scr-blkdpc](#)
- [ent-scr-blkdpc](#)
- [rtrv-scr-blkdpc](#)

## dlt-scr-blkopc

Use this command to remove a specific screening reference from the blocked OPC category.

**Parameters****sr (mandatory)**

Screening reference. The point code's unique screening reference name.

**Range:**

*ayyy*

1 alphabetic character followed by up to 3 alphanumeric characters

**area (optional)**

ITU international area. The *area* in the point code represented by *zone-area-id*.

**Range:**

*0 - 255, \*, C*

\*—the full range of values from 0–255

*C*—continue

**id (optional)**

ITU international ID. The *ID* in the point code represented by *zone-area-id*.

**Range:**

*0 - 7, \*, C*

\*—the full range of values from 0–7

*C*—continue

**mna (optional)**

16-bit ITU national main number area. The *mna* in the point code represented by *un-sna-mna*.

**Range:**

*0--31, \*, C*

\*—the full range of values from 0–31

*C -- Continue*

**msa (optional)**

24-bit ITU-national main signaling area value. The *msa* of the point code represented by *msa-ssa-sp*.

**Range:**

*0 - 255, \*, C*

\*—the full range of values from 0–7

*C*—continue

**nc (optional)**

Network cluster value. This parameter specifies one or more *nc* values for the network indicator and network cluster member values specified in the *ni* and *ncm* parameters. It specifies the *nc* of the point code represented by *ni-nc-ncm*.

**Range:**

0 - 255, \*, C

\*—the full range of values from 0–255

C—continue

**ncm (optional)**

Network cluster member value. This parameter specifies one or more *ncm* values for the network indicator and network cluster values identified in the *ni* and *nc* parameters. It specifies the *ncm* of the point code represented by *ni-nc-ncm*.

**Range:**

0 - 255, \*, C

\*—the full range of values from 0–255

C—continue

**ni (optional)**

Network indicator value. This parameter specifies one or more *ni* values for the network cluster and network cluster member values identified in the *nc* and *ncm* parameters. It specifies the *ni* of the point code represented by *ni-nc-ncm*.

**Range:**

0 - 255, \*, C

\*—the full range of values from 0–255

C—continue

**npc (optional)**

ITU national point code.

 **Note:**

Gateway screening allows the ITU national point code to be displayed and entered in the database only as a single number. For multiple-part ITU national point codes, see [Converting ITU National Point Code Formats](#) for information on converting the point code format.

**Range:**

0 - 16383, \*, C

\*—the full range of values from 0–16383

C—continue

**pcst (optional)**

Point code subtype. This parameter indicates whether the specified ITU international or ITU national point code has no subtype prefix or has the spare point code prefix (S-).

**Range:***none**s***Default:***none***sna (optional)**

16-bit ITU national sub number area. The *sna* in the point code represented by *un-sna-mna*.

**Range:***0--15, \*, C**\*—the full range of values from 0–15**C -- Continue***sp (optional)**

24-bit ITU national signaling point. The *sp* in the point code represented by *msa-ssa-sp*.

**Range:***0 - 255, \*, C**\*—the full range of values from 0–255**C—continue***ssa (optional)**

24-bit ITU national sub signaling area. The *ssa* in the point code represented by *msa-ssa-sp*.

**Range:***0 - 255, \*, C**\*—the full range of values from 0–255**C—continue***un (optional)**

16-bit ITU-national unit number. The *un* of the point code represented by *un-sna-mna*.

**Range:***0--127, \*, C**\*—the full range of values from 0–127**C -- Continue***zone (optional)**

ITU international zone. The *zone* in the point code represented by *zone-area-id*.

**Range:***0 - 7, \*, C**\*—the full range of values from 0–255**C—continue***Example**

```
dlt-scr-blkopc:sr=iec:ni=240:nc=010:ncm=010
```

```
dlt-scr-blkopc:sr=bop1:npc=128:pcst=s
```

```
dlt-scr-blkopc:sr=bop1:un=125:sna=12:mna=17
```

## Dependencies

A complete point code must be specified, using the `ni-nc-ncm`, `zone-area-id`, `msa-ssa-sp`, `un-sna-mna`, or `npc` combination unless a value of `c` is specified.

The blocked OPC specified by `ni-nc-ncm`, `zone-area-id`, `msa-ssa-sp`, `un-sna-mna`, or the `npc` parameter must already exist in the screening reference or within an existing range of OPCs.

The point code to delete cannot have the value `c-c-c` if there is another point code in the blocked screening reference. The last screening reference to be deleted must have `ni`, `zone`, `msa`, `un`, or `npc` equal to `c`.

ANSI point code value 000-000-000 and ITU-International point code value 0-000-0 are not allowed.

If the `msa=c` parameter is specified, then the `ssa` and `sp` parameters must have a value of `c` or must not be specified. If the `msa=c` parameter is specified, and the `ssa` and the `sp` parameters are not specified, then the `ssa` and `sp` parameters default to a value of `c`.

If the `un=c` parameter is specified, then the `sna` and `mna` parameters must have a value of `c` or must not be specified. If the `un=c` parameter is specified, and the `sna` and the `sp` parameters are not specified, then the `sna` and `mna` parameters default to a value of `c`.

If the `nc` parameter is specified as a range, the `ncm` parameter must be specified as an asterisk or as the full range.

If the `nc` parameter is specified as a single value or a range, a single value must be specified for the `ni` parameter.

If the `nc` parameter is specified as an asterisk, the `ncm` parameter must be specified as an asterisk or as the full range.

If the `ncm` parameter is specified as a single value, or a range other than the full range of 0–255, the `ni` and the `nc` parameters must be specified with a single value.

If the `ni` parameter is specified as an asterisk or as a range, the `nc` and `ncm` parameters must be specified as an asterisk or as the full range.

If the `ni=c` parameter is specified, then the `nc` and the `ncm` parameters must have a value of `c` or must not be specified. If the `ni=c` parameter is specified, and the `nc` and `ncm` parameters are not specified, then the `nc` and `ncm` parameters default to a value of `c`.

The spare point code subtype prefix (s-) is not supported for ANSI point codes (parameters `ni`, `nc`, `ncm`) or for 24-bit ITU national point codes (parameters `msa`, `ssa`, `sp`) or for 16-bit ITU national point codes (parameters `un`, `sna`, `mna`). The `pcst` parameter cannot be specified for ANSI, ITU-N16 or ITU-N24 point codes.

The Spare Point Code Support feature must be enabled before the `pcst` and `npcst` parameters can be specified.

The last screening reference (`sr`) entry cannot be deleted if it is referenced by another screen.

If the `zone=c` parameter is specified, then the `area` and `id` parameters must have a value of `c` or must not be specified. If the `zone=c` parameter is specified, and the `area` and the `id` parameters are not specified, then the `area` and `id` parameters default to a value of `c`.

The GWSOA parameter combination should be known and valid.

### Notes

If the screening reference is not referenced by any other screen, and if all entries are removed, the entire screening reference can be removed using `ni-nc-ncm`, `zone-area-id`, `un-sna-mna`, or `msa-ssa-sp` equal to `c-c-c` or `npc=c`. If more than one entry exists, `ni-nc-ncm`, `zone-area-id`, `un-sna-mna`, `msa-ssa-sp`, or `npc` must not equal `c`.

The asterisk is a parameter value indicating that the gateway screening process is screening all values for that parameter in the MSU. The asterisk parameter value does not mean that multiple entries whose values may be in the range implied by the asterisk will be removed. The only entry that will be removed by this command when the asterisk is specified as a parameter value is the entry that contains an asterisk as that parameter value.

For example, if the `dlt-scr-blkopc:sr=ied:ni=240:nc=010:nccm=":ssn=*` command is entered, the only entry that will be removed from the database is the entry in screening reference `iec` that contains the values `ni=240`, `nc=010`, `ncm=*`, and `ssn=*`. For an entry to be specified in this command with asterisks as parameter values, that entry must be shown in the `rtrv-scr-blkopc` output with asterisks as the same parameter values specified in the `dlt-scr-blkopc` command.

The asterisk (\*) value cannot be specified with the character `c`. For example, a point code `c-c-*` is not allowed.

A range of values is specified by separating the values that define the range by two ampersands (&&); for example, `ni=025&&100` specifies all network indicators for ANSI point codes from 25 - 100.

The character `c` is used in the blocked OPC screens to allow the screening process to continue for messages with point codes that do not match any point codes in the blocked OPC screens. When screening for a blocked OPC and the point code being screened does not match any of the point codes in the blocked DPC screens, the message is not rejected and the screening process continues.

There must be an entry in each unique blocked OPC screening reference to allow the screening process to continue. This entry consists of a screening reference, point code, `nsfi`, and `nsr`. The point code is `npc=c` or in the form of subfields `ni-nc-ncm`, `zone-area-id`, or `msa-ssa-sp`, `un-sna-mna` equal to `c-c-c`. When the character `c` is specified, the `nsfi` and `nsr` must be specified.

When the point code does not match any entries in the blocked OPC screens, the screening process is directed to the screening reference with the point code `c-c-c`. The `nsfi` and `nsr` in this entry are examined to determine the next step in the screening process.

The spare point code subtype prefix (s-) is supported only for ITU international and ITU national point codes. The `pcst` parameter indicates whether the specified point code has no subtype prefix or has the spare point code prefix.



## Output

```
dlt-scr-blkopc:sr=iec:ni=240:nc=010:ncm=010
```

```
rlghncxa03w 04-01-07 11:43:04 EST EAGLE 31.3.0
DLT-SCR-BLKOPC: SCREEN SET AFFECTED - IEC 25% FULL
DLT-SCR-BLKOPC: MASP A - COMPLTD
;
```

## Related Topics

- [chg-scr-blkopc](#)
- [ent-scr-blkopc](#)
- [rtrv-scr-blkopc](#)

# dlt-scr-cdpa

Use this command to remove a specific screening reference from the allowed called party address category.

## Parameters

### **sr (mandatory)**

Screening reference. The point code's unique screening reference name.

#### **Range:**

*ayyy*

1 alphabetic character followed by up to 3 alphanumeric characters

### **ssn (mandatory)**

Subsystem number.

#### **Range:**

*0 - 255, \**

\*—the full range of values from 0–255

### **area (optional)**

ITU international area. The *area* in the point code represented by *zone-area-id*.

#### **Range:**

*0 - 255, \*, C*

\*—the full range of values from 0–255

C—continue

### **id (optional)**

ITU international ID. The *ID* in the point code represented by *zone-area-id*.

#### **Range:**

*0 - 7, \*, C*

\*—the full range of values from 0–7

C—continue

**mna (optional)**

16-bit ITU national main number area. The *mna* in the point code represented by *un-sna-mna*.

**Range:**

0--31, \*

\*—the full range of values from 0–31

**msa (optional)**

24-bit ITU national signaling point. The *msa* in the point code represented by *msa-ssa-sp*.

**Range:**

0 - 255, \*, C

\*—the full range of values from 0–255

C—continue

**nc (optional)**

Network cluster value. This parameter specifies one or more *nc* values for the network indicator and network cluster member values specified in the *ni* and *ncm* parameters. It specifies the *nc* of the point code represented by *ni-nc-ncm*.

**Range:**

0 - 255, \*, C

\*—the full range of values from 0–255

C—continue

**ncm (optional)**

Network cluster member value. This parameter specifies one or more *ncm* values for the network indicator and network cluster values identified in the *ni* and *nc* parameters. It specifies the *ncm* of the point code represented by *ni-nc-ncm*.

**Range:**

0 - 255, \*, C

\*—the full range of values from 0–255

C—continue

**ni (optional)**

Network indicator value. This parameter specifies one or more *ni* values for the network cluster and network cluster member values identified in the *nc* and *ncm* parameters. It specifies the *ni* of the point code represented by *ni-nc-ncm*.

**Range:**

0 - 255, \*, C

\*—the full range of values from 0–255

C—continue

**npc (optional)**

ITU national point code.

 **Note:**

Gateway screening allows the ITU national point code to be displayed and entered in the database only as a single number. For multiple-part ITU national point codes, see [Converting ITU National Point Code Formats](#) for information on converting the point code format.

**Range:**

0 - 16383, \*, C

\*—the full range of values from 0–16383

C—continue

**pcst (optional)**

Point code subtype. This parameter indicates whether the specified ITU international or ITU national point code has no subtype prefix or has the spare point code prefix (s-).

**Range:**

*none*

*s*

**Default:**

*none*

**scmgfid (optional)**

SCCP management format ID. This parameter consists of a one-octet field and uniquely defines the function and format of each SCMG message. A single value or a range of values can be specified.

**Range:**

1 - 255, \*

\*—the full range of values from 0–255

**sna (optional)**

16-bit ITU national sub number area. The *sna* in the point code represented by *un-sna-mna*.

**Range:**

0--15, \*

\*—the full range of values from 0–15

**sp (optional)**

24-bit ITU national signaling point. The *sp* in the point code represented by *msa-ssa-sp*.

**Range:**

0 - 255, \*, C

\*—the full range of values from 0–255

C—continue

**ssa (optional)**

24-bit ITU national sub signaling area. The *ssa* in the point code represented by *msa-ssa-sp*.

**Range:**

0 - 255, \*, C

\*—the full range of values from 0–255

C—continue

**un (optional)**

16-bit ITU-national unit number. The *un* of the point code represented by *un-sna-mna*.

**Range:**

0--127, \*

\*—the full range of values from 0–127

**zone (optional)**

ITU international zone. The *zone* in the point code represented by *zone-area-id*.

**Range:**

0 - 7, \*, C

\*—the full range of values from 0–255

C—continue

**Example**

```
dlt-scr-cdpa:sr=iec:ni=240:nc=010:ncm=010:ssn=012
```

```
dlt-scr-cdpa:sr=cdpa:zone=1:area=2:id=3:ssn=1:sccpmt=9:ri=*:pcst=s
```

```
dlt-scr-cdpa:sr=cdp2:un=1:sna=2:mna=3:ssn=1
```

**Dependencies**

A complete point code must be specified, and must be one and only one of the five point code parameter combinations: *ni-nc-ncm*, *zone-area-id*, *msa-ssa-sp*, *un-sna-mna*, or *npc*, except for entering *c*.

The CDPA point code, *ssn*, and *scmgfid* to be removed must exist in the CDPA entity set.

ANSI point code value 000-000-000 and ITU-International point code value 0-000-0 are not allowed.

If the *nc* parameter is specified as a range, the *ncm* parameter must be specified as an asterisk or as the full range.

If the *nc* parameter is specified as a single value or a range, a single value must be specified for the *ni* parameter.

If the *nc* parameter is specified as an asterisk, the *ncm* parameter must be specified as an asterisk or as the full range.

If the *ncm* parameter is specified as a single value, or a range other than the full range of 0–255, the *ni* and *nc* parameters must be specified with a single value.

If the *ni* parameter is specified as an asterisk or as a range, the *nc* and *ncm* parameters must be specified as an asterisk or as the full range.

The specified screening reference (*sr*) must already exist in the database.

The Spare Point Code Support feature must be enabled before the `pcst` parameter can be specified.

The spare point code subtype prefix (s-) is not supported for ANSI point codes (parameters `ni`, `nc`, `ncm`) or for 24-bit ITU national point codes (parameters `msa`, `ssa`, `sp`) or for 16-bit ITU national point code (parameters `un`, `sna`, `mna`). The `pcst` parameter cannot be specified for ANSI, ITU-N24 or ITU-N16 point codes.

A CDPA screening reference (`sr`) cannot be deleted if it referenced by an entity in another screening set.

If the `ssn` parameter is a value other than 1, the `scmgfid` parameter cannot be specified.

If the `ssn=1` parameter is specified, the `scmgfid` parameter must be specified.

The GWSOA parameter combination should be known and valid.

### Notes

If only one entry exists and is not referenced by another screening table, the entire screening table is removed.

The asterisk is a parameter value indicating that the gateway screening process is screening all values for that parameter in the MSU. The asterisk parameter value does not mean that multiple entries whose values may be in the range implied by the asterisk will be removed. The only entry that will be removed by this command when the asterisk is specified as a parameter value is the entry that contains an asterisk as that parameter value.

For example, if the `dlt-scr-cdpa:sr=iec:ni=240:nc=010:ncm=":ssn=*` command is entered, the only entry that will be removed from the database is the entry in screening reference `iec` that contains the values `ni=240`, `nc=010`, `ncm=*`, and `ssn=*`. For an entry to be specified in this command with asterisks as parameter values, that entry must be shown in the `rtrv-scr-cdpa` output with asterisks as the same parameter values specified in the `dlt-scr-cdpa` command.

A range of values is specified by separating the values that define the range by two ampersands (&&); for example, `ni=025&&100` specifies all network indicators for ANSI point codes from 25 - 100 .

The spare point code subtype prefix (s-) is supported only for ITU international and ITU national point codes. The `pcst` parameter indicates whether the specified point code has no subtype prefix or has the spare point code prefix.

### Output

```
dlt-scr-cdpa:sr=iec:ni=240:nc=010:ncm=010:ssn=012
```

```
rlghncxa03w 04-01-07 11:43:04 EST EAGLE 31.3.0
DLT-SCR-CDPA: SCREEN SET AFFECTED - IEC 25% FULL
DLT-SCR-CDPA: MASP A - COMPLTD
;
```

### Related Topics

- [chg-scr-cdpa](#)

- [ent-scr-cdpa](#)
- [rtrv-scr-cdpa](#)

## dlt-scr-cgpa

Use this command to remove a specific screening reference from the allowed calling party address category.

### Parameters

#### **ri (mandatory)**

Routing indicator. Routing instructions to the receiving signaling point. In gateway screening, messages may be screened based on the value of the routing indicator.

#### **Range:**

##### **dpc**

Allow a called party address with a routing indicator value of "DPC/SSN."

##### **gt**

Screening stops and gateway screening is bypassed as a forced pass.

\*

Allow both routing indicator values.

#### **sccpmt (mandatory)**

SCCP message type.

#### **Range:**

##### **9**

UDT

##### **10**

UDTS

##### **17**

XUDT

##### **18**

XUDTS

\*

the full range of values

#### **sr (mandatory)**

Screening reference. This parameter specifies the point code's unique screening reference name.

#### **Range:**

*ayyy*

1 alphabetic character followed by up to 3 alphanumeric characters

#### **ssn (mandatory)**

Subsystem number.

**Range:**

1 - 255, \*

\*—the full range of values from 1–255

**area (optional)**ITU international area. The *area* in the point code represented by *zone-area-id*.**Range:**

0 - 255, \*

\*—the full range of values from 0–255

**id (optional)**ITU international ID. The *ID* in the point code represented by *zone-area-id*.**Range:**

0 - 7, \*

\*—the full range of values from 0–7

**mna (optional)**16-bit ITU national *main number area*. The *mna* in the point code represented by *un-sna-mna*.**Range:**

0--31, \*

\* -- the full range of values from 0--31

**msa (optional)**24-bit ITU-national main signaling area value. The *msa* of the point code represented by *msa-ssa-sp*.**Range:**

0 - 255, \*

\*—the full range of values from 0–255

**nc (optional)**Network cluster value. This parameter specifies one or more *nc* values for the network indicator and network cluster member values specified in the *ni* and *ncm* parameters. It specifies the *nc* of the point code represented by *ni-nc-ncm*.**Range:**

0 - 255, \*

\*—the full range of values from 0–255

**ncm (optional)**Network cluster member value. This parameter specifies one or more *ncm* values for the network indicator and network cluster values identified in the *ni* and *nc* parameters. It specifies the *ncm* of the point code represented by *ni-nc-ncm*.**Range:**

0 - 255, \*

\*—the full range of values from 0–255

**ni (optional)**

Network indicator value. This parameter specifies one or more *ni* values for the network cluster and network cluster member values identified in the *nc* and *ncm* parameters. It specifies the *ni* of the point code represented by *ni-nc-ncm*.

**Range:**

0 - 255, \*

\*—the full range of values from 0–255

**npc (optional)**

ITU national point code.

 **Note:**

Gateway screening allows the ITU national point code to be displayed and entered in the database only as a single number. For multiple-part ITU national point codes, see [Converting ITU National Point Code Formats](#) for information on converting the point code format.

**Range:**

0 - 16383, \*

\*—the full range of values from 0–16383

**pcst (optional)**

Point code subtype. This parameter indicates whether the specified ITU international or ITU national point code has no subtype prefix or has the spare point code prefix (s-).

**Range:**

*none*

*s*

**Default:**

*none*

**sna (optional)**

16-bit ITU national *sub number area*. The *sna* in the point code represented by *un-sna-mna*.

**Range:**

0--15, \*

\* -- the full range of values from 0--15

**sp (optional)**

24-bit ITU national signaling point. The *sp* in the point code represented by *msa-ssa-sp*.

**Range:**

0 - 255, \*

\*—the full range of values from 0–255

**ssa (optional)**

24-bit ITU national sub signaling area. The *ssa* in the point code represented by *msa-ssa-sp*.



**Range:**

0 - 255, \*

\*—the full range of values from 0–255

**un (optional)**16-bit ITU national *unit number*. The *un* of the point code represented by *un-sna-mna*.**Range:**

0--127, \*

\* -- the full range of values from 0--127

**zone (optional)**ITU international zone. The *zone* in the point code represented by *zone-area-id*.**Range:**

0 - 7, \*

\*—the full range of values from 0–7

**Example**

```
dlt-scr-cgpa:sr=iec:ni=240:nc=010:ncm=010:ssn=012
```

```
dlt-scr-cgpa:sr=cdp1:ni=5:nc=5:ncm=5:ssn=1:ri=dpc:sccpmt=009
```

```
dlt-scr-  
cgpa:sr=cgpa:zone=1:area=2:id=3:ssn=1:sccpmt=9:ri=*:pcst=s
```

```
dlt-scr-cgpa:sr=cgp1:un=1:sna=2:mna=1:ssn=1:sccpmt=9:ri=*
```

**Dependencies**

A complete point code must be specified, and must be one, and only one of the five point code parameter combinations: *ni-nc-ncm*, *zone-area-id*, *msa-ssa-sp*, *un-sna-mna*, or *npc*.

ANSI point code value 000-000-000 and ITU-International point code value 0-000-0 are not allowed.

The CGPA point code, *ri*, *ssn*, and *sccpmt* to be removed must exist in the CGPA entity set.

If the *nc* parameter is specified as a range, the *ncm* parameter must be specified as an asterisk or as the full range.

If the *nc* parameter is specified as a single value or a range, a single value must be specified for the *ni* parameter.

If the *nc* parameter is specified as an asterisk, the *ncm* parameter must be specified as an asterisk or as the full range.

If the *ncm* parameter is specified as a single value, or a range other than the full range of 0–255, the *ni* and the *nc* parameters must be specified with a single value.

If the *ni* parameter is specified as an asterisk or as a range, the *nc* and *ncm* parameters must be specified as an asterisk or as the full range.

The specified screening reference (*sr*) must already exist in the database.

The Spare Point Code Support feature must be enabled before the `pcst` parameter can be specified.

The spare point code subtype prefix (s-) is not supported for ANSI point codes (parameters `ni`, `nc`, `ncm`) or for 24-bit ITU national point codes (parameters `msa`, `ssa`, `sp`) or for 16-bit ITU national point codes (parameters `un`, `sna`, `mna`). The `pcst` parameter cannot be specified for ANSI, ITU-N24 or ITU-N16 point codes.

A CGPA screening reference (`sr`) cannot be deleted if it is referenced by an entity in another screening set.

The GWSOA parameter combination should be known and valid.

## Notes

The asterisk is a parameter value indicating that the gateway screening process is screening all values for that parameter in the MSU. The asterisk parameter value does not mean that multiple entries whose values may be in the range implied by the asterisk will be removed. The only entry that will be removed by this command when the asterisk is specified as a parameter value is the entry that contains an asterisk as that parameter value.

For example, if the `dlt-scr-cgpa:sr=ied:ni=240:nc=010:ncm=":ssn=*`  command is entered, the only entry that will be removed from the database is the entry in screening reference `iec` that contains the values `ni=240`, `nc=010`, `ncm=*`, and `ssn=*`. For an entry to be specified in this command with asterisks as parameter values, that entry must be shown in the `rtrv-scr-cgpa` output with asterisks as the same parameter values specified in the `dlt-scr-cgpa` command.

A range of values is specified by separating the values that define the range by two ampersands (`&&`); for example, `ni=025&&100` specifies all network indicators for ANSI point codes from 25 - 100.

The routing indicator in the calling party address provides routing instructions for the receiving signaling point. When the routing indicator specifies global title, the message is routed based on the global title digits. If the routing indicator specifies DPC, the message is routed based on the DPC/subsystem number in the calling party address.

The spare point code subtype prefix (s-) is supported only for ITU international and ITU national point codes. The `pcst` parameter indicates whether the specified point code has no subtype prefix or has the spare point code prefix.

## Output

```
dlt-scr-cgpa:sr=iec:ni=240:nc=010:ncm=010:ssn=012
```

```
rlghncxa03w 04-01-07 11:43:04 EST EAGLE 31.3.0
DLT-SCR-CGPA: SCREEN SET AFFECTED - IEC 25% FULL
DLT-SCR-CGPA: MASP A - COMPLTD
;
```

## Related Topics

- [chg-scr-cgpa](#)
- [ent-scr-cgpa](#)
- [rtrv-scr-cgpa](#)

## dlt-scr-destfld

Use this command to remove a specific screening reference from the allowed affected destination field (DESTFLD) category.

### Parameters

#### **sr (mandatory)**

Screening reference. This parameter specifies the point code's unique screening reference name.

##### **Range:**

*ayyy*

1 alphabetic character followed by up to 3 alphanumeric characters

#### **area (optional)**

ITU international area. The *area* in the point code represented by *zone-area-id*.

##### **Range:**

*0 - 255, \**

\*—the full range of values from 0–255

#### **id (optional)**

ITU international ID. The *ID* in the point code represented by *zone-area-id*.

##### **Range:**

*0 - 7, \**

\*—the full range of values from 0–7

#### **mna (optional)**

16-bit ITU national main number area. The *mna* in the point code represented by *un-sna-mna*.

##### **Range:**

*0--31, \**

\*—the full range of values from 0–31

#### **msa (optional)**

24-bit ITU-national main signaling area value. The *msa* of the point code represented by *msa-ssa-sp*.

##### **Range:**

*0 - 255, \**

\*—the full range of values from 0–255

#### **nc (optional)**

Network cluster value. This parameter specifies one or more *nc* values for the network indicator and network cluster member values specified in the *ni* and *ncm* parameters. It specifies the *nc* of the point code represented by *ni-nc-ncm*.

##### **Range:**

*0 - 255, \**

\*—the full range of values from 0–255

**ncm (optional)**

Network cluster member value. This parameter specifies one or more *ncm* values for the network indicator and network cluster values identified in the *ni* and *nc* parameters. It specifies the *ncm* of the point code represented by *ni-nc-ncm*.

**Range:**

0 - 255, \*

\*—the full range of values from 0–255

**ni (optional)**

Network indicator value. This parameter specifies one or more *ni* values for the network cluster and network cluster member values identified in the *nc* and *ncm* parameters. It specifies the *ni* of the point code represented by *ni-nc-ncm*.

**Range:**

0 - 255, \*

\*—the full range of values from 0–255

**npc (optional)**

ITU national point code.

**Note:**

Gateway screening allows the ITU national point code to be displayed and entered in the database only as a single number. For multiple-part ITU national point codes, see [Converting ITU National Point Code Formats](#) for information on converting the point code format.

**Range:**

0 - 16383, \*

\*—the full range of values from 0–255

**pcst (optional)**

Point code subtype. This parameter indicates whether the specified ITU international or ITU national point code has no subtype prefix or has the spare point code prefix (s-).

**Range:**

*none*

*s*

**Default:**

*none*

**sna (optional)**

16-bit ITU national sub number area. The *sna* in the point code represented by *un-sna-mna*.

**Range:**

0--15, \*

\*—the full range of values from 0–15

**sp (optional)**

24-bit ITU national signaling point. The *sp* in the point code represented by *msa-ssa-sp*.

**Range:**

0 - 255, \*

\*—the full range of values from 0–255

**ssa (optional)**24-bit ITU national sub signaling area. The *ssa* in the point code represented by *msa-ssa-sp*.**Range:**

0 - 255, \*

\*—the full range of values from 0–255

**un (optional)**16-bit ITU-national unit number. The *un* of the point code represented by *un-sna-mna*.**Range:**

0--127, \*

\*—the full range of values from 0–127

**zone (optional)**ITU international zone. The *zone* in the point code represented by *zone-area-id*.**Range:**

0 - 7, \*

\*—the full range of values from 0–7

**Example**

```
dlt-scr-destfld:sr=iec:ni=240:nc=010:ncm=010
```

```
dlt-scr-destfld:sr=dst1:zone=1:area=2:id=3:pcst=s
```

```
dlt-scr-destfld:sr=dst1:un=125:sna=12:mna=17
```

**Dependencies**

A complete point code must be specified, using the *ni-nc-ncm*, *zone-area-id*, *msa-ssa-sp*, *un-sna-mna*, or *npc* combination unless a value of *c* is specified.

ANSI point code value 000-000-000 and ITU-International point code value 0-000-0 are not allowed.

If the *zone=\** parameter is specified, then the *area=\** and the *id=\** parameters must be specified.

If the *area=\** parameter is specified, then the *id=\** parameter must be specified.

If the *ssa=\** parameter is specified, then the *sp=\** parameter must be specified.

If the *sna=\** parameter is specified, then the *mna=\** parameter must be specified.

If the *msa=\** parameter is specified, then the *ssa=\** and the *sp=\** parameters must be specified.

If the *un=\** parameter is specified, then the *sna=\** and the *mna=\** parameters must be specified.

If the *nc* parameter is specified as a range, the *ncm* parameter must be specified as an asterisk or as the full range.

If the `nc` parameter is specified as a single value or a range, a single value must be specified for the `ni` parameter.

If the `nc` parameter is specified as an asterisk, the `ncm` parameter must be specified as an asterisk or as the full range.

If the `ncm` parameter is specified as a single value, or a range other than the full range of 0–255, the `ni` and `nc` parameters must be specified with a single value.

If the `ni` parameter is specified as an asterisk or as a range, the `nc` and `ncm` parameters must be specified as an asterisk or as the full range.

The DESTFLD specified by `ni-nc-ncm`, `zone-area-id`, `msa-ssa-sp`, `un-sna-mna`, or the `npc` parameter must already exist in the screening reference.

If only one entry exists, the `sr` cannot be referenced by another screening table. If the `sr` is not referenced by another screening table, the entire screening table is deleted.

The Spare Point Code Support feature must be enabled before the `pcst` parameter can be specified.

The spare point code subtype prefix (s-) is not supported for ANSI point codes (parameters `ni`, `nc`, `ncm`) or for 24-bit ITU national point codes (parameters `msa`, `ssa`, `sp`) or for 16-bit ITU national point codes (parameters `un`, `sna`, `mna`). The `pcst` parameter cannot be specified for ANSI, ITU-N16 and ITU-N24 point codes.

If the `nsfi=fail` parameter is specified, then the `nni`, `nc`, `ncm`, `narea`, `nzone`, `nid`, `nmsa`, `nssa`, `nsp`, `nun`, `nsna`, `nmna`, and `npc` parameters cannot have a value of `c`.

The GWSOA parameter combination should be known and valid.

## Notes

The asterisk is a parameter value indicating that the gateway screening process is screening all values for that parameter in the MSU. The asterisk parameter value does not mean that multiple entries whose values may be in the range implied by the asterisk will be removed. The only entry that will be removed by this command when the asterisk is specified as a parameter value is the entry that contains an asterisk as that parameter value.

For example, if the `dlt-scr-destfld:sr=ied:ni=240:nc=010:ncm="":ssn=*` command is entered, the only entry that will be removed from the database is the entry in screening reference `iec` that contains the values `ni=240`, `nc=010`, `ncm=*`, and `ssn=*`. For an entry to be specified in this command with asterisks as parameter values, that entry must be shown in the `rtrv-scr-destfld` output with asterisks as the same parameter values specified in the `dlt-scr-destfld` command.

A range of values is specified by separating the values that define the range by two ampersands (&&); for example, `ni=025&&100` specifies all network indicators for ANSI point codes from 25 - 100.

The spare point code subtype prefix (s-) is supported only for ITU international and ITU national point codes. The `pcst` parameter indicates whether the specified point code has no subtype prefix or has the spare point code prefix.

## Output

```
dlt-scr-destfld:sr=iec:ni=240:nc=010:ncm=010
```

```
rlghncxa03w 04-02-13 11:49:47 EST EAGLE 31.3.0
DLT-SCR-DESTFLD: SCREEN SET AFFECTED - SS01 25% FULL
DLT-SCR-DESTFLD: MASP A - COMPLTD
;
```

## Related Topics

- [chg-scr-destfld](#)
- [ent-scr-destfld](#)
- [rtrv-scr-destfld](#)

# dlt-scr-dpc

Use this command to remove a specific screening reference from the allowed DPC category.

## Parameters

### **sr (mandatory)**

Screening reference. The point code's unique screening reference name.

#### **Range:**

*ayyy*

1 alphabetic character followed by up to 3 alphanumeric characters

### **area (optional)**

ITU international area. The *area* in the point code represented by *zone-area-id*.

#### **Range:**

*0 - 255, \**

\*—the full range of values from 0–255

### **id (optional)**

ITU international ID. The *ID* in the point code represented by *zone-area-id*.

#### **Range:**

*0 - 7, \**

\*—the full range of values from 0–7

### **mna (optional)**

16-bit ITU national main number area. The *mna* in the point code represented by *un-sna-mna*.

#### **Range:**

*0--31, \**

\*—the full range of values from 0–31

**msa (optional)**

24-bit ITU-national main signaling area value. The *msa* of the point code represented by *msa-ssa-sp*.

**Range:**

0 - 255, \*

\*—the full range of values from 0–255

**nc (optional)**

Network cluster value. This parameter specifies one or more *nc* values for the network indicator and network cluster member values specified in the *ni* and *ncm* parameters. It specifies the *nc* of the point code represented by *ni-nc-ncm*.

**Range:**

0 - 255, \*

\*—the full range of values from 0–255

**ncm (optional)**

Network cluster member value. This parameter specifies one or more *ncm* values for the network indicator and network cluster values identified in the *ni* and *nc* parameters. It specifies the *ncm* of the point code represented by *ni-nc-ncm*.

**Range:**

0 - 255, \*

\*—the full range of values from 0–255

**ni (optional)**

Network indicator value. This parameter specifies one or more *ni* values for the network cluster and network cluster member values identified in the *nc* and *ncm* parameters. It specifies the *ni* of the point code represented by *ni-nc-ncm*.

**Range:**

0 - 255, \*

\*—the full range of values from 0–255

**npc (optional)**

ITU national point code.

 **Note:**

Gateway screening allows the ITU national point code to be displayed and entered in the database only as a single number. For multiple-part ITU national point codes, see [Converting ITU National Point Code Formats](#) for information on converting the point code format.

**Range:**

0 - 16383, \*

\*—the full range of values from 0–16383

**pcst (optional)**

Point code subtype. This parameter indicates whether the specified ITU international or ITU national point code has no subtype prefix or has the spare point code prefix (s-).



**Range:***none**s***Default:***none***sna (optional)**

16-bit ITU national sub number area. The *sna* in the point code represented by *un-sna-mna*.

**Range:***0--15, \**

\*—the full range of values from 0–15

**sp (optional)**

24-bit ITU national signaling point. The *sp* in the point code represented by *msa-ssa-sp*.

**Range:***0 - 255, \**

\*—the full range of values from 0–255

**ssa (optional)**

24-bit ITU national sub signaling area. The *ssa* in the point code represented by *msa-ssa-sp*.

**Range:***0 - 255, \**

\*—the full range of values from 0–255

**un (optional)**

16-bit ITU-national unit number. The *un* of the point code represented by *un-sna-mna*.

**Range:***0--127, \**

\*—the full range of values from 0–127

**zone (optional)**

ITU international zone. The *zone* in the point code represented by *zone-area-id*.

**Range:***0 - 7, \**

\*—the full range of values from 0–7

**Example**

```
dlt-scr-dpc:sr=iec:ni=240:nc=010:ncm=010
```

```
dlt-scr-dpc:sr=dpc1:npc=128:pcst=s
```

```
dlt-scr-dpc:sr=dpc2:un=1:sna=2:mna=1
```

## Dependencies

A complete point code must be specified, using the `ni-nc-ncm`, `zone-area-id`, `msa-ssa-sp`, `un-sna-mna`, or `npc` combination unless a value of `c` is specified.

The DPC specified by `ni-nc-ncm`, `zone-area-id`, `msa-ssa-sp`, `un-sna-mna`, or the `npc` parameter must already exist in the screening reference or within an existing range of DPCs.

ANSI point code value 000-000-000 and ITU-International point code value 0-000-0 are not allowed.

If the `nc` parameter is specified as a range, the `ncm` parameter must be specified as an asterisk or as the full range.

If the `nc` parameter is specified as a single value or a range, a single value must be specified for the `ni` parameter.

If the `nc` parameter is specified as an asterisk, the `ncm` parameter must be specified as an asterisk or as the full range.

If the `ncm` parameter is specified as a single value, or a range other than the full range of 0–255, the `ni` and `nc` parameters must be specified with a single value.

If the `ni` parameter is specified as an asterisk or as a range, the `nc` and `ncm` parameters must be specified as an asterisk or as the full range.

If only one entry exists, the `sr` must not be referenced by another screening table. If the `sr` is not referenced by another screening table, the entire screening table is deleted.

The Spare Point Code Support feature must be enabled before the `pcst` parameter can be specified.

The spare point code subtype prefix (s-) is not supported for ANSI point codes (parameters `ni`, `nc`, `ncm`) or for 24-bit ITU national point codes (parameters `msa`, `ssa`, `sp`) or for 16-bit ITU national point codes (parameters `un`, `sna`, `mna`). The `pcst` parameter cannot be specified for ANSI, ITU-N24, or ITU-N16 point codes.

If the `nsfi=fail` parameter is specified, then the `nni`, `nc`, `nncm`, `narea`, `nzone`, `nid`, `nmsa`, `nssa`, `nsp`, `nun`, `nsna`, `nmna`, and `npc` parameters cannot have a value of `c`.

The GWSOA parameter combination should be known and valid.

## Notes

The asterisk is a parameter value indicating that the gateway screening process is screening all values for that parameter in the MSU. The asterisk parameter value does not mean that multiple entries whose values may be in the range implied by the asterisk will be removed. The only entry that will be removed by this command when the asterisk is specified as a parameter value is the entry that contains an asterisk as that parameter value.

For example, if the `dlt-scr-dpc:sr=ied:ni=240:nc=010:nccm=":ssn=*`  command is entered, the only entry that will be removed from the database is the entry in screening reference `iec` that contains the values `ni=240`, `nc=010`, `ncm=*`, and `ssn=*`. For an entry to be specified in this command with asterisks as parameter values, that entry must be shown in the `rtrv-scr-dpc` output with asterisks as the same parameter values specified in the `dlt-scr-dpc` command.

A range of values is specified by separating the values that define the range by two ampersands (&&); for example, `ni=025&&100` specifies all network indicators for ANSI point codes from 25 - 100.

The spare point code subtype prefix (s-) is supported only for ITU international and ITU national point codes. The `pcst` parameter indicates whether the specified point code has no subtype prefix or has the spare point code prefix.

### Output

```
dlt-scr-dpc:sr=iec:ni=240:nc=010:ncm=010
```

```
rlghncxa03w 04-01-07 11:43:04 EST EAGLE 31.3.0
DLT-SCR-DPC: SCREEN SET AFFECTED - IEC 25% FULL
DLT-SCR-DPC: MASP A - COMPLTD
;
```

### Related Topics

- [chg-scr-dpc](#)
- [ent-scr-dpc](#)
- [rtrv-scr-dpc](#)

## dlt-scr-isup

Use this command to delete an allowed ISUP screening reference from the Allowed ISUP entity set.

### Parameters

#### **isupmt/tupmt (mandatory)**

ISUP or TUP message type.

#### **Range:**

0 - 255, \*

\*—the full range of values from 0–255

#### **sr (mandatory)**

Screening reference. This parameter specifies the point code's unique screening reference name.

#### **Range:**

ayyy

1 alphabetic character followed by up to 3 alphanumeric characters

### Example

```
dlt-scr-isup:sr=iec:isupmt=9
```

```
dlt-scr-isup:sr=iec:isupmt=1&&2
```

```
dlt-scr-isup:tupmt=1:sr=tu01
```

## Dependencies

The specified `sr` must exist in the Allowed ISUP entity set.

The specified `isupmt` or `tupmt` parameter value must already exist in the specified `sr`.

The last entry in the specified `sr` cannot be deleted if the entry is referenced by another screen.

The GWSOA parameter combination should be known and valid.

The ISUPMT (ISUP Message Type) parameter must be specified for a SEAS command.

## Notes

An asterisk can be specified for a parameter value in the `chg/dlt-scr-isup` commands *only* if that parameter value was specified as an asterisk in the `ent-scr-isup` command to define the parameter value.

A range of values can be specified for the `isupmt` or `tupmt` parameter, by separating the values that define the range by two ampersands (&&); for example, `isupmt=025&&100` specifies all ISUP message types from 25 - 100. The value to the left of the && must be less than the value to the right of the && in the range.

## Output

No screen sets are listed in the following example, because the specified screening reference is not associated with any screen sets.

```
dlt-scr-isup:sr=iec:isupmt=9

      tekelecstp 02-09-02 11:59:41 EST  EAGLE 30.0.0
      DLT-SCR-ISUP: MASP A - COMPLTD
;

```

No screen sets are listed in the following example, because the specified screening reference is not associated with any screen sets. `dlt-scr-isup:sr=iec:isupmt=1&&2`

```
      tekelecstp 02-09-02 12:00:30 EST  EAGLE 30.0.0
      DLT-SCR-ISUP: MASP A - COMPLTD
;

```

The following example lists the screen sets that are associated with the specified screening reference. `dlt-scr-isup:tupmt=1:sr=tu01`

```
      tekelecstp 03-11-02 12:00:30 EST  EAGLE 31.3.0
      Extended Processing Time Required -- Please Wait
      Notice: The number of screensets affected is 2.
      DLT-SCR-ISUP: SCREEN SET AFFECTED - ist1 1% FULL
      DLT-SCR-ISUP: SCREEN SET AFFECTED - ist2 1% FULL
      DLT-SCR-ISUP: MASP A - COMPLTD
;

```

**Related Topics**

- [chg-scr-isup](#)
- [ent-scr-isup](#)
- [rtrv-scr-isup](#)

## dlt-scr-opc

Use this command to remove a specific screening reference from the allowed OPC category.

**Parameters****sr (mandatory)**

Screening reference. This parameter specifies the point code's unique screening reference name.

**Range:**

*ayyy*

1 alphabetic character followed by up to 3 alphanumeric characters

**area (optional)**

ITU international area. The *area* in the point code represented by *zone-area-id*.

**Range:**

*0 - 255, \**

\*—the full range of values from 0–255

**id (optional)**

ITU international ID. The *ID* in the point code represented by *zone-area-id*.

**Range:**

*0 - 7, \**

\*—the full range of values from 0–7

**mna (optional)**

16-bit ITU national main number area. The *mna* in the point code represented by *un-sna-mna*.

**Range:**

*0--31, \**

\*—the full range of values from 0–31

**msa (optional)**

24-bit ITU-national main signaling area value. The *msa* of the point code represented by *msa-ssa-sp*.

**Range:**

*0 - 255, \**

\*—the full range of values from 0–255

**nc (optional)**

Network cluster value. This parameter specifies one or more *nc* values for the network indicator and network cluster member values specified in the *ni* and *ncm* parameters. It specifies the *nc* of the point code represented by *ni-nc-ncm*.

**Range:**

0 - 255, \*

\*—the full range of values from 0–255

**ncm (optional)**

Network cluster member value. This parameter specifies one or more *ncm* values for the network indicator and network cluster values identified in the *ni* and *nc* parameters. It specifies the *ncm* of the point code represented by *ni-nc-ncm*.

**Range:**

0 - 255, \*

\*—the full range of values from 0–255

**ni (optional)**

Network indicator value. This parameter specifies one or more *ni* values for the network cluster and network cluster member values identified in the *nc* and *ncm* parameters. It specifies the *ni* of the point code represented by *ni-nc-ncm*.

**Range:**

0 - 255, \*

\*—the full range of values from 0–255

**npc (optional)**

ITU national point code.

Gateway screening allows the ITU national point code to be displayed and entered in the database only as a single number. For multiple-part ITU national point codes, see [Converting ITU National Point Code Formats](#) for information on converting the point code format.

**Range:**

0 - 16383, \*

\*—the full range of values from 0-16383

**pcst (optional)**

Point code subtype. This parameter indicates whether the specified ITU international or ITU national point code has no subtype prefix or has the spare point code prefix (s-).

**Range:**

*none*

*s*

**Default:**

*none*

**sna (optional)**

16-bit ITU national sub number area. The *sna* in the point code represented by *un-sna-mna*.

**Range:**

0--15, \*

\*—the full range of values from 0–15

**sp (optional)**

24-bit ITU national signaling point. The *sp* in the point code represented by *msa-ssa-sp*.

**Range:**

0 - 255, \*

\*—the full range of values from 0–255

**ssa (optional)**

24-bit ITU national sub signaling area. The *ssa* in the point code represented by *msa-ssa-sp*.

**Range:**

0 - 255, \*

\*—the full range of values from 0–255

**un (optional)**

16-bit ITU-national unit number. The *un* of the point code represented by *un-sna-mna*.

**Range:**

0--127, \*

\*—the full range of values from 0–127

**zone (optional)**

ITU international zone. The *zone* in the point code represented by *zone-area-id*.

**Range:**

0 - 7, \*

\*—the full range of values from 0–7

**Example**

```
dlt-scr-opc:sr=iec:ni=240:nc=010:ncm=010
```

```
dlt-scr-opc:sr=opc1:npc=128:pcst=s
```

```
dlt-scr-opc:sr=opc2:un=1:sna=2:mna=1
```

**Dependencies**

A complete point code must be specified, using the *ni-nc-ncm*, *zone-area-id*, *msa-ssa-sp*, *un-sna-mna*, or *npc* combination unless a value of *c* for “continue” is specified.

The OPC specified by *ni-nc-ncm*, *zone-area-id*, *msa-ssa-sp*, *un-sna-mna*, or the *npc* parameter must already exist in the screening reference or within an existing range of OPCs.

ANSI point code value 000-000-000 and ITU-International point code value 0-000-0 are not allowed.

If the *nc* parameter is specified as a range, the *ncm* parameter must be specified as an asterisk or as the full range.

If the *nc* parameter is specified as a single value or a range, a single value must be specified for the *ni* parameter.

If the `nc` parameter is specified as an asterisk, the `ncm` parameter must be specified as an asterisk or as the full range.

If the `ncm` parameter is specified as a single value, or a range other than the full range of 0–255, the `ni` and `nc` parameters must be specified with a single value.

If the `ni` parameter is specified as an asterisk or as a range, the `nc` and `ncm` parameters must be specified as an asterisk or as the full range.

If only one entry exists, the `sr` must not be referenced by another screening table. If the `sr` is not referenced by another screening table, the entire screening table is deleted.

The Spare Point Code Support feature must be enabled before the `pcst` parameter can be specified.

The spare point code subtype prefix (s-) is not supported for ANSI point codes (parameters `ni`, `nc`, `ncm`) or for 24-bit ITU national point codes (parameters `msa`, `ssa`, `sp`) or for 16-bit ITU national point codes (parameters `un`, `sna`, `mna`). The `pcst` parameter cannot be specified for ANSI, ITU-N24, or ITU-N16 point codes.

If the `nsfi=fail` parameter is specified, then the `nni`, `nc`, `ncm`, `narea`, `nzone`, `nid`, `nmsa`, `nssa`, `nsp`, `un`, `sna`, `mna`, and `npc` parameters cannot have a value of `c`.

The GWSOA parameter combination should be known and valid.

## Notes

The asterisk is a parameter value indicating that the gateway screening process is screening all values for that parameter in the MSU. The asterisk parameter value does not mean that multiple entries whose values may be in the range implied by the asterisk will be removed. The only entry that will be removed by this command when the asterisk is specified as a parameter value is the entry that contains an asterisk as that parameter value.

For example, if the `dlt-scr-dpc:sr=ied:ni=240:nc=010:ncm=":ssn=* command` is entered, the only entry that will be removed from the database is the entry in screening reference `iec` that contains the values `ni=240`, `nc=010`, `ncm=*`, and `ssn=*`. For an entry to be specified in this command with asterisks as parameter values, that entry must be shown in the `rtrv-scr-dpc` output with asterisks as the same parameter values specified in the `dlt-scr-dpc` command.

A range of values is specified by separating the values that define the range by two ampersands (`&&`); for example, `ni=025&&100` specifies all network indicators for ANSI point codes from 25 - 100.

The spare point code subtype prefix (s-) is supported only for ITU international and ITU national point codes. The `pcst` parameter indicates whether the specified point code has no subtype prefix or has the spare point code prefix.

## Output

```
dlt-scr-opc:sr=iec:ni=240:nc=010:ncm=010
```

```
rlghncxa03w 04-01-07 11:43:04 EST EAGLE 31.3.0
DLT-SCR-OPC: SCREEN SET AFFECTED - IEC 25% FULL
```



```
DLT-SCR-OPC: MASP A - COMPLTD  
;
```

### Related Topics

- [chg-scr-opc](#)
- [ent-scr-opc](#)
- [rtrv-scr-opc](#)

## dlt-scr-sio

Use this command to remove a specific screening reference from the allowed service indicator octet (SIO) category.

### Parameters

#### **nic (mandatory)**

Network indicator code. This parameter specifies whether the message originated from an international (0) or national (2) network.

#### **Range:**

0 - 3, \*

\*—the full range of values from 0–255

#### **pri (mandatory)**

New message priority. The new message priority in the SIO.

#### **Range: 0 - 3, \***

\*—the full range of values from 0–255

#### **Default:**

Current value

#### **si (mandatory)**

Service indicator. The service indicator identifies the type of message. The values are defined in Telcordia TR-NWT-000246.

#### **Range:**

**00**

**01-15**

#### **sr (mandatory)**

Screening reference. The point code's unique screening reference name.

#### **Range:**

**ayyy**

1 alphabetic character followed by up to 3 alphanumeric characters

#### **h0 (optional)**

This parameter is mandatory if the `si` parameter has a value of `00`, `01`, `02`, or `03`. Otherwise, the `h0` parameter is undefined.

**Range:**

0 - 15

**Default:**

Current value or undefined

**h1 (optional)**

This parameter is mandatory if the `si` parameter has a value of `00`, `01`, `02`, or `03`. Otherwise, the `h1` parameter is undefined.

**Range:**

0 - 15

**Default:**

Current value or undefined

**Example**

```
dlt-scr-sio:sr=iec:nic=1:si=1:h0=4:h1=2:pri=*
```

```
dlt-scr-sio:sr=iec:nic=1:si=3:pri=2
```

**Dependencies**

The `h0` and `h1` parameters cannot be specified if the `si` parameter is specified and is not equal to `00`, `01`, or `02`.

The parameter to be removed must be in the screening reference.

Valid combinations for the `h0/h1` parameters:

- `h0` is a single value— `h1` can be a single value, range, or an asterisk
- `h0` is a range— `h1` can be an asterisk
- `h0` is an asterisk— `h1` can be an asterisk

The `sr`, `nic`, `si`, `pri`, and `h0/h1` parameters cannot be removed if they are the last entry in the screening reference and the screening reference is part of a screen set.

If the `si` parameter has value of `00`, `01`, or `02`, the `h0` and `h1` parameters must be specified. Otherwise, the `h0` parameter cannot be specified.

If the value of the `si` parameter value is greater than 2, then the `h0` and `h1` parameters cannot be specified.

If asterisks or ranges are specified for the heading codes, nothing that matches the +combination of `nic`, `si`, and the specified heading codes can already exist in the allowed SIO entity set for the screening reference.

The specified screening reference (`sr`) must already exist in the database.

The GWSOA parameter combination should be known and valid.

For SEAS commands, the `pri` parameter specified must be in the range 0-3, \*.

For SEAS commands, the `h0` parameter specified must be in the range 0-15, \*.

For SEAS commands, the `h1` parameter specified must be in the range 0-15, \*.

## Notes

The network identifier specifies whether the message originated from an international (0) or a national (2) network.

The asterisk is a parameter value indicating that the gateway screening process is screening all values for that parameter in the MSU. The asterisk parameter value does not mean that multiple entries whose values may be in the range implied by the asterisk will be removed. The only entry that will be removed by this command when the asterisk is specified as a parameter value is the entry that contains an asterisk as that parameter value.

For example, if the `dlt-scr-sio:sr=ied:ni=240:nc=010:nccm=":ssn=*` command is entered, the only entry that will be removed from the database is the entry in screening reference *iec* that contains the values `ni=240`, `nc=010`, `nccm=*`, and `ssn=*`. For an entry to be specified in this command with asterisks as parameter values, that entry must be shown in the `rtrv-scr-sio` output with asterisks as the same parameter values specified in the `dlt-scr-sio` command.

A range of values is specified by separating the values that define the range by two ampersands (&&); for example, `ni=025&&100` specifies all network indicators for ANSI point codes from 25 - 100.

## Output

```
dlt-scr-sio:sr=iec:nic=1:si=3:pri=2
```

```
rlghncxa03w 04-02-14 16:45:50 EST EAGLE 31.3.0
DLT-SCR-SIO: SCREEN SET AFFECTED - SS01 25% FULL
DLT-SCR-SIO: SCREEN SET AFFECTED - SS04 35% FULL
DLT-SCR-SIO: MASP A - COMPLTD
;
```

## Related Topics

- [chg-scr-sio](#)
- [ent-scr-sio](#)
- [rtrv-scr-sio](#)

# dlt-scr-tt

Use this command to remove a specific screening reference from the allowed translation type category.

## Parameters

### **sr** (mandatory)

Screening reference. This parameter specifies the point code's unique screening reference name.

**Range:**

ayyy

1 alphabetic character followed by up to 3 alphanumeric characters

**type (mandatory)**

Translation type. The GTT type value in the CdPA.

**Range:**

0 - 255, \*

\*—the full range of values from 0–255

**Example**

```
dlt-scr-tt:sr=iec:type=012
```

**Dependencies**

The screening reference must exist.

The `sr` and `type` parameters cannot be removed if they are the last entry in the screening reference and the screening reference is part of a screen set.The allowed `type` to be removed must already exist in the screening reference.The single value or range specified for the allowed `type` to be deleted from the TT screen for the allowed TT screening reference must already exist in that TT screen.The value specified for the `type` parameter must be within the allowed range.

The GWSOA parameter combination should be known and valid.

**Notes**

The asterisk is a parameter value indicating that the gateway screening process is screening all values for that parameter in the MSU. The asterisk parameter value does not mean that multiple entries whose values may be in the range implied by the asterisk will be removed. The only entry that will be removed by this command when the asterisk is specified as a parameter value is the entry that contains an asterisk as that parameter value.

For example, if the `dlt-scr-tt:sr=ied:type=":ssn=*` command is entered, the only entry that will be removed from the database is the entry in screening reference `iec` that contains an asterisk as the value for the `type` parameter. For an entry to be specified in this command with an asterisk as the value for the `type` parameter, that entry must be shown in the `rtrv-scr-tt` output with an asterisk as the value for the `type` parameter.

**Output**

```
dlt-scr-tt:sr=iec:type=012
```

```
rlghncxa03w 04-01-07 11:43:04 EST EAGLE 31.3.0
DLT-SCR-TT:  SCREEN SET AFFECTED - IEC  25% FULL
DLT-SCR-TT:  MASP A - COMPLTD
```

;

**Related Topics**

- [chg-scr-tt](#)

- [ent-scr-tt](#)
- [rtrv-scr-tt](#)

## dlt-scrset

Use this command to remove a screen set definition from the database. A screen set is a group of screening references that belong to various categories. This command does not remove any gateway screening tables.

### Parameters

#### **scrn (mandatory)**

Screen set name. Each screening reference must have a unique name.

#### **Range:**

ayyy

1 alphabetic character followed by up to 3 alphanumeric characters

### Example

```
dlt-scrset:scrn=nc27
```

### Dependencies

The screen set name must exist.

Before the screen set can be removed, it must be removed from all linksets.

The GWSOA parameter combination should be known and valid.

### Notes

The system validates the command to ensure that the specified screen set name is in use.

### Output

```
dlt-scrset:scrn=nc27
```

```
rlghncxa03w 04-01-07 11:43:04 EST EAGLE 31.3.0  
DLT-SCRSET: MASP A - COMPLTD  
;
```

### Related Topics

- [chg-scrset](#)
- [ent-scrset](#)
- [rtrv-scrset](#)

## dlt-shlf

Use this command to remove a shelf from the system database.

## Parameters

### loc (mandatory)

Location of the shelf to be deleted.

#### Range:

1200, 1300, 2100, 2200, 2300, 3100, 3200, 3300, 4100, 4200, 4300, 5100, 5200, 5300,  
6100, 6200, 6300

## Example

```
dlt-shlf:loc=2300
```

```
dlt-shlf:loc=6200
```

## Dependencies

The frame and shelf values of the shelf location parameter (loc) must be within the valid range (xyzz, where x=frame and y=shelf; zz is always 00 for this command).

The equipment shelf must have been configured previously.

The specified shelf cannot have any configured cards.

The Shelf table is corrupt or cannot be found by the system.

The IMT table is corrupt or cannot be found by the system.

If the equipment shelf is the only provisioned shelf in the frame and a frame power threshold entry is configured in the Frame Power Threshold table for the frame, the shelf cannot be deleted until the frame power threshold entry is deleted from the Frame Power Threshold table.

## Notes

All shelves in the system can be removed, except the control shelf (1100).

Before a shelf can be removed from the database, all SS7 signaling links and TCP/IP data links must be deactivated and removed from the database and all cards in the shelf must be removed from the database. See *Database Administration - System Management User's Guide* for more information on shelf removal.

Refer to *Installation User's Guide* for an illustration of shelf locations.

## Output

```
dlt-shlf:loc=2300
```

```
rlghncxa03w 04-01-07 11:11:28 EST EAGLE 31.3.0  
DLT-SHLF: MASP A - COMPLTD
```

```
;
```



Requested SIP Prefix entry must exist in the SIPNNPFX table.

Requested SIP Phone Context entry must exist in the SIPPHCXT table.

Default Phone Context cannot be deleted from the SIPPHCXT table.

### Notes

None.

### Output

This example displays the output when all the parameters are specified:

```
dlt-sip-npp:phctxt=x+yz.com:px=12
```

```
tekelecstp 12-07-09 19:08:39 EST EAGLE 45.0.0
dlt-sip-npp:phctxt=x+yz.com:px=12
Command entered at terminal #4.
PHCTXID table is (3 of 101) 3% full.
DLT-SIP-NPP: MASP A - COMPLTD
```

;

### Related Topics

- [ent-sip-npp](#)
- [rtv-sip-npp](#)
- [chg-sip-npp](#)

## dlt-slk

Use this command to remove a signaling link from the system database.

### Parameters

#### **link (mandatory)**

Signaling link on the card specified in the `loc` parameter. The links can be specified in any sequence or pattern.

#### **Synonym:**

*port*

#### **Range:**

*a, b, a1 - a63, b1 - b63*

Not all card types support all link parameter values.

See [Table A-1](#) for valid link parameter range values for each type of card that can have a location specified in the `loc` parameter.

#### **loc (mandatory)**

The card location as stenciled on the shelf of the system.



**Range:**

1101 - 1108, 1111 - 1112, 1201 - 1208, 1211 - 1218, 1301 - 1308, 1311 - 1318,  
2101 - 2108, 2111 - 2118, 2201 - 2208, 2211 - 2218, 2301 - 2308, 2311 - 2318,  
3101 - 3108, 3111 - 3118, 3201 - 3208, 3211 - 3218, 3301 - 3308, 3311 - 3318,  
4101 - 4108, 4111 - 4118, 4201 - 4208, 4211 - 4218, 4301 - 4308, 4311 - 4318,  
5101 - 5108, 5111 - 5118, 5201 - 5208, 5211 - 5218, 5301 - 5308, 5311 - 5318,  
6101 - 6108, 6111 - 6118

**force (optional)**

This parameter must be used to remove the last link in a linkset without having to remove all of the routes that referenced the linkset.

**Range:**

**yes**

**no**

**Default:**

**no**

**Example**

```
dlt-slk:loc=1211:link=a  
dlt-slk:loc=1201:link=b:force=yes
```

**Dependencies**

Card locations 1113 - 1118 cannot be specified.

The frame and shelf portions of the specified card location (`loc`) can be 11 - 13, 21 - 23, 31 - 33, 41 - 43, 51 - 53, and 61 . (The card location is `xyss`, where `x` is the frame, `y` is the shelf, and `ss` is the slot.)

Links A16 - A31 and B16 - B31 cannot be specified for even-numbered card locations. HC MIM cards are dual-slot cards. The links are assigned only to the cards in odd-numbered locations.

Links A32-A63 and B32-B63 is only applicable for SLIC cards running the IPSG application.

The specified link must exist in the database.

The signaling link must be in the unavailable (UAV) state before it can be removed. Enter the `rept-stat-slk` command to verify the state of the signaling link.

The signaling link cannot have an active LFS test in progress when this command is entered to delete the link.

The `force=yes` parameter must be specified to remove the last signaling link in a linkset that is assigned to a route.

To remove the last signaling link on a card, the state of the card must be OOS-MT-DSBLD.

The card must be inhibited before the last link on the card can be deleted.

An IPLIMx or IPGWx signaling link assigned to a local host cannot be deleted if it has a socket or association with connection status `open=yes`.

The Route table must be accessible.

The Link table must be accessible.

The Linkset table must be accessible.

The slot portion of the specified card location (`loc`) can be 1 - 8 and 11 - 18 . Slots 09 and 10 cannot be specified. (The card location is `xyss`, where `x` is the frame, `y` is the shelf, and `ss` is the slot.)

If deleting the link causes the provisioned link count to fall below the `numslk` thresholds configured for the corresponding IPSPG-M3UA linkset (see the `chg-lsopts` command), then the command cannot be entered.

If values of 0 or 1 are specified for all of the `numslk` threshold parameters, then the last link can be deleted.

SLK can only be deleted if no LG Engine is associated with it.

If the `lsrestrict=on` parameter is specified (see the `chg-ss7opts` command), and if deleting the link would send the number of links assigned to the linkset below the value specified for the `tfatcabmlq` parameter (see the `chg-ls` command), then the link cannot be deleted.

The GTT destination must exist in the DSTN table.

## Notes

This command disassociates the equipment of a link from a logical signaling link. The link must first be placed in the unavailable (UAV) state by entering the `chg-slk` (or `canc-slk`) command before this command can be used to disconnect it. Entering this command results in the link entity being deleted from the STP's link entity set. The link is then considered to be "disconnected." The link on the STP becomes unassigned (spare) but retains the existing equipment type and options; the link remains in the "equipped" provisioning state unless that state is changed by subsequent local craft activity. The link is also no longer associated with its assigned linkset.

Not every card location represents a signaling link. Be sure to address a signaling link in this command.

*Installation Guide* provides an illustration of card locations.

## Signaling links and scheduled UI measurement reports

If the Integrated Measurements feature is turned on, the measurements subsystem is provisioned (see the `chg-measopts` command), and the latest deletion causes the provisioned link count to fall to 700, then the measurements subsystem automatically enables the scheduled UI measurements report.

MTT 2976 and MTT 3494 are deleted as part of EPM-B.

## Output

```
dlt-slk:loc=1211:link=a
```

```
rlghncxa03w 05-02-07 11:11:28 EST EAGLE5 33.0.0  
DLT-SLK: MASP A - COMPLTD
```

```
;
```



**Notes**

None.

**Output**

```
dlt-snmp-host:ipaddr=10.25.55.25

tekelecstp 12-06-13 11:08:11 EST 45.0.0-64.66.0
dlt-snmp-host:ipaddr=10.25.55.25
Command entered at terminal #4.
SNMP HOST table is (1 of 2) 50% full
DLT-SNMP-HOST: MASP A - COMPLTD
;
```

**Related Topics**

- [ent-snmp-host](#)
- [chg-snmp-host](#)
- [rtrv-snmp-host](#)

## dlt-spc

Use this command to delete an SPC (secondary point code) from the database. Also use this command to change an SPC by first removing the SPC from the database and then using the `ent-spc` command to enter the new SPC value.

**Parameters****Note:**

See [Point Code Formats and Conversion](#) in Appendix A for a detailed description of point code formats, rules for specification, and examples.

**spc (mandatory)**

ANSI destination point code with subfields *network indicator-network cluster-network cluster member (ni-nc-ncm)*.

**Synonym:***scca***Range:***000-255*

Specify a valid value for each subfield of the point code, and separate the subfields with a dash (-).

When `chg-sid:pctype=ansi` is specified, *ni = 000* is not valid.

When `chg-sid:pctype=ansi` is specified, *nc = 000* is not valid if *ni = 001-005*.

When `chg-sid:pctype=ansi` is specified, *nc = 000* is valid if *ni = 006-255*.

The point code *000-000-000* is not a valid point code.

**spc/spca/spci/spcn/spcn24/spcn16 (mandatory)**

Secondary point code.

**spci (mandatory)**

ITU international point code with subfields *zone-area-id*. The *prefix* subfield indicates a spare point code (*prefix-zone-area-id*)

**Range:**

*s-*, 0-255

Specify a valid value for each subfield of the point code, and separate the subfields with a dash (-).

*prefix*—*s*

*zone*—0-7

*area*—000-255

*id*—0-7

The point code 0-000-0 is not a valid point code.

**spcn (mandatory)**

ITU international point code with subfields *zone-area-id*. The *prefix* subfield indicates a spare point code (*prefix-zone-area-id*).

**Range:**

*s-*, 0-16383, *aa-zz*

Specify a valid value for each subfield of the point code, and separate the subfields with a dash (-).

*prefix*—*s-*

*nnnnn*—0-16383

*gc*—*aa-zz*

*m1-m2-m3-m4*—0-14 for each member; values must sum to 14

**spcn24 (mandatory)**

24-bit ITU national point code with subfields *main signaling area-sub signaling area-signaling point* (*msa-ssa-sp*).

**Range:**

000-255

Specify a valid value for each subfield of the point code, and separate the subfields with a dash (-).

*msa*—000-255

*ssa*—000-255

*sp*—000-255

**spcn16 (mandatory)**

16-bit ITU national point code with subfields *unit number sub number area main number area* (*un-sna-mna*).

**Range:**

000---127

Specify a valid value for each subfield of the point code, and separate the subfields with a dash (-).

*un*---000---127

```
sna---000---15
```

```
mna---000---31
```

### Example

```
dlt-spc:spc=10-20-30
dlt-spc:spcn24=98-98-98
dlt-spc:spcn=s-12345
dlt-spc:spcn16=121-10-30
```

### Dependencies

A secondary point code that is referenced in the Destination table cannot be deleted.

SPC table must be accessible.

Route Destination table must be accessible.

If the value specified for the `spc` parameter is referenced in the Linkset table, then the parameter cannot be deleted.

Linkset table must be accessible.

The MPC feature must be turned on before this command can be entered.

The value specified for the `spc` parameter must exist in the Secondary Point Code table.

### Notes

In this command, only ITU-international and ITU national point codes support the spare point code subtype prefix (s-).

### Output

```
dlt-spc:spc=10-20-30
```

```
rlghncxa03w 04-02-18 08:50:12 EST EAGLE 31.3.0
Secondary Point Code table is (7 of 40) 17% full
DLT-SPC: MASP A - COMPLTD
;
```

```
dlt-spc:spcn16=126-10-30
```

```
rlghncxa03w 14-06-22 08:50:12 EST EAGLE 46.0.0
Secondary Point Code table is (7 of 40) 17% full
DLT-SPC: MASP A - COMPLTD
;
```

### Related Topics

- [ent-spc](#)
- [rtrv-spc](#)

## dlt-srvsel

Use this command to delete a service selector.

### Parameters

#### **gti/gtia/gtii/gtin/gtin24 (mandatory)**

Global title indicator. For all service selector commands, the domain is defined as GTI and GTIA (ANSI), GTII (ITU international), and GTIN (ITU national). For the service selector commands, GTI and GTIA are equivalent.

##### **Range:**

2, 4

Supported value for ANSI: gti=2, gtia=2

Supported values for ITU: gtii=0, gtii=2, gtii=4, gtin=0, gtin=2, gtin=4, gtin24=2, gtin24=0, gtin24=4

#### **ssn (mandatory)**

Subsystem number.

##### **Range:**

0 - 255

#### **tt (mandatory)**

Translation type.

##### **Range:**

0 - 255

#### **nai (optional)**

Nature of Address indicator.

##### **Range:**

*sub*

*rsvd*

*natl*

*intl*

#### **naiv (optional)**

Nature of Address indicator value.

##### **Range:**

0 - 127

#### **np (optional)**

Numbering Plan.

**Range:*****e164******generic******x121******f69******e210******e212******e214******private*****npv (optional)**

Numbering Plan value.

**Range:*****0 - 15*****Example**`dlt-srvsel:gti=2:ssn=250:tt=10``dlt-srvsel:gtin=4:tt=0:ssn=100:np=e164:nai=sub``dlt-srvsel:gtin24=4:tt=4:ssn=20:np=e164:nai=intl``dlt-srvsel:gtii=4:tt=4:np=e164:nai=intl:ssn=9``dlt-srvsel:gtii=4:tt=5:np=e164:nai=intl:ssn=*``dlt-srvsel:gtii=0:tt=0:ssn=*`**Dependencies**

The `np` and `npv` parameters cannot be specified together in the command.

The `nai` and `naiv` parameters cannot be specified together in the command.

The value 0, 4 is not valid for the `gti` and `gtia` parameters.

The values 1 and 3 are not valid for the `gti/gtia/gtii/gtin/gtin24` parameters.

If the `gtii/gtin/gtin24=4` parameter is specified, then an `np(v)` and `nai(v)` parameter combination must be specified. These parameters can be specified in the following combinations: `np/naiv`, `npv/nai`, `np/nai`, or `npv/naiv`.

If the `gti/gtia/gtii/gtin/gtin24=0` or `2` parameter is specified, no `np(v)` and `nai(v)` parameter combinations can be specified.

An entry must already exist that matches the `gti/gtia/gtii/gtin/gtin24`, `tt`, `ssn`, and `np(v)` and `nai(v)` combination of parameters.

The requested service selector entry must exist in the database.

The GSM DBMM table must be accessible.



**Notes**

None

**Output**

```
dlt-srvsel:gti=2:ssn=250:tt=10
```

```
rlghncxa03w 07-10-05 16:40:40 EST EAGLE 37.5.0  
Service Selector table is (114 of 1024) 11% full  
DLT-SRVSEL: MASP A - COMPLTD  
;
```

**Related Topics**

- [chg-srvsel](#)
- [ent-srvsel](#)
- [rtrv-srvsel](#)

## dlt-ss-appl

Use this command to remove the application from the database.

**Parameters****appl (mandatory)**

Application type.

**Range:**

*lnp*

*inp*

*eir*

*vflex*

*atinpq*

*aiq*

*sfapp*

**Example**

```
dlt-ss-appl:appl=inp
```

**Dependencies**

The LNP feature must be turned on before the `appl=lnp` parameter can be specified.

The INP feature must be turned on before the `dlt-ss-appl:appl=inp` command can be entered.

The Equipment Identity Register (EIR) feature must be turned on before the `dlt-ss-appl:appl=eir` command can be entered.

The value specified for the `appl` parameter must already exist in the SS-APPL table.

The LNP database and the SS-APPL table are corrupt or cannot be found.

The subsystem must be inhibited before `status=offline` can be specified. This condition is not true in the case of SFAPP, as the status is not changed to offline for SFAPP, but the entry is deleted.

Application type must exist in the LNP database (non DBS 1.0 only)

Unable to access database. Severe database failure.

Failed reading SSAPPL table. (non-DBS 1.0 systems only)

The V-Flex feature must be turned on before the `appl=vflex` parameter can be specified.

The ATINP feature must be enabled before the `appl=atinpq` parameter can be entered.

The ANSI41 AIQ feature must be enabled before the `appl=aiq` parameter can be specified.

### Notes

When a subsystem application is deleted, the following message is displayed:

CAUTION: DELETED APPL SSN MAY BE REFERENCED BY GTT ENTRY

### Output

```
dlt-ss-appl:appl=aiq
```

```
tekelecstp 09-12-03 17:34:20 EST EAGLE 42.0.0
DLT-SS-APPL: MASP A - CAUTION: DELETED APPL SSN MAY BE REFERENCED BY GTT
ENTRY
DLT-SS-APPL: MASP A - COMPLTD
;
```

### Related Topics

- [chg-ss-appl](#)
- [ent-ss-appl](#)
- [rtv-ss-appl](#)

## dlt-subnetid

Use this command to delete a Subnet ID entry from the Subnet ID list, for the ISUP NP with EPAP feature.

### Parameters

**subnetid (mandatory)**  
Subnet ID

**Range:**  
1 - 15 digits

### Example

```
dlt-subnetid:subnetid=886933
```

### Dependencies

The `subnetid=none` parameter cannot be specified.

The SUBNETID table is corrupt or cannot be found by the system.

The specified Vendor ID entry must already exist in the SUBNETID table.

### Notes

None.

### Output

```
dlt-subnetid:subnetid=886933
```

```
rlghncxa03w 04-10-07 11:11:28 EST EAGLE 31.11.0
SUBNETID table is (6 of 50) 3% full
DLT-SUBNETID: MASP A - COMPLTD
;
```

### Related Topics

- [ent-subnetid](#)
- [rtrv-subnetid](#)

## dlt-t1

Use this command to delete an interface for E5-E1T1-B cards used as T1 or ST-HSL-A cards.

### Parameters

#### **loc (mandatory)**

The card location as stenciled on the shelf of the system.

#### **Range:**

1101 - 1108, 1111 - 1112, 1201 - 1208, 1211 - 1218, 1301 - 1308, 1311 - 1318,  
2101 - 2108, 2111 - 2118, 2201 - 2208, 2211 - 2218, 2301 - 2308, 2311 - 2318,  
3101 - 3108, 3111 - 3118, 3201 - 3208, 3211 - 3218, 3301 - 3308, 3311 - 3318,  
4101 - 4108, 4111 - 4118, 4201 - 4208, 4211 - 4218, 4301 - 4308, 4311 - 4318,  
5101 - 5108, 5111 - 5118, 5201 - 5208, 5211 - 5218, 5301 - 5308, 5311 - 5318,  
6101 - 6108, 6111 - 6118

#### **t1port (mandatory)**

T1 card port number. The value must be a T1 port for which an interface has already been configured on the specified T1 card.

**Range:**  
1 - 8

### Example

```
dlt-t1:loc=1205:t1port=2
```

### Dependencies

The specified card location (`loc` parameter) must be equipped.

The card in the specified card location (`loc` parameter) must be a LIMT1 card type.

The port specified by the `t1port` parameter must be already equipped with a T1 interface.

The E1/T1 table must be accessible.

The Card (IMT) table must be accessible.

All signaling links providing timeslots serviced by the specified T1 interface must be deleted before the T1 interface can be deleted. Use the `dlt-slk` command to delete the signaling links providing the timeslots.

Card locations 1113 - 1118 (E5-MASP and E5-MDAL cards) cannot be specified as values for the `loc` parameter.

### Notes

None.

### Output

```
dlt-t1:loc=1205:t1port=1
```

```
rlghncxa03w 04-02-20 09:07:58 EST EAGLE 31.3.0  
DLT-T1: MASP A - COMPLTD  
;
```

### Related Topics

- [chg-t1](#)
- [ent-t1](#)
- [rtrv-e1](#)
- [tst-t1](#)

## dlt-tt

Use this command to remove a translation type from the system database.

 **Note:**

When the EGTT feature is turned on, the GTT Selector (`ent/chg/dlt/rtrv-gttset`), GTT Set (`ent/dlt/rtrv-gttset`), and GTA (`ent/chg/dlt/rtrv-gta`) commands replace the Translation Type (`ent/dlt/rtrv-tt`) and Global Title Translation (`ent/chg/dlt/rtrv-gtt`) commands. However, the Translation Type and Global Title Translation commands continue to work according to their original functionality when the EGTT feature is turned on.

**Parameters****alias (optional)**

The global title translation type

**Range:**

000 - 255

**Default:**

No translation type given

**ttn (optional)**

Translation type name.

**Range:**

ayyyyyyy

1 alphabetic character followed by up to 8 alphanumeric characters

**Default:**

No translation name is given

**type/typea/typei/typen/typen24/typeis/typens (optional)**

Translation type. This parameter identifies the translation type and network type. This parameter is the decimal representation of the 1-byte field used in SS7.

The `type` and `typea` parameters specify an ANSI network.

The `typei` parameter specifies an ITU-international network.

The `typen` parameter specifies an ITU-national network.

The `typen24` parameter specifies a 24-bit ITU-national network.

The `typeis` parameter specifies an ITU-international spare network.

The `typens` parameter specifies an ITU-national spare network.

A translation type numeric value may be entered as ANSI type and as an ITU type. However, they are separate entities.

The point code domain translation types for GTT are handled by the EAGLE protocol processing as either ANSI or ITU; therefore, ITU applies to ITU-I, ITU-I spare, ITU-N, ITU-N spare, and ITU-N24.

**Range:**

0 - 255

**Default:**

No translation type is specified

**Example**

```
dlt-tt:type=230
dlt-tt:ttn=lidb
dlt-tt:type=230:ttn=lidb
dlt-tt:type=230:ttn=lidb:alias=030
dlt-tt:typeis=3
dlt-tt:typens=4
dlt-tt:typeis=1:ttn=setitu001
```

**Dependencies**

Asterisk (\*) parameter values are not allowed in this command.

To delete a translation type, the translation type, the translation name, or both, must be specified.

If the translation type is specified, it must already exist in the database for the network type.

If the translation name is specified, it must already exist in the database.

If the translation type is specified, it cannot be an `alias` value.

If both the translation type and translation name are specified, they must correspond.

The translation type cannot be deleted if there are current GTT entries that reference it.

To delete an `alias`, both the alias and the translation type must be specified, and both must already exist in the database for the network type.

If an `alias` is specified, it must be associated with the specified translation type and cannot be the value of an existing translation type.

The `type` or `ttn` parameter must be specified.

If aliases exist, they must be removed from the database before the translation types can be removed.

The GTT set associated with the translation type specified by the `ttn` parameter must have a set type of CDGTA (see the `ent-gttset` command).

The network domain of the translation type specified by the `ttn` parameter cannot be CROSS (see the `ent-gttset` command).

The `ttn=none` parameter cannot be specified.

**Notes**

If the specified translation type entry is not referenced by a current global title translation entry and does not have any aliases, the translation type entry is removed.

This command can delete only selector entries that have been provisioned by GTT Selector commands, have a GTI value of 2, and a set type of CdGTA.

If the EGTT feature is turned on:

- For ANSI, if the GTT selector of a true entry is deleted using the `dlt-gttset` command, then the aliases for the entry or the entry itself cannot be deleted.
- For ITU, if a true GTT selector entry (GTI=2 or GTI=4) is deleted using the `dlt-gttset` command, or if the GTTSN of an entry is changed using the `chg-gttset` command, then the aliases for that entry or the entry itself cannot be deleted.

### Output

```
dlt-tt:typens=4
```

```
tekelecstp 10-03-28 16:51:25 EST Eagle 42.0.0
DLT-TT: MASP A - COMPLTD
;
```

### Related Topics

- [ent-tt](#)
- [rtrv-tt](#)

## dlt-ttmap

Use this command to delete from the database a mapped SS7 message translation type (TT) for a given gateway linkset name. For example, suppose you are mapping the translation type 001 (before TT mapping) to 238 (after TT mapping). You can use this command to delete that mapping from the database.

### Parameters

#### **lsn (mandatory)**

Linkset name. The unique network identifier for the gateway linkset.

#### **Range:**

aaaaaaaaa

1 alphabetic character followed by 9 alphanumeric characters

#### **ett (optional)**

Translation type before mapping. The identification of the type of global title translation in the SS7 message *before* translation type mapping. This attribute is the decimal representation of the 1-octet binary field used by the SS7 protocol to identify the translation type.

#### **Range:**

0 - 255

#### **io (optional)**

Incoming or outgoing. The system uses this parameter to indicate whether the translation type mapping data provisioned for the gateway linkset is for SS7 messages *received* or *sent* on the linkset.

**Range:**

*i*  
incoming

*o*  
outgoing

**Default:**

Both incoming and outgoing

**Example**

```
dlt-ttmap:lsn=n c001:io=i:ett=128:mtt=55
```

**Dependencies**

The linkset must be defined and the linkset table must be accessible.

The translation type mapping table must be accessible.

None

**Notes**

None

**Output**

```
dlt-ttmap:lsn=nc001:io=i:ett=128:mtt=55

rlghncxa03w 04-02-22 11:18:50 EST EAGLE 31.3.0
TTMAP table for nc001 is (2 of 64) 3% full
DLT-TTMAP: MASP A - COMPLTD
;
```

**Related Topics**

- [chg-ttmap](#)
- [ent-ttmap](#)
- [rtrv-ttmap](#)

## dlt-uim-acthresh

Use this command to clear the level of activity threshold that is used to report UIM messages.

**Parameters****uimn (mandatory)**

The UIM number.

**Range:**

1000 - 1999



**Example**

Clears UIM number 1333 message threshold:

```
dlt-uim-acthresh:uimn=1333
```

**Dependencies**

The `uimn` parameter value must be a numeric value in the range of 1000–1999 .

The specified `uimn` value must exist in the UIM Threshold database table.

The `uimn` parameter must be within the valid range: 1000-1999 for UIMs.

**Notes**

None

**Output**

```
dlt-uim-acthresh:uimn=1333
```

```
rlghncxa03w 04-02-01 08:50:12 EST EAGLE 31.3.0
DLT-UIM-ACTHRESH: MASP A - COMPLTD
```

```
;
```

**Related Topics**

- [rtrv-uim-acthresh](#)
- [set-uim-acthresh](#)

## dlt-user

Use this command to remove a user from the system database.

**Parameters****uid (mandatory)**

User ID

**Range:**

```
azzzzzzzzzzzzzzz
```

1 alphabetic character followed by up to 15 alphanumeric characters

**Example**

```
dlt-user:uid=terryjohnson
```

**Dependencies**

The first character must be a letter.

## Notes

If the user being removed is logged onto the system, this command logs the user off immediately.

## Output

```
dlt-user:uid=terryjohnson
```

```
rlghncxa03w 04-01-07 11:11:28 EST EAGLE 31.3.0  
DLT-USER: MASP A - COMPLTD
```

```
;
```

## Related Topics

- [act-user](#)
- [chg-pid](#)
- [chg-user](#)
- [dact-user](#)
- [ent-user](#)
- [login](#)
- [logout](#)
- [rept-stat-user](#)
- [rtrv-secu-user](#)
- [rtrv-user](#)

# dlt-vendid

Use this command to delete a Vendor ID entry from the Vendor ID list, for the GSM MAP SRI Redirect to Serving HLR feature.

## Parameters

### **vendid (mandatory)**

Vendor ID

#### **Range:**

1 - 15 digits

## Example

```
dlt-vendid:vendid=886933
```

## Dependencies

The VENDID table is corrupt or cannot be found by the system.

The specified Vendor ID entry must already exist in the VendID table.

## Notes

None.

## Output

```
dlt-vendid:vendid=886933
```

```
rlghncxa03w 04-10-07 11:11:28 EST EAGLE 31.11.0
VENDID table is (6 of 200) 3% full
DLT-VENDID: MASP A - COMPLTD
;
```

## Related Topics

- [ent-vendid](#)
- [rtrv-vendid](#)

# dlt-vflx-cd

Use this command to delete call decision criteria from the Call Decision table. The V-Flex feature must be enabled before this command can be entered.

## Parameters

### **cdn (mandatory)**

Call decision name. This parameter specifies the entry in the Call Decision table to be deleted.

#### **Range:**

*ayyy*

1 alphabetic character followed by 3 alphanumeric characters

## Example

```
dlt-vflx-cd:cdn=cdn1
```

## Dependencies

The value specified for the `cdn` parameter cannot be a reserved word, such as *none*.

The Call Decision table is corrupt or cannot be found.

The value specified for the `cdn` parameter must already exist in the Call Decision table.

The V-Flex feature must be enabled before this command can be entered.

## Output

```
dlt-vflx-cd:cdn=cdn1
```

```
rlghncxa03w 08-05-07 11:11:28 EST EAGLE 39.0.0
```

```
DLT-VFLX-CD: MASP A - COMPLTD  
;
```

### Related Topics

- [chg-vflx-cd](#)
- [ent-vflx-cd](#)
- [rtrv-vflx-cd](#)

## dlt-vflx-rn

Use this command to delete a voice mail routing number from the Routing Number table. The V-Flex feature must be enabled before this command can be entered.

### Parameters

#### **rname (mandatory)**

Routing number name. This parameter specifies the voice mail routing number to be deleted.

#### **Range:**

ayyyyyyy

1 alphabetic character followed by 7 alphanumeric characters.

### Example

```
dlt-vflx-rn:rname=rn01
```

### Dependencies

The V-Flex feature must be enabled before this command can be entered.

The Routing Number table is corrupt or cannot be found.

The value specified for the `rname` parameter must already exist in the Routing Number table.

The value specified for the `rname` parameter cannot be referenced by an entry in the VMSID table.

The value specified for the `rname` parameter cannot be a reserved word such as *none*.

### Output

```
dlt-vflx-rn:rname=rn02
```

```
rlghncxa03w 08-05-29 08:51:12 EST EAGLE 39.0.0  
DLT-VFLX-RN: MASP A - COMPLTD  
;
```

### Related Topics

- [chg-vflx-rn](#)
- [ent-vflx-rn](#)
- [rtrv-vflx-rn](#)

## dlt-vflx-vmsid

Use this command to delete a voice mail server ID from the VMSID table.

### Parameters

#### **id (mandatory)**

The voice mail server to be deleted.

#### **Range:**

1 - 15 dgts, *dflt*

Valid digits are 0-9, A-F, a-f

*dflt* —the default VMS ID

### Example

```
dlt-vflx-vmsid:id=1234ae4
```

### Dependencies

The V-Flex feature must be enabled before this command can be entered.

The value specified for the *vmsid* parameter must already exist in the VMSID table.

The VMSID table is corrupt or cannot be found.

The Routing Number table is corrupt or cannot be found.

The GTT DBMM table is corrupt or cannot be found.

### Output

```
dlt-vflx-vmsid:id=1234ae5
```

```
rlghncxa03w 08-05-29 08:51:12 EST EAGLE 39.0.0
```

```
DLT-VFLX-VMSID: MASP A - COMPLTD
```

```
;
```

### Related Topics

- [chg-vflx-vmsid](#)
- [ent-vflx-vmsid](#)
- [rtrv-vflx-vmsid](#)

## dlt-vlr-prof

Use this command to delete a Visitor Location Register (VLR) Profile for a mobile subscriber for existing entries.

## Parameters

### **vlr (mandatory)**

VLR Number: Hexadecimal digit GT Number with variable length (1 to 16).

#### **Range:**

Hexadecimal digit string 1 to 16 digits

### **Example**

```
dlt-vlr-prof:vlr=4234
```

### **Dependencies**

VLR\_PROF table must be accessible.

VLR DBMM table must be accessible.

OLDVLR and NEWVLR parameter length must be in the range 1 to 5 digits as per current restriction.

OLDVLR or NEWVLR parameter must be existing in VLR-PROF table

Entry being deleted should not be referenced in roaming table

### **Output**

```
dlt-vlr-prof:vlr=9234
```

```
tekelecstp 17-11-23 14:08:49 MST EAGLE 46.5.1.5.0-73.2.0
```

```
  dlt-vlr-prof:vlr=9234
```

```
  Command entered at terminal #17.
```

```
;
```

```
tekelecstp 17-11-23 14:08:49 MST EAGLE 46.5.1.5.0-73.2.0
```

```
DLT-VLR-PROF: MASP A - Cannot access standby fixed disk.
```

```
DLT-VLR-PROF: MASP A - Simplex database update.
```

```
Command Accepted - Processing
```

```
VLR-PROF table is (4 of 500) 1% full.
```

```
;
```

```
tekelecstp 17-11-23 14:08:49 MST EAGLE 46.5.1.5.0-73.2.0
```

```
DLT-VLR-PROF: MASP A - COMPLTD
```

```
;
```

```
Command Executed
```

### **Output**

```
rtrv-vlr-prof
```

```
tekelecstp 17-11-23 14:21:51 MST EAGLE 46.5.1.5.0-73.2.0
```

```
  rtrv-vlr-prof:num=50000
```

```
  Command entered at terminal #17.
```

```
;
```

Command Accepted - Processing

tekelecstp 17-11-23 14:21:51 MST EAGLE 46.5.1.5.0-73.2.0

REFCNT	VLRIDX	VLRNb	FILTER	AGEOFLOC	LASTUEACTIVITY
no	1	1234	whitelist	no	
		1			
no	2	56545	whitelist	no	
		1			
no	3	4234	blacklist	no	
		0			
yes	4	9234	whitelist	no	
		0			

VLR-PROF table is (4 of 500) 1% full.

;

rtrv-vlr-prof:num=2

tekelecstp 17-11-23 14:23:35 MST EAGLE 46.5.1.5.0-73.2.0

rtrv-vlr-prof:num=2

Command entered at terminal #17.

;

Command Accepted - Processing

tekelecstp 17-11-23 14:23:35 MST EAGLE 46.5.1.5.0-73.2.0

REFCNT	VLRIDX	VLRNb	FILTER	AGEOFLOC	LASTUEACTIVITY
no	1	1234	whitelist	no	
		1			
no	2	56545	whitelist	no	
		1			

VLR-PROF table is (4 of 500) 1% full.

;

rtrv-vlr-prof:filter=blacklist

tekelecstp 17-11-23 14:23:23 MST EAGLE 46.5.1.5.0-73.2.0

rtrv-vlr-prof:filter=blacklist

Command entered at terminal #17.

;

Command Accepted - Processing

```
tekelecstp 17-11-23 14:23:23 MST EAGLE 46.5.1.5.0-73.2.0
```

VLRIDX	VLRNb	FILTER	AGEOFLOC	LASTUEACTIVITY	REFCNT
3	4234	blacklist	no	no	0

```
VLR-PROF table is (4 of 500) 1% full.
```

```
;
```

```
rtrv-vlr-prof:filter=whitelist:num=1
```

```
tekelecstp 17-10-12 18:11:44 EST EAGLE 46.5.1.5.0-73.2.0
```

```
rtrv-vlr-prof:filter=whitelist:num=1
```

```
Command entered at terminal #23.
```

```
;
```

```
Command Accepted - Processing
```

```
tekelecstp 17-10-12 18:11:44 EST EAGLE 46.5.1.5.0-73.2.0
```

VLRIDX	VLRNb	FILTER	AGEOFLOC	LASTUEACTIVITY	REFCNT
1	17071	whitelist	no	no	1

```
VLR-PROF table is (2 of 50000) 1% full.
```

```
;
```

```
Command Executed
```

```
rtrv-vlr-prof:vlr=1707
```

```
tekelecstp 17-10-12 18:11:00 EST EAGLE 46.5.1.5.0-73.2.0
```

```
rtrv-vlr-prof:vlr=1707
```

```
Command entered at terminal #23.
```

```
;
```

```
Command Accepted - Processing
```

```
tekelecstp 17-10-12 18:11:00 EST EAGLE 46.5.1.5.0-73.2.0
```

VLRIDX	VLRNb	FILTER	AGEOFLOC	LASTUEACTIVITY	REFCNT
2	1707	whitelist	no	no	1

```
VLR-PROF table is (2 of 50000) 1% full.
```

```
;
```

```
Command Executed
```



```

rtrv-vlr-prof:vlr=100

Command Accepted - Processing

    tekelecstp 17-11-27 14:43:15 MST  EAGLE 46.5.1.5.0-73.2.0
    rtrv-vlr-prof:vlr=100
    Command entered at terminal #2.
;

    tekelecstp 17-11-27 14:43:15 MST  EAGLE 46.5.1.5.0-73.2.0

    VLRIDX  VLRNb          FILTER      AGEOFLOC
LASTUEACTIVITY      REFCNT

    No VLR Profiles matching the specified criteria were found.

    VLR-PROF table is (3 of 500) 1% full.
;

```

### Legend

- **VLRIDX** - Index of entry in VLR table.
- **VLRNb** - VLR Number
- **FILTER** - Flag to findout whether the number is whitelisted, blacklisted, or graylisted.
- **GEOFLOC** - Whether age of location is supported or not.
- **LASTUEACTIVITY** - Whether the last use activity is supported or not.
- **REFCNT** - Number of times this entry is referred in VLR\_ROAM table.

### Related Topics

- [chg-vlr-prof](#)
- [ent-vlr-prof](#)
- [rtrv-vlr-prof](#)

## dlt-vlr-roaming

Use this command to delete a Visitor Location Register (VLR) Roaming entry for a mobile subscriber for existing entries.

### Parameters

#### **oldvlr (mandatory)**

VLR Number from which mobile subscriber has moved, hexadecimal digit GT number with variable length (1 to 16).

#### **Range:**

Hexadecimal digit string 1 to 16 digits

**newv1r (mandatory)**

VLR Number to which mobile subscriber has moved, hexadecimal digit GT number with variable length (1 to 16).

**Range:**

Hexadecimal digit string 1 to 16 digits

**Example**

```
dlt-vlr-roaming:newv1r=12345:oldv1r=56780
```

**Dependencies**

VLR\_PROF table must be accessible.

VLR\_DBMM table must be accessible.

VLR\_ROAM table must be accessible.

OLDVLR and NEWVLR parameter length must be in the range 1 to 5 digits as per current restriction.

OLDVLR or NEWVLR parameter must be existing in VLR-PROF table

The entry should be existing in VLR\_ROAM table

**Output**

```
dlt-vlr-roaming:newv1r=12345:oldv1r=56780
```

```
tekelecstp 17-11-23 16:23:44 MST EAGLE 46.5.1.5.0-73.2.0
```

```
  dlt-vlr-roaming:oldv1r=1234:newv1r=56545:time=20
```

```
  Command entered at terminal #17.
```

```
;
```

```
tekelecstp 17-11-23 16:23:44 MST EAGLE 46.5.1.5.0-73.2.0
```

```
DLT-VLR-ROAMING: MASP A - Cannot access standby fixed disk.
```

```
DLT-VLR-ROAMING: MASP A - Simplex database update.
```

```
Command Accepted - Processing
```

```
VLR-ROAMING table is (1 of 1000) 1% full.
```

```
;
```

```
tekelecstp 17-11-23 16:23:44 MST EAGLE 46.5.1.5.0-73.2.0
```

```
DLT-VLR-ROAMING: MASP A - COMPLTD
```

```
;
```

**Related Topics**

- [chg-vlr-roaming](#)
- [ent-vlr-roaming](#)
- [rtv-vlr-roaming](#)

## enable-ctrl-feat

Use this command to enable a controlled feature that the customer is entitled to use.

 **Note:**

The “LNP (Local Number Portability) feature” is turned on when the LNP ported TNS quantity is greater than 0 in the `rtrv-ctrl-feat` command output (an LNP ported TNS quantity feature access key has been enabled and turned on).

**Parameters****partnum (mandatory)**

Part number. The part number for the feature.

**Range:**

893000000 - 893999999

Do not include dashes in the 9-digit number.

**fak (optional)**

Feature Access Key. The Feature Access Key for the feature.

**Range:**

ayyyyyyyyyyy

13 alphanumeric characters

 **Note:**

The FAK parameter has no significance starting with Release 46.3. The parameter is used only for backward compatibility.

**Example**

```
enable-ctrl-feat:partnum=893xxxxxx
```

**Dependencies**

The phrase "Service Module cards" refers to E5-SM4G or E5-SM8G-B cards when any of these cards can be used. If a specific card is required, then the appropriate requirement is listed.

The Dual ExAP Config feature cannot be enabled before the E5-SM4G Throughput Cap feature is enabled.

The system serial number must be locked in the database before this command can be entered for the feature (see the `ent-serial-num` command).

A feature cannot be enabled with this command when the feature has already been enabled with a permanently ON feature access key or a feature access key for a quantity that is greater than the quantity specified in the command.

The GTT feature must be on before the IDP Screening for Prepaid feature can be enabled.

The value specified for the `partnum` parameter must be the correct part number for the feature.

A valid system serial number must be entered in the database before this command can be entered for the feature (see the `ent-serial-num` command).

The Feature Control database (FEATCTRL.TBL) is corrupt; database maintenance is required.

The LNP ELAP Configuration feature and the WNP feature must be turned on before the LNP SMS feature can be enabled.

The GTT feature must be turned on before the XGTT Table Expansion feature can be enabled.

Both cards that run the OAM application in the system must be GPSM-II cards before the XGTT Table Expansion feature can be enabled.

The DSTN5000 feature bit for the 5000 Routesets feature must be turned on before the 6000 Routesets, 7000 Routesets, 8000 Routesets, or 10,000 Routesets feature can be enabled.

The 7000 Routesets or 8000 Routesets feature cannot be enabled if more than 8000 alias point codes are already assigned in the system.

The 10,000 Routesets feature cannot be enabled if more than 10000 alias point codes are already assigned in the system.

If the LNP (an LNP ported TNs quantity), LNP 150,000 LRNs, or LNP 300,000 NPANXX feature is enabled, then none of the following features can be enabled unless the Dual ExAP Config feature is enabled:

- AINPQ
- A-Port
- ATINP
- Equipment Identity Register (EIR)
- G-Flex
- G-Port
- Info Analyzed Relay Base (IAR Base)
- INP
- IS41 GSM Migration (IGM)
- MO SMS ASD
- MO SMS GRN
- MO-based GSM SMS NP
- MO-based IS41 SMS NP
- MTP Msgs for SCCP Apps
- Portability Check for MO SMS
- Prepaid IDP Query Relay (IDP Relay)
- Prepaid SMS Intercept Phase 1 (PPSMS)
- TIF Number Portability
- TIF Number Substitution
- TIF Subscriber CgPN Blacklist

- V-Flex

The LNP feature (an LNP ported TNs quantity) must be enabled before the LNP 150,000 LRNs feature or the LNP 300.000 NPANXXs feature can be enabled.

A card with unknown hardware is detected in system (possibly in the process of loading, or a loading error has occurred).

The LNP ELAP Configuration feature must be enabled and turned on before any LNP quantity features can be enabled.

The LNP feature for 24 million TNs requires all Service Module cards with a minimum of 2GB of memory.

The LNP feature for 36 million TNs requires all Service Module cards with a minimum of 3GB of memory.

The LNP feature for LNP ported TNs quantities of 48 million TNs to 192 million TNs requires all Service Module cards with a minimum of 4GB of memory.

The LNP feature for LNP ported TNs quantities of 204 million TNs to 228 million TNs requires all Service Module cards with a minimum of 4GB of memory.

The 150,000 LNP LRNs feature requires all Service Module cards with a minimum of 2GB of memory.

The 300,000 LNP NPANXXs feature requires all Service Module cards with a minimum of 2GB of memory.

The GTT feature bit must be turned on (see the `chg-feat` command) before the following features can be enabled:

- Advanced GT Modification (AMGTT)
- ANSI41 AIQ
- ATI Number Portability Query (ATINP)
- Dual ExAP Config
- E5-SM4G Throughput Capacity
- Equipment Identity Register (EIR)
- G-Flex
- GSM Map Screening (GSM)
- Hex Digit Support for GTT
- Info Analyzed Relay Base (IAR Base)
- Intermediate GTT Loadsharing (IGTTLS)
- LNP ELAP Configuration
- LNP ported LRNs
- LNP ported NPANXXs
- LNP ported TNs
- MO SMS ASD
- MO SMS GRN
- MO SMS IS41-to-GSM Migration

- MO-based GSM SMS NP
- MO-based IS41 SMS NP
- MTP Msgs for SCCP Apps
- MTP Routed Gateway Screening Stop Action
- Portability Check for MO SMS (MNPSMS)
- Prepaid SMS Intercept Ph1 (PPSMS)
- SCCP Loop Detection
- TIF Additional Subscriber Data
- TIF Generic Routing Number
- TIF Number Portability
- TIF Number Substitution
- TIF Range CgPN Blacklist
- TIF SCS Forwarding
- TIF Simple Number Substitution
- TIF Subscriber CgPN Blacklist
- Transaction-based GTT Loadsharing (TBGTTLs)
- Voice Mail Router (V-Flex)

If the SCCP Conversion or TCAP Conversion feature is turned on, then the ANSI/ITU SCCP Conversion feature cannot be enabled.

The ANSI/ITU SCCP Conversion feature requires Service Module cards in the system.

The GSM Map Screening (GSM) feature must be turned on before the Enhanced GSM Map Screening (EGSM) feature can be enabled.

The Enhanced GSM Map Screening (EGSM) feature must be turned on before the MTP MAP Screening feature can be enabled.

The Measurements Platform feature must be turned on and the Measurements Platform collection function must be enabled (see the `chg-measopts:platformenable=on` parameter) before the MTP MAP Screening feature can be enabled (at least one MCPM card must be active).

The G-Port feature must be turned on before the following features can be enabled:

- GSM MAP SRI Redirect for Serving HLR
- ISUP NP with EPAP
- MNP Circular Route Prevention
- Prepaid SMS Intercept Phase 1 (PPSMS)

The GWS (Gateway Screening) feature must be turned on before the following features can be enabled:

- Integrated GLS
- ISUP NP with EPAP
- TIF Additional Subscriber Data

- TIF Generic Routing Number
- TIF Number Portability
- TIF Number Substitution
- TIF Range CgPN Blacklist
- TIF SCS Forwarding
- TIF Simple Number Substitution
- TIF Subscriber CgPN Blacklist

The following features cannot be enabled if the ANSIGFLEX system option is enabled (see the `chg-stpopts` command) AND E5-SM4G Throughput Cap quantity key for 6800 or above has not been enabled:

- 1100 TPS/DSM for ITU NP
- ANSI-41 INP Query (AINPQ)
- A-Port
- ATINP
- Equipment Identity Register (EIR)
- G-Flex MAP Layer Routing
- G-Port
- Info Analyzed Relay Base
- INP
- IS41 GSM Migration (IGM)
- MO SMS ASD
- MO SMS GRN
- MO SMS IS41-to-GSM Migration
- MO-based GSM SMS NP
- MO-based IS41 SMS NP
- Portability Check for MO SMS
- TIF Number Portability
- TIF Number Substitution
- TIF Selective Screening
- TIF Subscriber CgPN Blacklist
- V-Flex

The following features cannot be enabled if the ANSIGFLEX system option is enabled (see the `chg-stpopts` command) AND DSM is equipped in the system

- 1100 TPS/DSM for ITU NP
- ANSI-41 INP Query (AINPQ)
- A-Port
- ATINP
- Equipment Identity Register (EIR)

- G-Flex MAP Layer Routing
- G-Port
- Info Analyzed Relay Base
- INP
- IS41 GSM Migration (IGM)
- MO SMS ASD
- MO SMS GRN
- MO SMS IS41-to-GSM Migration
- MO-based GSM SMS NP
- MO-based IS41 SMS NP
- Portability Check for MO SMS
- TIF Number Portability
- TIF Number Substitution
- TIF Selective Screening
- TIF Subscriber CgPN Blacklist
- V-Flex

Before an LNP ported TNs quantity greater than 96 million numbers can be enabled, an ELAP system that supports a quantity greater than 96 million numbers must be available to the EAGLE.

- The ELAP software must be at version 4.0 to support LNP ported TNs quantities greater than 96 million numbers and up to 120 million numbers.
- The ELAP software must be at version 5.0 or greater to support LNP ported TNs quantities greater than 120 million numbers. A quantity greater than 120 million numbers cannot be enabled until the ELAP is upgraded to the required software level, and the appropriate ELAP commands are issued to convert the 120 Million LNP Numbers database structure to the data compaction structure for more than 120 million numbers.

The `rept-stat-mps` command can be entered at the EAGLE to determine the ELAP software version.

Service Module cards running the VSCCP application must be present in the system before the following features can be enabled:

- AINPQ
- ANSI41 AIQ
- A-Port
- ATI Number Portability Query (ATINP)
- EIR
- Enhanced GSM MAP Screening (EGMS)
- Flexible GTT Load Sharing
- G-Flex
- G-Port



- INP
- IS41 GSM Migration (IGM)
- LNP ELAP Configuration
- MO SMS ASD
- MO SMS B-Party Routing
- MO SMS GRN
- MO SMS IS41-to-GSM Migration
- MO-based GSM SMS NP
- MO-based IS41 SMS NP
- Origin-based SCCP Routing (OBSR)
- PPSMS
- SCCP Loop Detection
- TIF Additional Subscriber Data
- TIF Generic Routing Number
- TIF Number Portability
- TIF Number Substitution
- TIF Range CgPN Blacklist
- TIF SCS Forwarding
- TIF Simple Number Substitution
- TIF Subscriber CgPN Blacklist
- Transaction-based GTT Loadsharing (TBGTTLS)
- Weighted GTT Loadsharing (WGTTLTSL)
- V-Flex

Before LNP ported TNs quantities greater than 96 million numbers can be enabled, an ELAP system must be available to validate its software version to the EAGLE.

The Enhanced GTT (EGTT) feature must be turned on before the following features can be enabled

- Flexible Linkset Optional Based Routing (FLOBR)
- GTT Action - DISCARD
- GTT Action - DUPLICATE
- GTT Action - FORWARD
- MO SMS B-Party Routing
- Origin-based SCCP Routing

At least one of the EPAP-based ITU NP features (G-Port, A-Port, INP, IGM, EIR, IDP Relay, ANSI-41 INP Query, V-Flex, or PPSMS) must be turned on before the 1100 TPS/DSM for ITU NP feature can be enabled.

The GTT feature must be turned on before the A-Port feature can be enabled.

The GTT feature must be turned on before the G-Port feature can be enabled.

The GTT feature must be turned on before the IS41 GSM Migration (IGM) feature can be enabled.

If a DSM card with less than 4 gigabytes of memory is present in the system, the following features cannot be enabled

- A-Port
- MO SMS ASD
- MO SMS B-Party Routing
- MO SMS GRN
- MO SMS IS41-to-GSM Migration
- MO SMS Prepaid Intercept on B-Party
- Portability Check for MO SMS
- PPSMS

The PPSMS feature cannot be enabled if the LNP ELAP Configuration feature is turned on.

Service Module cards must be provisioned in the system before the Prepaid IDP Query Relay feature can be enabled.

The GTT feature must be turned on before the Prepaid IDP Query Relay feature can be enabled.

The IP User Interface feature must be enabled before the SEAS Over IP feature can be enabled.

If the TIF (Number Portability/ Additional Subscriber Data / Generic Routing Number) is enabled, then the LNP feature cannot be enabled. If the LNP feature is enabled, then the TIF (Number Portability/ Additional Subscriber Data / Generic Routing Number) feature cannot be enabled.

The Multiple Point Code (MPC) feature must be turned on before the Multiple Linksets to Single Adjacent PC (MLS) feature can be enabled.

The G-Flex feature must be turned on before the G-Flex MAP Layer Routing feature can be enabled.

The STP Options table is corrupt or cannot be found by the system.

The G-Port feature must be enabled before the following features can be enabled:

- G-Port SRI Query for Prepaid
- MT-Based GSM SMS NP

The A-Port feature must be enabled before the MT-Based IS41 SMS NP feature can be enabled.

The AMGTT CdPA Only feature cannot be enabled using the `enable-ctrl-feat` command. This feature is automatically enabled and turned on if the MGTT feature was on before upgrade to EAGLE Release 38.0 occurred.

The AMGTT CdPA Only feature must be turned on before the AMGTT CgPA Upgrade feature can be enabled.

If the AMGTT CdPA Only feature or the AMGTT CgPA Upgrade feature is turned on, then the AMGTT feature cannot be enabled.

The LNP (an LNP ported TNs quantity), LNP 150,000 LRNs, or LNP 300,000 NPANXX feature cannot be enabled if the INP or AINPQ feature is turned on or if any of the features listed below is enabled. If the LNP (an LNP ported TNs quantity), LNP 150,000 LRNs, or LNP 300,000 NPANXX feature is enabled, then none of the features listed below can be enabled.

- A-Port
- ATINP
- Equipment Identity Register (EIR)
- G-Flex
- G-Port
- Info Analyzed Relay Base (IAR Base)
- IDP Screening for Prepaid
- IS41 GSM Migration (IGM)
- MO SMS ASD
- MO SMS GRN
- MO SMS IS41-to-GSM Migration
- MO-based GSM SMS NP
- MO-based IS41 SMS NP
- MTP Msgs for SCCP Apps
- Portability Check for MO SMS (MNPSMS)
- Prepaid IDP Query Relay (IDP Relay)
- Prepaid SMS Intercept Phase 1 (PPSMS)
- TIF Number Portability
- TIF Number Substitution
- TIF Subscriber CgPN Blacklist
- V-Flex

The MT-Based GSM SMS NP feature must be enabled before the MT-Based GSM MMS NP feature can be enabled.

The LNP ported TNs 24 Million Quantity feature or greater must be turned on before the LRNQT feature can be enabled.

The Intermediate GTT Load Sharing feature must be turned on before the GTT LS ARI feature can be enabled.

The Flexible GTT Load Sharing feature must be enabled before the GTT LS ARI feature can be enabled.

The Flexible Linkset Optional Based Routing (FLOBR) feature must be turned on before the TCAP Opcode Based Routing (TOBR) feature can be enabled.

The Variable Length GTT (VGTT) feature must be turned on before the Support for 16 GTT Lengths in VGTT feature can be enabled.

The TOBR feature must be turned on before any of the TOBR Quantity features can be enabled.

A TOBR quantity feature cannot be enabled if a TOBR feature with a higher quantity is enabled.

If the TOBR quantity feature of maximum quantity level is enabled, then no other TOBR Quantity feature can be enabled.

The Prepaid IDP Query Relay feature must be turned on before the following features can be enabled:

- IDP A-Party Blacklist
- IDP A-Party Routing
- IDP Service Key Routing

The INP feature must be turned on before the INP CRP feature can be enabled.

The Default Country Code must be provisioned (see the `defcc` parameter in the `chg-stpopts` command) before the ATINP, IAR Base, MT-Based GSM SMS NP, or MT-Based IS41 SMS NP feature can be enabled.

If the system contains any cards other than those listed below, then the 2800 links quantity of the Large System # Links feature cannot be enabled:

- E5-ATM-B
- E5-E1T1-B
- E5-ENET-B
- E5-IPSM
- E5-MCPM-B
- E5-OAM
- E5-SM4G
- E5-SM8G-B
- E5-TSM
- HIPR2

The Info Analyzed Relay Base (IAR Base) feature must be enabled before the IAR NP, IAR GRN, or IAR ASD feature can be enabled.

The S-Port feature and the IDP A-Party Blacklist feature cannot both be enabled in the system.

The value specified for the `partnum` parameter must consist of 9 digits, without any dashes. The first three digits are 893. The next six values are numeric (0...9).

The Service Portability (S-Port) feature must be enabled before the S-Port Subscriber Differentiation feature can be enabled.

If the system is not in mixed mode and is equipped with GPSM-II/TDM card(s), then the Integrated GLS and Integrated Measurements features cannot be enabled.

The A-Port or IGM feature must be turned on before the LOCREQ Query Response feature can be enabled.

If a PCT feature of maximum quantity level is enabled, then a PCT feature of a lower quantity cannot be enabled.

A PCT feature cannot be enabled if the quantity is higher than the quantity of the associated FAK.

If a DSM card is provisioned in the system, then the FLOBR, GTT Action – DUPLICATE, and VGTT-16 features cannot be enabled.

If an EOAM card is in the active or standby MASP location, then the 10,000 Routesets feature cannot be enabled.

The VCI value for any ATM link (see the `ent-slk` command) must be less than or equal to 16383 before a 3 Links per Card feature quantity can be enabled.

The `mtplprst` option must be configured (see the `chg-stpopts` command) before the Origin-based MTP Routing feature can be enabled.

The `matchseq=dn` parameter must be specified (see the `chg-tifopts` command) before the TIF Number Substitution feature can be enabled.

Each provisioned Service Module card must have at least 4G memory before the AINPQ feature can be enabled.

At least one EPAP related feature must be turned on before the EPAP Data Split feature can be enabled.

The EPAP Data Split feature requires E5-SM4G or E5-SM8G-B cards.

ISUP NP with EPAP feature cannot be enabled once Dual ExAP Config feature has been enabled.

TIF Selective Screening feature is mutually exclusive with TIF Number Substitution feature. TIF Selective Screening feature uses Number Substitution digit field to store Call Types associated with DN.

The Default Country Code must be provisioned (see the `defcc` parameter in the `chg-stpopts` command) before the SIP NP feature can be enabled.

The J7 support feature cannot be enabled if ANSI or ITUN-24 SID is already provisioned.

The EPM A/E5-SM4G cards are not supported when the SMxG 13,600 TPS Throughput Capacity feature is enabled.

## Notes

### **XGTT or XMAP (GTT or MAP Table Increase) Feature**

After the XGTT feature is enabled, the feature cannot be disabled or turned off.

After the XMAP feature is enabled, the feature cannot be disabled or turned off.

### **1500 Links and 2000 Links Support**

After the 1500 Links feature or the 2000 Links Support feature is enabled, the feature cannot be disabled or turned off.

### **SE-HSL SLK Capacity**

The SE-HSL feature allows unchannelized E1 links to be provisioned. The maximum number of unchannelized signaling links that can be assigned to E5-E1T1-B cards in the system with each SE-HSL SLK Capacity quantity feature access key are:

- 893-0130-01—4
- 893-0130-02—8
- 893-0130-03—16
- 893-0130-04—24
- 893-0130-05—32
- 893-0130-06—40
- 893-0130-07—48
- 893-0130-08—56
- 893-0130-09—64
- 893-0130-10—72
- 893-0130-11—80
- 893-0130-12—88
- 893-0130-13—96
- 893-0130-14—104
- 893-0130-15—112
- 893-0130-16—120

#### LNP Ported Numbers Capacity, LNP NPANXXs, LNP LRNs, and LNP ELAP Configuration Features

[Table 4-21](#) lists the minimum Service Module hardware type required by each LNP quantity feature. Quantities of 204-228 million TNs require DSM cards and do not support E5-SM4G or E5-SM8G-B cards. Quantities of 240-504 million TNs require E5-SM4G or E5-SM8G-B cards.

**Table 4-21 Minimum Hardware Required for LNP Quantity Features**

Object / Capacity	Minimum Hardware	Part Number
156 Million TNs	4 GB Service Module card	893-0110-17
168 Million TNs	4 GB Service Module card	893-0110-18
180 Million TNs	4 GB Service Module card	893-0110-19
192 Million TNs	4 GB Service Module card	893-0110-20
204 Million TNs	This capacity was previously supported only on the 4 GB DSM card. Starting with EAGLE Release 46.0, the DSM card is no longer supported; therefore this specific capacity limit is no longer supported.	893-0110-21
216 Million TNs	This capacity was previously supported only on the 4 GB DSM card. Starting with EAGLE Release 46.0, the DSM card is no longer supported; therefore this specific capacity limit is no longer supported.	893-0110-22

**Table 4-21 (Cont.) Minimum Hardware Required for LNP Quantity Features**

Object / Capacity	Minimum Hardware	Part Number
228 Million TNs	This capacity was previously supported only on the 4 GB DSM card. Starting with EAGLE Release 46.0, the DSM card is no longer supported; therefore this specific capacity limit is no longer supported.	893-0110-23
240 Million TNs	E5-SM4G/E5-SM8G-B	893-0110-24
252 Million TNs	E5-SM4G/E5-SM8G-B	893-0110-25
264 Million TNs	E5-SM4G/E5-SM8G-B	893-0110-26
276 Million TNs	E5-SM4G/E5-SM8G-B	893-0110-27
288 Million TNs	E5-SM4G/E5-SM8G-B	893-0110-28
300 Million TNs	E5-SM4G/E5-SM8G-B	893-0110-29
312 Million TNs	E5-SM4G/E5-SM8G-B	893-0110-30
324 Million TNs	E5-SM4G/E5-SM8G-B	893-0110-31
336 Million TNs	E5-SM4G/E5-SM8G-B	893-0110-32
348 Million TNs	E5-SM4G/E5-SM8G-B	893-0110-33
360 Million TNs	E5-SM4G/E5-SM8G-B	893-0110-34
372 Million TNs	E5-SM4G/E5-SM8G-B	893-0110-35
384 Million TNs	E5-SM4G/E5-SM8G-B	893-0110-36
396 Million TNs	E5-SM4G/E5-SM8G-B	893-0110-37
408 Million TNs	E5-SM4G/E5-SM8G-B	893-0110-38
420 Million TNs	E5-SM4G/E5-SM8G-B	893-0110-39
432 Million TNs	E5-SM4G/E5-SM8G-B	893-0110-40
444 Million TNs	E5-SM4G/E5-SM8G-B	893-0110-41
456 Million TNs	E5-SM4G/E5-SM8G-B	893-0110-42
468 Million TNs	E5-SM4G/E5-SM8G-B	893-0110-43
480 Million TNs	E5-SM4G/E5-SM8G-B	893-0110-44
492 Million TNs	E5-SM4G/E5-SM8G-B	893-0110-45
504 Million TNs	E5-SM4G/E5-SM8G-B	893-0110-46
150,000 NPANXXs	4 GB Service Module card	893-0094-01
300,000 NPANXXs	4 GB Service Module card	893-0094-02
100,000 LRNs	4 GB Service Module card	893-0105-05
150,000 LRNs	4 GB Service Module card	893-0105-01

**Flexible GTT Load Sharing**

The Flexible GTT Load Sharing feature allows a PC or PC/SSN combination to be provisioned in multiple load-sharing relationships for post-GTT load sharing of intermediate and final GTT traffic.

Load sharing for intermediate GTT traffic requires the Intermediate GTT Load Sharing feature, which can be run in conjunction with the Flexible GTT Load Sharing feature.

Intermediate GTT load sharing is performed through the MRN table, and the GTT destination is a PC. If both the Intermediate and Flexible GTT Load Sharing features are on, different load-sharing relationships can be defined between the same set of PCs, and different sets of destinations can contain the same PCs.

Load sharing for final GTT traffic is performed through the MAP table, and the GTT destination is a PC/SSN combination. If the Flexible GTT Load Sharing feature is on, different load-sharing relationships can be defined between the same set of PC/SSNs, and different sets of destinations can contain the same PC/SSN combinations.

### **Weighted GTT Loadsharing**

The Weighted GTT Loadsharing feature allows a PC or PC/SSN combination to be provisioned with weights and threshold values to change the loadsharing method. This weight is relative to the weights of the PCs or PC/SSNs that have the same relative cost (RC group) and determines the relative percentage of traffic sent to the PC or PC/SSN. If the total available weight of the PCs or PC/SSNs in the RC group falls below the threshold, that RC group is not used and the next lowest RC group is used for traffic loadsharing.

### **SEAS Over IP**

All database commands associated with the SEAS Over IP feature can be entered after the SEAS Over IP feature is enabled.

### **SCCP Loop Detection**

The SCCP Loop Detection feature allows sets of point codes that form a routing loop in the network to be specified. These sets are linked with GTT sets and are checked during intermediate and final GTT traffic routing. If a loop exists, either the system can simply be notified or the traffic can be discarded. The SCCP Loop Detection feature requires the GTT feature and is supported on Service Module cards.

### **Multiple Linksets to a Single Adjacent PC (MLS)**

The MLS feature allows multiple linksets to be established to a single adjacent destination point code.

### **Voice Mail Router (V-Flex)**

The V-Flex feature allows calls to be routed to a specific voice mail server based on subscriber and call context data.

### **Proxy Point Code Capacity**

The Proxy Point Code feature allows the EAGLE to assume the point codes of other nodes. The total numbers of proxy point codes that can be provisioned in the system for each quantity are:

- 893-0187-01—10
- 893-0187-02—20
- 893-0187-03—30
- 893-0187-04—40
- 893-0187-05—50
- 893-0187-06—60
- 893-0187-07—70
- 893-0187-08—80



- 893-0187-09—90
- 893-0187-10—100

### E5-SM4G and E5-SM8G-B Throughput Capacity

The E5-SM4G and E5-SM8G-B Throughput Capacity feature is a quantity feature that is used to increase the SCCP traffic processing capacity of an E5-SM4G or E5-SM8G-B card.

- 893-0191-01—5000 TPS
- 893-0191-02—6800 TPS
- 893-0191-03—10,000 TPS
- 893-0191-04—13,600 TPS

[Table 4-22](#) displays the TPS capacities for each E5-SM4G Throughput Capacity Quantity

**Table 4-22 TPS Capacities**

Feature Quantity Part Number	Maximum TPS Capacity per Card	Maximum System TPS Capacity*
893-0191-01	3125 (if one or more EPAP-based features are enabled)	75,000 TPS with one or more EPAP-based features and 24+1 cards 96,875 TPS with one or more EPAP-based features and 31+1 cards
	5000 (if no EPAP-based features are enabled)	155,000 TPS (if one or more GTT-based features is turned on) and 31+1 cards 40,000 TPS (if one or more ELAP-based features is enabled) with 8+1 cards 85,000 TPS (if one or more ELAP-based features is enabled) with 17+1 cards
893-0191-02	6800	210,800 TPS with or without EPAP-based features and 31+1 cards 163,200 TPS with one or more EPAP-based features and 24+1 cards 54,400 TPS with ELAP and 8+1 cards 115,600 TPS with ELAP and 17+1 cards

Table 4-22 (Cont.) TPS Capacities

Feature Quantity Part Number	Maximum TPS Capacity per Card	Maximum System TPS Capacity*
893-0191-03**	10,000	310,000 TPS with or without EPAP-based features and 31+1 cards 240,000 TPS with one or more EPAP-related features and 24+1 cards 80,000 TPS with ELAP and 8+1 cards 170,000 TPS with ELAP and 17+1 cards
893-0191-04** ***	13,600	421,600 TPS with or without EPAP-based features and 31+1 cards 326,400 TPS with one or more EPAP-related features and 24+1 cards 108,800 TPS with ELAP and 8+1 cards 231,200 TPS with ELAP and 17+1 cards

\*32 cards implies an N+1 configuration, so 31 cards are used for calculating actual TPS capacity.

\*\* Requires E5-SM8G-B

\*\*\* Requires B cards (E5-E1T1-B is recommended) or SLIC cards throughout a node.

## HIPR2

The HIPR2 High Rate Mode feature (Part Number 893-0201-01) must be enabled before the EAGLE can use the entire channel for data and provide a throughput rate of 2.5Gbps. If this feature is not enabled, then the EAGLE provides an effective inter-shelf throughput rate of 1Gbps.

## Advanced GT Modification (AMGTT)

There are three AMGTT features:

- Part number 893-0218-01: Advanced Global Title Modification (AMGTT). Allows non-MGTT customers to enable CdPA and CgPA functions after upgrade.
- Part number 893-0218-02: Advanced Global Title Modification, Called Party Only (AMGTT CdPA Only). Allows existing MGTT customers to continue using CdPA modification functions after upgrade. Does not allow any CgPA modification capabilities. The AMGTT CdPA Only feature cannot be enabled by this command. It is automatically enabled upon upgrading from the source release to EAGLE release 38.0 if the MGTT feature was turned on prior to the upgrade.
- Part number 893-0218-03: Advanced Global Title Modification, Calling Party Upgrade (AMGTT CgPA Upgrade). Allows existing MGTT customers to upgrade to AMGTT after upgrade to EAGLE release 38.0. Requires the AMGTT CdPA Only feature to be enabled, and allows full AMGTT CdPA and CgPA modification.

## Prepaid IDP Query Relay

The IDPRCDPN(X) NPP Service must be turned on before the Prepaid IDP Query Relay feature can be turned on. The IDPRCGPN NPP service must be turned on to process Calling Party Numbers. The IDPRCGPN Service is reached from the IDPRCDPN Service. The following warning message appears while enabling the Prepaid IDP Query Relay feature:

### **Caution:**

Any of the IDPRCDPN(X) NPP services must be ON before turning ON the IDPR feature.

## MO SMS IS41-to-GSM Migration

The MO SMS IS41-to-GSM Migration feature addresses modifications to the MO-based IS41 SMS NP feature (893-0194-01) required to meet certain IS41-to-GSM Migration call flows. This feature also allows the IS412GSM Migration Prefix to be used as a prefix instead of the RTDB RN/SP when an SMS is destined for a GSM-migrated subscriber.

## SLS Bit Rotation by Incoming Linkset (ISLSBR)

The ISLSBR feature allows SLS Bit rotation to occur on an incoming linkset. This feature provides the ability to configure distribution in an ANSI or ITU network.

## Eagle Additional Subscriber Data

Prepaid IDP Query Relay and TIF framework features support ASD data, which can be associated with individual subscribers and ranges. IDPR and TIF ASD/GRN features address the addition of ASD fields into the EAGLE. The ASD feature allows generic data to be associated with DN and DN Block subscriber records.

## Prepaid SMS Intercept Ph1

The MOSMSGCDPN and MOSMSGCGPN services must be provisioned before the MO SMS Prepaid Check feature is turned on for "Prepaid SMS Intercept Ph1" to be functional. The following warning message appears while enabling the MO SMS Prepaid Check feature:

### **Caution:**

MOSMSGCDPN or/and MOSMSGCGPN NPP Services must be turned on for the feature to be functional.

## MO-based IS41 SMS NP and MO SMS IS41-to-GSM Migration

The MOSMSICDPN NPP service must be provisioned before the MO-based IS41 SMS NP or the MO SMS IS41-to-GSM Migration feature is turned on for the feature to be functional. The following warning message appears while enabling these features:

**▲ Caution:**

MOSMSICDPN NPP Services must be turned on for the feature to be functional.

**Portability Check for MO SMS**

The MOSMSGCGPN NPP service must be enabled before the Portability Check for MO SMS feature is turned on for the feature to be functional. The following warning message appears while enabling the feature:

**▲ Caution:**

MOSMSGCGPN NPP Services must be turned on for the feature to be functional.

**MO-based GSM SMS NP**

The MOSMSGCDPN NPP service must be provisioned before the MO-based GSM SMS NP feature is turned on for the feature to be functional. The following warning message appears while enabling the feature:

**▲ Caution:**

MOSMSGCDPN NPP Services must be turned on for the feature to be functional.

**GTT Load Sharing With Alternate Routing Indicator**

The GTT Load Sharing with Alternate Routing Indicator (GTT LS ARI) feature allows loadsharing relationships to be established between the MAP and MRN table in that the MAP and MRN sets allow provisioning of MRN and MAP sets, respectively, as the Alternate Mate RI if the point codes in the MAP or MRN table are unavailable.

**ST-HSL-A SLK Capacity**

The ST-HSL-A feature allows unchannelized T1 links to be provisioned. The total number of unchannelized signaling links that can be assigned to E5-E1T1-B cards in the system with each ST-HSL-A SLK Capacity quantity feature access key is enabled are:

- 893-0273-01—4
- 893-0273-02—8
- 893-0273-03—16
- 893-0273-04—24
- 893-0273-05—32
- 893-0273-06—40
- 893-0273-07—48
- 893-0273-08—56
- 893-0273-09—64
- 893-0273-10—72

- 893-0273-11—80
- 893-0273-12—88
- 893-0273-13—96
- 893-0273-14—104
- 893-0273-15—112
- 893-0273-16—120
- 893-0273-07—128
- 893-0273-18—136
- 893-0273-19—144
- 893-0273-20—152
- 893-0273-21—160
- 893-0273-22—168
- 893-0273-23—176
- 893-0273-24—180

#### **MO SMS ASD, MO SMS GRN**

The MOSMSGCGPN, MOSMSGCDPN, MOSMSICGPN, or MOSMSICDPN NPP service must be provisioned before the MO SMS ASD or MO SMS GRN feature is turned on for the feature to be functional. The following warning message appears while enabling the feature:

#### **Caution:**

MOSMSGCDPN, MOSMSICDPN, MOSMSGCGPN or/and MOSMSICGPN NPP Services must be turned on for the feature to be functional.

#### **Large MSU Support for IP Signaling**

The Large MSU Support for IP Signaling feature supports MSUs having a Service Information Field (SIF) up to 4095 bytes over M2PA and M3UA Protocols with Service Indicator (SI) values ranging from 6 to 15. The values for the Service Indicators are:

- 6, 7—Data
- 9—Broadband ISDN
- 10—Satellite ISDN
- 13—BICC
- 14—H.248
- 8, 11, 12, 15—Spare

#### **EPAP based features**

If Global Title Translation (GTT) is on and more than 25 SCCP cards are provisioned, then when the first EPAP based feature is enabled, a warning is issued to state that

the EAGLE must be connected to an EPAP T1200 or higher. Subsequent commands for enabling EPAP based features are accepted without any warning.

### **XUDT UDT Conversion feature**

The XUDT UDT Conversion feature allows the following SCCP message conversions:

- UDT(S) messages to XUDT(S) messages
- Non-segmented XUDT(S) messages to UDT(S) messages
- Segmented XUDT(S) messages to UDT(S) messages

MTT 3354 deleted for PR 165345 MB

### **3 Links per Card feature**

The 3 Links per Card feature is a quantity feature that supports a third link (A1) on an E5-ATM-B card. Each quantity FAK supports the 3 Links per card feature in an increment of 5 cards, up to a maximum of 385 cards. Part numbers range from 893-0391-01 (supports the feature on 5 cards) to 893-0391-77 (supports the feature on 385 cards).

### **Point Code and CIC Translation (PCT)**

The PCT feature is a quantity feature that allows the EAGLE to change the destination point code (DPC) and originating point code (OPC) of an MTP-routed MSU to previously configured values. The quantity is used to define the maximum number of allowed translations:

- 893-0372-01—25 translations
- 893-0372-02—50 translations
- 893-0372-03—75 translations
- 893-0372-04—100 translations
- 893-0372-05—150 translations
- 893-0372-06—200 translations
- 893-0372-07—250 translations
- 893-0372-08—1000 translations

### **Integrated GLS**

The E5-OAM Integrated GLS (Integrated GLS) feature allows the E5-MASP cards to support the function of GLS cards for Gateway Screening. If the Integrated GLS feature is turned on, then the E5-MASP accepts the bind requests for the GWS screenset from network cards, binds the requested screenset, and downloads the screenset to the requested network cards.

If the Integrated GLS feature is turned OFF, then the E5-MASP cards do not service the requests for binding screensets and the network cards continue to send binding requests for screen sets to the active GLS cards.

### **E5-ENET-B IPSP High Throughput**

The E5-ENET-B IPSP High Throughput feature allows the E5-ENET-B card running the IPSP application to have a maximum capacity of 9500 TPS. If the feature is not turned on, then the E5-ENET-B card running the IPSP application has a maximum capacity of 6500 TPS.

### **EPAP Data Split**

The EPAP Data Split feature allows EPAP data to be split into DN and IMSI subsets. Each subset is loaded on a specific set of E5-SM4G or E5-SM8G-B cards. The maximum capacity for each data subset (120 million) can be loaded on the associated set of cards. Therefore, splitting the data allows a system-wide EPAP data capacity of 240 million.

### Dual ExAP Config

Warning: Enabling the Dual ExAP Config feature will disable functions of ISUP NP with EPAP and TINP.

Prior to enabling the Dual ExAP Config feature, upgrade the ISUP NP with EPAP and TINP features to TIF if one or both of those features are present in the system.

The Dual ExAP Config feature is allowed to be turned on regardless of whether the ISUP NP with EPAP or TINP features are already turned on.

If the Dual ExAP Config is turned on while ISUP NP with EPAP and TINP are not upgraded to TIF, these two features will stop working.

### SIP Number Portability

The SIP-based Number Portability feature allows the E5-SM8G-B card running the SIPHC application to support SIP interfaces on EAGLE and also provide SIP based Number Portability using EAGLE's RTDB/RIDB.

### 1M System TPS

The 1M System TPS feature allows provisioning 1,000,000 TPS on SIGTRAN and ATM cards collectively. If the feature is not turned on, then the system will support 750,000 TPS or 500,000 TPS only based on the state of HIPR2 High Rate Mode feature. If the HIPR2 High Rate Mode feature is ON and the 1M System TPS is OFF, the system will support 750,000 TPS. If the HIPR2 High Rate Mode feature is OFF and the 1M System TPS is OFF, the system will support 500,000 TPS. HIPR2 High Rate Mode feature is a mandatory feature for turning ON the 1M System TPS feature.

### S13/S13' Interface for EIR

The Diameter S13/S13' Interface for EIR feature allows the E5-SM8G-B card running the DEIRHC application to support Diameter S13/S13' interface on EAGLE and also provide EIR functionality on 3G and LTE networks.

### Output

```
enable-ctrl-feat:partnum=893xxxxxx
```

```
tekelecstp 08-12-04 13:55:19 EST EAGLE 46.3.0
enable-ctrl-feat:partnum=893xxxxxx
Command entered at terminal #4.
ENABLE-CTRL-FEAT: MASP A - COMPLTD
;
```

This example shows the output when more than 25 SCCP cards are provisioned and first EPAP-based feature is enabled:

This warning is issued when the first and only the first EPAP based feature is enabled.

```
enable-ctrl-feat:partnum=89xxxxxxx
```

```
tekelecstp 10-02-26 15:40:56 EST EAGLE 46.3.0  
enable-ctrl-feat:partnum=893xxxxxx  
Command entered at terminal #4.
```

```
Warning: The Eagle must be connected to an EPAP T1200 or higher  
ENABLE-CTRL-FEAT: MASP A - COMPLTD
```

```
;
```

### Related Topics

- [chg-ctrl-feat](#)
- [rtrv-ctrl-feat](#)

## ent-acg-mic

Use this command to assign Automatic Call Gapping (ACG) controls to certain queries. The control can apply to all queries or to specific query services and called party digits. If the EAGLE LNP query service receives a query to which a control applies, then the EAGLE sends an ACG component, encoded as configured, with the response.

### Parameters

#### **drtn (mandatory)**

Duration index. The amount of time that the ACG is in effect. This number is mapped to a time value at the LNP node.

**Range:**

1 - 13

**Default:**

The current value

#### **aintvl (optional)**

AIN interval index

**Range:**

1 - 15

**Default:**

The current value

#### **dgts (optional)**

Digits

**Range:**

000 - 999, 000000 - 9999999999

Specify 3 digits or 6-10 digits.

#### **intvl (optional)**

IN Interval index. The amount of time between ACGs. This number is mapped to a time value for the LNP node.



**Range:**  
0 - 15

**Default:**  
Current value

**nd (optional)**  
Number of digits

**Range:**  
3, 6 - 10

**Default:**  
The current value

**serv (optional)**  
Query service

**Range:**

*ain*

*in*

**type (optional)**  
Type of control

**Range:**

*all*

*sd*

**Default:**  
*sd*

### Example

```
ent-acg-mic:type=all:nd=6:drtn=6:intvl=2:aintvl=7
```

```
ent-acg-mic:serv=ain:dgts=9194602132:drtn=13:aintvl=1
```

```
ent-acg-mic:type=sd:serv=in:dgts=919:drtn=8:intvl=3
```

### Dependencies

If the `type=all` parameter is specified, then the `nd`, `intvl`, and `aintvl` parameters must be specified.

If the `type=all` parameter is specified, the optional parameters `serv` and `dgts` cannot be specified.

If the `type=sd` parameter is specified, the optional parameters `serv` and `dgts` must be specified.

If the `type=sd` parameter is specified, then the `nd` parameter cannot be specified.

If the `serv=in` parameter is specified, the `aintvl` parameter cannot be specified.

If the `serv=ain` parameter is specified, the optional parameter `intvl` cannot be specified.

If the `serv=in` parameter is specified, the optional parameter `intvl` must be specified.

If the `serv=ain` parameter is specified, the optional parameter `aintvl` must be specified.

The `dgts` parameter value must be specified as 3 or 6–10 digits.

A valid value must be specified for the `nd` parameter.

The LNP feature must be turned on before this command can be entered.

If the `type=all` parameter is specified, then an MIC with the `type=all` parameter cannot already exist.

If the `type=sd` parameter is specified, a MIC with the same service and digits must not already exist.

The ACG MIC table must be accessible.

A maximum of 256 `type=sd` MICs are allowed.

### Notes

None

### Output

```
ent-acg-mic:type=all:nd=6:drtn=6:intvl=2:aintvl=7
```

```
rlghncxa03w 04-02-28 08:50:12 EST EAGLE 31.3.0
ACG MIC table is (11 of 256) 4% full of type SD
ENT-ACG-MIC: MASP A - COMPLTD
;
```

### Related Topics

- [chg-acg-mic](#)
- [dlt-acg-mic](#)
- [rept-stat-lnp](#)
- [rtrv-acg-mic](#)

## ent-acg-noc

Use this command to enter the values for the automatic call gapping (ACG) controls that you want to send when you reach the specified node overload level. The definition is comprised of the threshold LNP query rates for node overload levels and the values for the ACG to be sent when at the level. If a level is not defined, it is not used. Level 10 is predefined.

### Parameters

#### **drtn (mandatory)**

Duration index. The amount of time that the ACG is in effect. This number is mapped to a time value at the LNP node.

**Range:**

*1 - 13*

**Default:**

The current value

**intvl (mandatory)**

Interval index. The amount of time between ACGs. This number is mapped to a time value for the LNP node.

**Range:**

*0 - 15*

**Default:**

Current value

**lvl (mandatory)**

Overload level.

**Range:**

*1 - 9*

**qr (mandatory)**

Query rate. The number of LNP queries, which define a particular overload level, in a 30-second period.

**Range:**

*1 - 2147483647*

**and (optional)**

AIN number of digits. The number of digits in the global title address of an AIN query.

**Range:**

*6*

*10*

**Default:**

*6*

**ind (optional)**

IN number of digits. The number of digits in the global title address of an IN query.

**Range:**

*6*

*10*

**Default:**

*6*

**Example**

ent-acg-noc:lvl=3:qr=300000:and=10:ind=6:drtn=6:intvl=3

### Dependencies

The ACG NOC table must be accessible.

The LNP feature must be turned on before this command can be entered.

Either 6 or 10 must be specified for the `and` parameter.

The specified overload level must not already be defined.

Either 6 or 10 must be specified for the `ind` parameter.

### Notes

None

### Output

```
ent-acg-noc:lvl=3:qr=300000:and=10:ind=6:drtn=6:intvl=3
```

```
rlghncxa03w 04-02-28 08:50:12 EST EAGLE 31.3.0
ENT-ACG-NOC: MASP A - COMPLTD
;
```

### Related Topics

- [chg-acg-noc](#)
- [dlt-acg-noc](#)
- [rept-stat-lnp](#)
- [rtv-acg-noc](#)

## ent-appl-rtkey

Use this command to configure static entries in the Routing Key table, which associates a routing key with a socket name.

There are three types of routing keys, as follows:

- DPC, SI, SSN routing keys, which are used to route SCCP messages
- DPC, SI routing keys, which are used to route non-SCCP and non-ISUP messages
- DPC, SI, CIC routing keys, which are used to route ISUP messages

### Parameters

#### Note:

See [Point Code Formats and Conversion](#) in Appendix A for a detailed description of point code formats, rules for specification, and examples.

**asname (mandatory)**

Application Server (AS) name assigned to this routing key.

**Range:**

ayyyyyyyyyyyyyyy

Up to 15 alphanumeric characters; the first character must be a letter

**cice (optional)**

The end range of circuit identification codes assigned to the routing key.

**Range:**

0 - 4294967295

See [Table A-2](#) for valid CIC values for specified SI and MSU types.

**cics (optional)**

The start range of circuit identification codes assigned to the routing key.

**Range:**

0 - 4294967295

See [Table A-2](#) for valid CIC values for specified SI and MSU types.

**dpc (optional)**

ANSI destination point code with subfields *network indicator-network cluster-network cluster member (ni-nc-ncm)*.

**Synonym:**

*dPCA*

**Range:**

000-255

Specify a valid value for each subfield of the point code, and separate the subfields with a dash (-).

When *chg-sid:pctype=ansi* is specified, *ni = 000* is not valid.

When *chg-sid:pctype=ansi* is specified, *nc = 000* is not valid if *ni = 001-005*.

When *chg-sid:pctype=ansi* is specified, *nc = 000* is valid if *ni = 006-255*.

The point code *000-000-000* is not a valid point code.

**dpc/dPCA/dpci/dpcn/dpcn24/dpcn16 (optional)**

Destination point code.

**dpci (optional)**

ITU international destination point code with subfields *zone-area-id*. The *prefix* subfield indicates a spare point code (*prefix-zone-area-id*)

**Range:**

*s-*, 0-255

Specify a valid value for each subfield of the point code, and separate the subfields with a dash (-).

*prefix—s*

*zone—0-7*

*area—000-255*

*id—0-7*

The point code *0-000-0* is not a valid point code.

**dpcn (optional)**

ITU national destination point code in the format of a 5-digit number (*nnnnn*); or 2, 3, or 4 numbers (members) separated by dashes (*m1-m2-m3-m4*) as defined by the `chg-stpopts:npcfmti` flexible point code option. A group code must be specified when the ITUDUPPC feature is turned on (*nnnnn-gc,m1-m2-m3-m4-gc*). The *prefix* subfield indicates a spare point code (*prefix-nnnnn, prefix-nnnnn-gc, prefix-m1-m2-m3-m4, prefix-m1-m2-m3-m4-gc*).

**Range:**

*s-*, 0-16383, *aa-zz*

Specify a valid value for each subfield of the point code, and separate the subfields with a dash (-).

*prefix—s-*

*nnnnn—0-16383*

*gc—aa-zz*

*m1-m2-m3-m4—0-14* for each member; values must sum to 14

**dpcn24 (optional)**

24-bit ITU national destination point code with subfields *main signaling area-sub signaling area-signaling point* (*msa-ssa-sp*).

**Range:**

000-255

Specify a valid value for each subfield of the point code, and separate the subfields with a dash (-).

*msa—000–255*

*ssa—000–255*

*sp—000–255*

**dpcn16 (optional)**

16-bit ITU national point code with subfields *unit number sub number area main number area* (*un-sna-mna*).

**Range:**

000--127

Specify a valid value for each subfield of the point code, and separate the subfields with a dash (-).

*un---000---127*

*sna---000---15*

*mna---000---31*

**opc (optional)**

ANSI originating point code with subfields *network indicator-network cluster-network cluster member* (*ni-nc-ncm*).

**Synonym:**

*opca*

**Range:**

000-255

Specify a valid value for each subfield of the point code, and separate the subfields with a dash (-).

When `chg-sid:pctype=ansi` is specified, `ni = 000` is not valid.

When `chg-sid:pctype=ansi` is specified, `nc = 000` is not valid if `ni = 001–005`.

When `chg-sid:pctype=ansi` is specified, `nc = 000` is valid if `ni = 006–255`.

The point code `000-000-000` is not a valid point code.

#### **opc/opca/opci/opcn/opcn24/opcn16 (optional)**

Originating point code. This parameter is valid and required if a value of 4, 5, or 13 is specified for the `si` parameter and the `type=full` parameter is specified.

#### **opci (optional)**

ITU international destination point code with subfields *zone-area-id*. The *prefix* subfield indicates a spare point code (*prefix-zone-area-id*)

##### **Range:**

*s-*, 0-255

Specify a valid value for each subfield of the point code, and separate the subfields with a dash (-).

*prefix—s*

*zone—0-7*

*area—000-255*

*id—0-7*

The point code `0-000-0` is not a valid point code.

#### **opcn (optional)**

New ITU national originating point code in the format of a 5-digit number (*nnnnn*); or 2, 3, or 4 numbers (members) separated by dashes (*m1-m2-m3-m4*) as defined by the `chg-stpopts:npcfmti` flexible point code option. A group code must be specified when the ITUDUPPC feature is turned on (*nnnnn-gc*, *m1-m2-m3-m4-gc*). The *prefix* subfield indicates a spare point code (*prefix-nnnnn*, *prefix-nnnnn-gc*, *prefix-m1-m2-m3-m4*, *prefix-m1-m2-m3-m4-gc*).

##### **Range:**

*s-*, 0-16383, *aa-zz*

Specify a valid value for each subfield of the point code, and separate the subfields with a dash (-).

*prefix—s-*

*nnnnn—0-16383*

*gc—aa-zz*

*m1-m2-m3-m4—0-14* for each member; values must sum to 14

#### **opcn24 (optional)**

24-bit ITU national originating point code with subfields *main signaling area-sub signaling area-signaling point* (*msa-ssa-sp*).

##### **Range:**

000-255

Specify a valid value for each subfield of the point code, and separate the subfields with a dash (-).

*msa—000–255*

*ssa—000–255*

*sp—000–255*

**opc16 (optional)**

16-bit ITU national point code with subfields *unit number sub number area main number area* (*un-sna-mna*).

**Range:**

000--127

Specify a valid value for each subfield of the point code, and separate the subfields with a dash (-).

*un---000---127*

*sna---000---15*

*mna---000---31*

**rcontext (optional)**

Routing context. The new routing context for a routing key. The routing context uniquely identifies the routing key.

Routing context is mandatory for routing keys associated with SUA Application Servers. Routing context is optional for routing keys associated with M3UA Application Servers.

**Range:**

0 - 4294967295

**si (optional)**

Service indicator.

**Range:**

0-15 or equivalent text values

**Number =Text—Description**

0=*snm*—Signaling network management messages

1=*regtest*—Signaling network testing and maintenance regular

2=*spltes*—Signaling network testing and maintenance special

3=*sccp*—SCCP

4=*tup*—Telephone user part

5=*isup*—ISDN user part

13=*qbicc*

**ssn (optional)**

Subsystem number.

**Range:**

0 - 255

**type (optional)**

The type of routing key.

**Range:**

*full*

*partial*

*default*



**Default:**  
*full*

### Example

```
ent-appl-rtkey:asname=suaas1:dpc=8-8-8:si=3:ssn=5:rcontext=100
ent-appl-
rtkey:asname=suaas2:dpc=8-8-8:si=3:type=partial:rcontext=101
ent-appl-
rtkey:asname=suaas3:dpc=8-8-8:type=partial:rcontext=102
ent-appl-rtkey:asname=suaas4:si= 3:type=partial:rcontext=103
ent-appl-rtkey:asname=suaas5:type=default:rcontext=104
ent-appl-
rtkey:asname=m3uaas1:dpc=8-8-9:si=5:opc=3-3-3:cics=1:cice=100:r
context=200
ent-appl-
rtkey:asname=m3uaas2:dpc=8-8-9:si=5:opc=3-3-3:type=partial:rcon
text=201
ent-appl-
rtkey:asname=m3uaas3:dpc=8-8-9:si=5:type=partial:rcontext=202
ent-appl-
rtkey:asname=m3uaas4:dpc=8-8-9:type=partial:rcontext=203
ent-appl-rtkey:asname=m3uaas5:si= 5:type=partial:rcontext=204
ent-appl-rtkey:asname=m3uaas6:type=default:rcontext=205
ent-appl-
rtkey:dpci=s-3-11-1:si=5:opci=s-4-11-1:cics=1:cice=1000:asname=
asitu
ent-appl-rtkey:dpc=1-1-1:si=3:asname=as1:ssn=255
ent-appl-
rtkey:dpci=3-11-1:si=3:opci=4-11-1:cics=1:cice=1000:asname=asit
u:rcontext=7
ent-appl-
rtkey:dpcn16=121-10-15:si=3:opc16=121-10-16:asname=asitu
```

### Dependencies

The `srkq` parameter (see the `chg-sg-opts` command) limits the maximum number of static routing keys that can be provisioned using this command. For SS7IPGW and IPGWI applications running on E5-ENET-B cards, there is a limit of 2500 routing keys in the system.

The `ssn` parameter is valid only when the `si=3` (or `sccp`) parameter is specified.

The value specified for the `cics` parameter must be less than or equal to the value specified for the `cice` parameter.

The ISUP routing-over-IP feature must be turned on before a DPC/SI/CIC routing key to route ISUP messages can be specified.

A circuit identification code range (`cics - cice`) cannot be specified that overlaps an existing routing key.

When a value of 4, 5, or 13 (`tup`, `isup`, or `qbicc`) is specified for the `si` parameter, the `opc`, `cics`, and `cice` parameters are required. The `opc`, `cics`, and `cice` parameters can be specified only if a value of 4, 5, or 13 is specified for the `si` parameter. See [Table A-2](#) for valid `cic` and `si` values for MSU types.

Partial point codes are not allowed; no asterisks can be specified in the routing key in the command.

Mixed point code types are not allowed; the types for the `opc` and `dpc` parameters must match.

A DPC/SI routing key must be specified when the DPC is ANSI and the `si=4` parameter is specified (TUP is used only in an ITU network).

When the `type=full` parameter is specified, the `dpc` and `si` parameters must also be specified.

The group codes for the `dpc` and `opc` parameter values must match when both parameters are entered in the command.

The `rcontext` parameter must be specified for routing keys that are associated with SUA Application Servers.

The specified `rcontext` parameter value must not already exist in the database.

If specified, the service indicator parameter must be `si=3` for routing keys that are associated with SUA Application Servers.

An AS cannot be simultaneously assigned to a routing key with routing contexts and routing keys without routing context.

To assign an M3UA or SUA association to multiple routing keys with routing context, the M3UA/SUA association must be assigned to more than one AS and each AS must be assigned to a routing key with routing context.

The AS name and parameters specified for a routing key must use an address format that is valid for the adapter type used by the ASP associations assigned to the AS.

If the `type=default` parameter is specified, then the `rcontext` and `asname` parameters are the only optional parameters that can be specified.

The following four types of partial routing keys are supported:

- DPC/SI/OPC (ignore CIC) can be used as a partial match key for CIC- based traffic.
- DPC/SI (ignore all other fields) can be used as a partial match key for CIC- based traffic or SCCP traffic.
- DPC only (ignore all other fields) can be used as a partial match for any type of traffic.
- SI only (ignore all other fields) can be used as a partial match for any type of traffic.

The DPC entered cannot be an APC or SAPC for an IPGWx linkset. Routing keys cannot be provisioned for the fake adjacent node.

AS can be associated to only one routing key that contains a routing context value.

The J7 support feature must be enabled before the `dpcn16/opcn16` parameters can be specified.

Mixed point code types are not allowed, the types for the `opc` and `dpc` must match.

The routing context value should be unique.

The `opc`, `cics`, and `cice` parameters can be specified with the `si` parameter only if the `si` parameter has a value of 4, 5, or 13 (or `tup`, `isup`, or `qbicc`).

### Notes

The Routing Key table associates a routing key with a socket name or an Application Server (AS).

The routing key can be associated with up to 16 socket names or with 1 AS.

The OPC and DPC cannot specify a cluster route.

Group codes are required for ITU-N point codes and spare point codes (DPCN/OPCN) when the ITU Duplicate Point Code feature (ITUDUPPC) is turned on, and not allowed when the feature is off.

Routing context is a routing key parameter that uniquely identifies routing keys. Routing context is mandatory for routing keys associated with SUA Application Servers and optional for routing keys associated with M3UA Application Servers. An AS cannot be simultaneously assigned to routing keys with routing contexts and routing keys without routing contexts.

An AS cannot be simultaneously assigned to a routing key with routing contexts and routing keys without routing contexts.

An AS can be associated with multiple routing keys that do not contain routing context. An AS can be associated with only 1 routing key with routing context. To assign an M3UA or SUA association to multiple routing keys with routing context, the M3UA/SUA association must be assigned to more than one AS and each AS must be assigned to a routing key with routing context.

In this command, only ITU-international and ITU national point codes support the spare point code subtype prefix (s-).

The `opc`, `cics`, and `cice` parameters can be specified with the `si` parameter only if the `si` parameter has a value of 4, 5, or 13 (or `tup`, `isup`, or `qbicc`).

### Output

```
ent-appl-rtkey:dpc=2-2-2:asname=assoc1:type=partial
```

```
rlghncxa03w 08-04-17 15:35:05 EST EAGLE 38.0.0
ENT-APPL-RTKEY: MASP A - COMPLTD
;
```

### Related Topics

- [dlt-appl-rtkey](#)
- [rtrv-appl-rtkey](#)

## ent-as

Use this command to create an Application Server (AS) as a logical entity to serve a specific routing key. This command enters a new AS into the AS table and assigns an M3UA or SUA SCTP association to it, or assigns an M3UA or SUA SCTP association to an existing AS.

### Parameters

#### **aname (mandatory)**

Name of the M3UA or SUA SCTP association.

#### **Range:**

aaaaaaaaaaaaaaaa

Up to 15 alphanumeric characters; the first character must be a letter

#### **asname (mandatory)**

Name of the Application Server (AS).

#### **Range:**

aaaaaaaaaaaaaaaa

Up to 15 alphanumeric characters; the first character must be a letter

### Example

```
ent-as:asname=asx:aname=asxp1
```

### Dependencies

The specified `aname` must exist in the IPAPSOCK table.

The adapter layer for each association assigned to the AS must be defined.

SUA Application Servers must have routing keys with assigned routing contexts.

The service indicator must be `si=3` for routing keys that are associated with SUA Application Servers.

The adapter layer must be the same for all M3UA/SUA associations assigned to the AS.

The value specified for the `aname` parameter cannot refer to an IPLIMx or IPSG association.

The `asname=default` parameter cannot be specified.

An association can be assigned to a maximum of 50 application servers.

### Notes

The DCM card has 16 MB of memory. Socket/association limits are based on card memory as is the ratio of associations to sockets. This ratio, known as the trade ratio, defines the number of sockets that are equivalent to one association with respect to memory consumption.

By default the AS recovery timer value is set to 200 ms when an AS is entered. This value can be changed at any time using the `chg-as` command. The new timer value will be used the next time the AS enters the AS-Pending state.

The trade ratio states the quantity of associations to sockets that may be provisioned on a certain card, as follows:



**adapter (optional)**

The adapter layer for this association.

**Range:**

*diam*

*m2pa*

*m3ua*

*sua*

**Default:**

*m3ua* if the local host is an IPGWx card and the adapter type is not specified.

*m2pa* if the local host is an IPLIMx or IPSG card and the adapter type is not specified.

*diam* if the local host is a DEIR card running DEIRHC GPL and the adapter type is not specified.

**alhost (optional)**

Name of alternate local host. When specified, this parameter configures the SCTP association as a multi-homed endpoint.

**Range:**

XX, *none*

Any string of characters beginning with a letter and comprising up to 60 characters in length

*none*—the `alhost` is not configured; the SCTP association is configured as a uni-homed endpoint

**bufsize (optional)**

Association buffer size in Kilobytes.

**Range:**

8 - 400

**Default:**

200

**link (optional)**

The signaling link for this association.

**Synonym:**

*port*

**Range:**

*a, b, a1-a63, b1-b63*

Not all card types support all link parameter values.

See [Table A-1](#) for valid link parameter range values for each type of card that can have assigned signaling links.

**Default:**

*a*

**lport (optional)**

The SCTP port number for the Local Host.



If the `m2patset` parameter is specified, then the `adapter=m2pa` parameter must be specified.

If the card is running an IPLIMI application, then an association with `adapter=sua` or `m3ua` cannot be assigned as a value for the `lhost` parameter. If the card is running the DEIRHC GPL, then the adapter type must be DIAM.

Association connection parameters (`lhost`, `rhost`, `lport`, `rport`) must be unique.

The card location for the card associated with the `lhost` and `alhost` must exist in the IP Link table.

The allowed maximum is 1 association per signaling link on IPLIMx cards.

There is a maximum of 50 connections (association-to-AS assignments + sockets) per Local Host on IPGWx cards.

A maximum of 4000 connections (association-to-AS assignments + sockets) are allowed per system.

If the value specified for the `lhost` parameter refers to an IPSP card or a DEIR card running the DEIRHC GPL, then the `link` parameter cannot be specified.

The value specified for the `link` parameter must be valid for the card and application type:

- Link A—card running the SS7IPGW or IPGWI application
- Links A - A7 and B - B7—card running the IPLIMI application

A maximum of 32 associations can be provisioned on an IPSP card.

The value specified for the `host` parameter must begin with an alphabetic character and can contain a..z, A..Z, 0..9, - (hyphen), or . (period). If the host name contains a hyphen, then the host name must be enclosed within quotation marks.

LHOST with REALM and RHOST with REALM are mandatory parameters for an association with adapter type DIAM.

RHOST is a mandatory parameter for a DIAM association.

If the LHOST is defined on Port A its ALHOST must be on PORT B.

If the LHOST is defined on Port B its ALHOST must be on PORT A.

If the LHOST is defined on Port C, its ALHOST must be PORT D.

RHOST must be present in the IPHOST table.

Remote IP address (RHOST) must not exist in the IPLINK table.

The IP Socket/Association (IPAPSOCK) table cannot contain more than 4000 entries.

The requested buffer size increase cannot exceed the available buffer space on the card. Use the `rtrv-assoc` command with the `aname`, `lhost`, or `alhost` parameter to display used and total buffer space on the card.

IP address associated with the LHOST and ALHOST should be of the same IP version.

IP address associated with the LHOST and RHOST should be of the same IP version.

Association name must be unique

The `alhost` or `lhost` should be present in IP link table



The LHOST cannot be PORT D.

The ALHOST cannot be PORT C.

### Notes

The IPAPSOCK table is used to associate the Local Host/Local Port to a Remote Host/Remote Port. This fully specifies the connection.

For a diameter association, the IPAPSOCK table is used to associate the Local Host/Local Realm/Local Port to a Remote Host/Remote Realm/Remote Port. This fully specifies the diameter connection.

SCTP associations can be configured as either uni-homed or multi-homed endpoints. Uni-homed endpoints are SCTP associations configured with the `lhost` parameter specified and the `alhost` parameter not specified. In this case, the `lhost` represents an IP address that corresponds to either the A or B network of the IP application card (see `chg-ip-lnk`). Multi-homed endpoints are SCTP associations configured with both the `lhost` and `alhost` parameters specified. In this case, the `lhost` represents an IP address corresponding to one of the networks (A or B) of the IP card while the `alhost` represents an IP address corresponding to the other network of the same IP card.

If a valid `lhost` parameter is specified that equates to a valid IP address, the `lhost` maps directly to a card location in the IP Link table, which can then determine the card's application (IPLIMx or SS7IPGWx). If the application is an IPLIMx, two additional validation checks are made:

- The `adapter` parameter value must equal `m3ua` or `m2pa`.
- The `ipliml2` value for the IPLIMx signaling link must be the same as the association `adapter` parameter value.
- The `ipliml2` value for an IPLIMx signaling link cannot be set to `m3ua`.

If the determination of the application running on the card or the signal link cannot be performed when the `ent-assoc` command is executed, the check will be performed by the `chg-assoc` command.

An association with an `adapter` value of `m2pa` cannot be assigned to an SS7IPGW or IPGWI host.

There are fields in the IPAPSOCK table that receive default values even though there are no parameters on this command for changing those fields. If a different value is desired, the `chg-assoc` command must be used. The `chg-assoc` command can also be used if the hostnames are too long to fit on the command line with other parameters. The fields in question and their default values are:

- `open=no`
- `alw=no`
- `rmode=lin`
- `rmin=120`
- `rmax=800`
- `rtimes=10`
- `cwmin=3000`

- ver=rfc
- istrms=2
- ostrms=2

For the M2PA RFC feature, when the application is IPLIMx and the `adapter=m2pa` parameter is specified, the supported M2PA version is set to M2PA RFC by default.

For the S13/S13' EIR feature, if the E5-SM8G-B card is running the DEIRHC GPL, an adapter other than diam cannot be specified.

### Output

```
ent-
assoc:aname=assoc1:lhost=gw105.nc.tekelec.com:lport=1030 :rhost=gw10
0.nc.tekelec.com:rport=1030:adapter=m3ua

      rlghncxa03w 04-02-17 15:35:05 EST  EAGLE 31.3.0
      ENT-ASSOC: MASP A - COMPLTD
;
```

### Related Topics

- [chg-assoc](#)
- [dlt-assoc](#)
- [rtrv-assoc](#)

## ent-card

Use this command to add a card to the database. The card type and application specifies the function assigned to the card.

### Parameters

#### Note:

The phrase "Service Module card" refers to an E5-SM8G-B or SLIC card when any of these cards can be used to provision the VSCCP, DEIRHC, SIPHC, and ENUMHC application. The cards are provisioned with the `type=dsm` or `type=slic` and `appl=deirhc/enumhc/siphc/vsccp` parameters.

#### **app1 (mandatory)**

Application. The application for the card.

#### **Range:**

xyyyyyy

1 alphabetic character followed by up to 6 alphanumeric characters. Valid applications are:

*atmansi*—Used by E5-ATM-B cards to support ANSI high-speed ATM signaling links and T1 functions.

*atmitu*—Used by E5-ATM-B cards to support ITU E1 high-speed ATM signaling links and E1 functions.

*ccs7itu*—Used by E5-E1T1-B, and SLIC cards for ITU-TSS MTP functions.

*deirhc*—Used by E5-SM8G-B and SLIC cards to support the S13/S13' EIR feature.

*elap*- Used by E5-APP-B card to support ELAP/LNP functionality.

*enumhc*- Used by E5-SM8G-B and SLIC cards to support the ENUM application.

*epap* - Used by E5-APP-B card to support EPAP/RTDB functionality.

*eroute*—Used by STC and E5-STC cards for EAGLE 5 Integrated Monitoring Support functions.

*glS*—Used by E5-TSM cards for downloading gateway screening to LIM and Service Module cards.

*imf* --- Used by E5-APP-B card to support IMF functionality.

*ipgwi*—Used by E5-ENET-B cards for IP point-to-multipoint connectivity for ITU point codes.

*iplimi*—Used by E5-ENET-B cards for IP point-to-point connectivity for ITU point codes.

*ips*—Used by E5-IPSM and E5-ENET-B cards for the IP User Interface feature.

*ipsg*—Used by E5-ENET-B, and SLIC cards to support the combined functionality of IPLIMx M2PA and IPGWx M3UA.

*lsms* - Used by E5-APP-B card to support LSMS/LNP functionality.

*mcp*—Used by E5-MCPM-B cards for the Measurements Platform feature.

*nas* - Used by E5-APP-B card to support NAS (storage of LNPDB from LSMS) functionality.

*sfapp*— Used by SLIC cards to support the SFAPP application.

*siphc*— Used by E5-SM8G-B and SLIC Cards to support SIP application.

*ss7ansi*—Used by E5-E1T1-B, and SLIC cards for ANSI MTP functions.

*ss7ipgw*— Used by E5-ENET-B cards for TCP/IP point-to-multipoint connectivity.

*stplan*—Used by E5-ENET-B cards to support STP LAN functions.

*switch* - Used by Telco switch to add power consumed by Telco Switch to Frame Power Budget. This is not an application gpl.

*vsccp*—Used by Service Module cards to support EPAP-based features and LNP features. If no EPAP-based features or LNP features are turned on, and a Service Module card is present, the VSCCP GPL processes GTT traffic.

**loc (mandatory)**

The card location as stenciled on the shelf of the system.

**Range:**

1101 - 1108, 1111 - 1112, 1201 - 1208, 1211 - 1218, 1301 - 1308, 1311- 1318,  
2101 - 2108, 2111 - 2118, 2201 - 2208, 2211 - 2218, 2301 - 2308, 2311 - 2318,  
3101 - 3108, 3111 - 3118, 3201 - 3208, 3211 - 3218, 3301 - 3308, 3311 - 3318,  
4101 - 4108, 4111 - 4118, 4201 - 4208, 4211 - 4218, 4301 - 4308, 4311 - 4318,  
5101 - 5108, 5111 - 5118, 5201 - 5208, 5211 - 5218, 5301 - 5308, 5311 - 5318,  
6101 - 6108, 6111 - 6118, 6201 - 6208, 6211 - 6218, 6301 - 6308, 6311 - 6318

**type (mandatory)**

The type of hardware being added.

**Range:*****dcm***

Data Communications Module card (E5-ENET-B card). Applications for this card type are STPLAN, IPLIMI, SS7IPGW, and IPGWI.

***dsm***

E5-SM8G-B or SLIC card to support EPAP-based features, LNP features, and the GTT feature. The application for this card type is VSCCP. The E5-SM8G-B and SLIC cards also supports the S13/S13' EIR, ENUM, and SIP Number Portability features. The application for the E5-SM8G-B or SLIC card running the S13/S13' EIR, ENUM, or SIP application is DEIRHC, ENUMHC, or SIPHC respectively.

***e5appb***

E5-APP-B card to support ELAP, EPAP, IMF, LSMS, and NAS applications.

***enet***

E5-ENET-B card to support the IP Signaling Gateway. The application for this card type is IPSPG.

***enetb***

E5-ENET-B or SLIC card to support the IP Signaling Gateway. The application for this card type is IPSPG

***ipsm***

IP Services Module card (E5-IPSM or E5-ENET-B card) to support the IP User Interface feature. The application for this card type is IPS.

***limatm***

E5-ATM-B card to support high-speed signaling links. The application for this card type is ATMANSI.

***lime1atm***

E5-ATM-B card to support high-speed signaling links. The application for this card type is ATMITU.

***lime1***

E5-E1T1-B, or SLIC card used as an E1 card or an SE-HSL card. Applications for this card type are SS7ANSI and CCS7ITU.

***limt1***

E5-E1T1-B, or SLIC card used as a T1 card or an SE-HSL card; or E5- E1T1-B card used as an ST-HSL card. Applications for this card type are SS7ANSI or CCS7ITU

***mcpm***

E5-MCPM-B card used as a Measurement Collection and Polling Module (MCPM) card for the Measurements Platform feature. The application for this card type is MCP.

***slic***

SLIC card to support Service Module Applications and IP Signaling Gateway. The application for this card type are IPSPG (with or without GTT functionality), VSCCP, DEIRHC, SIPHC, ENUMHC, or SFAPP.

**stc**

E5-ENET-B or SLIC card used as a Signaling Transport Card (STC or E5-STC) for the EAGLE 5 Integrated Monitoring Support feature. The application for this card type is EROUTE.

**telco**

TELCO switch to add power consumed by Telco Switch to Frame Power Budget.

**tsm**

E5-TSM card used for Gateway Screening. The application for this card type is GLS.

**data (optional)**

The type of OAM/MPS data that can be loaded on an E5-SM8G-B or a SLIC card.

**Range:****dn**

only DN related data from EPAP is loaded on the card

**elap**

ELAP data are loaded on the card

**epap**

all RTDB data (DN + IMSI) from EPAP are loaded on the card

**Note:**

The *epap* value cannot be specified when the EPAP Data Split feature is ON.

**gtt**

only OAM data are loaded on the card. The card will not load any ELAP or EPAP data at all.

**imsi**

only IMSI related data from EPAP is loaded on the card

**nosccp**

only OAM data, excluding GTT data is loaded on the card. No GTT or MPS data will be downloaded on the card. This value (=nosccp) of the *data* parameter is valid only for IPSP card(s) with the *type=slic*.

**Note:**

The *nosccp* value signifies the absence of SCCP functionality on the IPSP card, and that it behaves as a regular IPSP card.

**Default:**

*nosccp*

**force (optional)**

If the `force=yes` parameter is used to add a LIM card to the database, it is recommended that you add the required number of Service Module cards to the database after the LIM card is added to avoid the loss of global title translation (GTT) traffic.

**Range:**

*no*

*yes*

**Default:**

*yes*

**sflog (optional)**

The `sflog=yes` parameter is used to configure a logging IPS card for logs collection.

**Range:**

*no*

*yes*

**Default:**

*no*

**srvname (optional)**

The name/identifier of the server/host running on E5-APP-B cards and Telco Switches.

**Range:**

YYYYYYYYYYYYYYYY

**Example**

```
ent-card:loc=1206:type=limatm:appl=atmansi:force=yes
ent-card:loc=1208:type=limatm:appl=atmansi:force=no
ent-card:loc=1105:type=enet:appl=ipsg
ent-card:loc=1201:type=dsm:appl=vsccp:data=dn
ent-card:loc=1101:type=e5appb:appl=epap:srvname=tklcepap:force=yes
ent-card:loc=1103:type=e5appb:appl=elap:srvname=tklcelap
ent-card:loc=6201:type=telco:appl=switch:srvname=telcol
ent-card:loc=1101:type=dsm:appl=siphc=data=dn
ent-card:loc=1101:type=dsm:appl=vsccp:data=elap
ent-card:loc=1104:type=dsm:appl=deirhc
ent-card:loc=1101:type=dsm:appl=enumhc
ent-card:loc=1111:type=ipsm:appl=ips:sflog=yes
ent-card:loc=1103:type=slic:appl=ipsg
ent-card:loc=1105:type=slic:appl=vsccp //odd slot
ent-card:loc=1106:type=slic:appl=vsccp //even slot
```

```
ent-card:loc=1108:type=slic:appl=sfapp
```

## Dependencies



### Note:

The LNP feature is "turned on" when an LNP ported TNs quantity is shown in the `rtrv-ctrl-feat` command output.

For features that are enabled with the `enable-ctrl-feat` command, use the `rtrv-ctrl-feat` command to verify whether a feature is enabled or turned on. For features that are turned on with the `chg-feat` command, use the `rtrv-feat` command to display the ON or OFF status of the features.

[Table A-7](#) shows the card names, the only valid card type (`type` parameter) and application (`appl` parameter) combinations, the card part numbers, and the maximum number of cards allowed in the database.

The card location must not be 1113-1118, xy09 or xy10 where *x* is the frame and *y* is the shelf.

The specified shelf location must be provisioned and present in the frame.

The specified card location cannot already be provisioned in the database.

The DSM card must be inserted into an odd-numbered location. The *n*+1 slot next to the DSM card must be empty, where *n* is the odd-numbered location (for example, if the DSM card is in location 1101, then the 1102 slot must be empty and unprovisioned).

The Measurements Platform feature must be turned on before the command can be entered for an MCPM card (`type=mcpm:appl=mcp`).

A valid value must be specified for the `appl` parameter.

The Shelf table is corrupt or cannot be found.

The IMT (Card) table is corrupt or cannot be found.

A card that is in an active maintenance state cannot be provisioned with this command. A card must be in the Out-of Service-Memory Administration (OOS-MA) state before it can be provisioned.

The *n*+1 slot next to the DSM card must be empty, where *n* is the odd-numbered location (for example, if the DSM card is in location 1101, then the 1102 slot must be empty and unprovisioned).

The GTT feature must be turned on to specify the `appl=vsccp` parameter.

The GWS feature must be turned on to specify the `appl=glis` parameter.

The LAN feature must be turned on to specify the `appl=stplan` parameter.

A valid card type must be specified. See the description for the `type` parameter for a list of valid values.

[Table A-7](#) lists the maximum number of cards of each card type and application that are allowed in the system.

The MAS Configuration table is corrupt or cannot be found.

All provisioned shelves must contain HIPR cards before more than 115 LIM-ATM cards can be provisioned.

If ELAP or EPAP is specified for the `data` parameter for VSCCP, then the Dual ExAP Config feature must be enabled.

When `data=gtt` is specified for VSCCP, either the Dual ExAP Config feature must be enabled or the EPAP Data Split feature must be turned ON.

If DN or IMSI is specified for the `data` parameter for VSCCP, the EPAP Data Split feature must be turned on.

If the EPAP Data Split feature is turned on or the Dual ExAP Config feature is enabled, and the value specified for the `loc` parameter indicates an E5-SM8G-B or SLIC card, then the `data` parameter must be specified. The `data` parameter can be specified only for an E5-SM8G-B or SLIC card running the VSCCP or SIPHC application on an IPSCP card.

**Note:**

The `data` parameter is valid only for SLIC IPSP cards, and not ENET/ENET-B IPSP cards.

The Diameter S13/S13' Interface for EIR feature must be enabled before the `type=dsm` and `appl=deirhc` parameters can be specified.

The `data` parameter is not allowed with the DEIRHC GPL.

The parameter `sflog=yes` can be specified only when the `type=ipsm` and `appl=ips` parameters are specified.

A maximum of 32 EPAP based cards can be provisioned with `type=dsm` and `data=EPAP/DN/IMSI`.

A maximum of 2 SFLOG cards can be provisioned.

The SIPNP feature must be enabled before the `type=dsm` and `appl=siphc` parameters can be specified.

The `DATA` parameter can only be equal to EPAP/ELAP when `type=dsm` and `appl=siphc` parameters are specified.

If the IPSP32 GPL is running on the location specified by the `loc` parameter, then `data=gtt` and `data=nosccp` are the only valid values for the `DATA` parameter. If the GPL is anything but IPSP32 GPL, `data=nosccp` cannot be used for the card on that location.

The `srvname` parameter must be specified for an E5-APP-B card and Telco Switch.

The `srvname` must be unique for each E5-APP-B card and Telco Switch to be provisioned in the system.

Unless the `force` parameter is specified, two E5-APP-B cards running the same application cannot be provisioned in slots drawing power from the same FAP power source. EAGLE shelf card slots XXX1, XXX2, XXX5, and XXX6 draw power from the A designation FAP power source. Cards XXX3, XXX4, XXX7, and XXX8 draw power from the B designation FAP power source.



The `srvname` parameter can only be used with E5-APP-B card or Telco Switch.

Telco switch can only be provisioned in a shelf with type equal to FPB.

E5-APP-B card and Telco switch cannot be provisioned in the same shelf. They are mutually exclusive.

A maximum of 6 Telco switches can be provisioned in a shelf.

E5-ENET-B, SLIC, and E5-APP-B cards can be provisioned if the shelf FAN bit is turned ON.

When re-entering the command for the provisioning of the 26<sup>th</sup> Service Module card, the re-entered command must specify `type=dsm` and the same `loc` value as the original command. See "Service Module Cards" under [Notes](#) for more information.

The `data` parameter can only be specified for IPSPG application running on SLIC card.

## Notes

### ITU Environment

The `force` parameter can be specified to add the card even if its addition would exceed the SCCP TPS threshold. If the `force=yes` parameter is specified, the command is accepted but the following warning message appears:

```
WARNING: System current rated TPS unable to support additional SS7  
card = use FORCE=YES.
```

If the `force=yes` parameter is specified, it is recommended that the required number of Service Module cards be added to the database after the LIM card is added. This action avoids the loss of GTT traffic. Another option is to add additional Service Module cards or to increase the SCCP TPS threshold, and then add the LIM card. This action prevents the alarm from being triggered.

For additional information on using the `force` parameter, see Chapter 4, "System Administration Procedures" of *Database Administration - System Management User's Guide*.

### STC Cards

STC cards are E5-ENET-B cards that run the EROUTE application. E5-ENET-B cards provisioned with `type=stc` can be referred to as E5-STC cards.

The `type=stc` and `appl=eroute` parameters apply only when the EAGLE 5 Integrated Monitoring Support (E5IS) feature is turned on.

An "n+1" STC configuration is required to provide redundancy: therefore, a minimum of two STC cards must be provisioned in the EAGLE.

The EAGLE can contain a maximum of 32 STC cards.

The STC cards must be provisioned in the same shelf that contains the cards or links being monitored.

## Cards Running the STPLAN Application

E5-ENET-B cards can be provisioned to run the STPLAN application. E5-ENET-B cards running the STPLAN application can be referred to as E5-SLAN cards.

An "n+1" STP LAN configuration is required to provide redundancy: therefore, a minimum of two E5-SLAN cards must be provisioned in the EAGLE. A minimum of 2 E5-SLAN cards must be provisioned in the EAGLE for "n+1" redundancy purposes.

The cards used to run the STPLAN application (E5-SLAN cards) must be provisioned in the same shelf that contains the cards or links being monitored.

## E5-SM8G-B/SLIC Cards

If an LNP feature quantity that is greater than 192 million numbers and less than 240 million numbers is present in a node, and there is an attempt to insert an E5-SM8G-B or SLIC card, then the card auto-inhibits (see the `alw-card` command).

## IPSM Cards

IPSM cards consist of E5-IPSM and E5-ENET-B cards.

A maximum of three IPSM cards are supported for a single EAGLE node, on any shelf or combination of shelves.

Apart from these, two more cards with application type IPS can be configured on E5-ENET-B cards for the SS7 Firewall Logging feature.

## IPSG Cards

IPSG cards consist of E5-ENET-B, or SLIC cards running the IP Signaling Gateway application (`type=enet`, `enetb` or `slic`, and `appl=ipsg`). The IPSG application combines the functionality of IPLIMx M2PA and IPGWx M3UA. They can also have GTT-enabled capabilities support with SLIC running the 64-bit IPSG GPL.

If an E5-ENET-B card is inserted in a slot provisioned for SLIC, then the E5-ENET-B card will be auto-inhibited and issue a degraded mode alarm.

## E5-ATM-B Cards

E5-ATM-B cards support ANSI and ITU implementations. The cards can support 3 ATM signaling links, operating at 1 Erlang.

## IP Signaling Capacity Guidelines

System limits on the total number of cards allowed in the system are not enforced by the `ent-card` command. If the HIPR2 High Rate Mode feature is turned off, then the total IP Signaling TPS for the system must be less than or equal to 500,000 TPS. If the HIPR2 High Rate Mode feature is turned on, then the total IP Signaling TPS for the system must be less than or equal to 750,000 TPS. If the HIPR2 High Rate Mode and 1M System TPS features are turned on, then the total IP Signaling TPS for the system must be less than or equal to 1,000,000 TPS.

## E5-TSM Cards

A maximum of eight E5-TSM cards are supported for a single EAGLE node, on any shelf or combination of shelves, to support the GLS application for Gateway Screening.

## Fast Copy Cards

E5-ENET-B, or SLIC cards running the IPSP or IPGHC GPL are considered to be *FC-capable*. A card running the IPGHC GPL must be in the IS-NR State before the card can be considered *FC-capable*. This restriction does not apply to cards running the IPSP GPL. An *FC-capable* card is considered *FC-enabled* when Fast Copy monitoring is enabled for the respective GPL.

### Service Module Cards

Service Module cards consist of E5-SM8G-B or SLIC cards.

If the `ent-card` command is issued while an EPAP-based feature is enabled, then a warning is issued only for the provisioning of the 26th Service Module card. The command must be re-entered within 30 seconds to be accepted. If the command is entered a second time with `type=dsm` and a different `loc` specified, the command will be rejected.

For Service Module applications (VSCCP, ENUMHC, SIPHC, DEIRHC), the `ent-card` command can be used to provision E5-SM4G and E5-SM8G-B cards only in even numbered slots and the next odd numbered slot has to be empty since these cards are dual slots. There is no such restriction with SLIC cards since it is a single slot card, as in, these applications can be provisioned either in even numbered slot or odd numbered slot.

### E5-E1T1-B Cards

E5-T1T1-B cards support ANSI and ITU implementations and can be used to replace the cards.

Each E5-E1T1-B card provides access to eight E1/T1 ports. Each card supports up to two SE-HSL signaling links on one of the eight ports (links A or B).

### EPM and EPM-B Based Cards

Release 44.0 introduces the E5-ATM-B, E5-ENET-B, and E5-MCPM-B cards and Release 45.0 introduces the E5-E1T1-B card, which are all based on a new EPM-B. If the Message Flow Control option is provisioned (see the [chg-stpopts](#) command), and fan trays are installed, then the EPM-B cards can co-exist and be hot-swapped with the EPM cards. The E5-ENET-B and SLIC card running the IPS application and the E5-MCPM-B card do not require Message Flow Control, except for cards configured as SFLOG.

### Service and Link Interface Cards

Release 46.3 introduced the EAGLE's Service and Link Interface Card (SLIC). These cards are the next generation, general purpose EAGLE processors and can be installed in any EAGLE shelf equipped with fan trays. In Release 46.3 the SLIC card supports the IPSP application and is hot-swappable with E5-ENET-B cards. In Release 46.5, the SLIC card supports VSCCP, SIPHC, ENUMHC, DEIRHC, CCS7ITU and SS7ANSI applications.

### MCPM Cards

E5-MCPM-B cards are the MCPM cards. These cards are used to perform Measurements collection and reporting functionality for nodes with a link capacity greater than 2,400 (1,200 if 15 Minute Measurements is enabled). E5-OAM Integrated Measurements is used for nodes with a link capacity of 2400/1200 or less.

### E5-APP-B Cards

E5-APP-B cards support the ELAP, EPAP, IMF, LSMS and NAS applications. E5-APP-B card is dual-slot card. These cards host the EPAP, ELAP, IMF, LSMS and NAS application servers that can be placed in any odd numbered slot in any EAGLE shelf. These cards do not connect to the IMT bus. The ENT-CARD command only reserves a slot in an EAGLE shelf for this card. An E5-APP-B card cannot be provisioned if there is another E5-APP-B card already on the same source of power unless the force parameter is specified.

### TELCO Switches

Telco Switches are not application cards. The support of Telco Switches is added in the ENT-CARD command to reserve a slot in an Eagle shelf (type=FPB) and add the power consumed by Telco Switch to the Frame Power Budget. These switches will not be connected to the IMT bus. Telco Switch and E5-APP-B cards will be mutually exclusive for a shelf. There can be a maximum of 6 Telco Switches in a shelf.

### Output

```
ent-card:loc=1206:type=lime1:appl=ss7ansi

      rlghncxa03w 06-06-01 11:11:28 EST  EAGLE 35.0.0
      ENT-CARD: MASP A - COMPLTD
;
```

```
ent-card:loc=1101:type=dsm:appl=siphc

tekelecstp 12-07-27 10:24:14 EST EAGLE 45.0.0
ent-card:loc=1101:type=dsm:appl=siphc
Command entered at terminal #4.
ENT-CARD: MASP A - COMPLTD
;
```

This example shows the output when the `ent-card` command is not re-issued within 30 seconds for the provisioning of 26th SCCP card when any EPAP based feature is enabled.

```
ent-card:type=dsm:appl=vsccp:loc=1306

      tekelecstp 10-02-27 23:06:21 EST  EAGLE 42.0.0
      ent-card:type=dsm:appl=vsccp:loc=1306
      Command entered at terminal #1.
;
```

CAUTION: Please ensure EPAP Application Server is running on hardware supporting 32 SCCP cards e.g.: T1200.  
Re-enter command within 30 seconds to confirm change.

```
      tekelecstp 10-02-27 23:06:21 EST  EAGLE 42.0.0
      ENT-CARD: MASP B - Command Aborted

> Command is not re-entered within 30 seconds.

      ENT-CARD command (Type=DSM) confirmation timer expired
```

This example shows the output when the `ent-card` command is re-issued within 30 seconds for the provisioning of 26th SCCP card when any EPAP based feature is enabled.

```
ent-card:type=dsm:appl=vsccp:loc=1306
```

```
tekelecstp 10-02-27 23:07:16 EST EAGLE 42.0.0
ent-card:type=dsm:appl=vsccp:loc=1306
Command entered at terminal #1.
```

```
;
```

```
CAUTION: Please ensure EPAP Application Server is running on
hardware supporting 32 SCCP cards e.g.:
T1200.
```

```
Re-enter command within 30 seconds to confirm change.
```

```
tekelecstp 10-02-27 23:07:16 EST EAGLE 42.0.0
ENT-CARD: MASP B - Command Aborted
```

```
> ent-card command is re-issued within 30 seconds.
```

```
> ent-card:type=dsm:appl=vsccp:loc=1306
```

```
Command Accepted - Processing
```

```
tekelecstp 10-02-27 23:07:28 EST EAGLE 42.0.0
ent-card:type=dsm:appl=vsccp:loc=1306
Command entered at terminal #1.
```

```
;
```

```
tekelecstp 10-02-27 23:07:28 EST EAGLE 42.0.0
ENT-CARD: MASP B - COMPLTD
```

```
;
```

This example shows the output when the `ent-card` command is issued for the provisioning of any additional (>26 and <=32) SCCP card when any EPAP based feature is enabled.

```
ent-card:type=dsm:appl=vsccp:loc=1307
```

```
tekelecstp 10-02-27 23:11:18 EST EAGLE 42.0.0
ent-card:type=dsm:appl=vsccp:loc=1307
Command entered at terminal #1.
```

```
;
```

```
tekelecstp 10-02-27 23:11:18 EST EAGLE 42.0.0
ENT-CARD: MASP B - COMPLTD
```

```
;
```

```
ent-card:loc=1105:type=e5appb:appl=epap:srvname=tklcepap1
```

```
tekelecstp 12-07-13 11:42:29 EST 45.0.0-64.37.0
ent-card:loc=1105:type=e5appb:appl=epap:srvname=tklcepap1
Command entered at terminal #4.
ENT-CARD: MASP A - COMPLTD
;
```

```
ent-card:loc=1103:type=e5appb:appl=elap:srvname=tklcelap1
```

```
tekelecstp 12-07-13 11:42:55 EST 45.0.0-64.37.0
ent-card:loc=1103:type=e5appb:appl=elap:srvname=tklcelap1
Command entered at terminal #4.
ENT-CARD: MASP A - COMPLTD
```

```
ent-card:loc=1101:type=e5appb:appl=epap:srvname=tklcepap2
```

```
tekelecstp 12-07-13 11:43:29 EST 45.0.0-64.37.0
ent-card:loc=1101:type=e5appb:appl=epap:srvname=tklcepap2
Command entered at terminal #4.
Command Rejected: E2667 - Same Power source of E5APPB cards running same
application

ENT-CARD: MASP A - Command Aborted
```

This example shows the output when the ent-card command is issued for provisioning the 1st TELCO Switch in a shelf.

```
ent-card:loc=6201:type=telco:appl=switch:srvname=telcol
tekelecstp 12-09-06 10:58:45 EST 45.0.0
ent-card:loc=6201:type=telco:appl=switch:srvname=telcol
Command entered at terminal #4.
```

WARNING: Minimum two TELCO Switches are needed per shelf.

```
ENT-CARD: MASP A - COMPLTD.
;
```

This example shows the output when the ent-card command is issued for the provisioning the 7th TELCO Switch in a shelf.

```
ent-card:lock=6211:type=telco:appl=switch:srvname=telcol1
```

```
tekelecstp 12-09-06 11:01:50 EST 45.0.0
ent-card:loc=6211:type=telco:appl=switch:srvname=telcol1
Command entered at terminal #4.
Command Rejected: E2678 - Maximum 6 TELCO Switches can be provisioned in a
```

```
shelf

ENT-CARD: MASP A - Command Aborted

ent-card:loc=1101:type=dsm:appl=siphc

tekelecstp 12-07-27 10:24:47 EST EAGLE 45.0.0
  ent-card:loc=1101:type=dsm:appl=siphc
  Command entered at terminal #4.
  ENT-CARD: MASP A - COMPLTD
;
```

This example shows the output to configure an E5-SM8G-B or SLIC card running the DEIRHC GPL.

```
ent-card:loc=1103:type=dsm:appl=deirhc

tekelecstp 13-04-5 10:24:47 EST EAGLE 45.1
  ent-card:loc=1103:type=dsm:appl=deirhc
  Command entered at terminal #4.
  ENT-CARD: MASP A - COMPLTD
;
```

This example shows the output to configure a logging card running the IPSHC GPL.

```
ent-card:loc=1111:type=ipsm:appl=ips:sflog=yes

tekelecstp 15-05-27 14:56:16 EST Eagle 46.3.0
  ent-card:loc=1111:type=ipsm:appl=ips:sflog=yes
  Command entered at terminal #4.
  ENT-CARD: MASP A - COMPLTD
;
```

This example shows the output to configure a SLIC card running the IPSTG GPL.

```
ent-card:loc=1101:type=slic:appl=ipstg

Command Accepted - Processing

tekelecstp 17-04-20 14:28:49 EST EAGLE 46.6.0.0.0-71.1.1.0
  ent-card:loc=1101:type=slic:appl=ipstg
  Command entered at terminal #1.
;
```

```
tekelecstp 17-04-20 14:28:49 EST EAGLE 46.6.0.0.0-71.1.1.0
  ENT-CARD: MASP A - Cannot access standby fixed disk.
  ENT-CARD: MASP A - Simplex database update.
  ENT-CARD: MASP A - COMPLTD
;
```

This example shows the output when DATA parameter is specified with an ENETB card running the IPSTG appl:

```
ent-card:loc=1101:type=enetb:appl=ipsg:data=gtt

tekelecstp 17-05-22 11:20:29 EST EAGLE 46.6
  ent-card:loc=1101:type=enetb:appl=ipsg:data=gtt
  Command entered at terminal #4.
Command Rejected: E3540 - DATA parm can be entered specified for IPSG appl
running on SLIC card only.

ENT-CARD: MASP A - Command Aborted
```

This example shows the output to configure a SLIC card running the SCCPHC GPL.

```
ent-card:loc=1105:type=slic:appl=vsccp

Command Accepted - Processing

  e9021503 18-03-22 12:47:26 EST EAGLE 46.5.1.0.0-70.40.0
  ent-card:loc=1105:type=slic:appl=vsccp
  Command entered at terminal #2.
;

  e9021503 18-03-22 12:47:27 EST EAGLE 46.5.1.0.0-70.40.0
*C 8446.0331 *C SCCP SYSTEM          SCCP is not available
;

  e9021503 18-03-22 12:47:27 EST EAGLE 46.5.1.0.0-70.40.0
ENT-CARD: MASP B - COMPLTD
```

This example shows the output to configure a SLIC card running the SFAPP GPL:

```
ent-card:loc=1108:type=slic:appl=sfapp

tekelecstp 17-11-13 04:40:52 EST EAGLE 46.5.1.5.0-73.2.0
  ent-card:loc=1108:type=slic:appl=sfapp
  Command entered at terminal #17.
;

Command Accepted - Processing
  tekelecstp 17-11-13 04:40:52 EST EAGLE 46.5.1.5.0-73.2.0
  ENT-CARD: MASP A - COMPLTD
;

Command Executed
```

### Related Topics

- [chg-card](#)
- [dlt-card](#)
- [init-card](#)
- [rept-stat-card](#)
- [rmv-card](#)
- [rtrv-card](#)



## ent-csl

Use this command to enter new screening data into the Common Screening List (CSL). The Common Screening List commands are used to tailor certain types of general screening information to specific features.

### Parameters

#### **ds (optional)**

Digit string. A unique string of digits that is used by the specified screening feature.

#### **Range:**

1-15 hexadecimal digits.

Valid digits are 0-9, a-f, A-F.

- 1-6 digits—Prepaid IDP Query Relay *ccnc* list
- 1-15 digits—Prepaid IDP Query Relay *gt* list
- 1-10 digits—Prepaid IDP Query Relay *skbcsm* list
- 4 digits—IDP Screening for Prepaid *skts* list
- 1-15 digits—IDP Screening for Prepaid *insl* list
- 1-15 digits—VFLEX *vmpfx* list
- 1-6 digits—Info Analyzed Relay Base *ccnc* list
- 1-15 digits—Info Analyzed Relay Base *gt* list
- 2 digits—Info Analyzed Relay Base *trig* list
- 1-15 digits — EIR *imsipfx* list

**Table 4-23** lists valid hexadecimal values for the Info Analyzed Relay Base *trig* list *ds* entries.

#### **feature (optional)**

Feature name. The name of the enabled feature for which the command is entered.



#### **Note:**

The `pn` or `feature` parameter must be specified to identify the feature.

#### **Range:**

*ayyyyyyyyyyyyyyyyyyyyyyyyyyy*

1 alphabetic character followed by up to 24 optional alphanumeric characters, including spaces and special characters, enclosed in double quotation marks (" ").

- EIR
- IDP Screening for Prepaid
- IDP Service Key Routing

- Info Analyzed Relay Base
- Prepaid IDP Query Relay
- VFLEX

**list (optional)**

The name of the Common Screening List associated with the feature.

**Note:**

This parameter must be specified when the feature uses more than one type of Common Screening List.

**Range:*****ccnc***

CC+NC List

***delpfx***

Delete Prefix List

***gt***

Global Title List

***imsipfx***

IMSI Screening Prefix List

***insl***

In Network Subscriber List

***npbypass***

SIP NPBYPASS List

***skbcm***

SK+BCSM List

***skts***

SK+TS List

***trig***

Trigger List

***vmpfx***

Voice Mail Prefix List

***opcdpc***

OPC + DPC List

The following screening lists are valid for the indicated features:

- *ccnc*, *gt*—Prepaid IDP Query Relay and Info Analyzed Relay Base
- *imsipfx* ---EIR

 **Note:**

If the list argument is not specified in this command, then `list=imsipfx` by default is taken.

- *skbcm*—Prepaid IDP Query Relay and IDP Service Key Routing
- *skts*, *insl*—IDP Screening for Prepaid
- *trig*—Info Analyzed Relay Base
- *vmprfx*—VFLEX
- *opcdpc*—Prepaid IDP Query Relay

The *delprfx* list is not supported at this time. This list should only be used by Oracle personnel.

**dpci/dpcn/dpcn24/dpcn16 (optional)**

Destination point code.

**dpci(optional)**

ITU international destination point code with subfields *zone-area-id*. The *prefix* subfield indicates a spare point code (*prefix-zone-area-id*).

**Range:**

*s-*, 0-255

Specify a valid value for each subfield of the point code, and separate the subfields with a dash (-).

*prefix-s*

*zone-0-7*

*area-000-255*

*id-0-7*

The point code *0-000-0* is not a valid point code.

**dpcn(optional)**

ITU national destination point code in the format of a 5-digit number (*nnnnn*); or 2, 3, or 4 numbers (members) separated by dashes (*m1-m2-m3-m4*) as defined by the `chg-stpopts:npcfmti` flexible point code option. A group code must be specified when the ITUDUPPC feature is turned on (*nnnnn-gc,m1-m2-m3-m4-gc*). The *prefix* subfield indicates a spare point code (*prefix-nnnnn*, *prefix-nnnnn-gc*, *prefix-m1-m2-m3-m4*, *prefix-m1-m2-m3-m4-gc*).

**Range:**

*s-*, 0-16383, *aa-zz*

Specify a valid value for each subfield of the point code, and separate the subfields with a dash (-).

*prefix-s-*

*nnnnn-0-16383*

*gc-aa-zz*

*m1-m2-m3-m4-0-14* for each member; values must sum to 14

**dpcn24(optional)**

24-bit ITU national destination point code with subfields *main signaling area-sub signaling area-signaling point (msa-ssa-sp)*.

**Range:**

000 - 255

Specify a valid value for each subfield of the point code, and separate the subfields with a dash (-).

*msa-000-255*

*ssa-000-255*

*sp-000-255*

**dpcn16(optional)**

16-bit ITU national point code with subfields *unit number sub number area main number area (un-sna-mna)*.

**Range:**

000 - 127

Specify a valid value for each subfield of the point code, and separate the subfields with a dash (-).

*un---000---127*

*sna---000---15*

*mna---000---31*

**opci/opcn/opcn24/opcn16 (optional)**

Originating point code.

**opci(optional)**

ITU international destination point code with subfields *zone-area-id*. The *prefix* subfield indicates a spare point code (*prefix-zone-area-id*).

**Range:**

*s-, 0-255*

Specify a valid value for each subfield of the point code, and separate the subfields with a dash (-).

*prefix-s*

*zone-0-7*

*area-000-255*

*id-0-7*

The point code *0-000-0* is not a valid point code.

**opcn(optional)**

New ITU national originating point code in the format of a 5-digit number (*nnnnn*); or 2, 3, or 4 numbers (members) separated by dashes (*m1-m2-m3-m4*) as defined by the *chg-sptopts:npcfnti* flexible point code option. A group code must be specified when the ITUDUPPC feature is turned on (*nnnnn-gc, m1-m2-m3-m4-gc*). The *prefix* subfield indicates a spare point code (*prefix-nnnnn, prefix-nnnnn-gc, prefix-m1-m2-m3-m4, prefix-m1-m2-m3-m4-gc*).

**Range:**

*s-, 0-16383, aa-zz*

Specify a valid value for each subfield of the point code, and separate the subfields with a dash (-).

*prefix-s-  
nnnnn-0-16383  
gc-aa-zz*

*m1-m2-m3-m4-0-14* for each member; values must sum to 14.

**opc24(optional)**

24-bit ITU national originating point code with subfields *main signaling area-sub signaling area-signaling point (msa-ssa-sp)*.

**Range:**

*000 - 255*

Specify a valid value for each subfield of the point code, and separate the subfields with a dash (-).

*msa-000-255  
ssa-000-255  
sp-000-255*

**opc16(optional)**

**opc24(optional)**

16-bit ITU national point code with subfields *unit number sub number area main number area (un-sna-mna)*.

**Range:**

*000 - 127*

Specify a valid value for each subfield of the point code, and separate the subfields with a dash (-).

*un---000---127  
sna---000---15  
mna---000---31*

**Range:**

*000 - 255*

Specify a valid value for each subfield of the point code, and separate the subfields with a dash (-).

*msa-000-255  
ssa-000-255  
sp-000-255*

**p1 (optional)**

Parameter Value 1. This parameter is specific to the feature and list that use the parameter.

**Range:**

*zzzzzzzzzz*

Valid values for the IDP Service Key Routing feature are:

- 3 or *prepaid1*—Prepaid Portability Type 3 for the SKBCSM list
- 4 or *prepaid2*—Prepaid Portability Type 4 for the SKBCSM list

- 6-35 or *prepaid3-prepaid32*—Prepaid Portability Types 6 through 35 for the SKBCSM list
- 255 or *prepaidno*—No Prepaid Portability Type for the SKBCSM list

Valid values for the EIR feature are:

- 1 or *range* - Check only Range IMEI Table for the IMSIPFX list
- 2 or *individual* - Check only Individual IMEI Table for the IMSIPFX list
- 3 or *both* - Check Individual IMEI Table then Range IMEI Table for the IMSIPFX list
- 4 or *none* - No check in either Individual or Range IMEI Table for the IMSIPFX list

Valid values for the Prepaid IDP Query Relay feature are:

- 0, 1—National or International for the DELPFX list, which is for Oracle personnel use ONLY.



#### Note:

The *p1* parameter is used by the IDP Service Key Routing feature or the EIR feature.

#### Default:

*prepaidno*

#### p2 (optional)

Parameter Value 2. The IDP Relay Service that is associated with an SKBCSM list DS entry. Multiple IDP Relay Services can be provisioned for use with NPP or Response Type for EIR feature that is associated with an *imsipfx* list DS Entry. This value can be entered as a number or as a mnemonic.

#### Range:

ZZZZZZZZZZ

Valid values for the Prepaid IDP Query Relay feature are:

- 1 or *idprcdpn* —IDPRCDPN Service for the SKBCSM list
- 2 or *idprcdpn2* —IDPRCDPN2 Service for the SKBCSM list
- 3 or *idprcdpn3* —IDPRCDPN3 Service for the SKBCSM list
- 4 or *idprcdpn4* —IDPRCDPN4 Service for the SKBCSM list

Valid values for the EIR feature are:

- 1 or *whitelist* - Response Type as Whitelist for *imsipfx* list.
- 2 or *graylist* - Response Type as Graylist for *imsipfx* list.
- 3 or *blacklist* - Response Type as Blacklist for *imsipfx* list.
- 4 or *unknown* - Response Type as Unknown for *imsipfx* list.



#### Note:

The *p2* parameter is used by the Prepaid IDP Query Relay feature or the EIR feature.

#### Default:

*idprcdpn*

**p3 (optional)**

Parameter 3. The parameter value is specific to the feature and list name that use this parameter. No feature currently uses this parameter.

**pc (optional)**

ANSI point code with subfields *network indicator-network cluster-network cluster member (ni-nc-ncm)*.

**Note:**

See [Point Code Formats and Conversion](#) for a detailed description of point code formats, rules for specification, and examples.

**Synonym:**

*pca*

**Range:**

*000-255*

Specify a valid value for each subfield of the point code, and separate the subfields with a dash (-).

When `chg-sid:pctype=ansi` is specified, *ni = 000* is not valid.

When `chg-sid:pctype=ansi` is specified, *nc = 000* is not valid if *ni = 001-005*.

When `chg-sid:pctype=ansi` is specified, *nc = 000* is valid if *ni = 006-255*.

The point code *000-000-000* is not a valid point code.

**pc/pca/pci/pcn/pcn24 (optional)**

Point code.

**pci (optional)**

ITU international point code with subfields *zone-area-id*.

**Range:**

*0-255*

Specify a valid value for each subfield of the point code, and separate the subfields with a dash (-).

*zone—0-7*

*area—000-255*

*id—0-7*

The point code *0-000-0* is not a valid point code.

**pcn (optional)**

ITU national destination point code in the format of a 5-digit number (*nnnnn*); or 2, 3, or 4 numbers (members) separated by dashes (*m1-m2-m3-m4*) as defined by the `chg-stpopts:npfmt` flexible point code option. A group code must be specified when the ITUDUPPC feature is turned on (*nnnnn-gc, m1-m2-m3-m4-gc*).

**Range:**

*s-, 0-16383, aa-zz*

Specify a valid value for each subfield of the point code, and separate the subfields with a dash (-).

*prefix—s-*

*nnnnn—0-16383*

*gc—aa-zz*  
*m1-m2-m3-m4—0-14* for each member; values must sum to 14

**pcn24 (optional)**

24-bit ITU national point code with subfields *main signaling area-sub signaling area-signaling point (msa-ssa-sp)*.

**Range:**

000-255

Specify a valid value for each subfield of the point code, and separate the subfields with a dash (-).

*msa—000–255*

*ssa—000–255*

*sp—000–255*

**pfxstrip (optional)**

This parameter in NPBYPASS list indicates whether matched prefix must be deleted or not.

**Range:**

*yes*

*no*

**Default:**

*no*

**pn (optional)**

Part number. The 9-digit "893xxxxxx" part number of the feature for which the command is entered. The `rtrv-ctrl-feat` command description shows the part number in the command output example.

**Note:**

The `pn` or `feature` parameter must be specified to identify the feature.

**Range:**

893000000 - 893999999

The first 3 digits are 893. Do not separate the digits with dashes or spaces. The following part numbers are valid for this command:

- 893012301---EIR
- 893015501—IDP Screening for Prepaid
- 893034201—Info Analyzed Relay Base
- 893016001—Prepaid IDP Query Relay
- 893016701—VFLEX

**scpgta (optional)**

Signaling Control Point (SCP) Global Title Address (GTA). The value used by the SKGTARTG Service Action in IDP Relay IDPRCDPN(X) Services to replace the SCCP CdPA GTA in the outgoing message.



**Range:**

1 - 21 hexadecimal digits. Valid digits are 0-9, a-f, A-F.

**Note:**

The `scpgta` parameter is used by the Prepaid IDP Query Relay feature.

**Default:**

none

**Example**

```
ent-csl:feature="Prepaid IDP Query Relay":list=ccnc:ds=123456
ent-csl:pn=893015001:list=insl:ds=123456789bcdEF
ent-csl:feature="Prepaid IDP Query
Relay":list=skbcm:ds=000000056:p2=idprcdpn2:scpgta=896589
ent-
csl:feature="EIR":list=imsipfx:ds=401134134:p1=range:p2=whitelis
t
ent-csl:pn=893016001:list=opcdpc:dpci=4-5-6
ent-csl:pn=893016001:list=opcdpc:dpci=4-5-6:opci=2-3-4
```

**Dependencies**

An enabled feature must be specified using either a valid part number (`pn` parameter) or feature name (`feature` parameter). The specified feature must use a Common Screening List.

The feature that is specified in the `feature` parameter must be enabled.

The `list` parameter must be specified for features that use more than one type of screening list.

The value specified for the `list` parameter must be valid for the specified screening feature.

The length of the digit string specified for the `ds` parameter must be valid for the screening feature and list type.

A valid `ds` parameter value is required for the specified feature and list type.

The following parameters are allowed with the indicated common screening list type:

- `list=gt` — `ds` parameter
- `list=ccnc` — `ds` parameter
- `list=imsipfx`—`ds` parameter
- `list=insl`—`ds` parameter
- `list=skbcm` — `ds` and `scpgta` parameters
- `list=skts` — `ds` parameter

- `list=trig` — `ds` parameter
- `list=vmpfx` — `ds` parameter

The leading digit pattern of the value specified for the `ds` parameter must be unique in the specified screening list for the indicated feature.

The Common Screening List table is corrupt or cannot be found.

Each list table is allowed to contain a maximum number of entries:

- IDP Screening for Prepaid
  - INSL —50 entries
  - SKTS—25 entries
- Prepaid IDP Query Relay
  - CCNC —20 entries
  - GT—500 entries
  - SKBCSM—150 entries
- VFLEX
  - VMPFX—100 entries
- Info Analyzed Relay Base
  - CCNC—20 entries
  - GT—500 entries
  - TRIG—150 entries
- EIR
  - IMSIPFX — 100000 entries

The `pc` or `ds` parameter must be specified in the command. The parameters cannot be specified together in the command.

The value specified for the feature parameter must be a valid feature name for a feature that uses a Common Screening List. The feature name must be specified as it appears in the `rtrv-ctrl-feat` command output. Enough of the name must be specified to make the name unique when two features begin with the same word or acronym.

The value specified for the `ds` parameter must be unique in the specified screening list for the indicated feature.

The `scpgta` and `pc` parameters cannot be specified together in the command.

If the `scpgta` parameter is specified, then the `ds` parameter must be specified.

A valid `p1` and `p2` parameter value is required for the specified feature and list type.

If list type `opcdpc` given, then `p1`, `p2`, `p3`, `ds`, `scpgta` and `pc` parameters cannot be specified.

For IDPR service, if list type `opcdpc` given, then `opc/dpc` parameter must be specified and the types for the OPC and DPC must match.

## Notes

[Table 4-23](#) lists the decimal values, the hexadecimal values, and the mnemonic for each TRIGTYPE code that can appear in the CSL TRIG list.

Table 4-23 TRIGTYPE Hexadecimal Codes

Hex	Decimal	Mnemonic	Hex	Decimal	Mnemonic
00	0	Unspecified	1A	26	Inter-LATA_ Toll_Call.
01	1	All_Calls.	1B	27	World_Zone_ Call.
02	2	Double_ Introducing _Star.	1C	28	International_ Call.
03	3	Single_ Introducing_ Star.	1D	29	Unrecognized _ Number.
04	4	Reserved	1E	30	Prior_ Agreement.
05	5	Double_ Introducing_ Pound.	1F	31	Specific_ Called_Party_ Digit_String
06	6	Single_ Introducing_ Pound.	20	32	Mobile_ Termination
07	7	Revertive_ Call.	21	33	Advanced_ Termination
08	8	0_Digit.	22	34	Location
09	9	1_Digit.	23	35	Locally_Allow ed _Specific_Digi t_String
0A	10	2_Digit.	24	36	Orgination_ Attempt_ Authorized.
0B	11	3_Digit.	25	37	Calling_ Routing_ Address _Available.
0C	12	4_Digit.	26	38	Initial_ Termination
0D	13	5_Digit.	27	39	Called_ Routing_ Address_ Available
0E	14	6_Digit.	29	40	O_Answer.
0F	15	7_Digit.	29	41	O_Disconnect .
10	16	8_Digit.	2A	42	O_Called_ Party_Busy.
11	17	9_Digit.	2B	43	O_No_Answer .

**Table 4-23 (Cont.) TRIGTYPE Hexadecimal Codes**

Hex	Decimal	Mnemonic	Hex	Decimal	Mnemonic
12	18	10_Digit.	40	64	Terminating_Resource_Available
13	19	11_Digit.	41	65	T_Busy.
14	20	12_Digit.	42	66	T_No_Answer
15	21	13_Digit.	43	67	T_No_Page_Response.
16	22	14_Digit.	44	68	T_Unroutable.
17	23	15_Digit.	45	69	T_Answer.
18	24	Local_Call.	46	70	T_Disconnect.
19	25	Intra-LATA_Toll_Call.			

**Output**

```
ent-csl:feature="VFLEX":list=vmpfx:ds=123456789abcdEF
```

```
tekelecstp 08-05-22 13:53:59 EST EAGLE 39.0.0
VM Prefix List table is (1 of 100) 1% full
ENT-CSL: MASP A - COMPLTD
```

```
;
```

```
ent-csl:pn=893040601:list=npbypass:ds=0000000012:pxstrip=yes
```

```
tekelecstp 12-06-25 15:29:14 EST EAGLE 45.0.0
ent-csl:pn=893040601:list=npbypass:ds=0000000012:pxstrip=yes
Command entered at terminal #4.
PFX List (2 of 1000) 1%
ENT-CSL: MASP A - COMPLTD
```

```
;
```

```
ent-
csl:feature="EIR":list=imsipfx:ds=4444444441:p1=range:p2=whitelist
```

```
tekelecstp 20-02-09 02:52:23 EST EAGLE 46.9.0.0.0
ent-csl:feature="eir":list=imsipfx:ds=4444444441:p1=range:p2=whitelist
Command entered at terminal #4.
PFX List ( 5 of 100000) 1%
ENT-CSL: MASP A - COMPLTD;
```

**Related Topics**

- [chg-csl](#)
- [dlt-csl](#)

- [rtrv-csl](#)
- [rtrv-ctrl-feat](#)

## ent-cspc

Use this command to add signaling points to a current broadcast signaling point code group. These point codes are notified of the receipt by the system of subsystem-prohibited (SSP) and subsystem-allowed (SSA) SS7 SCCP management messages from an application at an adjacent signaling point and subsystem. This command can also be used to add new groups to the table.

### Note:

The command must be entered first with the group only (no point code); then the command must be entered again with the group code and the point code.

### Parameters

### Note:

See [Point Code Formats and Conversion](#) in Appendix A for a detailed description of point code formats, rules for specification, and examples.

#### **grp (mandatory)**

Name of the group. This parameter is a character string associated with this broadcast list.

#### **Range:**

*ayyyyyyy*

1 alphabetic character followed by up to 7 alphanumeric characters

#### **pc (optional)**

ANSI point code with subfields *network indicator-network cluster-network cluster member (ni-nc-ncm)*.

#### **Synonym:**

*pca*

#### **Range:**

*000-255*

Specify a valid value for each subfield of the point code, and separate the subfields with a dash (-).

When *chg-sid:pctype=ansi* is specified, *ni = 000* is not valid.

When *chg-sid:pctype=ansi* is specified, *nc = 000* is not valid if *ni = 001–005*.

When *chg-sid:pctype=ansi* is specified, *nc = 000* is valid if *ni = 006–255*.

The point code *000-000-000* is not a valid point code.

#### **pc/pca/pci/pcn/pcn24/pcn16 (optional)**

Point code.

This parameter is mandatory when the group and point code are entered, after the group has been entered.

**pci (optional)**

ITU international point code with subfields *zone-area-id*. The *prefix* subfield indicates a spare point code (*prefix-zone-area-id*)

**Range:**

*s*-, 0-255

Specify a valid value for each subfield of the point code, and separate the subfields with a dash (-).

*prefix*—*s*

*zone*—0-7

*area*—000-255

*id*—0-7

The point code 0-000-0 is not a valid point code.

**pcn (optional)**

ITU national point code in the format of a 5-digit number (*nnnnn*); or 2, 3, or 4 numbers (members) separated by dashes (*m1-m2-m3-m4*) as defined by the `chg-stpopts:npcfmti` flexible point code option. A group code must be specified when the ITUDUPPC feature is turned on (*nnnnn-gc*, *m1-m2-m3-m4-gc*). The *prefix* subfield indicates a spare point code (*prefix-nnnnn*, *prefix-nnnnn-gc*, *prefix-m1-m2-m3-m4*, *prefix-m1-m2-m3-m4-gc*).

**Range:**

*s*-, 0-16383, *aa-zz*

Specify a valid value for each subfield of the point code, and separate the subfields with a dash (-).

*prefix*—*s*-

*nnnnn*—0-16383

*gc*—*aa-zz*

*m1-m2-m3-m4*—0-14 for each member; values must sum to 14

**pcn24 (optional)**

24-bit ITU national point code with subfields *main signaling area-sub signaling area-signaling point* (*msa-ssa-sp*).

**Range:**

*p*-, 000-255

Specify a valid value for each subfield of the point code, and separate the subfields with a dash (-).

*prefix*—*p*

*msa*—000-255

*ssa*—000-255

*sp*—000-255

**pcn16 (optional)**

16-bit ITU national point code with subfields *unit number sub number area main number area* (*un-sna-mna*). The *prefix* subfield indicates a private point code.

**Range:**

*p*-, 000-127

Specify a valid value for each subfield of the point code, and separate the subfields with a dash (-).

*prefix-p*

*un-000-127*

*sna-000-15*

*mna-000-31*

### Example

```
ent-cspc:grp=grp01:pc=144-201-001
ent-cspc:grp=group02:pcn24=10-100-10
ent-cspc:grp=grp01
ent-cspc:grp=grp01:pc=240-3-55
ent-cspc:grp=grp01:pci=7-233-5
ent-cspc:grp=grp01:pci=s-7-233-5
ent-cspc:grp=grp01:pcn24=234-56-245
ent-cspc:grp=grp01:pcn16=123-13-27
```

### Dependencies

Reserved words (for example, "none ") cannot be used to name a group.

The specified CSPC Broadcast group name must not exist if a point code is not specified. If the specified group name does not exist, and a point code is not specified, a new group is created.

The Spare Point Code Support feature must be enabled before the spare point code prefix s- can be specified for an ITU-I or ITU-N point code.

If the CSPC group name and a point code are specified, the group name must exist in the database.

The specified point code must exist in the Routing Table and cannot already exist in the specified group.

The destination point code must be a full point code (*ni-nc-ncm*).

The concerned signaling point code must have been specified previously as a full point code destination, or it must be a member of a previously specified cluster.

A maximum of 2550 Concerned Signaling Point Code Broadcast groups can be defined.

A maximum of 96 point codes can be defined for each group.

If the ANSI/ITU SCCP Conversion feature is not enabled, then the first point code to be entered defines the network type for the group. All subsequent point codes for the group must be for the same network type.

The ANSI/ITU SCCP Conversion feature must be enabled before the point codes in a group can be of different network types.

The point code must exist in the routing table.

A routeset and link that provides a path to the new CSPC must be configured before the `ent-cspc` command can be entered.

### Notes

To broadcast SSPs and SSAs to one or more mated applications, each mate's point code must be added to the CSPC group. Otherwise the broadcast is not sent to the mate.

In this command, only ITU-international and ITU national point codes support the spare point code subtype prefix ( `s-` ).

### Output

The command must be entered with just the `grp` parameter to define a new group in the database.

```
ent-cspc:grp=grp01

    rlgncxa03w 04-01-07 11:43:04 EST  EAGLE 31.3.0
    ENT-CSPC:  MASP A - COMPLTD
;
```

The command must specify an existing group and a point code to add the point code to the group.

```
ent-cspc:grp=grp01:pc=144-201-001

    rlgncxa03w 04-01-07 11:43:04 EST  EAGLE 31.3.0
    ENT-CSPC:  MASP A - COMPLTD
;
```

### Related Topics

- [dlt-cspc](#)
- [rtv-cspc](#)

## ent-dconn

Use this parameter to enter DEIR connection information. The DCONN table supports the provisioning information related to the Diameter connections.

### Parameters

#### **dcname (mandatory)**

Diameter connection name. This parameter specifies the unique logical name assigned to each diameter connection.



**Range:**

*aaaaaaaaaaaaaaaa*

A string of alphanumeric characters, beginning with a letter and up to 15 characters in length. Valid values are *a..z, A..Z, 0..9*.

**Default:**

No change to the current value

**System Default:**

*null*

**aname (mandatory)**

Association name linked with particular diameter connection.

**Range:**

*aaaaaaaaaaaaaaaa*

A string of alphanumeric characters, beginning with a letter and up to 15 characters in length. Valid values are *a..z, A..Z, 0..9*.

**Default:**

No change to the current value

**System Default:**

*null*

**maxtps (optional)**

Maximum TPS. This is the maximum TPS for a diameter connection. The unused card capacity will be allocated among the connections that have exceeded their RSVDTPS up to the limit of the MAXTPS value provisioned for the particular connection.

**Range:**

*100 - 8000*

**Default:**

No change to the current value

**System Default:**

*8000*

**rsvdtps (optional)**

Reserved TPS. This is the guaranteed TPS (Transactions per second) for a diameter connection. Total RSVDTPS on a card cannot exceed 8000.

**Range:**

*100 - 8000*

**Default:**

No change to the current value

**System Default:**

*250*

**td (optional)**

Diameter Peer Disconnect timer. This timer is used to control how long the S13 process will wait for a DPA (Disconnect Peer Answer) response before sending a DPR (Disconnect Peer Request). The value given to a timer is in seconds.

**Range:**

1 - 10

**Default:**

No change to the current value

**System Default:**

3

**tw (optional)**

Diameter Watchdog timer. This timer is used to control how long the S13 process will wait for a DWA (Diameter Watchdog Answer) response before sending a DWR (Diameter Watchdog Request). The value given to a timer is in seconds.

**Range:**

6 - 30

**Default:**

No change to the current value

**System Default:**

6

**Example**

```
ent-dconn:dcname=connection1:aname=assoc1:rsvdtps=1000
ent-dconn:dcname=connection2:aname=assoc2:rsvdtps=500:td=5:tw=10
ent-dconn:dcname=connection3:aname=assoc3:maxtps=5000:td=2
```

**Dependencies**

S13/S13' EIR feature must be enabled before entering any diameter connection.

DCONN table should be accessible.

A unique DCNAME must be specified for a new connection.

The adapter for the association linked to diameter connection on DEIR card must be of type DIAM.

ANAME must be present in IPAPSOCK table.

ANAME cannot be assigned to another diameter connection.

Any OPEN association cannot be assigned to a new diameter connection (the open parameter set to *yes/no* with the *chg-assoc* command).

RSVDTPS of all the diameter connections on a particular card must not exceed the MAXTPS.

RSVDTPS of a diameter connection must be less than or equal to MAXTPS.

## Notes

The `ent-assoc` command should be used to configure an association for the adapter type = DIAM prior to establishing any diameter connection.

Maximum of 32 connections can be provisioned per Diameter card and maximum of 16 diameter cards are allowed. So, maximum of 512 diameter connections can be provisioned.

## Output

```
ent-dconn:dcname=connection1:aname=assoc1:rsvdtps=1000
```

```
tekelecstp 13-03-20 15:04:28 EST EAGLE 45.1.0
ent-dconn:dcname=connection1:aname=assoc1:rsvdtps=1000
Command entered at terminal #4.
ENT-DCONN: MASP A - COMPLTD
;
```

```
ent-dconn:dcname=connection3:aname=assoc3:maxtps=5000:td=2
```

```
tekelecstp 12-06-25 15:04:28 EST EAGLE 45.1.0
ent-dconn:dcname=connection3:aname=assoc3:maxtps=5000:td=2
Command entered at terminal #4.
ENT-DCONN: MASP A - COMPLTD
;
```

## Related Topics

- [chg-dconn](#)
- [dlt-dconn](#)
- [rtrv-dconn](#)

# ent-dlk

Use this command to add a TCP/IP data link to the database. The TCP/IP data link is used to send copies of SS7 MSUs (selected by the gateway screening feature) to a remote host for further processing.

## Parameters

### **ipaddr** (mandatory)

The TCP/IP data link's IP address. This is a TCP/IP address expressed in standard dot notation. IP addresses consist of the system's network number and the machine's unique host number. An example IP address is `192.126.100.5`, where `192.126.100` is the network number and `5` is the machine's host number.

### **Range:**

**loc (mandatory)**

The card location as stenciled on the shelf of the system.

**Range:**

1101 - 1108, 1111 - 1112, 1201 - 1208, 1211 - 1218, 1301 - 1308, 1311 - 1318, 2101 - 2108, 2111 - 2118, 2201 - 2208, 2211 - 2218, 2301 - 2308, 2311 - 2318, 3101 - 3108, 3111 - 3118, 3201 - 3208, 3211 - 3218, 3301 - 3308, 3311 - 3318, 4101 - 4108, 4111 - 4118, 4201 - 4208, 4211 - 4218, 4301 - 4308, 4311 - 4318, 5101 - 5108, 5111 - 5118, 5201 - 5208, 5211 - 5218, 5301 - 5308, 5311 - 5318, 6101 - 6108, 6111 - 6118

**auto (optional)**

Automatic. This parameter specifies whether the hardware automatically determines duplex and speed.

 **Note:**

This parameter is valid only for E5-ENET-B cards (running the SLANHC GPL).

**Range:****yes**

Duplex and speed are automatically determined.

**no**

Duplex and speed are not automatically determined.

**Default:**

yes

**duplex (optional)**

The mode of operation of the interface

 **Note:**

This parameter is valid only for E5-ENET-B cards (running the SLANHC GPL).

**Range:****half**

The mode of operation of the interface is half duplex.

**full**

The mode of operation of the interface is full duplex.

**Default:**

half

**speed (optional)**

The bandwidth for the interface in megabits per second

**Range:****10****100****Default:****10****Example**

```
ent-dlk:loc=1201:ipaddr=196.3.202.45
ent-dlk:loc=1101:ipaddr=192.168.63.11:speed=10:duplex=half
ent-dlk:loc=1107:ipaddr=192.168.63.12:auto=yes
```

**Dependencies**

The shelf and card must be equipped.

The IP address (`ipaddr`) cannot be in the TCP/IP link table and cannot be a TCP/IP node.

The specified card cannot contain any data links.

The specified card's status must be out of service maintenance disabled (OOS-MT-DSBLD). Enter the `rept-stat-card` command to verify the state of the card.

The specified TCP/IP data link cannot be in the database.

The specified card must be running the STPLAN application.

The first octet of the IP Address cannot be 127. The 127 represents an IP address for loopback.

If the `auto=yes` parameter is specified, then the `speed` and `duplex` parameters cannot be specified.

The `speed` and `duplex` parameters must be specified together in the command.

If the `speed=100` parameter is specified, then an E5-ENET-B card (running the SLANHC GPL) must be used.

The IP address (`ipaddr`) cannot be in the TCP/IP link table and cannot be a TCP/IP router.

**Notes**

The value of the `ipaddr` parameter cannot match the TCP/IP default router's IP address (the `iprte` parameter of the `ent-ip-node` command).

**Output**

```
ent-dlk:loc=1201:ipaddr=196.3.202.45

tekelecstp 07-04-03 11:12:34 EST  EAGLE 37.0.0
ENT-DLK: MASP A - COMPLTD
;
```

The following example issues an error message because the first octet of the IP address is a loopback address. `ent-dlk:loc=1201:ipaddr=127.3.202.45`

```
rlghncxa03w 07-04-03 11:43:04 EST  EAGLE 37.0.0
Command Rejected : First octet of IPADDR cannot be 127.
ENT-DLK: MASP A - COMPLTD
;
```

### Related Topics

- [act-dlk](#)
- [canc-dlk](#)
- [dlt-dlk](#)
- [rept-stat-dlk](#)
- [rtrv-dlk](#)
- [tst-dlk](#)

## ent-dstn

Use this command to add a destination address (a destination point code, capability point code, or network cluster address) and the associated destination attributes to the destination point code table.

### Caution:

When using the Network Routing feature, limited network management is provided for point codes not covered by full point code routing, Cluster Routing, or Nested Cluster Routing.

### Parameters

#### Note:

See [Point Code Formats and Conversion](#) for a detailed description of point code formats, rules for specification, and examples.

#### **dpc/dpca/dpci/dpcn/dpcn24/dpcn16 (mandatory)**

Destination point code.

#### **dpc (optional)**

ANSI destination point code with subfields *network indicator-network cluster-network cluster member (ni-nc-ncm)*. The *prefix* subfield indicates a private point code (*prefix-ni-nc-ncm*).

#### **Synonym:**

*dpca*

**Range:***p*-, 000-255, \*

Specify a valid value for each subfield of the point code, and separate the subfields with a dash (-).

*prefix*—*p*-The asterisk value (\*) is not valid for the *ni* subfield.When *chg-sid:pctype=ansi* is specified, *ni = 000* is not valid.When *chg-sid:pctype=ansi* is specified, *nc = 000* is not valid if *ni = 001–005*.When *chg-sid:pctype=ansi* is specified, *nc = 000* is valid if *ni = 006–255*.The point code *000-000-000* is not a valid point code.**dpci (optional)**ITU international destination point code with subfields *zone-area-id*. The *prefix* subfield indicates a spare point code, private point code, or private and spare point code (*prefix-zone-area-id*).**Range:***s*-, *p*-, *ps*-, 0-255

Specify a valid value for each subfield of the point code, and separate the subfields with a dash (-).

*prefix*—*s*-, *p*-, *ps**zone*—0-7*area*—000-255*id*—0-7The point code *0-000-0* is not a valid point code.**dpcn (optional)**ITU national destination point code in the format of a 5-digit number (*nnnnn*); or 2, 3, or 4 numbers (members) separated by dashes (*m1-m2-m3-m4*) as defined by the *chg-stpopts:npcfmti* flexible point code option. A group code must be specified when the ITUDUPPC feature is turned on (*nnnnn-gc*, *m1-m2-m3-m4-gc*). The *prefix* subfield indicates a spare point code, private point code, or private and spare point code (*prefix-nnnnn*, *prefix-nnnnn-gc*, *prefix-m1-m2-m3-m4*, *prefix-m1-m2-m3-m4-gc*).**Range:***s*-, *p*-, *ps*-, 0-16383, *aa-zz*

Specify a valid value for each subfield of the point code, and separate the subfields with a dash (-).

*prefix*—*s*-, *p*-, *ps**nnnnn*—0-16383*gc*—*aa-zz**m1-m2-m3-m4*—0-14 for each member; values must sum to 14**dpcn24 (optional)**24-bit ITU national point code with subfields *main signaling area-sub signaling area-signaling point* (*msa-ssa-sp*). The *prefix* indicates a private point code (*prefix-msa-ssa-sp*).**Range:***p*-, 000-255

Specify a valid value for each subfield of the point code, and separate the subfields with a dash (-).

*prefix*—*p**msa*—000–255

ssa—000–255  
sp—000–255

**Default:**

No change to current value.

**dpcn16 (optional)**

16-bit ITU national point code with subfields *unit number sub number area main number area* (*un-sna-mna*). The *prefix* indicates a private point code (*prefix-un-sna-mna*).

**Range:**

*p*-, 000-127

Specify a valid value for each subfield of the point code, and separate the subfields with a dash (-).

*prefix-p*

*un-000-127*

*sna-000-15*

*mna-000-31*

**Default:**

No change to the current value.

**aliasa/aliasi/aliasn/aliasn24/aliasn16 (optional)**

Alias point code.

**aliasa (optional)**

ANSI alias point code with subfields *network indicator-network cluster-network cluster member* (*ni-nc-ncm*). This parameter is not valid if an ANSI (DPC or DPCA) point code is entered.

**Range:**

000-255

Specify a valid value for each subfield of the point code, and separate the subfields with a dash (-).

When *chg-sid:pctype=ansi* is specified, *ni = 000* is not valid.

When *chg-sid:pctype=ansi* is specified, *nc = 000* is not valid if *ni = 001–005*.

When *chg-sid:pctype=ansi* is specified, *nc = 000* is valid if *ni = 006–255*.

The point code *000-000-000* is not a valid point code.

**aliasi (optional)**

ITU international alias point code list with subfields *zone-area-id*. The *prefix* subfield indicates a spare point code (*prefix-zone-area-id*).

If an ITU international destination (DPCI) point code is entered, then the *dpci* and *aliasi prefix* subfields cannot be the same (both spare or both non-spare). Up to 2 comma-delimited entries can be entered in the point code list.

**Range:**

*s*-, 0-255

Specify a valid value for each subfield of the point code, and separate the subfields with a dash (-).



*prefix*—s  
*zone*—0-7  
*area*—000-255  
*id*—0-7

The point code 0-000-0 is not a valid point code.

#### **aliasn (optional)**

ITU national alias point code list in the format of a 5-digit number (*nnnnn*); or 2, 3, or 4 numbers (members) separated by dashes (*m1-m2-m3-m4*) as defined by the `chg-stpopts:npcfnti` flexible point code option. A group code must be specified when the ITUDUPPC feature is turned on (*nnnnn-gc*, *m1-m2-m3-m4-gc*). The *prefix* subfield indicates a spare point code (*prefix-nnnnn*, *prefix-nnnnn-gc*, *prefix-m1-m2-m3-m4*, *prefix-m1-m2-m3-m4-gc*).

If an ITU national destination (DPCN) point code is entered, then the *dpcn* and *aliasn* *prefix* subfields cannot be the same (both spare or both non-spare). Up to 2 comma-delimited entries can be entered in the point code list.

#### **Range:**

*s*-, 0-16383, *aa-zz*

Specify a valid value for each subfield of the point code, and separate the subfields with a dash (-).

*prefix*—s-

*nnnnn*—0-16383

*gc*—aa-zz

*m1-m2-m3-m4*—0-14 for each member; values must sum to 14

#### **aliasn24 (optional)**

24-bit ITU national alias point code with subfields *main signaling area-sub signaling area-signaling point* (*msa-ssa-sp*). This parameter is not valid if a 24-bit ITU national (DPCN24) point code is entered.

#### **Range:**

000-255

Specify a valid value for each subfield of the point code, and separate the subfields with a dash (-).

*msa*—000-255

*ssa*—000-255

*sp*—000-255

#### **aliasn16 (optional)**

16-bit ITU national *alias* point code with subfields *unit number-sub number area-main number area* (*un-sna-mna*). This parameter is not valid if a 16-bit ITU national (DPCN16) point code is entered.

#### **Range:**

000-127

Specify a valid value for each subfield of the point code, and separate the subfields with a dash (-).

*un*-000-127

*sna*-000-15

*mna*-000-31

**bei (optional)**

Broadcast exception indicator. This parameter specifies whether the STP broadcasts network management messages to adjacent signaling points.

**Note:**

The network management messages contain information about the indicated cluster and any of that cluster's member signaling points that are on its exception list. The messages whose broadcast is determined by this parameter are:

- TFP—transfer prohibited
- TCP—transfer cluster prohibited
- TFA—transfer allowed
- TCA—transfer cluster allowed

**Range:****yes**

Network management messages are not broadcast

**no**

Network management messages are broadcast

**Default:**

*yes* —If the DPC is a member whose associated cluster destination has `bei=yes` specified.

*no* —for DPCs in the cluster or if the DPC is a member whose associated cluster destination has `bei=no` specified or the `bei` parameter is not specified.

**c11i (optional)**

The Common Language Location Identifier assigned to this destination.

**Range:**

*ayyyyyyyyy*

1 alphabetic character followed by 10 alphanumeric characters

**Default:**

Null string

**domain (optional)**

The network in which the destination entity or node exists.

**Range:**

*ss7*

**Default:**

*ss7*

**e1ei (optional)**

Exception-list exclusion indicator, for cluster destinations only. This parameter specifies whether the system excludes or includes (maintains) a dynamic status exception list (x-list) for each cluster route used to reach the member signaling points that make up the cluster.

**Range:****yes**

Do not maintain a dynamic status x-list

**no**

Maintain a dynamic status x-list

**Default:**

*no*

**homescp (optional)**

This parameter specifies whether the destination point code (DPC) is considered a Home SCP when performing SCCP processing for messages with no Global Title Address Digits (Global Title Indicator (GTI) is set to zero). This parameter can only be set to "yes" for full DPCs.

**Range:****yes**

the DPC is considered a Home SCP

**no**

the DPC is not considered a Home SCP

**System Default:**

*no*

**homesmsc (optional)**

This parameter specifies whether the DPC is considered a Home SMSC when performing SCCP processing for messages with no Global Title Address Digits (GTI is set to zero). This parameter can only be set to "yes" for full DPCs.

**Range:****yes**

the DPC is considered a Home SMSC

**no**

the DPC is not considered a Home SMSC

**System Default:**

*no*

**ncai (optional)**

Nested cluster allowed indicator. Specifies whether the route to the cluster point code can be different for provisioned members of the cluster. A point code is a member of a cluster point code if it has the same network identifier (NI) and network cluster (NC) values as the cluster point code. This parameter can be specified only for cluster point

codes. Nested cluster routing is allowed if this parameter is set to *yes* and the CRMD and NCR features are turned on.

**Range:*****yes***

The cluster point code is a nested cluster point code. Point codes that are members of this cluster point code can be assigned to route sets that are different from the route set assigned to the cluster point code.

***no***

The cluster point code is not a nested cluster point code. Point codes that are members of this cluster point code must be assigned to the same route set assigned to the cluster point code.

**Default:**

*no*

**nprst (optional)**

NM bits reset. This parameter specifies whether the NM bits should be set to 00. This parameter applies only to ITU IAM messages. The `nptype=nm` parameter must be specified (see the `chg-tifopts` command) before this parameter can be specified.

**Range:*****off***

Do not set NM Bits to 00 in an ITU IAM message if the TIFOPTS `nptype` option value is *nm*

***on***

Set the NM Bits to 00 in an ITU IAM message if the TIFOPTS `nptype` option value is *nm*

**System Default:**

*off*

**ppc/ppca/ppci/ppcn/ppcn24/ppcn16 (optional)**

Proxy point code.

The proxy point code must be a full point code.

**ppc (optional)**

ANSI proxy point code with subfields *network indicator-network cluster-network cluster member (ni-nc-ncm)*.

The proxy point code must be a full point code.

**Synonym:**

*ppca*

**Range:**

*000-255*

Specify a valid value for each subfield of the point code, and separate the subfields with a dash (-).

When `chg-sid:pctype=ansi` is specified, *ni = 000* is not valid.

When `chg-sid:pctype=ansi` is specified, *nc = 000* is not valid if *ni = 001-005*.

When `chg-sid:pctype=ansi` is specified, *nc = 000* is valid if *ni = 006-255*.

The point code *000-000-000* is not a valid point code.

**ppci (optional)**

ITU international proxy point code with subfields *zone-area-id*. The *prefix* subfield indicates a spare point code (*prefix-zone-area-id*).

**Range:**

*s-*, 0-255

Specify a valid value for each subfield of the point code, and separate the subfields with a dash (-).

*prefix*—*s*

*zone*—0-7

*area*—000-255

*id*—0-7

The point code 0-000-0 is not a valid point code.

**ppcn (optional)**

ITU national proxy point code in the format of a 5-digit number (*nnnnn*); or 2, 3, or 4 numbers (members) separated by dashes (*m1-m2-m3-m4*) as defined by the `chg-stpopts:npcfmti` flexible point code option. A group code must be specified when the ITUDUPPC feature is turned on (*nnnnn-gc*, *m1-m2-m3-m4-gc*). The *prefix* subfield indicates a spare point code (*prefix-nnnnn*, *prefix-nnnnn-gc*, *prefix-m1-m2-m3-m4*, *prefix-m1-m2-m3-m4-gc*).

**Range:**

*s-*, 0-16383, *aa-zz*

Specify a valid value for each subfield of the point code, and separate the subfields with a dash (-).

*prefix*—*s-*

*nnnnn*—0-16383

*gc*—*aa-zz*

*m1-m2-m3-m4*—0-14 for each member; values must sum to 14

**ppcn24 (optional)**

24-bit ITU national proxy point code with subfields *main signaling area-sub signaling area-signaling point* (*msa-ssa-sp*).

**Range:**

000-255

Specify a valid value for each subfield of the point code, and separate the subfields with a dash (-).

*msa*—000-255

*ssa*—000-255

*sp*—000-255

**ppcn16 (optional)**

16-bit ITU national proxy point code with subfields *unit number-sub number area-main number area* (*un-sna-mna*).

**Range:**

000-127

Specify a valid value for each subfield of the point code, and separate the subfields with a dash (-).

*un*-000-127

*sna-000-15*

*mna-000-31*

**prx (optional)**

Proxy point code indicator. This parameter specifies whether a destination is used as a proxy point code.

**Range:****yes**

The destination is used as a proxy point code.

**no**

The destination is not used a proxy point code.

**Default:**

*no*

Will not be used as a proxy point code.

**rcause (optional)**

Release cause. The condition that triggers the sending of a Release message.

 **Note:**

If the `rlcopc` parameter is specified (see the `chg-tifopts` command), and a value of 0 - 127 is specified for the `rcause` parameter, then the `rcause` parameter value overrides the values specified for the TIFOPTS `rcausenp` and `rcausepfx` parameters.

**Range:**

*0 - 127, none*

*none* —use the values specified for the TIFOPTS table's `rcausenp` and `rcausepfx` parameters

**System Default:**

*none*

**sccpmsgcnv (optional)**

SCCP UDT(S)/XUDT(S) Message Conversion Indicator. The type of conversion performed on messages for the specified destination.

**Range:****none**

conversion is not required on messages for the destination

**udt2xudt**

convert all UDT(S) messages for the destination to XUDT(S) messages

**xudt2udt**

convert all non-segmented XUDT(S) messages for the destination to UDT(S) messages

**sxudt2udt**

convert all segmented and non-segmented XUDT(S) messages for the destination to UDT(S) messages

**Default:**

*none*

**spc/spca/spci/spcn/spcn24/spcn16 (optional)**

Secondary point code.

**spc (optional)**

ANSI secondary point code with subfields *network indicator-network cluster-network cluster member (ni-nc-ncm)*. The *prefix* subfield indicates a private point code (*prefix-ni-nc-ncm*).

**Synonym:**

*spca*

**Range:**

*000-255*

Specify a valid value for each subfield of the point code, and separate the subfields with a dash (-).

When *chg-sid:pctype=ansi* is specified, *ni = 000* is not valid.

When *chg-sid:pctype=ansi* is specified, *nc = 000* is not valid if *ni = 001-005*.

When *chg-sid:pctype=ansi* is specified, *nc = 000* is valid if *ni = 006-255*.

The point code *000-000-000* is not a valid point code.

**spci (optional)**

ITU international secondary point code with subfields *zone-area-id*. The *prefix* subfield indicates a spare point code, private point code, or private and spare point code (*prefix-zone-area-id*).

**Range:**

*s-, p-, ps-, 0-255*

Specify a valid value for each subfield of the point code, and separate the subfields with a dash (-).

*prefix—s-, p-, ps*

*zone—0-7*

*area—000-255*

*id—0-7*

The point code *0-000-0* is not a valid point code.

**spcn (optional)**

ITU national secondary point code in the format of a 5-digit number (*nnnnn*); or 2, 3, or 4 numbers (members) separated by dashes (*m1-m2-m3-m4*) as defined by the *chg-stpopts:npcfnti* flexible point code option. A group code must be specified when the ITUDUPPC feature is turned on (*nnnnn-gc, m1-m2-m3-m4-gc*). The *prefix* subfield indicates a spare point code, private point code, or private and spare point code (*prefix-nnnnn, prefix-nnnnn-gc, prefix-m1-m2-m3-m4, prefix-m1-m2-m3-m4-gc*).

**Range:***s-, p-, ps-, 0-16383, aa-zz*

Specify a valid value for each subfield of the point code, and separate the subfields with a dash (-).

*prefix—s-, p-, ps**nnnnn—0-16383**gc—aa-zz**m1-m2-m3-m4—0-14* for each member; values must sum to 14**spcn24 (optional)**24-bit ITU national secondary point code with subfields *main signaling area-sub signaling area-signaling point (msa-ssa-sp)*. The *prefix* subfield indicates a private point code (*prefix-msa-ssa-sp*).**Range:***p-, 000-255*

Specify a valid value for each subfield of the point code, and separate the subfields with a dash (-).

*prefix—p**msa—000—255**ssa—000—255**sp—000—255***spcn16 (optional)**16-bit ITU national secondary point code with subfields *unit number-sub number area-main number area (un-sna-mna)*. The *prefix* indicates a private point code (*prefix-un-sna-mna*).**Range:***p-, 000-127*

Specify a valid value for each subfield of the point code, and separate the subfields with a dash (-).

*prefix---p**un--000---127**sna---000---15**mna---000---31***splitiam (optional)**

This parameter specifies when and how to split an ITU IAM message into 1 IAM message + 1 SAM message.

This parameter applies only to ITU IAM messages.

**Range:***15-31, none**15-31* - Maximum number of CdPN digits allowed in the IAM message before splitting occurs. The remaining digits, up to a total of 32, are encoded in the SAM message.*none* -the value specified for the TIFOPTS table's `splitiam` parameter is used to determine when to split the IAM message**System Default:***none*



**Example**

To add destination 8-1-1 with CLLI of systest1:

```
ent-dstn:dpc=8-1-1:clli=systest1:bei=yes
```

To add destination 8 with ITU and national aliases:

```
ent-dstn:dpc=8-8-8:aliasi=1-2-3:aliasn=124
```

To add cluster 20-2-\*:

```
ent-dstn:dpc=20-2-*:elei=yes:bei=yes
```

To add a destination with an SPC of 100:

```
ent-dstn:dpc=20-2-2:spc=100-100-100
```

To add nested cluster 21-2-\*:

```
ent-dstn:dpc=21-2-*:elei=yes:bei=yes:ncai=yes
```

To add network routing destination 21-\*-\*:

```
ent-dstn:dpc=21-*-*
```

To add ITU national destination 7654 with a group code of FR and secondary point code of 7050:

```
ent-dstn:dpcn=7654-fr:spc=7050-fr
```

To add ITU-N 24-bit destination 15-100-10:

```
ent-dstn:dpcn24=15-100-10:bei=no
```

To add a 24-bit ITU-N destination with a 24-bit ITU-N secondary point code of 99:

```
ent-dstn:dpcn24=12-12-12:spcn24=99-99-99
```

To add destination 1-6-1 with a 24-bit ITU-N alias:

```
ent-dstn:dpci=1-6-1:aliasn24=4-4-4
```

To add private ANSI destination point code p-100-100-101 with spare point code alias s-1-123-1:

```
ent-  
dstn:dpca=p-100-100-101:spca=2-2-3:aliasi=s-1-123-1:aliasn=128
```

To add spare ITU-I destination point code s-2-100-1 with ANSI alias point code 121-120-120 and ITU-N alias spare point code s-129:

```
ent-  
dstn:dpci=s-2-100-1:spci=s-2-129-9:aliasa=121-120-120:aliasn=s-  
129
```

To add spare ITU-N destination point code s-231 with ITU-N secondary point code 129, ANSI alias point code 120, and ITU-I alias spare point code s-2-123-2:

```
ent-  
dstn:dpcn=s-231:spcn=129:aliasa=120-120-122:aliasi=s-2-123-2
```

To define a destination as a proxy point code:

```
ent-dstn:dpc=11-11-11:prx=yes
```

To associate a proxy point code with a destination point code:

```
ent-dstn:dpc=11-11-11:ppc=2-7-2
```

To add ITU-I destination point code 3-30-3 with ITU-I spare alias s-3-30-3:

```
ent-dstn:dpci=3-30-3:aliasi=s-3-30-3
```

To add ITU-N destination point code 8199-aa with ITU-I aliases s-4-0-7 and 4-0-7:

```
ent-dstn:dpcn=8199-aa:aliasi=s-4-0-7,4-0-7
```

To add destination 11 with SCCPMSGCNV type as UDT2XUDT:

```
ent-dstn:dpc=11-11-11:sccpmsgcnv=udt2xudt
```

To add ITU-N 16-bit destination 121-10-5:

```
ent-dstn:dpcn16=121-10-5
```

## Dependencies



### Note:

A full point code contains numerical values for all three segments of the point code.

The ANSI self-ID destination point code for the STP must be defined before ANSI destinations can be entered.

The ITU-I self-ID destination point code for the STP must be defined before ITU-I destinations can be entered.

The ITU-N self-ID or SPCN destination point code for the STP must be defined before ITU-N destinations can be entered.

The 24-bit ITU-N self-ID or SPCN24 destination point code for the STP must be defined before 24-bit ITU-N destinations can be entered. (See the `chg-sid` command.)

The Destination point code table can contain up to 2000 entries.

The destination address must be a full point code or a cluster point code.

The specified destination address cannot already exist in the Destination entity set.

A destination address cannot already be defined as an alias address.

The Spare Point Code Support feature must be enabled before the spare point code prefix (s-) can be specified for an ITU-I or ITU-N destination, secondary, or alias point code.

The specified `dpc` value cannot match the point code, secondary point code, or capability point code of the system.

A destination can have up to two alias point codes. A destination alias point code type (ANSI, ITU-I, ITU-N, ITU-N24) must not match that destination's true point code type. If both alias point codes are defined, the point code types of the aliases must not match.

Alias point codes are supported only for full point code destinations.

Alias point codes for destinations must be full point codes.

An alias point code cannot already be defined as a destination point code.

The format of the specified `dpcn` or `aliasn` parameter must match the format that was assigned with the `chg-stpopts:npcfmti` parameter.

If the 7000 Routesets or 8000 Routesets feature is enabled, then the total number of provisioned aliases in the system cannot exceed 8000. If the 10,000 Routesets feature is enabled, then the total number of provisioned aliases in the system cannot exceed 10000.

If an ANSI or ITU-I point code is specified, the `aliasn` or the `aliasn24` parameter can be specified, but not both.

A 24-bit ITU-N point code cannot have:

- A 14-bit ITU-N alias point code
- An ANSI alias point code

A 24-bit ITU-National point code can have an ITU-I point code alias. This allows conversion of 14-bit ITU-I routing label to 24-bit routing label and vice versa.

An ITU-I point code can have either a 14-bit ITU-N alias or a 24-bit ITU-N alias, but not both.

A 14-bit ITU-N point code cannot have a 24-bit ITU-N alias point code.

An ANSI point code cannot have a 24-bit ITU-N alias point code.

The CRMD feature must be turned on before a cluster destination point code (`ni-nc-*`) can be specified.

A cluster destination cannot be defined using the same network identifier (`ni`) and network cluster (`nc`) subfields of any previously defined alias ANSI point codes.

The CRMD (Cluster Routing and Management Diversity) and NCR (Nested Cluster Routing) features must be turned on before the `ncai` parameter can be specified.

If the `ncai=yes` parameter is specified, then the maximum number of provisioned nested clusters must be no greater than 500.

When a cluster point code is specified, the collection of signaling points sharing the same network identifier (`ni`) and network cluster (`nc`) subfields must have the same route set.

Cluster DPCs are not allowed to inherit cluster members that have routes with A or E linkset types.

Network routing is valid only if the Network Routing (NRT) feature is turned on.

When using network routing, if the destination point code has a value of `*` in the `nc` subfield, the `ncm` subfield must also be `*` (e.g., `dpc=21-*-*`).

The `ncai` parameter can be specified only for cluster destinations.

Alias ANSI point codes cannot have the same network identifier (`ni`) and network cluster (`nc`) subfields as a cluster point code that is already defined.

The CRMD feature must be turned on before the `elei` parameter can be specified.

The `elei` parameter can be specified only for cluster destinations (e.g., `dpc=ni-nc-*`).

The CLLI of the destination point code cannot match the CLLI of the system.

A reserved word cannot be specified for the destination identifier (`clli`).

If the corresponding destination for the specified destination point code is an adjacent signaling point (matched a Far End point code in its linkset entity set), the CLLI of the specified destination point code cannot be assigned to any other destination address.

The value of the `dpc` parameter must be a valid point code.

If specified, the `spc` parameter value must already be configured as a secondary point code in the Secondary Point Code table.

The value specified for the `spc` parameter must be a full point code.

If the `spc` parameter is specified, the `domain=ss7` parameter must be specified.

If the `spc` parameter is specified, then the value specified for the `dpc` parameter must be a full point code.

The network type of the value specified for the `spc` parameter must match the network type of the value specified for the `dpc` parameter.

If an ITU national destination is provisioned and the ITUDUPPC feature is turned on, and if the destination does not use an SPC, the group code of the destination must be the same as the group code of the ITU national true point code.

For example, if the ITU national true point code has a group code of `ee`, then you can add destinations with group codes of `ee` without using an SPC. Destinations with a group code of `ff`, however, must use an SPC with a group code of `ff`.

The Route table cannot be full.

If an ITU national destination is provisioned and the ITUDUPPC feature is turned on, and if the destination uses an SPC, then the group code of the destination must match the group code of the SPC.

For example, if the ITU national true point code has a group code of `ee`, then you can add destinations with group codes of `ee` without using an SPC. Destinations with a group code of `ff`, must use an SPC with a group code of `ff`.

The `ncai` parameter can be specified only for cluster destinations (for example (`dpc=ni-nc-*`)).

The value of the `clli` parameter cannot already exist in the Route table.

The ICNP feature must be turned on before the `icnpxlat`, `cgpafmt`, and `cdpafmt` parameters can be specified.

The NCR feature must be enabled before the `ncai` parameter can be enabled.

The MAS configuration table is corrupt or cannot be found.

The route table is corrupt or cannot be found.

If the 6000 Routesets feature is turned on, and the destination point code to be provisioned is above 5000, then the GPSM-II OAM cards must be used.

The `alias` parameter must be specified with a different point code type than the `dpc` parameter.

The `aliasa` and `dpca` parameters cannot be specified together in the command. The `aliasi` and `dpci` parameters and the `aliasn` and `dpcn` parameters cannot be specified

together in the command if the *prefix* subfields are the same (both are spare or both are non-spare).

The Proxy Point Code feature must be enabled before the `prx=yes` parameter can be specified.

The Proxy Point Code feature must be enabled before the `ppc` parameter can be specified.

If the `ppc` parameter or the `prx=yes` parameter is specified, then the value specified for the `dpc` parameter must be a full point code.

The `spc` and `ppc` parameters cannot be specified together in the command.

The values specified for the `dpc` and `ppc` parameters must have the same network type.

The values specified for the `dpc` and `ppc` parameters must have the same group code.

The number of proxy destinations cannot exceed the value given by the enabled Proxy Point Code quantity feature.

If the value of the `dpc` parameter is a private point code, then the `prx=yes` parameter cannot be specified.

If the value of the `dpc` parameter is a private point code, then the `ppc` parameter cannot be specified.

The `dpc` parameter and the `prx=yes` parameter must be specified before the `ppc` parameter can be specified.

The total number of proxy destinations cannot exceed the total capacity (100) of the Proxy Point Code feature.

The `prx` parameter must have a value of *yes* or *no*.

Cluster destination point codes cannot inherit cluster members that have routes using proxy linksets.

The spare ITU-I self-ID destination point code for the STP must be defined before spare ITU-I destinations can be entered.

The spare ITU-N self-ID destination point code for the STP must be defined before spare ITU-N destinations can be entered.

A maximum of two aliases can be specified per destination point code.

If the `dpci` parameter is specified, then a combination of ITUI and ANSI aliases cannot be specified. If the `dpcn` parameter is specified, then a combination of ITUN and ANSI aliases cannot be specified.

Two ITUI or two ITUN aliases can be specified for the same destination point code only if the aliases have different prefixes. One alias must be spare and one non-spare.

The TIF Number Portability feature must be enabled before the `rcause` or `nprst` parameter can be specified.

A TIF feature must be enabled before the `splitiam` parameter can be specified.

The XUDT UDT Conversion feature must be turned on before the `sccpmsgcnv` parameter can be specified.

The value specified for the `ppc` parameter must already exist in the DSTN table and the `prx=yes` parameter must be assigned.

ITU-N16 destination cannot be provisioned if ITU-N16 site id is not provisioned.

The J7 Support feature must be enabled before the `aliasn16` parameter can be specified.

If the J7 Support feature is enabled then the `aliasa` and `aliasn24` parameters cannot be specified.

Spare point codes for `aliasn 1` and `aliasn 2` must be different, and spare point codes for `aliasi 1` and `aliasi 2` must be different.

## Notes

Upon initial installation of the system, the self point code must be entered before you enter any destination.

When you define a DPC with the unique destination signaling point of a provisioned cluster, the DPC automatically inherits the route set of its cluster if the `ncai=no` parameter is specified. If the `ncai=yes` parameter is specified, the provisioned members can have a different route set.

When you define a cluster point code for previously defined destination signaling points, the cluster automatically inherits the unique route set of its members.

For ITU national duplicate point codes, you cannot change a destination's group code. To move a destination from one group to another, provision a new destination that uses the new group code and delete the old destination.

The system requires that the destination point code of each routeset be entered in the database. For example, to enter 6000 routesets in the database, 6000 destination point codes must be entered in the database.

If you have turned on the 5000 Routes feature, prior to provisioning the additional routing table entries, you must issue the `chg-stpopts` command to specify the maximum number of allowed DPCs and dynamic x-list entries.

If the 6000, 7000, 8000, or 10,000 Routesets feature is enabled, then in order to enter more than 2000 destination point codes, the maximum number of point codes that can be configured on the system must be changed to 6000, 7000, 8000, or 10000 respectively, using the `mtpdpcq` parameter of the `chg-stpopts` command.

In this command, only ITU-international and ITU national point codes and aliases support the spare point code subtype prefix (s-). Only ITU-international and ITU national point codes support the private and spare point code subtype prefix (ps-). All of the point code types support the private (internal) point code subtype prefix (p-). Aliases do not support the private (internal) point code prefix.

If the Proxy Point Code feature is enabled, then the value specified for the `ppc` or `dpc` parameter (when the destination point code is designated as a proxy point code) must be full point codes. Cluster point codes and private point codes are not supported.

One of `dpc/dpca/dpci/dpcn/dpcn24/dpcn16` is mandatory and they are mutually exclusive.

Only one of `aliasa/aliasi/aliasn/aliasn24/aliasn16` can be specified as they are mutually exclusive.

Only one of spc/spca/spci/spcn/spcn24/spcn16 can be specified as they are mutually exclusive.

### Output

This example shows the output with the NCR, NRT, and CRMD features off and all Routes and Routesets features off:

```
ent-dstn:dpc=8-8-8:aliasi=1-2-3:aliasn=124
```

```
rlghncxa03w 04-08-17 15:35:05 EST EAGLE 31.8.0
Destination table is (10 of 2000) 1% full
Alias table is (8 of 12000) 1% full
ENT-DSTN: MASP A - COMPLTD
;
```

This example shows the output with the NCR, NRT, and CRMD features off and the DSTN5000 (5000 Routes) feature on:

```
ent-dstn:dpc=8-8-8:aliasi=1-2-3:aliasn=124
```

```
rlghncxa03w 04-08-18 08:29:15 EST EAGLE 31.8.0
Destination table is (10 of 5000) 1% full
Alias table is (8 of 12000) 1% full
ENT-DSTN: MASP A - COMPLTD
;
```

This example shows the output with one or more of the NCR, NRT, or CRMD features on and the DSTN5000 (5000 Routes) feature on:

```
ent-dstn:dpc=8-8-8:aliasi=1-2-3:aliasn=124
```

```
rlghncxa03w 04-08-18 08:29:15 EST EAGLE 31.8.0
DESTINATION ENTRIES ALLOCATED: 5000
  FULL DPC(s): 9
  NETWORK DPC(s): 0
  CLUSTER DPC(s): 1
  TOTAL DPC(s): 10
  CAPACITY (% FULL): 1%
ALIASES ALLOCATED: 12000
  ALIASES USED: 8
  CAPACITY (% FULL): 1%
X-LIST ENTRIES ALLOCATED: 500
ENT-DSTN: MASP A - COMPLTD
;
```

This example shows the output with the NCR, NRT, and CRMD features off and the 6000 Routesets feature on:

```
ent-dstn:dpc=8-8-8:aliasi=1-2-3:aliasn=124
```

```
rlghncxa03w 04-08-18 08:29:15 EST EAGLE 31.8.0
Destination table is (60 of 6000) 1% full
Alias table is (8 of 12000) 1% full
ENT-DSTN: MASP A - COMPLTD
```

```
;
```

This example shows the output with one or more of the NCR, NRT, or CRMD features on and the 6000 Routesets feature on:

```
ent-dstn:dpc=8-8-8:aliasi=1-2-3:aliasn=124
```

```
rlghncxa03w 04-08-18 08:29:15 EST EAGLE 31.8.0
DESTINATION ENTRIES ALLOCATED: 6000
  FULL DPC(s): 46
  NETWORK DPC(s): 1
  CLUSTER DPC(s): 1
  TOTAL DPC(s): 12
  CAPACITY (% FULL): 1%
ALIASES ALLOCATED: 12000
  ALIASES USED: 8
  CAPACITY (% FULL): 1%
X-LIST ENTRIES ALLOCATED: 500
ENT-DSTN: MASP A - COMPLTD
```

```
;
```

This example shows the output with the NCR, NRT, and CRMD features off. When the 7000 Routesets quantity feature is on, the Destination table line shows "...of 7000". When the 8000 Routesets quantity feature is on, the Destination table line shows "...of 8000."

```
ent-dstn:dpc=8-8-8:aliasi=1-2-3:aliasn=124
```

```
rlghncxa03w 04-08-18 08:29:15 EST EAGLE 31.8.0
Destination table is (60 of 7000) 1% full
Alias table is (8 of 8000) 1% full
ENT-DSTN: MASP A - COMPLTD
```

```
;
```

This example shows the output with one or more of the NCR, NRT, or CRMD features on. When the 7000 Routesets quantity feature is on, the DESTINATION ENTRIES ALLOCATED line shows "7000". When the 8000 Routesets quantity feature is on, the DESTINATION ENTRIES ALLOCATED line shows "8000."

```
ent-dstn:dpc=8-8-8:aliasi=1-2-3:aliasn=124
```

```
rlghncxa03w 04-08-18 08:29:15 EST EAGLE 31.8.0
DESTINATION ENTRIES ALLOCATED: 8000
  FULL DPC(s): 9
  NETWORK DPC(s): 0
```



```

        CLUSTER DPC(s) :           1
        TOTAL DPC(s) :           10
        CAPACITY (% FULL) :       1%
    ALIASES ALLOCATED:           8000
        ALIASES USED:             8
        CAPACITY (% FULL) :       1%
    X-LIST ENTRIES ALLOCATED:     500
    ENT-DSTN: MASP A - COMPLTD
;

```

This example shows the output when none of the NCR, NRT, or CRMD features on. A destination is defined as a proxy point code.

```
ent-dstn:dpc=11-11-11:prx=yes
```

```

tekelecstp 07-03-07 16:34:32 EST  EAGLE 37.5.0
Destination table is (11 of 2000) 1% full
Alias table is (0 of 12000) 0% full
PPC table is (2 of 10) 20% full
ENT-DSTN: MASP A - COMPLTD
;

```

This example shows the output when one or more of the NCR, NRT, or CRMD features are on. The destination refers to a proxy point code.

```
ent-dstn:dpc=1-1-1:ppc=11-11-11
```

```

tekelecstp 07-03-05 17:34:18 EST  EAGLE 37.5.0
DESTINATION ENTRIES ALLOCATED:   2000
    FULL DPC(s) :                 27
    EXCEPTION DPC(s) :            0
    NETWORK DPC(s) :              1
    CLUSTER DPC(s) :              1
    Proxy DPC(s) :                 1
    TOTAL DPC(s) :                 30
    CAPACITY (% FULL) :            2%
    ALIASES ALLOCATED:            12000
    ALIASES USED:                  0
    CAPACITY (% FULL) :            0%
    X-LIST ENTRIES ALLOCATED:     500
    ENT-DSTN: MASP A - COMPLTD
;

```

This example shows the output when the NCR, NRT, and CRMD features are off and the 10,000 Routesets feature is on:

```
ent-dstn:dpc=8-8-8:aliasi=1-2-3:aliasn=124
```

```

rlghncxa03w 10-08-17 08:29:15 EST  EAGLE 43.0.0
Destination table is (10 of 10000) 1% full
Alias table is (8 of 10000) 1% full

```

```
ENT-DSTN: MASP A - COMPLTD  
;
```

This example shows the output when one or more of the NCR, NRT, or CRMD features and the 10,000 Routesets feature is on:

```
ent-dstn:dpc=8-8-8:aliasi=1-2-3:aliasn=124
```

```
rlghncxa03w 10-08-17 08:29:15 EST EAGLE 43.0.0  
DESTINATION ENTRIES ALLOCATED: 10000  
FULL DPC(s): 9  
NETWORK DPC(s): 0  
CLUSTER DPC(s): 1  
TOTAL DPC(s): 10  
CAPACITY (% FULL): 1%  
ALIASES ALLOCATED: 10000  
ALIASES USED: 8  
CAPACITY (% FULL): 1%  
X-LIST ENTRIES ALLOCATED: 500  
ENT-DSTN: MASP A - COMPLTD  
;
```

This example shows the output when the J7 feature is enabled:

```
ent-dstn:dpci=1-2-6:aliasn16=2-4-6
```

```
tekelecstp 13-02-27 13:58:55 EST 45.0.0-64.56.0  
ent-dstn:dpc=1-2-6:aliasn16=2-4-6  
Command entered at terminal #4.  
Destination table is (2 of 2000) 1% full  
Alias table is (1 of 12000) 0% full  
  
ENT-DSTN: MASP A - COMPLTD  
;
```

### Related Topics

- [chg-dstn](#)
- [chg-rte](#)
- [dlt-dstn](#)
- [dlt-rte](#)
- [ent-rte](#)
- [rept-stat-dstn](#)
- [rept-stat-rte](#)
- [rtrv-dstn](#)
- [rtrv-rte](#)

## ent-e1

Use this command to enter an interface into the system for E5-E1T1-B cards used as an E1 or SE-HSL cards.

Any of the 8 ports can be specified when the card is used as a standard E1 card. No more than 2 ports on the E5-E1T1-B can have defined E1 interfaces.

### Parameters

#### **e1port (mandatory)**

E1 card port number. The value must be an E1 port for which an interface has not been configured on the specified E1 card.

##### **Range:**

*1 - 8*

Any 2 of the 8 ports on an E5-E1T1-B card can be specified when the card is used as an SE-HSL card.

#### **loc (mandatory)**

The card location as stenciled on the shelf of the system.

##### **Range:**

*1101 - 1108, 1111 - 1112, 1201 - 1208, 1211 - 1218, 1301 - 1308, 1311 - 1318, 2101 - 2108, 2111 - 2118, 2201 - 2208, 2211 - 2218, 2301 - 2308, 2311 - 2318, 3101 - 3108, 3111 - 3118, 3201 - 3208, 3211 - 3218, 3301 - 3308, 3311 - 3318, 4101 - 4108, 4111 - 4118, 4201 - 4208, 4211 - 4218, 4301 - 4308, 4311 - 4318, 5101 - 5108, 5111 - 5118, 5201 - 5208, 5211 - 5218, 5301 - 5308, 5311 - 5318, 6101 - 6108, 6111 - 6118*

#### **crc4 (optional)**

CRC4 enable or disable indicator.

##### **Range:**

*on*

*off*

##### **Default:**

*on*

#### **encode (optional)**

Indicator for use of HDB3 or AMI encoding/decoding.

##### **Range:**

*hdb3*

*ami*

**Note:**

AMI encoding is supported for cards that are used as E1 cards (not as SE-HSL cards).

**Default:**

*hdb3*

**linkclass (optional)**

Link class for links that are assigned to E1 cards (“channelized” links) or SE-HSL cards (“unchannelized” links).

**Range:**

*chan*

*unchan*

**Default:**

*chan*

**minsurate (optional)**

Minimum signal unit rate. The minimum number of SUs present on a link uniformly distributed. This parameter is valid only when the `linkclass=unchan` parameter is specified for an SE-HSL card.

**Range:**

*500 - 2000*

**Default:**

*1000*

**si (optional)**

Value of two Spare International bits of NFAS data.

**Range:**

*0 - 3*

**Default:**

*0*

**sn (optional)**

Value of five Spare International bits of NFAS data.

**Range:**

*0 - 31*

**Default:**

*0*

**t1tse1 (optional)**

Timing source.

**Range:***line* - slave timing source*external* - master timing source**Default:***line***Example**

```
ent-e1:loc=1205:elport=1:crc4=off:encode=hdb3:si=2:sn=12
ent-e1:loc=1205:elport=2:encode=ami

ent-
e1:loc=1203:crc4=on:elport=2:encode=hdb3:linkclass=unchan:minsu
rate=2000

ent-e1:loc=1205:elport=1:crc4=off:encode=hdb3:eltsel=external:
si=2:sn=12

ent-e1:loc=1205:elport=1:crc4=off:encode=hdb3:eltsel=line:
si=2:sn=12
```

**Dependencies**

The card location specified by the `loc` parameter must be equipped.

The card specified by the `loc` parameter must be an LIME1 card type.

The E1/T1 table is corrupt or cannot be found.

The Card (IMT) table is corrupt or cannot be found.

The port specified by the `elport` parameter cannot already be equipped with an E1 interface.

The `minsurate` parameter can be specified only when the `linkclass=unchan` parameter is specified.

Only 2 ports can be used for E1 interfaces on an E5-E1T1-B card that is used as an SE-HSL card. Any 2 of the 8 ports can be used on the SE-HSL card.

The shelf FAN bit must be turned ON for the shelf on which an E5-E1T1-B card is being used as an E1 or SE-HSL card.

HIPR2 cards must be equipped in card locations `xy09` and `xy10` (`x` is the frame, `y` is the shelf) on each EAGLE shelf that contains one or more E5-E1T1-B cards that are used as E1 or SE-HSL cards.

An SE-HSL feature quantity must be enabled before the `linkclass=unchan` parameter can be specified for an SE-HSL card.

Channelized and unchannelized E1 ports (mixed mode) are not allowed on a single card (the card cannot be used as an E1 card and an SE-HSL card at the same time).

Card locations 1113 - 1118 (E5-MASP and E5-MDAL cards) cannot be specified as values for the `loc` parameter.

The `encode=ami` parameter is supported only for cards used as E1 cards (not as SE-HSL cards).

Locations `xy09` and `xy10`, where `x` is the frame and `y` is the shelf, cannot be specified as values for the `loc` parameter.

### Notes

One or two E1 interfaces must be defined on an E1 card after the E1 card type (LIME1) is defined in the database (see the `ent-card` command), and before the signaling links and associated timeslots are defined for the E1 card (see the `ent-slk` command).

External timing is derived from the EAGLE High-Speed Master Clock (1.544 MHz for T1 or 2.048 MHz for E1); therefore, the Master Timing feature is required. Line timing is derived from its received data stream, if present.

Up to 8 E1 interfaces can be defined on a card used as an E1 card after the E1 card type (LIME1) is defined in the database (with the `ent-card` command), and before the signaling links and associated timeslots are defined for the E1 card.

For an SE-HSL card, the `minsurate` parameter indicates the least number of SUs present on a link uniformly distributed. The number of SUs present is the `minsurate` parameter value (without link traffic) or the `minsurate` parameter value minus the number of MSUs (with link traffic).

### Output

```
ent-e1:loc=1205:elport=1:crc4=off:encode=hdb3:si=2:sn=12
```

```
rlghncxa03w 04-02-20 09:07:58 EST EAGLE 31.3.0
ENT-E1: MASP A - COMPLTD
;
```

### Related Topics

- [chg-e1](#)
- [dlt-e1](#)
- [rtv-e1](#)
- [tst-e1](#)

## ent-enum-acl

Use this command to make an entry in the ENUM Access Control List (ACL) Table. The ENUM ACL Table supports the provisioning information related to the allowed IP Addresses for the ENUM application.

### Parameters

#### **ipaddr (mandatory)**

This is a TCP/IP address expressed in standard dot notation. It specifies allowed IP addresses for the ENUM application.

#### **Range:**

Four numbers separated by dots, with each number in the range of 0-255, \*.

 **Note:**

It also supports wildcard characters as follows:

```
xxx.xxx.xxx.*
xxx.xxx.*.*
xxx.*.*.*
```

where xxx can be any number in range of 0-255.

**System Default:**  
0.0.0.0

**Example**

```
ent-enum-acl:ipaddr=10.248.13.9
ent-enum-acl:ipaddr=10.248.13.*
ent-enum-acl:ipaddr=10.248.*.*
ent-enum-acl:ipaddr=10.*.*.*
ent-enum-acl:ipaddr6="2003:db8::*"
ent-enum-acl:ipaddr6="2004:1234:abcd::3456:abc6"
ent-enum-acl:ipaddr6="2005:*:*:*:*:*:*:*"
```

**Dependencies**

The ENUM ACL Table should be accessible.

An overlapping IP Address cannot be provisioned in the ENUM ACL Table.

The IP Address specified by the IPADDR parameter must be a valid IP address.

A maximum of 100 IP addresses can be defined in the ENUM ACL Table.

The IP address specified by the IPADDR parameter must be unique.

**Notes**

Wildcard IP addresses are allowed to support the ranges of IP addresses.

**Output**

```
ent-enum-acl:ipaddr=10.248.13.*

tekelecstp 14-05-28 15:04:28 EST EAGLE 46.1.0
ent-enum-acl:ipaddr=10.248.13.*
Command entered at terminal #4.
ENT-ENUM-ACL: MASP A - COMPLTD
;
```

**Related Topics**

- [dlt-enum-acl](#)

- [rtrv-enum-acl](#)

## ent-enum-prof

Use this command to configure the data used to generate the ENUM response for three supported resource record formats such as NAPTR, NS and CNAME. The ENUM Profile Table is used to configure the resource record data.

### Parameters

#### **prn (mandatory)**

Profile name. This parameter specifies the unique logical name assigned to the profile entry used to generate the ENUM response.

##### **Range:**

*ZZZZZZZZZZ*

A string of alphanumeric characters, beginning with a letter and up to 10 characters in length. Valid values are a..z, A..Z, 0..9.

#### **rtrype (mandatory)**

Response type. This parameter specifies the response type for the profile. It identifies the profile used to generate the ENUM response for each resource record type.

##### **Range:**

*naptr*

*cname*

*ns*

##### **Default:**

No change to the current value

##### **System Default:**

*naptr*

#### **pref (optional)**

Preferred Response. This parameter will decide the values for the Order and Preference fields to be encoded for each NAPTR resource record. The values of these fields are only applicable when there are two NAPTR resource records in the ENUM response. This parameter is only valid for the NAPTR response type.

##### **Range:**

*yes*

*no*

##### **Default:**

No change to the current value

##### **System Default:**

*No*





**Example**

```
ent-enum-prof:prn=pr1:rtype=naptr:rrdomain=abc.oracle.com:sparm=sip
ent-enum-
prof:prn=pr2:rtype=naptr:rrdomain=abc1.oracle.com:pref=yes:sparm=sip
ent-enum-prof:prn=pr3:rtype=ns:rpdomain=def.oracle.com
ent-enum-prof:prn=pr4:rtype=cname:rpdomain=cname.123
ent-enum-prof:prn=pr5:rtype=naptr:rrdomain=abc2.oracle.com:sparm=sip
ent-enum-
prof:prn=pr6:rtype=naptr:rrdomain=sr71.blackbird.com:sparm=pstnsip
ent-enum-prof:prn=prof1:sparm=pstntel:rtype=naptr
ent-enum-prof:rtype=naptr:
prn=pr7:sparm=sip:rrdomain=a.b.com :prefix=7
```

**Dependencies**

The ENUM Profile Table should be accessible.

The domain name for regular expression (RRDOMAIN) can be specified only with RTYPE=NAPTR.

For RTYPE=NS or CNAME, the replacement domain name (RPDOMAIN) must be specified.

The SPARM, PREF and RRDOMAIN parameters are valid only for RTYPE=NAPTR.

The RRDOMAIN parameter is valid for SPARM=SIP or SPARM=PSTNSIP.

A unique profile name must be specified for a new profile.

A maximum of 1024 entries can be provisioned in the ENUM Profile Table.

The RRDOMAIN parameter must be specified with either SPARM=SIP or SPARM=PSTNSIP.

A profile name of "none" cannot be specified.

**Notes**

The requirement of using PREFIX in the regular expression is only for PSTN-SIP (NAPTR query). As such, PREFIX will not be applied for PSTN-TEL and SIP (NAPTR queries).

PREFIX can be configured for PSTN-TEL and SIP profiles, but it will not be used.

**Output**

```
> ent-enum-prof:prn=pr1:rtype=naptr:sparm=pstnsip:rrdomain=abc.oracle.com
tekelecstp 18-05-29 03:13:20 MST EST EAGLE 46.1.0
ent-enum-prof:prn=pr1:rtype=naptr:sparm=pstnsip:rrdomain=abc.oracle.com
Command entered at terminal #19.
;
```

```
Command Accepted - Processing
tekelecstp 18-05-29 03:13:20 MST EST EAGLE 46.1.0
```

```
ENT-ENUM-PROF: MASP B - COMPLTD
;
> ent-enum-
prof:prn=pr2:rtype=naptr:sparm=pstnsip:rrdomain=abc.oracle.com
tekelecstp 18-05-29 03:15:20 MST EST EAGLE 46.1.0
ent-enum-
prof:prn=pr2:rtype=naptr:sparm=pstnsip:rrdomain=abc.oracle.com
Command entered at terminal #19.
;

Command Accepted - Processing
tekelecstp 18-05-29 03:15:20 MST EST EAGLE 46.1.0
ENT-ENUM-PROF: MASP B - COMPLTD
;
> ent-enum-prof:prn=pr3:rtype=ns:rpdomain=def.oracle.com
tekelecstp 18-05-29 03:18:20 MST EST EAGLE 46.1.0
ent-enum-prof:prn=pr3:rtype=ns:rpdomain=def.oracle.com
Command entered at terminal #19.
;

Command Accepted - Processing
tekelecstp 18-05-29 03:18:20 MST EST EAGLE 46.1.0
ENT-ENUM-PROF: MASP B - COMPLTD
;
> ent-enum-
prof:prn=pr7:rtype=naptr:rrdomain=sr73.blackbird.com:sparm=sip

eagle10 16-08-12 15:13:28 MST EAGLE 46.4.0.0.0-69.8.0
2428.1321 CARD 1101 INFO Eagle RTDB Birthdate Mismatch
eagle10 16-08-12 15:13:48 MST EAGLE 46.4.0.0.0-69.8.0
ent-enum-
prof:prn=pr7:rtype=naptr:rrdomain=sr71.blackbird.com:sparm=sip
Command entered at terminal #17.
;

Command Accepted - Processing
eagle10 16-08-12 15:13:48 MST EAGLE 46.4.0.0.0-69.8.0
ENT-ENUM-PROF: MASP A - COMPLTD
;
Command Executed
Report Date:16-08-12 Time:15:13:28
;

ent-enum-prof:prn=prof1:sparm=pstntel:rtype=naptr

tekelecstp 16-08-25 06:14:53 EST EAGLE 46.4.0.0.0-69.10.0
ent-enum-prof:prn=prof1:sparm=pstntel:rtype=naptr
Command entered at terminal #4.
ENT-ENUM-PROF: MASP A - COMPLTD
;

> ent-enum-
```

```
prof:rtype=naptr:prn=pr7:sparm=sip:rrdomain=a.b.com:prefix=3698

Command Accepted - Processing

    tekelecstp 19-01-03 14:00:52 MST  EAGLE 46.8.0.0-75.18.11
    ent-enum-prof:rtype=naptr:prn=pr3:sparm=sip:rrdomain=abcd:prefix=3698
    Command entered at terminal #3.
;

    tekelecstp 19-01-03 14:00:52 MST  EAGLE 46.8.0.0-75.18.11
    ENT-ENUM-PROF: MASP B - COMPLTD
;
```

### Related Topics

- [chg-enum-prof](#)
- [dlt-enum-prof](#)
- [rtrv-enum-prof](#)

## ent-enum-profsel

Use this command to make an entry in the ENUM Profile Selection Table and the ENUM DN Block Table. The ENUM Profile Selection Table supports the provisioning information related to mapping of Entity Id to Profile Id. The ENUM DN Block Table supports the provisioning information related to mapping of DN Block to Profile Id.

### Parameters

#### **edn (optional)**

End Dialed Number

##### **Range:**

5-15 digits

#### **entityid (optional)**

Network Entity

##### **Range:**

1-15 hex-digits (0-9, a-f)

#### **prn1 (optional)**

Profile Name

##### **Range:**

*zzzzzzzzzz*

A string of alphanumeric characters, beginning with a letter and with a maximum length of 10 characters. Valid values are a..z, A..Z, 0..9.



**Note:**

Response type of specified profile must be NS

**prn2 (optional)**

Profile Name

**Range:**

*ZZZZZZZZZZ*

A string of alphanumeric characters, beginning with a letter and with a maximum length of 10 characters. Valid values are a..z, A..Z, 0..9.



**Note:**

Response type of specified profile must be CNAME

**prn3 (optional)**

Profile Name

**Range:**

*ZZZZZZZZZZ*

A string of alphanumeric characters, beginning with a letter and with a maximum length of 10 characters. Valid values are a..z, A..Z, 0..9.



**Note:**

Response type of specified profile must be NAPTR

**prn4 (optional)**

Profile Name

**Range:**

*ZZZZZZZZZZ*

A string of alphanumeric characters, beginning with a letter and with a maximum length of 10 characters. Valid values are a..z, A..Z, 0..9.



**Note:**

Response type of specified profile must be NAPTR

**sdn (optional)**

Start Dialed Number

**Range:**  
5-15 digits

### Example

```
ent-enum-  
profsel:entityid=12345:prn1=ns1:prn2=cname1:prn3=naptr1:prn4=naptr2
```

```
ent-enum-  
profsel:sdn=12345:edn=12400:prn1=ns1:prn2=cname1:prn3=naptr1:prn4=na  
ptr2
```

### Dependencies

The ENUM Profile Selection Table should be accessible.

The ENUM DN Block Table should be accessible.

The ENUM Profile Table should be accessible.

Either ENTITYID or SDN and EDN must be specified.

ENTITYID cannot be specified with SDN or EDN.

At least one profile must be specified.

The profile name specified by the prnX (x=1,2,3,4) parameter must be provisioned in the ENUM Profile Table.

SDN and EDN digit length must be the same.

EDN must be greater than or equal to SDN.

The response type specified by profile name prn1, prn2, prn3 and prn4 should be NS, CNAME, NAPTR and NAPTR respectively.

The entity ID value must be unique in the ENUM Profile Selection Table.

NAPTR profile names must be unique.

A maximum of 1024 entries can be provisioned in the ENUM Profile Selection Table.

A maximum of 1024 entries can be provisioned in the ENUM DN Block Table.

The SDN and EDN cannot already be provisioned in the ENUM Profile Selection Table.

The default profile cannot be associated with any profile selection entry.

If SDN is specified then EDN must be specified or vice-versa.

Overlapping SDN and EDN cannot already be provisioned in the ENUM DN Block Table.

### Notes

Response type specified by profile name prn1, prn2, prn3 and prn4 should be NS, CNAME, NAPTR and NAPTR respectively.

Entity Id and SDN/EDN are mutually exclusive.

SDN must be specified with EDN and vice-versa.

## Output

This example displays output when entity id specified:

```
ent-enum-
profsel:entityid=1234:prn1=ns1:prn2=cname1:prn3=naptr1:prn4=nap
tr2

tekelecstp 14-05-28 15:04:28 EST EAGLE 46.1.0
ent-enum-
profsel:entityid=1234:prn1=ns1:prn2=cname1:prn3=naptr1:prn3=naptr2
Command entered at terminal #4.
ENT-ENUM-PROFSEL: MASP A - COMPLTD
;
```

This example displays output when SDN and EDN specified:

```
ent-enum-
profsel:sdn=12345:edn=23456:prn1=ns1:prn2=cname1:prn3=naptr1:pr
n4=naptr2

tekelecstp 14-05-28 15:04:28 EST EAGLE 46.1.0
ent-enum-
profsel:sdn=12345:edn=23456:prn1=ns1:prn2=cname1:prn3=naptr1:prn3=naptr
2
Command entered at terminal #4.
ENT-ENUM-PROFSEL: MASP A - COMPLTD
;
```

## Related Topics

- [chg-enum-profsel](#)
- [dlt-enum-profsel](#)
- [rtrv-enum-profsel](#)

## ent-frm-pwr

Use this command to add a new entry to the Frame Power Threshold (FPT) table. The frame-level power threshold value in the table is compared with the current calculated maximum power consumption for a particular frame, and appropriate alarms are raised if that consumption exceeds the threshold limit.

The entries in the Frame Power Threshold table contain a Frame ID and the corresponding power threshold value. You can use the following commands to display the threshold and calculated maximum power consumption for the frames in the system.

- The `rtrv-frm-pwr` command displays the current provisioned frame power threshold for each provisioned frame.

- The `rtrv-stp:display=power` command displays the provisioned frame power threshold for each provisioned frame, and displays the maximum calculated power consumption for each frame, based on card population.
- The `rtrv-stp:display=power:frm=xxxx` command displays the provisioned frame power threshold for the specified frame, the maximum calculated power consumption for the frame based on card population, and the maximum power consumption for each card in the frame and for a fan assembly for each shelf.

**Note:**

The frame-level power threshold value needs to be determined from the capacity in Amps of the fuse alarm panel (FAP) for the frame. Contact your site engineer to determine the FAP capacity.

**Parameters****frm (mandatory)**

Frame ID.

**Range:****cf00**

Control frame

**ef00**

First extension frame

**ef01**

Second extension frame

**ef02**

Third extension frame

**ef03**

Fourth extension frame

**ef04**

Fifth extension frame

**thrshld (optional)**

Threshold. The frame-level power threshold value, in Amps. This value is compared with the current calculated maximum power consumption for a particular frame (use the `rtrv-stp:display=power:frm=` command to obtain the maximum power consumption value), and the appropriate alarms are raised if current consumption exceeds the threshold limit. The value of the `thrshld` parameter needs to be determined from the capacity of the fuse alarm panel (FAP) for the frame. Contact your site engineer to determine the frame FAP capacity.

**Range:**

30 - 65

**Default:**

30



### Example

Enter the frame power threshold value for the first extension frame.

```
ent-frm-pwr:frm=ef00:thrshld=55
```

### Dependencies

A valid value must be specified for the `frm` parameter.

The valid range for the `thrshld` parameter is 30-65 Amps.

The specified power threshold value (`thrshld` parameter) cannot already be provisioned for the specified frame.

The specified frame (`frm` parameter) must be a provisioned frame.

The Frame Power Threshold table must be accessible.

### Notes

The maximum calculated power for a frame is based on the cards that are populated in the system, and includes a fan tray assembly for every shelf (the system cannot detect the presence or absence of a fan tray, and assumes presence for the calculation). These values are typically much higher than the actual power being drawn; the values cannot be used as a gauge of the actual power consumption of the EAGLE.

### Output

```
ent-frm-pwr:frm=ef00:thrshld=55
```

```
tekelecstp 06-04-11 15:18:41 EST EAGLE 35.0.0
FRAME POWER THRESHOLD table is (4 of 10) 40% full
ENT-FRM-PWR: MASP A - COMPLTD
;
```

### Related Topics

- [chg-frm-pwr](#)
- [dlt-frm-pwr](#)
- [rtrv-frm-pwr](#)
- [rtrv-stp](#)

## ent-ftp-serv

Use this command to write an entry into the FTP Server table for an FTP Server.



**security (optional)**

The parameter specifies whether the FTP connection is secure or not.

**Range:**

*on*

Set the FTP connection to be secure.

*off*

Set the FTP connection to be unsecure.

**System Default:**

*on*

**Example**

```
ent-ftp-  
serv:app=meas:ipaddr=1.255.0.102:login=ftpmeas1:path="~meas":pr  
io=1  
  
ent-ftp-  
serv:app=user:ipaddr=1.255.0.102:login=tekperson1:path="~/data"  
:prio=1  
  
ent-ftp-serv:app=dist:ipaddr=192.168.53.195:  
  
login=pvftp:prio=1:path="/remote/labftp1/pvftp/dallen2ftp"  
  
ent-ftp-serv:app=db:ipaddr=192.168.53.195:  
  
login=pvftp:prio=1:path="/remote/labftp1/pvftp/aholden"  
  
ent-ftp-serv:ipaddr=10.248.13.9:app=meas:login=root:path="/  
root":prio=5:security=on  
  
ent-ftp-serv:ipaddr=10.248.13.9:app=sflog:login=root:path="/  
root":prio=1:security=on
```

**Dependencies**

A separate prompt appears for you to enter the FTP server password that will be used with the FTP Server Username (`login`). You must enter a password that is at least 1 and not more than 15 characters long. If you enter an invalid password (you press the Return key without entering a password, or you enter more than 15 characters), you must enter the entire command again to cause the password prompt to appear again. The password that you enter is not displayed as you enter it.

An entry for the specified application ID at the specified priority cannot already exist.

An entry for the specified application ID at the specified IP address cannot already exist.

The `app` parameter must specify an application that uses the FTP Support feature.

The `ipaddr` parameter must specify a valid IP address for the FTP server.

The `path` parameter value must be in a valid FTP path format.

The `prio` parameter specifies a priority for use of an FTP server by an application when the application has more than one FTP server defined in the table. Each FTP server defined for use by the application must have a priority from 1 to 10 assigned. The available FTP server with the highest priority (smallest number) will be used first by the application.

The FTP Server table can contain entries for a maximum of 10 FTP servers: however, the number of FTP servers supported by an application may be less than 10. Entries that are made for an application cannot be made for more than the maximum number of FTP servers supported by the application.

- The Measurements Platform application (`app=meas`) supports 3 FTP servers.
- The FTP-based Table Retrieve Application (FTRA) (`app=user`) supports 2 FTP servers.
- The Database (`app=db`) and Software Distribution (`app=dist`) applications each support 1 FTP server.
- The SS7 Firewall Logging application (`app=sflog`) supports 2 FTP servers.

The `security` parameter must be set with value ON when the SS7 Firewall Logging application (`app=sflog`) is configured.

### Notes

The same FTP server can be defined more than once, but the specified application must be different for each entry.

The FTP connection will be secure when the `security` parameter is ON. The secure FTP connection (SFTP) uses port 22, which must be opened in the customer's network.

### Output

```
ent-ftp-
serv:app=meas:ipaddr=1.255.0.102:login=ftpmeas1:path=~meas:prio=1

    rlghncxa03w 04-02-20 09:07:58 EST  EAGLE 31.3.0
Enter Password:*****
    FTP SERV table is (1 of 10) 10% full
    ENT-FTP-SERV: MASP A - COMPLTD
;

ent-ftp-
serv:app=user:ipaddr=1.255.0.102:login=tekperson1:path=~data:prio=
1

    rlghncxa03w 04-02-20 09:07:58 EST  EAGLE 31.3.0
Enter Password:*****
    FTP SERV table is (2 of 10) 20% full
    ENT-FTP-SERV: MASP A - COMPLTD
;
```

The following command provisions the FTP Server entry with 'security=on' to use a secure SFTP server.

```
ent-ftp-serv:ipaddr=10.248.13.100:app=user:login=root:path="/  
root":prio=4:security=on.
```

```
tekelecstp 12-09-19 14:49:17 EST 45.0.0-64.42.0  
ent-ftp-serv:ipaddr=10.248.13.100:app=user:login=root:path="/  
root":prio=4:security=on  
Command entered at terminal #4.  
Enter Password:***  
FTP SERV table is (3 of 10) 30% full  
ENT-FTP-SERV: MASP A- COMPLTD  
;
```

```
ent-ftp-  
serv:ipaddr=10.248.13.9:app=sflog:prio=1:login=root:path=data:s  
ecurity=on
```

```
tekelecstp 15-05-27 15:36:05 EST Eagle 46.3.0  
ent-ftp-  
serv:ipaddr=10.248.13.9:app=sflog:prio=1:login=root:path=data:security=  
on  
Command entered at terminal #4.  
Enter Password :*****  
FTP SERV table is (3 of 10) 30% full  
ENT-FTP-SERV: MASP A - COMPLTD  
;
```

### Related Topics

- [chg-ftp-serv](#)
- [dlt-ftp-serv](#)
- [rtv-ftp-serv](#)

## ent-gserv-data

Use this command to enter translation type, originating point code, or global title address data in the GSERV table. These values are used to determine whether a Send Routing Information (SRI) request should receive G-Port SRI Query for Prepaid service or normal G-Port SRI service.

### Parameters



#### Note:

See [Point Code Formats and Conversion](#) for a detailed description of point code formats, rules for specification, and examples.

### gta (optional)

Global title address. Use this parameter to specify a calling party (CgPA) global title address.

**Range:**

1 - 21 digits

**opc (optional)**

ANSI originating point code in the form of *network indicator-network cluster-network cluster member (ni-nc-ncm)*. The *prefix* subfield indicates a private point code *prefix-ni-nc-ncm*).

**Synonym:***opca***Range:***p-*, 000-255

Specify a valid value for each subfield of the point code, and separate the subfields with a dash (-).

*prefix—p-*

When *chg-sid:pctype=ansi* is specified, *ni = 000* is not valid.

When *chg-sid:pctype=ansi* is specified, *nc = 000* is not valid if *ni = 001-005*.

When *chg-sid:pctype=ansi* is specified, *nc = 000* is valid if *ni = 006-255*.

The point code *000-000-000* is not a valid point code.

**opc/opca/opci/opcn/opcn24 (optional)**

Originating point code. Use these parameters to specify message transfer part (MTP) originating point codes.

**opci (optional)**

ITU international originating point code with subfields *zone-area-id*.

**Range:***s-*, *p-*, *ps-*, 0-255

Specify a valid value for each subfield of the point code, and separate the subfields with a dash (-).

*prefix—s-, p-, ps**zone—0-7**area—000-255**id—0-7*

The point code *0-000-0* is not a valid point code.

**opcn (optional)**

ITU national originating point code in the format of a 5-digit number (*nnnnn*); or 2, 3, or 4 numbers (members) separated by dashes (*m1-m2-m3-m4*) as defined by the *chg-stpopts:npcfmti* flexible point code option. A group code must be specified when the ITUDUPPC feature is turned on (*nnnnn-gc*, *m1-m2-m3-m4-gc*).

**Range:***s-*, *p-*, *ps-*, 0-16383, *aa-zz*

Specify a valid value for each subfield of the point code, and separate the subfields with a dash (-).

*prefix—s-, p-, ps**nnnnn—0-16383**gc—aa-zz*

*m1-m2-m3-m4—0-14* for each member; values must sum to 14

**opcn24 (optional)**

24-bit ITU national originating point code with subfields *main signaling area-sub signaling area-signaling point (msa-ssa-sp)*.

**Range:***p*-, 000-255

Specify a valid value for each subfield of the point code, and separate the subfields with a dash (-).

*prefix*—*p**msa*—000—255*ssa*—000—255*sp*—000—255**tt (optional)**

Translation type. Use this parameter to specify a called party (CdPA) translation type.

**Range:**

0 - 255

**Example**

```
ent-gserv-data:tt=26
```

```
ent-gserv-data:opc=1-1-1
```

```
ent-gserv-data:gta=9194605500
```

**Dependencies**

Duplicate entries cannot exist in the GSERV table.

The system is busy, or the GSERV table is corrupted.

The G-Port SRI Query for Prepaid feature must be enabled before this command can be entered.

A new entry cannot be added to the GSERV table because all available space is in use. A maximum of 256 *tt* values, 50 *gta* values, and 50 *opc* values can be entered in the GSERV table.

The *tt*, *opc*, and *gta* parameters cannot be specified within the same command.

The G-Port feature must be enabled before this command can be entered.

**Notes**

A translation type, originating point code, or global title address value must be entered in the GSERV table and must match the corresponding SRI Query parameter for an SRI message to receive the G-Port SRI Query for Prepaid service.

The G-Port SRI Query for Prepaid feature must be on before entries in the GSERV table can be used to affect a G-Port SRI query

**Output**

```
ent-gserv-data:tt=26
```

```
mystp 06-07-27 22:58:17 EST EAGLE 35.2.0  
ENT-GSERV-DATA: MASP A - COMPLTD
```

**Related Topics**

- [dlt-gserv-data](#)
- [rtrv-gserv-data](#)

## ent-gsmmap-scrn

Use this command to assign the GSM (Global System for Mobile Telecommunication) MAP (Mobile Application Part) screening entries that filter or allow TCAP messages for certain MAP operation codes. The messages are filtered or allowed based on CgPA GTA+NPV+NAIV, CdPA GTA+NPV+NAIV, and forbidden (*forbid*) parameters. Each CgPA entry is associated with one or more CdPA entries and one or more CgPA entries are associated with a MAP Opcode. This command provisions both CgPA and CdPA entries into the database.

**Parameters****Note:**

See [Point Code Formats and Conversion](#) for a detailed description of point code formats, rules for specification, and examples.

**cgscr (mandatory)**

CGPA screening reference. This parameter specifies a CGPA entry for an OPNAME.

**Range:**

*ayyy*

1 alphabetic character and up to 3 optional alphanumeric characters

**opname (mandatory)**

Operation code name. This parameter references the operation code (*opcode*) defined with the `ent-gsms-opcode` command. GSM Map Screening is performed on the specified address or addresses for the referenced operation code.

**Range:**

*ayyyyyyy*

Up to 8 alphanumeric characters

**action (optional)**

The screening action to take if a message is forbidden as defined by the *forbid* parameter.

**Range:*****atierr***

Generate an ATI reject message. This option is only valid for ATI MAP operation codes.

***discard***

Discard the MSU



***dupdisc***

Route the original message to the duplicate node. The original message will not be sent to the original node. If, however, the duplicate node is not available for routing, the MSU is discarded.

***duplicate***

Route the message as normal to the original destination and route a copy of the original message to the duplicate node. If the MSU fails to route to the duplicate node, a UIM is generated indicating the duplicate routing failure.

***forward***

Route the original message to the forward node. The original message will not be sent to the original node. If, however, the forward node is not available for routing, the MSU is routed to the original node.

***pass***

Route the message as normal to the destination.

***route***

Route the message as normal to the original destination node; no UIM will be generated. The original destination is the node to which normal GTT would be sent if no GSM MAP actions are taken.

**Default:**

*discard*

***cdsr* (optional)**

CDPA screening reference. A CDPA entry for a combination of CGSR and OPNAME.

**Range:**

*ayyy*

1 alphabetic character and up to 3 optional alphanumeric characters

***eaddr* (optional)**

Ending CDPA address. This parameter is used with the *npv*, *naiv*, *cgsr*, and *cdsr* parameters.

**Range:**

1-15 digits

Valid digits are *0–9, a-f, A-F*

***forbid* (optional)**

Forbidden parameter value. A forbidden parameter for the entered address. If a forbidden parameter is detected, then the message is rejected by the action defined by the *action* parameter.

**Range:**

***all***

All parameters are forbidden. Take the specified screening action defined by the *action* parameter for messages arriving at the system.

***none***

None of the parameters are forbidden. Route the message to its destination.

**state**

Take the specified screening action defined by the `naction` parameter for messages arriving at the system that contain `state` as the forbidden parameter for the entered address/operation code combination.

**Note:**

The `state` parameter is valid only for GSM ATI messages.

**location**

Take the specified screening action defined by the `naction` parameter for messages arriving at the system that contain `location` as the forbidden parameter for the entered address/operation code combination.

**Note:**

The `location` parameter is valid only for GSM ATI messages.

**Default:**

*all*

**force (optional)**

Check Mated Application Override. This parameter must be used to complete command execution if the `pc/pca/pci/pcn/pcn24` and `ssn` parameter combination (if the `ssn` parameter has a value other than *none*) specified in the command is not already defined in the SCCP Application entity set (Remote Point Code/Mated Application Table).

**Range:**

*yes*

*no*

**Default:**

*no*

**mapset (optional)**

MAP set ID.

**Range:**

*1 - 36000, dflt*

*dflt* —Default MAP set

**naiv (optional)**

Nature of Address value for the address or range of CgPA and CdPA addresses. If a message is screened and does not contain matching `npv` and `naiv` values, the message is rejected. The message is rejected with the default action defined by the `ent-gsms-opcode` command for the operation code (`opcode`) parameter entry referenced by the operation name (`opname`) parameter.

This parameter must be specified with the `npv` parameter.

**Range:**  
0 - 127, \*

**Default:**  
\*

**npv (optional)**

Numbering Plan value for the address or range of CgPA and CdPA addresses. If a message is screened and does not contain matching npv and naiv values, the message is rejected. The message is rejected with the default action defined by the ent-gsms-opcode command for the operation code (opcode) parameter entry referenced by the operation name (opname) parameter.

This parameter must be specified with the naiv parameter.

**Range:**  
0 - 15, \*

**Default:**  
\*

**pc (optional)**

ANSI point code with subfields *network indicator-network cluster-network cluster member (ni-nc-ncm)*.

**Synonym:**  
*pca*

**Range:**  
000-255

Specify a valid value for each subfield of the point code, and separate the subfields with a dash (-).

When chg-sid:pctype=ansi is specified, *ni = 000* is not valid.

When chg-sid:pctype=ansi is specified, *nc = 000* is not valid if *ni = 001-005*.

When chg-sid:pctype=ansi is specified, *nc = 000* is valid if *ni = 006-255*.

The point code *000-000-000* is not a valid point code.

**pc/pca/pci/pcn/pcn24 (optional)**

Point code. The Point Code and SSN parameters are used to enter the node to which the input message will be routed.

**pci (optional)**

ITU international point code with subfields *zone-area-id*. The *prefix* subfield indicates a spare point code (*prefix-zone-area-id*).

**Range:**  
*s-*, 0-255

Specify a valid value for each subfield of the point code, and separate the subfields with a dash (-).

*prefix—s*

*zone—0-7*

*area—000-255*

*id—0-7*

The point code *0-000-0* is not a valid point code.

**pcn (optional)**

ITU national point code in the format of a 5-digit number (*nnnnn*); or 2, 3, or 4 numbers (members) separated by dashes (*m1-m2-m3-m4*) as defined by the `chg-stpopts:npcfmti` flexible point code option. A group code must be specified when the ITUDUPPC feature is turned on (*nnnnn-gc*, *m1-m2-m3-m4-gc*). The *prefix* subfield indicates a spare point code (*prefix-nnnnn*, *prefix-nnnnn-gc*, *prefix-m1-m2-m3-m4*, *prefix-m1-m2-m3-m4-gc*).

**Range:**

*s*-, 0-16383, *aa-zz*

Specify a valid value for each subfield of the point code, and separate the subfields with a dash (-).

*prefix*—*s*-

*nnnnn*—0-16383

*gc*—*aa-zz*

*m1-m2-m3-m4*—0-14 for each member; values must sum to 14

**pcn24 (optional)**

24-bit ITU national point code with subfields *main signaling area-sub signaling area-signaling point* (*msa-ssa-sp*).

**Range:**

000-255

Specify a valid value for each subfield of the point code, and separate the subfields with a dash (-).

*msa*—000–255

*ssa*—000–255

*sp*—000–255

**ri (optional)**

Routing indicator. This parameter specifies whether a subsequent global title translation is required.

This parameter can be specified only when the value specified for the `action` parameter is *forward*, *duplicate*, or *dupdisc*.

**Range:**

*gt*

*ssn*

**System Default:**

*ssn*

**saddr (optional)**

Starting origination address.

With the `npv`, `naiv`, and `cgsr` parameters, this parameter is for a single CGPA entry or the starting CGPA address in the range to be screened.

With the `npv`, `naiv`, and `cdsr` parameters, this parameter is for a single CDPA entry or the starting CDPA address in the range to be screened.

**Range:**

1-15 digits, \*

Valid digits are 0–9, a-f, A-F

**Default:**

\*

**ssn (optional)**

Subsystem Number. The Point Code and SSN are used to change the defined node where the input message will be routed.

**Range:**

002 - 255, none

**Default:**

none

**tt (optional)**

Translation type. The value that the CdPA TT is set to as the result of Enhanced GSM Map Screening.

This parameter can be specified only if the value specified for the `action` parameter is *forward*, *duplicate*, or *dupdisc*.

**Range:**

0 - 255, none

**Default:**

none

**Example**

The following example adds a MAP OPNAME of ATI with a range of allowed addresses, defines a forbidden parameter for that range of addresses and an action to take if the forbidden parameter is detected, and sets the NPV and NAIV values. This example is wrapped to the next line for readability:

```
ent-gsmmap-
scrn:saddr=919461:eaddr=919462:opname=ati:action=discard:forbid
=state :npv=1:naiv=4:cgsr=fela
```

The following example adds a MAP OPNAME of ATI of with a range of allowed addresses, defines a forbidden parameter for that range of addresses and an action to take if the forbidden parameter is detected, and sets the NPV and NAIV values. The command also defines an ITU International Point Code with Subsystem Number 5, and forbids by `location` messages that have an action of *forward*. This example is wrapped to the next line for readability:

```
ent-gsmmap-
scrn:saddr=919461:eaddr=919462:opname=ati:action=forward:pci=1-
1-1 :ssn=5:force=yes:forbid=location:cgsr=fela
```

The following example adds a MAP OPNAME of XYZ with an allowed hexadecimal address of abcdefabcdefabc, defines the action *discard* to take if a forbidden parameter is detected, and sets the NPV and NAIV values. The command also defines a CGSR of FELA. This example is wrapped to the next line for readability:

```
ent-gsmmap-
scrn:opname=xyz:saddr=abcdefabcdefabc:npv=10:naiv=10:cgsr=fela
:action=discard
```

```
ent-gsmmap-  
scrn:opname=test2:cgsr=t1:cdsr=cd3:saddr=125:pci=s-1-1-1:ssn=10 :act  
ion=duplicate  
  
ent-gsmmap-  
scrn:opname=test2:cgsr=cg1:cdsr=cd1:saddr=125:pci=1-1-1:ssn=10 :acti  
on=duplicate:mapset=11  
  
ent-gsmmap-  
scrn:opname=test3:cgsr=ad:action=forward:pc=1-1-2:ssn=12:ri=gt  
  
ent-gsmmap-  
scrn:opname=test4:cgsr=ks1:action=forward:mapset=df1t:pc=1-2-3 :ssn=  
12:tt=11
```

## Dependencies

The GSM Map Screening feature must be turned on before this command can be entered.

The EGMS feature must be turned on before:

- The `saddr=*` parameter can be specified.
- Values for the `saddr` and `eaddr` parameters can contain hexadecimal digits.
- The `cdsr` parameter can be specified.
- The `pc/pca` parameter can be specified.

If the `eaddr` parameter is specified, the `saddr` parameter must be specified.

If the `eaddr` parameter is specified, then its value must contain the same number of digits as the value of the `saddr` parameter.

If the `eaddr` parameter is specified, its value must be greater than the `saddr` parameter value.

If the `saddr=*` parameter is specified, then the `eaddr` parameter cannot be specified.

If the `opname` parameter is specified, its value must exist in the GSM MAP Op-Code table.

A value of *state* or *location* cannot be specified for the `forbid` parameter unless the operation code (`opcode`) referenced by the `opname` parameter is 71.

The `action=atierr` parameter cannot be specified unless the operation code (`opcode`) referenced by the `opname` parameter is 71.

The GSM MAP Screening table cannot be full.

The GSM MAP Screening table must have at least two free entries to provision a CgPA entry, because a default wildcard CdPA entry is created for each CgPA entry.

If a single entry is specified for the CgPA/CdPA (the `eaddr` parameter is not specified), then the combination of `saddr/npv/naiv` and `opname` parameters cannot already exist in the GSM MAP screening table.

If a range entry is specified for the CgPA/CdPA (the `eaddr` parameter is specified), then the `saddr/eaddr/npv/naiv` and `opname` combination cannot already exist or overlap another range entry in the GSM MAP screening table.

If a CdPA entry is being created, then the CGSR must already exist for the specified OPNAME.

If a CgPA entry is being created, the CGSR cannot already exist for the specified OPNAME.

The specified `cdsr` cannot already exist for the specified `cgsr`.

If specified, the `pc/pca/pci/pcn/pcn24` parameter must be a full point code.

If the `action` parameter is specified with a value of *forward*, *duplicate*, or *dupdisc*, the `pc/pca/pci/pcn/pcn24` and `ssn` parameters must be specified.

The `pc/pca/pci/pcn/pcn24` and `ssn` parameters can be specified only if the `action` parameter is specified with a value of *forward*, *duplicate*, or *dupdisc*.

The `force` parameter can be specified only if the `pc/pca/pci/pcn /pcn24` and `ssn` parameters are specified.

If the `pc/pca/pci/pcn/pcn24` and `ssn` parameters are specified, and the `force` parameter is not specified as *yes*, then the PC/SSN must be populated in the SCCP Application entity set (Remote Point Code/MAP Table).

The values for the `npv` and `naiv` parameters must both be numbers or asterisks (\*).

The GSM Map screening table must be accessible.

The GSM Map Op-Code table must be accessible.

The Route table must be accessible.

If specified, the `pc/pca/pci/pcn/pcn24` parameter value must exist as a destination in the Ordered Route entity set or reside in a cluster (ANSI only) that exists as a destination in the Ordered Route entity set (for global title routing).

The `opname` parameter must consist of alphanumeric characters.

The `opname` parameter must be entered.

The `cgsr` parameter must be entered.

The `saddr` and `eaddr` parameters must each be between 1 - 15 digits in length.

The `npv` parameter must be in range (0 - 15, \*).

The `naiv` parameter must be in range (0 - 127, \*).

The `saddr` parameter must have valid hexadecimal digits (0 – 9, a-f, A-F, or \*).

The `eaddr` parameter must have valid hexadecimal digits (0 – 9, a - f, A - F).

The `cgsr` and `cdsr` parameters must each begin with an alphabetic character.

The `cgsr` and `cdsr` parameters must each consist of 1-4 alphanumeric characters.

If the `action` parameter has a value of *forward*, *duplicate*, or *dupdisc*, then the `mapset` parameter must be specified.

If the `mapset`, `ri`, or `tt` parameter is specified, then the value specified for the `action` parameter must be *forward*, *duplicate*, or *dupdisc*.

The Flexible GTT Load Sharing feature must be enabled before the `mapset` parameter can be specified.

The specified MAP set must exist.

If the value of the `mapset` parameter is not `dfmt`, then the specified PC/SSN must exist in the specified MAP set.

If the `mapset=dfmt` parameter is specified, and the `force` parameter is not specified as `yes`, then the specified PC/SSN must exist in the specified MAP set.

The MAP Table must be accessible.

If the `action` parameter has a value of `forward`, `duplicate`, or `dupdisc`, then the value specified for the `pc/pca/pci/pcn/pcn24` parameter cannot be associated with a proxy point code.

If the `ri=ssn` parameter is specified, then the `ssn=none` parameter cannot be specified.

If the `forbid=none` parameter is specified, then the `action=pass` parameter must be specified.

If the FGTTLS feature is enabled, the `mapset` parameter is specified, and the `ssn` parameter is not specified or has a value of `none`, then the specified MAPSET/PC combination must already exist in the MAP table.

If the FGTTLS feature is not enabled and the `ssn` parameter is not specified or has a value of `none`, then the specified point code must already exist in the MAP table.

## Notes

GSM screening entries are handled differently from other screening entries such as GWS (gateway screening) in the system database. The following differences apply to provisioning GSM screening entries:

- GSM screening entries can be either single entries or range entries.
- Single entries have precedence in screening over range entries. Thus the single entries are searched first and if a match is found, the range entries are never searched.
- Range entries can overlap single entries.

In this command, only ITU-international and ITU national point codes support the spare point code subtype prefix (s-).

## Output

```
ent-gsmmap-
scrn:opname=test2:cgsr=cg1:cdsr=cd1:saddr=125:pci=1-1-1:ssn=10:ac
tion=duplicate:mapset=11
```

```
tekelecstp 06-05-29 13:24:41 EST EAGLE 35.0.0
GSM Map Screening table is (1 of 4000) 1% full
ENT-GSM MAP-SCRN: MASP A - COMPLTD
;
```

```
ent-gsmmap-
scrn:opname=test3:cgsr=ad:action=forward:pc=1-1-2:ssn=12:ri=gt
```

```
tekelecstp 08-01-18 17:03:01 EST EAGLE 38.0.0
GSM MAP Screening Table (4 of 4000) is 1% full
```



```
ENT-GSM MAP-SCRN: MASP A - COMPLTD
;

ent-gsmmap-
scrn:opname=test4:cgsr=ksl:action=forward:mapset=df1t:pc=1-2-3:
ssn=12:tt=11

tekelecstp 08-08-20 19:13:01 EST EAGLE 39.2.0
GSM MAP Screening Table (1 of 4000) is 1% full
ENT-GSM MAP-SCRN: MASP A - COMPLTD
;
```

### Related Topics

- [chg-gsmmap-scrn](#)
- [chg-map](#)
- [dlt-gsmmap-scrn](#)
- [dlt-map](#)
- [rtrv-gsmmap-scrn](#)
- [rtrv-map](#)

## ent-gsms-opcode

Use this command to assign the concerned GSM (Global System for Mobile Telecommunication) MAP (mobile application part) screening operation codes and the default screening action for the operation code. This command allows the craftsman to provision a list of all operation codes that the system uses in performing GSM screening.

### Parameters



#### Note:

See [Point Code Formats and Conversion](#) for a detailed description of point code formats, rules for specification, and examples.

### opcode (mandatory)

MAP operation code. This parameter refers to the actual decimal value of the MAP operation codes from the TCAP layer of GSM MAP messages.

#### Range:

0 - 255, \*

If a decimal Map Opcode is not found in the database, then the asterisk (wildcard \*), if provisioned, will constitute a match when screening the MSUs.

**opname (mandatory)**

Operation code name. The `opname` value is defined with the `ent-gsmmap-scrn` command.

**Range:**

*ayyyyyyy*

Up to 8 alphanumeric characters

**df1tact (optional)**

Default screening action for a MAP operation code. The default screening action is used when a matching CGPA address+NPV+NAIV entry is not found in the GSM MAP screening table.

**Range:*****atierr***

Do not route the MSU. An ATI (Any Time Interrogation) reject message is generated. This option is only valid for ATI MAP operation codes.

***discard***

Do not route the MSU. The MSU is discarded (thrown away) and an appropriate UIM is issued.

***dupdisc***

Route the original message to the duplicate node. The original message will not be sent to the original node. If, however, the duplicate node is not available for routing, the MSU is discarded.

***duplicate***

Route the message as normal to the original destination and route a copy of the original message to the duplicate node. If the MSU fails to route to the duplicate node, a UIM is generated indicating the duplicate routing failure.

***forward***

Route the original message to the forward node. The original message will not be sent to the original node. If, however, the forward node is not available for routing, the MSU is routed to the original node.

***pass***

Route the message as normal to the destination.

***route***

Route the message as normal to the original destination node; no UIM will be generated. The original destination is the node to which normal GTT would be sent if no GSM MAP actions are taken.

**Default:**

*discard*

**force (optional)**

Check Mated Application Override. This parameter must be used to complete command execution if the `pc/pca/pci/pcn/pcn24` and `ssn` parameter combination (if the `ssn` parameter has a value other than *none*) specified in the command is not already defined in the SCCP Application entity set (Remote Point Code/Mated Application Table).

**Range:***yes**no***Default:***no***mapset (optional)**

MAP set ID.

**Range:***1 - 36000, dflt**dflt* —Default MAP set**pc (optional)**ANSI point code with subfields *network indicator-network cluster-network cluster member (ni-nc-ncm)*.**Synonym:***pca***Range:***000-255*

Specify a valid value for each subfield of the point code, and separate the subfields with a dash (-).

When *chg-sid:pctype=ansi* is specified, *ni = 000* is not valid.When *chg-sid:pctype=ansi* is specified, *nc = 000* is not valid if *ni = 001–005*.When *chg-sid:pctype=ansi* is specified, *nc = 000* is valid if *ni = 006–255*.The point code *000-000-000* is not a valid point code.**pc/pca/pci/pcn/pcn24 (optional)**Point code. The *pc/pca/pci/pcn/pcn24* and *ssn* parameters allow the user to change the defined node to which the input message will be routed.**pci (optional)**ITU international point code with subfields *zone-area-id*. The *prefix* subfield indicates a spare point code (*prefix-zone-area-id*).**Range:***s-, 0-255*

Specify a valid value for each subfield of the point code, and separate the subfields with a dash (-).

*prefix—s**zone—0-7**area—000-255**id—0-7*The point code *0-000-0* is not a valid point code.**pcn (optional)**ITU national point code in the format of a 5-digit number (*nnnnn*); or 2, 3, or 4 numbers (members) separated by dashes (*m1-m2-m3-m4*) as defined by the *chg-stpopts:npcfmti* flexible point code option. A group code must be specified when the ITUDUPPC feature is turned on (*nnnnn-gc, m1-m2-m3-m4-gc*). The *prefix* subfield

indicates a spare point code (*prefix-nnnnn*, *prefix-nnnnn-gc*, *prefix-m1-m2-m3-m4*, *prefix-m1-m2-m3-m4-gc*).

**Range:**

*s*-, 0-16383, *aa-zz*

Specify a valid value for each subfield of the point code, and separate the subfields with a dash (-).

*prefix*—*s*-

*nnnnn*—0-16383

*gc*—*aa-zz*

*m1-m2-m3-m4*—0-14 for each member; values must sum to 14

**pcn24 (optional)**

24-bit ITU national point code with subfields *main signaling area-sub signaling area-signaling point* (*msa-ssa-sp*).

**Range:**

000-255

Specify a valid value for each subfield of the point code, and separate the subfields with a dash (-).

*msa*—000–255

*ssa*—000–255

*sp*—000–255

**ri (optional)**

Routing indicator. This parameter specifies whether a subsequent global title translation is required.

**Note:**

This parameter can be specified only when the value specified for the `dflfact` parameter is *forward*, *duplicate*, or *dupdisc*.

**Range:**

*gt*

*ssn*

**System Default:**

*ssn*

**ssn (optional)**

Subsystem Number. The `pc/pca/pci/pcn/pcn24` and `ssn` parameters are used to change the defined node where the input message will be routed.

**Range:**

002 - 255

**Default:**

*none*

**tt (optional)**

Translation type. The value that the CdPA TT is set to as the result of Enhanced GSM Map Screening.

The parameter can be specified only if the value specified for the `dfltact` parameter is *forward*, *duplicate*, or *dupdisc*.

**Range:**

0 - 255, none

**Default:**

none

**Example**

This example adds a MAP operation code of 71 with a name of ATI with a default action of DISCARD:

```
ent-gsms-opcode:opcode=71:opname=ati:dfltact=discard
```

This example adds a MAP operation code of 71 with a name of ATI, a default action of FORWARD, an international point code of 1, a subsystem number of 5, and forces:

```
ent-gsms-  
opcode:opcode=71:opname=ati:dfltact=forward:pci=1-1-1:ssn=5:force=yes
```

This example adds a MAP operation code of 71 with a name of ATI, a default action of DUPLICATE, an international point code of 1, a subsystem number of 5, and forces:

```
ent-gsms-  
opcode:opcode=71:opname=ati:dfltact=duplicate:pci=1-1-1:ssn=5:force=yes
```

This example adds a MAP operation code of 71 with a name of ATI, a default action of DUPDISC, an international point code of 1, a subsystem number of 5, and forces:

```
ent-gsms-  
opcode:opcode=71:opname=ati:dfltact=dupdisc:pci=1-1-1:ssn=5:force=yes
```

This example adds a MAP operation code of \* with a name of XYZ, a default action of DUPLICATE, an ANSI point code of 8, a subsystem number of 20:

```
ent-gsms-  
opcode:opcode=*:opname=xyz:pca=8-8-8:dfltact=duplicate:ssn=20
```

This example adds a MAP operation code of 22 with a name of ATI with a default action of DISCARD:

```
ent-gsms-opcode:opcode=22:opname=ati:dfltact=discard
```

This example shows a spare point code:

```
ent-gsms-  
opcode:opname=test3:opcode=3:pci=s-1-1-1:dfltact=duplicate:ssn=10:force
```

This example shows a MAP set value. The Flexible GTT Load Sharing feature is ON.

```
ent-gsms-
opcode:opname=test3:opcode=3:pc=1-1-1:dfltact=duplicate:ssn=10:mapset=7
```

This example adds a MAP operation code of 27 with a name of TEST3, a default action of FORWARD, an ANSI point code of 1, a subsystem number of 12 and a routing indicator of GT:

```
ent-gsms-
opcode:opname=test3:opcode=27:dfltact=forward:pca=1-1-2:ssn=12:ri=gt
```

This example shows a translation type value:

```
ent-gsms-
opcode:opname=test4:opcode=32:dfltact=forward:mapset=dfmt:pc=1-2-3:ssn=12:tt=11
```

### Dependencies

The GSM Map Screening feature must be turned on before this command can be entered.

A valid value must be specified for the `dfltact` parameter.

The `opcode` parameter value must be specified as a number in the range 0-255 or as \*.

The reserved word *none* cannot be specified as a value for the `opname` parameter.

The `pc/pca/pci/pcn/pcn24` and `ssn` parameters can be specified only if the `dfltact` parameter is specified and its value is *forward*, *duplicate*, or *dupdisc*.

If the `dfltact` parameter is specified with a value of *forward*, *duplicate*, or *dupdisc*, then the `pc/pca/pci/pcn/pcn24` and `ssn` parameter must be specified.

The `force` parameter can be specified only if the `pc/pca/pci/pcn/pcn24` and the `ssn` parameters are specified.

The `dfltact=atierr` parameter cannot be specified unless the value of the operation code referenced by the `opname` parameter is 71. The `atierr` option is valid only for ATI MAP operation codes, and the `opcode=71` parameter signifies an ATI MAP operation code.

The value specified for the `opcode` parameter cannot already exist in the GSM Map Op-Code table.

The value specified for the `opname` parameter cannot already be used in the GSM Map Op-Code table.

If the `pc/pca/pci/pcn/pcn24` and `ssn` parameters are specified, and the `force` parameter is not specified as *yes*, then the PC-SSN must exist in the SCCP Application entity set (Remote Point Code / Mated Application Table).

The Enhanced GSM Map Screening feature must be enabled and turned on before the `opcode=*` parameter can be specified.

If specified, the `pc/pca/pci/pcn /pcn24` parameter value must be a full point code.

The GSM MAP Op-Code table must be accessible.

The Route table must be accessible.

If specified, the `pc/pca/pci/pcn/pcn24` parameter value must exist as a destination in the Ordered Route entity set or reside in a cluster (ANSI only) that exists as a destination in the Ordered Route entity set (for global title routing).

The Enhanced GSM Map Screening feature must be enabled and turned on when the PC/PCA is specified.

The `opname` parameter must consist of alphanumeric characters.

The `opname` parameter must be no more than 8 characters in length.

If the `mapset`, `ri`, or `tt` parameter is specified, then the value specified for the `dfltact` parameter must be *forward*, *duplicate*, or *dupdisc*.

If the `dfltact` parameter is specified as *forward*, *duplicate*, or *dupdisc*, then the `mapset` parameter must be specified.

The Flexible GTT Load Sharing feature must be enabled before the `mapset` parameter can be specified.

The specified MAP set must exist.

If the `mapset` parameter is not specified as *dflt*, or if the `mapset=dflt` parameter is specified, and the `force` parameter is not specified as *yes*, then the specified PC/SSN must exist in the specified MAP set.

The MAP table must be accessible.

If the `dfltact` parameter has a value of *forward*, *duplicate*, or *dupdisc*, then the value specified for the `pc/pca/pci/pcn/pcn24` parameter cannot be associated with a proxy point code.

If the `ri=ssn` parameter is specified, then the `ssn=none` parameter cannot be specified.

If the FGTTLS feature is enabled, the `mapset` parameter is specified and the `ssn` parameter is not specified or has a value of *none*, then the specified MAPSET/PC combination must already exist in the MAP table.

If the FGTTLS feature is not enabled and the `ssn` parameter is not specified or has a value of *none*, then the specified point code must already exist in the MAP table.

## Notes

Origination Addresses are considered to be the SCCP CGPA address as well as the Numbering Plan and Nature of Address values.

In this command, only ITU-international and ITU national point codes support the spare point code subtype prefix (s-).

## Output

```
ent-gsms-  
opcode:opname=test3:opcode=3:pc=1-1-1:dfltact=duplicate:ssn=10:  
mapset=7
```

```
tekelecstp 06-05-29 13:21:58 EST EAGLE 35.0.0
```

```
ENT-GSMS-OPCODE: MASP A - COMPLTD
;

ent-gsms-
opcode:opname=test3:opcode=27:dfltact=forward:pca=1-1-2:ssn=12:ri=gt

tekelecstp 08-01-18 16:56:43 EST EAGLE 38.0.0
ENT-GSM-OPCODE: MASP A - COMPLTD
;

ent-gsms-
opcode:opname=test4:opcode=32:dfltact=forward:mapset=dflt:pc=1-2-3:ssn=12:tt=11

tekelecstp 08-08-20 19:13:01 EST EAGLE 39.2.0
ENT-GSM-OPCODE: MASP A - COMPLTD
;
```

### Related Topics

- [chg-gsms-opcode](#)
- [dlt-gsms-opcode](#)
- [rtrv-gsms-opcode](#)

## ent-gsmssn-scrn

Use this command to provision origination and destination SSNs (subsystem numbers) to be screened using the GSM (Global System for Mobile Telecommunication) MAP (mobile application part) screening feature. The value of the `ssn` parameter that is entered with this command is added to the GSM SSN screening table. All the MAP messages with the originating or destination SSN entered are screened using the GSM Map screening feature.

### Parameters

#### **ssn (mandatory)**

Subsystem number.

#### **Range:**

000 - 255

#### **type (mandatory)**

Subsystem type.

#### **Range:**

#### **dest**

destination SSN



**orig**  
origination SSN

### Example

The following example adds an originating subsystem of 10 to the GSM SSN Screening table:

```
ent-gsmssn-scrn:ssn=10:type=orig
```

### Dependencies

The GSM Map Screening feature must be turned on before this command can be entered.

The GSM SSN screening table is corrupt or cannot be found.

A value for the `ssn` and `type` parameter combination cannot be specified that already exists in the GSM SSN screening table.

The `ssn` value must be a valid numeric between **0** and **255**

The type parameter value must be *orig* or *dest*.

### Notes

None

### Output

```
ent-gsmssn-scrn:ssn=10:type=orig
```

```
rlghncxa03w 04-01-10 11:43:04 EST EAGLE 31.3.0  
ENT-GSMSSN-SCRN: MASP A - COMPLTD
```

```
;
```

### Related Topics

- [dlt-gsmssn-scrn](#)
- [rtrv-gsmssn-scrn](#)

## ent-gta

Use this command to specify the GTA (global title address) information for applicable global title selectors required to specify a global title entry.

This command adds the routing object (a destination address and a subsystem number) for messages requiring a global title translation. The translation is performed on the basis of the global title address (GTA), global title indicator (GTI), numbering plan (NP), nature of address indicator (NAI), and translation type (TT) of each SS7 SCCP message directed to the STP with a routing indicator of 0, indicating a GTT is required.

 **Note:**

If the EGTT feature is turned on, then the GTT Selector (`ent/chg/dlt/rtrvgttssel`), GTT Set (`ent/dlt/rtrv-gttset`), and GTA (`ent/chg/dlt/rtrvgta`) commands replace the Translation Type (`ent/dlt/rtrv-tt`) and Global Title Translation (`ent/chg/dlt/rtrv-gtt`) commands. It is not recommended to run `ent/dlt/rtrv-tt & ent/chg/dlt/rtrv-gtt` commands as it may cause the advance GTA fields of GTT entry to be reset to the default values.

**Parameters** **Note:**

See [Point Code Formats and Conversion](#) for a detailed description of point code formats, rules for specification, and examples.

**gttsn (mandatory)**

GTT set name. The entity to which global title addresses and selectors are assigned.

**Range:**

*ayyyyyyy*

1 leading alphabetic and up to 8 following alphanumeric characters

**xlat (mandatory)**

Translate indicator. This parameter specifies translation actions and routing actions.

**Range:**

*dpc*

*dpcngt*

*dpcssn*

*none*

**acn (optional)**

Application context name. This parameter specifies the ITU TCAP *acn* field in the incoming MSU.

**Range:**

*0 - 255, \*, none*

The *acn* supports up to 7 subfields separated by dash (e.g., *1-202-33-104-54-26-007*)

\* —any valid value in the ITU TCAP *acn* field in the incoming MSU

*none* —there is no ITU TCAP *acn* field in the incoming MSU

**actsn (optional)**

GTT Action Set Name.

**Range:**

*ayyyyyyy*

1 leading alphabetic character and up to 8 following alphanumeric characters

**ccgt (optional)**

Cancel called global title indicator.

**Range:**

*yes*

*no*

**Default:**

*no*

**cdselid (optional)**

CdPA Selector ID.

**Range:**

*0 - 65534*

**cdssn (optional)**

Starting CdPA subsystem number.

**Range:**

*0 - 255*

**cgcnvsn (optional)**

CgPA conversion set name.

**Range:**

*ayyyyyyy*

1 leading alphabetic character and up to 8 following alphanumeric characters

**cggtmod (optional)**

Calling party GT modification indicator. This parameter specifies whether calling party global title modification is required.

**Range:**

*yes*

*no*

**Default:**

*no*

**cgpc (optional)**

ANSI CgPA point code with subfields *network indicator-network cluster-network cluster member (ni-nc-ncm)*.

**Synonym:**

*cgpca*

**Range:**

0-255, \*

Specify a valid value for each subfield of the point code, and separate the subfields with a dash (-).

The asterisk (\*) value is not valid for the *ni* subfield.

When `chg-sid:pctype=ansi` is specified, *ni=000* is not valid.

When `chg-sid:pctype=ansi` is specified, *nc = 000* is not valid if *ni=001-005*.

When `chg-sid:pctype=ansi` is specified, *nc=000* is valid if *ni=006-255*.

When `chg-sid:pctype=ansi` is specified, *ni-\*-\** is valid if *ni =006-255*.

The point code *000-000-000* is not a valid point code.

**cgpcaction (optional)**

This parameter is used to provide the required abilities, indicating what any particular translation needs to do with CgPA PC.

**Range:***dfit*

protocol will be allowed to perform all the required processing/conversion with CGPC.

*ignore*

CGPC will be left as it was in incoming MSU.

*remove*

CGPC will be removed from outgoing MSU.

**Default:***dfit***cgpci (optional)**

ITU international CgPA point code with subfields *zone-area-id*. The *prefix* subfield indicates a spare point code (*prefix-zone-area-id*).

**Range:***s-, 0-255*

Specify a valid value for each subfield of the point code, and separate the subfields with a dash (-).

*prefix—s**zone—0-7**area—000-255**id—0-7*

The point code *0-000-0* is not a valid point code.

**cgpcn (optional)**

ITU national CgPA point code in the format of a 5-digit number (*nnnnn*); or 2, 3, or 4 numbers (members) separated by dashes (*m1-m2-m3-m4*) as defined by the `chg-stpopts:npcfmti` flexible point code option. A group code must be specified when the ITUDUPPC feature is turned on (*nnnnn-gc*, *m1-m2-m3-m4-gc*). The *prefix* subfield indicates a spare point code (*prefix-nnnnn*, *prefix-nnnnn-gc*, *prefix-m1-m2-m3-m4*, *prefix-m1-m2-m3-m4-gc*).

**Range:***s*-, 0-16383, *aa-zz*

Specify a valid value for each subfield of the point code, and separate the subfields with a dash (-).

*prefix*—*s*-*nnnnn*—0-16383*gc*—*aa-zz**m1-m2-m3-m4*—0-14 for each member; values must sum to 14**cgpcn24 (optional)**24-bit ITU national CgPA point code with subfields *main signaling area-sub signaling area-signaling point* (*msa-ssa-sp*).**Range:**

000-255

Specify a valid value for each subfield of the point code, and separate the subfields with a dash (-).

*msa*—000–255*ssa*—000–255*sp*—000–255**cgpcn16 (optional)**16-bit ITU national CgPA point code with subfields *unit number-sub number area-main number area* (*un-sna-mna*).**Range:**

000--127

Specify a valid value for each subfield of the point code, and separate the subfields with a dash (-).

*un*---000---127*sna*---000---15*mna*---000---31**cgselid (optional)**

CgPA Selector ID.

**Range:**

0 - 65534

**cgssn (optional)**

Starting CgPA subsystem number.

**Range:**

0 - 255

**defmapvr (optional)**

Default MAP version for MBR opcodes. This parameter is used to provide the default MAP version for supported MBR opcodes if Application Context Name (ACN) is not present in an incoming MAP message.

**Range:****v1****v2****v3****Default:**

v3

**dpc (optional)**

ANSI destination point code with subfields *network indicator-network cluster-network cluster member (ni-nc-ncm)*.

**Synonym:**

dpca

**Range:**

0-255, \*

Specify a valid value for each subfield of the point code, and separate the subfields with a dash (-).

The asterisk (\*) value is not valid for the *ni* subfield.

When *chg-sid:pctype=ansi* is specified, *ni=000* is not valid.

When *chg-sid:pctype=ansi* is specified, *nc = 000* is not valid if *ni=001-005*.

When *chg-sid:pctype=ansi* is specified, *nc=000* is valid if *ni=006-255*.

When *chg-sid:pctype=ansi* is specified, *ni-\*-\** is valid if *ni =006-255*.

The point code *000-000-000* is not a valid point code.

**dpc/dpca/dpci/dpcn/dpcn24/dpcn16 (optional)**

Point Code.

**dpci (optional)**

ITU international destination point code with subfields *zone-area-id*. The *prefix* subfield indicates a spare point code (*prefix-zone-area-id*).

**Range:**

s-, 0-255

Specify a valid value for each subfield of the point code, and separate the subfields with a dash (-).

*prefix—s**zone—0-7**area—000-255**id—0-7*

The point code *0-000-0* is not a valid point code.

**dpcn (optional)**

ITU destination point code in the format of a 5-digit number (*nnnnn*); or 2, 3, or 4 numbers (members) separated by dashes (*m1-m2-m3-m4*) as defined by the *chg-stpopts:npcfmti* flexible point code option. A group code must be specified when the ITUDUPPC feature is turned on (*nnnnn-gc*, *m1-m2-m3-m4-gc*). The *prefix* subfield indicates a spare point code (*prefix-nnnnn*, *prefix-nnnnn-gc*, *prefix-m1-m2-m3-m4*, *prefix-m1-m2-m3-m4-gc*).

**Range:***s-*, 0-16383, *aa-zz*

Specify a valid value for each subfield of the point code, and separate the subfields with a dash (-).

*prefix—s-**nnnnn—0-16383**gc—aa-zz**m1-m2-m3-m4—0-14* for each member; values must sum to 14**dpcn24 (optional)**24-bit ITU national destination point code with subfields *main signaling area-sub signaling area-signaling point (msa-ssa-sp)*.**Range:**

000-255

Specify a valid value for each subfield of the point code, and separate the subfields with a dash (-).

*msa—000–255**ssa—000–255**sp—000–255***dpcn16 (optional)**16-bit ITU national destination point code with subfields *unit number-sub number area-main number area (un-sna-mna)*.**Range:**

000--127

Specify a valid value for each subfield of the point code, and separate the subfields with a dash (-).

*un---000---127**sna---000---15**mna---000---31***eaddr (optional)**

End Address (similar to EGTA). This parameter specifies the end of a range of MAP digits (IMEI/MSI/MSISDN/VLRNB/SMRPOA/SMRPDA).

**Range:**

1 - 21 digits

If the Hex Digit Support for GTT feature is not enabled, the range is 1 - 21 decimal digits; valid digits are 0-9.

If the Hex Digit Support for GTT feature is enabled and on, the range is 1 - 21 hexadecimal digits; valid digits are 0-9, a-f, A-F.

**Default:**

Same as the specified SADDR value

**ecdssn (optional)**

Ending CdPA subsystem number.

**Range:**

0 - 255

**ecgssn (optional)**

Ending CgPA subsystem number.

**Range:**

0 - 255

**egta (optional)**

End global title address. This parameter specifies the end of a range of global title digits.

**Range:**

1 - 21 digits

If the Hex Digit Support for GTT feature is not enabled, the range is 1 - 21 decimal digits; valid digits are 0-9.

If the Hex Digit Support for GTT feature is enabled and on, the range is 1 - 21 hexadecimal digits; valid digits are 0-9, a-f, A-F.

**Default:**

Same as the specified `gta` value

**fallback (optional)**

Fallback option. The action taken when the final translation does not match while performing GTT using a FLOBR-specific GTT mode.

**Range:****yes**

perform GTT based on the last matched entry

**no**

GTT fails and the MSU is discarded

**sysdfit**

use the system-wide default fallback option in the SCCPOPTS table

**Default:**

*sysdfit*

**family (optional)**

The ANSI TCAP *family* field in the incoming MSU.

**Range:**

0 - 255, \*, *none*

\* —any valid value in the ANSI TCAP *family* field in the incoming MSU

*none* —there is no value in the ANSI TCAP *family* field in the incoming MSU

**force (optional)**

Check mated application override. This parameter must be used to complete command execution if the `pci/pcn` and `ssn` parameter combination specified in the command is not already defined in the SCCP Application entity set (Remote Point Code/Mated Application Table).

**Range:****yes****no**



**Default:***no***gta (optional)**

Global title address. The beginning of a range of global title digits.

**Range:***1 - 21 digits*

If the Hex Digit Support for GTT feature is not enabled, the range is 1 - 21 decimal digits; valid digits are 0-9.

If the Hex Digit Support for GTT feature is enabled and on, the range is 1 - 21 hexadecimal digits; valid digits are 0-9, a-f, A-F.

**gtmodid (optional)**

Global title modification identifier.

**Range:***aaaaaaaa*

1 alphabetic character followed by up to 8 alphanumeric characters

**Default:***none***loopset (optional)**

SCCP loopset name. This parameter associates a translation set with a loopset.

**Range:***aaaaaaaa*

1 leading alphabetic character and up to 7 following alphanumeric characters.

*none* —There is no association between the translation set and any loopset.

**Default:***none***mapset (optional)**

MAP set ID. This parameter specifies the Mated Application set ID.

**Range:***1 - 36000, dflt*

*dflt* —Default MAP set

**mrnset (optional)**

MRN set ID. The Mated Relay Node set ID.

**Range:***1 - 3000, dflt, none*

*dflt* —Default MRN set

*none* —The GTA translation does not participate in any load sharing

**opc (optional)**

ANSI originating point code with subfields *network indicator-network cluster-network cluster member (ni-nc-ncm)*.

**Synonym:***opca*

**Range:**

0-255, \*

Specify a valid value for each subfield of the point code, and separate the subfields with a dash (-).

The asterisk (\*) value is not valid for the *ni* subfield.

When `chg-sid:pctype=ansi` is specified, *ni=000* is not valid.

When `chg-sid:pctype=ansi` is specified, *nc = 000* is not valid if *ni=001-005*.

When `chg-sid:pctype=ansi` is specified, *nc=000* is valid if *ni=006-255*.

When `chg-sid:pctype=ansi` is specified, *ni-\*.\** is valid if *ni =006-255*.

The point code *000-000-000* is not a valid point code.

**opc/opca/opci/opcn/opcn24/opcn16 (optional)**

Originating Point Code

**opci (optional)**

ITU international originating point code with subfields *zone-area-id*. The *prefix* subfield indicates a spare point code (*prefix-zone-area-id*).

**Range:**

s-, 0-255

Specify a valid value for each subfield of the point code, and separate the subfields with a dash (-).

*prefix*—s*zone*—0-7*area*—000-255*id*—0-7

The point code *0-000-0* is not a valid point code.

**opcn (optional)**

ITU originating point code in the format of a 5-digit number (*nnnnn*); or 2, 3, or 4 numbers (members) separated by dashes (*m1-m2-m3-m4*) as defined by the `chg-stpopts:npcfmti` flexible point code option. A group code must be specified when the ITUDUPPC feature is turned on (*nnnnn-gc*, *m1-m2-m3-m4-gc*). The *prefix* subfield indicates a spare point code (*prefix-nnnnn*, *prefix-nnnnn-gc*, *prefix-m1-m2-m3-m4*, *prefix-m1-m2-m3-m4-gc*).

**Range:**

s-, 0-16383, aa-zz

Specify a valid value for each subfield of the point code, and separate the subfields with a dash (-).

*prefix*—s-*nnnnn*—0-16383*gc*—aa-zz*m1-m2-m3-m4*—0-14 for each member; values must sum to 14**opcn24 (optional)**

24-bit ITU national originating point code with subfields *main signaling area-sub signaling area-signaling point* (*msa-ssa-sp*).

**Range:**

000-255

Specify a valid value for each subfield of the point code, and separate the subfields with a dash (-).

*msa*—000-255

ssa—000–255  
sp—000–255

**opc16 (optional)**

16-bit ITU national originating point code with subfields *unit number-sub number area-main number area* (*un-sna-mna*).

**Range:**

000--127

Specify a valid value for each subfield of the point code, and separate the subfields with a dash (-).

un---000---127

sna---000---15

mna---000---31

**opcode (optional)**

The TCAP *opcode* field in the incoming MSU.

**Range:**

0 - 255, \*, none

\* —any valid value in the TCAP *opcode* field in the incoming MSU

none —there is no value in the TCAP *opcode* field in the incoming MSU

**opcsn (optional)**

The OPC GTT set name.

**Range:**

ayyyyyyy

1 leading alphabetic character and up to 8 following alphanumeric characters

**optsn (optional)**

Optional gtt set name.

**Range:**

ayyyyyyy

1 leading alphabetic character and up to 8 following alphanumeric characters.

**pc (optional)**

ANSI point code with subfields *network indicator-network cluster-network cluster member* (*ni-nc-ncm*). The *prefix* subfield indicates a private point code (*prefix-ni-nc-ncm*).

**Synonym:**

pca

**Range:**

p-, 000-255

Specify a valid value for each subfield of the point code, and separate the subfields with a dash (-).

prefix—p-

When `chg-sid:pctype=ansi` is specified, *ni = 000* is not valid.

When `chg-sid:pctype=ansi` is specified, `nc = 000` is not valid if `ni = 001-005`.

When `chg-sid:pctype=ansi` is specified, `nc = 000` is valid if `ni = 006-255`.

The point code `000-000-000` is not a valid point code.

#### **pc/pca/pci/pcn/pcn24/pcn16 (optional)**

Point code.

#### **pci (optional)**

ITU international destination point code with subfields *zone-area-id*. The *prefix* subfield indicates a spare point code, private point code, or private and spare point code (*prefix-zone-area-id*).

##### **Range:**

*s-, p-, ps-, 0-255*

Specify a valid value for each subfield of the point code, and separate the subfields with a dash (-).

*prefix—s-, p-, ps*

*zone—0-7*

*area—000-255*

*id—0-7*

The point code `0-000-0` is not a valid point code.

#### **pcn (optional)**

ITU national point code in the format of a 5-digit number (*nnnnn*); or 2, 3, or 4 numbers (members) separated by dashes (*m1-m2-m3-m4*) as defined by the `chg-stpopts:npcfmti` flexible point code option. A group code must be specified when the ITUDUPPC feature is turned on (*nnnnn-gc, m1-m2-m3-m4-gc*). The *prefix* subfield indicates a spare point code, private point code, or private and spare point code (*prefix-nnnnn, prefix-nnnnn-gc, prefix-m1-m2-m3-m4, prefix-m1-m2-m3-m4-gc*).

##### **Range:**

*s-, p-, ps-, 0-16383, aa-zz*

Specify a valid value for each subfield of the point code, and separate the subfields with a dash (-).

*prefix—s-, p-, ps*

*nnnnn—0-16383*

*gc—aa-zz*

*m1-m2-m3-m4—0-14* for each member; values must sum to 14

#### **pcn24 (optional)**

24-bit ITU national point code with subfields *main signaling area-sub signaling area-signaling point* (*msa-ssa-sp*). The *prefix* subfield indicates a private point code (*prefix-msa-ssa-sp*).

##### **Range:**

*p-, 000-255*

Specify a valid value for each subfield of the point code, and separate the subfields with a dash (-).

*prefix—p*

*msa—000-255*

*ssa—000-255*

*sp—000-255*

#### **pcn16 (optional)**

16-bit ITU national point code with subfields *unit number-sub number area-main number area* (*un-sna-mna*). The *prefix* subfield indicates a private point code (*prefix-un-sna-mna*).

**Range:**

*p*, 000--127

Specify a valid value for each subfield of the point code, and separate the subfields with a dash (-).

*prefix---p*

*un---000---127*

*sna---000---15*

*mna---000---31*

**pkgtype (optional)**

The ANSI and ITU TCAP package type.

**Range:**

***ituuni***

ITU unidirectional

***qwp***

Query with Permission

***qwop***

Query without Permission

***resp***

Response

***cwp***

Conversation with Permission

***cwop***

Conversation without Permission

***any***

Wildcard value

***bgn***

Begin

***end***

End

***cnt***

Continue

***ituabort***

ITU abort

***ansiabort***

ANSI abort

***ansiuni***

ANSI unidirectional

**ANSI TCAP Package Types**

*ansiuni, qwp, qwop, resp, cwp, cwop, ansiabort, any*

**ITU TCAP Package Types**

*bgn, ituabort, ituuni, any, end, cnt*

**ppmeasreqd (optional)**

This parameter specifies whether Per Path measurements are required.

**Range:**

***yes***

per path measurements are required

***no***

per path measurements are not required

**Default:**

No change to the current value

**prio (optional)**

This parameter assigns priority to an OPCODE GTTSET based translation.

**Range:**

*1 - 1024*

1 is the highest priority and 1024 the lowest

**Default:**

*1024*

**ri (optional)**

Routing indicator.

**Range:**

***gt***

Allow a called party address with a routing indicator value of "global title."

***ssn***

Allow a called party address with a routing indicator value of "DPC/SSN."

**saddr (optional)**

Start Address (similar to GTA). This parameter specifies the beginning of a range of MAP digits (IMEI/MSI/MSISDN/VLRNB/SMRPOA/SMRPDA).

**Range:**

*1 - 21 digits*

If the Hex Digit Support for GTT feature is not enabled, the range is 1 - 21 decimal digits; valid digits are 0-9.

If the Hex Digit Support for GTT feature is enabled and on, the range is 1 - 21 hexadecimal digits; valid digits are 0-9, a-f, A-F.

**ssn (optional)**

New translated subsystem number.

**Range:**  
002 - 255

**Default:**  
none

**testmode (optional)**

This parameter is used to invoke a field-safe Test Tool in order to debug the FLOBR/TOBR rules.

**▲ Caution:**

If the `testmode=on` parameter is specified, then the rule is used only by test messages. The rule is ignored by 'live' traffic. If the `testmode=off` parameter is specified, then both test and live messages use the rule. Changing from `testmode=off` to `testmode=on` is equivalent to deleting the rule for live traffic.

**Range:**

**on**  
Process the translation rules defined in the test message

**off**  
Perform standard GTT behavior

**Default:**  
*off*

**transmeasrqd (optional)**

GTT Translation Measurement Required. This parameter specifies whether to perform per GTT Translation Measurements.

**Range:**

**yes**  
perform per GTT Translation Measurements

**no**  
do not perform per GTT Translation Measurements

**Default:**  
*no*

**Example**

The lines in some examples are wrapped for readability:

```
ent-gta:gttsn=lidb:gta=9195554321:xlat=dpc:ri=gt:pc=001-255-253
ent-gta:gttsn=t800:gta=919460:xlat=dpc:ri=gt:pc=001-255-252
ent-gta:gttsn=t800:gta=919461:egta=919468:
xlat=dpc:ssn:ri=ssn:pc=001-255-252:ssn=254
ent-gta:gttsn=setint000:gta=391951212000000:
```

```
egta=391951212399999:xlat=dpcssn :ri=ssn:pci=1-253-1:ssn=255
ent-gta:gttsn=imsi:gta=591975593000000:
egta=591975593299999:xlat=dpcngt:ri=gt :pci=004-167-25
ent-gta:gttsn=test:gta=100000:egta=199999:
pca=1-1-1:ssn=123:xlat=dpcngt:gtmodid=set1
ent-gta:gttsn=test2:gta=123:egta=321:
pcn=222:ssn=10:xlat=dpcngt:ri=gt:gtmodid=set2
ent-gta:xlat=dpcssn:ri=ssn:pcn24=8-8-8:gttsn=any:gta=919833:ssn=20
ent-gta:xlat=dpcssn:ri=ssn:ssn=10:gta=12345678901:
egta=23456789012:gtmodid=set3:pcn=s-124: gttsn=setnat003
ent-gta:xlat=dpcssn:ri=ssn:ssn=10:gta=12345688901:
egta=23456889012:pcn=s-128-aa: gttsn=setnat003
ent-gta:gta=987666799012345678901:egta=987667321099765432101
xlat=dpcngt:ri=gt:pcn=s-124-aa:ccgt=no: gttsn=setnat003:gtmodid=set6
ent-gta:xlat=dpcssn:ri=ssn:ssn=10:gta=13345688901:
egta=24456889012:pci=s-1-230-2:gttsn=ituil
ent-
gta:gttsn=tbla:xlat=dpc:ri=gt:pc=1-1-1:gta=1234567700:mrnset=df1t
ent-gta:gttsn=tbla:xlat=dpc:ri=gt:pc=1-1-1:gta=1234567890:
egta=2234567890:mrnset=23
ent-gta:gttsn=tbla:xlat=dpcngt:ri=gt:pc=1-1-2:gta=2345678901:
egta=3456789012:mrnset=54
ent-gta:gttsn=tbla:xlat=dpcngt:ri=gt:pc=1-1-3:gta=3456789012:
egta=4567890123:mrnset=none
ent-gta:gttsn=tblx:xlat=dpcssn:ri=ssn:pc=1-1-1:gta=1234567890:
egta=2234567890:ssn=10: mapset=23
ent-gta:gttsn=tblx:xlat=dpc:ri=ssn:pc=2-2-2:gta=2345678911:
egta=3456789022:mapset=df1t
ent-
gta:gttsn=t800:gta=919460:xlat=dpc:ri=gt:pc=001-255-252:transmeasrqd
=yes
```

This example provisions GTA translations when TOBR is turned on.

```
ent-
gta:gttsn=setopcode:opcode=*:pkgtype=bgn:acn=*:xlat=dpc:ri=gt:pci=1-
1-1:prio=1024
```



This example provisions Advanced CdPA GTA translations.

```
ent-
gta:gttsn=setcdgta:gta=123456789012345678901:egta=2234567890123
45678901:

xlat=dpcssn:ri=ssn:pca=001-001-001:ssn=100:optsn=setcggta:opcsn
=setopc
```

This example provisions GTA translations when FLOBR is turned on.

```
ent-gta:gttsn=setcdgta:gta=1234567890:egta=2234567890:

xlat=dpcssn:ri=ssn:pca=001-001-001:ssn=100:fallback=yes:testmod
e=on

ent-gta:gttsn=setudts1:gta=423456789012345678901:

xlat=dpc:ri=gt:pc=2-2-2:egta=523456789012345678901:actsn=actudt
s1

ent-
gta:gttsn=setcggta:gta=323456789012345678901:egta=4234567890123
45678901:

xlat=dpcssn:ri=ssn:pca=001-001-001:ssn=20:optsn=setcgssn

ent-gta:gttsn=cggtadsc:gta=623456789012345678901:

egta=623456789012345678901: actsn=actdisc1

ent-gta:gttsn=setcgpca:cgpca=001-001-001:xlat=dpcssn:

ri=ssn: pca=001-001-001:ssn=20:optsn=setcgssn

ent-gta:gttsn=cgpcudt2:xlat=dpc:ri=gt:pc=2-2-2:

cgpca=001-001-009:actsn=actudts2

ent-gta:gttsn=setopc:opca=002-001-001:xlat=dpcssn:

ri=ssn: pca=001-001-001:ssn=20:optsn=setcgssn

ent-gta:gttsn=opcdis3:opca=002-001-001:actsn=actdisc1

ent-gta:gttsn=setcgssn:cgssn=100:ecgssn=200:

xlat=dpcssn:ri=ssn: pca=001-001-001:ssn=20

ent-gta:gttsn=cgssnud3:xlat=dpc:ri=gt:pc=001-002-003:

cgssn=100:ecgssn=200:actsn=actudts1: ppmeasreqd=yes

ent-
gta:gttsn=setans004:gta=981817:xlat=dpc:pc=1-1-1:ri=gt:cggmod=
yes

ent-gta:gttsn=tblx:xlat=dpcssn:ri=ssn:pc=1-1-1:

gta=1234567890:egta=2234567890:ssn=10:
mapset=23:loopset=raleigh1
```

The following example provisions the flexible GTA translations when the FLOBR and OBSR features are turned on.

```
ent-gta:gttsn=setcggta:gta=1234567890:egta=2234567890:
xlat=dpcssn:ri=ssn:pca=001-001-001:ssn=100:fallback=yes:opcsn=setopcsn
ent-gta:gttsn=setopc:opca=2-2-2:xlat=dpcssn:ri=ssn:
pca=001-001-002:ssn=100:optsn=setcggpc:fallback=no
ent-gta:gttsn=setcdgta:gta=567565756552:
xlat=dpc:ri=gt:pc=1-1-2:optsn=setcggpc:fallback=no:opcsn=setopc
```

This example provisions GTA translation when the FLOBR feature is turned on.

```
ent-gta:gttsn=setcdssn:cdssn=5:xlat=dpc:ri=gt:pc=1-1-1:opcsn=setopc
```

These examples provision the GTA translations when the TOBR and OBSR features are turned on.

```
ent-gta:gttsn=setopcode:pkgtype=qwop:opcode=none:family=*:
xlat=dpc:ri=gt:pc=2-2-2:opcsn=setopc: optsn=setcdgta
ent-gta:gttsn=setopcode:pkgtype=bgn:opcode=none:acn=1-2-3-4-5-6-7:
xlat=dpc:ri=gt:pc=2-2-2:opcsn=setopc: optsn=setcdgta
ent-gta:gttsn=setopcode:pkgtype=bgn:opcode=2:defmapvr=v2:
xlat=dpc:ri=gt:pci=2-2-2:opcsn=setopc:optsn=imsil
ent-
gta:gttsn=imsil:xlat=dpc:ri=gt:pc=1-1-1:saddr=1234567890:eaddr=2234567890
```

This example provisions a DPC translation when the FLOBR feature is turned on.

```
ent-gta:gttsn=setdpc:xlat=dpc:ri=gt:pc=1-1-1:dpc=1-1-2:optsn=setdpc1
ent-gta:gttsn=setcdgta:xlat=none:actsn=asetdisc:ppmeasreqd=yes
ent-gta:gttsn=setopcode:pkgtype=bgn:opcode=none:
acn=1-2-3-4-5-6-8:xlat=none:mapset=1: mrnset=1
```

Example for 16 bit PC and CGPCACTION param.

```
ent-gta:gttsn=gttl1:xlat=dpc:ri=ssn:pcn16=1-14-0:cgpcn16=45-1-0:
mapset=dflt:cgpcaction=ignore
```

### Dependencies

The EGTT feature must be turned on before this command can be entered.

The ANSI/ITU SCCP Conversion feature must be enabled before a translated PC that is of a different domain than the GTT set specified by the `gttsn` parameter can be specified.

The ANSI/ITU SCCP Conversion feature must be enabled before a translated PC and a translation type in different network types can be specified.

The `gttsn` parameter must be specified and must match an existing `gttsn`.

The `pc/pca/pci/pcn/pcn24/pcn16` parameter cannot be out of range.

If the `egta/eaddr` parameter is specified, then the values of the `gta/saddr` and `egta/eaddr` parameters must be the same length.

The length of the specified `gta/saddr` parameter must match the number of digits provisioned for the specified GTT set (`gttsn`) when VGTT is OFF. If the VGTT (variable length GTT) feature is turned on, then up to 10 GTA/SADDR lengths can exist per GTT set. If the Support for 16 GTT Lengths in VGTT feature is turned on, then up to 16 GTA/SADDR lengths can exist per GTT set.

The specified `gta/egta` or `saddr/eaddr` range must exist for the specified GTT set in the STP active database. While an exact match is not required, you cannot specify an overlap with another range. If the range overlaps, an error is generated that displays a list of overlapped global title addresses. An example follows that shows what happens when the user attempts to enter a global title address range (such as 8005550000 to 8005559999) that overlaps an existing range. The overlapping links must match. If they do not, the error message displays the list of overlapped global title addresses:

```
The following GTA ranges overlap the input GTA range START GTA END GTA
8005550000 8005551999 8005552000 8005553999 8005554000 8005555999 ENT-
GTA: MASP A - Command Aborted
```

If the translated point code is of type ANSI, the `ngti` parameter of the referred GTMOD cannot be 4. For ANSI PCs, the `ngti` value must be 2.

If the new or existing `pc/pca/pci/pcn/pcn24/pcn16` parameter is the STP point code or capability point code, then the `ccgt=no` parameter must be specified.

If the `xlat=dpcngt` parameter is specified, then the `ri=gt` parameter must be specified.

If the `ssn` parameter is specified, then the `xlat=dpcssn` parameter must be specified.

If the `xlat=dpcssn` parameter is specified, then the `ssn` parameter must be specified.

If the value specified for the `pc/pca/pci/pcn/pcn24/pcn16` parameter is the STP's true point code, the `xlat=dpcssn` and `ri=ssn` parameters must be specified.

If the value specified for the `pc/pca/pci/pcn/pcn24/pcn16` parameter is the STP's true point code and the `ssn` parameter is specified, the `ssn` parameter must exist in the SS-APPL table.

Unless the PC is the STP true PC, the value specified for the `pc/pca/pci/pcn/pcn24/pcn16` parameter must exist as a destination in the Route table or reside in a cluster that exists as a destination in the Route table (for global routing).

If a final GTT (the `ri=ssn` parameter is specified with the `xlat=dpc` parameter and without the `force=yes` parameter), then the PC (`pc/pca/pci/pcn/pcn24/pcn16`) must exist in the Remote Point Code/MAP table. The `force=yes` parameter can be specified to execute the command when the PC is not in the table; the following warning message is displayed in the scroll area of the terminal:

```
CAUTION: DPC DOES NOT EXIST IN MATED APPLICATION TABLE.
```

If the `ccgt=yes` parameter is specified, then the `ri=ssn` parameter must be specified.

If the `ri=gt` parameter is specified, then the `ccgt=no` parameter must be specified.

If the `pc/pca/pci/pcn/pcn24/pcn16` parameter is any of the STP's PCs or CPCs, then the `ccgt=no` parameter must be specified.

If the XGTT feature is enabled, the GTT table can contain up to either 400,000 or 1,000,000 entries, depending on the controlled feature Part Number that is enabled. If XGTT is not enabled, the GTT table can contain up to 269,999 user entries. An error message is displayed if a command entry would result in more than the allowed maximum number of entries in the table.

If the `egta/eaddr` parameter is specified, then the value of the `egta/eaddr` parameter must be greater than or equal to the value of the `gta/saddr` parameter.

The GTT Set Name must not be *none*.

The `pc/pca/pci/pcn/pcn24/pcn16` parameter must be a full PC.

If the VGTT feature is turned on, then up to 10 GTA/SADDR lengths can exist per GTT set. If the Support for 16 GTT Lengths in VGTT feature is turned on, then up to 16 GTA/SADDR lengths can exist per GTT set.

The GTT Selector table is corrupt or cannot be found.

The GTT Set table is corrupt or cannot be found.

The GTA table is corrupt or cannot be found.

The GTT DBMM table is corrupt or cannot be found.

A severe system fault has occurred, and the command was rejected.

The Site ID table is corrupt or cannot be found.

The SS-APPL table is corrupt or cannot be found.

The Route table is corrupt or cannot be found.

The MRN table is corrupt or cannot be found.

The MAP table is corrupt or cannot be found.

If the `ri=ssn` parameter is specified, then the `mrnset` parameter must not be specified.

If the Flexible GTT Load Sharing feature is enabled, then the specified PC must already exist in the specified MRN set.

The specified MRN set must already exist in the MRN table.

The `mrnset` parameter can only be specified when the Flexible GTT Load-Sharing feature is enabled.

If the `ri=gt` parameter is specified, then the `mrnset` parameter must be specified.

The `mapset` parameter can only be specified if the Flexible GTT Load Sharing feature is enabled, and the `ri=ssn` parameter is specified. If the `ri=ssn` parameter is specified, the `mapset` parameter must be specified. If the `ri=gt` parameter is specified, the `mapset` parameter cannot be specified.

The Flexible GTT Load Sharing feature must be enabled before the `mapset` parameter can be specified.

The specified PC and SSN must exist in the specified MAP set.

The specified MAP set must exist in the database.

If the `xlat=dpc` parameter is specified, and the `force` parameter is not specified as yes, then the specified PC and MAP set must exist in the MAP table.

The MAP table is corrupt or cannot be found.

The `gta`, `cgpc/cgpca/cgpci/cgpcn/cgpcn24/cgpcn16`, `opc/opca/opci/opcn/opcn24/opcn16`, `cgssn`, `cdssn`, `opcode/acn/pkgtype`, `opcode/family/pkgtype`, `dpc/dpca/dpci/dpcn/dpcn24/dpcn16`, or `saddr` parameter must be specified.

The `cdselid`, `cgselid`, and `optsn` parameters cannot be specified together in the command. If the GTT set has a set type of `cdgta`, `cdssn`, or `opcode`, then the `opcsn` parameter can be specified with one of the above parameters.

If the `cgssn` parameter is specified, then the `optsn` and `cgselid` parameters cannot be specified.

The `cgpc/cgpca/cgpci/cgpcn/cgpcn24/cgpcn16`, `opc/opca/opci/opcn/opcn24/opcn16` and `dpc/dpca/dpci/dpcn/dpcn24/dpcn16` parameters must have a valid value within the range for each subfield.

The value specified for the `ecgssn` or `ecdssn` parameter must be greater than the value specified for the `cgssn` or `cdssn` parameter.

The OBSR feature must be enabled before the `opcsn`, `optsn`, `cgpc/cgpca/cgpci/cgpcn/cgpcn24/cgpcn16`, `opc/opca/opci/opcn/opcn24/opcn16`, or (e) `cgssn` parameters can be specified.

If the GTT set specified by the `gttsn` parameter (GTTSN set) has a set type of `cdgta` (see the `ent-gttset` command), then the `optsn` parameter cannot specify a GTT set (OPTSN set) with a set type of `cgssn`.

If the GTTSN set has a set type of `cdgta`, then the OPTSN set must have a set type of `cgta` or `cgpc`.

The FLOBR feature must be turned on before a GTTSN set with a set type of `cgpc`, `cgta`, or `opc` can be specified with an OPTSN with a set type other than `cgssn`.

If the FLOBR feature is turned on, and the GTTSN set has a set type of `cdgta` or `cdssn`, then the OPTSN set cannot have a set type of `opc`.

If the TOBR feature is turned on, and the GTTSN set has a set type of `opcode`, then the OPTSN set cannot have a set type of `opc`.

If the GTTSN set has a set type of MBR (`imei/imsi/vlrnb/msisdn/smrpda/smrpoa`), then the OPTSN set type cannot have the same set type as GTTSN.

If the OPTSN set has a set type of MBR (`imei/imsi/vlrnb/msisdn/smrpda/smrpoa`), then the GTTSET must have a set type of MBR (`imei/imsi/vlrnb/msisdn/smrpda/smrpoa`) or `opcode`.

The GTA must be specified if the GTTSN set type has a value of `cdgta` or `cgta`. The GTA cannot be specified for other set types.

If the GTTSN set type has a value of *cgpc*, the *cgpc/cgpca/cgpci/cgpcn/cgpcn24/cgpcn16* parameter must be specified. This parameter cannot be specified for other set types.

The *opc/opca/opci/opcn/opcn24/opcn16* parameter must be specified if the GTTSN set type has a value of *opc*. These parameters cannot be specified for other set types.

If the GTTSN set type has a value of *cgssn*, the *cgssn* parameter must be specified. The *cgssn* parameter cannot be specified for GTTSN of other types.

The range specified by the *cdssn/ecdssn* and *cgssn/ecgssn* parameters cannot overlap a currently existing range for the specified GTT set.

The GTT set name specified by the *opcsn* parameter must have a set type of *opc* (see the *ent-gttset* command).

The OPC subsystem number set domain must be the same as the GTTSN set domain. If the GTT subsystem number set domain is ANSI, then the OPC subsystem number set domain must be ANSI. If the GTT subsystem number set domain is ITU, then the OPC subsystem number set domain must be ITU.

The translation entry specified by the *cgpc*, *opcode*, *opc*, or *dpc* parameters cannot already exist.

The *cgpc*, *cgssn*, *gta*, *opc*, *cdssn*, *opcode*, *dpc*, and *saddr* parameters cannot be specified together in the command.

If the *cgssn* and *cdssn* parameters are both specified in the same command (in any order), then only the value for the last of the two parameters specified is used during processing.

The Hex Digit Support for GTT feature must be turned on before hexadecimal digits can be specified for the *gta/saddr* or *egta/eaddr* parameter.

The value of the *loopset* parameter must already exist in the database.

The SCCP Loop Detection feature must be enabled before the *loopset* parameter can be specified.

The Loopset table is corrupt or cannot be found.

The value specified for the *pc* parameter cannot be associated with a proxy point code.

The AMGTT feature or the AMGTT CgPA Upgrade feature must be turned on before the *cggtmod* parameter can be specified.

The FLOBR feature must be turned on before the *fallback*, *cdselid*, *cdssn*, *ecdssn*, or *dpc* parameter can be specified.

The FLOBR feature must be turned on before the *gttsn* parameter can specify a GTT set with a set type other than *cdgta* (see the *ent-gttset* command) in the same command with the *cgselid* parameter.

The OBSR feature must be enabled or the FLOBR feature must be turned on before the *cgselid* parameter can be specified.

The ANSI/ITU SCCP Conversion feature must be enabled before the GTT set specified by the *optsn* parameter can have a different domain than the GTT set specified by the *gttsn* parameter.

A TOBR quantity feature must be turned on before the `opcode`, `pkgtype`, `acn`, `family`, `saddr`, `eaddr`, or `defmapvr` parameter can be specified.

The `opcode`, `pkgtype`, and `family` parameters must be specified together for ANSI TCAP translations. The `opcode`, `pkgtype`, and `acn` parameters must be specified together for ITU TCAP translations.

If the GTT set specified by the `gttsn` parameter has a set type of `opcode` (see the `ent-gttset` command), then the `opcode/acn/pkgtype` or `opcode/family/pkgtype` parameter must be specified. These parameters cannot be specified for GTT sets of any other set types.

If the GTT set specified by the `gttsn` parameter has a set type of `cdssn` (see the `ent-gttset` command), then the `cdssn` parameter must be specified. This parameter cannot be specified for GTT sets with other set types.

The maximum number of OPCODE translation entries cannot exceed the value that is set by the associated TOBR quantity feature.

The GTT set specified by the `gttsn` parameter must have a set type of `cdgta`, `opcode`, or `cdssn` (see the `ent-gttset` command) before the `opcsn` parameter can be specified.

The same value cannot be specified for the `gttsn` and `optsn` parameters.

The ANSI/ITU SCCP conversion feature must be enabled and the FLOBR feature must be turned on before the `cgcnvsn` parameter can be specified.

The GTT set specified by the `gttsn` parameter must have a set type of `cdgta` or `cggta` (see the `ent-gttset` command) before the `cgcnvsn` parameter can be specified.

If the `cgssn` parameter is specified, then the `ecdssn` parameter cannot be specified. If the `cdssn` parameter is specified, then the `ecgssn` parameter cannot be specified.

The GTT set specified by the `gttsn` parameter cannot be the same as the GTT set specified by the `cgcnvsn` parameter.

If the `family` parameter is specified, then a value of `ansiuni`, `qwp`, `qwop`, `resp`, `cwp`, `cwop`, `ansiabort`, or `any` must be specified for the `pkgtype` parameter.

If the `acn` parameter is specified, then a value of `bgn`, `ituabort`, `ituuni`, `any`, `end`, or `cnt` must be specified for the `pkgtype` parameter.

The GTT set specified by the `optsn`, `opcsn`, and `cgcnvsn` parameters must match an existing GTT set.

If the `pkgtype=ituabort` parameter is specified, then a value of `none` must be specified for the `acn` and `opcode` parameters.

If the `pkgtype=ansiabort` parameter is specified, then a value of `none` must be specified for the `family` and `opcode` parameters.

If the `family` and `opcode` parameters are specified in the command, then either both parameters must have a value of `none` or neither parameter can have a value of `none`.

The OBR feature must be enabled or the FLOBR feature must be turned on before the `optsn` parameter can be specified.

The specified GTT Action Set must already exist in the database.

Failure while reading GTT Action Set Table.

The `actsn=none` parameter cannot be specified.

The `dpc/dpca/dpci/dpcn/dpcn24/dpcn16` parameter must be specified if the GTTSN set type is `dpc` (see the `ent-gttset` command). If the GTT set has a set type other than `dpc`, then the `dpc/dpca/dpci/dpcn/dpcn24/dpcn16` parameter cannot be specified.

If the `xlat=none` parameter is specified, then the `ri`, `pc/pca/pci/pcn/pcn24/pcn16`, `force`, `ssn` and `ccgt` parameters cannot be specified.

The value specified for the `gtmodid` parameter must already exist in the GTMOD table.

The GTMOD table is corrupt or cannot be found.

The `gtmodid=none` parameter cannot be specified.

If the FGTTLS feature is enabled, and the `xlat=none` parameter is specified, then the `mrnset` or `mapset` parameter must be specified.

The specified GTT set must have a set type of `opcode` (see the `ent-gttset` command) before the `opcode/acn/pkgtype` or `opcode/family/pkgtype` parameters can be specified. The specified GTT set must have a set type of `cdssn`, `cgssn`, `cdgta/cgta`, `opc`, or `cgpc` before the `cdssn`, `cgssn`, `gta`, `opc`, or `cgpc` parameter, respectively, can be specified.

The `acn` and `family` parameters cannot be specified together in the command.

If the `opc` or `dpc` parameter is specified, then the `(e)gta`, `(e)cgssn`, `(e)cdssn`, `eaddr`, and `opcode` parameters cannot be specified.

The J7 Support feature must be enabled before the `cgpcn16/opcn16/dpcn16` parameters can be specified.

The J7 Support feature must not be enabled before the `cgpcn24/opcn24/dpcn24/cgpca/opca/dpca` parameters can be specified.

The `saddr` parameter must be specified if the GTT set specified by the `gttsn` parameter is of MBR type (IMEI/IMSI/MSISDN/VLRNB/SMRPOA/SMRPDA).

If the GTT set specified by the `optsn` parameter is of MBR type (IMEI/IMSI/MSISDN/VLRNB/SMRPOA/SMRPDA) in the GTA command for the ITU opcode entry, then the package type specified via the `pkgtype` parameter must be ITU BGN/CNT/END.

The `defmapvr` parameter can be specified in the GTA command for the ITU opcode entry if the GTT set specified by the `optsn` parameter is of MBR type (IMEI/IMSI/MSISDN/VLRNB/SMRPOA/SMRPDA).

The `PRI0` parameter can be specified with OP CODE GTT set types only.

If the `GTA/EGTA` parameter is specified, then the `EADDR` parameter cannot be specified.

If the `SADDR` parameter is specified, then the `ECGSSN/ECSSN` parameter cannot be specified.

If the `OPCODE` parameter is specified, then the `EADDR/EGTA/ ECGSSN/ECSSN` parameter cannot be specified.



If the `CGPC` parameter is specified, then the `EADDR/EGTA/ECGSSN/ECDSSN` parameter cannot be specified.

If the `ECGSSN/ECDSSN` parameter is specified, then the `EADDR/EGTA` parameter cannot be specified.

SSN configured for SFAPP cannot be used in any command for any configuration

## Notes

In this command, only ITU-international and ITU national point codes support the spare point code subtype prefix (s-) and the private and spare point code subtype prefix (ps-). All of the point code types support the private (internal) point code subtype prefix (p-).

When the Flexible GTT Load Sharing feature and the Intermediate GTT Load Sharing feature are on, multiple relationships can be defined among set of destination point codes in the MRN table, which already exists in the EAGLE. The relationship used in a particular translation is based on the GTA digits used for translation. The MRN set and the post-translation PC create a key that is used to perform lookups in the MRN table. The lookup results in a set of alternate PCs, one of which is selected, based on PC relative cost, to route the MSU in the most cost effective way.

When the Flexible GTT Load Sharing feature is enabled, multiple relationships can be defined among a set of PC/SSNs in the existing MAP table. The relationship used in a particular translation is based on the GTA digits used for translation.

When the Origin-based SCCP Routing feature is turned on, the CdPA GTA, CgPA GTA, CgPA PC, CgPA SSN, and OPC entries can be provisioned. When provisioning, the following rules apply:

- The Advanced CdPA GTA entry can associate with CgPA GTA set, CgPA PC set, or SELID and OPC set.
- The CgPA GTA, CgPA PC, or OPC entry can associate with the CgPA SSN set.
- The CgPA SSN entry cannot associate with any other GTT set.
- The Advanced CdPA GTA entry may contain SELID, which is (together with the CgPA information) derived from incoming MSU to search the Selector table again for the CgPA GTA or CgPA PC Set.

When the Origin-based SCCP Routing feature is enabled, the GTA and EGTA can be used for the CgPA translation as well as the CdPA GTA translation.

The Flexible GTT Load Sharing feature introduces the `mrnset` parameter. The MRN set and the post-translation PC create a key that is used to perform look ups in the MRN table. This lookup results in a set of alternate PCs, from which one is selected, based on PCs relative cost, to route the MSU in the most cost effective way.

A loopset consists of a set of point codes that form a routing loop in the network. If the SCCP Loop Detection feature is enabled, then the loopset can be associated with or disassociated from specified translation entries. Loopsets that are associated with translation entries are checked during intermediate and final GTT traffic routing. If a loop exists, then the system can be notified with or without discarding the associated traffic.

The maximum length of the resulting GTA string must not exceed 21 digits when translation is complete.

If the FLOBR GTT hierarchy is provisioned on a linkset, then translations do not have to be searched in a predetermined manner. If a translation points to another GTTSET/SELID, then database searches continue. The number of searches is limited by the following conditions:

- The same GTT set name cannot be referred more than once.
- Up to 7 database searches can be performed.
- For MBR, the same GTT set type (IMEI/IMSI/MSISDN/VLRNB/SMRPOA/SMRPDA) cannot be referred more than once.

If the FLOBR feature is turned on, then any translation can point to any GTTSETs other than that specified by the GTTSN. The CdPA GTA and CdPA SSN translations can also point to an OPCS. For CdPA GTA and CdPA SSN translations, if an OPTSN GTTSET/SELID is provisioned apart from an OPCS, then the OPTSN GTTSET/SELID takes precedence over the OPCS.

The MBR GTT set type translation entries (IMEI/IMSI/MSISDN/VLRNB/SMRPOA/SMRPDA) can be configured only when the TOBR feature is turned on. The GTT sets of the types mentioned above are allowed to be provisioned ONLY in GTA entries from a GTT set of the type OPCODE or one of the other GTT set types supported by this feature (SS7 Firewall).

Translations, supporting ANSI or ITU opcodes, associated with the TOBR feature:

- ANSI Opcode—ANSI opcode specifier, ANSI TCAP Package type, and Family
- ITU Opcode—ITU opcode, ITU TCAP Package Type, and ACN

Translations associated with the FLOBR feature:

- CdPA SSN Translations—Can be configured with routing and flexible routing data. The provisioning rules for CdPA SSN translations are the same as CgPA SSN translations in OBSR.
- DPC Translations—The provisioning rules for DPC translations are the same as OPC translations except that the OPCS parameter cannot be configured for DPC translations.

## Output

```
ent-
gta:gttsn=opcdis3:xlat=dpc:ri=gt:pc=1-1-1:opca=002-001-001:actsn=act
discl:ppmeasreqd=yes
```

```
tekelecstp 10-02-24 12:09:18 EST EAGLE 42.0.0
ENT-GTA: MASP A - COMPLTD
```

```
;
```

```
ent-
gta:gttsn=imsi1:xlat=dpc:ri=gt:pc=1-1-1:saddr=1234567890:eaddr=22345
67890
```

```
tekelecstp 15-05-24 12:09:18 EST EAGLE 46.3.0
ENT-GTA: MASP A - COMPLTD
```

```
;
```

```
ent-  
gta:gttsn=setopcode:opcode=*:pkgtype=bgn:acn=*:xlat=dpc:ri=gt:pc  
ci=1-1-1:prio=1024
```

```
tekelecstp 16-11-07 14:13:13 MST EAGLE 46.5.0.0-70.5.0  
ENT-GTA: MASP A - COMPLTD
```

```
;
```

```
ent-  
gta:gttsn=imsi3:xlat=dpc:ri=gt:pc=1-1-1:saddr=1234567890:transm  
easrqd=yes
```

```
tekelecstp 17-05-11 15:09:18 EST EAGLE 46.6.0  
ENT-GTA: MASP A - COMPLTD
```

```
;
```

### Related Topics

- [chg-gta](#)
- [dlt-gta](#)
- [rtrv-gta](#)

## ent-gtcnv

Use this command to provision the Default Global Title Conversion table. The table is used during conversion for MTP-routed cross network SCCP UDT(S), XUDT(S) and SCCP Management messages. It is also used during conversion for GT routed messages when a matching entry exists in the Global Title address table but the NGTI value is not provisioned.

### Parameters

#### **dir (mandatory)**

Direction of conversion.

#### **Range:**

##### ***atoi***

ANSI to ITU conversion

##### ***itoa***

ITU to ANSI conversion

##### ***both***

conversion in both directions

#### **gtixlat (mandatory)**

Global Title Indicator conversion. This parameter is expressed in the form of the ANSI GTI and the ITU GTI.

**Range:****22**

Converts an incoming ANSI GTI 2 to an outgoing ITU GTI 2 or an incoming ITU GTI 2 to an outgoing ANSI GTI 2

**24**

Converts an incoming ANSI GTI 2 to an outgoing ITU GTI 4 or an incoming ITU GTI 4 to an outgoing ANSI GTI 2

**tta (mandatory)**

ANSI translation type.

**Range:**

0 - 255, \*

**tti (mandatory)**

ITU translation type.

**Range:**

0 - 255, \*

**nai (optional)**

Nature of address indicator. This parameter is mandatory when `gtixlat=24` is specified, and not specified when `gtixlat=22` is specified.

**Range:**

0 - 63, \*

**Default:**

Not set

**np (optional)**

Numbering plan. This parameter is mandatory when `gtixlat=24` is specified, and not specified when `gtixlat=22` is specified.

**Range:**

0 - 15, \*

**Default:**

Not set

**npdd (optional)**

New prefix digits to be deleted. The number of new prefix digits to be deleted. These digits will be replaced with the new prefix digits string (`npds`).

**Range:**

0 - 21

**Default:**

0

**npds (optional)**

New prefix digits string. The new prefix digits string that will replace the received prefix digits string.

**Range:**

1 - 21 digits

If the Hex Digit Support for GTT feature is not enabled and on, the range is 1 - 21 decimal digits; valid digits are 0-9

If the Hex Digit Support for GTT feature is enabled and on, the range is 1 - 21 hexadecimal digits; valid digits are 0-9, a-f, A-F

**Default:**

No digits

**nsdd (optional)**

New suffix digits to be deleted. This parameter identifies the new suffix digits to be deleted that will replace the received suffix digits to be deleted.

**Range:**

0 - 21

**Default:**

0

**nsds (optional)**

New suffix digits string. The new suffix digits string that will replace the received suffix digits string.

**Range:**

1 - 21 digits

If the Hex Digit Support for GTT feature is not enabled and on, the range is 1 - 21 decimal digits; valid digits are 0-9

If the Hex Digit Support for GTT feature is enabled and on, the range is 1 - 21 hexadecimal digits; valid digits are 0-9, a-f, A-F

**Default:**

No digits

**Example**

The following example assigns an entry used for ANSI to ITU conversion where the conversion is from GTI 2 to GTI 2.

```
ent-gtcnv:dir=atoi:gtixlat=22:tta=10:tti=5
```

The following example assigns an entry used for ANSI to ITU conversion where the conversion is from GTI 2 to GTI 4. The `nsdd` parameter specifies that the last 3 digits are to be removed from the end of the address digits, and the `nsds` parameter specifies that the digits 123 are to be appended to the end of the remaining address digits.

```
ent-gtcnv:dir=atoi:gtixlat=24:tta=11:tti=7:nai=8:np=6:nsdd=3:nsds=123
```

The following example assigns an entry used for ITU to ANSI conversion where the conversion is from GTI 2 to GTI 2. The `npdd` parameter specifies that the first 3 digits are to be deleted from the beginning of the address digits, and the `npds` parameter specifies that the digits 407 should be appended to the beginning of the remaining address digits.

```
ent-gtcnv:dir=ittoa:gtixlat=22:tta=11:tti=7:npdd=3:npds=407
```

The following example assigns an entry used for ITU to ANSI conversion where the conversion is from GTI 2 to GTI 4. The `nsds` parameter specifies that the digits 45667 are to be appended to the end of the address digits.

```
ent-gtcnv:dir=ittoa:gtixlat=24:tta=11:tti=7:nai=8:np=6:nsds=45667
```

The following example assigns an entry used for ANSI/ITU conversion in both directions where the conversion is from GTI 2 to GTI 2.

```
ent-gtcnv:dir=both:gtixlat=22:tta=11:tti=7
```

The following example assigns an entry used for ANSI/ITU conversion where an incoming ANSI GTI 2 is converted to an outgoing ITU GTI 4 or an incoming ITU GTI 4 to an outgoing ANSI GTI 2.

```
ent-gtcnv:dir=both:gtixlat=24:tta=12:tti=9:nai=6:np=4
```

The following example assigns a default entry for ANSI to ITU conversion where the conversion is from GTI 2 to GTI 2.

```
ent-gtcnv:dir=atoi:gtixlat=24:tta=*:tti=4:nai=6:np=5
```

The following example assigns a default entry for ITU to ANSI where the conversion is from GTI 2 to GTI 4. The `npds` parameter specifies that the digits 919 are to be appended to the beginning of the address digits.

```
ent-gtcnv:dir=ittoa:gtixlat=24:tta=17:tti=*:nai=*:np=*:npds=919
```

The following example specifies hexadecimal digits for the `npds` parameter.

```
ent-  
gtcnv:dir=atoi:gtixlat=22:tta=*:tti=4:npdd=3:npds=abcdef0123456789
```

The following example assigns a default entry for ITU to ANSI where the conversion is from GTI 2 to GTI 4. The `npds` parameter specifies that the digits 123 are to be appended to the beginning of the address digits and the `nsds` parameter specifies that the digits 407 are to be appended to the end of the address digits

```
ent-  
gtcnv:dir=ittoa:gtixlat=24:tta=17:tti=*:nai=*:np=*:npds=123:nsds=407
```

## Dependencies

The ANSI/ITU SCCP Conversion feature must be enabled before this command can be entered.

If the `gtixlat=22` parameter is specified, then the `nai` and `np` parameters cannot be specified.

If the `gtixlat=24` parameter is specified, then the `nai` and `np` parameters must be specified.

If the `dir=both` parameter is specified, then a wildcard value (\*) cannot be specified for any of the other parameters.

If the `dir=atoi` parameter is specified, then a wildcard value (\*) can be specified only for the `tta` parameter.

If the `dir=ittoa` parameter is specified, then a wildcard value (\*) must be specified for the `tti`, `np`, and `nai` parameters.

The specified `dir`, `tta`, `tta`, `tta`, `np`, and `nai` parameter combination cannot already exist in the database.

The `nsdd/nsds` and `npdd/npds` parameters cannot be specified together in the command.

The Default Global Title Conversion table can contain a maximum of 1000 entries.

The Hex Digit Support for GTT feature must be enabled and on before hexadecimal digits can be specified for the `npds` and `nsds` parameters.

### Notes

The use of asterisks (wildcards) is allowed only once for each direction of ANSI to ITU and ITU to ANSI. This provides a configurable default.

In the conversion direction of ANSI to ITU, an asterisk can be specified only for the ANSI `tta` parameter.

In the conversion direction of ITU to ANSI, the asterisk value must be specified for the `itu`, `tta`, `np`, and `nai` parameters.

Asterisks are not allowed when conversion is in both directions (`dir=both`).

The suffix digit manipulation parameters `nsdd` and `nsds` cannot be specified in the same command with the prefix digit manipulation parameters `npdd` and `npds` parameters. The `npdd` and `nsdd` parameters specify how many digits to delete, if any, from the beginning or end respectively of the Global Title address digits. The `npds` and `nsds` parameters specify what digits, if any, to append to the beginning or end respectively of the Global Title address digits.

The `gtixlat` parameter is expressed in the form of the ANSI GTI and the ITU GTI. The `gtixlat` parameter is used to indicate the conversion of the Global Title Indicator between the ANSI and ITU standards. For example: A `gtixlat` value of 24 converts an incoming ANSI GTI 2 to an outgoing ITU GTI 4 or an incoming ITU GTI 4 to an outgoing ANSI GTI 2.

### Output

```
ent-gtcnv:dir=atoi:gtixlat=22:tta=10:tta=5
```

```
rlghncxa03w 04-01-07 11:43:07 EST EAGLE 31.3.0
ENT-GTCNV: MASP A - COMPLTD
;
```

### Related Topics

- [chg-gtcnv](#)
- [dlt-gtcnv](#)
- [rtrv-gtcnv](#)

## ent-gtmod

Use this command to enter GT Modification (GTMOD) data in the GTMOD table. The GTMOD entry consists of a GTMOD ID and GTMOD specific data. After the GTMOD ID is provisioned, it can be used in GTT and GTT Action commands.

### Parameters



#### Note:

Definitions for the feature options specified by the `on` and `off` parameters are located in the Notes section.

#### **gtmodid (mandatory)**

GTMOD identifier.

##### **Range:**

*ayyyyyyy*

1 leading alphabetic character followed by up to 8 alphanumeric characters

#### **cgpasnn (optional)**

Calling party subsystem number. This parameter specifies the calling party subsystem address that receives the message.

##### **Range:**

*002 - 255*

#### **ngti (optional)**

New global title indicator. This parameter specifies whether a new GTI translation format is type 2 or type 4.

##### **Range:**

*2*

*4*

#### **nnai (optional)**

New nature of address indicator. The value that replaces the received NNAI.

##### **Range:**

*0 - 127*

#### **nnp (optional)**

New numbering plan. The value that is used to replace the received numbering plan.

##### **Range:**

*0 - 15*

#### **npdd (optional)**

Number of prefix digits to be deleted. The number of digits to be deleted from the prefix of the received GT address.



**Range:***1 - 21***npds (optional)**

New prefix digits string. The digits to be prefixed to the received GT address.

**Range:***1 - 21 digits*

If the Hex Digit Support for GTT feature is not enabled, the range is 1 - 21 decimal digits; valid digits are *0-9*

If the Hex Digit Support for GTT feature is enabled and on, the range is 1 - 21 hexadecimal digits; valid digits are *0-9, a-f, A-F*

**nsdd (optional)**

Number of suffix digits to be deleted. The number of digits to be deleted from the suffix of the received GT address.

**Range: 1 - 21****nsds (optional)**

New suffix digits string. The digits to be suffixed to the received GT address.

**Range:***1 - 21 digits*

If the Hex Digit Support for GTT feature is not enabled, the range is 1 - 21 decimal digits; valid digits are *0-9*

If the Hex Digit Support for GTT feature is enabled and on, the range is 1 - 21 hexadecimal digits; valid digits are *0-9, a-f, A-F*

**ntt (optional)**

New Translation type. This parameter specifies the value that replaces the received Translation Type.

**Range:***0 - 255***off (optional)**

Disables or turns off the specified feature options. This parameter specifies a comma-separated list of feature options that are requested to be turned off. Up to 8 feature options can be specified in the list.

**Range:***gt0fill***on (optional)**

Enables or turns on the specified feature options. This parameter specifies a comma-separated list of feature options that are requested to be turned on. Up to 8 feature options can be specified in the list.

**Range:***gt0fill*

**precd (optional)**

Precedence. This parameter specifies whether the prefix or suffix takes precedence while modifying the received GT address.

**Range:****px**

if the `npdd` and `npds` parameters are specified

**sfx**

if the `nsdd` and `nsds` parameters are specified

**Example**

```
ent-gtmod:gtmodid=set1:npdd=5:npds=123:off=gt0fill:ntt=10
```

```
ent-gtmod:gtmodid=gtmodset4:npdd=5:npds=123:nsdd=2:
```

```
nsds=1234:ngti=4:on=gt0fill:nnai=12:nnp=5:precd=sfx
```

```
ent-gtmod:gtmodid=setntt:ntt=12
```

**Dependencies**

If the `ngti=4` parameter is specified, then the `nnp` and `nnai` parameters must be specified.

If the `ngti=2` parameter is specified, the `nnp` and `nnai` parameters cannot be specified.

The ANSI/ITU SCCP Conversion feature must be enabled before the `ngti` parameter can be specified.

The Hex Digit Support for GTT feature must be turned on before hexadecimal digits can be specified for the `npds` or `nsds` parameters.

The GTMOD table cannot contain more than 100000 entries.

The GTMOD table is corrupt or cannot be found.

At least one optional parameter must be specified.

The AMGTT, AMGTT CdPA Only, or AMGTT CgPA Upgrade feature must be turned on before any parameter except the `ntt` parameter can be specified.

The value specified for the `gtmodid` parameter cannot already exist in the GTMOD table.

The combined digit length of the values specified for the `npds` and `nsds` parameters cannot be greater than 21.

If the `npdd/npds` and `nsdd/nsds` parameters are specified, then the `precd` parameter must be specified.

The `gtmodid=none` parameter cannot be specified.

If the `precd` parameter is specified, then the `npdd`, `npds`, `nsdd`, or `nsds` parameter must be specified.

If the `on=gt0fill` parameter is specified, then the `ngti` parameter must be specified.

The same value cannot be specified for the `on` and `off` parameters.

SSN configured for SFAPP cannot be used in any command for any configuration

## Notes

### on/off options

- *gt0fill* —GT zero fill. Specifies whether the last 0 of the GTA is treated as a valid digit (OFF) or as filler (ON) during GT Modification for the gti(x)=2 to gti(x)=4 scenario.

### Output

```
ent-gtmod:gtmodid=set5:ngti=4:nnp=4:nnai=2:on=gt0fill
```

```
tekelecstp 10-03-08 14:43:31 EST EAGLE 42.0.0

GTMOD table is (2 of 50000) 1% full

ENT-GTMOD: MASP A - COMPLTD
;
```

### Related Topics

- [chg-gtmod](#)
- [dlt-gtmod](#)
- [rtrv-gtmod](#)

## ent-gtt

Use this command to add the routing object, DPC, and subsystem number for messages requiring global title translation. The translation is performed on the basis of the global title address (GTA) and translation type (TT) for each SS7 SCCP message directed to the STP's self-identity DPC or CPC with a routing indicator of 0, indicating a GTT is required.

### Note:

If the EGTT feature is turned on, then the GTT Selector (`ent/chg/dlt/rtrvgtttsel`), GTT Set (`ent/dlt/rtrv-gttset`), and GTA (`ent/chg/dlt/rtrvgta`) commands replace the Translation Type (`ent/dlt/rtrv-tt`) and Global Title Translation (`ent/chg/dlt/rtrv-gtt`) commands. It is not recommended to run `ent/dlt/rtrv-tt & ent/chg/dlt/rtrv-gtt` commands as it may cause the advance GTA fields of GTT entry to be reset to the default values.

## Parameters

### Note:

See [Point Code Formats and Conversion](#) for a detailed description of point code formats, rules for specification, and examples.

### **gta (mandatory)**

Global title address. The beginning of a range of global title digits.

#### **Range:**

1 - 21 digits

If the Hex Digit Support for GTT feature is not enabled, the range is 1 - 21 decimal digits; valid digits are 0-9.

If the Hex Digit Support for GTT feature is on, the range is 1 - 21 hexadecimal digits; valid digits are 0-9, a-f, A-F.

### **pc (mandatory)**

ANSI point code with subfields *network indicator-network cluster-network cluster member (ni-nc-ncm)*. The *prefix* subfield indicates a private point code (*prefix-ni-nc-ncm*).

#### **Synonym:**

*pca*

#### **Range:**

*p-*, 000-255

Specify a valid value for each subfield of the point code, and separate the subfields with a dash (-).

*prefix—p-*

When *chg-sid:pctype=ansi* is specified, *ni = 000* is not valid.

When *chg-sid:pctype=ansi* is specified, *nc = 000* is not valid if *ni = 001-005*.

When *chg-sid:pctype=ansi* is specified, *nc = 000* is valid if *ni = 006-255*.

The point code 000-000-000 is not a valid point code.

### **pc/pca/pci/pcn/pcn24 (mandatory)**

Point code.

### **pci (mandatory)**

ITU international point code with subfields *zone-area-id*. The *prefix* subfield indicates a spare point code, private point code, or private and spare point code (*prefix-zone-area-id*).

#### **Range:**

*s-*, *p-*, *ps-*, 0-255

Specify a valid value for each subfield of the point code, and separate the subfields with a dash (-).

*prefix—s-*, *p-*, *ps*

*zone—0-7*

*area—000-255*

*id—0-7*

The point code 0-000-0 is not a valid point code.

**pcn (mandatory)**

ITU national point code in the format of a 5-digit number (*nnnnn*); or 2, 3, or 4 numbers (members) separated by dashes (*m1-m2-m3-m4*) as defined by the `chg-stpopts:npcfmti` flexible point code option. A group code must be specified when the ITUDUPPC feature is turned on (*nnnnn-gc,m1-m2-m3-m4-gc*). The *prefix* subfield indicates a spare point code, private point code, or private and spare point code (*prefix-nnnnn, prefix-nnnnn-gc, prefix-m1-m2-m3-m4, prefix-m1-m2-m3-m4-gc*).

**Range:**

*s-, p-, ps-, 0-16383, aa-zz*

Specify a valid value for each subfield of the point code, and separate the subfields with a dash (-).

*prefix—s-, p-, ps*

*nnnnn—0-16383*

*gc—aa-zz*

*m1-m2-m3-m4—0-14* for each member; values must sum to 14

**pcn24 (mandatory)**

24-bit ITU national point code with subfields *main signaling area-sub signaling area-signaling point* (*msa-ssa-sp*). The *prefix* subfield indicates a private point code (*prefix-msa-ssa-sp*).

**Range:**

*p-, 000-255*

Specify a valid value for each subfield of the point code, and separate the subfields with a dash (-).

*prefix—p*

*msa—000–255*

*ssa—000–255*

*sp—000–255*

**ri (mandatory)**

Route indicator. This parameter specifies whether a subsequent global title translation is required.

**Range:**

***gt***

Subsequent translation is required.

***ssn***

Subsequent translation is not required.

**xlat (mandatory)**

Translate indicator. The type of global title translation to be performed.

**Range:**

***dpc***

***dpcssn***

***dpcngt***

**cggtmod (optional)**

Calling party GT modification indicator. This parameter specifies whether calling party global title modification is required.

**Range:**

*yes*

*no*

**Default:**

*no*

**egta (optional)**

Global title end address. The end of a range of global title digits.

**Range:**

1 - 21 digits

If the Hex Digit Support for GTT feature is not enabled, the range is 1 - 21 decimal digits; valid digits are 0-9.

If the Hex Digit Support for GTT feature is enabled and on, the range is 1 - 21 hexadecimal digits; valid digits are 0-9, a-f, A-F.

**Default:**

the *gta* value

**force (optional)**

When a final GTT is specified, the DPC and subsystem number must be configured in the mated application table (*xlat=dpc* and *ri=ssn*). The *force=yes* parameter overrides this restriction.

**Range:**

*yes*

*no*

**Default:**

*no*

**gtmodid (optional)**

Global title modification identifier.

**Range:**

*ayyyyyyy*

1 leading alphabetic character followed by up to 8 alphanumeric characters

**Default:**

*none*

**loopset (optional)**

SCCP loopset name. This parameter associates a translation set with a loopset.

**Range:**

*ayyyyyyy*

1 alphabetic character followed by up to 7 alphanumeric characters.

*none* —There is no association between the translation set and any loopset

**Default:**  
*none*

**mapset (optional)**  
MAP set ID.

**Range:**  
*1 - 36000, dflt*  
*dflt* —Default MAP set

**mrnset (optional)**  
MRN set ID.

**Range:**  
*1 - 3000, dflt, none*  
*dflt* —Default MRN Set ID  
*none* —Removes the specified MRN Set ID from the MRN table

**ssn (optional)**  
Subsystem number. The subsystem address that will receive the message. This parameter is required and can only be specified if the `xlat=dpcssn` parameter is specified.

**Range:**  
*002 - 255*

**ttn (optional)**  
Translation type name. The name is of local significance only, and is related to the translation type.

**Range:**  
*ayyyyyyy*  
1 alphabetic character followed by up to 8 alphanumeric characters

**Default:**  
No translation name is given

**type/typea/typei/typen/typen24/typeis/typens (optional)**  
Translation type. This parameter identifies the translation type and network type. This parameter is the decimal representation of the 1-byte field used in SS7. The `type` and `typea` parameters specify an ANSI network. The `typei` parameter specifies an ITU-international network. The `typen` parameter specifies an ITU-national network. The `typen24` parameter specifies a 24-bit ITU-national network. The `typeis` parameter specifies an ITU-international spare network. The `typens` parameter specifies an ITU-national spare network. A translation type numeric value may be entered as an ANSI type (`type/typea`) and as an ITU type (`typei/typen/typen24/typeis/typens`). However, they are separate entities. The point code domain translation types for GTT are handled by the EAGLE protocol processing as either ANSI or ITU; therefore, ITU applies to ITU-I, ITU-I spare, ITU-N, ITU-N spare, and ITU-N24.

**Range:**  
*000 - 255*

**Default:**  
No translation type is specified

### Example

The lines in the following examples are wrapped for readability:

```
ent-gtt:type=3:gta=9195551212:egta=9195552000:  
xlat=dpcssn:ri=ssn:pc=001-255-255:ssn=255  
ent-gtt:ttn=lidb1:gta=9105551212:egta=9105554000:  
xlat=dpcngt:ri=gt:pc=001-255-254  
ent-gtt:ttn=c800:gta=9195554321:xlat=dpc:ri=gt:pc=001-255-253  
ent-gtt:type=4:gta=919460:xlat=dpc:ri=ssn:pc=001-255-252  
ent-gtt:type=4:gta=919461:xlat=dpcssn:ri=gt:ssn=254  
ent-gtt:typea=210:ttn=test:gta=100000:egta=199999:  
pca=1-1-1:ssn=123:xlat=dpcngt:ri=gt:gtmodid=abc1  
ent-gtt:type=100:ttn=test2:gta=123:egta=321:  
pcn=222:ssn=10:xlat=dpcngt:ri=gt:gtmodid=id1  
ent-gtt:pcn24=8-8-8:gta=919833:xlat=dpcssn:ri=ssn:ssn=20:typen24=4  
ent-gtt:typea=100:ttn=test2:gta=123:egta=321:  
pci=2-2-2:ssn=10:xlat=dpcngt:ri=gt  
ent-gtt:xlat=dpcssn:ssn=10:ri=gt:pci=s-1-21-1:gta=123456:typei=3  
ent-gtt:xlat=dpcssn:ssn=10:ri=gt:pcn=s-124:gta=123456:typen=3  
ent-gtt:xlat=dpcssn:ssn=10:ri=gt:pcn=s-125-aa:gta=123456:typen=3  
ent-gtt:type=1:xlat=dpc:ri=gt:pc=1-1-1:  
gta=1234567890:egta=2234567890:mrnset=23  
ent-gtt:type=1:xlat=dpcngt:ri=gt:pc=1-1-2:  
gta=2345678901:egta=3456789012:mrnset=54  
ent-gtt:type=1:xlat=dpcngt:ri=gt:pc=1-1-3:  
gta=3456789013:egta=3456789019:mrnset=df1t  
ent-gtt:type=1:xlat=dpcngt:ri=gt:pc=1-1-3:  
gta=3456789012:egta=4567890123:mrnset=none  
ent-gtt:type=1:xlat=dpcssn:ri=ssn:pc=1-1-1:  
gta=1234567890:egta=2234567890:ssn=10:mapset=23  
ent-gtt:type=1:xlat=dpcssn:ri=ssn:pc=2-2-2:  
gta=2345678911:egta=3456789022:ssn=25:mapset=df1t
```



This example specifies hexadecimal digits for the *gta* and *egta* parameters.

```
ent-
gtt:ttt=set1:xlat=dpc:ssn:ri=ssn:ssn=10:pc=1-1-1:gta=abcd:egta=a
bce
```

This example specifies that calling party GT modification is required.

```
ent-gtt:xlat=dpc:pc=1-1-1:ri=gt:gta=981234:type=4:cggmod=yes
```

```
ent-gtt:xlat=dpc:ri=gt:pci=s-1-1-4:gta=123456:typeis=5
```

```
ent-gtt:xlat=dpc:ri=gt:pcn=s-111:gta=123456:typens=5
```

### Dependencies

The end address must be greater than or equal to the start address.

The *pcn* parameter format must match the format that was assigned with the *chg-stpopts:npcfmti* parameter.

Point code entries must be full point codes. Partial point codes are not allowed.

The start global title address length must be equal to the number of digits specified by the given translation type. If the VGTT (variable length GTT) feature is turned on, then up to 10 GTA lengths per translation type can be provisioned. When this command is entered to create entries, the software keeps track of the lengths and allows only 10 different lengths. The global title address specified for the translation type must then have the same number of digits as an existing GTA.

If the end global title address is specified, its length must equal the length of the start global title address.

The maximum length of the resulting GTA string must not exceed 21 digits when translation is complete.

If the translation type is specified, then it must already exist and cannot be an alias.

The ANSI/ITU SCCP Conversion feature must be enabled before a translated PC and a translation type in different network types can be specified.

When the translated point code is of type ANSI, the *ngti* parameter of the referred GTMOD cannot have a value of 4. For ANSI PCs, the *ngti* parameter must have a value of 2.

The range, as specified by the start and end global title addresses, cannot exist in the global title translation data for the specified translation type. Each range may be contained completely within a previously defined range, in which case splitting is performed. However, if the ranges overlap, splitting cannot occur, the command is rejected, and a list of overlapped global title addresses is displayed. An example follows that shows what happens when the user attempts to enter a global title address range (such as 8005550000 to 8005559999) that overlaps an existing range. The overlapping links must match. If they do not, error message E2401 is generated displaying the list of overlapped global title addresses:

```
The following GTA ranges overlap the input GTA range
START GTA END GTA 8005550000 8005551999 8005552000 8005553999
8005554000 8005555999 ENT-GTT: MASP A - Command Aborted
```

If a final GTT is specified with the `ri=ssn` parameter and the `xlat=dpc` parameter, and if the value of the `force` parameter is not `yes`, the point code must be configured in the Remote Point Code/MAP Table.

The `xlat=dpcssn` parameter must be specified before the `ssn` parameter can be specified.

If the `xlat=dpcssn` parameter is specified, then the `ssn` parameter must be specified.

[Table 4-24](#) shows the valid combinations for the `xlat`, `ri`, and `ssn` parameters. All other combinations are rejected.

**Table 4-24 Valid ent-gtt Routing Parameter Combinations**

<b>XLAT Value</b>	<b>RI Value</b>	<b>Routing Action</b>	<b>SSN Value</b>
DPC	GT	Translate DPC only and route on GT	Cannot specify
DPC	SSN	Translate DPC only and route on SSN	Cannot specify
DPCSSN	GT	Translate DPC and SSN and route on GT	Must specify
DPCSSN	SSN	Translate DPC and SSN and route on SSN	Must specify
DPCNGT	GT	Translate DPC only and route on GT	Cannot specify

If the XGTT feature is enabled, then the GTT table can have up to either 400,000 or 1,000,000 entries, depending on the controlled feature Part Number that is enabled. If XGTT is not enabled, then the GTT table can contain up to 269,999 user entries.

To enter this command, the Remote Point Code table cannot be full.

To enter this command, the subsystem table for primary remote point codes cannot be full.

If the `ri=ssn` parameter is specified, the `mrnset` parameter cannot be specified.

If the Flexible GTT Load Sharing feature is enabled, the specified PC must already exist in the specified MRN set.

The specified MRN set must already exist in the MRN table.

The Flexible GTT Load Sharing feature must be enabled before the `mrnset` parameter can be specified.

If the `ri=gt` parameter is specified, then the `mrnset` parameter must be specified.

The MRN table is corrupt or cannot be found.

If the `ri=gt` parameter is specified, the `mapset` parameter cannot be specified.

The Flexible GTT Load Sharing feature must be enabled before the `mapset` parameter can be specified.

The `mapset` parameter can only be specified if the Flexible GTT Load Sharing feature is enabled, and the `ri=ssn` parameter is specified. If the `ri=ssn` parameter is specified, the

`mapset` parameter must be specified. If the `ri=gt` parameter is specified, the `mapset` parameter cannot be specified.

The specified PC and SSN must exist in the specified MAP set.

At least one entry must be provisioned in the specified MAP set in the MAP table.

If the `xlat=dpc` parameter is specified, and the `force` parameter is not specified as yes, the specified PC and MAP set must exist in the MAP table.

The MAP table is corrupt or cannot be found.

The Hex Digit Support for GTT feature must be turned on before hexadecimal digits can be specified for the `gta` or `egta` parameters.

The SCCP Loop Detection feature must be enabled before the `loopset` parameter can be specified.

The value of the `loopset` parameter must already exist in the database.

The `tt` or the `ttn` parameter must be specified.

The value specified for the `pc/pca/pci/pcn/pcn24` parameter must be a valid point code.

The SCCP Loop Detection feature must be enabled before the `loopset` parameter can be specified.

The value of the `loopset` parameter must exist in the Loopset table.

If the value of the `pc/pca/pci/pcn/pcn24` parameter is the True Point Code, then the `xlat=dpcssn` parameter and the `ri=ssn` parameter must be specified.

If the `ssn` parameter is specified, and if the value of the `pc/pca/pci/pcn/pcn24` parameter is the True Point Code, then the value of the `ssn` parameter must exist in the SS-APPL table.

The value of the `pc/pca/pci/pcn/pcn24` parameter must exist as a destination in the ordered route entity set or must reside in a cluster (ANSI only) that exists as a destination in the ordered route entity set (for global title routing).

If the VGTT feature is turned on, then up to 10 GTA lengths can exist per translation type. If the Support for 16 GTT Lengths in VGTT feature is turned on, then up to 16 GTA lengths can exist per translation type.

The value of the `tt` parameter must not be defined as an alias.

If both the translation type (`tt`) and translation type name (`ttn`) are specified, the translation type name (`ttn`) must match that of the specified translation type (`tt`).

If the `tt` parameter is not specified, then the value of the `ttn` parameter must match the value of a `tt` parameter in the STP database.

If the `xlat=dpcngt` parameter is specified, then the `ri=gt` parameter must be specified.

The site identification table is corrupt or cannot be found.

The Route table is corrupt or cannot be found.

The Loopset table is corrupt or cannot be found.

The database is corrupt or cannot be found.

The GTT table cannot be full.

The value specified for the `pc` parameter cannot be associated with a proxy point code.

The AMGTT feature or the AMGTT CgPA Upgrade feature must be turned on before the `cggmod` parameter can be specified.

The GTT set associated with the translation type specified by the `ttn` parameter must have a set type of `cdgta` (see the `ent-gttset` command).

The value specified for the `gtmodid` parameter must already exist in the GTMOD table.

The GTMOD table is corrupt or cannot be found.

The `gtmodid=none` parameter cannot be specified.

The network domain of the translation type specified by the `ttn` parameter cannot be CROSS (see the `ent-gttset` command).

The `ttn=none` parameter cannot be specified.

The length of the specified `gta` parameter must match the number of digits provisioned for the specified GTT set (`gttsn`) when the VGTT feature is turned off. If the VGTT feature is turned on, then up to 10 GTA lengths can exist per GTT set. If the Support for 16 GTT Lengths in VGTT feature is turned on, then up to 16 GTA lengths can exist per GTT set.

SSN configured for SFAPP cannot be used in any command for any configuration

## Notes

The routing indicator provides routing instructions to the receiving signaling point. If the routing indicator specifies global title, global title translation then needs to be performed at another signaling point.

Up to 200,000 entries are allowed for an individual translation type if all SCCP cards are E5-TSM cards or DSM cards.

The ANSI point code 0 and the ITU-I point code 0-000-0 are not valid point codes.

The EAGLE does not require a MAP table entry to be configured prior to provisioning a GTT entry. The EAGLE assumes that the GTT entry is for a solitary point code/subsystem and automatically creates a MAP entry for the point code/subsystem.

In this command, only ITU-international and ITU national point codes support the spare point code subtype prefix (s-) and the private and spare point code subtype prefix (ps-). All of the point code types support the private (internal) point code subtype prefix (p-).

When the Flexible GTT Load Sharing (FGTTLS) feature and the Intermediate GTT Load Sharing feature are on, multiple relationships can be defined among a set of destination point codes in the MRN table that exists in the EAGLE. The relationship used in a particular translation is based on the GTA digits used for translation. The MRN set and the post-translation PC creates a key that is used to perform lookups in the MRN table. The lookup results in a set of alternate PCs, one of which is selected, based on the PCs relative cost, to route the MSU in the most cost-effective way.

The FGTTLS feature introduces the `mrnset` parameter. The MRNSET and post-translation PC create a key that is used to perform lookup tasks in the MRN table. This lookup results in

a set of alternate PCs, from which one is selected, based on the PCs relative cost, to route the MSU in the most cost-effective way.

When the FGTTLS feature is turned on, multiple relationships can be defined among set of PC/SSNs in the existing MAP table. The relationship used in a particular translation is based on the GTA digits used for translation.

When the FGTTLS feature is ON, the `mapset` parameter is used. The MAP set and PC/SSN creates a key that is used to perform lookup tasks in the MAP table. The lookup into the MAP table results in a set of mate PC/SSNs, from which one is selected to route the MSU in the most cost-effective way.

If the AMGTT feature is turned off, then the Default GT Conversion Table is used for conversion.

A loopset consists of a set of point codes that form a routing loop in the network. If the SCCP Loop Detection feature is enabled, then the loopset can be associated with or disassociated from specified translation entries. Loopsets that are associated with translation entries are checked during intermediate and final GTT traffic routing. If a loop exists, then the system can be notified with or without discarding the associated traffic.

If the OBSR or FLOBR feature is turned on, then this command can provision only translation entries with a set type of CdGTA.

If the EGTT feature is turned on, then the following occurs:

- For ANSI, if the GTT selector of a true entry is deleted using the `dlt-gttset` command, then a GTT entry cannot be created for that translation type.
- For ITU, if a true GTT selector entry (GTI=2 or GTI=4) is deleted using the `dlt-gttset` command, or if the GTT set name of an entry is changed using the `chg-gttset` command, then a GTT entry cannot be created for that translation type.

### Output

```
ent-
gtt:xlata=dpc:pc=12-1-11:ri=gt:gta=981234:type=4:cggmod=yes:gtm
odid=set1
```

```
tekelecstp 10-03-09 12:06:11 EST EAGLE 42.0.0
ENT-GTT: MASP A - COMPLTD
```

```
;
```

### Related Topics

- [chg-gtt](#)
- [dlt-gtt](#)
- [rtrv-gtt](#)

## ent-gttact

Use this command to enter a Global Title Translations (GTT) Action entry. A GTT Action entry consists of an Action ID, an action, and action-specific data. The action specified in the entry determines the actions performed the MSU during translation.

## Parameters



### Note:

Definitions for the feature options specified by the `on` and `off` parameters are located in the Notes section.

### **act (mandatory)**

Action. The action applied to the message.

#### **Range:**

##### ***disc***

discard message with no return error

##### ***dup***

route a copy of the message to a specified duplicate node

##### ***fwd***

route the original message to a specified forward node instead of the destination indicated by the GTT/ DB data

##### ***scpval***

perform the SCCP MAP validation on MO/MT-FSM messages

##### ***sflog***

send a copy of original message to SFLOG card

##### ***sfthrot***

discard message if threshold exceeded

##### ***srvc***

apply service (GPORT/GFLEX/SMSMR) on the message

##### ***tcaperr***

discard message that has a specified TCAP error

##### ***udts***

discard message and send UDTS/XUDTS

##### ***sfapp***

route message to SFAPP card

### **actid (mandatory)**

This parameter specifies the Action ID associated with the GTT action entry.

#### **Range:**

*ayyyyyyy*

1 leading alphabetic character and up to 8 following alphanumeric characters

### **atcaperr (optional)**

ANSI TCAP Error Cause. The reason for discarding the message containing the ANSI TCAP portion that is associated with the TCAPERR GTT Action.

**Range:**

0 - 255

**atirescgmodid (optional)**

Calling party global title modification identifier for ATI. The GTMOD ID to be associated with the calling party of a SFAPP GTT Action entry.

**Range:**

ayyyyyyy

1 leading alphabetic character followed by up to 8 alphanumeric characters

**Default:**

None

**bursts (optional)**

This parameter signifies the number of previous 30-second windows from which the unused capacity can be carried over to the current window.

**Range:**

0 - 2

**Default:**

0

**cdgtmodid (optional)**

Called party global title modification identifier. The GTMOD ID to be associated with the called party of a GTT Action entry.

**Range:**

ayyyyyyy

1 leading alphabetic character followed by up to 8 alphanumeric characters

**Default:**

None

**cggtmodid (optional)**

Calling party global title modification identifier. The GTMOD ID to be associated with the calling party of a GTT Action entry.

**Range:**

ayyyyyyy

1 leading alphabetic character followed by up to 8 alphanumeric characters

**Default:**

None

**cgpc (optional)**

ANSI point code with subfields *network indicator-network cluster-network cluster member (ni-nc-ncm)*. The *prefix* subfield indicates a private point code (*prefix-ni-nc-ncm*).

**Synonym:**

cgpca

**Range:***p*-, 000-255

Specify a valid value for each subfield of the point code, and separate the subfields with a dash (-).

*prefix*—*p*-When `chg-sid:pctype=ansi` is specified, *ni* = 000 is not valid.When `chg-sid:pctype=ansi` is specified, *nc* = 000 is not valid if *ni* = 001-005.When `chg-sid:pctype=ansi` is specified, *nc* = 000 is valid if *ni* = 006-255.

The point code 000-000-000 is not a valid point code.

**cgpci (optional)**ITU international destination point code with subfields *zone-area-id*. The *prefix* subfield indicates a spare point code, private point code, or private and spare point code (*prefix-zone-area-id*).**Range:***s*-, *p*-, *ps*-, 0-255

Specify a valid value for each subfield of the point code, and separate the subfields with a dash (-).

*prefix*—*s*-, *p*-, *ps**zone*—0-7*area*—000-255*id*—0-7

The point code 0-000-0 is not a valid point code.

**cgpcn (optional)**ITU national point code in the format of a 5-digit number (*nnnnn*); or 2, 3, or 4 numbers (members) separated by dashes (*m1-m2-m3-m4*) as defined by the `chg-stpopts:npcfmti` flexible point code option. A group code must be specified when the ITUDUPPC feature is turned on (*nnnnn-gc*, *m1-m2-m3-m4-gc*). The *prefix* subfield indicates a spare point code, private point code, or private and spare point code (*prefix-nnnnn*, *prefix-nnnnn-gc*, *prefix-m1-m2-m3-m4*, *prefix-m1-m2-m3-m4-gc*).**Range:***s*-, *p*-, *ps*-, 0-16383, *aa-zz*

Specify a valid value for each subfield of the point code, and separate the subfields with a dash (-).

*prefix*—*s*-, *p*-, *ps**nnnnn*—0-16383*gc*—*aa-zz**m1-m2-m3-m4*—0-14 for each member; values must sum to 14**cgpcn24 (optional)**24-bit ITU national point code with subfields *main signaling area-sub signaling area-signaling point* (*msa-ssa-sp*). The *prefix* subfield indicates a private point code (*prefix-msa-ssa-sp*).**Range:***p*-, 000-255

Specify a valid value for each subfield of the point code, and separate the subfields with a dash (-).

*prefix*—*p**msa*—000-255*ssa*—000-255*sp*—000-255



**cgpcn16 (optional)**

16-bit ITU national point code with subfields *unit number-sub number area-main number area* (*un-sna-mna*). The *prefix* subfield indicates a private point code (*prefix-un-sna-mna*).

**Range:**

*p, 000--127*

Specify a valid value for each subfield of the point code, and separate the subfields with a dash (-).

*prefix---p*

*un---000---127*

*sna---000---15*

*mna---000---31*

**cgpcogmsg (optional)**

The data that is used as the Calling Party Point Code in the outgoing message.

**Range:*****dflt***

Default. The standard Global Title Translation process supplies the CgPA PC.

***cgpcicmsg***

CgPA PC data from the incoming MSU

***opcicmsg***

OPC data from the incoming MSU

***provcgpc***

provisioned CGPC/CGPCA/CGPCI/CGPCN/CGPCN24/CGPCN16 data in the GTT Action

***remove***

CGPC will be removed from outgoing MSU

**Default:**

*dflt*

**defactid (optional)**

Default Action ID. The default action that is performed when the  *fwd* GTT Action fails to route the MSU or when the *sfthrot* or *scpvval* GTT Action fails.

**Range: ayyyyyyyy**

1 leading alphabetic character followed by 8 alphanumeric characters

The *defactid* parameter can take one of the following values:

- GTT Action ID with a GTT Action of *disc*, *udts*, or *tcaperr* (see the *act* parameter). This value must already be defined in the GTT Action table.
- *fallback* —The MSU is routed using routing data in the translated MSU when action is  *fwd* . When action is set to *scpvval/sfthrot*, the MSU is discarded.

**Default:***fallback***failactid (optional)**

Fail Action ID. The default action that is performed to route the message when the VLR Validation fails on Stateful App.

**Range:***ayyyyyyy*

1 leading alphabetic character followed by 8 alphanumeric characters

The *failactid* parameter can take one of the following values:

- GTT Action ID with a GTT Action of *disc*, *udts* or *tcaperr* (see the *act* parameter). This value must already be defined in the GTT Action table.
- *fallback* -The MSU is discarded.

**Default:***fallback***fdwgtt (optional)**

Forward GTT. The forward GTT Action ID that is to be used to route the MSU.

**Range:***ayyyyyyy***hlraddr (optional)**

It is used to address the HLR for the ATI message.

**Range:**

*USECDPA* --- Use the CDPA GTA from the query message

*TCAPPARM* --- GTT translation shall be performed on MAP Parameter. MAP parameter will be used in SCCP CDPA for GTT translation

*FWDACT* --- Route the message to a specified forward node indicated in FWD GTT Action ID

**Default:***USECDPA***itcaperr (optional)**

ITU TCAP Error Cause. The reason for discarding the message containing the ITU TCAP portion that is associated with the TCAPERR GTT Action.

**Range:***0 - 255***loopset (optional)**

SCCP loopset name. The loopset associated with a GTT action.

**Range:***ayyyyyyy*

1 leading alphabetic character and up to 7 following alphanumeric characters.

*none* —There is no association between the screening action and any loopset.

**Default:***none***mapset (optional)**

MAP Set ID. This parameter specifies the Mated Application Set ID.

**Range:***1 - 36000, dflt**dflt* —Default MAP set**mrnset (optional)**

MRN Set ID. The Mated Relay Node Set ID.

**Range:***1 - 3000, dflt, none**dflt* —Default MRN Set ID*none* —The GTT Action does not participate in any load sharing.**ndgt (optional)**

Number of digits to be matched. This parameter is used to specify the number of digits that must be matched between the *SCCP* parameter and *MAP* parameter.

**Range:***1 - 21, all**all* —All the digits present in the *SCCP* parameter and *MAP* parameter are matched.**Default:***all***off (optional)**

Disables or turns off the specified feature options. This parameter specifies a comma-separated list of feature options that are requested to be turned off. Up to 8 feature options can be specified in the list.

**Range:***uimreqd**useicmsg**handlresp***on (optional)**

Enables or turns on the specified feature options. A comma-separated list of feature options that are requested to be turned on. Up to 8 feature options can be specified in the list.

**Range:***uimreqd**useicmsg**handlresp*

**pc (optional)**

ANSI point code with subfields *network indicator-network cluster-network cluster member (ni-nc-ncm)*. The *prefix* subfield indicates a private point code (*prefix-ni-nc-ncm*).

**Synonym:**

*pca*

**Range:**

*p-*, 000-255

Specify a valid value for each subfield of the point code, and separate the subfields with a dash (-).

*prefix—p-*

When *chg-sid:pctype=ansi* is specified, *ni = 000* is not valid.

When *chg-sid:pctype=ansi* is specified, *nc = 000* is not valid if *ni = 001-005*.

When *chg-sid:pctype=ansi* is specified, *nc = 000* is valid if *ni = 006-255*.

The point code *000-000-000* is not a valid point code.

**pci (optional)**

ITU international destination point code with subfields *zone-area-id*. The *prefix* subfield indicates a spare point code, private point code, or private and spare point code (*prefix-zone-area-id*).

**Range:**

*s-*, *p-*, *ps-*, 0-255

Specify a valid value for each subfield of the point code, and separate the subfields with a dash (-).

*prefix—s-*, *p-*, *ps*

*zone—0-7*

*area—000-255*

*id—0-7*

The point code *0-000-0* is not a valid point code.

**pcn (optional)**

ITU national point code in the format of a 5-digit number (*nnnnn*); or 2, 3, or 4 numbers (members) separated by dashes (*m1-m2-m3-m4*) as defined by the *chg-stpopts:npcfmti* flexible point code option. A group code must be specified when the ITUDUPPC feature is turned on (*nnnnn-gc*, *m1-m2-m3-m4-gc*). The *prefix* subfield indicates a spare point code, private point code, or private and spare point code (*prefix-nnnnn*, *prefix-nnnnn-gc*, *prefix-m1-m2-m3-m4*, *prefix-m1-m2-m3-m4-gc*).

**Range:**

*s-*, *p-*, *ps-*, 0-16383, *aa-zz*

Specify a valid value for each subfield of the point code, and separate the subfields with a dash (-).

*prefix—s-*, *p-*, *ps*

*nnnnn—0-16383*

*gc—aa-zz*

*m1-m2-m3-m4—0-14* for each member; values must sum to 14

**pcn24 (optional)**

24-bit ITU national point code with subfields *main signaling area-sub signaling area-signaling point (msa-ssa-sp)*. The *prefix* subfield indicates a private point code (*prefix-msa-ssa-sp*).

**Range:***p-*, 000-255

Specify a valid value for each subfield of the point code, and separate the subfields with a dash (-).

*prefix—p**msa—000—255**ssa—000—255**sp—000—255***pcn16 (optional)**16-bit ITU national point code with subfields *unit number-sub number area-main number area (un-sna-mna)*. The *prefix* subfield indicates a private point code (*prefix-un-sna-mna*).**Range:***p--*, 000--127

Specify a valid value for each subfield of the point code, and separate the subfields with a dash (-).

*prefix---p**un---000---127**sna---000---15**mna---000---31***psirescgmodid (optional)**

Calling party global title modification identifier for PSI. The GTMOD ID to be associated with the calling party of a SFAPP GTT Action entry.

**Range:***ayyyyyyyy*

1 leading alphabetic character followed by up to 8 alphanumeric characters

**Default:**

None

**ri (optional)**

Routing indicator. The routing indicator in the SCCP called party address of the duplicated copy of MSU.

**Range:***gt**ssn*

route by subsystem number

**Default:***ssn***scfaddr (optional)**

GSM SCFAddressparameter must be specified when sfapp action needs to be performed.

**Range:**

*2 digits - 18 digits*

**snai (optional)**

The service nature of address indicator.

**Range:**

*Sub* --- Subscriber Number

*Natl* --- National significant number

*intl* --- International number

*rnidn* --- Routing number prefix and international dialed/directory number

*rnndn* --- Routing number prefix and national dialed/directory number

*rnsdn* --- Routing number prefix and subscriber dialed/directory number

*ccrndn* --- Country code, routing number, and national directory number

**snp (optional)**

The service numbering plan.

**Range:**

*e164* --- E.164 numbering plan

*e212* --- E.212 numbering plan

*e214* --- E.214 numbering plan

**sprm (optional)**

SCCP Parameter. This parameter is used to determine whether the SCCP GTA, NP, and NAI (if GTI=4 and NP/NAI is present) will be picked up from CDPA or CGPA and used for comparison.

**Range:**

*CDPA* --- SCCP CDPA GTA, NP, and NAI (if GTI=4 and NP/NAI is present) will be used for comparison

*CGPA* --- SCCP CGPA GTA, NP, and NAI (if GTI=4 and NP/NAI is present) will be used for comparison

**Default:**

*CDPA*

**svccerr (optional)**

The action to be taken when the Service triggered by GTT Action Service fails. The MSU can be processed by either applying the results of the pre-Service GTT, or continue with the specific Service error.

**Range:**

*SRVC* --- Continue with specific service error

*GTT* --- Apply the result of pre-GTT service

**Default:***SRVC***srvcname (optional)**Service to be applied on the MSU when *act* is set to *srvc*.**Range:***GFLEX, GPORT, SMSMR***ssn (optional)**

Subsystem number. The subsystem number in the SCCP called party address of the MSU.

**Range:***2 - 255***Default:**

none

**threshold (optional)**

If the number of MSUs serviced by the SFTHROT action exceeds this value, MSUs are discarded.

**Range:***1- 42949676295***Default:***1***tpm (optional)**

TCAP Parameter. This parameter is used to determine whether the MAP digits, NP, and NON (if NP and NON are present) will be picked up from SMRPDA or SMRPOA and used for comparison.

**Range:***SMRPDA* --- MAP digits, NP, and NON (if NP and NON are present) from SMRPDA will be used for comparison*SMRPOA* --- MAP digits, NP, and NON (if NP and NON are present) from SMRPOA will be used for comparison**Default:***SMRPDA***tt (optional)**

New Translation Type

**Range:***0 - 255***udtserr (optional)**

UDTS Error Cause. The reason associated with the UDTS GTT Action for discarding the message.

**Range:***0 - 255*

**valtype (optional)**

Validation Type. This parameter is used to decide whether SCCP/TCAP parameter should be used for the validation of the MSU or IR21.xml file data should be used for the validation of the MSU. This parameter is mandatory when act=scpval.

**Range:***sccptotcap**ir21totcap***Example**

Provisioning GTT Action entry with action type duplicate:

```
ent-gttact:actid=dup1:act=dup:pc=1-1-1:ssn=10:ri=ssn:mapset=20

ent-gttact:actid=actudts:act=udts:udtserr=10

ent-gttact:actid=actdisc:act=disc

ent-gttact:actid=actfwd:act=fwd:pc=2-2-2:ssn=2:ri=ssn:mapset=10

ent-gttact:act=dup:actid=actdup2:pca=1-1-1:ssn=15:ri=gt:
cdgtmodid=set1:cggtmodid=set5:loopset=loop1:cgpca=2-2-2:cgpcogmsg=pr
ovcgpc

ent-gttact:actid=actfwd2:act=fwd:pc=2-2-2:ssn=2:
ri=ssn:defactid=actdisc:on=useicmsg

ent-
gttact:act=dup:actid=actdup3:pc=1-1-1:ri=gt:mrnset=dflt:cgpc=2-2-2

ent-
gttact:act=fwd:actid=actfwd3:pc=1-1-1:ri=gt:mrnset=dflt:cgpcogmsg=df
lt

ent-gttact:act=fwd:actid=actfwd4:pc=1-1-1:
ri=gt:mrnset=dflt:defactid=fallback

ent-gttact:actid=acttcap:act=tcaperr:atcaperr=5

ent-
gttact:act=fwd:actid=actfwd5:pcn16=1-14-0:ri=gt:mrnset=dflt:cgpcogms
g=remove

ent-
gttact:actid=actsrvc:act=srvc:srvcname=gflex:snp=e164:snai=sub:svce
rr=gtt

ent-gttact:actid=actsflog:act=sflog

ent-gttact:actid=sfthrot1:act=sfthrot:bursts=1:threshold=2500

ent-
gttact:actid=scpval1:act=scpval:valtype=sccptotcap:sprm=cdpa:tprm=sm
rpda:
ndgt=15:on=uimreqd:defactid=actdisc
```



```

ent-gttact:actid=scpval1:act=scpval:valtype=ir21totcap

ent-
gttact:actid=sfapp10:act=sfapp:scfaddr=19:hlraddr=usecdpa:faila
ctid=actdisc

ent-
gttact:actid=sfapp10:act=sfapp:scfaddr=19:hlraddr=tcapparm:tt=1
0

ent-
gttact:actid=sfapp10:act=sfapp:scfaddr=19:hlraddr=fwdact:fwdgtt
=actsfapp

ent-
gttact:actid=sfapp10:act=sfapp:scfaddr=19:atirescgmodid=set1

ent-
gttact:actid=sfapp10:act=sfapp:scfaddr=19:12:psirescgmodid=set5

ent-gttact:actid=sfapp10:act=sfapp:scfaddr=19:on=handlresp

```

### Dependencies

A value of *disc*, *udts*, *tcaperr*, *scpval*, or *sfapp* must be specified for the `act` parameter before a value of *uimreqd* can be specified for the `on` or `off` parameter.

The GTT Action table cannot contain more than 2000 entries.

The GTT Action table is corrupt or cannot be found.

If a value of *dup* or *fwd* is specified for the `act` parameter then the `pc/pca/pci/pcn/pcn24/pcn16` parameter must be specified.

If the `ri=ssn` parameter is specified, then the `ssn` parameter must be specified.

If the value of the `cgpcogmsg=provcgpc` parameter is specified, then the `cgpc/cgpc/cgpci/cgpcn/cgpcn24/cgpcn16` parameter must be specified.

The `sprm` and `tprm` parameters must be specified when `act` is set to *scpval*.

If the `hlraddr=tcapparm` parameter is specified, then the `tt` parameter must be specified.

If the `hlraddr=fwdact` parameter is specified, then the `fwdgtt` parameter must be specified.

The GTT Action - DISCARD feature must be enabled before a value of *disc*, *udts*, or *tcaperr* can be specified for the `act` parameter.

The GTT Action - DUPLICATE feature must be enabled before the `act=dup` parameter can be specified.

The specified PC and SSN must already exist in the specified MAP set.

If the `ri=ssn` parameter is specified, then the `mrnset` parameter cannot be specified.

The Flexible GTT Load-Sharing feature must be enabled before the `mrnset` parameter can be specified.

If the `ri=gt` parameter is specified, then the `mapset` parameter cannot be specified.

The Flexible GTT Load Sharing feature must be enabled before the `mapset` parameter can be specified.

The specified MAP set must already exist in the database.

The specified MRN set must already exist in the MRN table.

If the Flexible GTT Load Sharing feature is enabled, the specified PC must already exist in the specified MRN set.

The point code specified for the `pc/pca/pci/pcn/pcn24/pcn16` and `cgpc/cgpca/cgpci/cgpcn/cgpcn24/cgpcn16` parameters must be within the range specified by the parameter definition.

The point code specified for the `pc/pci/pcn/pcn24/pcn16` parameter must be a full point code.

A value of `dup` or `fwd` must be specified for the `act` parameter before the `pc/pca/pci/pcn/pcn24/pcn16`, `cgpc/cgpca/cgpci/cgpcn/cgpcn24/cgpcn16`, `ssn`, `ri`, `mrnset`, `mapset`, `loopset`, `cgpcogmsg`, `cdgtmodid`, or `cggmodid` parameter can be specified and before a value of `useicmsg` can be specified for the `on` or `off` parameter.

The `act=tcaperr` parameter must be specified before the `atcaperr` and `itcaperr` parameters can be specified.

The `act=udts` parameter must be specified before the `udtserr` parameter can be specified.

The `act=fwd/sfthrot/scpval/sfapp` parameter must be specified before the `defactid` parameter can be specified.

The Service Numbering Plan (`snp`), Service Nature of Address Indicator (`sna`), Service name (`srvname`) and Service Error Cause (`svcerr`) parameters can only be specified if action type is `svc`.

The `threshold` or `bursts` parameter can only be specified when `act=sfthrot` is specified.

The `tprm`, `sprm`, and `ndgt` parameters can only be specified if action type is `scpval/sfapp`.

The `scfaddr`, `hlraddr`, `tt`, `failactid` and `fwdggt` parameters can only be specified if action type is `sfapp`.

A value of `none` or `fallback` cannot be specified for the `actid` parameter.

The GTT Action entry specified by the `actid` parameter cannot already exist in the database.

If the value specified for the `pc/pca/pci/pcn/pcn24/pcn16` parameter is the STP true point code, then the value specified for the `ssn` parameter must already exist in the SS-APPL table.

The value specified for the `pc/pca/pci/pcn/pcn24/pcn16` parameter must already exist as a destination in the Route table.

The value specified for the `pc` parameter cannot be associated with a proxy point code.

The MAP table is corrupt or cannot be found.

If the `pc/pca/pci/pcn/pcn24/pcn16`, `ri=ssn` and `ssn` parameters are specified, then the PC/SSN must be populated in the SCCP Application entity set (Remote Point Code/MAP Table).

The SS-APPL table is corrupt or cannot be found.

The Route table is corrupt or cannot be found.

The STP Self-identity table is corrupt or cannot be found.

The MRN table is corrupt or cannot be found.

If the value specified for the `pc/pca/pci/pcn/pcn24/pcn16` parameter is the STP's true point code, then the `ri=ssn` parameter must be specified.

The value specified for the `loopset` parameter must already exist in the database.

The SCCP Loop Detection feature must be enabled before the `loopset` parameter can be specified.

The Loopset table is corrupt or cannot be found.

The GTT Action - FORWARD feature must be enabled before the `act=fwd` parameter can be specified.

The GTMOD table is corrupt or cannot be found.

The value specified for the `pc/pca/pci/pcn/pcn24/pcn16` parameter must be a point code that is already associated with a valid route.

The AMGTT feature must be enabled before the `cggtmodid` parameter can be specified.

The value specified for the `cdgtmodid` and `cggtmodid` parameters must already exist in the GTMOD table.

A value of *none* cannot be specified for the `cdgtmodid` or `cggtmodid` parameter.

A value of *disc*, *utds*, or *tcaperr* must be specified for the `defactid/failactid` parameter.

The GTT Action ID specified by the `defactid` or `failactid` parameter must already exist.

The values specified for the `pc/pca/pci/pcn/pcn24/pcn16` and `cgpc/cgpca/cgpci/cgpcn/cgpcn24/cgpcn16` parameters must have the same domain.

The `loopset=none` parameter cannot be specified.

The `defactid=none` or `failactid=none` parameter cannot be specified.

The same value cannot be specified for the `on` and `off` parameters.

The `snp`, `snai`, and `srvcname` parameters must be specified when `act` is set to `svrc`.

The GFLEX Feature must be activated if the GFLEX service is entered with the SRVCNAME parameter.

The GPORT Feature must be activated if the GPORT service is entered with the SRVCNAME parameter.

When the service specified is GFLEX, SNAI must be specified as subscriber, national or international.

The Portability Check for Mobile Originated SMS feature/PPSMS feature must be turned ON, or the MO SMS ASD/MO SMS B-Party Routing/MO SMS GRN/MO SMS IS41-to-GSM Migration/MO-based GSM SMS NP/MO-based IS41 SMS NP feature must be ENABLED before the SMSMR Service is entered with SRVCNAME parameter.

When service is specified as GPORT or SMSMR, the SNP must be specified as E164.

The GTT Action - FORWARD/DISCARD/DUPLICATE feature must be enabled before the `act=svrc` parameter can be specified.

The GTT destination must exist in the DSTN table.

More than 32 SFTHROT GTT Actions are not permitted.

A value of *fwd*, *dup*, or *scpval* must be specified for the `act` parameter before a value of *useicmsg* can be specified for the `on` or `off` parameter.

The EGTT feature must be on before the SCPVAL GTT Action can be entered.

A value of *none* cannot be specified for the `atirescgmodid` and `psirescgmodid` parameter.

The value specified for the `atirescgmodid` and `psirescgmodid` parameters must already exist in the GTMOD table.

AMGTT feature must be enabled, if `atirescgmodid` or `psirescgmodid` is specified.

## Notes

### on/off options

- *uimreqd* —UIM required. Specifies whether a UIM should be generated.
- *useicmsg* —Use Incoming Message. Specifies whether to apply GTT Action data to the message as the message was received (OFF) or after any EPAP or GTT translation/modification data has been applied (ON).
- *handlresp* —Specifies whether the ATI/PSI response will be sent to SFAPP card or not.

GTI, TT and NPDS must be provisioned in GTMOD table to associate `gtmodid` with ATIRESCGMODID or PSIRESCGMODID.

### Output

```
ent-gttact:actid=discl:act=disc
```

```
tekelecstp 10-02-04 18:29:41 EST EAGLE 42.0.0
ent-gttact:actid=discl:act=disc
Command entered at terminal #4.
```

```
GTT Action table is (1 of 2000) 1% full
```

```
ENT-GTTACT: MASP A - COMPLTD
```

```
;
```

```
ent-gttact:actid=sfthrot1:act=sfthrot
```

```
tekelecstp 15-05-27 15:43:58 EST Eagle 46.3.0
ent-gttact:actid=sfthrot1:act=sfthrot
Command entered at terminal #4.
```

```
GTT Action table is (1 of 2000) 1% full
```

```
ENT-GTTACT: MASP A - COMPLTD
```

```
;
```

```
ent-gttact:actid=sflog1:act=sflog
```

```
tekelecstp 15-05-27 15:43:58 EST Eagle 46.3.0
ent-gttact:actid=sflog1:act=sflog
Command entered at terminal #4.
```

```
GTT Action table is (1 of 2000) 1% full
```

```
ENT-GTTACT: MASP A - COMPLTD
```

```
;
```

```
ent-
```

```
gttact:actid=scpvall:act=scpval:sprm=cdpa:tprm=smrpda:ndgt=15:
on=uimreqd:defactid=actdisc
```

```
tekelecstp 15-05-29 10:25:11 EST Eagle 46.3.0
ent-gttact:actid=scpvall:act=scpval:sprm=cdpa:tprm=smrpda:ndgt=15:
on=uimreqd:defactid=actdisc
Command entered at terminal #4.
```

```
GTT Action table is (10 of 2000) 1% full
```

```
ENT-GTTACT: MASP A - COMPLTD
```

```
;
```

```
ent-gttact:actid=sfapp10:act=sfapp:scfaddr=19:hlraddr=usecdpa
```

```
tekelecstp 17-11-22 10:01:01 EST EAGLE 46.5.1.5.0-73.2.0
ent-gttact:actid=sfapp10:act=sfapp:scfaddr=19:hlraddr=usecdpa
Command entered at terminal #17.
```

```
;
```

```
Command Accepted - Processing
```

```
tekelecstp 17-11-22 10:01:01 EST EAGLE 46.5.1.5.0-73.2.0
```

```
GTT-ACT table is (9 of 2000) 1% full.
```

```
;
```

```
tekelecstp 17-11-22 10:01:02 EST EAGLE 46.5.1.5.0-73.2.0
```

```
ENT-GTTACT: MASP B - COMPLTD
;
Command Executed

ent-gttact:actid=sfapp13:act=sfapp:scfaddr=16:failactid=fallback

tekelecstp 17-11-22 10:07:39 EST EAGLE 46.5.1.5.0-73.2.0
7406.1083 SYSTEM INFO REPT COND: system alive
tekelecstp 17-11-22 10:07:47 EST EAGLE 46.5.1.5.0-73.2.0
ent-gttact:actid=sfapp13:act=sfapp:scfaddr=16:failactid=fallback
Command entered at terminal #17.
;

Command Accepted - Processing
tekelecstp 17-11-22 10:07:47 EST EAGLE 46.5.1.5.0-73.2.0

GTT-ACT table is (10 of 2000) 1% full.

;
tekelecstp 17-11-22 10:07:47 EST EAGLE 46.5.1.5.0-73.2.0
ENT-GTTACT: MASP B - COMPLTD
;
Command Executed

ent-gttact:actid=sfapp3:scfaddr=6762:act=sfapp:atirescgmodid=set1

tekelecstp 18-05-07 10:13:26 EST EAGLE 46.7.0.0.0-74.5.0
ent-gttact:actid=sfapp3:scfaddr=6762:act=sfapp:atirescgmodid=set1
Command entered at terminal #4.

GTT-ACT table is (3 of 2000) 1% full.

ENT-GTTACT: MASP A - COMPLTD
;
```

### Related Topics

- [chg-gttact](#)
- [dlt-gttact](#)
- [rtrv-gttact](#)

## ent-gttapath

Use this command to enter a GTT Action path entry. A GTT Action path consists of pairs of "setname + value" for Opcode/CgGTA/CdGTA. Each "setname + value" pair must already be defined in the GTT translation table.

### Parameters

#### **gttpn (mandatory)**

GTT Path name.

**Range:***ayyyy*

1 leading alphabetic character and up to 4 following alphanumeric characters

**acn (optional)**Application context name. The ITU TCAP*acn* field in the incoming MSU.**Range:***0 - 255, none**none*—there is no ITU TCAP *acn* field in the incoming MSU**cdgta (optional)**

Called Party Global Title Address.

**Range:**

1 - 21 digits

If the Hex Digit Support for GTT feature is not enabled, the range is 1 - 21 decimal digits; valid digits are *0-9*If the Hex Digit Support for GTT feature is enabled and on, the range is 1 - 21 hexadecimal digits; valid digits are *0-9, a-f, A-F***cdgttsn (optional)**

GTT set name (CDPA type).

**Range:***ayyyyyyy*

1 leading alphabetic and up to 8 following alphanumeric characters

**cggta (optional)**

Calling Party Global Title Address.

**Range:**

1 - 21 digits

If the Hex Digit Support for GTT feature is not enabled, the range is 1 - 21 decimal digits; valid digits are *0-9*If the Hex Digit Support for GTT feature is enabled and on, the range is 1 - 21 hexadecimal digits; valid digits are *0-9, a-f, A-F***cggtsn (optional)**

GTT set name (CGPA type).

**Range:***ayyyyyyy*

1 leading alphabetic and up to 8 following alphanumeric characters.

**family (optional)**The ANSI TCAP*family* field in the incoming MSU.**Range:***0 - 255, none**none* —there is no value in the ANSI TCAP *family* field in the incoming MSU**opcode (optional)**This parameter specifies the TCAP*opcode* field in the incoming MSU.

**Range:***0 - 255, none**none*—there is no value in the TCAP *opcode* field in the incoming MSU**opgttsn (optional)**

GTT set name (Opcode type).

**Range:***ayyyyyyy*

1 leading alphabetic and up to 8 following alphanumeric characters

**pkgtype (optional)**

The ANSI and ITU TCAP package type.

**Range:***ituuni*

ITU unidirectional

*qwp*

Query with Permission

*qwop*

Query without Permission

*resp*

Response

*cwp*

Conversation with Permission

*cwop*

Conversation without Permission

*any*

Wildcard value

*bgn*

Begin

*end*

End

*cnt*

Continue

*ituabort*

ITU abort

*ansiabort*

ANSI abort

*ansiuni*

ANSI unidirectional

ANSI TCAP Package Types—*ansiuni, qwp, qwop, resp, cwp, cwop, ansiabort, any*ITU TCAP Package Types—*bgn, ituabort, ituuni, any, end, cnt*



**Example**

```
ent-
gttapath:gttpn=path1:opgttsn=opsn1:acn=111-111-111-111-111-111-
111: opcode=123:pkgtype=ituuni:cdgttsn=cdsn1:cdgta=7654
```

```
ent-
gttapath:gttpn=path2:cggtsn=cgsn2:cggta=45673:opgttsn=opsn2:op
code=124: family=2:pkgtype=ansiuni
```

```
ent-
gttapath:gttpn=path3:opgttsn=opsn2:pkgtype=ansiuni:opcode=124:f
amily=2: cggtsn=cgsn3:cggta=987654:cdgttsn=cdsn1:cdgta=123456
```

**Dependencies**

If the `family` parameter is specified, then a value of *ansiuni*, *qwp*, *qwop*, *resp*, *cwp*, *cwop*, *ansiabort*, or *any* must be specified for the `pkgtype` parameter.

If the `acn` parameter is specified, then a value of *bgn*, *ituabort*, *ituuni*, *any*, *end*, or *cnt* must be specified for the `pkgtype` parameter.

If the `pkgtype=ituabort` parameter is specified, then a value of *none* must be specified for the `acn` and `opcode` parameters.

If the `pkgtype=ansiabort` is specified then a value of *none* must be specified for the `family` and `opcode` parameters.

The `opcode`, `pkgtype`, and `family` parameters must be specified together for ANSI TCAP translations. The `opcode`, `pkgtype`, and `acn` parameters must be specified together for ITU TCAP translations.

If the `family` and `opcode` parameters are specified in the command, then both parameters must have a value of *none* or neither parameter can have a value of *none*.

The GTA table is corrupt or cannot be found.

The GTT DBMM table is corrupt or cannot be found.

A value of *none* cannot be specified for the `opgttsn`, `cggtsn`, or `cdgttsn` parameter.

The GTT Action Path table cannot contain more than 10000 entries.

The GTT Action Path table is corrupt or cannot be found.

The path specified cannot already exist in the GTT Action Path table.

The `acn` and `family` parameters cannot be specified together in the command.

The GTT Action - DISCARD, GTT Action - FORWARD, or GTT Action - DUPLICATE feature must be enabled before this command can be entered.

A translation entry corresponding to the specified (`opgttsn + opcode + pkgtype + acn/family`)/(`cgtsn + cggta`)/(`cdgttsn + cdgta`) parameters must already exist.

At least one GTT set-value combination must be specified.

The value specified for the `opgttsn`, `cggtsn`, or `cdgttsn` parameter must match an existing GTT setname.

The GTT set name specified by the `opgttsn`, `cggtsn`, and `cdgttsn` parameters must have set types of `opcode`, `cggta`, and `cdgta`, respectively.

The GTT Set table must be accessible.

The GTA value specified by the `cggta` or `cdgta` parameter must be the start GTA in the translation entry.

The GTT path name specified by the `gttprn` parameter must not exist in the GTT Action Path table.

The value specified for the `gttprn` parameter cannot be a reserved word.

### Output

```
ent-
gttapath:gttprn=path2:cggtsn=cgsn2:cggta=45673:opgttsn=opsn2:opcode=
124:family=2:pkgtype=ansiuni
```

```
tekelecstp 10-02-04 18:29:41 EST EAGLE 42.0.0
ent-
gttapath:gttprn=path2:cggtsn=cgsn2:cggta=45673:opgttsn=opsn2:opcode=124:
family=2:pkgtype=ansiuni
Command entered at terminal #4.

GTT Action Path table is (1 of 10000) 1% full

ENT-GTTAPATH: MASP A - COMPLTD
;
```

### Related Topics

- [chg-gttapath](#)
- [dlt-gttapath](#)
- [rtrv-gttapath](#)

## ent-gttaset

Use this command to enter a Global Title Translations (GTT) Action Set. A GTT Action Set consists of an Action Set name and a group of actions. The specified actions determine what actions that applied to the MSU during translation.

### Parameters



#### Note:

Definitions for the feature options specified by the `on` and `off` parameters are located in the Notes section.

**actsn (mandatory)**

GTT Action Set Name.

**Range:**

ayyyyyyy

1 leading alphabetic character and up to 8 following alphanumeric characters

**actid1 (optional)**

GTT Action ID 1. The first action ID associated with the GTT action set.

**Range:**

ayyyyyyy

1 leading alphabetic character and up to 8 following alphanumeric characters

**actid2 (optional)**

GTT Action ID 2. The second action ID associated with the GTT action set.

**Range:**

ayyyyyyy

1 leading alphabetic character and up to 8 following alphanumeric characters

**actid3 (optional)**

GTT Action ID 3. The third action ID associated with the GTT action set.

**Range:**

ayyyyyyy

1 leading alphabetic character and up to 8 following alphanumeric characters

**actid4 (optional)**

GTT Action ID 4. The fourth action ID associated with the GTT action set.

**Range:**

ayyyyyyy

1 leading alphabetic character and up to 8 following alphanumeric characters

**actid5 (optional)**

GTT Action ID 5. The fifth action ID associated with the GTT action set.

**Range:**

ayyyyyyy

1 leading alphabetic character and up to 8 following alphanumeric characters

**actid6 (optional)**

GTT Action ID 6. The sixth action ID associated with the GTT action set.

**Range:**

ayyyyyyy

1 leading alphabetic character and up to 8 following alphanumeric characters

**off (optional)**

Disables or turns off the specified feature options. This parameter specifies a comma-separated list of feature options that are requested to be turned off. Up to 8 feature options can be specified in the list.

**Range:*****testmode*****on (optional)**

Enables or turns on the specified feature options. This parameter specifies a comma-separated list of feature options that are requested to be turned on. Up to 8 feature options can be specified in the list.

**Range:*****testmode*****Example**

```
ent-gttaset:actsn=asetdisc1:actid1=disc1
ent-gttaset:actsn=aset2:actid1=dup1:actid2=disc1
ent-gttaset:actsn=aset3:actid1=actfwd:actid2=actdup1:on=testmode
ent-gttaset:actsn=aset4:actid1=dup1:actid2=actsrvc
ent-gttaset:actsn=aset5:actid1=dup1:actid2=scpval1:actid3=fwd1
```

**Dependencies**

The GTT Action table must be accessible.

The Action ID specified by the *actid1/actid2/actid3/actid4/actid5/actid6* parameter(s) must already exist in the GTT Action table.

At least one Action ID in the Action Set must be associated with an action other than *none* or *fallback*.

The value specified by the *actid* parameter cannot already exist in a GTT Action Set.

The GTT Action Set table cannot contain more than 20000 entries

Failure while reading the GTT Action Set table.

The *actsn=none* parameter cannot be specified.

Only one Action ID in an Action Set can be associated with an action of *disc*, *udts*, *srvc*, *sflog*, *sfthrot*, or *tcaperr*.

If an Action ID associated with an action of *fwd* is specified, then no other Action ID in the Action Set can be associated with an action of *disc*, *udts*, *tcaperr*, *srvc*, or *fwd*.

If an Action ID associated with an action of *srvc* is specified, then no other Action ID in the same Action Set can be associated with an action of *fwd*, *disc*, *udts*, *tcaperr*, or *srvc*.

If the Action Set contains 5 Action IDs associated with an action of *dup*, then the remaining action ID cannot be associated with an action of *dup*.

Action IDs associated with an action of *disc*, *udts*, *tcaperr*, or *fwd* must be the last actions in an Action Set.

Action IDs associated with an action of *sfthrot* must be the first action in an Action Set.

If the Action Set contains 2 Action IDs associated with an action of *scpval*, then the remaining Action ID cannot be associated with an action of *scpval*.

One of the optional parameters must be specified.

The `actid1/actid2/actid3/actid4/actid5/actid6` parameters must each specify a unique GTT Action ID in the command.

The EGTT feature must be on before this command can be entered.

The same values cannot be specified for the `on` and `off` parameters.

A maximum of 2 SCPVAL GTT Actions are allowed in an Action Set. Both Action Sets should have a different combination of SPRM and TPRM.

## Notes

### on/off options

- `testmode` —invokes a field-safe Test Tool used to debug the GTT Action Set rules

### Output

```
ent-
gttaset:actsn=asetdisc1:actid1=disc1:actid2=dup1:actid3=dup2:ac
tid4=dup3: actid5=dup4:actid6=dup5:on=testmode
```

```
tekelecstp 10-02-04 18:29:41 EST EAGLE 42.0.0
ent-
gttaset:actsn=asetdisc1:actid1=disc1:actid2=dup1:actid3=dup2:actid4=dup
3:actid5=dup4:
actid6=dup5:on=testmode
Command entered at terminal #4.

GTT Action Set table is (1 of 20000) 1% full

ENT-GTTASET: MASP A - COMPLTD
;
```

### Related Topics

- [chg-gttaset](#)
- [dlt-gttaset](#)
- [rtrv-gttaset](#)

## ent-gttset

Use this command to assign applicable global title selectors to a GTT set for enhanced global title translations. If the EGTT feature is turned on, then the GTT Selector (`ent/chg/dlt/rtrv-gttset`), GTT Set (`ent/dlt/rtrv-gttset`), and GTA (`ent/chg/dlt/rtrv-gta`) commands replace the Translation Type (`ent/dlt/rtrv-tt`) and Global Title Translation (`ent/chg/dlt/rtrv-gtt`) commands. However, the Translation Type and Global Title Translation commands continue to work according to their original functionality when the EGTT feature is on.

## Parameters

 **Note:**

The nature of address indicator parameters (`naiv` or `nai`) and the numbering plan parameters (`npv` or `np`) can be specified using a mnemonic or an explicit value. Either the mnemonic or the explicit value can be specified: however, both values cannot be specified at the same time for the same parameter. [NAIV/NAI Mapping](#) shows the mapping between the `naiv` and `nai` values. [NPV/NP Mapping](#) shows the mapping between the `npv` and `np` values.

**gti/gtia/gtii/gtin/gtin24/gtiis/gtins/gtin16 (mandatory)**

Global title indicator.

For all EGTT selector commands, the domain is defined as GTI and GTIA (ANSI), GTII (ITU international), GTIN (ITU national), GTIN24 (24-bit ITU national), GTIIS (ITU international spare), GTINS (ITU national spare) and GTIN16 (16-bit ITU National).

For the selector commands, `gti` and `gtia` are equivalent. GTT selectors can be provisioned for the same translation type (TT) with different ITU domains. GTT selectors are provisioned independently for each domain. For example, if an entry with `gtii=2` and `tt=4` already exists, an entry with `gtin=2` and `tt=4` can be specified.

**Range:**

0, 2, 4

Supported values for ANSI: `gti=0, 2` and `gtia=0, 2`

Supported values for ITU: `gtii/gtin/gtin24/gtiis/gtins/gtin16=0, 2, 4`

**cdgtasn (optional)**

CdPA GTA GTT set name.

**Range:**

ayyyyyyy

1 leading alphabetic and up to 8 following alphanumeric characters

**cdgttsn (optional)**

CdPA GTT set name.

**Range:**

ayyyyyyy

1 leading alphabetic and up to 8 following alphanumeric characters

**cggtasn (optional)**

CgPA GTA GTT set name.

**Range:**

ayyyyyyy

1 leading alphabetic and up to 8 following alphanumeric characters

**cggttsn (optional)**

CgPA GTT set name.

**Range:***ayyyyyyy*

1 leading alphabetic and up to 8 following alphanumeric characters

**cgpcsn (optional)**

CgPA PC GTT set name.

**Range:***ayyyyyyy*

1 leading alphabetic and up to 8 following alphanumeric characters

**cgssn (optional)**

CgPA subsystem number.

**Range: 0 - 255****eaglegen (optional)**

This parameter specifies whether the selector is used by EAGLE generated messages.

**Range:***yes*

Indicates selector used only by Eagle generated MSU.

**gttsn (optional)**

GTT set name. A GTT set is an entity to which global title addresses and selectors are assigned.

**Range:***ayyyyyyy*

1 leading alphabetic and up to 8 following alphanumeric characters

**lsn (optional)**

Linkset name.

**Range:***ayyyyyyyy*

1 alphabetic character followed by up to 9 alphanumeric characters

**msgtype (optional)**

SCCP message type.

Allow one or more SCCP message types (UDT/UDTS/XUDT/XUDTS) for every GTT Selector entry. This will help in screening different message types differently.

**Range:***sub**u**us**x**xs*

*all*

**Default**

*all*

**nai (optional)**

Nature of address indicator.

**Range:**

*sub*

*rsvd*

*natl*

*intl*

**naiv (optional)**

Nature of address indicator value.

**Range:**

*0 - 127*

**np (optional)**

Numbering plan.

**Range:**

*e164*

*generic*

*x121*

*f69*

*e210*

*e212*

*e214*

*private*

**npv (optional)**

Numbering plan value.

**Range:**

*0 - 15*

**selid (optional)**

Selector ID.

**Range:**

*0 - 65534*



**tt (optional)**

Translation type.

**Range:**

0 - 255

**Example**

```

ent-gtttsel:gti=0:cdgttsn=acdgta
ent-gtttsel:gtia=2:tt=10:gttsn=t800
ent-gtttsel:gtia=2:tt=253:gttsn=setans253
ent-gtttsel:gtii=4:tt=0:np=e164:nai=intl:gttsn=setint000
ent-gtttsel:gtii=2:tt=0:gttsn=setint000
ent-gtttsel:gtin=4:tt=9:np=e214:nai=natl:gttsn=imsi
ent-gtttsel:gtii=4:tt=0:np=e164:nai=sub:gttsn=setint000
ent-gtttsel:gtia=2:tt=20:cdgtasn=setcdgta:
cggtasn=setcggta:cgssn=10:selid=0
ent-gtttsel:gtia=2:tt=21:cggttsn=setcgpc:cdgttsn=setcdgta:
cgssn=20:selid=1:lsn=ls10
ent-
gttsel:gtii=2:tt=40:cdgtasn=setcdgta:cgpcsn=setcgpc:cgssn=12
ent-gtttsel:gtii=2:tt=41:cgpcsn=setcgpc:cgssn=255:selid=65534
ent-gtttsel:gtin=4:tt=60:npv=5:naiv=5:cdgtasn=setcdgta
ent-gtttsel:gtin=4:tt=60:npv=5:naiv=6:cgpcsn=setcgpc:cgssn=112
ent-gtttsel:gtia=2:tt=9:cdgttsn=lidb:eaglegen=yes
ent-gtttsel:gti=0:cdgttsn=acdgta:selid=1
ent-gtttsel:gtin16=0:cgpcsn=abc
ent-gtttsel:gtin16=2:cgpcsn=abc:tt=10
ent-gtttsel:gtin16=4:cgpcsn=abc:tt=10:np=x121:nai=natl
ent-gtttsel:msgtype=u:gtin16=4:cgpcsn=abc:tt=10:np=x121:nai=natl
ent-
gttsel:msgtype=u,us,x:gtii=4:cdgtasn=abc:tt=10:np=x121:nai=natl

```

**Dependencies**

The EGTT feature must be turned on before this command can be entered.

The `np` and `npv` parameters cannot be specified in the same command.

The `nai` and `naiv` parameters cannot be specified in the same command.

The `gti`, `gtia=4`, `gti(x)=1`, and `gti(x)=3` parameters cannot be specified.

If the `gti/gtia/gtii/gtin/gtin24/gtiis/gtins/gtin16=2` parameter is specified, then the `np/npv` and `nai/naiv` parameters cannot be specified.

If the `gtii/gtin/gtin24/gtiis/gtins/gtin16=4` parameter is specified, the `np(v)` and `nai(v)` parameters must be specified. These parameters can be specified in any combination: `np/naiv`, `npv/nai`, `np/nai`, or `npv/naiv`.

A value of *none* cannot be specified for the `gttsn`, `cdgtasn`, `cggtasn`, `cgpcsn`, `cdgttsn`, and `cggttsn` parameters.

The GTT Selector table must be accessible.

The GTT Set table must be accessible.

At least one GTT set name parameter must be specified. These parameters include:

- `cdgtasn`, `cggtasn`, or `cgpcsn` if the OBSR feature is enabled
- `cdgttsn` or `cggttsn` if the FLOBR feature is turned on
- `gttsn` if the OBSR feature is not enabled and the FLOBR feature is not turned on

The OBSR feature must be enabled before the `cggtasn`, `cgpcsn`, `cgssn`, or `cdgtasn` parameters can be specified.

The SSNSELID Table cannot contain more than 100,000 entries.

The SSNSELID table must be accessible.

The linkset specified by the `lsn` parameter must already exist.

The Linkset table is corrupt or cannot be found.

The FLOBR feature must be turned on before the `lsn`, `eaglegen`, `cdgttsn`, and `cggttsn` parameters can be specified.

If the FLOBR feature is turned on, then the `cdgtasn`, `cggtasn`, and `cgpcsn` parameters cannot be specified.

The value specified for the `cdgtasn` or `gttsn` parameter must match the name of an existing GTT set.

The GTT set specified by the `cdgtasn` or `gttsn` parameter must have a set type of *cdgta* (see the `ent-gttset` command).

An entry cannot already exist that matches the `eaglegen`, `gti`, `tt`, and `np(v)`, and `nai(v)` parameter combination for the specified CdPA and/or CgPA selector. If a GTT Selector entry is already provisioned for the given `gti`, `tt`, `np(v)` and `nai(v)` combination with `msgtype=all`, another entry for the same combination but different `msgtype` (`u/us/x/xs`) is not allowed.

The GTT set specified by the `gttsn`, `cdgtasn`, or `cdgttsn` parameter must already exist in the GTT Set table.

The network domain of the specified GTT selector must match the domain of the GTT set that is specified by the `gttsn`, `cdgtasn`, or `cdgttsn` parameter, unless the domain of the GTT set has a value of *cross*.

The GTT set specified by the `cggttsn`, `cggtasn` or `cgpcsn` parameter must already exist in the GTT Set table.

The network domain of the GTT set that is specified by the `cggttsn`, `cggtasn`, or `cgpcsn` parameter must match the domain specified by the `gti(x)` parameter.

The set type of the GTT set specified by the `cggtasn` or `cgpcsn` parameter must match the set type of the corresponding entry in the GTT Set table.

The GTT Set specified by the `cdgtasn` or `gttsn` parameter must have a set type of `cdgta` (see the `ent-gttset` command).

The `gttsn` parameter cannot be specified if the OBSR feature is enabled or the FLOBR feature is turned on.

The GTTDBMM Table cannot contain more than 42,502 entries.

The GTTDBMM table is corrupt or cannot be found.

A database error occurred while trying to access the SSNSELID table.

If the `gti(x)=4` parameter is specified, then the GTT selector table cannot have more than 5 `nai` entries per `tt/np` combination.

The `cggtasn`, `cgpcsn`, and `cggttsn` parameters cannot be specified together in the command.

The `gttsn`, `cdgtasn`, and `cdgttsn` parameters cannot be specified together in the command.

If the `gttsn`, `cdgttsn`, or `cdgtasn` parameter is specified, then the `cgssn` parameter cannot be specified. If the `cggtasn`, `cgpcsn` or `cggttsn` parameter is specified, then the `cgssn` parameter must be specified.

If the `cdgttsn` or `cggttsn` parameter is specified, then the `lsn` parameter must be specified.

If the `eaglegen=yes` parameter is specified, then the `msgtype`, `lsn`, `selid`, `gttsn`, `cdgtasn`, `cgssn`, `cggttsn`, `cggtasn`, and `cgpcsn` parameters cannot be specified.

If the `gti(x)=0` parameter is specified, then the `eaglegen`, `tt`, `np/npv`, and `nai/naiv` parameters cannot be specified.

If a value of 2 or 4 is specified for the `gti(x)` parameter, then the `tt` parameter must be specified.

For existing TTs with `gtii/gtin/gtin24/gtiis/gtins/gtin16=4`, the domain of the new entry must match the existing domain.

The MBR supported GTT set types (IMEI/IMSI/MSISDN/VLRNB/SMRPDA/SMRPOA) cannot be referenced by GTT selectors.

SSN configured for SFAPP cannot be used in any command for any configuration

## Notes

For `gtii/gtin=4`, DFLT may appear in the `rtrv-gttset` output, but `dfit` cannot be specified as value for the `np` or `nai` parameters when the `ent-gttset` command is entered. If a new GTT selector is specified that matches an existing GTT selector's GTI and TT and the existing selector has `dfit` as the value for the `np` and/or `nai` parameters, a new entry is created with the new `np` and `nai` parameter values. The

existing GTT selector entry with the *dfit* value is also retained. The *np/nai* parameter value *dfit* can be specified for the *chg/dlt/rtrv-gtttsel* commands.

The Origin-based SCCP Routing feature allows two GTT sets to be assigned to a GTT selector: CDGTASN and CGGTASN or CDGTASN and CGPCSN. The CGGTASN and CGPCSN GTT sets are mutually exclusive and cannot be assigned to the same GTT selector.

There is no J7 FAK dependency on the GTIA/GTIN16/GTIN24 parameters. The command can be entered successfully whether the J7 FAK is enabled or not enabled.

GTT Selector entries configured using the GTIN24/GTIN16 parameters shall be treated as ITU-N24 entries if the J7 FAK is disabled and shall be treated as ITU-N16 entries if the J7 FAK is enabled.

In the *msgtype* parameter, the parameter values correspond to SCCP message types as given in the following list:

- 'u' implies SCCP UDT message
- 'us' implies SCCP UDTS message
- 'x' implies SCCP XUDT message
- 'xs' implies to SCCP XUPTS messages, and
- 'all' implies all SCCP messages

Using this parameter, a GTT Selector entry can be made to select one or more types of messages. For similar *gti(x)*, *tt*, *np* and *nai* values but different *msgtype* values, different selector entries will be made.

The user cannot enter a selector with an existing message type again. For example, if the user is trying to add a selector with message type as "xs, u" and an existing message type is "xs, x", it cannot be added because the selector with message type "xs" already exists and the message type is a part of a key to the GTT Selector table and cannot be changed.

To enter a selector with message type *xs, u* either delete the existing *xs, x* entry and enter a selector again with "xs, x, u" as the message type, or add an another entry with the message type as "u". Please refer the output for example.

## Output

```
ent-gtttsel:gti=0:cdgttsn=acdgt
```

```
tekelecstp 10-04-05 15:41:49 EST Eagle 42.0.0
ent-gtttsel:gti=0:cdgttsn=acdgt
Command entered at terminal #4.
ENT-GTTSEL: MASP A - COMPLTD
```

```
;
```

```
ent-gtttsel:msgtype=u,us:gti=0:cdgttsn=acdgt
```

```
tekelecstp 17-05-11 13:09:15 EST EAGLE 46.6.0.0.0-71.2.0
ent-gtttsel:msgtype=u,us:gti=0:cdgttsn=acdgt
Command entered at terminal #4.
```

```

ENT-GTTSEL: MASP A - COMPLTD
;

ent-
gttset:msgtype=x,xs:gtin=4:np=e164:nai=intl:tt=0:cggttsn=gttcgg
ta

tekelecstp 17-12-27 06:35:47 EST EAGLE 46.6.0.0.0-71.21.0
ent-
gttset:msgtype=x,xs:gtin=4:np=e164:nai=intl:tt=0:cggttsn=gttcggta
Command entered at terminal #4.
ENT-GTTSEL: MASP A - COMPLTD
;

rtrv-gttset

tekelecstp 17-12-27 06:35:51 EST EAGLE 46.6.0.0.0-71.21.0
rtrv-gttset
Command entered at terminal #4.

MSGTYPE      GTI      CG      CDPA      CGPA
ANSI TT NP      NAI SSN SELID LSN      GTTSET
GTTSET

MSGTYPE      GTI      CG      CDPA      CGPA
INT TT NP      NAI SSN SELID LSN      GTTSET
GTTSET

MSGTYPE      GTI      CG      CDPA      CGPA
NAT TT NP      NAI SSN SELID LSN      GTTSET
GTTSET
x,xs      4      0      e164      intl any none any      -----
gttcggta
(---- )

MSGTYPE      GTI      CG      CDPA      CGPA
N24 TT NP      NAI SSN SELID LSN      GTTSET
GTTSET

MSGTYPE      GTI      CG      CDPA      CGPA
INTS TT NP      NAI SSN SELID LSN      GTTSET
GTTSET

MSGTYPE      GTI      CG      CDPA      CGPA
NATS TT NP      NAI SSN SELID LSN      GTTSET
GTTSET

```

```
;
ent-
gttset:msgtype=xs,u:gtin=4:np=e164:nai=intl:tt=0:cggttsn=gttcggta
```

```
tekelecstp 17-12-27 06:36:27 EST EAGLE 46.6.0.0.0-71.21.0
ent-gttset:msgtype=xs,u:gtin=4:np=e164:nai=intl:tt=0:cggttsn=gttcggta
Command entered at terminal #4.
E5121 Cmd Rej: CdPA/CgPA GTT Selector already exists
```

ENT-GTTSEL: MASP A - Command Aborted

```
ent-
gttset:msgtype=xs,u:gtin=4:np=e164:nai=intl:tt=0:cdgttsn=gttcdgta
```

```
tekelecstp 17-12-27 06:39:10 EST EAGLE 46.6.0.0.0-71.21.0
ent-gttset:msgtype=xs,u:gtin=4:np=e164:nai=intl:tt=0:cdgttsn=gttcdgta
Command entered at terminal #4.
ENT-GTTSEL: MASP A - COMPLTD
```

```
;
```

```
rtrv-gttset
```

```
tekelecstp 17-12-27 06:39:17 EST EAGLE 46.6.0.0.0-71.21.0
rtrv-gttset
Command entered at terminal #4.
```

MSGTYPE	GTI	ANSI	TT	NP	NAI	SSN	SELID	LSN	CDPA	CGPA
									GTTSET	GTTSET
MSGTYPE	GTI	INT	TT	NP	NAI	SSN	SELID	LSN	CDPA	CGPA
									GTTSET	GTTSET
MSGTYPE	GTI	NAT	TT	NP	NAI	SSN	SELID	LSN	CDPA	CGPA
x,xs	4	0		e164	intl	any	none	any	gttcdgta (cdgta)	gttcggta (cggta)
MSGTYPE	GTI	N24	TT	NP	NAI	SSN	SELID	LSN	CDPA	CGPA
									GTTSET	GTTSET
MSGTYPE	GTI	INTS	TT	NP	NAI	SSN	SELID	LSN	CDPA	CGPA
									GTTSET	GTTSET
MSGTYPE	GTI	NATS	TT	NP	NAI	SSN	SELID	LSN	CDPA	CGPA
									GTTSET	GTTSET

;

**Related Topics**

- [chg-gttset](#)
- [dlt-gttset](#)
- [rtv-gttset](#)

## ent-gttset

Use this command to specify the attributes of a new GTT set (a set of global title translations). A GTT set consists of a GTT set name, the number of digits allocated for the GTA (global title address), the domain of the point codes used in the translation, and a pointer to a GTA tree. After the GTT set is provisioned, you can enter subsequent GTT Selector commands and GTA commands.

**Parameters****gttsn (mandatory)**

GTT set name. A GTT set is an entity to which global title addresses and selectors are assigned.

**Range:**

ayyyyyyy

1 leading alphabetic character and up to 8 following alphanumeric characters

**netdom (mandatory)**

Network domain. This command does not distinguish between ITU national or ITU international because the Enhanced Global Title Translation (EGTT) feature does not discriminate between the ITU-I and ITU-N translations.

This parameter refers to the incoming message network domain.

**Range:**

*ansi*

*itu*

*cross*

**checkmulcomp (optional)**

This option indicates whether or not to find translation for multiple components (up to 3 components, if present) of a TCAP message.

**Range:**

*on*

Perform lookup for translation for multiple components.

*off*

Perform lookup for translation for first component only.

**Default:**

No change to the current value

**gttsetmeasrqd (optional)**

GTTSET Measurement required. This parameter specifies whether to perform per GTTSET measurements.

**Range:****yes**

perform per GTTSET Measurements

**no**

do not perform per GTTSET Measurements

**pertrans**

perform per GTT Translation Measurements

**Default:**

No change to the current value

**ndgt (optional)**

Number of digits. This parameter specifies the number of digits required for GTAs associated with the GTT set.

**Range:**

1 - 21

**Default:**

6

**npsn (optional)**

GTT set name (Not Present Set Name). This parameter can have IMEI/IMSI/MSISDN/VLRNB/SMRPOA/SMRPDA GTT set types.

**Range:**

ayyyyyyy

1 leading alphabetic character and up to 8 following alphanumeric characters

**settype (optional)**

GTT set type.

**Range:**

**cdgta**

**cdssn**

**cggta**

**cgpc**

**cgssn**

**dpc**



*imei*

*imsi*

*msisdn*

*opc*

*opcode*

*smrpda*

*smrpoa*

*vlrnb*

**sxudt (optional)**

Segmented XUDT. This parameter specifies whether TOBR will support the processing of segmented XUDT message.

**Range:**

*yes*

perform decoding of segmented XUDT message

*no*

do not perform decoding of segmented XUDT message

**Default:**

*no*

**Example**

```
ent-gttset:gttsn=lidb:ndgt=10:netdom=ansient-  
gttset:gttsn=t800:netdom=ansi  
  
ent-gttset:gttsn=setint000:netdom=itu:ndgt=15  
  
ent-gttset:gttsn=setcdgt:netdom=cross:ndgt=10:settype=cdgta  
ent-gttset:gttsn=setcggg:netdom=ansi:ndgt=11:settype=cggta  
ent-gttset:gttsn=setxyz:netdom=ansi:ndgt=11:settype=cggta  
ent-gttset:gttsn=setopc:netdom=itu:settype=opc  
ent-gttset:gttsn=setcggp:netdom=ansi:settype=cggp  
ent-gttset:gttsn=setssn:netdom=ansi:settype=cgssn  
ent-gttset:gttsn=setopcode:settype=opcode  
ent-gttset:gttsn=setcdssn:netdom=ansi:settype=cdssn  
ent-gttset:gttsn=setdpc:netdom=ansi:settype=dpc  
ent-gttset:gttsn=imsi1:settype=imsi:netdom=itu  
ent-gttset:gttsn=msisdn1:settype=msisdn:npsn=imsi1:netdom=itu
```

```
ent-gttset:gtttsn=setopcode:settype=opcode:netdom=itu:checkmulcomp=on
ent-gttset:gtttsn=imei1:settype=imei:netdom=itu
ent-
gttset:gtttsn=imsi1:settype=imsi:netdom=itu:gttsetmeasrqd=pertrans
ent-gttset:gtttsn=opl1:settype=opcode:netdom=itu:sxudt=yes
```

### Dependencies

The EGTT feature must be turned on before this command can be entered.

The GTT Set table cannot contain more than 2000 entries.

The `gtttsn=none` parameter cannot be specified.

If the VGTT (Variable Length GTT) feature is turned on, the `ndgt` parameter cannot be specified.

The `gtttsn` parameter must be specified and must not match an existing `gtttsn`.

The GTT Set table must be accessible.

The GTT DBMM table must be accessible.

If the `settype` parameter has a value of `cgssn`, `opc`, `cgpc`, `cdssn`, `opcode`, or `dpc`, then the `ndgt` parameter cannot be specified.

The `netdom=cross` parameter can be specified if the `settype=cdgta/imei/imsi/msisdn/vlrnb/smrpoa/smrpda` parameter is specified.

The Origin-based SCCP Routing feature must be turned on if the value of the `settype` parameter is `cgta`, `cgssn`, `opc`, or `cgpc`.

If the OBSR feature is enabled or the FLOBR feature is turned on, then the `settype` parameter must be specified.

The ANSI/ITU SCCP Conversion feature must be enabled before the `netdom=cross` parameter can be specified.

The TOBR feature must be turned on before the `settype=opcode/imei/imsi/msisdn/vlrnb/smrpoa/smrpda` parameter can be specified.

The OBSR feature must be enabled or the FLOBR feature must be turned on before the `settype` parameter can be specified and before more than 950 GTT set entries can be provisioned.

The FLOBR feature must be turned on before a value of `cdssn` or `dpc` can be specified for the `settype` parameter.

The `NPSN` parameter must be specified with the `IMEI/IMSI/MSISDN/VLRNB/SMRPOA/SMRPDA` GTT set types.

`NPSN` must be of MBR set type only.

The GTT set type of the GTT set entry referred to by the `NPSN` parameter should be different from the GTT set type referred to by the `GTTSN` parameter.

The value specified for the `NPSN` parameter must match the name of an existing GTT set of `IMEI/IMSI/MSISDN/VLRNB/SMRPOA/SMRPDA` set types.

The GTTSET domain and associated NPSN set domain must match when the SCCP conversion feature is not ON.

CHECKMULCOMP parameter can be specified with OPCODE GTT set types only.

The SXUDT parameter must be specified with the OPCODE GTT set type only.

### Notes

When the Origin-based SCCP Routing feature is turned on, VGTT is supported only for CdPA GTA and CgPA GTA. The cross network domain is supported for CdPA GTA and IMEI/IMSI/MSISDN/VLRNB/SMRPOA/SMRPDA GTT set type entries.

### Output

```
ent-gttset:gttsn=setcdssn:netdom=ansi:settype=cdssn
```

```
tekelecstp 10-03-12 18:28:54 EST EAGLE 42.0.0  
ENT-GTTSET: MASP A - COMPLTD
```

```
GTT-SET table is (3 of 2000) 1% full.
```

```
;
```

```
ent-gttset:gttsn=setimsi:netdom=itu:settype=imsi:npsn=msisdn
```

```
tekelecstp 15-06-12 18:28:54 EST EAGLE 46.3.0  
ENT-GTTSET: MASP A - COMPLTD
```

```
GTT-SET table is (3 of 2000) 1% full.
```

```
;
```

```
ent-  
gttset:gttsn=setopcode:settype=opcode:netdom=itu:checkmulcomp=on
```

```
tekelecstp 16-10-10 13:54:11 MST EAGLE 46.5.0.0.0-70.5.0  
ENT-GTTSET: MASP A - COMPLTD
```

```
;
```

```
ent-  
gttset:gttsn=imei1:netdom=itu:settype=imei:gttsetmeasrqd=yes
```

```
tekelecstp 17-05-11 15:30:34 EST EAGLE 46.6.0  
ENT-GTTSET: MASP A - COMPLTD
```

```
GTT-SET table is (3 of 10000) 1% full.
```

```
;
```

```
ent-gttset:gttsn=opcode1:netdom=itu:settype=opcode:sxudt=yes

tekelecstp 17-07-15 15:22:17 EST EAGLE 46.6.0
  ENT-GTTSET: MASP A - COMPLTD

  GTT-SET table is (5 of 10000) 1% full.
;
```

### Related Topics

- [chg-gttset](#)
- [dlt-gttset](#)
- [rtrv-gttset](#)

## ent-gws-redirect

Use this command to provision the gateway screening redirect function. The Redirect table must be provisioned before configuring gateway screening to redirect received MSUs. The values that are specified with this command are stored in the Redirect table, and they are used to set the variable fields of the MSUs being redirected. For example, if the `ri=gt` parameter is specified, the value `gt` is set for the routing indicator in the called party address (CDPA) of the MSU being redirected.

### Parameters



#### Note:

See [Point Code Formats and Conversion](#) for a detailed description of point code formats, rules for specification, and examples.

#### **dpc (mandatory)**

Specifies the value used to set the ANSI destination point code field in the routing label of the MSU that is being redirected. The ANSI point code has subfields *network indicator-network cluster-network cluster member* (*ni-nc-ncm*).

#### **Synonym:**

*dpca*

#### **Range:**

000-255

Specify a valid value for each subfield of the point code, and separate the subfields with a dash (-).

When `chg-sid:pctype=ansi` is specified, *ni = 000* is not valid.

When `chg-sid:pctype=ansi` is specified, *nc = 000* is not valid if *ni = 001–005*.

When `chg-sid:pctype=ansi` is specified, *nc = 000* is valid if *ni = 006–255*.

The point code *000-000-000* is not a valid point code.

#### **dpca/dpci/dpcn/dpcn24/dpcn16 (mandatory)**

Destination point code.

**dpci (mandatory)**

Specifies the value used to set the ITU international destination point code field in the routing label of the MSU that is being redirected. The point code has subfields *zone-area-id*.

**Range:**

0-255

Specify a valid value for each subfield of the point code, and separate the subfields with a dash (-).

*zone*—0-7

*area*—000-255

*id*—0-7

The point code 0-000-0 is not a valid point code.

**dpcn (mandatory)**

Specifies the value used to set the ITU national destination point code field in the routing label of the MSU that is being redirected. The point code is in the format of a 5-digit number (*nnnnn*); or 2, 3, or 4 numbers (members) separated by dashes (*m1-m2-m3-m4*) when the `chg-stpopts:npcfnti` flexible point code option is on. A group code (*gc*) must be specified when the ITUDUPPC feature is on (*nnnnn-gc*, *m1-m2-m3-m4-gc*).

**Range:**

0-16383, *aa-zz*

Specify a valid value for each subfield of the point code, and separate the subfields with a dash (-).

*nnnnn*—0-16383

*gc*—*aa-zz*

*m1-m2-m3-m4*—0-14 for each member; values must sum to 14

**dpcn24 (mandatory)**

Specifies the value used to set the 24-bit ITU national destination point code field in the routing label of the MSU that is being redirected. The point code has subfields *main signaling area-sub signaling area-signaling point* (*msa-ssa-sp*).

**Range:**

000-255

Specify a valid value for each subfield of the point code, and separate the subfields with a dash (-).

*msa*—000-255

*ssa*—000-255

*sp*—000-255

**dpcn16 (mandatory)**

Specifies the value used to set the 16-bit ITU national destination point code field in the routing label of the MSU that is being redirected. The point code has subfields *unit number-sub number area-main number area* (*un-sna-mna*).

**Range:**

000---127

Specify a valid value for each subfield of the point code, and separate the subfields with a dash (-).

*un---000---127*

*sna---000---15*

*mna---000---31*

**gta (mandatory)**

Specifies the value used to set the global title address (dialed digits) in the SCCP called party address of the MSU being redirected.

**Range:**

*1 - 21 digits*

**ri (mandatory)**

Specifies the value used to set the routing indicator in the SCCP called party address of the MSU being redirected. Use the *gt* value to route by global title digits or use the *ssn* value to route by subsystem number.

**Range:**

*gt*

*ssn*

**ssn (mandatory)**

Specifies the value used to set the subsystem number (SSN) in the SCCP called party address of the MSU being redirected. This number is the SSN of the SCP to which all MSUs meeting the redirect criteria are to be redirected.

**Range:***000 - 255*

**tt (mandatory)**

Identifies the type of the global title translation (GTT). This value is the decimal representation of the 1-byte field used in SS7 and is used to set the type of the GTT in the SCCP called party address of the MSU being redirected.

**Range:** *000 - 255*

**enabled (optional)**

Specifies whether MSUs that have passed gateway screening are to be redirected (*enabled=on*) or routed as normal (*enabled=off*).

**Range:**

*on*

*off*

**Default:**

*on*

**Example**

```
ent-gws-redirect:dpc=1-40-1:ri=gt:ssn=10:tt=1:gta=180833:enabled=on
```

```
ent-gws-  
redirect:dpc=1-40-1:ri=ssn:ssn=10:tt=1:gta=1800833:enabled=off
```

```
ent-gws-redirect:dpcn16=1-14-0:ri=gt:ssn=10:tt=10:gta=1:enabled=on
```

## Dependencies

The `dpc/dpca/dpci/dpcn/dpcn24/dpcn16` parameter must be defined in the Destination table or defined as the STP site point code.

If the `dpc/dpca/dpci/dpcn/dpcn24/dpcn16` parameter is defined as a destination, it must have at least one route defined.

The redirect function data can be entered only once.

## Notes

The SCCP screening functions (CGPA, TT, CDPA, and AFTPC) cannot select an MSU to be redirected.

Do not apply a Redirect Stop Action on the Adjacent Node point code for the BLKOPC and OPC screening functions.

Do not apply a Redirect Stop Action for an allowed DPC screen rule if the rule contains the self-identity point code of the EAGLE where the screening rule is applied. This is because the redirection of SLTAs and SLTMs (Signal Link Test Messages and Acknowledgements) will not return to the originating EAGLE and will cause the link to fail.

If `gwsa=off` and `gws=off` are specified for all linksets, gateway screening and the GWS redirect function for the DTA feature are disabled.

## Output

```
ent-gws-  
redirect:dpc=1-40-1:ri=gt:ssn=10:tt=1:gta=180833:enabled=on
```

```
rlghncxa03w 03-11-10 11:43:04 EST EAGLE 31.6.0  
ENT-GWS-REDIRECT: MASP A - COMPLTD
```

```
;
```

## Related Topics

- [chg-gws-redirect](#)
- [dlt-gws-redirect](#)
- [rtrv-gws-redirect](#)

# ent-home-smsc

Use this command to enter HOME SMSC specific addresses, currently used to identify Short Message Service Centers in the database. This command updates the HOME SMSCADDR table.

## Parameters

### **smsc (mandatory)**

Identifies the type of the Short Message Service Center address.

**Range:**

1-21 hexadecimal digits. Valid digits are 0-9, a-f, A-F .

**Example**

```
ent-home-smsc:smc=256489
```

```
ent-home-smsc:smc=256489a98bccee56ad237
```

**Dependencies**

The Portability Check for Mobile Originated SMS (MNPSMS) feature must be turned on or one of the following features must be enabled before this command can be entered.

- MO SMS IS41-to-GSM Migration
- MO-based GSM SMS NP
- MO-based IS41 SMS NP
- MT-Based GSM SMS NP
- MT-Based IS41 SMS NP

The specified HOME SMSC address cannot already exist in the HOME SMSCADDR table.

The HOME SMSCADDR table can contain a maximum of 500 entries.

The HOME SMSCADDR table must be accessible.

The GSM DBMM table must be accessible.

**Notes**

None

**Output**

```
ent-home-smsc:smc=256489
```

```
rlghncxa03w 04-02-28 08:50:12 EST EAGLE 31.3.0  
ENT-HOME-SMSC: MASP A - COMPLTD
```

```
;
```

**Related Topics**

- [dlt-home-smsc](#)
- [rtrv-home-smsc](#)

## ent-homern

Use this command to enter up to 100 routing number prefixes for the operating network into the HOMERN table.



## Parameters

### **rn (mandatory)**

The home routing number prefix.

#### **Range:**

1-15 hexadecimal digits. Valid digits are *0-9, a-f, A-F*.

## Example

```
ent-homern:rn=C441234
```

## Dependencies

The HOMERN table cannot be full.

The routing number must not already exist in the HOMERN table.

The `rn=none` parameter cannot be specified.

The A-Port, AINPQ, G-Port, INP, or V-Flex feature must be turned on before this command can be entered.

The HOMERN table must be accessible.

## Notes

None

## Output

```
ent-homern:rn=C441234
```

```
rlghncxa03w 04-01-28 08:50:12 EST EAGLE 31.3.0
HOMERN table is (1 of 100) 1% full
ENT-HOMERN: MASP A - COMPLTD
;
```

## Related Topics

- [dlt-homern](#)
- [rtrv-homern](#)

# ent-ip-conn

Use this command to enter SIP/ENUM/SCCP/SFAPP/IPS with SFLOG connection information. The IPCONN table supports the provisioning information related to the SIP/ENUM/SCCP/SFAPP/IPS with SFLOG connections.

## Parameters









The value specified for the `host` parameter cannot already exist in the IP Host table.

The IP Host table can have a maximum of 4096 host entries.

If a remote host is used (the `type=remote` parameter is specified), then the value specified for the IP Address cannot already exist in the IP Link table.

If a local host is used (the `type=local` parameter is specified), then the value specified for the IP Address must already exist in the IP Link table.

A valid value must be specified for the realm parameter. If the realm contains a hyphen, then the realm must be enclosed within quotation marks.

HOST and REALM must be specified together for the host associated with diameter connection.

### Notes

If the realm contains a hyphen, then the realm must be enclosed within quotation marks.

Realm is mandatory for all the IP hosts associated with diameter connections.

### Output

```
ent-ip-  
host:host=gw100.nc.tekelec.com:ipaddr=150.001.001.001:type=local
```

```
rlghncxa03w 05-07-17 15:35:05 EST EAGLE 34.0.0  
ENT-IP-HOST: MASP A - COMPLTD
```

```
;
```

### Related Topics

- [dlt-ip-host](#)
- [rtrv-ip-host](#)

## ent-ip-node

Use this command to define the IP address of a node that will be receiving messages from the STPLAN application.

### Parameters

#### **cap (mandatory)**

The maximum percentage of Ethernet capacity for the node connection. This capacity is added to other connections to this node for the total capacity of the node.



#### **Note:**

The value specified for this parameter can be used to calculate throughput for E5-ENET-B cards. Refer to the *Notes* section for more information.

**Range:**

1 - 100

**ipaddr (mandatory)**

The node's IP address. This is a TCP/IP address expressed in standard dot notation. IP addresses consist of the system's network number and the machine's unique host number. An example IP address is *192.126.100.5*, where *192.126.100* is the network number and *5* is the machine's host number.

**Range:**

4 numbers separated by dots  
1-233-first number  
0-255-the other three numbers

**ipappl (mandatory)**

The IP application supported by the node.

**Range:**

*stplan*

**ipport (mandatory)**

The logical IP port that addresses the application on the node.

**Range:**

1024 - 5000

**loc (mandatory)**

The card location as stenciled on the shelf of the system that contains the TCP/IP link that will be directly connected to the node.

**Range:**

1101 - 1108, 1111 - 1112, 1201 - 1208, 1211 - 1218, 1301 - 1308, 1311 - 1318,  
2101 - 2108, 2111 - 2118, 2201 - 2208, 2211 - 2218, 2301 - 2308, 2311 - 2318,  
3101 - 3108, 3111 - 3118, 3201 - 3208, 3211 - 3218, 3301 - 3308, 3311 - 3318,  
4101 - 4108, 4111 - 4118, 4201 - 4208, 4211 - 4218, 4301 - 4308, 4311 - 4318,  
5101 - 5108, 5111 - 5118, 5201 - 5208, 5211 - 5218, 5301 - 5308, 5311 - 5318,  
6101 - 6108, 6111 - 6118

**iprte (optional)**

The default router IP address. This is a TCP/IP address expressed in standard dot notation. IP addresses consist of the system's network number and the machine's unique host number. An example IP address is *192.126.100.5*, where *192.126.100* is the network number and *5* is the machine's host number.

**Range:**

4 numbers separated by dots  
1-233-first number  
0-255-the other three numbers

**Example**

```
ent-ip-  
node:ipaddr=13.49.210.50:ipappl=stplan:ipport=1024:loc=1201:cap  
=15:iprte=193.4.201.84
```

## Dependencies

The shelf and card must be equipped.

The node IP address cannot be *127.x.x.x*, where *x* is a number from 1 to 254.

The specified card location must be equipped with a TCP/IP data link.

The IP address must be unique to the TCP/IP link table and to the TCP/IP nodes.

Only one node can be connected for each data link and each application. The IP address, IP application, and card location combination must be unique in the database.

The IP port on each node cannot already be assigned to another application.

The class of the IP address (*ipaddr*) must match the class of the assigned TCP/IP data link's IP address. The system supports three classes of IP addresses, Class A, Class B, and Class C. Class A IP addresses can contain only the values 1 - 126 in the first field of the IP address. Class B IP addresses can contain only the values 128 - 191 in the first field of the IP address. Class C IP addresses can contain only the values 192 - 223 in the first field of the IP address.

The network portion of the IP address (*ipaddr*) must match the network portion of the IP address assigned to the TCP/IP data link. The network portion of the IP address is based on the class of the IP address. If the IP address is a Class A IP address, the first field is the network portion of the IP address. If the IP address is a Class B IP address, the first two fields are the network portion of the IP address. If the IP address is a Class C IP address, the first three fields are the network portion of the IP address.

If the network portion and class of the IP address of the TCP/IP node matches the class of the assigned TCP/IP data link's IP address, the *iprte* parameter cannot be specified. The *iprte* parameter can be specified only with the *ent-ip-node* command when the network portion and class of the TCP/IP node does not match the class of the assigned TCP/IP data link's IP address. The values of the *ipaddr* parameter, the IP address of the TCP/IP node, and the *iprte* parameter cannot be the same.

The capacity of all connections to the given node cannot be greater than 100%.

The router's IP address must not be assigned to a local TCP/IP data link.

The router's IP address must be in the same network as the node's IP address.

## Notes

If the IP address is a Class A IP address, do not use the IP addresses *127.x.x.x*, where *x* is a number from 1 - 254. These addresses are reserved for loopback.

## Using the CAP Value to Calculate Throughput for E5-ENET-B Cards

The value specified for the *cap* parameter can be used to calculate the throughput in transactions per second (TPS) for E5-ENET-B cards. The TPS value is the smaller of the following values:

- `GPL_CARD_CAPACITY`
  - E5-ENET-B card—15000
- `175 [or 17.5] * cap` parameter value



**▲ Caution:**

The 175 multiplier is used only when the link negotiates to 100 Mbits/second full duplex. If the link is a different value than 100 Mbits/second full duplex, then a multiplier of 17.5 is used.

**Output**

```
ent-ip-
node:ipaddr=13.49.210.50:ipappl=stplan:ipport=1024:loc=1201:cap
=15:iprte=193.4.201.84
```

```
rlghncxa03w 04-01-18 08:50:12 EST EAGLE 31.3.0
ENT-IP-NODE: OAM A - COMPLTD
```

```
;
```

**Related Topics**

- [dlt-ip-node](#)
- [rtrv-ip-node](#)

## ent-ip-rte

Use this command to configure the destination IP address, subnet mask, and the gateway IP address for the specified card in the Static IP Route table.

**Parameters****loc (mandatory)**

Card location. The unique identifier of a specific IP card in the system.

**Range:**

1101 - 1108, 1111 - 1112, 1201 - 1208, 1211 - 1218, 1301 - 1308, 1311 - 1318,  
2101 - 2108, 2111 - 2118, 2201 - 2208, 2211 - 2218, 2301 - 2308, 2311 - 2318,  
3101 - 3108, 3111 - 3118, 3201 - 3208, 3211 - 3218, 3301 - 3308, 3311 - 3318,  
4101 - 4108, 4111 - 4118, 4201 - 4208, 4211 - 4218, 4301 - 4308, 4311 - 4318,  
5101 - 5108, 5111 - 5118, 5201 - 5208, 5211 - 5218, 5301 - 5308, 5311 - 5318,  
6101 - 6108, 6111 - 6118

**dest (mandatory)**

Destination IP Address. The IP Address of a remote destination host or network to be reached.

**Range:**

4 numbers separated by dots, with each number in the range of 0–255.  
The IP address 0.0.0.0 is not valid.

**gtwy (optional)**

Gateway IP Address. The IP address assigned to the gateway router that will properly forward IP datagrams with the destination IP address (*dest*) to the next-hop gateway router or final destination host.

**Range:**

4 numbers separated by dots, with each number in the range of 0–255.  
The IP address 0.0.0.0 is not valid.

**submask (mandatory)**

The subnet mask of the destination IP address, in the form of an IP address with a restricted range of values. This parameter is required if the `ipaddr` parameter is entered.

**Range:**

The value must be valid for the class of the entered IP address.

**Valid for Class A Networks**

- 255.0.0
- 255.192.0
- 255.224.0
- 255.240.0
- 255.248.0
- 255.252.0
- 255.254.0
- 255.255.128.0

**Valid for Class A or B Networks**

- 255.255.0.0
- 255.255.192.0
- 255.255.224.0
- 255.255.240.0
- 255.255.248.0
- 255.255.252.0
- 255.255.254.0
- 255.255.255.128

**Valid for Class A, B, or C Networks**

- 255.255.255.0
- 255.255.255.192
- 255.255.255.224
- 255.255.255.240
- 255.255.255.248
- 255.255.255.252

 **Note:**

The value `255.255.255.255` must be specified if the destination IP address represents a host address. If the destination IP address represents a network address, a value must be specified that identifies the network ID and host ID portions of the address.

**Example**

```
ent-ip-rte:loc=1301:dest=128.252.10.5:submask=255.255.255.255:  
gtwy=140.188.13.33
```

**Dependencies**

The specified destination IP address (`dest` parameter):

- Must not be the default route (0.0.0.0)
- Must not correspond to any loopback address (i.e. 127.X.X.X)
- Must be unique per card
- Must not reside on any local network on the card

The specified gateway IP address (`gtwy` parameter):

- Must not be the default route (0.0.0.0)
- Must not correspond to any loopback address (i.e. 127.X.X.X)
- Must correspond to a host IP address that resides on any local network on the card

The IP address must be defined for any or all networks for the card before this command can be entered. (See the [chg-ip-lnk](#) command.)

Each destination IP address entered into the Static IP Route table must be unique for the card.

A maximum of 64 static IP routes can be defined for a card.

A maximum of 2048 static IP routes can be defined in the IP Route table.

The network address specified by the `dest` and `submask` parameters must be different from the network address specified by the `pvn` and `pvnmask`, `fcna` and `fcnamask`, and `fcnb` and `fcnbmask` parameters of the NETOPTS table.

**Notes**

The Static IP Route table is used to store static IP route entries. Static routes are maintained across card initialization, failures, and reloads. These types of routes are used when the IP Layer cannot determine routes dynamically. Static IP route entries can be added or deleted dynamically.

## Output

```
ent-ip-rte:loc=1301:dest=128.252.10.5:submask=255.255.255.255:  
gtwy=140.188.13.33
```

```
rlghncxa03w 12-07-24 15:35:05 EST EAGLE 45.0.0  
IP Route table is (1 of 2048) 1% full  
ENT-IP-RTE: MASP A - COMPLTD  
;
```

## Related Topics

- [dlt-ip-rte](#)
- [rtrv-ip-rte](#)

# ent-j1

Use this command to enter a J1 interface on a T1 card.

## Parameters

### loc (mandatory)

The card location as stenciled on the shelf of the system.

#### Range:

1101 - 1108, 1111 - 1112, 1201 - 1208, 1211 - 1218, 1301 - 1308, 1311 - 1318, 2101 - 2108, 2111 - 2118, 2201 - 2208, 2211 - 2218, 2301 - 2308, 2311 - 2318, 3101 - 3108, 3111 - 3118, 3201 - 3208, 3211 - 3218, 3301 - 3308, 3311 - 3318, 4101 - 4108, 4111 - 4118, 4201 - 4208, 4211 - 4218, 4301 - 4308, 4311 - 4318, 5101 - 5108, 5111 - 5118, 5201 - 5208, 5211 - 5218, 5301 - 5308, 5311 - 5318, 6101 - 6108, 6111 - 6118

### j1port (mandatory)

J1 port number.

The value must be a J1 port for which an interface has not been configured on the specified J1 card.

#### Range:

1-8

### encode (optional)

Indicator for use of B8ZS or AMI encoding/decoding.

#### Range:

b8zs

ami

#### Default:

b8zs

**j1tsel (optional)**

Timing source

**Range:***line*

slave timing source

*external*

master timing source

**Default:***line***l1 (optional)**

T1 cable length in feet between the EAGLE and the connecting node.

**Range:**

0-655

**Default:**

133

**Example**

```
ent-j1:loc=1101:j1port=1:encode=ami:j1tsel=external
```

```
ent-j1:loc=1102:j1port=1:j1tsel=line
```

```
ent-j1:loc=1103:j1port=2
```

**Dependencies**

The specified card location (loc parameter) must be equipped.

The J1 table must be accessible.

The Card (IMT) table must be accessible.

The port specified by the j1port parameter must not be already equipped with a J1 interface.

Card locations 1113 - 1118 (OAM, TDM, MDAL cards) cannot be specified as values for the loc parameter.

The specified card location must be provisioned with type as limt1 and appl as ccs7itu.

The card must not be provisioned with any E1/T1 ports.

The j1port parameter must be in the range from 1 to 8.

IMT card location cannot be specified.

The J7 support feature must be enabled before the J1 port can be provisioned.

**Notes**

There is not a new card type for J1. The J1 interface will be provisioned on a T1.

Once the J1 interface is provisioned on it, no T1 interface will be allowed on the T1 card.

This card will be treated as a J1 card.

### Output

```
ent-j1:loc=1101:j1port=1:encode=ami:j1tsel=external
```

```
tekelecstp 13-12-20 12:12:36 EST 46.0.0-65.3.0
ent-j1:loc=1101:j1port=1:encode=ami:j1tsel=external
ENT-J1: MASP A - COMPLTD
;
```

### Related Topics

- [chg-j1](#)
- [dlt-j1](#)
- [rtrv-j1](#)
- [tst-j1](#)

## ent-lbp

Use this command to assign a far-end loopback point for testing data signaling link elements in a SS7 transmission path.

### Parameters

#### **lbp (mandatory)**

Loopback point ID. A far-end loopback point that lies along an SS7 signaling link path between the STP and the target device (up to and including the target device).

#### **Range:**

1 - 32

#### **lfst (mandatory)**

Link fault sectionalization test. The type of link fault sectionalization loopback test to be performed.

#### **Range:**

**lft**  
latching loopback test

**nlt**  
nonlatching loopback test

#### **link (mandatory)**

SS7 signaling link. The SS7 signaling link that is to be tested.

#### **Synonym:**

*port*

**Range:**

*a, b, a1 - a31, b1 - b31*

Not all card types support all `link` parameter values.

See [Table A-1](#) for valid `link` parameter range values for each type of card that can have assigned signaling link ports.

**loc (mandatory)**

Card location. The unique identifier of a specific application subsystem located in the STP.

**Range:**

*1101 - 1108, 1111 - 1112, 1201 - 1208, 1211 - 1218, 1301 - 1308, 1311 - 1318, 2101 - 2108, 2111 - 2118, 2201 - 2208, 2211 - 2218, 2301 - 2308, 2311 - 2318, 3101 - 3108, 3111 - 3118, 3201 - 3208, 3211 - 3218, 3301 - 3308, 3311 - 3318, 4101 - 4108, 4111 - 4118, 4201 - 4208, 4211 - 4218, 4301 - 4308, 4311 - 4318, 5101 - 5108, 5111 - 5118, 5201 - 5208, 5211 - 5218, 5301 - 5308, 5311 - 5318, 6101 - 6108, 6111 - 6118*

**rle (mandatory)**

Remote link element. The link element to be looped back for testing.

**Range:**

*ds0*

*ocu*

*csu*

*dsu*

*nei*

**clli (optional)**

The Common Language Location Identifier (CLLI) code, or other mnemonic identifier, used to refer to the given loopback point.

**Range:**

*ayyyyyyyyy*

1 alphabetic character followed by up to 10 alphanumeric characters

**rep (optional)**

Repetition count. The number of link elements of the same type (not including the target device) that lie between the STP and the link element to be tested.

**Range:**

*0 - 31*

**Default:**

0—If the link element to be looped back for testing is NEI (*rle=nei* is specified)

0—If the LFS test is NLT (non-latched); *lfst=nl* is specified

0—If no other LBP for this link has the same *rle* value

1–30—Next sequential number for subsequent loopback points of the link to be tested (*rle* is specified as anything but *nei*)

### Example

```
ent-  
lbp:loc=1101:link=a:lbp=1:rle=ds0:lfst=llt:rep=0:clli=rlghncxa05w  
  
ent-lbp:loc=1101:port=a:lbp=2:rle=nei:lfst=llt  
  
ent-  
lbp:loc=1205:port=a1:lbp=1:rle=ds0:lfst=llt:clli=rlghncxa05w:rep=1
```

### Dependencies

The Link Fault Sectionalization (LFS) feature must be on before this command can be entered.

The card location (`loc` parameter) must be equipped.

The `rle=ds0` parameter and the `rle=nei` parameter cannot be specified when the `lfst=nl` parameter is specified. The DS0 and Network Element Interface (NEI) link elements do not support non-latching loopbacks.

If the `rle=nei` parameter is specified, the `rep=0` parameter must be specified.

The `rep` parameter can be specified only if the `lfst=llt` parameter is specified.

Each specified `rep` parameter value must be greater than any previously specified `rep` value and less than any subsequent specified `rep` value.

The specified `clli` cannot be a reserved word.

The loopback point (LBP) cannot have been previously defined.

The value specified for the `lbp` parameter cannot exceed the `lbp` parameter value previously defined for a loopback point with `rle=nei` specified.

For each SS7 signaling link, only one loopback point with `rle=nei` specified can be defined.

The `rep` parameter must be specified if taking the default value results in duplicate `rep` values for loopback points.

The loopback point with `rle=nei` specified must be the terminating SS7 signaling link element.

The card location must contain a provisioned E5-E1T1-B card, provisioned with the LIMIT1 card type, that is running either the SS7ANSI or CCS7ITU application.

The card location (`loc` parameter) must not be reserved by the system.

The Link Fault Sectionalization database Loopback Point (LBP) table is not accessible.

The values specified for the `loc` and `link` parameters must already exist in the database.

### Notes

None



## Output

```
ent-lbp:loc=1101:link=a:lbp=2:rle=nei:lfst=llt
```

```
rlghncxa03w 05-02-17 15:35:05 EST EAGLE5 33.0.0
ENT-LBP: MASP A - COMPLTD
;
```

## Related Topics

- [act-lbp](#)
- [chg-lbp](#)
- [dact-lbp](#)
- [dlt-lbp](#)
- [rtrv-lbp](#)

# ent-lg-card

Use this command to create a new LG card. An LG Card is associated with a single LG Group. The command class is TKLC\_INTERNAL inheriting properties of DEBUG class. The Load Generator is supported on IPSP, IPLHC, IPGHC and SS7HC GPLs.

## Parameters

### **grp (mandatory)**

LG group name

#### **Range:**

ayyyyyyyyy Up to 10 alphanumeric characters; the first character must be a letter.

### **loc (mandatory)**

The card location as stenciled on the shelf of the system.

#### **Range:**

1101 - 1108, 1111 - 1112, 1201 - 1208, 1211 - 1218, 1301 - 1308, 1311 - 1318,  
2101 - 2108, 2111 - 2118, 2201 - 2208, 2211 - 2218, 2301 - 2308, 2311 - 2318,  
3101 - 3108, 3111 - 3118, 3201 - 3208, 3211 - 3218, 3301 - 3308, 3311 - 3318,  
4101 - 4108, 4111 - 4118, 4201 - 4208, 4211 - 4218, 4301 - 4308, 4311 - 4318,  
5101 - 5108, 5111 - 5118, 5201 - 5208, 5211 - 5218, 5301 - 5308, 5311 - 5318,  
6101 - 6108, 6111 - 6118

## Example

```
ent-lg-card:loc=1301:grp=lgroup1
```

## Dependencies

The card location must not be 1113-1118, or xy09 and xy10 where x is the frame and y is the shelf.

The valid card types are DCM, ENET, LIME1, and LIMT1.

The specified group name value must exist in the database.

The card location specified in the `loc` parameter must not be associated with another LG group.

The LG Card table is corrupt or cannot be found.

The card in the specified card location must be a LIM and must exist.

The card location specified in the `loc` parameter must be equipped.

The LG Group table is corrupt or cannot be found.

The `loc` and `grp` parameters are mandatory

The IMT table is corrupt or cannot be found.

Only E-5 Class cards are supported card types for a card to be an LG card

## Output

### Related Topics

- [act-lg-card](#)
- [chg-lg-card](#)
- [dact-lg-card](#)
- [dlt-lg-card](#)
- [rept-stat-lg](#)
- [rtrv-lg-card](#)

## ent-lg-engine

Use this command to create an LG engine. An LG Engine is associated with a single LG Card. The command class is `TKLC_INTERNAL` inheriting properties of `DEBUG` class. The Load Generator is supported on `IPSG`, `IPLHC`, `IPGHC` and `SS7HC` GPLs.

### Parameters

#### **engine (mandatory)**

**Range: ayyyyyyyyy**

Up to 10 alphanumeric characters; the first character must be a letter.

#### **event (mandatory)**

**Range: ayyyyyyyyy**

Up to 10 alphanumeric characters; the first character must be a letter

#### **loc (mandatory)**

The card location as stenciled on the shelf of the system.

**Range:**

*1101 - 1108, 1111 - 1112, 1201 - 1208, 1211 - 1218, 1301 - 1308, 1311 - 1318, 2101 - 2108, 2111 - 2118, 2201 - 2208, 2211 - 2218, 2301 - 2308, 2311 - 2318, 3101 - 3108,*

3111 - 3118, 3201 - 3208, 3211 - 3218, 3301 - 3308, 3311 - 3318, 4101 - 4108,  
4111 - 4118, 4201 - 4208, 4211 - 4218, 4301 - 4308, 4311 - 4318, 5101 - 5108,  
5111 - 5118, 5201 - 5208, 5211 - 5218, 5301 - 5308, 5311 - 5318, 6101 - 6108,  
6111 - 6118

**action (optional)**

Transmitting and receiving actions of a LG Engine.

**Range:*****snk***

Rx Action: Sink Mode

***ret***

Rx Action: Return Mode

***retl2***

Rx Action: Return by L2 Mode

***cong***

Rx Action: Congestion

***cap***

Rx Action: capture mode

***pbk***

Tx Action: Playback mode

**port (optional)**

The signaling link on the card specified in the `loc` parameter. The links can be specified in any sequence or pattern.

**Synonym:**

*link*

**Range:**

*a, b, a1 - a31, b1 - b31*

Not all card types support all `link` parameter values.

See [Summary of Range Values for :link Parameter](#) for valid `link` parameter range values for each type of card that can have a location specified in the `loc` parameter.

**rxengine (optional)**

Receiving LG Engine name.

**Range:**

*ayyyyyyyy*

Up to 10 alphanumeric characters; the first character must be a letter.

**txrate (optional)**

Transmission rate of a LG Engine.

**Range:**

*0 - 10000*

### Example

```
ent-lg-  
engine:engine=txengine1:loc=1302:event=txisup1:port=a:txrate=100  
  
ent-lg-engine:engine=rxengine1:loc=1302:event=rxisup1:action=cap  
  
ent-lg-  
engine:engine=txengine2:loc=1302:event=txisup2:action=pbk:rxengine=r  
xengine1
```

### Dependencies

The value specified for the `engine` parameter cannot already exist in the LG Engine table.

The LG Engine table is corrupt or cannot be found.

The number of engines associated with a card should not exceed the max limit.

The number of events associated with a engine should not exceed the max limit.

The `txrate` parameter cannot be specified with the parameter `event` of Rx type.

The `action` parameter of type PBK can only be assigned to Tx event direction.

The engine name specified shouldn't be an Eagle reserved name

The `action` parameter of type SNK/RET/RETL2/CONG/CAP can only be assigned to RX event direction.

The card location specified in the `loc` parameter must be of a provisioned LG card.

The port specified in the command must be provisioned.

The `rxengine` parameter cannot be specified with the `action` parameter of type other than PBK.

The specified `Rx engine` parameter value must be associated with the card.

The Rxengine specified must pre-exist in the LG Engine table.

Engine specified in RxEngine parameter must of Rx Type.

The LG Event name specified in the command must exist in the table

The LG Engine table cannot already be full.

SIF Size > 272 not supported on ss7hc

The Rx Event can not be associated to more than one Engine on the same LG card

The LG Card and Event specified in the command must belong to same network

The `port` parameter cannot be specified with the parameter `event` of Rx type.

### Output

#### Related Topics

- [act-lg-engine](#)
- [dact-lg-engine](#)

- [dlt-lg-engine](#)
- [rept-stat-lg](#)
- [rtrv-lg-engine](#)

## ent-lg-event

Use this command to create a new LG event. The command class is TKLC\_INTERNAL inheriting properties of DEBUG class. The Load Generator is supported on IPSG, IPLHC, IPGHC and SS7HC GPLs.

### Parameters

#### **dir (mandatory)**

Type of Event (Tx or Rx)

#### **Range:**

***Tx***  
Transmit Event

***Rx***  
Receive Event

#### **dpc (mandatory)**

ANSI destination point code with subfields *network indicator-network cluster-network cluster member (ni-nc-ncm)*. The *prefix* subfield indicates a private point code (*prefix-ni-nc-ncm*).

#### **Synonym:**

*dPCA*

#### **Range:**

*p-*, 000-255, \*

Specify a valid value for each subfield of the point code, and separate the subfields with a dash (-).

*prefix—p-*

The asterisk value (\*) is not valid for the *ni* subfield.

When *chg-sid:pctype=ansi* is specified, *ni = 000* is not valid.

When *chg-sid:pctype=ansi* is specified, *nc = 000* is not valid if *ni = 001–005*.

When *chg-sid:pctype=ansi* is specified, *nc = 000* is valid if *ni = 006–255*.

The point code 000-000-000 is not a valid point code.

#### **dpc/dPCA/dpci/dpcn/dpcn24 (mandatory)**

Destination point code

#### **dpci (mandatory)**

ITU international destination point code with subfields *zone-area-id*. The *prefix* subfield indicates a spare point code, private point code, or private and spare point code (*prefix-zone-area-id*).

#### **Range:**

*s-*, *p-*, *ps-*, 0-255

Specify a valid value for each subfield of the point code, and separate the subfields with a dash (-).

*prefix*—*s*-, *p*-, *ps*

*zone*—*0-7*

*area*—*000-255*

*id*—*0-7*

The point code *0-000-0* is not a valid point code.

#### **dpcn (mandatory)**

ITU national destination point code in the format of a 5-digit number (*nnnnn*); or 2, 3, or 4 numbers (members) separated by dashes (*m1-m2-m3-m4*) as defined by the `chg-stpopts:npcfmti` flexible point code option. A group code must be specified when the ITUDUPPC feature is turned on (*nnnnn-gc*, *m1-m2-m3-m4-gc*). The *prefix* subfield indicates a spare point code, private point code, or private and spare point code (*prefix-nnnnn*, *prefix-nnnnn-gc*, *prefix-m1-m2-m3-m4*, *prefix-m1-m2-m3-m4-gc*).

##### **Range:**

*s*-, *p*-, *ps*-, *0-16383*, *aa-zz*

Specify a valid value for each subfield of the point code, and separate the subfields with a dash (-).

*prefix*—*s*-, *p*-, *ps*

*nnnnn*—*0-16383*

*gc*—*aa-zz*

*m1-m2-m3-m4*—*0-14* for each member; values must sum to 14

#### **dpcn24 (mandatory)**

24-bit ITU national point code with subfields *main signaling area-sub signaling area-signaling point* (*msa-ssa-sp*). The *prefix* indicates a private point code (*prefix-msa-ssa-sp*).

##### **Range:**

*p*-, *000-255*

Specify a valid value for each subfield of the point code, and separate the subfields with a dash (-).

*prefix*—*p*

*msa*—*000-255*

*ssa*—*000-255*

*sp*—*000-255*

#### **event (mandatory)**

##### **Range:**

ayyyyyyyyy Up to 10 alphanumeric characters; the first character must be a letter

#### **h0h1 (mandatory)**

SNM Type

##### **Range:**

*tfa*

*tfp*

*tfc*

*tfr*

*rct*

*upu*

**opc (mandatory)**

ANSI originating point code with subfields network indicator-network cluster-network cluster member (ni-nc-ncm).

**Range:**

*p*-, 000-255, \*

Specify a valid value for each subfield of the point code, and separate the subfields with a dash (-).

*prefix*—*p*-

The asterisk value (\*) is not valid for the *ni* subfield.

When *chg-sid:pctype=ansi* is specified, *ni = 000* is not valid.

When *chg-sid:pctype=ansi* is specified, *nc = 000* is not valid if *ni = 001–005*.

When *chg-sid:pctype=ansi* is specified, *nc = 000* is valid if *ni = 006–255*.

The point code *000-000-000* is not a valid point code.

**opc/opca/opci/opcn/opcn24 (mandatory)**

Originating Point Code

**opci (mandatory)**

ITU international originating point code with subfields *zone-area-id*. The *prefix* subfield indicates a spare point code (*prefix-zone-area-id*).

**Range:**

*s*-, *p*-, *ps*-, 0-255

Specify a valid value for each subfield of the point code, and separate the subfields with a dash (-).

*prefix*—*s*-, *p*-, *ps*

*zone*—0-7

*area*—000-255

*id*—0-7

The point code *0-000-0* is not a valid point code.

**opcn (mandatory)**

ITU national originating point code in the format of a 5-digit number (*nnnnn*); or 2, 3, or 4 numbers (members) separated by dashes (*m1-m2-m3-m4*) as defined by the *chg-stpopts:npcfmti* flexible point code option. A group code must be specified when the ITUDUPPC feature is turned on (*nnnnn-gc*, *m1-m2-m3-m4-gc*). The prefix subfield indicates a spare point code (*prefix-nnnnn*, *prefix-nnnnn-gc*, *prefix-m1-m2-m3-m4*, *prefix-m1-m2-m3-m4-gc*).

**Range:**

*s*-, *p*-, *ps*-, 0-16383, *aa-zz*

Specify a valid value for each subfield of the point code, and separate the subfields with a dash (-).

*prefix*—*s*-, *p*-, *ps*

*nnnnn*—0-16383

*gc*—*aa-zz*

*m1-m2-m3-m4*—0-14 for each member; values must sum to 14

**opc24 (mandatory)**

24-bit ITU national originating point code with subfields *main signaling area-sub signaling area-signaling point (msa-ssa-sp)*.

**Range:**

*p*-, 000-255

Specify a valid value for each subfield of the point code, and separate the subfields with a dash (-).

*prefix—p*

*msa—000—255*

*ssa—000—255*

*sp—000—255*

**si (mandatory)**

MSU Service Indicator

**Range:**

0 - 15

SI value:

0 = SNM

1,2, 6-12, 14 = TEST

3 = SCCP

4 = TUP

5 = ISUP

13 = BICC

15 = H248

**cause (optional)**

Cause Code for UPU

**Range:**

0 - 15

**Default:**

0

**class (optional)**

Internal or External

**Range:**

*int*

Internal

**cnglv1 (optional)**

Congestion Level for TFCs

**Range:**

0 - 3

**Default:**

0

**cpc (optional)**

ANSI capability point code with subfields *network indicator-network cluster-network cluster member (ni-nc-ncm)*.



**Synonym:***cpc***Range:***000-255*

Specify a valid value for each subfield of the point code, and separate the subfields with a dash (-).

When *chg-sid:pctype=ansi* is specified, *ni = 000* is not valid.

When *chg-sid:pctype=ansi* is specified, *nc = 000* is not valid if *ni = 001-005*.

When *chg-sid:pctype=ansi* is specified, *nc = 000* is valid if *ni = 006-255*.

The point code *000-000-000* is not a valid point code.

**cpc/cpca/cpci/cpcn/cpcn24 (optional)**

Capability point code. The code used by the SS7 protocol to identify a group of functionally related STPs in the signaling network to which the STP belongs.

**cpci (optional)****Range:***s-, 0-255*

Specify a valid value for each subfield of the point code, and separate the subfields with a dash (-).

*prefix—s**zone—0-7**area—000-255**id—0-7*

The point code *0-000-0* is not a valid point code.

**Default:**

No change to existing point code value.

**cpcn (optional)**

ITU national point code in the format of a 5-digit number (*nnnnn*); or 2, 3, or 4 numbers (members) separated by dashes (*m1-m2-m3-m4*) as defined by the *chg-stpopts:npcfnti* flexible point code option. A group code must be specified when the ITUDUPPC feature is turned on (*nnnnn-gc*, *m1-m2-m3-m4-gc*). The *prefix* subfield indicates a spare point code (*prefix-nnnnn*, *prefix-nnnnn-gc*, *prefix-m1-m2-m3-m4*, *prefix-m1-m2-m3-m4-gc*).

**Range:***s-, 0-16383, aa-zz*

Specify a valid value for each subfield of the point code, and separate the subfields with a dash (-).

*prefix—s-**nnnnn—0-16383**gc—aa-zz**m1-m2-m3-m4—0-14* for each member; values must sum to 14**Default:**

No change to existing point code value.

**cpcn24 (optional)**

24-bit ITU national point code with subfields *main signaling area-sub signaling area-signaling point* (*msa-ssa-sp*).

**Range:**

000-255

Specify a valid value for each subfield of the point code, and separate the subfields with a dash (-).

*msa—000—255*

*ssa—000—255*

*sp—000—255*

**Default:**

No change to existing point code value.

**egta (optional)**

End global title address. The end of a range of global title digits.

**Range:**

1 - 21

**maxcic (optional)**

Maximum CIC Selector

**Range:**

0 - 4294967295

**Default:**

4294967295

**maxsize (optional)**

Maximum Service Message SIF Size

**Range:**

0 - 4095

**maxs1s (optional)**

Maximum SLS selector

**Range:**

0-255 -ANSI

0-15 -ITU

**Default:**

255 -ANSI

15 -ITU

**mincic (optional)**

Minimum CIC Selector

**Range:**

0 - 4294967295

**Default:**

0

**minsize (optional)**

Minimum Service Message SIF Size

**Range:**  
*0 - 4095*

**Default:**  
*60 -SCCP MSUs*  
*40 -other MSUs*

**System Default:**  
*0*

**minsls (optional)**  
Minimum SLS Selector

**Range:**  
*0-255 -ANSI*  
*0-15 -ITU*

**Default:**  
*0*

**priority (optional)**  
Service Message Priority

**Range:**  
*0 - 3*

**Default:**  
*0*

**ri (optional)**  
GTT or SSN

**Range:**  
*gtt*

*ssn*

**sclass (optional)**

**Range:**  
*0 - 1*

**sgta (optional)**  
Start of global title address. The beginning of a range of global title digits.

**Range:**  
*1 - 21*

**ssn (optional)**  
Subsystem number. The application's subsystem number. This attribute is composed of the decimal representation of the 1-byte field used in the SS7 protocol.

**Range:**  
*2 - 255*

**Default:**

5

**System Default:**

0

**tt (optional)**

Translation type.

**Range:**

0 - 255

**Default:**

100

**type (optional)**

Event Type

**Range:**

MSU

**Default:**

MSU

**usrid (optional)**

User ID for UPUs

**Range:**

0 - 15

**Default:**

5

**System Default:**

0

**Example**

```
ent-lg-event:event=txisup1:dir=tx:type=msu:si=5:dpc=2-2-2:opc=1-1-1
```

```
ent-lg-event:event=txisup1:dir=tx:si=5:dpc=4-4-4:opc=3-3-3
```

```
ent-lg-event:event=rxisup1:dir=rx:dpc=3-3-3
```

**Dependencies**

If the `mincic/maxcic` parameter is specified, the `si` parameter must be 4 (*tup*), 5 (*isup*) or 13 (*bicc*).

If the `tt/ssn/sgta/egta` parameter is specified, the `si=3` (*sccp*) parameter must be specified.

If the `h0h1/cnglv1/cause/usrid/cpc` parameter is specified, the `si=0` (*snm*) parameter must be specified.

When failed to read LG Event table.

The event name specified shouldn't be an Eagle reserved name

- The `event` and `dir` parameters must be specified.
- The `dpc` parameter is mandatory with Rx event type
- The `opc`, `dpc`, and `si` parameters are mandatory with Tx event.
- The `h0h1` parameter is mandatory for `si=0` (snm) Tx event.
- The `mincic` specified must be less than `maxcic`.
- The `minsize` specified must be less than `maxsize`.
- The `minsls` specified must be less than `maxsls`.
- The value specified for the event parameter cannot already exist in the LG Event table.
- ITU SLS must be less than 15.
- The LG Event Table cannot be full.
- A valid SIF size must be specified with SI value.
- The same `dpc` parameter cannot be assigned to more than one Event of Rx type.
- When other optional parameters are specified with Rx event
- When `sgta/egta/tt` parameters are specified with `RI=SSN` for Tx event
- The network type for the `opc` and `dpc` parameters must match.
- If the `ri=gt` parameter is specified, then the `sgta/egta` parameters must be specified.
- The lengths of the `sgta` and `egta` parameters must match.
- The `egta` and `sgta` parameters must be specified together in the command.
- The value specified for the `egta` parameter must be greater than or equal to the value specified for the `sgta` parameter.

### Notes

Mandatory and optional event parameters can be organized into two groups: generic and event type specific parameters. The generic parameters are applicable to any event type whereas event type specific are applicable only to a specific event type.

Generic event parameters are shown below:

**Table 4-25 ENT-LG-EVENT Generic Parameters**

Parameter	Description	Mand/Opt	Applicable Event Direction	Valid Values
event	event name	M	Any	
dir	transmit or receive	M	Any	Tx, Rx
class	internal or external	O	Tx	INT Default : INT
type	event type (msu)	O	Any	MSU Default: MSU

Configurable parameters specific to each type of event are shown below:

Common MSU related configuration parameters when DIR (direction) parameter is Rx, are as follows:

**Table 4-26 ENT-LG-EVENT Rx MSU Event Type common Parameters**

Parameter	Description	Mand/Opt	Valid Values
dpca	Destination PC (ANSI)	M	
dpci	Destination PC (ITU)	M	
dpcn	Destination PC (ITU National)	M	
dpcn24	Destination PC (24 bit ITU national)	M	

Common MSU related configuration parameters when DIR (direction) parameter is Tx, are as follows:

**Table 4-27 ENT-LG-EVENT Tx MSU Event Type common Parameters**

Parameter	Description	Mand/Opt	Valid Values
dpca	Destination PC (ANSI)	M	
dpci	Destination PC (ITU)	M	
dpcn	Destination PC (ITU National)	M	
dpcn24	Destination PC (24 bit ITU national)	M	
opca	Origination PC (ANSI)	M	
opci	Origination PC (ITU)	M	
opcn	Origination PC (ITU National)	M	
opcn24	Origination PC (24 bit ITU national)	M	
priority	Service message priority	O	
minsls	Minimum SLS selector	O	
maxsls	Maximum SLS selector	O	
minsize	Minimum service message SIF size	O	0 – 4095
maxsize	Maximum service message SIF size	O	0 – 4095
si	MSU service indicator	M	0-SNM, 1,2, 6-12, 14 - TEST 3-SCCP, 4-TUP, 5-ISUP, 13-BICC 15-H248

For MSU event type, Service indicators (SI) can have different formats, and consequently unique parameters. Following tables list these parameters related to MSU event type and SI.

**Table 4-28 ENT-LG-EVENT Tx MSU Event Type Specific Parameters (SI = 0)**

Parameter	Description	Mand/Opt	Valid Values
h0h1	SNM type	M	TFA, TFP, TFC, TFR, RCT or UPU
cpca	concerned destination (ANSI)	O	
cpci	concerned destination (ITU)	O	
cpcn	concerned destination (ITU National)	O	
cpcn24	concerned destination (24 bit ITU National)	O	
cnglvl	congestion level for TFCs	O	0-3
cause	cause code for UPUs	O	0-15
usrid	user ID for UPUs	O	0-15

**Table 4-29 ENT-LG-EVENT Tx MSU Event Type Specific Parameters (SI = 1, 2, 6-12, 14, 15)**

Parameter	Description	Mand/Opt	Valid Values
None			

**Table 4-30 ENT-LG-EVENT Tx MSU Event Type Specific Parameters (SI = 3)**

Parameter	Description	Mand/Opt	Valid Values
tt	Translation Type	O	0 – 255
ssn	Sub System Number	O	0 – 255
sgta	Start of global title address	O	1-21 digits
egta	End of global title address	O	1-21 digits
sclass	Class of service	O	0 – 1
ri	Routing Indicator (GT or SSN)	O	GT, SSN

**Table 4-31 ENT-LG-EVENT Tx MSU Event Type Specific Parameters (SI = 4, 5, 13)**

Parameter	Description	Mand/Opt	Valid Values
mincic	Minimum CIC selector	O	0..4294967295
maxcic	Maximum CIC selector	O	0..4294967295

**Output****Related Topics**

- [chg-lg-event](#)
- [dlt-lg-event](#)
- [rept-stat-lg](#)
- [rtrv-lg-event](#)

## ent-lg-grp

Use this command to create an LG group. The command class is TKLC\_INTERNAL inheriting properties of DEBUG class. The Load Generator is supported on IPSTG, IPLHC, IPGHC and SS7HC GPLs.

**Parameters****grp (mandatory)****Range:**

aaaaaaaaaa

Up to 10 alphanumeric characters; the first character must be a letter

**Example**

```
ent-lg-grp:grp=lgroup1
```

**Dependencies**

The group name specified shouldn't be an Eagle reserved name

An LG group with the specified name shouldn't pre-exist in the system.

The LG Group table cannot be full.

The LG Group table is corrupt or cannot be found.

**grp** is mandatory parameter for this command

**Output****Related Topics**

- [act-lg-grp](#)
- [dact-lg-grp](#)
- [dlt-lg-grp](#)
- [rept-stat-lg](#)
- [rtrv-lg-grp](#)

## ent-lnp-serv

Use this command to reserve an LNP translation type for a unique LNP service. The available services include up to six query services (*ain*, *in*, *pcs*, *lnpqs*, *wnp*, and *lnqt*) and



any combination of six message relay or user-defined services. Translation type names can also be defined and are defaulted to the corresponding reserved service type names.

**Note:**

LNP Translation Type name referenced in the ENT-LNP-SERV command is different from the Translation Type name referenced in ENT-TT command.

A maximum of 10 LNP services can be assigned in systems with up to 12 million numbers, and a maximum of 15 LNP services can be assigned in systems with more than 12 million numbers (using ELAP). Two of these assigned services will always be reserved for administration of AIN and IN Translation Types. Administration of Message Relay user defined services will also be allowed.

**Parameters****serv (mandatory)**

Reserved service type name.

**Range:**

*ain*

*in*

*pcs*

*wnp*

*class*

*lidb*

*cnam*

*isvm*

*lnpqs*

*wsmc*

*udf1*

*udf2*

*udf3*

*udf4*

*lrnqt*

**alias (optional)**

Alias translation type.

**Range:**  
*000 - 255*

**df1tact (optional)**

This parameter specifies the default action associated with the LNP TT Service entry.

**Range:**

*ayyyyyyy*

1 leading alphabetic followed by up to 8 alphanumeric characters. This parameter can have one of the following values:

- a valid GTT Action ID of type *disc/udts/tcaperr* that already exists in the GTT Action table
- *fallback* —Fallback to the relay data for MSUs relayed by LNP using relay data from the LNP database provided by the LNP Message Relay service. For an LNP Query message, the MSU is sent to the LNP local subsystem.
- *falltogtt* —Fallback to GTT. The GTT selector search is performed again, using *gttselid=none*.

**Default:**

*fallback*

**dv (optional)**

Digits valid.

**Range:**

*sccp*

*tcap*

**Default:**

*sccp* —If *serv* has a value of *class*, *lidb*, *cnam*, *isvm*, *wsmcsc*, *udf1*, *udf2*, *udf3*, *udf4*

*tcap* —If *serv* has a value of *ain*, *in*, *pcs*, *wnp*, *lnpqs*, *lnqt*

**gttselid (optional)**

GTT Selector ID. This parameter specifies the ID used to perform GTT on the MSU processed by the LNP Message Relay or LNP Query Service.

**Range:**

*0 - 65534*

**Default:**

*none*

**off (optional)**

Disables or turns off the specified feature options. This parameter specifies a comma-separated list of feature options that are requested to be turned off. Up to 10 feature options can be specified in the list.

**Range:**

*gttrqd*

**on (optional)**

Enables or turns on the specified feature options. This parameter specifies a comma-separated list of feature options that are requested to be turned on. Up to 10 feature options can be specified in the list.

**Range:**

*gttrqd*

**rqdtb1nop (optional)**

The action performed with a message that arrives at an SCCP card that does not have the necessary LNP table, and the current message routing is subsystem.

**Range:**

*udts*

generate UDTs for the processed MSU

*disc*

discard the processed MSU

**Default:**

No change to the current value

**tt (optional)**

Translation type.

**Range:**

*000 - 255*

**ttn (optional)**

User defined LNP Translation Type name.

**Range:**

*ayyyyyyy*

1 alphabetic character followed by up to 7 alphanumeric characters, the value *none* is not allowed.

**Default:**

Reserved service type name (*serv* parameter)

**Example**

```
ent-lnp-
serv:serv=class:tt=10:ttn=class1:dfltact=disc1:on=gttrqd:gttsel
id=100
```

```
ent-lnp-serv:serv=lidb:tt=16:dv=tcap:ttn=mrlidb
```

```
ent-lnp-serv:serv=lrnqt:tt=239:dv=tcap
```

**Dependencies**

The same value cannot be specified for the *on* and *off* parameters.

The *dfltact=none* parameter cannot be specified.

The EGTT feature must be turned on before the `gttselid`, `dfltact`, or `on/off=gtrrqd` parameter can be specified.

If a GTT Action ID is specified as the value for the `dfltact` parameter, then the Action ID must already exist in the GTT Action table.

If a GTT Action ID is specified as a value for the `dfltact` parameter, then the GTT Action ID must be associated with an action of `disc/udts/tcaperr`.

The LNP feature must be turned on before this command can be entered.

The PLNP feature must be turned on before the `serv=pcs` parameter can be specified.

The WNP feature must be turned on before the `serv=wnp` parameter can be specified.

The LNP SMS feature must be turned on before the `serv=wsmc` parameter can be specified.

If a value of `udf1`, `udf2`, `udf3`, or `udf4` is specified for the `serv` parameter, then the `dfltact`, `gttselid` and `on/off=gtrrqd` parameters cannot be specified.

The `tt` parameter must be specified if the `alias` parameter is not specified.

The `tt=none` parameter cannot be specified.

If a value of `udf1`, `udf2`, `udf3`, `udf4`, or `wsmc` is specified for the `serv` parameter, then the `dv=sccp` parameter must be specified.

If the `lnpqs`, `ain`, `in`, `pcs`, `wnp`, or `lrnqt` value is specified for the `serv` parameter, then the `dv=tcap` parameter must be specified.

A reserved service type name can be specified for the `ttn` parameter only if it matches the `serv` parameter value.

The value of the `tt` parameter cannot already exist in the LNP database.

If the `tt` parameter is specified, then the value of the `serv` parameter cannot exist in the LNP database.

A maximum of 6 Message Relay services are allowed.

If the `alias` parameter is specified, then the `serv` parameter must already have an assigned translation type.

When the `alias` parameter is specified, its value cannot already exist in the LNP database as a true translation type for this service.

If the `alias` parameter is specified, then the specified alias cannot be in use.

The LNP database is corrupt or cannot be found.

If the `tt` parameter is specified, then its value cannot already exist in the LNP database as an alias for this service.

The LNP TT SERV table is corrupt or cannot be found.

The value of the `ttn` parameter cannot exist in the LNP database.

The LRNQT feature must be turned on before the `serv=lrnqt` parameter can be specified.

If the `alias` parameter is specified, then the `tt`, `ttn`, and `dv` parameters cannot be specified.

The GTT Action table is corrupt or cannot be found.

The `nrqdtblnop` parameter requires that the Dual ExAP Config feature is enabled.

The `defactid=none` parameter cannot be specified.

## Notes

### on/off options

*gttrqd* —GTT required. Specifies whether GTT is performed after the successful completion of an LNP Message Relay service and before initiation of an LNP Query service. This option has a default of OFF.

Translation type names must be unique for LNP services.

A translation type name can be a reserved service type name only if it matches the specified service.

## TTN

LNP Translation type name referenced in the ENT-LNP-SERV command is different from the Translation type name referenced in ENT-TT command.

## Output

```
ent-lnp-serv:tt=1:serv=lib:on=gttrqd:dfltact=falltogtt
```

```
rlghncxa03w 10-11-08 08:50:12 EST EAGLE 43.0.0
ENT-LNP-SERV: MASP A - COMPLTD
;
```

## Related Topics

- [chg-lnp-serv](#)
- [dlt-lnp-serv](#)
- [rtv-lnp-serv](#)

# ent-loopset

Use this command to enter the loopset information into the database. This command updates the Loopset table.

## Parameters

### **name (mandatory)**

Loopset name. This parameter specifies an entry in the Loopset table. The `name=none` parameter cannot be specified.

### **Range:**

ayyyyyyy

1 alphabetic and up to 7 alphanumeric characters

**pc1 (mandatory)**

ANSI point code list with subfields *network indicator-network cluster-network cluster member (ni-nc-ncm)*. The *prefix* subfield indicates a private point code (*prefix-ni-nc-ncm*). This parameter allows up to 6 comma-delimited entries in the point code list.

**Synonym:**

*pcla*

**Range:**

*p-*, *000-255*

Specify a valid value for each subfield of the point code, and separate the subfields with a dash (-).

*prefix—p-*

When *chg-sid:pctype=ansi* is specified, *ni = 000* is not valid.

When *chg-sid:pctype=ansi* is specified, *nc = 000* is not valid if *ni = 001-005*.

When *chg-sid:pctype=ansi* is specified, *nc = 000* is valid if *ni = 006-255*.

The point code *000-000-000* is not a valid point code.

**pc1i (mandatory)**

ITU international point code list with subfields *zone-area-id*. The *prefix* subfield indicates a spare point code, private point code, or private and spare point code (*prefix-zone-area-id*). This parameter allows up to 6 comma-delimited entries in the point code list.

**Range:**

*s-*, *p-*, *ps-*, *0-255*

Specify a valid value for each subfield of the point code, and separate the subfields with a dash (-).

*prefix—s-*, *p-*, *ps*

*zone—0-7*

*area—000-255*

*id—0-7*

The point code *0-000-0* is not a valid point code.

**pc1n (mandatory)**

ITU national point code list in the format of a 5-digit number (*nnnnn*); or 2, 3, or 4 numbers (members) separated by dashes (*m1-m2-m3-m4*) as defined by the *chg-stpopts:npcfnti* flexible point code option. A group code must be specified when the ITUDUPPC feature is turned on (*nnnnn-gc*, *m1-m2-m3-m4-gc*). The *prefix* subfield indicates a spare point code (*prefix-nnnnn*, *prefix-nnnnn-gc*, *prefix-m1-m2-m3-m4*, *prefix-m1-m2-m3-m4-gc*). This parameter allows up to 6 comma-delimited entries in the point code list.

**Range:**

*s-*, *p-*, *ps-*, *0-16383*, *aa-zz*

Specify a valid value for each subfield of the point code, and separate the subfields with a dash (-).

*prefix—s-*, *p-*, *ps*

*nnnnn—0-16383*

*gc—aa-zz*

*m1-m2-m3-m4—0-14* for each member; values must sum to 14

**pc1n24 (mandatory)**

24-bit ITU national point code list with subfields *main signaling area-sub signaling area-signaling point (msa-ssa-sp)*. This parameter allows up to 6 comma-delimited entries in the point code list.

**Range:***p*-, 000-255

Specify a valid value for each subfield of the point code, and separate the subfields with a dash (-).

*prefix—p**msa—000—255**ssa—000—255**sp—000—255***pc1n16 (mandatory)**16-bit ITU national point code with subfields *unit number sub number area main number area (un-sna-mna)*. This parameter allows up to 6 comma-delimited entries in the point code list.**Range:***p---*, 000---127

Specify a valid value for each subfield of the point code, and separate the subfields with a dash (--).

*prefix---**p**un---*000---127*sna---*000---15*mna---*000---31**mode (optional)**

Mode of operation. This parameter specifies whether the message is discarded when an SCCP loop is detected.

**Range:*****notify***

Generates a UIM without discarding the message.

***discard***

Generates a UIM and discards the message.

**Default:***notify***Example**This example creates a new loopset using the default mode of *notify* .`ent-loopset:name=rtp1:pc1=3-3-3,5-5-5,7-7-7,3-4-3`This example creates a new loopset and sets the mode to *discard* .`ent-loopset:name=rtp2:mode=discard:pc1=3-3-3,5-5-5,7-7-7,3-4-3`

This example creates a new loopset with four 16-bit ITU-N point codes.

`ent-loopset:name=rtp1:pc1n16=3-3-3,5-5-5,7-7-7,3-4-3`**Dependencies**The value of the `name` parameter cannot already exist in the database.

The SCCP Loop Detection feature must be enabled before this command can be entered.

The GTT feature must be turned on before this command can be entered.

The Loopset table can hold a maximum of 1,000 loopset entries, with each entry containing up to 12 point codes. Additional loopset entries and point codes cannot be added when the table is full.

The Loopset table must be accessible.

The values for the `pcl` parameter must be unique.

The `name=none` parameter cannot be specified.

At least one valid point code must be specified as a value for the `pcl` parameter.

The values for the `pcl` parameter cannot consist of any invalid point codes. The valid point codes must be consecutively specified and separated by commas.

### Notes

There is no J7 FAK dependency on the `apcln16/rpcln16/pcln16/npc1n16/pc2n16/npc2n16` parameters. The command can be entered successfully when the J7 FAK is not enabled.

There is no J7 FAK dependency on the `apcln24/rpcln24/pcln24/npc1n24/pc2n24/npc2n24` parameters. The command can be entered successfully when the J7 FAK is enabled.

There is no J7 FAK dependency on the `apcl/ apcla/rpcla/pcla/npc1a/pc2a/npc2a` parameters. The command can be entered successfully when the J7 FAK is enabled.

### Output

The following example creates a new loopset and sets the mode to *discard*. `ent-loopset:name=rtp2:mode=discard:pcl=3-3-3,5-5-5,7-7-7,3-4-3`

```

rlghncxa03w 07-02-10 08:31:28 EST  EAGLE Rel 35.6.0
LOOPSET table is (12 of 1000) 1% full
ENT-LOOPSET: MASP A - COMPLTD
;

```

### Related Topics

- [chg-loopset](#)
- [dlt-loopset](#)
- [rtrv-loopset](#)

## ent-ls

Use this command to add a linkset, with its assigned far-end point code and other linkset attributes, to the database.



## Parameters



### Note:

See [Point Code Formats and Conversion](#) for a detailed description of point code formats, rules for specification, and examples.

### **apc (mandatory)**

ANSI adjacent destination point code with subfields *network indicator-network cluster-network cluster member (ni-nc-ncm)*. The *prefix* subfield indicates a private point code (*prefix-ni-nc-ncm*).

#### **Synonym:**

*apca*

#### **Range:**

*p-*, 000-255

Specify a valid value for each subfield of the point code, and separate the subfields with a dash (-).

*prefix-p-*

When `chg-sid:pctype=ansi` is specified, `ni = 000` is not valid.

When `chg-sid:pctype=ansi` is specified, `nc = 000` is not valid if `ni = 001-005`.

When `chg-sid:pctype=ansi` is specified, `nc = 000` is valid if `ni = 006-255`.

The point code `000-000-000` is not a valid point code.

### **apc/apca/apci/apcn/apcn24/apcn16 (mandatory)**

Adjacent point code. The DPC of the adjacent signaling node at the far end of the linkset.

### **apci (mandatory)**

ITU international adjacent destination point code with subfields *zone-area-id*. The *prefix* subfield indicates a spare point code, private point code, or private and spare point code (*prefix-zone-area-id*).

#### **Range:**

*s--*, *p--*, *ps--*, 0--255

Specify a valid value for each subfield of the point code, and separate the subfields with a dash (-).

*prefix--s--*, *p--*, *ps*

*zone--0-7*

*area--000--255*

*id--0--7*

The point code `0--000--0` is not a valid point code.

### **apcn (mandatory)**

ITU national adjacent destination point code in the format of a 5-digit number (*nnnnn*); or 2, 3, or 4 numbers (members) separated by dashes (*m1-m2-m3-m4*) as defined by the `chg-stpopts:npcfmti` flexible point code option. A group code must be specified when the ITUDUPPC feature is turned on (*nnnnn-gc*, *m1-m2-m3-m4-gc*). The *prefix* subfield indicates a spare point code, private point code, or private and

spare point code (*prefix-nnnnn*, *prefix-nnnnn-gc*, *prefix-m1-m2-m3-m4*, *prefix-m1-m2-m3-m4-gc*).

**Range:**

*s--*, *p--*, *ps--*, *0--16383*, *aa--zz*

Specify a valid value for each subfield of the point code, and separate the subfields with a dash (-).

*prefix--s--*, *p--*, *ps*

*nnnnn--0--16383*

*gc--aa--zz*

*m1--m2--m3--m4---0--14* for each member; values must sum to 14

**apcn24 (mandatory)**

24-bit ITU national adjacent destination point code with subfields *main signaling area-sub signaling area-signaling point* (*msa-ssa-sp*). The *prefix* subfield indicates a private point code (*prefix-msa-ssa-sp*).

**Range:**

*p---*, *000---255*

Specify a valid value for each subfield of the point code, and separate the subfields with a dash (-).

*prefix--p*

*msa---000---225*

*ssa---000---225*

*sp---000---225*

**apcn16 (mandatory)**

16-bit ITU national point code with subfields *unit number sub number area main number area* (*un-sna-mna*). The *prefix* subfield indicates a private point code (*prefix-un-sna-mna*).

**Range:**

*p--*, *000--127*

Specify a valid value for each subfield of the point code, and separate the subfields with a dash (-).

*prefix---p*

*un---000--127*

*sna---000--15*

*mna---000--31*

**lsn (mandatory)**

Linkset name. Each linkset name must be unique in the system.

**Range:**

*ayyyyyyyy*

1 alphabetic character followed by up to 9 alphanumeric characters

**lst (mandatory)**

Linkset type. The linkset type of the specified linkset as defined in Telcordia GR-246-CORE, T1.111.5.

**Range:**

- a**  
Access links
- b**  
Bridge links
- c**  
Cross links
- d**  
Diagonal links
- e**  
Extended links
- prx**  
Proxy links

**adapter (optional)**

The adapter layer for links provisioned in an IPSG linkset.

**Range:**

- m3ua**
- m2pa**

**Default:**

*m2pa*

**apcntype (optional)**

ITU-N Adjacent Point Code Type. The format used for changeover and changeover acknowledgement messages.

**Range:**

- itun**  
ITU National Adjacent Point Code Type
- itunchina**  
ITU National China Adjacent Point Code Type

**Default:**

*itun*

**as18 (optional)**

Adjacent SLS 8-bit indicator. This parameter specifies whether the adjacent node is sending MSUs with 8-bit SLSSs.

**Range:***yes**no***Default:***no***asnotif (optional)**

AS notification. This parameter specifies whether AS notifications should be sent for IPSG-M3UA linkset.

**Range:***yes**no***Default:***yes***bei (optional)**

Broadcast exception indicator. This parameter specifies whether TFP (transfer prohibited) messages are allowed to be broadcast on the linkset.

**Range:***yes*

TFPs are not broadcast

*no*

TFPs are broadcast

**Default:***no***cggmod (optional)**

Calling party GT modification indicator. This parameter specifies whether calling party global title modification is required for the specified linkset.

**Range:***yes**no***Default:***no***cgpnb1set (optional)**

Calling party blacklist set

**Range:***1-255, none*

**System Default:***none***chgntp3opc (optional)**

Change MTP3 OPC. This parameter specifies whether to change MTP3 OPC with SPC. With this parameter off, OPC-to-SPC conversion will not take place and the outgoing MSU will have the original OPC.

**Range:***on**off***Default:***on***c11i (optional)**

Far-end Common Language Location Identifier (CLLI). The CLLI assigned to the linkset.

**Range:***ayyyyyyyyyy*

1 alphabetic character followed by up to 10 alphanumeric characters

**Default:**

CLLI of the adjacent point code

**gnameset (optional)**

Generic Name Set type. The new settype for an IPSG-M3UA linkset.

**Range:***seta**setb**both***System Default:***both***gsmscrn (optional)**

GSM MAP screening. This parameter specifies whether GSM MAP screening is allowed.

**Range:***on**off***Default:***off***gttmode (optional)**

Global title translation mode. The GTT Mode hierarchy for each link set.

**Range:*****cd***

CdPA GTT only

***cg***

CgPA GTT only

***acdcd***

Advanced CdPA GTT, CdPA GTT

***acdcgcd***

Advanced CdPA GTT, CgPA GTT, CdPA GTT

***acdcdcg***

Advanced CdPA GTT, CdPA GTT, CgPA GTT

***cgacdcd***

CgPA GTT, Advanced CdPA GTT, CdPA GTT

***cgcd***

CgPA GTT, CdPA GTT

***sysdfit***

System wide default value

***fcd***

FLOBR CdPA only

***fcg***

FLOBR CgPA only

***fcgxcd***

FLOBR CgPA, FLOBR CdPA

***xcdfcg***

FLOBR CdPA, FLOBR CgPA

***cdcg***

CdPA GTT, CgPA GTT

**Default:***sysdfit***gwsa (optional)**

Gateway screening action. This parameter specifies whether gateway screening is on or off for the specified linkset.

**Range:*****on******off*****Default:***on* —if *scrn* is specified*off* —if *scrn* is not specified

**gwsd (optional)**

Gateway screening MSU discard. This parameter specifies whether the discarding of MSUs that bypass the gateway screening function due to load-shedding is on or off. This parameter is also used with the redirect function; MSUs that cannot be screened are discarded if `gwsd=on` is specified.

**Range:***on**off***Default:***off***gwsn (optional)**

Gateway screening messaging. This parameter specifies whether messages are generated for each message screened by gateway screening.

**Range:***on, off***Default:***off***ipsg (optional)**

IP signaling gateway adjacent point code. This parameter specifies whether a linkset is entered for an IP SG card. The specified adjacent point code is an IP gateway adjacent point code.

**Range:***yes**no***Default:***no***islrsb (optional)**

Incoming rotated signaling link selection (SLS) bit. The bit (1–4 for ITU and 1 – 8 for ANSI linksets) to rotate as the new SLS LSB (Least Significant Bit) of the incoming linkset. The SLS is not modified in the outgoing message.

[Table 4-32](#) shows how the rotation affects the four bits of the ITU SLS during linkset selection:

If This Bit is Selected...	Then Bit Locations 4 3 2 1 Are Rotated To...	Description
Bit 4	3 2 1 4	SLS = 0110 becomes Rotated SLS = 1100 SLS = 1011 becomes Rotated SLS = 0111
Bit 3	2 1 4 3	SLS = 0110 becomes Rotated SLS = 1001 SLS = 1011 becomes Rotated SLS = 1110

If This Bit is Selected...	Then Bit Locations 4 3 2 1 Are Rotated To...	Description
Bit 2	1 4 3 2	SLS = 0110 becomes Rotated SLS = 0011 SLS = 1011 becomes Rotated SLS = 1101
Bit 1	No rotation is performed because bit 1 is the existing LSB	-

Table 4-33 shows how the rotation affects the eight bits of the ANSI SLS during linkset selection:

If This Bit is Selected...	Then Bit Locations 8 7 6 5 4 3 2 1 Are Rotated To...	Description
Bit 8	7 6 5 4 3 2 1 8	SLS = 10010110 becomes Rotated SLS = 00101101 SLS = 11001011 becomes Rotated SLS = 10010111
Bit 7	6 5 4 3 2 1 8 7	SLS = 10010110 becomes Rotated SLS = 01011010 SLS = 11001011 becomes Rotated SLS = 00101111
Bit 6	5 4 3 2 1 8 7 6	SLS = 10010110 becomes Rotated SLS = 10110100 SLS = 11001011 becomes Rotated SLS = 01011110
Bit 5	4 3 2 1 8 7 6 5	SLS = 10010110 becomes Rotated SLS = 01101001 SLS = 11001011 becomes Rotated SLS = 10111100
Bit 4	3 2 1 8 7 6 5 4	SLS = 10010110 becomes Rotated SLS = 11010010 SLS = 11001011 becomes Rotated SLS = 01111001
Bit 3	2 1 8 7 6 5 4 3	SLS = 10010110 becomes Rotated SLS = 10100101 SLS = 11001011 becomes Rotated SLS = 11110010
Bit 2	1 8 7 6 5 4 3 2	SLS = 10010110 becomes Rotated SLS = 01001011 SLS = 11001011 becomes Rotated SLS = 11100101
Bit 1	No rotation is performed because bit 1 is the existing LSB.	

This parameter is used for ITU or ANSI messages on a per-linkset basis.

**Range:**  
1 - 8



ITU linksets— 1 - 4  
ANSI linksets— 1 - 8

The `rsls8=yes` parameter must be specified (see the `chg-lsopts` command) before a value greater than 5 can be specified for the `islsrsb` parameter.

**Default:**  
*1*

**itutfr (optional)**

ITU TFR (Transfer Restricted) procedure indicator. This parameter specifies whether the TFR procedure is on or off on a per-linkset basis. This parameter is valid for ITU national linksets only.

**Range:**  
*on*  
*off*

**Default:**  
*off*

**l3tset (optional)**

Link timer set. This parameter value is the value that is defined with the `chg-l3t` command.

**Range:**  
*1*

**Default:**  
*1*

**lsusealm (optional)**

IPTPS linkset alarm threshold percent. The percent of the linkset TPS (IPTPS) at which an alarm is generated to indicate that the actual linkset TPS is approaching the configured IPTPS value for the linkset.

**Range:**  
*10 - 100*

**Default:**  
*100*

**maxslktps (optional)**

Maximum per signaling link TPS. The maximum capacity a link is permitted when sufficient unused capacity is present on the host card.



**Note:**

This parameter can only be specified for links in IPSP linksets.

 **Note:**

If the HIPR2 High Rate Mode feature is turned off, then the sum of the TPS values assigned to all linksets in the system must be less than or equal to 500,000. If the HIPR2 High Rate Mode feature is turned on, then the sum of the TPS values assigned to all linksets in the system must be less than or equal to 750,000. If the HIPR2 High Rate Mode and 1M System TPS features are turned on, then the sum of the TPS values assigned to all linksets in the system must be less than or equal to 1,000,000.

**Range:**

25 - 12,000

 **Note:**

The maximum value that can be specified for this parameter depends on the type of IPSP card that is used:

- E5-ENET-B card when the E5-ENET-B IPSP High Throughput feature is turned off-6500 TPS
- E5-ENET-B card when the E5-ENET-B IPSP High Throughput feature is turned on-9500 TPS
- SLIC card - 12,000 TPS

**System Default:**

value of `slktps/rsvdslktps` parameter

**mtprse (optional)**

ANSI or ITU MTP Restart equipped. This parameter specifies whether the node adjacent to the linkset is equipped with MTP Restart.

**Range:**

**yes**  
equipped

**no**  
not equipped

**Default:**

*no*

**multgc (optional)**

Multiple group codes. This parameter specifies whether multiple group codes can be specified.

**Range:**

**yes**

**no**

**Default:**

*no*

**nis (optional)**

Network Indicator Spare. This parameter specifies whether the Network Indicator Spare option is on or off for the specified linkset. When this option is enabled, the Network Spare value for network indicator for both ANSI and ITU-National (ITU-N) links is supported by the system.

**Range:**

**on**

**off**

**Default:**

*off*

**ppc (optional)**

ANSI proxy point code with subfields *network indicator-network cluster-network cluster member (ni-nc-ncm)*.

The proxy point code must be a full point code.

**Synonym:**

*ppca*

**Range:**

*000-255*

Specify a valid value for each subfield of the point code, and separate the subfields with a dash (-).

When *chg-sid:pctype=ansi* is specified, *ni = 000* is not valid.

When *chg-sid:pctype=ansi* is specified, *nc = 000* is not valid if *ni = 001-005*.

When *chg-sid:pctype=ansi* is specified, *nc = 000* is valid if *ni = 006-255*.

The point code *000-000-000* is not a valid point code.

**ppc/ppca/ppci/ppcn/ppcn24/ppcn16 (optional)**

Proxy Point Code

The proxy point code must be a full point code.

**ppci (optional)**

ITU international proxy point code with subfields *zone-area-id*. The *prefix* subfield indicates a spare point code.

**Range:**

*s-, 0-255, none*

Specify a valid value for each subfield of the point code, and separate the subfields with a dash (-).

*prefix—s*

*zone—0-7*

*area—000-255*

*id—0-7*

Enter *none* to delete the point code.

The point code *0-000-0* is not a valid point code.

**ppcn (optional)**

ITU national proxy point code in the format of a 5-digit number (*nnnnn*); or 2, 3, or 4 numbers (*members*) separated by dashes (*m1-m2-m3-m4*) as defined by the `chg-stpopts:npcfmti` flexible point code option. A group code must be specified when the ITUDUPPC feature is turned on (*nnnnn-gc,m1-m2-m3-m4-gc*). The *prefix* subfield indicates a spare point code (*prefix-nnnnn, prefix-nnnnn-gc, prefix-m1-m2-m3-m4, prefix-m1-m2-m3-m4-gc*).

**Range:**

*s-*, 0-16383, *aa-zz*

Specify a valid value for each subfield of the point code, and separate the subfields with a dash (-).

*prefix—s-*

*nnnnn—0-16383*

*gc—aa-zz*

*m1-m2-m3-m4—0-14* for each member; values must sum to 14

**ppcn24 (optional)**

24-bit ITU national point code with subfields *main signaling area-sub signaling area-signaling point (msa-ssa-sp)*.

**Range:**

000-255

Specify a valid value for each subfield of the point code, and separate the subfields with a dash (-).

*msa—000–255*

*ssa—000–255*

*sp—000–255*

**ppcn16 (optional)**

16-bit ITU national point code with subfields *unit number sub number area main number area (un-sna-mna)*.

**Range:**

000---127

Specify a valid value for each subfield of the point code, and separate the subfields with a dash (-).

*un---000---127*

*sna---000---15*

*mna---000---31*

**randsls (optional)**

Random SLS (signaling link selection). This parameter is used to apply random SLS generation for the specified linkset.

The `randsls=perls` parameter must be specified in the `chg-stpopts` command before specifying the `randsls` parameter in the `ent-ls` command to enable random SLS generation on a per linkset basis.

**Range:*****off***

Disables random SLS generation on a specified linkset.

***class0***

Enables random SLS generation for Class0 SCCP traffic on a specified linkset.

***all***

Enables random SLS generation for Class0 and Class1 SCCP traffic on a specified ITU linkset and for Class0 and ISUP traffic on a specified ANSI linkset.

**Default:**

*off*

**rcontext (optional)**

Routing context. The new routing context for an IPSP-M3UA linkset.

**Range:**

0 - 4294967295

**System Default:**

*none*

**scrn (optional)**

Gateway screening screen set. The gateway screening screen set assigned to this linkset.

**Range:**

*ayyy*

1 alphabetic character followed by up to 3 alphanumeric characters  
*none* —Deletes screen set association with the linkset

**s1ktps (optional)**

Reserved per signaling link TPS for IPSP Linkset. The capacity guaranteed to each link in the linkset.

**Note:**

This parameter is required for each link in an IPSP linkset. The parameter cannot be specified for links in non-IPSP linksets. The guaranteed capacity for the links hosted by an IPSP card cannot exceed the IPSP card capacity.

 **Note:**

If the HIPR2 High Rate Mode feature is turned off, then the sum of the TPS values assigned to all linksets in the system must be less than or equal to 500,000. If the HIPR2 High Rate Mode feature is turned on, then the sum of the TPS values assigned to all linksets in the system must be less than or equal to 750,000. If the HIPR2 High Rate Mode and 1M System TPS features are turned on, then the sum of the TPS values assigned to all linksets in the system must be less than or equal to 1,000,000.

**Synonym:***rsvdslktps***Range:***0 - 12,000* **Note:**

The maximum value that can be specified for this parameter depends on the type of IPSP card that is used:

- E5-ENET-B card when the E5-ENET-B IPSP High Throughput feature is turned off-6500 TPS
- E5-ENET-B card when the E5-ENET-B IPSP High Throughput feature is turned on-9500 TPS
- SLIC card - 12,000 TPS

**s1kusealm (optional)**

IPTPS signaling link alarm threshold percent. The percent of the link TPS at which an alarm is generated to indicate that the actual link TPS is approaching the alarmed IPTPS (*s1ktps/rsvdslktps* or *maxs1ktps*) configured for the link.

**System Default:***80***s1sci (optional)**

5-bit to 8-bit SLS conversion indicator. This parameter specifies whether the 5-bit to 8-bit SLS conversion feature is used to select links for outgoing messages direct to the given linkset. When enabled, the system replaces any 5-bit SLS values contained in received messages, with a random 8-bit value before the 5-bit SLS values are used by the STP to select the outgoing link in that linkset.

**Range:**

**yes**  
enabled

**no**  
disabled

**Default:***no***s1socbit (optional)**

Other CIC (Circuit Identification Code) Bit. If the SLSOCB feature is turned on, this parameter specifies whether the Other CIC Bit option is to be used during link selection. If the option is to be used, specify which bit (5– 16) of the CIC is to be used as the other CIC bit. During link selection, the specified bit acts as the most significant bit of the new SLS and bits 2 through 4 of the received CIC become the least significant bits of the new SLS. This parameter is used for ITU-ISUP messages. The SLS is not modified in the outgoing message. The following example shows a received CIC where bit 9 is the other CIC bit (*s1socbit=9*). The new SLS is 0100.

16	15	14	13	12	11	10	9	8	7	6	5	4	3	2	1
0	0	0	0	1	0	0	0	1	0	0	1	1	0	0	1
New SLS							0					1	0	0	

**Range:***5 - 16, none***Default:***none***s1srsb (optional)**

Rotated signaling link selection (SLS) bit. The bit (1–4) to rotate as the new SLS Least Significant Bit (LSB). The SLS is not modified in the outgoing message. [Table 4-35](#) shows how the rotation affects the four bits of the SLS during linkset selection:

If This Bit is Selected...	Then Bit Locations 4 3 2 1 Are Rotated To...	Description
Bit 4	3 2 1 4	SLS = 0110 becomes Rotated SLS = 1100 SLS = 1011 becomes Rotated SLS = 0111
Bit 3	2 1 4 3	SLS = 0110 becomes Rotated SLS = 1001 SLS = 1011 becomes Rotated SLS = 1110
Bit 2	1 4 3 2	SLS = 0110 becomes Rotated SLS = 0011 SLS = 1011 becomes Rotated SLS = 1101
Bit 1	No rotation is performed because bit 1 is the existing LSB	-

This parameter is used for ITU messages on a per-linkset basis.

**Range:***1 - 4***Default:***1*

**sltset (optional)**

SLTM record. The SLTM record to be associated with the linkset.

**Range:**

0 - 20

0—sets the linkset to SLT reflect mode

**Default:**

1 - ANSI

2 - ITU

**spc (optional)**

ANSI secondary point code with subfields *network indicator-network cluster-network cluster member (ni-nc-ncm)*. The *prefix* subfield indicates a private point code (*prefix-ni-nc-ncm*).

**Range:**

000-255

Specify a valid value for each subfield of the point code, and separate the subfields with a dash (-).

When *chg-sid:pctype=ansi* is specified, *ni = 000* is not valid.

When *chg-sid:pctype=ansi* is specified, *nc = 000* is not valid if *ni = 001–005*.

When *chg-sid:pctype=ansi* is specified, *nc = 000* is valid if *ni = 006–255*.

The point code *000-000-000* is not a valid point code.

**spc/spca/spci/spcn/spcn24/spcn16 (optional)**

Secondary point code.

**spci (optional)**

ITU international secondary point code with subfields *zone-area-id*. The *prefix* subfield indicates a spare point code (*prefix-zone-area-id*).

**Range:**

s-, 0-255

Specify a valid value for each subfield of the point code, and separate the subfields with a dash (-).

*prefix*—s

*zone*—0-7

*area*—000-255

*id*—0-7

The point code *0-000-0* is not a valid point code.

**spcn (optional)**

ITU national secondary point code in the format of a 5-digit number (*nnnnn*); or 2, 3, or 4 numbers (members) separated by dashes (*m1-m2-m3-m4*) as defined by the *chg-stpopts:npcfmti* flexible point code option. A group code must be specified when the ITUDUPPC feature is turned on (*nnnnn-gc,m1-m2-m3-m4-gc*). The *prefix* subfield indicates a spare point code (*prefix-nnnnn, prefix-nnnnn-gc, prefix-m1-m2-m3-m4, prefix-m1-m2-m3-m4-gc*).

**Range:**

s-, 0-16383, aa-zz

Specify a valid value for each subfield of the point code, and separate the subfields with a dash (-).

*prefix*—s-



*nnnnn*—0-16383  
*gc*—aa-zz  
*m1-m2-m3-m4*—0-14 for each member; values must sum to 14

**spcn24 (optional)**

24-bit ITU national secondary point code with subfields *main signaling area-sub signaling area-signaling point (msa-ssa-sp)*.

**Range:**

*000-255*

Specify a valid value for each subfield of the point code, and separate the subfields with a dash (-).

*msa*—000–255

*ssa*—000–255

*sp*—000–255

**spcn16 (optional)**

16-bit ITU national point code with subfields *unit number sub number area main number area (un-sna-mna)*.

**Range:**

*000--127*

Specify a valid value for each subfield of the point code, and separate the subfields with a dash (-).

*un---*000---127

*sna---*000---15

*mna---*000---31

**tpsalmtype (optional)**

IPSG IPTPS threshold alarm type. The IPTPS threshold that can be alarmed.

**Range:*****slktps***

the SLKTPS/RSVDSLKTPS threshold is alarmed

***maxslktps***

the MAXSLKTPS threshold is alarmed

**System Default:**

*slktps*

**visualizedata (optional)**

Linkset based Visualization option.

**Range:*****off***

Visualization is off on this linkset

***risky***

Only risky opcodes (based on FS11) will be visualize on this linkset

**all**

All opcodes will be visualize on this linkset

**System Default:**

*off*

**Example**

Adds linkset WY64438 with APC 144-201-1 AND LIST C:

```
ent-ls:lsn=wy644368:apc=144-201-001:lst=c
```

Adds linkset LSITUA1 with APCN 5 and LST C. The APCN uses a four-part format where the maximum number of bits in each position is defined by the `chg-stpopts:npcfmt1` parameter:

```
ent-ls:lsn=lsitua1:apcn=5-5-5-1:lst=c
```

Adds linkset EXP123 with APCN 2-3-4-5-aa, which has a duplicate point code group of *aa* and linkset type *a*. The ITU national duplicate point code (ITUDUPPC) feature is turned on, so the ITU national point code contains a group code:

```
ent-ls:lsn=exp123:apcn=2-3-4-5-aa:lst=a
```

Add a linkset in which all applicable MSUs arriving on the linkset are screened using the GSM MAP screening feature:

```
ent-ls:lsn=lsitu1:apcn=5000:lst=a:gsmscrn=on
```

Adds linkset LSN24 with 24-bit ITU-N APCN24 10-100-10 and linkset type *a*:

```
ent-ls:lsn=lsn24:apcn24=10-100-10:lst=a
```

Adds linkset LSA2 with private APC *p-1-2-4*:

```
ent-ls:lst=a:lsn=lsa2:apc=p-1-2-4
```

Adds linkset LSN410234 with private and spare APCN *ps-1-1-1-2047-aa*:

```
ent-ls:lst=b:lsn=lsn410234:apcn=ps-1-1-1-2047-aa
```

Adds linkset LSI00001 with spare APC *s-1-1-209-7*:

```
ent-ls:lst=b:lsn=lsi00001:apci=s-1-1-209-7
```

Adds linkset LSN24 with APCN24 10-100-10 with an APCNTYPE of *itunchina* and linkset type *a*:

```
ent-ls:lsn=lsn24:apcn24=10-100-10:lst=a:apcntype=itunchina
```

Adds linkset LSA using the global title translation mode *CGACDCD*:

```
ent-ls:lsn=lsa:lst=a:apca=1-1-1:gttmode=cgacdcd
```

Enables random SLS generation for Class0 and Class1 SCCP traffic on ITU linkset LSA:

```
ent-ls:lsn=lsa:lst=a:apci=1-1-2:randsls=all
```

Adds a linkset in which calling party global title modification is required for all GT routed MSUs arriving on the linkset:

```
ent-ls:lsn=ls2:apc=2-2-2:lst=a:cggmod=yes
```

Adds an IP SG-M3UA linkset:

```
ent-
ls:lsn=ls1201:apc=10-10-10:lst=a:adapter=m3ua:ipsg=yes:slktps=1
00
```

Adds an IPSEG-M2PA linkset:

```
ent-ls:lsn=lsm2pa:apc=5-6-7:lst=c:ipsg=yes:slktps=300
```

Adds a linkset and sets the Incoming SLS Bit Rotation on the 2nd Bit:

```
ent-ls:lsn=lsa:lst=a:apci=1-1-2:islsrsb=2
```

Adds linkset LSA using GTT mode FCDFCG when the Flexible Option Based Routing (FLOBR) feature is turned on:

```
ent-ls:lsn=lsa:lst=a:apca=1-1-1:gttmode=fcdfcg
```

Adds ANSI linkset LSA and sets the Incoming SLS Bit Rotation to the 6th bit (the 6th bit in the SLS is used as the LSB):

```
ent-ls:lsn=lsa:lst=a:apca=1-1-1:islsrsb=6
```

Converts the linkset to SLT reflect mode:

```
ent-ls:lsn=ls1:lst=a:apca=1-1-1:sltset=0
```

Add linkset LS1 with 16-bit ITU-N APCN16 120-11-12 and sets linkset to SLT reflect mode:

```
ent-ls:lsn=ls1:lst=a:apcn16=120-11-12:sltset=0
```

Add linkset ls113 with gnameset=seta

```
ent-ls:lsn=ls113:gnameset=seta
```

Add linkset ls113 with cgpnblset=5

```
ent-ls:lsn=ls113:cgpnblset=5
```

## Dependencies

The value specified for the `apc` parameter must be a full point code.

The specified adjacent point code cannot exist as an alias point code.

If the `gwsa=on`, `gwsn=on`, and `gwsd=on` parameters are specified, the `scrn` parameter must be specified.

The specified adjacent point code cannot be the same as the self-ID destination point code of the STP.

The specified adjacent point code cannot be the same as any self-ID capability point codes of the STP.

If the system is configured for ANSI point codes, and the `nc=0` parameter is specified, then the value of the `ni` parameter must be 6 or greater.

The specified linkset name cannot already exist in the database.

The specified adjacent point code cannot be assigned to any other linkset.

The maximum number of linksets that can be defined in the system is 1024.

The specified screen set (`scrn` parameter) must exist in the database.

If the `gwsd=on` parameter is specified, the `gwsa=on` parameter must be specified.

If a destination point code matching the specified far-end point code exists, the far-end CLLI for the given linkset must match the destination identifier (DI) of that matching destination.

The `mtprse` parameter can be specified only if the MTP Restart feature MTPRS (for ANSI) is turned on. The `rtrv-feat` command can be used to verify whether the feature is turned on (`mtprs=yes` in the output).

If the `ipgwapc=yes` parameter is specified or the `ipsg=yes` and the `adapter=m3ua` parameters are specified, then the `mtprse=yes` parameter cannot be specified.

The `asl8=yes` parameter can be assigned only to an ANSI linkset (a linkset containing an adjacent point code in the SS7 domain).

The `apcntype` parameter can be specified only for ITU-N and ITU-N24 linksets.

The Other CIC (Circuit Identification Code) Bit Used feature (SLSOCB) feature must be turned on before the `slsobit` parameter can be specified.

The `slsobit` parameter is valid only for ITU linksets.

The `slsrsb` parameter is valid only for ITU linksets.

The GSM Map Screening feature must be turned on (see the `enable/chg-ctrl-feat` commands) before the `gmscrn` parameter can be specified.

The `itutfr` parameter is valid only for ITU linksets.

The ITU National Duplicate Point Code (ITUDUPPC) feature must be turned on before the `multgc=yes` parameter can be specified.

The `multgc=yes` parameter is valid only for ITU-N or ITU-I point codes.

If the HIPR2 High Rate Mode feature is turned off, then the sum of the TPS values assigned to all linksets in the system must be less than or equal to 500,000. If the HIPR2 High Rate Mode feature is turned on, then the sum of the TPS values assigned to all linksets in the system must be less than or equal to 750,000. If the HIPR2 High Rate Mode and 1M System TPS features are turned on, then the sum of the TPS values assigned to all linksets in the system must be less than or equal to 1,000,000.

The `ipgwapc=yes` or the `ipsg=yes` parameter must be specified before the `lsusealm` parameter can be specified.

The `ipgwapc=yes` or the `ipsg=yes` parameter must be specified before the `slkusealm` parameter can be specified.

The Enhanced GSM Map Screening feature must be turned on before the `gmscrn=on` parameter can be specified for an ANSI linkset.

The `mtprse` parameter can be specified only if the MTP Restart feature ITUMTPRS (for ITU), is turned on. The `rtrv-feat` command can be used to verify whether the feature is turned on (`itumtrs=yes` in the output).

The STP Site ID table is corrupt or cannot be found.

The Linkset table is corrupt or cannot be found.

The Route table is corrupt or cannot be found.

The MAS Configuration table is corrupt or cannot be found.

A point code cannot be assigned to a linkset as an APC if the point code has been provisioned with exception routes.

The Route Exception table is corrupt or cannot be found.

The Origin-based SCCP Routing feature must be turned on before the `gttmode` parameter can have a value of `acdc`, `cgacdc`, `acdcg`, `acdcg`, `cg`, `cdg`, or `cg`.

If APCN is specified for the Adjacent Point Code then the format of APCN must match the format dictated by the NPCFMTI parameter via the CHG-STPOPTS command.

The value of the `dpc/dpca/dpci/dpcn/dpcn24/dpcn16` parameter must exist in the Destination Point Code table.

The `gsmscrn` parameter can be specified only for ITU linksets.

The value specified for the `spc` parameter must be a full point code.

If the Multiple Linksets to a Single Adjacent Point Code (MLS) feature is enabled and turned on, then a maximum of 6 non-IPGW linksets can be created using the same adjacent point code.

The values specified by the `spc` and `apc` parameters must have the same network type.

The Multiple Linksets to a Single Adjacent Point Code (MLS) feature must be turned on before the `spc` parameter can be specified.

The value specified by the `spc` parameter must already exist in the SPC table.

The SPC table must be accessible.

The specified combination of the `apc` and `spc` parameters must be unique for each linkset.

The value specified for the `spc` parameter cannot already be specified as a secondary point code for an adjacent destination point code.

The Proxy Point Code feature must be enabled before the `lst=prx` parameter can be specified.

The Proxy Point Code feature must be enabled before the `ppc` parameter can be specified.

The value specified for the `ppc` parameter must be a full point code.

The `lst=prx` parameter must be specified before the `ppc` parameter can be specified. If the `lst=prx` parameter is specified, then the `ppc` parameter must be specified.

The values specified for the `apc` and `ppc` parameters must have the same network type.

The values specified for the `apc` and `ppc` parameters must have the same group code.

The `spc` and `ppc` parameters cannot be specified together in the command.

The `ppc` parameter cannot be specified for more than 10 linksets.

Two adjacent point codes cannot reference each other as proxy point codes.

The `apc` parameter and the `prx=yes` parameter must be specified before the `ppc` parameter can be specified.

A valid value must be specified for the `lst` parameter.

The `spc` and `ppc` parameters cannot be specified together in the command.

All of the linksets for an adjacent destination point code must be of the same type.

The specified combination of the `apc` and `ppc` parameters must be unique for each linkset.

The value specified for the proxy point code must be defined in the Destination table before the `lst=prx` parameter can be specified.

If multiple linksets are defined for the `apc` parameter, and if a proxy point code is defined for the `apc` parameter, then the first linkset defined in the `ent-ls` command must use the proxy point code.

The AMGTT feature or the AMGTT CgPA Upgrade feature must be turned on before the `cggmod` parameter can be specified.

The `ipsg=yes` parameter must be specified before the `adapter` parameter can be specified.

The `ipsg=yes` and `adapter=m3ua` parameters must be specified before the `asnotif` parameter can be specified.

The `ipsg=yes` and the `adapter=m3ua` parameters must be specified before the `rcontext` parameter can be specified.

If the `ipsg=yes` parameter is specified, then the `slktps/rsvdslktps` or `maxslktps` parameter must be specified.

The `ipsg=yes` parameter must be specified before the `slktps/rsvdslktps` or `maxslktps` parameter can be specified.

The `ipsg=yes` and `adapter=m3ua` parameters must be specified before the `lst=a` parameter can be specified.

A maximum of one IPGW linkset or a maximum of 6 of any other linksets are allowed between any APC and the EAGLE.

If the `ipsg=yes` and `adapter=m3ua` parameters are specified, then the `multgc=yes` parameter cannot be specified.

The ISLSBR feature must be enabled before the `islsrsb` parameter can be specified.

The FLOBR feature must be turned on before a value of `fcd`, `fcg`, `fcgfcg`, or `fcdfcg` can be specified for the `gttmode` parameter.

The SAPC table is corrupt or cannot be found.

The `rsls8=yes` parameter (see the `chg-lsopts` command) must be specified for an ANSI linkset before a value greater than 5 can be specified for the `islsrsb` parameter.

If an ITU linkset is used, then a value of 1 – 4 must be specified for the `islsrsb` parameter.

The value specified for the `slktps/rsvdslktps` parameter must be less than or equal to the value specified for the `maxslktps` parameter.

The value specified for the `ppc` parameter must already exist in the DSTN table and the `prx=yes` parameter must be assigned (see the `ent-dstn` command).

The `sltset=0` parameter can be specified only for a type A linkset (`lst=a`).

The value specified for the `slktps/rsvdslktps` and `maxslktps` parameters must be within the allowed range.

The ITUTFR **cannot** be specified for a linkset to be configured for APCN16.

The NIS **cannot** be specified for a linkset to be configured for APCN16.

The PPC specified must not be a private point code.

The MTP Restart Equipped (MTPRSE) parameter is only valid for adjacent ANSI nodes in the SS7 domain.

The adapter type specified must be either `m3ua` or `m2pa`.

### Notes

Of the 1024 maximum linksets supported, up to 255 of the linksets can be gateway linksets.

The system supports a maximum of 2800 links and all of them can be used at one time.

The links that directly connect the system with an adjacent node are grouped into one or more linksets. A linkset can contain up to 8 (international standards) or 16 (national standards) signaling links, depending on how the system was configured when the network was created.

Each linkset must be assigned the same physical links at both ends of the link (local and adjacent signaling points) and each link must be assigned the same link number.

Signaling link acknowledgments (SLTA) are the same type of maintenance message as the SLTMs received on the link.

If the `gwsa=off` and `gws=off` parameters are specified, all MSUs are passed.

If the `gwsa=off` and `gws=off` parameters are specified for all linksets, gateway screening and the GWS redirect function for the DTA feature are disabled.

If the `gwsa=off` and `gws=on` parameters are specified, all MSUs pass, but MRNs are generated if an MSU matches a screening condition.

If the `gwsa=on` and `gws=off` parameters are specified, MSUs are screened but messages are not generated.

If the `gwsa=on` and `gws=on` parameters are specified, MSUs are screened and MRNs are generated at the rate of one MRN every 20 seconds per link.

If the `asl8=yes` parameter is specified with the `lst=a` parameter (a linkset containing access signaling links), this indicates that the originator of the MSUs is generating 8-bit SLSs. For other linkset types, the `asl8=yes` parameter indicates that the adjacent STP is converting 5-bit SLSs to 8-bit SLSs. The SLS in MSUs received by the system on a linkset that has the `asl8=yes` parameter assigned to it will not be converted. These MSUs are assumed to contain 8-bit SLSs.

The Network Indicator Spare (`nis`) parameter can be specified only for ANSI and ITU-N links.

The `mtprse` parameter value can be specified independently of the value specified on the `mtprsi` parameter of the `chg-stpopts` command.

The MTP restart option (`mtprse`) is not a valid option on point-to-multipoint IP links (DCM cards equipped as SS7IPGW links).

When two linksets are used as a combined linkset, each linkset must have the same `slsci` and `asl8` values and the same `slsobit` and `islsrsb/slsrsb` values.

 **Caution:**

This is not enforced in the system and there is no warning mechanism if the values of these parameters are not the same for each linkset.

MTP restart provides an orderly process for bringing signaling links back into service after the system has been isolated and restarted. A greater preference is given to restoring the STP to network service in an orderly fashion than to the speed of recovery. The time required is system dependent as shown:

- up to 64 LIMs—62 seconds (Link Alignment Delay)
- 64 - 127 LIMs—97 seconds
- 128 - 191 LIMs—132 seconds
- more than 191 LIMs—167 seconds

The `slsrsb` parameter alone does not provide an even distribution of ITU-ISUP messages across all links within a linkset. The system uses all four bits of the SLS to determine the actual link to route messages. Because the static bit is simply rotated within the SLS, all possible values of the SLS field are still not realized. The `slsobit` parameter must also be specified to provide an even distribution across all links within the linkset. If both parameters are specified for a given linkset, the SLS field is processed in the following order.

- The SLS is modified using the Other CIC Bit option.
- The modified SLS is modified again using the Rotated SLS Bit option.
- The modified SLS is used by the existing linkset and link selection algorithms to select a link
- The ISUP message is sent out the link containing the original, unmodified SLS field.

If the ITU National Duplicate Point Code (ITUDUPPC) feature is turned on, for each group that is defined, a separate ITU national C linkset must be provisioned. The C linkset is used as the alternate route for point codes in the group.

In this command, only ITU-international and ITU national point codes support the spare point code subtype prefix (s-) and the private and spare point code subtype prefix (ps-). All point code types support the private (internal) point code subtype prefix (p-).

The ITU National and ITU National China Adjacent Point Code types indicate the format that is used for changeover and changeover acknowledgement messages. China specifies a 16-bit field for data in changeover messages. The FSN occupies the first 12 bits. The trailing 4 bits are spare and are coded as 0. ITU uses a 24-bit field for data in the extended changeover/changeover acknowledgement messages. The FSN is encoded in the first 12 bits. The last 12 bits of the field are spare and are coded as zero.



The `randsls` parameter value applies to SCCP ITU-T messages and Class0 and ISUP ANSI messages when random SLS generation is set to occur on a per linkset basis (the `randsls=perls` parameter is specified in the `chg-stpopts` command).

If the `randsls=perls` parameter is specified in the `chg-stpopts` command, it is recommended that the linksets in a combined linkset be provisioned with the same `randsls` value to avoid undesired SLS distribution.

The value specified for the `ppc` parameter must be a full point code. Cluster point codes and private point codes are not supported.

Invalid point codes (ANSI network = 0) can be used for the adjacent point code of an IPGWx linkset. Private point codes (p-) can be used for IPGWx linksets, as adjacent point codes (`ent-ls:apc=xxx`) or internal point codes (`ent-rmt-appl:ipc=xxx`). Ordinary point codes can be used in all cases as APCs or IPCs.

If the ISLSBR feature is turned on, and Incoming SLS Bit Rotation is applied to an MSU, then the outgoing SLS bit rotation is not applied for that MSU. If the ISLSBR feature is turned off, or Incoming SLS Bit Rotation is not applied to an MSU, then the outgoing SLS bit rotation is applied for that MSU.

The valid ISLSRSB values for ITU link sets are 1 – 4 and for ANSI link sets are 1 – 8.

The `randsls` parameter is applied on an incoming linkset for ANSI messages and on an outgoing linkset for ITU messages.

The `chgntp3opc` parameter is applied on the outgoing linkset.

The `chgntp3opc` parameter will be nullified if the `sccpopts:mtprgtd` option is set to `fullgtd`.

## Output

```
ent-ls:lsn=lsa:lst=a:apca=1-1-1:gtdmode=fcdfcg
```

```
tekelecstp 09-03-22 12:14:11 EST EAGLE 41.0.0
Link set table is (1 of 1024) 1% full.
ENT-LS: MASP A - COMPLTD
;
```

## Related Topics

- [chg-ls](#)
- [chg-lsopts](#)
- [dlt-ls](#)
- [ent-dstn](#)
- [rtrv-ls](#)

# ent-map

Use this command to create new entries in the MAP table, which allow the assignment of mated applications and Alternate RI Mate searches for use with SCCP network management. A mated application is used if the local application becomes

unavailable. An Alternate RI Mate is used if all mated applications within a MAP Set become unavailable or congested.

 **Note:**

A MAP set is a logical grouping of a set of PC/SSNs that already exist in the EAGLE MAP table. The Flexible GTT Load Sharing (FGTTLS) feature allows a PC/SSN combination to be part of more than one load-sharing group, with each PC/SSN combination defined by a different MAP set.

 **Note:**

If the FGTTLS feature is enabled, then all existing entries in the MAP table and all existing GTA translations in the GTT table with `ri=ssn` are stored in default MAP sets. Additional MAP sets can be provisioned, and GTT entries can be associated to the MAP sets.

 **Note:**

The GTT Load Sharing with Alternate Routing Indicator (GTT LS ARI) feature must be enabled to provision Alternate RI Mates.

## Parameters

 **Note:**

See [Point Code Formats and Conversion](#) for a detailed description of point code formats, rules for specification, and examples.

### **pc (mandatory)**

ANSI point code with subfields *network indicator-network cluster-network cluster member (ni-nc-ncm)*.

**Synonym:**

*pca*

**Range:**

*000-255*

Specify a valid value for each subfield of the point code, and separate the subfields with a dash (-).

When `chg-sid:pctype=ansi` is specified, *ni = 000* is not valid.

When `chg-sid:pctype=ansi` is specified, *nc = 000* is not valid if *ni = 001–005*.

When `chg-sid:pctype=ansi` is specified, *nc = 000* is valid if *ni = 006–255*.

The point code *000-000-000* is not a valid point code.

### **pc/pca/pci/pcn/pcn24/pcn16 (mandatory)**

Primary remote point code.

**pci (mandatory)**

ITU international point code with subfields *zone-area-id*. The *prefix* subfield indicates a spare point code (*prefix-zone-area-id*).

**Range:**

*s-*, 0-255

Specify a valid value for each subfield of the point code, and separate the subfields with a dash (-).

*prefix*—*s*

*zone*—0-7

*area*—000-255

*id*—0-7

The point code 0-000-0 is not a valid point code.

**pcn (mandatory)**

ITU national point code in the format of a 5-digit number (*nnnnn*); or 2, 3, or 4 numbers (members) separated by dashes (*m1-m2-m3-m4*) as defined by the `chg-stpopts:npcfmti` flexible point code option. A group code must be specified when the ITUDUPPC feature is turned on (*nnnnn-gc,m1-m2-m3-m4-gc*). The *prefix* subfield indicates a spare point code (*prefix-nnnnn*, *prefix-nnnnn-gc*, *prefix-m1-m2-m3-m4*, *prefix-m1-m2-m3-m4-gc*).

**Range:**

*s-*, 0-16383, *aa-zz*

Specify a valid value for each subfield of the point code, and separate the subfields with a dash (-).

*prefix*—*s-*

*nnnnn*—0-16383

*gc*—*aa-zz*

*m1-m2-m3-m4*—0-14 for each member; values must sum to 14

**pcn24 (mandatory)**

24-bit ITU national point code with subfields *main signaling area-sub signaling area-signaling point* (*msa-ssa-sp*).

**Range:**

000-255

Specify a valid value for each subfield of the point code, and separate the subfields with a dash (-).

*msa*—000-255

*ssa*—000-255

*sp*—000-255

**pcn16 (mandatory)**

16-bit ITU national point code with subfields *unit number-sub number area-main number area* (*un-sna-mna*).

**Range:**

000---127

Specify a valid value for each subfield of the point code, and separate the subfields with a dash (--).

*un*---000---127

*sna---000---15*

*mna---000---31*

**ssn (mandatory)**

Subsystem number. The application's subsystem number. This attribute is composed of the decimal representation of the 1-byte field used in the SS7 protocol.

**Range:**

*2 - 255*

**grp (optional)**

Concerned point code broadcast list (CSPC) group name. The name of a group of point codes that should be notified of the subsystem status. A different CSPC group can be assigned to each mated PC/SSN. For ANSI, the EAGLE broadcasts SSP or SSA to the mate subsystem only if the mate's point code is provisioned as part of the CSPC group to receive an SSP or SSA. This parameter must be provisioned for a node if the node is to receive SSP or SSA broadcasts, even if the node is a mated application.

**Range:**

*ayyyyyyy*

1 alphabetic character followed by up to 7 alphanumeric characters

**Default:**

Current value.

 **Note:**

If the `grp` parameter value is specified, and the specified point code and SSN is assigned to multiple mated applications, the `grp` value for all mated applications containing the specified point code and SSN will be changed to the values specified in this procedure.

**mapset (optional)**

MAP Set ID.

**Range:**

*dflt*

*new*

**Default:**

*dflt* if the FGTTLS feature is not enabled

**materc (optional)**

Mate relative cost. The RC assigned to the mate PC/SSN that is being added to the entity set. The EAGLE determines the multiplicity mode based on the relative costs (the `rc` and `materc` parameters) of the subsystem.

**Range:**

*0 - 99*

**Default:**

50

**mpc (optional)**

ANSI point code with subfields *network indicator-network cluster-network cluster member (ni-nc-ncm)*.

**Synonym:***mpca***Range:**

000-255

Specify a valid value for each subfield of the point code, and separate the subfields with a dash (-).

When *chg-sid:pctype=ansi* is specified, *ni = 000* is not valid.

When *chg-sid:pctype=ansi* is specified, *nc = 000* is not valid if *ni = 001–005*.

When *chg-sid:pctype=ansi* is specified, *nc = 000* is valid if *ni = 006–255*.

The point code *000-000-000* is not a valid point code.

**Default:**

000

**mpc/mpca/mpci/mpcn/mpcn24/mpcn16 (optional)**

Mate remote point code.

**mpci (optional)**

ITU international destination point code with subfields *zone-area-id*. The *prefix* subfield indicates a spare point code (*prefix-zone-area-id*).

**Range:***s-*, 0-255

Specify a valid value for each subfield of the point code, and separate the subfields with a dash (-).

*prefix—s**zone—0-7**area—000-255**id—0-7*

The point code *0-000-0* is not a valid point code.

**Default:**

0-000-0

**mpcn (optional)**

ITU national point code with subfield ITU number (*nnnnn*). The *prefix* subfield indicates a spare point code.

**Range:***s-*, 0-16383, *aa-zz*

Specify a valid value for each subfield of the point code, and separate the subfields with a dash (-).

*prefix—s-**nnnnn—0-16383**gc—aa-zz*

*m1-m2-m3-m4—0-14* for each member; values must sum to 14

**Default:**

00000

**mpcn24 (optional)**

24-bit ITU national point code with subfields *main signaling area-sub signaling area-signaling point (msa-ssa-sp)*.

**Range:**

000-255

Specify a valid value for each subfield of the point code, and separate the subfields with a dash (-).

*msa—000–255**ssa—000–255**sp—000–255***Default:**

000

**mpcn16 (optional)**

16-bit ITU national point code with subfields *unit number-sub number area-main number area (un-sna-mna)*.

**Range:**

000---127

Specify a valid value for each subfield of the point code, and separate the subfields with a dash (--).

*un---000---127**sna---000---15**mna---000---31***Default:**

000

**mrcc (optional)**

Message routing under congestion. This parameter indicates whether Class 0 messages to the specified PC/SSN can be routed to the next preferred node/subsystem when that PC/SSN is congested.

**Range:***yes**no***Default:***yes* —if ANSI*no* —if ITU**mrnpc (optional)**

ANSI point code with subfields *network indicator-network cluster-network cluster member (ni-nc-ncm)*.

**Synonym:***mrnpca***Range:***000-255*

Specify a valid value for each subfield of the point code, and separate the subfields with a dash (-).

When *chg-sid:pctype=ansi* is specified, *ni = 000* is not valid.

When *chg-sid:pctype=ansi* is specified, *nc = 000* is not valid if *ni = 001-005*.

When *chg-sid:pctype=ansi* is specified, *nc = 000* is valid if *ni = 006-255*.

The point code *000-000-000* is not a valid point code.

**Default:***000***mrnpc/mrnpca/mrnpai/mrnpai/mrnpai/mrnpai/mrnpai/mrnpai (optional)**

Alternate RI Mate point code.

**mrnpai (optional)**

ITU international point code with subfields *zone-area-id*. The *prefix* subfield indicates a spare point code (*prefix-zone-area-id*).

**Range:***s-, 0-255*

Specify a valid value for each subfield of the point code, and separate the subfields with a dash (-).

*prefix—s**zone—0-7**area—000-255**id—0-7*

The point code *0-000-0* is not a valid point code.

**Default:***0-000-0***mrnpai (optional)**

ITU national point code with subfield ITU number (*nnnnn*). The *prefix* subfield indicates a spare point code.

**Range:***s-, 0-16383, aa-zz*

Specify a valid value for each subfield of the point code, and separate the subfields with a dash (-).

*prefix—s-**nnnnn—0-16383**gc—aa-zz*

*m1-m2-m3-m4—0-14* for each member; values must sum to 14

**Default:***00000***mrnpai24 (optional)**

24-bit ITU national point code with subfields *main signaling area-sub signaling area-signaling point* (*msa-ssa-sp*).

**Range:**

000-255

Specify a valid value for each subfield of the point code, and separate the subfields with a dash (-).

*msa—000—255**ssa—000—255**sp—000—255***Default:**

000

**mrnpcn16 (optional)**16-bit ITU national point code with subfields *unit number-sub number area-main number area (un-sna-mna)*.**Range:**

000--127

Specify a valid value for each subfield of the point, and separate the subfields with a dash (-).

*un---000---127**sna---000---15**mna---000--31***Default:**

000

**mrnset (optional)**

Alternate RI Mate MRN Set ID. The MRN Set where the Alternate RI Mate search is performed.

**Range:**1 - 3000, *dflt**dflt* —default MRN SetIf the `mrnpc` parameter is specified, and the `mrnset` parameter is not specified, then the value for the `mrnset` parameter is automatically set to *dflt*.**mssn (optional)**

Mate subsystem number. The mate application's subsystem number. This attribute is the decimal representation of the one-byte field used in the SS7 protocol.

**Range:**

2 - 255

**Default:**

Parameter is not used

**mwt (optional)**

Mate point code weight. The weight assigned to the mate PC/SSN that is being added to a weighted entity set.

**Range:**

1 - 99



**rc (optional)**

Relative cost. The EAGLE determines the multiplicity mode based on the relative costs (the `rc` and `materc` parameters) of the subsystem. (See *Notes* for additional information on multiplicity modes).

**Range:**

0 - 99

**Default:**

10

**srm (optional)**

Subsystem routing messages. This parameter specifies whether subsystem routing messages (SBR, SNR) are transmitted between the mated applications.

 **Note:**

This value can be provisioned in any of the multiplicity modes, but its value only affects traffic if the multiplicity mode is *DOM* or *COM*. See the *Notes* section for more information on multiplicity modes.

**Range:**

*yes*

*no*

**Default:**

*yes* —if ANSI

*no* —if ITU

**sso (optional)**

Subsystem status option. This parameter specifies whether or not the PC/SSN is to initiate a subsystem test when a RESUME is received for the PC.

**Range:**

*on*

*off*

**Default:**

*off*

**thr (optional)**

Threshold. The in-service threshold assigned to each PC/SSN in a weighted entity set or RC group. The Weighted GTT Loadsharing feature must be turned on before this parameter can be specified.

**Note:**

If this parameter is not specified, a value of 1% is assigned to each weighted PC/SSN.

**Range:**

1 - 100

**wt (optional)**

Weight. The weight assigned to the primary PC/SSN that is being added to the weighted entity set.

**Range:**

1 - 99

**Example**

In this example, the `rc` parameter is not required for a solitary PC/SSN pair. If the `rc` parameter is not specified, the relative cost defaults to 10.

```
ent-map:pc=1-1-1:ssn=10:grp=xyz
```

This example enters 1 and 1 into the MAP table. The `rc` and `materc` parameters are required for this command, which defines a map group.

```
ent-
```

```
map:pc=1-1-0:ssn=10:rc=10:mpc=1-1-1:mssn=10:materc=20:grp=xyz:srm=on
```

These examples enter a solitary point code in the MAP table with the Subsystem Status Option set to ON:

```
ent-map:pc=1-1-3:ssn=20:grp=abc:sso=on
```

```
ent-map:pc=2-2-3:ssn=20:grp=abc
```

This example sets the Subsystem Status Option to ON for the primary and mate:

```
ent-map:pc=1-1-4:ssn=10:rc=10:mpc=1-1-1:mssn=10:materc=20:sso=on
```

This example enters a solitary point code in the MAP table with the Subsystem Status Option set to OFF (the default):

```
ent-map:pc=1-1-6:ssn=10:rc=10:mpc=1-1-7:mssn=10:materc=20
```

This example creates a new MAP Set with Alternate RI Mate 1-1-3/1:

```
ent-
```

```
map:pc=1-1-1:ssn=15:rc=10:mpc=1-1-2:mssn=25:materc=20:mapset=new:mrnset=1:mrnpc=1-1-3
```

The following example creates a new MAP set, and enters 1 and 1 into the newly created MAP set:

```
ent-map:pc=1-1-1:ssn=10:rc=10:mpc=1-1-2:mssn=20:materc=20:mapset=new
```

The following example enters 1 and 1 into the default MAP set:

```
ent-
```

```
map:pc=1-1-1:ssn=15:rc=10:mpc=1-1-2:mssn=25:materc=20:mapset=df1t
```

The following example creates a new MAP set and enters a solitary PC/SSN value of 1:

```
ent-map:pc=1-1-1:ssn=10:mapset=new
```

This example enters a solitary PC/SSN of 1 into the default MAP set:

```
ent-map:pc=1-1-2:ssn=15:mapset=df1t
```

This example creates a new MAP set and enters a solitary PC/SSN 1 with the subsystem option ON. It specifies the `sso=on` parameter for all instances of PC/SSN 1:

```
ent-map:pc=1-1-1:ssn=10:sso=on:mapset=new
```

This example enters a solitary PC/SSN of 1 into the default MAP set with the subsystem option ON. The `sso=on` parameter is specified for all instances of PC/SSN 1:

```
ent-map:pc=1-1-3:ssn=15:sso=on:mapset=df1t
```

These examples create a weighted shared PC/SSN pair:

```
ent-
map:pc=1-1-1:ssn=10:rc=20:wt=30:mpc=1-2-1:mssn=10:materc=20:mwt=20
```

```
ent-
map:pc=1-1-1:ssn=10:rc=20:wt=30:mpc=1-2-1:mssn=10:materc=20:mwt=20:thr=40
```

This example creates a new MAP Set with a different ITU network type point code for the Alternate RI Mate PC:

```
ent-
map:pci=1-001-1:ssn=15:rc=10:mpci=1-001-2:mssn=25:materc=20:mapset=new:mrnpcn=00126:mrnset=2
```

Example for 16 bit PC:

```
ent-
map:pcn16=1-2-3:ssn=10:rc=20:wt=30:mpcn16=1-1-1:mssn=10:materc=20:mwt=20:thr=40
```

## Dependencies

The PC/SSN pair cannot already exist in the MAP table.

The specified MPC/MSSN pair cannot already exist in the MAP table.

The `apca` and `pcn24/pcn16` parameters cannot be specified for the same MAP set. The `pci` and `pcn` parameters cannot be specified for the same MAP set if the MAP set contains a true point code.

If a subsystem is configured for a subsystem number (SSN) value in the SS-APPL table, then the specified MAP table entry for that subsystem must be a valid point code type for that subsystem. The following point code types are not valid for the indicated subsystems:

- For the INP subsystem, the True Point code cannot be an ITU-I point code.
- For the AIQ, ATINPQ, VFLEX, and EIR subsystems, the True Point code cannot be an ITU-N24 point code.

The ANSI/ITU SCCP Conversion feature must be enabled before the network type of the CPC broadcast group can be different from the network type of the point code.

If the `pci`, `pcn`, or `pcn24/pcn16` parameter is specified, then the `srn=yes` parameter cannot be specified.

The primary remote point code must already exist in the Route table, as a destination in the ordered route entity set, or in a cluster destination for which ordered routes are specified.

If a CSPC broadcast list group name is specified, it must already exist.

A maximum of 1024 unique remote point codes are allowed.

A maximum of 12 SSNs per remote point code can be entered.

The primary subsystem DPCs must be full point codes.

The mate subsystem DPCs must be full point codes.

The LNP, V-Flex, EIR, or INP feature must be turned on or the ANSI41 AIQ or ATINP feature must be enabled before a value that is a true point code can be specified for the `pca/mpca` parameter.

The AINPQ, EIR, INP, or V-Flex feature must be turned on or the ANSI41 AIQ or ATINP feature must be enabled before a value that is a true point code can be specified for the `pcn/mpcn` parameter.

The EIR or V-Flex feature must be turned on or the ANSI41 AIQ or ATINP feature must be enabled before a value that is a true point code can be specified for the `pci/mpci` parameter.

If the `mpc/mpca/mpci/mpcn/mpcn24/mpcn16` parameter is specified, then the value must exist in the Routing table.

If the `mssn` or `materc` parameter is specified, then the `mpc` parameter must be specified.

If the `pc` parameter value is an EAGLE true point code, the subsystem must have a lower relative cost than all other mated subsystems in the group.

The `ssn` parameter cannot be specified with a point code value that is the system true point code.

A true point code cannot be routed to itself.

The `mpc` and `mssn` parameters cannot have the same values as the `pc` and `ssn` parameters.

The point code must already exist in the Concerned Point Code (CSPC) group.

The number of MPC Subsystem entries must not exceed the table capacity.

The Route table is corrupt or cannot be found.

The Site Identification table is corrupt or cannot be found.

If the Flexible GTT Load Sharing feature is not enabled, then the `mapset` parameter cannot be specified. If the Flexible GTT Load Sharing feature is enabled, then the `mapset` parameter must be specified.

The EAGLE True PC can be provisioned only in the default MAP set.

The Weighted GTT Loadsharing feature must be turned on before the `wt`, `mwt`, or `thr` parameters can be specified.

If the `thr` parameter is specified, the `wt` and `mwt` parameters must be specified.

If the `mpc` parameter is specified, the `rc` parameter must be specified.

The `wt` and `mwt` parameters must be specified together in the same command.

If the `materc` parameter value equals the `rc` parameter value, a Loadshared Group is indicated, and the `rc`, `mpc`, `materc`, and `mwt` parameters must be specified.

If the `chg-sid:pctype=ansi` command is entered, a value of `ni=000` cannot be specified.

If the `chg-sid:pctype=ansi` command is entered, and a value of `ni=001 – 005` is specified, a value of `nc=000` cannot be specified.

If the `mpc` parameter value is a true point code, the subsystem must have a lower RC than all other mated subsystems in the entity set.

The maximum number of entries in the MAP table cannot be exceeded.

The maximum number of possible entries in the MAP table for the specified True Point Code cannot be exceeded. Maximum entries for the ANSI, ITU-I, and ITU-N point codes are:

- ANSI—2 (ANS41 AIQ and LNP), 4 (ANSI41 AIQ, ATINPQ, INP, and V-FLEX)
- ITU-I—4 (ANSI41 AIQ, ATINPQ, EIR, V-FLEX)
- ITU-N—5 (ANSI41 AIQ, ATINPQ, EIR, INP, and V-FLEX)

**Note:**

LNP is mutually exclusive with ATINPQ and V-FLEX, unless the Dual ExAP Config feature is enabled.

If the `mwt` parameter is specified, the `mpc` parameter must be specified.

If the `mpc` parameter is specified, the `mssn` and `materc` parameters must be specified.

The entity set being created must be either solitary or dominant to use the true point code as a point code.

The MAP table is corrupt or cannot be found.

If the `thr` parameter is specified, the `rc1`, `rc2`, `rc3`, and `rc4` parameters must be of equal value.

If the `mpc` parameter is specified, then the `mssn` parameter must be specified.

SRM=YES cannot be entered with ITU point codes.

If the `mpc` or `mssn` parameter is specified, then the `materc` parameter must be specified.

If the `pc/ssn` parameters and the `mpc/mssn` parameters are specified, then the `rc` parameter must be specified.

If the `pcn` or `mpcn` parameter is specified, then the format of the parameter must match the format dictated by the `chg-stpopts:npcfmti` command.

A True PC cannot be routed to itself.

The Spare Point Code Support feature must be enabled to allow provisioning of an ITU-I or ITU-N spare point code.

The True Point Code can be provisioned only in the default MAPSET.

Unable to access database. Severe database failure.

Failed reading SS APPL table.

The values specified for the `pc` and `mpc` parameters cannot be associated with proxy point codes.

If the `mrnset` parameter is specified, then the `mrnpc` parameter must be specified.

The GTT LS ARI feature must be enabled before the `mrnset` or `mrnpc` parameters can be specified.

The value specified for the `mrnpc/mrnpca/mrnpca/mrnpca/mrnpca24/mrnpca16` parameter must be a full point code.

The point codes and alternate RI Mate point codes must have the same network type as shown:

- ITUI, ITU-N, ITU-I spare, ITU-N-spare—ITUI, ITU-N, ITU-I spare, ITU-N-spare
- ANSI—ANSI
- ITUN-24—ITUN-24
- ITUN-16 ---ITUN-16

The value specified for the `mrnset` parameter must already exist in the MRN table.

The MRN table is corrupt or cannot be found.

The value specified for the `mrnpc` parameter must already exist in the specified MRN Set.

The `mrnset` parameter cannot be specified if the MAP Set specified by the `mapset` parameter contains a True Point Code.

The `ent-map` command will reject provisioning of local subsystem for ITUN16 SID, so that ITUN16 MSUs won't be forwarded to Local Subsystems.

SSN configured for SFAPP cannot be used in any command for any configuration

## Notes

Up to 128 PC/SSN pairs can be entered into a mated PC/SSN group.

## Multiplicity Modes

For the `-map` commands, an entity set consists of a group of PC/SSNs that are used for traffic distribution, and an RC group consists of PC/SSNs within an entity set that have the same RC. In *loadsharing* mode, an entity set contains 1 RC group. In *combined loadsharing/dominant* mode, an entity set can contain multiple loadsharing groups.

### Note:

For *dominant* and *combined loadsharing/dominant* modes, the PC/SSN in the MAP table where traffic distribution initializes is determined by the result of GTT translation and is referred to as the preferred PC/SSN. The preferred PC/SSN may not be the lowest cost entry.

The EAGLE supports the following multiplicity modes for nodes/subsystems:

- When a PC/SSN pair is not replicated, the pair is in *solitary* (SOL) mode. The subsystem acts as the only application, with no backup. If this subsystem fails, messages routed to it are discarded and SCCP management returns “Subsystem Unavailable” messages to the originator.
- A group of replicated PC/SSN pairs are in *dominant* (DOM) mode if each PC/SSN pair in the group has a unique RC. The specified subsystem with the lowest RC acts as the primary subsystem, while the mate subsystem acts as a backup.
- A group of replicated PC/SSN pairs are in *load sharing* (SHR) mode if each PC/SSN pair in the group has the same RC. All messages are evenly distributed at the SCCP level to all nodes/subsystems in the group. If failure occurs, the non-affected subsystem assumes the load of its failed mate.
- The *combined load sharing/dominant* (COM) mode supports a combination of load sharing and dominant mode. A group of PC/SSN pairs are in COM mode when at least two of the PC/SSN pairs have the same RC and another node subsystem in the group has a different RC.

If the XMAP feature is enabled, the MAP table can have up to either 2000 or 3000 entries, depending on the controlled feature Part Number that is enabled. If XMAP is not enabled, the MAP table can contain up to 1024 user entries.

The `SSO` parameter changes the initialization of the subsystem status (“prohibited” or “allowed”) for PC/SSN MAP entries. The EAGLE previously marked the subsystem status “allowed” for each PC/SSN entry. The `SSO` parameter marks the subsystem status “prohibited” for each new entry that has `SSO=ON`. This causes the EAGLE to generate an SST to the remote point-code when an MTP-RESUME is received. Upon reception of an SSA, the subsystem status is marked “allowed”.

In this command, only ITU-international and ITU national point codes support the spare point code subtype prefix (s-).

When the Flexible GTT Load Sharing feature is on, MAP load sharing sets are supported. Each set is identified by the `mapset` parameter.

When the Weighted GTT Loadsharing feature is turned on, weighted entity sets and RC groups are supported, and threshold values can be assigned to each PC/SSN.

When the GTT Load Sharing with Alternate Routing Indicator feature is enabled, an Alternate RI Mate can be provisioned.

## Output

```
ent-
map:pc=1-1-1:ssn=10:rc=10:mpc=1-1-2:mssn=20:materc=20:mapset=new
```

```
tekelecstp 11-03-22 11:22:28 EST EAGLE 44.0.0
ent-
map:pc=1-1-1:ssn=10:rc=10:mpc=1-1-2:mssn=20:materc=20:mapset=new
Command entered at terminal #4.
ENT-MAP: MASP A - MESSAGE: EXTENDED PROCESSING REQUIRED

New MAPSET Created : MAPSETID = 362
```

```

ENT-MAP: MASP A - COMPLTD
;

ent-map:pc=1-1-1:ssn=10:rc=10:mapset=dflt:mrnset=1:mrnpc=1-1-2

tekelecstp 11-03-12 11:22:28 EST EAGLE 44.0.0
ent-map:pc=1-1-1:ssn=10:rc=10:mapset=dflt:mrnset=1:mrnpc=1-1-2
Command entered at terminal #4.
ENT-MAP: MASP A - MESSAGE: EXTENDED PROCESSING REQUIRED
ENT-MAP: MASP A - COMPLTD
;

ent-map:pc=1-1-1:ssn=100:rc=10:mrc=no:srm=no

tekelecstp 11-03-12 11:22:28 EST EAGLE 44.0.0
ent-map:pc=1-1-1:ssn=100:rc=10:mrc=no:srm=no
Command entered at terminal #4.
ENT-MAP: MASP A - MESSAGE: EXTENDED PROCESSING REQUIRED
CAUTION: THE VALUE OF SRM IS EFFECTIVE WHEN MULT IS COM OR DOM AND
THE VALUE OF MRC IS EFFECTIVE WHEN MULT IS DOM.
ENT-MAP: MASP A - COMPLTD
;

```

### Related Topics

- [chg-map](#)
- [dlt-map](#)
- [rtrv-map](#)

## ent-mate-stp

Use this command to enter mate or self PC ( point code) into the database.



### Note:

This command is used to populate the mate STP table, and is used to route responses to queries generated by the EAGLE for SFAPP UC #3/4 back to the originating EAGLE if a member of a set of EAGLEs is forming a gateway. For messages to be routed properly, the table in each of the members of the set must have the same entries.

### Parameters

#### pc (mandatory)

ANSI point code with subfields *network indicator-network cluster-network cluster member (ni-nc-ncm)*.



**Synonym:***pca***Range:**

000-255 The point code 000-000-000 is not a valid point code.

**pc/pca/pci/pcn/pcn24/pcn16 (mandatory)**

Point code.

**Note:**See [Point Code Formats and Conversion](#) for a detailed description of point code formats, rules for specification, and examples.**pci (mandatory)**ITU international point code with subfields *zone-area-id*. The *prefix* subfield indicates a spare point code (*prefix-zone-area-id*)**Range:***s-*, 0-255

Specify a valid value for each subfield of the point code, and separate the subfields with a dash (-).

*prefix-s**zone-0-7**area-000-255**id-0-7*

The point code 000-000-000 is not a valid point code.

**pcn (mandatory)**ITU international point code with subfields *zone-area-id*. The *prefix* subfield indicates a spare point code (*prefix-zone-area-id*)**Range:***s-*, 0-16383, *aa-zz*

Specify a valid value for each subfield of the point code, and separate the subfields with a dash (-).

*prefix-s**nnnn-0-16383**gc-aa-zz**m1-m2-m3-m4-0-14* for each member; values must sum to 14**pcn24 (mandatory)**24-bit ITU national point code with subfields *main signaling area-sub signaling area-signaling point* (*msa-ssa-sp*).

**Range:***000-255*

Specify a valid value for each subfield of the point code, and separate the subfields with a dash (-).

*msa-000-255**ssa-000-255**sp-000-255***pcn16 (mandatory)**

16-bit ITU national point code with subfields *main signaling area-sub signaling area-signaling point (msa-ssa-sp)*.

**Range:***000---127*

Specify a valid value for each subfield of the point code, and separate the subfields with a dash (-).

*un---000---127**sna---000---15**mna---000---31***Example**

This example adds a point code:

```
ent-mate-stp:pc=10-20-30
```

This example adds a 24-bit ITU-N secondary point code:

```
ent-mate-stp:pcn24=99-99-99
```

This example adds a spare ITU-N secondary point code:

```
ent-mate-stp:pcn=s-12345
```

This example adds a 16-bit ITU-N secondary point code:

```
ent-mate-stp:pcn16=121-5-10
```

**Dependencies**

Mate STP point code must be present in either destination table or SID table.

Point code already exist in mate STP table.

Point code entered must be in same network as other existing point codes.

Mate stp table is full.

**Notes**

- The command is rejected when the point code is in invalid format.
- The command is rejected when point code is of a different network than the existing point codes/code's network.

- The command is rejected when the stp\_table is full, as in, there are 16 point codes in the table already.
- The command is rejected when the point code specified already exists in the table.
- The command is rejected when no DPC (destination point code) exists for the specified point code. To add a new point code in the STP table, either it should be in the SID table or it should exist in the destination point code table.

### Output

```
ent-mate-stp:pci=3-3-1
```

```
Searching destination table on disk - please wait...
```

```
Searching route table on disk - please wait...
```

```
Command Accepted - Processing
```

```
tekelecstp 18-05-28 17:24:37 MST EAGLE 46.6.2.0.0-73.19.0
```

```
ent-mate-stp:pci=3-3-1
```

```
Command entered at terminal #2.
```

```
;
```

```
tekelecstp 18-05-28 17:24:38 MST EAGLE 46.6.2.0.0-73.19.0
```

```
ENT-MATE-STP: MASP B - COMPLTD
```

### Related Topics

- [dlt-mate-stp](#)
- [rtrv-mate-stp](#)

## ent-mrn

Use this command to assign point codes and Alternate RI Mates in the Mated Relay Node (MRN) table. The Intermediate GTT Loadsharing feature must be on before this command can be entered. The GTT Load Sharing with Alternate Routing Indicator (GTT LS ARI) feature must be enabled to provision Alternate RI Mates.

If the Flexible GTT Loadsharing feature is enabled, use this command to create a new MRN set, or to add entries to an existing MRN set in the MRN table. If the Flexible GTT Loadsharing feature is turned on, then MRN sets are used.

#### Note:

If only the Intermediate GTT Loadsharing feature is turned on, the MRN table can contain a maximum of 3000 entries. If the Intermediate GTT Loadsharing feature is on and the Flexible GTT Loadsharing feature is enabled, the MRN table can contain a maximum of 6000 entries.

**▲ Caution:**

If any entries are provisioned in the SCCP-SERV table, the maximum number of entries that the MRN table can contain is reduced by that amount. Check the `rtrv-sccp-serv` command output to see if entries exist in the SCCP-SERV table.

**✎ Note:**

An MRN set is a logical grouping of PCs that already exist in the EAGLE MRN table. The Intermediate GTT Loadsharing feature allows PCs to be part of more than one load-sharing group, with each PC defined by a different MRN set. If the Intermediate GTT Loadsharing feature is enabled, then all existing entries in the MRN table and all existing GTA translations in the GTT table with `ri=gta` are stored in default MRN sets. Additional MRN sets can be provisioned, and GTT entries can be associated to the MRN sets.

**Parameters****✎ Note:**

See [Point Code Formats and Conversion](#) for a detailed description of point code formats, rules for specification, and examples.

If a point code is being added to an existing weighted entity set, and the `df1wt` parameter is not specified, the `wt1/wt2/wt3/wt4` parameter must be specified. The `wt1/wt2/wt3/wt4` parameter can only be specified if at least two of the `rc/rc1/rc2/rc3/rc4` parameters are equal, creating a weighted entity set.

**pc (mandatory)**

ANSI point code with subfields *network indicator-network cluster-network cluster member (ni-nc-ncm)*.

**Synonym:**

*pca*

**Range:**

000-255

Specify a valid value for each subfield of the point code, and separate the subfields with a dash (-).

When `chg-sid:pctype=ansi` is specified, *ni = 000* is not valid.

When `chg-sid:pctype=ansi` is specified, *nc = 000* is not valid if *ni = 001-005*.

When `chg-sid:pctype=ansi` is specified, *nc = 000* is valid if *ni = 006-255*.

The point code *000-000-000* is not a valid point code.

**pc/pca/pci/pcn/pcn24/pcn16 (mandatory)**

Post-GTT-translated point code.

**pci (mandatory)**

ITU international point code with subfields *zone-area-id*. The *prefix* subfield indicates a spare point code (*prefix-zone-area-id*).

**Range:**

*s-*, 0-255

Specify a valid value for each subfield of the point code, and separate the subfields with a dash (-).

*prefix*—*s*

*zone*—0-7

*area*—000-255

*id*—0-7

The point code 0-000-0 is not a valid point code.

**pcn (mandatory)**

ITU national point code in the format of a 5-digit number (*nnnnn*); or 2, 3, or 4 numbers (members) separated by dashes (*m1-m2-m3-m4*) as defined by the `chg-stpopts:npcfmti` flexible point code option. A group code must be specified when the ITUDUPPC feature is turned on (*nnnnn-gc*, *m1-m2-m3-m4-gc*). The *prefix* subfield indicates a spare point code (*prefix-nnnnn*, *prefix-nnnnn-gc*, *prefix-m1-m2-m3-m4*, *prefix-m1-m2-m3-m4-gc*).

**Range:**

*s-*, 0-16383, *aa-zz*

Specify a valid value for each subfield of the point code, and separate the subfields with a dash (-).

*prefix*—*s-*

*nnnnn*—0-16383

*gc*—*aa-zz*

*m1-m2-m3-m4*—0-14 for each member; values must sum to 14

**pcn24 (mandatory)**

24-bit ITU national point code with subfields *main signaling area-sub signaling area-signaling point* (*msa-ssa-sp*).

**Range:**

000-255

Specify a valid value for each subfield of the point code, and separate the subfields with a dash (-).

*msa*—000-255

*ssa*—000-255

*sp*—000-255

**pcn16 (mandatory)**

16-bit ITU national point code with subfields *unit number-sub number area-main number area* (*un-sna-mna*).

**Range:**

000---127

Specify a valid value for each subfield of the point code, and separate the subfields with a dash (-).

*un*---000---127

*sna---000---15*

*mna---000---31*

**df1twt (optional)**

Default weight. The weight to be assigned to a specified PC that is not assigned a weight with the *wt/wt1/wt2/wt3/wt4* parameter.

 **Note:**

If a PC weight is specified with the *wt/wt1/wt2/wt3/wt4* parameter and the *df1twt* parameter is specified, the default weight is ignored, and the PC is assigned the weight specified by its respective weight parameter.

**Range:**

*1 - 99*

**mappc (optional)**

ANSI point code with subfields *network indicator-network cluster-network cluster member (ni-nc-ncm)*.

**Synonym:**

*mappca*

**Range:**

*000-255*

Specify a valid value for each subfield of the point code, and separate the subfields with a dash (-).

When *chg-sid:pctype=ansi* is specified, *ni = 000* is not valid.

When *chg-sid:pctype=ansi* is specified, *nc = 000* is not valid if *ni = 001-005*.

When *chg-sid:pctype=ansi* is specified, *nc = 000* is valid if *ni = 006-255*.

The point code *000-000-000* is not a valid point code.

**Default:**

*000*

**mappc/mappca/mappci/mappcn/mappcn24/mappcn16 (optional)**

Alternate RI Mate point code.

**mappci (optional)**

ITU international point code with subfields *zone-area-id*. The *prefix* subfield indicates a spare point code (*prefix-zone-area-id*).

**Range:**

*s-, 0-255*

Specify a valid value for each subfield of the point code, and separate the subfields with a dash (-).

*prefix—s*

*zone—0-7*

*area—000-255*

*id—0-7*

The point code *0-000-0* is not a valid point code.

**Default:**

0-000-0

**mappcn (optional)**

ITU national point code in the format of a 5-digit number (*nnnnn*); or 2, 3, or 4 numbers (members) separated by dashes (*m1-m2-m3-m4*) as defined by the `chg-stpopts:npcfnti` flexible point code option. A group code must be specified when the ITUDUPPC feature is turned on (*nnnnn-gc*, *m1-m2-m3-m4-gc*). The *prefix* subfield indicates a spare point code (*prefix-nnnnn*, *prefix-nnnnn-gc*, *prefix-m1-m2-m3-m4*, *prefix-m1-m2-m3-m4-gc*).

**Range:***s-*, 0-16383, *aa-zz*

Specify a valid value for each subfield of the point code, and separate the subfields with a dash (-).

*prefix—s-**nnnnn—0-16383**gc—aa-zz**m1-m2-m3-m4—0-14* for each member; values must sum to 14**Default:**

00000

**mappcn24 (optional)**

24-bit ITU national point code with subfields *main signaling area-sub signaling area-signaling point* (*msa-ssa-sp*).

**Range:**

000-255

Specify a valid value for each subfield of the point code, and separate the subfields with a dash (-).

*msa—000–255**ssa—000–255**sp—000–255***Default:**

000

**mappcn16 (optional)**

16-bit ITU national point code with subfields *unit number-sub number area-main number area* (*un-sna-mna*).

**Range:**

000---127

Specify a valid value for each subfield of the point code, and separate the subfields with a dash (-).

*un---000---127**sna---000---15**mna---000---31***Default:**

000

**mapset (optional)**

Alternate RI Mate MAP Set ID. The MAP Set where the Alternate RI Mate search is performed.

**Range:**

1 - 36000, *dflt*  
*dflt*—default MAP Set

**Note:**

If the `mappc` and `mapssn` parameters are specified, and the `mapset` parameter is not specified, then the `mapset` parameter is automatically set to a value of *dflt*.

**mapssn (optional)**

Alternate RI Mate subsystem number.

**Range:**

2 - 255, \*, *none*

**Default:**

*none*

**mrnset (optional)**

MRN set ID.

**Range:**

1 - 3000, *dflt*, *new*  
*dflt*—default MRN set  
*new*—create a new MRN set

**pc1 (optional)**

ANSI point code with subfields *network indicator-network cluster-network cluster member (ni-nc-ncm)*.

**Synonym:**

*pca1*

**Range:**

000-255

Specify a valid value for each subfield of the point code, and separate the subfields with a dash (-).

When `chg-sid:pctype=ansi` is specified, *ni = 000* is not valid.

When `chg-sid:pctype=ansi` is specified, *nc = 000* is not valid if *ni = 001–005*.

When `chg-sid:pctype=ansi` is specified, *nc = 000* is valid if *ni = 006–255*.

The point code *000-000-000* is not a valid point code.

**pc1/pca1/pci1/pcn1/pcn241/pcn161 (optional)**

Alternate post-GTT-translated point code.

**pc2 (optional)**

ANSI point code with subfields *network indicator-network cluster-network cluster member (ni-nc-ncm)*.



**Synonym:***pca2***Range:***000-255*

Specify a valid value for each subfield of the point code, and separate the subfields with a dash (-).

When *chg-sid:pctype=ansi* is specified, *ni = 000* is not valid.

When *chg-sid:pctype=ansi* is specified, *nc = 000* is not valid if *ni = 001-005*.

When *chg-sid:pctype=ansi* is specified, *nc = 000* is valid if *ni = 006-255*.

The point code *000-000-000* is not a valid point code.

**pc2/pca2/pci2/pcn2/pcn242/pcn162 (optional)**

Alternate post-GTT-translated point code.

**pc3 (optional)**

ANSI point code with subfields *network indicator-network cluster-network cluster member (ni-nc-ncm)*.

**Synonym:***pca3***Range:***000-255*

Specify a valid value for each subfield of the point code, and separate the subfields with a dash (-).

When *chg-sid:pctype=ansi* is specified, *ni = 000* is not valid.

When *chg-sid:pctype=ansi* is specified, *nc = 000* is not valid if *ni = 001-005*.

When *chg-sid:pctype=ansi* is specified, *nc = 000* is valid if *ni = 006-255*.

The point code *000-000-000* is not a valid point code.

**pc3/pca3/pci3/pcn3/pcn243/pcn163 (optional)**

Alternate post-GTT-translated point code.

**pc4 (optional)**

ANSI point code with subfields *network indicator-network cluster-network cluster member (ni-nc-ncm)*.

**Synonym:***pca4***Range:***000-255*

Specify a valid value for each subfield of the point code, and separate the subfields with a dash (-).

When *chg-sid:pctype=ansi* is specified, *ni = 000* is not valid.

When *chg-sid:pctype=ansi* is specified, *nc = 000* is not valid if *ni = 001-005*.

When *chg-sid:pctype=ansi* is specified, *nc = 000* is valid if *ni = 006-255*.

The point code *000-000-000* is not a valid point code.

**pc4/pca4/pci4/pcn4/pcn244/pcn164 (optional)**

Alternate post-GTT-translated point code.

**pci1 (optional)**

ITU international point code with subfields *zone-area-id*. The *prefix* subfield indicates a spare point code, (*prefix-zone-area-id*).

**Range:**

*s-*, 0-255

Specify a valid value for each subfield of the point code, and separate the subfields with a dash (-).

*prefix—s*

*zone—0-7*

*area—000-255*

*id—0-7*

The point code 0-000-0 is not a valid point code.

**pci2 (optional)**

ITU international point code with subfields *zone-area-id*. The *prefix* subfield indicates a spare point code (*prefix-zone-area-id*).

**Range:**

*s-*, 0-255

Specify a valid value for each subfield of the point code, and separate the subfields with a dash (-).

*prefix—s*

*zone—0-7*

*area—000-255*

*id—0-7*

The point code 0-000-0 is not a valid point code.

**pci3 (optional)**

ITU international point code with subfields *zone-area-id*. The *prefix* subfield indicates a spare point code (*prefix-zone-area-id*).

**Range:**

*s-*, 0-255

Specify a valid value for each subfield of the point code, and separate the subfields with a dash (-).

*prefix—s*

*zone—0-7*

*area—000-255*

*id—0-7*

The point code 0-000-0 is not a valid point code.

**pci4 (optional)**

ITU international point code with subfields *zone-area-id*. The *prefix* subfield indicates a spare point code (*prefix-zone-area-id*).

**Range:**

0-255

Specify a valid value for each subfield of the point code, and separate the subfields with a dash (-).

*zone—0-7*

*area—000-255*

*id—0-7*

The point code 0-000-0 is not a valid point code.

**pcn1 (optional)**

ITU national point code in the format of a 5-digit number (*nnnnn*); or 2, 3, or 4 numbers (members) separated by dashes (*m1-m2-m3-m4*) as defined by the `chg-stpopts:npcfmti` flexible point code option. A group code must be specified when the ITUDUPPC feature is turned on (*nnnnn-gc*, *m1-m2-m3-m4-gc*). The *prefix* subfield indicates a spare point code (*prefix-nnnnn*, *prefix-nnnnn-gc*, *prefix-m1-m2-m3-m4*, *prefix-m1-m2-m3-m4-gc*).

**Range:**

*s*-, 0-16383, *aa-zz*

Specify a valid value for each subfield of the point code, and separate the subfields with a dash (-).

*prefix*—*s*-

*nnnnn*—0-16383

*gc*—*aa-zz*

*m1-m2-m3-m4*—0-14 for each member; values must sum to 14

**pcn2 (optional)**

ITU national point code in the format of a 5-digit number (*nnnnn*); or 2, 3, or 4 numbers (members) separated by dashes (*m1-m2-m3-m4*) as defined by the `chg-stpopts:npcfmti` flexible point code option. A group code must be specified when the ITUDUPPC feature is turned on (*nnnnn-gc*, *m1-m2-m3-m4-gc*). The *prefix* subfield indicates a spare point code (*prefix-nnnnn*, *prefix-nnnnn-gc*, *prefix-m1-m2-m3-m4*, *prefix-m1-m2-m3-m4-gc*).

**Range:**

*s*-, 0-16383, *aa-zz*

Specify a valid value for each subfield of the point code, and separate the subfields with a dash (-).

*prefix*—*s*-

*nnnnn*—0-16383

*gc*—*aa-zz*

*m1-m2-m3-m4*—0-14 for each member; values must sum to 14

**pcn241 (optional)**

24-bit ITU national point code with subfields *main signaling area-sub signaling area-signaling point* (*msa-ssa-sp*).

**Range:**

000-255

Specify a valid value for each subfield of the point code, and separate the subfields with a dash (-).

*msa*—000–255

*ssa*—000–255

*sp*—000–255

**pcn242 (optional)**

24-bit ITU national point code with subfields *main signaling area-sub signaling area-signaling point* (*msa-ssa-sp*).

**Range:**

000-255

Specify a valid value for each subfield of the point code, and separate the subfields with a dash (-).

*msa—000–255*  
*ssa—000–255*  
*sp—000–255*

**pcn243 (optional)**

24-bit ITU national point code with subfields *main signaling area-sub signaling area-signaling point (msa-ssa-sp)*.

**Range:**

*000–255*

Specify a valid value for each subfield of the point code, and separate the subfields with a dash (-).

*msa—000–255*  
*ssa—000–255*  
*sp—000–255*

**pcn244 (optional)**

24-bit ITU national point code with subfields *main signaling area-sub signaling area-signaling point (msa-ssa-sp)*.

**Range:**

*000–255*

Specify a valid value for each subfield of the point code, and separate the subfields with a dash (-).

*msa—000–255*  
*ssa—000–255*  
*sp—000–255*

**pcn3 (optional)**

ITU national point code in the format of a 5-digit number (*nnnnn*); or 2, 3, or 4 numbers (members) separated by dashes (*m1-m2-m3-m4*) as defined by the `chg-stpopts:npcfmti` flexible point code option. A group code must be specified when the ITUDUPPC feature is turned on (*nnnnn-gc*, *m1-m2-m3-m4-gc*). The *prefix* subfield indicates a spare point code (*prefix-nnnnn*, *prefix-nnnnn-gc*, *prefix-m1-m2-m3-m4*, *prefix-m1-m2-m3-m4-gc*).

**Range:**

*s-*, *0-16383*, *aa-zz*

Specify a valid value for each subfield of the point code, and separate the subfields with a dash (-).

*prefix—s-*  
*nnnnn—0-16383*  
*gc—aa-zz*  
*m1-m2-m3-m4—0-14* for each member; values must sum to 14

**pcn4 (optional)**

ITU national point code in the format of a 5-digit number (*nnnnn*); or 2, 3, or 4 numbers (members) separated by dashes (*m1-m2-m3-m4*) as defined by the `chg-stpopts:npcfmti` flexible point code option. A group code must be specified when the ITUDUPPC feature is turned on (*nnnnn-gc*, *m1-m2-m3-m4-gc*). The *prefix* subfield indicates a spare point code (*prefix-nnnnn*, *prefix-nnnnn-gc*, *prefix-m1-m2-m3-m4*, *prefix-m1-m2-m3-m4-gc*).

**Range:**

*s*-, 0-16383, *aa-zz*

Specify a valid value for each subfield of the point code, and separate the subfields with a dash (-).

*prefix—s-*

*nnnnn—0-16383*

*gc—aa-zz*

*m1-m2-m3-m4—0-14* for each member; values must sum to 14

**pcn161 (optional)**

16-bit ITU national point code with subfields *unit number-sub number area-main number area (un-sna-mna)*.

**Range:**

*000---127*

Specify a valid value for each subfield of the point code, and separate the subfields with a dash (-).

*un---000---127*

*sna---000---15*

*mna---000---31*

**pcn162 (optional)**

16-bit ITU national point code with subfields *unit number-sub number area-main number area (un-sna-mna)*.

**Range:**

*000---127*

Specify a valid value for each subfield of the point code, and separate the subfields with a dash (-).

*un---000---127*

*sna---000---15*

*mna---000---31*

**pcn163 (optional)**

16-bit ITU national point code with subfields *unit number-sub number area-main number area (un-sna-mna)*.

**Range:**

*000---127*

Specify a valid value for each subfield of the point code, and separate the subfields with a dash (-).

*un---000---127*

*sna---000---15*

*mna---000---31*

**pcn164 (optional)**

16-bit ITU national point code with subfields *unit number-sub number area-main number area (un-sna-mna)*.

**Range:**

000---127

Specify a valid value for each subfield of the point code, and separate the subfields with a dash (-).

*un---000---127*

*sna---000---15*

*mna---000---31*

**rc (optional)**

Relative cost. The relative cost of the route for the primary PC.

**Range:**

0 - 99

**rc1 (optional)**

Relative cost 1. The relative cost of the route for mate PC 1.

**Range:**

0 - 99

**rc2 (optional)**

Relative cost 2. The relative cost of the route for mate PC 2.

**Range:**

0 - 99

**rc3 (optional)**

Relative cost 3. The relative cost of the route for mate PC 3.

**Range:**

0 - 99

**rc4 (optional)**

Relative cost 4. The relative cost of the route for mate PC 4.

**Range:**

0 - 99

**thr (optional)**

Threshold. The in-service threshold of all PCs in a weighted entity set or RC group. The Weighted GTT Loadsharing feature must be turned on before this parameter can be specified.

 **Note:**

If a threshold value is not specified when creating a new RC group in an existing entity set, the new RC group is assigned a threshold value of 1%.

**Range:**  
1 - 100

**wt (optional)**

Weight. The weight assigned to the primary PC.

 **Note:**

If PCs are being added to an existing entity set, the `wt` parameter cannot be specified. If a new entity set is being created, the `wt` parameter can only be specified if at least two of the specified RC values are equal, which creates a weighted entity set.

**Range:**  
1 - 99

**wt1 (optional)**

Weight 1. The weight assigned to the mate PC 1 that is being added to the weighted entity set.

**Range:**  
1 - 99

**wt2 (optional)**

Weight 2. The weight assigned to the mate PC 2 that is being added to the weighted entity set.

**Range:**  
1 - 99

**wt3 (optional)**

Weight 3. The weight assigned to the mate PC 3 that is being added to the weighted entity set. The Weighted GTT Loadsharing feature must be turned on before this parameter can be specified.

**Range:**  
1 - 99

**wt4 (optional)**

Weight 4. The weight assigned to the mate PC 4 that is being added to the weighted entity set.

**Range:**  
1 - 99

**Example**

This example enters point code 1 into the MRN table with a relative cost of 10 and associates point code 1 with it as a point code with a relative cost of 20.

```
ent-mrn:pc=1-1-0:rc=10:pc1=1-1-1:rc1=20
```

This example updates the group containing point code 1 in the MRN table, to add point code 1 with relative cost of 20 and point code 1 with relative cost of 30 to the group.

```
ent-mrn:pc=1-1-0:rc=10:pc1=1-1-1:rc1=20:pc2=1-1-10:rc2=30
```

These examples include spare point codes:

```
ent-mrn:pci=s-2-2-1:rc=10:pci1=s-2-2-2:rc1=11:pci2=2-100-1:rc2=12
```

```
ent-mrn:pcn=s-1-1-1-123-aa:rc=1:pcn1=1-1-1-235-aa:rc1=2:pcn2=s-1-1-1-235-aa:rc2=3
```

```
ent-mrn:pc=1-1-1:rc=10:pc1=1-1-2:rc1=10:mrnset=df1t
```

```
ent-
```

```
mrn:pc=1-1-1:rc=10:pc1=1-1-2:rc1=20:pc2=1-1-3:rc2=30:apc3=1-1-4:rc3=40:apc4=1-1-5:rc4=50:mrnset=new
```

```
ent-mrn:pc=1-1-3:pc1=1-1-6:rc1=60:pc2=1-1-7:rc2=70:mrnset=111
```

These examples create a new weighted entity set:

```
ent-mrn:pc=1-1-0:rc=10:wt=30:pc1=1-1-1:rc1=10:wt1=10
```

```
ent-mrn:pc=1-1-0:rc=10:wt=30:pc1=1-1-1:rc1=10:wt1=10:thr=50
```

```
ent-
```

```
mrn:pc=1-1-0:rc=10:pc1=1-1-1:rc1=10:pc2=1-3-2:rc2=20:wt2=30:pc3=1-10-2:rc3=20:df1twt=20
```

```
ent-
```

```
mrn:pc=1-1-0:rc=10:pc1=1-1-1:rc1=10:wt1=30:pc2=1-3-2:rc2=10:df1twt=20:thr=60
```

```
ent-
```

```
mrn:pc=1-1-0:pc1=2-2-2:rc1=20:pc2=1-1-10:rc2=30:pc3=1-3-2:rc3=10:wt3=20:df1twt=30
```

```
ent-
```

```
mrn:pc=1-1-0:pc1=2-2-2:rc1=20:wt1=10:pc2=1-1-10:rc2=20:wt2=40:thr=30
```

```
ent-
```

```
mrn:pc=1-1-0:pc1=2-2-2:rc1=20:wt1=40:pc2=1-1-10:rc2=20:pc3=1-3-2:rc3=20:df1twt=25:thr=30
```

```
ent-mrn:pc=1-1-0:pc1=2-2-2:rc1=20:wt1=10:pc2=1-1-10:rc2=30:wt2=40
```

```
ent-mrn:pc=1-1-0:rc=10:pc1=1-1-1:rc1=20:pc2=1-1-10:rc2=30:mapset=1:mappc=2-1-1:mapssn=*
```

```
ent-
```

```
mrn:pc=1-1-0:rc=10:pc1=1-1-1:rc1=20:pc2=1-1-10:rc2=30:mappc=2-1-1:mapssn=*
```



```
ent-  
mrn:pci=1-001-0:rc=10:pci1=1-001-1:rc1=20:pci2=1-001-10:rc2=30:  
mapset=1: mappcn=00126:mapssn=12
```

```
ent-  
mrn:pcn16=1-14-0:rc=10:wt=30:pcn161=40-2-3:rc1=10:wt1=10:mrnset  
=dflt
```

### Dependencies

The Intermediate Global Title Translation Loadsharing feature must be turned on before this command can be entered.

The `apca` and `pcn24/pcn16` parameters cannot be specified for the same MRN set.

When a point code parameter is specified, its relative cost parameter must be specified.

Point codes cannot have the same value as the EAGLE SID.

The same point code value cannot be entered more than once in the MRN table.

ITU-N point codes must be in the format set by the `npcfmti` parameter of the `chg-stpopts` command. (Use the `rtrv-stpopts` command to display the STP option settings.)

Remote point codes must already exist as destinations in the Ordered Route entity set or reside in a cluster destination for which ordered routes are specified.

One or more point codes in the command will exceed the maximum number of point codes that can be entered into the MRN table (3000 if the IGTTLS feature is turned on and 6000 if the IGTTLS and FGTTLS features are turned on)..

The Flexible GTT Load-Sharing feature must be enabled before the `mrnset` parameter can be specified.

If the Flexible GTT Loadsharing feature is enabled, then the specified PC must already exist in the specified MRN set.

The specified MRN set must already exist in the MRN table.

When creating a new weighted entity set, the `mrnset=new` or `mrnset=dflt` parameter must be specified.

Each point code group can contain a maximum of 128 point codes.

The Weighted GTT Loadsharing feature must be turned on before the `wt/wt1/wt2/wt3/wt4`, `thr`, and `dfltwt` parameters can be specified.

If the `wt/wt1/wt2/wt3/wt4` parameter is specified, the corresponding `pc/pc1/pc2/pc3pc4` parameter must be specified.

When creating or modifying a weighted entity set, the `dfltwt` parameter must be specified, or an individual weight must be specified for each PC.

Entity sets in a solitary or dominant loadsharing mode cannot have weights assigned to the PCs. When creating an entity set, if all of the RC values are unique, the `wt/wt1/wt2/wt3/wt4` and `thr` parameters cannot be specified.

If the `thr` parameter is specified, the `rc1`, `rc2`, `rc3`, and `rc4` parameters must be of equal value.

If the `thr` parameter is specified, the associated `wt/wt1/wt2/wt3/wt4` parameter or the `df1tw1` parameter must be specified.

At least one additional point code must be specified.

Any specified point code must be a full point code.

If the `chg-sid:pctype=ansi` command is entered, a value of `ni=000` cannot be specified.

If the `chg-sid:pctype=ansi` command is entered, and a value of `ni=001 – 005` is specified, a value of `nc=000` cannot be specified

The SID table is corrupt or could not be found by the system.

If a new point code is being added to the MRN table, the `pc` and `rc` parameters must be specified together in the command.

If the Flexible GTT Loadsharing feature is enabled, and the `mrnset=new` parameter is specified, the `pc` and `rc` parameters must be specified together in the command.

The Route table is corrupt or could not be found by the system.

If the `pc1/pc2/pc3/pc4` parameter is specified, the `pc` parameter value must already exist in the MRN table.

A new point code that is specified in the command must not already exist in the MRN table.

If the `rc` parameter is not specified, the `wt` parameter cannot be specified.

If PCs are being added to a weighted entity set, the `wt/wt1/wt2/wt3/wt4` parameter or the `df1tw1` parameter must be specified.

If PCs are being added to a non-weighted entity set, the `wt/wt1/wt2/wt3/wt4` and the `df1tw1` parameters cannot be specified.

At least one optional parameter must be specified.

If the `wt/wt1/wt2/wt3/wt4` parameters are specified, the `df1tw1` parameter cannot be specified.

The value specified for the `pc/pc1/pc2/pc3/pc4` parameter cannot be associated with a proxy point code.

The GTT LS ARI feature must be enabled before the `mapset`, `mappc`, or `mapssn` parameter can be specified.

The value specified for the `mappc/mappca/mappci/mappcn/mappcn24/mappcn16` parameter must be a full point code.

The point codes and alternate RI Mate point codes must have the same network type as shown:

- ITUI, ITU-N, ITU-I spare, ITU-N-spare—ITUI, ITU-N, ITU-I spare, ITU-N-spare
- ANSI—ANSI
- ITUN-24—ITUN-24
- ITUN-16---ITUN-16

The specified MAPSET must already exist in the MAP table.

If the `mapset` parameter is specified, then the `mappc` and `mapssn` parameters must be specified.

The `mappc` and `mapssn` parameters must be specified together in the command.

The values specified for the `mappc` and `mapssn` parameters must already exist in the specified MAP Set.

The values specified for the `mapset` and `mappc` parameters must already exist in the MAP table.

The value specified for the `mappc` parameter cannot match an STP point code.

The `ent-mrn` command cannot be used to change an Alternate RI Mate that has already been specified for an MRN Set. Use the `chg-mrn` command to modify the Alternate RI Mate.

SSN configured for SFAPP cannot be used in any command for any configuration

### Notes

For the `-mrn` commands, an entity set consists of a group of PCs that are used for traffic distribution, and an RC group consists of PCs within an entity set that have the same RC. In loadsharing mode, an entity set contains 1 RC group. In combined/dominant loadsharing mode, an entity set can contain multiple loadsharing groups.

The EAGLE supports the following modes for nodes and subsystems:

- A group of replicated PCs are in *dominant* mode if each PC in the group has a unique RC. The specified subsystem with the lowest RC acts as the primary subsystem, while the mate subsystem acts as a backup. In the event of congestion, messages route to the mate subsystem. When the congestion subsides, messages are again routed to the primary (dominant) subsystem.
- A group of replicated PCs are in *load sharing* mode if each PC in the group has the same RC. All messages are evenly distributed at the SCCP level to all nodes/subsystems in the group. In the event of congestion or failure, the non-affected subsystem assumes the load of its failed or congested mate.
- The *combined load sharing/dominant* mode supports a combination of load sharing and dominant mode. A group of PCs are in combined load sharing/dominant mode when at least two of the PCs have the same RC and another node subsystem in the group has a different RC. A combination of node accessibility and RC determines the preferred PC.

The `ent-mrn` command cannot be used to change the relative cost value for a point code; the `chg-mrn` command must be used.

In this command, only ITU-international and ITU national point codes support the spare point code subtype prefix (s-).

If the `ent-mrn` command is used to add PCs to an existing weighted entity set, and the threshold is specified, all RC group values specified with `rc/rc1/rc2/rc3/rc4` parameters for the alternate post-GTT-translated point codes must be equal.

The following rules apply when the `ent-mrn` command is used to add PCs to RC groups:

- If a threshold value is specified and the PCs are being added to an existing RC group in the existing entity set, the RC group threshold is changed to the specified

threshold value and both pre-existing and new PCs in the RC group assume the new threshold value.

- If a threshold value is specified and the PCs are creating a new RC group in the existing entity set, the new RC group assumes the specified threshold value.
- If a threshold value is not specified and the PCs are being added to an existing RC group in the existing entity set, the RC group threshold does not change and the PC assumes the threshold value of the existing RC group.

When the Weighted GTT Loadsharing feature is turned on, weighted entity sets and RC groups are supported, and threshold values can be assigned to each PC.

Entries cannot be provisioned in the MRN table unless routes are also provisioned for corresponding point codes. However, an entry without a configured route may result from upgrading to a new EAGLE release. If such an entry occurs, then traffic will not be routed to the corresponding point code. The entry can be deleted, or a route for the entry can be configured.

When a node is marked congested in the MRN or MAP table, traffic continues to be routed to that node. When the congested node becomes prohibited, traffic is diverted to another node.

### Output

```
ent-
mrn:pc=1-1-1:rc=10:pc1=1-1-2:rc1=20:pc2=1-1-3:rc2=30:apc3=1-1-4:rc3=
40:apc4=1-1-5: rc4=50: mrnset=new
```

```
tekelecstp 11-03-04 12:59:14 EST EAGLE 44.0.0
ent-
mrn:pc=1-1-1:rc=10:pc1=1-1-2:rc1=20:pc2=1-1-3:rc2=30:apc3=1-1-4:rc3=40:apc4=1
-1-5: rc4=50:mrnset=new
Command entered at terminal #4.
ENT-MRN: MASP A - MESSAGE: EXTENDED PROCESSING REQUIRED

New MRNSET Created : MRNSETID = 112
ENT-MRN: MASP A - COMPLTD
;
```

```
ent-
mrn:pc=1-1-0:rc=10:pc1=1-1-1:rc1=10:mrnset=dfld:mapset=dfld:mappc=1-
1-2:mapssn=10
```

```
tekelecstp 11-03-04 12:15:32 EST EAGLE 44.0.0
ent-
mrn:pc=1-1-0:rc=10:pc1=1-1-1:rc1=10:mrnset=dfld:mapset=dfld:mappc=1-1-2:mapss
n=10
Command entered at terminal #4.
ENT-MRN: MASP A - MESSAGE: EXTENDED PROCESSING REQUIRED
ENT-MRN: MASP A - COMPLTD
;
```

### Related Topics

- [chg-mrn](#)

- [dlt-mrn](#)
- [rtrv-mrn](#)

## ent-na

Use this command to enter a new network appearance in the Network Appearance table.

### Parameters

#### **na (mandatory)**

Network appearance.

##### **Range:**

0 - 4294967295

#### **type (mandatory)**

Type of the network appearance.

##### **Range:**

*ansi*

*itui*

*ituis*

*itun*

*ituns*

*itun24*

*itun16*

#### **gc (optional)**

Group Code of the network appearance.

##### **Range:**

*yy*

### Example

```
ent-na:type=ansi:na=10
```

```
ent-na:type=itun:na=11:gc=fr
```

### Dependencies

The value specified for the `na` parameter cannot already exist in the Network Appearance table.

The Network Appearance table can contain a maximum of 45 entries.

The value specified for the `gc` or `na` parameter cannot already be equipped.

A value of `itun` or `ituns` must be specified for the `type` parameter before the `gc` parameter can be specified.

If the ITUDUPPC feature is turned on, and a value of *itun* or *ituns* is specified for the `type` parameter, then the `gc` parameter must be specified.

If the ITUDUPPC feature is turned off, then the `gc` parameter cannot be specified.

The value specified for the `gc` parameter must already exist in the SID or SPC table.

The Spare Point Code Support feature must be enabled before the `ituis` or `ituns` network type can be specified.

The J7 Support feature must be enabled before the `type=itun16` parameter is specified.

If the J7 support feature is enabled then the `type=(ansi or itun24)` parameter can not be specified.

### Notes

Network Appearance identifies the SS7 network context of the message, for the purposes of logically separating signaling traffic between the SGP and ASP over a common SCTP association. A unique network appearance value can be associated with ANSI, ITUI, 14-bit ITU-N or 24-bit ITU-N networks. When the ITUDUPPC (ITU National Duplicate Point Code) feature is turned on, network appearance can be associated with a specific 14-bit ITU-N group code.

### Output

```
ent-na:type=ansi:na=10
```

```
rlghncxa03w 04-02-20 09:07:58 EST EAGLE 31.3.0
ENT-NA: MASP A - COMPLTD
;
```

### Related Topics

- [dlt-na](#)
- [rtv-na](#)

## ent-npp-as

Use this command to enter a Numbering Plan Processor (NPP) Action Set (AS). An AS is a collection of Conditioning Actions (CAs), Service Actions (SAs), and Formatting Actions (FAs).

### Parameters



#### Note:

CAs and FAs are processed in the order that they are specified in the comma-separated list.

 **Note:**

CAs and FAs are processed in consecutive order.

 **Note:**

SAs are processed in order of high-to-low precedence and must be specified in high-to-low precedence order in the comma-separated list. The SAs cannot be duplicated in the list. If multiple SAs in the list have the same precedence, then those SAs are processed in the order in which they appear in the list.

 **Note:**

SAs are processed in order of high-to-low precedence. The SAs must be specified in high-to-low precedence order in the list, and cannot be duplicated in the comma separated list. If multiple SAs in the list have the same precedence, then those SAs are processed in the order in which they appear in the list.

 **Note:**

The `ac*`, `dn*`, `sn*`, and `cc*` values refer to all CAs that begin with `ac`, `dn`, `sn`, or `cc`, respectively.

 **Note:**

Refer to the *Numbering Plan Processor (NPP) Overview* and to the Feature Manual for the feature of interest for more information on provisioning Action Sets and for definitions for the CA, FA, and SA values.

 **Note:**

The `sa(X)dgts` parameters are currently not supported by any feature.

 **Note:**

The `sa(X)val` parameters are used by the TIF Range CgPN Blacklist, TIF Subscriber CgPN Blacklist, and TIF Selective Screening features. Up to 2 numerical values can be specified in each list.

**Note:**

Support of a numerical values list (`sa (X) val` parameter) is specific to the Service and Service Action.

**asn (mandatory)**

Action set name. The name of the AS.

**Range:**

*ayyyyyyyyy*

1 alphabetic character followed by up to 9 alphanumeric characters

**ca (optional)**

Conditioning Action list. A comma-separated CA list that can be applied to an incoming digit string. Up to 12 CAs can be specified in the list. The CAs are processed in the order in which they are specified in the list.

**Range:**

*ac1, ac2, ac3, ac4, ac5, ac6, ac7, ac8, accgpn, accgpn1, accgpn2, accgpn3, accgpn4, accgpn5, accgpn6, accgpn7, accgpn8, acdef, aclac, cc1, cc2, cc3, ccdef, cccgpn, dn1, dn2, dn3, dn4, dn5, dn6, dn7, dn8, dn9, dn11, dn12, dn13, dn14, dn15, dnx, fpx, ign1, ign2, ign3, ign4, ign5, ign6, ign7, ign8, ign9, ign10, pfxa1, pfxa2, pfxa3, pfxa4, pfxa5, pfxa6, pfxa7, pfxa8, pfxb1, pfxb2, pfxb3, pfxb4, pfxb5, pfxb6, pfxb7, pfxb8, pfxc1, pfxc2, pfxc3, pfxc4, pfxc5, pfxc6, pfxc7, pfxc8, pfxd1, pfxd2, pfxd3, pfxd4, pfxd5, pfxd6, pfxd7, pfxd8, pfxe1, pfxe2, pfxe3, pfxe4, pfxe5, pfxe6, pfxe7, pfxe8, pfxf1, pfxf2, pfxf3, pfxf4, pfxf5, pfxf6, pfxf7, pfxf8, sn1, sn2, sn3, sn4, sn5, sn6, sn7, sn8, sn9, sn10, sn11, sn12, sn13, sn14, sn15, snx, znx*

**fa (optional)**

Formatting Action list. A comma-separated FA list that can be applied to the outgoing digit string. Up to 12 FAs can be specified in the list. The FAs are processed in the order they are specified in the list and cannot be duplicated.

**Range:**

*ac, asd, asdothor, cc, dlma, dlmb, dlmc, dlmd, dlme, dlmf, dlmg, dlmh, dlmi, dlmj, dlmk, dlml, dlmm, dlmn, dlmo, dlmp, dn, fpx, grn, grnothor, orig, pfxa, pfxb, pfxc, pfxd, pfxe, pfxf, rn, rnospodn, rnosposn, rnospozsn, sn, sp, sfrimsi, vmid, zn*

**Default:**

*orig*

**ofnai (optional)**

Outgoing filter nature of address indicator. This parameter specifies the filter nature of address indicator (FNAI) class of the outgoing digit string.

**Range:*****intl***

*intl* value provisioned in the `chg-npp-serv` command

***natl***

*natl* value provisioned in the `chg-npp-serv` command



**nai1**

*nai1* value provisioned in the `chg-npp-serv` command

**nai2**

*nai2* value provisioned in the `chg-npp-serv` command

**nai3**

*nai3* value provisioned in the `chg-npp-serv` command

**unkn**

*unkn* value provisioned in the `chg-npp-serv` command

**inc**

NAI of the incoming digit string

**Default:**

*inc*

**sa (optional)**

Service Action list. A comma-separated SA list that can be applied to an incoming digit string. Up to 8 SAs can be specified in the list. The SAs must be specified in high-to-low precedence order in the list, and cannot be duplicated in the list.

**Note:**

SAs are service-specific.

**Range:**

*asdlkup, blk1stqry, blk1strly, blnfnrls, blrls, cdial, ccncchk, cdpnnp, cgpnasdrqd, cgpngrnrqd, cgpnpn, cgpnrng, cgpnsvcrqd, crp, fpxrls, fraudchk, fwdscs, grnlkup, inprtg, lacck, migrate, nocgpnrls, npnrls, nprelay, nprls, nscgpn, nscdpn, pprelay, rtdbrtn, rtdbtsp, rtdbrtnsp, skgtartg, snsccgpn, selscr, tifgnbl, tiflsbl, tifrdnbl*

**sa1dgts (optional)**

Service Action 1 digit string. This parameter specifies a digit string that can be used with the first SA.

**Range:**

1 - 8 hexadecimal digits. Valid digits are 0-9, a-f, A-F.

**sa1val (optional)**

Service Action 1 numerical values list. A comma-separated numerical values list that can be used with the first SA.

**Range:**

0 - 65534

**sa2dgts (optional)**

Service Action 2 digit string. A digit string that can be used with the second SA.

**Range:**

1 - 8 hexadecimal digits Valid digits are 0-9, a-f, A-F.

**sa2va1 (optional)**

Service Action 2 numerical values list. A comma-separated numerical values list that can be used with the second SA.

**Range:**

0 - 65534

**sa3dgtts (optional)**

Service Action 3 digit string. A digit string that can be used with the third SA.

**Range:**

1-8 hexadecimal digits. Valid digits are 0-9, a-f, A-F.

**sa3va1 (optional)**

Service Action 3 numerical values list. A comma-separated numerical values list that can be used with the third SA.

**Range:**

0 - 65534

**sa4dgtts (optional)**

Service Action 4 digit string. A digit string that can be used with the fourth SA.

**Range:**

1-8 hexadecimal digits. Valid digits are 0-9, a-f, A-F.

**sa4va1 (optional)**

Service Action 4 numerical values list. A comma-separated numerical values list that can be used with the fourth SA.

**Range:**

0 - 65534

**sa5dgtts (optional)**

Service Action 5 digit string. A digit string that can be used with the fifth SA.

**Range:**

1-8 hexadecimal digits. Valid digits are 0-9, a-f, A-F.

**sa5va1 (optional)**

Service Action 5 numerical values list. A comma-separated numerical values list that can be used with the fifth SA.

**Range:**

0 - 65534

**sa6dgtts (optional)**

Service Action 6 digit string. A digit string that can be used with the sixth SA.

**Range:**

1-8 hexadecimal digits. Valid digits are 0-9, a-f, A-F.

**sa6va1 (optional)**

Service Action 6 numerical values list. A comma-separated numerical values list that can be used with the sixth SA.

**Range:**  
0 - 65534

**sa7dgt**s (optional)

Service Action 7 digit string. A digit string that can be used with the seventh SA.

**Range:**  
1-8 hexadecimal digits. Valid digits are 0-9, a-f, A-F.

**sa7val** (optional)

Service Action 7 numerical values list. A comma-separated numerical values list that can be used with the seventh SA.

**Range:**  
0 - 65534

**sa8dgt**s (optional)

Service Action 8 digit string. A digit string that can be used with the eighth SA.

**Range:**  
1-8 hexadecimal digits. Valid digits are 0-9, a-f, A-F.

**sa8val** (optional)

Service action 8 numerical values list. A comma-separated numerical values list that can be used with the eighth SA.

**Range:**  
0 - 65534

**Example**

```
ent-npp-as:asn=asn1:ca=ign1,ign2,ign4,znx:fa=zn
ent-npp-as:asn=asn4:ca=fpx,cc2,ign3,dn4:fa=dn,cc
ent-npp-as:asn=asn5:ca=ac8,sn8,cc3:fa=sn,ac,cc:
sa=rtdbtrn,rtdbtsp,rtdbtrnsp,cdial
ent-npp-as:asn=asn1:ca=znx:fa=asd:sa=asdlkup
ent-npp-
as:asn=asn10:ca=cc2,ac2,snx:sa=migrate,cdpnp:fa=cc,rnosposn
ent-npp-
as:asn=asn9:ca=fpx,cc2,dnx:sa=fraudchk,pprelay:fa=cc,dn
ent-npp-as:asn=set10:ca=znx:sa=blrls,blnfndrls,nscgpn:
sa1val=10,20:sa2val=31,41:fa=zn:ofnai=intl
ent-npp-as:asn=asn7:ca=cc2,ac3,sn5:sa=inprt,skgtartg
ent-npp-as:asn=set32:ca=cc2,accgpn5,snx
ent-npp-
as:asn=tifcd7:ca=znx:sa=selscr,cgpnnp:sa1val=12,none:fa=zn
ent-npp-as:asn=set1:ca=znx:sa=tifgnbl
```

## Dependencies

The value specified for the `asn` parameter cannot already exist in the NPP AS table.

One of the following combinations of Conditioning Actions must be specified for the AS:

- `znx`
- `cc*`, `dn*`
- `cc*`, `ac*`, `sn*`

The Formatting Actions specified for the AS must contain the corresponding Formatting Action that a Conditioning Action will populate or load.

The AS must contain a CA that can load or populate the specified FA.

The CAs within an AS cannot condition more than 32 digits.

The AS cannot contain CAs that load or populate the same FA.

Conditioning Actions must be specified for inclusion in an individual Action Set using valid number conditioning rules:

- If the ZNX Conditioning Action is specified, then the CC\*, AC\*, SN\*, DN\*, and DNX Conditioning Actions cannot be specified.
- If the CC\* AND DN\* or DNX Conditioning Actions are specified, then the AC\*, SN\*, SNX, and ZNX Conditioning Actions cannot be specified.
- If the CC\*, AC\*, AND SN\* or SNX Conditioning Actions are specified, then the DN\*, DNX, and ZNX Conditioning Actions cannot be specified.

The AS cannot contain the following combinations of FAs:

- If the DN FA is specified, then the AC, SN, and ZN FAs cannot be specified.
- If the ZN FA is specified, then the AC, CC, SN, and DN FAs cannot be specified.
- If the SN FA is specified, then the ZN and DN FAs cannot be specified.
- If the RNOSPODN, RNOSPOSN, or RNOSPOZN FA is specified, then the RN, SP, SN, DN, and ZN FAs cannot be specified.
- The RNOSPODN, RNOSPOSN, and RNOSPOZN FAs cannot be specified together in the command.

If specified, the FPFX CA must be the first value (*fpfx*) in the `ca` list.

If specified, the ZNX, SNX, or DNX CA must be the final value (*znx*, *snx*, or *dnx*) in the `ca` list.

A maximum of 1024 (1K) AS entries can be specified in the NPP system.

If no Service Actions are provisioned, then the `sa1val` parameter cannot be specified.

If less than 2 Service Actions are provisioned, then the `sa2val` parameter cannot be specified.

If less than 3 Service Actions are provisioned, then the `sa3val` parameter cannot be specified.

If less than 4 Service Actions are provisioned, then the `sa4val` parameter cannot be specified.

If less than 5 Service Actions are provisioned, then the `sa5val` parameter cannot be specified.

If less than 6 Service Actions are provisioned, then the `sa6val` parameter cannot be specified.

If less than 7 Service Actions are provisioned, then the `sa7val` parameter cannot be specified.

If less than 8 Service Actions are provisioned, then the `sa8val` parameter cannot be specified.

If no Service Actions are provisioned, then the `sa1dgts` parameter cannot be specified.

If less than 2 Service Actions are provisioned, then the `sa2dgts` parameter cannot be specified.

If less than 3 Service Actions are provisioned, then the `sa3dgts` parameter cannot be specified.

If less than 4 Service Actions are provisioned, then the `sa4dgts` parameter cannot be specified.

If less than 5 Service Actions are provisioned, then the `sa5dgts` parameter cannot be specified.

If less than 6 Service Actions are provisioned, then the `sa6dgts` parameter cannot be specified.

If less than 7 Service Actions are provisioned, then the `sa7dgts` parameter cannot be specified.

If less than 8 Service Actions are provisioned, then the `sa8dgts` parameter cannot be specified.

## Notes



### Note:

When a new Action Set is entered using the `ent-npp-as` command, the FANF, FASP, FARN, FANE, FASCRC, and FASCRCG FA lists are unpopulated. These lists are populated using the `chg-npp-as` command.

## Output

```
ent-npp-as:asn=asn6:ca=znx:sa=nscdpn,nscgpn:fa=zn:ofnai=intl
```

```
tekelecstp 09-08-18 11:25:31 EAGLE 41.1.0  
NPP-AS table is (5 of 1024) 1% full.
```

```
ENT-NPP-AS: MASP A - COMPLTD
```

```
;
```

**Related Topics**

- [chg-npp-as](#)
- [dlt-npp-as](#)
- [rtrv-npp-as](#)

## ent-npp-srs

Use this command to enter a Numbering Plan Processor (NPP) Service Rule Set entry. A Service Rule Set (SRS) is a collection of NPP Rules that are associated with a NPP Service. A NPP Rule is an association between a single NPP filter and a single NPP Action Set.

**Parameters****asn (mandatory)**

Action set name. The name of the AS.

**Range:**

ayyyyyyyyy

1 alphabetic character followed by up to 9 alphanumeric characters

**fd1 (mandatory)**

Filter digit length. This parameter specifies the number of digits on the incoming digit string that is filtered by the NPP.

**Range:**

1 - 32, \*

\*—multiple lengths of digit strings can be filtered

**fna1 (mandatory)**

Filter nature of address indicator. The filter Nature of Address Indicator (NAI) class.

**Range:*****intl***

filter messages with NAI=INTL

***natl***

filter messages with NAI=NATL

***nai1***

filter messages with NAI=NAI1

***nai2***

filter messages with NAI=NAI2

***nai3***

filter messages with NAI=NAI3

***unkn***

filter messages when NAI=UNKN

The `chg-npp-serv` command is used to assign values to the various FNAI classes.

**fpfx (mandatory)**

Filter prefix. The prefix used to filter incoming digit strings.

**Range:**

1-16 digits \*, ?

1 - 16 hexadecimal digits inclusive of single digit wildcard (?); or wildcard (\*) matching the entire digit string; valid digits are ?, 0-9, a-f, A-F.

**srvn (mandatory)**

Service name. The name of the NPP service.

**Range:*****nppt***

NPP Test Service

***idprcdpn***

IDPRCDPN Service

***idprcgpn***

IDPRCGPN Service

***tif***

TIF Service

***tif2***

TIF2 Service

***tif3***

TIF3 Service

***mosmsicgpn***

MOSMSICGPN Service

***mosmsicdpn***

MOSMSICDPN Service

***mosmsgcgpn***

MOSMSGCGPN Service

***mosmsgcdpn***

MOSMSGCDPN Service

***iarcdpn***

IARCDPN Service

***iarcgpn***

IARCGPN Service

***idprcdpn2***

IDPRCDPN2 Service

***idprcdpn3***

IDPRCDPN3 Service

***idprcdpn4***  
IDPRCDPN4 Service

***tifcgpn***  
TIFCGPN Service

***tifcgpn2***  
TIFCGPN2 Service

***tifcgpn3***  
TIFCGPN3 Service

**invkserv (optional)**

Invoke service name. The name of the NPP service to be invoked.



**Note:**

As of Release 44.0, only the *tifcgpn*, *tifcgpn2*, *tifcgpn3*, and *none* values are supported.

**Range:**

***nppt***  
NPP Test Service

***idprcdpn***  
IDPRCDPN Service

***idprcgpn***  
IDPRCGPN Service

***tif***  
TIF Service

***tif2***  
TIF2 Service

***tif3***  
TIF3 Service

***mosmsicgpn***  
MOSMSICGPN Service

***mosmsicdpn***  
MOSMSICDPN Service

***mosmsgcgpn***  
MOSMSGCGPN Service

***mosmsgcdpn***  
MOSMSGCDPN Service

***iarcdpn***  
IARCDPN Service



***iarcgpn***  
IARCGPN Service

***idprcdpn2***  
IDPRCDPN2 Service

***idprcdpn3***  
IDPRCDPN3 Service

***idprcdpn4***  
IDPRCDPN4 Service

***tifcgpn***  
TIFCGPN Service

***tifcgpn2***  
TIFCGPN2 Service

***tifcgpn3***  
TIFCGPN3 Service

***none***  
no additional NPP services are invoked

**Default:**  
*none*

### Example

```
ent-npp-srs:svn=nppt:fpfx=a:fdl=10:fnai=intl:asn=asn2
ent-npp-
srs:svn=tif:fnai=INTL:fpfx=9090:fdl=:asn=set1:invkserv=tifcgpn
ent-npp-srs:svn=nppt:asn=testzn1:fnai=nai2:fdl=:fpfx=1?2?3
ent-npp-srs:svn=tif:fpfx=12:fdl=:fnai=intl:asn=set32
```

### Dependencies

The value specified for the `asn` parameter must exist in the NPP AS table.

The AS specified by the `asn` parameter cannot contain Conditioning Actions that are not supported by the service specified by the `svn` parameter.

The AS specified by the `asn` parameter cannot contain Service Actions that are not supported by the service specified by the `svn` parameter.

The AS specified by the `asn` parameter cannot contain Formatting Actions that are not supported by the service specified by the `svn` parameter.

The AS specified by the `asn` parameter cannot contain Service Actions that do not conform to the precedence order supported by the service specified by the `svn` parameter.

The Conditioning Actions in the AS specified by the `asn` parameter cannot condition more digits than allowed by the `fdl` parameter.

If the `fdl=*` parameter is specified, then the AS specified by the `asn` parameter must contain Conditioning Actions that support variable digit string conditioning.

A maximum of 8192 (8K) rules can be specified in the NPP system.

A maximum of 4096 (4K) service rules can be specified in the NPP system.

The NPP Rule cannot already exist within the NPP Rule table.

If a values other than `*` is specified for the `fpfx` and `fdl` parameters, then the value specified for the `fpfx` parameter cannot be greater than the value specified for the `fdl` parameter.

All of the features that are associated with the Service Actions in the AS specified by the `asn` parameter must be turned on before the AS can be used.

The Service Actions in the AS specified by the `asn` parameter cannot violate mutual exclusivity rules defined by the service specified by the `srvn` parameter.

The AS specified by the `asn` parameter cannot contain an OFNAI class with a value of *none*.

At least one TIF feature must be turned on before an AS containing the CDIAL Service Action can be specified as a value for the `asn` parameter.

The TIF SCS Forwarding feature must be turned on before an AS containing the FWDSCS Service Action can be specified.

The TIF Simple Number Substitution feature must be turned on before an AS containing the SNSCGPN Service Action can be specified as a value for the `asn` parameter.

The TIF Number Portability feature must be turned on before an AS containing the CRP, NPNRLS, CGPNNPRQD, NPVELA, or NPRLS Service Action can be specified as a value for the `asn` parameter.

The IDPR ASD feature must be enabled before an AS containing the ASDLKUP or CGPNASDRQD Service Action can be specified as a value for the `asn` parameter with the IDPRCDPN(X) or IDPRCGPN service.

The IDPR GRN feature must be enabled before an AS containing the GRNLKUP or GPNGRNRQD Service Action can be specified as a value for the `asn` parameter with the IDPRCDPN(X) or IDPRCGPN service.

An AS containing the ASDLKUP and CGPNASDRQD and SAs cannot be specified as a value for the `asn` parameter.

An AS containing the GRNLKUP and GPNGRNRQD Service Actions cannot be specified as a value for the `asn` parameter.

The TIF GRN feature must be enabled before an AS containing the GRNLKUP or GPNGRNRQD SAs can be specified as a value for the `asn` parameter with the TIF services.

The TIF ASD feature must be enabled before an AS containing the ASDLKUP or CGPNASDRQD SA can be specified as a value for the `asn` parameter with the TIF services.

If a value of *mosmsgcdpn*, *mosmsgcgpn*, *mosmsicdpn*, or *mosmsicgpn* is specified for the `srvn` parameter, then the MO SMS ASD feature must be enabled before an AS containing the ASDLKUP or CGPNASDRQD Service Action can be specified as a value for the `asn` parameter.

If a value of *mosmsgcdpn*, *mosmsgcgpn*, *mosmsicdpn*, or *mosmsicgpn* is specified for the *srvn* parameter, then the MO SMS GRN feature must be enabled before an AS containing the CGPNRNRQD or GRNLKUP Service Action can be specified as a value for the *asn* parameter.

If the *fpfx=\**  parameter is specified, then an AS containing the FPFX Conditioning Action cannot be specified as value for the *asn* parameter.

The value specified for the *fpfx* parameter cannot have a ? as the final character.

The TIF Number Substitution feature must be enabled before an AS containing the NSCGPN or NSCDPN Service Action can be specified.

The AS specified by the *asn* parameter cannot contain both the NSCGPN and SNSCGPN Service Actions.

If a value of *mosmsgcdpn* or *mosmsgcgpn* is specified for the *srvn* parameter, then the Prepaid SMS Intercept Ph1 feature must be enabled before an AS containing the PPRELAY Service Action can be specified as a value for the *asn* parameter.

If the *srvn=mosmsgcgpn* parameter is specified, then the Portability Check for MO SMS feature must be enabled before an AS containing the FRAUDCHK Service Action can be specified as a value for the *asn* parameter.

If the *srvn=mosmsicdpn* parameter is specified, then the MO SMS IS41-to-GSM Migration feature must be enabled before an AS containing the MIGRATE Service Action can be specified as a value for the *asn* parameter.

If the *srvn=mosmsicdpn* parameter is specified, then the MO-based IS41 SMS NP feature must be enabled before an AS containing the CDPNNP Service Action can be specified as a value for the *asn* parameter.

If the *srvn=mosmsgcdpn* parameter is specified, then the MO-based GSM SMS NP feature must be enabled before an AS containing the CDPNNP Service Action can be specified as a value for the *asn* parameter.

The IDP A-Party Routing feature must be enabled before the AS specified by the *asn* parameter can contain the CGPNRTG Service Action.

The IDP A-Party Blacklist feature must be enabled before the AS specified for the *asn* parameter can contain the BLKLSTQRY or BLKLSTRLY Service Action.

If the AS specified by the *asn* parameter contains the BLKLSTQRY Service Action, then the AS cannot contain any other Service Actions.

The NPP Unlimited SDWC Characters feature must be turned on before a single digit wildcard (?) can be specified as a value for the *fpfx* parameter more than 25 times across all of the rules for an NPP service.

If the *srvn=idprcdpn (X)* parameter is specified, then the Action Set specified by the *asn* parameter cannot contain both the ACCGPN\* and the CCCGPN Conditioning Actions.

If a value of *iarcdpn* or *iargcpn* is specified for the *srvn* parameter, then the IAR ASD feature must be enabled before an AS containing the ASDLKUP or CGPNASDRQD Service Action can be specified as a value for the *asn* parameter.

If a value of *iarcdpn* or *iargcpn* is specified for the *srvn* parameter, then the IAR GRN feature must be enabled before an AS containing the GRNLKUP or CGPNGRNRQD Service Action can be specified as a value for the *asn* parameter.

If a value of *iarcdpn* or *iargcpn* is specified for the *srvn* parameter, then the IAR Base feature must be enabled before an AS containing the CCNCCHK, CDIAL, or CGPNSRVRQD Service Action can be specified as a value for the *asn* parameter.

If a value of *iarcdpn* or *iargcpn* is specified for the *srvn* parameter, then the IAR NP feature must be enabled before an AS containing the CDNNP or CGNNP Service Action can be specified as a value for the *asn* parameter.

If the NPP Service specified by the *srvn* parameter does not support invoking another NPP Service, then only a value of *none* can be specified for the *invkserv* parameter.

If the NPP Service specified by the *srvn* parameter can invoke the TIFCGPN NPP Service, then only a value of *tifcgn* or *none* can be specified for the *invkserv* parameter.

If the NPP Service specified by the *srvn* parameter can invoke the TIFCGPN2 NPP Service, then only a value of *tifcgn2* or *none* can be specified for the *invkserv* parameter.

If the NPP Service specified by the *srvn* parameter can invoke the TIFCGPN3 NPP Service, then only a value of *tifcgn3* or *none* can be specified for the *invkserv* parameter.

If the AS specified by the *asn* parameter contains the ASDOTHER or GRNOTHER Formatting Action, then the *invkserv=none* parameter cannot be specified.

If the AS specified by the *asn* parameter contains the CGPNASDRQD, CGPNGRNQD, CGPNSVCRQD, NSCGPN, or SNSCGPN Service Action, then only a value of *none* can be specified for the *invkserv* parameter.

The TIF Range CgPN Blacklist feature must be enabled before:

- an AS containing the NOCGPNRLS Service Action can be specified as a value for the *asn* parameter and a value of *tif*, *tif2*, or *tif3* can be specified for the *srvn* parameter
- an AS containing the FPFXRLS Service Action can be specified as a value for the *sn* parameter and a value of *tifcgn*, *tifcgn2*, or *tifcgn3* can be specified for the *srvn* parameter.

If the AS specified by the *asn* parameter contains the FPFXRLS Service Action, then no other Service Action can be specified in the AS.

If the AS specified by the *asn* parameter contains the FPFXRLS Service Action, then the AS must also contain a numerical values list with 2 numerical values.

If the AS specified by the *asn* parameter contains the FPFXRLS Service Action, then the 2 numerical values specified by the numerical values list must each be between 0-127.

If the AS specified by the *asn* parameter contains the NOCGPNRLS Service Action, then the AS must also contain a numerical values list with 2 numerical values.

If the AS specified by the *asn* parameter contains the NOCGPNRLS Service Action, then the 2 numerical values specified by the numerical values list must each be between 0-127.

The TIF Subscr CgPN Blacklist feature must be enabled before an AS containing the BLRLS or BLNFNDRLS Service Action can be specified as a value for the *asn* parameter, and a value of *tifcgn*, *tifcgn2*, or *tifcgn3* can be specified as a value for the *srvn* parameter.

If the AS specified by the `asn` parameter contains the BLRLS Service Action, then the AS must also contain a numerical values list with 2 numerical values.

If the AS specified by the `asn` parameter contains the BLRLS Service Action, then the 2 numerical values specified by the numerical values list must each be between 0-127.

If the AS specified by the `asn` parameter contains the BLNFNDRLS Service Action, then the AS must also contain a numerical values list with 2 numerical values.

If the AS specified by the `asn` parameter contains the BLNFNDRLS Service Action, then the 2 numerical values specified by the numerical values list must each be between 0-127.

If the Service specified by the `srvn` parameter does not support a numerical value list for the first Service Action in the AS specified by the `asn` parameter, then the `sa1val` parameter in the AS can only have a value of *none*.

If the Service specified by the `srvn` parameter does not support a numerical value list for the second Service Action in the AS specified by the `asn` parameter, then the `sa2val` parameter in the AS can only have a value of *none*.

If the Service specified by the `srvn` parameter does not support a numerical value list for the third Service Action in the AS specified by the `asn` parameter, then the `sa3val` parameter in the AS can only have a value of *none*.

If the Service specified by the `srvn` parameter does not support a numerical value list for the fourth Service Action in the AS specified by the `asn` parameter, then the `sa4val` parameter in the AS can only have a value of *none*.

If the Service specified by the `srvn` parameter does not support a numerical value list for the fifth Service Action in the AS specified by the `asn` parameter, then the `sa5val` parameter in the AS can only have a value of *none*.

If the Service specified by the `srvn` parameter does not support a numerical value list for the sixth Service Action in the AS specified by the `asn` parameter, then the `sa6val` parameter in the AS can only have a value of *none*.

If the Service specified by the `srvn` parameter does not support a numerical value list for the seventh Service Action in the AS specified by the `asn` parameter, then the `sa7val` parameter in the AS can only have a value of *none*.

If the Service specified by the `srvn` parameter does not support a numerical value list for the eighth Service Action in the AS specified by the `asn` parameter, then the `sa8val` parameter in the AS can only have a value of *none*.

If the Service specified by the `srvn` parameter does not support a digit string for the first Service Action in the AS specified by the `asn` parameter, then the `sa1dgts` parameter in the AS can only have a value of *none*.

If the Service specified by the `srvn` parameter does not support a digit string for the second Service Action in the AS specified by the `asn` parameter, then the `sa2dgts` parameter in the AS can only have a value of *none*.

If the Service specified by the `srvn` parameter does not support a digit string for the third Service Action in the AS specified by the `asn` parameter, then the `sa3dgts` parameter in the AS can only have a value of *none*.

If the Service specified by the `sravn` parameter does not support a digit string for the fourth Service Action in the AS specified by the `asn` parameter, then the `sa4dgt` parameter in the AS can only have a value of `none`.

If the Service specified by the `sravn` parameter does not support a digit string for the fifth Service Action in the AS specified by the `asn` parameter, then the `sa5dgt` parameter in the AS can only have a value of `none`.

If the Service specified by the `sravn` parameter does not support a digit string for the sixth Service Action in the AS specified by the `asn` parameter, then the `sa6dgt` parameter in the AS can only have a value of `none`.

If the Service specified by the `sravn` parameter does not support a digit string for the seventh Service Action in the AS specified by the `asn` parameter, then the `sa7dgt` parameter in the AS can only have a value of `none`.

If the Service specified by the `sravn` parameter does not support a digit string for the eighth Service Action in the AS specified by the `asn` parameter, then the `sa8dgt` parameter in the AS can only have a value of `none`.

If the NPP Unlimited SDWC Characters feature is turned on, then the value specified for the `fpfx` parameter cannot contain more than three single digit wildcards (?).

If the NPP Unlimited SDWC Characters feature is turned on, then the value specified for the `fpfx` parameter can contain single digit wildcards (?) within only the first six digits.

The TIF Selective Screening feature must be enabled before an AS containing the SELSCR, FPFXRLS, BLRLS, or BLNFNDRLS Service Action can be specified as a value for the `asn` parameter, and a value of `tif`, `tif2`, or `tif3` can be specified as a value for the `sravn` parameter.

If the AS specified by the `asn` parameter contains the SELSCR Service Action, then no TIF Number Substitution (NSCGPN or NSCDPN) Service Action can be specified in the AS.

If the AS specified by the `asn` parameter contains the SELSCR Service Action, then the 2 numerical values specified by the numerical values list must be none or between 0-127.

Only one call type can be specified for the SELSCR SA. If the AS specified by the `asn` parameter contains the SELSCR SA, the corresponding SA Digit String specified must be none or between 1-FF.

The CGPNSVCRQD and NPNRLS Service Actions cannot exist within the same Action Set.

SUBCDPN must be configured in TIFOPTS in order to apply TIFRDNBL SA.

ASD related SAs cannot be configured in same srs.

## Notes

None.

The following error messages were deleted in release 41.1 for PR 135911: E4856 and E4958. These two error messages were re-added and slightly modified for PR 194229 that is in releases 42.1 and 44.0 (and later). These two error messages are NOT in release 43.0.

## Output

```
ent-npp-srs:srvn=nppt:fpfx=abc:fdl=16:fnai=intl:asn=asn3
```

```
tekelecstp 09-02-19 13:57:09 EST EAGLE 40.1.0
NPP-SRS table is (1 of 8192) 1% full.
```

```
ENT-NPP-SRS: MASP A - COMPLTD
```

```
;
```

## Related Topics

- [chg-npp-as](#)
- [chg-npp-srs](#)
- [dlt-npp-srs](#)
- [ent-npp-as](#)
- [rtrv-npp-as](#)
- [rtrv-npp-srs](#)

# ent-pct

Use this command to enter Point Code and CIC Translations.

## Parameters

### **epc (mandatory)**

ANSI point code with subfields *network indicator-network cluster-network cluster member (ni-nc-ncm)*.

#### **Synonym:**

*epca*

#### **Range:**

*000-255*

Specify a valid value for each subfield of the point code, and separate the subfields with a dash (-).

When *chg-sid:pctype=ansi* is specified, *ni = 000* is not valid.

When *chg-sid:pctype=ansi* is specified, *nc = 000* is not valid if *ni = 001–005*.

When *chg-sid:pctype=ansi* is specified, *nc = 000* is valid if *ni = 006–255*.

The point code *000-000-000* is not a valid point code.

### **epci (mandatory)**

ITU international destination point code with subfields *zone-area-id*.

#### **Range:**

*0-255*

Specify a valid value for each subfield of the point code, and separate the subfields with a dash (-).

*zone—0–7*

*area—000–255*

*id—0-7*

The point code *0-000-0* is not a valid point code.

**epcn (mandatory)**

ITU national point code in the format of a 5-digit number (*nnnnn*); or 2, 3, or 4 numbers (members) separated by dashes (*m1-m2-m3-m4*) as defined by the `chg-stpopts:npcfmti` flexible point code option. A group code must be specified when the ITUDUPPC feature is turned on (*nnnnn-gc, m1-m2-m3-m4-gc*).

**Range:**

*0-16383, aa-zz*

Specify a valid value for each subfield of the point code, and separate the subfields with a dash (-).

*nnnnn—0-16383*

*gc—aa-zz*

*m1-m2-m3-m4—0-14* for each member; values must sum to 14

**realpc (mandatory)**

ANSI point code with subfields *network indicator-network cluster-network cluster member (ni-nc-ncm)*.

**Synonym:**

*realpca*

**Range:**

*000-255*

Specify a valid value for each subfield of the point code, and separate the subfields with a dash (-).

When `chg-sid:pctype=ansi` is specified, *ni = 000* is not valid.

When `chg-sid:pctype=ansi` is specified, *nc = 000* is not valid if *ni = 001–005*.

When `chg-sid:pctype=ansi` is specified, *nc = 000* is valid if *ni = 006–255*.

The point code *000-000-000* is not a valid point code.

**realpci (mandatory)**

ITU international destination point code with subfields *zone-area-id*.

**Range:**

*0-255*

Specify a valid value for each subfield of the point code, and separate the subfields with a dash (-).

*zone—0–7*

*area—000–255*

*id—0-7*

The point code *0-000-0* is not a valid point code.

**realpcn (mandatory)**

ITU national point code in the format of a 5-digit number (*nnnnn*); or 2, 3, or 4 numbers (members) separated by dashes (*m1-m2-m3-m4*) as defined by the `chg-stpopts:npcfmti` flexible point code option. A group code must be specified when the ITUDUPPC feature is turned on (*nnnnn-gc, m1-m2-m3-m4-gc*).

**Range:**

*0-16383, aa-zz*



Specify a valid value for each subfield of the point code, and separate the subfields with a dash (-).

*nnnnn—0-16383*

*gc—aa-zz*

*m1-m2-m3-m4—0-14* for each member; values must sum to 14

**ecice (optional)**

The end of the Emulated Circuit Identification Code range.

**Range:**

**0-4095**

ITU TUP/ISUP

**0-16383**

ANSI ISUP

**0-4294967295**

ANSI Q.BICC

\*

**Default:**

\*

**ecics (optional)**

The start of the Emulated Circuit Identification Code range.

**Range:**

**0-4095**

ITU TUP/ISUP

**0-16383**

ANSI ISUP

**0-4294967295**

ANSI Q.BICC

\*

**Default:**

\*

**filtpc (optional)**

ANSI point code with subfields *network indicator-network cluster-network cluster member (ni-nc-ncm)*.

**Synonym:**

*filtpca*

**Range:**

*0-255, \**

Specify a valid value for each subfield of the point code, and separate the subfields with a dash (-).

The asterisk (\*) value is not valid for the *ni* subfield.

When `chg-sid:pctype=ansi` is specified, `ni = 000` is not valid.  
 When `chg-sid:pctype=ansi` is specified, `nc = 000` is not valid if `ni = 001-005`.  
 When `chg-sid:pctype=ansi` is specified, `nc = 000` is valid if `ni = 006-255`.  
 When `chg-sid:pctype=ansi` is specified, `ni-*.*` is valid if `ni = 006-255`.  
 The point code `000-000-000` is not a valid point code.

**filtpci (optional)**

ITU international destination point code with subfields `zone-area-id`.

**Range:**

`0-255, *`

Specify a valid value for each subfield of the point code, and separate the subfields with a dash (-).

`zone—0-7`

`area—000-255`

`id—0-7`

The point code `0-000-0` is not a valid point code.

**filtpcn (optional)**

ITU national point code in the format of a 5-digit number (`nnnnn`); or 2, 3, or 4 numbers (members) separated by dashes (`m1-m2-m3-m4`) as defined by the `chg-stpopts:npcfmti` flexible point code option. A group code must be specified when the ITUDUPPC feature is turned on (`nnnnn-gc`, `m1-m2-m3-m4-gc`).

**Range:**

`0-16383, aa-zz`

Specify a valid value for each subfield of the point code, and separate the subfields with a dash (-).

`nnnnn—0-16383`

`gc—aa-zz`

`m1-m2-m3-m4—0-14` for each member; values must sum to 14

**rcice (optional)**

The end of the Real Circuit Identification Code range.

**Range:**

**`0-4095`**

ITU TUP/ISUP

**`0-16383`**

ANSI ISUP

**`0-4294967295`**

ANSI Q.BICC

\*

**Default:**

\*

**rcics (optional)**

The start of the Real Circuit Identification Code range.

**Range:**

**0-4095**  
ITU TUP/ISUP

**0-16383**  
ANSI ISUP

**0-4294967295**  
ANSI Q.BICC

\*

**Default:**

\*

**relcause (optional)**

Release Cause

**Range:**

0 - 127

**Default:**

0

**si (optional)**

Service Indicator

**Range:**

**0**  
NM

**3**  
SCCP

**5**  
ISUP

**4**  
TUP

**13**  
ANSI Q. BICC

\*

**Default:**

\*

**ssn (optional)**

SCCP Subsystem number

**Range:**

0 - 255

**Default:**

\*

**Example**

```
ent-pct:epc=1-1-1:realpc=2-2-2:si=5:ecics=100:ecice=200
```

```
ent-pct:epc=1-1-2:realpc=2-2-3:si=3:ssn=10:filtpc=5-5-5
```

**Dependencies**

If the `ecice` or `rcice` parameter is specified, then the `ecics` or `rcics` parameter must be specified, respectively.

The value specified for the `ecice/rcice` parameter must be equal to or greater than the value specified for the `ecics/rcics` parameter, respectively.

Full point codes must be specified as the values for the `realpc/realpca/realpci/realpcn` and `epc/epca/epci/epcn` parameters.

The PCT table is corrupt or cannot be found.

The PCT table cannot contain more entries than the amount specified by the FAK for the PCT quantity feature.

The `si=3` parameter must be specified before the `ssn` parameter can be specified.

The values specified for the `realpc/realpca/realpci/realpcn` and `filtpc/filtpca/filtpci/filtpcn` parameters must already exist in the Route table.

The Route table is corrupt or cannot be found.

The values specified for the `epc/epca/epci/epcn`, `filtpc/filtpca/filtpci/filtpcn`, and `realpc/realpca/realpci/realpcn` parameters must have the same domain.

A PCT quantity feature must be enabled before this command can be specified.

If the `ssn` or `ecics` parameter is specified, then the `si` parameter must be specified.

Duplicate values for the following Key combinations are not allowed:

- `epc/epca/epci/epcn + filtpc/filtpca/filtpci/filtpcn + si + ssn/(ecics/ecice)`
- `realpc/realpca/realpci/realpcn + filtpc/filtpca/filtpci/filtpcn + si + ssn/(rcics/rcice)`

The values specified for the `realpc/realpca/realpci/realpcn` and `filtpc/filtpca/filtpci/filtpcn` parameters must have at least one route for each value defined in the Route table.

If the ITUDUPPC feature is turned on, and ITU-N Point codes are specified, then the values specified for the `epcn`, `realpcn`, and `filtpcn` parameters must have the same group code.

A total of 250 unique `epc` and `rpc` values are supported in the PCT table.

A total of 100 PCT Translations with a single `epc` and `realpc` value are supported in the PCT table.

A spare point code cannot be specified as a value for the `epci/epcn`, `filtpci/filtpcn`, and `realpci/realpcn` parameters.

The `ecics` parameter must be specified before the `relcause` parameter can be specified.

A value of 4, 5, or 13 must be specified for the `si` parameter before the `ecice/ecics` and `rcice/rcics` parameters can be specified.

If the `rcics` parameter is specified, then the `ecics` parameter must be specified.

If the `ecics`, `ecice`, and `rcics` parameters are specified, then the `rcice` parameter must be specified.

The values specified for the `epc/epca/epci/epcn`, `filtpc/filtpca/filtpci/filtpcn`, and `realpc/realpca/realpci/realpcn` parameters cannot be the same as the STP point code.

The values specified for the `epc/epca/epci/epcn`, `filtpc/filtpca/filtpci/filtpcn`, and `realpc/realpca/realpci/realpcn` parameters cannot be the same as the STP capability point code.

The value specified for the `ecics/ecice` and `rcics/rcice` parameters must be within the range specified by the parameter definition.

The difference between the values specified for the `ecice` and `ecics` parameters must be equal to the difference between the values specified for the `rcice` and `rcics` parameters.

A value of 5 or 13 must be specified for the `si` parameter before the `relcause` parameters can be specified.

The `ssn` and `cic` parameters cannot be specified together in the command.

If the `ecics`, `rcics`, and `rcice` parameters are specified, then the `ecice` parameter must be specified.

If the same value is specified for the `epc` and `realpc` parameters, then the values specified for the `ecics/ecice` and `rcics/rcice` parameters cannot indicate the same range.

Only one of the `filtpc/filtpca/filtpci/filtpcn` parameters can be specified in the command.

The value specified for the `epc/epci/epcn` parameter cannot be the same as a secondary point code.

## Output

```
ent-
pct:epc=1-1-1:realpc=5-5-5:si=13:ecics=10:ecice=20:relcause=15
```

```
tekelecstp 10-08-10 18:29:41 EST EAGLE 43.0.0
ent-pct:epc=1-1-1:realpc=5-5-5:si=13:ecice=10:ecics=20:relcause=15
Command entered at terminal #4.
ENT-PCT: MASP A - COMPLTD
```

```
;
```

**Related Topics**

- [dlt-pct](#)
- [rtrv-pct](#)

## ent-rmt-appl

Use this command to assign user parts to an internal point code that, in turn, assigns user parts to an End Office node.

**Parameters****Note:**

See [Point Code Formats and Conversion](#) for a detailed description of point code formats, rules for specification, and examples.

**ipc (mandatory)**

ANSI point code with subfields network indicator-network cluster-network cluster member (*ni-nc-ncm*). The *prefix* subfield indicates a private point code (*prefix-ni-nc-ncm*).

**Synonym:**

*ipca*

**Range:**

*p-*, 000-255

Specify a valid value for each subfield of the point code, and separate the subfields with a dash (-).

*prefix—p-*

When *chg-sid:pctype=ansi* is specified, *ni = 000* is not valid.

When *chg-sid:pctype=ansi* is specified, *nc = 000* is not valid if *ni = 001-005*.

When *chg-sid:pctype=ansi* is specified, *nc = 000* is valid if *ni = 006-255*.

The point code 000-000-000 is not a valid point code.

**ipc/ipca/ipci/ipcn/ipcn24/ipcn16 (mandatory)**

End Node's internal point code.

**ipci (mandatory)**

ITU international destination point code with subfields *zone-area-id*. The *prefix* subfield indicates a spare point code, private point code, or private and spare point code (*prefix-zone-area-id*).

**Range:**

*s-*, *p-*, *ps-*, 0-255

Specify a valid value for each subfield of the point code, and separate the subfields with a dash (-).

*prefix—s-, p-, ps*

*zone—0-7*

*area—000-255*

*id—0-7*

The point code 0-000-0 is not a valid point code.

**ipcn (mandatory)**

ITU national point code with subfield ITU number (*nnnnn*). The *prefix* subfield indicates a spare point code, private point code, or private and spare point code (*prefix-nnnnn*, *prefix-nnnnn-gc*, *prefix-m1-m2-m3-m4*, *prefix-m1-m2-m3-m4-gc*).

**Range:**

*s*-, *p*-, *ps*-, 0-16383, *aa-zz*

Specify a valid value for each subfield of the point code, and separate the subfields with a dash (-).

*prefix*—*s*-, *p*-, *ps*

*nnnnn*—0-16383

*gc*—*aa-zz*

*m1-m2-m3-m4*—0-14 for each member; values must sum to 14

**ipcn24 (mandatory)**

24-bit ITU national point code with subfields *main signaling area-sub signaling area-signaling point* (*msa-ssa-sp*). The *prefix* indicates a private point code (*prefix-msa-ssa-sp*).

**Range:**

*p*-, 000-255

Specify a valid value for each subfield of the point code, and separate the subfields with a dash (-).

*prefix*—*p*

*msa*—000–255

*ssa*—000–255

*sp*—000–255

**ipcn16 (mandatory)**

16-bit ITU national point code with subfields *unit number-sub number area-main number area* (*un-sna-mna*). The *prefix* indicates a private point code (*prefix-un-sna-mna*).

**Range:**

*p*--, 000---127

Specify a valid value for each subfield of the point code, and separate the subfields with a dash (-).

*prefix*---*p*

*un*---000---127

*sna*---000---15

*mna*---000---31

**si (mandatory)**

Service indicator value that designates which user part is assigned to the IPC.

**Range:**

3 - 15

**ssn (optional)**

SCCP subsystem number. Valid only if `si=3`. Use `ssn` as the starting value of the range if `ssne` is specified.

**Range:**

0 - 255

**ssne (optional)**

The end of the range of subsystem numbers.

**Range:**

1 - 255

**Example**

```
ent-rmt-appl:ipc=0-0-1:si=3:ssn=5
ent-rmt-appl:ipc=0-0-1:si=3:ssn=5:ssne=100
ent-rmt-appl:ipc=0-0-1:si=5
ent-rmt-appl:ipcn24=1-100-1:si=5
ent-rmt-appl:ipc=p-1-1-1:si=3:ssn=5:ssne=102
ent-rmt-appl:ipci=ps-2-2-2:si=5
ent-rmt-appl:ipcn16=1-2-1:si=5
```

**Dependencies**

Partial point codes are not allowed.

The `ssn` parameter is required if `si=3`.

The `ssn` and `ssne` parameters are not allowed unless `si=3`.

The `ssne` parameter value must be greater than the `ssn` parameter value.

The specified IPC must be previously defined in the destination table.

The new entry cannot conflict with an existing entry.

**Notes**

To specify a range of subsystem numbers, specify the `ssn` parameter value as the start of the range and the `ssne` parameter value as the end of the range.

In this command, only ITU-international and ITU national point codes support the spare point code subtype prefix (s-) and the private and spare point code subtype prefix (ps-). All of the point code types support the private (internal) point code subtype prefix (p-).

**Output**

```
ent-rmt-appl:ipc=0-0-1:si=3:ssn=5
```

```
rlghncxa03w 04-01-07 11:11:28 EST EAGLE 31.3.0
ENT-RMT-APPL: MASP A - COMPLTD
```

;



**Related Topics**

- [dlt-rmt-appl](#)
- [rtrv-rmt-appl](#)

## ent-rte

Use this command to add a route to the system.

**▲ Caution:**

When using the Network Routing feature, limited network management is provided for point codes not covered by full point code routing, Cluster Routing, or Nested Cluster Routing.

**Parameters****✎ Note:**

See [Point Code Formats and Conversion](#) for a detailed description of point code formats, rules for specification, and examples.

**lsn (mandatory)**

The linkset name associated with this route.

**Range:**

ayyyyyyyyy

1 alphabetic character followed by 9 alphanumeric characters

**rc (mandatory)**

The relative cost of the route

**Range:**

0 - 99

**dpc (optional)**

ANSI destination point code with subfields *network indicator-network cluster-network cluster member (ni-nc-ncm)*. The *prefix* subfield indicates a private point code (*prefix-ni-nc-ncm*).

**Synonym:**

*dpca*

**Range:**

*p-*, 000-255, \*

Specify a valid value for each subfield of the point code, and separate the subfields with a dash (-).

*prefix—p-*

The asterisk value (\*) is not valid for the *ni* subfield.

When `chg-sid:pctype=ansi` is specified, `ni = 000` is not valid.

When `chg-sid:pctype=ansi` is specified, `nc = 000` is not valid if `ni = 001–005`.

When `chg-sid:pctype=ansi` is specified, `nc = 000` is valid if `ni = 006–255`.

The point code `000-000-000` is not a valid point code.

#### **dpc/dpca/dpci/dpcn/dpcn24/dpcn16 (optional)**

Destination point code.

#### **dpci (optional)**

ITU international point code with subfields *zone-area-id*. The *prefix* subfield indicates a spare point code, private point code, or private and spare point code (*prefix-zone-area-id*).

##### **Range:**

*s-, p-, ps-, 0-255*

Specify a valid value for each subfield of the point code, and separate the subfields with a dash (-).

*prefix—s-, p-, ps*

*zone—0-7*

*area—000-255*

*id—0-7*

The point code `0-000-0` is not a valid point code.

#### **dpcn (optional)**

ITU national point code in the format of a 5-digit number (*nnnnn*); or 2, 3, or 4 numbers (members) separated by dashes (*m1-m2-m3-m4*) as defined by the `chg-stpopts:npcfmti` flexible point code option. A group code must be specified when the ITUDUPPC feature is turned on (*nnnnn-gc, m1-m2-m3-m4-gc*).

The *prefix* subfield indicates a spare point code, private point code, or private and spare point code (*prefix-nnnnn, prefix-nnnnn-gc, prefix-m1-m2-m3-m4, prefix-m1-m2-m3-m4-gc*).

##### **Range:**

*s-, p-, ps-, 0-16383, aa-zz*

Specify a valid value for each subfield of the point code, and separate the subfields with a dash (-).

*prefix—s-, p-, ps*

*nnnnn—0-16383*

*gc—aa-zz*

*m1-m2-m3-m4—0-14* for each member; values must sum to 14

#### **dpcn24 (optional)**

24-bit ITU national point code with subfields *main signaling area-sub signaling area-signaling point* (*msa-ssa-sp*). The *prefix* indicates a private point code (*prefix-msa-ssa-sp*).

##### **Range:**

*p-, 000-255*

Specify a valid value for each subfield of the point code, and separate the subfields with a dash (-).

*prefix—p*

*msa—000–255*

*ssa—000–255*

*sp—000–255*

#### **dpcn16 (optional)**

16-bit ITU national point code with subfields *unit number sub number area main number area* (*un-sna-mna*). The *prefix* indicates a private point code (*prefix-un-sna-mna*).

**Range:***p--*, *000---127*

Specify a valid value for each subfield of the point code, and separate the subfields with a dash (-).

*prefix---p**un---000---127**sna---000---15**mna---000---31***force (optional)**

This parameter allows a route to be added to the database even if the linkset to be assigned to the route does not have any signaling links in it.

**Range:***yes***Example**

Adds route for DPC 1 to linkset WE123642:

```
ent-rte:dpc=1-1-1:lsn=we123642:rc=25
```

Adds route for DPC 21-\*\*-\* to linkset WE123642:

```
ent-rte:dpc=21-**-*:lsn=we123642:rc=25
```

Adds route for DPCN24 10-100-14 to linkset WE123624:

```
ent-rte:dpcn24=10-100-14:lsn=we123624:rc=10
```

Adds route for private DPC p-1-1-1 to linkset WE123642:

```
ent-rte:dpc=p-1-1-1:lsn=we123642:rc=25
```

Adds route for private and spare DPCN ps-4082-ge to linkset E1NITUN:

```
ent-rte:dpc=ps-4082-ge:lsn=e1ntitun:rc=10
```

Adds route for private DPCN24 p-10-100-14 to linkset WE123642:

```
ent-rte:dpcn24=p-10-100-1:lsn=we123642:rc=10
```

Adds route for private and spare DPCI s-1-100-1 to linkset UE123642:

```
ent-rte:dpci=s-1-100-1:lsn=ue123642:rc=10
```

Adds route for DPCN16 121-10-15 to linkset WE123642:

```
ent-rte:dpcn16=121-10-15:lsn=we123642:rc=10
```

**Dependencies**

The value of the `lsn` parameter must exist in the STP database.

The DPC must be in the Destination Point Code table.

The destination point code of a route must be a full point code (*ni-nc-ncm*), a cluster point code (*ni-nc-\**), or a network point code (*ni-\*.\**).

If the specified destination address is a full point code address (*ni-nc-ncm*) and is a member of a provisioned cluster (*ni-nc-\**), whether ordered routes can be assigned is determined by the destination address's NCAI (nested cluster allowed indicator). The `ncai=yes/no` parameter is set with the `ncai` parameter of the `ent/chg-dstn` commands.

- If the `ncai=no` parameter is specified, destinations comprising a cluster inherit their ordered routes from the cluster.
- If the `ncai=yes` parameter is specified, then the destination address is a member of a provisioned nested cluster where ordered routes can be assigned to a provisioned member.

If the specified destination address is a network cluster address (*ni-nc-\**), the assignment of the specified ordered route attributes is determined by the setting of the destination address's NCAI (nested cluster allowed indicator). The `ncai=yes/no` parameter is set with the `ncai` parameter of the `ent/chg-dstn` commands.

- If the `ncai=no` parameter is specified, the collection of signaling point codes having the same network identifier (the `ni` parameter) and network cluster (the `nc` parameter) code are assigned the specified ordered route.
- If the `ncai=yes` parameter is specified, then the specified destination is a network cluster address where provisioned members's signaling point codes can be assigned the same or different ordered routes from the cluster.

If the `dpcn` parameter is specified, the format of the point code(s) must match the format that was assigned with `chg-stpopts:npcfmti`.

The `dpc/dpca/dpci/dpcn/dpcn24/dpcn16` parameter cannot be specified with a private point code (-p) unless the route is an IPGW route.

The route destination's type must match the route's linkset adjacent point code or the route's linkset secondary adjacent point code type.

If the `ipgwapc=yes` parameter is specified for the linkset, then the associated `dpc/dpca/dpci/dpcn/dpcn24/dpcn16` parameter cannot have a cluster route assigned.

The linkset must be defined with at least one link. To override this requirement, specify `force=yes`.

The 6-Way Loadsharing on Routesets feature must be turned on before more than 2 routes can be provisioned with the same relative cost.

A linkset can be entered only once as a route for each destination or for a routeset.

If the specified destination address is a network address (*ni-\*.\**), or network cluster address (*ni-nc-\**), the linkset type (see the `chg-ls` command) used in the route must be *b*, *c*, or *d*.

All routes with ANSI DPCs must use ANSI linkset APCs. A route with an ITU-I DPC can go over an ITU-N APC and an ITU-N DPC can go over an ITU-I APC.

If the link set name (the `lsn` parameter) references a link set that has the `ipgwapc=yes` parameter specified, the DPC must not be a cluster route.

The NRT feature must be turned on before the `dpc/dpca` parameter can be specified using the asterisk (\*) in the `nc` or `ncm` subfields.

When using network routing, if the DPC has a value of \* in the *nc* field, the *ncm* field must also be \* (for example, `dpc=21-*-*`).

The Route table is corrupt or cannot be found.

The STP Site ID table is corrupt or cannot be found.

The Linkset table is corrupt or cannot be found.

The value of the `dpc/dpca/dpci/dpcn/dpcn24/dpcn16` parameter cannot be the same as the EAGLE point code.

The value of the `dpc/dpca/dpci/dpcn/dpcn24/dpcn16` parameter cannot be the same as the EAGLE capability point code.

The value of the `dpc/dpca/dpci/dpcn/dpcn24/dpcn16` parameter cannot have already been assigned to an APC or SAPC for an IPGWx linkset. The entered route must include the APC or SAPC's linkset with the destination equal to the APC or SAPC.

If `dpcn` is specified then the format of `dpcn` must match the format dictated by the `chg-stpopts:npcfmti` command

The ITU-N ordered route destination's group code must match the route's Link Set Adjacent PC's group code for all linksets other than IPGWI and IPLHC.

The group code must match for all linksets because the ITU Duplicate Point Code feature is on.

All linksets in a routeset must have the same network type. The network type of the routeset must be the same as the network type of the destination point code.

If multiple routes are defined for the destination point code, and if a proxy point code is assigned to the destination point code, then the first route defined in the `ent-rte` command must use the proxy linkset.

If the `dpc` parameter has a network cluster address (*ni-nc-\**) or network address (*ni-\*-\**), then the `lst=prx` parameter cannot be specified.

The SAPC table is corrupt or cannot be found.

## Notes

In this command, only ITU-international and ITU national point codes support the spare point code subtype prefix (s-) and the private and spare point code subtype prefix (ps-). All of the point code types support the private (internal) point code subtype prefix (p-).

## Output

```
ent-rte:dpc=1-1-1:lsn=we123642:rc=25
```

```
rlghncxa03w 04-01-07 11:11:28 EST EAGLE 31.3.0
ENT-RTE: MASP A - COMPLTD
```

```
;
```

## Related Topics

- [chg-dstn](#)
- [chg-rte](#)
- [dlt-dstn](#)
- [dlt-rte](#)
- [ent-dstn](#)
- [rept-stat-dstn](#)
- [rept-stat-rte](#)
- [rtrv-dstn](#)
- [rtrv-rte](#)

## ent-rtx

Use this command to enter an exception route entry. An exception route is associated with an entry in the Routing table. When the Origin-Based MTP Routing feature is enabled and turned on, the least cost route available for an MSU to be routed to a Destination Point Code over a specified linkset is used.

Up to 6 routes can be defined to a single entry in the Routing table. Up to 8000 routesets can be defined for an STP. This total must include at least one normal route (not an exception route). The remaining 7999 routesets can include any combination of normal and exception routes.

### Note:

A routeset is a collection of routes to a destination. Each routeset can have up to 6 routes, with 16 links on each route. An exception routeset is a collection of up to 6 exception routes that have the same DPC, exception class, and criteria.

## Parameters

### **dpc (mandatory)**

ANSI destination point code with subfields *network indicator-network cluster-network cluster member (ni-nc-ncm)*. The *prefix* subfield indicates a private point code (*prefix-ni-nc-ncm*).

### **Synonym:**

*dpca*

### **Range:**

*p-*, 000-255

Specify a valid value for each subfield of the point code, and separate the subfields with a dash (-).

*prefix—p-*

When `chg-sid:pctype=ansi` is specified, *ni = 000* is not valid.

When `chg-sid:pctype=ansi` is specified, *nc = 000* is not valid if *ni = 001-005*.

When `chg-sid:pctype=ansi` is specified, *nc = 000* is valid if *ni = 006-255*.

The point code *000-000-000* is not a valid point code.

**dpc/dpca/dpci/dpcn/dpcn24/dpcn16 (mandatory)**

Destination point code.

**dpci (mandatory)**

ITU international point code with subfields *zone-area-id*. The *prefix* subfield indicates a spare point code, private point code, or private and spare point code (*prefix-zone-area-id*).

**Range:**

*s-, p-, ps-, 0-255*

Specify a valid value for each subfield of the point code, and separate the subfields with a dash (-).

*prefix—s-, p-, ps*

*zone—0-7*

*area—000-255*

*id—0-7*

The point code *0-000-0* is not a valid point code.

**dpcn (mandatory)**

ITU national point code in the format of a 5-digit number (*nnnnn*); or 2, 3, or 4 numbers (members) separated by dashes (*m1-m2-m3-m4*) as defined by the `chg-stpopts:npcfmiti` flexible point code option. A group code must be specified when the ITUDUPPDC feature is turned on (*nnnnn-gc*, *m1-m2-m3-m4-gc*). The *prefix* subfield indicates a spare point code, private point code, or private and spare point code (*prefix-nnnnn*, *prefix-nnnnn-gc*, *prefix-m1-m2-m3-m4*, *prefix-m1-m2-m3-m4-gc*).

**Range:**

*s-, p-, ps-, 0-16383, aa-zz*

Specify a valid value for each subfield of the point code, and separate the subfields with a dash (-).

*prefix—s-, p-, ps*

*nnnnn—0-16383*

*gc—aa-zz*

*m1-m2-m3-m4—0-14* for each member; values must sum to 14

**dpcn24 (mandatory)**

24-bit ITU national point code with subfields *main signaling area-sub signaling area-signaling point* (*msa-ssa-sp*). The *prefix* subfield indicates a private point code (*prefix-msa-ssa-sp*).

**Range:**

*p-, 000-255*

Specify a valid value for each subfield of the point code, and separate the subfields with a dash (-).

*prefix—p*

*msa—000-255*

*ssa—000-255*

*sp—000-255*

**dpcn16 (mandatory)**

16-bit ITU national point code with subfields *unit number sub number area main number area* (*un-sna-mna*). The *prefix* subfield indicates a private point code (*prefix-un-sna-mna*).

**Range:***p--, 000--127*

Specify a valid value for each subfield of the point code, and separate the subfields with a dash (-).

*prefix--p**un---000---127**sna---000---15**mna---000---31***lsn (mandatory)**

Linkset Name. The name of the linkset that is associated with the specified exception route.

**Range:***ayyyyyyyy*

1 alphabetic character followed by up to 9 alphanumeric characters

**rc (mandatory)**

Relative Cost. The relative cost associated with the specified exception route.

**Range:***0 - 99***cic (optional)**

Starting Circuit Identification Code. This parameter is used alone or together with the `ecic` parameter as exception routing criteria for the specified exception route.

**Range:***0 - 16383***ecic (optional)**

Ending Circuit Identification Code. This parameter, together with the `cic` parameter, defines the CIC range that is used as exception routing criteria for the specified exception route.

**Range:***0 - 16383***force (optional)**

The `force=yes` parameter must be specified when the `ilsn` parameter value is the same as the `lsn` parameter value.

**Range:***yes***ilsn (optional)**

Incoming Link Set Name. The name of the originating linkset. This value is used as part of the exception routing criteria for the specified exception route.

**Range:***ayyyyyyyy*

1 alphabetic character followed by up to 9 alphanumeric characters



**opc (optional)**

ANSI origination point code with subfields *network indicator-network cluster-network cluster member (ni-nc-ncm)*. The *prefix* subfield indicates a private point code (*prefix-ni-nc-ncm*).

**Synonym:**

*opca*

**Range:**

*p-*, 000-255

Specify a valid value for each subfield of the point code, and separate the subfields with a dash (-).

*prefix—p-*

When *chg-sid:pctype=ansi* is specified, *ni = 000* is not valid.

When *chg-sid:pctype=ansi* is specified, *nc = 000* is not valid if *ni = 001-005*.

When *chg-sid:pctype=ansi* is specified, *nc = 000* is valid if *ni = 006-255*.

The point code *000-000-000* is not a valid point code.

**opc/opca/opci/opcn/opcn24/opcn16 (optional)**

Originating Point Code

**opci (optional)**

ITU international point code with subfields *zone-area-id*. The *prefix* subfield indicates a spare point code, private point code, or private and spare point code (*prefix-zone-area-id*).

**Range:****opcn (optional)**

ITU national point code in the format of a 5-digit number (*nnnnn*); or 2, 3, or 4 numbers (members) separated by dashes (*m1-m2-m3-m4*) as defined by the *chg-stpopts:npcfmit* flexible point code option. A group code must be specified when the ITUDUPPDC feature is turned on (*nnnnn-gc*, *m1-m2-m3-m4-gc*). The *prefix* subfield indicates a spare point code, private point code, or private and spare point code (*prefix-nnnnn*, *prefix-nnnnn-gc*, *prefix-m1-m2-m3-m4*, *prefix-m1-m2-m3-m4-gc*).

**Range:**

*s-*, *p-*, *ps-*, 0-16383, *aa-zz*

Specify a valid value for each subfield of the point code, and separate the subfields with a dash (-).

*prefix—s-*, *p-*, *ps*

*nnnnn—0-16383*

*gc—aa-zz*

*m1-m2-m3-m4—0-14* for each member; values must sum to 14

**opcn24 (optional)**

24-bit ITU national point code with subfields *main signaling area-sub signaling area-signaling point (msa-ssa-sp)*. The *prefix* subfield indicates a private point code (*prefix-msa-ssa-sp*).

**Range:**

*p-*, 000-255

Specify a valid value for each subfield of the point code, and separate the subfields with a dash (-).

```

prefix—p
msa—000–255
ssa—000–255
sp—000–255

```

**opc16 (optional)**

16-bit ITU national point code with subfields *unit number sub number area main number area* (*un-sna-mna*). The *prefix* subfield indicates a private point code (*prefix-un-sna-mna*).

**Range:**

```
p--, 000--127
```

Specify a valid value for each subfield of the point code, and separate the subfields with a dash (--).

```
prefix---p
```

```
un--000---127
```

```
sna--000--15
```

```
mna--000--31
```

**si (optional)**

Service Indicator. This parameter is used as part of the exception routing criteria for the specified exception route.

**Range:**

```
3 - 15
```

**Example**

```
ent-rtx:dpca=1-1-1:opca=2-3-3:lsn=1set1:rc=30
```

```
ent-rtx:dpca=1-3-1:ilsn=1set2:lsn=1set3:rc=20
```

```
ent-rtx:dpca=2-100-1:si=5:lsn=1set5:rc=50
```

**Dependencies**

Only one of the *opc*, *ilsn*, *cic*, or *si* parameters can be specified for a exception route entry.

For an ANSI origination point code that is defined using asterisks (*nnn-\*-\**), the value of the *network identifier* subfield (*nnn*) must be greater than 5.

If the *ecic* parameter is specified, the *cic* parameter must also be specified.

The *ecic* parameter value cannot be less than the *cic* parameter value.

The *opc/opca/opci/opcn/opcn24/opcn16* parameter value cannot be the same as the *dpc* parameter value.

The Origin-Based MTP Routing feature must be enabled and turned on before this command can be entered.

The point code specified by the *dpc/dpca/dpci/dpcn/dpcn24/dpcn16* parameter must already exist in the Route table.

The value specified for the `dpc` parameter cannot already be used as an adjacent point code (APC).

The linkset name, as defined by the `ilsn` or `lsn` parameter, must exist.

An exception route entry cannot already exist with the same input parameter values, other than the relative cost.

The 6-Way Loadsharing on Routesets feature must be turned on before more than 2 routes can be provisioned with the same relative cost for a given exception route criteria.

A maximum of 6 exception routes can be associated with the specified DPC and criteria.

A maximum total of 8000 exception routes and normal routes can be defined for the EAGLE. At least one route must be a normal (not exception) route. The remaining routes (up to 7999) can be all normal routes, all exception routes, or any combination of normal and exception routes.

The network domain of the adjacent point code in the linkset or of the routes in the specified routeset must be the same as the network domain of the specified destination point code or its alias.

The adjacent or secondary point code type and group code of the linkset or linksets in the specified routeset must match the point code type and group code of the destination point code.

The specified CIC/ECIC range must not overlap an existing range.

The Linkset table is corrupt or cannot be found.

The Route table is corrupt or cannot be found.

The Route Exception table is corrupt or cannot be found.

If the `ilsn` and `lsn` parameters have the same value, or if the value specified for the `opc/opca/opci/opcn/opcn24/opcn16` parameter is the same as the APC of the linkset specified by the `lsn` parameter, then the `force=yes` parameter must be specified.

The `opcn` parameter must be in the same ITU-N group as the `dpcn` parameter.

The Group Code of the APCN in the `ilsn` parameter must be the same as the Group Code of the `dpcn` parameter.

ANSI network routing and cluster point codes as OPC exception route criteria are not allowed for ITU destinations.

ITU point codes as OPC exception route criteria are not allowed for ANSI Network and Cluster destination.

If the `lsn` parameter is specified, then the `rc` parameter must be specified.

If a proxy destination is used, then this command cannot be entered.

The value specified for the destination point code must be a full point code and not a cluster or network point code.

The destination point code specified by the `dpc` parameter must have routes provisioned.

The Nested Cluster Routing feature must be turned on before an exception route can be assigned to cluster members.

The STPOPTS table is corrupt or cannot be found.

The value specified for the `opc/opca/opci/opcn/opcn24/opcn16` parameter cannot be the same as the adjacent point code of the linkset specified by the `lsn` parameter.

The J7 Support feature must be enabled before the `dpcn16/opcn16` parameter can be specified.

### Output

```
ent-rtx:dpci=2-100-1:si=5:lsn=1set5:rc=50
```

```
stdcfg2b 06-05-19 18:20:11 EST EAGLE 35.0.0  
ENT-RTX: MASP A - COMPLTD
```

### Related Topics

- [chg-rtx](#)
- [dlt-rtx](#)
- [rept-stat-rtx](#)
- [rtrv-rtx](#)

## ent-scr-aftpc

Use this command to add a specific allowed affected point code (AFTPC) screening reference in the AFTPC entity set.

### Parameters



#### Note:

See [Point Code Formats and Conversion](#) for a detailed description of point code formats, rules for specification, and examples.

### **nsfi (mandatory)**

The next screening category that is used in the gateway screening process.

#### Range:

##### **stop**

The gateway screening process ends and the message proceeds through normal routing.

### **sr (mandatory)**

Screening reference. The point code's unique screening reference name.

**Range:**

ayyy

1 alphabetic character followed by up to 3 alphanumeric characters

**ssn (mandatory)**

Subsystem number.

**Range:**

0 - 255, \*

\*—the full range of values from 0–255

**actname (optional)**Name of the gateway screening stop action set. Stop actions must be administered using this parameter in conjunction with the gateway screening stop action table (see `chg-gws-actset` and `rtrv-gws-actset` ).**Range:**

ayyyyy

1 alphabetic character followed by up to 5 alphanumeric characters.

**area (optional)**ITU international area. The *area* in the point code represented by *zone-area-id*.**Range:**

0 - 255, \*

**id (optional)**ITU international ID. The *ID* in the point code represented by *zone-area-id*.**Range:**

0 - 7, \*

\*—the full range of values from 0–255

**mna (optional)**16-bit ITU national main number area. The *mna* in the point code represented by *un-sna-mna*.**Range:**

0--31, \*

\*---the full range of values from 0--31

**msa (optional)**24-bit ITU-national main signaling area value. The *msa* of the point code represented by *msa-ssa-sp*.**Range:**

0 - 255, \*

\*—the full range of values from 0–255

**nc (optional)**Network cluster value. This parameter specifies one or more *nc* values for the network indicator and network cluster member values specified in the *ni* and *ncm* parameters. It specifies the *nc* of the point code represented by *ni-nc-ncm*.

**Range:**

0 - 255, \*

\*—the full range of values from 0–255

**ncm (optional)**

Network cluster member value. This parameter specifies one or more *ncm* values for the network indicator and network cluster values identified in the *ni* and *nc* parameters. It specifies the *ncm* of the point code represented by *ni-nc-ncm*.

**Range:**

0 - 255, \*

\*—the full range of values from 0–255

**ni (optional)**

Network indicator value. This parameter specifies one or more *ni* values for the network cluster and network cluster member values identified in the *nc* and *ncm* parameters. It specifies the *ni* of the point code represented by *ni-nc-ncm*.

**Range:**

0 - 255, \*

\*—the full range of values from 0–255

**npc (optional)**

ITU national point code.

 **Note:**

Gateway screening allows the ITU national point code to be displayed and entered in the database only as a single number. For multiple-part ITU national point codes, see [Converting ITU National Point Code Formats](#) for information on converting the point code format.

**Range:**

0 - 16383, \*

\*—the full range of values from 0–16383

**nsr (optional)**

Next screening reference. This parameter specifies which screening reference in the specified screening category (*nsfi*) is to be used in the screening process.

**Range:**

ayyy

1 alphabetic character followed by up to 3 alphanumeric characters

**Default:**

No change to the current value

**pcst (optional)**

Point code subtype. This parameter indicates whether the specified ITU international or ITU national point code has no subtype prefix or has the spare point code prefix (S-).

**Range:***none**s***Default:***none***sna (optional)**

16-bit ITU national sub number area. The *sna* in the point code represented by *un-sna-mna*.

**Range:***0--15, \***\*---the full range of values from 0--15***sp (optional)**

24-bit ITU national signaling point. The *sp* in the point code represented by *msa-ssa-sp*.

**Range:***0 - 255, \***\*---the full range of values from 0--255***ssa (optional)**

24-bit ITU national sub signaling area. The *ssa* in the point code represented by *msa-ssa-sp*.

**Range:***0 - 255, \***\*---the full range of values from 0--255***un (optional)**

16-bit ITU-national unit number. The *un* of the point code represented by *un-sna-mna*.

**Range:***0--127, \***\*---the full range of values from 0--127***zone (optional)**

ITU international zone. The *zone* in the point code represented by *zone-area-id*.

**Range:***0 - 7, \***\*---the full range of values from 0--255***Example**

```
ent-scr-aftpc:sr=iec:ni=240:nc=010:ncm=010:ssn=012:nsfi=stop
```

```
ent-scr-  
aftpc:sr=iec:ni=240:nc=010:ncm=010:ssn=012:nsfi=stop:actname=copy
```

```
ent-scr-aftpc:nsfi=stop:sr=af01:ssn=1:msa=255:ssa=255:sp=255
```

```
ent-scr-aftpc:sr=aft1:zone=1:area=2:id=3:nsfi=stop:ssn=1:pcst=s
```

```
ent-scr-aftpc:nsfi=stop:sr=af02:ssn=1:un=10:sna=2:mna=5
```

## Dependencies

### ▲ Caution:

Even though gateway screening is in the screen test mode, as defined by the `gwsa=off` and `gwsn=on` parameters, the gateway screening action in the stop action set specified by the `actname` parameter of the screen set *will* be performed at the end of the screening process.

A complete point code must be specified, and must be one, and only one of the five point code parameter combinations: `ni-nc-ncm`, `zone-area-id`, `msa-ssa-sp`, `un-sna-mna`, or `npc`.

ANSI point code value 000-000-000 and ITU-International point code value 0-000-0 are not allowed.

The value of the `actname` parameter must already be defined in the Gateway Screening Stop Action table with the `chg-gws-actset` command.

The character `c` is not a valid value for the `ni`, `nc`, `ncm`, `zone`, `area`, `id`, `msa`, `ssa`, `sp`, `un`, `sna`, `mna`, and `npc` parameters.

If `zone=*` is specified, `area=*` and `id=*` must be specified.

If `area=*` is specified, `id=*` must be specified.

If `msa=*` is specified, `ssa=*` and `sp=*` must be specified.

If `ssa=*` is specified, `sp=*` must be specified.

If `un=*` is specified, `sna=*` and `mna=*` must be specified.

If `sna=*` is specified, `mna=*` must be specified.

If specified, the `nsfi` parameter value must be `stop`.

If the `nsfi=stop` parameter is specified, the `nsr` parameter cannot be specified.

If the screening reference exists, the new affected point code and subsystem number to be added cannot already exist in the AFTPC entity set.

The Spare Point Code Support feature must be enabled before the `pcst` parameter can be specified.

The spare point code subtype prefix (s-) is not supported for ANSI point codes (parameters `ni`, `nc`, `ncm`) or for 24-bit ITU national point codes (parameters `msa`, `ssa`, `sp`) or for 16-bit ITU national point codes (parameters `un`, `sna`, `mna`). The `pcst` and `npcst` parameters cannot be specified for ANSI, ITU-N24 and ITU-N16 point codes.

The Gateway Screening Rules table can contain a maximum of 360,600 rules.

If the `nc` parameter is specified as a range, the `ncm` parameter must be specified as an asterisk or as the full range.



If the `nc` parameter is specified as a single value or a range, a single value must be specified for the `ni` parameter.

If the `nc` parameter is specified as an asterisk, the `ncm` parameter must be specified as an asterisk or as the full range.

If the `ncm` parameter is specified as a single value, or a range other than the full range of 0–255, the `ni` and `nc` parameters must be specified with a single value.

If the `ni` parameter is specified as an asterisk or as a range, the `nc` and `ncm` parameters must be specified as an asterisk or as the full range.

The Gateway Screening Stop Action table must be accessible.

The J7 support feature must be enabled before the `un`, `sna`, or `mna` parameters can be specified.

The J7 support feature must not be enabled before the `msa`, `ssa`, or `sp` parameters can be specified.

The GWSOA parameter combination should be known and valid.

### Notes

A range of values is specified by separating the values that define the range by two ampersands (&&); for example, `ni=025&&100` specifies all network indicators for ANSI point codes from 25 - 100.

If the screening reference is valid, but does not exist, a new AFTPC screen is created.

If the screening reference exists, a new rule is added to the AFTPC screening table.

If asterisks or ranges are specified for the allowed AFTPCs, nothing that matches the specified range of AFTPCs can already exist in the AFTPC screen for the screening reference.

If the screen set reaches 100% capacity (indicated by the 100% Full message), the system allows subsequent entries. An error occurs, however, when downloading the screen set to an LIM. Ensure that screen sets do not exceed 100% capacity. Remove screen set entries until the capacity is below 100%.

An asterisk cannot not be specified for a parameter value in this command unless an asterisk was specified for the parameter value in the original `ent-scr-aftpc` command.

The spare point code subtype prefix (s-) is supported only for ITU international and ITU national point codes. The `pcst` parameter indicates whether the specified point code has no subtype prefix to has the spare point code prefix.

There is no feature dependency on ANSI point code parameters, i.e., `ni`, `nc`, `ncm`. The command can be entered successfully whether the J7 feature is enabled or not enabled.

### Output

```
ent-scr-aftpc:sr=iec:ni=240:nc=010:ncm=010:ssn=012:nsfi=stop
```

```
rlghncxa03w 04-01-07 11:43:04 EST EAGLE 31.3.0
```

```
ENT-SCR-AFTPC: SCREEN SET AFFECTED - IEC 25% FULL
ENT-SCR-AFTPC: MASP A - COMPLTD
;
```

### Related Topics

- [chg-scr-aftpc](#)
- [dlt-scr-aftpc](#)
- [rtrv-scr-aftpc](#)

## ent-scr-blkdpc

Use this command to add a specific blocked destination point code (BLKDPC) screening reference, and associated attributes, to the BLKDPC's table. The associated attributes are: destination point code, next screening function identifier, and next screening reference. The destination point codes listed on this screen are prohibited from sending SS7 messages to the network.

### Parameters

#### **nsfi (mandatory)**

The next screening category that is used in the gateway screening process, or it indicates that the gateway screening process should stop.

#### **Range:**

##### ***cgpa***

Allowed CGPA is the next screening category.

##### ***destfld***

Allowed destination field (DESTFLD) is the next screening category.

##### ***fail***

Discard the received message.

##### ***isup***

ISUP message type (ISUP) is the next screening category.

##### ***stop***

The gateway screening process ends and the message proceeds through normal routing.

#### **sr (mandatory)**

Screening reference. The point code's unique screening reference name.

#### **Range:**

*ayyy*

1 alphabetic character followed by up to 3 alphanumeric characters

#### **actname (optional)**

Name of the gateway screening stop action set. Stop actions must be administered using this parameter in conjunction with the gateway screening stop action table (see `chg-gws-actset` and `rtrv-gws-actset` ).

**Range:**

ayyyy

1 alphabetic character followed by up to 5 alphanumeric characters

**area (optional)**ITU international area. The *area* in the point code represented by *zone-area-id*.**Range:**

0 - 255, \*, C

\*—the full range of values from 0–255

C—continue

**id (optional)**ITU international ID. The *ID* in the point code represented by *zone-area-id*.**Range:**

0 - 7, \*, C

\*—the full range of values from 0–7

C—continue

**mna (optional)**16-bit ITU national main number area. The *mna* in the point code represented by *un-sna-mna*.**Range:**

0--31, \*, C

\*--the full range of values from 0--31

C -- continue

**msa (optional)**24-bit ITU-national main signaling area value. The *msa* of the point code represented by *msa-ssa-sp*.**Range:**

0 - 255, \*, C

\*—the full range of values from 0–255

C—continue

**nc (optional)**Network cluster value. This parameter specifies one or more *nc* values for the network indicator and network cluster member values specified in the *ni* and *ncm* parameters. It specifies the *nc* of the point code represented by *ni-nc-ncm*.**Range:**

0 - 255, \*, C

\*—the full range of values from 0–255

C—continue

**ncm (optional)**Network cluster member value. This parameter specifies one or more *ncm* values for the network indicator and network cluster values identified in the *ni* and *nc* parameters. It specifies the *ncm* of the point code represented by *ni-nc-ncm*.

**Range:**

0 - 255, \*, C

\*—the full range of values from 0–255

C—continue

**ni (optional)**

Network indicator value. This parameter specifies one or more ni values for the network cluster and network cluster member values identified in the nc and ncm parameters. It specifies the ni of the point code represented by *ni-nc-ncm*.

**Range:**

0 - 255, \*, C

\*—the full range of values from 0–255

C—continue

**npc (optional)**

ITU national point code.

**Note:**

Gateway screening allows the ITU national point code to be displayed and entered in the database only as a single number. If you are using multiple-part ITU national point codes, see [Converting ITU National Point Code Formats](#) in Appendix A for information on converting the point code format.

**Range:**

0 - 16383, \*, C

\*—the full range of values from 0–16383

C—continue

**nsr (optional)**

Next screening reference. This parameter specifies which screening reference in the screening category (*nsfi*) is to be used in the screening process.

**Range:**

ayyy

1 alphabetic character followed by up to 3 alphanumeric characters

**Default:**

No value given

**pcst (optional)**

Point code subtype. This parameter indicates whether the specified ITU international or ITU national point code has no subtype prefix or has the spare point code prefix (s-).

**Range:***none**s***Default:***none*

**sna (optional)**

16-bit ITU national sub number area. The *sna* in the point code represented by *un-sna-mna*.

**Range:**

0---15, \*, C

\*---the full range of values from 0--15

C -- continue

**sp (optional)**

24-bit ITU national signaling point. The *sp* in the point code represented by *msa-ssa-sp*.

**Range:**

0 - 255, \*, C

\*—the full range of values from 0–255

C—continue

**ssa (optional)**

24-bit ITU national sub signaling area. The *ssa* in the point code represented by *msa-ssa-sp*.

**Range:**

0 - 255, \*, C

\*—the full range of values from 0–255

C—continue

**un (optional)**

16-bit ITU-national unit number. The *un* of the point code represented by *un-sna-mna*.

**Range:**

0---127, \*, C

\*---the full range of values from 0--127

C --continue

**zone (optional)**

ITU international zone. The *zone* in the point code represented by *zone-area-id*.

**Range:**

0 - 7, \*, C

\*—the full range of values from 0–7

C—continue

**Example**

```
ent-scr-blkdpc:sr=iec:ni=c:nc=c:ncm=c:nsfi=cgpa:nsr=wrds
```

```
ent-scr-blkdpc:sr=iec:ni=c:nc=c:ncm=c:nsfi=stop
```

```
ent-scr-blkdpc:sr=iec:ni=c:nc=c:ncm=c:nsfi=stop:actname=copy
```

```
ent-scr-blkdpc:sr=iec:ni=240:nc=*:ncm=*:nsfi=fail
```

```
ent-scr-blkdpc:sr=bdp1:zone=1:area=2:id=3:nsfi=fail:pcst=none
```

```
ent-scr-blkdpc:sr=bdp1:zone=2:area=2:id=3:nsfi=fail:pcst=s
```

```
ent-scr-blkdpc:sr=bdp1:npc=128:nsfi=fail:pcst=s
```

```
ent-scr-blkdpc:sr=b101:un=1:sna=2:mna=3:nsfi=fail
```

## Dependencies

### ▲ Caution:

Even though gateway screening is in the screen test mode, as defined by the `gwsa=off` and `gws=on` parameters, the gateway screening action in the stop action set specified by the `actname` parameter of the screen set will be performed at the end of the screening process.

The Gateway Screening Rules table can contain a maximum of 360,600 rules.

A complete point code must be specified, using the `ni-nc-ncm`, `zone-area-id`, `un-sna-mna`, `msa-ssa-sp`, or `npc` combination unless a value of `c` is specified.

ANSI point code value 000-000-000 and ITU-International point code value 0-000-0 are not allowed.

At least one optional parameter must be specified.

When a blocked screening reference is created, the first entry for the `ni-nc-ncm`, `zone-area-id`, `msa-ssa-sp`, or `un-sna-mna` must be `c-c-c` or `npc=c` must be specified. Subsequent entries can be specific point codes.

If the `actname` parameter is specified, then the `nsfi=stop` parameter must be specified.

The value of the `actname` parameter must already be defined in the Gateway Screening Stop Action table with the `chg-gws-actset` command.

If the `area=*` parameter is specified, then the `id=*` parameter must be specified.

If the `msa=*` parameter is specified, then the `ssa=*` and the `sp=*` parameters must be specified.

If the `un=*` parameter is specified, then the `sna=*` and the `mna=*` parameters must be specified.

If the `msa=c` parameter is specified, then the `ssa` and the `sp` parameters must have a value of `c` or cannot be specified. If the `msa=c` parameter is specified, and the `ssa` and the `sp` parameters are not specified, then the `ssa` and `sp` parameters default to a value of `c`.

If the `un=c` parameter is specified, then the `sna` and the `mna` parameters must have a value of `c` or cannot be specified. If the `un=c` parameter is specified, and the `sna` and the `mna` parameters are not specified, then the `sna` and `mna` parameters default to a value of `c`.

If the `nc` parameter is specified as a range, the `ncm` parameter must be specified as an asterisk or as the full range.

If the `nc` parameter is specified as a single value or a range, a single value must be specified for the `ni` parameter.

If the `nc` parameter is specified as an asterisk, the `ncm` parameter must be specified as an asterisk or as the full range.

If the `ncm` parameter is specified as a single value, or a range other than the full range of 0–255, the `ni` and `nc` parameters must be specified with a single value.

If the `ni` parameter is specified as an asterisk or as a range, the `nc` and `ncm` parameters must be specified as an asterisk or as the full range.

If the `ni=c` parameter is specified, then the `nc` and `ncm` parameters must have a value of `c` or cannot be specified. If the `ni=c` parameter is specified, and the `nc` and the `ncm` parameters are not specified, then the `nc` and `ncm` parameters default to a value of `c`.

If the specified `ni-nc-ncm`, `zone-area-id`, `un-sna-mna` or `msa-ssa-sp` is not equal to `c-c-c`, or if the `npc=c` parameter is not specified, then the `nsfi=fail` parameter must be specified, and the `nsr` parameter cannot be specified.

If the `nsfi` parameter has a value other than `stop` or `fail`, the `nsr` parameter must be specified and must exist.

The `nsfi` and `nsr` parameters must point to an existing screen, or the `nsfi=stop` parameter must be specified, and the `nsr` parameter cannot be specified.

If the `sr` does not exist, then the `ni-nc-ncm`, `zone-area-id`, `un-sna-mna` or `msa-ssa-sp` parameters must equal `c-c-c`, or the `npc=c` parameter must be specified, and the `nsfi=fail` parameter cannot be specified.

If the specified screening reference exists:

- The `ni-nc-ncm`, `zone-area-id`, `un-sna-mna` or `msa-ssa-sp` must equal `c-c-c` or `npc` cannot equal `c`.
- The `nsfi` parameter must have a value of `fail`.
- The `nsr` parameter cannot be specified.
- The blocked DPC, given by `ni-nc-ncm`, `zone-area-id`, or `npc`, to be added to the BLKDPC screening table for the blocked DPC screening reference cannot exist as defined or within an existing range of DPCs.

The Spare Point Code Support feature must be enabled before the `pcst` parameter can be specified.

The `pcst` parameter cannot be specified with `c` for a blocked screen reference (`sr`).

The spare point code subtype prefix (s-) is not supported for ANSI point codes (parameters `ni`, `nc`, `ncm`) or for 24-bit ITU national point codes (parameters `msa`, `ssa`, `sp`) or 16-bit ITU national point codes (parameters `un`, `sna`, `mna`). The `pcst` parameter cannot be specified for ANSI, ITU-N16 and ITU-N24 point codes.

If the `ssa=*`  parameter is specified, then the `sp=*`  parameter must be specified.

If the `sna=*`  parameter is specified, then the `mna=*`  parameter must be specified.

If the `zone=*`  parameter is specified, then the `area=*`  and the `id=*`  parameters must be specified.

If the `zone=c` parameter is specified, then the `area` and `id` parameters must have a value of `c` or cannot be specified. If the `zone=c` parameter is specified, and the `area` and `id` parameters are not specified, then the `area` and `id` parameters default to a value of `c`.

The value of the `nsfi` parameter must be valid for the BLKDPC entity type.

If a blocked screening reference exists, then the `ni`, `zone`, `msa`, `un`, and `npc` parameters cannot have a value of `c`.

The Gateway Screening Stop Action table is corrupt or cannot be found.

The J7 support feature must be enabled before the `un/sna/mna` parameters are specified.

The J7 support feature must not be enabled before the `msa,ssa,sp` parameters are specified.

The GWSOA parameter combination should be known and valid.

## Notes

When a blocked DPC screening reference is created, the first entry for a point code must be `c-c-c`, or `c` for the `npc` parameter. Subsequent entries must be specific point codes.

The character `c` is used in the blocked DPC screens to allow the screening process to continue for messages with point codes that do not match any point codes in the blocked DPC screens. When screening for a blocked DPC and the point code being screened does not match any of the point codes in the blocked DPC screens, the message is not rejected and the screening process continues.

There must be an entry in the blocked DPC screens to allow the screening process to continue. This entry consists of a screening reference, point code, `nsfi`, and `nsr`. The point code is in the form of `npc=c`, or of subfields equal to `c-c-c`. When the character `c` is specified, the `nsfi` and `nsr` parameters must be specified.

If the character `c` is specified for the parameters `ni-nc-ncm`, `zone-area-id`, `un-sna-mna` or `msa-ssa-sp`, the character `c` is the only value that can be specified for all three parameters. No other values can be used. For example, a point code `c-c-255` is not allowed. The point code must be `c-c-c`. The asterisk value cannot be used with the character `c` (for example, a point code `c-c-*` is not allowed).

When the point code does not match any entries in the blocked DPC screens, the screening process is directed to the screening reference with the point code `c-c-c` or `npc=c`. The `nsfi` and `nsr` in this entry are examined to determine the next step in the screening process.

If the current `ni-nc-ncm`, `zone-area-id`, `un-sna-mna` or `msa-ssa-sp` is equal to `c-c-c` or `npc=c`, only the `nsfi` and `nsr` parameters can be changed. Otherwise, only the blocked DPC can be changed.

A range of values is specified by separating the values that define the range by two ampersands (`&&`); for example, `ni=025&&100` specifies all network indicators for ANSI point codes from 25 - 100.

An asterisk cannot not be specified for a parameter value in this command unless an asterisk was specified for the parameter value in the original `ent-scr-blkdpc` command.

If the screen set reaches 100% capacity (indicated by the 100% Full message), the system allows subsequent entries. An error occurs, however, when downloading the screen set to an LIM. Ensure that screen sets do not exceed 100% capacity. Remove screen set entries until the capacity is below 100%.

The spare point code subtype prefix (`s-`) is supported only for ITU international and ITU national point codes. The `pcst` parameter indicates whether the specified point code has no subtype prefix or has the spare point code prefix.

There is no feature dependency on ANSI point code parameters, i.e., `ni`, `nc`, `ncm`. The command can be entered successfully whether the J7 feature is enabled or not enabled.



## Output

```
ent-scr-blkdpc:sr=iec:ni=c:nc=c:ncm=c:nsfi=cgpa:nsr=wrds
```

```
rlghncxa03w 04-01-07 11:43:04 EST EAGLE 31.3.0
ENT-SCR-BLKDPC: SCREEN SET AFFECTED - IEC 25% FULL
ENT-SCR-BLKDPC: MASP A - COMPLTD
;
```

## Related Topics

- [chg-scr-blkdpc](#)
- [dlt-scr-blkdpc](#)
- [rtrv-scr-blkdpc](#)

# ent-scr-blkopc

Use this command to add a specific blocked originating point code (BLKOPC) screening reference and associated attributes `OPC`, `nsfi`, and `nsr` to the BLKOPC entity set. Any messages received on the link assigned to this screening reference that match the attributes in this table are blocked from entering the network.

## Parameters

### **nsfi (mandatory)**

This parameter specifies the next screening category that is used in the gateway screening process, or it indicates that the gateway screening process should stop.

#### **Range:**

##### ***blkdpc***

Blocked DPC is the next screening category.

##### ***cgpa***

Allowed CGPA is the next screening category.

##### ***dpc***

Allowed DPC is the next screening category.

##### ***fail***

Discard the received message.

##### ***sio***

Allowed SIO is the next screening category.

##### ***stop***

The gateway screening process ends and the message proceeds through normal routing.

### **sr (mandatory)**

Screening reference. The point code's unique screening reference name.

**Range:**

ayyy

1 alphabetic character followed by up to 3 alphanumeric characters

**actname (optional)**

Name of the gateway screening stop action set. Stop actions must be administered using this parameter in conjunction with the gateway screening stop action table (see `chg-gws-actset` and `rtrv-gws-actset` ).

**Range:**

ayyyyy

1 alphabetic character followed by up to 5 alphanumeric characters

**area (optional)**

ITU international area. The *area* of the point code represented by *zone-area-id*.

**Range:**

0 - 255, \*, C

\*—the full range of values from 0–255

C—continue

**id (optional)**

ITU international ID. This parameter specifies the *ID* of the point code represented by *zone-area-id*.

**Range:**

0 - 7, \*, C

\*—the full range of values from 0–255

C—continue

**mna (optional)**

16-bit ITU national main number area. The *mna* in the point code represented by *un-sna-mna*.

**Range:**

0--31, \*, C

\*--the full range of values from 0--31

C ---continue

**msa (optional)**

24-bit ITU-national main signaling area value. The *msa* of the point code represented by *msa-ssa-sp*.

**Range:**

0 - 255, \*, C

\*—the full range of values from 0–255

C—continue

**nc (optional)**

Network cluster value. This parameter specifies one or more *nc* values for the network indicator and network cluster member values specified in the *ni* and *ncm* parameters. It specifies the *nc* of the point code represented by *ni-nc-ncm*.

**Range:**

0 - 255, \*, C

\*—the full range of values from 0–255  
C—continue

**ncm (optional)**

Network cluster member value. This parameter specifies one or more *ncm* values for the network indicator and network cluster values identified in the *ni* and *nc* parameters. It specifies the *ncm* of the point code represented by *ni-nc-ncm*.

**Range:**

0 - 255, \*, C

\*—the full range of values from 0–255  
C—continue

**ni (optional)**

Network indicator value. This parameter specifies one or more *ni* values for the network cluster and network cluster member values identified in the *nc* and *ncm* parameters. It specifies the *ni* of the point code represented by *ni-nc-ncm*.

**Range:**

0 - 255, \*, C

\*—the full range of values from 0–255  
C—continue

**npc (optional)**

ITU national point code.

**Note:**

Gateway screening allows the ITU national point code to be displayed and entered in the database only as a single number. For multiple-part ITU national point codes, see [Converting ITU National Point Code Formats](#) for information on converting the point code format.

**Range:**

0 - 16383, \*, C

\*—the full range of values from 0–255  
C—continue

**nsr (optional)**

Next screening reference. This parameter indicates which screening reference in the specified screening category (*nsfi*) is to be used in the screening process.

**Range:**

*ayyy*

1 alphabetic character followed by up to 3 alphanumeric characters

**pcst (optional)**

Point code subtype. This parameter indicates whether the specified ITU international or ITU national point code has no subtype prefix or has the spare point code prefix (S-).

**Range:***none**s***Default:***none***sna (optional)**16-bit ITU national sub number area. The *sna* in the point code represented by *un-sna-mna*.**Range:***0--15, \*, C**\*--the full range of values from 0--15**C ---continue***sp (optional)**24-bit ITU national signaling point. The *sp* in the point code represented by *msa-ssa-sp*.**Range:***0 - 255, \*, C**\*—the full range of values from 0–255**C—continue***ssa (optional)**24-bit ITU national sub signaling area. The *ssa* in the point code represented by *msa-ssa-sp*.**Range:***0 - 255, \*, C**\*—the full range of values from 0–255**C—continue***un (optional)**16-bit ITU-national unit number. The *un* of the point code represented by *un-sna-mna*.**Range:***0--127, \*, C**\*--the full range of values from 0--127**C ---continue***zone (optional)**ITU internationalzone. The *zone* in the point code represented by *zone-area-id*.**Range:***0 - 7, \*, C**\*—the full range of values from 0–255**C—continue***Example**

```
ent-scr-blkopc:sr=iec:ni=c:nc=c:ncm=c:nsfi=cgpa:nsr=wrds
```

```
ent-scr-blkopc:sr=iec:ni=c:nc=c:ncm=c:nsfi=stop
```

```
ent-scr-blkopc:sr=iec:ni=c:nc=c:ncm=c:nsfi=stop:actname=copy
```

```
ent-scr-blkopc:sr=iec:ni=240:nc=*:ncm=*:nsfi=fail
```

```

ent-scr-blkopc:sr=bo30:nsfi=stop:msa=c:ssa=c:sp=c
ent-scr-blkopc:sr=bo30:nsfi=fail:msa=1:ssa=2:sp=3
ent-scr-blkopc:sr=bo30:nsfi=fail:msa=3:ssa=*:sp=*
ent-scr-blkopc:sr=bop1:zone=1:area=2:id=3:nsfi=fail:pcst=none
ent-scr-blkopc:sr=bop1:npc=128:nsfi=fail:pcst=s
ent-scr-blkopc:sr=bl01:un=1:sna=2:mna=3:nsfi=fail

```

## Dependencies

### ▲ Caution:

Even though gateway screening is in the screen test mode, as defined by the `gwsa=off` and `gwsn=on` parameters, the gateway screening action in the stop action set specified by the `actname` parameter of the screen set will be performed at the end of the screening process.

The Gateway Screening Rules table can contain a maximum of 360,600 rules.

A complete point code must be specified, using the `ni-nc-ncm`, `zone-area-id`, `un-sna-mna`, `msa-ssa-sp`, or `npc` combination unless a value of `c` is specified.

The ANSI point code value 000-000-000 and the ITU-International point code value 0-000-0 cannot be specified.

At least one optional parameter must be specified.

When a blocked screening reference is created, the first entry for the `ni-nc-ncm`, `zone-area-id`, `msa-ssa-sp` or `un-sna-mna` must be `c-c-c` or `npc=c` must be specified. Subsequent entries can be specific point codes.

If asterisks or ranges are specified for the blocked OPCs, nothing that matches the specified range of blocked OPCs can already exist in the BLKOPC screening table for the screening reference.

If the `actname` parameter is specified, then the `nsfi=stop` parameter must be specified.

The value of the `actname` parameter must exist in the Gateway Screening Stop Action table.

If `area=*` is specified, `id=*` must be specified.

If `msa=*` is specified, `ssa=*` and `sp=*` must be specified.

If `un=*` is specified, `sna=*` and `mna=*` must be specified.

If the `msa=c` parameter is specified, then the `ssa` and `sp` parameters must have a value of `c` or cannot be specified. If the `msa=c` parameter is specified, and the `ssa` and the `sp` parameters are not specified, then the `ssa` and `sp` parameters default to a value of `c`.

If the `un=c` parameter is specified, then the `sna` and `mna` parameters must have a value of `c` or cannot be specified. If the `un=c` parameter is specified, and the `sna` and

the `mna` parameters are not specified, then the `sna` and `mna` parameters default to a value of `c`.

If the `nc` parameter is specified as a range, the `ncm` parameter must be specified as an asterisk or as the full range.

If the `nc` parameter is specified as a single value or a range, a single value must be specified for the `ni` parameter.

If the `nc` parameter is specified as an asterisk, the `ncm` parameter must be specified as an asterisk or as the full range.

If the `ncm` parameter is specified as a single value, or a range other than the full range of 0–255, the `ni` and `nc` parameters must be specified with a single value.

If the `ni` parameter is specified as an asterisk or as a range, the `nc` and `ncm` parameters must be specified as an asterisk or as the full range.

If the `ni=c` parameter is specified, then the `nc` and the `ncm` parameters must have a value of `c` or cannot be specified. If the `ni=c` parameter is specified, and the `nc` and the `ncm` parameters are not specified, then the `nc` and `ncm` parameters default to a value of `c`.

If the specified `ni-nc-ncm`, `zone-area-id`, `un-sna-mna` or `msa-ssa-sp` is not equal to `c-c-c`, or if the `npc=c` parameter is not specified, then the `nsfi=fail` parameter must be specified, and the `nsr` parameter cannot be specified.

If the value of the `nsfi` parameter is not `stop` or `fail`, then the `nsr` parameter must be specified.

The `nsfi` and `nsr` parameters must point to an existing screen, or the `nsfi=stop` parameter must be specified, and the `nsr` parameter cannot be specified.

If the `sr` does not exist, then the `ni-nc-ncm`, `zone-area-id`, `un-sna-mna` or `msa-ssa-sp` parameters must equal `c-c-c`, or the `npc=c` parameter must be specified, and the `nsfi=fail` parameter cannot be specified.

If the specified screening reference exists:

- The `ni-nc-ncm`, `zone-area-id`, `un-sna-mna` or `msa-ssa-sp` must equal `c-c-c` or `npc=c` cannot be specified.
- The `nsfi` parameter must be `fail`.
- The `nsr` parameter cannot be specified.
- The blocked OPC, specified by `ni-nc-ncm`, `zone-area-id`, `un-sna-mna`, `msa-ssa-sp`, or `npc`, to be added to the BLKOPC screening table for the blocked OPC screening reference cannot exist as defined or within an existing range of OPCs.

The Spare Point Code Support feature must be enabled before the `pcst` parameter can be specified.

The `pcst` parameter cannot be specified with `c` for a blocked screen reference (`sr`).

The spare point code subtype prefix (`s-`) is not supported for ANSI point codes (parameters `ni`, `nc`, `ncm`) or for 24-bit ITU national point codes (parameters `msa`, `ssa`, `sp`) or for 16-bit ITU national point codes (parameters `un`, `sna`, `sna`). The `pcst` parameter cannot be specified for ANSI, ITU-N16 and ITU-N24 point codes.

If `ssa=*`  is specified, `sp=*`  must be specified.

If `sna=*` is specified, `mna =*` must be specified.

If `zone=*` is specified, `area=*` and `id=*` must be specified.

If the `zone=c` parameter is specified, then the `area` and `id` parameters must have a value of `c` or cannot be specified. If the `zone=c` parameter is specified, and the `area` and the `id` parameters are not specified, then the `area` and `id` parameters default to a value of `c`.

The specified `nsfi` parameter value must be valid for the BLKOPC entity type.

The Gateway Screening Stop Action table is corrupt or cannot be found.

If a blocked screening reference exists, then the `ni`, `zone`, `msa`, `un` and `npc` parameters cannot have a value of `c`.

The J7 support feature must be enabled before the `un/ sna/ mna` parameters are specified.

The J7 support feature must not be enabled before the `msa`, `ssa`, `sp` parameters are specified.

The GWSOA parameter combination should be known and valid.

## Notes

When a blocked DPC screening reference is created, the first entry for a point code must be `c-c-c`, or the `npc=c` parameter must be specified. Subsequent entries must be specific point codes.

The character `c` is used in the blocked DPC screens to allow the screening process to continue for messages with point codes that do not match any point codes in the blocked DPC screens. When screening for a blocked DPC and the point code being screened does not match any of the point codes in the blocked DPC screens, the message is not rejected and the screening process continues.

There must be an entry in the blocked DPC screens to allow the screening process to continue. This entry consists of a screening reference, point code, `nsfi`, and `nsr`. The point code is in the form of `npc=c` or subfields equal to `c-c-c`. When the character `c` is specified, the `nsfi` and `nsr` parameters must be specified.

If the character `c` is specified for the parameters `ni-nc-ncm`, `zone-area-id`, `un-sna-mna` or `msa-ssa-sp`, the character `c` is the only value that can be specified for all three parameters. For example, a point code `c-c-255` is not allowed. The point code must be `c-c-c`. The asterisk value cannot be used with the character `c` (for example, a point code `c-c-*` is not allowed).

When the point code does not match any entries in the blocked DPC screens, the screening process is directed to the screening reference with the point code `c-c-c` or `npc=c`. The `nsfi` and `nsr` in this entry are examined to determine the next step in the screening process.

If the current `ni-nc-ncm`, `zone-area-id`, `un-sna-mna` or `msa-ssa-sp` is equal to `c-c-c` or `npc=c`, only the `nsfi` and `nsr` can be changed. Otherwise, only the blocked DPC can be changed.

A range of values is specified by separating the values that define the range by two ampersands (&&); for example, `ni=025&&100` specifies all network indicators for ANSI point codes from 25 - 100.

An asterisk cannot not be specified for a parameter value in this command unless an asterisk was specified for the parameter value in the original `ent-scr-blkopc` command.

If the screen set reaches 100% capacity (indicated by the 100% Full message), the system allows subsequent entries. An error occurs, however, when downloading the screen set to an LIM. Ensure that screen sets do not exceed 100% capacity. Remove screen set entries until the capacity is below 100%.

The spare point code subtype prefix (s-) is supported only for ITU international and ITU national point codes. The `pcst` parameter indicates whether the specified point code has no subtype prefix or has the spare point code prefix.

There is no feature dependency on ANSI point code parameters, i.e., `ni`, `nc`, `ncm`. The command can be entered successfully whether the J7 feature is enabled or not enabled.

### Output

```
ent-scr-blkopc:sr=iec:ni=c:nc=c:ncm=c:nsfi=cgpa:nsr=wrds5
```

```
rlghncxa03w 04-01-07 11:43:04 EST EAGLE 31.3.0
ENT-SCR-BLKOPC: SCREEN SET AFFECTED - IEC 25% FULL
ENT-SCR-BLKOPC: MASP A - COMPLTD
;
```

### Related Topics

- [chg-scr-blkopc](#)
- [dlt-scr-blkopc](#)
- [rtrv-scr-blkopc](#)

## ent-scr-cdpa

Use this command to add a specific allowed called party address (CDPA) screening reference in the CDPA entity set.

### Parameters

#### **nsfi (mandatory)**

This parameter specifies the next screening category that is used in the gateway screening process, or it indicates that the gateway screening process should stop.

#### **Range:**

##### ***aftp***

Allowed affected point code is the next screening category.

##### ***stop***

The gateway screening process ends and the message proceeds through normal routing.

#### **sr (mandatory)**

Screening reference. This parameter specifies the screening reference name for the CdPA.



**Range:***ayyy*

1 alphabetic character followed by up to 3 alphanumeric characters

**ssn (mandatory)**

Subsystem number

**Range:***0 - 255, \****actname (optional)**

Name of the gateway screening stop action set. Stop actions must be administered using this parameter in conjunction with the gateway screening stop action table (see `chg-gws-actset` and `rtrv-gws-actset` ).

**Range:***ayyyyy*

1 alphabetic character followed by up to 5 alphanumeric characters

**area (optional)**ITU international area. The *area* in the point code represented by *zone-area-id*.**Range:***0 - 255, \**

\*—the full range of values from 0–255

**id (optional)**ITU international ID. The *ID* in the point code represented by *zone-area-id*.**Range:***0 - 7, \**

\*—the full range of values from 0–7

**mna (optional)**

16-bit ITU national main number area. The *mna* in the point code represented by *un-sna-mna*.

**Range:***0--31, \**

\*--the full range of values from 0--31

**msa (optional)**

24-bit ITU-national main signaling area value. The *msa* of the point code represented by *msa-ssa-sp*.

**Range:***0 - 255, \**

\*—the full range of values from 0–255

**nc (optional)**

Network cluster value. This parameter specifies one or more *nc* values for the network indicator and network cluster member values specified in the *ni* and *ncm* parameters. It specifies the *nc* of the point code represented by *ni-nc-ncm*.

**Range:**

0 - 255, \*

\*—the full range of values from 0–255

**ncm (optional)**

Network cluster member value. This parameter specifies one or more *ncm* values for the network indicator and network cluster values identified in the *ni* and *nc* parameters. It specifies the *ncm* of the point code represented by *ni-nc-ncm*.

**Range:**

0 - 255, \*

\*—the full range of values from 0–255

**ni (optional)**

Network indicator value. This parameter specifies one or more *ni* values for the network cluster and network cluster member values identified in the *nc* and *ncm* parameters. It specifies the *ni* of the point code represented by *ni-nc-ncm*.

**Range:**

0 - 255, \*

\*—the full range of values from 0–255

**npc (optional)**

ITU national point code.

 **Note:**

Gateway screening allows the ITU national point code to be displayed and entered in the database only as a single number. For multiple-part ITU national point codes, see [Converting ITU National Point Code Formats](#) for information on converting the point code format.

**Range:**

0 - 16383, \*

\*—the full range of values from 0–16383

**nsr (optional)**

Next screening reference. This parameter specifies which screening reference in the specified screening category (*nsfi*) is to be used in the screening process.

**Range:**

ayyy

1 alphabetic character followed by up to 3 alphanumeric characters

**Default:**

No value given

**pcst (optional)**

Point code subtype. This parameter indicates whether the specified ITU international or ITU national point code has no subtype prefix or has the spare point code prefix (s-).

**Range:***none**s***Default:***none***scmgfid (optional)**

SCMG Format ID. The following SCCP message types are screened against the Allowed CDPA table and all others are passed: UDT, UDTS, XU DT, XU DTS.

**Range:***1 - 255, \***\*—the full range of values from 1–255***sna (optional)**

16-bit ITU national sub number area. The *sna* in the point code represented by *un-sna-mna*.

**Range:***0---15, \***\*---the full range of values from 0--15***sp (optional)**

24-bit ITU national signaling point. The *sp* in the point code represented by *msa-ssa-sp*.

**Range:***0 - 255, \***\*—the full range of values from 0–255***ssa (optional)**

24-bit ITU national sub signaling area. The *ssa* in the point code represented by *msa-ssa-sp*.

**Range:***0 - 255, \***\*—the full range of values from 0–255***un (optional)**

16-bit ITU-national unit number. The *un* of the point code represented by *un-sna-mna*.

**Range:***0---127, \***\*---the full range of values from 0--127***zone (optional)**

ITU international zone. The *zone* in the point code represented by *zone-area-id*.

**Range:***0 - 7, \***\*—the full range of values from 0–7*

### Example

```
ent-scr-cdpa:sr=iec:ni=240:nc=010:ncm=*:ssn=224:nsfi=aftpc:nstr=wrds5
ent-scr-
cdpa:sr=iec:ni=240:nc=010:ncm=*:ssn=224:nsfi=stop:actname=copy
ent-scr-
cdpa:sr=cdp1:zone=1:area=2:id=3:ssn=1:nsfi=stop:scmgfid=1:pcst=s
ent-scr-cdpa:sr=cdp2:un=1:sna=2:mna=1:ssn=1:nsfi=stop
```

### Dependencies

#### Caution:

Even though gateway screening is in the screen test mode, as defined by the `gwsa=off` and `gws=on` parameters, the gateway screening action in the stop action set specified by the `actname` parameter of the screen set *will* be performed at the end of the screening process.

The Gateway Screening Rules table can contain a maximum of 360,600 rules.

A complete point code must be specified, and must be one and only one of the five point code parameter combinations: `ni-nc-ncm`, `zone-area-id`, `un-sna-mna`, `msa-ssa-sp`, or `npc`.

ANSI point code value 000-000-000 and ITU-International point code value 0-000-0 are not allowed.

At least one optional parameter must be specified.

The new CDPA entry to be added cannot match any specific, range, or asterisk entry already existing in the specified screening table.

The character `c` is not a valid value for the `ni`, `nc`, `ncm`, `zone`, `area`, `id`, `msa`, `ssa`, `sp`, `una`, `sna`, `mna`, and `npc` parameters.

The value of the `actname` parameter must already be defined in the Gateway Screening Stop Action table with the `chg-gws-actset` command.

When the `actname` parameter is specified, the `nsfi=stop` parameter must be specified.

If the `nc` parameter is specified as a range, the `ncm` parameter must be specified as an asterisk or as the full range.

If the `nc` parameter is specified as a single value or a range, a single value must be specified for the `ni` parameter.

If the `nc` parameter is specified as an asterisk, the `ncm` parameter must be specified as an asterisk or as the full range.

If the `ncm` parameter is specified as a single value, or a range other than the full range of 0–255, the `ni` and the `nc` parameters must be specified with a single value.

If the `ni` parameter is specified as an asterisk or as a range, the `nc` and `ncm` parameters must be specified as an asterisk or as the full range.

If the `nnc` parameter is specified as a range, the `nncm` parameter must be specified as an asterisk or as the full range.

When `nsfi=aftpc` is specified, the `ssn=1` parameter must be specified.

When `nsfi` is a value other than `stop`, the `nsr` parameter must be specified.

When `nsfi=stop` is specified, the `nsr` parameter cannot be specified.

When `ssn=1` is specified, the `scmgfid` parameter must be specified.

When `ssn` is not 1, the `scmgfid` parameter cannot be specified.

The Spare Point Code Support feature must be enabled before the `pcst` parameter can be specified.

The spare point code subtype prefix (s-) is not supported for ANSI point codes (parameters `ni`, `nc`, `ncm`) or for 24-bit ITU national point codes (parameters `msa`, `ssa`, `sp`) or for 16-bit ITU national point codes (parameters `un`, `sna`, `mna`). The `pcst` parameter cannot be specified for ANSI, ITU-N16 or ITU-N24 point codes.

The specified value for the `nsfi` parameter is not valid for `cdpa` screen.

The Gateway Screening Stop Action table must be accessible.

The next screening function identifier (`nsfi`) and the next screening reference (`nsr`) must point to an existing screen, or the `nsfi=stop` parameter must be specified and the `nsr` parameter cannot be specified.

The J7 support feature must be enabled before the `un/sna/mna` parameters are specified.

The J7 support feature must not be enabled before the `msa/ssa/sp` parameters are specified.

The GWSOA parameter combination should be known and valid.

## Notes

If the screening reference is valid, but does not exist, a new CDPA screen is created.

If the screening reference exists, a new rule is added to the CDPA screening table.

A range of values is specified by separating the values that define the range by two ampersands (&&); for example, `ni=025&&100` specifies all network indicators for ANSI point codes from 25 - 100.

If the screen set reaches 100% capacity (indicated by the 100% Full message), the system will allow subsequent entries. An error will occur, however, when downloading the screen set to a LIM. Screen sets should not exceed 100% capacity. Remove screen set entries until the capacity is below 100%.

An asterisk cannot not be specified for a parameter value in this command unless an asterisk was specified for the parameter value in the original `ent-scr-cdpa` command.

The spare point code subtype prefix (s-) is supported only for ITU international and ITU national point codes. The `pcst` parameter indicates whether the specified point code has no subtype prefix or has the spare point code prefix.

There is no feature dependency on ANSI point code parameters, i.e., `ni`, `nc`, `ncm`. The command can be entered successfully whether the J7 feature is enabled or not enabled.

### Output

```
ent-scr-cdpa:sr=iec:ni=240:nc=010:ncm=*:ssn=224:nsfi=aftpc:nsr=wrds5
```

```
rlghncxa03w 04-01-07 11:43:04 EST EAGLE 31.3.0
ENT-SCR-CDPA: SCREEN SET AFFECTED - IEC 25% FULL
ENT-SCR-CDPA: MASP A - COMPLTD
;
```

### Related Topics

- [chg-scr-cdpa](#)
- [dlt-scr-cdpa](#)
- [rtrv-scr-cdpa](#)

## ent-scr-cgpa

Use this command to add a specific allowed calling party address (CGPA) screening reference in the CGPA entity set.

### Parameters

#### **nsfi (mandatory)**

This parameter specifies the next screening category that is used in the gateway screening process, or it indicates that the gateway screening process should stop.

#### **Range:**

##### ***cdpa***

Allowed called party address is the next screening category.

##### ***stop***

The gateway screening process ends and the message proceeds through normal routing.

##### ***tt***

Allowed translation type is the next screening category.

#### **ri (mandatory)**

Routing indicator. This parameter provides routing instructions to the receiving signaling point. In gateway screening, messages may be screened based on the value of the routing indicator.

**Range:****dpc**

Allow a called party address with a routing indicator value of "DPC/SSN."

**gt**

Screening stops and gateway screening is bypassed as a forced pass.

\*

A full range of values.

**sr (mandatory)**

Screening reference. The screening reference name for the CgPA.

**Range:**

ayyy

1 alphabetic character followed by up to 3 alphanumeric characters

**ssn (mandatory)**

Subsystem number

**Range:**

1 - 255, \*

**actname (optional)**

Name of the gateway screening stop action set. Stop actions must be administered using this parameter in conjunction with the gateway screening stop action table (see `chg-gws-actset` and `rtrv-gws-actset` ).

**Range:**

ayyyyy

1 alphabetic character followed by up to 5 alphanumeric characters

**area (optional)**

ITU international area. The *area* in the point code represented by *zone-area-id*.

**Range:**

0 - 255, \*

\*—the full range of values from 0–255

**id (optional)**

ITU international ID. The *ID* in the point code represented by *zone-area-id*.

**Range:**

0 - 7, \*

\*—the full range of values from 0–7

**mna (optional)**

16-bit ITU national main number area. The *mna* in the point code represented by *un-sna-mna*.

**Range:**

0---31, \*

\*---the full range of values from 0--31

**msa (optional)**

24-bit ITU-national main signaling area value. The *msa* of the point code represented by *msa-ssa-sp*.

**Range:**

0 - 255, \*

\*—the full range of values from 0–255

**nc (optional)**

Network cluster value. This parameter specifies one or more *nc* values for the network indicator and network cluster member values specified in the *ni* and *ncm* parameters. It specifies the *nc* of the point code represented by *ni-nc-ncm*.

**Range:**

0 - 255, \*

\*—the full range of values from 0–255

**ncm (optional)**

Network cluster member value. This parameter specifies one or more *ncm* values for the network indicator and network cluster values identified in the *ni* and *nc* parameters. It specifies the *ncm* of the point code represented by *ni-nc-ncm*.

**Range:**

0 - 255, \*

\*—the full range of values from 0–255

**ni (optional)**

Network indicator value. This parameter specifies one or more *ni* values for the network cluster and network cluster member values identified in the *nc* and *ncm* parameters. It specifies the *ni* of the point code represented by *ni-nc-ncm*.

**Range:**

0 - 255, \*

\*—the full range of values from 0–255

**npc (optional)**

ITU national point code.

**Note:**

Gateway screening allows the ITU national point code to be displayed and entered in the database only as a single number. For multiple-part ITU national point codes, see [Converting ITU National Point Code Formats](#) for information on converting the point code format.

**Range:**

0 - 16383

**nsr (optional)**

Next screening reference. This parameter indicates which screening reference in the specified screening category (*nsfi*) is to be used in the screening process.



**Range:***ayyy*

1 alphabetic character followed by up to 3 alphanumeric characters

**pcst (optional)**

Point code subtype. This parameter indicates whether the specified ITU international or ITU national point code has no subtype prefix or has the spare point code prefix (S-).

**Range:***none**s***Default:***none***sccpmt (optional)**

SCCP message type

**Range:****9**

UDT

**10**

UDTS

**17**

XUDT

**18**

XUDTS

\*

**Default:**

\*

**sna (optional)**16-bit ITU national sub number area. The *sna* in the point code represented by *un-sna-mna*.**Range:***0--15, \***\*--the full range of values from 0--15***sp (optional)**24-bit ITU national signaling point. The *sp* in the point code represented by *msa-ssa-sp*.**Range:***0 - 255, \***\*—the full range of values from 0–255*

**ssa (optional)**

24-bit ITU national sub signaling area. The *ssa* in the point code represented by *msa-ssa-sp*.

**Range:**

0 - 255, \*

\*—the full range of values from 0–255

**un (optional)**

16-bit ITU-national unit number. The *un* of the point code represented by *un-sna-mna*.

**Range:**

0--127, \*

\*--the full range of values from 0--127

**zone (optional)**

ITU international zone. The *zone* in the point code represented by *zone-area-id*.

**Range:**

0 - 7, \*

\*—the full range of values from 0–255

**Example**

```
ent-scr-
cgpa:sr=iec:ni=240:nc=010:ncm=*:ssn=224:nsfi=aftpc:nsr=wr5:ri=dpc

ent-scr-
cgpa:sr=iec:ni=240:nc=010:ncm=*:ssn=224:nsfi=stop:ri=dpc:actname=cop
Y

ent-scr-
cgpa:sr=cdp1:ni=5:nc=5:ncm=5:ssn=1:ri=dpc:sccpmt=9:nsfi=sdpa:nsr=cdp
1

ent-scr-
cgpa:sr=cgpa:zone=1:area=2:id=3:ssn=1:sccpmt=9:ri=*:nsfi=stop:pcst=s

ent-scr-cgpa:sr=cgp1:un=1:sna=2:mna=1:ssn=1:sccpmt=9:nsfi=stop:ri=*
```

**Dependencies****▲ Caution:**

Even though gateway screening is in the screen test mode, as defined by the `gwsa=off` and `gwsn=on` parameters, the gateway screening action in the stop action set specified by the `actname` parameter of the screen set will be performed at the end of the screening process.

The Gateway Screening Rules table can contain a maximum of 360,600 rules.

A complete point code must be specified, and must be one, and only one of the five point code parameter combinations: `ni-nc-ncm`, `zone-area-id`, `un-sna-mna`, `msa-ssa-sp`, or `npc`.

ANSI point code value 000-000-000 and ITU-International point code value 0-000-0 are not allowed.

The new CGPA point code, `ri`, `sccpmt`, and `ssn` to be added can not already exist in the CGPA entity set.

The character `c` is not a valid value for the `ni`, `nc`, `ncm`, `zone`, `area`, `id`, `msa`, `ssa`, `sp`, `un`, `sna`, `mna`, and `npc` parameters.

The value of the `actname` parameter must already be defined in the Gateway Screening Stop Action table with the `chg-gws-actset` command.

When the `actname` parameter is specified, the `nsfi=stop` parameter must be specified.

If `area=*` is specified, `id=*` must be specified.

If `msa=*` is specified, `ssa=*` and `sp=*` must be specified.

If `un=*` is specified, `sna=*` and `mna=*` must be specified.

If the `nc` parameter is specified as a range, the `ncm` parameter must be specified as an asterisk or as the full range.

If the `nc` parameter is specified as a single value or a range, a single value must be specified for the `ni` parameter.

If the `nc` parameter is specified as an asterisk, the `ncm` parameter must be specified as an asterisk or as the full range.

If the `ncm` parameter is specified as a single value, or a range other than the full range of 0–255, the `ni` and `nc` parameters must be specified with a single value.

If the `ni` parameter is specified as an asterisk or as a range, the `nc` and `ncm` parameters must be specified as an asterisk or as the full range.

The Spare Point Code Support feature must be enabled before the `pcst` parameter can be specified.

The spare point code subtype prefix (`s-`) is not supported for ANSI point codes (parameters `ni`, `nc`, `ncm`) or for 24-bit ITU national point codes (parameters `msa`, `ssa`, `sp`) or for 16-bit ITU national point codes (parameters `un`, `sna`, `mna`). The `pcst` parameter cannot be specified for ANSI, ITU-N16 or ITU-N24 point codes.

The screen referenced by `nsfi` and `nsr` must already exist.

The `nsr` parameter must be specified, if `nsfi` is not equal to `stop`.

When `nsfi=stop` is specified, the `nsr` parameter cannot be specified.

The `nsfi=tt` parameter can be specified only if the `ri=gt` parameter or the `ri=*` parameter is specified.

The `nsfi=cdpa` parameter can be specified only if the `ri=dpc` parameter or the `ri=*` parameter is specified.

If `ssa=*` is specified, `sp=*` must be specified.

If `sna=*` is specified, `mna=*` must be specified.

If `zone=*` is specified, `area=*` and `id=*` must be specified.

The specified value for the `nsfi` parameter is not valid for `cgpa` screen.

The Gateway Screening Stop Action table must be accessible.

Valid values must be specified for the `nsccpmt` and `sccpmt` parameters.

The J7 Support feature must be enabled before the `un/ sna/ mna` parameters are specified.

The J7 Support feature must not be enabled before the `msa/ ssa/ sp` parameters are specified.

The GWSOA parameter combination should be known and valid.

### Notes

A range of values is specified by separating the values that define the range by two ampersands (&&); for example, `ni=025&&100` specifies all network indicators for ANSI point codes from 25 - 100 .

If the screening reference is valid, but does not exist, a new CGPA screening table is created.

If the screening reference exists, a new rule is added to the CGPA screening table. Only one rule may exist for a given `ni-nc-ncm/ssn/ri/sccpmt` (or `zone-area-id` or `npc`) combination. This implies that for a given combination, only one value of `ri` may be specified. The `ri` for a given combination can be `dpc`, `gt`, or `*`, but not `dpc` and `gt` independently.

If the screen set reaches 100% capacity (indicated by the 100% Full message), the system will allow subsequent entries. An error will occur, however, when downloading the screen set to a LIM. Screen sets should not exceed 100% capacity. Remove screen set entries until the capacity is below 100%.

An asterisk cannot not be specified for a parameter value in this command unless an asterisk was specified for the parameter value in the original `ent-scr-cgpa` command.

The spare point code subtype prefix (s-) is supported only for ITU international and ITU national point codes. The `pcst` parameter indicates whether the specified point code has no subtype prefix or has the spare point code prefix.

There is no feature dependency on ANSI point code parameters, i.e., `ni`, `nc`, `ncm`. The command can be entered successfully whether the J7 Support feature is enabled or not enabled.

### Output

```
ent-scr-
cgpa:sr=iec:ni=240:nc=010:ncm=*:ssn=224:nsfi=aftpc:nsr=wr5:ri=dpc
```

```
rlghncxa03w 04-01-07 11:43:04 EST EAGLE 31.3.0
ENT-SCR-CGPA: SCREEN SET AFFECTED - IEC 25% FULL
ENT-SCR-CGPA: MASP A - COMPLTD
```

```
;
```

### Related Topics

- [chg-scr-cgpa](#)
- [dlt-scr-cgpa](#)
- [rtrv-scr-cgpa](#)

## ent-scr-destfld

Use this command to add an allowed affected destination field (DESTFLD) screening reference and associated attributes (destination point code, next screening function identifier, and next screening reference) to the allowed DESTFLD entity set. One or more point codes can be associated with the allowed DESTFLD screening reference. MTP Network Management messages regarding the DESTFLDs listed in this entity set are accepted from another network.

### Parameters

#### **nsfi (mandatory)**

This parameter indicates that the gateway screening process should stop.

#### **Range:**

##### ***stop***

The gateway screening process ends and the message proceeds through normal routing.

#### **sr (mandatory)**

Screening reference. The point code's unique screening reference name.

#### **Range:**

*ayyy*

1 alphabetic character followed by up to 3 alphanumeric characters.

#### **actname (optional)**

Name of the gateway screening stop action set. Stop actions must be administered using this parameter in conjunction with the gateway screening stop action table (see `chg-gws-actset` and `rtrv-gws-actset` ).

#### **Range:**

*ayyyy*

1 alphabetic character followed by up to 5 alphanumeric characters.

#### **area (optional)**

ITU international area. The *area* in the point code represented by *zone-area-id*.

#### **Range:**

*0 - 255, \**

\*—the full range of values from 0–255

#### **id (optional)**

ITU international ID. The *ID* in the point code represented by *zone-area-id*.

#### **Range:**

*0 - 7, \**

\*—the full range of values from 0–7

#### **mna (optional)**

16-bit ITU national main number area. The *mna* in the point code represented by *un-sna-mna*.

**Range:**

0--31, \*

\*--the full range of values from 0--31

**msa (optional)**

24-bit ITU-national main signaling area value. The *msa* of the point code represented by *msa-ssa-sp*.

**Range:**

0 - 255, \*

\*—the full range of values from 0–255

**nc (optional)**

Network cluster value. This parameter specifies one or more *nc* values for the network indicator and network cluster member values specified in the *ni* and *ncm* parameters. It specifies the *nc* of the point code represented by *ni-nc-ncm*.

**Range:**

0 - 255, \*

\*—the full range of values from 0–255

**ncm (optional)**

Network cluster member value. This parameter specifies one or more *ncm* values for the network indicator and network cluster values identified in the *ni* and *nc* parameters. It specifies the *ncm* of the point code represented by *ni-nc-ncm*.

**Range:**

0 - 255, \*

\*—the full range of values from 0–255

**ni (optional)**

Network indicator value. This parameter specifies one or more *ni* values for the network cluster and network cluster member values identified in the *nc* and *ncm* parameters. It specifies the *ni* of the point code represented by *ni-nc-ncm*.

**Range:**

0 - 255, \*

\*—the full range of values from 0–255

**npc (optional)**

ITU national point code.

**Note:**

Gateway screening allows the ITU national point code to be displayed and entered in the database only as a single number. For multiple-part ITU national point codes, see [Converting ITU National Point Code Formats](#) for information on converting the point code format.

**Range:**

0 - 16383, \*

\*—the full range of values from 0–16383

**nsr (optional)**

Next screening reference. This parameter indicates which screening reference in the specified screening category (*nsfi*) is to be used in the screening process.

**Range:**

*ayyy*

1 alphabetic character followed by up to 3 alphanumeric characters

**pcst (optional)**

Point code subtype. This parameter indicates whether the specified ITU international or ITU national point code has no subtype prefix or has the spare point code prefix (S-).

**Range:**

*none*

*s*

**Default:**

*none*

**sna (optional)**

16-bit ITU national sub number area. The *sna* in the point code represented by *un-sna-mna*.

**Range:**

*0--15, \**

\*---the full range of values from 0--15

**sp (optional)**

24-bit ITU national signaling point. The *sp* in the point code represented by *msa-ssa-sp*.

**Range:**

*0 - 255, \**

\*---the full range of values from 0--255

**ssa (optional)**

24-bit ITU national sub signaling area. The *ssa* in the point code represented by *msa-ssa-sp*.

**Range:**

*0 - 255*

\*---the full range of values from 0--255

**un (optional)**

16-bit ITU-national unit number. The *un* of the point code represented by *un-sna-mna*.

**Range:**

*0--127, \**

\*---the full range of values from 0--127

**zone (optional)**

ITU international zone. The *zone* in the point code represented by *zone-area-id*.

**Range:**

0 - 7

\*—the full range of values from 0–7

**Example**

```
ent-scr-destfld:sr=iec:ni=240:nc=010:ncm=010-012:nsfi=stop
ent-scr-destfld:sr=iecl:ni=1:nc=1:ncm=1:nsfi=stop:actname=copy
ent-scr-destfld:sr=dstl:zone=1:area=2:id=3:nsfi=stop:pcst=s
ent-scr-destfld:sr=iec:un=120:sna=10:mna=15:nsfi=stop
```

**Dependencies****▲ Caution:**

Even though gateway screening is in the screen test mode, as defined by the `gwsa=off` and `gws=on` parameters, the gateway screening action in the stop action set specified by the `actname` parameter of the screen set will be performed at the end of the screening process.

The Gateway Screening Rules table can contain a maximum of 360,600 rules.

The destination point code specified by `ni-nc-ncm`, `zone-area-id`, `un-sna-mna`, `msa-ssa-sp`, or the `npc` parameter must not already exist in the screening reference or within an existing range of DPCs.

ANSI point code value 000-000-000 and ITU-International point code value 0-000-0 are not allowed.

If the `actname` parameter is specified, then the `nsfi=stop` parameter must be specified.

The value of the `actname` parameter must already be defined in the Gateway Screening Stop Action table with the `chg-gws-actset` command.

If the `area=*` parameter is specified, then the `id=*` parameter must be specified.

If the `msa=*` parameter is specified, then the `ssa=*` and the `sp=*` parameters must be specified.

If the `un=*` parameter is specified, then the `sna=*` and the `mna=*` parameters must be specified.

If the `nc` parameter is specified as a range, the `ncm` parameter must be specified as an asterisk or as the full range.

If the `nc` parameter is specified as a single value or a range, a single value must be specified for the `ni` parameter.

If the `nc` parameter is specified as an asterisk, the `ncm` parameter must be specified as an asterisk or as the full range.

If the `ncm` parameter is specified as a single value, or a range other than the full range of 0–255, the `ni` and `nc` parameters must be specified with a single value.



If the `ni` parameter is specified as an asterisk or as a range, the `nc` and `ncm` parameters must be specified as an asterisk or as the full range.

The `nsfi=stop` parameter must be specified in the command.

If the `nsfi=stop` parameter is specified, then the `nsr` parameter cannot be specified.

If the `ssa=*` parameter is specified, then the `sp=*` parameter must be specified.

If the `sna=*` parameter is specified, then the `mna=*` parameter must be specified.

If the `zone=*` parameter is specified, then the `area=*` and the `id=*` parameters must be specified.

The Spare Point Code Support feature must be enabled before the `pcst` parameter can be specified.

The spare point code subtype prefix (s-) is not supported for ANSI point codes (parameters `ni`, `nc`, `ncm`) or for 24-bit ITU national point codes (parameters `msa`, `ssa`, `sp`) or for 16-bit ITU national point codes (parameters `un`, `sna`, `mna`). The `pcst` and `npcst` parameters cannot be specified for ANSI, ITU-N16 or ITU-N24 point codes.

If the `nsfi=fail` parameter is specified, then the `nni`, `nc`, `nncm`, `narea`, `nzone`, `nid`, `nmsa`, `nssa`, `nsp`, `nun`, `nsna`, `nmna`, and `npc` parameters cannot have a value of `c`.

The Gateway Screening Stop Action table must be accessible.

The J7 support feature must be enabled before the `un/ sna/ mna` parameters are specified.

The J7 support feature must not be enabled before the `msa/ ssa/ sp` parameters are specified.

The GWSOA parameter combination should be known and valid.

## Notes

A range of values is specified by separating the values that define the range by two ampersands (`&&`); for example, `ni=025&&100` specifies all network indicators for ANSI point codes from 25-100.

An asterisk cannot not be specified for a parameter value in this command unless an asterisk was specified for the parameter value in the original `ent-scr-destfld` command.

The spare point code subtype prefix (s-) is supported only for ITU international and ITU national point codes. The `pcst` parameter indicates whether the specified point code has no subtype prefix or has the spare point code prefix.

There is no feature dependency on ANSI point code parameters, i.e., `ni`, `nc`, `ncm`. The command can be entered successfully whether the J7 feature is enabled or not enabled.

## Output

```
ent-scr-destfld:sr=iec:ni=240:nc=010:ncm=010-012:nsfi=stop
```

```
rlghncxa03w 04-02-13 11:49:47 EST EAGLE 31.3.0
ENT-SCR-DESTFLD: SCREEN SET AFFECTED - IEC 25% FULL
ENT-SCR-DESTFLD: MASP A - COMPLTD
;
```

## Related Topics

- [chg-scr-destfld](#)
- [dlt-scr-destfld](#)
- [rtrv-scr-destfld](#)

# ent-scr-dpc

Use this command to add an allowed DPC screening reference and associated attributes (destination point code, next screening function identifier, next screening function reference) to the allowed DPC entity set. One or more DPCs may be associated with the allowed DPC screening reference. The DPCs listed in this entity set are allowed to receive SS7 messages from another network.

## Parameters

### **nsfi (mandatory)**

This parameter specifies the next screening category that is used in the gateway screening process, or it indicates that the gateway screening process should stop.

#### **Range:**

##### ***blkdpc***

Blocked DPC is the next screening category.

##### ***cgpa***

Allowed CGPA is the next screening category.

##### ***destfld***

Allowed destination field (DESTFLD) is the next screening category.

##### ***isup***

ISUP message type (ISUP) is the next screening category.

##### ***stop***

The gateway screening process ends and the message proceeds through normal routing.

### **sr (mandatory)**

Allowed DPC screening reference name. A set of one or more allowed destination point codes.

**Range:**

ayyy

1 alphabetic character followed by up to 3 alphanumeric characters

**actname (optional)**

Name of the gateway screening stop action set. Stop actions must be administered using this parameter in conjunction with the gateway screening stop action table (see `chg-gws-actset` and `rtrv-gws-actset` ).

**Range:**

ayyyyy

1 alphabetic character followed by up to 5 alphanumeric characters

**area (optional)**

ITU international area. The *area* in the point code represented by *zone-area-id*.

**Range:**

0 - 255, \*, C

\*—the full range of values from 0–255

C—continue

**id (optional)**

ITU international ID. The *ID* in the point code represented by *zone-area-id*.

**Range:**

0 - 7, \*, C

\*—the full range of values from 0–7

C—continue

**mna (optional)**

16-bit ITU national main number area. The *mna* in the point code represented by *un-sna-mna*.

**Range:**

0---31, \*, C

\*---the full range of values from 0--31

C ---continue

**msa (optional)**

24-bit ITU-national main signaling area value. The *msa* of the point code represented by *msa-ssa-sp*.

**Range:**

0 - 255, \*, C

\*—the full range of values from 0–255

C—continue

**nc (optional)**

Network cluster value. This parameter specifies one or more *nc* values for the network indicator and network cluster member values specified in the *ni* and *ncm* parameters. It specifies the *nc* of the point code represented by *ni-nc-ncm*.

**Range:**

000 - 255, \*, C

\*—the full range of values from 0–255

C—continue

**ncm (optional)**

Network cluster member value. This parameter specifies one or more *ncm* values for the network indicator and network cluster values identified in the *ni* and *nc* parameters. It specifies the *ncm* of the point code represented by *ni-nc-ncm*.

**Range:**

0 - 255, \*, C

\*—the full range of values from 0–255

C—continue

**ni (optional)**

Network indicator value. This parameter specifies one or more *ni* values for the network cluster and network cluster member values identified in the *nc* and *ncm* parameters. It specifies the *ni* of the point code represented by *ni-nc-ncm*.

**Range:**

0 - 255, \*, C

\*—the full range of values from 0–255

C—continue

**npc (optional)**

ITU national point code.

**Note:**

Gateway screening allows the ITU national point code to be displayed and entered in the database only as a single number. For multiple-part ITU national point codes, see [Converting ITU National Point Code Formats](#) for information on converting the point code format.

**Range:**

0 - 16383, \*, C

\*—the full range of values from 0–16383

C—continue

**nsr (optional)**

Next screening reference. This parameter indicates which screening reference in the specified screening category (*nsfi*) is to be used in the screening process.

**Range:**

ayyy

1 alphabetic character followed by up to 3 alphanumeric characters

**Default:**

No value given

**pcst (optional)**

Point code subtype. This parameter indicates whether the specified ITU international or ITU national point code has no subtype prefix or has the spare point code prefix (s-).

**Range:**

*none*

**s****Default:***none***sna (optional)**

16-bit ITU national sub number area. The *sna* in the point code represented by *un-sna-mna*.

**Range:**

0--15, \*, C

\*--the full range of values from 0--15

C ---continue

**sp (optional)**

24-bit ITU national signaling point. This parameter specifies the *sp* in the point code represented by *msa-ssa-sp*.

**Range:**

0 - 255, \*, C

\*—the full range of values from 0–255

C—continue

**ssa (optional)**

24-bit ITU national sub signaling area. The *ssa* in the point code represented by *msa-ssa-sp*.

**Range:**

0 - 255, \*, C

\*—the full range of values from 0–255

C—continue

**un (optional)**

16-bit ITU-national unit number. The *un* of the point code represented by *un-sna-mna*.

**Range:**

0--127, \*, C

\*--the full range of values from 0--127

C ---continue

**zone (optional)**

ITU international zone. This parameter specifies the *zone* in the point code represented by *zone-area-id*.

**Range:**

0 - 7, \*, C

\*—the full range of values from 0–7

C—continue

**Example**

```
ent-scr-dpc:sr=iec:ni=240:nc=010:ncm=010:nsfi=stop:actname=cncf
```

```
ent-scr-dpc:sr=iec:ni=240:nc=010:ncm=010:nsfi=blkdpc:nsr=bdp1
```

```
ent-scr-dpc:sr=dpc1:zone=1:area=2:id=3:nsfi=fail:pcst=none
```

```
ent-scr-dpc:sr=dpc1:zone=2:area=2:id=3:nsfi=fail:pcst=s
```

```
ent-scr-dpc:sr=dpc1:npc=128:nsfi=fail:pcst=s
```

```
ent-scr-dpc:sr=dpc2:un=1:sna=2:mna=1:nsfi=stop
```

## Dependencies

### Caution:

Even though gateway screening is in the screen test mode, as defined by the `gwsa=off` and `gws=on` parameters, the gateway screening action in the stop action set specified by the `actname` parameter of the screen set will be performed at the end of the screening process.

The Gateway Screening Rules table can contain a maximum of 360,600 rules.

The destination point code specified by `ni-nc-ncm`, `zone-area-id`, `msa-ssa-sp`, `un-sna-mna`, or the `npc` parameter must not already exist in the screening reference or within an existing range of DPCs.

If the `actname` parameter is specified, then the `nsfi=stop` parameter must be specified.

ANSI point code value 000-000-000 and ITU-International point code value 0-000-0 are not allowed.

The value of the `actname` parameter must already be defined in the Gateway Screening Stop Action table with the `chg-gws-actset` command.

If the `area=*` parameter is specified, then the `id=*` parameter must be specified.

If the `msa=*` parameter is specified, then the `ssa=*` and the `sp=*` parameters must be specified.

If the `un=*` parameter is specified, then the `sna=*` and the `mna=*` parameters must be specified.

If the `nc` parameter is specified as a range, the `ncm` parameter must be specified as an asterisk or as the full range.

If the `nc` parameter is specified as a single value or a range, a single value must be specified for the `ni` parameter.

If the `nc` parameter is specified as an asterisk, the `ncm` parameter must be specified as an asterisk or as the full range.

If the `ncm` parameter is specified as a single value, or a range other than the full range of 0–255, the `ni` and `nc` parameters must be specified with a single value.

If the `ni` parameter is specified as an asterisk or as a range, the `nc` and `ncm` parameters must be specified as an asterisk or as the full range.

The `nsfi` and `nsr` parameters must point to an existing screen, or the `nsfi=stop` parameter must be specified, and the `nsr` parameter cannot be specified.

If the `nsfi=stop` parameter is not specified, then the `nsr` parameter must be specified.

If the `ssa=*` parameter is specified, then the `sp=*` parameter must be specified.

If the `sna=*` parameter is specified, then the `mna=*` parameter must be specified.

If the `zone=*` parameter is specified, then the `area=*` and `id=*` parameters must be specified.

The Spare Point Code Support feature must be enabled before the `pcst` parameter can be specified.

The spare point code subtype prefix (s-) is not supported for ANSI point codes (parameters `ni`, `nc`, `ncm`) or for 24-bit ITU national point codes (parameters `msa`, `ssa`, `sp`) or for 16-bit ITU national point codes (parameters `un`, `sna`, `mna`). The `pcst` parameter cannot be specified for ANSI, ITU-N16 or ITU-N24 point codes.

If the `nsfi=fail` parameter is specified, then the `ni`, `nc`, `ncm`, `area`, `zone`, `id`, `msa`, `ssa`, `sp`, `un`, `sna`, `mna`, and `npc` parameters cannot have a value of `c`.

The value of the `nsfi` parameter must be valid for the BLKDPC entity type.

The Gateway Screening Stop Action table is corrupt or cannot be found.

The J7 support feature must be enabled before the `un/ sna/ mna` parameters are specified.

The J7 support feature must not be enabled before the `msa/ ssa/ sp` parameters are specified.

The GWSOA parameter combination should be known and valid.

## Notes

When a DPC screening reference is created, the first entry for a point code must be `c-c-c`, or `c` for the `npc` parameter. Subsequent entries must be specific point codes.

The character `c` is used in the DPC screens to allow the screening process to continue for messages with point codes that do not match any point codes in the DPC screens. When screening for a DPC and the point code being screened does not match any of the point codes in the DPC screens, the message is not rejected and the screening process continues.

There must be an entry in the DPC screens to allow the screening process to continue. This entry consists of a screening reference, point code, `nsfi`, and `nsr`. The point code is in the form of `npc=c` or subfields equal to `c-c-c`. When the character `c` is specified, the `nsfi` and `nsr` parameters must be specified.

If the character `c` is specified for the parameters `ni-nc-ncm`, `zone-area-id`, `un-sna-mna` or `msa-ssa-sp`, the character `c` is the only value that can be specified for all three parameters. For example, a point code `c-c-255` is not allowed. The asterisk (\*) value cannot be used with the character `c` (for example, a point code `c-c-*` is not allowed).

When the point code does not match any entries in the blocked DPC screens, the screening process is directed to the screening reference with the point code `c-c-c` or `npc=c`. The `nsfi` and `nsr` in this entry are examined to determine the next step in the screening process.

If the current `ni-nc-ncm`, `zone-area-id`, `un-sna-mna` or `msa-ssa-sp` is equal to `c-c-c` or `npc=c`, only the `nsfi` and `nsr` can be changed. Otherwise, only the blocked DPC can be changed.

A range of values is specified by separating the values that define the range by two ampersands (&&); for example, `ni=025&&100` specifies all network indicators for ANSI point codes from 25 - 100 .

An asterisk cannot be specified for a parameter value in this command unless an asterisk was specified for the parameter value in the original `ent-scr-dpc` command.

If the screen set reaches 100% capacity (indicated by the 100% Full message), the system allows subsequent entries. An error occurs, however, when downloading the screen set to an LIM. Ensure that screen sets do not exceed 100% capacity. Remove screen set entries until the capacity is below 100%.

The spare point code subtype prefix (s-) is supported only for ITU international and ITU national point codes. The `pcst` parameter indicates whether the specified point code has no subtype prefix or has the spare point code prefix.

There is no feature dependency on ANSI point code parameters, i.e., `ni`, `nc`, `ncm`. The command can be entered successfully whether the J7 feature is enabled or not enabled.

### Output

```
ent-scr-dpc:sr=iec:ni=240:nc=010:ncm=010:nsfi=stop:actname=cncf
```

```
rlghncxa03w 04-01-07 11:43:04 EST EAGLE 31.3.0
ENT-SCR-DPC: SCREEN SET AFFECTED - IEC 25% FULL
ENT-SCR-DPC: MASP A - COMPLTD
;
```

### Related Topics

- [chg-scr-dpc](#)
- [dlt-scr-dpc](#)
- [rtv-scr-dpc](#)

## ent-scr-isup

Use this command to add an allowed ISUP or TUP screening reference to the Allowed ISUP entity set. One or more message types can be associated with the allowed ISUP screening reference. The ISUP message types listed in this entity set are accepted from another network.

### Parameters

#### **isupmt/tupmt (mandatory)**

ISUP or TUP message type.

#### **Range:**

0 - 255, \*

\*—the full range of values from 0–255

#### **sr (mandatory)**

Individual ISUP screening reference to which this rule will be added. If the specified `sr` does not exist, it will be created.



**Range:***ayyy*

1 alphabetic character followed by up to 3 alphanumeric characters

**actname (optional)**

Name of the gateway screening stop action set. Stop actions must be administered using this parameter in conjunction with the gateway screening stop action table (see `chg-gws-actset` and `rtrv-gws-actset` ).

**Range:***ayyyyy*

1 alphabetic character followed by up to 5 alphanumeric characters

**nsfi (optional)**

This parameter specifies the next screening category that is used in the gateway screening process.

**Range:***stop*

The gateway screening process ends and the message proceeds through normal routing.

**nsr (optional)**

Next screening reference. This parameter indicates which screening reference in the specified screening category (*nsfi*) is to be used in the screening process.

**Range:***ayyy*

1 alphabetic character followed by up to 3 alphanumeric characters

**Example**

```
ent-scr-isup:sr=iec:isupmt=1:nsfi=stop
ent-scr-isup:sr=ibig:isupmt=1&&128:nsfi=stop
ent-scr-isup:sr=iall:isupmt=*:nsfi=stop
ent-scr-isup:tupmt=20:sr=tu01:nsfi=stop
```

**Dependencies**

If the `actname` parameter is specified, the `nsfi=stop` parameter must be specified.

The value of the `actname` parameter must already be defined in the Gateway Screening Stop Action table with the `chg-gws-actset` command.

The specified `isupmt` parameter or `tupmt` parameter value must not already exist in the specified `sr`.

If the `nsfi` parameter is specified, the value must be `stop`.

The `nsr` parameter cannot be specified if the `nsfi=stop` parameter is specified.

The GWSOA parameter combination should be known and valid.

The Gateway Screening Rules table can contain a maximum of 360,600 rules.

## Notes

A range of values can be specified for the `isupmt` or `tupmt` parameter by separating the values that define the range by two ampersands (&&); for example, `isupmt=025&&100` specifies all ISUP message types from 25-100. The value to the left of the && must be less than the value to the right of the && in the range.

An asterisk cannot not be specified for a parameter value in this command unless an asterisk was specified for the parameter value in the original `ent-scr-isup` command.

TUP does not apply to SEAS. ISUP Message Type is the default.

To use TUP message type screening, an SIO screening reference with `si=04` (TUP) must exist in the SIO table. The TUP screening reference specifies the SIO screening reference as the next screening reference parameter (`nsr`) value.

To use ISUP message type screening, an SIO screening reference with `si=05` (ISUP) must exist in the SIO table. The ISUP screening reference specifies the ISUP SIO screening reference as the next screening reference parameter (`nsr`) value.

To screen for TUP and ISUP message types using a combined ISUP/TUP screen set, the SIO screening reference with `si=4` and the SIO screening reference with `si=5` must be two different screening references. The TUP screening reference specifies the SIO screening reference as the next screening reference parameter (`nsr`) value, and the ISUP screening reference specifies the SIO ISUP screening reference as the next screening reference parameter (`nsr`) value.

## Output

When a screen reference is specified that is not yet associated with a screen set, the following output appears:

```
ent-scr-isup:sr=iec:isupmt=1:nsfi=stop

      tekelecstp 04-09-02 09:39:13 EST  EAGLE 31.3.0
      ENT-SCR-ISUP: MASP A - COMPLTD
;

```

When a screen reference is specified that is already associated with one or more screen sets, the following output appears:

```
ent-scr-isup:tupmt=20:sr=tu01:nsfi=stop

      tekelecstp 04-11-17 16:22:27 EST  EAGLE 31.4.0
      Extended Processing Time Required -- Please Wait
      Notice: The number of screensets affected is  2.
      ENT-SCR-ISUP: SCREEN SET AFFECTED - ist1    1% FULL
      ENT-SCR-ISUP: SCREEN SET AFFECTED - ist2    1% FULL
      ENT-SCR-ISUP: MASP A - COMPLTD
;

```

**Related Topics**

- [chg-scr-isup](#)
- [dlt-scr-isup](#)
- [rtrv-scr-isup](#)

## ent-scr-opc

Use this command to add an allowed OPC screening reference and associated attributes (originating point code, next screening function identifier, next screening function reference) to the allowed OPC entity set. One or more OPCs may be associated with the allowed OPC screening reference. Each OPC listed in this entity set is allowed to send SS7 messages to the customer's network.

**Parameters****nsfi (mandatory)**

This parameter specifies the next screening category that is used in the gateway screening process, or it indicates that the gateway screening process should stop.

**Range:*****blkdpc***

Blocked DPC is the next screening category.

***blkopc***

Blocked OPC is the next screening category.

***cgpa***

Allowed CGPA is the next screening category.

***dpc***

Allowed DPC is the next screening category.

***sio***

Allowed SIO is the next screening category.

***stop***

The gateway screening process ends and the message proceeds through normal routing.

**sr (mandatory)**

Screening reference. A set of one or more allowed OPCs.

**Range:**

*ayyy*

1 alphabetic character followed by up to 3 alphanumeric characters

**actname (optional)**

Name of the gateway screening stop action set. Stop actions must be administered using this parameter in conjunction with the gateway screening stop action table (see `chg-gws-actset` and `rtrv-gws-actset` ).

**Range:**

ayyyy

1 alphabetic character followed by up to 5 alphanumeric characters

**area (optional)**ITU international area. The *area* in the point code represented by *zone-area-id*.**Range:**

0 - 255, \*, C

\*—the full range of values from 0–255

C—continue

**id (optional)**ITU international ID. The *ID* in the point code represented by *zone-area-id*. A**Range:**

0 - 7, \*, C

\*—the full range of values from 0–7

C—continue

**mna (optional)**16-bit ITU national main number area. The *mna* in the point code represented by *un-sna-mna*.**Range:**

0--31, \*, C

\*--the full range of values from 0--31

C—continue

**msa (optional)**24-bit ITU-national main signaling area value. The *msa* of the point code represented by *msa-ssa-sp*.**Range:**

0 - 255, \*, C

\*—the full range of values from 0–255

C—continue

**nc (optional)**Network cluster value. This parameter specifies one or more *nc* values for the network indicator and network cluster member values specified in the *ni* and *ncm* parameters. It specifies the *nc* of the point code represented by *ni-nc-ncm*.**Range:**

0 - 255, \*, C

\*—the full range of values from 0–255

C—continue

**ncm (optional)**Network cluster member value. This parameter specifies one or more *ncm* values for the network indicator and network cluster values identified in the *ni* and *nc* parameters. It specifies the *ncm* of the point code represented by *ni-nc-ncm*.**Range:**

0 - 255, \*, C

\*—the full range of values from 0–255  
C—continue

**ni (optional)**

Network indicator value. This parameter specifies one or more *ni* values for the network cluster and network cluster member values identified in the *nc* and *ncm* parameters. It specifies the *ni* of the point code represented by *ni-nc-ncm*.

**Range:**

0 - 255, \*, C

\*—full range of values from 0-255

C—continue

**npc (optional)**

ITU national point code.

**Note:**

Gateway screening allows the ITU national point code to be displayed and entered in the database only as a single number. For multiple-part ITU national point codes, see [Converting ITU National Point Code Formats](#) for information on converting the point code format.

**Range:**

0 - 16383, \*, C

\*—full range of values from 0-255

C—continue

**nsr (optional)**

Next screening reference. This parameter indicates which screening reference in the specified screening category (*nsfi*) is to be used in the screening process.

**Range:**

*ayyy*

1 alphabetic character followed by up to 3 alphanumeric characters

**Default:**

No value given

**pcst (optional)**

Point code subtype. This parameter indicates whether the specified ITU international or ITU national point code has no subtype prefix or has the spare point code prefix (S-).

**Range:**

*none*

*s*

**Default:**

*none*

**sna (optional)**

16-bit ITU national sub number area. The *sna* in the point code represented by *un-sna-mna*.

**Range:**

0---15, \*, C

\*---the full range of values from 0--15

C—continue

**sp (optional)**

24-bit ITU national signaling point. The *sp* in the point code represented by *msa-ssa-sp*.

**Range:**

0 - 255, \*, C

\*—full range of values from 0-255

C—continue

**ssa (optional)**

24-bit ITU national sub signaling area. The *ssa* in the point code represented by *msa-ssa-sp*.

**Range:**

0 - 255, \*, C

\*—full range of values from 0-255

C—continue

**un (optional)**

16-bit ITU-national unit number. The *un* of the point code represented by *un-sna-mna*.

**Range:**

0---127, \*, C

\*---the full range of values from 0--127

C—continue

**zone (optional)**

ITU international zone. The *zone* in the point code represented by *zone-area-id*.

**Range:**

0 - 7, \*, C

\*—full range of values from 7

C—continue

**Example**

```
ent-scr-opc:sr=iec:nsfi=stop
```

```
ent-scr-opc:sr=iec:ni=240:nsfi=sio:nsr=iec
```

```
ent-scr-opc:sr=iec:ni=240:nc=010:ncm=010:nsfi=stop:actname=copy
```

```
ent-scr-opc:sr=iec:ni=240:nc=010:ncm=010:nsfi=dpc:nsr=iec
```

```
ent-scr-opc:sr=opc1:zone=1:area=2:id=3:nsfi=fail:pcst=none
```

```
ent-scr-opc:sr=opc1:zone=2:area=2:id=3:nsfi=fail:pcst=s
```

```
ent-scr-opc:sr=opc1:npc=128:nsfi=fail:pcst=s
```

```
ent-scr-opc:sr=opc2:un=1:sna=2:mna=1:nsfi=stop
```

## Dependencies

### ▲ Caution:

Even though gateway screening is in the screen test mode, as defined by the `gwsa=off` and `gwsn=on` parameters, the gateway screening action in the stop action set specified by the `actname` parameter of the screen set will be performed at the end of the screening process.

The Gateway Screening Rules table can contain a maximum of 360,600 rules.

A complete point code must be specified, using the `ni-nc-ncm`, `zone-area-id`, `msa-ssa-sp`, `un-sna-mna` or `npc` combination unless a value of `c` is specified.

The OPC specified by `ni-nc-ncm`, `zone-area-id`, `msa-ssa-sp`, `un-sna-mna` or the `npc` parameter must already exist in the screening reference or within an existing range of OPCs.

ANSI point code value 000-000-000 and ITU-International point code value 0-000-0 are not allowed.

If the `actname` parameter is specified, then the `nsfi=stop` parameter must be specified.

The value of the `actname` parameter must already be defined in the Gateway Screening Stop Action table with the `chg-gws-actset` command.

If the `area=*` parameter is specified, then the `id=*` parameter must be specified.

If the `msa=*` parameter is specified, then the `ssa=*` and the `sp=*` parameters must be specified.

If the `un=*` parameter is specified, then the `sna=*` and the `mna=*` parameters must be specified.

If the `nc` parameter is specified as a range, the `ncm` parameter must be specified as an asterisk or as the full range.

If the `nc` parameter is specified as a single value or a range, a single value must be specified for the `ni` parameter.

If the `nc` parameter is specified as an asterisk, the `ncm` parameter must be specified as an asterisk or as the full range.

If the `ncm` parameter is specified as a single value, or a range other than the full range of 0–255, the `ni` and `nc` parameters must be specified with a single value.

If the `ni` parameter is specified as an asterisk or as a range, the `nc` and `ncm` parameters must be specified as an asterisk or as the full range.

The `nsfi` and `nsr` parameters must point to an existing screen, or the `nsfi=stop` parameter must be specified, and the `nsr` parameter cannot be specified.

If the `nsfi=stop` parameter is not specified, then the `nsr` parameter must be specified.

The `nsr` parameter must be specified if `nsfi` is not equal to `stop`.

If the `ssa=*` parameter is specified, then the `sp=*` parameter must be specified.

If the `sna=*` parameter is specified, then the `mna=*` parameter must be specified.

If the `zone=*` parameter is specified, then the `area=*` and `id=*` parameters must be specified.

The Spare Point Code Support feature must be enabled before the `pcst` parameter can be specified.

The spare point code subtype prefix (s-) is not supported for ANSI point codes (parameters `ni`, `nc`, `ncm`) or for 24-bit ITU national point codes (parameters `msa`, `ssa`, `sp`) or for 16-bit ITU national point codes (parameters `un`, `sna`, `mna`). The `pcst` parameter cannot be specified for ANSI, ITU-N16 or ITU-N24 point codes.

If the `nsfi=fail` parameter is specified, then the `nni`, `nc`, `ncm`, `narea`, `nzone`, `nid`, `nmsa`, `nssa`, `nsp`, `nun`, `nsna`, `nmna`, and `npc` parameters cannot have a value of `c`.

The value of the `nsfi` parameter must be valid for the OPC entity type.

The Gateway Screening Stop Action table is corrupt or cannot be found.

The J7 support feature must be enabled before the `un/ sna/ mna` parameters are specified.

The J7 support feature must not be enabled before the `msa/ ssa/ sp` parameters are specified.

The GWSOA parameter combination should be known and valid.

## Notes

When an OPC screening reference is created, the first entry for a point code must be `c-c-c` or `c` for the `npc` parameter. Subsequent entries must be specific point codes.

The character `c` is used in the OPC screens to allow the screening process to continue for messages with point codes that do not match any point codes in the OPC screens. When screening for a DPC and the point code being screened does not match any of the point codes in the DPC screens, the message is not rejected and the screening process continues.

There must be an entry in the OPC screens to allow the screening process to continue. This entry consists of a screening reference, point code, `nsfi`, and `nsr`. The point code is in the form of `npc=c` or subfields equal to `c-c-c`. When the character `c` is specified, the `nsfi` and `nsr` parameters must be specified.

If the character `c` is specified for the parameters `ni-nc-ncm`, `zone-area-id`, `un-sna-mna` or `msa-ssa-sp`, the character `c` is the only value that can be specified for all three parameters. For example, a point code `c-c-255` is not allowed. The point code must be `c-c-c`. The asterisk value cannot be used with the character `c` (for example, a point code `c-c-*` is not allowed).

When the point code does not match any entries in the blocked OPC screens, the screening process is directed to the screening reference with the point code `c` or `npc=c`. The `nsfi` and `nsr` in this entry are examined to determine the next step in the screening process.



If the current `ni-nc-ncm`, `zone-area-id`, `un-sna-mna` or `msa-ssa-sp` is equal to `c-c-c` or `npc=c`, only the `nsfi` and `nsr` can be changed. Otherwise, only the OPC can be changed.

A range of values is specified by separating the values that define the range by two ampersands (&&); for example, `ni=025&&100` specifies all network indicators for ANSI point codes from 25 - 100.

An asterisk cannot not be specified for a parameter value in this command unless an asterisk was specified for the parameter value in the original `ent-scr-opc` command.

If the screen set reaches 100% capacity (indicated by the 100% Full message), the system allows subsequent entries. An error occurs, however, when downloading the screen set to an LIM. Ensure that screen sets do not exceed 100% capacity. Remove screen set entries until the capacity is below 100%.

The spare point code subtype prefix (s-) is supported only for ITU international and ITU national point codes. The `pcst` parameter indicates whether the specified point code has no subtype prefix or has the spare point code prefix.

There is no feature dependency on ANSI point code parameters, i.e., `ni`, `nc`, `ncm`. The command can be entered successfully whether the J7 feature is enabled or not enabled.

### Output

```
ent-scr-opc:sr=iec:nsfi=stop
```

```
rlghncxa03w 04-01-07 11:43:04 EST EAGLE 31.3.0
ENT-SCR-OPC: SCREEN SET AFFECTED - IEC 25% FULL
ENT-SCR-OPC: MASP A - COMPLTD
;
```

### Related Topics

- [chg-scr-opc](#)
- [dlt-scr-opc](#)
- [rtrv-scr-opc](#)

## ent-scr-sio

Use this command to add an allowed SIO screening reference and associated attributes (network indicator, service indicator, message priority, H0 heading code, H1 heading code, next screening function identifier, next screening function reference) to the allowed SIO entity set.

 **Note:**

To use TUP message type screening, an SIO screening reference with `si=04` (TUP) must be defined in the SIO table. This SIO screening reference is specified in the `ent-scr-isup` command as the next screening reference (`nsr`) value in a screening reference for TUP message types

**Parameters****nic (mandatory)**

Network indicator code. NIC for the SIO screening reference specified in the `sr` parameter. The NIC is the last 2 bits of the subservice field of an SIO.

**Range:**

0 - 3, \*

\*—full range of values from 0-3

**nsfi (mandatory)**

This parameter specifies the next screening category that is used in the gateway screening process, or it indicates that the gateway screening process should stop.

**Range:*****blkdpc***

Blocked DPC is the next screening category.

***cdpa******cgpa***

Allowed CGPA is the next screening category.

***destfld***

Allowed destination field (DESTFLD) is the next screening category.

***dpc***

Allowed DPC is the next screening category.

***isup***

ISUP message type (ISUP) is the next screening category.

***stop***

The gateway screening process ends and the message proceeds through normal routing.

**pri (mandatory)**

Message priority. A single priority, or the beginning of a range of priorities for the SIO screening reference specified by the `sr` parameter .

**Range:**

0 - 3, \*

\*—full range of values from 0-3

**si (mandatory)**

Service indicator. SI for the SIO screening reference specified in the `sr` parameter. The SI is the first 4 bits of an SIO. The SS7 code directs the message to the MTP-user at the destination code.

**Range:**

00 - 15

**sr (mandatory)**

The allowed SIO screening reference name. This parameter specifies a set of one or more `si/nic/pri` combinations.

**Range:**

ayyy

1 alphabetic character followed by up to 5 alphanumeric characters

**actname (optional)**

Name of the gateway screening stop action set. Stop actions must be administered using this parameter in conjunction with the gateway screening stop action table (see `chg-gws-actset` and `rtrv-gws-actset` ).

**Range:**

ayyyyy

1 alphabetic character followed by up to 5 alphanumeric characters

**h0 (optional)**

H0 heading code. New H0 heading code for the screening reference specified in the `sr` parameter.

**Range:**

0 - 15, \*

\*—full range of values from 0-15

**Default:**

Value given if `si` value is 00, 01, 02

**h1 (optional)**

H1 Heading Code. H1 heading code for the screening reference specified in the `sr` parameter.

**Range:**

0 - 15, \*

\*—full range of values from 0-15

**Default:**

Value given if `si` value is 00, 01, 02

**nsr (optional)**

Next screening reference. This parameter specifies which screening reference in the specified screening category (`nsfi`) is to be used in the screening process.

**Range:**

ayyy

1 alphabetic character followed by up to 3 alphanumeric characters

**Example**

```
ent-scr-sio:sr=iec:nic=1:si=1:h0=01&&03:h1=*:pri=*:nsfi=dpc:nsr=abc
ent-scr-sio:sr=iec:nic=1:si=3:pri=2:nsfi=stop
ent-scr-sio:sr=iec:nic=1:si=4:pri=3:nsfi=stop:actname=cncf
```

**Dependencies****▲ Caution:**

Even though gateway screening is in the screen test mode, as defined by the `gwsa=off` and `gwsn=on` parameters, the gateway screening action in the stop action set specified by the `actname` parameter of the screen set will be performed at the end of the screening process.

If the `actname` parameter is specified, then the `nsfi=stop` parameter must be specified.

The value of the `actname` parameter must already be defined in the Gateway Screening Stop Action table with the `chg-gws-actset` command.

If the `si` parameter is equal to 00, 01, or 02, the `h0` and `h1` parameters must be specified. Otherwise, the `h0` parameter cannot be specified.

Valid combinations for the `h0/h1` and `nh0/nh1` parameters are:

- `h0` is a single value—`h1` can be a single value, range, or an asterisk
- `h0` is a range—`h1` can be an asterisk
- `h0` is an asterisk—`h1` can be an asterisk

If the screening reference exists, the `nic`, `si`, `h0/h1`, and priorities to be added to the allowed SIO entity set for the SIO screening reference cannot exist in that allowed SIO entity set.

If asterisks or ranges are specified for the heading codes, nothing that matches the combination of `nic`, `si`, and the specified heading codes can already exist in the allowed SIO entity set for the screening reference.

If the screening reference does not exist, a new screening reference for the allowed SIO entity set is created.

The `nsfi` and `nsr` parameters must point to an existing screen, or the `nsfi=stop` parameter must be specified, and the `nsr` parameter cannot be specified.

The values specified for the `nsfi` and `si` parameters must meet the mapping requirements as shown:

- `nsfi=destfld` — `si=00`
- `nsfi=cdpa` — `si=03`
- `nsfi=cgpa` — `si=03`
- `nsfi=isup` — `si=05`

Use [Table 4-36](#) to determine the acceptable combination of the specified parameter values:

**Table 4-36 Additional Valid ent-scr-sio Parameter Combinations**

si value:	nic value	pri value	h0 value:	h1 value:
00	s, *	s, *, r	s	s, *, r
00	s, *	s, *, r	*, r	*
01, 02	s, *	s, *, r	s	s, *, r
01, 02	s, *	s, *, r	*, r	*
03-15	s, *	s, *, r	u	u
<b>Legend</b>				
<ul style="list-style-type: none"> <li>• s = single value</li> <li>• r = range</li> <li>• * = asterisk</li> <li>• u = unspecified</li> </ul>				

The Gateway Screening Stop Action table must be accessible.

If the `nsfi` parameter has a value other than `stop` or `fail`, the `nsr` parameter must be specified and must exist.

If the `nsfi=stop` parameter is specified, then the `nsr` parameter must be specified.

If the `si` parameter is greater than 2, the `h0` and `h1` parameters must not be specified.

The Gateway Screening Rules table can contain a maximum of 360,600 rules.

The GWSOA parameter combination should be known and valid.

For SEAS commands, the `pri` parameter specified must be in the range 0-3, \*.

For SEAS commands, the `h0` parameter specified must be in the range 0-15, \*.

For SEAS commands, the `h1` parameter specified must be in the range 0-15, \*.

### Notes

A range of values is specified by separating the values that define the range by two ampersands (&&); for example, `pri=0&&2` specifies all message priorities for the range 0 - 2.

If the screen set reaches 100% capacity (indicated by the **100% Full** message), the system will allow subsequent entries. An error will occur, however, when downloading the screen set to a LIM. Screen sets should not exceed 100% capacity. Remove screen set entries until the capacity is below 100%.

To use TUP message type screening, an SIO screening reference with `si=04` (TUP) must be defined in the SIO table. To use ISUP message type screening, a rule with `si=05` (ISUP) must be defined in the SIO table. To use a combined ISUP/TUP screen set for TUP and ISUP message screening, the SIO screening reference with `si=4` and the SIO screening reference with `si=5` must be two different screening references.

The `h0` and `h1` parameters cannot be specified if `si` is not equal to 00, 01, or 02.

An asterisk cannot not be specified for a parameter value in this command unless an asterisk was specified for the parameter value in the original `ent-scr-sio` command.

### Output

```
ent-scr-sio:sr=iec:nic=1:si=1:h0=01&&03:h1=*:pri=*:nsfi=dpc:nsr=abc
```

```
rlghncxa03w 04-02-14 16:45:50 EST EAGLE 31.3.0
ENT-SCR-SIO: SCREEN SET AFFECTED - SS01 25% FULL
ENT-SCR-SIO: SCREEN SET AFFECTED - SS04 35% FULL
ENT-SCR-SIO: MASP A - COMPLTD
```

```
;
```

### Related Topics

- [chg-scr-sio](#)
- [dlt-scr-sio](#)
- [rtrv-scr-sio](#)

## ent-scr-tt

Use this command to add a specific allowed translation type (TT) screening reference in the TT entity set.

### Parameters

#### **nsfi (mandatory)**

This parameter specifies the next screening category that is used in the gateway screening process, or it indicates that the gateway screening process should stop.

#### **Range:**

##### ***cdpa***

Allowed CDPA is the next screening category.

##### ***stop***

The gateway screening process ends and the message proceeds through normal routing.

#### **sr (mandatory)**

Screening reference. The point code's unique screening reference name.

#### **Range:**

*ayyy*

1 alphabetic character followed by up to 3 alphanumeric characters

#### **type (mandatory)**

Translation type. The GTT type value in the CdPA. This value is the decimal representation of the 1-byte field used in SS7.

**Range:**

000 - 255, \*

\*—full range of values from 0-255

**actname (optional)**

The name of the gateway screening stop action set. Stop actions must be administered using this parameter in conjunction with the gateway screening stop action table (see `chg-gws-actset` and `rtrv-gws-actset` ).

**Range:**

ayyyy

1 alphabetic character followed by up to 5 alphanumeric characters.

**nsr (optional)**

Next screening reference. This parameter indicates which screening reference in the specified screening category (`nsfi`) is to be used in the screening process.

**Range:**

ayyy

1 alphabetic character followed by up to 3 alphanumeric characters

**Default:**

No value given

**Example**

```
ent-scr-tt:sr=iec:type=012:nsfi=cdpa:nsr=wr5
```

```
ent-scr-tt:sr=iec:type=012:nsfi=stop:actname=copy
```

**Dependencies****▲ Caution:**

Even though gateway screening is in the screen test mode, as defined by the `gwsa=off` and `gws=on` parameters, the gateway screening action in the stop action set specified by the `actname` parameter of the screen set will be performed at the end of the screening process.

If the screening reference is valid, but does not exist, a new TT screen is created.

If the screening reference exists, a new rule is added to the TT screening table.

An asterisk cannot not be specified for a parameter value in this command unless an asterisk was specified for the parameter value in the original `ent-scr-tt` command.

If the `actname` parameter is specified, the `nsfi=stop` parameter must be specified.

The value of the `actname` parameter must already be defined in the Gateway Screening Stop Action table with the `chg-gws-actset` command.

If the `nsfi=stop` parameter is specified, the `nsr` parameter cannot be specified.

If the `nsfi` parameter has a value other than `stop`, the `nsr` parameter must be specified.

If the `nsr` parameter is specified, the specified screening reference must exist.

If the screening reference (`sr`) exists, the single value or range specified for the allowed `type` to be added to the TT screen for the allowed TT screening reference must not already exist in that TT screen.

If an asterisk is specified for the allowed `type`, nothing can already exist in the TT screen for the screening reference.

The Gateway Screening Stop Action table is corrupt or cannot be found.

The specified value for the `nsfi` parameter is not valid for TT screen.

The screen referenced by `sfi` and `nsr` must already exist.

The Gateway Screening Rules table can contain a maximum of 360,600 rules.

The value specified for the `type` parameter must be within the allowed range.

The GWSOA parameter combination should be known and valid.

### Notes

If the screen set reaches 100% capacity (indicated by the 100% Full message), the system will allow subsequent entries. An error will occur, however, when downloading the screen set to a LIM. Screen sets should not exceed 100% capacity. Remove screen set entries until the capacity is below 100%.

### Output

```
ent-scr-tt:sr=iec:type=012:nsfi=cdpa:nsr=wr5
```

```
rlghncxa03w 04-01-07 11:43:04 EST EAGLE 31.3.0
ENT-SCR-TT: SCREEN SET AFFECTED - IEC 25% FULL
ENT-SCR-TT: MASP A - COMPLTD
```

```
;
```

### Related Topics

- [chg-scr-tt](#)
- [dlt-scr-tt](#)
- [rtrv-scr-tt](#)

## ent-scrset

Use this command to create a new screen set and point it to its first screen. A screen set is a set of screens (filters) that can be assigned to a linkset. SS7 messages transmitted on a linkset assigned to a screen set require screening by the system, if screening is enabled.

### Parameters

#### **nsfi (mandatory)**

This parameter specifies the next screening category that is used in the gateway screening process, or it indicates that the gateway screening process should stop.



**Range:*****blkdpc***

Blocked DPC is the next screening category.

***blkopc***

Blocked OPC is the next screening category.

***dpc***

Allowed DPC is the next screening category.

***opc***

Allowed OPC is the next screening category.

***sio***

Allowed SIO is the next screening category.

***stop***

The gateway screening process ends and the message proceeds through normal routing.

**scrn (mandatory)**

Screenset name.

**Range:**

*ayyy*

1 alphabetic character followed by up to 3 alphanumeric characters

**actname (optional)**

The name of the gateway screening stop action set. Stop actions must be administered using the *actname* parameter in conjunction with the gateway screening stop action table (see `chg-gws-actset` and `rtrv-gws-actset` ).

**Range:**

*ayyyyy* 1 alphabetic character followed by up to 5 alphanumeric characters.

**destfld (optional)**

This parameter turns on and off the automatic allowed affected destination screening for network management messages against the routing table, self point codes, and capability point codes. When this parameter is ON, the automatic screening is applied at the end of the provisioned screen set.

**Range:**

*yes*

*no*

**Default:**

*yes*

**nsr (optional)**

Next screening reference. This parameter indicates which screening reference in the specified screening category (*nsfi*) is to be used in the screening process.

**Range:**

ayyy

1 alphabetic character followed by up to 3 alphanumeric characters

**Default:**

No value given

**Example**

```
ent-scrset:scrn=ss01:nsfi=opc:nsr=iec
ent-scrset:scrn=ss02:nsfi=stop
ent-scrset:scrn=empt:nsfi=stop:destfld=yes
ent-scrset:scrn=scl1:nsfi=stop:actname=copy
```

**Dependencies**

Even though gateway screening is in the screen test mode, as defined by the parameters `gwsa=off` and `gws=on`, the gateway screening action in the stop action set specified by the `actname` parameter of the screen set will be performed at the end of the screening process.

The `nsfi=stop` parameter must be specified before the `actname` parameter can be specified.

The value of the `actname` parameter must already be defined in the Gateway Screening Stop Action table with the `chg-gws-actset` command. These values are shown in the `ACT NAME` field of the `rtrv-gws-actset` command output.

If the `nsfi=stop` parameter is specified, then the `nsr` parameter cannot be specified.

The specified screen set name cannot be in use by another screen set.

A maximum of 63 user-defined screen sets can be defined in the database.

The `nsfi` and `nsr` parameters must point to one or more existing entities in another entity set, or the `nsfi=stop` parameter must be specified, and the `nsr` parameter cannot be specified.

If the `nsfi=stop` parameter is not specified, then the `nsr` parameter must be specified.

The Gateway Screening (GWS) Stop Action Set table must be accessible.

The `nsfi` parameter must be valid for the SCRSET entity.

The Gateway Screening (GWS)/Global Title Translation (GTT) shared database resource (DBMM.TBL) cannot be full.

The GWSOA parameter combination should be known and valid.

**Notes**

Entering a new screen set may take a few minutes of processor time. The following message appears in the scroll area:

```
Extended processing time required-please wait
```

If the screen set reaches 100% capacity (indicated by the 100% Full message), the system will allow subsequent entries. An error will occur, however, when downloading the screen set to a LIM. Screen sets should not exceed 100% capacity. Remove screen set entries until the capacity is below 100%.

### Output

```
ent-scrset:scrn=ss01:nsfi=opc:nsr=iec
```

```
rlghncxa03w 04-01-07 11:43:04 EST EAGLE 31.3.0
ENT-SCRSET:  SCREEN SET AFFECTED - SS01  25% FULL
ENT-SCRSET:  MASP A - COMPLTD
;
```

### Related Topics

- [chg-scrset](#)
- [dlt-scrset](#)
- [rtrv-scrset](#)

## ent-serial-num

Use this command to enter and lock the NT serial number into the database for an EAGLE STP.

You must enter the serial number at least once without specifying the *lock* parameter. As long as you enter the command without the *lock* parameter, you can enter the system serial number as many times as needed. After the correct serial number is entered, you must use the *lock=yes* parameter to lock the serial number table. You cannot change the serial number with administration commands after the table is locked.

### Parameters

#### **serial (mandatory)**

The system NT Serial Number.

#### **Range:**

aayyyyyyy

Up to 10 alphanumeric characters; mixed case is allowed.

The first two characters (the prefix) must be letters. The remaining characters must be numbers. The serial number cannot contain spaces or special characters.

#### **lock (optional)**

This parameter is used to lock the Serial Number table when the serial number is entered for the system.

**▲ Caution:**

After the serial number is locked, you cannot enter it again or change it in the database. You can use the command without the `lock` parameter to enter the serial number as many times as needed; then enter the command with the `lock` parameter and the correct serial number to lock the serial number table.

**Range:**

`yes`

**Default:**

Not locked

**Example**

```
ent-serial-num:serial=nt00000123
ent-serial-num:serial=nt00000123:lock=yes
```

**Dependencies**

The serial number must be entered at least once without specifying the `lock` parameter.

The system serial number that is entered when the `lock` parameter is specified must match the serial number that was previously entered in the Serial Number table by using the command without the `lock` parameter.

The system serial number cannot be entered again after the Serial Number table is locked.

The system serial number must start with two alphabetical characters.

The format of the serial number should be AANNNNNNNN where NNNNNNNN must be numeric digits (0 - 9).

The format of the serial number needs to be 2 alphabetical letters followed by 8 numbers (e.g., NT01234567.)

**Notes**

None

**Output**

```
ent-serial-num:serial=nt00000123

rlghncxa03w 04-01-05 16:40:40 EST EAGLE 31.3.0
ENT-SERIAL-NUM: MASP A - COMPLTD
;
```

**Related Topics**

- [rtrv-serial-num](#)

## ent-shlf

Use this command to add an equipment shelf to the database.

### Parameters

#### **loc (mandatory)**

The location of the shelf.

##### **Range:**

*1200, 1300, 2100, 2200, 2300, 3100, 3200, 3300, 4100, 4200, 4300, 5100, 5200, 5300, 6100, 6200, 6300*

#### **type (mandatory)**

The type of equipment shelf to be configured.

##### **Range**

*ext, fpb*

#### **fan (optional)**

This parameter turns ON/OFF the FAN option. If it is turned ON, the FAN power for this shelf will be added to the Frame Power Budget.

##### **Range**

*off,*

*on*

### Example

```
ent-shlf:type=ext:loc=1200
ent-shlf:type=imtswh:loc=6100
ent-shlf:type=fpb:loc=6200:fan=on
```

### Dependencies

The frame and shelf values of the shelf location parameter (`loc`) must be within the valid range (`xyzz`, where `x`=frame and `y`=shelf; `zz` is always `00` for this command).

The specified shelf location must not have been configured previously.

The Shelf table is corrupt or cannot be found by the system.

A shelf cannot be provisioned at location 1100. This location is reserved for the control shelf.

The shelf locations 6200 and 6300 are reserved for shelf type FPB only. However, shelf with `type=fpb` can be provisioned in any shelf location from 1200 to 6300.

### Notes

None

## Output

```
ent-shlf:type=ext:loc=1200

    rlghncxa03w 04-01-07 11:11:28 EST  EAGLE 31.3.0
    ENT-SHLF: MASP A - COMPLTD
;

ent-shlf:type=fpb:loc=6300:fan=on

tekelecstp 03-09-12 11:11:28 EST  EAGLE 45.0.0
ENT-SHLF: MASP A - COMPLTD
;
```

## Related Topics

- [dlt-shlf](#)
- [rtrv-shlf](#)

# ent-sid

Use this command to define additional true point codes for an STP. This command allows newly defined true point codes to be distributed to the cards without requiring system initialization.

## Parameters

### **pc (optional)**

ANSI point code with subfields *network indicator-network cluster-network cluster member (ni-nc-ncm)*.

#### **Synonym:**

*pca*

#### **Range:**

*000-255*

Specify a valid value for each subfield of the point code, and separate the subfields with a dash (-).

When `chg-sid:pctype=ansi` is specified, *ni = 000* is not valid.

When `chg-sid:pctype=ansi` is specified, *nc = 000* is not valid if *ni = 001–005*.

When `chg-sid:pctype=ansi` is specified, *nc = 000* is valid if *ni = 006–255*.

The point code *000-000-000* is not a valid point code.

### **pc/pca/pci/pcn/pcn24/pcn16 (optional)**

STP true point code.

### **pci (optional)**

ITU international point code with subfields *zone-area-id*. The *prefix* subfield indicates a spare point code (*prefix-zone-area-id*).

**Range:***s*-, 0-255

Specify a valid value for each subfield of the point code, and separate the subfields with a dash (-).

*prefix*—*s**zone*—0-7*area*—000-255*id*—0-7

The point code 0-000-0 is not a valid point code.

**pcn (optional)**

ITU national point code in the format of a 5-digit number (*nnnnn*); or 2, 3, or 4 numbers (members) separated by dashes (*m1-m2-m3-m4*) as defined by the `chg-stpopts:npcfmti` flexible point code option. A group code must be specified when the ITUDUPPC feature is turned on (*nnnnn-gc*, *m1-m2-m3-m4-gc*). The *prefix* subfield indicates a spare point code (*prefix-nnnnn*, *prefix-nnnnn-gc*, *prefix-m1-m2-m3-m4*, *prefix-m1-m2-m3-m4-gc*).

**Range:***s*-, 0-16383, *aa-zz*

Specify a valid value for each subfield of the point code, and separate the subfields with a dash (-).

*prefix*—*s*-*nnnnn*—0-16383*gc*—*aa-zz**m1-m2-m3-m4*—0-14 for each member; values must sum to 14**pcn24 (optional)**

24-bit ITU national point code with subfields *main signaling area-sub signaling area-signaling point* (*msa-ssa-sp*).

**Range:**

000-255

Specify a valid value for each subfield of the point code, and separate the subfields with a dash (-).

*msa*—000-255*ssa*—000-255*sp*—000-255**pcn16 (optional)**

16-bit ITU national point code with subfields *unit number sub number area main number area* (*un-sna-mna*).

**Range:**

000---127

Specify a valid value for each subfield of the point code, and separate the subfields with a dash (-).

*un*---000---127*sna*---000---15*mna*---000---31

### Example

To create a site identification STP PC for ITU-N and ITU-I:

```
ent-sid:pcn=123:pci=1-1-1
```

To create a site identification STP PC for ITU-N Spare and ITU-I Spare:

```
ent-sid:pcn=s-123:pci=s-1-1-1
```

To create a site identification STP PC for ITU-N16:

```
ent-sid:pcn16=125-1-6
```

### Dependencies

At least one optional parameter must be specified.

The Spare Point Code Support feature must be enabled before an ITU-I or ITU-N spare point code can be specified.

If the system is configured for ANSI format point codes, the specified network indicator value (*ni*) of the `pc` parameter must be 6 or greater when the specified cluster value is 0 (*nc*).

The `pcn` and `pcn24` parameters cannot be specified together in the command.

The specified STP point code must not have been previously defined as a capability point code.

An STP point code cannot exist that is the same type (ANSI, ITU-I, ITU-N, ITU-N24, ITU-N16, ITU-ISpare, or ITU-NSpare) as the specified STP point code or must not have been previously defined as a capability point code.

The value of the `pc/pca/pci/pcn/pcn24/pcn16` parameter must be a full point code.

The SID table is corrupt or cannot be found.

ITU-N STP destination point codes can be specified only as full point codes.

Invalid parameter was specified.

ANSI or ITUN-24 SID cannot be provisioned if the J7 feature is enabled.

### Notes

The SID Table can simultaneously contain the node's true point codes of any following point code types: ANSI, ITU-I, ITU-N or ITU-N24, ITU-ISpare, and ITU-NSpare. (Only ITU-N or ITU-N24, not both, can be defined in the SID Table.)

In this command, only ITU-international and ITU national point codes support the spare point code subtype prefix ( `s-` ).

Feature 53120 introduces Spare Point Code Support.

When the J7 feature is enabled, ANSI and ITUN-24 point codes are not allowed for the SID table.



## Output

```
ent-sid:pcn=123:pci=1-1-1
```

```
rlghncxa03w 05-01-07 11:11:28 EST EAGLE 31.12.0
ENT-SID: MASP A - COMPLTD
```

```
;
```

```
ent-sid:pcn16=125-1-5
```

```
tekelecstp 13-02-26 11:52:41 EST 45.0.0-64.56.0
ent-sid:pcn16=125-1-5
Command entered at terminal #4.
ENT-SID: MASP A - COMPLTD
```

```
;
```

## Related Topics

- [chg-sid](#)
- [rtrv-sid](#)

# ent-sip-npp

Use this command to configure number normalization rules (SIPPHCXT and SIPNPFEX). SIPPHCXT table will be used to provision the phone-context. SIPNPFEX table will be used to configure the prefixes against each phone context and it will also contain number of digits to be deleted (NPDD) and new prefix to be added (NPDS).

## Parameters

### **phctxt (mandatory)**

Phone Context

#### **Range:**

```
XXXXXXXXXXXXXXXXXXXXXXXXXXXXXXXXXXXXXXXXXXXXXXXXXXXXXXXXXXXXXXXXXXXX
```

A string of 1 to 64 characters. Valid values are (0-9, A-Z), +, \*, #, .(period), @ or DFLT (default).

### **npdd (optional)**

Number of prefix digits to be deleted from the incoming digit string. If NPDD is zero then no digits are deleted.

#### **Range:**

```
XXXXXXXXXXXX
```

An integer in the range of 0 to 15.

#### **Default:**

No change to the current value.

**System Default:***0***npds (optional)**

New prefix digits to be substituted to digit string after deleting the NPDD. If NPDS is NONE then no digits are prepended.

**Range:***ZZZZZZZZZZZZZZZZ*

A string of 1 to 15 characters. Valid values are hex digits (0-9, A-F) and NONE.

**Default:**

No change to the current value

**System Default:***none***px (optional)**

Prefix

**Range:***ZZZZZZZZZZZZZZZZ*

A string of 1 to 15 characters. Valid values are hex digits (0-9, A-F), +, \*, -, #.

**Example**

```
ent-sip-npp:phctxt=abc.com:px=101
```

```
ent-sip-npp:phctxt=abc.com:px=121:npdd=5:npds=2f
```

```
ent-sip-npp:phctxt=a*bc.com:px=91*:npdd=5:npds=af1
```

```
ent-sip-npp:phctxt=df1t:px=*121#
```

**Dependencies**

SIPNP Feature must be enabled before entering any number normalization rules.

SIP Phone Context table (SIPPHCXT) should be accessible.

SIP Prefix table (SIPNPFX) should be accessible.

SIP DBMM 2 table should be accessible.

A maximum of 101 entries can be added in the SIP Phone Context table (SIPPHCXT).

A maximum of 50 prefixes for each phone context can be added in the SIP Prefix table (SIPNPFX).

Prefixes must be unique. Duplicate Prefix entries are not allowed.

Phone Contexts must be unique. Duplicate Phone Context entries are not allowed.

At least one NPDD or NPDS must be specified with non-default (other than 0, NONE) value.

SIPPHCXT table can have a maximum of 101 Phone Contexts which includes 100 Unique and 1 DFLT.

A valid Phone Context/Prefix value should be given.

The PHCTXT parameter value must contain no more than 64 characters and the PFX parameter value must contain no more than 15 characters.

### Notes

None.

### Output

This example displays the output when all the parameters are specified:

```
ent-sip-npp:phctxt=a*bc.com:pfx=91:npdd=5:npds=af1
```

```
tekelecstp 12-07-16 10:05:45 EST EAGLE 45.0.0
ent-sip-npp:phctxt=a*bc.com:pfx=91:npdd=5:npds=af1
Command entered at terminal #4.
PHCTXTID table is (2 of 101) 2% full.
ENT-SIP-NPP: MASP A - COMPLTD
;
```

This example displays the output when just the phctxt and pfx parameters are specified:

```
ent-sip-npp:phctxt=linea.com:pfx=*121#
```

```
tekelecstp 12-07-09 18:59:31 EST 45.0.0-64.35.0
ent-sip-npp:phctxt=linea.com:pfx=*121#
Command entered at terminal #4.
PHCTXTID table is (1 of 101) 1% full.
ENT-SIP-NPP: MASP A - COMPLTD
;
```

### Related Topics

- [dlt-sip-npp](#)
- [rtrv-sip-npp](#)
- [chg-sip-npp](#)

## ent-slk

Use this command to add a low-speed or high-speed (ATM or IP) signaling link to a linkset in the database.

Signaling links are the only elements in the database directly supported by a hardware device. When a link is added to a linkset, the link remains in the state OOS-MT-DSBLD (out of service maintenance disabled) until it is activated.

For E5-E1T1-B cards, use this command to associate a signaling link and a timeslot with the E1, T1 or J1 interface that will service the timeslot.

For E5-E1T1-B cards used for SE-HSL links, use this command to assign links A and B on any 2 of the 8 E5-E1T1-B card ports.

Up to 64 signaling links can be assigned to one E5-E1T1-B card, allowing links A, A1 - A31, B, and B1 - B31 to be provisioned.

Up to 128 signaling links can be assigned to SLIC cards running IPSPG application, allowing links A, A1 - A63, B, and B1 - B63 to be provisioned.

Up to 3 signaling links can be assigned to an E5-ATM-B card, allowing links A, A1, and B to be provisioned.

 **Note:**

The `link` parameter has been added as a synonym for the `port` parameter. Either port or link can be used for a few more EAGLE releases; then the `port` parameter will be removed.

## Parameters

### **link (mandatory)**

The signaling link on the card specified in the `loc` parameter. The links can be specified in any sequence or pattern.

**Synonym:**

*port*

**Range:**

*a, b, a1 - a63, b1 - b63*

Not all card types support all `link` parameter values.

See [Table A-1](#) for valid `link` parameter range values for each type of card that can have a location specified in the `loc` parameter.

### **loc (mandatory)**

The card location as stenciled on the shelf of the system.

**Range:**

*1101 - 1108, 1111 - 1112, 1201 - 1208, 1211 - 1218, 1301 - 1308, 1311 - 1318, 2101 - 2108, 2111 - 2118, 2201 - 2208, 2211 - 2218, 2301 - 2308, 2311 - 2318, 3101 - 3108, 3111 - 3118, 3201 - 3208, 3211 - 3218, 3301 - 3308, 3311 - 3318, 4101 - 4108, 4111 - 4118, 4201 - 4208, 4211 - 4218, 4301 - 4308, 4311 - 4318, 5101 - 5108, 5111 - 5118, 5201 - 5208, 5211 - 5218, 5301 - 5308, 5311 - 5318, 6101 - 6108, 6111 - 6118*

### **lsn (mandatory)**

Linkset name. The linkset name must be unique.

**Range:**

*ayyyyyyyyy*

1 alphabetic character followed by up to 9 alphanumeric characters

### **s1c (mandatory)**

Signaling link code. The SLC must be unique within the linkset. It must be the same at both the system location and the distant node.

**Range:**

*0 - 15*

**aname (optional)**

Association name. The association assigned to the signaling link added in an IPSPG linkset.

**Range:**

aaaaaaaaaaaaaaaa

Up to 15 alphanumeric characters; the first character must be a letter

**atmtsel (optional)**

ATM timing selector. The timing source for the ATM signaling link—internal, line, or external. Internal timing is derived from an internal clock source operating at 1.544 MHz  $\pm$  200 Hz for ANSI links and 2.048 MHz  $\pm$  103 Hz for ITU links. External timing is derived from the High-Speed Master Clock (T1 or E1). Line timing is derived from its received data stream, if present.

**▲ Caution:**

The internal timing source is used for debug purposes only, and is not to be used for production operation.

If you are using the 2.048 MHz reference clock as the timing source for E1 signaling links, the `atmtsel=external` parameter must be specified for high-speed ATM signaling links. The `atmtsel` parameter is not valid in the command when the `elport` parameter is specified for an E1 signaling link. For information on the E1 interface, see the *Database Administration - SS7 User's Guide*.

**Range:**

*external*

*internal*

*line*

**Default:**

*line*

**bps (optional)**

Transmission rate for the link in bits per second.

**✎ Note:**

Links with different speeds can be mixed within a linkset. Mixing of high speed links and low speed links in a linkset is supported for migration purposes and is not recommended for standard provisioning.

**Range:**

*1536000, 1544000, 1984000, 2048000, 56000, 64000*

The value specified for the `bps` parameter must be supported for the associated card application:

- SS7ANSI—56000 or 64000
- CCS7ITU—56000 or 64000
- ATMANSI—1544000
- SS7ANSI, CCS7ITU (E1 SE-HSL cards)—1984000
- SS7ANSI, CCS7ITU, (T1 SE-HSL-A cards)—1536000
- ATMITU—2048000
- CCS7ITU, (J1 cards) --- 64000

**Default:**  
*56000*

**Default: (For J1 links)**  
*64000*

**e1atmcrc4 (optional)**

CRC4 multi-frame structure enable/disable indicator.

**Range:**

*on*

*off*

**Default:**  
*on*

**e1atmsi (optional)**

Value of two Spare International bits of NFAS data.

**Range:**  
*0 - 3*

**Default:**  
*3*

**e1atmsn (optional)**

Value of five Spare National bits of NFAS data.

**Range:**  
*0 - 31*

**Default:**  
*0*

**e1port (optional)**

Port for the E1 interface on the E1 card where a signaling link and timeslot or an SE-HSL link is being assigned.

**Range:**  
*1 - 8*

Any 2, but no more than 2, of the 8 ports on an E5-E1T1-B card can be specified when the card is used as an SE-HSL card.

**Default:**

1

**ecm (optional)**

Error correction method.

**Range:***basic**pcr***Default:***basic***j1port (optional)**

Port for the J1 interface on the J1 card where a signaling link and timeslot is being assigned.

**Range:**

1-8

Ports 1 through 8 can be specified for E5-E1T1B cards.

**Default:**

1

**l2tset (optional)**

Level 2 timer set

A signaling link can be assigned to any of the thirty-five timer sets.

**Range:**

1 - 40

1-10 —ANSI low speed links

11-20 —ITU low speed links

21-25 —ITUN China high speed links

26-30 —ITUN Q703.A high speed links

31-35 —Unchannelized T1 high speed links

36 --40---- ITUN16 Japan low speed links

**Default:**

1 — ANSI low speed links

11 — ITU low speed links

21 — ITUN China high speed links (SE-HSL link in a linkset defined with the `apctype=ituchina` parameter)26 — ITUN Q703.A high speed links (SE-HSL link in a linkset defined with the `apctype=itun` parameter)

31 — Unchannelized T1 high speed links

36----ITUN16 Japan low speed links

**l1 (optional)**

ATM line length in feet.

**Range:**

0 - 7

- 0 —0-110 feet
- 1 —110-220 feet
- 2 —220-330 feet
- 3 —330-440 feet
- 4 —440-550 feet
- 5 —550-660 feet
- 6 —More than 660 feet
- 7 —Allows use of external line buildout networks

**Default:**

0

**lpset (optional)**

Link parameter set identifier

**Range:**

1 - 30

**Default:**

1 — ANSI

21 — ITU

**pcrn1 (optional)**

Threshold of the number of MSUs available for retransmission. If the error correction method being used is PCR and this threshold is reached, no new MSUs or FISUs are sent. The retransmission cycle is continued up to the last MSU entered into the retransmission buffer in the order in which they were originally transmitted.

**Range:**

1 - 1023

low speed E1/T1 links: 1 - 127

unchannelized T1 links: 1 - 1023

**Default:**

76 — low speed E1/T1 links.

608 — unchannelized T1 links.

**pcrn2 (optional)**

Threshold of the number of MSU octets available for retransmission. If the error correction method being used is PCR, and this threshold is reached, no new MSUs or FISUs are sent. The retransmission cycle is continued up to the last MSU entered into the retransmission buffer in the order in which they were originally transmitted.

**Range:**

300 - 287744

low speed E1/T1 links: 300 -35500

unchanelized T1 links: 7200 -287744

**Default:**

3800 — low speed E1/T1 links.

32224 — unchannelized T1 links.

**t1port (optional)**

Port for the T1 interface on the T1 card where a signaling link and timeslot or an ST-HSL-A link is being assigned.



**Range:**

1 - 8

Any 2, but no more than 2, of the 8 ports on an E5-E1T1-B card can be specified when the card is used as an ST-HSL-A card.

**Default:**

1

**ts (optional)**

E1 or T1 timeslot for the assigned signaling link.

**Range:**

1 - 31

**E1 range:**

1-31

**T1 range:**

1 - 24

**J1 range:**

1-24

**vci (optional)**

Virtual channel identifier.

**Range:**

5, 32 - 65535

0-4 and 6-31 are reserved values; they cannot be specified in the command.

**Default:**

5

**vpi (optional)**

Virtual path identifier.

**Range:**

0 - 4095

**Default:**

0

**Example**

```
ent-
slk:loc=1201:link=a:slc=3:lsn=c1201001:l2tset=3:bps=64000:ecm=b
asic
```

```
ent-
slk:loc=1201:link=a:slc=3:lsn=c1201001:l2tset=3:ecm=pcr:pcrn1=5
0:pcrn2=4000
```

This example adds signaling link A to linkset LSHCAP:

```
ent-slk:loc=1304:link=a:slc=0:lsn=lshcap:lpset=3:vci=5:vpi=15
```

```
ent-
slk:loc=1302:link=a:slc=5:lsn=atm1302a:lpset=3:vci=10:vpi=15:l1
=0:atmtsel=external
```

This example adds a link to linkset LS1 at 56 KB:

```
ent-slk:loc=1205:link=a1:slc=0:lsn=ls1
```

This example assigns a timeslot for the signaling link on an E1 card that uses E1 port 1:

```
ent-slk:loc=1206:link=a:slc=0:lsn=e1jwk:ts=1
```

This example assigns a timeslot for a signaling link on an E1 card that uses E1 port 2:

```
ent-slk:loc=1205:link=b:slc=0:lsn=e1typ:ts=1:e1port=2
```

This example adds a timeslot for a signaling link using E1 port 2 and signaling link B2:

```
ent-slk:loc=1205:link=b2:slc=0:lsn=e1typ:ts=1:e1port=2
```

This example adds a timeslot for a signaling link using signaling link A2. The T1 interface defaults to the interface defined for T1 port 1 (`t1port` parameter not specified):

```
ent-slk:loc=1207:link=a2:slc=0:lsn=t1jwk:bps=64000:ts=1
```

This example adds a timeslot for a signaling link using T1 port 2 and signaling link B2:

```
ent-slk:loc=1207:link=b2:slc=0:lsn=t1typ:ts=1:t1port=2
```

This example adds a signaling link to linkset LS1 at 2048000 bps for an ATM card that will use the CRC4 multi-frame structure:

```
ent-  
slk:loc=1205:link=a:slc=0:lsn=ls1:bps=2048000:atmsel=line:e1atmcrc4=  
on
```

This example adds a link to linkset LS1 at 56 Kbps for a card that is provisioned as an E1 card:

```
ent-slk:loc=1205:link=a31:slc=0:lsn=ls1:e1port=4:ts=4
```

This example adds a link to linkset LS2 at 64 Kbps for a card provisioned as a T1 card:

```
ent-slk:loc=1207:link=b27:slc=3:lsn=ls2:t1port=8:ts=6:bps=64000
```

This example adds signaling link B to linkset LSE5ATM on an E5-ATM-B card:

```
ent-slk:loc=1305:link=b:slc=1:lsn=lse5atm:lpset=3:vci=5:vpi=15
```

This example adds signaling link A1 to linkset L2E5ATM on an E5-ATM-B card:

```
ent-slk:loc=1303:link=a1:slc=1:lsn=l2e5atm:lpset=3:vci=5:vpi=15
```

This example assigns a timeslot for the signaling link on a J1 card that uses the J1 port:

```
ent-  
slk:lsn=ls2:j1port=2:slc=9:port=a3:loc=1102:ts=5:bps=64000:ecm=basic
```

## Dependencies

Card locations 1113 - 1118 cannot be specified.

The `ecm=pcr` parameter must be specified before the `pcrn1` and `pcrn2` parameters can be specified for the SS7ANSI and CCS7ITU applications.

The value specified for the `bps` parameter must be supported for the associated card application.

If the card application is SS7ANSI or CCS7ITU, then a value of 56000 or 64000, respectively, must be specified for the `bps` parameter. If SE-HSL or ST-HSL-A cards are used, then a value of 1984000 or 1536000, respectively, must be specified for the `bps` parameter.

A value of 1544000 must be specified for the `bps` parameter if the card application is ATMANSI.

A value 2048000 must be specified for the `bps` parameter if the card type is LIME1ATM.

The card application must be ATMANSI before the `bps=1544000` parameter can be specified. The card application must be ATMITU before the `bps=2048000` parameter can be specified.

A value of 1984000 or 1536000 must be specified for the `bps` parameter if the card is an E5-E1T1-B card used for SE-HSL or ST-HSL-A links (the `linkclass=unchan` parameter is specified in the `ent-e1` or `ent-t1` command) respectively.

The values 0 - 4 and 6 - 31 cannot be specified for the `vci` parameter; these values are reserved system values.

The linkset type must be valid for the card:

- The linkset adjacent point code (APC) type must be the same as the card application type (ANSI or ITU).
- IPSP-M2PA linksets cannot contain IPGWx and IPSP-M3UA link types. During migration to an IPSP-M2PA linkset, link types other than IPGWx or IPSP-M3UA can be added to the linkset. After the linkset is transitioned to IPSP-M2PA, only IPSP-M2PA and IPLIMx links can be added.
- IPSP-M3UA linksets cannot contain SS7IPGW, IPGWI, and IPGHC link types. After the linkset is transitioned to IPSP-M3UA, only IPSP-M3UA links can be added to the linkset.

The specified linkset name must exist in the database.

The value of the `slc` parameter cannot be used by more than one link in the linkset.

A card must be equipped in the specified card location.

The card in the specified card location must be a LIM or MIM and must exist.

A link cannot be already assigned to the specified port.

The parameters that are specified for the command must be valid for the type of card in the specified card location.

If a low-speed link is assigned to a card (card application is not ATMANSI or ATMITU), then the ATM high-speed link and E1 ATM parameters (`atmtsel`, `elatmcr4`, `etatmsi`, `elatmsn`, `ll`, `lpset`, `vci`, and `vpi`) cannot be specified.

If an ATM high-speed link is assigned to a card (card application is ATMANSI), then the low-speed link parameters (`ecm`, `l2tset`, `pcrn1`, and `pcrn2`) cannot be specified.

If an IP link is assigned to a card (card application is SS7IPGW, IPGWI, or IPLIMI), then the following low-speed link parameters, ATM high-speed link parameters, and E1 ATM high-speed link parameters cannot be specified: `lpset`, `vci`, `vpi`, `ll`,

atmtsel, elatmcrc4, elatmsi, elatmsn, ecm, l2tset, pcrn1, and pcrn2.

The value specified for the `link` parameter must be valid for the specified card type and application:

- A4 - A-15 and B4 - B15—card type is LIME1 or LIMT1 for an E5-E1T1-B card, and the card application is SS7ANSI or CCS7ITU
- A16 - A31 and B16 - B31 --- card type is LIME1 or LIMT1 for an E5-E1T1-B card used as an E1 or T1 card, and the card application is SS7ANSI or CCS7ITU.
- A4 - A31 and B4 - B31—cannot be specified for an SE-HSL or an ST-HSL-A card
- A - A7 and B - B7—E5-ENET-B cards running the IPLIMI application
- A - A15 and B - B15—E5-ENET-B, or SLIC cards running the IPSG application
- A, A1 - A63 and B, B1 - B63-SLIC card running the IPSG application

HIPR2 cards must be in card locations `xy09` and `xy10` on any shelf that contains one or more E5-E1T1-B, E5-ENET-B, or SLIC cards. When links A4 - A31 or B4 - B31 are specified, the system verifies that HIPR2 cards are in card locations `xy09` and `xy10` on the same shelf with the specified E5-E1T1-B, E5-ENET-B, or SLIC card.

If the card application is SS7IPGW or IPGWI, then the `link=a` parameter must be specified.

If an E5-E1T1-B card is used for SE-HSL or ST-HSL-A links, then only the `link=a` parameter or `link=b` parameter can be specified.

If the specified linkset has a mate linkset, only 1 SS7IPGW or IPGWI signaling link can be assigned to the specified linkset. The assigned link must be an SS7IPGW or IPGWI link.

Up to 8 IPGWx signaling links can be assigned to one linkset if the linkset is not mated.

If an IP link is assigned to a card running the SS7IPGW application, then the `lsn` parameter must reference a linkset that specifies an IP gateway adjacent point code.

If an IP link is assigned to a card running the IPGWI application, then the `lsn` parameter must reference a linkset that specifies an IP gateway adjacent point code.

If the `multgc=yes` parameter is specified, then all links assigned to the linkset must be of the same type.

If `multgc=yes` parameter is specified, then the card in the specified location must be running the IPGWI, IPLIMI, or IPSG application.

Linksets with 14-bit ITU-N and 24-bit ITU-N APCs or SAPCs can contain only IPGWI or IPLIMI M3UA links. These links support 14-bit ITU-N and 24-bit ITU-N traffic simultaneously.

Linksets containing 24-bit ITU-N APCs or SAPCs cannot contain E1 ATM links. These links do not support 24-bit ITU-N traffic.

A maximum of 1200, 1500, 2000, or 2800 links is allowed in the system. The maximum depends on the enabled Large System # Links quantity (see the `rtrv-ctrl-feat` command output). A FAK is required to enable support for more than 1200 links. A mixture of T1 ATM high-speed, E1 ATM high-speed, SE-HSL, IP, and low-speed signaling links is supported.

If a card location is specified for an E1, T1, or Channel card (card type LIME1, LIMT1, or LIMCH), then the `ts` parameter must be specified.

A specific timeslot can be assigned in the `ts` parameter to only one E1 signaling link for the E1 interface that services that timeslot.

A specific timeslot can be assigned in the `ts` parameter to only one T1 signaling link for the T1 interface that services that timeslot.

The `ts` parameter value for a T1 link must be in the range 1-24.

The `ts` parameter cannot be specified for E5-E1T1-B cards that are used for SE-HSL or ST-HSL-A links (the `linkclass=unchan` parameter is specified in the `ent-e1` or `ent-t1` command).

The Card (IMT) table is corrupt or cannot be found.

The Link table is corrupt or cannot be found.

The Linkset table is corrupt or cannot be found.

The E1/T1 table is corrupt or cannot be found.

The Extended Link table is corrupt or cannot be found.

If the card is an IPSPG card, then the `ipsg=yes` parameter must be specified (see the `ent-ls` command).

If an IPSPG linkset and card are used, then the `aname` parameter must be specified.

If the `aname=m3ua` parameter is specified, then a maximum of 16 signaling links can be assigned.

If the `aname=m2pa` parameter is specified, then only one signaling link can be assigned.

The total TPS of all signaling links configured for an IPSPG card cannot exceed 6500 TPS for an E5-ENET-B or SLIC card when the `type=enetb` parameter is specified (see the `ent-card` command).

The total TPS of all signaling links configured for an IPSPG card cannot exceed 10,000 TPS for a SLIC card when the `type=slic` parameter is specified (see the `ent-card` command).

If the HIPR2 High Rate Mode feature is turned off, then the sum of the TPS values assigned to all linksets in the system must be less than or equal to 500,000. If the HIPR2 High Rate Mode feature is turned on, then the sum of the TPS values must be less than or equal to 750,000. If the HIPR2 High Rate Mode and 1M System TPS features are turned on, then the sum of the TPS values assigned to all linksets in the system must be less than or equal to 1,000,000. The total provisioned system TPS is equal to SIGTRAN TPS + ATM TPS.

The value specified for the `aname` parameter must already exist in the database.

The adapter assigned to the association must be the same as the adapter assigned to the linkset.

The value specified for the `aname` parameter must be associated with the value specified for the `loc` parameter.

Linksets must have same routing context to share an association.

The `aname` parameter can be specified only for IPSPG links.

The specified parameter must be valid for the card type and use:

- `elport` —E5-E1T1-B cards used as E1 cards
- `t1port` —E5-E1T1-B cards used as T1 cards
- `j1port`—E5-E1T1-B cards used as J1 cards
- `ts` —E5-E1T1-B cards used as E1/T1 cards
- `lsn`, `slc`, `loc`, `port`, `bps`, `lpset`, `atmsel`, `vci`, `vpi`, `elatmcr4`, `elatmsi`, and `elatmsn` —E5-ATM-B cards. Low-speed link parameters (`ecm`, `l2tset`, `pcrn1`, and `pcrn2`) cannot be specified.
- `elport` and `l2tset` —E5-E1T1-B cards used as SE-HSL cards
- `t1port` and `l2tset`—E5-E1T1-B cards used as ST-HSL-A cards

The E1 interface for the card at the location specified by the `loc` parameter must be defined (see the `ent-e1` command) before a signaling link can be assigned to the port.

The card location specified by the `elloc` parameter must contain an E5-E1T1-B card that is used as an E1 card.

The specified card slot must be equipped with the valid card type.

The value specified for the `ts` parameter cannot already be in use by the E1 card.

The T1 interface of the T1 card specified by the `loc` parameter must already be defined (see the `ent-t1` command) before a signaling link can be assigned to the card.

If a multi-port LIM card is used, then the `bps=56000` parameter must be specified.

If the `loc` parameter indicates an ST-HSL-A card, then the `t1port` parameter must be specified.

If the `loc` parameter indicates an SE-HSL card, then the `elport` parameter must be specified.

If the link is In-Service, then this command cannot be entered.

Links must be available in the linkset that is specified by the `lsn` parameter.

The domain of the linkset specified by the `lsn` parameter must match the domain of the link specified by the `link` parameter.

The link capacity cannot exceed the maximum allowed by the SE-HSL or ST-HSL-A FAK.

The L2 timer range must be valid for the type of signaling link being provisioned as shown:

- ANSI LSL—1 - 10
- ITU LSL—11 - 20
- E1-HSL (China)—21 - 25
- E1-HSL (ITUN)—26 - 30
- T1-HSL-A—31 - 35
- J1 LSL ---- 36-40

The same value cannot be specified for the `aname` parameter for multiple links in the same linkset.

The same value must be specified for the `ecm` parameter for all links in a linkset.

The T1 interface on the card at the location specified by the `loc` parameter must be defined (see the `ent-t1` command) before a signaling link can be assigned to the port.

The N1/N2 thresholds for PCR Error Correction Mode (ECM) specified by the `pcrn1` and `pcrn2` parameters must be within the range specified for the link type. Only low speed E1/T1 (LSL) and Unchannelized T1 links support PCR ECM.

E5-ATM-B cards must be inhibited before the card can support an A1 link.

If a 3 Links per Card feature quantity is enabled, and an E5-ATM-B card is used, then the value specified for the `vci` parameter must be less than or equal to 16383.

A 3 Links per Card feature quantity must be enabled before the `link=a1` parameter can be specified for an E5-ATM-B card.

The maximum number of E5-ATM-B cards with 3 links cannot exceed the value that is set by the 3 Links per Card quantity feature.

The value specified for the `link` parameter when an ATM card is used must be valid:

- `a-a1`, `b`—E5-ATM-B card running the ATMANSI or ATMITU application

The BPS parameter value must be 64000 for J1 links. By default, BPS is 64000 for J1 links.

The Time Slot parameter value must not be greater than 24 for J1 links. The range for the Time Slot is 1 - 24.

The ECM parameter value must be BASIC for J1 links. By default, ECM is BASIC for J1 links.

The J1 table must be accessible.

A specific timeslot can be assigned in the `ts` parameter to only one J1 signaling link for the J1 interface that services that timeslot.

The value specified for the SLC parameter must be in the range of 0 to 15.

The value specified for TS parameter must be in the range of 0 to 15.

## Notes

The `ll` parameter is not available in the SEAS database.

If a signaling link is assigned to a card that is running the ATMANSI or ATMITU application, and the `bps`, `vci`, `vpi`, `elatmcrc4`, `elatmsi`, `elatmsn`, `ll`, `atmsel`, and `lpset` parameters are not specified, then the ATM default values are assigned for these parameters.

The MTP Level 2 timers (`l2tset` parameter) are not valid for IP links or for ATM links.

A link is equipped when it is physically operational, that is, when the hardware is in place that is needed to support the link.

## Signaling Links for E5-E1T1-B Cards

An E5-E1T1-B card can be used for E1, T1, or J1 card functions, but not both at the same time. E1 cards and T1 cards can coexist in the same EAGLE.

Each signaling link for an E1, T1, or J1 card must be associated with a timeslot assigned in this command. Each signaling link and timeslot assigned for an E1, T1, or J1 card must be associated with an E1, T1, or J1 interface that has been defined for one of the ports on the card (see the ent-e1 or ent-t1 command, respectively).

Timeslots and signaling links are defined in the ent-slk command by a combination of card location (`loc` parameter), the signaling link that uses the timeslot (A, A1-A31, B, B1-B31), the timeslot number (`ts`), and the port for the servicing E1, T1, or J1 interface on the E1, T1, or J1 card (`e1port` or `t1port` parameter). Timeslot numbers must be unique to the E1, T1, or J1 interface that services the timeslot; that is, the same timeslot cannot be assigned to the same E1, T1, or J1 interface for more than one signaling link.

Each E5-E1T1-B card used as an E1 card can have up to 64 signaling links assigned to the card. Each E1 interface on the card can service 1-31 timeslots.

Each E5-E1T1-B card used as a T1 card can have up to 64 signaling links assigned to the card. Each T1 interface on the card can service 1-24 timeslots.

Each E5-E1T1-B card used as a J1 card can have up to 64 signaling links assigned to the card. Each J1 interface on the card can service 1-24 timeslots.

### Signaling Links for E5-ATM-B Cards

An E5-ATM-B card can support E1 or T1 card functions: however, the card cannot support both functions at the same time. Cards running E1 and T1 functions can coexist in the same EAGLE.

Each E5-ATM-B card can have up to 3 signaling links assigned to the card. Only the A, A1, or B link can be used. The card must be inhibited, a 3 Links per Card feature quantity must be enabled, and the value specified for the `vc1` parameter must be less than or equal to 16383 before the A1 link can be provisioned.

The A, A1, and B links can be provisioned for a location if a card is not seated in that location. However, if a card other than an E5-ATM-B card is inserted in this location, then the card is auto-inhibited.

### Signaling Links for IPSP Cards

An IPSP card supports both M2PA and M3UA signaling links.

The E5-ENET-B card supports up to 32 signaling links per card, 16 M3UA links per association, and 32 associations per card.

The SLIC card supports up to 128 signaling links per card, 16 M3UA links per association, and 128 associations per card.

Multiple M3UA signaling links with routing context (different linksets/AS, up to 16) can use a single association.

Each M3UA AS-ASP instance maps to a signaling link. Signaling link state depends upon AS-ASP state, as well as administrative action.

The IPSP card can share M2PA linksets with IPLIMI, and IPLHC cards, but the card cannot share M3UA linksets with SS7IPGW, IPGWI, and IPGHC cards.

The IPSP card supports ANSI and ITU and ITUN/ITUN24 signaling links simultaneously on one card and on one association. Each signaling link resides in a set of networks determined by the APC and SAPCs of the assigned linkset.



The `slktps` parameter specified for the IPSPG linkset (see the `ent/chg-ls` command) specifies the TPS for each link provisioned for that linkset.

### HSL and LSL in same linkset

Mixing of high speed links and low speed links in a linkset is supported for migration purposes and is not recommended for standard provisioning.

### Signaling links and scheduled UI measurement reports

If the Integrated Measurements feature is turned on, then the measurements subsystem automatically disables the scheduled UI measurements reports, including the daily scheduled reports, if the entered link causes the provisioned link count to exceed 700.

### Output

```
ent-slk:loc=1303:link=a1:slc=7:lsn=12e5atm:lpset=3:vci=5:vpi=15
```

```
eagle1 10-10-11 13:15:03 EST EAGLE 43.0.0
ent-slk:loc=1303:port=a1:slc=7:lsn=12e5atm:ts=1:elport=1
Command entered at terminal #4.
ENT-SLK: MASP A - COMPLTD
;
```

### J1 links output:

```
ent-
slk:lsn=ls2:j1port=2:slc=9:port=a3:loc=1102:ts=5:bps=64000:ecm=
basic
```

```
tekelecstp 13-12-20 11:11:40 EST 46.0.0-65.3.0
ent-
slk:lsn=ls2:j1port=2:slc=9:port=a3:loc=1102:ts=5:bps=64000:ecm=basic
Command entered at terminal #4.
ENT-SLK: MASP A - COMPLTD
;
```

### Related Topics

- [act-slk](#)
- [blk-slk](#)
- [canc-slk](#)
- [dact-slk](#)
- [dlt-slk](#)
- [inh-slk](#)
- [rept-stat-slk](#)
- [rtrv-slk](#)
- [tst-slk](#)
- [ublk-slk](#)



If the string contains characters other than alphanumeric characters, the entire string must be enclosed in double quotes (" ").  
The string can be entered in upper and lower case; however, the system converts upper case alphabetic characters to lower case.

**Default:**  
*public*

**trappport (optional)**

SNMP interface trap port ID.

**Range:**  
*162, 1024..65535*  
This is the port through which the SNMP agent will transmit traps to the Manager.

**Default:**  
*162*

**Example**

```
ent-snmp-host:host=snmpmgr:ipaddr=192.168.54.100
ent-snmp-host:host="linux-server":
ipaddr=10.25.60.99:hb=300:trapcomm="password"
```

**Dependencies**

An entry for the specified IPADDR cannot already exist.

An entry for the specified HOST cannot already exist.

A maximum of two SNMP Hosts can be configured.

The specified heartbeat value must be within the range for the HB parameter.

The SNMP feature must be enabled before an SNMP Host can be configured.

The specified PORT value must be within the allowed range.

**Notes**

None.

**Output**

```
ent-snmp-host:host=snmphost1:ipaddr=192.168.54.100

tekelecstp 12-06-13 10:31:11 EST 45.0.0-64.66.0
ent-snmp-host:host=snmphost1:ipaddr=192.168.54.100
Command entered at terminal #4.
SNMP HOST table is (1 of 2) 50% full
ENT-SNMP-HOST: MASP A-COMPLTD
;
```

```
ent-snmp-host:host="snmp-
srvr":ipaddr=10.25.55.25:hb=300:trapcomm="passwd"
```

```
tekelecstp 12-06-13 10:33:31 EST 45.0.0-64.66.0
ent-snmp-host:host="snmp-srvr":ipaddr=10.25.55.25:hb=300:trapcomm="passwd"
Command entered at terminal #4
SNMP HOST table is (2 of 2) 100% full
ENT-SNMP-HOST: MASP A - COMPLTD
;
```

### Related Topics

- [chg-snmp-host](#)
- [dlt-snmp-host](#)
- [rtrv-snmp-host](#)

## ent-spc

Use this command to enter an SPC (secondary point code) into the database.

### Parameters

#### **spc (mandatory)**

ANSI point code with subfields network indicator-network cluster-network cluster member (*ni-nc-ncm*).

#### **Synonym:**

*spca*

#### **Range:**

*000-255*

Specify a valid value for each subfield of the point code, and separate the subfields with a dash (-).

When *chg-sid:pctype=ansi* is specified, *ni = 000* is not valid.

When *chg-sid:pctype=ansi* is specified, *nc = 000* is not valid if *ni = 001-005*.

When *chg-sid:pctype=ansi* is specified, *nc = 000* is valid if *ni = 006-255*.

The point code *000-000-000* is not a valid point code.

#### **spc/spca/spci/spcn/spcn24/spcn16 (mandatory)**

Secondary point code.



#### **Note:**

See [Point Code Formats and Conversion](#) for a detailed description of point code formats, rules for specification, and examples.

#### **spci (mandatory)**

ITU international secondary point code with subfields *zone-area-id*. The *prefix* subfield indicates a spare point code (*prefix-zone-area-id*).

**Range:***s-*, 0-255

Specify a valid value for each subfield of the point code, and separate the subfields with a dash (-).

*prefix—s**zone—0-7**area—000-255**id—0-7*

The point code 0-000-0 is not a valid point code.

**spcn (mandatory)**

ITU national point code in the format of a 5-digit number (*nnnnn*); or 2, 3, or 4 numbers (members) separated by dashes (*m1-m2-m3-m4*) as defined by the `chg-stpopts:npcfnt` flexible point code option. A group code must be specified when the ITUDUPPC feature is turned on (*nnnnn-gc*, *m1-m2-m3-m4-gc*). The *prefix* subfield indicates a spare point code (*prefix-nnnnn*, *prefix-nnnnn-gc*, *prefix-m1-m2-m3-m4*, *prefix-m1-m2-m3-m4-gc*).

**Range:***s-*, 0-16383, *aa-zz*

Specify a valid value for each subfield of the point code, and separate the subfields with a dash (-).

*prefix—s-**nnnnn—0-16383**gc—aa-zz**m1-m2-m3-m4—0-14* for each member; values must sum to 14**spcn24 (mandatory)**

24-bit ITU national point code with subfields *main signaling area-sub signaling area-signaling point* (*msa-ssa-sp*).

**Range:**

000-255

Specify a valid value for each subfield of the point code, and separate the subfields with a dash (-).

*msa—000-255**ssa—000-255**sp—000-255***spcn16 (mandatory)**

16-bit ITU national point code with subfields *unit number sub number area main number area* (*un-sna-mna*).

**Range:**

000---127

Specify a valid value for each subfield of the point code, and separate the subfields with a dash (-).

*un---000---127**sna---000---15**mna---000---31*

### Example

This example adds a secondary point code:

```
ent-spc:spc=10-20-30
```

This example adds a 24-bit ITU-N secondary point code:

```
ent-spc:spcn24=99-99-99
```

This example adds a spare ITU-N secondary point code:

```
ent-spc:spcn=s-12345
```

This example adds a 16-bit ITU-N secondary point code:

```
ent-spc:spcn16=121-5-10
```

### Dependencies

The Spare Point Code Support feature must be enabled before a spare point code (prefix s-) can be specified in the command.

The value specified for the `spc` parameter must be a full point code.

The ANSI point code range requirements have been violated for an ANSI SID. For the ANSI secondary point code with subfields *ni-nc-ncm*, the *ni* component cannot equal 000, the *nc* component cannot equal 000 if the *ni* component is 001 - 005

The specified secondary point code to be added must not already exist as a secondary point code.

A maximum of 40 secondary point codes may be defined.

The MPC feature must be turned on before a secondary point code can be added using this command.

The value specified for the `spc` parameter cannot already exist in the Destination table as a destination point code, true point code, or concerned point code.

The specified secondary point code cannot match an existing true point code or capability point code in the Site Identification table.

STP Site ID table must be accessible.

SPC table must be accessible.

Route Destination table must be accessible.

The value specified for the `spc/spca/spci/spcn/spcn24/spcn16` parameter cannot be the same as any Emulated Point Code value in the PCT table.

The J7 support feature must be enabled before the `spcn16` parameter can be specified.

The SPC/SPCA/SPCN24 parameters are not allowed if the J7 support feature is enabled.

### Notes

If the `spcn` parameter is specified, its format must match the format that was assigned with the `chg-stpopts:npcfmti` parameter.

In this command, only ITU-international and ITU national point codes support the spare point code subtype prefix (s-).

## Output

```
ent-spc:spc=10-20-30
```

```
rlghncxa03w 04-02-18 08:50:12 EST EAGLE 31.3.0  
Secondary Point Code table is (7 of 40) 17% full  
ENT-SPC: MASP A - COMPLTD
```

```
;
```

```
ent-spc:spcn16=121-2-15
```

```
tekelecstp 13-02-27 17:01:18 EST EAGLE 45.0.0-64.56.0  
Secondary Point Code table is (3 of 40) 8% full.  
ENT-SPC: MASP A - COMPLTD
```

```
;
```

## Related Topics

- [dlt-spc](#)
- [rtrv-spc](#)

# ent-srvsel

Use this command to assign the applicable service selectors required to specify a service entry for DSM services.

## Parameters



### Note:

Definitions for the feature options specified by the on and off parameters are located in the Notes section.



### Note:

The nature of address indicator parameters (*naiv* or *nai*) and the numbering plan parameters (*npv* or *np*) can be specified using a mnemonic or an explicit value. Either the mnemonic or the explicit value can be specified; however, both values cannot be specified at the same time for the same parameter. [NAIV/NAI Mapping](#) shows the mapping between the *naiv* and *nai* values. [Table A-6](#) shows the mapping between the *npv* and *np* values.

**gti/gtia/gtii/gtin/gtin24 (mandatory)**

Global title indicator. For all service selector commands, the domain is defined as GTI and GTIA (ANSI), GTI (ITU international), and GTIN (ITU national). For the service selector commands, GTI and GTIA are equivalent.

**Range:**

Supported value for ANSI: `gti=2` and `gtia=2`

Supported values for ITU: `gtii= 0, 2, 4`; `gtin=0, 2, 4`; `gtin24= 0, 2, 4`

**serv (mandatory)**

DSM service.

**Note:**

The `gport` service cannot be used for the Prepaid SMS Intercept Phase 1 (PPSMS) or the Portability Check for Mobile Originated SMS feature; use the `smsmr` service. The `mnp` service includes the G-Port, A-Port, and IS41 GSM Migration services.

**Range:*****eir***

Equipment Identity Register

***gflex***

GSM flexible numbering

***gport***

GSM number portability

***inpq***

INP query

***inpmr***

INP message relay

***smsmr***

MO SMS ASD, MO SMS B-Party Routing, MO SMS GRN, MO-based GSM SMS NP, MO-based IS41 SMS NP, MO SMS IS41-to-GSM Migration, Portability Check for MO SMS, Prepaid SMS Intercept Phase 1

***idps***

IDP Screening for Prepaid

***idpr***

Prepaid IDP Query Relay

***mnp***

Mobile Number Portability

***vflex***

Voice Mail Router



**atinp**

ATI Number Portability Query (ATINP)

**ttr**

Triggerless TCAP Relay

**aiq**

ANSI41 Analyzed Information Query

**ssn (mandatory)**

Subsystem number.

**Range:**

0 - 255

**tt (mandatory)**

Translation type.

**Range:**

0 - 255

**df1tact (optional)**

This parameter specifies the default Action ID associated with the service selector entry.

**Range:**

ayyyyyyy

1 leading alphabetic followed by up to 8 alphanumeric characters

The `df1tact` parameter can have one of the following values:

- a GTT Action ID that exists in the GTT Action table and has an associated GTT Action of *disc/udts/tcaperr*
- *fallback* —Fallback to the Relay data. The relayed MSU is routed as per routing data provided by the service.
- *falltogtt* —Fallback to GTT. If the `gttselid` parameter has a value other than *none*, and the GTT selector search fails, then the GTT selector search is performed again using `gttselid=none`.

**Default:***fallback***gttselid (optional)**

The GTT Selector ID used for performing GTT on messages relayed by the service.

**Range:**

0 - 65534

**nai (optional)**

Nature of Address indicator.

**Range:***sub**rsvd*

*natl*

*intl*

**naiv (optional)**

Nature of Address indicator value.

**Range:**

*0 - 127*

**np (optional)**

Numbering Plan.

**Range:**

*e164*

*generic*

*x121*

*f69*

*e210*

*e212*

*e214*

*private*

**npv (optional)**

Numbering Plan value.

**Range:**

*0 - 15*

**off (optional)**

Disables or turns off the specified feature options. A comma-separated list of feature options that are requested to be turned off. Up to 10 feature options can be specified in the list.

**Range:**

*gttrqd*

**on (optional)**

Enables or turns on the specified feature options. A comma-separated list of feature options that are requested to be turned on. Up to 10 feature options can be specified in the list.

**Range:**

*gttrqd*

**rqdtblnop (optional)**

The action performed if a message arrives at an SCCP card that does not have the necessary RTDB table, and the current message routing is GT.

**Range:*****udts***

generate UDTS for the processed MSU

***gtt***

fall through to GTT for the processed MSU

***disc***

discard the processed MSU

**snai (optional)**

Service nature of address indicator.

**Range:*****natl***

National significant number

***intl***

International number

***rnidn***

Routing number prefix and international dialed/directory number

***rnndn***

Routing number prefix and national dialed/directory number

***rnsdn***

Routing number prefix and subscriber dialed/directory number

***ccrndn***

Country code, routing number, and national directory number

***sub***

Subscriber number

**snp (optional)**

Service numbering plan.

**Range:*****e164******e212******e214*****Example**

```
ent-srvsel:gtii=4:tt=20:np=e164:nai=intl:serv=eir:ssn=*
```

```
ent-
```

```
srvsel:gtin24=4:tt=4:np=e164:nai=intl:serv=gport:snp=e164:snai=  
intl:ssn=9
```

```
ent-srvsel:gtii=4:tt=4:np=e164:nai=intl:serv=eir:ssn=11
```

```

ent-
srvsel:gtin=4:tt=9:np=e214:nai=natl:snp=e164:snai=intl:serv=gflex:ss
n=250

ent-srvsel:gtii=2:tt=6:snai=intl:snp=e164:serv=smsmr:ssn=10

ent-
srvsel:gtii=2:tt=6:snai=intl:snp=e164:serv=gport:ssn=10:on=gttrqd:gt
tselid=4: dfltact=act2

ent-
srvsel:gtii=4:tt=20:np=e164:nai=intl:serv=eir:ssn=:rqdtblnop=disc

ent-srvsel:gtii=0:tt=0:serv=idpr:ssn=*

```

### Dependencies

The Service Selector table cannot contain more than 1024 entries.

The G-Flex feature must be turned on before the `serv=gflex` parameter can be specified.

The INP feature must be turned on before the `serv=inpnr` or `serv=inpq` parameter can be specified.

The G-Port feature must be turned on before the `serv=gport` parameter can be specified.

The Equipment Identity Register (EIR) feature must be turned on before the `serv=eir` parameter can be specified.

The `np` and `npv` parameters cannot be specified together in the command.

The `nai` and `naiv` parameters cannot be specified together in the command.

The `gtia=4` parameter cannot be specified.

The values 1 and 3 are not valid for the `gti/gtia/gtii/gtin/gtin24` parameters.

If the `gti/gtia/gtii/gtin/gtin24=0` , 2 parameter is specified, then the `np(v)` and `nai(v)` parameter combinations cannot be specified.

If the `gtii/gtin/gtin24=4` parameter is specified, then an `np(v)` and `nai(v)` parameter combination must be specified. The parameters can be specified in the following combinations: `np/naiv`, `npv/nai`, `np/nai`, or `npv/naiv`.

If the `serv` parameter has a value of `inpnr`, `gport` or `eir`, then the `gtia` and `gti` parameters cannot be specified.

If the `serv=inpnr` parameter is specified, then the `snp=e164` parameter must be specified.

If the `serv=inpq` parameter is specified, then the `gtii` parameter cannot be specified.

If the value specified for the `snai` parameter is `rnidn`, `rnndn`, or `rnsdn`, then the value specified for the `serv` parameter must be `inpnr`, `gport`, or `smsmr`.

If the value specified for the `serv` parameter is `gflex`, `gport`, `inpnr`, or `smsmr`, then the `snai` and `snp` parameters must be specified.

If the value specified for the `serv` parameter is `aiq`, `atinp`, `eir`, `idpr`, `inpq`, `ttr`, or `vflex` then the `snai` and `snp` parameters cannot be specified.

If the `snai=ccrndn` parameter is specified, then the value specified for the `serv` parameter must be `gport` or `smsmr`.

If the value specified for the `serv` parameter is `gport` or `smsmr`, then the `snp=e164` parameter must be specified.

An entry cannot already exist that matches the new `gti/gtii/gtin/gtin24`, `tt`, `ssn`, `np(v)`, and `nai(v)` combination of parameters.

For the specified `gti/gtia/gtii/gtin`, `tt`, `np(v)`, `nai(v)`, and `ssn=*` parameters, an entry matching a specific `ssn` cannot already exist.

For the specified `gti/gtia/gtii/gtin`, `tt`, `np(v)`, `nai(v)`, and `ssn` parameters, an entry matching the `ssn=*` parameter cannot already exist.

If the `ansigflex` STP option is enabled (see the `chg-stpotps` command), then an ITU service selector cannot be entered.

The IDP Screening for Prepaid feature must be on before the `serv=idps` parameter can be specified.

If the `serv=idps` parameter is specified, then the supported mandatory parameters are `tt`, `serv`, `ssn`, `gtin`, and `gtii`. Supported optional parameters are `np` and `nai`.

The Prepaid IDP Query Relay feature must be turned on or the IAR Base feature must be enabled before the `serv=ttr` parameter can be specified.

If a value of `idpr` or `ttr` is specified for the `serv` parameter, then the only valid mandatory service parameters are `tt`, `serv`, `ssn`, `gtii`, and `gtin`, and the only valid optional parameters are `np` and `nai`.

If the A-Port or IGM feature is enabled, then the `serv=gport` parameter cannot be specified.

An entry cannot already exist that matches the new `gti/gtii/gtin/gtin24`, `tt`, `ssn`, `np(v)`, and `nai(v)` combination of parameters.

An entry cannot already exist that matches the new `gti/gtii/gtin/gtin24`, `tt`, `ssn`, `np(v)`, and `nai(v)` combination of parameters.

An entry cannot already exist that matches the new `gti/gtii/gtin/gtin24`, `tt`, `ssn`, `np(v)`, and `nai(v)` combination of parameters.

The V-Flex feature must be turned on before the `serv=vflex` parameter can be specified.

The ATINP feature must be enabled before the `serv=atinp` parameter can be specified.

The PPSMS or Portability Check for Mobile Originated SMS feature must be turned on, or the MO SMS ASD, MO SMS GRN, MO SMS B-Party Routing, MO SMS IS41-to-GSM Migration, MO-based GSM SMS NP, or MO-based IS41 SMS NP feature must be enabled before the `serv=smsmr` parameter can be specified.

If a value of `aiq`, `atinp`, or `eir` is specified for the `serv` parameter, then the `gtin24` parameter cannot be specified.

The Prepaid IDP Query Relay feature must be turned on before the `serv=idpr` parameter can be specified.

The ANSI41 AIQ feature must be enabled before the `serv=aiq` parameter can be specified.

The A-Port or IGM feature must be turned on, or the A-Port or IGM feature must be enabled and the G-Port feature must be turned on before the `serv=mnp` parameter can be specified.

If a DSM4G card is active in the system, then the `on=gtrrqd` parameter cannot be specified.

The `dfltact`, `gttselid`, and `on/off=gtrrqd` parameters are supported for only the IDPR, TTR, MNP, GPORT, SMSMR, GFLEX, and INPMR services.

If a GTT Action ID is specified as the value for the `dfltact` parameter, then the Action ID must already exist in the GTT Action table.

The GTT Action table is corrupt or cannot be found.

A valid value must be specified for the `dfltact` parameter.

The EGTT feature must be turned on before the `gttselid` or `dfltact` parameter can be specified.

The same value cannot be specified for the `on` and `off` parameters.

The `dfltact=none` parameter cannot be specified.

The EPAP Data Split feature or the Dual ExAP Config feature must be on before the `rqdtblnop` parameter can be specified.

If a value of `inpq`, `vflex`, `atinp`, or `eir` is specified for the `serv` parameter, then the `rqdtblnop=gtt` parameter cannot be specified.

If a value of `aiq` or `idps` is specified for the `serv` parameter, then the `rqdtblnop` parameter cannot be specified.

The requested service selector entry must exist in the database.

The GSM DBMM table must be accessible.

Only for IDP Relay feature, `gtii/gtin/gtin24=0` can be specified.

If the `serv=idpr` parameter is specified and the `gti/gtia/gtii/gtin/gtin24=0, tt=0` parameter is entered, then the `gti/gtia/gtii/gtin/gtin24=2, tt=0` parameter combinations cannot be entered. The parameters can be specified in the following combinations: `gtii=0 tt=0`, or `gtii=2 tt=0`.

## Notes

### on/off options

- `gtrrqd` —GTT required. Specifies whether GTT is required after service execution is complete and the message is relayed by the service. This option is supported for the IDPR, MNP, TTR, GPORT, SMSMR, GFLEX, and INPMR services.

## Output

```
ent-srvsel:gtia=4:tt=10:ssn=25:snai=natl:serv=aiq
```

```
tekelecstp 09-12-03 16:40:40 EST EAGLE 42.0.0  
Service Selector table is (114 of 1024) 11% full  
ENT-SRVSEL: MASP A - COMPLTD
```

```
;
```

```
ent-srvsel:gtia=2:tt=20:ssn=105:snai=natl:serv=inp
```

```
tekelecstp 13-09-26 11:51:11 EST EAGLE 46.0.0  
Service Selector table is (11 of 1024) 1% full  
ENT-SRVSEL: MASP A - COMPLTD
```

```
;
```

## Related Topics

- [chg-srvsel](#)
- [dlt-srvsel](#)
- [rtrv-srvsel](#)

# ent-ss-appl

Use this command to reserve a subsystem number for an application and set the application status to be online or offline. One subsystem can be defined per application. The application must be unique.

## Parameters

### **appl** (mandatory)

Application type.

#### **Range:**

*Inp*

*inp*

*eir*

*vflex*

*atinpq*

*aiq*

*sfapp*

### **ssn** (mandatory)

Primary subsystem number.

**Range:**

2 - 255

**rqdtblnop (optional)**

The action performed if a message arrives at an SCCP card that does not have the necessary RTDB table, and the current message routing is subsystem.

**Range:*****udts***

generate UDTs for the processed MSU

***disc***

discard the processed MSU

**stat (optional)**

Status. In the case of SFAPP, stat can only have the value of online and it defaults to this value.

**Range:*****offline******online*****Default:***offline (online in case of SFAPP)***Example**

```
ent-ss-appl:appl=lnp:ssn=16:stat=online
```

```
ent-ss-appl:appl=inp:ssn=15:stat=offline:rqdtblnop=disc
```

**Dependencies**

The LNP feature must be turned on before the `appl=lnp` parameter can be specified.

The INP feature must be turned on before the `appl=inp` parameter can be specified.

The EIR feature must be turned on before the `appl=eir` parameter can be specified.

The value specified for the `appl` parameter cannot already be assigned.

The maximum number of applications must not already be assigned.

The LNP database is corrupt or cannot be found.

For LNP, the STP true point code and LNP subsystem must exist in the MAP table.

For INP, the STP true point code and INP subsystem must exist in the MAP table.

For EIR, the STP true point code and EIR subsystem must exist in the MAP table.

STP True Point Code must exist in MAP table

The SSAPPL table is corrupt or cannot be found (non-DBS 1.0 systems only).

The SSAPPL table is corrupt or cannot be found (DBS 1.0 systems only)



If the V-Flex feature is turned on, then the STP true point code and V-Flex subsystem must exist in the MAP table.

The V-Flex feature must be turned on before the `appl=vflex` parameter can be specified.

The RPC3 table is corrupt or cannot be found.

The ATINP feature must be enabled before the `appl=atinpq` parameter can be specified.

For ATINP, the STP true point code and ATINPQ subsystem must exist in the MAP table.

The value specified for the `ssn` parameter cannot already exist in the SS-APPL table.

The specified MAP table entry for a subsystem number (SSN) value in the SS-APPL table, must be a valid point code type for that subsystem. The following point code types are not valid for the indicated subsystems:

- For the INP subsystem, the True Point code cannot be an ITU-I point code.
- For the EIR subsystem, the True Point code cannot be an ANSI point code.
- For the AIQ, ATINPQ, or VFLEX subsystem, the True Point code can not be an ITU-N24 point code.

The ANSI41 AIQ feature must be enabled before the `appl=aiq` parameter can be specified.

The STP true point code and a MAP entry for the AIQ subsystem must be provisioned in the MAP table before the `appl=aiq` parameter can be specified.

The EPAP Data Split feature OR Dual ExAP Config feature must be on before the `rqdtblnop` parameter can be specified.

If the `appl=aiq` parameter is specified, then the `rqdtblnop` parameter cannot be specified.

If the `appl=sfapp` parameter is specified, then the `stat` parameter cannot take the value `offline`.

For SFAPP, the value specified in the `ssn` parameter should not have an existing entry in MAP table that is associated with STP's own True PC; however, it is valid if the `ssn` is associated with point codes other than the STP's own True PC in any table.

## Notes

If not specified, the application subsystem status defaults to OFFLINE. When the application is OFFLINE, the application subsystem is down. For SFAPP, this defaults to ONLINE and cannot be changed to OFFLINE in any case.

The LNP application status applies to both message relay and LNP query.

## Output

```
ent-ss-appl:appl=aiq:ssn=18:stat=online
```

```
tekelecstp 09-12-03 16:40:40 EST EAGLE 42.0.0
```

```
ENT-SS-APPL: MASP A - COMPLTD  
;
```

### Related Topics

- [chg-ss-appl](#)
- [dlt-ss-appl](#)
- [rtrv-ss-appl](#)

## ent-subnetid

Use this command to enter elements into the Subnet ID list, for the ISUP NP with EPAP feature. Each entry is identified by the Subnet ID and the Subnet number.

The Subnet ID length (`subnetidlen` parameter) must be entered first, before the command is entered the second time to enter the Subnet ID and Subnet Number.

### Parameters

#### **subnetid (optional)**

Vendor Subnet ID

##### **Range:**

1 - 15 digits

Valid digits are 0-9, a-f, A-F.



#### **Note:**

The number must contain the number of digits defined by the `subnetidlen` parameter.

#### **subnetidlen (optional)**

Subnet ID Length.

##### **Range:**

1 - 15

All Subnet IDs defined for the ISUP NP with EPAP feature must contain this number of digits.

#### **subnetnum (optional)**

Subnet Number. A reference to the prefix number for the ISUP NP with EPAP feature (see the `chg-prefix` command).

##### **Range:**

**1**

Corresponds to the prefix defined with prefix number 1

**2**

Corresponds to the prefix defined with prefix number 2

**3**  
Corresponds to the prefix defined with prefix number 3

**4**  
Corresponds to the prefix defined with prefix number 4

**5**  
Corresponds to the prefix defined with prefix number 5

### Example

```
ent-subnetid:subnetidlen=6
ent-subnetid:subnetid=886933:subnetnum=1
```

### Dependencies

The value *none* cannot be specified for the `subnetid` parameter.

The ISUP NP with EPAP feature must be enabled before this command can be entered.

The SUBNETID table can contain a maximum of 50 entries.

The specified ID entry cannot already exist in the SUBNETID table.

The SUBNETID table is corrupt or cannot be found by the system.

All SUBNETID table entries must have the number of digits defined by the `subnetidlen` parameter value.

The prefix with the same prefix number as the specified Subnet Number must already be provisioned for the ISUP NP with EPA feature.

The Subnet ID length cannot be changed unless the SUBNETID table is empty. All Subnet IDs must be deleted from the table before a different Subnet ID length can be entered.

The Subnet ID length must be entered before any Subnet IDs can be defined.

The `subnetidlen` parameter cannot be specified in the same command with the `subnetid` and `subnetnum` parameters.

### Notes

None.

### Output

The Subnet ID length must be entered first.

```
ent-subnetid:subnetidlen=6

rlghncxa03w 04-10-07 11:11:28 EST  EAGLE 31.11.0
ENT-SUBNETID: MASP A - COMPLTD
;
```

The first Subnet ID and Subnet number can be entered after the Subnet ID length has been entered.

```
ent-subnetid:subnetid=886933:subnetnum=1

    rlghncxa03w 04-10-07 11:11:28 EST  EAGLE 31.11.0
    VENDID table is (6 of 50) 11% full
    ENT-SUBNETID: MASP A - COMPLTD
;

```

### Related Topics

- [dlt-subnetid](#)
- [rtrv-subnetid](#)

## ent-t1

Use this command to enter an interface for an E5-E1T1-B card used as a T1 or ST-HSL-A card.

### Parameters

#### **loc (mandatory)**

The card location as stenciled on the shelf of the system.

#### **Range:**

*1101 - 1108, 1111 - 1112, 1201 - 1208, 1211 - 1218, 1301 - 1308, 1311 - 1318, 2101 - 2108, 2111 - 2118, 2201 - 2208, 2211 - 2218, 2301 - 2308, 2311 - 2318, 3101 - 3108, 3111 - 3118, 3201 - 3208, 3211 - 3218, 3301 - 3308, 3311 - 3318, 4101 - 4108, 4111 - 4118, 4201 - 4208, 4211 - 4218, 4301 - 4308, 4311 - 4318, 5101 - 5108, 5111 - 5118, 5201 - 5208, 5211 - 5218, 5301 - 5308, 5311 - 5318, 6101 - 6108, 6111 - 6118*

#### **t1port (mandatory)**

T1 card port number. The value must be a T1 port for which an interface has not been configured on the specified T1 card.

#### **Range:**

*1 - 8*

Any 2 of the 8 ports on an E5-E1T1-B card can be specified when the card is used as an ST-HSL-A card.

#### **encode (optional)**

Indicator for use of B8ZS or AMI encoding/decoding.

#### **Range:**

*b8zs*

*ami*

#### **Default:**

*b8zs*

**framing (optional)**

Indicator for framing format. *esfperf* is the framing format with performance monitoring.

**Range:**

*sf, esf, esfperf*

**Default:**

*sf*

**linkclass (optional)**

Link class for links assigned to T1 cards (channelized links) or ST-HSL-A cards (unchannelized links).

**Range:**

*chan*

*unchan*

**Default:**

*chan*

**t1 (optional)**

T1 cable length in feet between the EAGLE and the connecting node.

**Range:**

*0 - 655*

**Default:**

*133*

**minsurate (optional)**

Minimum signal unit rate. The minimum number of SUs present on a link uniformly distributed.

 **Note:**

The `linkclass=unchan` parameter must be specified for an ST-HSL-A card before this parameter can be specified.

**Range:**

*400 - 1600*

**Default:**

*1000*

**t1tse1 (optional)**

Timing source.

**Range:**

*line - slave timing source*

*external - master timing source*

**Default:**  
*line*

### Example

```
ent-t1:loc=1205:t1port=1:encode=ami:framing=sf:ll=100
ent-t1:loc=1203:t1port=1
ent-t1:loc=1203:t1port=2:linkclass=unchan:minsrate=1200
ent-
t1:loc=1205:t1port=1:encode=ami:t1tsel=external:framing=sf:ll=100
ent-t1:loc=1205:t1port=2:encode=b8zs:t1tsel=line:framing=sf
```

### Dependencies

The specified card location (`loc` parameter) must be equipped.

The card specified by the `loc` parameter must be a LIMT1 card type.

The E1/T1 table must be accessible.

The Card (IMT) table must be accessible.

The port specified by the `t1port` parameter must not be already equipped with a T1 interface.

HIPR2 cards must be equipped in card locations `xy09` and `xy10` (`x` is the frame, `y` is the shelf) on each EAGLE shelf that contains one or more /E5-E1T1-B cards that are used as T1 cards or ST-HSL-A cards.

Card locations 1113 - 1118 (E5-MASP and E5-MDAL cards) cannot be specified as values for the `loc` parameter.

The `linkclass=unchan` parameter must be specified before the `minsrate` parameter can be specified.

An ST-HSL-A feature quantity must be enabled before the `linkclass=unchan` parameter can be specified for an ST-HSL-A card.

Channelized and unchannelized T1 ports (mixed mode) cannot be specified on a single card (the card cannot be used as a T1 card and an ST-HSL-A card at the same time).

Only 2 of the 8 ports can be used for T1 interfaces on an E5-E1T1-B card that is used as an ST-HSL-A card.

The ST-HSL-A feature must be turned on before the `framing=esfperf` parameter can be specified.

### Notes

One or two T1 interfaces must be defined on a T1 card after the T1 card type (LIMT1) is defined in the database, and before the signaling links and associated timeslots are defined for the T1 card.

External timing is derived from the EAGLE High-Speed Master Clock (1.544 MHz for T1 or 2.048 MHz for E1); therefore, the Master Timing feature is required. Line timing is derived from its received data stream, if present.

Up to 8 T1 interfaces can be defined on an /E5-E1T1-B card used as a T1 card after the T1 card type (LIMT1) is defined in the database, and before the signaling links and associated timeslots are defined for the T1 card.

For an ST-HSL-A card, the `minsurate` parameter indicates the least number of SUs present on a link uniformly distributed. The number of SUs present is the `minsurate` parameter value (without link traffic) and the `minsurate` parameter value minus the number of MSUs (with link traffic).

### Output

```
ent-t1:loc=1205:tlport=1:encode=ami:framing=sf:ll=100
```

```
rlghncxa03w 04-02-20 09:07:58 EST EAGLE 31.3.0
ENT-T1: MASP A - COMPLTD
```

```
;
```

### Related Topics

- [chg-t1](#)
- [dlt-t1](#)
- [rtrv-t1](#)
- [tst-t1](#)

## ent-tt

Use this command to add a translation type to the system database.

### Note:

If the EGTT feature is turned on, then the GTT Selector (`ent/chg/dlt/rtrvgttset`), GTT Set (`ent/dlt/rtrv-gttset`), and GTA (`ent/chg/dlt/rtrvgta`) commands replace the Translation Type (`ent/dlt/rtrv-tt`) and Global Title Translation (`ent/chg/dlt/rtrv-gtt`) commands. It is not recommended to run `ent/dlt/rtrv-tt & ent/chg/dlt/rtrv-gtt` commands as it may cause the advance GTA fields of GTT entry to be reset to the default values.

### Parameters

#### **type/typea/typei/typen/typen24/typeis/typens (mandatory)**

The translation type and network type. This value is the decimal representation of the 1-byte field used in SS7.

The `type` and `typea` parameters specify an ANSI network.

The `typei` parameter specifies an ITU-international network.

The `typen` parameter specifies an ITU-national network.

The `typen24` parameter specifies a 24-bit ITU-national network.

The `typeis` parameter specifies an ITU-international spare network.

The `typens` parameter specifies an ITU-national spare network.

A translation type numeric value may be entered as ANSI type (*type/typea*) and as an ITU type (*typei/typen/typen24/typeis/typens*). However, they are separate entities. The point code domain translation types for GTT are handled by the EAGLE protocol processing as either ANSI or ITU; therefore, ITU applies to ITU-I, ITU-I spare, ITU-N, ITU-N spare, and ITU-N24.

**Range:**

000 - 255

**Default:**

No translation type is specified

**alias (optional)**

The alias of the global title translation type

**Range:**

000 - 255

**Default:**

No alias assignment is made.

**ndgt (optional)**

The number of digits contained in the global title translation. This parameter is not valid if the VGTT (variable length GTT) feature is turned on.

**Range:**

1 - 21

**Default:**

6 (not applicable if the VGTT feature is on)

**ttn (optional)**

Translation type name.

**Range:**

ayyyyyyy

1 alphabetic character followed by up to 8 alphanumeric characters

**Default:**

"set" + "ans"|"int"|"nat"|"24n"|"ins"|"nas" + 3-digit TT value

**Example**

```
ent-tt:type=230:ttn=lidb:ndgt=5
```

```
ent-tt:type=230:ttn=lidb:alias=007
```

```
ent-tt:type=2:ndgt=5
```

```
ent-tt:type=3
```

```
ent-tt:typens=2
```

```
ent-tt:typeis=1:ttn=setitu001
```

**Dependencies**

The translation type specified by *type/typea/typei/typen/typen24/typeis/typens* cannot already exist in the database containing the ANSI and ITU types.



The `alias` and `ndgt` parameters cannot be specified together in the command.

The translation type name must be unique.

The `ndgt` parameter is not valid if the VGTT (variable length GTT) feature is turned on.

The value specified for the `type/typeea/typeei/typen/typen24/typeis/typens` parameter cannot be an alias value.

The value specified for the `type/typeea/typeei/typen/typen24/typeis/typens` parameter must already exist in the database for the network type.

The value specified for the `ttn` parameter must already exist in the database.

The values specified for the `type/typeea/typeei/typen/typen24/typeis/typens` and `ttn` parameters must refer to the same entity.

The value specified for the `alias` parameter must be associated with the specified translation type and cannot be the value of an existing translation type.

The value specified for the `alias` parameter cannot be an existing alias value for the specified network type.

The network domain of the translation type specified by the `ttn` parameter cannot be CROSS (see the `ent-gttset` command) when entering an alias entry for that `ttn`.

The `ttn=none` parameter cannot be specified.

## Notes

The new translation type is entered into the translation type table along with the translation name and the number of digits used by the translation type.

The `ttn` parameter always refers to a translation type. Aliases do not have translation type names.

If the OBSR or FLOBR feature is turned on, then the `ent-tt` command can be used to provision only CdGTA GTT sets and GTT selectors. NP and NAI values cannot be specified for GTT selectors using the `ent-tt` command as `gtii=4` entries cannot be provisioned with this command.

If the EGTT feature is on, then the following occurs for this command:

- For ANSI, if the GTT selector of a true entry is deleted using the `dlt-gttset` command, a new entry using the same TTN cannot be created. If the true selector is deleted for an entry using the `dlt-gttset` command, then its aliases cannot be entered.
- For ITU, if a true GTT selector entry (GTI=2 or GTI=4) is deleted using the `dlt-gttset` command, or if the GTT set name of an entry is changed using the `chg-gttset` command, then a new entry for the same TTN cannot be created. If a true GTT selector entry is deleted using the `dlt-gttset` command, or if the GTT set name of an entry is changed using the `chg-gttset` command, then its aliases cannot be created.

## Output

```
ent-tt:typeeis=1:ttn=setitu001
```

```
tekelecstp 10-04-28 16:45:34 EST Eagle 42.0.0  
ENT-TT: MASP A - COMPLTD  
;
```

## Related Topics

- [dlt-tt](#)
- [rtrv-tt](#)

# ent-ttmap

Use this command to add a mapped SS7 message translation type (TT) for a given gateway linkset name. With this command you can add to the database the identification of the type of allowed global title translation in the SS7 message before and after translation type mapping. For example, you can use this command to add to the database that you want the SS7 message translation type 001 (before TT mapping) mapped to 254 (after TT mapping).

## Parameters

### **ett** (mandatory)

Translation type before mapping. The identification of the type of global title translation in the SS7 message *before* translation type mapping. This attribute is the decimal representation of the 1-octet binary field used by the SS7 protocol to identify the translation type.

#### **Range:**

000 - 255

### **io** (mandatory)

Incoming or outgoing. The system uses this parameter to indicate whether the translation type mapping data provisioned for the gateway linkset is for SS7 messages *received* or *sent* on the linkset.

#### **Range:**

*i*  
incoming

*o*  
outgoing

### **lsn** (mandatory)

Linkset name. The unique network identifier for the gateway linkset.

#### **Range:**

ayyyyyyyy

1 alphabetic character followed by 9 alphanumeric characters

**mtt (mandatory)**

Mapped translation type. The identification of the type of global title translation in the SS7 message after translation type mapping. This attribute is the decimal representation of the 1-octet binary field used by the SS7 protocol to identify the translation type.

**Range:**

000 - 255

**Example**

```
ent-ttmap:lsn=nc001:io=i:ett=128:mtt=16
```

**Dependencies**

The linkset must be defined.

The linkset table must be accessible.

The translation type mapping table must be accessible.

The Translation Type Mapping table must not be full for the linkset specified in the `lsn` parameter. Translation type mapping entries are supported for up to 255 linksets.

**Notes**

None

**Output**

```
ent-ttmap:lsn=nc001:io=i:ett=128:mtt=16
```

```
rlghncxa03w 04-02-21 13:09:27 EST EAGLE 31.3.0  
ENT-TTMAP: MASP A - COMPLTD
```

```
TTMAP table for nc001 is (2 of 64) 3% full
```

```
;
```

**Related Topics**

- [chg-ttmap](#)
- [dlt-ttmap](#)
- [rtrv-ttmap](#)

## ent-user

Use this command to add a user to the database. When you first enter the command, the system prompts you for the user's password, which must follow the administered password guidelines. For security reasons, the password is not displayed. After successfully entering a user password, you are prompted to verify it by entering it again.

## Parameters

### Note:

All `cc (X)` parameters consist of a configurable command class name (`ayy`), and indicator (`-yes` or `-no`) to specify whether the command class is allowed. A value of `ayy-yes` indicates that the value is allowed. A value of `ayy-no` indicates that the value is not allowed.

### **uid (mandatory)**

User ID

#### **Range:**

`azzzzzzzzzzzzzzzzz`

1 alphabetic character followed by up to 15 alphanumeric characters (including asterisks, single quotes, and commas)

### **a11 (optional)**

This parameter specifies whether the user ID is assigned all non-configurable command classes (LINK, SA, SYS, PU, DB, DBG, LNP).

#### **Range:**

`yes`

`no`

#### **Default:**

`no`

### **cc1 (optional)**

Configurable command class name and an indicator to specify whether the User ID can enter commands assigned to the specified command class.

#### **Range:**

`ayy-yes`, `ayy-no`

`ayy`—Command class name of 1 alphabetic character followed by 2 alphanumeric characters

`no` —the command class is not allowed

`yes` —the command class is not allowed

### **cc2 (optional)**

Configurable command class name and an indicator to specify whether the User ID can enter commands assigned to the specified command class.

#### **Range:**

`ayy-yes`, `ayy-no`

`ayy`—Command class name of 1 alphabetic character followed by 2 alphanumeric characters

`no` —the command class is not allowed

`yes` —the command class is not allowed

**cc3 (optional)**

Configurable command class name and an indicator to specify whether the User ID can enter commands assigned to the specified command class.

**Range:**

*ayy-yes*, *ayy-no*

*ayy*—Command class name of 1 alphabetic character followed by 2 alphanumeric characters

*no*—the command class is not allowed

*yes*—the command class is allowed

**cc4 (optional)**

Configurable command class name and an indicator to specify whether the User ID can enter commands assigned to the specified command class.

**Range:**

*ayy-yes*, *ayy-no*

*ayy*—Command class name of 1 alphabetic character followed by 2 alphanumeric characters

*no*—the command class is not allowed

*yes*—the command class is allowed

**cc5 (optional)**

Configurable command class name and an indicator to specify whether the User ID can enter commands assigned to the specified command class.

**Range:**

*ayy-yes*, *ayy-no*

*ayy*—Configurable command class name of 1 alphabetic character followed by 2 alphanumeric characters

*no*—the command class is not allowed

*yes*—the command class is allowed

**cc6 (optional)**

Configurable command class name and an indicator to specify whether the User ID can enter commands assigned to the specified command class.

**Range:**

*ayy-yes*, *ayy-no*

*ayy*—Configurable command class name of 1 alphabetic character followed by 2 alphanumeric characters

*no*—the command class is not allowed

*yes*—the command class is allowed

**cc7 (optional)**

Configurable command class name and an indicator to specify whether the User ID can enter commands assigned to the specified command class.

**Range:**

*ayy-yes*, *ayy-no*

*ayy*—Configurable command class name of 1 alphabetic character followed by 2 alphanumeric characters

*no*—the command class is not allowed

*yes*—the command class is allowed

**cc8 (optional)**

Configurable command class name and an indicator to specify whether the User ID can enter commands assigned to the specified command class.

**Range:**

*ayy-yes, ayy-no*

*ayy*—Configurable command class name of 1 alphabetic character followed by 2 alphanumeric characters

*no* —the command class is not allowed.

*yes* —the command class is allowed

**db (optional)**

Access to all commands in command class Database Administration.

**Range:**

*yes*

*no*

**Default:**

*no*

**dbg (optional)**

Access to all commands in command class Debug.

**Range:**

*yes*

*no*

**Default:**

*no*

**link (optional)**

Access to all commands in command class Link Maintenance.

**Range:**

*yes*

*no*

**Default:**

*no*

**page (optional)**

The maximum age of the password, in days. The STP automatically prompts the user for a new password at login if the user's password is older than the value specified for this parameter.

**Range:**

*0-999*

**Default:**

The value specified for the `page` parameter in the `chg-secu-dflt` command

**pu (optional)**

Access to all commands in command class Program Update.

**Range:**

*yes*

*no*

**Default:**

*no*

**revoke (optional)**

Revoke the user ID. The system rejects login attempts for a revoked user ID.

**Range:**

*yes*

*no*

**Default:**

*no*

**sa (optional)**

Access to all commands in command class Security Administration.

**Range:**

*yes*

*no*

**Default:**

*no*

**sys (optional)**

Access to all commands in command class System Maintenance.

**Range:**

*yes*

*no*

**Default:**

*no*

**uout (optional)**

User ID aging interval. The number of successive days a user ID can go unused (no successful login) before the system denies login of that user ID.

**Range:**

*0 - 999*

**Default:**

The value specified for the `uout` parameter in the `chg-secu-dflt` command

## Example

```
ent-user:uid=john:db=yes  
ent-user:uid=john*mayer:db=yes  
ent-user:uid=user123:cc5=u21=yes:cc8=u32=yes
```

## Dependencies

Passwords cannot be created or modified from a telnet terminal (terminal IDs 17-40) without the OA&M IP Security Enhancements feature turned on.

The specified user ID cannot already exist.

The user IDs *seas* or *none* cannot be entered because they are reserved for system use. Up to 100 users can be entered.

The `revoke=yes` parameter cannot be specified for a user ID with system administration authorization.

The Command Class Management feature must be enabled before a configurable command class name can be specified in the `cc1-cc8` parameters.

The CCCNAMES table must be accessible.

The UserID table must be accessible.

The Security Defaults table must be accessible.

The `cc1-cc8` parameter values must have valid default or provisioned configurable command class names. Default names are *u01-u32*.

## Notes

To disable user ID aging, specify the `uout=0` parameter.

The *Database Administration Manual - System Management* provides a list of all commands allowed within each command class.

Up to 8 configurable command class name parameters can be specified in one command. Additional commands can be entered to assign user access for more than 8 names. To assign user access for all 32 available configurable command class names, four commands could be entered with 8 names specified in each command.

A password must be entered for the newly-created userID. The system issues a separate prompt for this password and disables character echo at the terminal so that the entered password is not displayed on the screen.

After the password has been entered, the system issues a second prompt, and the password must be entered again. This ensures that no typing mistakes were made on the first entry.

Use the following rules for creating passwords:

- A new password cannot contain more than 12 characters.
- A new password must contain at least the number of characters that is specified in the `minlen` parameter of the `chg-secu-dflt` command.



- A new password must contain at least the number of alphabetic (`alpha` parameter), numeric (`num` parameter), and punctuation (`punc` parameter) characters that is specified in the `chg-secu-dflt` command.
- A new password cannot contain the associated user ID.

As a default, the command class `Basic` is assigned to all users. If no other command class is assigned, the user still has access to commands in the `Basic` class.

### Output

```
ent-user:uid=john*mayer:db=yes
```

```
rlghncxa03w 04-01-07 11:11:28 EST EAGLE 31.3.0
ENT-USER: MASP A - COMPLTD
;
```

### Related Topics

- [act-user](#)
- [chg-pid](#)
- [chg-user](#)
- [dact-user](#)
- [dlt-user](#)
- [login](#)
- [logout](#)
- [rept-stat-user](#)
- [rtrv-secu-user](#)
- [rtrv-user](#)

## ent-vendid

Use this command to enter elements into the Vendor ID list, for the GSM MAP SRI Redirect to Serving HLR (also called GSM MAP SRI Redirect) feature. Each entry is identified by the Vendor ID and the Vendor number.

The Vendor ID length (`vendidlen` parameter) must be entered first, before the command is entered the second time to enter the Vendor ID and Vendor Number.

### Parameters

#### **vendid (optional)**

Vendor ID

#### **Range:**

1 - 15 digits

#### **vendidlen (optional)**

Vendor ID Length. All Vendor IDs defined for the GSM MAP SRI Redirect for Serving HLR feature must contain this number of digits.

**Range:**  
1 - 15

**vendnum (optional)**

Vendor Number. The Vendor Number is used as a reference to the prefix for the GSM MAP SRI Redirect for Serving HLR feature.



**Note:**

The prefix values in the range are defined in the `chg-prefix` command.

**Range:**

**1 - 128**

**1**

Corresponds to the prefix defined with prefix number 1

**2**

Corresponds to the prefix defined with prefix number 2

..

..

**128**

Corresponds to the prefix defined with prefix number 128

**vendtype (optional)**

Vendor Type. The Vendor Type is used with the GSM MAP SRI Redirect for Serving HLR feature to allow multiple networks for the same equipment vendor.

**Range:**  
1 - 32

**Example**

```
ent-vendidvend:len=6
```

```
ent-vendid:vendid=886933:vendnum=1:vendtype=1
```

```
ent-vendid:vendid=886939:vendnum=5:vendtype=9
```

**Dependencies**

The `vendid=none` parameter cannot be specified.

The GSM MAP SRI Redirect feature must be enabled before this command can be entered.

The VENDID table can contain a maximum of 500 entries.

The specified ID entry cannot already exist in the VENDID table.

The VENDID table is corrupt or cannot be found by the system.

All VENDID table entries must have the number of digits defined by the `vendidlen` parameter value.

The prefix with the same prefix number as the specified Vendor Number must already be provisioned for the GSM MAP SRI Redirect feature.

The Vendor ID length cannot be changed unless the VENDID table is empty. All Vendor IDs must be deleted from the table before a different Vendor ID length can be entered.

The Vendor ID length must be entered before any Vendor IDs can be defined.

The `vendidlen` parameter cannot be specified in the same command with the `vendid`, `vendidlen`, and `vendtype` parameters. Either the `vendidlen` parameter, or the `vendid`, `vendidlen`, and `vendtype` parameters can be specified in the command.

### Notes

None.

### Output

```
ent-vendid:vendidlen=6

    rlghncxa03w 04-10-07 11:11:28 EST  EAGLE 31.11.0
    ENT-VENDID: MASP A - COMPLTD
;

ent-vendid:venid=886933:vendnum=1:vendtype=1

    rlghncxa03w 04-10-07 11:11:28 EST  EAGLE 31.11.0
    VENDID table is (6 of 200) 3% full
    ENT-VENDID: MASP A - COMPLTD
;

ent-vendid:vendid=886939:vendnum=5:vendtype=9

    tekelecstp 14-05-30 14:12:00 EST  EAGLE 46.1.0
    VENDID table is (35 of 500) 7% full
    ENT-VENDID: MASP A - COMPLTD
;
```

### Related Topics

- [dlt-vendid](#)
- [rtrv-vendid](#)

## ent-vflx-cd

Use this command to provision the call decision criteria that is used to create a voice mail routing number. This command creates a new entry in the V-Flex Call Decision Table. The V-Flex feature must be enabled before this command can be entered.

## Parameters

### **bcap (mandatory)**

The INAP/CAP bearer capabilities for the call.

The INAP/CAP bearer capabilities are used to determine the type of mail that is used by the call, such as voice, video, multimedia, etc.

**Range:**

*0 - 31, none*

*none* —BCAP is not present in the incoming MSU.

### **cdn (mandatory)**

Call decision name. This parameter specifies an entry in the call decision table.

**Range:**

*ayyy*

1 alphabetic character followed by 3 alphanumeric characters

### **dnstat (mandatory)**

Dialed number status. This parameter specifies whether the MSISDN is found in the EPAP RTDB.

**Range:**

*fnd*

DN found in RTDB

*nfn*

DN not found in RTDB

*\**

It does not matter whether the DN is found in RTDB

### **rnidx (mandatory)**

Routing number index. The index associated with the generated voice mail routing number.

**Range:**

*0 - 9*

### **vmdig (mandatory)**

Voice mail number or voice mail prefix digits. A voice mail number or voice mail digits for the call decision entry.

 **Note:**

If the call is redirected (the `rdi=redir` parameter is specified), then the value specified for the `vmdig` parameter represents a voice mail number. If the call is not redirected (the `rdi=dir` parameter is specified), then the value specified for the `vmdig` parameter represents a set of voice mail digits.

**Range:**

*1 - 15*

Valid digits are *0-9, A-F, a-f*

**rdi (optional)**

Redirection indicator. This parameter specifies whether the call is redirected.

**Range:**

**dir**  
call is not redirected

**redir**  
call is redirected

**Default:**

*dir*

**Example**

```
ent-vflx-
cd:dnstat=fnd:rdi=redir:bcap=31:vmDIG=abcdef123456abc:rnidx=0:cdn=cdn1
```

**Dependencies**

The V-Flex feature must be enabled before this command can be entered.

The value specified for the `cdn` parameter cannot be a reserved word, such as *none*.

The value specified for the `cdn` parameter cannot already exist in the Call Decision table.

An entry with the specified `dnstat`, `rdi`, `bcap`, and `vmDIG` parameters cannot already exist in the Call Decision table.

The Call Decision table is corrupt or cannot be found.

The value specified for the `vmDIG` parameter cannot differ from a value that already exists in the Call Decision table by only the value of the `dnstat` parameter. The values specified for the `rdi` and `bcap` parameters must differ as well.

The maximum number of 25 entries cannot already be provisioned for a given `rdi`, `dnstat`, and `bcap`.

**Output**

```
ent-vflx-
cd:dnstat=fnd:rdi=redir:bcap=31:vmDIG=abcdef123456abc:rnidx=0:cdn=cdn1
```

```
rlghncxa03w 08-05-07 11:11:28 EST EAGLE 39.0.0
ENT-VFLX-CD: MASP A - COMPLTD
```

;

```
ent-vflx-
cd:dnstat=nfnd:bcap=none:vmDIG=dadbeefeed:rnidx=9:cdn=cdn2
```

```
rlghncxa03w 08-05-07 11:11:28 EST EAGLE 39.0.0
```

```
ENT-VFLX-CD: MASP A - COMPLTD  
;
```

### Related Topics

- [chg-vflx-cd](#)
- [dlt-vflx-cd](#)
- [rtrv-vflx-cd](#)

## ent-vflx-rn

Use this command to associate a routing number name to a set of voice mail routing numbers. This command creates an entry in the Routing Number table. The V-Flex feature must be enabled before this command can be entered.

### Parameters

#### **rn (mandatory)**

Routing number. The voice mail routing number.

#### **Range:**

1 - 15 digits. Valid digits are 0-9, A-F, a-f.

#### **rnname (mandatory)**

Routing number name. The name associated with the voice mail routing number.

#### **Range:**

*ayyyyyyy*

1 alphabetic character followed by 7 alphanumeric characters

### Example

```
ent-vflx-rn:rnname=rn01:rn=123ABCD012
```

### Dependencies

The V-Flex feature must be enabled before this command can be specified.

The Routing Number table is corrupt or cannot be found.

The Routing Number table cannot contain more than 10,000 entries.

The value specified for the `rnname` parameter cannot already exist in the database.

The value specified for the `rn` parameter cannot already exist in the database.

The value specified for the `rnname` parameter cannot be a reserved word, such as *none*.

### Output

```
ent-vflx-rn:rnname=rn01:rn=1234ABCD056
```

```
rlghncxa03w 08-05-07 11:11:28 EST EAGLE 39.0.0
```

```
ENT-VFLX-RN: MASP A - COMPLTD  
;
```

### Related Topics

- [chg-vflx-rn](#)
- [dlt-vflx-rn](#)
- [rtrv-vflx-rn](#)

## ent-vflx-vmsid

Use this command to provision a voice mail server ID and associate up to 10 routing number names with the ID. This command creates an entry in the VMSID table. The V-Flex feature must be enabled before this command can be entered.

### Parameters

#### **id (mandatory)**

The ID of the voice mail server.

##### **Range:**

1 - 15 digits, *dflt*

Valid digits are 0-9, A-F, a-f

*dflt*—a set of routing numbers used when a query is received with an invalid MSISDN or an MSISDN that is not found in the RTDB

#### **idx0 (optional)**

Index 0. The routing number name for index 0.

##### **Range:**

*ayyyyyyy*

1 alphabetic character followed by up to 7 alphanumeric characters

#### **idx1 (optional)**

Index 1. The routing number name for index 1.

##### **Range:**

*ayyyyyyy*

1 alphabetic character followed by up to 7 alphanumeric characters

#### **idx2 (optional)**

Index 2. The routing number name for index 2.

##### **Range:**

*ayyyyyyy*

1 alphabetic character followed by upto 7 alphanumeric characters

#### **idx3 (optional)**

Index 3. The routing number name for index 3.

##### **Range:**

*ayyyyyyy*

1 alphabetic character followed by up to 7 alphanumeric characters

**idx4 (optional)**

Index 4. The routing number name for index 4.

**Range:**

ayyyyyyy

1 alphabetic character followed by up to 7 alphanumeric characters

**idx5 (optional)**

Index 5. The routing number name for index 5.

**Range:**

ayyyyyyy

1 alphabetic character followed by up to 7 alphanumeric characters

**idx6 (optional)**

Index 6. The routing number name for index 6.

**Range:**

ayyyyyyy

1 alphabetic character followed by up to 7 alphanumeric characters

**idx7 (optional)**

Index 7. The routing number name for index 7.

**Range:**

ayyyyyyy

1 alphabetic character followed by up to 7 alphanumeric characters

**idx8 (optional)**

Index 8. The routing number name for index 8.

**Range:**

ayyyyyyy

1 alphabetic character followed by up to 7 alphanumeric characters

**idx9 (optional)**

Index 9. The routing number name for index 9.

**Range:**

ayyyyyyy

1 alphabetic character followed by up to 7 alphanumeric characters

**Example**

This example provisions a VMS ID and associates a routing number name with index 0:

```
ent-vflx-vmsid:id=123456abcdef123:idx0=RN45
```

This example provisions a VMS ID and associates routing number names with index 0 and index 5:

```
ent-vflx-vmsid:id=DADBEEFEED:idx0=rn15:idx5=rn30
```

**Dependencies**

The V-Flex feature must be enabled before this command can be entered.

The values specified for the `idx*` parameters must already exist in the Routing Number table.



The Routing Number table is corrupt or cannot be found.

The VMSID table is corrupt or cannot be found.

The value specified for the `id` parameter cannot already exist in the VMSID table.

The GTT DBMM table is corrupt or cannot be found.

The `idx*=none` parameter cannot be specified.

The VMSID table contains a maximum of 1000 entries.

The value specified for the `rnname` parameter must already exist in the Routing Number table.

### Output

```
ent-vflx-vmsid:id=123456abcdef123:idx0=rn45
```

```
rlghncxa03w 08-05-07 11:11:28 EST EAGLE 39.0.0  
ENT-VFLX-VMSID: MASP A - COMPLTD
```

```
;
```

```
ent-vflx-vmsid:id=DADBEEFEED:idx0=rn15:idx5=rn30
```

```
rlghncxa03w 08-05-07 11:11:28 EST EAGLE 39.0.0  
ENT-VFLX-VMSID: MASP A - COMPLTD
```

```
;
```

### Related Topics

- [chg-vflx-vmsid](#)
- [dlt-vflx-vmsid](#)
- [rtrv-vflx-vmsid](#)

## ent-vlr-prof

Use this command to enter a Visitor Location Register (VLR) Profile for a mobile subscriber. A VLR-Profile entry helps in getting information required to locate the user while roaming and is subsequently used in VLR-ROAM table.

### Parameters

#### **vlr** (mandatory)

VLR Number: Hexadecimal digit GT Number with variable length (1 to 16).

#### **Range:**

Hexadecimal digit string 1 to 16 digits

#### **filter** (optional)

Determines the category in which the number falls into.

**Range:**  
*whitelist*

*blacklist*

*graylist*

**Default:**  
*graylist*

**ageofloc (optional)**

Determines whether the duration at which the location was last updated must be taken into consideration.

**Range:**  
*yes*

*no*

**Default:**  
*no*

**lastact (optional)**

Determines whether last user activity must be taken into consideration.

**Range:**  
*yes*

*no*

**Default:**  
*no*

**imeirtrv (optional)**

Determines whether the VLR challenge by the IMEI is enabled for the given profile entry's last user activity has to be taken into consideration.

**Range:**  
*yes*

*no*

**Default:**  
*no*

**Example**

```
ent-vlr-prof:vlr=12345
```

```
ent-vlr-prof:vlr=4234:filter=blacklist
```

```
ent-vlr-prof:vlr=4234:filter=blacklist
```

```
ent-vlr-prof:vlr=12345:imeirtrv=no
```

**Dependencies**

VLR\_PROF table must be accessible.

VLR parameter must be unique.

VLR parameter specified must neither be a subset of more than 2 existing vlrs present nor be a superset of more than 2 existing vlr entries in VLR-PROF table.

### Output

```
ent-vlr-prof:vlr=9234:ageofloc=no:lastact=yes

tekelecstp 17-11-23 14:08:49 MST EAGLE 46.5.1.5.0-73.2.0
ent-vlr-prof:vlr=9234:ageofloc=no:lastact=yes
Command entered at terminal #17.
;

tekelecstp 17-11-23 14:08:49 MST EAGLE 46.5.1.5.0-73.2.0
ENT-VLR-PROF: MASP A - Cannot access standby fixed disk.
ENT-VLR-PROF: MASP A - Simplex database update.
Command Accepted - Processing

VLR-PROF table is (4 of 500) 1% full.
;

tekelecstp 17-11-23 14:08:49 MST EAGLE 46.5.1.5.0-73.2.0
ENT-VLR-PROF: MASP A - COMPLTD
;
Command Executed
```

The following example shows that VLR parameter specified must not be a superset of more than 2 existing vlr entries present in VLR-PROF table:

```
ent-vlr-prof:vlr=1234

E3608 Cmd Rej: Max no of VLR entries provisioned with same leading
digits

tekelecstp 17-11-27 13:06:46 MST EAGLE 46.5.1.5.0-73.2.0
ent-vlr-prof:vlr=1234
Command entered at terminal #2.
;

tekelecstp 17-11-27 13:06:46 MST EAGLE 46.5.1.5.0-73.2.0
ENT-VLR-PROF: MASP A - Cannot access standby fixed disk.
ENT-VLR-PROF: MASP A - Simplex database update.

List of existing matching entries for entered VLR:

1      123      whitelist  no
no      0

2      12      whitelist  no
no      0

ENT-VLR-PROF: MASP A - Command Aborted
;
```

The below example shows that VLR parameter specified must not be a subset of more than 2 existing vlr entries present in VLR-PROF table:

```
ent-vlr-prof:vlr=1

E3608 Cmd Rej: Max no of VLR entries provisioned with same leading digits

tekelecstp 17-11-27 13:06:46 MST EAGLE 46.5.1.5.0-73.2.0
ent-vlr-prof:vlr=1
Command entered at terminal #2.
;

tekelecstp 17-11-27 13:06:46 MST EAGLE 46.5.1.5.0-73.2.0
ENT-VLR-PROF: MASP A - Cannot access standby fixed disk.
ENT-VLR-PROF: MASP A - Simplex database update.

List of existing matching entries for entered VLR:

1      123      whitelist  no      no      0
2      12       whitelist  no      no      0

ENT-VLR-PROF: MASP A - Command Aborted
;
```

### Related Topics

- [chg-vlr-prof](#)
- [dlt-vlr-prof](#)
- [rtrv-vlr-prof](#)

## ent-vlr-roaming

Use this command to enter a Visitor Location Register (VLR) roaming entry for a mobile subscriber. A VLR-Roaming entry uses existing entries for both new as well as old entries from vlr-prof table.

### Parameters

#### **oldvlr (mandatory)**

VLR Number from which mobile subscriber has moved, hexadecimal digit GT number with variable length (1 to 16).

#### **Range:**

Hexadecimal digit string 1 to 16 digits

#### **newvlr (mandatory)**

VLR Number to which mobile subscriber has moved, hexadecimal digit GT number with variable length (1 to 16).

#### **Range:**

Hexadecimal digit string 1 to 16 digits

**time (mandatory)**

Duration for which the roaming must occur. Time is in minutes.

**Range:**

1-1440

**Example**

```
ent-vlr-roaming:newvlr=12345:oldvlr=56780:time=10
```

**Dependencies**

VLR\_PROF table must be accessible.

VLR\_DBMM table must be accessible.

VLR\_ROAM table must be accessible.

OLDVLR as well as NEWVLR parameter length must be in the range 1 to 5 digits as per current restriction.

OLDVLR or NEWVLR parameter must be existing in VLR-PROF table

The entry should not be existing in VLR\_ROAM table

OLDVLR as well as NEWVLR parameter must not be mentioned as blacklisted in vlr table.

Entries over 1000 are not allowed

Value for OLDVLR and NEWVLR parameter must not be same.

**Output**

```
ent-vlr-roaming:oldvlr=1234:newvlr=56545:time=20
```

```
tekelecstp 17-11-23 16:23:44 MST EAGLE 46.5.1.5.0-73.2.0
```

```
ent-vlr-roaming:oldvlr=1234:newvlr=56545:time=20
```

```
Command entered at terminal #17.
```

```
;
```

```
tekelecstp 17-11-23 16:23:44 MST EAGLE 46.5.1.5.0-73.2.0  
ENT-VLR-ROAMING: MASP A - Cannot access standby fixed disk.  
ENT-VLR-ROAMING: MASP A - Simplex database update.  
Command Accepted - Processing
```

```
VLR-ROAMING table is (1 of 1000) 1% full.
```

```
;
```

```
tekelecstp 17-11-23 16:23:44 MST EAGLE 46.5.1.5.0-73.2.0  
ENT-VLR-ROAMING: MASP A - COMPLTD
```

```
;
```

**Related Topics**

- [chg-vlr-roaming](#)
- [dlt-vlr-roaming](#)

- [rtrv-vlr-roaming](#)

## flash-card

Use this command to load all flash images (GPL) supported by a specified card. This command performs the same functions as the `init-flash` and the `act-flash` commands.

### Parameters

#### **code (mandatory)**

The GPL type to be loaded.

##### **Range:**

##### ***appr***

Approved GPL

##### ***trial***

Trial GPL

#### **loc (mandatory)**

Card address. The location of the card as stenciled on the shelf of the system.

##### **Range:**

*1101 - 1108, 1111 - 1113, 1115, 1201 - 1208, 1211 - 1218, 1301 - 1308, 1311 - 1318, 2101 - 2108, 2111 - 2118, 2201 - 2208, 2211 - 2218, 2301 - 2308, 2311 - 2318, 3101 - 3108, 3111 - 3118, 3201 - 3208, 3211 - 3218, 3301 - 3308, 3311 - 3318, 4101 - 4108, 4111 - 4118, 4201 - 4208, 4211 - 4218, 4301 - 4308, 4311 - 4318, 5101 - 5108, 5111 - 5118, 5201 - 5208, 5211 - 5218, 5301 - 5308, 5311 - 5318, 6101 - 6108, 6111 - 6118*

#### **force (optional)**

This parameter is used to force the command to work on an IS-NR card. Links provisioned on the card are inhibited during command execution. The card and inhibited links are restored to their previous state when the command is completed.

##### **Range:**

##### ***yes***

##### ***no***

##### **Default:**

*no*

#### **mode (optional)**

This parameter converts the flash GPL of cards present in the Upgrade SET lists (`RTRV-UPGRADE-CONFIG:DISPLAY=SETS`)

**Range:*****migrate2***

Flashes all the cards present in the Upgrade SETs that are running on BLMCAP and/or BLSLC32. Converts BLMCAP to BLDC32 and BLSLC32 to BLSLC932 respectively.

Cards running BLDC32 or BLSLC64 are not affected.

Uses the data in the SETs to decide which cards to migrate simultaneously. The migration sequence follows the same sequence as used by the Upgrade operations. The OAM cancels the links and boots the cards as the flash GPL changes occur. The use of SETs by the OAM ensures that sufficient signaling link capacity remains available at all times, and prevents disabling all links in the same linkset.

**Example**

```
flash-card:loc=1105:code=trial
flash-card:loc=1105:code=appr:force=yes
flash-card:mode=migrate2
```

**Dependencies**

Cards do not have to be provisioned to use the `flash-card` command. However, if the specified card is provisioned and not inhibited, use of the `force` parameter is required.

The specified card locations must be running a flashable software image.

This command cannot be used to load flash images for MUX cards. Use the `init-flash` command.

If the even-numbered E5-TDM (1114,1116) is specified, the flash occurs on the odd-numbered E5-MCAP running OAM (1113,1115).

The specified card location cannot be the active E5-MASP (either the active E5-MCAP or the active E5-TDM).

No other action command can be in progress when this command is entered.

The card specified in the location parameter must be present and able to communicate over the IMT. The card does not have to be provisioned in the database.

If the card is already running the specified code load, it cannot be loaded by this command.

This command cannot be entered if an IMT Rate Change sequence is in progress.

This command cannot be entered during an Extended Bit Error Rate Test (BERT).

**Notes**

The specified card must be present and able to communicate over the IMT.

A card that is already running the specified code load cannot be reflashed using the `force` parameter. The `act-flash` and `init-flash` commands must then be used to reload the same code level.

**Output**

```
flash-card:code=appr:force=yes:loc=1112

Command Accepted - Processing

    tekelecstp 18-01-18 16:06:22 MST  EAGLE 46.5.1.5.0-73.3.0
    flash-card:code=appr:force=yes:loc=1112
    Command entered at terminal #1.
;

    tekelecstp 18-01-18 16:06:55 MST  EAGLE 46.5.1.5.0-73.3.0
    Flash Card: FLASH GPL required to be downloaded on card 1112
    BLMCAP      : Running version 143-001-000  Expected version 143-002-000
;

    tekelecstp 18-01-18 16:07:14 MST  EAGLE 46.5.1.5.0-73.3.0
    Flash Card: Downloading BLMCAP on card 1112
    Flash Card: Card(s) will reset after the flash GPL download.
;

    tekelecstp 18-01-18 16:07:56 MST  EAGLE 46.5.1.5.0-73.3.0
    Flash Card: Activating BLMCAP on card 1112
;

    tekelecstp 18-01-18 16:08:25 MST  EAGLE 46.5.1.5.0-73.3.0
    Flash Card: Card 1112 flash activation complete.
;

    Flash Card: Activating links on card 1112.
;

    tekelecstp 18-01-11 16:09:11 EST  EAGLE5 39.0.0
    Command Completed.
;

> flash-card:mode=migrate2

Command Accepted - Processing

    tk1c1121001 20-03-02 01:05:43 EST  EAGLE 46.9.0.0.0-76.11.0
    flash-card:mode=migrate2
    Command entered at terminal #3.
;

    tk1c1121001 20-03-02 01:05:43 EST  EAGLE 46.9.0.0.0-76.11.0
    Recovery Required: Manually flash inhibited card 1112.
;

    tk1c1121001 20-03-02 01:05:43 EST  EAGLE 46.9.0.0.0-76.11.0
    Recovery Required: Manually flash inhibited card 1107.
;

    tk1c1121001 20-03-02 01:05:43 EST  EAGLE 46.9.0.0.0-76.11.0
```



```
Network Conversion: Inhibiting card 1108.

;

tklc1121001 20-03-02 01:05:43 EST EAGLE 46.9.0.0.0-76.11.0
** 8007.0539 ** ENET 1108,A          Ethernet Interface Down
;

tklc1121001 20-03-02 01:06:04 EST EAGLE 46.9.0.0.0-76.11.0
* 8010.0107 * IMT BUS A             Minor IMT failure detected
;

tklc1121001 20-03-02 01:06:06 EST EAGLE 46.9.0.0.0-76.11.0
8011.0106   IMT BUS A             IMT Bus alarm cleared
;

tklc1121001 20-03-02 01:06:06 EST EAGLE 46.9.0.0.0-76.11.0
Network Conversion: Downloading BLSL932 on IPSP card 1108
Network Conversion: Card(s) will reset after the flash GPL
download.
;

tklc1121001 20-03-02 01:06:07 EST EAGLE 46.9.0.0.0-76.11.0
MBUS DBG: GPL download timeout: 1140000 (MS) 19 (MINS)
;

tklc1121001 20-03-02 01:07:56 EST EAGLE 46.9.0.0.0-76.11.0
Network Conversion: Card 1108 flash download complete.
;

tklc1121001 20-03-02 01:08:11 EST EAGLE 46.9.0.0.0-76.11.0
* 8023.0004 * GPL SYSTEM BLSL932   Card is running non-activated
GPL
;

tklc1121001 20-03-02 01:08:14 EST EAGLE 46.9.0.0.0-76.11.0
Network Conversion: FLASH GPL(s) required to be activated on card
1108
      BLSL932 : Running inactive version 059-011-000
;

tklc1121001 20-03-02 01:08:14 EST EAGLE 46.9.0.0.0-76.11.0
Network Conversion: Activating BLSL932 on card 1108
;

tklc1121001 20-03-02 01:08:53 EST EAGLE 46.9.0.0.0-76.11.0
Network Conversion: Card 1108 flash activation complete.
;

tklc1121001 20-03-02 01:09:00 EST EAGLE 46.9.0.0.0-76.11.0
8029.0005   GPL SYSTEM BLSL932   Alarm cleared running non-
```

```
activated GPL
;

tklc1121001 20-03-02 01:09:06 EST EAGLE 46.9.0.0.0-76.11.0
Network Conversion: Allowing card 1108

;

tklc1121001 20-03-02 01:09:07 EST EAGLE 46.9.0.0.0-76.11.0
MBUS DBG: Card Loading Timeout: 8 minutes.

;

tklc1121001 20-03-02 01:09:07 EST EAGLE 46.9.0.0.0-76.11.0
Network Conversion: Cards loading, wait for them to return to IS-NR.

;

tklc1121001 20-03-02 01:09:39 EST EAGLE 46.9.0.0.0-76.11.0
8033.0096 CARD 1108 IP6G69 Card has been reloaded

;

tklc1121001 20-03-02 01:09:48 EST EAGLE 46.9.0.0.0-76.11.0
8035.0540 ENET 1108,A Ethernet Interface Up

;

tklc1121001 20-03-02 01:10:24 EST EAGLE 46.9.0.0.0-76.11.0
Command Completed.

;
```

### Related Topics

- [act-flash](#)
- [init-flash](#)
- [chg-upgrade-config](#)
- [rtrv-upgrade-config](#)

## format-disk

Use this command to format and initialize a removable drive or standby Terminal Disk Module (TDM).



### Note:

The `format-disk` command leaves the disk unusable until the `chg-db` and `copy-gpl` commands are entered.

### Parameters

#### **type (mandatory)**

The type of drive to format.

**Range:**

***fixed***

The standby fixed disk on the standby TDM

***meas***

The removable measurement drive

***system***

The removable system drive

***usb***

Argument to be used by Oracle personnel only.

**force (optional)**

This parameter provides some protection against data loss due to reformatting a used system removable drive.

**Range:**

***yes***

***no***

**Default:**

*no*

**loc (optional)**

The location of the disk that is being formatted.

**Range:**

***1114***

The TDM

***1116***

The TDM

***1113***

The latched USB port

***1115***

The latched USB port

**low (optional)**

This parameter provides control over whether a low-level format will be performed on the target disk. Specifying `low=no` can be used to decrease formatting time.

**Range:**

***yes***

***no***

**Default:**

*yes*

**prtnggrp (optional)**

Partition group. The disk partition group to be formatted. Specifying the inactive group is relevant only when `type=fixed` is specified.

**▲ Caution:**

Do not enter the `format-disk:prtnggrp=inactive` command unless directed to by the Customer Care Center to avoid possible loss of a previously archived software release.

**Range:**

*active*

*inactive*

**Default:**

*active*

**Example**

```
format-disk:type=system
```

```
format-disk:type=meas:force=yes
```

**Dependencies**

The `type=fixed` parameter must be specified before the `prtnggrp` parameter can be specified.

If the `prtnggrp` parameter is specified, then the `low=no` parameter must be specified.

Measurements collection must be inhibited during execution of this command. If measurements are not inhibited, this command cannot be executed.

- Do not enter the `chg-measopts:collect=on` command while the `format-disk` command is in progress. This results in read and write errors, because the standby disk is not accessible.
- Do not enter the `format-disk` command until the 30 minute measurements processing or the midnight measurements processing has completed, because inhibiting measurements during these periods results in the loss of measurement data for the period being processed.

If a removable flash drive that is inserted into the latched USB port contains EAGLE data, then the `force=yes` parameter is required.

If a plug-in flash drive that is inserted into the flush-mounted USB port contains EAGLE data, then the `force=yes` parameter is required.

If the medium that is being formatted contains system data, then the `force=yes` parameter is required.

The `force=yes` parameter must be specified if the drive to be formatted is recognized as a system removable drive. This parameter is optional if the drive is not recognized as a system removable drive. Only drives that have a **dms.cfg** file are recognized as system removable drives.

A removable drive must be inserted and made ready before the `type=meas` or `type=system` parameter can be specified in the command.

If the `force=yes` parameter is specified, the disk should not require low-level formatting, and the `format=no` parameter should be specified.

The card with the standby OAM must be available when this command is entered.

The standby fixed disk could not be accessed. There could be a hardware problem.

The active fixed disk could not be accessed. There could be a hardware problem.

The source and destination disks are not compatible. There could be a hardware problem.

The system cannot determine the capacity of the disk that is being formatted.

Refer to *Database Administration - System Management User's Guide* for detailed instructions to resolve this issue.

The standby fixed disk contains security log entries that have not yet been uploaded. Upload the log entries before formatting the disk to avoid loss of log data.

The OAMHC GPL version that is running in the active OAM card location must be the same GPL version that is running in the standby OAM card location.

OAM Measurements collection cannot be in progress when this command is entered.

A value of 1114 or 1116 must be specified for the `loc` parameter before the `type=fixed` parameter can be specified.

An E5-MCAP card must be installed before the `type=usb` parameter can be specified.

The OAM card must be able to read the media being formatted.

The `format-disk` command cannot be issued when SFAPP(P)->OAM sync is ON.

## Notes

The `low=no` parameter should be specified when upgrading a spare TDM. The `low=yes` parameter should be specified when there is a suspected hardware problem.

When the `type=meas` parameter is specified, a measurements removable drive is built.

When the `type=system` parameter is specified, a system removable drive is built.

A system removable drive can contain only GPLs and the database, not measurement data. After formatting, the drive does not contain any data, but can be used as the destination disk of the `copy-gpl` and `chg-db:action=backup:dest=remove` commands. The `copy-gpl` command copies all approved GPLs from the fixed disk on the active TDM to the system removable drive, providing a backup copy of the approved GPLs. The `chg-db:action=backup:dest=remove` command copies the database from the current partition of the fixed disk on the active TDM to a system removable drive, providing a backup copy of the database.

A measurements removable drive can contain only measurement data, not database information and GPLs. After formatting, the drive does not contain any data, but can be used as the destination disk of the `copy-meas` command. The `copy-meas`

command copies all measurement data from the fixed disk on the active TDM to a measurements removable drive for offline processing of the measurement data.

The database audit and GPL audit facilities are automatically disabled during execution of this command. When this command has completed (successful or not), the database and GPL audit facilities are automatically re-enabled.

All commands that affect the database are disallowed for the duration of the command. Attempts to use such commands are rejected, and an error message is displayed explaining that the command has been rejected.

During the upgrade process, files made obsolete by the upgrade process are deleted, freeing up disk space.

If the `format-disk` command is initiated and the standby OAM initialization is not complete, command processing is delayed. If standby initialization fails, the command proceeds to allow the standby TDM to recover from a previous `format-disk` or `copy-disk` failure. In such cases, the following messages appear:

```
Standby MASP has not finished initializing - please wait...
```

```
Standby MASP initialization timed out - continuing...
```

The `dms.cfg` file on either the active TDM or a system formatted removable drive is used by the `format-disk` command when formatting the target disk. The location of the `dms.cfg` file cannot be specified by the `format-disk` command. The value of the `type` parameter is used to determine the target disk to format and the location of the `dms.cfg` file on which to base the format. [Table 4-37](#) shows the location of the `dms.cfg` file based on the value of the `type` parameter for the `format-disk` command.

**Table 4-37 DMS.CFG File Location for format-disk Command**

Value of the type Parameter	Target Disk (Card Location)	Location of the DMS.CFG File
<i>fixed</i>	Standby TDM (1114 or 1116)	Latched USB Port (1113 or 1115)
<i>system</i>	Latched USB Port (1113 or 1115)	Active TDM (1114 or 1116)
<i>meas</i>	Latched USB Port (1113 or 1115)	Active TDM (1114 or 1116)

The `format-disk` command can create a maximum disk partition size of 2047 Mbytes, based on a 16-bit cluster size. A cluster is composed of 64 512-Kilobyte sectors. The physical capacity of the disk being formatted determines the formatted size of the disk and the number of partitions created on the disk.

[Table 4-38](#) shows the format capacities of each type of disk used on the system and the number of partitions created on each disk.

**Table 4-38 Disk Format Capacity**

Target Disk Type	Disk Location	Target Capacity	Number of Partitions	Formatted Size of Partition
Latched USB Port	1113 or 1115	2 Gigabytes	1	1.9 GB
TDM	1114 or 1116	540 Mbytes	1	507 Mbytes
TDM	1114 or 1116	2 Gigabytes	1	2014 Mbytes
TDM	1114 or 1116	4 Gigabytes	2	2047 Mbytes

**Output**

```
format-disk:type=system
```

```
rlghncxa03w 04-01-07 00:57:31 EST EAGLE 31.3.0
Format-disk of system removable media started.
```

```
rlghncxa03w 04-01-07 00:57:31 EST EAGLE 31.3.0
Format-disk (removable media) format in progress.
```

```
rlghncxa03w 04-01-07 00:57:31 EST EAGLE 31.3.0
Format-disk (removable media) format in progress.
```

```
rlghncxa03w 04-01-07 00:57:31 EST EAGLE 31.3.0
Format-disk (removable media) format is complete.
```

```
rlghncxa03w 04-01-07 00:57:31 EST EAGLE 31.3.0
Format-disk of system removable media completed.
Measurements collection may be turned on now if desired.
```

```
;
```

```
format-disk:type=fixed:low=no:force=yes
```

```
rlghncxa03w 04-01-07 00:57:31 EST EAGLE 31.3.0
Format-disk of standby fixed disk started.
Extended processing required, please wait.
```

```
;
```

```
rlghncxa03w 04-01-07 00:57:31 EST EAGLE 31.3.0
Format-disk (fixed) format in progress.
```

```
rlghncxa03w 04-01-07 00:57:31 EST EAGLE 31.3.0
Format-disk (fixed) format is complete.
```

```
rlghncxa03w 04-01-07 00:57:31 EST EAGLE 31.3.0
Format-disk of standby fixed disk completed.
Measurements collection may be turned on now if desired.
```

```
;
```

### Related Topics

- [chg-db](#)
- [copy-disk](#)
- [copy-gpl](#)
- [copy-meas](#)
- [disp-disk-dir](#)
- [rept-stat-db](#)
- [rtrv-gpl](#)

## inh-alm

Use this command to inhibit the reporting of alarms for the given device. Inhibited alarms will not generate unsolicited output or cause alarm indicators to be turned on. All `rept-stat-xxx` commands continue to display the alarm with an indication that the device has its alarms inhibited.

The frame alarm LEDs are off for the inhibited alarm. This command does not affect the alarm counts on the VT320 banner. The fourth box on the right of the VT320 Control Area indicates the number of devices in the system with inhibited alarms.

### Parameters



#### Note:

See [Point Code Formats and Conversion](#) for a detailed description of point code formats, rules for specification, and examples.

### **dev (mandatory)**

Device. The device where the reporting of alarms is to be inhibited.

#### Range:

##### ***applsock***

IP gateway application socket

##### ***as***

IP gateway Application Server

##### ***card***

Cards in the database

##### ***cdt***

Customer defined troubles

##### ***clock***

System clock



**dlk**

IP ports on the VSCCP, EROUTE, STPLAN, MCP, and FC-capable cards

**e1port**

E1 port on E5-E1T1-B cards

**enet**

Ethernet

**ls**

Linksets

**lsmsconn**

Communication link between the LSMS and the EMS

**route**

Route

**rtx**

Exception Route

**slk**

Signaling links

**t1port**

T1 port on E5-E1T1, or E5-E1T1-B cards

**tps**

TPS subsystem

**trm**

Terminals

**asname (optional)**

Gateway Application Server name. Used with the `dev=as` parameter to inhibit alarms for the named Application Server.

**Range:**

*ayyyyyyyyyyyyyyy*

up to 15 alphanumeric characters; the first character must be a letter

**cic (optional)**

Starting Circuit Identification Code. Used with the `ecic` parameter to define the CIC range that is used as an exception routing criterion for the specified exception route.

**Range:**

*0 - 16383*

**dpc (optional)**

ANSI destination point code with subfields network indicator-network cluster-network cluster member (*ni-nc-ncm*). The *prefix* subfield indicates a private point code (*prefix-ni-nc-ncm*).

**Synonym:**

*dpca*

**Range:***p*-, 000-255, \*

Specify a valid value for each subfield of the point code, and separate the subfields with a dash (-).

*prefix*—*p*-The asterisk value (\*) is not valid for the *ni* subfield.When *chg-sid:pctype=ansi* is specified, *ni = 000* is not valid.When *chg-sid:pctype=ansi* is specified, *nc = 000* is not valid if *ni = 001–005*.When *chg-sid:pctype=ansi* is specified, *nc = 000* is valid if *ni = 006–255*.The point code *000-000-000* is not a valid point code.**dpc/dpca/dpci/dpcn/dpcn24 /dpcn16 (optional)**

Destination Point Code

**dpci (optional)**ITU international destination point code with subfields *zone-area-id*. The *prefix* subfield indicates a spare point code, private point code, or private and spare point code (*prefix-zone-area-id*).**Range:***s*-, *p*-, *ps*-, 0-255

Specify a valid value for each subfield of the point code, and separate the subfields with a dash (-).

*prefix*—*s*-, *p*-, *ps**zone*—0-7*area*—000-255*id*—0-7The point code *0-000-0* is not a valid point code.**dpcn (optional)**ITU national destination point code in the format of a 5-digit number (*nnnnn*); or 2, 3, or 4 numbers (members) separated by dashes (*m1-m2-m3-m4*) as defined by the *chg-stpopts:npcfmti* flexible point code option. A group code must be specified when the ITUDUPPC feature is turned on (*nnnnn-gc*, *m1-m2-m3-m4-gc*). The *prefix* subfield indicates a spare point code, private point code, or private and spare point code (*prefix-nnnnn*, *prefix-nnnnn-gc*, *prefix-m1-m2-m3-m4*, *prefix-m1-m2-m3-m4-gc*).**Range:***s*-, *p*-, *ps*-, 0-16383, *aa-zz*

Specify a valid value for each subfield of the point code, and separate the subfields with a dash (-).

*prefix*—*s*-, *p*-, *ps**nnnnn*—0-16383*gc*—*aa-zz**m1-m2-m3-m4*—0-14 for each member; values must sum to 14**dpcn24 (optional)**24-bit ITU national destination point code with subfields *main signaling area-sub signaling area-signaling point*. The *prefix* subfield indicates a private point code.**Range:***p*-, 000-255

Specify a valid value for each subfield of the point code, and separate the subfields with a dash (-).

*prefix*—*p*  
*msa*—000–255  
*ssa*—000–255  
*sp*—000–255

**dpcn16 (optional)**

16-bit ITU national point code with subfields *unit number sub number area main number area* (*un-sna-mna*). The *prefix* subfield indicates a private point code.

**Range:**

*p*--, 000---127

Specify a valid value for each subfield of the point code, and separate the subfields with a dash (-).

*prefix*---*p*

*un*---000---127

*sna*---000---15

*mna*---000---31

**dur (optional)**

Duration. The period for which the alarms are inhibited.

**Range:*****perm***

permanent inhibition of an alarm

***temp***

temporary inhibition of an alarm

***timed***

inhibition of an alarm for a specified duration

 **Note:**

If the `dur=temp` parameter is specified, then an alarm inhibit lasts as long as the alarm is present. If the system boots or switches over, then the alarm inhibit is removed. If the `dur=perm` parameter is specified, then the alarm inhibit remains after the alarm is cleared or is no longer present, and after a boot/switchover. The `dur=timed` parameter behaves the same as the `dur=perm` parameter, but for a set time period.

**Default:**

*perm*

**e1port (optional)**

Port ID. The E1 port on the specified E1 card.

This parameter is mandatory if the `dev=e1port` parameter is specified.

**Range:**

1 - 8

**ecic (optional)**

Ending Circuit Identification Code. Used with the `cic` parameter to define the CIC range that is used as exception routing criteria for the specified exception route.

**Range:**

0 - 16383

**edate (optional)**

Expiry date. The date on which a timed alarm inhibit expires, at the time specified in the `etime` parameter value.

 **Note:**

This parameter is valid and required when the `dur=timed` parameter is specified.

**Range:**

101 - 991231

Specify the date in the format of *year*, followed by *month*, followed by *day* (*yymmdd*).

**etime (optional)**

Expiry time. The time at which a timed alarm inhibit expires, on the date specified in the `edate` parameter value.

This parameter is valid and required when the `dur=timed` parameter is specified.

**Range:**

0 - 2359

Specify the time in the format of *hour* followed by *minute* (*hhmm*).

**force (optional)**

Allows critical alarms to be inhibited on a device.

This parameter is mandatory if the `lvl=crit` parameter is specified.

The `critalminh` STP option must be turned on before this parameter can be specified.

**Range:****yes****no****Default:***no***id (optional)**

Identification number of the customer-defined trouble. Customer-defined troubles 1 - 4 are generated critical alarms and cannot be specified as values for this parameter.

**Range:**

5 - 16

**ilsn (optional)**

Incoming Link Set Name. The name of the originating linkset. The parameter value is used as part of the exception routing criteria for the specified exception route.

**Range:**

ayyyyyyyyy

1 alphabetic character followed by up to 9 alphanumeric characters

**link (optional)**

Signaling link on the card specified in the `loc` parameter.

**Synonym:**

*port*

**Range:**

*a, b, a1 - a31, b1 - b31*

*a1, a2, b1, b2* — `dev=lsmsconn`

*a, b, a1-a31, b1-b31* — `dev=slk` for an E5-E1T1, or E5-E1T1-B

*a1, b1* — `dev=dlk` for an FC-capable card

*a, b* — `dev=enet`

**loc (optional)**

The card location as stenciled on the shelf of the system.

**Range:**

*1101 - 1113, 1115, 1201 - 1218, 1301 - 1318, 2101 - 2118, 2201 - 2218, 2301 - 2318, 3101 - 3118, 3201 - 3218, 3301 - 3318, 4101 - 4118, 4201 - 4218, 4301 - 4318, 5101 - 5118, 5201 - 5218, 5301 - 5318, 6101 - 6118*

**lsn (optional)**

Linkset name. The name of the linkset for which the report information is to be displayed.

**Range:**

ayyyyyyyyy

1 alphabetic character followed by up to 9 alphanumeric characters

**lv1 (optional)**

The alarm severity level (critical, major, or minor).

**Range:**

*crit*

*majr*

*minr*

**Default:**

*majr*

**opc (optional)**

ANSI point code with subfields *network indicator-network cluster-network cluster member (ni-nc-ncm)*. The *prefix* subfield indicates a private point code (*prefix-ni-nc-ncm*).

**Synonym:**

*opca*

**Range:**

*0-255*

Specify a valid value for each subfield of the point code, and separate the subfields with a dash (-).

*zone—0-7*

*area—000-255*

*id—0-7*

The point code *0-000-0* is not a valid point code.

**opc/opca/opci/opcn/opcn24/opcn16 (optional)**

Origination point code.

**opci (optional)**

ITU international destination point code with subfields *zone-area-id*. The *prefix* subfield indicates a spare point code, private point code, or private and spare point code (*prefix-zone-area-id*).

**Range:**

*s-, p-, ps-, 0-255*

Specify a valid value for each subfield of the point code, and separate the subfields with a dash (-).

*prefix—s-, p-, ps*

*zone—0-7*

*area—000-255*

*id—0-7*

The point code *0-000-0* is not a valid point code.

**opcn (optional)**

ITU national destination point code in the format of a 5-digit number (*nnnnn*); or 2, 3, or 4 numbers (members) separated by dashes (*m1-m2-m3-m4*) as defined by the `chg-stpopts:npcfmti` flexible point code option. A group code must be specified when the ITUDUPPC feature is turned on (*nnnnn-gc, m1-m2-m3-m4-gc*). The *prefix* subfield indicates a spare point code, private point code, or private and spare point code (*prefix-nnnnn, prefix-nnnnn-gc, prefix-m1-m2-m3-m4, prefix-m1-m2-m3-m4-gc*).

**Range:**

*s-, p-, ps-, 0-16383, aa-zz*

Specify a valid value for each subfield of the point code, and separate the subfields with a dash (-).

*prefix—s-, p-, ps*

*nnnnn—0-16383*

*gc—aa-zz*

*m1-m2-m3-m4—0-14* for each member; values must sum to 14

**opcn24 (optional)**

24-bit ITU national destination point code with subfields *main signaling area-sub signaling area-signaling point (msa-ssa-sp)*. The *prefix* subfield indicates a private point code (*prefix-msa-ssa-sp*).

**Range:***p*-, 000-255

Specify a valid value for each subfield of the point code, and separate the subfields with a dash (-).

*prefix—p**msa—000—255**ssa—000—255**sp—000—255***opc<sub>n</sub>16 (optional)**

16-bit ITU national point code with subfields *unit number sub number area main number area (un-sna-mna)*. The *prefix* subfield indicates a private point code (*prefix-un-sna-mna*).

**Range:***p--*, 000---127

Specify a valid value for each subfield of the point code, and separate the subfields with a dash (-).

*prefix---p**un---000---127**sna---000---15**mna---000---31***si (optional)**

Service Indicator. This parameter is used as the exception routing criterion for the specified exception route.

**Range:**

0 - 15

**sname (optional)**

Gateway application socket. Used with the `dev=applsock` parameter to inhibit alarms for the named application socket.

**Range:***ayyyyyyyyyyyyyyy*

1 to 15 alphanumeric characters

**t1port (optional)**

Port ID. This parameter is mandatory if the `dev=t1port` parameter is specified.

**Range:**

1 - 8

**term (optional)**

Terminal ID. The ID number of the terminal whose characteristics are to be retrieved and displayed.

**Range:**

1 - 40

**Example**

```
inh-alm:dev=route:dpc=1-1-1:dur=perm:lvl=crit:force=yes
inh-alm:dev=rtx:dpc=1-101-1:opc=4-4-4
inh-
alm:dev=route:dpc=1-1-1:dur=timed:lvl=crit:edate=050515:etime=2300:force=yes
inh-alm:dev=enet:loc=1201:port=a
inh-alm:dev=enet:loc=1101:port=a:dur=temp:lvl=minr
inh-alm:loc=1102:dev=dlk:port=a1
inh-alm:dev=rtx:dpcn16=121-10-15:opc16=121-10-16
```

**Dependencies**

This command is not allowed in upgrade mode.

The parameters that can be specified with the `dev` parameter vary, depending on the value specified for the `dev` parameter as shown:

- `dev=(any value)` — `dur` or `lvl`
- `dev=asname` — `as`
- `dev=dpc/dpca/dpci/dpcn/dpcn24/dpcn16` — `route`
- `dev=id` — `cdt`
- `dev=loc` — `card`, `dlk`, `elport`, `slk`, `tlport`, `enet`
- `dev=lsn` — `ls`
- `dev=elport` — `elport`
- `dev=link (link=a, b)` — `dlk`, `slk`, `enet`
- `dev=link (link=a1, b1)` — `dlk` (For FC-capable cards)
- `dev=link (link=a, b, a1, a2, b1, b2, a3, b3)` — `slk`
- `dev=link (link=a1, a2, b1, b2)` — `lsmconn`
- `dev=sname` — `applsock`
- `dev=tlport` — `tlport`
- `dev=trm` — `trm`

No other action command can be in progress when this command is entered.

The linkset specified by the `lsn` parameter must be equipped in the database.

This command will not execute while the signaling link is running either a Link Fault Sectionalization test or a Loopback test. An AST of LFS or LPBK must be cleared before signaling link alarms can be inhibited.

This command cannot be used to permanently inhibit XLIST point codes.

Before critical alarms can be inhibited, the STP option `criticalminh` must be enabled. The `chg-stpopts:criticalminh=yes` command enables this option.



Alarms cannot already be inhibited for the specified device.

The Device Alarm Inhibit table is corrupt or cannot be found.

The STP Options table is corrupt or cannot be found.

If the `lvl=crit` parameter is specified, the `force=yes` parameter must be specified.

When the `dev=card` parameter is specified, the `loc` parameter must be specified.

When the `dev=dlk` parameter is specified, the `loc` parameter must be specified.

When the `dev=slk` parameter is specified, the `loc` parameter and the `link` parameter must be specified.

When the `dev=elport` parameter is specified, the `loc` and `elport` parameters must be specified.

When the `dev=tlport` parameter is specified, the `loc` and `tlport` parameter must be specified.

When the `dev=ls` parameter is specified, the `lsn` parameter must be specified.

When the `dev=trm` parameter is specified, the `trm` parameter must be specified.

When the `dev=cdt` parameter is specified, the `id` parameter must be specified.

When the `dev=lsmsconn` parameter is specified, the `link` parameter must be specified.

When the `dev=route` parameter is specified, the `dpc/dpca/dpci/dpcn/dpcn24/dpcn16` parameter must be specified.

When the `dev=applsock` parameter is specified, the `sname` parameter must be specified.

If the `dev=as` parameter is specified, the `asname` parameter must be specified.

If the `sname` parameter is specified, the socket name must exist in the IPAPSOCK table.

If a point code parameter is specified, the point code must exist in the Routing table.

If the `dev=slk` or `dev=dlk` parameter is specified, the specified `link` must exist in the database.

The card location that is specified in the `loc` parameter must be equipped.

The specified device type must be supported by the card in the specified card location.

The Origin-Based MTP Routing feature must be on before the `dev=rtx` parameter can be specified.

Permanent alarm inhibit is not allowed on the cluster PC if either the cluster or a member PC of the cluster is already alarm inhibited.

When the `dur=timed` parameter is specified, the `edate` and `etime` parameters must be specified.

If the `dur` parameter has a value other than *timed*, the `edate` and `etime` parameters cannot be specified.

The `edate` parameter value must be a date equal to or later than the current system date. If the current system date is specified, then the `etime` parameter value must be a time later than the current system time. If a date later than the current system date is specified, then the `etime` parameter value can be any valid time in the format *hhmm*.

This command cannot be used to change the level of inhibition on a device.

If the `dev=enet` parameter is specified, then the `loc` and `port` parameters must be specified.

The card specified by the `loc` parameter must be provisioned with an IPS, MCP, STPLAN, EROUTE, VSCCP, IPSG, IPLIMI, IPLIMI, SS7IPGW, or IPGWI application.

The value specified for the `elport/tlport` parameter must be in the range 1-8.

The `link` parameter must be valid for the selected device type.

The J7 Support feature must be enabled before the `opcn16/dpcn16` parameters can be specified.

### Notes

If critical alarms are inhibited, all alarms (critical, major, and minor) are disabled. Likewise, if major alarms are inhibited, both major and minor alarms are disabled.

The `dur` parameter allows alarms to be inhibited on a temporary basis. If a device has its alarms temporarily disabled, the device's alarms are automatically enabled after the alarm clears.

In this command, only ITU-international and ITU national point codes support the spare point code subtype prefix (s-) and the private and spare point code subtype prefix (ps-). All of the point code types support the private (internal) point code subtype prefix (p-).

### Output

```
inh-alm:dev=route:dpc=1-1-1:dur=perm:lvl=crit
```

```
rlghncxa03w 04-02-23 13:20:59 EST EAGLE 31.3.0  
Alarms are permanently inhibited.
```

```
;
```

```
rlghncxa03w 04-02-23 13:20:59 EST EAGLE 31.3.0  
Command Completed.
```

```
;
```

```
inh-alm:dev=rtx:dpc=1-101-1:opc=4-4-4
```

```
stdcfg2b 06-05-27 20:20:35 EST EAGLE 35.0.0  
Alarms are permanently inhibited  
Command Completed.
```

```
;
```

```
inh-  
alm:dev=route:dpc=1-1-1:dur=timed:lvl=crit:edate=050515:etime=2  
300:force=yes
```

```
tekelecstp 07-02-27 13:20:59 EST EAGLE 35.6.0  
Alarms are timed inhibited.
```

```
;
```

```
tekelecstp 07-02-27 13:20:59 EST EAGLE 35.6.0  
Command Completed
```

```
;
```

```
inh-alm:dev=enet:loc=1201:port=a
```

```
stdcfg2b 07-02-07 20:20:35 EST EAGLE 35.6.0  
Alarms are permanently inhibited  
Command Completed.
```

```
;
```

```
inh-alm:dev=enet:loc=1101:port=a:dur=temp:lvl=minr
```

```
stdcfg2b 07-02-07 20:20:35 EST EAGLE 35.6.0  
Temporary alarm inhibit level less than alarm level on device  
Command Completed.
```

```
;
```

### Related Topics

- [rept-stat-alm](#)
- [rept-stat-card](#)
- [rept-stat-cdt](#)
- [rept-stat-dlk](#)
- [rept-stat-dstn](#)
- [rept-stat-ls](#)
- [rept-stat-rte](#)
- [rept-stat-rtx](#)
- [rept-stat-seas](#)
- [rept-stat-slk](#)
- [rept-stat-sys](#)
- [rept-stat-trbl](#)
- [rept-stat-trm](#)
- [rtrv-log](#)
- [unhb-alm](#)

## inh-card

Use this command to change the state of the card from in-service normal (IS-NR) to Out-of-Service Maintenance-Disabled (OOS-MT-DSBLD). A user can then test the card or physically remove it from the shelf.

### Parameters

#### **e1oc (optional)**

End location. The location of the last card of a range of cards to be inhibited.

#### **Range:**

1101 - 1108, 1111 - 1113, 1115, 1201 - 1208, 1211 - 1218, 1301 - 1308, 1311 - 1318, 2101 - 2108, 2111 - 2118, 2201 - 2208, 2211 - 2218, 2301 - 2308, 2311 - 2318, 3101 - 3108, 3111 - 3118, 3201 - 3208, 3211 - 3218, 3301 - 3308, 3311 - 3318, 4101 - 4108, 4111 - 4118, 4201 - 4208, 4211 - 4218, 4301 - 4308, 4311 - 4318, 5101 - 5108, 5111 - 5118, 5201 - 5208, 5211 - 5218, 5301 - 5308, 5311 - 5318, 6101 - 6108, 6111 - 6118

#### **force (optional)**

Force indicator. This parameter is required if:

- The specified card is the last card supporting a linkset, SCCP subsystem, MPS-to-Service Module connection, E1, T1, Measurements Platform subsystem, or GLS
- The TDM contains a security log with un-uploaded entries or any other TDM process in progress
- The specified E5-E1T1-B card is in channel bridging mode
- The specified card has the last in-service SEAS terminal configured.

#### **Range:**

*yes*

*no*

#### **Default:**

*no*



#### **Note:**

If the `force` parameter is specified in the command along with the `sloc` and `e1oc` parameters, then the `force` parameter's value is applied to all the cards within the `sloc-e1oc` range, including `sloc` and `e1oc`.

#### **1oc (optional)**

Card address. The card location as stenciled on the shelf of the system.

#### **Range:**

1101 - 1108, 1111 - 1113, 1115, 1201 - 1208, 1211 - 1218, 1301 - 1308, 1311 - 1318, 2101 - 2108, 2111 - 2118, 2201 - 2208, 2211 - 2218, 2301 - 2308, 2311 - 2318, 3101 - 3108, 3111 - 3118, 3201 - 3208, 3211 - 3218, 3301 - 3308, 3311 - 3318, 4101 - 4108,

4111 - 4118, 4201 - 4208, 4211 - 4218, 4301 - 4308, 4311 - 4318, 5101 - 5108,  
5111 - 5118, 5201 - 5208, 5211 - 5218, 5301 - 5308, 5311 - 5318, 6101 - 6108,  
6111 - 6118

### sloc (optional)

Start location. The location of the first card of a range of cards to be inhibited.

#### Range:

1101 - 1108, 1111 - 1113, 1115, 1201 - 1208, 1211 - 1218, 1301 - 1308, 1311 -  
1318, 2101 - 2108, 2111 - 2118, 2201 - 2208, 2211 - 2218, 2301 - 2308, 2311 -  
2318, 3101 - 3108, 3111 - 3118, 3201 - 3208, 3211 - 3218, 3301 - 3308, 3311 -  
3318, 4101 - 4108, 4111 - 4118, 4201 - 4208, 4211 - 4218, 4301 - 4308, 4311 -  
4318, 5101 - 5108, 5111 - 5118, 5201 - 5208, 5211 - 5218, 5301 - 5308, 5311 -  
5318, 6101 - 6108, 6111 - 6118

### Example

```
inh-card:loc=1101
inh-card:loc=1201:force=yes
inh-card:sloc=1101:eloc=1111
inh-card:sloc=1101:eloc=1111:force=yes
```

### Dependencies

No other action commands can be in progress when this command is entered.

TDM and MDAL cards cannot be inhibited. E5-APP-B cards and Telco Switches cannot be inhibited. Card locations 1114, 1116, 1117, xx09, and xx10 cannot be specified as values for the `loc` parameter.

If the card contains signaling or data links, all links must be out of service (OOS-MT-DSBLD) before the card can be inhibited.

If the card is type LIME1, all signaling links providing timeslots serviced by the E1 interfaces assigned to the card must be deactivated, unless `force=yes` is specified.

If the card is type LIMT1, all signaling links providing timeslots serviced by the T1 interfaces assigned to the card must be deactivated, unless `force=yes` is specified.

The shelf and card must be equipped.

If the specified card is the only in-service MPS-Service Module, the `force=yes` parameter must be specified.

If inhibiting the Service Module card would cause less than 80% of the in-service normal (IS-NR) LIM cards to have VSCCP service (i.e., cause the system to enter an unstable loading mode), the `force=yes` parameter must be specified.

If the Integrated GLS feature is turned OFF and the specified card is only GLS card remaining, then the `force=yes` parameter is required.

The card that is specified by the `loc/sloc/eloc` parameter cannot be running the active OAM.

If the specified card has the last in-service SEAS Terminal configured, then the `force=yes` parameter must be specified to inhibit the card.

The card location (`loc`) must be within the allowed range.

The standby fixed disk cannot be initialized while un-uploaded security log entries exist.

The `loc` parameter cannot be specified with the `eloc` and `sloc` parameters.

Either the `loc` parameter or the `eloc` and `sloc` parameters must be specified.

The `eloc` and `sloc` parameters must be specified together in the command.

The `sloc` parameter value cannot be greater than the `eloc` parameter value.

The `inh-card` command cannot be issued when SFAPP(P)->OAM sync is ON.

This command cannot be entered when CAT2 IPISM to OAM syncing is in progress.

### Notes

The function of this command is the same as the `rmv-card` command.

When this command is entered, the card is initialized and enters the OOS-MT-DSBLD state. It has no affect if the card is already OOS-MT-DSBLD.

#### Caution:

This command can be used to disable Measurements Platform measurements collection after the collection function has been enabled with the `chg-measopts:platformenable=on` command. To disable collection, ALL MCPM cards in the system must be inhibited. THIS CAN RESULT IN LOSING ALL PAST MEASUREMENT DATA ON THE CARDS. Use the `alw-card` command to enable measurements collection after the MCPM cards have been inhibited.

When an IPISM card is inhibited, the active SEAS terminals are set to the state OOS-MT/FLT.

### Output

```
inh-card:loc=1101
```

```
rlghncxa03w 04-01-07 11:11:28 EST EAGLE 31.3.0
Card has been inhibited.
```

```
;
```

```
inh-card:sloc=1101:eloc=1107
```

```
Command Accepted - Processing
```

```
tekelecstp 15-04-22 16:52:31 MST EAGLE5 47.0.0-66.1.0
inh-card:sloc=1101:eloc=1107
Command entered at terminal #4.
```

```
;
```

```
tekelecstp 15-04-22 16:52:31 MST EAGLE5 47.0.0-66.1.0
```

```
inh-card command for location 1101-1107 Started
;

tekelecstp 15-04-22 16:52:31 MST EAGLE5 47.0.0-66.1.0
LOC 1101: INHIBIT OPERATION COMPLETED
LOC 1103: INHIBIT OPERATION COMPLETED
LOC 1105: INHIBIT OPERATION COMPLETED
LOC 1107: INHIBIT OPERATION COMPLETED
ALL CARDS HAVE BEEN INHIBITED
inh-card command for location 1101-1107 Completed
;

tekelecstp 15-04-22 16:52:31 MST EAGLE5 47.0.0-66.1.0
Command Completed.
;
```

### Related Topics

- [alw-card](#)
- [dlt-card](#)
- [ent-card](#)
- [init-card](#)
- [rept-stat-card](#)
- [rmv-card](#)
- [rtrv-card](#)

## inh-imt

The interprocessor message transport bus (IMT bus) is the main communications artery between all subsystems in the system. This command removes the IMT bus from service.

### Caution:

Use this command only when directed by the Customer Care Center.

### Parameters

#### **bus (mandatory)**

IMT bus to be inhibited

#### **Range:**

*a, b*

#### **force (optional)**

This parameter forces inhibition of a specified bus where an IMT Rate change sequence is in progress.

**Range:**

**yes**

**no**

**Default:**

*no*

**Example**

```
inh-imt:bus=a
```

```
inh-imt:bus=a:force=yes
```

**Dependencies**

Valid IMT bus entries are "A" or "B".

The alternate IMT bus must be in-service normal (IS-NR) in order for the specified bus to be inhibited.

This command cannot be entered during an IMT Fault Isolation Test or an Extended Bit Error Rate Test (BERT).

The `force=yes` parameter must be specified to inhibit a bus where an IMT Rate Change sequence is in progress.

If an IMT Rate Change sequence is in progress on the alternate bus, then this command cannot be entered.

**Notes**

Cards not connected to the other IMT bus will reinitialize.

All traffic is rerouted to the alternate IMT bus.

The function of this command is the same as the `rmv-imt` command.

**Output**

```
inh-imt:bus=a
```

```
rlghncxa03w 04-01-07 11:11:28 EST  EAGLE 31.3.0  
Inhibit IMT Bus A command issued
```

```
rlghncxa03w 04-01-07 13:12:41 EST  EAGLE 31.3.0  
3116.0098   IMT BUS A                IMT inhibited
```

```
;
```

**Related Topics**

- [alw-imt](#)
- [clr-imt-stats](#)
- [conn-imt](#)
- [disc-imt](#)



- [rept-imt-lvl1](#)
- [rept-imt-lvl2](#)
- [rept-stat-imt](#)
- [rmv-imt](#)
- [rst-imt](#)

## inh-map-ss

Use this command to shut down (inhibit) a mated application subsystem. Currently, the AIQ, ATINPQ, EIR, INP, INPQS, LNP, and V-Flex and subsystems can be inhibited. The specified subsystem attempts a coordinated shutdown. If the coordinated shutdown fails, a UIM is issued indicating the shutdown failed. If the `force` parameter is specified, the subsystem is forced to shut down, and a coordinated shutdown is not performed.

### Parameters

#### **ssn (mandatory)**

The AIQ, ATINPQ, EIR, INP, LNP or V-Flex subsystem number.

#### **Range:**

*2 - 255*

#### **force (optional)**

This parameter forces the shutdown of the AIQ, ATINPQ, EIR, INP, LNP or V-Flex subsystem.

#### **Range:**

*yes*

*no*

#### **Default:**

*no*

### Example

```
inh-map-ss:ssn=10
```

```
inh-map-ss:ssn=10:force=yes
```

### Dependencies

The EIR, INP, LNP, or V-Flex feature must be turned on or the ANSI41 AIQ or ATINP feature must be enabled before this command can be entered.

No other action command can be in progress when this command is entered.

The specified `ssn` parameter value must represent the AIQ, ATINPQ, EIR, INP, LNP or V-Flex subsystem.

The EAGLE must be configured with at least one card running the SCCP application.

**Notes**

If the LNPQS subsystem is disabled, any GTT requiring Message Relay is also disabled because they both use the same database. This causes the EAGLE to generate a TFP for the EAGLE CPCs. Traffic is then routed to the mate. If both Message Relay GTT and non Message Relay GTT use the same CPC, this could affect the GTT.

**Table 4-39 Route Set Test When LNP is Offline**

Network Management	Concerned PC	Network Management
RSP	CPC	TFA concerning CPC
RSP	LNP CPC	None
RSP	TPC	TFA concerning TPC
RSR	CPC	TFA concerning CPC
RSR	LNP CPC	TFP concerning LNP CPC
RSR	TPC	TFA concerning TPC

[Table 4-40](#) shows what actions the system takes when LNP is offline and a message arrives requiring LNP. This table assumes that SCCP cards are available.

**Table 4-40 Receiving Messages when LNP is Offline**

Routing Indicator in Incoming Message	DPC	Result of GTT	Message Handling	Network Management
rt-on-gt	Capability PC	rt-on-ssn, LNP subsystem	Reroute to mate	TFP concerning CPC
rt-on-gt	True PC	rt-on-ssn, LNP subsystem	Reroute to mate	None
rt-on-gt	Capability PC	Message Relay required	Generate UDTS	TFP concerning CPC
rt-on-gt	True PC	Message Relay required	Generate UDTS	None
rt-on-ssn	Capability PC	Not applicable	Generate UDTS	None
rt-on-ssn	True PC	Not applicable	Generate UDTS	SSP concerning True PC

**Output**

```
inh-map-ss:ssn=30
```

```
rlghncxa03w 04-02-24 10:37:22 EST EAGLE5 31.0.0
Inhibit map subsystem command sent to all SCCP cards.
Command Completed.
```

```
;
```

```
inh-map-ss:ssn=30:force=yes
```

```
rlghncxa03w 04-02-24 10:37:22 EST EAGLE5 31.0.0
Inhibit map subsystem command sent to all SCCP cards.
Command Completed.
```

```
;
```

### Related Topics

- [alw-map-ss](#)
- [rept-stat-lnp](#)
- [rept-stat-sccp](#)

## inh-slk

Use this command to prevent message signal units (MSU) from being transmitted on a specified, previously uninhibited signaling link.



### Note:

The signaling link's inhibited status is not preserved across a LIM reboot.

### Parameters

#### link (mandatory)

The signaling link on the card that is specified in the `loc` parameter. The links can be specified in any sequence or pattern.

#### Synonym:

*port*

#### Range:

*a, b, a1 - a63, b1 - b63*

Not all card types support all `link` parameter values.

See [Table A-1](#) for valid `link` parameter range values for each type of card that can have a location specified in the `loc` parameter.

#### loc (mandatory)

The card location as stenciled on the shelf of the system.

#### Range:

*1101 - 1108, 1111 - 1112, 1201 - 1208, 1211 - 1218, 1301 - 1308, 1311 - 1318,  
2101 - 2108, 2111 - 2118, 2201 - 2208, 2211 - 2218, 2301 - 2308, 2311 - 2318,  
3101 - 3108, 3111 - 3118, 3201 - 3208, 3211 - 3218, 3301 - 3308, 3311 - 3318,  
4101 - 4108, 4111 - 4118, 4201 - 4208, 4211 - 4218, 4301 - 4308, 4311 - 4318,  
5101 - 5108, 5111 - 5118, 5201 - 5208, 5211 - 5218, 5301 - 5308, 5311 - 5318,  
6101 - 6108, 6111 - 6118*

### Example

```
inh-slk:loc=1307:link=b
```

## Dependencies

A card location must be specified that is valid and defined in the database.

No other action command can be in progress when this command is entered.

The card must be equipped and must be one of the following cards:

- E5-E1T1-B, card running the SS7ANSI or CCS7ITU application
- E5-ATM-B card running the ATMANSI or ATMITU application
- E5-ENET-B card running the IPLIMI, or IPSG application
- SLIC card running the IPSG application

The card must contain signaling links.

The signaling link must be equipped in the database.

If an IPSG-M3UA signaling link is used, then this command cannot be entered.

This command is not valid for E5-ENET-B cards with IPGWI links.

If an ATM card is used, then a valid value must be specified for the `link` parameter:

- `a-a1`, `b`—E5-ATM-B card running the ATMANSI or ATMITU application

This command is not supported for links associated with J7 APCs.

This command is not valid for IPSG-M3UA signaling links.

## Notes

If the link is already inhibited, the system does not execute the command.

If the link is aligned, it attempts to perform a changeover to alternate links. If it is not aligned, it cannot carry traffic.

If the link is the last link in the linkset, or if the node assigned to the link is inaccessible by another route, then the SS7 changeover procedure cannot occur, the inhibit request is denied, and UIM 1150 is issued. The UIM can be retrieved from the logs or from a terminal with the appropriate TRM settings.

If the `inh-slk` command is followed by the `init-card` command, the inhibition of the signaling link is not preserved after the `init-card` command completes.

The `inh-slk` command might time out if a far-end remote does not respond to the inhibit message.

## Output

```
inh-slk:loc=1301:link=a
```

```
rlghncxa03w 05-01-07 11:11:28 EST EAGLE5 33.0.0  
Inhibit Link message sent to card
```

```
;
```

## Related Topics

- [act-slk](#)
- [blk-slk](#)
- [dact-slk](#)
- [dlt-slk](#)
- [ent-slk](#)
- [rept-stat-slk](#)
- [rtrv-slk](#)
- [tst-slk](#)
- [ublk-slk](#)
- [unhb-slk](#)

# inh-trm

Use this command to set the primary state of a serial port to OOS-MT-DSBLD . It sets the secondary state to MANUAL . The serial port is not available to perform service functions. There is no outgoing traffic from the serial port, and all incoming traffic is ignored.

## Parameters

### **trm (mandatory)**

The ID of serial port to be inhibited

#### **Range:**

*1 - 40*

### **force (optional)**

This parameter forces the removal of a specified terminal, even if it is last in-service SEAS terminal available.

#### **Range:**

*yes*

*no*

#### **Default:**

*no*

## Example

```
inh-trm:trm=5
```

```
inh-trm:trm=1:force=yes
```

## Dependencies

No other action command can be in progress when this command is entered.

The IP User Interface feature must be enabled before terminal ports 17 through 40 can be specified for the `trm` parameter.

The terminal specified by the `trm` parameter must be equipped.

This command cannot be used to inhibit the terminal from which the command is entered.

The `force=yes` parameter must be specified to inhibit the last in-service SEAS terminal.

### Notes

When inhibiting an already inhibited terminal, a warning message is echoed to the scroll area, but no action is taken.

### Output

```
inh-trm:trm=5
```

```
rlghncxa03w 04-01-07 11:11:28 EST EAGLE 31.3.0  
Inhibit message sent to terminal
```

```
;
```

```
inh-trm:trm=17:force=yes
```

```
tekelecstp 07-01-23 18:46:01 EST EAGLE 37.5.0  
Inhibit message sent to terminal
```

```
;
```

### Related Topics

- [act-echo](#)
- [alw-trm](#)
- [canc-echo](#)
- [chg-trm](#)
- [dact-echo](#)
- [rept-stat-trm](#)
- [rmv-trm](#)
- [rst-trm](#)
- [rtrv-trm](#)

## init-card

Use this command to cause a soft reset of a card. It has the same result as a hard reset (card boots, application, and data load), except that connect status is not affected; that is, if a card is not connected, it stays that way.

When the command is issued, there is a 10-second wait before the card is reset. This wait period is intended to ensure that all database updates are complete before the card is reset.

**▲ Caution:**

Resetting more than 8 Service Module cards at once may result in an extended reload time for the Service Module cards.

**Parameters****app1 (optional)**

Application. The type of application residing on the card.

**▲ Caution:**

Because the `app1` parameter causes all LIMs running the assigned application to reload, it should be used only during periods of low traffic.

**Range:**

*xyyyyyy*

1 alphabetic character followed by up to 6 alphanumeric characters. Valid applications are:

*all*—Used to reset EAGLE cards. Cannot be specified unless `serial=yes` is also specified.

*atmansi*—Used by E5-ATM-B cards to support high-speed ATM signaling links and T1 functions.

*atmitu*—Used by E5-ATM-B cards to support E1 high-speed signaling links and E1 functions.

*ccs7itu*—Used by E5-E1T1-B cards for ITU-TSS MTP functions.

*deirhc*—Used by E5-SM8G-B and SLIC cards to support the S13/S13' EIR feature.

*enumhc*—Used by E5-SM8G-B and SLIC cards to support the ENUM application.

*eroute*—Used by E5-ENET-B cards for EAGLE 5 Integrated Monitoring Support functions.

*gls*—Used by E5-TSM cards for downloading gateway screening to LIM cards and Service Module cards.

*ipgwi*—Used by E5-ENET-B cards for point-to-multipoint IP connectivity for ITU point codes. The system allows a maximum of 125 cards to be assigned the IPGWI application.

*iplimi*—Used by E5-ENET-B cards for point-to-point IP connectivity for ITU point codes.

*ips*—Used by E5-IPSM and E5-ENET-B cards for the IP User Interface feature.

*ipsg*—Used by E5-ENET-B cards to support the combined functionality of IPLIMx M2PA and IPGWx M3UA.

*mcp*—Used by E5-MCPM-B cards for the Measurements Platform feature

*oam*—Used by both MASP Cards running GPLs that support the OAM application

*siphc*—Used by E5-SM8G-B and SLIC Cards to support SIP application

*ss7ansi*—Used by E5-E1T1-B cards for the MTP functions

*ss7ipgw*—Application software for point-to-multipoint IP connectivity. The system allows a maximum of 125 cards to be assigned the SS7IPGW application.

*stplan*—Used by E5-ENET-B cards to support STP LAN functions

*vsccp*—Used by Service Module cards to support EPAP-based features and LNP features. If no EPAP-based features or LNP features are turned on, and a Service Module card is present, the *vsccp* application processes normal GTT traffic.

**Default:**

The application assigned to the card

**data (optional)**

High memory refresh. This parameter causes data to be reloaded to the specified card.

 **Note:**

The LNP feature or an EPAP-based feature must be turned on or the ATINP feature must be enabled before this parameter can be specified. This parameter applies only to Service Module cards that (1) run the VSCCP application and contain an RTDB or (2) run the DEIRHC application.

**Range:*****refresh***

Causes data to be reloaded to the specified card.

***persist***

Indicates that the database is not to be reloaded to the card. Used to request that the EAGLE perform a warm restart of the requested cards. The EAGLE performs various checks to ensure that all conditions necessary to initiate the warm restart are in place. The *force* parameter is required if all of the specified cards do not meet the warm restart requirements. During the card initialization and loading sequence, a warm restart is performed for all cards that meet the warm restart conditions.

**Default:**

*refresh*

**force (optional)**

Force indicator. Enables the command to be processed under the following conditions:

- If *serial=yes* and all cards of the specified GPL type are not IS-NR or OOS-MT-DSBLD.
- If *initclk=yes* and the TDM card specified in the *loc* parameter is the only good HS clock source that is currently active. A temporary clock outage will occur.
- If *initclk=yes* and *appl=oam* is specified (bitfiles on both TDMs will be initialized). A temporary clock outage will occur.

**Range:**

***yes***

***no***

**Default:**

*no*



**initclk (optional)**

Initialize TDM Bitfile indicator. If TDM reload would cause a system clock outage, the `initclk` parameter cannot be specified unless `force=yes` is also specified.

**▲ Caution:**

The resulting clock outage will probably cause loss of traffic on all links.

The following scenarios will cause such clock outages:

- Simplex MASP configuration (a system with a single TDM).
- Bad clock status on the remaining TDM.

**Range:**

*yes, no*

If `initclk=yes` is specified with a single TDM card location, the bitfile for the specified TDM reloads.

If `initclk=yes` is specified with `appl=oam` and `force=yes`, the bitfile reloads on both TDMs.

**loc (optional)**

Card address. The card location as stenciled on the shelf of the system.

**Range:**

*1101 - 1108, 1111 - 1116, 1201 - 1208, 1211 - 1218, 1301 - 1308, 1311 - 1318, 2101 - 2108, 2111 - 2118, 2201 - 2208, 2301 - 2318, 3101 - 3108, 3111 - 3118, 3201 - 3208, 3211 - 3218, 3301 - 3308, 3311 - 3318, 4101 - 4108, 4111 - 4118, 4201 - 4208, 4211 - 4218, 4301 - 4308, 4311 - 4318, 5101 - 5108, 5111 - 5118, 5201 - 5208, 5211 - 5218, 5301 - 5308, 5311 - 5318, 6101 - 6108, 6111 - 6118*

When the `initclk` parameter is not specified, the listed card locations are valid.

When the `initclk` parameter is specified, card locations 1113, 1114, 1115, and 1116 are valid.

Entering locations 1114 and 1116 results in the same action as entering 1113 and 1115.

**Default:**

All valid card locations are initialized.

**perdata (optional)**

Persist a particular DB type on all cards (irrespective of the card's type).

**Range:**

*all*

Persist all data (GTT/MPS) that can be persisted on the card

*mps*

Persist only MPS data on the card that supports persistence of MPS DB

*gtt*

Persist only GTT data on the card that supports persistence of GTT DB

**Default:**

*all*

**Note:**

The `perdata` parameter can only be specified where `data=persist` is given.

**prtnggrp (optional)**

Partition group. The disk partition group that is used as the source for downloading the appropriate GPL.

A value of 1113 or 1115 must be specified for the `loc` parameter before this parameter can be specified.

**Range:*****active***

the active partition group

***inactive***

the inactive partition group

**Default:**

*active*

**serial (optional)**

Controls the manner in which cards are initialized.

**Range:*****yes***

cards of the specified APPL type are initialized one at a time

***no***

cards of the specified APPL type are initialized simultaneously

**Default:**

*no*

**type (optional)**

SM Type. The type of RTDB data that can be loaded on an E5-SM8G-B or SLIC card.

**Range:*****dn***

initialize SM cards running the SIPHC, ENUMHC or SCCPHC gpl, with SM type DN or EPAP.

***elap***

initialize SM cards running the SIPHC or SCCPHC gpl, with SM type ELAP.

***epap***

initialize SCCPHC cards running the SIPHC, ENUMHC, DEIRHC, or SCCPHC gpl, with SM type DN, IMSI, or EPAP.

***gtt***

initialize SM cards running the SCCPHC gpl, with SM type GTT.

**imsi**

initialize SM cards running the DEIRHC or SCCPHC gpl, with SM type IMSI or EPAP.

**nosccp**

initialize the SLIC card running the IPSP application having no GTT functionality.

**Default:**

*none*

**Example**

```
init-card:loc=1113:prtnggrp=inactive
init-card:loc=1101:data=persist
init-card:loc=1113:initclk=yes
init-card:appl=oam:initclk=yes:force=yes
init-card:appl=ipsg
init-card:type=epap
init-card:appl=deirhc
init-card:appl=deirhc:data=persist
init-card:appl=enumhc
init-card:appl=ipsg:type=gtt
init-card:appl=ipsg:type=nosccp
init-card:appl=ipsg:data=persist:perdata=gtt
```

**Dependencies**

The shelf and card must be equipped.

The `loc` or `appl` or `type` parameter must be specified in the command. The parameters cannot be specified together in the command, except for when `appl=ipsg`.

This command cannot be entered when CAT2 IPSP to OAM syncing is in progress.

 **Note:**

An exception to this MTT is when `appl=ipsg`. In this case, it is possible to specify the 'type' parameter. The legal values of the 'type' parameter with `appl=ipsg` are `type=gtt` (Initialize all GTT-enabled IPSP cards) and `type=nosccp` (Initialize all GTT-disabled IPSP cards).

The following card locations (`loc` parameter) are not allowed for this command: 1117, 1118, and all `xy09` and `xy10` card locations (where `x` is the frame and `y` is the shelf).

If the `loc` and `initclk` parameters are specified, the `loc` parameter value must be card location 1113 or 1115. If the `appl` and `initclk` parameters are specified, the `appl` parameter value must be `oam`.

The `force` parameter must be specified for the cards that are not in the In-service Normal state.

The `serial` parameter is valid only when used with the `appl` parameter.

The `appl=all` parameter can be specified only when the `serial=yes` parameter is also specified.

A valid value must be specified for the `appl` parameter.

The `initclk`, `appl`, and `data` parameters must be specified before the `force` parameter can be specified.

The `data` parameter is valid only for SCCP card locations or GPLs/MPS database (VSCCP) card locations or GPLs/SIP/ENUM/DEIR card locations, GPLs, or GTT-enabled IPSP card locations.

The card location (`loc`) must be within the allowed range.

The specified card must exist in the card database and must be a logical processing element.

An EPAP-based feature or an LNP feature that is warm-restart-capable must be enabled, or SIP or DEIR must be enabled, or at least one ENUM card or one GTT-enabled IPSP card must be present before this command can be entered with the `data=persist` parameter.

If the `serial=yes` parameter is specified, the `appl` parameter must specify a network type application value or must be equal to `all`.

A primary Service Module card must be provisioned.

The command cannot be executed if system maintenance is in progress.

The A-Port, EIR, G-Flex, G-Port, INP, IS41 GSM Migration (IGM), LNP ELAP Configuration, PPSMS, Prepaid IDP Relay Query (IDP Relay), or V-Flex feature must be turned on, or the ATINP feature must be enabled before the `data` parameter can be specified.

If a removable drive is inserted in the system, then the `prtnggrp=inactive` parameter cannot be specified.

The `loc` parameter must be specified with a value of 1113 or 1115 before the `prtnggrp` parameter can be specified.

If an Extended BERT is running, the `appl` parameter cannot be specified in this command to initialize multiple cards.

If type specified is `epap`, `elap` or `gtt` for VSCCP, then the Dual ExAP Config, SIPNP or DEIR feature must be enabled. For `appl=ipsg` and `type=gtt`, no such features must be enabled.

If type specified is `imsi` or `dn` for VSCCP, then the EPAP Data Split feature must be ON.

The `data` parameter can only be specified for VSCCP/SIPHC/IPSP Application cards.

 **Note:**

The `data` parameter is valid only for SLIC IPSPG cards and not for ENET/ENET-B IPSPG cards.

If the IPSPG application is running with SLIC H/W on the location specified by the `loc` parameter, then `type=gtt` and `type=nosccp` are the only valid values of the `type` parameter. For any other APPL, `type=nosccp` is an invalid value of the `type` parameter.

The `perdata` parameter is only valid when `data=persist` and the `loc/appl` parameter is specified. The `type` parameter with `perdata` is redundant and not allowed.

 **Note:**

- The card at the specified `loc` must either run the IPSPG32 GPL or VSCCP application
- The card `appl` specified must either be IPSPG or VSCCP

With IPSPG/VSCCP application, the `type` parameter is allowed. For `appl=ipsg`, `type` can be `nosccp/gtt` only. And, for `appl=vscpp`, `type` can be `dn/imsi/epap/elap/gtt` only.

The `init-card` command cannot be issued when SFAPP(P)->OAM sync is ON.

**Notes**

The TDM card has a processor but no application.

If the `type` specified is `gtt` in the `init-card` command and only a GTT-enabled IPSPG card is present in system, then the MTT 3115 will not be observed, as there is no dependency of the Dual ExAP feature on GTT-enabled IPSPG card.

**Table 4-41 Using init-card Parameters**

SCENARIO	INIT COMMAND
Cold boot all VSCCP cards	<code>init-card:appl=vscpp</code>
Cold boot all GTT-enabled IPSPG cards	<code>init-card:appl=ipsg:type=gtt</code>
Cold boot all GTT-disabled IPSPG cards	<code>init-card:appl=ipsg:type=nosccp</code>
Warm boot all GTT-enabled IPSPG cards	<code>init-card:appl=ipsg:type=gtt:data=persist:perdata=gtt</code>
Warm boot a GTT-enabled IPSPG card location (e.g., 1106)	<code>init-card:loc=1106:data=persist:perdata=gtt</code>

**Table 4-41 (Cont.) Using init-card Parameters**

SCENARIO	INIT COMMAND
Warm boot all cards of the specified application that have ExAP/DN/IMSI data (e.g., vsccp)	init- card:appl=vsccp:type=dn:data=persist:perdata=mps
Warm boot a card that has MPS and/or GTT data (e.g., 1106)	init- card:loc=1106:data=persist:perdata=all
Boot all IPSPG cards and persist GTT data on all GTT-enabled IPSPG cards	init- card:appl=ipsg:data=persist:perdata=gtt
Boot all SCCP cards and persist whatever data is on those cards	init- card:appl=vsccp:data=persist:perdata=all

**Output**

```
init-card:loc=1201
```

```
Init Card command issued to card 1201
```

```
3021.0013 * CARD 1201 CCS7ITU Card is isolated from the system
```

```
3022.0201 * SLK 1201,A lsnssp2 SLK unavailable for traffic
          SLC=0 FECLLI=-----
```

```
3023.1201 * SLK 1201,B lsnstpi SLK unavailable for traffic
          SLC=0 FECLLI=-----
```

```
;
```

```
init-card:appl=all:serial=yes
```

```
Command entered at terminal #3.
```

```
Init Card command issued to card 1201
```

```
* 3021.0013 * CARD 1201 SS7ANSI Card is isolated from the system
** 3022.0236 ** SLK 1201,A lsnssp2 REPT-LKF: not aligned
          SLC=0 FECLLI=----- CLASS=MTP2
```

```
3023.0014 CARD 1201 SS7ANSI Card is present
```

```
3024.0200 SLK 1201,A lsnssp2 RCVRY-LKF: link available
          SLC=0 FECLLI=----- CLASS=MTP2
```

```
Init Card command issued to card 1202
```

```
* 3026.0013 * CARD 1202 ATMANSI Card is isolated from the system
```

```
** 3026.0236 ** SLK 1202,A lsnssp3 REPT-LKF: not aligned
```

```

                                SLC=0    FECLLI=-----    CLASS=SAAL

3027.0014    CARD 1202 ATMANSI    Card is present

3028.0200    SLK 1202,A lsnssp3    RCVRV-LKF: link available
                                SLC=0    FECLLI=-----    CLASS=SAAL
;

init-card:loc=1101:data=refresh

Command entered at terminal #10.
Init Card command issued to card 1101
** 1127.0013 ** CARD 1101 SCCP    Card is isolated from the
system
                                ASSY SN: 97361659

1128.0329    SCCP SYSTEM          SCCP capacity normal, card(s)
abnormal

1129.0014    CARD 1101 SCCP          Card is present
                                ASSY SN: 97361659

1234.1238    SYSTEM              INFO Full LNP database reload initiated:
                                CARD=1101    GPL=SCCP    CAUSE=USER REQUEST
Report Date: 00-02-24 Time: 16:27:19

5402.1241    SYSTEM              INFO REPT EVT: LNP Incremental Loading.
                                database levels loaded :      0 of 1145
Report Date: 00-02-24 Time: 16:52:04

1234.1239    SYSTEM              INFO LNP updates inhibited: loading
stability
Report Date: 00-02-24 Time: 16:52:07

1234.1240    SYSTEM              INFO LNP updates allowed: loading
stability
Report Date: 00-02-24 Time: 16:52:09

1130.0096    CARD 1101 SCCP          Card has been reloaded

1131.0328    SCCP SYSTEM          SCCP is available
;

init-card:loc=1115:initclk=yes

tekelecstp 04-07-17 13:01:59 EST EAGLE 31.6.0
Init Card command issued to card 1115
;

tekelecstp 04-07-17 13:01:59 EST EAGLE 31.6.0
* 3021.0013 * CARD 1115 OAMHC    Card is isolated from the
system
```

```
;

tekelecstp 04-07-17 13:03:10 EST  EAGLE 31.6.0
3022.0014  CARD 1115 OAMHC      Card is present
          ASSY SN: 1216115

;

init-card:appl=siphc

tekelecstp 12-07-09 19:08:39 EST  EST EAGLE 45.0.0
init-card:appl=siphc
Command entered at terminal #18.

;

Command Accepted - Processing
tekelecstp 12-07-09 19:08:39 EST  EST EAGLE 45.0.0
Init Card command issued to card 1101

;

tekelecstp 12-07-09 19:08:39 EST  EST EAGLE 45.0.0
Initialized all SIPHC cards.

;

Command Executed

Report Date:02-13-06  Time:17:09:52

;

tekelecstp 12-07-09 19:08:39 EST  EST EAGLE 45.0.0
** 2167.0013 ** CARD 1101 SIPHC      Card is isolated from the system;

tekelecstp 12-07-09 19:08:39 EST  EST EAGLE 45.0.0
2168.0014  CARD 1101 SIPHC      Card is present

tekelecstp 12-07-09 19:08:39 EST  EST EAGLE 45.0.0
2169.0096  CARD 1101 SIPHC      Card has been reloaded

;

init-card:appl=deirhc

eagle7 13-06-21 10:05:10 MST  EAGLE 45.1.0
init-card:appl=deirhc:data=persist
Command entered at terminal #18.

;

Command Accepted - Processing
eagle7 13-06-21 10:15:11 MST  EAGLE 45.1.0
Init Card command issued to card 1207

;

eagle7 13-06-21 10:15:11 MST  EAGLE 45.1.0
Init Card command issued to card 1217

eagle7 13-06-21 10:15:11 MST  EAGLE 45.1.0
Initialized all DEIRHC cards.
```



```
;
Command Executed
  eagle7 13-06-21 10:15:14 MST EAGLE 45.1.0
** 6738.0013 ** CARD 1207 DEIRHC      Card is isolated from the
system
          ASSY SN: 10209135227
;
  eagle7 13-06-21 10:15:14 MST EAGLE 45.1.0
*C 6739.0483 *C DEIR SYSTEM          DEIR System is not available
;
  eagle7 13-06-21 10:15:14 MST EAGLE 45.1.0
** 6740.0539 ** ENET 1207,A         Ethernet Interface Down
;
  eagle7 13-06-21 10:15:15 MST EAGLE 45.1.0
** 6741.0539 ** ENET 1207,B         Ethernet Interface Down
;
  eagle7 13-06-21 10:15:15 MST EAGLE 45.1.0
** 6742.0084 ** DLK 1207,A DEIRHC   IP Connection Unavailable
          Failed Channels: Prov Dnld UDP
;
  eagle7 13-06-21 10:15:15 MST EAGLE 45.1.0
** 6743.0013 ** CARD 1217 DEIRHC   Card is isolated from the
system
          ASSY SN: 10208097026
;
  eagle7 13-06-21 10:15:15 MST EAGLE 45.1.0
** 6744.0539 ** ENET 1217,A         Ethernet Interface Down
;
  eagle7 13-06-21 10:15:16 MST EAGLE 45.1.0
** 6745.0539 ** ENET 1217,B         Ethernet Interface Down
;
  eagle7 13-06-21 10:15:16 MST EAGLE 45.1.0
** 6746.0084 ** DLK 1217,A DEIRHC   IP Connection Unavailable
          Failed Channels: Prov Dnld UDP
;
  eagle7 13-06-21 10:16:01 MST EAGLE 45.1.0
6757.0014 CARD 1217 DEIRHC      Card is present
          ASSY SN: 10208097026
;
  eagle7 13-06-21 10:16:01 MST EAGLE 45.1.0
6759.0014 CARD 1207 DEIRHC      Card is present
          ASSY SN: 10209135227
;
  eagle7 13-06-21 10:23:01 MST EAGLE 45.1.0
6834.1238 SYSTEM INFO Full database reload initiated:
          CARD=1207 GPL=DEIRHC CAUSE=USER REQUEST
          Report Date:13-06-21 Time:10:17:59
;
  eagle7 13-06-21 10:18:45 MST EAGLE 45.1.0
6768.0540 ENET 1207,A           Ethernet Interface Up
;
  eagle7 13-06-21 10:18:46 MST EAGLE 45.1.0
6769.0540 ENET 1207,B           Ethernet Interface Up
;
  eagle7 13-06-21 10:23:01 MST EAGLE 45.1.0
```

```
6834.1238  SYSTEM      INFO      Full database reload initiated:
          CARD=1217  GPL=DEIRHC  CAUSE=USER REQUEST
          Report Date:13-06-21  Time:10:18:46
;
eagle7 13-06-21 10:18:46 MST  EAGLE 45.1.0
6770.0085  DLK 1207,A  DEIRHC  IP Connection Available
;
eagle7 13-06-21 10:18:46 MST  EAGLE 45.1.0
6771.0540  ENET 1217,A  Ethernet Interface Up
;
eagle7 13-06-21 10:18:46 MST  EAGLE 45.1.0
6772.0540  ENET 1217,B  Ethernet Interface Up
;
eagle7 13-06-21 10:18:47 MST  EAGLE 45.1.0
6773.0085  DLK 1217,A  DEIRHC  IP Connection Available
;
eagle7 13-06-21 10:19:02 MST  EAGLE 45.1.0
6777.0096  CARD 1207 DEIRHC  Card has been reloaded
;
eagle7 13-06-21 10:19:05 MST  EAGLE 45.1.0
6775.0485  DEIR SYSTEM  DEIR System is available
;
eagle7 13-06-21 10:19:06 MST  EAGLE 45.1.0
6778.0096  CARD 1217 DEIRHC  Card has been reloaded
;

init-card:appl=deirhc:data=persist

eagle7 13-06-21 10:05:10 MST  EAGLE 45.1.0
init-card:appl=deirhc:data=persist
Command entered at terminal #18.
;

eagle7 13-06-21 10:05:11 MST  EAGLE 45.1.0
Verifying card(s) persistent database - please wait
;
Command Accepted - Processing
eagle7 13-06-21 10:05:11 MST  EAGLE 45.1.0
Init Card command issued to card 1207
;
eagle7 13-06-21 10:05:11 MST  EAGLE 45.1.0
Init Card command issued to card 1217

eagle7 13-06-21 10:05:11 MST  EAGLE 45.1.0
Initialized all DEIRHC cards.
;
Command Executed
eagle7 13-06-21 10:05:14 MST  EAGLE 45.1.0
** 6738.0013 ** CARD 1207 DEIRHC  Card is isolated from the system
          ASSY SN: 10209135227
;
eagle7 13-06-21 10:05:14 MST  EAGLE 45.1.0
*C 6739.0483 *C DEIR SYSTEM  DEIR System is not available
```

```
;
eagle7 13-06-21 10:05:14 MST EAGLE 45.1.0
** 6740.0539 ** ENET 1207,A          Ethernet Interface Down
;
eagle7 13-06-21 10:05:15 MST EAGLE 45.1.0
** 6741.0539 ** ENET 1207,B          Ethernet Interface Down
;
eagle7 13-06-21 10:05:15 MST EAGLE 45.1.0
** 6742.0084 ** DLK 1207,A  DEIRHC   IP Connection Unavailable
          Failed Channels:  Prov  Dnld  UDP
;
eagle7 13-06-21 10:05:15 MST EAGLE 45.1.0
** 6743.0013 ** CARD 1217 DEIRHC     Card is isolated from the
system
          ASSY SN:  10208097026
;
eagle7 13-06-21 10:05:15 MST EAGLE 45.1.0
** 6744.0539 ** ENET 1217,A          Ethernet Interface Down
;
eagle7 13-06-21 10:05:16 MST EAGLE 45.1.0
** 6745.0539 ** ENET 1217,B          Ethernet Interface Down
;
eagle7 13-06-21 10:05:16 MST EAGLE 45.1.0
** 6746.0084 ** DLK 1217,A  DEIRHC   IP Connection Unavailable
          Failed Channels:  Prov  Dnld  UDP
;
eagle7 13-06-21 10:06:01 MST EAGLE 45.1.0
6757.0014   CARD 1217 DEIRHC     Card is present
          ASSY SN:  10208097026
;
eagle7 13-06-21 10:06:01 MST EAGLE 45.1.0
6759.0014   CARD 1207 DEIRHC     Card is present
          ASSY SN:  10209135227
;
eagle7 13-06-21 10:08:45 MST EAGLE 45.1.0
6768.0540   ENET 1207,A          Ethernet Interface Up
;
eagle7 13-06-21 10:08:46 MST EAGLE 45.1.0
6769.0540   ENET 1207,B          Ethernet Interface Up
;
eagle7 13-06-21 10:08:46 MST EAGLE 45.1.0
6770.0085   DLK 1207,A  DEIRHC   IP Connection Available
;
eagle7 13-06-21 10:08:46 MST EAGLE 45.1.0
6771.0540   ENET 1217,A          Ethernet Interface Up
;
eagle7 13-06-21 10:08:46 MST EAGLE 45.1.0
6772.0540   ENET 1217,B          Ethernet Interface Up
;
eagle7 13-06-21 10:08:47 MST EAGLE 45.1.0
6773.0085   DLK 1217,A  DEIRHC   IP Connection Available
;
eagle7 13-06-21 10:09:02 MST EAGLE 45.1.0
6777.0096   CARD 1207 DEIRHC     Card has been reloaded
;
```

```
eagle7 13-06-21 10:09:05 MST EAGLE 45.1.0
6775.0485 DEIR SYSTEM DEIR System is available
;
eagle7 13-06-21 10:09:06 MST EAGLE 45.1.0
6778.0096 CARD 1217 DEIRHC Card has been reloaded
;

init-card:type=elap

init-card:type=elap
Command entered at terminal #17.
;

Command Accepted - Processing
Init Card command issued to card 1205
;

Initialized all ELAP cards.
6160.0013 ** CARD 1205 VSCCP Card is isolated from the system
6161.0331 *C SCPELAP SYSTEM SCCP is not available
6162.0014 CARD 1205 SCCPHC Card is present
;
```

### Related Topics

- [dlt-card](#)
- [ent-card](#)
- [init-sys](#)
- [rept-stat-card](#)
- [rmv-card](#)
- [rtrv-card](#)

## init-ext-stats

Use this command to cause the HIPR2 cards to collect Extended Statistics for later retrieval.

### Parameters

#### **bus (optional)**

The IMT bus that contains the HIPR2 card where extended statistics are collected.

#### **Range:**

- a**  
collect statistics for HIPR2 cards on the A bus

**b**  
collect statistics for HIPR2 cards on the B bus

**both**  
collect statistics for HIPR2 cards on both buses

**Default:**  
*both*

**delay (optional)**

The number of milliseconds to wait before collecting HIPR2 Extended Statistics.

**Range:**  
*0 - 10000*

 **Note:**

The specified value is automatically rounded to a 10 ms boundary.

**Default:**  
*0*

**e1oc (optional)**

The ending card location for a range of HIPR2 cards where extended statistics are collected.

 **Note:**

Statistics are collected from only valid In-Service Normal HIPR2 cards within the range.

**Range:**  
*1109, 1110, 1209, 1210, 1309, 1310, 2109, 2110, 2209, 2210, 2309, 2310, 3109, 3110, 3209, 3210, 3309, 3310, 4109, 4110, 4209, 4210, 4309, 4310, 5109, 5110, 5209, 5210, 5309, 5310, 6109, 6110*

**Default:**  
*6110*

**1oc (optional)**

The location of a single HIPR2 card where statistics are collected.

**Range:**  
*1109, 1110, 1209, 1210, 1309, 1310, 2109, 2110, 2209, 2210, 2309, 2310, 3109, 3110, 3209, 3210, 3309, 3310, 4109, 4110, 4209, 4210, 4309, 4310, 5109, 5110, 5209, 5210, 5309, 5310, 6109, 6110*

**Default:**  
all HIPR2 cards within the range specified by the `s1oc` and `e1oc` parameters

**sloc (optional)**

The starting card location for a range of HIPR2 cards where extended statistics are collected.

**Note:**

Statistics are collected from only valid In-Service Normal HIPR2 cards within the location range.

**Range:**

1109, 1110, 1209, 1210, 1309, 1310, 2109, 2110, 2209, 2210, 2309, 2310, 3109, 3110, 3209, 3210, 3309, 3310, 4109, 4110, 4209, 4210, 4309, 4310, 5109, 5110, 5209, 5210, 5309, 5310, 6109, 6110

**Default:**

1109

**Example**

```
init-ext-stats
init-ext-stats:bus=a
init-ext-stats:sloc=1109:eloc=1110
init-ext-stats:loc=1109
```

**Dependencies**

The value specified for the `loc` or `sloc` and `eloc` parameters must indicate a valid card location. See the description of the desired parameter for a list of valid values.

The range specified by the `sloc` and `eloc` parameters must include an MUX card location.

The value specified for the `loc` parameter must be a valid MUX card location or the range specified by the `sloc` and `eloc` parameters must include an MUX card location.

The value specified for the `delay` parameter must be between 0 - 10000.

A value of *a*, *b*, or *both* must be specified for the `bus` parameter.

The `loc` parameter cannot be specified in the same command with the `sloc` and `eloc` or `bus` parameters.

An `init-ext-stats` or `copy-ext-stats` command cannot already be in progress when this command is entered.

**Output**

```
init-ext-stats

e5oam 10-02-06 00:56:54 EST EAGLE 42.0.0
init-ext-stats
Command entered at terminal #6.
;
```

```

e5oam 10-02-06 00:56:54 EST EAGLE 42.0.0
INIT-EXT_STATS: Init msg sent to the following MUX cards:
    CARD Location: 1209
    CARD Location: 1210
    CARD Location: 1109
    CARD Location: 1110
;

e5oam 10-02-06 00:56:54 EST EAGLE 42.0.0
Command Completed.
;

```

### Related Topics

- [copy-ext-stats](#)

## init-flash

Use this command to load the Board PROM to the inactive FLASH memory of a specified card or range of cards. When a card is reinitialized, it runs this version of the GPL in the card's inactive FLASH memory.

### Parameters

#### **bits (optional)**

This parameter must be specified for one E5-class card in conjunction with `mode=rplceb1` or `mode=cnvrtbit`. It indicates whether the bootloader or the flash image will be converted to a 32-bit or a 64-bit image. The E5-class card must be inhibited before the bootloader or the flash image can be changed through this mode.

#### **Range:**

**32 - convert to a 32-bit bootloader or flash image**

**64 - convert to a 64-bit bootloader or flash image**

#### **boot (optional)**

This parameter specifies whether the EPME5-class card should boot after the command successfully completes.

Multiple images can be flashed without having to boot after each flash. If multiple images are being flashed to the E5-class card, this parameter can be used to prevent the card from booting after each image is flashed. If multiple images are being flashed and the card is allowed to boot after each flash, an image that is not activated after the card boots will be lost on a subsequent reset of the card. This option does not apply to MUX cards or IMT Switch cards.

#### **Range:**

##### **yes**

Reboot the card after the command completes successfully

##### **no**

Do not reboot the card after the command completes successfully.

**Default:**

yes

For E5-class cards, if the mode parameter is not specified or if `mode=foregrnd`, `mode=imgselct` or `mode=pvjoy`, then default value of `boot` parameter is `yes`. If the mode parameter is specified for E5-class card(s) as `mode=backgrnd`, then default value of `boot` parameter is `no`.

**code (optional)**

The version of the GPL being loaded onto the card.

**Range:*****appr***

The approved GPL version

***trial***

The trial GPL version

The code parameter must be specified if the mode parameter is not specified as `mode=imgselct`; the code parameter must not be specified if the mode parameter is specified as `mode=imgselct`.

**e1oc (optional)**

End location. The location of the last card of a range of cards to be initialized.

**Range:**

*1101 - 1113, 1115, 1201 - 1218, 1301 - 1318, 2101 - 2118, 2201 - 2218, 2301 - 2318, 3101 - 3118, 3201 - 3218, 3301 - 3318, 4101 - 4118, 4201 - 4218, 4301 - 4318, 5101 - 5118, 5201 - 5218, 5301 - 5318, 6101 - 6118*

**force (optional)**

This parameter is required to force the flash download on the in-service card(s).

**Range:**

*yes*

*no*

**Default:**

*no*

**gp1 (optional)**

Generic program load. The flash GPL type that is running on the cards in the specified range of cards.

**Range:**

*xyyyyyyy*

1 alphabetic character followed by up to 7 alphanumeric characters.

Valid GPLs: *bldc32, bldc64, blmcap, blslc32, blslc64, hipr2, and multiple.*

Use "`gpl=multiple`" to simultaneously flash multiple E5-class cards running different GPLs, such as BLDC32, BLDC64, BLMCAP, BLSLC32, and BLSLC64. The command will then flash all E5-class cards in the specified range.



**initclk (optional)**

Initialize clock. If this parameter is specified, then the card location should be 1113 or 1115.

**Range:**

*yes*

*no*

**Default:**

*no*

**loc (optional)**

The location of a single card to be initialized.

**Range:**

*1101 - 1113, 1115, 1201 - 1218, 1301 - 1318, 2101 - 2118, 2201 - 2218, 2301 - 2318, 3101 - 3118, 3201 - 3218, 3301 - 3318, 4101 - 4118, 4201 - 4218, 4301 - 4318, 5101 - 5118, 5201 - 5218, 5301 - 5318, 6101 - 6118*

**mode (optional)**

If this parameter is specified for the E5-class cards, it indicates that the flashing of the E5-class card or range of cards will be performed in the specified mode. This parameter can be specified only for E5-class cards.

**Range:**

*backgrnd*

In this mode, the flash image will be copied into an inactive FLASH memory area of an E5-class card or range of cards. If the E5-class card in the specified location is provisioned, the E5-class card can be flashed without inhibiting it. The image uploaded with `mode=backgrnd` will run after the card boots upon receiving the command `init-flash:mode=imgselct`.

*cnvrtbit*

When used with this `mode` parameter value, `init-flash` will convert the E5-class card specified with the `loc` parameter to run on either a 32-bit or 64-bit flash image. The card will start running the target 32-bit or 64-bit flash image after it boots. The E5-class card must be inhibited before it can be flashed in this mode, and the `sloc/eloc` parameters may not be used.

*foregrnd*

In this mode, the flash image will be copied into an inactive FLASH memory area of an E5-class card or range of cards. After the E5-class card initializes, it runs this version of the GPL in the card's inactive FLASH memory. If the E5-class card in the specified location is provisioned, the E5-class card must be inhibited before it can be flashed in this mode.

*imgselct*

This mode will initialize the card(s), and load & run the image previously copied to the local FLASH memory with mode=backgrnd. Do not use this mode unless directed by Oracle's Customer Service.

#### *pvjoy*

In this mode, the flash image will be copied into inactive FLASH memory of an E5-class card or range of cards and the card(s) will initialize. After the E5-class card initializes, it will run the version of the GPL in the card's inactive FLASH memory. If the E5-class card in the specified location is provisioned, then the E5-class card can be flashed without inhibiting the E5-class card in the specified location. Debug must be enabled on the active OAM before this mode parameter value can be specified. Do not use this mode unless directed by Oracle's Customer Service.

#### *rplcebl*

In this mode, `init-flash` will replace the bootloader in the E5-class card specified with the `loc` parameter with either a 32-bit or 64-bit bootloader image and begin using it the next time the card boots. The E5-class card must be inhibited before the bootloader can be changed through this mode, and the `sloc/eloc` parameters may not be used.

#### **Default:**

*foregrnd*

#### **sloc (optional)**

Start location. Location of the first card of a range of cards to be initialized.

#### **Range:**

*1101 - 1113, 1115, 1201 - 1218, 1301 - 1318, 2101 - 2118, 2201 - 2218, 2301 - 2318, 3101 - 3118, 3201 - 3218, 3301 - 3318, 4101 - 4118, 4201 - 4218, 4301 - 4318, 5101 - 5118, 5201 - 5218, 5301 - 5318, 6101 - 6118*

#### **Example**

```
init-flash:loc=1105:code=trial
init-flash:loc=1113:code=appr:initclk=yes
init-flash:loc=1115:code=appr:initclk=yes:force=yes
init-flash:loc=1115:code=trial:initclk=no
init-flash:sloc=1302:eloc=1306:gpl=blisim:code=appr
init-flash:sloc=6305:eloc=6305:code=appr:gpl=blispm
init-flash:sloc=1105:eloc=1306:appr:gpl=blmcap:mode=foregrnd
init-flash:loc=1205:code=appr:mode=backgrnd
init-flash:sloc=1201:eloc=1311:code=trial:gpl=blmcap:mode=backgrnd
init-flash:sloc=1201:eloc=1311:code=trial:mode=imgselct
init-flash:loc=1301:mode=rplcebl:bits=64
init-flash:loc=1301:code=trial:mode=cnvrtbit:bits=64
init-flash:sloc=1103:eloc=1306:code=appr:gpl=blmcap
```

## Dependencies

The specified card must be an E5-class card or Service Module card. A MUX card can be specified for locations `xy09` and `xy10` (`x` is the frame and `y` is the shelf).

Each specified card does not have to be defined in the database, but it does have to be aligned on the IMT bus.

If the card in the specified card location is provisioned, then the card must be inhibited before this command is entered (unless the card is a MUX card or E5-class card with mode set to `backgrnd`, `imgselct` or `pvjoy`).

If the target card is a MUX card, then both card locations specified in the `sloc` and `eloc` parameters must contain MUX cards on the same IMT bus. For these cards, the bus is implicit based on the specified location. Location `xy09` specifies the MUX A Bus, and location `xy10` specifies the MUX B Bus (`x` is the frame and `y` is the shelf). For example, `sloc=1109:eloc=6109` specifies all MUX cards on the A Bus only; `sloc=1110:eloc=6110` specifies all MUX cards on the B Bus only. MUX cards from both the A bus and B bus cannot be flash downloaded simultaneously.

The `boot` parameter can be specified only if the target is an E5-class card.

A card location that contains the active MASP cannot be specified for the `loc`, `sloc`, or `eloc` parameter.

The provisioning subsystem mode (simple, duplex) must be established prior to executing the command.

The `loc` parameter cannot be specified with the `eloc` and `sloc` parameters.

The `loc` parameter or the `eloc` and `sloc` parameters must be specified.

If the `eloc` and `sloc` parameters are specified, the `gpl` parameter must be specified. MUX cards in the locations specified in the `sloc` and `eloc` parameters must be running the specified general program load (`gpl`). If the GPL specified is not multiple, then other cards in the range of card locations can be running other GPLs, but will not be initialized and only the cards within the range that are running the specified GPL will be initialized.

The `sloc` parameter value must be less than the `eloc` parameter value, when the two parameters are specified.

The specified card cannot be running an inactive flash GPL when the command is executed. If the `sloc` and `eloc` parameters are specified, cards within the range running an inactive flash GPL will be skipped. If there are no cards in the list because all the cards are running an inactive flash GPL, then UIM 1119 (example in Notes section) will be raised and the command will be rejected.

If the `initclk` parameter is specified, the card location parameter value must be `1113` or `1115`.

If TDM reload would cause a system clock outage, the `initclk` parameter cannot be specified unless `force=yes` is also specified.

 **Caution:**

The resulting clock outage will probably cause loss of traffic on all links.

No other related command can be in progress when this command is entered.

A card location that is valid and defined in the database must be specified.

The `eloc` and `sloc` parameters must be specified together in the command.

MUX cards specified in the `sloc` and `eloc` location parameters must be running the specified GPL. For other GPLs including multiple, all cards within the range running the specified GPL will be flashed.

This command cannot be entered if an IMT Rate Change sequence is in progress.

This command cannot be entered during an Extended Bit Error Rate Test (BERT).

The boot parameter cannot be specified with the `mode=backgrnd`, `mode=imgselct` or `mode=pvjoy` for the E5-class card.

A card location that contains the MASP cannot be specified for the `sloc` or `eloc` parameter.

The mode parameter cannot be specified with the non E5-class card.

The `gpl=multiple` parameter can be specified only if the `sloc` and `eloc` parameters are specified.

The `gpl=multiple` parameter can be specified only if the card locations in the `sloc` and `eloc` parameters are E5-class cards.

The code parameter cannot be specified with `mode=imgselct` parameter for the E5-class card(s). If the `mode=imgselct` parameter is not specified, then the code parameter must be specified.

The GPL parameter cannot be specified when the `mode=rplcebl` or `mode=cnvrtbit` parameter is used with the E5-class card.

The `mode=cnvrtbit` parameter must be specified with the `loc`, `code`, and `bits` parameters. Any other parameters like `force`, `boot`, `initclk`, and `sloc/eloc` cannot be specified when the `mode=cnvrtbit` parameter is specified.

The `mode=rplcebl` parameter must be specified with the `loc` and `bits` parameters. Any other parameters like `force`, `boot`, `initclk`, `code`, and `sloc/eloc` cannot be specified when the `mode=rplcebl` parameter is specified.

The `mode=cnvrtbit` parameter can be specified only when the E5-class card is an SM8GB card type.

The `mode=rplcebl` parameter can be specified only when the E5-class card is either an SM8GB or a SLIC card type.

The `mode=cnvrtbit` parameter can be specified with the `bits=64` parameter only when the E5-class card is running a 32-bit flash image (i.e., either BLMCAP or BLSLC32).

The `mode=cnvrtbit` parameter can be specified with the `bits=32` parameter only when the E5-class card is running a 64-bit flash image (as in, BLDC64).

## Notes

Card locations 1114, 1116, and 1117 are not valid and cannot be specified.

For the E5-class cards, multiple images can be flashed without having to boot the card after each flash. If multiple images are being flashed to the card the `boot=no` parameter can be used to prevent the card from booting after each image is flashed. After flashing any number of images, the card can be reset either by entering the `init-flash` command with the `boot=yes` parameter or by entering the `init-card` command. If multiple images are being flashed and the card is allowed to boot after each flash, any images that are not activated after the card boots will be lost on a subsequent reset of the card.

If E5-OAMs are being used, then the `init-flash` command can be accepted even when the cards specified in the `sloc` and `eloc` parameter range contains 1113 and/or 1115 locations in it. But the cards in 1113 and 1115 are never included in the list to flash the cards.

For example, if "`sloc=1111:eloc=1215:gpl=blmcap`", neither 1113 nor 1115 would be included in the list to flash the cards and the command will be accepted. The only way to flash an E5-OAM card is to specify `loc=1113/1115` but the card location specified cannot be the active E5-MASP.

For `mode=backgrnd` or `mode=imgselct` to be accepted, the E5-class target card must already be running a 45.0.0=64.XX.YY release version or higher.

When the `sloc` and `eloc` parameters are specified for E5-class cards and one or more cards in the range are running an inactive Flash GPL, then UIM 1119 will be raised along with the flash results. UIM 1119 will capture the first 5 card locations along with the total number of cards that have been skipped because of running an inactive Flash GPL. Example:

```
XXXX.1119    CARD <Active OAM location>    INFO    Cards out of phase
with flash procedure
                Card List: 1101, 1102, 1103, 1105, 1111, ... ( 1
others)
```

To use a 64-bit flash image, the EAGLE must be running Release 46.3 or higher. Steps for converting an E5-SM8G-B card running BLMCAP to BLDC64 GPL and vice-versa:

- Flash BLMCAP --> BLDC64:
  1. Make sure the E5-SM8G-B card is running BLMCAP Release 46.3 or higher.
  2. Replace the bootloader with the new 64-bit version:

```
init-flash:loc=xxxx:mode=rplcebl:bits=64
```

- This command will not cause the card to boot.
- If the card is already running the new bootloader, this command does nothing.

**3. Flash card to BLDC64:**

```
init-flash:loc=xxxx:code=yyyyy:mode=cnvrtbit:bits=64
```

**4. Activate flash.****5. The card is now running the 64-bit flash image.****• Flash BLDC64 --> BLMCAP:****1. The card is running BLDC64.****2. Flash card to BLMCAP (Release 46.3 or higher):**

```
init-flash:loc=xxxx:code=yyyyy:mode=cnvrtbit:bits=32
```

**3. Activate flash.****4. The card is now running the 32-bit flash image.**

SLIC cards run either the 32-bit BLSLC32 flash GPL or the 64-bit BLSLC64 flash GPL.

To convert a SLIC card from the 32-bit to the 64-bit flash image:

**1. Inhibit the card:**

```
inh-card:loc=xxxx:force=yes
```

The card will boot and return to state OOS-MT-DSBLD.

**2. Flash the card:**

```
init-flash:loc=xxxx:code=appr:64gpl=blslc64
```

The card will boot and return to state OOS-MT-DSBLD.

**3. Activate the 64-bit BLSLC64 flash GPL:**

```
act-flash:loc=xxxx
```

The card will now accept 64-bit application GPLs from the OAM.

To convert a SLIC card from the 64-bit to the 32-bit flash image:

**1. Inhibit the card:**

```
inh-card:loc=xxxx:force=yes
```

The card will boot and return to state OOS-MT-DSBLD.

**2. Flash the card:**

```
init-flash:loc=xxxx:code=appr:gpl=blslc32
```

The card will boot and return to state OOS-MT-DSBLD.

### 3. Activate the 32-bit BLSLC32 flash GPL:

```
act-flash:loc=xxxx
```

The card will now accept 32-bit application GPLs from the OAM.

#### Output

```
init-flash:loc=1105:code=trial
```

```
rlghncxa03w 04-01-05 13:05:05 EST  EAGLE 31.3.0  
FLASH Memory Downloading for card 1105 Started.
```

```
rlghncxa03w 04-01-05 13:05:05 EST  EAGLE 31.3.0  
BPHCAP Downloading for card 1105 Complete.
```

```
rlghncxa03w 04-01-05 13:05:05 EST  EAGLE 31.3.0  
Command Completed.
```

```
;
```

```
init-flash:loc=1113:code=appr:initclk=yes
```

```
rlghncxa03w 04-03-08 10:02:04 EST  EAGLE 31.6.0  
FLASH Memory Download for card 1113 Started.
```

```
;
```

```
rlghncxa03w 04-03-08 10:02:23 EST  EAGLE 31.6.0  
FLASH Memory Download for card 1113 Completed.
```

```
;
```

```
init-flash:sloc=1101:eloc=1112:gpl=blmcap:code=appr
```

```
tekelecstp 18-01-15 02:28:23 EST  EAGLE 46.6.0.0.0-71.5.0  
FLASH Memory Download for cards 1101 - 1112 Started.  
LOC 1101 : PASSED  
LOC 1102 : PASSED  
LOC 1112 : PASSED
```

```
ALL CARD RESULTS PASSED
```

```
;
```

```
Command Completed.
```

#### Related Topics

- [act-flash](#)
- [clr-imt-stats](#)
- [flash-card](#)
- [init-imt-gpl](#)

- [rept-imt-info](#)
- [rept-imt-lvl1](#)
- [rept-imt-lvl2](#)
- [tst-imt](#)

## init-imt-gpl

Use this command to load the specified IMT GPL software to the specified card and to reset that card. The application software is reloaded following IMT reset.

### Parameters

#### **code (mandatory)**

The IMT GPL to load to the card.

#### **Range:**

##### ***appr***

The approved GPL version

##### ***refresh***

Reload approved GPL version without card reset

##### ***trial***

The trial GPL version

#### **loc (optional)**

The location of the card to be initialized.

#### **Range:**

1101 - 1108, 1111 - 1112, 1201 - 1208, 1211 - 1218, 1301 - 1308, 1311 - 1318, 2101 - 2108, 2111 - 2118, 2201 - 2208, 2211 - 2218, 2301 - 2308, 2311 - 2318, 3101 - 3108, 3111 - 3118, 3201 - 3208, 3211 - 3218, 3301 - 3308, 3311 - 3318, 4101 - 4108, 4111 - 4118, 4201 - 4208, 4211 - 4218, 4301 - 4308, 4311 - 4318, 5101 - 5108, 5111 - 5118, 5201 - 5208, 5211 - 5218, 5301 - 5308, 5311 - 5318, 6101 - 6108, 6111 - 6118

#### **Default:**

All locations

### Example

```
init-imt-gpl:loc=1201:code=trial
```

```
init-imt-gpl:code=refresh
```

```
init-imt-gpl:code=appr
```

### Dependencies

The card location shelf must be within the allowed ranges as specified on the `loc` parameter. The shelf is the first two digits of the `loc` parameter.

The card location slot must be within the allowed ranges as specified on the `loc` parameter. The slot is the second two digits of the `loc` parameter.

The card location cannot contain a card with flash memory (MUX).



When this command is entered, no other action command can be in progress.

If the `code=appr` or `code=trial` parameter is specified, the `loc` parameter must be specified.

If the `code=trial` parameter is specified, the `loc` parameter must be specified, and the specified card location must be equipped and in service.

If the `code=appr` or `code=refresh` parameter is specified, the card must be connected to at least one IMT bus and communicating with the active MASP when the command is entered.

This command cannot be entered if the `clr-imt-stats`, `rept-imt-info`, `rept-imt-lvl1`, `rept-imt-lvl2`, or `tst-imt` command is running.

This command must not be entered during IMT statistics collection following an hourly boundary.

A card location that is valid and defined in the database must be specified.

This command cannot be entered during an Extended Bit Error Rate Test (BERT).

### Notes

None

### Output

```
init-imt-gpl:loc=1201:code=trial

      rlghncxa03w 04-02-27 16:53:22 EST   EAGLE 31.3.0
      Initializing IMT GPL for card 1201.

      rlghncxa03w 04-02-27 16:53:22 EST   EAGLE 31.3.0
* 0192.0013 * CARD 1201 SS7ANSI         Card is isolated from the system

      rlghncxa03w 04-02-27 16:53:22 EST   EAGLE 31.3.0
0193.0014   CARD 1201 SS7ANSI         Card is present

      rlghncxa03w 04-02-27 16:53:22 EST   EAGLE 31.3.0
0194.0096   CARD 1201 SS7ANSI         Card has been reloaded
;
```

### Related Topics

- [alw-card](#)
- [inh-card](#)
- [init-card](#)
- [rept-stat-card](#)

## init-mux

This command is used to reset an individual MUX card, or a given IMT Bus A or B (which includes all MUX cards for that bus).

The command boots the MUX card processor and brings down the respective IMT bus temporarily (approximately 10 seconds) until the MUX card(s) come back into service.

 **Note:**

When a card is disconnected from the IMT Bus, it may take several seconds for the card IMT Status to be updated. If an `init-mux` or `disc-imt` command is entered for the alternate IMT Bus before the card IMT Status is updated, then the card may reboot. After disconnecting the card from the IMT bus, use the `rept-stat-imt` or `rept-stat-card` command to determine whether the card IMT status is updated. Do not issue the `disc-imt` or `init-mux` command for the alternate IMT bus until the card status is updated.

**Parameters****bus (optional)**

The MUX bus to be reset. All MUX cards on the specified bus are reset.

**Range:**

*a*

*b*

**Default:**

*a*

**force (optional)**

This parameter is specified to override normal safeguards. The `force=yes` parameter can be used to reset an entire MUX bus when the alternate bus is non-functional or to reset one MUX card during a fault isolation test (see the `tst-imt` command).

 **Caution:**

If the `force=yes` parameter is specified, and the alternate IMT bus is OOS, then all of the cards on the IMT that are running a GPL will initialize. If one or more cards are not aligned on the alternate bus, placing the alternate IMT in IS-ANR, only the non-aligned cards will initialize. Either occurrence could result in nodal isolation.

**Range:**

*yes*

*no*

**Default:**

*no*

**hs (optional)**

This parameter is specified to set the speed of the MUX bus. If the `hs=yes` parameter is specified, the MUX bus speed is set to 2.5 Gbps. If the `hs=no` parameter is specified, the MUX bus speed is set to 1 Gbps.

**Range:**

*yes*

*no*

**Default:**

*yes*

**loc (optional)**

The location of a single MUX card to be reset.

**Range:**

*1109, 1110, 1209, 1210, 1309, 1310, 2109, 2110, 2209, 2210, 2309, 2310, 3109, 3110, 3209, 3210, 3309, 3310, 4109, 4110, 4209, 4210, 4309, 4310, 5109, 5110, 5209, 5210, 5309, 5310, 6109, 6110*

**Example**

```
init-mux:bus=a
init-mux:bus=a:hs=no
init-mux:loc=1109
init-mux:loc=6202
```

**Dependencies**

An `act/init-flash` command cannot be in progress when this command is entered.

The `bus` or `loc` parameter must be specified in the command. Both parameters cannot be specified in the command.

The `hs` parameter can be specified only when the `bus` parameter is specified.

The `force=yes` parameter must be specified before this command can be entered during an IMT Fault Isolation test.

This command cannot be entered during an Extended Bit Error Rate Test (BERT) even if the `force=yes` parameter is specified.

This command is not allowed during the IMT statistics collection period following an hourly boundary (IMT performance monitoring).

This command cannot be entered if an IMT Rate Change sequence is in progress.

If one or more cards are not aligned on the alternate bus, the alternate IMT state will become IS-ANR. If the alternate bus is IS-ANR, then the `force=yes` parameter must be specified.

## Notes

The `hs` parameter should be specified only as a tool to facilitate updating spare cards for releases that support MUX bus speeds of 2.5 Gbps only. The `hs` parameter is persistent as long as the card remains powered. If the card loses power, it will default back to 2.5 Gbps.

## Output

```
init-mux:loc=1109

    rlgncxa03w 05-07-13 08:15:10 EST  EAGLE 31.3.0
    Command Completed.
;
```

## Related Topics

- [act-flash](#)
- [init-flash](#)

# init-network

Use this command to reset all the network cards. The network cards are E5- TSMs and LIMs; that is, anything not part of the Maintenance and Administration Subsystem (MAS). This command resets all the network cards by reloading GPLs and data to the cards. Use of this command requires maintenance personnel to be located at the site.

### Caution:

Using this command causes network nodal isolation; however, if the network nodal isolation is less than two seconds, it may not be detected and may not be reported. Also, in some cases when network nodal isolation has been detected and a large number of maintenance troubles are being reported, the network nodal isolation message may not be reported. An alarm is generated, however.

## Parameters

### **force** (optional)

Force the resetting of all the network cards.

#### Range:

*yes*

*no*

#### Default:

*no*

## Example

```
init-network
```

## Dependencies

The MASP must be in either *Upgrade Phase 3* mode or *Full Function* mode. (See the “Notes” section for this command for more information.)

The system database must be coherent when this command is entered.

At least one card with the SS7ANSI or CCS7ITU application installed must exist with an in-service active signaling link.

The `force=yes` parameter must be specified to override the required four-card SS7ANSI or CCS7ITU configuration. The system then selects the best available of the remaining SS7ANSI or CCS7ITU cards.

This command cannot be entered during an Extended Bit Error Rate Test (BERT).

## Notes

### Upgrade Phase 3

*Upgrade Phase 3* mode means that the MASPs are running GPLs that match the major revision defined for the approved GPLs, but the other network processors are only prepared to be upgraded.

### Full Function

*Full Function* mode means that all MASPs are running GPLs that match the major revision defined for the approved GPLs. *Full Function* mode is the normal operating mode for the MASP.

## Output

The command output scrolls into the scroll area of your display contiguously. However, for purposes of this example, each part has an explanation preceding it.

```
init-network
```

```

rlghncxa03w 06-05-27 08:15:10 EST EAGLE 35.0.0
(Reports the selection of an alternate card.)
rlghncxa03w 06-05-27 08:15:10 EST EAGLE 35.0.0
1234.1107  SYSTEM      INFO  INW ALT card as first to be
preloaded
CARD=1201  GPL=SS7ANSI
Report Date: 06-05-27  Time: 16:29:15

```

Reports the selection of a main card.

```
init-network
```

```

rlghncxa03w 06-05-27 08:15:10 EST EAGLE 35.0.0
1234.1108  SYSTEM      INFO  INW MAIN card as last to be reset
CARD=1202  GPL=SS7ANSI
Report Date: 06-05-27  Time: 16:29:17

```

Reports that the card cross loading is inhibited.

init-network

```
rlghncxa03w 06-05-27 16:30:02 EST EAGLE 35.0.0
1234.1109   SYSTEM      INFO  Asserted DDL inhibition
          CARD=1113   GPL=OAM
          Report Date: 06-05-27   Time: 16:27:18
```

Reports that a card reset has been issued.

init-network

```
rlghncxa03w 06-05-27 16:30:02 EST EAGLE 35.0.0
1234.1110   SYSTEM      INFO  Card reset command issued
          CARD=1204   GPL=SS7ANSI
          Report Date: 06-05-27   Time: 16:30:18
```

Reports that a card is being allowed to load.

init-network

```
rlghncxa03w 06-05-27 16:30:02 EST EAGLE 35.0.0
1234.1111   SYSTEM      INFO  Allowing card to load
          CARD=1204   GPL=SS7ANSI
          Report Date: 06-05-27   Time: 16:30:18
```

Reports that INW is waiting for validation of card loading.

init-network

```
rlghncxa03w 06-05-27 16:30:02 EST EAGLE 35.0.0
1234.1112   SYSTEM      INFO  Waiting for validation of card loading
          CARD=1204   GPL=SS7ANSI
          Report Date: 06-05-27   Time: 16:30:18
```

Reports that INW has detected successful completion of card loading.

init-network

```
rlghncxa03w 06-05-27 16:30:02 EST EAGLE 35.0.0
1234.1113   SYSTEM      INFO  Detected card loaded
          CARD=1204   GPL=SS7ANSI
          Report Date: 06-05-27   Time: 16:30:18
```

Reports that INW has detected the reset or removal of a card.

```
init-network
```

```
rlghncxa03w 06-05-27 16:30:02 EST EAGLE 35.0.0
1234.1114   SYSTEM      INFO Detected card reset or removed
           CARD=1204   GPL=SS7ANSI
           Report Date: 06-05-27  Time: 16:30:18
```

Reports that the card is being allowed to crossload.

```
init-network
```

```
rlghncxa03w 06-05-27 16:30:02 EST EAGLE 35.0.0
1234.1115   SYSTEM      INFO Allowed card to skip DDL inhibited
           CARD=1204   GPL=SS7ANSI
           Report Date: 06-05-27  Time: 16:30:18
```

Reports that DDL inhibition has been removed.

```
init-network
```

```
rlghncxa03w 06-05-27 16:30:02 EST EAGLE 35.0.0
1234.1116   SYSTEM      INFO Removed DDL inhibition
           CARD=1113   GPL=OAM
           Report Date: 06-05-27  Time: 16:30:18
```

If `init-network` is entered during an upgrade, reports that the upgrade is to continue.

```
init-network
```

```
rlghncxa03w 06-05-27 16:30:02 EST EAGLE 35.0.0
1234.1117   SYSTEM      INFO Initialize OAMs to continue upgrade
           CARD=1113   GPL=OAM
           Report Date: 06-05-27  Time: 16:30:18
```

Reports that a card must be reset manually or removed.

```
init-network
```

```
rlghncxa03w 06-05-27 16:30:02 EST EAGLE 35.0.0
1234.1118   SYSTEM      INFO Card must be manually reset/removed
           CARD=1204   GPL=SS7ANSI
           Report Date: 06-05-27  Time: 16:30:18
```

Reports that a card has failed to reset.

```
init-network
```

```
rlghncxa03w 06-05-27 16:30:02 EST EAGLE 35.0.0
1234.1119   SYSTEM      INFO Card failed to reset
          CARD=1204    GPL=SS7ANSI
          Report Date: 06-05-27  Time: 16:30:18
```

Reports that a DDL inhibition assertion has failed.

```
init-network
```

```
rlghncxa03w 06-05-27 16:30:02 EST EAGLE 35.0.0
1234.1120   SYSTEM      INFO Failed to assert DDL inhibition
          CARD=1113    GPL=OAM
          Report Date: 06-05-27  Time: 16:30:18
```

Reports that an internal error has stopped an `init-network` .

```
init-network
```

```
rlghncxa03w 06-05-27 16:30:02 EST EAGLE 35.0.0
Command Aborted : Internal error.
```

Reports that a failure to load a card has stopped an `init-network` .

```
init-network
```

```
rlghncxa03w 06-05-27 16:30:02 EST EAGLE 35.0.0
Command Aborted : Card 1206 failed to load.
```

## init-sys

Use this command to reset all cards in the system (except HIPR2 cards). When this command is entered, a caution message is displayed in the scroll area requesting to re-enter the command to confirm the operation. The command must be re-entered within 30 seconds. The only valid commands that can be entered after entering this command the second time are the `login` and `act-user` commands.

### Caution:

This command causes a complete system reload, and should be used only during periods of low traffic. Use this command only when directed by the Customer Care Center.



**▲ Caution:**

When this command executes, the system does not retain the manually initiated state (for example, OOS-MT-DSBLD) for the signaling link, card, or the terminal. After the command executes, the system attempts to bring all provisioned links, cards, and terminals on line, including those that were previously out of service. Each device must be put back into its previous state after the system is back on line. It is advisable to print or electronically capture the output of the `rept-stat-slk`, `rept-stat-card`, and `rept-stat-trm` commands for reference prior to issuing the `init-sys` command. To restore a device to its previous state, issue the appropriate inhibit/deactivate command listed in this manual in the section for each of the above `rept-stat` commands.

**Parameters****data (optional)**

High memory refresh. This parameter causes data to be reloaded to the specified card. This parameter is used to reload data if the G-Flex, G-Port, INP, or LNP feature is on, or the ATINP feature is enabled. This parameter is applicable only to network cards containing the MPS database (VSCCP/ENUM or S13 card running DEIRHC gpl).

**Range:*****refresh***

Causes data to be reloaded to the specified card.

***persist***

Indicates that the database is not to be reloaded to the card. Used to request that the EAGLE perform a warm restart of the requested cards. The EAGLE performs various checks to ensure that all conditions necessary to initiate the warm restart are in place.

**Default:**

*refresh*

**force (optional)**

Allows the command to be processed if the `data=persist` parameter is specified and all the network cards containing the LNP database cannot maintain a persistent LNP database over the reset.

**Range:**

*yes*

*no*

**Default:**

*no*

**perdata (optional)**

Persist a particular DB type on all cards (irrespective of the card's type).

**Range:***all*

Persist all data (GTT/MPS) that can be persisted on the card

*mps*

Persist only MPS data on the card that supports persistence of MPS DB

*gtt*

Persist only GTT data on the card that supports persistence of GTT DB

**Default:***all***Note:**The `perdata` parameter can only be specified where `data=persist` is given.**Example**

```
init-sys
init-sys:data=persist
init-sys:data=persist:perdata=mps
```

**Dependencies**

When this command is entered, another `init-sys` command cannot be in progress on another port.

An EPAP-based feature or an LNP feature that is warm-restart-capable must be enabled, or SIP or DEIR must be enabled, or at least one ENUM card or one GTT-enabled IPSP card must be present before this command can be entered with the `data=persist` parameter.

The value specified for the `data` parameter for the confirmation command must be the same value that was specified the first time.

The `force` parameter is valid only with the `data` parameter.

The `perdata` parameter is valid only with the `data` parameter.

The `init-sys` command cannot be issued when SFAPP(P)->OAM sync is ON.

This command cannot be entered when CAT2 IPSM to OAM syncing is in progress.

**Notes**

When this command is entered the first time, 30 seconds are allowed to enter the command again. After the command is accepted, a delay of 10 seconds gives the system time to broadcast the information message regarding the system initialization.

From the time that the `init-sys` command is accepted, you must wait approximately two minutes before you can log into the system. If the system terminal is in the VT-100/VT-320 mode, the terminal display will be refreshed with nonzero alarm counts. During this 2-minute interval, an intermediate screen refresh caused by the MASPs' role change from active to standby, and from standby to active. This screen refresh is typically a partial refresh and the alarm indicators are set to zero.

If you are logged into the system in the KSR mode, you receive UAM 0009 (MASP became active) to indicate that you are now able to log into the system. UAM 0009 could be issued twice due to possible transient MASP role change (switching from active to standby). Following the execution of the `init-sys` command, the MASP that was active before the `init-sys` command was entered will be the active MASP when the system has finished reinitializing. E5-TSM cards are reloaded only in the event of power failure or hardware reboot. The execution of this command does not require E5-TSM cards to be reloaded.

When the `init-sys` command is given with `data=persist` and `perdata=all`, it means that all cards in the system will boot, but those that contain either MPS or GTT data as persistent will be warm booted, while others will be cold booted.

When the OA&M IP Security feature and the parameter SSH in SECUDFLT table are turned ON, and an IPSM card is inserted and initialized for the first time or is removed, inserted, and initialized again, the "SSH Host Keys Regenerated" UIM is displayed. The UIM shows the generated SSH Host Key fingerprint that must be provided at the secure client in order for secure information transfer to occur. The SSH Host Key fingerprint is changed whenever power is lost and restored to an IPSM card.

```
rlghncxa03 03-07-11 07:05:00 EST EAGLE 30.2.0
0021.1493 CARD 1111 INFO SSH Host Keys Regenerated
DSA Server Host Key FTRA-formatted Fingerprint=
84 7c 92 8b c 7c ds 19 1c 6 4b de 5c 8f c5 4d
Report Date:03-07-11 Time:22:27:36
```

When the OA&M IP Security feature and the parameter SSH in SECUDFLT table are turned ON, and an IPSM card is restarted with this command, the "SSH Host Keys Loaded" UIM is displayed. The UIM shows the current SSH Host Key fingerprint. The SSH Host Key fingerprint is not changed if the IPSM card does not lose power.

```
rlghncxa03 01-07-11 07:05:00 EST EAGLE 30.2.0
0021.1493 CARD 1111 INFO SSH Host Keys Loaded
DSA Server Host Key FTRA-formatted Fingerprint=
84 7c 92 8b c 7c ds 19 1c 6 4b de 5c 8f c5 4d
Report Date:03-07-11 Time:22:27:36
```

## Output

This example shows the output when the `init-sys` command is entered once, then entered again within 30 seconds, causing the system to start resetting all of its cards:

```
init-sys
```

```
rlghncxa03w 04-01-07 07:05:00 EST EAGLE 31.3.0
Command entered at terminal #3

rlghncxa03w 04-01-07 07:05:01 EST EAGLE 31.3.0
CAUTION: This command causes a complete system reload, and
will result in traffic loss.
Re-enter command within 30 seconds to confirm.
```

```
init-sys
```

```
rlghncxa03w 04-01-07 07:05:16 EST  EAGLE 31.3.0  
Command entered at terminal #3
```

```
rlghncxa03w 04-01-07 07:05:17 EST  EAGLE 31.3.0  
Init System command issued at terminal #3
```

This example shows the output when the `init-sys` command is entered once, and more than 30 seconds pass with no other keyboard entry:

```
init-sys
```

```
rlghncxa03w 04-01-05 07:05:00 EST  EAGLE 31.3.0  
Command entered at terminal #3.
```

```
rlghncxa03w 04-01-05 07:05:01 EST  EAGLE 31.3.0  
CAUTION: This command causes a complete system reload, and  
will result in traffic loss.  
Re-enter command within 30 seconds to confirm.
```

```
rlghncxa03w 04-01-05 07:05:31 EST  EAGLE 31.3.0  
Init System command aborted due to confirmation timeout
```

This example shows the output when the `init-sys` command is entered once and then the `rls-alm:lvl=minr` command is entered, letting the 30-second timer expire for the second entry of the `init-sys` command:

```
init-sys
```

```
rlghncxa03w 04-01-05 07:05:00 EST  EAGLE 31.3.0  
Command entered at terminal #3
```

```
rlghncxa03w 04-01-05 07:05:01 EST  EAGLE 31.3.0  
CAUTION: This command causes a complete system reload, and  
will result in traffic loss.  
Re-enter command within 30 seconds to confirm.
```

```
rls-alm:lvl=minr  
rlghncxa03w 04-01-05 07:05:10 EST  EAGLE 31.3.0  
Command entered at terminal #3
```

```
rlghncxa03w 04-01-05 07:05:11 EST  EAGLE 31.3.0  
All the minor alarms are released
```

```
rlghncxa03w 04-01-05 07:05:12 EST  EAGLE 31.3.0  
Command Completed
```

```
rlghncxa03w 04-01-05 07:05:31 EST  EAGLE 31.3.0  
Init System command aborted due to confirmation timeout
```

This example shows the output when the `init-sys` command is entered twice within 30 seconds, and the `data=persist` parameter is specified to perform a warm restart of the requested cards without reloading the database to the cards:

```
init-sys:data=persist

rlghncxa03w 04-01-05 07:05:31 EST  EAGLE 31.3.0
Command entered at terminal #3

rlghncxa03w 04-01-05 07:05:31 EST  EAGLE 31.3.0
CAUTION: This command causes a complete system reload, and will
result in
traffic loss.
Re-enter command within 30 seconds to confirm.

init-sys:data=persist
rlghncxa03w 04-01-05 07:05:31 EST  EAGLE 31.3.0
Command entered at terminal #3
rlghncxa03w 04-01-05 07:05:31 EST  EAGLE 31.3.0
Init System command issued at terminal #3
```

This example shows the output when the `init-sys` command is entered twice within 30 seconds, and the `force=yes` and `data=persist` parameter is specified to perform a warm restart of the requested cards without reloading the database to the cards:

```
init-sys:data=persist:force=yes

tekelecstp 02-01-01 21:49:15 MST  EAGLE5 46.2.0-65.42.0
init-sys:data=persist:force=yes
Command entered at terminal #17.
;

tekelecstp 02-01-01 21:49:15 MST  EAGLE5 46.2.0-65.42.0
Verifying card(s) persistent database - please wait

Command Accepted - Processing
tekelecstp 02-01-01 21:49:15 MST  EAGLE5 46.2.0-65.42.0
CAUTION: This command causes a complete system reload, and
will result in traffic loss.
Re-enter command within 30 seconds to confirm.
;
Command Executed

init-sys:data=persist:force=yes

tekelecstp 02-01-01 21:49:20 MST  EAGLE5 46.2.0-65.42.0
init-sys:data=persist:force=yes
Command entered at terminal #17.
;
```

```
Command Accepted - Processing
Command Executed
```

### Related Topics

- [act-gpl](#)
- [chg-db](#)
- [chg-gpl](#)
- [copy-gpl](#)
- [copy-meas](#)
- [disp-disk-dir](#)
- [rept-stat-db](#)

## lock

Use this command to lock a terminal's keyboard. When the keyboard is locked, the system accepts no keyboard commands other than the `unlock` command. The keyboard remains locked until the logged on user's login password is entered at the UNLOCK prompt. When the keyboard is locked, any idle terminal monitor in effect for the terminal is suspended temporarily.

### Parameters

This command has no parameters.

### Example

```
lock
```

### Dependencies

The terminal cannot be an MGMT terminal used for Network Surveillance.

The terminal cannot be a TELNET terminal (terminal IDs 17-40).

### Notes

A locked terminal can also be unlocked by entering the `inh-trm` command, followed by the `alw-trm` command.

### Output

```
lock
```

```
rlghncxa03w 04-02-17 16:02:05 EST  EAGLE 31.3.0
Terminal keyboard is locked. Enter UNLOCK command to unlock.
;
```

### Related Topics

- [unlock](#)

# login

Use this command to log into the system. After you enter this command, the system requests a password. For security reasons, the password is not displayed at the terminal.

## Parameters

### **uid (mandatory)**

User ID. The system prompts the user for a valid password after entering in this ID.

#### **Range:**

*azzzzzzzzzzzzzzz*

1 alphabetic character followed by up to 15 alphanumeric characters

## Example

```
login:uid=john
```

## Dependencies

The user cannot be logged onto any terminal while changing the password.

The user ID must not be logged in to another port already, and it must not be revoked.

The user ID must have been logged in successfully within the number of days specified on the `uout` parameter of the `ent-user` command.

The OA&M IP Security Enhancements feature must be turned on before the password can be changed from a Telnet terminal (IDs 17-40) if the user is logging in with the assigned ID and password for the first time, or the password has expired.

The password can contain up to 12 characters.

The password must contain at least the number of characters specified by the `minlen` parameter in the `chg-secu-dflt` command.

The password must contain at least the number of alphabetic characters specified by the `alpha` parameter in the `chg-secu-dflt` command.

The password must contain at least the number of numeric characters specified by the `num` parameter in the `chg-secu-dflt` command.

The password must contain at least the number of punctuation characters specified by the `punc` parameter in the `chg-secu-dflt` command.

The password cannot contain the associated User ID.

The number of days specified by the `minintrvl` parameter in the `chg-secu-dflt` command must pass between password changes.

The password must contain fewer duplicate characters from the existing password than the number specified by the `pchreuse` parameter in the `chg-secu-dflt` command.

The password cannot be the same as a previous password if the limit in the password history, specified by the `preuse` parameter of the `chg-secu-dflt` command, has been reached.

The current password cannot be entered as the new password.

The values specified for the `uid` parameter and for the password must already exist.

### Notes

The `act-user` command can be used in place of `login`. The `act-user` command has been provided in compliance with TL1 standards.

When a new system is shipped, the user ID and password are set to the system. These should be changed immediately to ensure system security.

### Output

When the `login` command is entered, a password prompt occurs. If the password and User ID are valid, then the login is processed. When a password change is required, password rules are displayed, and a new password is requested. The login is granted if the change is successful, then or if no password change is necessary.

After login is granted, a banner is displayed. This banner consists of the warning text provided on the `chg-secu-dflt` command, indications about the last login, and any unsuccessful login attempts.

This example shows the output for a normal login path with no request for new password:

```
login:uid=eagle

eagle5 10-02-19 19:37:16 EST EAGLE5 42.0.0
User logged in on terminal 3.
;

eagle5 10-02-19 19:37:16 EST EAGLE5 42.0.0
NOTICE: This is a private computer system.
Unauthorized access or use may lead to prosecution.
0 LOGIN failures since last successful LOGIN
Last successful LOGIN was on port 3 on 10-02-18 @ 20:38:26
;
```

This example shows the output for a login where a password change is required:

```
login:uid=user1

Enter Password :
Enter new password (password has expired and must be changed) :
Verify Password :
Command Accepted - Processing
e5oam 10-02-19 23:30:57 EST EAGLE 42.0.0
login:uid=user1
Command entered at terminal #3.
;

e5oam 10-02-19 23:30:59 EST EAGLE 42.0.0
New password must contain:
- between 8 and 12 characters
- at least 1 alphabetic character(s) ('a'-'z')
```



- at least 1 numeric character(s) ('0'-'9')
  - at least 1 punctuation character(s) (e.g. \$%@#)
- New password must:
- be unique from the old password
  - be unique from the last 2 historical password(s)
  - not reuse more than 4 character(s) from the old password

;

The following is an example of logging when the EAGLE OA&M IP Security control feature (893400001) has a status of OFF. That Feature Control Status blocks all alarming with the use of non-secure IP protocols for FTP servers and the terminal SSH setting:

```
tekelecstp 16-10-24 13:31:13 EST EAGLE 46.5.0.0.0-70.6.0
login:uid=eagle
Command entered at terminal #3.
```

;

```
tekelecstp 16-10-24 13:31:17 EST EAGLE 46.5.0.0.0-70.6.0
User logged in on terminal 3.
```

;

```
tekelecstp 16-10-24 13:31:17 EST EAGLE 46.5.0.0.0-70.6.0
```

```
Copyright (c) 1993, 2015, Oracle and/or its affiliates. All rights
reserved.
```

```
NOTICE: This is a private computer system.
Unauthorized access or use may lead to prosecution.
1 LOGIN failures since last successful LOGIN
Last successful LOGIN was on port 4 on 16-10-24 @ 13:06:06
```

```
***WARNING: OA&M IP Security FAK-OFF, insecure access protocols
not alarmed
```

;

### Related Topics

- [act-user](#)
- [chg-pid](#)
- [chg-secu-dflt](#)
- [chg-user](#)
- [dact-user](#)
- [dlt-user](#)
- [ent-user](#)
- [logout](#)
- [rept-stat-user](#)
- [rtrv-secu-dflt](#)

- [rtrv-secu-user](#)
- [rtrv-user](#)

## logout

Use this command to end a user session. The `logout` command has the same affect as the `canc/dact-user` commands.

### Parameters

This command has no parameters.

### Example

```
logout
```

### Dependencies

None

### Notes

The `canc/dact-user` commands can be used in place of `logout`.

### Output

```
logout
```

```
rlghncxa03w 06-06-05 07:05:31 EST EAGLE 35.0.0  
Command Completed.  
;
```

### Related Topics

- [act-user](#)
- [chg-pid](#)
- [chg-user](#)
- [dact-user](#)
- [dlt-user](#)
- [ent-user](#)
- [login](#)
- [rept-stat-user](#)
- [rtrv-secu-user](#)
- [rtrv-user](#)



**Example**

```
pass:loc=1201:cmd="ping 198.89.1.2"  
pass:loc=1111:cmd="soipdata -f"  
pass:loc=6312:cmd="help"
```

**Dependencies**

The value specified for the `loc` parameter must be valid for the card type and application:

- E5-ENET-B card running the IPGWI, IPLIMI, IPSP, SS7IPGW, or STPLAN application
- STC or E5-STC card running the EROUTE application
- IPSM card running the IPS application
- Service Module card running the VSCCP application
- E5-TSM card running the GLS application

The specified card location is out of range.

Syntax error found in the `pass` command.

Card is not in service

The `pass` command must include either the `cmd` or `shellcmd` parameter.

**Notes**

None

**Output**

Output is shown in the individual Pass commands.

## rept-ftp-meas

Use this command to manually initiate generation and FTP transfer of a measurements report from the Measurements Platform MCPM or Integrated Measurements enabled E5-OAM to an FTP server.

**Parameters****enttype (mandatory)**

Entity type to report on in the measurements report.

**Range:*****aiq***

Measurements for ANSI41 AIQ

***atinpq***

Measurements for ATINP

***deir***

Measurements for S13/S13' EIR

***eir***

Measurements for Equipment Identity Register

***enum***

Measurements for ENUM Mobile Number Portability and Tier One Address Resolution

***gttapath***

Measurements for GTT Actions Per-Path

***gttset***

Measurements per GTTSET

***idpr***

Measurements for IDPR

***link***

Measurements for signaling links

***Inkset***

Measurements for linksets

***Inp***

Measurements for local number portability

***Isdestni***

Measurements for linkset destination network identifiers

***Isonismt***

Measurements for ISUP message type screening

***Isorigni***

Measurements for linkset originating network identifiers

***mapscrn***

Measurements for GSM MAP message screening

***np***

Measurements for INP, INP CRP, G-Port, A-Port, MO-based GSM SMS NP, MO-based IS41 SMS NP, IGM, MT-Based GSM SMS NP, and MT-Based IS41 SMS NP

***origni***

Measurements for originating network identifiers greater than 5

***origninc***

Measurements for originating network identifiers (less than 5, small networks) for network clusters

***sctpasoc***

Measurements per association for the SCTP protocol (used to carry M3UA, M2PA, and SUA traffic)

**sctpcard**

Measurements per card for the SCTP protocol (used to carry M3UA, M2PA, and SUA traffic)

**sfthrot**

Measurements for SFTHROT GTT Action

**sip**

Measurements for SIP

**stp**

Measurements pertaining to the Signaling Transfer Point in general or summarized totals recorded on the STP

**stplan**

Measurements for STP Local Area Network data links

**tt**

Measurements for translation types

**ua**

Measurements per application server/association for the M3UA and SUA protocols

**vflex**

Measurements for V-Flex

**type (mandatory)**

Type of measurement report.

**Range:**

**avl**

Availability measurements

**avld**

Daily availability measurements

**avldth**

Day to hour availability measurements.

**comp**

Component measurements

**gtwy**

Internetwork gateway-related data from the STP for ANSI and ITU measurements. ANSI gateway measurements are pegged on a per-linkset, per-Network Indicator basis, whereas ITU measurements are pegged on a per-linkset basis.

**mtcd**

Daily maintenance measurements

**mtcdth**

Day-to-hour maintenance measurements

**mtch**

Hourly maintenance measurements

***mtcs***  
Link/linkset maintenance status

***nm***  
Network management, on-demand

***rbase***  
Schedule-report type record base measurements

***systot***  
STP system totals

**day (optional)**  
Day of the week for the specified daily measurement report.

**Range:**

***mon***

***tue***

***wed***

***thu***

***fri***

***sat***

***sun***

**Default:**  
If not specified, the previous single day is reported.

**hh (optional)**  
Half-hour for the specified report. The end time for the collection interval. For example, *hh=0300* generates a report for the interval 2:30-3:00.

**Range:**  
*0000 - 2400*  
*hhmm* where *hh=00 -24* (hour) and *mm=00 or 30* (minute)

**period (optional)**  
The relative period for the report.

**Range:**

***active***

***last***

***specific***

**qh (optional)**  
Quarter-hour for the specified report. The end time for the collection interval. For example, *qh=0315* generates a report for the interval 3:00-3:15.

**Range:**

0000 - 2400

*hhmm* where *hh* = 00-24 (hour) and *mm* = 00, 15, 30 or 45**Example**

```
rept-ftp-meas:type=systot:enttype=stp
rept-ftp-meas:type=systot:enttype=sip
rept-ftp-meas:type=mtch:enttype=deir
rept-ftp-meas:type=mtch:enttype=enum
rept-ftp-meas:type=mtcd:enttype=sfthrot
rept-ftp-meas:type=mtch:enttype=gttset
```

**Dependencies**

This command cannot be used to specify a report type if that report type is currently printing.

A primary MCPM card must be available when this command is entered.

The 15 Minute Measurements feature must be turned on and the 15 Minute Measurements collection option (`chg-measopts:collect15min=on` command) must be on before the `qh` parameter can be specified.

The LNP feature must be turned on before the `mtchlnp=on`, `mtcdlnp=on`, or `enttype=lnp` parameter can be specified.

The GSM Map Screening feature must be turned on before the `mtcdmap=on` and `enttype=mapscrn` parameters can be specified

The EIR feature must be turned on before the `enttype=eir` parameter can be specified,.

If a value of *avl*, *avld*, *comp*, *gtwy*, *mtcd*, or *systot* is specified for the `type` parameter, then the value specified for the `hh` parameter must indicate a half-hour boundary (the end of the requested half-hour for the report). If the `type=mtch` parameter is specified, then the value specified for the `hh` parameter must indicate an hourly boundary (half hours ending in 00, such as 0100, etc).

The `qh` parameter must specify a quarter-hourly boundary (the end of the requested quarter-hour for the report) for valid report types (*avld(th)*, *mtcd(th)*, *mtch*, *nm*, *rbase*, and *mtcs*) cannot be specified.

Hourly collection and report processing cannot be in progress when report type `mtch` is specified.

Day-to-hour collection and report processing cannot be in progress

- When report type *mtcd* is specified
- When report type *mtcdth* is specified

Daily collection and report processing cannot be in progress when report type *mtcd* is specified.

Half-hourly collection and report processing cannot be in progress when report type *comp*, *systot*, *avl*, or *gtwy* is specified.



Quarter-hourly collection and report processing cannot be in progress when report type *comp*, *systot*, *avl*, or *gtwy* is specified.

5-minute collection and report processing cannot be in progress when report type *nm* is specified.

The *mtcdth* report type is unavailable between midnight and 1:00 AM (0100).

The *day* parameter can be specified only for report type *mtcd* and entity types *aiq*, *eir*, *lnp*, *np*, *vflex*, *mapscrn*, *atinpq*, and *gttath*.

The *hh* and *qh* parameters cannot be specified together in the command.

When the *period=last* parameter is specified, the *hh*, *qh*, and *day* parameter cannot be specified.

When the *period=active* parameter is specified, the *hh*, *qh*, and *day* parameters cannot be specified.

When the *period=specific* parameter is specified, the *hh*, *qh*, or *day* parameters must be specified.

Table 4-42 indicates valid parameter combinations for measurements reports; invalid combinations will generate an error message.

**Table 4-42 rept-ftp-meas Valid Parameter Combinations**

Parameter	avl	avld	avldth	comp	gtwy	mtcd	mtcdth	mtch	mtcs	nm	systot	rbase
entity												
aiq						X		X				
atinpq						X		X				
deir						X		X				
eir						X		X				
enum						X		X				
gttapat						X		X				
h												
gttset						X		X				
idpr											X	
link	X	X	X	X		X	X		X	X		X
linkset				X	X	X	X		X	X		X
lnp						X		X				
lsdest					X							
ni												
lsonis					X							
mt												
lsoorigin					X							
i												
mapscrn						X		X				
np						X		X				



- If the `period=specific` parameter is specified, then a value of `avl`, `mtcd`, `comp`, `systot`, `gtwy`, or `mtch` must be specified for the `type` parameter.
- If the `type=mtcd` and `period=specific` parameters are specified, then a value of `lnp`, `mapscrn`, `np`, `eir`, `vflex`, `atinpq`, `aiq`, or `gttapath` must be specified for the `enttype` parameter.
- If the `period=active` parameter is specified, then a value of `mtcs` or `rbase` must be specified for the `type` parameter.
- If the `period=last` parameter is specified, then a value of `mtcs` or `rbase` cannot be specified for the `type` parameter.

At least one ENUM card must be present before the `enttype=enum` parameter can be specified.

The EGTT feature must be turned ON before `enttype=gttset` parameter can be specified.

### Notes

None

### Output



#### Note:

Refer to *Measurements Reference* for the current release for `rept-ftp-meas` output examples.

```
rept-ftp-meas:type=mtcd:enttype=gttapath
```

```
tekelecstp 10-02-11 15:31:25 EST EAGLE 42.0.0
FTP measurement report request sent to primary MCP.
tekelecstp 10-02-11 15:31:25 EST EAGLE 42.0.0
Measurement Server Connection Successful
tekelecstp 10-02-11 15:31:25 EST EAGLE 42.0.0
REPT-FTP-MEAS request was successful.
```

```
;
```

```
rept-ftp-meas:type=systot:enttype=sip
```

```
tekelecstp 12-07-27 13:12:38 EST EAGLE 45.0.0
rept-ftp-meas:type=systot:enttype=sip
Command entered at terminal #4.
```

```
;
```

```
tekelecstp 12-07-27 13:12:38 EST EAGLE 45.0.0
```

```
FTP measurement report request sent to primary MCP.  
;
```

```
tekelecstp 12-07-27 13:12:38 EST EAGLE 45.0.0  
REPT-FTP-MEAS request was successful.  
;
```

```
rept-ftp-meas:type=mtcd:enttype=deir
```

```
tekelecstp 13-03-15 13:12:38 EST EAGLE 45.1.0  
rept-ftp-meas:type=mtcd:enttype=deir  
Command entered at terminal #4.
```

```
tekelecstp 13-03-15 13:12:38 EST EAGLE 45.1.0  
FTP measurement report request sent to primary MCP.
```

```
tekelecstp 13-03-15 13:12:38 EST EAGLE 45.1.0  
REPT-FTP-MEAS request was successful.
```

```
rept-ftp-meas:type=mtcd:enttype=enum
```

```
tekelecstp 14-05-15 13:12:38 EST EAGLE 46.1.0  
rept-ftp-meas:type=mtcd:enttype=enum  
Command entered at terminal #4.  
;
```

```
tekelecstp 14-05-15 13:12:38 EST EAGLE 46.1.0  
FTP measurement report request sent to primary MCP.  
;
```

```
tekelecstp 14-05-15 13:12:38 EST EAGLE 46.1.0  
REPT-FTP-MEAS request was successful.  
;
```

```
rept-ftp-meas:type=mtcd:enttype=sfthrot
```

```
tekelecstp 15-04-15 13:12:38 EST EAGLE 46.3.0  
rept-ftp-meas:type=mtcd:enttype=sfthrot  
Command entered at terminal #4.  
tekelecstp 15-04-15 13:12:38 EST EAGLE 46.3.0  
FTP measurement report request sent to primary MCP.
```

```
tekelecstp 15-04-15 13:12:38 EST EAGLE 46.3.0
```

```
REPT-FTP-MEAS request was successful
;

rept-ftp-meas:type=mtcd:enttype=gttset

tekelecstp 17-05-11 15:12:30 EST EAGLE 46.6.0
rept-ftp-meas:type=mtcd:enttype=gttset
Command entered at terminal #4.
tekelecstp 17-05-11 15:12:30 EST EAGLE 46.6.0
FTP measurement report request sent to primary MCP.

tekelecstp 17-05-11 15:12:30 EST EAGLE 46.6.0
REPT-FTP-MEAS request was successful
;
```

### Related Topics

- [rept-meas](#)

## rept-imt-info

Use this command to display the following statistics:

- IMT bus error statistics currently stored in the IMT fault isolation hourly statistics
- Current IMT bus use statistics. Bus use is the percentage of the capacity of the IMT bus that is used for data during a particular time.
- MUX card error statistics

### Parameters

#### **report (mandatory)**

The type of report that is generated.

#### **Range:**

***err***  
IMT bus error statistics

***hmuxerr***  
HMUX card error statistics

***hiprerr***  
HIPR card error statistics

***hipr2err***  
HIPR2 card error statistics

#### **ebucket (optional)**

End bucket. The last one-hour time period (*bucket*) for which error statistics are reported.

**Range:**  
*0 - 15*

**Default:**

If `sbucket` is specified—current `sbucket` value; information for only that time period is displayed.

If `sbucket` is not specified—`15`, the report includes statistics for all 16 time periods

**e1oc (optional)**

End location. Specifies the card location of the last card in the range for the report.

**Range:**

*1101 - 1113, 1115, 1201 - 1218, 1301 - 1318, 2101 - 2118, 2201 - 2218, 2301 - 2318, 3101 - 3118, 3201 - 3218, 3301 - 3318, 4101 - 4118, 4201 - 4218, 4301 - 4318, 5101 - 5118, 5201 - 5218, 5301 - 5318, 6101 - 6118*

**Default:**

If `sloc` is specified—current `sloc` value; displays information for one card

If `sloc` is not specified—`1115`, which corresponds to IMT address 251 (`e=251`); displays information for entire range of locations.

**erronly (optional)**

This parameter filters the output to display only non-zero counts in the error report.

**Range:**

*yes*

*no*

**Default:**

*yes*

**eshelf (optional)**

The end shelf location for MUX statistics. This shelf location is the last shelf in the range.

**Range:**

*1100, 1200, 1300, 2100, 2200, 2300, 3100, 3200, 3300, 4100, 4200, 4300, 5100, 5200, 5300, 6100*

**Default:**

`sshelf` is specified—the report starts with the `sshelf` value

`sshelf` and `eshelf` are not specified—the report is generated for all shelves equipped with the specified MUX type

**eslot (optional)**

The end slot location for MUX statistics for the cards in the MUX shelf.

**Range:**

*1 - 18*

**Default:**

`sslot` is specified—current `sslot` value

`sslot` is not specified—no default

**mode (optional)**

The display mode used in the error report.

**Range:*****full***

Displays information for each card along with a summary report

***stats***

Displays only individual card statistics

***summary***

Displays the summary portion of the report

**Default:**

*summary*

**sbucket (optional)**

Start bucket. The first one-hour time period (bucket) for which error statistics are reported.

**Range:**

0 - 15

**Default:**

0

**sloc (optional)**

Start location. The card location of the first card in the range for the report.

**Range:**

1101 - 1113, 1115, 1201 - 1218, 1301 - 1318, 2101 - 2118, 2201 - 2218, 2301 - 2318, 3101 - 3118, 3201 - 3218, 3301 - 3318, 4101 - 4118, 4201 - 4218, 4301 - 4318, 5101 - 5118, 5201 - 5218, 5301 - 5318, 6101 - 6118

**Default:**

*eloc* is specified—current *eloc* value

*eloc* and *sloc* are not specified—displays information for entire range of card locations

**sshelf (optional)**

The starting shelf location for MUX statistics. This location is the first shelf in the range.

**Range:**

1100, 1200, 1300, 2100, 2200, 2300, 3100, 3200, 3300, 4100, 4200, 4300, 5100, 5200, 5300, 6100

**Default:**

*eshelf* is specified—current *eshelf* value

*eshelf* and *sshelf* are not specified—report is generated for all shelves equipped with the specified MUX type

**sslot (optional)**

The starting slot location for MUX statistics for the cards in the MUX shelf.

**Range:**

1 - 18

**Default:**

eslot is specified—current eslot value  
eslot is not specified—no default

**term (optional)**

The serial port (printer location) where the report is sent.

**Range:**

1 - 16

**Default:**

Report displays on the terminal where the command is issued

**Example**

```
rept-imt-info:report=err
rept-imt-info:report=err:sloc=1101:eloc=1102:mode=stats
rept-imt-info:report=err:sloc=1101:eloc=1102:mode=full:erronly=no
rept-imt-info:report=hiprerr:sbucket=0
rept-imt-info:report=hiprerr:sshelf=1100:sslot=1:eslot=2:sbucket=0
```

**Dependencies**

No related IMT command can be in progress when this command is entered. Only one report can be active at a time.

This command cannot be entered at a telnet terminal (terminal ID 17-40).

This command cannot be entered during an IMT statistics collection period following an hourly boundary (IMT performance monitoring).

The ending hourly time period cannot be less than the starting hourly time period.

If the `sslot` and `eslot` parameters are specified, then the `sshelf` parameter must be specified and the `eshelf` parameter cannot be specified (slot information is reported for a single shelf).

A value of `hmutexerr`, `hiprerr`, or `hipr2err` must be specified for the `report` parameter before the `sshelf` and `eshelf` parameters can be specified.

The MUX card slots (09 and 10) cannot be specified for the `sslot` and `eslot` parameter values.

A card location that is valid and defined in the database must be specified.

This command cannot be entered during an Extended Bit Error Rate Test (BERT).

The shelf locations specified by the `sshelf` and `eshelf` parameters must be provisioned in the frame.

The `report=err` parameter must be specified before the `erronly` and `mode` parameters can be specified.

The `sshelf` parameter must be specified, and a value of `hiprerr` or `hipr2err` must be specified for the `report` parameter before the `sslot` and `eslot` parameters can be specified.



A value of *hiprerr*, *hipr2err*, or *hmutexerr* must be specified for the `report` parameter before the `sshelf` or `eshelf` parameter can be specified.

### Notes

This command can be canceled using the **F9** function key or the `canc-cmd` command. See `canc-cmd` for more information.

### Hourly Bucket Statistics

Hourly Bucket Statistics apply to cards on the IMT bus and to MUX cards. Each hourly time period (*bucket*) contains the statistics for a single hour. A total of 16 hourly time periods, numbered 0 - 15, exist. Hourly time period 0 is the most-recent (current), and hourly time period 15 is the least-recent (oldest).

Each hour the statistics for the current hourly time period expire, and the hourly time periods advance. That is, after the advance, the statistics previously reported in hourly time period 0 are now reported in the hourly time period 1, and so on. The statistics reported in the hourly time period 15 are no longer available after the change.

When a card is reinitialized, it begins collecting statistics in hourly time period 0 and changes to hourly time period 1 at the start of the next hour. Thus, the first statistics that a card collects after being reinitialized may be for a partial hour.

### MUX Statistics

A MUX card stores the statistics separately for each card on its shelf. If the `sloc` and `eloc` parameters are specified, then the card sends the statistics for each card to the OAM application for display. If the `sloc` and `eloc` parameters are not specified, then the card sends an aggregate number to the OAM application to represent statistics for all cards on its shelf.

### Low Speed Summary

**Table 4-43** `rept-imt-info` Statistics, Low Speed Summary (`rept-imt-info:report=(hmutexerr, hiprerr, or hipr2err)`)

Stat Label – Low Speed Error & Event Counts	Explanation of Stat	Probable Cause	Recommended Action
IMT Rx Packet CRC Error	Receive CRC error: Bad Checksum in received IMT packet. Caused by corrupted data within the received packet. Detected by hardware.	Maintenance activity: Card insertion, removal, or boot. Does not occur in a normal system and indicates a hardware failure: defective LIM card, MUX card, FC cable or backplane.	Clear IMT stats, wait 1 hour and retrieve stats again. If stats are clear, there is no action to perform. If errors continue, a hardware issue is present. Contact the Customer Care Center.

**Table 4-43 (Cont.) rept-imt-info Statistics, Low Speed Summary (rept-imt-info:report=(hmutexerr, hiprerr, or hipr2err))**

Stat Label – Low Speed Error & Event Counts	Explanation of Stat	Probable Cause	Recommended Action
IMT Rx Packet Format Error	Receive Format error: Occurs when the End of Message byte of an IMT packet is found missing. Detected by hardware/software.	Maintenance activity: Card insertion, removal, or boot. Does not occur in a normal system and indicates a hardware failure: defective LIM card, MUX card, FC cable or backplane.	Clear IMT stats, wait 1 hour and retrieve stats again. If stats are clear, there is no action to perform. If errors continue, a hardware issue is present. Contact the Customer Care Center.
IMT Rx Violation Error	Violation Error: Received an illegal character from the physical IMT transport (TAXI Interface). Detected by hardware	Card insertion, removal, or boot or defective hardware	Clear IMT stats, wait 1 hour and retrieve stats again. If stats are clear, there is no action to perform. If errors continue, a problem may exist. Contact the Customer Care Center.
IMT Rx Command Error	Reserved.	Reserved.	Reserved.
IMT Rx FIFO Full	Receive FIFO Full: Watermark indication that this interface receiving data off the TAXI line is receiving traffic in excess of what it can handle. Some traffic will have been discarded. May cause retransmissions, CRC errors and Format errors.	Relatively heavy traffic on this interface can cause these counts to increment. If these counts occur in the field, a software problem may exist.	Clear IMT stats, wait 1 hour and retrieve stats again. If stats are clear, there is no action to perform. If errors continue, a problem may exist. Contact the Customer Care Center.
IMT Rx FIFO Half Full	Receive FIFO Half Full: Watermark indication that the interface receiving data off the TAXI line has received substantial traffic.	Relatively heavy traffic on this interface can cause these counts to increment.	None. FIFO Half Full is an indication; no action is required.
IMT Tx FIFO Full	Transmit FIFO Full: The FIFO has overflowed and data has been lost. This stat is only meaningful for MUX card columns.	Relatively heavy traffic on this interface can cause these counts to increment. This condition should never occur. These events may indicate a software problem	Clear IMT stats, wait 1 hour and retrieve stats again. If stats are clear, there is no action to perform. If errors continue, a problem may exist. Contact the Customer Care Center.

**Table 4-43 (Cont.) rept-imt-info Statistics, Low Speed Summary (rept-imt-info:report=(hmutexerr, hiprerr, or hipr2err))**

Stat Label – Low Speed Error & Event Counts	Explanation of Stat	Probable Cause	Recommended Action
IMT Tx FIFO Half Full	Transmit FIFO Half Full: Watermark indication that this interface is backed up through ½ of its available storage.  This stat is only meaningful for MUX card columns.	Indicates that data was transmitted at a relatively high rate for a short period.	None. FIFO Half Full is just an indication; no action is required.
CPU Rx FIFO Empty Before SOM	Occurs when valid packet data is read from the CPU Rx FIFO and the beginning (SOM) of the packet is found missing before all data was read.	The SOM was corrupted while being written into the CPU Rx FIFO from the low speed link.	None. This error will automatically empty the FIFO so it is ready to continue receiving data. If the error continues, contact the Customer Care Center.
CPU Rx FIFO Empty Before EOM	Occurs when valid packet data is read from the CPU Rx FIFO and the end (EOM) of the packet is found missing before all data was read.	The SOM was corrupted while being written into the CPU Rx FIFO or a partial packet was written into the FIFO from the low speed link.	None. This error will automatically empty the FIFO so that it is ready to continue receiving data. If the error continues, contact the Customer Care Center.
CPU Rx Packet SOM Before EOM	A Start of Message was received when an End of Message was expected from the IMT bus.	Packet was corrupted in the system (EOM lost) and has another packet appended to it.	None. If the problem persists, contact the Customer Care Center.
CPU Rx Packet CRC Error	Occurs when valid packet data is read from the CPU Rx FIFO and transferred to the processor memory and calculated CRC does NOT match the CRC word at the end of the packet.	The data was corrupted while being written into the CPU Rx FIFO or data coming from the low speed link is corrupted.	None. If the problem persists, contact the Customer Care Center.
DMA Terminal Count	Received IMT packet length is longer than the max allowed. Detected by hardware.	Card insertion/removal or boot.	None if card has booted or was just inserted. Clear the stats and if the problem persists, contact the Customer Care Center.

**Table 4-43 (Cont.) rept-imt-info Statistics, Low Speed Summary (rept-imt-info:report=(hmutexerr, hiprerr, or hipr2err))**

Stat Label – Low Speed Error & Event Counts	Explanation of Stat	Probable Cause	Recommended Action
CPU Tx Buffer EOB	A packet that was being transmitted from the CPU Tx Buffer did not have an EOM.	The data was corrupted while being written into or being read from the FIFO.	None. If the problem persists, contact the Customer Care Center.
CPU Tx Buffer Full	Transmit Buffer Full: The Tx Buffer unexpectedly filled up.	Either the COM software attempted to transmit too much data at once or the Tx logic was unable to transmit the data.	None. If the problem persists, contact the Customer Care Center.
CPU Tx Buffer Half Full	Transmit Buffer Half Full: Watermark indication that this interface is backed up through ½ of its available storage.	Relatively heavy outbound traffic on this interface can cause these counts to increment.	None. Buffer Half Full is just an indication, no action is required.
CPU Rx FIFO Full	Receive FIFO Full: The Rx FIFO unexpectedly filled up.	Indicates that data was received at a higher rate than could be processed by the Communications processor.	Clear IMT stats, wait 1 hour and retrieve stats again. If stats are clear, there is no action to perform. If the errors continue, a problem may exist. Contact the Customer Care Center.
CPU Rx FIFO Half Full	Receive FIFO Half Full: Watermark indication that this interface is backed up through ½ of its available storage.	Relatively heavy inbound traffic on this interface can cause these counts to increment.	None. FIFO half full is just an indication, no action is required.
IMT Bypass FIFO Full	IMT Bypass FIFO Full: The bypass FIFO unexpectedly filled up.	Relatively heavy traffic on this interface can cause these counts to increment. If these counts occur in the field, a software problem may exist.	Clear IMT stats, wait 1 hour and retrieve stats again. If stats are clear, there is no action to perform. If the errors continue, a problem may exist. Contact the Customer Care Center.
IMT Bypass FIFO Half Full	IMT Bypass FIFO Half Full: Watermark indication that this interface is backed up through ½ of its available storage.	Relatively heavy inbound traffic on this interface can cause these counts to increment.	None. FIFO half full is just an indication, no action is required.

**High Speed Summary**

Table 4-44 rept-imt-info Statistics, High Speed Summary

Stat Label – High Speed Error & Event Counts	Explanation of Stat	Probable Cause	Recommended Action
IMT Rx Disparity Error	Fibre Channel Receive Packet with Disparity Errors: Parity error in received packet. Usually caused by corrupted data.	Should not occur in a properly functioning system and may indicate a hardware failure.	Clear IMT stats, wait 1 hour and retrieve stats again. If stats are clear, there is no action to perform. If errors continue, a problem may exist. Contact the Customer Care Center.
IMT Rx Sync Lost Error (This error count is not used in MUX card.)	Fibre Channel Receive Lost Synchronization Errors: The receiver on this interface lost synchronization.	Should not occur in a properly functioning system and may indicate a hardware failure.	Clear IMT stats, wait 1 hour and retrieve stats again. If stats are clear, there is no action to perform. If errors continue, a problem may exist. Contact the Customer Care Center.
IMT Rx Code Word Error	Fibre Channel Receive code Word Errors: Error in received packet. Caused by corrupted data.	Should not occur in a properly functioning system and may indicate a hardware failure.	Clear IMT stats, wait 1 hour and retrieve stats again. If stats are clear, there is no action to perform. If the errors continue, a problem may exist. Contact the Customer Care Center.
IMT Rx Packet SOM Before EOM	Fibre Channel Receive Packet with Start of Message without a previous End of Message Errors: The software detected the start of a new packet before the end of the previous packet was detected.	Should not occur in a properly functioning system and may indicate a hardware failure.	Clear IMT stats, wait 1 hour and retrieve stats again. If stats are clear, there is no action to perform. If errors continue, a problem may exist. Contact Customer Care Center.
IMT Bypass FIFO Full	Fibre Channel Bypass FIFO Full: The FIFO has over run and data has been lost. May result in significant downstream errors.	Should not occur in a properly functioning system, and may indicate a software or hardware failure.	Clear IMT stats, wait 1 hour and retrieve stats again. If stats are clear, there is no action to perform. If errors continue, a problem may exist. Contact the Customer Care Center.

Table 4-44 (Cont.) rept-imt-info Statistics, High Speed Summary

Stat Label – High Speed Error & Event Counts	Explanation of Stat	Probable Cause	Recommended Action
IMT Bypass FIFO Half Full	Fibre Channel Bypass FIFO Half Full: Watermark indication that this interface has backed up to the half way point of its capabilities.	Relatively heavy traffic on this interface can cause these counts to increment.	None. FIFO Half Full is just an indication: no action is required.
IMT Rx FIFO Full	Fibre Channel Receive FIFO Full: The FIFO has over run and data has been lost. May result in significant downstream errors.	Should not occur in a properly functioning system. Indicates a software or hardware failure	Clear IMT stats, wait 1 hour and retrieve stats again. If stats are clear, there is no action to perform. If errors continue, a problem may exist. Contact the Customer Care Center.
IMT Rx FIFO Half Full	Fibre Channel Receive FIFO Half Full: Watermark indication that this interface has backed up to the half way point of its capabilities.	Relatively heavy traffic on this interface can cause these counts to increment.	None. FIFO Full in this case is just an indication; no action is required.
IMT Tx FIFO Full	Fibre Channel Transmit FIFO Full: Watermark indication that this interface has transmitted substantial traffic.	Relatively heavy traffic on this interface can cause these counts to increment.	None. FIFO Full in this case is just an indication; no action is required.
IMT Tx FIFO Half Full	Fibre Channel Transmit FIFO Half Full: Watermark indication that this interface has backed up to the half way point of its capabilities.	Relatively heavy traffic on this interface can cause these counts to increment.	None. FIFO Half Full is just an indication; no action is required.
CPU Rx Fifo Full	Receive FIFO Full: The Rx FIFO unexpectedly filled up.	Indicates that data was received at a higher rate than could be processed by the Communications processor.	Clear IMT stats, wait 1 hour and retrieve stats again. If stats are clear, there is no action to perform. If the errors continue, a problem may exist. Contact the Customer Care Center.

Table 4-44 (Cont.) rept-imt-info Statistics, High Speed Summary

Stat Label – High Speed Error & Event Counts	Explanation of Stat	Probable Cause	Recommended Action
CPU Rx FIFO Half Full	Receive FIFO Half Full: Watermark indication that this interface is backed up through ½ of its available storage.	Relatively heavy inbound traffic on this interface can cause these counts to increment.	None. FIFO half full is just an indication, no action is required.
CPU Rx FIFO Empty Before SOM	Occurs when valid packet data is read from the CPU Rx FIFO and the beginning (SOM) of the packet is found missing before all data was read.	The SOM was corrupted while being written into the CPU Rx FIFO from the high speed link.	None. This error will automatically empty the FIFO so that it is ready to continue receiving data. If the problem persists, contact the Customer Care Center.
CPU Rx FIFO Empty Before EOM	Occurs when valid packet data is read from the CPU Rx FIFO and the beginning (SOM) of the packet is found missing before all data was read.	The SOM was corrupted while being written into the CPU Rx FIFO or a partial packet was written into the FIFO from the high speed link.	None. This error will automatically empty the FIFO so that it is ready to continue receiving data. If the problem persists, contact the Customer Care Center.
CPU Rx Packet SOM Before EOM	A Start of Message was received when an End of Message was expected from the Fibre Channel bus.	Packet was corrupted in the system (EOM lost) and has another packet appended to it.	None. If the problem persists, contact the Customer Care Center.
CPU Rx Packet CRC Error	Occurs when valid packet data is read from the CPU Rx FIFO and transferred to the processor memory and calculated CRC does NOT match the CRC word at the end of the packet.	The data was corrupted while being written into the CPU Rx FIFO or data coming from the high speed link is corrupted.	None. If the problem persists, contact the Customer Care Center.
DMA Terminal Count	Received IMT packet length (on Fibre Channel) is longer than the max allowed. Detected by hardware.	Card insertion/removal or boot.	None if card has booted or was just inserted. Clear the stats and if the problem persists, contact the Customer Care Center.
CPU Tx Buffer EOB	A packet that was being transmitted from the CPU Tx Buffer did not have an EOM.	The data was corrupted while being written into or being read from the FIFO.	None. If the problem persists, contact Customer Care Center.

Table 4-44 (Cont.) rept-imt-info Statistics, High Speed Summary

Stat Label – High Speed Error & Event Counts	Explanation of Stat	Probable Cause	Recommended Action
CPU Tx Buffer Full	Transmit Buffer Full: The Tx Buffer unexpectedly filled up.	Either the COM software attempted to transmit too much data at once or the Tx logic was unable to transmit the data.	None. If the problem persists, contact the Customer Care Center.
CPU Tx Buffer Half Full	Transmit Buffer Half Full: Watermark indication that this interface is backed up through ½ of its available storage.	Relatively heavy outbound traffic on this interface can cause these counts to increment.	None. Buffer Half Full is an indication, no action is required.
IXP Rx FIFO Full	Fibre Channel IXP Receive FIFO Full: The IXP Rx FIFO momentarily became full. This event can occur under normal conditions and it does not indicate an issue.	Relatively heavy traffic on this interface can cause these counts to increase.	None. FIFO Full in this case is just an indication; no action is required.
IXP Rx FIFO Half Full	Fibre Channel IXP Receive FIFO Half Full: Watermark indication that this interface has backed up to the half way point of its capabilities.	Relatively heavy traffic on this interface can cause these counts to increment.	None. FIFO Full in this case is just an indication; no action is required.
IMT Rx Byte Per Minute AVG	Average per minute	Normal behavior	None. Information only.
IMT Rx Byte Per Second AVG	Average per second	Normal behavior	None. Information only.
IMT Tx Byte Per Minute AVG	Average per minute	Normal behavior	None. Information only.
IMT Tx Byte Per Second AVG	Average per second	Normal behavior	None. Information only.
IMT Rx Packet Per Minute AVG	Average per minute	Normal behavior	None. Information only.
IMT Rx Packet Per Second AVG	Average per second	Normal behavior	None. Information only.
IMT Tx Packet Per Minute AVG	Average per minute	Normal behavior	None. Information only.
IMT Tx Packet Per Second AVG	Average per second	Normal behavior	None. Information only.
IMT Rx Errors Per Minute AVG	Average per minute	Normal behavior	None. Information only.
IMT Rx Errors Per Second AVG	Average per second	Normal behavior	None. Information only.
IMT Tx Errors Per Minute AVG	Average per minute	Normal behavior	None. Information only.



Table 4-44 (Cont.) rept-imt-info Statistics, High Speed Summary

Stat Label – High Speed Error & Event Counts	Explanation of Stat	Probable Cause	Recommended Action
IMT Tx Errors Per Second AVG	Average per second	Normal behavior	None. Information only.
IMT Rx Safety Per Minute AVG	Average per minute	Normal behavior	None. Information only.
IMT Rx Safety Per Second AVG	Average per second	Normal behavior	None. Information only.
IMT Rx MSU Byte Per Minute AVG	Average bytes per minute received on the line card interface within reliable delivery packets.	Normal behavior	None. Information only.
IMT Rx MSU Byte Per Second AVG	Average bytes per second received on the line card interface within reliable delivery packets.	Normal behavior	None. Information only
IMT Rx ASU Byte Per Minute AVG	Average bytes per minute received on the line card interface within acknowledgment packets.	Normal behavior	None. Information only.
IMT Rx ASU Byte Per Second AVG	Average bytes per second received on the line card interface within acknowledgment packets.	Normal behavior	None. Information only
IMT Rx DSU Byte Per Minute AVG	Average bytes per minute received on the line card interface within best effort delivery packets.	Normal behavior	None. Information only.
IMT Rx DSU Byte Per Second AVG	Average bytes per second received on the line card interface within best effort delivery packets.	Normal behavior	None. Information only.
IMT Rx MSU Byte Count	Number of bytes received on the line card interface within reliable delivery packets.	Normal behavior	None. Information Only
IMT Rx ASU Byte Count	Number of bytes received on the line card interface within acknowledgment packets.	Normal behavior	None. Information only.

Table 4-44 (Cont.) rept-imt-info Statistics, High Speed Summary

Stat Label – High Speed Error & Event Counts	Explanation of Stat	Probable Cause	Recommended Action
IMT Rx DSU Byte Count	Number of bytes received on the line card interface within best effort delivery packets.	Normal behavior	None. Information only.
IMT RX HSU Byte Count	Number of bytes received on the line card interface within mux specific packets.	Normal behavior	None. Information only.
IMT Rx LSSU Byte Count	Number of bytes received on the line card interface within virtual circuit alignment packets.	Normal behavior	None. Information only.
IMT Rx TSU Byte Count	Number of bytes received on the line card interface within test data packets.	Normal behavior	None. Information only.
IMT Rx SSU Byte Count	Number of bytes received on the line card interface within safety packets.	Normal behavior.	None. Information only.
IMT Rx BSU Byte Count	Number of bytes received on the line card interface within broadcast packets.	Normal behavior	None. Information only.
IMT Rx Byte Other	Number of bytes received on the line card interface within data packets other than the above.	Normal behavior	None. Information only.
IMT Rx Total Byte Count	Number of bytes received on the line card interface within all types of packets.	Normal behavior	None. Information only.
IMT Rx MSU Packet Count	Number of reliable delivery packets received on the IMT.	Normal behavior	None. Information only.
IMT Rx ASU Packet Count	Number of acknowledgment packets received on the IMT.	Normal behavior	None. Information only.
IMT Rx DSU Packet Count	Number of best effort delivery message data packets received on the IMT.	Normal behavior	None. Information only.
IMT Rx HSU Packet Count	Number of mux card data packets received on the IMT.	Normal behavior	None. Information only.

Table 4-44 (Cont.) rept-imt-info Statistics, High Speed Summary

Stat Label – High Speed Error & Event Counts	Explanation of Stat	Probable Cause	Recommended Action
IMT Rx LSSU Packet Count	Number of virtual circuit alignment packets received on the IMT.	Normal behavior	None. Information only.
IMT Rx TSU Packet Count	Number of test data packets received on the IMT.	Normal behavior.	None. Information only.
IMT Rx SSU Packet Count	Number of safety packets received on the IMT.	Normal behavior	None. Information only.
IMT Rx BSU Packet Count	Number of broadcast data packets received on the IMT.	Normal behavior	None. Information only.
IMT Rx Packet Other	Number of all packets types not counted by one of the above.	Normal behavior	None. Information only.
IMT Rx Total Packet Count	Number of packets received on the IMT, all types.	Normal behavior	None. Information only.
IMT Rx MSU Packet Safety Count	Number of reliable delivery message data packets that did not arrive to the intended recipient on the IMT.	Normal behavior	None. Information only.
IMT Rx ASU Packet Safety Count	Number of acknowledgment packets that did not arrive to the intended recipient on the IMT.	Normal behavior	None. Information only.
IMT Rx DSU Packet Safety Count	Number of best effort delivery packets that did not arrive to the intended recipient on the IMT.	Normal behavior	None. Information only.
IMT Rx HSU Packet Safety Count	Number of mux card packets that did not arrive to the intended recipient on the IMT.	Normal behavior	None. Information only.
IMT Rx LSSU Packet Safety Count	Number of virtual circuit alignment packets that did not arrive to the intended recipient on the IMT.	Normal behavior	None. Information only.
IMT Rx TSU Packet Safety Count	Number of test data packets that did not arrive to the intended recipient on the IMT.	Normal behavior	None. Information only.

Table 4-44 (Cont.) rept-imt-info Statistics, High Speed Summary

Stat Label – High Speed Error & Event Counts	Explanation of Stat	Probable Cause	Recommended Action
IMT Rx SSU Packet Safety Count	Number of safety packets that did not arrive to the intended recipient on the IMT.	Normal behavior	None. Information only.
IMT Rx BSU Packet Safety Count	Number of broadcast data packets that did not arrive to the intended recipient on the IMT.	Normal behavior	None. Information only.
IMT Rx Other Packet Safety Count	Number of other packets types not included above that did not arrive to the intended recipient on the IMT.	Normal behavior	None. Information only.
IMT Rx Total Packet Safety Count	Number of all packets that did not arrive to the intended recipient on the IMT.	Normal behavior	None. Information only.
IMT Rx Packet Violation Error	Number of packets received that contained an illegal character.	Card insertion, removal, boot or defective hardware	Clear IMT stats, wait 1 hour and retrieve stats again. If stats are clear, there is no action to perform. If errors continue, a hardware issue exists. Contact Customer Care Center.
IMT Rx Packet CRC Error	Receive CRC error: Bad Checksum in received IMT packet. Caused by corrupted data within the received packet. Detected by hardware.	Card insertion, removal, or boot. Does not occur in a normal system and indicates a hardware failure: defective LIM card, MUX card, FC cable or backplane.	Clear IMT stats, wait 1 hour and retrieve stats again. If stats are clear, there is no action to perform. If errors continue, a hardware issue exists. Contact Customer Care Center.
IMT Rx Packet Format Error	Receive Format error: Occurs when the End of Message byte of an IMT packet is found missing. Detected by hardware/software.	Card insertion, removal, or boot. Does not occur in a normal system and indicates a hardware failure: defective LIM card, MUX card, FC cable or backplane.	Clear IMT stats, wait 1 hour and retrieve stats again. If stats are clear, there is no action to perform. If errors continue, a hardware issue exists. Contact Customer Care Center.

**Table 4-44 (Cont.) rept-imt-info Statistics, High Speed Summary**

<b>Stat Label – High Speed Error &amp; Event Counts</b>	<b>Explanation of Stat</b>	<b>Probable Cause</b>	<b>Recommended Action</b>
IMT Rx Packet Discard Error	Number of packets received that were discarded by this interface.	Relatively heavy traffic on this interface can cause these counts to increment.	Clear IMT stats, wait 1 hour and retrieve stats again. If stats are clear then there is no action to perform. If errors continue, a problem may exist. Contact Customer Care Center.
IMT Tx Packet Format Error	Number of packets transmitted that were detected to contain a data format error.	Maintenance activity: Card insertion, removal, or boot. Does not occur in a normal system and indicates a hardware failure: defective LIM card, MUX card, FC cable or backplane.	Clear IMT stats, wait 1 hour and retrieve stats again. If stats are clear then there is no action to perform. If errors continue, a problem may exist. Contact Customer Care Center.
IMT Tx Packet Discard Error	Number of packets that were discarded by the transmit interface.	Relatively heavy traffic on this interface can cause these counts to increment.	Clear IMT stats, wait 1 hour and retrieve stats again. If stats are clear then there is no action to perform. If errors continue a problem may exist. Contact Customer Care Center.

**Miscellaneous Summary****Table 4-45 rept-imt-info Statistics, Miscellaneous Summary**

<b>Stat Label – Low Speed Error &amp; Event Counts</b>	<b>Explanation of Stat</b>	<b>Probable Cause</b>	<b>Recommended Action</b>
Shelf ID UART Framing Error	The Mux card at this location detected a framing error within the data stream containing its shelf address, transmitted by the MASP through the clock cable.	These errors can occur when a Mux card or a MASP has booted or been inserted/ removed from the slot.	Clear IMT stats, wait 1 hour and retrieve stats again. If stats are clear, there is no action to perform. If the errors continue, a problem may exist. Contact the Customer Care Center.

**Table 4-45 (Cont.) rept-imt-info Statistics, Miscellaneous Summary**

Stat Label – Low Speed Error & Event Counts	Explanation of Stat	Probable Cause	Recommended Action
Shelf ID UART Overrun Error	The Mux card at this location detected a overrun error in the data stream containing its shelf address, transmitted by the MASP through the clock cable.	These errors can occur when a Mux card or a MASP has booted or been inserted/ removed from the slot.	Clear IMT stats, wait 1 hour and retrieve stats again. If stats are clear, there is no action to perform. If the errors continue, a problem may exist. Contact the Customer Care Center.

**Output**

An asterisk (\*) is appended to each statistic in the output when one or more MUX cards are unable to report statistics during the collection of IMT statistics.

IMT statistics are displayed as '-' instead of zero for counts when the IMT bus is down or inhibited in the output for `rept-imt-info` reports for MUX cards.

```
rept-imt-info:report=err
```

```
rlghncxa03w 04-02-27 12:47:07 EST EAGLE 31.3.0
```

```
IMT Fault Isolation Error Statistics
```

```
=====
```

```
SUMMARY REPORT: Totals accumulated from all requested cards for all buckets
```

Statistic	Bus A Value	Bus B Value
-----	-----	-----
Rcv CRC Err	12	1
Primary Ctl Rcv Err	23	3
Violation Err	34	5
CPU Rcv FIFO Full	45	12

```
;
```

```
rept-imt-info:report=err:sloc=1101:eloc=1102:mode=stats
```

```
rlghncxa03w 04-02-27 12:47:07 EST EAGLE 31.3.0
```

```
IMT Fault Isolation Error Statistics
```

```
-----
```

```
Totals accumulated from all requested cards for each bucket
```

Bucket	Statistic	Bus A Value	Bus B Value
-----	-----	-----	-----
00	Rcv CRC Err	1	2
	Rcv Invalid Len	1012345678	0
	CPU Rcv FIFO Full	23	123
01	No errors in this bucket.		

```
.
```

. (data continues for each hourly time period)  
;

rept-imt-  
info:report=err:sloc=1101:eloc=1102:mode=full:erronly=no

rlghncxa03w 04-02-27 12:47:07 EST EAGLE 31.3.0

IMT Fault Isolation Error Statistics

-----  
Totals accumulated from all requested cards for each bucket

Bucket	Statistic	Bus A Value	Bus B Value
-----	-----	-----	-----
00	Rcv CRC Err	0	0
	Rcv Format Err	0	0
	Rcv Invalid Len	1	0
	Primary Ctl Rcv Err	0	0
	Primary Ctl Tx Err	0	0
	Primary Ctl Sanity Err	0	0
	Violation Err	1	0
	IMT Rcv FIFO Half Full	0	0
	IMT Rcv FIFO Full	0	0
	CPU Rcv FIFO Half Full	0	0
	CPU Rcv FIFO Full	0	0
	MSU Retransmitted	0	0
	DMA Terminal Ct Intrpt	0	0
	SSU Pkts Txd	0	0
	SSU Pkts Rcvd	0	0
01	Rcv CRC Err	3	0
	Rcv Format Err	0	0
	Rcv Invalid Len	0	0
	Primary Ctl Rcv Err	0	0
	Primary Ctl Tx Err	0	0
	Primary Ctl Sanity Err	0	0
	Violation Err	0	0
	IMT Rcv FIFO Half Full	0	0
	IMT Rcv FIFO Full	0	0
	CPU Rcv FIFO Half Full	0	0
	CPU Rcv FIFO Full	0	0
	MSU Retransmitted	0	0
	DMA Terminal Ct Intrpt	0	0
	SSU Pkts Txd	0	0
	SSU Pkts Rcvd	0	0

. (data continues for each hourly time period)

=====  
SUMMARY REPORT: Totals accumulated from all requested cards for all buckets

Statistic	Bus A Value	Bus B Value
-----	-----	-----
Rcv CRC Err	3	0
Rcv Format Err	0	0
Rcv Invalid Len	1	0
Primary Ctl Rcv Err	1012345678	0

```

Primary Ctl Tx Err          0          0
Primary Ctl Sanity Err     0          0
Violation Err              1          0
IMT Rcv FIFO Half Full    0          0
IMT Rcv FIFO Full         0          0
CPU Rcv FIFO Half Full    23         0
CPU Rcv FIFO Full         0          0
MSU Retransmitted         0          0
DMA Terminal Ct Intrpt    0          0
SSU Pkts Txd              1          0
SSU Pkts Rcvd            0          0
;

```

This example output displays the output when IMT Bus A and Bus B are normal and all HMUX cards are reporting the statistics:

```
rept-imt-info:report=hmuxerr:sbucket=0
```

```
rlghncxa03w 10-01-17 00:10:20 PST EAGLE 42.0.0
```

```

HMUX Summary Report: Summed across all requested cards for each bucket
Collecting HMUX stats: Extended processing time required.
HMUX Hourly Bucket Statistics

```

```

=====
Bucket Low Speed Statistic          BUS A Value  BUS B Value
-----
00  IMT Rx Packet CRC Error          0123456789   0123456789
    IMT Rx Packet Format Error       0123456789   0123456789
    IMT Rx Violation Error           0123456789   0123456789
    CPU Rx FIFO Full                 0123456789   0123456789
    CPU Rx FIFO Half Full            0123456789   0123456789
    CPU Rx FIFO Empty Before SOM     0123456789   0123456789
    CPU Rx FIFO Empty Before EOM     0123456789   0123456789
    CPU Rx Packet SOM Before EOM     0123456789   0123456789
    CPU Rx Packet CRC Error          0123456789   0123456789
    DMA terminal count                0123456789   0123456789
    CPU Tx Buffer EOB                 0123456789   0123456789
    CPU Tx Buffer Full                 0123456789   0123456789
    CPU Tx Buffer Half Full           0123456789   0123456789
    IMT Bypass FIFO Full             0123456789   0123456789
    IMT Bypass FIFO Half Full        0123456789   0123456789
    IMT Rx FIFO Full                 0123456789   0123456789
    IMT Rx FIFO Half Full            0123456789   0123456789

High Speed Statistic                BUS A Value  BUS B Value
-----
    IMT Rx Packet CRC Error          0123456789   0123456789
    IMT Rx Disparity Error           0123456789   0123456789
    IMT Rx Sync Lost Error           0123456789   0123456789
    IMT Rx Code Word Error           0123456789   0123456789
    CPU Rx FIFO Full                 0123456789   0123456789
    CPU Rx FIFO Half Full            0123456789   0123456789
    CPU Rx FIFO Empty Before SOM     0123456789   0123456789
    CPU Rx FIFO Empty Before EOM     0123456789   0123456789
    CPU Rx Packet SOM Before EOM     0123456789   0123456789

```



CPU Rx Packet CRC Error	0123456789	0123456789
DMA terminal count	0123456789	0123456789
CPU Tx Buffer EOB	0123456789	0123456789
CPU Tx Buffer Full	0123456789	0123456789
CPU Tx Buffer Half Full	0123456789	0123456789
IMT Bypass FIFO Full	0123456789	0123456789
IMT Bypass FIFO Half Full	0123456789	0123456789
IMT Rx FIFO Full	0123456789	0123456789
IMT Rx FIFO Half Full	0123456789	0123456789
Misc Speed Statistic	BUS A Value	BUS B Value
-----	-----	-----
Shelf ID UART Framing Error	0123456789	0123456789
Shelf ID UART Overrun Error	0123456789	0123456789

## HMUX CUMULATIVE Statistics

```
=====
=====
```

Low Speed Statistic	BUS A Value	BUS B Value
-----	-----	-----
IMT Rx Packet CRC Error	0123456789	0123456789
IMT Rx Packet Format Error	0123456789	0123456789
IMT Rx Violation Error	0123456789	0123456789
CPU Rx FIFO Full	0123456789	0123456789
CPU Rx FIFO Half Full	0123456789	0123456789
CPU Rx FIFO Empty Before SOM	0123456789	0123456789
CPU Rx FIFO Empty Before EOM	0123456789	0123456789
CPU Rx Packet SOM Before EOM	0123456789	0123456789
CPU Rx Packet CRC Error	0123456789	0123456789
DMA terminal count	0123456789	0123456789
CPU Tx Buffer EOB	0123456789	0123456789
CPU Tx Buffer Full	0123456789	0123456789
CPU Tx Buffer Half Full	0123456789	0123456789
IMT Bypass FIFO Full	0123456789	0123456789
IMT Bypass FIFO Half Full	0123456789	0123456789
IMT Rx FIFO Full	0123456789	0123456789
IMT Rx FIFO Half Full	0123456789	0123456789
High Speed Statistic	BUS A Value	BUS B Value
-----	-----	-----
IMT Rx Packet CRC Error	0123456789	0123456789
IMT Rx Disparity Error	0123456789	0123456789
IMT Rx Sync Lost Error	0123456789	0123456789
IMT Rx Code Word Error	0123456789	0123456789
CPU Rx FIFO Full	0123456789	0123456789
CPU Rx FIFO Half Full	0123456789	0123456789
CPU Rx FIFO Empty Before SOM	0123456789	0123456789
CPU Rx FIFO Empty Before EOM	0123456789	0123456789
CPU Rx Packet SOM Before EOM	0123456789	0123456789
CPU Rx Packet CRC Error	0123456789	0123456789
DMA terminal count	0123456789	0123456789
CPU Tx Buffer EOB	0123456789	0123456789
CPU Tx Buffer Full	0123456789	0123456789
CPU Tx Buffer Half Full	0123456789	0123456789

```

IMT Bypass FIFO Full          0123456789    0123456789
IMT Bypass FIFO Half Full    0123456789    0123456789
IMT Rx FIFO Full             0123456789    0123456789
IMT Rx FIFO Half Full        0123456789    0123456789

Misc Speed Statistic          BUS A Value  BUS B Value
-----
Shelf ID UART Framing Error   0123456789    0123456789
Shelf ID UART Overrun Error   0123456789    0123456789

```

;

This example shows the output when IMT Bus A and Bus B are normal and all MUX cards are reporting the statistics:

```
rept-imt-info:report=hiprerr:sbucket=0
```

```
rlghncxa03w 10-01-17 00:10:20 PST EAGLE 42.0.0
```

```
  HIPR Summary Report: Summed across all requested cards for each bucket
```

```
  HIPR Hourly Bucket Statistics
```

```
=====
```

```

Bucket Loc  Low Speed Statistic          BUS A Value  BUS B Value
-----
00         IMT Rx Packet CRC Error      0123456789    0123456789
           IMT Rx Packet Format Error   0123456789    0123456789
           IMT Rx Violation Error       0123456789    0123456789
           IMT Rx Command Error         0123456789    0123456789
           IMT Rx FIFO Full             0123456789    0123456789
           IMT Rx FIFO Half Full        0123456789    0123456789
           IMT Tx FIFO Full             0123456789    0123456789
           IMT Tx FIFO Half Full        0123456789    0123456789

           High Speed Statistic          BUS A Value  BUS B Value
           -----
           IMT Rx Packet Format Error   0123456789    0123456789
           IMT Rx Disparity Error       0123456789    0123456789
           IMT Rx Sync Lost Error       0123456789    0123456789
           IMT Rx Code Word Error       0123456789    0123456789
           IMT Rx Packet SOM Before EOM 0123456789    0123456789
           IMT Rx Packet CRC Error      0123456789    0123456789
           IMT Bypass FIFO Full         0123456789    0123456789
           IMT Bypass FIFO Half Full    0123456789    0123456789
           IMT Rx FIFO Full             0123456789    0123456789
           IMT Rx FIFO Half Full        0123456789    0123456789
           IMT Tx FIFO Full             0123456789    0123456789
           IMT Tx FIFO Half Full        0123456789    0123456789
           IXP Rx FIFO Full             0123456789    0123456789
           IXP Rx FIFO Half Full        0123456789    0123456789

           Misc Speed Statistic          BUS A Value  BUS B Value
           -----
           Shelf ID UART Framing Error   0123456789    0123456789

```

Shelf ID UART Overrun Error 0123456789 0123456789

HIPR CUMULATIVE Statistics

```

=====
====
Low Speed Statistic          BUS A Value  BUS B Value
-----
IMT Rx Packet CRC Error     0123456789  0123456789
IMT Rx Packet Format Error   0123456789  0123456789
IMT Rx Violation Error      0123456789  0123456789
IMT Rx Command Error        0123456789  0123456789
IMT Rx FIFO Full            0123456789  0123456789
IMT Rx FIFO Half Full       0123456789  0123456789
IMT Tx FIFO Full            0123456789  0123456789
IMT Tx FIFO Half Full       0123456789  0123456789

High Speed Statistic         BUS A Value  BUS B Value
-----
IMT Rx Packet Format Error   0123456789  0123456789
IMT Rx Disparity Error       0123456789  0123456789
IMT Rx Sync Lost Error       0123456789  0123456789
IMT Rx Code Word Error       0123456789  0123456789
IMT Rx Packet SOM Before EOM 0123456789  0123456789
IMT Rx Packet CRC Error     0123456789  0123456789
IMT Bypass FIFO Full         0123456789  0123456789
IMT Bypass FIFO Half Full    0123456789  0123456789
IMT Rx FIFO Full            0123456789  0123456789
IMT Rx FIFO Half Full       0123456789  0123456789
IMT Tx FIFO Full            0123456789  0123456789
IMT Tx FIFO Half Full       0123456789  0123456789
IXP Rx FIFO Full            0123456789  0123456789
IXP Rx FIFO Half Full       0123456789  0123456789

Misc Speed Statistic         BUS A Value  BUS B Value
-----
Shelf ID UART Framing Error  0123456789  0123456789
Shelf ID UART Overrun Error  0123456789  0123456789
;

```

This example shows the output when both IMT Bus A and Bus B are normal and all MUX cards are reporting the statistics:

```

rept-imt-
info:report=hiprerr:sshelf=1100:sslot=1:eslot=2:sbucket=0

rlghncxa03w 10-01-17 00:10:20 PST EAGLE 42.0.0
  HIPR Summary Report: Summed across all requested cards for each
bucket

  HIPR Hourly Bucket Statistics

```

=====

====

Bucket	Loc	Low Speed Statistic	BUS A Value	BUS B Value
00	1101	IMT Rx Packet CRC Error	0123456789	0123456789
		IMT Rx Packet Format Error	0123456789	0123456789
		IMT Rx Violation Error	0123456789	0123456789
		IMT Rx Command Error	0123456789	0123456789
		IMT Rx FIFO Full	0123456789	0123456789
		IMT Rx FIFO Half Full	0123456789	0123456789
		IMT Tx FIFO Full	0123456789	0123456789
		IMT Tx FIFO Half Full	0123456789	0123456789

Bucket	Loc	Low Speed Statistic	BUS A Value	BUS B Value
00	1102	IMT Rx Packet CRC Error	0123456789	0123456789
		IMT Rx Packet Format Error	0123456789	0123456789
		IMT Rx Violation Error	0123456789	0123456789
		IMT Rx Command Error	0123456789	0123456789
		IMT Rx FIFO Full	0123456789	0123456789
		IMT Rx FIFO Half Full	0123456789	0123456789
		IMT Tx FIFO Full	0123456789	0123456789
		IMT Tx FIFO Half Full	0123456789	0123456789

	High Speed Statistic	BUS A Value	BUS B Value
	IMT Rx Packet Format Error	0123456789	0123456789
	IMT Rx Disparity Error	0123456789	0123456789
	IMT Rx Sync Lost Error	0123456789	0123456789
	IMT Rx Code Word Error	0123456789	0123456789
	IMT Rx Packet SOM Before EOM	0123456789	0123456789
	IMT Rx Packet CRC Error	0123456789	0123456789
	IMT Bypass FIFO Full	0123456789	0123456789
	IMT Bypass FIFO Half Full	0123456789	0123456789
	IMT Rx FIFO Full	0123456789	0123456789
	IMT Rx FIFO Half Full	0123456789	0123456789
	IMT Tx FIFO Full	0123456789	0123456789
	IMT Tx FIFO Half Full	0123456789	0123456789
	IXP Rx FIFO Full	0123456789	0123456789
	IXP Rx FIFO Half Full	0123456789	0123456789
	Misc Speed Statistic	BUS A Value	BUS B Value
	Shelf ID UART Framing Error	0123456789	0123456789
	Shelf ID UART Overrun Error	0123456789	0123456789

## HIPR CUMULATIVE Statistics

Low Speed Statistic	BUS A Value	BUS B Value
IMT Rx Packet CRC Error	0123456789	0123456789
IMT Rx Packet Format Error	0123456789	0123456789
IMT Rx Violation Error	0123456789	0123456789
IMT Rx Command Error	0123456789	0123456789

```

IMT Rx FIFO Full          0123456789  0123456789
IMT Rx FIFO Half Full    0123456789  0123456789
IMT Tx FIFO Full         0123456789  0123456789
IMT Tx FIFO Half Full    0123456789  0123456789

High Speed Statistic      BUS A Value  BUS B Value
-----
IMT Rx Packet Format Error 0123456789  0123456789
IMT Rx Disparity Error    0123456789  0123456789
IMT Rx Sync Lost Error    0123456789  0123456789
IMT Rx Code Word Error    0123456789  0123456789
IMT Rx Packet SOM Before EOM 0123456789  0123456789
IMT Rx Packet CRC Error   0123456789  0123456789
IMT Bypass FIFO Full      0123456789  0123456789
IMT Bypass FIFO Half Full 0123456789  0123456789
IMT Rx FIFO Full          0123456789  0123456789
IMT Rx FIFO Half Full    0123456789  0123456789
IMT Tx FIFO Full          0123456789  0123456789
IMT Tx FIFO Half Full    0123456789  0123456789
IXP Rx FIFO Full          0123456789  0123456789
IXP Rx FIFO Half Full    0123456789  0123456789

Misc Speed Statistic      BUS A Value  BUS B Value
-----
Shelf ID UART Framing Error 0123456789  0123456789
Shelf ID UART Overrun Error 0123456789  0123456789

```

;

rept-imt-info:report=hipr2err:sbucket=0

tekelecstp 11-16-12 14:01:34 EST EAGLE 44.0.0

HIPR2 Summary Report: Summed across all requested cards for each bucket

HIPR2 Hourly Bucket Statistics

=====

```

Bucket Loc  Low Speed Statistic      BUS A Value
BUS B Value -----
-----
00  ----  IMT Rx Packet CRC Error    0123456789
0123456789
          IMT Rx Packet Format Error    0123456789
0123456789
          IMT Rx Violation Error        0123456789
0123456789
          IMT Rx Command Error          0123456789
0123456789
          IMT Rx FIFO Full              0123456789
0123456789

```

0123456789	IMT Rx FIFO Half Full	0123456789	
0123456789	IMT Tx FIFO Full	0123456789	
0123456789	IMT Tx FIFO Half Full	0123456789	
Value	High Speed Statistic	BUS A Value	BUS B
-----	-----	-----	
0123456789	IMT Rx Disparity Error	0123456789	
0123456789	IMT Rx Code Word Error	0123456789	
0123456789	IMT Rx Packet SOM Before EOM	0123456789	
0123456789	IMT Bypass FIFO Full	0123456789	
0123456789	IMT Bypass FIFO Half Full	0123456789	
0123456789	IMT Rx FIFO Full	0123456789	
0123456789	IMT Rx FIFO Half Full	0123456789	
0123456789	IMT Tx FIFO Full	0123456789	
0123456789	IMT Tx FIFO Half Full	0123456789	
0123456789	IXP Rx FIFO Full	0123456789	
0123456789	IXP Rx FIFO Half Full	0123456789	
0123456789	IMT Rx Byte Per Minute AVG	0123456789	
0123456789	IMT Rx Byte Per Second AVG	0123456789	
0123456789	IMT Tx Byte Per Minute AVG	0123456789	
0123456789	IMT Tx Byte Per Second AVG	0123456789	
0123456789	IMT Rx Packet Per Minute AVG	0123456789	
0123456789	IMT Rx Packet Per Second AVG	0123456789	
0123456789	IMT Tx Packet Per Minute AVG	0123456789	
0123456789	IMT Tx Packet Per Second AVG	0123456789	
0123456789	IMT Rx Errors Per Minute AVG	0123456789	
0123456789	IMT Rx Errors Per Second AVG	0123456789	
0123456789	IMT Tx Errors Per Minute AVG	0123456789	

---

0123456789	IMT Tx Errors Per Second AVG	0123456789
0123456789	IMT Rx Safety Per Minute AVG	0123456789
0123456789	IMT Rx Safety Per Second AVG	0123456789
0123456789	IMT Rx MSU Byte Per Minute AVG	0123456789
0123456789	IMT Rx MSU Byte Per Second AVG	0123456789
0123456789	IMT Rx ASU Byte Per Minute AVG	0123456789
0123456789	IMT Rx ASU Byte Per Second AVG	0123456789
0123456789	IMT Rx DSU Byte Per Minute AVG	0123456789
0123456789	IMT Rx DSU Byte Per Second AVG	0123456789
0123456789	IMT Rx MSU Byte Count	0123456789
0123456789	IMT Rx ASU Byte Count	0123456789
0123456789	IMT Rx DSU Byte Count	0123456789
0123456789	IMT Rx HSU Byte Count	0123456789
0123456789	IMT Rx LSSU Byte Count	0123456789
0123456789	IMT Rx TSU Byte Count	0123456789
0123456789	IMT Rx SSU Byte Count	0123456789
0123456789	IMT Rx BSU Byte Count	0123456789
0123456789	IMT Rx Byte Other	0123456789
0123456789	IMT Rx Total Byte Count	0123456789
0123456789	IMT Rx MSU Packet Count	0123456789
0123456789	IMT Rx ASU Packet Count	0123456789
0123456789	IMT Rx DSU Packet Count	0123456789
0123456789	IMT Rx HSU Packet Count	0123456789
0123456789	IMT Rx LSSU Packet Count	0123456789
0123456789	IMT Rx TSU Packet Count	0123456789
0123456789	IMT Rx SSU Packet Count	0123456789
0123456789	IMT Rx BSU Packet Count	0123456789
0123456789	IMT Rx Packet Other	0123456789

0123456789	IMT Rx Total Packet Count	0123456789	
0123456789	IMT Rx MSU Packet Safety Count	0123456789	
0123456789	IMT Rx ASU Packet Safety Count	0123456789	
0123456789	IMT Rx DSU Packet Safety Count	0123456789	
0123456789	IMT Rx HSU Packet Safety Count	0123456789	
0123456789	IMT Rx LSSU Packet Safety Count	0123456789	
0123456789	IMT Rx TSU Packet Safety Count	0123456789	
0123456789	IMT Rx SSU Packet Safety Count	0123456789	
0123456789	IMT Rx BSU Packet Safety Count	0123456789	
0123456789	IMT Rx Other Packet Safety Count	0123456789	
0123456789	IMT Rx Total Packet Safety Count	0123456789	
0123456789	IMT Rx Packet Violation Error	0123456789	
0123456789	IMT Rx Packet CRC Error	0123456789	
0123456789	IMT Rx Packet Format Error	0123456789	
0123456789	IMT Rx Packet Discard Error	0123456789	
0123456789	IMT Tx Packet Format Error	0123456789	
0123456789	IMT Tx Packet Discard Error	0123456789	
	Misc Speed Statistic	BUS A Value	BUS B
Value	-----	-----	
-----			
0123456789	Shelf ID UART Framing Error	0123456789	
0123456789	Shelf ID UART Overrun Error	0123456789	

HIPR2 CUMULATIVE Statistics

	=====		
	Low Speed Statistic	BUS A Value	BUS B
Value	-----	-----	
-----			
	IMT Rx Packet CRC Error	0123456789	



---

0123456789	IMT Rx Packet Format Error	0123456789
0123456789	IMT Rx Violation Error	0123456789
0123456789	IMT Rx Command Error	0123456789
0123456789	IMT Rx FIFO Full	0123456789
0123456789	IMT Rx FIFO Half Full	0123456789
0123456789	IMT Tx FIFO Full	0123456789
0123456789	IMT Tx FIFO Half Full	0123456789
0123456789	High Speed Statistic	BUS A Value
BUS B Value	-----	-----
-----	-----	-----
0123456789	IMT Rx Disparity Error	0123456789
0123456789	IMT Rx Code Word Error	0123456789
0123456789	IMT Rx Packet SOM Before EOM	0123456789
0123456789	IMT Bypass FIFO Full	0123456789
0123456789	IMT Bypass FIFO Half Full	0123456789
0123456789	IMT Rx FIFO Full	0123456789
0123456789	IMT Rx FIFO Half Full	0123456789
0123456789	IMT Tx FIFO Full	0123456789
0123456789	IMT Tx FIFO Half Full	0123456789
0123456789	IXP Rx FIFO Full	0123456789
0123456789	IXP Rx FIFO Half Full	0123456789
0123456789	IMT Rx Byte Per Minute AVG	0123456789
0123456789	IMT Rx Byte Per Second AVG	0123456789
0123456789	IMT Tx Byte Per Minute AVG	0123456789
0123456789	IMT Tx Byte Per Second AVG	0123456789
0123456789	IMT Rx Packet Per Minute AVG	0123456789
0123456789	IMT Rx Packet Per Second AVG	0123456789
0123456789	IMT Tx Packet Per Minute AVG	0123456789

---

---

0123456789	IMT Tx Packet Per Second AVG	0123456789
0123456789	IMT Rx Errors Per Minute AVG	0123456789
0123456789	IMT Rx Errors Per Second AVG	0123456789
0123456789	IMT Tx Errors Per Minute AVG	0123456789
0123456789	IMT Tx Errors Per Second AVG	0123456789
0123456789	IMT Rx Safety Per Minute AVG	0123456789
0123456789	IMT Rx Safety Per Second AVG	0123456789
0123456789	IMT Rx MSU Byte Per Minute AVG	0123456789
0123456789	IMT Rx MSU Byte Per Second AVG	0123456789
0123456789	IMT Rx ASU Byte Per Minute AVG	0123456789
0123456789	IMT Rx ASU Byte Per Second AVG	0123456789
0123456789	IMT Rx DSU Byte Per Minute AVG	0123456789
0123456789	IMT Rx DSU Byte Per Second AVG	0123456789
0123456789	IMT Rx MSU Byte Count	0123456789
0123456789	IMT Rx ASU Byte Count	0123456789
0123456789	IMT Rx DSU Byte Count	0123456789
0123456789	IMT Rx HSU Byte Count	0123456789
0123456789	IMT Rx LSSU Byte Count	0123456789
0123456789	IMT Rx TSU Byte Count	0123456789
0123456789	IMT Rx SSU Byte Count	0123456789
0123456789	IMT Rx BSU Byte Count	0123456789
0123456789	IMT Rx Byte Other	0123456789
0123456789	IMT Rx Total Byte Count	0123456789
0123456789	IMT Rx MSU Packet Count	0123456789
0123456789	IMT Rx ASU Packet Count	0123456789
0123456789	IMT Rx DSU Packet Count	0123456789
0123456789	IMT Rx HSU Packet Count	0123456789

---

0123456789	IMT Rx LSSU Packet Count	0123456789
0123456789	IMT Rx TSU Packet Count	0123456789
0123456789	IMT Rx SSU Packet Count	0123456789
0123456789	IMT Rx BSU Packet Count	0123456789
0123456789	IMT Rx Packet Other	0123456789
0123456789	IMT Rx Total Packet Count	0123456789
0123456789	IMT Rx MSU Packet Safety Count	0123456789
0123456789	IMT Rx ASU Packet Safety Count	0123456789
0123456789	IMT Rx DSU Packet Safety Count	0123456789
0123456789	IMT Rx HSU Packet Safety Count	0123456789
0123456789	IMT Rx LSSU Packet Safety Count	0123456789
0123456789	IMT Rx TSU Packet Safety Count	0123456789
0123456789	IMT Rx SSU Packet Safety Count	0123456789
0123456789	IMT Rx BSU Packet Safety Count	0123456789
0123456789	IMT Rx Other Packet Safety Count	0123456789
0123456789	IMT Rx Total Packet Safety Count	0123456789
0123456789	IMT Rx Packet Violation Error	0123456789
0123456789	IMT Rx Packet CRC Error	0123456789
0123456789	IMT Rx Packet Format Error	0123456789
0123456789	IMT Rx Packet Discard Error	0123456789
0123456789	IMT Tx Packet Format Error	0123456789
0123456789	IMT Tx Packet Discard Error	0123456789
BUS B Value	Misc Speed Statistic	BUS A Value
-----	-----	-----
0123456789	Shelf ID UART Framing Error	0123456789
0123456789	Shelf ID UART Overrun Error	0123456789

;

This example shows the output when IMT Bus A is inhibited:

```
rept-imt-info:report=hiprerr:sbucket=0
```

```
rlghncxa03w 10-01-27 00:10:20 PST EAGLE 42.0.0
```

```
  HIPR Summary Report: Summed across all requested cards for each bucket
```

```
  HIPR Hourly Bucket Statistics
```

```
=====
```

Bucket Loc	Low Speed Statistic	BUS A Value	BUS B Value
-----	-----	-----	-----
00	IMT Rx Packet CRC Error	-	0
	IMT Rx Packet Format Error	-	0
	IMT Rx Violation Error	-	101
	IMT Rx Command Error	-	0
	IMT Rx FIFO Full	-	0
	IMT Rx FIFO Half Full	-	0
	IMT Tx FIFO Full	-	0
	IMT Tx FIFO Half Full	-	0
	High Speed Statistic	BUS A Value	BUS B Value
	-----	-----	-----
	IMT Rx Packet Format Error	-	0
	IMT Rx Disparity Error	-	0
	IMT Rx Sync Lost Error	-	0
	IMT Rx Code Word Error	-	0
	IMT Rx Packet SOM Before EOM	-	0
	IMT Rx Packet CRC Error	-	0
	IMT Bypass FIFO Full	-	0
	IMT Bypass FIFO Half Full	-	0
	IMT Rx FIFO Full	-	0
	IMT Rx FIFO Half Full	-	0
	IMT Tx FIFO Full	-	0
	IMT Tx FIFO Half Full	-	0
	IXP Rx FIFO Full	-	0
	IXP Rx FIFO Half Full	-	0
	Misc Speed Statistic	BUS A Value	BUS B Value
	-----	-----	-----
	Shelf ID UART Framing Error	-	0
	Shelf ID UART Overrun Error	-	0

```
  HIPR CUMULATIVE Statistics
```

```
=====
```

Low Speed Statistic	BUS A Value	BUS B Value
-----	-----	-----
IMT Rx Packet CRC Error	-	0
IMT Rx Packet Format Error	-	0
IMT Rx Violation Error	-	1165
IMT Rx Command Error	-	0
IMT Rx FIFO Full	-	0
IMT Rx FIFO Half Full	-	0

```

IMT Tx FIFO Full           -           0
IMT Tx FIFO Half Full     -           1

High Speed Statistic      BUS A Value  BUS B Value
-----
IMT Rx Packet Format Error -           0
IMT Rx Disparity Error    -           0
IMT Rx Sync Lost Error    -           0
IMT Rx Code Word Error    -           0
IMT Rx Packet SOM Before EOM -          0
IMT Rx Packet CRC Error   -           0
IMT Bypass FIFO Full      -           1
IMT Bypass FIFO Half Full -           1
IMT Rx FIFO Full          -           0
IMT Rx FIFO Half Full     -           0
IMT Tx FIFO Full          -           0
IMT Tx FIFO Half Full     -           0
IXP Rx FIFO Full          -           0
IXP Rx FIFO Half Full     -           0

Misc Speed Statistic      BUS A Value  BUS B Value
-----
Shelf ID UART Framing Error -          35
Shelf ID UART Overrun Error -           0

```

;

This example shows the output when at least one card on the IMT Bus does not respond when statistics are collected:

```
rept-imt-info:report=hiprerr:sbucket=0
```

```
rlghncxa03w 10-01-27 00:10:20 PST EAGLE 42.0.0
```

```
  HIPR Summary Report: Summed across all requested cards for each
bucket
```

HIPR Hourly Bucket Statistics

```

=====
====
Bucket Loc  Low Speed Statistic      BUS A Value  BUS B Value
-----
00      ----  IMT Rx Packet CRC Error          0           0
          IMT Rx Packet Format Error      0           0
          IMT Rx Violation Error        128          0
          IMT Rx Command Error          0           0
          IMT Rx FIFO Full              0           0
          IMT Rx FIFO Half Full         0           0
          IMT Tx FIFO Full              36           0
          IMT Tx FIFO Half Full         182          0

High Speed Statistic      BUS A Value  BUS B Value
-----
IMT Rx Packet Format Error  0           0
IMT Rx Disparity Error     0           0

```

IMT Rx Sync Lost Error	0	0
IMT Rx Code Word Error	0	0
IMT Rx Packet SOM Before EOM	0	0
IMT Rx Packet CRC Error	0	0
IMT Bypass FIFO Full	0	0
IMT Bypass FIFO Half Full	0	0
IMT Rx FIFO Full	0	0
IMT Rx FIFO Half Full	0	0
IMT Tx FIFO Full	0	0
IMT Tx FIFO Half Full	0	0
IXP Rx FIFO Full	0	0
IXP Rx FIFO Half Full	0	0
Misc Speed Statistic	BUS A Value	BUS B Value
-----	-----	-----
Shelf ID UART Framing Error	2	0
Shelf ID UART Overrun Error	0	0

## HIPR CUMULATIVE Statistics

```
=====
```

Low Speed Statistic	BUS A Value	BUS B Value
-----	-----	-----
IMT Rx Packet CRC Error	0	0*
IMT Rx Packet Format Error	0	0*
IMT Rx Violation Error	1415	0*
IMT Rx Command Error	0	0*
IMT Rx FIFO Full	0	0*
IMT Rx FIFO Half Full	0	0*
IMT Tx FIFO Full	120	0*
IMT Tx FIFO Half Full	1113	0*
High Speed Statistic	BUS A Value	BUS B Value
-----	-----	-----
IMT Rx Packet Format Error	0	0*
IMT Rx Disparity Error	0	0*
IMT Rx Sync Lost Error	15	0*
IMT Rx Code Word Error	0	0*
IMT Rx Packet SOM Before EOM	0	0*
IMT Rx Packet CRC Error	0	0*
IMT Bypass FIFO Full	1	0*
IMT Bypass FIFO Half Full	1	0*
IMT Rx FIFO Full	0	0*
IMT Rx FIFO Half Full	0	0*
IMT Tx FIFO Full	0	0*
IMT Tx FIFO Half Full	0	0*
IXP Rx FIFO Full	0	0*
IXP Rx FIFO Half Full	0	0*
Misc Speed Statistic	BUS A Value	BUS B Value
-----	-----	-----
Shelf ID UART Framing Error	59	0*
Shelf ID UART Overrun Error	0	0*

;

## Legend

### IMT Statistics:

- **Bucket**—The hourly time periods (*buckets*) for which a report was requested.
- **Statistic**—The error statistic type for the IMT buses A and B.
- **Bus A Value**—The number of occurrences of the type of error displayed in the Statistic column for the IMT bus A.
- **Bus B Value**—The number of occurrences of the type of error displayed in the Statistic column for the IMT bus B.
- **Low Speed Statistic**—The error statistic type for the low speed 125 Mbps secondary rings with MUX cards installed on buses A (xy09 card locations) and B (xy10 card locations).
- **High Speed Statistic**—The error statistic type for the high-speed 1 Gbps primary ring with MUX cards installed on buses A (xy09 card locations) and B (xy10 card locations).
- **Misc Speed Statistics**—Shelf ID Universal Asynchronous Receiver Transmitter (UART) error counts on the MUX cards installed on buses A (xy09 card locations) and B (xy10 card locations).
- **Bucket Summary**—The error count for each parameter for one hour for HMUX cards installed on buses A (xy09 card locations) and B (xy10 card locations). (The count is for the most recent part of an hour if the card was booted within an hour of executing the `rept-imt-info` command.)
- **Cumulative**—The running total error count for each parameter since card initialization for HMUX cards installed on buses A (xy09 card locations) and B (xy10 card locations).

### MUX Statistics:

- **Bucket**—The hourly time periods (*buckets*) for which a report was requested.
- **Loc**—The card location (shelf and slot) for which information is displayed.
- **Low Speed Statistic**—The error statistic type for the low speed 125 Mbps secondary rings with MUX cards installed on buses A (xy09 card locations) and B (xy10 card locations).
- **High Speed Statistic**—The error statistic type for the high-speed 1 Gbps primary ring with MUX cards installed on buses A (xy09 card locations) and B (xy10 card locations).
- **Misc Speed Statistic**—The miscellaneous error statistic type.
- **Bus A**—The number of occurrences of the type of error displayed in the Statistic column for the IMT bus A.
- **Bus B**—The number of occurrences of the type of error displayed in the Statistic column for the IMT bus B.

### Related Topics

- [clr-imt-stats](#)
- [init-imt-gpl](#)
- [rept-imt-lvl1](#)

- [rept-imt-lvl2](#)
- [tst-imt](#)

## rept-imt-lvl1

Use this command to display IMT level 1 statistics for a card or a range of cards. A summary report of totals for all cards is also generated.

### Parameters

#### **e (optional)**

End address. The IMT address of the last card in the range. A decimal value or a hexadecimal value can be specified for this parameter (see [Table 4-46](#) to map the values by card location).

#### **Range:**

*0 - 251*

The value can be specified in decimal (*0-251*) or hexadecimal (*h'00 – h'fe*)

#### **Default:**

If the *s* parameter is specified, the default value is the *s* parameter value.

If the *s* parameter is not specified, the *e* parameter cannot be specified and the *sloc* parameter must be specified.

#### **e1oc (optional)**

End location. The card location of the last card in the range.

#### **Range:**

*1101 - 1108, 1111 - 1113, 1115, 1201 - 1208, 1211 - 1218, 1301 - 1308, 1311 - 1318, 2101 - 2108, 2111 - 2118, 2201 - 2208, 2211 - 2218, 2301 - 2308, 2311 - 2318, 3101 - 3108, 3111 - 3118, 3201 - 3208, 3211 - 3218, 3301 - 3308, 3311 - 3318, 4101 - 4108, 4111 - 4118, 4201 - 4208, 4211 - 4218, 4301 - 4308, 4311 - 4318, 5101 - 5108, 5111 - 5118, 5201 - 5208, 5211 - 5218, 5301 - 5308, 5311 - 5318, 6101 - 6108, 6111 - 6118*

#### **Default:**

If *sloc* is specified—current *sloc* value; displays information for one card

If *sloc* is not specified— *1115*, which corresponds to IMT address 251 (*e=251*); displays information for entire range of locations.

#### **eshelf (optional)**

End Shelf location. The shelf location of the last shelf in the range.

#### **Range:**

*1100, 1200, 1300, 2100, 2200, 2300, 3100, 3200, 3300, 4100, 4200, 4300, 5100, 5200, 5300, 6100*

#### **Default:**

if the *sshelf* parameter is specified—current *sshelf* value

if the *sshelf* parameter is not specified— *6100*, which displays information for entire range of shelves

#### **filter (optional)**

The filter that determines the information that is displayed in the report.



**Range:**

***error***

display all error counts

***perf***

display performance counts

***erroronly***

display non-zero error counts

***full***

display zero and non-zero error counts and performance counts

**Default:**

*full*

**hs (optional)**

This parameter specifies whether to include High Speed interface counts in the report.

**Range:**

***no***

do not include High Speed interface counts

***yes***

include High Speed interface counts

**Default:**

*no*

**r (optional)**

Report type value

**Range:**

***full***

Displays information for each card along with a summary report.

***stats***

Displays only individual card statistics.

***summary***

Displays the summary portion of the report.

**Default:**

*full*

**s (optional)**

Start address. The IMT address of the first (or only) card in the range. A decimal value or a hexadecimal value can be specified for this parameter (see [Table 4-46](#) to map the values by card location).

**Range:**

*0 - 251*

The value can be specified in decimal (0-251) or hexadecimal (h'00 – h'fb)

**sloc (optional)**

Start location. The card location of the first card in the range.

**Range:**

1101 - 1108, 1111 - 1113, 1115, 1201 - 1208, 1211 - 1218, 1301 - 1308, 1311 - 1318, 2101 - 2108, 2111 - 2118, 2201 - 2208, 2211 - 2218, 2301 - 2308, 2311 - 2318, 3101 - 3108, 3111 - 3118, 3201 - 3208, 3211 - 3218, 3301 - 3308, 3311 - 3318, 4101 - 4108, 4111 - 4118, 4201 - 4208, 4211 - 4218, 4301 - 4308, 4311 - 4318, 5101 - 5108, 5111 - 5118, 5201 - 5208, 5211 - 5218, 5301 - 5308, 5311 - 5318, 6101 - 6108, 6111 - 6118

**Default:**

If `eloc` is specified—current `eloc` value

If `eloc` is not specified—1201, which corresponds to IMT address 0 (`s=0`).

**sshelf (optional)**

Start Shelf location. The shelf location of the first shelf in the range.

 **Note:**

This parameter specified alone is the equivalent to specifying the IMT address range. For example, “sshelf=1200” is equivalent to specifying the IMT address range as “s=h'00:e=h'0f”.

**Range:**

1100, 1200, 1300, 2100, 2200, 2300, 3100, 3200, 3300, 4100, 4200, 4300, 5100, 5200, 5300, 6100

**Default:**

if the `eshelf` parameter is specified—the current `eshelf` value

if the `eshelf` parameter is not specified—1100, which displays information for the entire range of shelves

**trm (optional)**

This parameter specifies the terminal port where the report is sent.

**Range:**

1 - 40

**Default:**

Report displays on the terminal where the command was issued

**Example**

This example requests low speed interface counts.

```
rept-imt-lvl1:s=h'00:e=h'00
```

This example requests a summary report of low speed interface counts.

```
rept-imt-lvl1:s=h'00:e=h'00:r=summary
```

This example requests low speed interface counts.

```
rept-imt-lvl1:sshelf=1200
```

This example requests low speed interface counts for individual cards.

```
rept-imt-lvl1:sshelf=1200:r=stats
```

This example requests low speed and high speed interface counts.

```
rept-imt-lvl1:ssshelf=1200:hs=yes
```

This example requests low speed and high speed interface counts.

```
rept-imt-lvl1:s=h'00:e=h'00:hs=yes
```

This example requests an error report for non-zero error counts.

```
rept-imt-lvl1:s=h'00:e=h'00:filter=error-only
```

This example requests an error report for zero and non-zero error counts.

```
rept-imt-lvl1:s=h'00:e=h'00:filter=error
```

## Dependencies

Only one report status command can be in progress at a time.

The `s`, `sloc`, or `ssshelf` parameter must be specified in the command.

This command cannot be entered during IMT statistics collection following an hourly boundary.

The command cannot be entered if the `clr-imt-stats`, `rept-imt-info`, `rept-imt-lvl2`, or `tst-imt` command is running.

Only one of the `sloc/eloc`, `s/e`, and `ssshelf/eshelf` parameter combinations can be specified in the command.

A card location that is valid and defined in the database must be specified.

This command cannot be entered during an Extended Bit Error Rate Test (BERT).

## Notes

[Table 4-46](#) maps each card location to the decimal and hexadecimal [Converting ITU National Point Code Formats](#) values that can be specified for the `s` and `e` parameters.

**Table 4-46 Hexadecimal/Decimal Values for `s` and `e` Parameters**

Card Location	Hexadecimal Value	Decimal Value	Card location	Hexadecimal Value	Decimal Value
Control Shelf 11					
1101	h'f0	240	1102	h'f1	241
1103	h'f2	242	1104	h'f3	243
1105	h'f4	244	1106	h'f5	245
1107	h'f6	246	1108	h'f7	247
1111	h'f8	248	1112	h'f9	249
1113	h'fa	250	1115	h'fb	251
Extension Shelf 12					
1201	h'00	0	1202	h'01	1
1203	h'02	2	1204	h'03	3
1205	h'03	4	1206	h'05	5
1207	h'06	6	1208	h'07	7
1211	h'08	8	1212	h'09	9
1213	h'0a	10	1214	h'0b	11
1215	h'0c	12	1216	h'0d	13

Table 4-46 (Cont.) Hexadecimal/Decimal Values for s and e Parameters

Card Location	Hexadecimal Value	Decimal Value	Card location	Hexadecimal Value	Decimal Value
1217	h'0e	14	1218	h'0f	15
Extension Shelf 13					
1301	h'10	16	1302	h'11	17
1303	h'12	18	1304	h'13	19
1305	h'14	20	1306	h'15	21
1307	h'16	22	1308	h'17	23
1311	h'18	24	1312	h'19	25
1313	h'1a	26	1314	h'1b	27
1315	h'1c	28	1316	h'1d	29
1317	h'1e	30	1318	h'1f	31
Extension Shelf 21					
2101	h'20	32	2102	h'21	33
2103	h'22	34	2104	h'23	35
2105	h'24	36	2106	h'25	37
2107	h'26	38	2108	h'27	39
2111	h'28	40	2112	h'29	41
2113	h'2a	42	2114	h'2b	43
2115	h'2c	44	2116	h'2d	45
2117	h'2e	46	2118	h'2f	47
Extension Shelf 22					
2201	h'30	48	2202	h'31	49
2203	h'32	50	2204	h'33	51
2205	h'34	52	2206	h'35	53
2207	h'36	54	2208	h'37	55
2211	h'38	56	2212	h'39	57
2213	h'3a	58	2214	h'3b	59
2215	h'3c	60	2216	h'3d	61
2217	h'3e	62	2218	h'3f	63
Extension Shelf 23					
2301	h'40	64	2302	h'41	65
2303	h'42	66	2304	h'43	67
2305	h'44	68	2306	h'45	69
2307	h'46	70	2308	h'47	71
2311	h'48	72	2312	h'49	73
2313	h'4a	74	2314	h'4b	75
2315	h'4c	76	2316	h'4d	77
2317	h'4e	78	2318	h'4f	79
Extension Shelf 31					
3101	h'50	80	3102	h'51	81
3103	h'52	82	3104	h'53	83
3105	h'54	84	3106	h'55	85
3107	h'56	86	3108	h'57	87
3111	h'58	88	3112	h'59	89

**Table 4-46 (Cont.) Hexadecimal/Decimal Values for s and e Parameters**

Card Location	Hexadecimal Value	Decimal Value	Card location	Hexadecimal Value	Decimal Value
3113	h'5a	90	3114	h'5b	91
3115	h'5c	92	3116	h'5d	93
3117	h'5e	94	3118	h'5f	95
Extension Shelf 32					
3201	h'60	96	3202	h'61	97
3203	h'62	98	3204	h'63	99
3205	h'64	100	3206	h'65	101
3207	h'66	102	3208	h'67	103
3211	h'68	104	3212	h'69	105
3213	h'6a	106	3214	h'6b	107
3215	h'6c	108	3216	h'6d	109
3217	h'6e	110	3218	h'6f	111
Extension Shelf 33					
3301	h'70	112	3303	h'71	113
3303	h'72	114	3304	h'73	115
3305	h'74	116	3306	h'75	117
3307	h'76	118	3308	h'77	119
3311	h'78	120	3312	h'79	121
3313	h'7a	122	3314	h'7b	123
3315	h'7c	124	3316	h'7d	125
3317	h'7e	126	3318	h'7f	127
Extension Shelf 41					
4101	h'80	128	4102	h'81	129
4103	h'82	130	4104	h'83	131
4105	h'84	132	4106	h'85	133
4107	h'86	134	4108	h'87	135
4111	h'88	136	4112	h'89	137
4113	h'8a	138	4114	h'8b	139
4115	h'8c	140	4116	h'8d	141
4117	h'8e	142	4118	h'8f	143
Extension Shelf 42					
4201	h'90	144	4202	h'91	145
4203	h'92	146	4204	h'93	147
4205	h'94	148	4206	h'95	149
4207	h'96	150	4208	h'97	151
4211	h'98	152	4212	h'99	153
4213	h'9a	154	4214	h'9b	155
4215	h'9c	156	4216	h'9d	157
4217	h'9e	158	4218	h'9f	159
Extension Shelf 43					
4301	h'a0	160	4302	h'a1	161
4303	h'a2	162	4302	h'a3	163
4305	h'a4	164	4306	h'a5	165

**Table 4-46 (Cont.) Hexadecimal/Decimal Values for s and e Parameters**

Card Location	Hexadecimal Value	Decimal Value	Card location	Hexadecimal Value	Decimal Value
4307	h'a6	166	4308	h'a7	167
4311	h'a8	168	4312	h'a9	169
4313	h'aa	170	4314	h'ab	171
4315	h'ac	172	4316	h'ad	173
4317	h'ae	174	4318	h'af	175
Extension Shelf 51					
5101	h'b0	176	5102	h'b1	177
5103	h'b2	178	5104	h'b3	179
5105	h'b4	180	5106	h'b5	181
5107	h'b6	182	5108	h'b7	183
5111	h'b8	184	5112	h'b9	185
5113	h'ba	186	5114	h'bb	187
5115	h'bc	188	5116	h'bd	189
5117	h'be	190	5118	h'bf	191
Extension Shelf 52					
5201	h'c0	192	5202	h'c1	193
5204	h'c2	194	5204	h'c3	195
5205	h'c4	196	5206	h'c5	197
5307	h'c6	198	5208	h'c7	199
5211	h'c8	200	5212	h'c9	201
5213	h'ca	202	5214	h'cb	203
5215	h'cc	204	5216	h'cd	205
5217	h'ce	206	5218	h'cf	207
Extension Shelf 53					
5301	h'd0	208	5302	h'd1	209
5303	h'd2	210	5304	h'd3	211
5305	h'd4	212	5306	h'd5	213
5307	h'd6	214	5308	h'd7	215
5311	h'd8	216	5312	h'd9	217
5313	h'da	218	5314	h'db	219
5315	h'dc	220	5316	h'dd	221
5317	h'de	222	5318	h'df	223
Extension Shelf 61					
6101	h'e0	224	6102	h'e1	225
6103	h'e2	226	6104	h'e3	227
6105	h'e4	228	6106	h'e5	229
6107	h'e6	230	6108	h'e7	231
6111	h'e8	232	6112	h'e9	233
6113	h'ea	234	6114	h'eb	235
6115	h'ec	236	6116	h'ed	237
6117	h'ee	238	6118	h'ef	239

**Low speed ring counts and performance counts**

If an HMUX card is not present in the shelf, then HMUX low speed ring counts are not displayed. If HIPR or HIPR2 cards are not present in the shelf, then performance counts are not displayed.

Table 4-47 describes the statistics that are shown in the report for each card and in the Summary of totals for all requested cards, and their possible causes and corrective actions.

These statistics are displayed when the `rept-imt-lvl1:sloc=xxxx:eloc=yyyy:r=full` command is entered.

**Table 4-47 Level 1 IMT Statistics**

IMT Statistic	Explanation Of Statistic	Probable Causes	Recommended Action
Rx CRC Error	Receive CRC error: Bad Checksum in received IMT packet. Caused by corrupted data within the received packet. Detected by hardware.	Maintenance activity: Card insertion, removal, or boot. Does not occur in a normal system. Indicates a hardware failure: defective LIM card, MUX card, FC cable or backplane.	Clear IMT stats, wait 1 hour and retrieve stats again. If stats are clear, there is no action to perform. If errors continue, a hardware issue is present. Contact Customer Care Center.
Rx Format Error	Receive Format Error: Occurs when the End of Message byte of an IMT packet is found missing. Detected by hardware.	Service/Maintenance activity: Card insertion, removal, or boot. Does not occur in a normal system. Indicates a hardware failure: defective LIM card, MUX card, FC cable or backplane.	Clear IMT stats, wait 1 hour and retrieve stats again. If stats are clear, there is no action to perform. If errors continue, a hardware issue is present. Contact Customer Care Center.
Rx Inv Len	Receive Packet with Invalid Length: Card received an IMT packet where the actual length of the packet did not match the length indicated in the length field. Detected by software	Software defect. Does not occur in a normal system.	Contact Customer Care Center.
Rx FIFO Half Full	Receive FIFO Half Full: Watermark indication that this interface receiving data off the TAXI line has received substantial traffic.	Relatively heavy traffic on this interface can cause these counts to increment.	None. FIFO Half Full is an indication; no action required.

Table 4-47 (Cont.) Level 1 IMT Statistics

IMT Statistic	Explanation Of Statistic	Probable Causes	Recommended Action
Rx FIFO Full	Receive FIFO Full: Watermark indication that this interface receiving data off the TAXI line is receiving traffic in excess of what it can handle. Some traffic will have been discarded. May cause retransmissions, CRC errors and Format errors. Detected by hardware	Relatively heavy traffic on this interface can cause these counts to increment. Seeing these counts in the field may indicate a software problem.	Clear IMT stats, wait 1 hour and retrieve stats again. If stats are clear, there is no action to perform. If errors continue, a problem may exist. Contact the Customer Care Center.
CPU Rx FIFO Half Full	CPU Receive FIFO Half Full: Communication CPU on the card is becoming congested. Detected by hardware.  This stat is only meaningful for cards that contain a BPxxxx GPL.	Relatively heavy traffic on this interface can cause these counts to increment. May indicate a SW problem.	None: FIFO Half Full is an indication; no action required.
CPU Rx FIFO Full	CPU Receive FIFO Full: Communication CPU on the card is becoming congested. Data has been dropped. May cause retransmissions, format and large packet errors. Detected by hardware.  This stat is only meaningful for cards that contain a BPxxxx GPL.	Relatively heavy traffic on this interface can cause these counts to increment. May indicate a SW problem.	Clear IMT stats, wait 1 hour and retrieve stats again. If stats are clear, there is no action to perform. If errors continue, a hardware issue is present. Contact Customer Care Center.



Table 4-47 (Cont.) Level 1 IMT Statistics

IMT Statistic	Explanation Of Statistic	Probable Causes	Recommended Action
CPU Rx MSU FIFO Full	<p>CPU Receive MSU FIFO Full: Watermark indication that the MSU traffic is in excess of what the card can handle. Traffic will have been discarded. Expect retransmissions and possibly other errors.</p> <p>This stat is only meaningful for cards that contain the IMTPCI GPL; the FIFO stores data determined to be a MSU with no CRC error.</p>	Relatively heavy traffic on this interface can cause these counts to increment. May indicate a SW problem.	Clear IMT stats, wait 1 hour and retrieve stats again. If stats are clear, there is no action to perform. If errors continue, a hardware issue is present. Contact Customer Care Center.
CPU Rx LSSU FIFO Full	<p>CPU Receive LSSU FIFO Full: Watermark indication that the LSSU traffic is in excess of what the card can handle.</p> <p>This stat is only meaningful for cards that contain the IMTPCI GPL; the FIFO stores data determined to be a LSSU with no CRC error.</p>	May indicate a hardware failure (i.e.: a defective board), although a software issue is also possible.	Clear IMT stats, wait 1 hour and retrieve stats again. If stats are clear, there is no action to perform. If errors continue, a hardware issue exists. Contact Customer Care Center.
CPU Rx XSU FIFO Full	<p>CPU Receive XSU FIFO Full: Watermark indication that the XSU traffic is in excess of what the card can handle.</p> <p>This stat is only meaningful for cards that contain the IMTPCI GPL; the FIFO stores data determined not to be a MSU, LSSU or ASU, and no CRC error. Data internal to this card has been lost.</p>	Relatively heavy traffic on this interface can cause these counts to increment.	Clear IMT stats, wait 1 hour and retrieve stats again. If stats are clear, there is no action to perform. If errors continue, a hardware issue exists. Contact Customer Care Center.

Table 4-47 (Cont.) Level 1 IMT Statistics

IMT Statistic	Explanation Of Statistic	Probable Causes	Recommended Action
ASU Rx FIFO Half Full	<p>CPU Receive ASU FIFO Half Full: Watermark indication that this interface has received substantial ASU traffic.</p> <p>This stat is only meaningful for cards that contain a BPxxxx GPL; the FIFO stores data determined to be an ASU with no CRC error.</p>	Relatively heavy traffic on this interface can cause these counts to increment.	None. FIFO Half Full is an indication. No action required.
ASU Rx FIFO Full	<p>CPU Receive ASU FIFO Full: Watermark indication that the ASU traffic is in excess of what the card can handle. ASUs will have been lost resulting in retransmission and other possible LVL1 errors.</p> <p>This stat is only meaningful for cards that contain a BPxxxx or IMTPCI GPL; the FIFO stores data determined to be an ASU with no CRC error.</p>	Relatively heavy traffic on this interface can cause these counts to increment. Seeing these counts in the field may indicate a software problem.	Clear IMT stats, wait 1 hour and retrieve stats again. If stats are clear, there is no action to perform. If errors continue, a hardware issue exists. Contact Customer Care Center.
SSU Packet Rx	Safety Packets Received: This message type detects the loss of a card in the system if virtual connections between cards are lost.	Card insertion, removal, or boot, heavy traffic, abnormal conditions and/or software/hardware problems can result in these packets being generated.	None. These counts are an indication. No action required.
ASU Safety Pkt	ASU Safety Packets: ASU Unit has timed out on the IMT.	Card insertion, removal, or boot	None. These counts are only an indication. No action required.
TSU Safety Pkt	TSU Safety Packets: TSU Unit has timed out on the IMT	Card insertion, removal, or boot	None. These counts are only an indication. No action required.
BSU Safety Pkt	BSU Safety Packets: BSU Unit has timed out on the IMT.	Card insertion, removal, or boot	None. These counts are only an indication. No action required.
SSU Safety Pkt	SSU Safety Packets: SSU Unit has timed out on the IMT	Card insertion, removal, or boot	None. These counts are only an indication. No action required.

Table 4-47 (Cont.) Level 1 IMT Statistics

IMT Statistic	Explanation Of Statistic	Probable Causes	Recommended Action
Other Safety Pkt	Other Safety Packets Received: Possible message types are MSU, DSU, ISU, and/or HSU.	Card insertion, removal, or boot	None. These counts are only an indication. No action required.
Pri Ctrl Rx Error	Primary control receive error: Corrupted packet received. Detected by hardware	Card insertion, removal, or boot	Clear IMT stats, wait 1 hour and retrieve stats again. If stats are clear, there is no action to perform. If errors continue, a problem may exist. Contact Customer Care Center.
Pri Ctrl Sanity Err	Primary Control Sanity Error: Internal hardware monitoring self check failed. Detected by hardware	Indicates that the hardware receive logic was unable to successfully process the incoming packet. May indicate a hardware problem.	Clear IMT stats, wait 1 hour and retrieve stats again. If stats are clear, there is no action to perform. If errors continue, a problem may exist. Contact Customer Care Center.
RX HW flow control event	Indicates the number of times the HW RX FIFO's backed up to a point to request the other end to HOLD until room is made available in the RX FIFO.  Counts in the MUX column indicate the receiver was backed up on the MUX.  Counts in the COM side indicate the LIM receiver was backed up.	Does not indicate a problem just an indication of low level congestion. Should excessive counts be seen it could indicate a problem.	None. RX HW flow control event is an indication. No action is required.
Pri Ctrl No SOM	Primary Control No Start of Message Error: Incoming data was detected without a start of message (SOM.)  This stat is only meaningful for cards that contain a BPxxxx GPL.	Card insertion, removal, or boot.	Clear IMT stats, wait 1 hour and retrieve stats again. If stats are clear there is no action to perform. If errors continue, a problem may exist. Contact Customer Care Center.

Table 4-47 (Cont.) Level 1 IMT Statistics

IMT Statistic	Explanation Of Statistic	Probable Causes	Recommended Action
Pri Ctrl Tx Err	<p>Primary Control Transmit Error: Transmit logic encountered a problem sending a packet. Detected by hardware.</p> <p>This stat is only meaningful for application cards.</p>	Card insertion, removal, or boot.	Clear IMT stats, wait 1 hour and retrieve stats again. If stats are clear, there is no action to perform. If errors continue, a problem may exist. Contact Customer Care Center.
Tx FIFO Half Full	<p>Transmit FIFO Half Full: Watermark indication that this interface is backed up through ½ of its available storage.</p> <p>This stat is only meaningful for MUX card columns.</p>	Indicates that data was transmitted at a relatively high rate for a short period.	None. FIFO Half Full is an indication. No action is required.
Tx FIFO Full	<p>Transmit FIFO Full: The FIFO has overflowed and data has been lost.</p> <p>This stat is only meaningful for MUX card columns.</p>	Relatively heavy traffic on this interface can cause these counts to increment. May indicate a software problem	Clear IMT stats, wait 1 hour and retrieve stats again. If stats are clear, there is no action to perform. If errors continue, a problem may exist. Contact Customer Care Center.
Future Field	Reserved	Reserved	Reserved
Future Field	Reserved	Reserved	Reserved
IMT Tx FIFO Half Full	<p>Transmit FIFO Half Full: Watermark indication that this interface is backed up through ½ of its available storage.</p> <p>This stat is only meaningful for MUX card columns.</p>	Indicates that data was transmitted at a relatively high rate for a short period.	None. FIFO Half Full is just an indication; no action is required.
IMT Tx FIFO Full	<p>Transmit FIFO Full: The FIFO has overflowed and data has been lost.</p> <p>This stat is only meaningful for MUX card columns.</p>	May indicate a software problem.	Clear IMT stats, wait 1 hour and retrieve stats again. If stats are clear, there is no action to perform. If errors continue, a problem may exist. Contact Customer Care Center.
Tx FIFO 3/4 Full	Reserved	Reserved	Reserved

Table 4-47 (Cont.) Level 1 IMT Statistics

IMT Statistic	Explanation Of Statistic	Probable Causes	Recommended Action
IMT By-pass FIFO Half Full	Watermark indication that this interface has backed to fill half on the FIFO.  This stat is only meaningful for cards that contain a BLMCAP GPL.	May indicate that data was transmitted at a relatively high rate for a short period.	None. FIFO Half Full is an indication. No action is required.
IMT By-pass FIFO Full	By-pass FIFO overflowed data has been lost.  This stat is only meaningful for cards that contain a BLMCAP GPL.	Very little if any data flows through this FIFO. May indicate a hardware problem	Clear IMT stats, wait 1 hour and retrieve stats again. If stats are clear, there is no action to perform. If errors continue, a problem may exist. Contact Customer Care Center. The card may need to be replaced.
Pass thru CRC Error Lost Multicast Pkt	Reserved  Lost Multicast Packets: This counter increments when the interface detects that one of these packets has not been delivered to a card in the list.  This stat is only meaningful for application card columns.	Reserved  Card insertion, removal, or boot. These events may indicate a software problem.	Reserved  Clear IMT stats, wait 1 hour and retrieve stats again. If stats are clear, there is no action to perform. If errors continue, a problem may exist. Contact Customer Care Center.
Invalid Interrupt	The interface generated a spurious interrupt.  This stat is only meaningful for cards that contain an IMTPCI GPL.	May indicate a software or hardware defect.	Clear IMT stats, wait 1 hour and retrieve stats again. If stats are clear, there is no action to perform. If errors continue, a problem may exist. Contact Customer Care Center. The card may need to be replaced.
Error Int Overflow	Deprecated	Deprecated	Deprecated

Table 4-47 (Cont.) Level 1 IMT Statistics

IMT Statistic	Explanation Of Statistic	Probable Causes	Recommended Action
Large Pkt Error	<p>Large Packet Error: The interface has detected packets larger than allowed in the data stream.</p> <p>This stat is meaningful for all cards except those containing the IMTPCI GPL.</p>	Card insertion, removal, boot, or a hardware error. May indicate a hardware problem.	Clear IMT stats, wait 1 hour and retrieve stats again. If stats are clear, there is no action to perform. If errors continue, a problem may exist. Contact Customer Care Center.
MSU Retran / MUX LVL1 Cong	<p>COM - Retransmissions occur when a transmitted MSU does not receive an acknowledgment (ASU) within an engineered timeout value. Detected by software.</p> <p>This stat is only meaningful for application cards.</p> <p>MUX - Count of occurrences that the MUX has reached level 1 congestion on the transmit path to the LIM (works in conjunction with MFC)</p>	<p>COM - Card insertion, removal, or boot. May indicate hardware, software or configuration problems.</p> <p>MUX - Nothing specific to do except for monitor for excessive counts</p>	<p>COM - Clear IMT stats, wait 1 hour and retrieve stats again. If stats are clear, there is no action to perform. If errors continue, a problem may exist. Contact Customer Care Center.</p> <p>MUX - Clear IMT stats, wait 1 hour and retrieve stats again. If stats are clear, there is no action to perform. If errors continue, a problem may exist. Contact Customer Care Center.</p>

Table 4-47 (Cont.) Level 1 IMT Statistics

IMT Statistic	Explanation Of Statistic	Probable Causes	Recommended Action
MSU ROE / MUX LVL2 Cong	<p>COM - MSU Returned On Error: Number of MSUs returned to the application as undeliverable. Each application is responsible for indicating their need for MSUs to be returned if undeliverable. This count is for messages that the application has deemed important and requested that they be returned if undeliverable. Detected by software.</p> <p>MUX - Count of occurrences that the MUX has reached level 2 congestion on the transmit path to the LIM (works in conjunction with MFC)</p>	<p>COM - Destination card is not available to receive packets.</p> <p>MUX - Nothing specific to do except monitor for excessive counts</p>	<p>COM - None. MSU Returned on Error is an indication. No action is required.</p> <p>MUX - Clear IMT stats, wait 1 hour and retrieve stats again. If stats are clear, there is no action to perform. If errors continue, a problem may exist. Contact Customer Care Center.</p>
VC OS Cnt / MUX Cong Disc	<p>COM - Virtual Circuit Out of Service Count: Count of times a Virtual Circuit (VC) on this card has gone Out of Service.</p> <p><b>Note:</b> The A and B bus counts will be the same. For the VC to drop, communications on both busses must be lost.</p> <p>This stat is only meaningful for application cards.</p> <p>MUX - Count of occurrences that the MUX has reached congestion discard on the transmit path to the LIM. More data is being delivered to the transmit queue than can be transmitted to the slot/LIM.</p>	<p>COM - Destination card is not available to receive packets, or software/hardware errors that cause the virtual connection(s) to be dropped. Could occur during normal maintenance (card replacement/ upgrades, or booting).</p> <p>MUX - Packets are being dropped or re-transmitted internally. This should not occur.</p>	<p>COM - Clear IMT stats, wait 1 hour and retrieve stats again. If stats are clear, there is no action to perform. If errors continue, a problem may exist. Contact Customer Care Center.</p> <p>MUX - Contact Customer Care Center.</p>

Table 4-47 (Cont.) Level 1 IMT Statistics

IMT Statistic	Explanation Of Statistic	Probable Causes	Recommended Action
Bus Disconnect Count	<p>Bus Disconnect Count:</p> <p>Counts the times that the card has been disconnected from the bus.</p> <p><b>Note:</b> The A and B bus counts can be different.</p> <p>This stat is only meaningful for application cards.</p>	Any event that disconnects the card from the bus can cause this counter to increment (e.g. connectivity problems to the IMT bus, or issuing the <code>disc-imt</code> or <code>inh-imt</code> command)	If commands that disconnect the card from the bus have not been issued, clear IMT stats, wait 1 hour and retrieve stats again. If stats are clear, there is no action to perform. If errors continue, a problem may exist. Contact Customer Care Center.
Violation Error	<p>Received an illegal character from the physical IMT transport (TAXI Interface). Detected by hardware</p>	Card insertion, removal, or boot or defective hardware	Clear IMT stats, wait 1 hour and retrieve stats again. If stats are clear, there is no action to perform. If errors continue, a problem may exist. Contact Customer Care Center.
Info: MSU Dropped no Rept	<p>MSU Dropped With No Report: Number of undeliverable MSUs that are not being returned to the application.</p> <p><b>Note:</b> This statistic may be non-zero after executing the <code>rept-imt-lvl1</code> or <code>clr-imt-stats</code> command. During execution of these commands, the active MASP generates MSUs to unpopulated card slots. These MSUs result in an "MSU Dropped With No Report" count. To determine the number of unexpected "MSU Dropped With No Report" occurrences, the active MASP must be excluded from the <code>rept-imt-lvl1</code> card range.</p>	Destination card is not available to receive packets.	None. MSU Dropped is an indication. No action is required.



Table 4-47 (Cont.) Level 1 IMT Statistics

IMT Statistic	Explanation Of Statistic	Probable Causes	Recommended Action
GBSU Resync	The count of how many times the GBSU receive sequence numbers have been resynchronized	These counts will occur on new card insertions, removals, boots, or a hardware error.	None. GBSU Resync is an indication. No action required.
GBSU Invalid Seq	The count of how many times a cards received a GBSU out of sequence.	This is unlikely but could occur on one bus (GBSU lost) and not the other bus.	Clear IMT stats, wait 1 hour and retrieve stats again. If stats are clear there is no action to perform. If stats continue to increase (and there are no booting cards), it is possible that the card's Dynamic Database may be inconsistent. Review the DDB status and if an issue exists, contact My Oracle Support.
GBSU Lost Packet	The count of lost GBSU packets in the system (This is received, not sent). In a clean system with counts cleared this count should stay at 0x00.	GBSUs may be occasionally lost in a congested system.	Use the LVL2 stats to determine/find the path of the lost GBSU. Clear IMT stats, wait 1 hour and retrieve stats again. If stats are clear there is no action to perform. If stats continue to increase (and there are no booting cards), there could be a problem with the system. Contact the My Oracle Support.
GBSU RX GRP Discard	This count reflects the amount of overhead that the GBSU logic adds to these cards , and it is the number of GBSU's sent to this card that the card was not subscribed for.	GBSU Discards are normal events.	None. GBSU RX GRP Discard is an indication. No action required.

**Level 1 IMT Statistics, Low Speed Performance Counts**

The probable cause for all Level 1 IMT Statistics, Low Speed Performance Counts is normal behavior. These counts are information only, and no action is required.

These statistics are displayed when the `rept-imt-lvl1:sloc=xxxx:eloc=yyyy:r=full` command is entered.

- All Packets—Number of packets transmitted on the IMT, all types

- All bytes—Number of bytes transmitted on the IMT, all types
- MSU Packets—Number of reliable delivery message data packets transmitted on the IMT
- MSU Bytes—Number of reliable delivery message data bytes transmitted on the IMT
- ASU Packets—Number of acknowledgment packets transmitted on the IMT
- ASU Bytes—Number of acknowledgment bytes transmitted on the IMT
- DSU Bytes—Number of best effort delivery message data bytes transmitted on the IMT
- HSU Packets—Number of mux card data packets transmitted on the IMT
- HSU Bytes—Number of mux card data bytes transmitted on the IMT
- TSU Bytes—Number of test bytes transmitted on the IMT
- TSU Packets—Number of test packets transmitted on the IMT
- LSSU Packets—Number of virtual circuit alignment packets transmitted on the IMT
- LSSU Bytes—Number of virtual circuit alignment bytes transmitted on the IMT
- BSU Packets—Number of broadcast data packets transmitted on the IMT
- BSU Bytes—Number of broadcast data bytes transmitted on the IMT
- SSU Packets—Number of Safety packets transmitted on the IMT
- SSU Bytes—Number of safety bytes transmitted on the IMT
- Othr Packets—Number of all packets types not counted by one of the above
- Othr Bytes—Number of all data bytes not counted by one of the above
- TAXI Util—Approximate percentage utilization of Low Speed data bus

### High Speed Error Summary for Level 1 IMT Statistics

Table 4-48 displays the High Speed Error Summary for Level 1 IMT Statistics.

These statistics are displayed when the `rept-imt-lvl1:sloc=xxxx:eloc=yyyy:r=full` command is entered.

**Table 4-48 Level 1 IMT Statistics, High Speed Error Summary**

Stat Label	Explanation of Stat	Probable Cause	Recommended Action
HS Rx Packet CRC Error	Fibre Channel Receive Packet with CRC Errors: Checksum error in received packet. Caused by corrupted data.	May indicate a hardware failure	Clear IMT stats, wait 1 hour and retrieve stats again. If stats are clear, there is no action to perform. If errors continue a problem may exist. Contact My Oracle Support.
HS Rx Packet Format Error	Fibre Channel Receive Packet with Format Errors: Format error in received packet. Usually caused by corrupted data.	May indicate a hardware failure	Clear IMT stats, wait 1 hour and retrieve stats again. If stats are clear, there is no action to perform. If errors continue a problem may exist. Contact My Oracle Support.

Table 4-48 (Cont.) Level 1 IMT Statistics, High Speed Error Summary

Stat Label	Explanation of Stat	Probable Cause	Recommended Action
HS Rx Disparity Error	Fibre Channel Receive Packet with Disparity Errors: Error in received packet. Caused by corrupted data.	May indicate a hardware failure	Clear IMT stats, wait 1 hour and retrieve stats again. If stats are clear, there is no action to perform. If errors continue a problem may exist. Contact My Oracle Support.
HS Rx Sync Lost Error	Fibre Channel Receive Lost Synchronization Errors: The interface lost sync on the received stream.	May indicate a hardware failure.	Clear IMT stats, wait 1 hour and retrieve stats again. If stats are clear, there is no action to perform. If errors continue a problem may exist. Contact My Oracle Support.
HS Rx Code Word Error	Fibre Channel Receive code Word Errors: Error in received packet. Caused by corrupted data.	May indicate a hardware failure.	Clear IMT stats, wait 1 hour and retrieve stats again. If stats are clear, there is no action to perform. If errors continue a problem may exist. Contact My Oracle Support.
HS Rx Packet SOM Before EOM	Fibre Channel Receive Packet with Start of Message without a previous End of Message Errors: The software received detected the start of a new packet before the end of the previous packet was detected.	May indicate a hardware failure.	Clear IMT stats, wait 1 hour and retrieve stats again. If stats are clear, there is no action to perform. If errors continue a problem may exist. Contact My Oracle Support.
HS Bypass FIFO Half Full	Fibre Channel Bypass FIFO Half Full: Watermark indication that this interface has backed up to the half way point of its capabilities.	Relatively heavy traffic on this interface can cause these counts to increment.	None. FIFO Half Full is an indication. No action is required.
HS Bypass FIFO Full	Fibre Channel Bypass FIFO Full: The FIFO has over run and data has been lost. May result is significant downstream errors.	Indicates a software or hardware failure	Clear IMT stats, wait 1 hour and retrieve stats again. If stats are clear, there is no action to perform. If errors continue a problem may exist. Contact My Oracle Support.

**Table 4-48 (Cont.) Level 1 IMT Statistics, High Speed Error Summary**

Stat Label	Explanation of Stat	Probable Cause	Recommended Action
HS Rx FIFO Half Full	Fibre Channel Receive FIFO Half Full: Watermark indication that this interface has backed up to the half way point of its capabilities.	Relatively heavy traffic on this interface can cause these counts to increment.	None. FIFO Half Full is an indication. No action is required.
HS Rx FIFO Full	Fibre Channel Receive FIFO Full: The FIFO has over run and data has been lost. May result in significant downstream errors.	Indicates a software or hardware failure	Clear IMT stats, wait 1 hour and retrieve stats again. If stats are clear, there is no action to perform. If errors continue a problem may exist. Contact My Oracle Support.
HS Tx FIFO Half Full	Fibre Channel Transmit FIFO Half Full: Watermark indication that this interface has backed up to the half way point of its capabilities.	Relatively heavy traffic on this interface can cause these counts to increment.	None. FIFO Half Full is an indication. No action is required.
HS Tx FIFO Full	Fibre Channel Transmit FIFO Full: Watermark indication that this interface has transmitted substantial traffic.	Relatively heavy traffic on this interface can cause these counts to increment.	None. FIFO Full is an indication. No action is required.
IXP RX FIFO Half Full	Fibre Channel IXP Receive FIFO Half full: Watermark indication that this interface has backed up to the half way point of its capabilities.	Relatively heavy traffic on this interface can cause these counts to increment.	None. FIFO Half Full is an indication. No action is required.
IXP Rx FIFO Full	Fibre Channel IXP Receive FIFO Full: The IXP Rx FIFO momentarily became full. This event can occur under normal conditions and it does not indicate an issue.	Relatively heavy traffic on this interface can cause these counts to increment.	None. FIFO Full is an indication. No action is required.
HS RX Large PKT Discard	A packet larger than allowed was processed on the receive path of the Fibre Channel. May result in significant downstream errors.	Indicates a software or hardware failure, unless the BUS is being brought up or being taken down.	Clear IMT stats, wait 1 hour and retrieve stats again. If stats are clear, there is no action to perform. If errors continue a problem may exist. Contact My Oracle Support.

**Output**

rept-imt-lvl1:sloc=1201

Command Accepted - Processing

```
tklc1070501 02-02-11 23:10:45 MST UNKNOWN ???.?-65.10.0
rept-imt-lvl1:sloc=1201
Command entered at terminal #5.
```

;

```
tklc1070501 02-02-11 23:10:45 MST UNKNOWN ???.?-65.10.0
Retrieving LVL1 data from Eagle cards...
```

```
-----
---
Card: H'0000      Elapsed Time (day - h:m:s):  0 - 04:56:52.0

                                A Bus                                B
Bus
  Error Counts                                COM      MUX
COM      MUX
-----
-----
Rx CRC Error                                0          0
0          0
Rx Format Error                              0          0
0          0
Rx Inv Len                                  0          N/A
0          0
Rx FIFO Half Full                           0          0
0          0
Rx FIFO Full                                0          0
0          0
CPU Rx FIFO Half Full                       0          N/A
0          N/A
CPU Rx FIFO Full                             0          N/A
0          N/A
CPU Rx MSU FIFO Full                         0          N/A
0          N/A
CPU Rx LSSU FIFO Full                       0          N/A
0          N/A
CPU Rx XSU FIFO Full                         0          N/A
0          N/A
ASU Rx FIFO Half Full                       0          N/A
0          N/A
ASU Rx FIFO Full                             0          N/A
0          N/A
SSU Packet Rx                               0          N/A
0          N/A
ASU Safety Pkt                              0          N/A
0          N/A
TSU Safety Pkt                              0          N/A
```

0	N/A			
	BSU Safety Pkt	0	N/A	0
N/A				
	SSU Safety Pkt	0	N/A	0
N/A				
	Other Safety Pkt	0	N/A	0
N/A				
	Pri Ctrl Rx Err	0	N/A	0
N/A				
	Pri Ctrl Sanity Err	0	N/A	0
N/A				
	RX HW flow control event	0	N/A	0
N/A				
	Pri Ctrl No SOM	0	N/A	0
N/A				
	Pri Ctrl Tx Err	0	N/A	0
N/A				
	Tx FIFO Half Full	0	N/A	0
N/A				
	Tx FIFO Full	0	N/A	0
N/A				
	Future Field	0	N/A	0
N/A				
	Future Field	0	N/A	0
N/A				
	IMT Tx FIFO Half Full	0	0	0
0				
	IMT Tx FIFO Full	0	0	0
0				
	Tx FIFO 3/4 Full	0	N/A	0
N/A				
	IMT By-pass FIFO Half Full	0	N/A	0
N/A				
	IMT By-pass FIFO Full	0	N/A	0
N/A				
	Pass thru CRC Error	0	N/A	0
N/A				
	Lost Multicast Pkt	0	N/A	0
N/A				
	Invalid Interrupt	0	N/A	0
N/A				
	Error Int Overflow	0	N/A	0
N/A				
	Large Pkt Error	0	N/A	0
N/A				
	MSU Retran / MUX LVL1 Cong	0	0	0
0				
	MSU ROE / MUX LVL2 Cong	0	0	0
0				
	VC OS Cnt / MUX Cong Disc	0	0	0
0				
	Bus Disconnect Count	0	N/A	0
N/A				
	Violation Error	0	0	0
0				

Low Speed Perf Counts		A Bus		B Bus
Rx	Tx	Rx	Tx	
-----	-----	-----	-----	-----
135K	All Packets	120K	3440K	3328K
63M	All Bytes	13M	69M	
0K	MSU Packets	--	--	
2042K	MSU Bytes	--	--	8K
17K	ASU Packets	--	--	
374K	ASU Bytes	--	--	209K
0K	DSU Packets	--	--	
0K	DSU Bytes	--	--	
0K	HSU Packets	--	--	
0K	HSU Bytes	--	--	
87K	TSU Packets	--	--	
12522K	TSU Bytes	--	--	12522K
3223K	LSSU Packets	--	--	
51575K	LSSU Bytes	--	--	
0K	BSU Packets	--	--	
0K	BSU Bytes	--	--	
0K	SSU Packets	--	--	
0K	SSU Bytes	--	--	
0K	Othr Packets	--	--	
0K	Othr Bytes	--	--	
0	TAXI Util	--	--	

;

tklc1070501 02-02-11 23:10:54 MST UNKNOWN ???-65.10.0

## =====

SUMMARY REPORT: Totals accumulated from 1 User slots

Error Counts	A Bus		B Bus
	COM	MUX	COM
MUX			
-----	-----	-----	-----
Rx CRC Error	0	0	0
0			
Rx Format Error	0	0	0
0			
Rx Inv Len	0	0	0
0			
Rx FIFO Half Full	0	0	0
0			
Rx FIFO Full	0	0	0
0			
CPU Rx FIFO Half Full	0	0	0
0			
CPU Rx FIFO Full	0	0	0
0			
CPU Rx MSU FIFO Full	0	N/A	0
N/A			
CPU Rx LSSU FIFO Full	0	N/A	0
N/A			
CPU Rx XSU FIFO Full	0	N/A	0
N/A			
ASU Rx FIFO Half Full	0	N/A	0
N/A			
ASU Rx FIFO Full	0	N/A	0
N/A			
SSU Packet Rx	0	N/A	0
N/A			
ASU Safety Pkt	0	N/A	0
N/A			
TSU Safety Pkt	0	N/A	0
N/A			
BSU Safety Pkt	0	N/A	0
N/A			
SSU Safety Pkt	0	N/A	0
N/A			
Other Safety Pkt	0	N/A	0
N/A			
Pri Ctrl Rx Err	0	N/A	0
N/A			
Pri Ctrl Sanity Err	0	N/A	0
N/A			
RX HW flow control event	0	N/A	0
N/A			
Pri Ctrl No SOM	0	N/A	0
N/A			
Pri Ctrl Tx Err	0	N/A	0
N/A			



0	Tx FIFO Half Full	0	N/A
0	N/A		
0	Tx FIFO Full	0	N/A
0	N/A		
0	Future Field	0	N/A
0	N/A		
0	Future Field	0	N/A
0	N/A		
0	IMT Tx FIFO Half Full	0	0
0	0		
0	IMT Tx FIFO Full	0	0
0	0		
0	Tx FIFO 3/4 Full	0	N/A
0	N/A		
0	IMT By-pass FIFO Half Full	0	N/A
0	N/A		
0	IMT By-pass FIFO Full	0	N/A
0	N/A		
0	Pass thru CRC Error	0	N/A
0	N/A		
0	Lost Multicast Pkt	0	N/A
0	N/A		
0	Invalid Interrupt	0	N/A
0	N/A		
0	Error Int Overflow	0	N/A
0	N/A		
0	Large Pkt Error	0	N/A
0	N/A		
0	MSU Retran / MUX LVL1 Cong	0	0
0	0		
0	MSU ROE / MUX LVL2 Cong	0	0
0	0		
0	VC OS Cnt / MUX Cong Disc	0	0
0	0		
0	Bus Disconnect Count	0	N/A
0	N/A		
0	Violation Error	0	0
0	0		

		A Bus		B Bus
Rx	Low Speed Perf Counts	Rx	Tx	
	Tx			
-----	-----	-----	-----	-----
3M	All Packets	0M	3M	
	0M			
63M	All Bytes	13M	69M	
	15M			
0K	MSU Packets	--	--	
	17K			
2042K	MSU Bytes	--	--	8K
17K	ASU Packets	--	--	
	31K			
	ASU Bytes	--	--	209K

```

374K
DSU  Packets      --      --      0K      0K
DSU  Bytes       --      --      0K      0K
HSU  Packets      --      --      0K      0K
HSU  Bytes       --      --      0K      0K
TSU  Packets      --      --      87K     87K
TSU  Bytes       --      --     12522K  12522K
LSSU Packets     --      --      3223K   0K
LSSU Bytes      --      --     51575K  0K
BSU  Packets     --      --      0K      0K
BSU  Bytes      --      --      0K      0K
SSU  Packets     --      --      0K      0K
SSU  Bytes      --      --      0K      0K
Othr Packets     --      --      0K      0K
Othr Bytes      --      --      0K      0K

```

```

-----
SUMMARY REPORT HS Totals accumullated from      1 HIPR2 Slots
                                                1 HIPR Slots
                                                0 HMUX Slots

```

```

High Speed Error Summary          A Bus      B Bus
-----
HS Rx Packet CRC Error           --          0
HS Rx Packet Format Error         --          0
HS Rx Disparity Error            --          0
HS Rx Sync Lost Error           --          0
HS Rx Code Word Error            --          0
HS Rx Packet SOM Before EOM      --          0
HS Bypass FIFO Half Full         --          0
HS Bypass FIFO Full              --          0
HS Rx FIFO Half Full             --          0
HS Rx FIFO Full                  --          0
HS Tx FIFO Half Full             --          0
HS Tx FIFO Full                  --          0
IXP Rx FIFO Half Full           --          0
IXP Rx FIFO Full                --          0
HS RX Large PKT discard          --          0

```

```

-----
;END OF REPORT

```

```

;
tklc1070501 02-02-11 23:11:06 MST UNKNOWN ???.?-65.10.0
Command Completed.

```

rept-imt-lvl1:e=251:s=0:r=summary

Command Accepted - Processing

stpa9020901 16-12-30 05:20:16 EST EAGLE 46.5.0.0.0-70.12.0  
rept-imt-lvl1:e=251:s=0:r=summary  
Command entered at terminal #6.

;

stpa9020901 16-12-30 05:20:16 EST EAGLE 46.5.0.0.0-70.12.0  
Retrieving LVL1 data from Eagle cards...

=====  
===

SUMMARY REPORT: Totals accumulated from 218 User slots

Bus	Error Counts	A Bus		B
		COM	MUX	COM
MUX	-----	-----	-----	-----
	-----			
	Rx CRC Error	0	0	
553	1			
	Rx Format Error	0	7	0
458				
	Rx Inv Len	23	2942	23
3397				
	Rx FIFO Half Full	1	0	
6	0			
	Rx FIFO Full	0	0	
2	0			
	CPU Rx FIFO Half Full	0	0	
0	0			
	CPU Rx FIFO Full	0	0	
0	0			
	CPU Rx MSU FIFO Full	0	N/A	0
N/A				
	CPU Rx LSSU FIFO Full	0	N/A	0
N/A				
	CPU Rx XSU FIFO Full	0	N/A	0
N/A				
	ASU Rx FIFO Half Full	0	N/A	0
N/A				
	ASU Rx FIFO Full	0	N/A	0
N/A				
	SSU Packet Rx	10501	N/A	10501
N/A				
	ASU Safety Pkt	0	N/A	0
N/A				
	TSU Safety Pkt	0	N/A	0
N/A				
	BSU Safety Pkt	0	N/A	0

N/A

SSU Safety Pkt	138	N/A	163	N/A
Other Safety Pkt	0	N/A	0	N/A
Pri Ctrl Rx Err	3	N/A	4	N/A
Pri Ctrl Sanity Err	0	N/A	0	N/A
RX HW flow control event	0	3	2	6
Pri Ctrl No SOM	0	N/A	0	N/A
Pri Ctrl Tx Err	0	N/A	0	N/A
Tx FIFO Half Full	0	N/A	0	N/A
Tx FIFO Full	0	N/A	0	N/A
GBSU Resync	6627053	N/A	6627053	N/A
GBSU Invalid Seq	1	N/A	1	N/A
IMT Tx FIFO Half Full	0	111133	0	118851
IMT Tx FIFO Full	0	0	0	0
Tx FIFO 3/4 Full	0	N/A	0	N/A
GBSU Lost Packet	89	N/A	89	N/A
GBSU RX GRP Discard	0	N/A	0	N/A
Future	0	N/A	0	N/A
Lost Multicast Pkt	2432	N/A	0	N/A
Invalid Interrupt	0	N/A	0	N/A
Error Int Overflow	0	N/A	0	N/A
Large Pkt Error	0	N/A	0	N/A
MSU Retran/MUX LVL1 Cong	186038	6281	186314	15016
MSU ROE/MUX Cong BSU Disc	184	0	184	0
VC OS Cnt/MUX Cong Disc	4574195	0	4574195	0
Bus Disconnect Count	0	N/A	0	N/A
Violation Error	80	27521	80	25791
Info: MSU Dropped no Rept	91798	N/A	91798	N/A

Low Speed Perf Counts	A Bus		B Bus	
	Rx	Tx	Rx	Tx
All Packets	26247M	35191M	30881M	39758M
All Bytes	265659M	473133M	262981M	411159M
MSU Packets	6574660K	6574652K	11342489K	11342478K
MSU Bytes	155370714K	159559021K	153192761K	190935334K
ASU Packets	17831677K	17831688K	17815194K	17815215K
ASU Bytes	78708121K	78708353K	78526845K	78527060K
DSU Packets	4830K	4830K	0K	0K
DSU Bytes	360553K	360554K	0K	0K
HSU Packets	102720K	5132K	102702K	5130K
HSU Bytes	2077810K	438111K	2077455K	437868K
TSU Packets	238690K	238684K	238691K	238691K
TSU Bytes	33997710K	33997698K	33996473K	33996461K
LSSU Packets	2020343K	109602K	2020155K	109705K
LSSU Bytes	32376702K	1804919K	32374244K	1807059K
BSU Packets	103665K	11270920K	103000K	11200670K
BSU Bytes	2697154K	293504718K	2678460K	291483278K
SSU Packets	36K	57K	36K	57K
SSU Bytes	792K	778K	792K	777K
Othr Packets	0K	0K	0K	0K
Othr Bytes	9K	0K	9K	0K

```

SUMMARY REPORT HS Totals accumullated from      32 HIPR2 Slots
                                                0 HIPR Slots
                                                0 HMUX Slots

```

High Speed Error Summary	A Bus	B Bus
HS Rx Packet CRC Error	0	0
HS Rx Packet Format Error	0	0
HS Rx Disparity Error	0	0
HS Rx Sync Lost Error	0	0
HS Rx Code Word Error	0	0
HS Rx Packet SOM Before EOM	0	0
HS Bypass FIFO Half Full	0	0
HS Bypass FIFO Full	0	0
HS Rx FIFO Half Full	0	0
HS Rx FIFO Full	0	0
HS Tx FIFO Half Full	0	0
HS Tx FIFO Full	0	0
IXP Rx FIFO Half Full	5288	3752
IXP Rx FIFO Full	5288	3752
HS RX Large PKT discard		0

```

-----
---
;END OF REPORT
;

  stpa9020901 16-12-30 05:20:18 EST EAGLE 46.5.0.0.0-70.12.0
  -> 0x4320c28 (imtu_mgr): 0x4320c28 (imtu_mgr): difftime = 40013
start_time
= 3, current time = 40016
difftime = 40013 start_time = 3, current time = 40016

;

stpa9020901 16-12-30 05:20:26 EST EAGLE 46.5.0.0.0-70.12.0
Command Completed.

;

```



#### Note:

In the top portion of this sample output "Error Counts" there are three types of possible output for each field:

- 1) A decimal number (indicates a count)
- 2) "—" (indicates NO DATA)
- 3) "N/A" (indicates this field is not supported)

## Legend

- **Card**—IMT address of the card in hexadecimal
- **Elapsed Time (day - h:m:s)**— Amount of time that has elapsed since a card reset has occurred or the IMT statistics were cleared with the `clr-imt-stats` command. This is shown in the format *day - h:m:s*, where *day* is the number of days that have elapsed, and *h:m:s* is the amount of time in the current day in hours, minutes, and seconds (and tenths of seconds).
- **"--" "--"** in the statistics column signifies that the statistics count is not applicable for the corresponding Card type.
- **Error Count**—IMT level 1 error statistics displayed in this report.
- **Perf Count**—IMT level 1 performance statistics displayed in this report.
- **A Bus value** and **B Bus value**—Values of the IMT level 1 statistics on IMT bus A and IMT bus B. Refer to the Notes section for descriptions of the statistics that are shown in the report for each card and in the Summary of totals for all requested cards, and their possible causes and corrective actions. Contact My Oracle Support if the count is excessive in relation to other cards.

"Excessive" count is primarily determined by the operator based upon:

- Overall system behavior
- Duration of time from when the last statistics were taken
- Statistics of an individual card in relation to other cards

The following types of Packets are included in the counts:

- **Safety Packet**—When an IMT packet goes around the IMT, a pre-determined value in the packet is decremented by each card. When this value reaches zero, the card that receives the value equal to zero logs this as a safety packet and removes the IMT packet from the IMT.
- **Message Signaling Unit (MSU)**—IMT packet containing data
- **Acknowledgement Signaling Unit (ASU)**—ACK for an MSU that is sent from the destination card back to the originating card.
- **Test Signaling Unit (TSU)**—Typically used to keep the card on the bus. There are many types of TSUs one of which performs a heartbeat function.
- **Broadcast Signaling Unit (BSU)**—Function is the same as an MSU except that each card will process the BSU and then copy it to the next card for processing. Used for IMT maintenance functions.
- **Safety Signaling Unit (SSU)**—Anytime a packet times out (Safety Packet), the card that logged a safety packet sends an SSU to make sure the original destination card is still on the IMT bus.
- **Isolation Signaling Unit (ISU)**—These are only used by the Fault Isolation test (`tst-imt`), in an attempt to isolate a hard failure on an IMT bus.
- **Other Packets and Other Bytes**—These include the ISUs when Fault Isolation test (`tst-imt`) is run (IMT bus is inhibited).
- **GBSU**—GBSU Lost Packet and GBSU RX GRP Discard.

**Related Topics**

- [clr-imt-stats](#)
- [conn-imt](#)
- [disc-imt](#)
- [rept-imt-info](#)
- [rept-imt-lvl2](#)
- [rept-stat-imt](#)
- [rmv-imt](#)
- [rst-imt](#)
- [tst-imt](#)

## rept-imt-lvl2

Use this command to display IMT level 2 statistics for a card. This report displays IMT traffic statistics for one or both IMT busses in the system. The report can be filtered as follows:

- Report statistics between the source card (specified with the `loc` or `l` parameter), whose statistics pool is queried for report information, and another card (specified with the `sloc` or `s` parameter).
- Report statistics between the source card and a range of cards (specified with the `sloc/eloc` or `s/e` parameter combination).

**Parameters****b (optional)**

IMT bus identification.

**Range:****a**

Displays statistics for IMT bus A.

**b**

Displays statistics for IMT bus B.

**both**

Displays statistics for both IMT busses, A and B.

**Default:**

*both*

**e (optional)**

End address. The IMT address of the last card in the range. A decimal value or a hexadecimal value can be specified for this parameter (see [Table 4-46](#) to map the values by card location).

**Range:**

*0 - 251*

The value can be specified in decimal (0 – 251) or hexadecimal (*h'00 – h'fe*).

**Default:**

If the `s` parameter is specified, the default is the `s` parameter value.  
If the `s` parameter is not specified, the default is `251`.

**e1oc (optional)**

End location. Specifies the card location of the last card in the range.

**Range:**

*1101 - 1108, 1111 - 1113, 1115, 1201 - 1208, 1211 - 1218, 1301 - 1308, 1311 - 1318, 2101 - 2108, 2111 - 2118, 2201 - 2208, 2211 - 2218, 2301 - 2308, 2311 - 2318, 3101 - 3108, 3111 - 3118, 3201 - 3208, 3211 - 3218, 3301 - 3308, 3311 - 3318, 4101 - 4108, 4111 - 4118, 4201 - 4208, 4211 - 4218, 4301 - 4308, 4311 - 4318, 5101 - 5108, 5111 - 5118, 5201 - 5208, 5211 - 5218, 5301 - 5308, 5311 - 5318, 6101 - 6108, 6111 - 6118*

**Default:**

If `sloc` is specified—current `s1oc` value; displays information for one card.  
If `sloc` is not specified—`1115`, which corresponds to IMT address `251` (`e=251`); displays information for entire range of locations.

**1 (optional)**

Source card IMT address. The IMT address of the card whose statistics pool is to be queried for report information.

**Range:**

*0 - 251*

**1oc (optional)**

Source card location. The location of the card whose statistics pool is to be queried for report information.

**Range:**

*1101 - 1108, 1111 - 1113, 1115, 1201 - 1208, 1211 - 1218, 1301 - 1308, 1311 - 1318, 2101 - 2108, 2111 - 2118, 2201 - 2208, 2211 - 2218, 2301 - 2308, 2311 - 2318, 3101 - 3108, 3111 - 3118, 3201 - 3208, 3211 - 3218, 3301 - 3308, 3311 - 3318, 4101 - 4108, 4111 - 4118, 4201 - 4208, 4211 - 4218, 4301 - 4308, 4311 - 4318, 5101 - 5108, 5111 - 5118, 5201 - 5208, 5211 - 5218, 5301 - 5308, 5311 - 5318, 6101 - 6108, 6111 - 6118*

**s (optional)**

Start address. The IMT address of the first (or only) card in the range. A decimal value or a hexadecimal value can be specified for this parameter (see [Table 4-46](#) to map the values by card location).

**Range:**

*0 - 251*

The value can be specified in decimal (`0 - 251`) or hexadecimal (`h'00 - h'fe`)

**Default:**

If `e` is specified—current `1` parameter value.  
If `e` is not specified—`0`.

**s1oc (optional)**

Start location. The card location of the first card in the range.



**Range:**

1101 - 1108, 1111 - 1113, 1115, 1201 - 1208, 1211 - 1218, 1301 - 1308, 1311 - 1318, 2101 - 2108, 2111 - 2118, 2201 - 2208, 2211 - 2218, 2301 - 2308, 2311 - 2318, 3101 - 3108, 3111 - 3118, 3201 - 3208, 3211 - 3218, 3301 - 3308, 3311 - 3318, 4101 - 4108, 4111 - 4118, 4201 - 4208, 4211 - 4218, 4301 - 4308, 4311 - 4318, 5101 - 5108, 5111 - 5118, 5201 - 5208, 5211 - 5218, 5301 - 5308, 5311 - 5318, 6101 - 6108, 6111 - 6118

**Default:**

If `eloc` is specified—current `sloc` value.

If `eloc` is not specified—IMT address 0 (`s=0`).

**trm (optional)**

Serial port (printer location) where the report is to be sent.

**Range:**

1 - 40

**Default:**

The report displays on the terminal where the command was issued.

**Example**

```
rept-imt-lvl2:l=00:s=00:e=02:b=a
```

**Dependencies**

The `s/e` parameters and `sloc/eloc` parameters cannot be specified together in the command.

This command cannot be entered if the `clr-imt-stats`, `rept-imt-info`, `rept-imt-lvl1`, or `tst-imt` command is running.

The `l` or `loc` parameter must be specified.

This command cannot be entered during IMT statistics collection following an hourly boundary.

The `l` parameter or the `loc` parameter must be specified. Both parameters cannot be specified.

A card location must be specified that is valid and defined in the database.

This command cannot be entered during an Extended Bit Error Rate Test (BERT).

**Notes**

[Table 4-46](#) maps each card location to the decimal and hexadecimal values that can be specified for the `s` and `e` parameters.

[Table 40](#) maps each card location to the decimal and hexadecimal values that can be specified for the `s` and `e` parameters.

**Output**

If the source card location falls within the range of cards specified with the `sloc/eloc` or `s/e` parameters, then the output report for the source card shows zeros. The zeros are reported because the source card location does not use the IMT to communicate with itself and, therefore, does not report any values or pegs for traffic routed to itself.

This command reports the values or pegs received, transmitted, or re-transmitted across the IMT bus.

```
rept-imt-lvl2:sloc=1101:eloc=1115:loc=1101
```

```
tklc1170501 17-05-17 04:23:21 EST EAGLE 46.5.0.0.0-70.32.0
```

```
rept-imt-lvl2:sloc=1101:eloc=1115:loc=1101
```

```
Command entered at terminal #18.
```

```
;
```

```
Command Accepted - Processing
```

```
tklc1170501 17-05-17 04:23:21 EST EAGLE 46.5.0.0.0-70.32.0
```

```
Retrieving data from card...
```

```
-----  
Card: H'00f0
```

```
Bus: A
```

Field		f0	f1	f2	f3	f4	f5	f6	f7
Link Status		ALGN	ALGN	ALGN	ALGN	ALGN	-OS-	ALGN	-OS-
OS Count	(dec)	1	3	3	3	12	0	12	0
Transmit BSN	(dec)	0	2	2	2	2	0	2	0
Transmit FSN	(dec)	0	209	2	2	2	0	2	0
Receive BSN	(dec)	0	209	2	2	2	0	2	0
Receive FSN	(dec)	1	3	3	3	3	1	3	1
Unack Messages	(dec)	0	0	0	0	0	0	0	0
Invalid Length	(dec)	0	0	0	0	0	0	0	0
Invalid rx BSN	(dec)	0	0	0	0	0	0	0	0
Invalid rx FSN	(dec)	0	0	0	0	0	0	0	0
GBSU sync count	(dec)	2	5	5	5	17	0	17	0
GBSU seq err	(dec)	0	0	0	0	0	0	0	0
GBSU lost pkt	(dec)	0	0	0	0	0	0	0	0
RTB Address	(hex)	0000	0000	0000	0000	0000	0000	0000	0000
Retx Count	(dec)	0	0	0	0	0	0	0	0
Minimum ack time	(ms)	4	4	4	4	4	0	4	0
Maximum ack time	(ms)	0	0	0	0	0	0	0	0

```
;
```

```
tklc1170501 17-05-17 04:23:23 EST EAGLE 46.5.0.0.0-70.32.0
```

```
-----  
Card: H'00f0
```

```
Bus: A
```

Field		f8	f9	fa	fb
Link Status		ALGN	ALGN	-OS-	ALGN
OS Count	(dec)	1	4	131	175
Transmit BSN	(dec)	2	2	2	158
Transmit FSN	(dec)	2	2	2	142
Receive BSN	(dec)	2	2	2	142
Receive FSN	(dec)	3	3	3	159
Unack Messages	(dec)	0	0	0	0
Invalid Length	(dec)	0	0	0	0
Invalid rx BSN	(dec)	0	0	0	0
Invalid rx FSN	(dec)	0	0	0	0
GBSU sync count	(dec)	1	5	0	0

```

GBSU seq err      (dec)      0      0      0      0
GBSU lost pkt     (dec)      0      0      0      0
RTB Address       (hex)    0000  0000  0000  0000
Retx Count        (dec)      0      0      1      0
Minimum ack time  (ms)      4      4      4      4
Maximum ack time  (ms)      0      0      0      0
;
tklcl170501 17-05-17 04:23:24 EST  EAGLE 46.5.0.0.0-70.32.0

```

-----  
---

```

Card:  H'00f0      Bus:  B

Field              f0      f1      f2      f3      f4      f5      f6
f7
-----
Link Status        ALGN   ALGN   ALGN   ALGN   ALGN   -OS-   ALGN  -
OS-
OS Count           (dec)    1     3     3     2    12     0
11  0
Transmit BSN       (dec)    0     0     0     0     0     0
0   0
Transmit FSN       (dec)    0     0     0     0     0     0
0   0
Receive BSN        (dec)    0     0     0     0     0     0
0   0
Receive FSN        (dec)    1     1     1     1     1     1
1   1
Unack Messages     (dec)    0     0     0     0     0     0
0   0
Invalid Length     (dec)    0     0     0     0     0     0
0   0
Invalid rx BSN     (dec)    0     0     0     0     0     0
0   0
Invalid rx FSN     (dec)    0     0     0     0     0     0
0   0
GBSU sync count    (dec)    0     0     0     0     0     0
0   0
GBSU seq err       (dec)    0     0     0     0     0     0
0   0
GBSU lost pkt      (dec)    0     0     0     0     0     0
0   0
RTB Address        (hex)   0000  0000  0000  0000  0000  0000  0000
0000
Retx Count         (dec)    0     1     1     1     0     0
0   0
Minimum ack time   (ms)    4     4     4     4     4     0
4   0
Maximum ack time   (ms)    0     0     0     0     0     0
0   0
;
tklcl170501 17-05-17 04:23:25 EST  EAGLE 46.5.0.0.0-70.32.0

```

-----

```

---
Card:  H'00f0      Bus:  B

Field                f8      f9      fa      fb
-----
Link Status          ALGN    ALGN    -OS-    ALGN
OS Count             (dec)   0       3      128     172
Transmit BSN         (dec)   0       0       0       0
Transmit FSN         (dec)   0       0       0       0
Receive BSN          (dec)   0       0       0       0
Receive FSN          (dec)   1       1       1       1
Unack Messages       (dec)   0       0       0       0
Invalid Length       (dec)   0       0       0       0
Invalid rx BSN       (dec)   0       0       0       0
Invalid rx FSN       (dec)   0       0       0       0
GBSU sync count      (dec)   0       0       0       0
GBSU seq err         (dec)   0       0       0       0
GBSU lost pkt        (dec)   0       0       0       0
RTB Address          (hex)   0000    0000    0000    0000
Retx Count           (dec)   0       0       1       0
Minimum ack time     (ms)    4       4       4       4
Maximum ack time     (ms)    0       0       0       0
;
tklcl170501 17-05-17 04:23:26 EST  EAGLE 46.5.0.0.0-70.32.0

```

```

-----
;END OF REPORT
;

```

```

tklcl170501 17-05-17 04:23:26 EST  EAGLE 46.5.0.0.0-70.32.0
Command Completed.
;
Command Executed

```

### Legend

- **Card**—IMT address of the card location specified by the 1 parameter in this command in hexadecimal
- **Bus**—IMT bus for which the IMT level 2 statistics are being reported
- **Field**—IMT level 2 statistics displayed in this report
- **00 - ef**—IMT address of the cards on the IMT bus in hexadecimal
- **Link Status**—Status of the link: ALGN (aligned) or OS (out of service)
- **OS Count**—Number of times the link has cycled between being aligned and being out of service
- **Transmit BSN**—Number of BSNs transmitted.
- **Transmit FSN**—Number of FSNs transmitted
- **Receive BSN**—Number of BSNs received
- **Receive FSN**—Sequence number for the next FSN that the source card location expects to receive

- **Unack Messages**—Number of unacknowledged messages received
- **Invalid Length**—Number of messages received with invalid length indicators
- **Invalid rx BSN**—Number of invalid BSNs received
- **Invalid rx FSN**—Number of invalid FSNs received
- **Invalid LSSU**—Number of invalid LSSUs received
- **Invalid ASU**—Number of invalid ASUs received
- **RTB Address**—Address of the retransmission buffer, in hexadecimal
- **Retx count**—Number of re-transmitted MSUs
- **Minimum ack time**—Minimum amount of time for an acknowledgment, in milliseconds
- **Maximum ack time**—Maximum amount of time for an acknowledgment, in milliseconds
- **GBSU sync count**— The count of how many times the GBSU sequence numbers have been resynced (This is received, not sent)
- **GBSU seq err**— The count of how many times a cards received a GBSU out of sequence
- **GBSU lost pkt**—The count of lost GBSU packets in the system (This is received, not sent)

#### Related Topics

- [clr-imt-stats](#)
- [conn-imt](#)
- [disc-imt](#)
- [rept-imt-info](#)
- [rept-imt-lvl1](#)
- [rept-stat-imt](#)
- [rmv-imt](#)
- [rst-imt](#)
- [tst-imt](#)

## rept-meas

Use this command to generate measurement reports on demand. The reports display on the UI terminal, and are not transferred to the customer FTP server when the Measurements Platform feature is enabled.

#### Parameters

**enttype (mandatory)**

Entity type to report on.

**Range:**

***idpr***

Measurements for IDPR

***link***

Measurements for signaling links

***Inkset***

Measurements for linksets

***Inp***

Measurements for local number portability

***Isdestni***

Measurements for linkset destination network identifiers

***Isonismt***

Measurements for ISUP message type screening

***Isorigni***

Measurements for linkset originating network identifiers

***mapscrn***

Measurements for GSM MAP message screening

***origni***

Measurements for originating network identifiers greater than 5

***originic***

Measurements for originating network identifiers (less than 5, small networks) for network clusters

***sctpasoc***

Measurements per association for the SCTP protocol (used to carry M3UA, M2PA, SUA and DIAM traffic)

***sctpcard***

Measurements per card for the SCTP protocol (used to carry M3UA, M2PA, SUA and DIAM traffic)

***sip***

Measurements for SIP

***stp***

Measurements pertaining to the Signaling Transfer Point in general or summarized totals recorded on the STP

***stplan***

Measurements for STP Local Area Network data links

***tt***

Measurements for translation types

***ua***

Measurements per application server/association for the M3UA and SUA protocols

**type (mandatory)**

Type of measurement report.

**Range:*****avl***

Availability measurements

***avld***

Daily availability measurements

***avldth***

Day to hour availability measurements.

***comp***

Component measurements

***gtwy***

Internetwork gateway-related data from the STP for ANSI and ITU measurements. ANSI gateway measurements are pegged on a per-linkset, per-Network Indicator basis, whereas ITU measurements are pegged on a per-linkset basis.

***mtcd***

Daily maintenance measurements

***mtcdth***

Day-to-hour maintenance measurements

***mtcs***

Link/linkset maintenance status

***nm***

Network management, on-demand

***rbase***

Schedule-report type record base measurements

***systot***

STP system totals

**aname (optional)**

Association name. This parameter specifies the name assigned to the association in the IPAPSOCK table.

**Range:**

aaaaaaaaaaaaaaaa

Up to 15 alphanumeric characters; the first character must be a letter

**app1 (optional)**

GPL to report measurements on.

This parameter can be used only with the *stplan-avl* (*enttype=stplan:type=avl*) measurement report.

**Range:**

xyyyyyyy

1 alphabetic character followed by up to 7 alphanumeric characters. Valid GPLs are:

- atmhc* —Used by E5-ATM-B cards to allow the card to support up to 3 signaling links
- ipghc* —Used by E5-ENET-B cards to support point-to-multipoint IP connectivity for ANSI and ITU point codes
- iplhc* —Used by E5-ENET-B cards for point-to-point IP connectivity for ANSI and ITU point codes
- sccphc* —Used by E5-SM4G and E5-SM8G-B cards to support EPAP-based features and the LNP ELAP Configuration feature. If no EPAP-based or LNP ELAP Configuration feature is turned on, and an E5-SM4G or E5-SM8G-B card is present, then the GPL processes normal GTT traffic.
- slanhc* —Used by E5-ENET-B cards to support the STPLAN application
- ss7hc* —Used by E5-E1T1-B cards. Allows the card to support up to 64 (E5-E1T1-B) signaling links for E1 and T1 functions.

**asname (optional)**

Application server name. The name of the application server.

**Range:**

*aaaaaaaaaaaaaaaa*

Up to 15 alphanumeric characters; the first character must be a letter.

**day (optional)**

Day of the week for daily measurement reports.

**Range:**

*mon*

*tue*

*wed*

*thu*

*fri*

*sat*

*sun*

**Default:**

The previous single day report is generated.

**hh (optional)**

Half-hour interval. The ending time for the collection interval; for example, *hh=0300* generates a report for 2:30-3:00.

**Range:**

*0000 - 2400*

*hhmm* where *hh*= 00-24 (hour) and *mm*= 00 or 30 (minute)

**Default:**

The *hh* parameter value is not given.

**link (optional)**

The link on the card specified in the *loc* parameter



**Synonym:***port***Range:***a, b, a1 - a31, b1 - b31*Not all card types support all `link` parameter values.See [Table A-1](#) for valid `link` parameter range values for each type of card that can have assigned signaling link ports.**Default:**

none

**loc (optional)**

The card location as stenciled on the shelf of the system.

**Range:***1101 - 1108, 1111 - 1112, 1201 - 1208, 1211 - 1218, 1301 - 1308, 1311 - 1318,  
2101 - 2108, 2111 - 2118, 2201 - 2208, 2211 - 2218, 2301 - 2308, 2311 - 2318,  
3101 - 3108, 3111 - 3118, 3201 - 3208, 3211 - 3218, 3301 - 3308, 3311 - 3318,  
4101 - 4108, 4111 - 4118, 4201 - 4208, 4211 - 4218, 4301 - 4308, 4311 - 4318,  
5101 - 5108, 5111 - 5118, 5201 - 5208, 5211 - 5218, 5301 - 5308, 5311 - 5318,  
6101 - 6108, 6111 - 6118***Default:**

none

**lsn (optional)**

Linkset name for the linkset where link or linkset measurements are reported.

**Range:***ayyyyyyyyy*

1 alphabetic character followed by up to 9 alphanumeric characters

**Default:**

none

**nc (optional)**

Network cluster for the specified GTWY measurement report.

**Range:***0 - 255***Default:**

none

**ni (optional)**

Network indicator for the specified GTWY measurement report.

**Range:***0 - 255***Default:**

none

**nzo (optional)**

Print non-zero measurements only.

**Range:**

*yes*

*no*

**Default:**

*yes* for types *avl*, *avld*, and *avldth*.

This parameter is not used with the other report types.

**period (optional)**

Relative time period to report.

**Range:**

*last*

The previous collection interval

*specific*

A specific half-hourly interval (specified with the *hh* parameter)

*active*

The current collection interval

*all*

All collection intervals.

**Default:**

none

**qh (optional)**

Quarter-hour interval. This parameter implies the ending time for the collection interval; for example, *qh=0315* generates a report for **3:00-3:15**.

**Range:**

0000 - 2400

*hhmm* where *hh*= 00-24 (hour) and *mm*= 00, 15, 30, or 45 (minute)

**Default:**

none

**trm (optional)**

Serial port (printer location) where the report is to be sent.

**Range:**

1 - 16

**Default:**

none

**tt (optional)**

Translation type to be reported.

**Range:**

0 - 255

**Default:**  
none

### Example

```
rept-meas:enttype=link:type=avl:loc=1201:link=a
rept-meas:type=systot:enttype=tt:tt=26
rept-meas:type=mtcd:enttype=sctpasoc:aname=assoc01
rept-meas:type=mtcdth:enttype=ua:aname=assoc01:asname=appserv01
rept-meas:enttype=sip:type=mtcd
```

### Dependencies

This command cannot be used to specify a report type if that report type is currently printing.

Valid parameter combinations depend on the report type specified. These combinations are shown in [Table 4-49](#). An X in a cell indicates that the parameter is valid for the report type shown.

**Table 4-49 Valid Parameter Combinations for the type Parameter**

Parameter Value	systot	comp	mtcd	mtcdth	mtch	mtcs	nm	avl	avld	avldth	gtwy	rbase
enttype: link		X	X	X		X	X	X	X	X		X
enttype: linkset		X	X	X		X	X				X	X
enttype: ln			X		X							
enttype: lsdestnt											X	
enttype: lsonism											X	
enttype: lorignt											X	
enttype: mapscrn			X		X							
enttype: orignt											X	
enttype: origntc											X	
enttype: sctpasoc		X	X	X								
enttype: sctpcard		X	X	X								
enttype: sip	X		X									
enttype: stp	X		X	X		X					X	X

**Table 4-49 (Cont.) Valid Parameter Combinations for the type Parameter**

stplan	X		X	X				X		
tt	X									
ua		X	X	X						
period:										
last	X	X	X	X	X		X	X	X	X
specific	X	X			X		X			X
active		X				X	X	X		X
all			X				X			
nzo							X	X	X	

The entity specified by the `loc` parameter must be equipped in the database.

When `enttype=link` is specified, the card in the location specified by the `loc` parameter must be a LIM.

Quarter-hourly collection and report processing cannot be in progress when report type `comp`, `systot`, `avl`, or `gtwy` is specified.

The `mtcdth` report type is unavailable between midnight and 1:00 AM (0100).

Day-to-hour collection and report processing cannot be in progress when report type `mtcd` or `mtcdth` is specified.

Daily collection and report processing cannot be in progress when report type `mtcd` is specified.

Half-hourly collection and report processing cannot be in progress when report type `comp`, `systot`, `avl`, or `gtwy` is specified.

5-minute collection and report processing cannot be in progress when report type `nm` is specified.

If the `nc` parameter is specified for origin reports, then the `ni` parameter must be specified.

If the `ni` parameter is specified for origin reports, then measurements data must be available at the time the command is entered.

The **day** parameter can be specified only for report type `mtcd` and entity types `lnp` and `mapscrn`.

A primary MCPM card must be available when the Measurements Platform collection option is enabled and this command is entered.

The 15 Minute Measurements feature must be turned on and the 15 Minute Measurements collection option must be on before the `qh` parameter can be specified.

The `hh` parameter must specify a half-hourly boundary (the end of the requested half-hour for the report) for valid report types.

The `hh` and `qh` parameters cannot be specified together in the command.

When the `period=last` parameter is specified, the `hh`, `qh`, and `day` parameters cannot be specified.

If the `period=active` parameter is specified, then the `hh` and `qh` parameters cannot be specified.

When the `period=specific` parameter is specified, the `hh`, `qh`, or `day` parameter must be specified. The `hh`, `qh`, and `day` parameters can be specified only if the `period=specific` parameter is specified.

A quarter-hour boundary must be specified for the `qh` parameter.

The `hh` and `qh` parameters cannot be specified if a value of `avld`, `mtcd`, `nm`, `rbase`, or `mtcs` is specified for the `type` parameter.

If the `link` parameter is specified, the `loc` parameter must be specified.

The `lsn` and `loc` parameters cannot be specified together in the command.

If the `enttype=link` parameter is specified, then the `loc` and `port` parameters or the `lsn` parameter must be specified.

The `enttype=stplan` and the `type=avl` parameters must be specified before the `apl` parameter can be specified.

The `period=active` parameter cannot be specified when the `enttype=stp` parameter or the `enttype=tt` parameter is specified.

If a value of `idpr`, `origni`, `origininc`, `stp`, `stplan`, or `tt` is specified for the `enttype` parameter, or if the `type=systot` parameter is specified, then the `lsn` parameter cannot be specified.

For entity type `avl`, if `period=all` is specified, the `loc` and `port` parameters must be specified.

A value of `avl`, `avld`, or `avldth` must be specified for the `type` parameter before the `nzo=yes` parameter can be specified.

The `apl` and `loc` parameters cannot be specified in the same command.

The `type=systot` and `loc` parameters cannot be specified in the same command.

If the `type=gtwy` parameter is specified, and the value of the `enttype` parameter is `Isorigni`, `Isdestni`, or `Isonismt`, then the `ni` parameter cannot be specified for ITU linksets. The `ni` parameter is allowed only for ANSI linksets.

If the `type=gtwy` parameter is specified, and a value of `Isdestni`, `Isonismt`, or `Isorigni` is specified for the `enttype` parameter for an ITU linkset, then only the `lsn` parameter can be specified.

If the `enttype=sctpcard` parameter is specified, then the card in the location specified by the `loc` parameter must be an IPLIMx, IPGWx, or IPSG card.

The `enttype=sctpasoc` or `enttype=ua` parameter must be specified before the `aname` parameter can be specified.

The `enttype=ua` parameter must be specified before the `asname` parameter can be specified.

If the `enttype=sctpcard` parameter is specified, then the `loc` parameter must be specified.

If the `enttype=sctpcard` parameter is specified, then a card must be installed in the location specified by the `loc` parameter.

The `enttype=link` parameter must be specified before the `link` parameter can be specified.

The `type=gtwy` parameter and the `enttype=origininc` parameter must be specified before the `nc` parameter can be specified.

The `type=gtwy` parameter must be specified, and a value of *Isdestni*, *Isonismt*, *Isorigni*, *origni*, or *origininc* must be specified for the `enttype` parameter before the `ni` parameter can be specified.

The `enttype=tt` parameter must be specified before the `tt` parameter can be specified. If the `enttype=tt` parameter is specified, then the `tt` parameter must be specified.

If a value of *sctpasoc* or *ua* is specified for the `enttype` parameter, then the `aname` parameter must be specified.

The association specified by the `aname` parameter must be provisioned in the system.

If the `enttype=ua` parameter is specified, then the `asname` parameter must be specified.

The application server specified by the `asname` parameter must be provisioned in the system.

The association specified by the `aname` parameter must be assigned to the application server specified by the `asname` parameter.

The `lsn` and `link` parameters cannot be specified together in the command.

If the `period=all` parameter is specified, then the `hh` and `qh` parameters cannot be specified.

Either the specified Linkset does not exist or no link is configured for it.

The A-Port, G-Port, IS41 GSM Migration, or Prepaid SMS Intercept Ph1 feature must be enabled, or the INP, MO SMS IS41-to-GSM Migration, MO-based GSM SMS NP, or MO-based IS41 SMS NP feature must be turned on before the `mtchnp=on` parameter or the `mtcdnp=on` parameter can be specified.

The value specified for the `appl` parameter must be a supported GPL.

If the `loc` parameter is specified, then a value of *stplan*, *link*, or *sctpcard* must be specified for the `enttype` parameter. If the `enttype=lnkset` parameter is specified, then the `loc` parameter cannot be specified.

If the `enttype=link` parameter is specified, then the values specified for the `loc` and `link` parameters must already exist in the database.

Period/type combinations:

- If a value of *rbase* or *mtcs* is specified for the `type` parameter, then a value of *active* must be specified for the `period` parameter.
- If a value of *avld*, *avldth*, *mtcdth*, or *nm* is specified for the `type` parameter, then the `period=specific` parameter cannot be specified.
- If the `period=active` parameter is specified, then a value of *avld*, *avldth*, *mtcd*, *mtcdth*, or *systot* cannot be specified for the `type` parameter.

- The `type=avl` parameter must be specified before the `period=all` parameter can be specified.

SIPNP Feature must be enabled before the `enttype=sip` and `type=mtcd/systot` parameters can be specified.

The location specified must be in the range from 1101 to 6118, except for MUX cards.

If the `enttype=tt` parameter is specified, then the `tt` parameter must be specified.

The `type` parameter must be one of the AVL, AVLD, AVLDTH, COMP, GTWY, MTCD, MTCDDTH, MTCS, NM, RBASE, or SYSTOT range values.

An entity type (ENTTYPE) of DEIR, EIR, or VFLX requires the DAY parameter to be specified.

Retrievals with the `rept-meas` command for `period= LAST, SPECIFIC, and ALL` are rejected by the EAGLE if either `measplat` or `integrated measurements` is not enabled.

This command cannot be entered when CAT2 IPSM to OAM syncing is in progress.

### Notes

INP, GSM MAP Screening, LNP, G-Port, A-Port, and IGM measurements are available via FTP transfer only.

If an on-demand report is requested while the collection for that interval is in progress, the requested report will not be generated. The `rept-meas` command must be entered again.

If this command is executed, and one or more cards did not respond to the request for measurements because the card was Out-Of-Service, then the following warning message may appear:

```
Measurement data represents an incomplete interval
```

This message does not indicate that data was lost.

If this command is executed, and measurements data does not exist for the specified time, then the following message may appear:

```
LINK-COMP MEASUREMENT:  LOC: 1201, LINK: A, LSN: (MTP2)  
Measurement data are not current.
```

Default values are shown for LOC, LINK, and LSN. These values always appear in the message, no matter what values were specified in command.

### Output



#### Note:

Refer to *Measurements Reference* for `rept-meas` output examples.

### Related Topics

- [chg-meas](#)

- [copy-meas](#)
- [rept-ftp-meas](#)
- [rtrv-meas-sched](#)

## rept-stat-alm

Use this command to provide status of all alarms.

### Parameters

#### **clli** (optional)

CLLI string. Displays only alarms that pertain to a particular CLLI.

#### **Range:**

*ayyyyyyyyy*

#### **dev** (optional)

Device. The type of device for which alarms are displayed.

#### **Range:**

*applsock*

*as*

*card*

*cdt*

*clock*

*dlk*

*ls*

*lsmsconn*

*route*

*slk*

*trm*

*rtx*

*e1port*

*t1port*

*tps*

*enet*

#### **display** (optional)

Type of alarms to be displayed. When the `display=inhb` parameter is specified, the Alarm Inhibit Report appears in the command output and provides information about inhibited



alarms in the system. The `dev` parameter can be specified with this parameter to display the Alarm Inhibit Report for a specific device type.

**Range:**

*inhb*

**dur (optional)**

Duration. This parameter indicates whether to display permanently inhibited alarms, temporarily inhibited alarms, or timed inhibited alarms. This parameter is valid only when the `display=inhb` parameter is specified.

**Range:**

*perm*

*temp*

*timed*

**edate (optional)**

Expiry date. This parameter allows the user to see timed alarm inhibits that will expire on the specified date.

**Range:**

*101 - 991231*

Specify the date in the format *year*, followed by *month*, followed by *day*.

**Example**

```
rept-stat-alm
rept-stat-alm:display=inhb:dev=card
rept-stat-alm:display=inhb:clli=slkset1:dev=ls
rept-stat-alm:display=inhb
rept-stat-alm:display=inhb:dur=timed
rept-stat-alm:display=inhb:dur=timed:edate=040520
```

**Dependencies**

No other `rept-stat-xxx` command can be in progress when this command is entered.

The `dur` parameter can be specified only if the `display=inhb` parameter is specified.

The `dur`, `dev`, or `clli` parameter can be specified only if the `display=inhb` parameter is specified.

The `edate` parameter can be specified only if the `dur=timed` parameter is specified.

The `dev` parameter can have only the values *slk*, *ls*, or *route* if the `clli` parameter is specified.

The `dur` parameter must be compatible with the specified device.

The value specified for the `c11i` parameter must already exist in the DSTN table.

The value specified for the `edate` parameter must be greater than the system date.

## Notes

None

## Output

This example shows the output when the system is clean and before a maintenance baseline has been established:

```
rept-stat-alm

tekelecstp 21-06-04 00:00:14 MST EAGLE 47.0.0.0.0-78.12.0
ALARM TRANSFER= LMC
ALARM MODE          CRIT= SIENT      MAJR= SILENT      MINR= SIENT
ALARM FRAME 1      CRIT= 0          MAJR= 0           MINR= 0
ALARM FRAME 2      CRIT= 0          MAJR= 0           MINR= 0
ALARM FRAME 3      CRIT= 0          MAJR= 0           MINR= 0
ALARM FRAME 4      CRIT= 0          MAJR= 0           MINR= 0
ALARM FRAME 5      CRIT= 0          MAJR= 0           MINR= 0
ALARM FRAME 6      CRIT= 0          MAJR= 0           MINR= 0
PERM. INH. ALARMS CRIT= 0          MAJR= 0           MINR= 0
TEMP. INH. ALARMS CRIT= 0          MAJR= 0           MINR= 0
TIMED INH. ALARMS CRIT= 0          MAJR= 0           MINR= 0
ACTIVE ALARMS      CRIT= 0          MAJR= 0           MINR= 0
TOTAL ALARMS       CRIT= 0          MAJR= 0           MINR= 0

Command Completed.
;
```

This example shows the output after critical and minor alarms are generated. Major alarms still show SILENT.

```
rept-stat-alm

tekelecstp 21-06-04 00:00:14 MST EAGLE 47.0.0.0.0-78.12.0
ALARM TRANSFER= LMC
ALARM MODE          CRIT= AUDIBLE     MAJR= SILENT      MINR= AUDIBLE
ALARM FRAME 1      CRIT= 2          MAJR= 0           MINR= 17
ALARM FRAME 2      CRIT= 0          MAJR= 0           MINR= 0
ALARM FRAME 3      CRIT= 0          MAJR= 0           MINR= 0
ALARM FRAME 4      CRIT= 0          MAJR= 0           MINR= 0
ALARM FRAME 5      CRIT= 0          MAJR= 0           MINR= 0
ALARM FRAME 6      CRIT= 0          MAJR= 0           MINR= 0
PERM. INH. ALARMS CRIT= 0          MAJR= 0           MINR= 0
TEMP. INH. ALARMS CRIT= 0          MAJR= 0           MINR= 0
TIMED INH. ALARMS CRIT= 0          MAJR= 0           MINR= 0
ACTIVE ALARMS      CRIT= 2          MAJR= 0           MINR= 17
TOTAL ALARMS       CRIT= 2          MAJR= 0           MINR= 17

Command Completed.
;
```

This example shows inhibited alarms:

```
rept-stat-alm
```

```
tklcl1131002 21-05-30 01:17:10 EST EAGLE 47.0.0.0-78.12.0
ALARM TRANSFER= RMC
ALARM MODE          CRIT= AUDIBLE          MAJR= SILENT          MINR= AUDIBLE
ALARM FRAME 1      CRIT= 7              MAJR= 254            MINR= 36
ALARM FRAME 2      CRIT= 0              MAJR= 0              MINR= 0
ALARM FRAME 3      CRIT= 0              MAJR= 0              MINR= 0
ALARM FRAME 4      CRIT= 0              MAJR= 0              MINR= 0
ALARM FRAME 5      CRIT= 0              MAJR= 0              MINR= 0
ALARM FRAME 6      CRIT= 0              MAJR= 0              MINR= 0
PERM. INH. ALARMS  CRIT= 0              MAJR= 1              MINR= 0
TEMP. INH. ALARMS CRIT= 0              MAJR= 0              MINR= 0
TIMED INH. ALARMS CRIT= 0              MAJR= 0              MINR= 0
ACTIVE ALARMS      CRIT= 7              MAJR= 253            MINR= 36
TOTAL ALARMS       CRIT= 7              MAJR= 254            MINR= 36
```

```
Command Completed.
```

```
;
```

This example includes the Alarm Inhibit report for the card in location 1301.

```
rept-stat-alm:display=inhb:dev=card
```

```
rlghncxa03w 10-02-27 15:00:53 EST EAGLE 42.0.0
ALARM TRANSFER= RMC
ALARM MODE          CRIT= SILENT          MAJR= SILENT          MINR= SILENT
ALARM FRAME 1      CRIT= 11             MAJR= 24              MINR= 17
ALARM FRAME 2      CRIT= 0              MAJR= 0              MINR= 0
ALARM FRAME 3      CRIT= 0              MAJR= 0              MINR= 0
ALARM FRAME 4      CRIT= 0              MAJR= 0              MINR= 0
ALARM FRAME 5      CRIT= 0              MAJR= 0              MINR= 0
ALARM FRAME 6      CRIT= 0              MAJR= 0              MINR= 0
PERM. INH. ALARMS  CRIT= 0              MAJR= 4              MINR= 2
TEMP. INH. ALARMS  CRIT= 1              MAJR= 3              MINR= 1
TIMED. INH. ALARMS CRIT= 0              MAJR= 0              MINR= 0
ACTIVE ALARMS      CRIT= 11             MAJR= 23              MINR= 15
TOTAL ALARMS       CRIT= 13             MAJR= 30              MINR= 18
```

```
ALARM INHIBIT REPORT
```

```
-----
DEVICE    DEVICE IDENTIFIER  DURATION  INH LVL  ALM LVL  DATE
TIME
-----
CARD      1301                PERM      MAJR     MAJR
-----
```

```
Command Completed.
```

```
;
```

This example includes the Alarm Inhibit report for multiple device types. It includes point codes with point code subtype prefixes, and exception routes that require a second line of display to uniquely identify the exception class/criteria of the routes. A plus sign (+) following the alarm level indicates that the current alarm is not inhibited because the level of the inhibit is less than the level of the alarm.

```
rept-stat-alm:display=inhb
```

```
rlghncxa03w 10-02-27 15:00:53 EST EAGLE 42.0.0
ALARM TRANSFER= RMC
ALARM MODE          CRIT= AUDIBLE          MAJR= SILENT          MINR= SILENT
ALARM FRAME 1      CRIT= 2              MAJR= 8              MINR= 0
ALARM FRAME 2      CRIT= 0              MAJR= 0              MINR= 0
ALARM FRAME 3      CRIT= 0              MAJR= 0              MINR= 0
ALARM FRAME 4      CRIT= 0              MAJR= 0              MINR= 0
ALARM FRAME 5      CRIT= 0              MAJR= 0              MINR= 0
ALARM FRAME 6      CRIT= 0              MAJR= 0              MINR= 0
PERM. INH. ALARMS  CRIT= 0              MAJR= 1              MINR= 0
TEMP. INH. ALARMS CRIT= 0              MAJR= 1              MINR= 0
TIMED INH. ALARMS CRIT= 0              MAJR= 0              MINR= 0
ACTIVE ALARMS      CRIT= 2              MAJR= 6              MINR= 0
TOTAL ALARMS       CRIT= 2              MAJR= 8              MINR= 0
```

#### ALARM INHIBIT REPORT

```
-----
DEVICE    DEVICE IDENTIFIER    DURATION  INH LVL  ALM LVL  DATE    TIME
-----
CARD      1101                 PERM      MINR     MAJR+    ---     ---
ENET      1201,A               PERM      MAJR     MAJR     ---     ---
ENET      1201,B               TEMP      MAJR     MAJR     ---     ---
ENET      1101,A               PERM      MINR     MAJR+    ---     ---
```

Command Completed.

```
;
```

This example shows timed inhibited alarm information:

```
rept-stat-alm:display=inhb:dur=timed
```

```
rlghncxa03w 10-02-27 15:00:53 EST EAGLE 42.0.0
ALARM TRANSFER= RMC
ALARM MODE          CRIT= SILENT          MAJR= SILENT          MINR= SILENT
ALARM FRAME 1      CRIT= 5              MAJR= 3              MINR= 6
ALARM FRAME 2      CRIT= 0              MAJR= 0              MINR= 0
ALARM FRAME 3      CRIT= 0              MAJR= 0              MINR= 0
ALARM FRAME 4      CRIT= 0              MAJR= 0              MINR= 0
ALARM FRAME 5      CRIT= 0              MAJR= 0              MINR= 0
ALARM FRAME 6      CRIT= 0              MAJR= 0              MINR= 0
PERM. INH. ALARMS  CRIT= 0              MAJR= 0              MINR= 0
TEMP. INH. ALARMS CRIT= 0              MAJR= 0              MINR=
0
TIMED. INH. ALARMS CRIT= 1              MAJR= 2              MINR= 1
ACTIVE ALARMS      CRIT= 4              MAJR= 1              MINR= 5
```

```

TOTAL ALARMS          CRIT= 5          MAJR= 3          MINR= 6

ALARM INHIBIT REPORT
-----
DEVICE    DEVICE IDENTIFIER  DURATION  INH LVL  ALM LVL  DATE
TIME
-----  -----
-----  -----  -----  -----  -----  -----
1000    ROUTE ps-004-005-006          TIMED     CRIT     CRIT     06-08-01
1200    E1PORT  1101,1              TIMED     MAJR     MAJR     06-10-05
1100    T1PORT  1301,3              TIMED     MAJR     MAJR     06-08-01
1100    APPLSOCK sock1234567890      TIMED     MINR     MAJR     06-10-05

Command Completed.
;

```

This example shows timed inhibited alarm information for alarms that will expire on the specified date:

```
rept-stat-alm:display=inhb:dur=timed:edate=061001
```

```

upg1040403 10-02-27 14:09:58 EST EAGLE 42.0.0
ALARM TRANSFER= RMC
ALARM MODE          CRIT= SILENT          MAJR= SILENT          MINR= SILENT
ALARM FRAME 1      CRIT= 5          MAJR= 3          MINR= 6
ALARM FRAME 2      CRIT= 0          MAJR= 0          MINR= 0
ALARM FRAME 3      CRIT= 0          MAJR= 0          MINR= 0
ALARM FRAME 4      CRIT= 0          MAJR= 0          MINR= 0
ALARM FRAME 5      CRIT= 0          MAJR= 0          MINR= 0
ALARM FRAME 6      CRIT= 0          MAJR= 0          MINR= 0
PERM. INH. ALARMS  CRIT= 0          MAJR= 0          MINR= 0
TEMP. INH. ALARMS  CRIT= 0          MAJR= 0          MINR=
0
TIMED. INH. ALARMS  CRIT= 1          MAJR= 2          MINR= 1
ACTIVE ALARMS      CRIT= 4          MAJR= 1          MINR= 5
TOTAL ALARMS      CRIT= 5          MAJR= 3          MINR= 6

```

```

ALARM INHIBIT REPORT
-----
DEVICE    DEVICE IDENTIFIER  DURATION  INH LVL  ALM LVL  DATE
TIME
-----  -----
-----  -----  -----  -----  -----  -----
1000    ROUTE ps-004-005-006          TIMED     CRIT     CRIT     06-10-01
1200    E1PORT  1101,1              TIMED     MAJR     MAJR     06-10-01

```

Command Completed.

This example shows inhibited alarm information for the linksets with the specified CLLI:

```
rept-stat-alm:display=inhb:clli=slkset1:dev=ls
```

```
upg1040403 10-03-27 14:09:58 EST EAGLE 42.0.0
ALARM TRANSFER= RMC
ALARM MODE          CRIT= SILENT          MAJR= SILENT          MINR= SILENT
ALARM FRAME 1      CRIT= 5              MAJR= 3              MINR= 6
ALARM FRAME 2      CRIT= 0              MAJR= 0              MINR= 0
ALARM FRAME 3      CRIT= 0              MAJR= 0              MINR= 0
ALARM FRAME 4      CRIT= 0              MAJR= 0              MINR= 0
ALARM FRAME 5      CRIT= 0              MAJR= 0              MINR= 0
ALARM FRAME 6      CRIT= 0              MAJR= 0              MINR= 0
PERM. INH. ALARMS  CRIT= 0              MAJR= 0              MINR= 0
TEMP. INH. ALARMS CRIT= 0              MAJR= 0              MINR= 0
TIMED. INH. ALARMS CRIT= 1              MAJR= 2              MINR= 1
ACTIVE ALARMS      CRIT= 4              MAJR= 1              MINR= 5
TOTAL ALARMS       CRIT= 5              MAJR= 3              MINR= 6
```

ALARM INHIBIT REPORT

```
-----
DEVICE  DEVICE IDENTIFIER  DURATION  INH LVL  ALM LVL  DATE      TIME
-----  -
LS      slkset1              TIMED     MAJR     MAJR     06-10-01 1200
```

Command Completed.

## Legend

- **ALARM TRANSFER**—The destination of the alarms. LMC=Local Maintenance Center, RMC=Remote Maintenance Center.
- **ALARM MODE**—Displays whether the critical, major, and minor alarms are silent or audible
- **ALARM FRAME 1**—Number of critical, major, and minor alarms detected in the control frame CF-00 (frame 1)
- **ALARM FRAME 2**—Number of critical, major, and minor alarms detected in extension frame EF-00 (frame 2)
- **ALARM FRAME 3**—Number of critical, major, and minor alarms detected in extension frame EF-01 (frame 3)
- **ALARM FRAME 4**—Number of critical, major, and minor alarms detected in extension frame EF-02 (frame 4)
- **ALARM FRAME 5**—Number of critical, major, and minor alarms detected in extension frame EF-03 (frame 5)
- **ALARM FRAME 6**—Number of critical, major, and minor alarms detected in extension frame EF-04 (frame 6) and all the miscellaneous OAP alarms.
- Following list contains miscellaneous OAP alarms:  
MPS\_UNAVAILABLE EPAP\_AVAILABLE

LSMS\_Q3\_ASSOC\_UNAVAILABLE  
 LSMS\_Q3\_ASSOC\_AVAILABLE  
 LSMS\_Q3\_ASSOC\_BULK\_LOAD\_DONE  
 LSMS\_Q3\_ASSOC\_BULK\_LOAD\_REQD  
 SEAS\_OAP\_AVAILABLE  
 SEAS\_OAP\_UNAVAIL  
 SEAS\_OAP\_UAL\_UNAVAIL  
 LSMS\_EMS\_AGENT\_UNAVAILABLE  
 OAP\_FILESYSTEM\_FULL  
 SEAS\_OAP\_ONE\_TDM\_UNAVAIL  
 OAP\_CONFIG\_CHECKSUM\_MISMATCH  
 OAP\_CONFIG\_CHECKSUM\_MATCH  
 SEAS\_X25\_LINK\_UNAVAIL  
 SEAS\_X25\_UAL\_UNAVAIL  
 SEAS\_X25\_PVC\_UNAVAIL  
 SEAS\_X25\_PVC\_SES\_UNAVAIL  
 SEAS\_X25\_LINK\_AVAIL

- **PERM. INH. ALARMS**—Number of alarms that are permanently inhibited per alarm level
- **TEMP. INH. ALARMS**—Number of alarms that are temporarily inhibited per alarm level
- **TIMED. INH. ALARMS**—Number of alarms that are timed inhibited per alarm level
- **ACTIVE ALARMS**—Number of alarms still active per alarm level.
- **TOTAL ALARMS**—Total number of alarms per alarm level. The inhibited alarm count plus the active alarm count equals the total alarm count.
- **CRIT**—Critical alarms with silent/audible indicator
- **MAJOR**—Major alarms with silent/audible indicator
- **MINOR**—Minor alarms with silent/audible indicator

Alarm Inhibit Report:

- **DEVICE**—Device for which alarms are currently inhibited. Only devices that are alarm inhibited are shown.
- **ELEMENT**—Element of the device for which alarms are inhibited (such as card location, port, routing key, socket or association name)
- **DURATION**—Indicates whether the device is alarm inhibited permanently or temporarily or for a specific length of time
- **INH LVL**—Level in which devices are alarm inhibited (Critical, Major, Minor). The `inh-alm` command defaults the level to Major. Devices cannot be alarm inhibited at a critical level unless the `chg-stpopts` command's `critalmnh` parameter is turned on.





**Default:**  
Current value

**sname (optional)**

Socket name. The name of the IP application socket to be reported.

**Range:**  
ayyyyyyyyyyyyyyy  
Up to 15 alphanumeric characters; the first character must be a letter

**Default:**  
All IP application sockets are reported

**Example**

```
rept-stat-applsock  
rept-stat-applsock:port=b
```

**Dependencies**

The `name` parameter value, if specified, must exist in the Socket table.

A valid value must be specified for the `host` parameter. If the host name contains a hyphen, then the host name must be enclosed within quotation marks.

**Notes**

This command displays the primary states (PST) and the secondary state (SST).  
Primary states are:

- IS-NR—In-service normal
- IS-ANR—In-service abnormal (congested)
- OOS-MT—Out of service
- OOS-MT-DSBLD—Out-of-service maintenance-disabled (provisioned to be out of service by closing, prohibiting, or deactivation)

Secondary states are:

- ALMINH—Alarm inhibited
- OOS—Out-of-service
- NEA—Near-end allowed
- FEA—Far-end allowed
- NEP—Near-end prohibited
- FEP—Far-end prohibited

**Output**

```
rept-stat-applsock  
  
rlghncxa03w 04-02-17 15:35:05 EST EAGLE 31.3.0  
SOCKET          PST          SST  
socred          OOS-MT      ALMINH
```

```

socyellow      IS-ANR      ----
socblue       OOS-MT-DSBLD  ----
Command Completed
;

rept-stat-applsock

rlghncxa03w 04-02-17 15:35:05 EST EAGLE 31.3.0
SOCKET      PST      SST
ipg11051    IS-NR     NEA-FEA
ipg11071    IS-NR     NEA-FEA
ipl1201     IS-NR     NEA-FEA
Command Completed.
;

rept-stat-applsock:link=b

rlghncxa03w 04-02-17 15:35:05 EST EAGLE 34.0.0
SOCKET      PST      SST
ipl1201b    IS-NR     NEA-FEA
Command Completed.
;

```

## rept-stat-as

Use this command to generate a report of the Application Server (AS) association status.

### Parameters

#### **aname (optional)**

Association name to report on. This parameter causes the ASP states for a given association and all of the AS's that it is assigned to be displayed.

#### **Range:**

aaaaaaaaaaaaaaaa

Up to 15 alphanumeric characters; the first character must be a letter

#### **asname (optional)**

Application Server name; the AS name to report on. This parameter causes the the PST, SST, ASP state, and ASP-ID for each association in the AS to be displayed.

#### **Range:**

aaaaaaaaaaaaaaaa

Up to 15 alphanumeric characters; the first character must be a letter

### Example

```
rept-stat-as
```

## Dependencies

If an association is specified in the command, the specified association must exist in the AS table.

## Notes

This command can be canceled using the **F9** function key or the `canc-cmd` command. See `canc-cmd` for more information.

If the command is specified without a parameter, status for all AS associations is displayed.

This command displays the following states: ACTIVE, UP, DOWN, PENDING.

## Output

```
rept-stat-as
```

ASNAME	PST	SST
m3ua0001	OOS-MT	AS-INACTIVE
m3ua0002	IS-NR	AS-ACTIVE
m3ua0003	OOS-MT-DSBLD	AS-DOWN
m3ua0004	IS-ANR	AS-PENDING

Command Completed.

```
;
```

```
rept-stat-as:asname=m3ua0001
```

ASNAME	PST	SST	ASP STATE	ASPID
m3ua0001	OOS-MT	AS-INACTIVE		
m3ua_1301	OOS-MT-DSBLD	----	ASP-DOWN	
m3ua_1302	OOS-MT	CONNECTING	ASP-DOWN	
m3ua_1303	IS-NR	ESTABLISHED	ASP-INACTIVE	

Command Completed.

```
;
```

```
rept-stat-as:aname=m3ua_1303
```

ASNAME	ANAME	ASP STATE
m3ua0001	m3ua_1303	ASP-INACTIVE

```

m3ua0002          m3ua_1303          ASP-ACTIVE
m3ua0003          m3ua_1303          ASP-DOWN

```

```

Command Completed.
;

```

### Related Topics

- [chg-as](#)
- [ent-as](#)
- [rtrv-as](#)

## rept-stat-assoc

Use this command to generate a report of the SCTP association's status.

### Parameters

#### **aname (optional)**

Name of association to report on.

##### **Range:**

aaaaaaaaaaaaaaaa

Up to 15 alphanumeric characters; the first character must be a letter

#### **lhost (optional)**

The Local Host name as defined in the IP Host table.

##### **Range:**

XX

A string of characters up to 60 characters in length; the first character must be a letter  
Valid characters are *a-z*, *A-Z*, *0-9*, - (dash), and . (period).

#### **link (optional)**

The signaling link associated with this socket.

##### **Synonym:**

*port*

##### **Range:**

*a, b, a1-a63, b1-b63*

Not all card types support all *link* parameter values.

See [Table A-1](#) for valid *link* parameter range values for each type of card that can have assigned signaling links ports.

#### **rhost (optional)**

Name of Remote Host as defined in the IP Host table.

##### **Range:**

XX

A string of characters up to 60 characters in length. The first character must be a letter.  
Valid characters are *a-z*, *A-Z*, *0-9*, - (dash), and . (period).

## Example

```
rept-stat-assoc
```

```
rept-stat-assoc:aname= a23456789012345
```

## Dependencies

If an association is specified in the command, the specified association must exist in the AS table.

A valid value must be specified for the `host` parameter. If the host name contains a hyphen, then the host name must be enclosed within quotation marks.

## Notes

This command can be canceled using the **F9** function key or the `canc-cmd` command. See `canc-cmd` for more information.

This command displays the primary states (PST) and the secondary state (SST).

Primary states are:

- IS-NR—In-service normal
- IS-ANR—In-service abnormal (congested)
- OOS-MT—Out of service
- OOS-MT-DSBLD—Out-of-service maintenance-disabled (provisioned to be out of service by closing, prohibiting, or deactivation)

Connection states are:

- RESTRICTED
- OUT-OF-SERVICE
- CONNECTING
- ESTABLISHED—Valid only for M2PA associations

The **LINK** field values in the output are displayed as:

- "\*\*\*"—If the association is assigned to multiple links.
- "--"—If the association is not assigned to any link.
- Appropriate LINK ID—If the association is assigned to only one link.

## Output

```
rept-stat-assoc
```

```

eagle10212 08-01-29 10:41:52 EST EAGLE 38.0.0
                CARD IPLNK
  ANAME          LOC  PORT  LINK PST          SST
ASPID
  ipgi1303a      1303 A     A   OOS-MT      OOS
undefined
  ip11301b      1301 A     B   IS-NR      ESTABLISHED

```

```

a1          1305 A    **   OOS-MT-DSBLD   OOS
undefined
ipg1308a1   1308 A    A    OOS-MT-DSBLD   OOS
undefined
sca         1306 A    A    IS-ANR         CONGESTED
a2         1304 A    A    IS-ANR         EXCESS RETRANS
undefined
sca7       1307 A,B  A    IS-NR          ESTABLISHED
undefined
lavern     1305 A    A    IS-NR          ESTABLISHED
ipl1313b   1313 A    B    OOS-MT-DSBLD   OOS
ipl1302a   1302 A    A    IS-NR          ESTABLISHED
n          1315 A    A    OOS-MT         CONNECTING
ipg1305a1  1305 A    A    OOS-MT-DSBLD   OOS
undefined
ipl1301b3  1301 A    B3   IS-NR          ESTABLISHED
m2pa1107a0 1107 A    --   OOS-MT-DSBLD   OOS
m2pa1107a1 1107 A    --   OOS-MT-DSBLD   OOS
ipg1215a01 1215 A    **   IS-NR          ESTABLISHED
undefined
ipg1215a02 1215 A    **   IS-NR          ESTABLISHED
undefined
ipg1215a03 1215 A    --   OOS-MT-DSBLD   OOS
undefined
ipg1215a04 1215 A    **   OOS-MT         OOS
undefined
ipg1215a05 1215 A    --   OOS-MT-DSBLD   OOS
undefined
sg1305a    1305 A    A    IS-NR          ESTABLISHED
undefined
Command Completed.

```

This example shows the output when the `aname` parameter is specified for an IPGWx association:

```
rept-stat-assoc:aname=a2
```

```

eagle10212 08-01-29 10:41:52 EST  EAGLE 38.0.0
CARD IPLNK
ANAME      LOC  PORT  LINK  PST      SST      ASPID
a2         1304 A    A    IS-ANR  EXCESS RETRANS  undefined
ALARM STATUS = * 0536 IP Connection Excess Retransmits

ASNAME     ANAME     ASP-STATE
as1        a2        ASP-UP

```

```
Command Completed.
```

This example shows the output when the `aname` parameter is specified for an M2PA association:

```
rept-stat-assoc:aname=assocm2pa
```

```
eagle10212 07-05-29 10:41:52 EST EAGLE 37.0.0
                CARD IPLNK
ANAME          LOC PORT  LINK PST          SST
assocm2pa     1301 A    A    IS-NR      ESTABLISHED
```

```
Command Completed.
```

This example shows the output when the `aname` parameter is specified for an IPSG-M3UA association:

```
rept-stat-assoc:aname=sg1305a
```

```
eagle10212 08-02-06 17:00:42 EST EAGLE 38.0.0
                CARD IPLNK
ANAME          LOC PORT  LINK PST          SST
ASPID
sg1305a       1305 A    A    IS-NR      ESTABLISHED
undefined
LSN          ANAME          ASP STATE
ls1305a     sg1305a          ACTIVE
```

```
Command Completed.
```

This example shows the output when the `port/link` parameter is specified for IPSG associations:

```
rept-stat-assoc:port=a15
```

```
tekelecstp 10-01-05 10:47:26 EST EAGLE 42.0.0
                CARD IPLNK
ANAME          LOC PORT  LINK PST          SST
ASPID
ipsgm3ua     1101 A    A15 IS-NR      ESTABLISHED
undefined
ipsgm2pa     1102 B    A15 IS-NR      ESTABLISHED
```

```
Command Completed.
```

This example shows the output when no parameter is specified for DIAM association:

```
rept-stat-assoc
```

```
tekelecstp 13-04-24 11:24:19 EST EAGLE 45.1.0
rept-stat-assoc
```

```

Command entered at terminal #26.
;

Command Accepted - Processing
tekelecstp 13-04-24 11:24:19 EST EAGLE 45.1.0
CARD IPLNK
ANAME          LOC  PORT  LINK  PST          SST          ASPID
abc1           1105  B     --   IS-NR        ESTABLISHED
undefined
abc2           1105  B     --   IS-NR        ESTABLISHED
undefined

Command Completed.
;
```

### Related Topics

- [chg-assoc](#)
- [ent-assoc](#)
- [rtrv-assoc](#)

## rept-stat-card

Use this command to display the card status and maintenance activity states. The output includes card location, the GPL version being used by the card, device type, device primary state, device secondary state, and device associated state.

### Parameters

#### **app1 (optional)**

Application. The status of cards running the specified application.

#### **Range:**

xyyyyyy

1 alphabetic character followed by up to 6 alphanumeric characters. Valid applications are:

*atmansi* —Used by E5-ATM-B cards to support ATM high-speed signaling links and T1 functions.

*atmitu* —Used by E5-ATM-B cards to support E1 high-speed signaling links and E1 functions.

*ccs7itu* —Used by E5-E1T1-B cards for ITU MTP functions.

*deirhc* —Used by E5-SM8G-B and SLIC cards to support the DEIR application.

*elap* —Used by E5-APP-B cards to support the ELAP application.

*enumhc* —Used by E5-SM8G-B cards to support the ENUM Mobile Number Portability and Tier One Address Resolution application.

*epap* —Used by E5-APP-B cards to support the EPAP application.

*eroute* —Used by STC cards and E5-STC cards for the EAGLE 5 Integrated Monitoring Support functions

*gls* —Used by E5-TSM cards for downloading gateway screening to LIM and Service Module cards



*ipgwi* —Used by E5-ENET-B cards for point-to-multipoint IP connectivity for ITU point codes. A maximum of 125 cards can be assigned the IPGWI application.

*iplimi* —Used by E5-ENET-B cards for point-to-point IP connectivity for ITU point codes

*ips* —Used by E5-IPSM and E5-ENET-B cards for the IP User Interface feature.

*ipsg* —Used by E5-ENET-B, and SLIC cards to support the combined functionality of IPLIMx M2PA and IPGWx M3UA

*lsms* - Used by E5-APP-B cards to support LSMS application.

*mcp* —Used by E5-MCPM-B cards for the Measurements Platform feature.

*nas* - Used by E5-APP-B cards to support the NAS application.

*siphc* — Used by E5-SM8G-B cards to support the SIP application.

*ss7ansi* —Used by E5-E1T1-B cards for ANSI MTP functions

*ss7ipgw* —Used by E5-ENET-B cards for point-to-multipoint IP connectivity. The system allows a maximum of 125 cards to be assigned the SS7IPGW application.

*stplan* —Used by E5-ENET-B cards to support STP LAN functions.

*switch* - Used by Telco switch to add power consumed by Telco Switch to Frame Power Budget. This is not an application gpl.

*vsccp* —Used by Service Module cards to support EPAP-based features and the LNP ELAP Configuration features. If no EPAP-based or LNP ELAP Configuration feature is turned on, and a Service Module card is present, then normal GTT traffic is processed.

**data (optional)**

Data filter specification. The status of cards running the specified application with specified data.

**Range:***nosccp*

displays the status of a GTT-disabled IPSG card

*gtt*

displays the status of a GTT-enabled IPSG card and SM GTT card

 **Note:**

The `data` parameter is valid for IPSG and VSCCP applications only. If the `data` parameter is not specified, then both types of IPSG (GTT disabled and GTT enabled) cards will be displayed under `appl=ipsg`.

**links (optional)**

Filter specification. Report the maximum number of links, only equipped links, or only unequipped links on the card in the specified card location (`loc`).

**Range:***all*

Reports the maximum number of links available on the card in the specified `loc`

*equip*

Reports only links that are equipped

***unequip***

Reports only links that are unequipped

**Default:**

*equip*

**loc (optional)**

Card address. The card location as stenciled on the shelf of the system.

**Range:**

*1101 - 1117, 1201 - 1218, 1301 - 1318, 2101 - 2118, 2201 - 2218, 2301 - 2318, 3101 - 3118, 3201 - 3218, 3301 - 3318, 4101 - 4118, 4201 - 4218, 4301 - 4318, 5101 - 5118, 5201 - 5218, 5301 - 5318, 6101 - 6118, 6201 - 6218, 6301 - 6318*

**Default:**

A status of all cards is displayed.

**mode (optional)**

Mode. The type of report to display (full or summary).

**Range:**

*full*

**Default:**

A summary report is displayed.

**stat (optional)**

Primary state filter. This parameter cannot be used with the `loc` or `mode` parameters. This filter allows printing of cards in a specified state (all in-service cards, for example).

**Range:**

*all*

All of the primary states

*alminh*

Alarms inhibited

*anr*

In service abnormal (IS-ANR)

*dsbld*

Out of service maintenance disabled (OOS-MT-DSBLD)

*mt*

Out of service maintenance (OOS-MT)

*nr*

In service normal (IS-NR)

**Default:**

*all*

**Example**

```
rept-stat-card
```

```
rept-stat-card:loc=1201
rept-stat-card:loc=1201:mode=full
rept-stat-card:stat=alminh
rept-stat-card:appl=ss7ansi
rept-stat-card:appl=siphc
rept-stat-card:loc=1205:links=equip:mode=full
rept-stat-card:appl=epap
rept-stat-card:appl=switch
rept-stat-card:appl=elap
rept-stat-card:appl=lsms
rept-stat-card:appl=nas
rept-stat-card:appl=enumhc
rept-stat-card:appl=ipsg:data=gtt
rept-stat-card:appl=ipsg:data=nosccp
```

### Dependencies

No other command can be in progress when this command is entered.

The `mode` parameter can be specified only when the `loc` parameter is specified.

Only one of the `loc` or `stat` parameters can be specified in the command.

Unless the `appl=vcssp/ipsg`, no other parameter can be specified with the `appl` parameter.

The shelf and card must be equipped.

The card location (`loc`) must be within the allowed range.

A valid value must be specified for the `appl` parameter.

The card location specified by the `loc` parameter must be equipped.

The `data` parameter is not valid with an APPL other than IPSG/VSCCP.

The `data` parameter can take `nosccp` as a value only when the APPL specified is IPSG.

### Notes

LIM cards show MFC results for SNM, SLAN, SCCP, EROUTE, INM and MTP3. SCCP cards show MFC results for SNM, INM and MTP3 when the `mode=full` and `loc` parameters are specified.

The status displayed is for the previous 5 minutes and the previous 24 hours.

The following MFC status codes are used: G to indicate service request GRANTED, D to indicate service request DENIED, and N to indicate NO OPERATIONAL SERVERS AVAILABLE.

This command can be canceled using the **F9** function key or the `canc-cmd` command. See `canc-cmd` for more information.

The `mode=full` parameter gives more information than the summary report.

A plus (+) symbol in the output indicates that the flash GPL currently being run has not yet been activated on the card. See the `act/init-flash` command for a list of flash GPLs.

E1 alarms are displayed in the alarm status field. When the `mode=full` parameter is specified, separate fields display status information from the UAM for each E1 interface on the card. For each E1 interface, the display shows the highest priority E1 failure that exists on that E1 card. When no E1 errors exist, the clearing E1 UAM text is displayed. When an E1 interface is not assigned to the card, no output is generated for that E1 position.

T1 alarms are displayed in the alarm status field. When the `mode=full` parameter is specified, separate fields display status information from the UAM for each T1 interface on the card. For each T1 interface, the display shows the highest priority T1 failure that exists on that T1 card. When no T1 errors exist, the clearing T1 UAM text is displayed. When an T1 interface is not assigned to the card, no output is generated for that T1 position.

If the `links=all` parameter is specified, then the maximum number of supported SS7 links on the card is displayed as shown. If the `links=unequip` parameter is specified, then the number of links displayed is equal to the maximum supported links minus the provisioned links. If the `links=equip` parameter is specified, then only the provisioned links are displayed.

Multiple cards of the same card type but different capacity can be installed into a slot configured with the `ent-card` command. The number of links supported cannot be determined until the card is physically installed into the configured slot.

**Table 4-50 Maximum Supported Links based on Card Type and GPL**

GPL with Card Type	Maximum Supported Links	
	Card Hardware Verified	Card Hardware Unknown
ATMHC on E5-ATM-B	3	3
SS7HC on E5-E1T1-B	64	64
IPLHC on E5-ENET-B	16	16
IPGHC on E5-ENET-B	1	1
IPSG on E5-ENET-B/SLIC	32	32
IPSG on SLIC	128	128
SIPHC on E5-SM8G-B/SLIC	17 (16 TCP & 1 UDP)	17 (16 TCP & 1 UDP)
ENUMHC on E5-SM8G-B/SLIC	1 (UDP)	1 (UDP)
DEIRHC on E5-SM8G-B/SLIC	32	32

The CARD WARNING field in the command output indicates a specific condition that can hinder the normal functioning of a card. For E5-E1T1-B cards, the "Obsolete Framer" warning indicates that a port configured on the card may get stuck in a Loss of Frame (LOF) state. If an E5-E1T1-B card displaying this warning is reloaded, and one of the ports on the card is reporting LOF, then the OAM reboots the card up to 5 times to attempt to clear the LOF condition when the card changes state from IS-ANR to IS-NR.

GTT-enabled IPSG cards have the IPSG application running on SLIC hardware, which is capable of SCCP (GTT) processing. GTT-disabled IPSG cards also have IPSG application running on E5-ENET-B or SLIC hardware, but they do not have SCCP (GTT) processing

capability. To sort one from the other, the `data` parameter is used. The `data` parameter cannot be used with any application other than IPSP/VSCCP.

Interface A/D will be used for ExAP connectivity and interface B/C used for signaling network on the SLIC card running the DEIR/SIP/ENUM application.

### Fast Copy Cards

E5-ENET-B, or SLIC cards running the IPSP or E5-ENET-B cards running the IPGHC GPL are considered to be *FC-capable*. A card running the IPGHC GPL must be in the IS-NR State before the card can be considered *FC-capable*. This restriction does not apply to cards running the IPSP GPL. An *FC-capable* card is considered *FC-enabled* when Fast Copy monitoring is enabled for the respective GPL.

### Output

The clock status fields are reported when the `mode=full` report is selected. The clock status report includes a CLOCK A, CLOCK B, and CLOCK I status. The High Speed clock status report (displayed for ATM, E1 and T1 cards) includes HS CLOCK A, HS CLOCK B, and HS CLOCK I. The valid values for each clock status are *Idle*, *Active*, and *Fault*. The meanings of these values are:

- *Idle* —Clock is available but is not being used by the card
- *Active* —Clock is available and is being used by the card
- *Fault* —Clock is unavailable

*Idle* and *Active* are shown when the CLK or HS CLK distribution to the card is good. The *Active* value does not denote that the card is actually using the clock source for link alignment. Use the `rtrv-slk`, `rtrv-e1`, and `rtrv-t1` commands to determine what clock source each card is using for link alignment.

If the `mode=full` parameter is specified for an FC-enabled card, and Fast Copy functionality has been provisioned for the GPL (see the `chg-eisopts` command), then Fast Copy status and FC Link status is shown. For an E5-ENET-B or SLIC card running the IPGHC GPL, Fast Copy and Fast Copy link status is shown only when the card is in IS-NR state.

Abbreviated output is indicated by 3 vertical dots as shown:

```
.
.
.
```

The E5-MCPM-B card is an MCPM card. The *Type* field displays MCPM.

```
rept-stat-card
```

```
rlghncxa03w 12-03-09 16:35:57 IST EAGLE 45.0.0
CARD   VERSION   TYPE      GPL       PST       SST
AST
1102   128-002-000 LIMATM   ATMHC    IS-NR     Active
-----
1103   125-020-000 DSM      SCCPHC   IS-NR     Active
-----
```

```

1105 125-020-000 DSM      SCCPHC  IS-NR    Active   -----
1106 130-001-000 TSM      GLSHC   IS-NR    Active   -----
1107 125-020-000 STC      EROUTE  IS-NR    Active   -----
1108 134-000-000 MCPM     MCPHC   IS-NR    Active   -----
1109 125-020-000 HIPR2    HIPR2   IS-NR    Active   -----
1110 125-020-000 HIPR2    HIPR2   IS-NR    Active   -----
1111 125-020-000 IPSM     IPS      IS-NR    Active   -----
1113 070-019-002 E5MCAP   OAMHC   IS-NR    Standby  -----
1114 ----- E5TDM    IS-NR    Active   -----
1115 070-019-002 E5MCAP   OAMHC   IS-NR    Active   -----
1116 ----- E5TDM    IS-NR    Active   -----
1117 ----- MDAL     IS-NR    Active   -----
1201 138-008-000 SLIC     IPSPG   IS-NR    Active   -----
1206 134-060-000 DSM      DEIRHC  IS-NR    Active   -----
1209 125-020-000 HIPR2    HIPR2   IS-NR    Active   -----
1210 125-020-000 HIPR2    HIPR2   IS-NR    Active   -----
1112 138-008-000 SLIC     IPSPG   IS-NR    Active   -----
1309 125-017-000 HIPR2    HIPR2   IS-NR    Active   -----
1310 125-017-000 HIPR2    HIPR2   IS-NR    Active   -----
1311 125-020-000 STC      EROUTE  IS-NR    Active   -----
2103 128-018-000 DCM      IPLHC   IS-NR    Active   -----
2108 128-018-000 DCM      SLANHC  IS-NR    Active   -----
2109 128-022-000 HIPR2    HIPR2   IS-NR    Active   -----
2110 128-022-000 HIPR2    HIPR2   IS-NR    Active   -----
2111 128-018-000 STC      ERTHC   IS-NR    Active   -----
1213 053-000-058 E5ENET   IPSPG   IS-NR    Active   -----
Command Completed.

```

;

This example shows the card status for the OAMHC of MASP A located in slot 1113, which is currently active.

This example also shows a Hardware Verification Code. The HW VERIFICATION CODE field is shown only in the mode=full report. "-----" is shown for cards with valid hardware. A numerical value is shown when invalid hardware is detected. All such cards will be auto-inhibited. The numerical values are listed in [Table 4-51](#). The E5-MDAL and MUX cards do not display the field in mode=full reports on their locations.

```
rept-stat-card:loc=1113:mode=full
```

```

tekelecstp 02-01-08 04:34:09 EST  EAGLE 46.0.0
CARD  VERSION  TYPE  GPL  PST  SST  AST
1113  134-068-000  E5MCAP  OAMHC  IS-NR  Active  -----
ALARM STATUS          = No Alarms
BLMCAP  GPL version = 134-054-000
IMT BUS A              = Conn
IMT BUS B              = Conn
CLOCK A                = Fault
CLOCK B                = Active
CLOCK I                = Idle
MBD BIP STATUS        = Valid
MOTHER BOARD ID       = E5-MCAP
DBD STATUS            = Valid
DBD TYPE              = 1G ENET

```

```

DBD MEMORY SIZE      = 4096M
HW VERIFICATION CODE = ----
CURRENT TEMPERATURE  = 32C ( 90F)
PEAK TEMPERATURE:    = 32C ( 90F)      [02-01-08 04:31]
TROUBLE TEXT VER.    = Rev 134.10.2
APPLICATION SERVICING

```

```

                                TVG   MFC           TVG   MFC
IPLNK STATUS
  IPLNK  IPADDR           STATUS   PST
  A      -----          ----    ----

```

Command Completed.

;

This example shows all cards that have alarms inhibited in the system:

```
rept-stat-card:stat=alminh
```

```

rlghncxa03w 04-02-04 12:57:21 EST EAGLE 31.6.0
CARD  VERSION      TYPE   APPL   PST           SST       AST
1211  023-001-000  LIMATM ATMANSI  IS-NR         Active  ALMINH

```

Command Completed.

;

This example shows a full report for a specified HIPR2 card:

```
rept-stat-card:loc=1109:mode=full
```

```

tekelecstp 02-01-08 04:45:17 EST EAGLE 46.0.0
CARD  VERSION      TYPE   GPL           PST           SST
AST
1109  134-046-000  HIPR2   HIPR2        IS-NR         Active

```

-----

```

ALARM STATUS      = No Alarms.
TRIAL VERSION      = HIPR2 134-069-000
FPGA VERSION       = HIPR2 008-002-005-009
CURRENT TEMPERATURE = NA
PEAK TEMPERATURE:  = NA

```

Command Completed.

;

This example shows output for an STC card used by the E5IS feature:

```
rept-stat-card:loc=1107
```

```

rlghncxa03w 10-01-09 16:35:57 IST EAGLE 42.0.0
CARD  VERSION      TYPE   GPL           PST           SST

```

```

AST
1107  128-015-000  STC      EROUTE  IS-NR      Active  -----
ALARM STATUS      = No Alarms.
BPDCM  GPL version = 128-108-000
IMT BUS A         = Conn
IMT BUS B         = Conn
CLOCK A          = Active
CLOCK B          = Idle
CLOCK I          = Idle
MBD BIP STATUS   = Valid
MOTHER BOARD ID  = Invalid
DBD STATUS       = Valid
DBD TYPE         = Invalid
DBD MEMORY SIZE  = 512M
HW VERIFICATION CODE = ----
EROUTE % OCCUP   = 0%
NTP broadcast = VALID
Command Completed.
;

```

This example shows a full report for an STC card:

```
rept-stat-card:loc=1107:mode=full
```

```

rlghncxa03w 10-01-09 16:35:57 IST  EAGLE 42.0.0
CARD  VERSION  TYPE      GPL      PST      SST      AST
1107  128-015-000  STC      EROUTE  IS-NR    Active  -----
ALARM STATUS      = No Alarms.
BPDCM  GPL version = 128-108-000
IMT BUS A         = Conn
IMT BUS B         = Conn
CLOCK A          = Active
CLOCK B          = Idle
CLOCK I          = Idle
MBD BIP STATUS   = Valid
MOTHER BOARD ID  = Invalid
DBD STATUS       = Valid
DBD TYPE         = Invalid
DBD MEMORY SIZE  = 512M
HW VERIFICATION CODE = ----
EROUTE % OCCUP   = 0%
NTP broadcast = VALID
IPLNK STATUS
  IPLNK  IPADDR          STATUS  PST
  A      -----      DOWN   OOS-MT
  B      192.168.63.45  UP     IS-NR
STC IP CONNECTION
  PORT  PST      SST
  A     OOS-MT  Unavail
  B     IS-NR   Active

```

This example shows output for an MCPM card used by the Measurements Platform feature:



```
rept-stat-card:loc=1105
```

```

rlghncxa03w 11-05-04 15:10:19 EST EAGLE 44.0.0
CARD   VERSION      TYPE      GPL      PST      SST
AST
1105   128-001-000  MCPM     MCP      IS-NR    Idle

```

```

-----
ALARM STATUS      = No Alarms.
BPDCM  GPL VERSION = 128-001-000
IMT BUS A         = Conn
IMT BUS B         = Conn

```

```
Command Completed.
```

```
;
```

This example shows output for an E5-SM4G card:

```
rept-stat-card:loc=6111
```

```

tk1c1110501 10-12-09 17:26:29 EST EAGLE5 43.0.0
CARD   VERSION      TYPE      GPL      PST      SST
AST
6111   128-015-000  DSM      SCCPHC   IS-NR    Active

```

```

-----
ALARM STATUS      = No Alarms.
BLIXP  GPL version = 133-044-000
IMT BUS A         = Conn
IMT BUS B         = Conn
CURRENT TEMPERATURE = 31C ( 88F)
PEAK TEMPERATURE:  = 32C ( 90F)      [07-04-12 15:55]
SCCP % OCCUP      = 1%

```

```
Command Completed.
```

```
;
```

This example shows a full report for an E5-SM4G card. The MFC option is ON.

```
rept-stat-card:loc=6111:mode=full
```

```

rlghncxa03w 11-02-09 16:35:57 IST EAGLE 44.0.0
CARD   VERSION      TYPE      GPL      PST      SST
AST
6111   134-000-000  DSM      SCCPHC   IS-NR    Active

```

```

-----
ALARM STATUS      = No Alarms.
BLIXP  GPL version = 133-044-000
IMT BUS A         = Conn
IMT BUS B         = Conn
CLOCK A           = Active
CLOCK B           = Idle
CLOCK I           = Idle
MBD BIP STATUS    = Valid

```

```

MOTHER BOARD ID      = SMXG A
DBD STATUS            = Valid
DBD TYPE              = 1G ENET
DBD MEMORY SIZE      = 4096M
HW VERIFICATION CODE = ----
CURRENT TEMPERATURE  = 31C ( 88F)
PEAK TEMPERATURE:    = 32C ( 90F)      [07-04-12 15:55]
SCCP % OCCUP         = 1%
APPLICATION SERVICING

                TVG      MFC                TVG      MFC
SNM      REQ STATUS = 24 hr: ----- ---, 5 min: ----- ---
INM      REQ STATUS = 24 hr: ----- ---, 5 min: ----- ---
MTP3     REQ STATUS = 24 hr:          ---, 5 min:          ---

IPLNK STATUS
IPLNK  IPADDR          STATUS      PST
A      10.220.9.9      UP          IS-NR
B      10.220.9.8      UP          IS-NR

DSM IP CONNECTION
PORT   PST            SST
A      OOS-MT         Unavail
B      OOS-MT         Unavail

```

Command Completed.

This example shows the output for all cards running the VSCCP application:

```
rept-stat-card:appl=vsccp
```

```

tklcl1110501 07-04-12 17:28:02 EST EAGLE5 46.0.0
CARD  VERSION      TYPE      GPL      PST      SST      AST
1107  128-015-000    DSM      SCCPHC   IS-NR    Active   -----
1317  -----          DSM      SCCPHC   OOS-MT   Isolated -----
2217  128-015-000    DSM      SCCPHC   IS-NR    Active   -----
2317  -----          DSM      SCCPHC   OOS-MT   Isolated -----
3103  -----          DSM      SCCPHC   OOS-MT-DSBLD Manual   -----
3201  128-015-000    DSM      SCCPHC   IS-NR    Active   -----
3203  128-015-000    DSM      SCCPHC   IS-NR    Active   -----
3205  128-015-000    DSM      SCCPHC   IS-NR    Active   -----
3207  128-015-000    DSM      SCCPHC   IS-NR    Active   -----
3211  128-015-000    DSM      SCCPHC   IS-NR    Active   -----
3213  128-015-000    DSM      SCCPHC   IS-NR    Active   -----
3215  128-015-000    DSM      SCCPHC   IS-NR    Active   -----
3217  128-015-000    DSM      SCCPHC   IS-NR    Active   -----
5317  128-015-000    DSM      SCCPHC   IS-NR    Active   -----
6101  128-015-000    DSM      SCCPHC   IS-NR    Active   -----
6103  128-015-000    DSM      SCCPHC   IS-NR    Active   -----
6105  128-015-000    DSM      SCCPHC   IS-NR    Active   -----
6107  128-015-000    DSM      SCCPHC   IS-NR    Active   -----
6111  128-015-000    DSM      SCCPHC   IS-NR    Active   -----
6113  128-015-000    DSM      SCCPHC   IS-NR    Active   -----
6115  128-015-000    DSM      SCCPHC   IS-NR    Active   -----
6117  128-015-000    DSM      SCCPHC   IS-NR    Active   -----

```

Command Completed.

;

This example shows a full report for a HIPR2 card:

```
rept-stat-card:loc=2109:mode=full
```

```
rlghncxa03w 09-06-04 15:10:19 EST EAGLE 5 41.1.0
CARD   VERSION      TYPE      GPL      PST      SST
AST
2109   128-022-000   HIPR2     HIPR2    IS-NR    Active
```

-----

```
ALARM STATUS      = No Alarms.
TRIAL VERSION     = HIPR2 023-099-008
FPGA VERSION      = HIPR2 008-001-003-002
CURRENT TEMPERATURE = 73C (164F)
PEAK TEMPERATURE: = 73C (164F)      [02-01-05 10:12]
```

Command Completed.

;

This example shows a full report for a card running the IPSG GPL. Fast Copy functionality has been provisioned for the IPSG GPL.

```
rept-stat-card:loc=1102:mode=full
```

```
stpc9070501 11-05-04 17:43:56 EDT EAGLE5 44.0.0
CARD   VERSION      TYPE      GPL      PST      SST
AST
1102   009-054-000   E5ENET    IPSG     IS-NR    Active
```

-----

```
ALARM STATUS      = No Alarms.
BLIXP   GPL version = 009-054-000
IMT BUS A         = Conn
IMT BUS B         = Conn
CLOCK A          = Idle
CLOCK B          = Active
CLOCK I          = Idle
MBD BIP STATUS   = Valid
MOTHER BOARD ID  = EPM A
DBD STATUS       = Valid
DBD TYPE         = 1G ENET
DBD MEMORY SIZE  = 512M
HW VERIFICATION CODE = ----
CURRENT TEMPERATURE = 42C (108F)
PEAK TEMPERATURE: = 43C (110F)      [11-05-04 13:55]
```

SIGNALING LINK STATUS

```
      SLK   PST           LS           CLLI           E5IS
      A     IS-NR        stpa113n    stpa113n
INACTIVE
      B     IS-NR        sc2a115n    sc2a115n
INACTIVE
```

```

A1    IS-NR                stpa113n    stpa113n    INACTIVE
B1    IS-NR                sc2a115n    sc2a115n    INACTIVE
A4    IS-NR                sp2a115n    sp2a115n    INACTIVE
B4    IS-NR                sp3a116n    sp3a116n    INACTIVE
A5    IS-NR                sp2a115n    sp2a115n    INACTIVE
B5    IS-NR                sp3a116n    sp3a116n    INACTIVE
IPLNK STATUS
IPLNK  IPADDR              STATUS     PST
A      10.251.100.166      UP         IS-NR
B      10.251.102.27       UP         IS-NR
FCLNK STATUS
A1     172.21.48.242       UP         IS-NR
B1     172.22.48.242       UP         IS-NR
FASTCOPY STATUS
ONLINE
ASSOCIATION STATUS
ANAME          PST          SST
ipn1102am2pa   IS-NR        ESTABLISHED
ipn1102a1m2pa   IS-NR        ESTABLISHED
gwn1102bm3ua   IS-NR        ESTABLISHED
gwn1102b1m3ua   IS-NR        ESTABLISHED
ipns1102a4m2pa IS-NR        ESTABLISHED
ipns1102a5m2pa IS-NR        ESTABLISHED
gwns1102b4m3ua IS-NR        ESTABLISHED
gwns1102b5m3ua IS-NR        ESTABLISHED
APPLICATION SERVICING
          TVG     MFC          TVG     MFC
SNM      REQ STATUS = 24 hr: ----- ---, 5 min: ----- ---
SLAN     REQ STATUS = 24 hr: ----- ---, 5 min: ----- ---
SCCP     REQ STATUS = 24 hr: ----- ---, 5 min: ----- ---
EROUTE   REQ STATUS = 24 hr: ----- G--, 5 min: ----- G--
INM      REQ STATUS = 24 hr: ----- G--, 5 min: ----- ---
MTP3     REQ STATUS = 24 hr:          G--, 5 min:          G--

```

Command Completed.

;

This example shows a full report for a card running the IPSP application and receiving pure MTP routed traffic. The MFC option and E5IS feature are ON.

```
rept-stat-card:loc=1105:mode=full
```

```

e1080403 11-03-10 14:46:53 EST EAGLE 44.0.0
CARD   VERSION   TYPE   GPL     PST     SST     AST
1105   134-000-000   E5ENETB  IPSP    IS-NR   Active  -----
ALARM STATUS           = No Alarms.
BLMCAP  GPL version = 056-042-000
IMT BUS A              = Conn
IMT BUS B              = Conn
CLOCK A                = Active
CLOCK B                = Idle
CLOCK I                = Idle
MBD BIP STATUS         = Valid
MOTHER BOARD ID       = EPM A

```

```

DBD STATUS          = Valid
DBD TYPE            = 1G ENET
DBD MEMORY SIZE     = 512M
HW VERIFICATION CODE = ----
CURRENT TEMPERATURE = 43C (110F)
PEAK TEMPERATURE:  = 45C (113F)      [11-03-08 10:18]
SIGNALING LINK STATUS
  SLK   PST           LS           CLLI           E5IS
  B2    IS-NR         ipsg1105b2  -----
INACTIVE
IPLNK STATUS
  IPLNK IPADDR        STATUS    PST
  A     10.254.101.121 UP      IS-NR
  B     10.254.100.4  UP      IS-NR
ASSOCIATION STATUS
  ANAME          PST           SST
  m3ua1105b2     IS-NR         ESTABLISHED
APPLICATION SERVICING
          TVG    MFC           TVG    MFC
SNM      REQ STATUS = 24 hr: GDNHSI ---, 5 min: GD---- ---
SLAN     REQ STATUS = 24 hr: ----- GDN, 5 min: ----- G--
SCCP     REQ STATUS = 24 hr: ----- ---, 5 min: ----- ---
EROUTE   REQ STATUS = 24 hr: ----- GDN, 5 min: ----- G--
INM      REQ STATUS = 24 hr: G----- ---, 5 min: G----- ---
MTP3     REQ STATUS = 24 hr: ---, 5 min: ---

```

Command Completed.

;

This example shows a full report for an E5-TSM card:

```
rept-stat-card:loc=1106:mode=full
```

```

tekelecstp 10-12-09 19:15:28 EST EAGLE 43.0.0
CARD  VERSION      TYPE      GPL      PST      SST
AST
1106  130-001-000  TSM      GLSHC    IS-NR    Active
-----
ALARM STATUS          = No Alarms.
BLIXP  GPL version = 133-044-000
IMT BUS A             = Conn
IMT BUS B             = Conn
CLOCK A               = Active
CLOCK B               = Idle
CLOCK I               = Idle
MBD BIP STATUS        = Valid
MOTHER BOARD ID       = EPM A
DBD STATUS            = Valid
DBD TYPE              = None
DBD MEMORY SIZE       = 512M
HW VERIFICATION CODE  = ----
CURRENT TEMPERATURE   = 44C (112F)
PEAK TEMPERATURE:    = 44C (112F)      [10-10-05 19:10]

```

Command Completed.

This example shows the output when E5-MCAP, E5-TDM, and E5-MDAL cards are used:

rept-stat-card

```
e5oam 14-12-01 15:38:32 EST EAGLE 46.2.0
CARD   VERSION      TYPE      GPL      PST      SST      AST
1109   030-009-000    HIPR2     HIPR2    IS-NR    Active   -----
1110   030-009-000    HIPR2     HIPR2    IS-NR    Active   -----
1113   030-010-008    E5MCAP    OAMHC    IS-NR    Standby  -----
1114   -----        E5TDM                    IS-NR    Active   -----
1115   030-010-008    E5MCAP    OAMHC    IS-NR    Active   -----
1116   -----        E5TDM                    IS-NR    Active   -----
1117   -----        E5MDAL                    OOS-MT    Isolated -----
```

Command Completed.

;

This example shows the output for a HIPR2 card, which does not support thermal monitoring:

rept-stat-card:loc=2109

```
rlghncxa03w 09-06-04 15:10:19 EST EAGLE 5 41.1.0
CARD   VERSION      TYPE      GPL      PST      SST      AST
2109   128-022-000    HIPR2     HIPR2    IS-NR    Active   -----
ALARM STATUS      = No Alarms.
TRIAL VERSION     = HIPR2 023-099-008
FPGA VERSION      = HIPR2 008-001-003-002
CURRENT TEMPERATURE = NA
PEAK TEMPERATURE: = NA
```

Command Completed.

;

This example shows the output for a HIPR2 card when the card is not in-service:

rept-stat-card:loc=1109

```
rlghncxa03w 09-06-04 15:10:19 EST EAGLE 5 41.1.0
CARD   VERSION      TYPE      GPL      PST      SST      AST
1209   -----        HIPR2     HIPR2    OOS-MT    Isolated -----
ALARM STATUS      = No Alarms.
TRIAL VERSION     = HIPR2 023-099-008
FPGA VERSION      = HIPR2 -----
CURRENT TEMPERATURE = ----
PEAK TEMPERATURE: = ----
```

Command Completed.

;

This example shows the output for an E5-OAM card when the Integrated Measurements feature is turned on:

```
rept-stat-card:loc=1113
```

```

tekelecstp 02-01-08 04:50:35 EST EAGLE 46.0.0
CARD   VERSION      TYPE      GPL      PST      SST
AST
1113   134-068-000   E5MCAP   OAMHC    IS-NR    Active
-----
ALARM STATUS      = No Alarms
BLMCAP GPL version = 134-054-000
IMT BUS A         = Conn
IMT BUS B         = Conn
CURRENT TEMPERATURE = 31C ( 88F)
PEAK TEMPERATURE: = 32C ( 90F)      [02-01-08 04:31]

Command Completed.
;
```

This example shows a full report for the E5-MASP of MASP A located in slot 1113, which is currently active:

```
rept-stat-card:loc=1113:mode=full
```

```

tekelecstp 10-01-07 09:37:39 EST EAGLE 42.0.0
CARD   VERSION      TYPE      GPL      PST      SST
AST
1113   030-002-022   E5MCAP   OAMHC    IS-NR    Active
-----
ALARM STATUS      = No Alarms.
BLMCAP GPL version = 030-004-000
IMT BUS A         = Conn
IMT BUS B         = Conn
CLOCK A          = Active
CLOCK B          = Idle
CLOCK I          = Idle
MBD BIP STATUS   = Valid
MOTHER BOARD ID  = E5-MCAP
DBD STATUS       = Valid
DBD TYPE         = 1G ENET
DBD MEMORY SIZE  = 2048M
HW VERIFICATION CODE = ----
CURRENT TEMPERATURE = 0C ( 32F)
PEAK TEMPERATURE: = 0C ( 32F)      [00-00-00 00:00]
TROUBLE TEXT VER. = Rev 133.1.2
TVG STATUS
IPLNK STATUS
  IPLNK IPADDR      STATUS  PST
  A     192.168.1.1  UP     IS-NR
```

This example shows a full report for an E5-MASP card when an IP mismatch condition exists:

```
rept-stat-card:loc=1113:mode=full
```

```
tekelecstp 10-01-07 09:37:39 EST EAGLE 42.0.0
CARD   VERSION   TYPE      GPL       PST       SST       AST
1113   030-002-022  E5MCAP   OAMHC     IS-NR     Active    -----
ALARM STATUS      = No Alarms.
BLMCAP GPL version = 030-004-000
IMT BUS A         = Conn
IMT BUS B         = Conn
CLOCK A           = Active
CLOCK B           = Idle
CLOCK I           = Idle
MBD BIP STATUS    = Valid
MOTHER BOARD ID   = E5-MCAP
DBD STATUS        = Valid
DBD TYPE          = 1G ENET
DBD MEMORY SIZE   = 2048M
HW VERIFICATION CODE = ----
CURRENT TEMPERATURE = 0C ( 32F)
PEAK TEMPERATURE:  = 0C ( 32F)      [00-00-00 00:00]
TROUBLE TEXT VER. = Rev 133.1.2
TVG STATUS
IPLNK STATUS
  IPLNK IPADDR      STATUS   PST
  A     192.168.1.1  UP      IS-NR
  IP Mismatch exists, reset required
```

This example shows a full report for an E5-ENET-B used as an STC card:

```
rept-stat-card:loc=1102:mode=full
```

```
rlghncxa03w 11-03-09 16:35:57 EST EAGLE 44.0.0
CARD   VERSION   TYPE      GPL       PST       SST       AST
1102   134-000-000  STC      ERTHC     IS-NR     Active    -----
ALARM STATUS      = No Alarms.
BLMCAP GPL version = 032-000-000
IMT BUS A         = Conn
IMT BUS B         = Conn
CLOCK A           = Fault
CLOCK B           = Fault
CLOCK I           = Idle
MBD BIP STATUS    = Valid
MOTHER BOARD ID   = EPM B
DBD STATUS        = Valid
DBD TYPE          = 1G ENET
DBD MEMORY SIZE   = 2048M
HW VERIFICATION CODE = ----
CURRENT TEMPERATURE = 62C (144F)
PEAK TEMPERATURE:  = 63C (146F)      [02-04-18 19:53]
EROUTE % OCCUP    = 0%
SOCKET = INACTIVE
```



```

NTP broadcast = VALID
IPLNK STATUS
  IPLNK  IPADDR          STATUS  PST
  A      192.168.210.166  UP      IS-NR
  B      -----          DOWN    OOS-MT
STC IP CONNECTION
  PORT  PST          SST
  A     IS-NR        Active
  B     OOS-MT       Unavail

```

Command Completed.

;

This example shows a full report for an E5-ATM-B card.

```
rept-stat-card:loc=1107:mode=full
```

```

rlghncxa03w 11-03-10 14:00:53 EST EAGLE5 44.0.0
CARD  VERSION      TYPE      GPL      PST      SST
AST
1107  134-000-000  LIMATM   ATMHC    IS-NR    Active
-----
ALARM STATUS      = * 0022 Clock B for card failed, Clock A
normal
BLMCAP  GPL version = 023-000-000
IMT BUS A      = Conn
IMT BUS B      = Conn
CLOCK A        = Active
CLOCK B        = Fault
CLOCK I        = Idle
HS CLOCK A     = Active
HS CLOCK B     = Fault
HS CLOCK I     = Idle
MBD BIP STATUS = Valid
MOTHER BOARD ID = EPM B
DBD STATUS     = Valid
DBD TYPE       = ATM
DBD MEMORY SIZE = 2048M
HW VERIFICATION CODE = ----
CURRENT TEMPERATURE = 54C (130F)
PEAK TEMPERATURE:   = 55C (131F) [20-12-22 10:55]
SIGNALING LINK STATUS
  SLK  PST          LS          CLLI
  A    IS-NR        lsatm1     -----
  B    IS-NR        lsatm1     -----
  A1   IS-NR        lsatm12    -----
APPLICATION SERVICING
          MFC          MFC
SNM      REQ STATUS = 24 hr: ---, 5 min: ---
SLAN     REQ STATUS = 24 hr: ---, 5 min: ---
SCCP     REQ STATUS = 24 hr: ---, 5 min: ---
INM      REQ STATUS = 24 hr: G--, 5 min: G--
MTP3     REQ STATUS = 24 hr: G--, 5 min: G--

```

Command Completed.

;

This example shows the output for an E5-ENET-B card used as an IPSM card:

```
rept-stat-card:loc=1103:mode=full
```

```
rlghncxa03w 11-03-09 16:35:57 IST EAGLE 44.0.0
CARD   VERSION   TYPE     GPL      PST      SST      AST
1103   134-000-000  IPSM    IPSHC    IS-NR    Active   -----
ALARM STATUS      = No Alarms.
BLMCAP GPL version = 032-000-000
IMT BUS A         = Conn
IMT BUS B         = Conn
CLOCK A           = Active
CLOCK B           = Idle
CLOCK I           = Idle
MBD BIP STATUS    = Valid
MOTHER BOARD ID  = EPM B
DBD STATUS        = Valid
DBD TYPE          = 1G ENET
DBD MEMORY SIZE   = 2048M
HW VERIFICATION CODE = ----
CURRENT TEMPERATURE = 62C (144F)
PEAK TEMPERATURE:  = 63C (146F) [02-09-14 14:49]
SFLOG = NO
      IPLNK IPADDR      STATUS  PST
      A     10.220.9.9   UP      IS-NR
```

Command Completed.

;

This example shows the output for an E5-MCPM-B card:

```
rept-stat-card:loc=1108
```

```
tekelecstp 11-04-25 19:44:35 EST EAGLE5 44.0.0
CARD   VERSION   TYPE     GPL      PST      SST      AST
1108   134-000-000  MCPM    MCPHC    IS-NR    Active   -----
ALARM STATUS      = No Alarms.
BLMCAP GPL version = 134-000-000
IMT BUS A         = Conn
IMT BUS B         = Conn
CLOCK A           = Active
CLOCK B           = Idle
CLOCK I           = Idle
MBD BIP STATUS    = Valid
MOTHER BOARD ID  = EPM B
DBD STATUS        = Valid
DBD TYPE          = 1G ENET
DBD MEMORY SIZE   = 4096M
HW VERIFICATION CODE = ----
```

```

CURRENT TEMPERATURE = 42C (108F)
PEAK TEMPERATURE:  = 42C (108F) [11-04-24 04:32]
IPLNK STATUS
  IPLNK  IPADDR          STATUS  PST
  A      10.250.37.176   UP      IS-NR
MCP IP CONNECTION
  PORT  PST          SST
  A     IS-NR       Active

```

Command Completed.

;

This example shows a full report for an E5-MCPM-B card:

```
rept-stat-card:loc=1108:mode=full
```

```

tekelecstp 11-04-25 19:44:35 EST EAGLE5 44.0.0
CARD  VERSION      TYPE      GPL      PST      SST
AST
  1108  134-000-000  MCPM      MCPHC    IS-NR    Active

```

-----

```

ALARM STATUS      = No Alarms.
BLMCAP  GPL version = 134-000-000
IMT BUS A         = Conn
IMT BUS B         = Conn
CLOCK A           = Active
CLOCK B           = Idle
CLOCK I           = Idle
MBD BIP STATUS    = Valid
MOTHER BOARD ID   = EPM B
DBD STATUS        = Valid
DBD TYPE          = 1G ENET
DBD MEMORY SIZE   = 4096M
HW VERIFICATION CODE = ----
CURRENT TEMPERATURE = 42C (108F)
PEAK TEMPERATURE:  = 42C (108F) [11-04-24 04:32]
IPLNK STATUS
  IPLNK  IPADDR          STATUS  PST
  A      10.250.37.176   UP      IS-NR
MCP IP CONNECTION
  PORT  PST          SST
  A     IS-NR       Active

```

Command Completed.

;

This example shows the output for an E5-ENET-B card used as an IPSP card:

```
rept-stat-card:loc=1111:mode=full
```

```

stpc9070501 11-05-23 15:30:39 EDT EAGLE5 44.0.0
CARD  VERSION      TYPE      GPL      PST      SST

```

```

AST
1111 009-003-000 E5ENETB IPSG      IS-NR      Active      -----
ALARM STATUS      = No Alarms.
BLMCAP  GPL version = 009-003-000
IMT BUS A        = Conn
IMT BUS B        = Conn
CLOCK A         = Idle
CLOCK B         = Active
CLOCK I         = Idle
MBD BIP STATUS   = Valid
MOTHER BOARD ID = EPM B
DBD STATUS      = Valid
DBD TYPE        = 1G ENET
DBD MEMORY SIZE = 2048M
HW VERIFICATION CODE = ----
CURRENT TEMPERATURE = 46C (115F)
PEAK TEMPERATURE:  = 46C (115F)      [11-05-23 15:09]
SIGNALING LINK STATUS
  SLK  PST          LS          CLLI          E5IS
  A    OOS-MT       ls1111n00   tk1cc1111n0  INACTIVE
  A4   OOS-MT       lr1111n08   tkc1111n8   INACTIVE
IPLNK STATUS
  IPLNK IPADDR      STATUS    PST
  A     10.251.105.68  UP        IS-NR
  B     -----      ----     ----
ASSOCIATION STATUS
  ANAME          PST          SST
  egwn1111am3ua  OOS-MT      CONNECTING
  egwns1111a4m3ua OOS-MT      CONNECTING
APPLICATION SERVICING
          TVG    MFC          TVG    MFC
SNM      REQ STATUS = 24 hr: ----- ---, 5 min: ----- ---
SLAN     REQ STATUS = 24 hr: ----- ---, 5 min: ----- ---
SCCP     REQ STATUS = 24 hr: ----- ---, 5 min: ----- ---
EROUTE   REQ STATUS = 24 hr: ----- G--, 5 min: ----- G--
INM      REQ STATUS = 24 hr: ----- ---, 5 min: ----- ---
MTP3     REQ STATUS = 24 hr: ----- ---, 5 min: ----- ---

```

Command Completed.

;

This example shows a full report when the EPAP Data Split feature is enabled:

```
rept-stat-card:loc=1201:mode=full
```

```

epap240m 12-01-29 11:53:07 CST  EAGLE 45.0.0
CARD  VERSION    TYPE    GPL      PST          SST      AST
1201  074-012-005  LIME1  SS7HC    IS-NR      Active  -----
ALARM STATUS      = No Alarms.
BPMP  GPL version = 134-015-000
IMT BUS A        = Conn
IMT BUS B        = Conn
CLOCK A         = Idle
CLOCK B         = Active

```

```

CLOCK I          = Idle
MBD BIP STATUS  = Valid
MOTHER BOARD ID = MPL
DBD STATUS      = Valid
DBD TYPE        = None
DBD MEMORY SIZE = 0M
HW VERIFICATION CODE = ----
SIGNALING LINK STATUS
  SLK   PST           LS           CLLI
  A     OOS-MT-DSBLD  lsa1      -----
APPLICATION SERVICING
          TVG   MFC           TVG   MFC
SNM      REQ STATUS = 24 hr: ----- ---, 5 min: ----- ---
SLAN     REQ STATUS = 24 hr: ----- ---, 5 min: ----- ---
SCCP     REQ STATUS = 24 hr: ----- ---, 5 min: ----- ---
INM      REQ STATUS = 24 hr: ----- ---, 5 min: ----- ---
MTP3     REQ STATUS = 24 hr: ----- ---, 5 min: ----- ---
SCPDN    REQ STATUS = 24 hr: ----- ---, 5 min: ----- ---
SCPIMSI  REQ STATUS = 24 hr: ----- ---, 5 min: ----- ---

```

Command Completed.

;

This example shows a full report when the Dual ExAP Config feature is enabled:

**rept-stat-card:loc=1201:mode=full**

```

epap240m 12-01-29 11:53:07 CST EAGLE 45.0.0
  CARD   VERSION   TYPE     GPL      PST      SST
AST
  1201   074-012-005 LIMDS0   SS7ML    IS-NR    Active
-----
ALARM STATUS      = No Alarms.
BPMPPL  GPL version = 134-015-000
IMT BUS A        = Conn
IMT BUS B        = Conn
CLOCK A          = Idle
CLOCK B          = Active
CLOCK I          = Idle
MBD BIP STATUS  = Valid
MOTHER BOARD ID = MPL
DBD STATUS      = Valid
DBD TYPE        = None
DBD MEMORY SIZE = 0M
HW VERIFICATION CODE = ----
SIGNALING LINK STATUS
  SLK   PST           LS           CLLI
  A     OOS-MT-DSBLD  lsa1      -----
APPLICATION SERVICING
          TVG   MFC           TVG   MFC
SNM      REQ STATUS = 24 hr: ----- ---, 5 min: ----- ---
SLAN     REQ STATUS = 24 hr: ----- ---, 5 min: ----- ---
SCCP     REQ STATUS = 24 hr: ----- ---, 5 min: ----- ---
INM      REQ STATUS = 24 hr: ----- ---, 5 min: ----- ---
MTP3     REQ STATUS = 24 hr: ----- ---, 5 min: ----- ---

```

```

SCPEPAP REQ STATUS = 24 hr:    ---, 5 min:    ---
SCPELAP REQ STSTUS = 24 hr:    ---, 5 min:    ---

```

Command Completed.

;

This example shows a full report when both EPAP Data Split feature and Dual ExAP Config features are enabled:

rept-stat-card:loc=1201:mode=full

```

epap240m 12-01-29 11:53:07 CST EAGLE 45.0.0
CARD  VERSION      TYPE      GPL      PST      SST      AST
1201  074-012-005  LIMDS0   SS7ML   IS-NR    Active   -----
ALARM STATUS      = No Alarms.
BPMPPL  GPL version = 134-015-000
IMT BUS A         = Conn
IMT BUS B         = Conn
CLOCK A          = Idle
CLOCK B          = Active
CLOCK I          = Idle
MBD BIP STATUS   = Valid
MOTHER BOARD ID  = MPL
DBD STATUS       = Valid
DBD TYPE         = None
DBD MEMORY SIZE  = 0M
HW VERIFICATION CODE = ----
SIGNALING LINK STATUS
  SLK  PST          LS      CLLI
  A    OOS-MT-DSBLD lsa1    -----
APPLICATION SERVICING
          TVG  MFC          TVG  MFC
SNM     REQ STATUS = 24 hr: ----- ---, 5 min: ----- ---
SLAN    REQ STATUS = 24 hr: ----- ---, 5 min: ----- ---
SCCP    REQ STATUS = 24 hr: ----- ---, 5 min: ----- ---
INM     REQ STATUS = 24 hr: ----- ---, 5 min: ----- ---
MTP3    REQ STATUS = 24 hr:          ---, 5 min:          ---
SCPDN   REQ STATUS = 25 hr:          ---, 5 min:          ---
SCPIMSI REQ STATUS = 25 hr:          ---, 5 min:          ---
SEPELAP REQ STATUS = 25 hr:          ---, 5 min:          ---

```

Command Completed.

;

This example shows output for an E5-SM8G-B card running the SIP application:

rept-stat-card:loc=1205

```
tekelecstp 12-06-29 15:03:34 EST EAGLE 45.0.0
```

```

CARD   VERSION      TYPE      GPL      PST      SST
AST
1205   134-045-000  DSM       SIPHC    IS-NR     Active
-----
ALARM STATUS          = No Alarms.
BLIXP  GPL version = 134-045-000
IMT BUS A              = Conn
IMT BUS B              = Conn
Command Completed.
;

```

This example shows output for an E5-SM8G-B card running the SIP application with mode=full:

```

rept-stat-card:loc=1101:mode=full

tekelecstp 12-06-29 15:03:34 EST EAGLE 45.0.0
  rept-stat-card:loc=1101:mode=full
  Command entered at terminal #18.
;

Command Accepted - Processing
tekelecstp 12-06-29 15:03:34 EST EAGLE 45.0.0
CARD   VERSION      TYPE      GPL      PST      SST
AST
  1101   029-042-007  DSM       SIPHC    IS-NR     Active
-----
ALARM STATUS          = * 0022 Clock B for card failed, Clock A
normal
BLIXP  GPL version = 059-042-000
IMT BUS A              = Conn
IMT BUS B              = Disc
CLOCK A                = Active
CLOCK B                = Fault
CLOCK I                = Idle
MBD BIP STATUS        = Valid
MOTHER BOARD ID       = SMXG A
DBD STATUS             = Valid
DBD TYPE               = None
DBD MEMORY SIZE       = 4096M
HW VERIFICATION CODE = ----
CURRENT TEMPERATURE   = 46C (115F)
PEAK TEMPERATURE:    = 46C (115F)      [02-13-06 17:11]
IPLNK STATUS
  IPLNK  IPADDR          STATUS      PST
  A      192.168.120.132  UP          IS-NR
  B      -----         ----       ----
DSM IP CONNECTION
  PORT   PST             SST
  A      IS-NR           Active
SIP CONNECTION STATUS
  CNAME      PROT          PST          OPEN
  conn1      TCP           IS-NR        YES
  conn2      UDP           IS-NR
YES

```

Command Completed.

;

This example shows output for an E5-SM8G-B card running the ENUM application:

rept-stat-card:loc=1205

```
tekelecstp 14-05-26 15:03:34 EST EAGLE 46.1.0
CARD  VERSION      TYPE      GPL      PST      SST      AST
1205  135-016-000    DSM      ENUMHC   IS-NR    Active   -----
ALARM STATUS      = No Alarms.
BLIXP  GPL version = 135-016-000
IMT BUS A          = Conn
IMT BUS B          = Conn
Command Completed.
```

;

This example shows the output when E5-APP-B cards exist in the system:

rept-stat-card

```
tekelecstp 12-14-13 11:48:18 EST 46.1.0-0.0.0
rept-stat-card
Command entered at terminal #4.
CARD  VERSION      TYPE      GPL      PST      SST      AST
1105  -----      E5APPB   EPAP     RSRVD    Avail    -----
1107  -----      E5APPB   ELAP     RSRVD    Avail    -----
1109  000-000-000    HIPR2    HIPR2    IS-NR    Active   -----
1110  000-000-000    HIPR2    HIPR2    IS-NR    Active   -----
1113  255-255-255    GPSPM    EOAM     IS-NR    Active   -----
1114  -----      E5TDM    IS-NR    IS-NR    Active   -----
1115  255-255-255    GPSPM    EOAM     IS-NR    Standby  -----
1116  -----      TDM      IS-NR    IS-NR    Active   -----
1117  -----      E5MDAL   IS-NR    IS-NR    Active   -----
6202  -----      TELCO    SWITCH   RSRVD    Avail    -----
6203  -----      TELCO    SWITCH   RSRVD    Avail    -----
Command Completed.
```

;

This example shows the report for a card location equipped with an E5-APP-B card:

rept-stat-card:loc=1105

```
tekelecstp 12-07-13 11:49:35 EST 45.0.0-64.37.0
rept-stat-card:loc=1105
Command entered at terminal #4.
CARD  VERSION      TYPE      GPL      PST      SST      AST
1105  -----      E5APPB   EPAP     RSRVD    Avail    -----
Command Completed.
```

;

These examples show the report for E5-APP-B application cards:



```
rept-stat-card:appl=epap
```

```
tekelecstp 12-07-13 11:52:44 EST 45.0.0-64.37.0
rept-stat-card:appl=epap
Command entered at terminal #4.
CARD   VERSION      TYPE      GPL      PST      SST
AST
1105   -----      E5APPB   EPAP     RSRVD    Avail
-----
```

```
Command Completed.
```

```
;
```

```
rept-stat-card:appl=elap
```

```
tekelecstp 12-07-13 11:54:41 EST 45.0.0-64.37.0
rept-stat-card:appl=elap
Command entered at terminal #4.
CARD   VERSION      TYPE      GPL      PST      SST
AST
1107   -----      E5APPB   ELAP     RSRVD    Avail
-----
```

```
Command Completed.
```

```
;
```

```
rept-stat-card:appl=lsms
```

```
tekelecstp 12-07-13 11:54:41 EST 45.0.0-64.37.0
rept-stat-card:appl=lsms
Command entered at terminal #4.
CARD   VERSION      TYPE      GPL      PST      SST
AST
1103   -----      E5APPB   LSMS     RSRVD    Avail
-----
```

```
Command Completed.
```

```
;
```

```
rept-stat-card:appl=nas
```

```
tekelecstp 12-07-13 11:54:41 EST 45.0.0-64.37.0
rept-stat-card:appl=nas
Command entered at terminal #4.
CARD   VERSION      TYPE      GPL      PST      SST
```

```

AST
1101  -----  E5APPB  NAS          RSRVD          Avail  -----

```

```

Command Completed.
;

```

This example shows the report for a card location equipped with a Telco Switch:

```
rept-stat-card:loc=6202
```

```

tekelecstp 12-09-06 11:43:37 EST 45.0.0
rept-stat-card:loc=6202
Command entered at terminal #4.
CARD  VERSION      TYPE      GPL      PST      SST      AST
6202  -----      TELCO    SWITCH  RSRVD    Avail    -----

```

```

Command Completed.
;

```

This example shows the report for Telco Switches with parameter appl=switch:

```
rept-stat-card:appl=switch
```

```

tekelecstp 12-09-06 11:44:19 EST 45.0.0
rept-stat-card:appl=switch
Command entered at terminal #4.
CARD  VERSION      TYPE      GPL      PST      SST      AST
6201  -----      TELCO    SWITCH  RSRVD    Avail    -----
6202  -----      TELCO    SWITCH  RSRVD    Avail    -----

```

```

Command Completed.
;

```

This example shows output for an E5-SM8G-B card running the DEIRHC GPL:

```
rept-stat-card:loc=1105
```

```

tekelecstp 13-04-24 11:18:57 EST  EAGLE 45.1.0
rept-stat-card:loc=1105
Command entered at terminal #26.
;

```

```

Command Accepted - Processing

```

```

tekelecstp 02-01-24 11:18:57 EST  EAGLE 45.1.0
CARD  VERSION      TYPE      GPL      PST      SST      AST
1105  011-056-006  DSM      DEIRHC  IS-NR    Active  ---
ALARM STATUS          = No Alarm
BLIXP  GPL version    = 008-056-003
IMT BUS A              = Conn

```

```

IMT BUS B          = Conn
CURRENT TEMPERATURE = 33C ( 92F)
PEAK TEMPERATURE:  = 33C ( 92F)      [13-04-24 11:00]
DEIR SM DATA TYPE = IMSI

```

Command Completed.

;

This example shows output for the DEIR application with mode=full:

```
rept-stat-card:loc=1105:mode=full
```

```

tekelecstp 13-04-24 11:28:54 EST EAGLE 46.4.0.0-69.3.1
rept-stat-card:loc=1105:mode=full
Command entered at terminal #26.

```

;

Command Accepted - Processing

```

tekelecstp 02-01-24 11:22:54 EST EAGLE 45.1.0
CARD  VERSION      TYPE      GPL      PST      SST
AST
1101  47-003-001  SLIC     DEIRHC   IS-NR     Active
-----

```

```

ALARM STATUS      = normal
BLDC64  GPL version = 008-056-003
IMT BUS A         = Conn
IMT BUS B         = Conn
CLOCK A          = Active
CLOCK B          = Idle
CLOCK I          = Idle
MBD BIP STATUS   = Valid
MOTHER BOARD ID  = SLIC
DBD STATUS       = Valid
DBD TYPE         = None
DBD MEMORY SIZE  = 8192M
HW VERIFICATION CODE = ----
CURRENT TEMPERATURE = 67C (153F 73C (164F)      [16-05-25 :40]
DEIR SM DATA TYPE = IMSI

```

```

IPLNK STATUS
  IPLNK  IPADDR      STATUS      PST
  A      192.168.120.135  UP          IS-NR      89
  C      10.248.14.55    DOWN        OOS-MT
  D      192.168.120.138  DOWN        OOS-MT

```

```

DSM IP CONNECTION
  PORT  PST          SST

```

```

IS-NR      Active
  D        OOS-MT      Unavail

```

```

DEIR CONNECTION STATUS
  DCNAME      STATUS      ANAME      STATUS
  abc1        UP          abc1       IS-NR
  abc2        UP          abc2       IS-NR
  abc3        DOWN       abc3       IS-NR

```

Command Completed.

;

This example shows the full report when an IPS card is provisioned as an SFLOG card:

```
rept-stat-card:loc=1107:mode=full
```

```
tekelecstp 15-05-27 15:43:58 EST EAGLE 46.3.0
CARD  VERSION      TYPE      GPL      PST      SST      AST
1107  131-010-000    IPSM      IPSHC    IS-NR    Active   -----
ALARM STATUS      = No Alarm
BLIXP  GPL version = 133-044-000
IMT BUS A         = Conn
IMT BUS B         = Conn
CLOCK A          = Fault
CLOCK B          = Active
CLOCK I          = Idle
MBD BIP STATUS   = Valid
MOTHER BOARD ID  = EPM B
DBD STATUS       = Valid
DBD TYPE         = 1G ENET
DBD MEMORY SIZE  = 2048M
HW VERIFICATION CODE = ----
CURRENT TEMPERATURE = 45C (113F)
PEAK TEMPERATURE: = 45C (113F)      [15-05-27 15:43]
SFLOG = YES
IPLNK STATUS
  IPLNK IPADDR      STATUS  PST
  A     10.254.101.121  UP     IS-NR
```

Command Completed.

;

This example shows the full report for an SCCP card with the SFLOG MFC service:

```
rept-stat-card:loc=1101:mode=full
```

```
tekelecstp 15-07-07 07:02:54 EST EAGLE5 46.3.0
CARD  VERSION      TYPE      GPL      PST      SST      AST
1101  017-001-013    DSM      SCCPHC    IS-NR    Active   -----
ALARM STATUS      = No Alarms.
BLIXP  GPL version = 021-001-000
IMT BUS A         = Conn
IMT BUS B         = Conn
CLOCK A          = Active
CLOCK B          = Idle
CLOCK I          = Idle
MBD BIP STATUS   = Valid
MOTHER BOARD ID  = SMXG A
DBD STATUS       = Valid
DBD TYPE         = None
DBD MEMORY SIZE  = 4096M
HW VERIFICATION CODE = ----
CURRENT TEMPERATURE = 46C (115F)
```

```

PEAK TEMPERATURE:      = 46C (115F)      [15-07-07 07:02]
SCCP % OCCUP           = 1%
APPLICATION SERVICING

          TVG      MFC          TVG      MFC
SNM      REQ STATUS = 24 hr: ----- ---, 5 min: ----- ---
INM      REQ STATUS = 24 hr: ----- ---, 5 min: ----- ---
MTP3     REQ STATUS = 24 hr:          G--, 5 min:      ---
SFLOG    REQ STATUS = 24 hr:          ---, 5 min:      ---

IPLNK STATUS
IPLNK  IPADDR          STATUS      PST
A      -----          ----      ----
B      -----          ----      ----

DSM IP CONNECTION
PORT  PST              SST
A     OOS-MA          Ueq
B     OOS-MA          Ueq

```

Command Completed.

;

This example shows output for a SLIC card running the IPSG GPL with mode=full:

```
rept-stat-card:loc=1203:mode=full
```

```

stpa1090701 16-04-1624 11:09:37 EST EAGLE5 46.3.0.0.0-68.18.0
rept-stat-card:loc=1203:mode=full
Command entered at terminal #4.

```

;

```

stpa1090701 16-04-16 11:09:37 EST EAGLE5 46.3.0.0.0-68.18.0
1203 138-018-000 SLIC IPSG IS-NR Active

```

-----

.

```
BLSLC32 GPL version = 138-018-000
```

Idle

Valid

```

MOTHER BOARD ID      = SLIC
DBD STATUS            = Valid
DBD TYPE              = None
DBD MEMORY SIZE      = 16384M

```

39C (103F)

```
PEAK TEMPERATURE:      = 43C (110F)      [16-04-12 06:24]
```

```

SLK  PST              LS              CLLI
A    IS-NR            sd1c114a          -----
A1   IS-NR            sd2c114a          -----
A2   IS-NR            sd3c114a          -----
A3   IS-NR            sd4c114a          -----
A4   IS-NR            sd5c114a          -----

```

```

IPLNK 103.50          UP              IS-NR
B      -----          ----          ----

```

```

eipa1203am2pa        IS-NR          ESTABLISHED
eipi1203a1m2pa        IS-NR          ESTABLISHED
eipis1203a2m2pa       IS-NR          ESTABLISHED
eipn1203a3m2pa        IS-NR          ESTABLISHED

```

```

          eipc1203a4m2pa      IS-NR          ESTABLISHED
APPLICATION SERVICING
          SNM      REQ STATUS = 24 hr: G--, 5 min: ---
          SLAN     REQ STATUS = 24 hr: ---, 5 min: ---
          SCCP     REQ STATUS = 24 hr: ---, 5 min: ---
          INM      REQ STATUS = 24 hr: G--, 5 min: ---
          MTP3     REQ STATUS = 24 hr: G--, 5 min: G--
          SCPEPAP  REQ STATUS = 24 hr: ---, 5 min: ---
          SCPELAP  REQ STATUS = 24 hr: ---, 5 min: ---

;

rept-stat-card

Command Accepted - Processing

tekelecstp 16-05-25 12:38:37 EST EAGLE 46.4.0.0.0-69.3.1
rept-stat-card
Command entered at terminal #3.

;

tekelecstp 16-05-25 12:38:38 EST EAGLE 46.4.0.0.0-69.3.1
CARD  VERSION      TYPE      GPL      PST      SST      AST
1101  -----      SLIC     GLSHC    OOS-MT-DSBLD  MEA
----- 1105  139-003-000 TSM      GLSHC    IS-NR      Active
-----
1106  -----      SLIC     GLSHC    OOS-MT-DSBLD  MEA      -----
1109  139-003-000 HIPR2    HIPR2    IS-NR      Active    -----
1110  139-003-000 HIPR2    HIPR2    IS-NR      Active    -----
1112  139-003-000 SLIC     IPSG     IS-NR      Active    -----
1113  030-003-001 E5MCAP  OAMHC    IS-NR      Active    -----
1114  -----      E5TDM           IS-NR      Active    -----
1115  030-003-001 E5MCAP  OAMHC    IS-NR      Standby   -----
1116  -----      E5TDM           IS-NR      Active    -----
1117  -----      E5MDAL           OOS-MT      Isolated  -----

Command Completed.

```

This example shows output for a SLIC card running the ENUMHC GPL with mode=full:

```

rept-stat-card:loc=1103:mode=full

tekelecstp 16-06-22 03:19:34 EST EAGLE 46.4.0.0.0-69.3.1
rept-stat-card:loc=1103:mode=full
Command entered at terminal #18.

;

Command Accepted - Processing
tekelecstp 16-06-22 03:19:34 EST EAGLE 46.4.0.0.0-69.3.1
CARD  VERSION      TYPE      GPL      PST      SST      AST
1103  139-002-000 SLIC     ENUMHC   IS-NR      Active    -----

```

```

ALARM STATUS          = No Alarms.
BLSLC32 GPL version = 139-002-000
IMT BUS A             = Conn
IMT BUS B             = Conn
CLOCK A               = Active
CLOCK B               = Idle
CLOCK I               = Idle
MBD BIP STATUS        = Valid
MOTHER BOARD ID      = SLIC
DBD STATUS            = Valid
DBD TYPE              = None
DBD MEMORY SIZE       = 16384M
HW VERIFICATION CODE = ----
CURRENT TEMPERATURE  = 73C (164F)
PEAK TEMPERATURE:    = 73C (164F)      [16-06-22 00:30]
IPLNK STATUS
  IPLNK  IPADDR          STATUS  PST
  A      192.168.120.132  UP      IS-NR
  B      10.248.13.81    UP      IS-NR

DSM IP CONNECTION
  PORT  PST              SST
  A     IS-NR            Active

ENUM CONNECTION STATUS
  CNAME  PROT           PST      OPEN
  conn1  UDP            IS-NR    YES
Command Completed.
;

```

This example shows output for a SLIC card running the SIPHC GPL with mode=full:

```

rept-stat-card:loc=1101:mode=full

tekelecstp 16-06-21 02:40:34 EST EAGLE 46.4.0.0-69.3.1
  rept-stat-card:loc=1101:mode=fullentered at terminal #18.
;

Command Accepted - Processing
  tekelecstp 16-06-21 02:40:34 EST EAGLE 46.4.0.0-69.3.1
  1101  139-002-000  SLIC      SIPHC      IS-NR
Active  ----
  BLSLC32 GPL version = 139-002-000
SLIC
None
  DBD MEMORY SIZE       = 16384M
CURRENT TEMPERATURE    = 73C (164F)
PEAK TEMPERATURE:     = 73C (164F)      [16-06-21 02:40]
IPLNK STATUS
  IPLNK  IPADDR          STATUS  PST
  A      192.168.120.131  UP      IS-NR
  B      10.248.13.76    UP      IS-NR

```

```

DSM IP CONNECTION
  A      IS-NR      Active

```

This example shows output for a SLIC card running the ERTHC GPL with mode=full:

```
rept-stat-card:mode=full:loc=1107
```

```

tekelecstp 16-07-14 05:52:22 EST EAGLE 46.4.0.0.0-69.3.1
rept-stat-card:mode=full:loc=1107
Command entered at terminal #18.

```

```
;
```

```
Command Accepted - Processing
```

```

tekelecstp 16-07-14 05:52:22 EST EAGLE 46.4.0.0.0-69.3.1
CARD  VERSION      TYPE      GPL      PST      SST      AST
1107  139-002-000    SLIC      ERTHC    IS-NR    Active   -----
ALARM STATUS      = No Alarms.
BLSLC32 GPL version = 139-002-000
IMT BUS A         = Conn
IMT BUS B         = Conn
CLOCK A           = Active
CLOCK B           = Idle
CLOCK I           = Idle
MBD BIP STATUS    = Valid
MOTHER BOARD ID   = SLIC
DBD STATUS        = Valid
DBD TYPE          = None
DBD MEMORY SIZE   = 16384M
HW VERIFICATION CODE = ----
CURRENT TEMPERATURE = 73C (164F)
PEAK TEMPERATURE:  = 73C (164F)      [16-07-14 05:50]
EROUTE % OCCUP    = 0%
NTP broadcast     = VALID
IPLNK STATUS
  IPLNK  IPADDR      STATUS      PST
  A      -----    DOWN       OOS-MT
  B      -----    DOWN       OOS-MT
STC IP CONNECTION
  PORT  PST      SST
  A     OOS-MT  Unavail
  B     OOS-MT  Unavail

```

```
Command Completed.
```

```
;
```

```
Command Executed
```

This example shows output for a SLIC card running the MCPHC GPL with mode=full:

```
rept-stat-card:mode=full:loc=1107
```

```

tekelecstp 16-07-14 06:09:15 EST EAGLE 46.4.0.0.0-69.3.1
rept-stat-card:mode=full:loc=1107

```



```

Command entered at terminal #18.
;

Command Accepted - Processing
tekelecstp 16-07-14 06:09:15 EST EAGLE 46.4.0.0.0-69.3.1
CARD   VERSION      TYPE      GPL      PST      SST
AST
1107   139-002-000   SLIC      MCPHC    IS-NR     Active
-----
ALARM STATUS          = No Alarms.
BLSLC32 GPL version = 139-002-000
IMT BUS A             = Conn
IMT BUS B             = Conn
CLOCK A              = Active
CLOCK B              = Idle
CLOCK I              = Idle
MBD BIP STATUS       = Valid
MOTHER BOARD ID     = SLIC
DBD STATUS           = Valid
DBD TYPE             = None
DBD MEMORY SIZE      = 16384M
HW VERIFICATION CODE = ----
CURRENT TEMPERATURE = 73C (164F)
PEAK TEMPERATURE:   = 74C (166F) [16-07-14 06:06]
IPLNK STATUS
IPLNK  IPADDR          STATUS    PST
A      10.248.13.93    ACTIVE    IS-NR     MCP IP
CONNECTION
PORT   PST             SST
A      OOS-MT          Unavail

Command Completed.
;
Command Executed

```

This example shows output for a SLIC card running the SCCPHC GPL with mode=full:

```

rept-stat-card:loc=1107:mode=full

tekelecstp 16-07-14 06:37:51 EST EAGLE 46.4.0.0.0-69.3.1
rept-stat-card:loc=1107:mode=full
Command entered at terminal #18.
;

Command Accepted - Processing
tekelecstp 16-07-14 06:37:51 EST EAGLE 46.4.0.0.0-69.3.1
CARD   VERSION      TYPE      GPL      PST      SST
AST
1107   139-002-000   SLIC      SCCPHC    IS-NR     Active
-----
ALARM STATUS          = No Alarms.
BLSLC32 GPL version = 139-002-000
IMT BUS A             = Conn
IMT BUS B             = Conn
CLOCK A              = Active

```

```

CLOCK B          = Idle
CLOCK I          = Idle
MBD BIP STATUS   = Valid
MOTHER BOARD ID = SLIC
DBD STATUS       = Valid
DBD TYPE         = None
DBD MEMORY SIZE  = 16384M
HW VERIFICATION CODE = ----
CURRENT TEMPERATURE = 72C (162F)
PEAK TEMPERATURE:  = 73C (164F)      [16-07-14 06:24]
SCCP % OCCUP     = 0%
APPLICATION SERVICING

                MFC          MFC
SNM   REQ STATUS = 24 hr: ---, 5 min: ---
INM   REQ STATUS = 24 hr: ---, 5 min: ---
MTP3  REQ STATUS = 24 hr: ---, 5 min: ---
SFLOG REQ STATUS = 24 hr: ---, 5 min: ---
IPLNK STATUS
IPLNK IPADDR          STATUS    PST
A   -----          ----     ----
B   -----          ----     ----
DSM IP CONNECTION
PORT  PST            SST
A     OOS-MA         Ueq
B     OOS-MA         Ueq

```

Command Completed.

```

;
Command Executed

```

## Legend

- **CARD**—Location of the card
- **VERSION**—Version number of the application loaded on the card. Dashes (- - - -) in the version column indicate one of the following conditions about the card:
  - The card is configured but is not physically present in the system.
  - The card does not run a GPL, such as TDM or MDAL cards.
  - The card is IS-ANR or is in the process of being loaded.
- **TYPE**—Card type entered in the database.
- **APPL**—Application loaded on the card
- **PST**—Primary state of the card. See [Possible Values for PST/SST/AST](#) .
- **SST**—Secondary state of the card. See [Possible Values for PST/SST/AST](#) .
- **AST**—Associated state of the card. See [Possible Values for PST/SST/AST](#) .

Message Flow Control status is displayed in these fields: SNM REQ STATUS (SNM messages), SLAN REQ STATUS (STPLAN messages), SCCP REQ STATUS (SCCP messages), EROUTE REQ STATUS (EROUTE messages), INM REQ STATUS (INM messages), MTP3 REQ STATUS (MTP3 messages), and SFLOG REQ STATUS.

For card type STC (EROUTE application), the MFC status is not displayed.

Message Flow Control status output is displayed as a series of these letters:

- **G**—MFC found a service with available capacity. Indicates normal system behavior.
- **D**—Servers were present in the system, but no server had available capacity. Indicates an overload, but MFC is working correctly.
- **N**—No operational server cards were available in the system for use by this card over the corresponding interval.

The HW VERIFICATION CODE field is shown only in the mode=full report. ----- is shown in the HW VERIFICATION CODE field for cards with valid hardware detected. One of the following numerical values is shown when invalid hardware is detected, and all such cards will be auto-inhibited.

\* It is possible that the card will continually boot in these cases, before the alarm is ever displayed.

**Table 4-51 Auto-Inhibit Hardware Verification Codes**

HW Verification Code	Card or Application Code	Description	Associated UAM Code
058	SS7IPGW, IPGWI, IPLIMI	E5-ENET-B does not support > 16 associations (IPLIMx). E5-ENET-B does not support > 50 associations (IPGWx).	422
059	VSCCP	MPS database has been detected to exceed capacity of Service Module extended memory (only for GPORT, GFLEX, INP, EIR features). UAMs 281, 283, and 285 are used for LNP and LNP ELAP Configuration features.	422
090	Various	Flash image on the card is incompatible with the current release of the EAGLE	570
099	E5-TSM	E5-TSM card equipped has one or more daughterboard.	99
102*	SS7IPGW, IPGWI	Non-DCM detected in slot.	99
103	SS7IPGW, IPGWI, IPLIMI	E5-ENET-B does not support >16 associations (IPLIMx). E5-ENET-B does not support >50 associations (IPGWx).	276
103	IPSG	E5-ENET-B does not support >32 associations (IPSG).	276
104	SS7IPGW, IPGWI,	E5-ENET-B does not support >0 sockets (IPLIMx). E5-ENET-B does not support >0 sockets (IPGWx).	276

Table 4-51 (Cont.) Auto-Inhibit Hardware Verification Codes

HW Verification Code	Card or Application Code	Description	Associated UAM Code
105	SS7IPGW, IPGWI, IPLIMI	E5-ENET-B does not support > 0 (sockets + associations) (IPLIMx). E5-ENET-B does not support > 50 (sockets + associations) (IPGWx).	276
106	SS7IPGW, IPGWI, IPLIMI	E5-ENET-B does not support >3200Kb SCTP buffers (IPLIMx). E5-ENET-B does not support >3200Kb SCTP buffers (IPGWx).	276
132	IPLIMI	The actual card in the slot must be a high capacity MIM or LIME1 if card is provisioned as a LIME1 card.	99
136	E5-ATM-B	E5-ATM-B is provisioned	297
140	MCPHC	MCP card not running with D2G memory	422
141	IPS	E5-IPSM card not running with D2G memory.	422
142	MCP	E5-MCPM-B card not running with D4G memory.	422
150	various	Card is obsolete.	47
165	VSCCP	Hardware configuration does not support configured feature set.	99
170	EROUTE	Non-E5-ENET-B card detected in slot provisioned for eroute with card type STC.	99
171	STPLAN	Non-E5-ENET-B card detected in slot provisioned for STPLAN with card type DCM.	99
172	IPSG	Non-SLIC card detected in slot provisioned for IPSG and card type is SLIC with data=gtt.	99
174	IPSG	SLIC hardware detected having 32-bit flash GPL (BLSLC32) in a slot provisioned for IPSG and card type is SLIC with data=gtt.	99

Table 4-51 (Cont.) Auto-Inhibit Hardware Verification Codes

HW Verification Code	Card or Application Code	Description	Associated UAM Code
179	E5-ATM-B, E5-ENET-B, E5-E1T1-B	EPM-B based card detected and MFC is OFF.	99
180	SCCP, SS7ANSI  DEIR, ENUM, SIP	SCCP card equipped with DCM with MOBR on.  If ports C and D are configured, the card location must be populated with SLIC cards only.	441

**Related Topics**

- [dlt-card](#)
- [ent-card](#)
- [init-card](#)
- [rmv-card](#)
- [rtrv-card](#)

## rept-stat-cdl

Use this command to generate a report of the signaling links currently in Command Driven Loopback (CDL) testing, including the amount of time the link has been in CDL testing.

Command Driven Loopback is the ability to locally drive a signaling link into a manual line loopback. The data received on the signaling link is echoed (transmitted) back. This is effectively the reverse of the `tst-slk:loopback=lxvr` command, which loops the transmitted data back to the receive.

**Parameters****link (optional)**

SS7 signaling links. The signaling links that is being tested.

**Synonym:**

*port*

**Range:**

*a, b, a1 - a31, b1 - b31*

Not all card types support all `link` parameter values.

See [Table A-1](#) for valid `link` parameter range values for each type of card that can have assigned signaling link ports.

**Default:**

All signaling links that are in CDL testing are displayed.

**loc (optional)**

The card location as stenciled on the shelf of the system.

**Range:**

1101 - 1108, 1111 - 1112, 1201 - 1208, 1211 - 1218, 1301 - 1308, 1311 - 1318, 2101 - 2108, 2111 - 2118, 2201 - 2208, 2211 - 2218, 2301 - 2308, 2311 - 2318, 3101 - 3108, 3111 - 3118, 3201 - 3208, 3211 - 3218, 3301 - 3308, 3311 - 3318, 4101 - 4108, 4111 - 4118, 4201 - 4208, 4211 - 4218, 4301 - 4308, 4311 - 4318, 5101 - 5108, 5111 - 5118, 5201 - 5208, 5211 - 5218, 5301 - 5308, 5311 - 5318, 6101 - 6108, 6111 - 6118

**Default:**

All cards containing signaling links that are in CDL testing are displayed.

**loopback (optional)**

Loopback test type.

**Range:**

*line*

*payload*

**Note:**

The payload value is valid only on LIM-ATM and E1-ATM cards.

**Default:**

All loopback tests are displayed.

**Example**

```
rept-stat-cdl
rept-stat-cdl:loc=1201
rept-stat-cdl:loc=1203:link=a
rept-stat-cdl:loopback=payload
```

**Dependencies**

If the `link` parameter is specified, the `loc` parameter must be specified.

The card location specified in the `loc` parameter must be equipped.

The signaling link specified in the `link` parameter must be equipped.

This command is not available during upgrade.

The card location specified in the `loc` parameter cannot be reserved by the system.

**Notes**

This command can be canceled using the **F9** function key or the `canc-cmd` command. See `canc-cmd` for more information

## Output

```
rept-stat-cdl
```

```
tekelecstp 03-11-27 01:29:06 EST  EAGLE 31.3.0
SLK      CDL      CDL-TIME
1102,A1  LINE      00:04:01
1201,A   PAYLOAD   01:04:11
1203,A   LINE      00:22:21
1203,B   LINE      20:04:01
1208,A   LINE      01:05:22
1211,A   PAYLOAD   00:14:01
```

```
;
```

## Legend

- **SLK**—The card and assigned signaling link that is in CDL testing
- **CDL**—Command Driven Loopback test type (LINE or PAYLOAD)
- **CDL-TIME**—Time that the signaling link has been in CDL testing. This value can be up to 99:59:59. The test can run longer than 100 hours, but this field will not record times longer than 100 hours.

## Related Topics

- [act-cdl](#)
- [dact-cdl](#)

# rept-stat-cdt

Use this command to display the customer-defined troubles. The Customer-Definable Alarms feature can be used to connect up to 10 external devices to the system for alarm reporting. These devices are defined in the system database as customer-defined troubles, and they are monitored so that any change in the state of these devices is reported as an unsolicited alarm message (UAM).

## Parameters

This command has no parameters.

## Example

```
rept-stat-cdt
```

## Dependencies

No other status command can be in progress when this command is entered.

## Notes

These troubles are customer-defined and configured by the factory.

## Output

rept-stat-cdt

```
rlghncxa03w 04-01-07 20:20:43 EST EAGLE 31.3.0
ID                ALARM STATUS
1   *C 0058 Critical Customer Trouble detected
2   *C 0050 Critical Holdover Clock trouble detected
3   *C 0058 Critical Customer Trouble detected
4   *C 0058 Critical Customer Trouble detected
5   I ** 0059 Major Customer Trouble detected
6   ** 0052 Major Holdover Clock trouble detected
7   ** 0059 Major Customer Trouble detected
8   ** 0059 Major Customer Trouble detected
9   I * 0060 Minor Customer Trouble detected
10  * 0054 Minor Holdover Clock trouble detected
11  * 0060 Minor Customer Trouble detected
12  * 0060 Minor Customer Trouble detected
13  * 0060 Minor Customer Trouble detected
14  I * 0060 Minor Customer Trouble detected
15  * 0060 Minor Customer Trouble detected
16  * 0060 Minor Customer Trouble detected
;
```

## Legend

- **ID**—The customer defined trouble ID number followed by the status of the customer-defined trouble.
- **ALARM STATUS**—The status of the alarm for the specified device.

## Related Topics

- [act-alm-trns](#)
- [canc-alm-trns](#)
- [dact-alm-trns](#)
- [rept-stat-clk](#)
- [rept-stat-trbl](#)
- [rls-alm](#)
- [rtrv-obit](#)
- [rtrv-trbl](#)

# rept-stat-clk

Use this command to display the clock status summary for cards in the system.



## Parameters

### **mode (optional)**

Display mode. When `mode=full` is specified, the "Cards with bad clock source" section of the report is displayed

### **Range:**

*full*

### **Example**

```
rept-stat-clk  
rept-stat-clk:mode=full
```

### **Dependencies**

No other `rept-stat-xxx` command can be in progress when this command is entered.

### **Notes**

The clock status report includes the status of all the clocks in the system (Clock A, Clock B, Clock I, High Speed (HS) Clock A, HS Clock B, etc.).

The Time Slot Counter Synchronization (TSC) clock appears only if the Time Slot Counter Synchronization (TSCSYNC) feature is turned on. See the `chg-feat` command.

The Composite clock sections of the report are the *Primary Comp Clock (CLK)* and *Secondary Comp CLK* fields in the COMPOSITE SYSTEM CLOCK section: the summary of the number of cards having bad status or using COMP CLKs: and the *CLK* columns in the "Cards with bad clock source" section that appears when the `mode=full` parameter is specified.

The HS clock sections of the report are the *Primary HS Clock (CLK)*, *Secondary HS CLK*, *HS CLK TYPE*, and *HS CLK LINELEN* fields in the HIGH SPEED SYSTEM CLOCK section: the summary of the number of cards having bad status or using HS CLKs: and the *HS CLK* columns in the "Cards with bad clock source" section that appears when the `mode=full` parameter is specified.

HS clock capable cards can support a link that is provisioned to use HS Master Timing. These cards include all cards with type LIME1 or LIMT1 and all cards that run the ATMANSI or ATMITU applications. The clock status values are the same as those listed in the `rept-stat-card:mode=full:loc=xxx` report.

For a complete list of the cards and their applications, see [Table A-7](#).

If HS clock A and B status is included in the "Cards with bad clock source" section, then cards that cannot be provisioned to use HS Master Timing display dashes for HS clock A and B status.

The PST/SST for the Primary Composite Clock (Comp Clk) 1114, Primary Comp Clk 1116, Secondary Comp Clk 1114, Secondary Comp Clk 1116, Primary HS Clk 1114, Primary HS Clk 1116, Secondary HS Clk 1114, and Secondary HS Clk 1116 can be one of the following values:

- IS-NR/active—clock source is valid, clock chosen as source
- IS-NR/idle—clock source is valid, clock not chosen as source
- OOS-MT/fault—clock source is invalid

The PST/ SST for the Composite System Clock and High Speed System Clock can be one of the following values:

- IS-NR/Idle—all cards showing good clock, clock not required
- IS-ANR/Idle—some cards showing bad clock, clock not required
- OOS-MT/Idle—all cards showing bad clock, clock not required
- IS-NR/Active—all cards “requiring clocks” showing good clock, clocks required
- IS-ANR/Fault—some cards “requiring clocks” showing bad clock, clocks required
- OOS-MT/Fault—all cards “requiring clocks” showing bad clock, clocks required



#### Note:

An asterisk (\*) indicates that the card requires the indicated clock.

### Output



#### Note:

A TDM card can use a local clock that is generated independently on each TDM as a clock source for the corresponding internal system clock. The system does not report the “cards bad” status for these internal clocks.



#### Note:

The use of HS CLK I is not automatic when both the high-speed primary and secondary clocks are invalid. An E5-ATM-B card must be provisioned (using the `ent-slk:atmtsel=internal` command) to use the high-speed internal clock.



#### Note:

The *Using* field in the Composite Clock section describes all of the cards that are using the Composite Clock, not just HS clock capable cards.

The following example shows output when two GPSM-II cards are configured, and HS clock capable cards are not configured. The TSCSYNC feature is not turned on.

```
rept-stat-clk
```

```
tekelecstp 08-06-07 14:40:13 EST EAGLE 39.0.0
```

```

COMPOSITE                                PST      SST      AST
  SYSTEM CLOCK                            IS-NR    Idle
-----
ALARM STATUS = No Alarms.
  Primary Comp Clk 1114  (CLK A)  IS-NR    Active
-----
  Primary Comp Clk 1116  (CLK B)  IS-NR    Active
-----
  Secondary Comp Clk 1114 (CLK A)  IS-NR    Idle
-----
  Secondary Comp Clk 1116 (CLK B)  IS-NR    Idle
-----

Clock      Using      Bad
CLK A      2          0
CLK B      0          0
CLK I      0          --

HIGH SPEED                                PST      SST      AST
  SYSTEM CLOCK                            IS-NR    Idle
-----
ALARM STATUS = No Alarms.
  Primary HS Clk 1114  (HS CLK A)  IS-NR    Active
-----
  Primary HS Clk 1116  (HS CLK B)  IS-NR    Active
-----
  Secondary HS Clk 1114 (HS CLK A)  IS-NR    Idle
-----
  Secondary HS Clk 1116 (HS CLK B)  IS-NR    Idle
-----

HS CLK TYPE 1114      = RS422
HS CLK LINELEN 1114  = -----
HS CLK TYPE 1116      = RS422
HS CLK LINELEN 1116  = -----

Clock      Using      Bad
HS CLK A   0          0
HS CLK B   0          0
HS CLK I   0          --

Command Completed.
;

```

The following example shows output when two GPSSM-II cards are configured and an HS clock capable card is configured. The TSCSYNC feature is not turned on.

```
rept-stat-clk
```

```

tekelecstp 08-06-07 14:40:13 EST  EAGLE 39.0.0
COMPOSITE                                PST      SST      AST
  SYSTEM CLOCK                            IS-NR    Idle
-----
ALARM STATUS = No Alarms.

```

```

Primary Comp Clk 1114 (CLK A) IS-NR Active -----
Primary Comp Clk 1116 (CLK B) IS-NR Active -----
Secondary Comp Clk 1114 (CLK A) IS-NR Idle -----
Secondary Comp Clk 1116 (CLK B) IS-NR Idle -----

Clock      Using      Bad
CLK A      3              0
CLK B      0              0
CLK I      0              --

HIGH SPEED                                PST      SST      AST
SYSTEM CLOCK                             IS-NR    Active  -----
ALARM STATUS = No Alarms.
Primary HS Clk 1114 (HS CLK A) IS-NR    Active  -----
Primary HS Clk 1116 (HS CLK B) IS-NR    Active  -----
Secondary HS Clk 1114 (HS CLK A) IS-NR    Idle    -----
Secondary HS Clk 1116 (HS CLK B) IS-NR    Idle    -----

HS CLK TYPE 1114 = RS422
HS CLK LINELEN 1114 = -----
HS CLK TYPE 1116 = RS422
HS CLK LINELEN 1116 = -----

```

```

Clock      Using      Bad
HS CLK A   1          0
HS CLK B   0          0
HS CLK I   0          --

```

Command Completed.

;

The following example shows output when two GPSSM-II cards are configured and HS clock capable cards are not configured. The TSCSYNC feature is turned on.

rept-stat-clk

```

tekelecstp 08-05-07 14:40:13 EST EAGLE 39.0.0
COMPOSITE                                PST      SST      AST
SYSTEM CLOCK                             IS-NR    Active  -----
ALARM STATUS = No Alarms.
Primary Comp Clk 1114 (CLK A) IS-NR    Active  -----
Primary Comp Clk 1116 (CLK B) IS-NR    Active  -----
Secondary Comp Clk 1114 (CLK A) IS-NR    Idle    -----
Secondary Comp Clk 1116 (CLK B) IS-NR    Idle    -----

Clock      Using      Bad
CLK A      2          0
CLK B      0          0
CLK I      0          --

Prefer Clock A for TSC CLOCK

HIGH SPEED                                PST      SST      AST
SYSTEM CLOCK                             IS-NR    Active  -----

```

```

ALARM STATUS = No Alarms.
  Primary HS Clk 1114   (HS CLK A)  IS-NR      Active
-----
  Primary HS Clk 1116   (HS CLK B)  IS-NR      Active
-----
  Secondary HS Clk 1114 (HS CLK A)  IS-NR      Idle
-----
  Secondary HS Clk 1116 (HS CLK B)  IS-NR      Idle
-----

HS CLK TYPE 1114      = RS422
HS CLK LINELEN 1114   = -----
HS CLK TYPE 1116      = RS422
HS CLK LINELEN 1116   = -----

Clock      Using      Bad
HS CLK A   0          0
HS CLK B   0          0
HS CLK I   0          --

Command Completed.
;

```

The following example shows output when two GPSM-II cards are configured and an HS clock capable card is configured. The TSCSYNC feature is turned on.

```
rept-stat-clk
```

```

tekelecstp 08-06-07 14:40:13 EST  EAGLE 39.0.0
COMPOSITE                                PST      SST      AST
  SYSTEM CLOCK                            IS-NR    Active
-----
ALARM STATUS = No Alarms.
  Primary Comp Clk 1114 (CLK A)  IS-NR    Active
-----
  Primary Comp Clk 1116 (CLK B)  IS-NR    Active
-----
  Secondary Comp Clk 1114 (CLK A) IS-NR    Idle
-----
  Secondary Comp Clk 1116 (CLK B) IS-NR    Idle
-----

Clock      Using      Bad
CLK A      3          0
CLK B      0          0
CLK I      0          --

Prefer Clock A   for TSC CLOCK

HIGH SPEED                                PST      SST      AST
  SYSTEM CLOCK                            IS-NR    Active
-----
ALARM STATUS = No Alarms.
  Primary HS Clk 1114   (HS CLK A)  IS-NR    Active

```

```

-----
      Primary HS Clk 1116      (HS CLK B)  IS-NR      Active     -----
      Secondary HS Clk 1114    (HS CLK A)  IS-NR      Idle       -----
      Secondary HS Clk 1116    (HS CLK B)  IS-NR      Idle       -----

HS CLK TYPE 1114      = RS422
HS CLK LINELEN 1114  = -----
HS CLK TYPE 1116      = RS422
HS CLK LINELEN 1116  = -----

Clock      Using      Bad
HS CLK A   1          0
HS CLK B   0          0
HS CLK I   0          --

Command Completed.
;

```

The following example shows output when the `mode=full` parameter is specified and HS clock capable cards are configured. The TSCSYNC feature is turned on.

```
rept-stat-clk:mode=full
```

```

tekelecstp 08-06-07 14:40:13 EST  EAGLE 39.0.0
COMPOSITE                                PST      SST      AST
      SYSTEM CLOCK                        IS-ANR   Fault    -----
ALARM STATUS = No Alarms.
      Primary Comp Clk 1114  (CLK A)   IS-NR    Active   -----
      Primary Comp Clk 1116  (CLK B)   -----  -----  -----
      Secondary Comp Clk 1114 (CLK A)   IS-NR    Idle     -----
      Secondary Comp Clk 1116 (CLK B)   -----  -----  -----

Clock      Using      Bad
CLK A      4          1
CLK B      0          5
CLK I      0          --

Prefer Clock A   for TSC CLOCK

HIGH SPEED                                PST      SST      AST
      SYSTEM CLOCK                        OOS-MT   Fault    -----
ALARM STATUS = No Alarms.
      Primary HS Clk 1114  (HS CLK A)  IS-NR    Active   -----
      Primary HS Clk 1116  (HS CLK B)   -----  -----  -----
      Secondary HS Clk 1114 (HS CLK A)   IS-NR    Idle     -----
      Secondary HS Clk 1116 (HS CLK B)   -----  -----  -----

HS CLK TYPE 1114      = E1 UNFRAMED
HS CLK LINELEN 1114  = SHORThAUL
HS CLK TYPE 1116      = -----
HS CLK LINELEN 1116  = -----

Clock      Using      Bad
HS CLK A   0          1

```

```

HS CLK B      0          1
HS CLK I      0          --

```

Cards with bad clock source:

CARD	CLK A	CLK B	HS CLK A	HS CLK B
1103	*Active	*Fault	-----	-----
1104	Active	Fault	*Fault	*Fault
1106	*Active	*Fault	-----	-----
1113	Active	Fault	-----	-----
1205	Fault	Fault	-----	-----

Command Completed.

;

The following example shows output when HS clock capable cards are not configured. The TSCSYNC feature is not turned on.

```
rept-stat-clk
```

```

tekelecstp 08-06-07 14:40:13 EST  EAGLE 39.0.0
COMPOSITE                                PST      SST      AST
      SYSTEM CLOCK                        IS-NR    Active
-----
ALARM STATUS = No Alarms.
      Primary Comp Clk 1114  (CLK A)  IS-NR    Active
-----
      Primary Comp Clk 1116  (CLK B)  IS-NR    Active
-----
      Secondary Comp Clk 1114 (CLK A)  IS-NR    Idle
-----
      Secondary Comp Clk 1116 (CLK B)  IS-NR    Idle
-----

Clock      Using      Bad
CLK A      3          0
CLK B      0          0
CLK I      0          --

HIGH SPEED                                PST      SST      AST
      SYSTEM CLOCK                        IS-NR    Idle
-----
ALARM STATUS = No Alarms.
      Primary HS Clk 1114  (HS CLK A)  IS-NR    Active
-----
      Primary HS Clk 1116  (HS CLK B)  IS-NR    Active
-----
      Secondary HS Clk 1114 (HS CLK A)  IS-NR    Idle
-----
      Secondary HS Clk 1116 (HS CLK B)  IS-NR    Idle
-----

HS CLK TYPE 1114      = RS422
HS CLK LINELEN 1114  = -----
HS CLK TYPE 1116      = RS422

```

```
HS CLK LINELEN 1116 = -----
```

Clock	Using	Bad
HS CLK A	0	0
HS CLK B	0	0
HS CLK I	0	--

```
Command Completed.
```

```
;
```

### Legend

- **COMPOSITE SYSTEM CLOCK**—Composite System clock status
- **ALARM STATUS**—System clock alarms; "No alarms" is shown when there are no alarms.
- **PRIMARY COMP CLK**—The status of the primary Composite clock input for a particular TDM
- **SECONDARY COMP CLK**—The status of the secondary Composite clock input for a particular TDM
- **CLK A** – Internal Eagle Clock sourced by the 1114 TDM from the selected clock source.
- **CLK B** – Internal Eagle Clock sourced by the 1116 TDM from the selected clock source.
- **CLK I** – Local clock generated independently on each LIM card.
- **Prefer CLOCK x for TSC CLOCK**—The preferred clock source of the Time Slot Counter Synchronization (TSC) clock; appears only when the TSCSYNC feature is turned on.
- **HIGH SPEED SYSTEM CLOCK**—HS system clock status
- **ALARM STATUS**—HS System clock alarms; "No alarms" is shown when there are no alarms.
- **PRIMARY HS CLK**—The status of the high-speed primary clock input for a particular TDM
- **SECONDARY HS CLK**—The status of the high-speed secondary clock input for a particular TDM
- **HS CLK TYPE**—HS clock source (see the chg-stpopts command) for a particular TDM
- **HS CLK LINELEN**—HS clock line length (see the chg-stpopts command) for a particular TDM
- **HS CLK A** – Internal Eagle High Speed Clock sourced by the 1114 TDM from the selected clock source.
- **HS CLK B** – Internal Eagle High Speed Clock sourced by the 1116 TDM from the selected clock source.
- **HS CLK I** – Local clock generated independently on each LIM card. The value for the internal high-speed clock (Cards using HSCLK I) is generated differently from the internal system clock (Cards using CLK I). The internal high speed clock is generated by the XILINX on the ATM applique's card. The internal system clock is generated by the Xilinx on the LIM main board when the LIM card does not have a valid system clock source (e.g., both A system clock and B system clock are bad at the LIM card).

### Related Topics

- [rept-stat-card](#)



- [rept-stat-dstn](#)
- [rept-stat-imt](#)
- [rept-stat-ls](#)
- [rept-stat-sccp](#)
- [rept-stat-slk](#)
- [rept-stat-trbl](#)

## rept-stat-cluster

Use this command to report summary status and statistical information for all provisioned clusters. Use this command also to report detailed routeset information for a specific cluster, provisioned cluster member, or dynamically-created x-list entry.



### Note:

This command does not support 24-bit ITU national point codes.

### Parameters

#### **dpc (optional)**

ANSI destination point code of the cluster whose status is to be reported, with subfields *network indicator-network cluster-network cluster member (ni-nc-ncm)*. The *prefix* subfield indicates a private point code (*prefix-ni-nc-ncm*).

#### **Synonym:**

*dpcn*

#### **Range:**

*p-*, 000-255, \*

Specify a valid value for each subfield of the point code, and separate the subfields with a dash (-).

*prefix—p-*

The asterisk value (\*) is not valid for the *ni* subfield.

When *chg-sid:pctype=ansi* is specified, *ni = 000* is not valid.

When *chg-sid:pctype=ansi* is specified, *nc = 000* is not valid if *ni = 001–005*.

When *chg-sid:pctype=ansi* is specified, *nc = 000* is valid if *ni = 006–255*.

The point code *000-000-000* is not a valid point code.

#### **Default:**

Display summary for all provisioned clusters

#### **mode (optional)**

The type of display. Specify *mode=full* to display additional information for the specified DPC.

#### **Range:**

*full*

**Default:**  
Display summary report

**stat (optional)**

This parameter reports on destinations whose status is the same as the state indicated by the parameter.

**Range:**

***all***  
All of the primary states

***alminh***  
Alarms inhibited

***anr***  
In service abnormal (IS-ANR)

***dsbld***  
Out of service maintenance disabled (OOS-MT-DSBLD)

***mt***  
Out of service maintenance (OOS-MT)

***nr***  
In service normal (IS-NR)

**Default:**  
*all*

**Example**

```
rept-stat-cluster
rept-stat-cluster:stat=alminh
rept-stat-cluster:stat=MT
rept-stat-cluster:dpc=20-2-*
rept-stat-cluster:dpc=20-2-*:mode=full
rept-stat-cluster:dpc=20-2-5
```

**Dependencies**

If the `mode=full` parameter is specified, the `dpc/dpca` parameter must be specified.

The `stat` parameter cannot be specified with the `dpc/dpca` parameter in the command.

The Cluster Routing and Management Diversity (CRMD) feature must be turned on before this command can be entered.

The specified DPC must exist.

If a DPC is specified, it must be an x-list entry, a cluster DPC, or a member of a provisioned cluster.

The destination address must be a full point code or a cluster point code specified as `ni-nc-*`. A DPC with `ni-nc-**` or `ni-nc-***` cannot be specified.

No other `rept-stat-xxx` command can be in progress when this command is entered.

### Notes

If no parameters are specified, a summary report is produced, showing all provisioned clusters and their status.

If an FPC corresponding to a provisioned cluster member or an x-list entry is specified, then the status of only the specified FPC, along with routeset status, is displayed.

If a cluster destination is specified on the `dpc/dpca` parameter, then the status of the cluster and the routesets that have been defined for that cluster is displayed.

If the `mode=full` parameter and a DPC are specified, the Route/Destination table is searched, and all entries (cluster DPCs, provisioned cluster member DPCs, and x-list DPCs) belonging to the parent cluster are displayed along with their status. Also, if circular routing is in effect for the DPC, information useful in diagnosing and correcting the situation is displayed.

In the summary report, and in the detailed output when a cluster DPC is being reported, the number of provisioned members of the cluster, and the number of x-list entries that have been created for the cluster, are reported in the PROV and X-LIST columns, respectively.

When detailed information for an x-list entry is being reported, the reasons that the x-list entry was created, and the amount of time remaining on the x-list expiration timer, if applicable, in the format hh:mm is shown in the X-REASON and X-TIME columns, respectively. In x-list entries for which the expiration timer is not applicable, dashes "-----" are displayed.

MTT 4735 and 4732 deleted by MB

### Output

This example shows the output when no parameters are specified. Summary information for all of the defined cluster DPCs is shown. The report shows the number of provisioned and x-list members of each cluster.

```
rept-stat-cluster
```

```
rlghncxa03w 04-01-07 08:51:31 EST EAGLE 34.0.0
  DPCA      ORIG   PST    SST      AST      PROV  XLIST
  020-002-*  CLUST  IS-NR  Allowed  ACCESS    2     3
  020-020-*  CLUST  IS-NR  Allowed  ACCESS    3     5
  020-021-*  CLUST  OOS-MT Prohibit INACCESS  5     2
  020-022-*  CLUST  IS-NR  Allowed  ALMINH    2     3
```

```
Command Completed.
```

```
;
```

This example shows the output when a provisioned cluster member DPC is specified. The report shows status information for the specified DPC plus route information.

```
rept-stat-cluster:dpc=20-2-1
```

```
rlghncxa03w 04-01-07 08:51:31 EST EAGLE 34.0.0
  DPCA          ORIG   PST     SST     AST
  020-002-001  PROV   IS-ANR Restrict ACCESS
ALARM STATUS      = No Alarms.
RTE COST  LSN      APCA          LS STAT   NON-ADJ   ROUTE STAT
1   10   lsnppp   003-003-003  Allowed  Allowed   Allowed
2   --   -----   ***-***-***  -----  -----   -----
3   --   -----   ***-***-***  -----  -----   -----
4   --   -----   ***-***-***  -----  -----   -----
5   --   -----   ***-***-***  -----  -----   -----
6   --   -----   ***-***-***  -----  -----   -----
```

```
Command Completed.
```

```
;
```

This example shows the output when a specific cluster DPC is specified. The report shows count information about the cluster's provisioned and x-list members, plus the route information.

```
rept-stat-cluster:dpc=20-2-*
```

```
rlghncxa03w 04-01-07 08:51:31 EST EAGLE 34.0.0
  DPCA          ORIG   PST     SST     AST     PROV  X-LIST
  020-002-*    CLUST  IS-NR   Allowed ACCESS    2     3
ALARM STATUS      = No Alarms.
RTE COST  LSN      APCA          LS STAT   NON-ADJ   ROUTE STAT
1   10   lsnppp   003-003-003  Allowed  Allowed   Allowed
2   --   -----   ***-***-***  -----  -----   -----
3   --   -----   ***-***-***  -----  -----   -----
4   --   -----   ***-***-***  -----  -----   -----
5   --   -----   ***-***-***  -----  -----   -----
6   --   -----   ***-***-***  -----  -----   -----
```

```
Command Completed.
```

```
;
```

This example shows the output when an x-list cluster member DPC is specified. The report shows x-list related information ( X-REASON, X-TIME ) plus the route information. The report identifies the specified DPC as an x-list DPC.

```
rept-stat-cluster:dpc=20-2-5
```

```
rlghncxa03w 04-01-07 08:51:31 EST EAGLE 34.0.0
  DPCA          ORIG   PST     SST     AST     X-REASON X-TIME
  020-002-005  X-LIST IS-ANR Restrict ACCESS  RT      08:20
ALARM STATUS      = No Alarms.
RTE COST  LSN      APCA          LS STAT   NON-ADJ   ROUTE STAT
1   10   lsnppp   003-003-003  Allowed  Allowed   Allowed
2   --   -----   ***-***-***  -----  -----   -----
```

```

3  --  -----  ***-***-***  -----  -----  -----
4  --  -----  ***-***-***  -----  -----  -----
5  --  -----  ***-***-***  -----  -----  -----
6  --  -----  ***-***-***  -----  -----  -----

```

Command Completed.

;

This example shows the output when a cluster DPC and `mode=full` is specified. The report shows summary status information for the provisioned and x-list DPCs that are members of the specified cluster.

```
rept-stat-cluster:dpc=20-2-*:mode=full
```

```

rlghncxa03w 04-01-07 08:51:31 EST EAGLE 34.0.0
  DPCA          ORIG    PST    SST      AST      PROV  X-LIST
  020-002-*     CLUST  IS-NR  Allowed  ACCESS    2      3
ALARM STATUS      = No Alarms.
RTE COST  LSN      APCA          LS STAT  NON-ADJ  ROUTE STAT
  1   10  lsnppp  003-003-003  Allowed  Allowed  Allowed
  2   --  -----  ***-***-***  -----  -----  -----
  3   --  -----  ***-***-***  -----  -----  -----
  4   --  -----  ***-***-***  -----  -----  -----
  5   --  -----  ***-***-***  -----  -----  -----
  6   --  -----  ***-***-***  -----  -----  -----
  DPCA          ORIG    PST    SST      AST      X-REASON X-TIME
  020-002-*     CLUST  IS-NR  Allowed  ACCESS    -----  -----
  020-002-001   PROV    OOS-MT Prohibit  INACCESS  -----  -----
  020-002-002   PROV    IS-ANR Restrict  ACCESS    -----  -----
  020-002-126   X-LIST  IS-ANR Restrict  ACCESS    RT      08:20
  020-002-127   X-LIST  OOS-MT Prohibit  INACCESS  CR      -----
  020-002-128   X-LIST  IS-ANR Restrict  ACCESS    CG RT   05:40
CIRCULAR ROUTING
XMIT LSN= -----  RC=--
RCV  LSN= -----
MEMBER = ***-***-***

```

Command Completed.

;

This example shows the output when the `stat` parameter is specified. Only those clusters having a primary state (PST) matching the specified value are reported.

```
rept-stat-cluster:stat=alminh
```

```

rlghncxa03w 04-01-07 08:51:31 EST EAGLE 34.0.0
  DPCA          ORIG    PST    SST      AST      PROV  XLIST
  020-022-*     CLUST  IS-NR  Allowed  ALMINH    2      3

```

Command Completed.

;

This example shows the output when specifying the `dpc` and `mode=full` parameters re specified. If a circular routing alarm is raised for a cluster member DPC, specifying these parameters displays information pertinent to the cluster member that is experiencing the circular routing condition.

```
rept-stat-cluster:dpc=20-2-127:mode=full
```

```
rlghncxa03w 04-01-07 08:51:31 EST EAGLE 34.0.0
DPCA          ORIG    PST     SST     AST
020-002-127  PROV    OOS-MT  Prohibit INACCESS
ALARM STATUS  = *C 0319 Circular routing detected
RTE COST  LSN      APCA          LS STAT  NON-ADJ  ROUTE STAT
1   10   lsnppp  003-003-003  Allowed  Allowed  Allowed
2   --   -----  ***-***-***  -----  -----  -----
3   --   -----  ***-***-***  -----  -----  -----
4   --   -----  ***-***-***  -----  -----  -----
5   --   -----  ***-***-***  -----  -----  -----
6   --   -----  ***-***-***  -----  -----  -----
DPCA          ORIG    PST     SST     AST     X-REASON X-TIME
020-002-*     CLUST  IS-NR   Allowed ACCESS  -----  -----
020-002-001   PROV    OOS-MT  Prohibit ACCESS  -----  -----
020-002-002   PROV    IS-ANR  Restrict ACCESS  -----  -----
020-002-126   X-LIST  IS-ANR  Restrict ACCESS  RT      08:20
020-002-127   X-LIST  OOS-MT  Prohibit INACCESS CG CR   -----
020-002-128   X-LIST  IS-ANR  Restrict ACCESS  CR CG RT 05:40
CIRCULAR ROUTING
XMIT LSN= lsnppp RC=--
RCV LSN= lsn01a
MEMBER = ***-***-***
```

```
Command Completed.
```

```
;
```

If a circular routing alarm is raised for a cluster DPC, then specifying the `dpc` and `mode=full` parameters displays information pertinent to the cluster member experiencing the circular routing condition. The value for the `MEMBER` field in this example represents the cluster member that had the circular routing condition. This is the same member for which an x-list entry could not be created.



#### Note:

The circular routing member information shown in this output report displays as `***-***-***` if the specified DPC is not a cluster DPC or the information is not known by maintenance at the time the report is generated.

```
rept-stat-cluster:dpc=20-2-*:mode=full
```

```
rlghncxa03w 04-01-07 08:51:31 EST EAGLE 34.0.0
DPCA          ORIG    PST     SST     AST     PROV  X-LIST
020-002-*     CLUST  IS-NR   Allowed ACCESS  2      3
```

```

ALARM STATUS          = *C 0319 Circular routing detected
RTE COST  LSN        APCA          LS STAT  NON-ADJ  ROUTE STAT
1   10   lsnppp      003-003-003  Allowed  Allowed  Allowed
2   --   -----   ***-***-***  -----  -----  -----
3   --   -----   ***-***-***  -----  -----  -----
4   --   -----   ***-***-***  -----  -----  -----
5   --   -----   ***-***-***  -----  -----  -----
6   --   -----   ***-***-***  -----  -----  -----

DPCA          ORIG  PST   SST   AST   X-REASON X-TIME
020-002-*     CLUST IS-NR Allowed ACCESS -----
020-002-001   PROV  OOS-MT Prohibit INACCESS -----
020-002-002   PROV  IS-ANR Restrict ACCESS -----
020-002-126   X-LIST IS-ANR Restrict ACCESS RT      08:20
020-002-127   X-LIST OOS-MT Prohibit INACCESS CR      -----
020-002-128   X-LIST IS-ANR Restrict ACCESS CG RT   05:40

CIRCULAR ROUTING
XMIT LSN= lsnppp RC=--
RCV LSN= lsn01a
MEMBER = 020-002-129

```

Command Completed.

;

This example includes private point codes:

```
rept-stat-cluster:dpc=20-2-*:mode=full
```

```

rlghncxa03w 05-01-06 10:09:59 EST EAGLE 34.0.0
DPCA          ORIG  PST   SST   AST   PROV  XLIST
020-002-*     CLUST OOS-MT Idle   INACCESS  0      0
ALARM STATUS          = No Alarms.
RTE COST  LSN        APCA          LS STAT  NON-ADJ  ROUTE
STAT
1   10   ls11345678  p-001-001-003  Allowed  Allowed  Allowed
2   --   -----   *****-***  -----  -----  -----
-----
3   --   -----   *****-***  -----  -----  -----
-----
4   --   -----   *****-***  -----  -----  -----
-----
5   --   -----   *****-***  -----  -----  -----
-----
6   --   -----   *****-***  -----  -----  -----
-----

DPCA          ORIG  PST   SST   AST   X-REASON X-TIME
020-002-*     CLUST IS-NR Allowed ACCESS -----
p-020-002-001 PROV  OOS-MT Prohibit INACCESS -----
p-020-002-002 PROV  IS-ANR Restrict ACCESS -----
020-002-126   X-LIST IS-ANR Restrict ACCESS RT      08:20
020-002-127   X-LIST OOS-MT Prohibit INACCESS CR      -----
020-002-128   X-LIST IS-ANR Restrict ACCESS CG RT   05:40

CIRCULAR ROUTING INFO:
XMIT LSN=----- RC=--
RCV LSN=-----

```

```
MEMBER =-----
Command Completed.
;
```

### Legend

- **ORIG**—Origination of the destination point code being reported. Possible values that can appear in the column are:
- **CLUST**—Entry is a provisioned cluster (*ni-nc-\**) DPC
- **PROV**—Entry is a provisioned cluster member (*ni-nc-ncm*)
- **X-LIST**—Entry is a non-provisioned (i.e. dynamically-created) x-list cluster member
- **PST**—Primary state of the cluster. See [Possible Values for PST/SST/AST](#).
- **SST**—Secondary state of the cluster. See [Possible Values for PST/SST/AST](#).
- **AST**—Associated state of the cluster. See [Possible Values for PST/SST/AST](#).
- **X-REASON**—Reasons that the X-LIST entries currently exist. The two-letter indicator values that can appear in this column are:
  - **RT**—X-LIST entry created due to routing
  - **CG**—X-LIST entry created due to congestion
  - **CR**—X-LIST entry created due to circular routing

The circular routing transmit/receive linkset information shown in the `mode=full` detailed output report displays as “-----” if no circular routing alarm exists for the DPC or the information is not known by maintenance at the time the report is generated.

### Related Topics

- [chg-feat](#)
- [chg-stpopts](#)
- [rept-stat-cluster](#)
- [rtv-stpopts](#)

## rept-stat-db

Use this command to display a report showing various status indicators for the active and standby OAM database and the status of the database on each of the network cards.

If the A-Port, AINPQ, Diameter S13/S13' Interface for EIR, EIR, G-Flex, G-Port, INP, LNP ELAP Configuration, Prepaid SMS Intercept Ph1 (PPSMS), SIP NP, or V-Flex feature is turned on, or the ATINP feature is enabled, then the status of the MPS databases and Service Module cards is displayed.

### Parameters

#### **db (optional)**

Report section or sections to display in the output. The content of each section depends on the specified or default value of the `display` parameter. MPS output appears only if a feature that uses the MPS is turned on in the system (A-Port, AINPQ, Diameter S13/S13'



Interface for EIR, EIR, G-Flex, G-Port, INP, PPSMS, SIP NP, V-Flex, or the LNP ELAP Configuration controlled feature) or the ATINP feature is enabled.

**Range:*****all***

displays database and card output for the STP and MPS report sections

***mps***

displays database and card output for the MPS report section

***stp***

displays database and card output for the STP report section

***gtt***

displays database and card output for the GTT-enabled IPSP card report section

**Default:**

*all*

**display (optional)**

Output type.

**Range:*****all***

Displays operational status of all databases (MASP A, MASP B, and MDAL) and all cards equipped in the database on the system.

***brief***

Displays operational status of databases in the active and standby MASP and of MPS databases if a feature that uses the MPS is turned on

***except***

Displays operational status information contained in the `display=brief` output along with the cards whose database level does not match the active fixed disk current partition or active MPS database

***version***

Displays the same information that is displayed with the `display=all` parameter except that the individual database status column is replaced with the database format version and status. Details of the status of the backup databases are displayed for MASP cards. No version information is shown for MPS databases; use the `rept-stat-mps` command.

**Default:**

*brief*

**loc (optional)**

The card location as stenciled on the shelf of the system.

**Range:**

*1101 - 1108, 1111 - 1112, 1201 - 1208, 1211 - 1218, 1301 - 1308, 1311 - 1318, 2101 - 2108, 2111 - 2118, 2201 - 2208, 2211 - 2218, 2301 - 2308, 2311 - 2318, 3101 - 3108, 3111 - 3118, 3201 - 3208, 3211 - 3218, 3301 - 3308, 3311 - 3318,*

4101 - 4108, 4111 - 4118, 4201 - 4208, 4211 - 4218, 4301 - 4308, 4311 - 4318, 5101 - 5108, 5111 - 5118, 5201 - 5208, 5211 - 5218, 5301 - 5308, 5311 - 5318, 6101 - 6108, 6111 - 6118, 1113, 1115

### Example

```
rept-stat-db
rept-stat-db:display=all
rept-stat-db:loc=1207
rept-stat-db:db=stp
rept-stat-db:db=gtt
```

### Dependencies

The `db` and `loc` parameters cannot be specified at the same time. Also, `display=except` and `display=version` cannot be specified with `db=gtt`.

For E5-OAM cards, values of 1117 and 1118 cannot be specified for the `loc` parameter.

One of the following features must be turned on, the ATINP feature must be enabled, or at least one ENUM card must be provisioned before the `db=mps` parameter can be specified:

- A-Port
- AINPQ
- EIR
- G-Flex
- G-Port
- INP
- LNP ELAP Configuration
- Prepaid SMS Intercept Ph1
- SIP NP
- V-Flex

The shelf and card must be equipped.

The card location slot must be between 1 and 18, but not 9 or 10.

The shelf location must be 11xx, 12xx, 13xx, 21xx, 22xx, 23xx, 31xx, 32xx, 33xx, 41xx, 42xx, 43xx, 51xx, 52xx, 53xx, or 61xx.

The frame value of the shelf location parameter (`loc`) must be within the valid range.

A valid value must be specified for the `display` parameter.

### Notes

If the `display`, `db`, or `loc` parameter is specified and the database for a particular card location is not accessible, hyphens are displayed in place of the data.

The output of the `rept-stat-db` command with no parameters specified or with the `display=brief` parameter shows the following information:

- Activity status of both the active and standby MASP, the date and time the last backup was performed on the removable drive (if inserted) and the fixed disk backup partition, coherency, the number of updates (level) to the backup partition of the fixed disk, and the current partition of the fixed disk
- If the A-Port, AINPQ, Diameter S13/S13' Interface for EIR, EIR, G-Flex, G-Port, INP, PPSMS, SIPNP (if used with EPAP), or V-Flex feature is turned on, or the ATINP feature is enabled, EPAP A and EPAP B database status followed by Service Module card database status
- If the SIP NP (if used with ELAP) or LNP ELAP Configuration controlled feature is turned on, ELAP A and ELAP B database status followed by Service Module card database status
- If one or more GTT-enabled IPSP cards are configured, the GTT database status for all such cards

The output when the `display=except` parameter is specified shows the coherency and the number of updates for all the cards whose database level does not match the active fixed disk current partition, reference database level, or is incoherent. All databases that are not accessible are also displayed. In addition, the time stamp for the last database update is displayed for every card.

The output when the `display=all` parameter is specified shows the coherency and the number of updates for all of the distributed databases. In addition, the time stamp for the last database update is displayed for every card.

The output when the `display=version` parameter is specified shows the coherency and the number of updates for the active and standby databases, along with the database version and the operational status of each of these databases. If the LNP feature is turned on, the version of the LNP database is shown. No version is shown for EPAP or ELAP databases; use the `rept-stat-mps` command to display version information for these databases.

The output when the `loc` parameter specifies an equipped card shows the coherency and the number of updates to its database. In addition, the time stamp for the last database update is displayed for the specific card location.

The `db` parameter is used to limit the output of the command to the EAGLE STP information or the MPS information or GTT information for an IPSP card. The information is displayed as indicated by the `display` parameter value (`display=version` is not valid for `db=mps` and `db=gtt`; the command does not display the MPS database versions). The default `db` parameter value is `all`, which displays the information for the STP and MPS databases and cards as indicated by the `display` parameter value.

## Output

### Note:

Removable drive database information is shown only for the Active OAM slot, whether or not a removable drive is inserted into the standby OAM.

 **Note:**

A status of 'OK' indicates that the database has no errors.

This example shows the output for a specified card. The disk is OFF-LINE indicating the disk has been dismounted. This is not necessarily a problem.

```
rept-stat-db:loc=1114
```

```
tekelecstp 08-08-29 08:38:25 NZST EAGLE 39.2.0
CARD/APPL LOC C T LEVEL TIME LAST UPDATE EXCEPTION
-----
TDM-CRNT 1114 - - - - - OFF-LINE
TDM-BKUP 1114 - - - - -
```

```
;
```

This example shows the output for a specified Service Module card used for EPAP or ELAP. The A-Port, AINPQ, Diameter S13/S13' Interface for EIR, EIR, G-Flex, G-Port, INP, LNP ELAP Configuration, PPSMS, SIP NP, or V-Flex feature is turned on, or the ATINP feature is enabled.

```
rept-stat-db:loc=1201
```

```
tekelecstp 08-08-29 08:38:25 NZST EAGLE 39.2.0
CARD/APPL LOC C T LEVEL TIME LAST UPDATE EXCEPTION
-----
VSCCP 1201 Y N 12 08-05-29 08:53:48 -

EAGLE RTDB REPORT
CARD/APPL LOC C BIRTHDATE LEVEL EXCEPTION
-----
VSCCP 1201 Y 08-05-29 16:12:50 12345 -
```

```
;
```

This example shows the output when the A-Port, AINPQ, Diameter S13/S13' Interface for EIR, EIR, G-Flex, G-Port, INP, LNP ELAP Configuration, PPSMS, SIP NP, and V-Flex features are not turned on, and the ATINP feature is not enabled:

```
rept-stat-db
```

```
tekelecstp 08-08-29 08:38:25 NZST EAGLE 39.2.0
DATABASE STATUS: >> OK <<
          TDM 1114 ( ACTV )          TDM 1116 ( STDBY)
          C LEVEL TIME LAST BACKUP C LEVEL TIME LAST BACKUP
          - - - - -
-----
          FD BKUP Y 11 08-05-29 08:20:13 NZST Y 11 08-05-29 08:20:13
NZST
          FD CRNT Y 11 Y 11
          MDAL 1117
```

```

- -----
RD BKUP Y          1 08-05-29 15:44:20 NZST
;

```

This example shows the output when the A-Port, AINPQ, Diameter S13/S13' Interface for EIR, EIR, G-Flex, G-Port, INP, LNP ELAP Configuration, PPSMS, SIP NP, and V-Flex features are not turned on, and the ATINP feature is not enabled:

```
rept-stat-db:display=all
```

```

tekelecstp 08-08-29 08:39:24 NZST  EAGLE 39.2.0
DATABASE STATUS: >> OK <<
          TDM 1114 ( ACTV )          TDM 1116 ( STDBY)
          C  LEVEL      TIME LAST BACKUP      C  LEVEL      TIME LAST
BACKUP
-----
          FD BKUP Y          11 08-05-29 08:20:13 NZST Y          11 08-05-29
08:20:13 NZST
          FD CRNT Y          11                      Y          11
          MDAL 1117
          - -----
          RD BKUP Y          1 08-05-29 15:44:20 NZST
          CARD/APPL  LOC  C  T  LEVEL          TIME LAST UPDATE      EXCEPTION
          -----  - - - - -
          -----
          SS7ANSI    1102  Y  N  11          08-05-29 08:04:00      -
          SS7ANSI    1103  Y  N  11          08-05-29 08:04:00      -
          VSCCP      1105  Y  N  11          08-05-29 08:04:00      -
          STPLAN     1107  Y  N  11          08-05-29 08:04:00      -
          TDM-CRNT   1114  Y  N  11          08-05-29 08:04:00      -
          TDM-BKUP   1114  Y  -  11          08-05-29 08:04:00      -
          TDM-CRNT   1116  Y  N  11          08-05-29 08:04:00      -
          TDM-BKUP   1116  Y  -  11          08-05-29 08:04:00      -
          MDAL       1117  Y  -  1          08-05-29 15:06:29      DIFF LEVEL
          VSCCP      1201  Y  N  11          08-05-29 08:04:00      -
          VSCCP      1203  Y  N  11          08-05-29 08:04:00      -
;

```

This example shows the output when the A-Port, AINPQ, Diameter S13/S13' Interface for EIR, EIR, G-Flex, G-Port, INP, LNP ELAP Configuration, PPSMS, SIP NP, and V-Flex features are not turned on, and the ATINP feature is not enabled:

 **Note:**

This command does not display version information for MPS databases. Use the `rept-stat-mps` command to display MPS database version information.



```
rept-stat-db:display=except
```

```
tekelecstp 08-08-29 08:55:54 NZST EAGLE 39.2.0
DATABASE STATUS: >> OK <<
          TDM 1114 ( ACTV )          TDM 1116 ( STDBY)
          C  LEVEL    TIME LAST BACKUP    C  LEVEL    TIME LAST
BACKUP
-----
      FD BKUP Y          11 08-05-29 08:20:13 NZST Y          11 08-05-29
08:20:13 NZST
      FD CRNT Y          12                      Y          12
          MDAL 1117
          -----
      RD BKUP Y          1 07-10-24 15:44:20 NZST
CARD/APPL LOC  C  T  LEVEL          TIME LAST UPDATE    EXCEPTION
-----
      SS7ANSI          1103 Y  N  10          08-05-29 08:03:48  DIFF LEVEL
      TDM-BKUP          1114 Y  -  11          08-05-29 08:04:00  DIFF LEVEL
      TDM-BKUP          1116 Y  -  11          08-05-29 08:04:00  DIFF LEVEL
      MDAL              1117 Y  -  1          08-05-24 15:06:29  DIFF LEVEL
;

```

This example shows the output when the LNP ELAP Configuration controlled feature is turned on, and ELAP is used:

```
rept-stat-db
```

```
tekelecstp 02-10-29 08:39:24 NZST EAGLE 30.0.0
DATABASE STATUS: >> OK <<
          TDM 1114 ( ACTV )          TDM 1116 ( STDBY)
          C  LEVEL    TIME LAST BACKUP    C  LEVEL    TIME LAST
BACKUP
-----
      FD BKUP Y          11 02-10-29 08:20:13 NZST Y          11 02-10-29
08:20:13 NZST
      FD CRNT Y          11                      Y          11
          MDAL 1117
          -----
      RD BKUP Y          1 02-10-24 15:44:20 NZST
          ELAP A ( ACTV )
          C  BIRTHDATE          LEVEL          EXCEPTION
          -  -----
RTDB              Y  02-10-29 08:20:04          12345          -
RTDB-EAGLE              02-10-29 08:20:04          12345          -
          ELAP B ( STDBY )
          C  BIRTHDATE          LEVEL          EXCEPTION
          -  -----
RTDB              Y  02-10-29 08:20:04          12345          -

```









```

          C  LEVEL      TIME LAST BACKUP      C  LEVEL      TIME LAST
BACKUP  - - - - -
-----
          FD BKUP Y          11 08-05-29 08:20:13 NZST Y          11 08-05-29
08:20:13 NZST
          FD CRNT Y          12
          MDAL 1117
          - - - - -
          RD BKUP Y          1 02-10-24 15:44:20 NZST
CARD/APPL LOC  C  T  LEVEL      TIME LAST UPDATE      EXCEPTION
-----
SS7ANSI  1103 Y  N  10          08-05-29 08:03:48      DIFF LEVEL
TDM-BKUP 1114 Y  -  11          08-05-29 08:04:00      DIFF LEVEL
TDM-BKUP 1116 Y  -  11          08-05-29 08:04:00      DIFF LEVEL
MDAL     1117 Y  -  1          08-05-29 15:06:29      DIFF LEVEL
          EPAP A ( ACTV )
          C  BIRTHDATE          LEVEL      EXCEPTION
          - - - - -
          PDB                   Y  08-05-29 08:20:04          12345      -
          RTDB                   Y  08-05-29 08:20:04          12345      -
          RTDB-EAGLE              Y  08-05-29 08:20:04          12345      -
          EPAP B ( STDBY )
          C  BIRTHDATE          LEVEL      EXCEPTION
          - - - - -
          PDB                   Y  08-05-29 08:20:04          12345      -
          RTDB                   Y  08-05-29 08:20:04          12345      -
          RTDB-EAGLE              Y  08-05-29 08:20:04          12345      -
          EAGLE RTDB REPORT
CARD/APPL LOC  C  BIRTHDATE          LEVEL      EXCEPTION
-----
VSCCP    1203 Y  08-05-29 08:20:04          12340      DIFF LEVEL
;

```

This example shows the output when the A-Port, AINPQ, Diameter S13/S13' Interface for EIR, G-Flex, G-Port, EIR, INP, LNP ELAP Configuration, PPSMS, SIPNP, and V-Flex features are not turned on, and the ATINP feature is not enabled:

rept-stat-db:db=stp

```

tekelecstp 08-08-29 08:39:24 NZST  EAGLE 39.2.0
DATABASE STATUS: >> OK <<
          TDM 1114 ( ACTV )          TDM 1116 ( STDBY)
          C  LEVEL      TIME LAST BACKUP      C  LEVEL      TIME LAST
BACKUP  - - - - -
-----
          FD BKUP Y          11 08-05-29 08:20:13 NZST Y          11 08-05-29
08:20:13 NZST
          FD CRNT Y          11
          MDAL 1117
          - - - - -

```



```

-----
RD BKUP Y          1 08-05-24 15:44:20 NZST
CARD/APPL LOC C T LEVEL          TIME LAST UPDATE  EXCEPTION
-----
-----
SS7ANSI  1103 Y N  10          08-05-29 08:03:48  DIFF LEVEL
TDM-BKUP  1114 Y -  11          08-05-29 08:04:00  DIFF LEVEL
TDM-BKUP  1116 Y -  11          08-05-29 08:04:00  DIFF LEVEL
MDAL      1117 Y -  1          08-05-29 15:06:29  DIFF LEVEL
;

```

This example shows the output when the LNP ELAP Configuration controlled feature is turned on, and ELAP is used:

```
rept-stat-db:db=mps
```

```

tekelecstp 02-10-29 08:55:54 NZST EAGLE 30.0.0
          ELAP A ( ACTV )
          C BIRTHDATE          LEVEL          EXCEPTION
          - - - - -
RTDB      Y 02-10-29 08:20:04    12345          -
RTDB-EAGLE      02-10-29 08:20:04    12345          -
          ELAP B ( STDBY )
          C BIRTHDATE          LEVEL          EXCEPTION
          - - - - -
RTDB      Y 02-10-29 08:20:04    12345          -
RTDB-EAGLE      02-10-29 08:20:04    12345          -
;

```

This example shows the output when the LNP ELAP Configuration feature is turned on, and ELAP is used. Card 1203 indicates a value 12 in the exception column. The value indicates the number of times that the Corruption Cross Correction function has corrected the card during the time that the card has been in service. More specifically, the card has encountered 12 corrupted records and has subsequently repaired them. This value persists until the card is reset.

```
rept-stat-db:display=all:db=mps
```

```

tekelecstp 02-10-29 08:55:54 NZST EAGLE 31.6.0
          ELAP A ( ACTV )
          C BIRTHDATE          LEVEL          EXCEPTION
          - - - - -
RTDB      Y 02-10-29 08:20:04    12345          -
RTDB-EAGLE      02-10-29 08:20:04    12345          -
          ELAP B ( STDBY )
          C BIRTHDATE          LEVEL          EXCEPTION
          - - - - -
RTDB      Y 02-10-29 08:20:04    12345          -
RTDB-EAGLE      02-10-29 08:20:04    12345          -
          EAGLE RTDB REPORT
CARD/APPL LOC C BIRTHDATE          LEVEL          EXCEPTION  IN-

```



```

RTDB                Y 08-05-29 08:20:04      12345      -
RTDB-EAGLE          Y 08-05-29 08:20:04      12345      -
EPAP B ( STDBY )
C BIRTHDATE          LEVEL      EXCEPTION
- - - - -
PDB                 Y 08-05-29 08:20:04      12345      -
RTDB                 Y 08-05-29 08:20:04      12345      -
RTDB-EAGLE          Y 08-05-29 08:20:04      12345      -
;

```

This example shows the output when the A-Port, AINPQ, Diameter S13/S13' Interface for EIR, EIR, G-Flex, G-Port, EIR, INP, PPSMS, SIP NP, or V-Flex feature is turned on, or the ATINP feature is enabled, and EPAP is used:

```
rept-stat-db:display=all:db=mps
```

```

tekelecstp 08-05-29 08:55:54 NZST  EAGLE 39.2.0
EPAP A ( ACTV )
C BIRTHDATE          LEVEL      EXCEPTION
- - - - -
PDB                 Y 07-08-29 08:20:04      12345      -
RTDB                 Y 07-08-29 08:20:04      12345      -
RTDB-EAGLE          Y 07-08-29 08:20:04      12345      -

EPAP B ( STDBY )
C BIRTHDATE          LEVEL      EXCEPTION
- - - - -
PDB                 Y 07-08-29 08:20:04      12345      -
RTDB                 Y 07-08-29 08:20:04      12345      -
RTDB-EAGLE          Y 07-08-29 08:20:04      12345      -

EAGLE RTDB REPORT
CARD/APPL  LOC  C BIRTHDATE          LEVEL      EXCEPTION      IN-
SRVC
-----
VSCCP      1201 Y 07-08-29 08:20:04      12345      -
10d 23h 21m
VSCCP      1203 Y 07-08-29 08:20:04      12345      -
10d 23h 21m
VSCCP      1105 Y 07-08-29 08:20:04      12345      -
5d 3h 1m
;

```

This example shows the output when the A-Port, AINPQ, Diameter S13/S13' Interface for EIR, EIR, G-Flex, G-Port, INP, PPSMS, SIP NP, or V-Flex feature is turned on, or the ATINP feature is enabled, and EPAP is used:

```
rept-stat-db:display=except:db=mps
```

```

tekelecstp 08-08-29 08:55:54 NZST  EAGLE 39.2.0
EPAP A ( ACTV )

```

```

C BIRTHDATE          LEVEL          EXCEPTION
- - - - -
PDB                  Y 07-08-29 08:20:04    12345      -
RTDB                  Y 07-08-29 08:20:04    12345      -
RTDB-EAGLE           Y 07-08-29 08:20:04    12345      -

EPAP B ( STDBY )
C BIRTHDATE          LEVEL          EXCEPTION
- - - - -
PDB                  Y 07-08-29 08:20:04    12345      -
RTDB                  Y 07-08-29 08:20:04    12345      -
RTDB-EAGLE           Y 07-08-29 08:20:04    12345      -

EAGLE RTDB REPORT
CARD/APPL  LOC  C BIRTHDATE          LEVEL          EXCEPTION      IN-SRVC
- - - - -
VSCCP      1203 Y 07-08-29 08:20:04    12340      DIFF LEVEL      10d 23h
21m
;

```

This example shows the output when E5-MCAP and E5-TDM cards are used:

rept-stat-db

```

e5oam 08-12-01 15:25:40 EST EAGLE 40.1.0
DATABASE STATUS: >> OK <<
          TDM 1114 ( STDBY)          TDM 1116 ( ACTV )
          C  LEVEL      TIME LAST BACKUP      C  LEVEL      TIME LAST BACKUP
          - - - - -
-----
FD BKUP Y          36 08-11-19 09:38:25 EST Y          36 08-11-19 09:38:25
EST
FD CRNT Y          39
          MCAP 1113          MCAP 1115
          - - - - -
RD BKUP Y          36 08-11-19 09:27:17 EST Y          36 08-11-19 09:27:17
EST
USB BKP - - - - - Y          3 08-11-07 01:11:22
EST
;

```

rept-stat-db:display=all

```

e5oam 08-12-01 15:26:27 EST EAGLE 40.1.0
DATABASE STATUS: >> OK <<
          TDM 1114 ( STDBY)          TDM 1116 ( ACTV )
          C  LEVEL      TIME LAST BACKUP      C  LEVEL      TIME LAST BACKUP
          - - - - -
-----
FD BKUP Y          36 08-11-19 09:38:25 EST Y          36 08-11-19 09:38:25
EST

```



```

FD CRNT Y          39                                Y          39
          MCAP 1113                                MCAP 1115
-----
RD BKUP Y          36 08-11-19 09:27:17 EST Y          36 08-11-19
09:27:17 EST
USB BKP - - - - - - - - - -
-----
CARD/APPL  LOC  C  T  LEVEL          TIME LAST UPDATE  EXCEPTION
-----
-----
MCP          1108 - - - - -
IPS          1111 Y N 39          08-11-22 10:21:54 -
OAM-RMV     1113 Y - 36          08-11-18 23:36:19 DIFF LEVEL
TDM-CRNT    1114 Y N 39          08-11-22 10:21:54 -
TDM-BKUP    1114 Y - 36          08-11-18 23:36:38 DIFF LEVEL
OAM-RMV     1115 Y - 36          08-11-18 23:36:19 DIFF LEVEL
OAM-USB     1115 Y - 3          08-11-07 01:11:22 DIFF LEVEL
TDM-CRNT    1116 Y N 39          08-11-22 10:21:54 -
TDM-BKUP    1116 Y - 36          08-11-18 23:36:38 DIFF LEVEL

```

The examples show output when the Dual ExAP Config feature is enabled and both LNP and EPAP base features are turned ON:

rept-stat-db

```

exap 12-07-03 09:31:29 MST EAGLE 45.0.0-64.34.0
DATABASE STATUS: >> OK <<
          TDM 1114 ( STDBY )          TDM 1116 ( ACTV )
          C  LEVEL      TIME LAST BACKUP      C  LEVEL      TIME LAST
BACKUP
-----
-----
FD BKUP Y          1 - - - Y          1 - - -
FD CRNT Y          79                                Y          79
          MCAP 1113                                MCAP 1115
          - - - - -                                - - - - -
RD BKUP Y          1 - - - Y          1 - - -
USB BKP - - - - - - - - - - - - - - - - - - - -
-----
          ELAP A ( STDBY )
          C  BIRTHDATE          LEVEL      EXCEPTION
          - - - - -            - - - - -            - - - - -
RTDB          Y 11-08-01 13:50:00          6 -
RTDB-EAGLE          11-08-01 13:50:00          6 -
-----
          ELAP B ( ACTV )
          C  BIRTHDATE          LEVEL      EXCEPTION
          - - - - -            - - - - -            - - - - -
RTDB          Y 11-08-01 13:50:00          6 -
RTDB-EAGLE          11-08-01 13:50:00          6 -
-----
          EPAP A ( STDBY )
          C  BIRTHDATE          LEVEL      EXCEPTION
          - - - - -            - - - - -            - - - - -

```

```
PDB          09-06-12 12:09:46 104552913 -
RTDB         Y 09-06-12 12:09:46 104552913 -
RTDB-EAGLE   09-06-12 12:15:06 104552913 -
```

EPAP B ( ACTV )

```
  C BIRTHDATE          LEVEL      EXCEPTION
  - - - - -
PDB          09-06-12 12:09:46 104552913 -
RTDB         Y 09-06-12 12:09:46 104552913 -
RTDB-EAGLE   09-06-12 12:15:06 104552913 -
```

;

rept-stat-db:display=all

exap 12-07-03 09:35:32 MST EAGLE 45.0.0-64.34.0

DATABASE STATUS: >> OK <<

TDM 1114 ( STDBY)

TDM 1116 ( ACTV )

```
  C LEVEL      TIME LAST BACKUP      C LEVEL      TIME LAST BACKUP
  - - - - -
FD BKUP Y      1      -      -      Y      1      -      -
FD CRNT Y      79
MCAP 1113
- - - - -
RD BKUP Y      1      -      -      Y      1      -      -
USB BKP -      -      -      -      -      -      -      -
```

```
CARD/APPL LOC C T LEVEL      TIME LAST UPDATE      EXCEPTION
- - - - -
VSCCP      1101 Y N 79      12-07-02 11:10:56      -
VSCCP      1103 Y N 79      12-07-02 11:10:56      -
IPS        1105 Y N 79      12-07-02 11:10:56      -
SS7ANSI    1107 Y N 79      12-07-02 11:10:56      -
IPSG       1108 - - -      -      -      -
VSCCP      1111 Y N 79      12-07-02 11:10:56      -
OAM-RMV    1113 Y - 1      -      -      DIFF LEVEL
TDM-CRNT   1114 Y N 79      12-07-02 11:10:56      -
TDM-BKUP   1114 Y - 1      00-00-00 00:00:00      DIFF LEVEL
OAM-RMV    1115 Y - 1      -      -      DIFF LEVEL
OAM-USB    1115 - - -      -      -      -
TDM-CRNT   1116 Y N 79      12-07-02 11:10:56      -
TDM-BKUP   1116 Y - 1      00-00-00 00:00:00      DIFF LEVEL
VSCCP      1201 - - -      -      -      -
CCS7ITU    1203 - - -      -      -      -
VSCCP      1205 - - -      -      -      -
```

ELAP A ( STDBY )

```
  C BIRTHDATE          LEVEL      EXCEPTION
  - - - - -
RTDB         Y 11-08-01 13:50:00      6      -
RTDB-EAGLE   11-08-01 13:50:00      6      -
```

```

ELAP B ( ACTV )
C BIRTHDATE          LEVEL          EXCEPTION
- - - - -
RTDB                  Y 11-08-01 13:50:00      6          -
RTDB-EAGLE           11-08-01 13:50:00      6          -

EPAP A ( STDBY )
C BIRTHDATE          LEVEL          EXCEPTION
- - - - -
PDB                   09-06-12 12:09:46      104552913  -
RTDB                  Y 09-06-12 12:09:46      104552913  -
RTDB-EAGLE           09-06-12 12:15:06      104552913  -

EPAP B ( ACTV )
C BIRTHDATE          LEVEL          EXCEPTION
- - - - -
PDB                   09-06-12 12:09:46      104552913  -
RTDB                  Y 09-06-12 12:09:46      104552913  -
RTDB-EAGLE           09-06-12 12:15:06      104552913  -

EAGLE RTDB REPORT
CARD/APPL  LOC  C BIRTHDATE          LEVEL          EXCEPTION  IN-
SRVC
-----
VSCCP      1101 Y 11-08-01 17:50:00      6          -
7d 16h 33m
VSCCP      1111 Y 09-06-12 12:15:06      104552913  -
4d 18h 27m

```

;

rept-stat-db:db=mps

exap 12-07-03 09:36:17 MST EAGLE 45.0.0-64.34.0

```

ELAP A ( STDBY )
C BIRTHDATE          LEVEL          EXCEPTION
- - - - -
RTDB                  Y 11-08-01 13:50:00      6          -
RTDB-EAGLE           11-08-01 13:50:00      6          -

ELAP B ( ACTV )
C BIRTHDATE          LEVEL          EXCEPTION
- - - - -
RTDB                  Y 11-08-01 13:50:00      6          -
RTDB-EAGLE           11-08-01 13:50:00      6          -

EPAP A ( STDBY )
C BIRTHDATE          LEVEL          EXCEPTION
- - - - -
PDB                   09-06-12 12:09:46      104552913  -
RTDB                  Y 09-06-12 12:09:46      104552913  -
RTDB-EAGLE           09-06-12 12:15:06      104552913  -

```

```

                                EPAP B ( ACTV )
                                C  BIRTHDATE          LEVEL          EXCEPTION
                                -  -----          -          -
PDB                                09-06-12 12:09:46  104552913          -
RTDB                               Y  09-06-12 12:09:46  104552913          -
RTDB-EAGLE                         09-06-12 12:15:06  104552913          -

```

```
;
```

The examples shows the GTT DB level on ACTIVE and STANDBY MASP when there is some GTT data available on the OAMs:

```
rept-stat-db:db=gtt
```

```
tekelecstp 16-08-25 02:57:00 EST  EAGLE 46.5.0.0.0-70.4.0
```

```
rept-stat-db:db=gtt
```

```
Command entered at terminal #23.
```

```
;
```

```
Command Accepted - Processing
```

```
tekelecstp 16-08-25 02:57:00 EST  EAGLE 46.5.0.0.0-70.4.0
```

```
DATABASE STATUS: >> OK <<
```

```
TDM 1114 ( ACTV )
```

```
TDM 1116 ( STDBY )
```

```
C  LEVEL      TIME LAST BACKUP
```

```
C  LEVEL      TIME LAST BACKUP
```

```
-  -----  -
```

```
-----
```

```
GTT  Y      5651 16-08-25 02:57:00      Y      5651 16-08-25 02:57:00
```

The examples shows the GTT DB level on ACTIVE and STANDBY MASP when there is no GTT data on the OAMs:

```
rept-stat-db:db=gtt
```

```
tekelecstp 16-08-25 02:57:00 EST  EAGLE 46.5.0.0.0-70.4.0
```

```
rept-stat-db:db=gtt
```

```
Command entered at terminal #23.
```

```
;
```

```
Command Accepted - Processing
```

```
tekelecstp 16-08-25 02:57:00 EST  EAGLE 46.5.0.0.0-70.4.0
```

```
DATABASE STATUS: >> OK <<
```

```
TDM 1114 ( ACTV )
```

```
TDM 1116 ( STDBY )
```

```
C  LEVEL      TIME LAST BACKUP
```

```
C  LEVEL      TIME LAST BACKUP
```

```
-  -----  -
```

```
-----
```

```
GTT  Y      5651 16-08-25 02:57:00      Y      5651 16-08-25 02:57:00
```

This example shows the GTT DB level on ACTIVE and STANDBY MASP and also on all GTT enabled IPSG cards, irrespective of their state.

```
rept-stat-db:db=gtt:display=all
```

```
tekelecstp 16-08-25 02:57:00 EST  EAGLE 46.5.0.0.0-70.4.0
```

```
rept-stat-db:db=gtt:display=all
```

```
Command entered at terminal #22.
```

```
;
```

```

Command Accepted - Processing
  tekelecstp 16-08-25 02:57:00 EST   EAGLE 46.5.0.0.0-70.4.0
  DATABASE STATUS: >> OK <<
                TDM 1114 ( ACTV )                TDM 1116 ( STDBY )
                C  LEVEL      TIME LAST BACKUP    C  LEVEL      TIME LAST
BACKUP
-----
GTT   Y      5651 16-08-25 02:57:00      Y      5651 16-08-25
02:57:00

CARD/APPL  LOC  C  T  LEVEL      TIME LAST UPDATE  EXCEPTION
-----
IPSG       1102 -  -  -          -          -          -
IPSG       1105 Y  N  5651      16-08-25 02:59:30  -
IPSG       1106 Y  N  5651      16-08-25 02:59:35  -
IPSG       1108 -  -  -          -          -          -
;
Command Executed

```

This example shows that with `db=gtt`, only two values of `DISPLAY` parameter are supported viz., `ALL` and `BRIEF`. This command will give an appropriate error message when `display=except` or `display=version` is specified with `db=gtt`.

```
rept-stat-db:display=except:db=gtt
```

```

tekelecstp 16-11-28 16:00:19 MST   EAGLE 46.5.0.0.0-70.7.0
  rept-stat-db:display=except:db=gtt
  Command entered at terminal #23.
;

```

E2155 Cmd Rej: Invalid parameter combination specified

```
> rept-stat-db:display=version:db=gtt
```

```

tekelecstp 16-11-28 16:06:31 MST   EAGLE 46.5.0.0.0-70.7.0
  rept-stat-db:display=version:db=gtt
  Command entered at terminal #23.
;

```

E2155 Cmd Rej: Invalid parameter combination specified

### Legend

- **DATABASE STATUS**—Indicates any database alarms on the MASP. Not used with `loc` parameter output.
  - **>> OK<<**—No database alarms
  - **>>NOT OK (DMS)<<**—Database DMS alarms are present
  - **>>NOT OK (DRMS)<<**—Database DRMS alarms are present
  - **>>NOT OK (DMS,DRMS)<<**—Database DMS and DRMS alarms are present

- **(ACTV MASP)**—The specified MASP is the active processor. Not used with `loc` parameter.
- **(STDBY MASP)**—The specified MASP is the standby processor. Not used with `loc` parameter.
- **(NOACCS)**—The specified processor is not accessible. Not used with `loc` parameter.
- **C**—Indicates whether the database is coherent
- **Y** —the database is coherent
- **N** —the database is not coherent
- Dash ( - )—the database is not accessible
- **LEVEL**—Number of updates made to the database partitions
- **TIME LAST BACKUP**—Date and time the last change was performed on the removable drives (if inserted) and the backup partition of the fixed disk. Not used with `loc` parameter.
- **TIME LAST UPDATE**—Date and time of the last update on the card database from OAM. Not used with `loc` parameter.
- **GTT**—The Global Title Translation database on the OAM. This database is downloaded to Service Module and GTT enabled IPGS cards. If the birthdate or level do not match the SM/GTT enabled IPGS card, then the corresponding card generates an alarm.
- **RD BKUP**—Removable drive backup partition
- **FD BKUP**—Fixed disk backup partition
- **FD CRNT**—Fixed disk current partition. Not used with the `loc` parameter output.
- **DIFF CONTENTS**—The specified database's contents are different compared to the other database in that partition.
- **DIFF LEVEL**—The specified database's level does not match the level of the current partition of the active fixed disk (**FD CRNT**).
- **DIFF TIME**—The specified database's level matches the level of the current partition of the active fixed disk (**FD CRNT**), but the time that the database was updated, compared to the current partition of the active fixed disk (**FD CRNT**), is different. This exception indicator appears only if the time and date stamp in an update packet or in memory becomes corrupted.
- **CORRUPTED**—The specified database is corrupted.
- **INCOHERENT**—The specified database is incoherent.
- **EXCEPTION**—The following values can appear:
  - The condition of the specified database with which the system has detected a problem. These conditions are: **DIFF CONTENTS**, **DIFF LEVEL**, **DIFF TIME**, **CORRUPTED**, and **INCOHERENT**. A “-” indicates that the database was not accessible. A blank entry indicates that the database has no problems. This field is used with the `display=except`, `display=all`, and `loc` parameter outputs.
  - A value that indicates the number of times that the Corruption Cross Correction function has corrected the card during the time that the card has been in service. This value persists until the card is reset.
- **IN-SRVC**—Length of time the card has been in service

- **CARD/APPL**—Card type or application assigned to the card specified in the **LOC** field. Not used with the `display=brief` (default) output.
  - **TDM-BKUP**—Backup partition on the fixed disk on the TDM
  - **TDM-CRNT**—Current partition on the fixed disk on the TDM
- **LOC**—Card location of the database. Not used with `display=brief` (default) output.
- **T**—Indicates whether the specified database is in transition. A database is in transition when the database for the link interface module (LIM) or E5-TSM being loaded with the new screen set information after an update to the database, and the database has not reached the current reported database level. Not used with `display=brief` (default) output.
- **Y**—the database is in transition
- **N**—the database is not in transition.
- **TIME LAST BACKUP**—The date and time the last change was performed on the specified card and its associated database. A dash (–) in this field for the fixed drive (FD) or removable drive (RD) indicates that no backup has been created on that drive. Not used with `display=brief` (default) output.
- **VERSION**—Version number of each database (including the LNP database if the LNP feature is on)
  - **xxx-xxx-xxx**—Version number of the database
  - **UNKNOWN**—The `rept-stat-db` command can show the version number only for a database that is version 20.0.0 or later. Any database version that is earlier than version 20.0.0 cannot be determined and UNKNOWN is displayed for the database version number.
  - A dash “-” —The database is not available. Used only with `display=version` output.
- **STATUS**—Operational status of the database version. Used only with `display=version` output.
  - **NORMAL**—The database version is fully operational.
  - Blank entry—Indicates the database is not available or is unknown. A numeric value indicates the database is invalid. The value displayed is the status value found in the field and is for diagnostic purposes.
- **BIRTHDATE**—Date and time of creation for the database
- **EPAP A (ACTV)**—The active EAGLE Application Processor. This section appears only if the A-Port, AINPQ, Diameter S13/S13' Interface for EIR, G-Port, G-Flex, EIR, INP, PPSMS, SIP NP (if used with EPAP), or V-Flex features are turned on or the ATINP feature is enabled.
  - **PDB**—Provisioning database status information
  - **RTDB**—Provisioning database status information used to create the resident Realtime Database. The RTDB information may be different than the PDB information if the PDB has been reloaded, or if the RTDB has not been loaded from the PDB. If the RTDB birthdate is different than the PDB or if the level is too old to be able to resynchronize the databases, then a "Reload Required" alarm is generated.

- **RTDB-EAGLE**—EPAP resident Realtime Database status information. This database is downloaded to Service Module cards. If the birthdate or level do not match the Service Module card, then the Service Module card generates an alarm. The RTDB is reloaded from the PDB, and the birthdate and level are reset and do not match the database status information. This database status mismatch condition indicates an abnormal condition that requires Service Module cards to be reloaded.
- **EPAP B (STDBY)**—The standby EAGLE Application Processor. This section appears only if the A-Port, AINPQ, Diameter S13/S13' Interface for EIR, G-Port, G-Flex, EIR, INP, PPSMS, SIP NP (if used with EPAP), or V-Flex features are turned on, or the ATINP feature is enabled.
  - **PDB**—Provisioning database status information
  - **RTDB**—The provisioning database status information used to create the resident Realtime Database. The RTDB information may be different than the PDB information if the PDB has been reloaded, or if the RTDB has not been loaded from the PDB. If the RTDB birthdate is different than the PDB or if the level is too old to be able to resynchronize the databases, then a "Reload Required" alarm is generated.
  - **RTDB-EAGLE**—EPAP resident Realtime Database status information. This database is downloaded to Service Module cards. If the birthdate or level do not match the Service Module card, then the Service Module card generates an alarm. The RTDB is reloaded from the PDB, and the birthdate and level are reset and do not match the database status information. This database status mismatch condition indicates an abnormal condition that requires Service Module cards to be reloaded.
- **ELAP A (ACTV)**—The active EAGLE LNP Application Processor. This section appears only if the LNP ELAP Configuration or SIP NP (if used with ELAP) feature is turned on.
  - **RTDB-EAGLE**—ELAP resident Database status information. This database is downloaded to Service Module cards. If the birthdate or level do not match the Service Module card, then the Service Module card generates an alarm.
  - **TIME LAST UPDATE**—Date and time of the last update of the RTDB from the LSMS
- **ELAP B (STDBY)**—The standby EAGLE LNP Application Processor. This section appears only if the LNP ELAP Configuration or SIP NP (if used with ELAP) feature is turned on.
  - **RTDB-EAGLE**—The ELAP resident Realtime Database status information. This database is downloaded to Service Module cards. If the birthdate or level do not match the Service Module card, then the Service Module card generates an alarm.
  - **TIME LAST UPDATE**—Date and time of the last update of the RTDB from the LSMS

#### Related Topics

- [chg-db](#)
- [copy-meas](#)
- [disp-disk-dir](#)

## rept-stat-ddb

Use this command to obtain the most recent dynamic database (DDB) audit report. The DDB audit report displays the checksums of the Route, Linkset, Link, CM Card, CM Cluster, Mated Application, and MTP globals. The report displays the exact status of active MTP card after audit and cause of that status.



## Parameters

### **display (optional)**

This parameter specifies the type of report to display.

#### **Range:**

*brief*

*all*

#### **Default:**

*brief*

### **filter (optional)**

This parameter provides a full DDB audit report for cards that meet the specified criteria.

#### **Range:**

*resp*

Responding cards

*nrsp*

Non-responding cards

*incn*

Inconsistent cards

*cons*

Consistent cards

*ncons*

Not-consistent cards: includes cards marked as inconsistent, DDB update in progress, having idle period less than quiet period, and sending replies marked as NO\_DATA

*ndat*

Cards marked as "No Data" because the checksum of dynamic tables is not available

*nddl*

Cards marked as "No Data " because the checksum of dynamic tables is not available due to the DDL crossload being in incomplete state

*nddb*

Cards marked as "No Data" because the checksum of dynamic tables is not available due to non-initialization of DDB

*duip*

Cards returning replies marked as "DDB update in progress"

*duipt*

Cards returning replies marked as "DDB update in progress" due to incomplete evaluation of TSRC task

***duipc***

Cards returning replies marked as "DDB update in progress" due to incomplete checksum calculation

***nquiet***

Cards returning replies having idle period less than the quiet period

**list (optional)**

This parameter displays a list of cards that meet the specified criteria.

**Range:*****resp***

Responding cards

***nrsp***

Non-responding cards

***incn***

Inconsistent cards

***cons***

Consistent cards

***ncons***

Not-consistent cards, including cards marked as inconsistent, DDB update in progress, having idle period less than quiet period, and sending replies marked as NO\_DATA

***ndat***

Cards marked as "No Data " because the checksum of dynamic tables is not available

***nddl***

Cards marked as "No Data " because the checksum of dynamic tables is not available due to the DDL crossload being in incomplete state

***nddb***

Cards marked as "No Data " because the checksum of dynamic tables is not available due to non-initialization of the DDB

***duip***

Cards returning replies marked as "DDB update in progress"

***duipt***

Cards returning replies marked as "DDB update in progress" due to incomplete evaluation of TSRC task

***duipc***

Cards returning replies marked as "DDB update in progress" due to incomplete checksum calculation

***nquiet***

Cards returning replies marked as having the idle period less than the quiet period

**Example**

```
rept-stat-ddb
```

```
rept-stat-ddb:display=all
rept-stat-ddb:list=resp
rept-stat-ddb:filter=nddb
```

### Dependencies

Audit data is available only if the execution of a periodic or manual DDB audit is complete (see the `aud-data` command).

If the system is in upgrade mode, then this command cannot be entered.

The `display`, `list`, and `filter` parameters cannot be specified together in the command.

### Notes

A question mark (?) indicates that the corresponding card's status is not evaluated (Inconsistent/Consistent) when system status is marked as ABORTED.

Cards having an additional status of IGNORED responded with "DDB update in progress". These cards are not considered for calculating system status.

### Output

The MATED APPL field is displayed only for Service Module cards.

```
rept-stat-ddb:display=all

tekelecstp 09-07-21 21:10:17 GMT EAGLE 41.1.0
DDB AUDIT REPORT
  SYSTEM STATUS           : INCONSISTENT
  ACTIVE MTP CARDS       : 21
  NON RESPONDING CARDS   : 7: 1207 1208 1211 1212 2108 2111
2112
  RESPONDING CARDS       : 14
  CARDS WITH NO DATA    : 2
  CARDS WITH DATA       : 12
  CARDS FAILING QUIET PRD : 0
  CARDS WITH DDB UPD IN PRG : 3
  CARDS CONSIDERED FOR CKSM : 9
  INCONSISTENT CARDS     : 2: 1203 2103
  CONSISTENT CARDS       : 7
  AUDIT START TIME       : 21/07/2009 21:07:54
  QUIET PERIOD           : 600 ms

RTE      LINK SET  LINK      CM CARD  CM CLSTR  MATED APPL
MTP GLOBLs
  LOC    STATUS    CAUSE          IDLE      DDB UPD
ADDN'L STATUS
  H'000003e8 H'000003e8 H'000003e8 H'000003e8 H'000003e8 H'000003e8
H'000003e8
  1201  CONSISTENT          700      1000
  H'000003e8 H'000003e8 H'000003e8 H'000003e8 H'000003e8 H'000003e8
H'000003e8
  1202  CONSISTENT          700      1000
```

```
H'000007d0 H'000007d0 H'000007d0 H'000007d0 H'000007d0 H'000007d0
H'000007d0
  1203 INCONSISTENT                700      1000
-----
-----
      1204 NODATA          (DDB INIT)  -----
H'00000bb8 H'00000bb8 H'00000bb8 H'00000bb8 H'00000bb8 H'00000bb8
H'00000bb8
  1205 IN UPDATE 1      (TSRC,DDB)    700      1000      (IGNORED)
H'000003e8 H'000003e8 H'000003e8 H'000003e8 H'000003e8 H'000003e8
H'000003e8
  1206 CONSISTENT                700      1000
-----
-----
      1207 NORESP                -----
-----
      1208 NORESP                -----
-----
      1211 NORESP                -----
-----
      1212 NORESP                -----
H'000003e8 H'000003e8 H'000003e8 H'000003e8 H'000003e8 H'000003e8
H'000003e8
  1213 CONSISTENT                700      1000
H'000003e8 H'000003e8 H'000003e8 H'000003e8 H'000003e8 -----
H'000003e8
  2101 CONSISTENT                700      1000
H'000003e8 H'000003e8 H'000003e8 H'000003e8 H'000003e8 -----
H'000003e8
  2102 CONSISTENT                700      1000
H'000007d0 H'000007d0 H'000007d0 H'000007d0 H'000007d0 -----
H'000007d0
  2103 INCONSISTENT                700      1000      (WWA UPD=2)
-----
-----
      2104 NODATA          (DDL XLOAD)  -----
H'00000bb8 H'00000bb8 H'00000bb8 H'00000bb8 H'00000bb8 -----
H'00000bb8
  2105 IN UPDATE 2      (DDB)          700      1000      (IGNORED)
H'00000bb8 H'00000bb8 H'00000bb8 H'00000bb8 H'00000bb8 -----
H'00000bb8
  2106 IN UPDATE 2      (TSRC,DDB)    700      1000      (IGNORED)
H'000003e8 H'000003e8 H'000003e8 H'000003e8 H'000003e8 -----
H'000003e8
  2107 CONSISTENT                700      1000
-----
-----
      2108 NORESP                -----
-----
      2111 NORESP                -----
-----
```

```
-----
      2112 NORESP
      Command Completed.
;
-----
```

rept-stat-ddb

```
tekelecstp 09-07-21 21:10:32 GMT EAGLE 41.1.0
DDB AUDIT REPORT
SYSTEM STATUS           : OK
ACTIVE MTP CARDS       : 10
NON RESPONDING CARDS   : 0
RESPONDING CARDS      : 10
CARDS WITH NO DATA    : 0
CARDS WITH DATA      : 10
CARDS FAILING QUIET PRD : 0
CARDS WITH DDB UPD IN PRG : 0
CARDS CONSIDERED FOR CKSM : 10
INCONSISTENT CARDS    : 0
CONSISTENT CARDS      : 0
AUDIT START TIME      : 21/07/2009 21:07:54
QUIET PERIOD          : 20 ms
```

Command Completed.

;

rept-stat-ddb:filter=incn

```
tekelecstp 09-07-21 21:09:32 GMT EAGLE 41.1.0
DDB AUDIT REPORT
SYSTEM STATUS           : INCONSISTENT
ACTIVE MTP CARDS       : 21
NON RESPONDING CARDS   : 7: 1207 1208 1211 1212 2108 2111
2112
RESPONDING CARDS      : 14
CARDS WITH NO DATA    : 2
CARDS WITH DATA      : 12
CARDS FAILING QUIET PRD : 0
CARDS WITH DDB UPD IN PRG : 3
CARDS CONSIDERED FOR CKSM : 9
INCONSISTENT CARDS    : 2: 1203 2103
CONSISTENT CARDS      : 7
AUDIT START TIME      : 21/07/2009 21:07:54
QUIET PERIOD          : 600 ms
```

RTE	LINK SET	LINK	CM CARD	CM CLSTR	MATED APPL
MTP GLOBL					
LOC	STATUS	CAUSE	IDLE	DDB UPD	
ADDN'L STATUS					
H'000007d0	H'000007d0	H'000007d0	H'000007d0	H'000007d0	H'000007d0
H'000007d0					
1203	INCONSISTENT		700	1000	

```

      H'000007d0 H'000007d0 H'000007d0 H'000007d0 H'000007d0 -----
H'000007d0
      2103 INCONSISTENT                700          1000          (WWA UPD=2)

```

Command Completed.

;

```
rept-stat-ddb:list=nrsp
```

```

tekelecstp 09-07-21 21:07:54 GMT EAGLE 41.1.0
DDB AUDIT REPORT CARD LIST [ NON RESPONDING CARDS ] (6)
      1207, 1208, 1211, 1212, 2108, 2111

```

Command Completed.

;

MTP Cards sending replies marked as "DDB update in progress" are distributed in two rows depending upon the number of times the MTP card consecutively reported "DDB updates in progress". `rept-stat-ddb:list=duip`

```

tekelecstp 09-07-21 21:07:54 GMT EAGLE 41.1.0
DDB AUDIT REPORT CARD LIST [ DDB UPDATE IN PROGRESS ] (2)
DDB UPDATES IN PROGRESS (>= 6 TIMES) (0)

```

```
DDB UPDATES IN PROGRESS (< 6 TIMES) (2)
```

```
      1205, 2105
```

Command Completed.

;

```
rept-stat-ddb:list=nquiet
```

```

tekelecstp 09-07-21 21:07:54 GMT EAGLE 41.1.0
DDB AUDIT REPORT CARD LIST [CARDS WITH NQUIET] (0)

```

Command Completed.

;

## Legend

- **SYSTEM STATUS:**
  - **OK**—DDB is consistent on all active MTP cards or no active MTP card is present in system
  - **INCONSISTENT**—DDB is inconsistent
  - **UNKNOWN**—"All active MTP cards in the system responded without the checksum of DDB table" or "No active MTP card in the system responded to audit request"

- **ABORTED**—"Checksums collected failed to meet the quiet period requirement" or "Number of cards responded with "DDB update in progress" greater than 25% number of cards responded with data"
- **ACTIVE MTP CARDS**—Number of active MTP cards
- **NON RESPONDING CARDS**—Number of non-responding cards
- **RESPONDING CARDS**—Number of responding cards
- **CARDS WITH NO DATA**—Cards sending replies without the checksum of dynamic tables, due to incomplete DDL crossload or DDB initialization
- **CARDS WITH DATA**—Cards sending replies with checksums
- **CARDS FAILING QUIET PRD**—Cards failing quiet time requirement
- **CARDS WITH DDB UPD IN PRG**—Cards sending replies marked as "DDB update in progress" due to DDB checksum not evaluated completely or TSRC task is incomplete
- **CARDS CONSIDERED FOR CKSM**—Cards sending correct replies. Replies are not marked with "DDB update in progress" or "Reply with no data".
- **INCONSISTENT CARDS**—Cards that are inconsistent
- **CONSISTENT CARDS**—Cards that are consistent
- **AUDIT START TIME**—Time that the audit started (*DD/MM/YYYYY hh:ms:ssformat*)
- **QUIET PERIOD**—Minimum DDB idle time, in milliseconds, during which no DDB updates are applied
- **RTE**—Checksum of RTE Table
- **LINK SET**—Checksum of Link Set Table
- **LINK**—Checksum of Link Table
- **CM CARD**—Checksum of CM Card
- **CM CLSTR**—Checksum of CM Cluster
- **MATED APPL**—Checksum of Mated Application
- **MTP GLOBS**—Checksum of MTP Globals Table
- **IDLE (PERIOD)**—Time elapsed, in milliseconds, since the last DDB update was received by this card
- **DDB UPD**—Total DDB updates received on the card
- **ADDN'L STATUS**—Display more information for the card, including WWA updates or whether card is considered for audit calculations
- **CAUSE**—Display the reason for sending replies of type "reply with no data " or "DDB update in progress". This value can be DDL (crossload not completed), DDB (dynamic database is not initialised), (TSRC, DDB) (TSRC task is not completed) or DDB (checksums still needs to apply on tables).
- **?**—Card status is not evaluated (inconsistent/consistent) if the system status is marked as "ABORTED"
- **IGNORED**—Card responded with "DDB update in progress" and is not considered for calculating system status
- **WWA UPD**—Number of entries that were updated by the WWA

**Related Topics**

- [aud-data](#)
- [dbg-ddb](#)

## rept-stat-deir

Use this command to display the overall status of the Diameter EIR service on the EAGLE.

**Parameters****dcname (optional)**

Diameter connection name. This parameter specifies the unique logical name assigned to each diameter connection. It shall display Status, TPS and Statistics of the Diameter connection specified.

**Range:**

*aaaaaaaaaaaaaaaa*

A string of alphanumeric characters, beginning with a letter and up to 15 characters in length. Valid values are a..z, A..Z, 0..9.

**System Default:**

*null*

**loc (optional)**

Diameter card location for which Card status, overall card TPS and total statistics of the card is to be reported.

**Range:**

*1101 - 1108, 1111 - 1112, 1201 - 1208, 1211 - 1218, 1301 - 1308, 1311 - 1318, 2101 - 2108, 2111 - 2118, 2201 - 2208, 2211 - 2218, 2301 - 2308, 2311 - 2318, 3101 - 3108, 3111 - 3118, 3201 - 3208, 3211 - 3218, 3301 - 3308, 3311 - 3318, 4101 - 4108, 4111 - 4118, 4201 - 4208, 4211 - 4218, 4301 - 4308, 4311 - 4318, 5101 - 5108, 5111 - 5118, 5201 - 5208, 5211 - 5218, 5301 - 5308, 5311 - 5318, 6101 - 6108, 6111 - 6118*

**mode (optional)**

Display Diameter connection statistics.

**Range:**

*perf*

Displays per card TPS statistics, DEIR Service statistics, and per connection TPS statistics.

*stat*

Displays per card TPS statistics, DEIR Service statistics, and per connection service statistics.

**peakreset (optional)**

Reset peak values for a card or a specified diameter connection.



**Range:**

*yes*

Reset the peak value.

*no*

Do not reset the peak value.

**Example**

```
rept-stat-deir
rept-stat-deir:loc=1207
rept-stat-deir:dcname=dc1207a
rept-stat-deir:mode=perf
rept-stat-deir:peakreset=yes:loc=1207
rept-stat-deir:mode=perf:loc=1207
rept-stat-deir:mode=stat:loc=1207
rept-stat-deir:mode=stat
```

**Dependencies**

S13/S13' EIR Feature must be activated before retrieving the overall status of DEIR cards.

The (1) `mode` and `loc` parameters, (2) `loc` and `peakreset` parameters, or (3) `dcname` and `peakreset` parameters can be specified together. No other combination is allowed.

The location specified with this command should be of a DEIR card running DEIRHC gpl.

At least one Diameter EIR card running the DEIRHC gpl must be configured.

The Diameter connection name specified must be present in the DCONN table.

The card at the specified location must support this command.

Diameter card location or diameter connection name must be specified with `peakrest` parameter.

**Notes**

If optional parameters are specified, only the entries that match the entered parameters are displayed.

**Output**

This example displays output when no parameter is specified:

```
rept-stat-deir
```

```
tekelecstp 14-03-21 01:16:07 MST EAGLE 46.0.0 65.11.0
```

```

rept-stat-deir
Command entered at terminal #19.
;

Command Accepted - Processing
tekelecstp 14-03-21 01:16:07 MST EAGLE 46.0.0 65.11.0
DEIR ALARM STATUS = ** 0484 DEIR System normal, card(s) abnormal
DEIR Cards Configured=16 Cards IS-NR= 1
Average CPU Usage = 1%

CARD      VERSION    PST          SST          AST          TPS    PTPS
-----
1201  -----  OOS-MT      Isolated    -----    0      0
1313  -----  OOS-MT      Isolated    -----    0      0
1101  013-011-001 IS-NR      Active      -----    86     86
1103  013-011-001 IS-NR      Active      -----    0      0
1105  013-011-001 IS-ANR     MPS Unavl   -----    0      0
-----

TOTAL DEIR SERVICE STATISTICS:
=====
SERVICE  SUCCESS  ERROR  WARNINGS  OVERFLOW  TOTAL
DEIR SRV: 1          0      2608      0      2609

Command Completed.
;

```

This example displays the AST state in the output when no parameter is specified and EPAP data is downloading on the card:

```

rept-stat-deir

eagle5stp 15-12-03 16:20:28 EST EAGLE5 46.3.0.0.0-68.3.0
rept-stat-deir
Command entered at terminal #20.
;

Command Accepted - Processing
eagle5stp 15-12-03 16:20:28 EST EAGLE5 46.3.0.0.0-68.3.0
DEIR ALARM STATUS = *C 0483 DEIR System is not available
DEIR Cards Configured= 1 Cards IS-NR= 0
Average CPU Usage = 0%

CARD      VERSION    PST          SST          AST          TPS    PTPS
-----
1101  015-003-013 IS-ANR     Standby    23%+      0      0
-----

```

```

-----
---

TOTAL DEIR SERVICE STATISTICS:

=====
===
SERVICE    SUCCESS      ERROR        WARNINGS     OVERFLOW     TOTAL
DEIR SRV: 0          0            0            0            0            0

Command Completed.
;

```

This example displays output when LOC parameter is specified:

```
rept-stat-deir:loc=1101
```

```

tekelecstp 14-03-21 01:19:26 MST EAGLE 46.0.0 65.11.0
rept-stat-deir:loc=1101
Command entered at terminal #19.
;

```

```

Command Accepted - Processing
tekelecstp 14-03-21 01:19:26 MST EAGLE 46.0.0 65.11.0
CARD  VERSION      TYPE   PST          SST          AST
1101  013-011-001  DSM   IS-NR        Active       -----
CARD ALARM STATUS      = No Alarms.
CPU USAGE = 1 %

```

```

TPS STATISTICS:

=====
===
                TPS      PEAK-TPS    PEAKTIMESTAMP
-----
                101      101         02-01-02 01:16:32

```

```

PER CONNECTION TPS STATISTICS:

=====
===
DCNAME          STATUS  RSVD-TPS  MAX-TPS  TPS  Peak-TPS
PEAKTIMESTAMP
-----
---

```

```

d1          UP      250      8000      1      1      02-01-02
01:19:03
d2          UP      250      8000     100    100    02-01-02
01:19:03
d31         DOWN    250      8000      0      0      02-01-02
01:19:03
d41         DOWN    250      8000      0      0      02-01-02
01:19:03
d3          DOWN    250      8000      0      0      02-01-02
01:19:03
d4          DOWN    250      8000      0      0      02-01-02
01:19:03
dd10        DOWN    250      8000      0      0      02-01-02
01:19:03

```

```

-----
Command Completed.
;

```

This example displays output when DCNAME parameter is specified:

```
rept-stat-deir:dcname=d1
```

```

tekelecstp 14-03-21 01:20:22 MST EAGLE 46.0.0 65.11.0
rept-stat-deir:dcname=d1
Command entered at terminal #19.
;

```

Command Accepted - Processing

```
tekelecstp 14-03-21 01:20:27 MST EAGLE 46.0.0 65.11.0
DCONN ALARM STATUS      = No Alarms.
```

```
DCNAME          STATUS
d1              UP
```

TPS STATISTICS:

```

=====
RSVD-TPS  MAX-TPS  TPS  PEAK-TPS  PEAKTIMESTAMP
250      8000      1    1          02-01-02 01:20:03

```

DCONN STATISTICS

```

=====
SUCCESS  ERROR  WARNING  OVERFLOW  TOTAL
0        0      30       0         30

```

Command Completed.

;

This example displays output when MODE=PERF parameter is specified:

rept-stat-deir:mode=perf

```
tekelecstp 14-03-21 01:24:15 MST EAGLE 46.0.0 65.11.0
rept-stat-deir:mode=perf
Command entered at terminal #19.
```

;

Command Accepted - Processing

```
tekelecstp 14-03-21 01:24:15 MST EAGLE 46.0.0 65.11.0
DEIR ALARM STATUS = ** 0484 DEIR System normal, card(s) abnormal
DEIR Cards Configured=16 Cards IS-NR= 1
Average CPU Usage = 1%
```

CARD	VERSION	PST	SST	TPS	PTPS
------	---------	-----	-----	-----	------

PTIMESTAMP

```
-----
---
1201 ----- OOS-MT Isolated 0 0
00-00-00 00:00:00
1303 ----- OOS-MT Isolated 0 0
00-00-00 00:00:00
1101 013-011-001 IS-NR Active 101 101
02-01-02 01:23:09
1103 013-011-001 IS-NR Active 0 0
00-00-00 00:00:00
1105 013-011-001 IS-ANR MPS Unavl 0 0
00-00-00 00:00:00
-----
---
```

TOTAL DEIR SERVICE STATISTICS:

```
=====
===
SERVICE SUCCESS ERROR WARNINGS OVERFLOW TOTAL
DEIR SRV: 0 0 3035 0 3035
-----
---
```

PER CONNECTION TPS STATISTICS:

```
=====
===
```

DCNAME	STATUS	RSVD-TPS	MAX-TPS	TPS	Peak-TPS	PEAKTIMESTAMP
-----						
d1	UP	250	8000	1	1	02-01-02
01:24:03						
d2	UP	250	8000	100	100	02-01-02
01:24:03						
d31	DOWN	250	8000	0	0	02-01-02
01:24:03						
d41	DOWN	250	8000	0	0	02-01-02
01:24:03						
d3	DOWN	250	8000	0	0	02-01-02
01:24:03						
d4	DOWN	250	8000	0	0	02-01-02
01:24:03						
dd10	DOWN	250	8000	0	0	02-01-02
01:24:03						
b1	DOWN	250	8000	0	0	00-00-00
00:00:00						
b2	DOWN	250	8000	0	0	00-00-00
00:00:00						
b31	DOWN	250	8000	0	0	00-00-00
00:00:00						
b41	DOWN	250	8000	0	0	00-00-00
00:00:00						
b3	DOWN	250	8000	0	0	00-00-00
00:00:00						
b4	DOWN	1500	8000	0	0	00-00-00
00:00:00						
b10	DOWN	250	8000	0	0	00-00-00
00:00:00						
aasw234edf56tgr	DOWN	250	8000	0	0	02-01-02
01:24:10						
-----						

Command Completed.

;

This example displays output when MODE=PERF parameter is specified along with location:

```
rept-stat-deir:mode=perf:loc=1101
```

```
tekelecstp 14-03-21 01:27:25 MST EAGLE 46.0.0 65.11.0
rept-stat-deir:mode=perf:loc=1101
Command entered at terminal #19.
```

;

Command Accepted - Processing

```
tekelecstp 14-03-21 01:27:26 MST EAGLE 46.0.0 65.11.0
```

```

CARD   VERSION   TYPE   PST           SST           AST
1101   013-011-001 DSM    IS-NR         Active        DB_DIFF
CARD ALARM STATUS = * 0034 Card database is inconsistent
CPU USAGE = 1 %

```

TPS STATISTICS:

```

=====
===
                TPS    PEAK-TPS    PEAKTIMESTAMP
-----
                101    101         02-01-02 01:23:09

```

PER CONNECTION TPS STATISTICS:

```

=====
===
DCNAME          STATUS  RSVD-TPS  MAX-TPS  TPS  Peak-TPS
PEAKTIMESTAMP
-----
d1              UP      250      8000    1    1      02-01-02
01:27:04
d2              UP      250      8000   100  100     02-01-02
01:27:04
d31             DOWN    250      8000    0    0      02-01-02
01:27:04
d41             DOWN    250      8000    0    0      02-01-02
01:27:04
d3              DOWN    250      8000    0    0      02-01-02
01:27:04
d4              DOWN    250      8000    0    0      02-01-02
01:27:04
dd10            DOWN    250      8000    0    0      02-01-02
01:27:04

```

```

-----
---
Command Completed.
;

```

This example displays output when peakreset is specified with location:

```
rept-stat-deir:peakreset=yes:loc=1217
```

```

Command Accepted - Processing
tekelecstp 13-04-15 05:38:52 MST EAGLE 45.1.0
rept-stat-deir:peakreset=yes:loc=1101

```

```

      Command entered at terminal #2.
;

tekelecstp 13-04-1505:38:52 MST  EAGLE 45.1.0
      Command Completed.
;

```

This example displays output when peakreset is specified with dcname:

```
rept-stat-deir:peakreset=yes:dcname=dc1217
```

```

Command Accepted - Processing
      tekelecstp 13-05-10 09:38:52 MST  EAGLE 45.1.0
      rept-stat-deir:peakreset=yes:dcname=dc1217
      Command entered at terminal #2.
;

```

```

      tekelecstp 13-04-1505:38:52 MST  EAGLE 45.1.0
      Command Completed.
;

```

This example displays output when MODE = STAT parameter is specified:

```
rept-stat-deir:mode=stat
```

```

      tekelecstp 14-03-21 01:24:15 MST  EAGLE 46.0.0 65.11.0
      rept-stat-deir:mode=stat
      Command entered at terminal #19.
;

```

```

Command Accepted - Processing
      tekelecstp 14-03-21 01:24:15 MST  EAGLE 46.0.0 65.11.0
      DEIR ALARM STATUS = ** 0484 DEIR System normal, card(s) abnormal
      DEIR Cards Configured=16          Cards IS-NR= 1
      Average CPU Usage = 1%

```

CARD	VERSION	PST	SST	TPS	PTPS	PTIMESTAMP
1201	-----	OOS-MT	Isolated	0	0	00-00-00
00:00:00						
1303	-----	OOS-MT	Isolated	0	0	00-00-00
00:00:00						
1101	013-011-001	IS-NR	Active	101	101	02-01-02
01:23:09						
1103	013-011-001	IS-NR	Active	0	0	00-00-00



```

00:00:00
  1105  013-011-001 IS-ANR      MPS Unavl 0      0
00-00-00 00:00:00

```

```

-----
---
```

## TOTAL DEIR SERVICE STATISTICS:

```

=====
===
SERVICE  SUCCESS  ERROR  WARNINGS  OVERFLOW  TOTAL
DEIR SRV: 0      0      3035      0      3035

```

```

-----
---
```

## PER CONNECTION SERVICE STATISTICS:

```

=====
===
DCNAME          STATUS  SUCCESS  WARNING  ERRORS  OVERFLOW
TOTAL
-----
---
```

d1	UP	0	30	0	0	30
d2	UP	0	3004	0	0	
3004						
d31	DOWN	0	0	0	0	0
d41	DOWN	0	0	0	0	0
d3	DOWN	0	0	0	0	0
d4	DOWN	0	0	0	0	0
dd10	DOWN	0	0	0	0	0
b1	DOWN	0	0	0	0	0
b2	DOWN	0	0	0	0	0
b31	DOWN	0	0	0	0	0
b41	DOWN	0	0	0	0	0
b3	DOWN	0	0	0	0	0
b4	DOWN	0	0	0	0	0
b10	DOWN	0	0	0	0	0
aasw234edf56tgr	DOWN	0	0	0	0	0
x1	DOWN	0	0	0	0	0

```

-----
---
```

Command Completed.

This example displays output when MODE = STAT parameter is specified along with location:

```
rept-stat-deir:mode=stat:loc=1101
```

```
tekelecstp 14-03-21 01:33:22 MST EAGLE 46.0.0 65.11.0
rept-stat-deir:mode=stat:loc=1101
Command entered at terminal #19.
```

```
;
```

```
Command Accepted - Processing
```

```
tekelecstp 14-03-21 01:33:22 MST EAGLE 46.0.0 65.11.0
CARD   VERSION      TYPE    PST          SST          AST
1101   013-011-001    DSM     IS-NR        Active       DE_DIFF
CARD ALARM STATUS      = ** 0484 DEIR System normal, card(s) abnormal
CPU USAGE = 1 %
```

```
TPS STATISTICS:
```

```
=====
              TPS      PEAK-TPS    PEAKTIMESTAMP
-----
              101      101         02-01-02 01:23:09
```

```
PER CONNECTION SERVICE STATISTICS:
```

```
=====
DCNAME          STATUS  SUCCESS  WARNING  ERRORS  OVERFLOW  TOTAL
-----
d1              UP      0        30       0       0         30
d2              UP      0        3005    0       0        3005
d31             DOWN    0         0       0       0         0
d41             DOWN    0         0       0       0         0
d3              DOWN    0         0       0       0         0
d4              DOWN    0         0       0       0         0
dd10            DOWN    0         0       0       0         0
-----
```

```
Command Completed.
```

```
;
```

## Legend

This section defines the fields of the following `rept-stat-deir` reports:

- `rept-stat-deir`
- `rept-stat-deir:loc=1207`
- `rept-stat-deir:dcname=dc1207a`
- `rept-stat-deir:mode=perf`

- rept-stat-deir:peakreset=yes:loc=1207
- rept-stat-deir:peakreset=yes:dcname=dc1217
- rept-stat-deir:mode=stat
- rept-stat-deir:mode=stat:loc=1101

A dash (-) in an output field indicates that the statistic does not apply.

- **CARD IS-NR** -Number of DEIR cards running the DEIRHC GPL that can be used by the system (status is In-Service Normal, IS-NR).
- **CARD**-Card location of the DEIR card running the DEIRHC GPL
- **P**- The primary Service Module card. This card provides the MPS status to the EAGLE. This indicator is displayed between the card location and the GPL version.
- **VERSION** -Version number of the DEIRHC GPL running on the DEIR card.
- **PST** -Primary state of the card. See [Possible Values for PST/SST/AST](#).
- **SST**-Secondary state of the card. See [Possible Values for PST/SST/AST](#).
- **AST** -Associated state of the card. See [Possible Values for PST/SST/AST](#).
- **TPS** - TPS (Transactions per second) indicates the number of Diameter messages which are received on the DEIR cards or specified diameter connection.
- **RSVD-TPS**- Reserved TPS is the guaranteed TPS for a diameter connection.
- **MAX-TPS** - This is the maximum TPS for a diameter connection
- **PTPS/PEAK-TPS** ---
  - PTPS indicates the maximum TPS occurred on the card when executed with loc parameter.
  - PTPS indicates the maximum TPS occurred on a diameter connection when executed with dcname parameter.
- **PTIMESTAMP/PEAKTIMESTAMP** - The time when the PTPS occurred on the card or specified diameter connection.
- **DCNAME** -Diameter connection name.
- **STATUS** - UP or DOWN status of the diameter connection.
- **DEIR ALARM STATUS** - Displays DEIR system related alarms. If there are no system alarms present, this field displays No Alarms.
- **CARD ALARM STATUS** - Displays DEIR card specific alarms. If there are no card alarms present, this field displays No Alarms.
- **DCONN ALARM STATUS** - Displays diameter connection specific alarms. If there are no connection related alarms present, this field displays No Alarms.
- **TOTAL DEIR SERVICE STATISTICS**-System-wide view of per-service statistics. The report tracks the following information:
  - **SERVICE** --- Service running on the DEIR card. Currently only the EIR service is supported for the DEIR card.
  - **SUCCESS** -Total number of messages successfully processed by the DEIR card for the EIR service.

- **ERROR** -Total number of messages with errors which are received by the DEIR cards for the EIR service.
- **WARNINGS** -Total number of messages received for which either IMEI lookup failure occurred or Unknown equipment status is sent in response by the DEIR card for the EIR service.
- **OVERFLOW** - Number of messages discarded due to congestion on a DEIR card.
- **TOTAL** - Total number of messages received. It should be the sum of (Success + Error + Warnings) messages.
- **TPS STATISTICS**- Section of the report that provides TPS statistics on each Service Module card or diameter connection.
  - **TPS** - TPS (Transactions per second) indicates the number of Diameter messages which are received on the DEIR cards or specified diameter connection.
  - **PTPS** - PTPS indicates the maximum TPS that occurred on the card or specified diameter connection.
  - **PTIMESTAMP** - The time when the PTPS occurred on the card or specified diameter connection.
- **PER CONNECTION SERVICE STATISTICS** - Service statistics corresponds to each diameter connection
  - **DCNAME**-Diameter connection name.
  - **STATUS**- UP or DOWN status of the diameter connection.
  - **SUCCESS**-Total number of messages successfully processed on this particular Diameter connection by the DEIR card for the Diameter EIR service.
  - **WARNING**-Total number of messages received on this particular Diameter connection for which either IMEI lookup failure occurred or Unknown equipment status is sent in response by the DEIR card for Diameter EIR service.
  - **ERRORS**-Total number of messages with errors which are received on this particular Diameter connection by the DEIR cards for the Diameter EIR service.
  - **OVERFLOW**-Number of messages received on this particular Diameter connection and discarded due to congestion.
  - **TOTAL**- Total number of messages received on this particular diameter connection. It should be the sum of (Success + Warning + Errors) messages.
- **DCONN STATISTICS** -Statistics of diameter connection are displayed when DCNAME parameter is specified in `rept-stat-deir` command.
  - **SUCCESS**-Total number of messages successfully processed on this particular Diameter connection by the DEIR card for the Diameter EIR service.
  - **ERROR**-Total number of messages with errors which are received on this particular Diameter connection by DEIR cards for the Diameter EIR service.
  - **WARNING**-Total number of messages received on this particular Diameter connection for which either IMEI lookup failure occurred or Unknown equipment status is sent in response by the DEIR card for the Diameter EIR service.
  - **OVERFLOW**-Number of messages received on this particular Diameter connection and discarded due to congestion.
  - **TOTAL**- Total number of messages received. It should be the sum of (Success + Error + Warning) messages.

- **PER CONNECTION TPS STATISTICS** - TPS statistics corresponds to each diameter connection.
  - **DCNAME** -Diameter connection name.
  - **STATUS** -- UP or DOWN status of the diameter connection.
  - **RSVD-TPS** - Reserved TPS is the guaranteed TPS for a diameter connection.
  - **MAX-TPS** - This is the maximum TPS for a diameter connection.
  - **TPS** - TPS (Transactions per second) indicates the number of Diameter messages which are received on the DEIR cards or specified diameter connection.
  - **Peak-TPS** - Peak-TPS indicates the maximum TPS that occurred on the card or specified diameter connection.
  - **PEAKTIMESTAMP** - The time when the Peak-TPS occurred on the card or specified diameter connection.

#### Related Topics

- [rtrv-dconn](#)

## rept-stat-dlk

Use this command to show the status of the TCP/IP data links. The secondary state (SST) of the TCP/IP data links shows whether the link is available, unavailable, or manually removed from service.

#### Parameters

##### **loc (optional)**

The card location as stenciled on the shelf of the system.

##### **Range:**

*1101 - 1108, 1111 - 1112, 1201 - 1208, 1211 - 1218, 1301 - 1308, 1311 - 1318, 2101 - 2108, 2111 - 2118, 2201 - 2208, 2211 - 2218, 2301 - 2308, 2311 - 2318, 3101 - 3108, 3111 - 3118, 3201 - 3208, 3211 - 3218, 3301 - 3308, 3311 - 3318, 4101 - 4108, 4111 - 4118, 4201 - 4208, 4211 - 4218, 4301 - 4308, 4311 - 4318, 5101 - 5108, 5111 - 5118, 5201 - 5208, 5211 - 5218, 5301 - 5308, 5311 - 5318, 6101 - 6108, 6111 - 6118*

##### **Default:**

All data links are shown.

#### Example

```
rept-stat-dlk
```

```
rept-stat-dlk:loc=1104
```

#### Dependencies

No other `rept-stat-xxx` command can be in progress when this command is entered.

The ACM is the only valid card type for this command.

The shelf and card must be equipped.

The specified card must have a TCP/IP data link assigned to it.

The card location, frame, shelf, or slot must be within the allowed range.

The data link must be equipped in the database.

A card location that is valid and defined in the database must be specified.

### Notes

None

### Output

```
rept-stat-dlk
```

```
rlghncxa03w 10-01-27 17:00:36 EST EAGLE 42.0.0
DLK          PST          SST          AST
1104         IS-NR        Active     ----
1206         IS-NR        Active     ALMINH
Command Completed.
```

```
;
```

```
rept-stat-dlk:loc=1104
```

```
rlghncxa03w 10-01-27 17:00:36 EST EAGLE 42.0.0
DLK          PST          SST          AST
1104         IS-NR        Active     ----
ALARM STATUS = No Alarms.
Command Completed.
```

```
;
```

### Legend

- **DLK**—Card location of the TCP/IP data link
- **PST**—Primary state of the TCP/IP data link. See [Possible Values for PST/SST/AST](#).
- **SST**—Secondary state of the TCP/IP data link. See [Possible Values for PST/SST/AST](#).
- **AST**—Associated state of the TCP/IP data link. See [Possible Values for PST/SST/AST](#).

### Related Topics

- [act-dlk](#)
- [canc-dlk](#)
- [dlt-dlk](#)
- [ent-dlk](#)
- [rtrv-dlk](#)
- [tst-dlk](#)

## rept-stat-dstn

Use this command to generate a report of the MTP point code status for provisioned point codes. Any provisioned destination can be specified, including a cluster destination (*ni-nc-\**) or a network destination (*ni-\*-\**).

### Parameters



#### Note:

See [Point Code Formats and Conversion](#) for a detailed description of point code formats, rules for specification, and examples.

#### **dpc (optional)**

ANSI point code with subfields *network indicator-network cluster-network cluster member (ni-nc-ncm)*. The *prefix* subfield indicates a private point code (*prefix-ni-nc-ncm*).

#### **Synonym:**

*dpca*

#### **Range:**

*p-*, *000-255*, *\**, *\*\**, *\*\*\**

Specify a valid value for each subfield of the point code, and separate the subfields with a dash (-).

*prefix—p-*

The asterisk values *\**, *\*\**, and *\*\*\** are not valid for the *ni* subfield.

If *\*\** or *\*\*\** is specified for the *nc* subfield, either *\**, *\*\**, or *\*\*\** must be specified for the *ncm* subfield.

When *chg-sid:pctype=ansi* is specified, *ni=000* is not valid.

When *chg-sid:pctype=ansi* is specified, *nc=000* is not valid if *ni=001-005*.

When *chg-sid:pctype=ansi* is specified, *nc=000* is valid if *ni=006-255*.

When *chg-sid:pctype=ansi* is specified, *ni-\*-\** is valid if *ni= 006-255*.

The point code *000-000-000* is not a valid point code.

#### **dpc/dpca/dpci/dpcn/dpcn24/dpcn16 (optional)**

Destination point code.

#### **dpci (optional)**

ITU international point code with subfields *zone-area-id*. The *prefix* subfield indicates a spare point code, private point code, or private and spare point code (*prefix-zone-area-id*).

#### **Range:**

*s-*, *p-*, *ps-*, *0-255*

Specify a valid value for each subfield of the point code, and separate the subfields with a dash (-).

*prefix—s-*, *p-*, *ps*

*zone—0-7*

*area—000-255*

*id—0-7*The point code *0-000-0* is not a valid point code.**dpcn (optional)**

ITU national point code in the format of a 5-digit number (*nnnnn*); or 2, 3, or 4 numbers (members) separated by dashes (*m1-m2-m3-m4*) as defined by the `chg-stpopts:npcfmti` flexible point code option. A group code must be specified when the ITUDUPPC feature is turned on (*nnnnn-gc*, *m1-m2-m3-m4-gc*). The *prefix* subfield indicates a spare point code, private point code, or private and spare point code (*prefix-nnnnn*, *prefix-nnnnn-gc*, *prefix-m1-m2-m3-m4*, *prefix-m1-m2-m3-m4-gc*).

**Range:***s-*, *p-*, *ps-*, *0-16383*, *aa-zz*

Specify a valid value for each subfield of the point code, and separate the subfields with a dash (-).

*prefix—s-*, *p-*, *ps**nnnnn—0-16383**gc—aa-zz**m1-m2-m3-m4—0-14* for each member; values must sum to 14**dpcn24 (optional)**

24-bit ITU national destination point code with subfields *main signaling area-sub signaling area-signaling point* (*msa-ssa-sp*). The *prefix* subfield indicates a private point code (*prefix-msa-ssa-sp*).

**Range:***p-*, *000-255*

Specify a valid value for each subfield of the point code, and separate the subfields with a dash (-).

*prefix—p**msa—000-255**ssa—000-255**sp—000-255***dpcn16 (optional)**

16-bit ITU national point code with subfields *unit number sub number area main number area* (*un-sna-mna*). The *prefix* subfield indicates a private point code (*prefix-un-sna-mna*).

**Range:***p--*, *000---127*

Specify a valid value for each subfield of the point code, and separate the subfields with a dash (-).

*prefix---p**un---000---127**sna---000---15**mna---000---31***mode (optional)**

The type of display to produce. This parameter displays the point code's subsystem status along with the normal output.



**Range:****full**

Comprehensive display of point code status, including *rtx*. If entered with a point code, status for that point code is displayed. If specified without a point code, the status of all routesets is displayed.

**rtx**

Displays exception route status, other than circular routing, if the Origin-based MTP Routing feature is on.

**Default:**

A summary report is displayed.

**stat (optional)**

The primary state filter. The state of the destination for which to generate a report. To generate a report for all destinations whose state is DSBLD, specify `stat=dsbld`.

**Range:****all**

All of the primary states

**alminh**

Alarms inhibited

**anr**

In service abnormal (IS-ANR)

**dsbld**

Out of service maintenance disabled (OOS-MT-DSBLD)

**mt**

Out of service maintenance (OOS-MT)

**nr**

In service normal (IS-NR)

**Default:**

*all*

**Example**

```
rept-stat-dstn
rept-stat-dstn:dpci=2-004-1:mode=full
rept-stat-dstn:dpc=9-3-6:mode=full
rept-stat-dstn:dpc=9-3-*:mode=full
rept-stat-dstn:dpc=9-3-*
rept-stat-dstn:dpc=9-3-**
rept-stat-dstn:dpc=9-3-***
rept-stat-dstn:dpc=9-3-***:stat=mt
rept-stat-dstn:dpc:9-4-***:stat=alminh
```

```
rept-stat-dstn:dpc=9-3-*:mode=rtx
rept-stat-dstn:mode=full
rept-stat-dstn:mode=rtx
rept-stat-dstn:dpc=1-1-1
rept-stat-dstn:dpcn16=1-1-1
```

### Dependencies

No other `rept-stat-xxx` command can be in progress when this command is entered.

If a `dpc` parameter is specified, it must be the true destination point code (not an alias) and it must be defined in the database.

The `stat` parameter can be specified with the `dpc` parameter only if the `dpc` parameter specifies one of the *ni-nc-\** formats.

An x-list DPC cannot be specified in the `dpc` parameter.

The `mode=rtx` parameter cannot be specified unless the Origin-Based MTP Routing feature is enabled and on.

The `mode` parameter cannot be specified with the `dpc` parameter if the `dpc` parameter specifies one of the *ni-nc-\** formats.

When the `mode=full` parameter is specified, the `dpc/dpca/dpcn/dpci/dpcn24` parameter must be specified.

The destination address must be a full point code, a network destination, or a cluster point code.

### Notes

This command can be canceled using the **F9** function key or the `canc-cmd` command. See `canc-cmd` for more information.

This command does not report the x-list point codes. Use the `rept-stat-cluster` command for a report of x-list point codes.

If the `mode=rtx` parameter is specified with a specific DPC, additional linkset, route and exception route information associated with the specified DPC is displayed.

In this command, only ITU-international and ITU national point codes support the spare point code subtype prefix (s-) and the private and spare point code subtype prefix (ps-). All of the point code types support the private (internal) point code subtype prefix p-).

Summary description of the reports that are produced by the various DPC parameter syntaxes is shown:

- `rept-stat-dstn:dpc=ni-nc-ncm`—Report for fully provisioned destination *ni-nc-ncm*
- `rept-stat-dstn:dpc=ni-*-*`—Report for provisioned network destination with the specified network indicator. If \* is specified in the *nc* field, \* must be specified in the *ncm* field.
- `rept-stat-dstn:dpc=ni-***`—Report for the full network cluster for the specified *ni*

- `rept-stat-dstn:dpc=ni-***-*`—Report for the full network cluster and the network cluster address (if any) for the specified *ni*
- `rept-stat-dstn:dpc=ni-nc-*`—Report for provisioned cluster destination *ni-nc-\**
- `rept-stat-dstn:dpc=ni-nc-**-*`—Report showing all destinations whose network (*ni*) and cluster (*nc*) components match those specified. The network cluster address *ni-nc-\** (if it exists) is not reported.
- `rept-stat-dstn:dpc=ni-nc-***`—Report showing all destinations whose network (*ni*) and cluster (*nc*) components match those specified. The network cluster address *ni-nc-\** (if it exists) is also reported.
- `rept-stat-dstn:dpcn24=msa-ssa-sp`—Report for fully provisioned 24-bit destination *main signaling area-sub signaling area-signaling point*

If the `mode=rtx` parameter is specified without a specific DPC, then status is provided for all exception route sets.

If the `mode=full` parameter is specified with a specific destination point code, then additional linkset, route, and exception route information associated with the specified destination is displayed, along with information that can be used to correct circular routing. If the `mode=full` parameter is specified without a specific destination point code, then status is provided for all regular and exception route sets.

## Output

If the `dpc` parameter is not specified:

- If the `mode` parameter is not specified, then the command output lists the status of all provisioned destination point codes (DPCs) (routesets) in the system.
- If the `mode=rtx` parameter is specified, then the output lists the status of only those DPCs against which exception routes have been provisioned, and the status of the provisioned exception route sets associated with each DPCs.
- If the `mode=full` parameter is specified, then the command lists the status of all provisioned DPCs in the system, and the status of the provisioned exception route sets, if any, associated with each DPC.

If the `dpc` parameter is specified:

- If the `mode` parameter is not specified, then the output lists the status of all provisioned routes in the route set specified by that DPC.
- If the `mode=rtx` parameter is specified, then the output lists the status of all provisioned routes in the routeset specified by that DPC, and the status of all provisioned exception routesets associated with that DPC.
- If the `mode=full` parameter is specified, then the output lists the status of all provisioned routes in the routeset specified by that DPC, the status of all provisioned exception route sets associated with that DPC, any aliases associated with that DPC, and circular routing alarm information if any for that DPC.

This example shows the output when no parameters are specified:

```
rept-stat-dstn
```

```
tekelecstp 10-10-15 14:59:15 EST EAGLE 43.0.0
```

```
rept-stat-dstn
Command entered at terminal #4.
Extended Processing Time may be Required
```

DPCA	PST	SST	AST
001-001-003	OOS-MT	Idle	INACCESS
001-001-004	OOS-MT	Idle	INACCESS
001-001-005	OOS-MT	Idle	INACCESS
001-001-006	OOS-MT	Idle	INACCESS
001-001-007	OOS-MT	Idle	INACCESS
001-001-008	OOS-MT	Idle	INACCESS
001-001-009	OOS-MT	Idle	INACCESS
001-001-010	OOS-MT	Idle	INACCESS
001-001-011	OOS-MT	Idle	INACCESS
001-001-012	OOS-MT	Idle	INACCESS
001-001-013	OOS-MT	Idle	INACCESS
001-001-014	OOS-MT	Idle	INACCESS
001-001-015	OOS-MT	Idle	INACCESS
001-001-016	OOS-MT	Idle	INACCESS
001-001-017	OOS-MT	Idle	INACCESS
001-001-018	OOS-MT	Idle	INACCESS
001-001-019	OOS-MT	Idle	INACCESS
001-001-020	OOS-MT	Idle	INACCESS
001-001-021	OOS-MT	Idle	INACCESS
001-001-022	OOS-MT	Idle	INACCESS
001-001-023	OOS-MT	Idle	INACCESS
001-001-024	OOS-MT	Idle	INACCESS
001-001-025	OOS-MT	Idle	INACCESS
001-002-003	OOS-MT	Idle	INACCESS
DPCN	PST	SST	AST
DPCN24	PST	SST	AST
DPCI	PST	SST	AST

```
Command Completed.
```

```
;
```

This example shows the output when a cluster destination on the `dpc` parameter is specified. This output shows the cluster status and routeset information. Information on cluster members is not shown. Use `rept-stat-cluster` to obtain this information.

```
rept-stat-dstn:dpc=9-3-*
```

```
tekelecstp 09-03-21 10:31:06 EST EAGLE 41.0.0
DPCA          PST          SST          AST
009-003-*     IS-NR          Allowed     ACCESS
ALARM STATUS  = No Alarms.
RTE COST  LSN      APCA          LS STAT  NON-ADJ  ROUTE STAT
1*  10  lsnstpa    042-036-123  Allowed  Allowed  Allowed
2   20  lsnstpb    092-240-103  Allowed  Allowed  Allowed
3   30  lsnstpc    128-101-022  Allowed  Allowed  Allowed
4   --  -----    ***-***-***  -----  -----  -----
```

```

5  --  -----  ***-***-***  -----  -----  -----
6  --  -----  ***-***-***  -----  -----  -----

```

Command Completed.

;

This example shows the output for an FPC or cluster destination for which circular routing has been detected:

rept-stat-dstn:dpc=9-3-6:mode=full

```

tekelecstp 08-03-21 10:31:06 EST  EAGLE 41.0.0
  DPCA          PST          SST          AST
  009-003-006   OOS-MT          Prohibit  INACCESS
ALARM STATUS    = *C  xxxx Circular routing detected
RTE COST  LSN          APCA          LS STAT  NON-ADJ  ROUTE
STAT
  1*  10  lsnstpa          042-036-123  Allowed  Allowed
Allowed
  2   20  lsnstpb          092-240-103  Allowed  Allowed
Allowed
  3   30  lsnstpc          128-101-022  Allowed  Allowed
Allowed
  4  --  -----  ***-***-***  -----  -----
-----
  5  --  -----  ***-***-***  -----  -----
-----
  6  --  -----  ***-***-***  -----  -----
-----

```

SSN SUBSYSTEM STATUS

```

  ALIASA          ALIASN          ALIASI
  -----

```

CIRCULAR ROUTING INFO:

```

XMIT LSN= lsnstpb  RC=--
RCV  LSN= lsn01a
MEMBER= ***-***-***

```

Exception Routes:

Command Completed.

;

This example shows the outout when a cluster destination and the mode=full parameter is specified:

rept-stat-dstn:dpc=9-3-\*:mode=full

```

tekelecstp 09-03-15 10:31:06 EST  EAGLE 41.0.0
  DPCA          PST          SST          AST

```

```

009-003-*          IS-NR          Allowed  ACCESS
ALARM STATUS      = *C  xxxx Circular routing detected
RTE COST  LSN      APCA          LS STAT  NON-ADJ  ROUTE STAT
1*  10  lsnstpa    042-036-123  Allowed  Allowed  Allowed
2   20  lsnstpb    092-240-103  Allowed  Allowed  Allowed
3   30  lsnstpc    128-101-022  Allowed  Allowed  Allowed
4   --  -----   ***-***-***  -----  -----  -----
5   --  -----   ***-***-***  -----  -----  -----
6   --  -----   ***-***-***  -----  -----  -----

```

```
SSN  SUBSYSTEM STATUS
```

```

ALIASA          ALIASN          ALIASI
-----          -----          -----

```

```

CIRCULAR ROUTING INFO:
XMIT LSN=lsnstpb  RC=20
RCV  LSN=lsn01a
MEMBER= 009-003-006

```

```
Exception Routes:
```

```
Command Completed.
```

```
;
```

This example shows the circular routing alarm for a cluster destination. The alarm indicates that circular routing was detected for a member of the cluster, but no x-list entry could be created for that cluster. Circular routing detected on a cluster destination does not automatically force the output to display the status of the cluster as “OOS-MT Prohibit INACCESS” as it does for an FPC destination.

```
rept-stat-dstn:dpc=9-3-*
```

```

stdcfg1a 09-03-16 14:09:24 EST  EAGLE 41.0.0
DPCA          PST          SST          AST
009-003-*          IS-NR          Allowed  ACCESS
ALARM STATUS      = *C  xxxx Circular routing detected
RTE COST  LSN      APCA          LS STAT  NON-ADJ  ROUTE STAT
1*  10  lsnstpa    042-036-123  Allowed  Allowed  Allowed
2   20  lsnstpb    092-240-103  Allowed  Allowed  Allowed
3   30  lsnstpc    128-101-022  Allowed  Allowed  Allowed
4   --  -----   ***-***-***  -----  -----  -----
5   --  -----   ***-***-***  -----  -----  -----
6   --  -----   ***-***-***  -----  -----  -----

```

```
Command Completed.
```

```
;
```

This example shows the output if an FPC is specified for which no subsystems are defined. Also, because aliases cannot be defined for cluster destinations, this report shows only an empty header. The circular routing information portion of this report displays “-----” for the linkset names when no circular routing condition exists for the DPC.

```
rept-stat-dstn:dpc=9-3-*:mode=full
```

```
stdcfg1a 08-02-16 14:09:24 EST EAGLE 38.0.0
Command entered at terminal #4.
      DPCA          PST          SST          AST
009-003-*          IS-NR          Allowed     ACCESS
ALARM STATUS      = No Alarms.
RTE COST  LSN          APCA          LS STAT  NON-ADJ  ROUTE
STAT
  1*  10  lsnstpa          042-036-123  Allowed  Allowed
Allowed
  2   20  lsnstpb          092-240-103  Allowed  Allowed
Allowed
  3   30  lsnstpc          128-101-022  Allowed  Allowed
Allowed
  4   --  -----  ---***-***-***  -----  -----
-----
  5   --  -----  ---***-***-***  -----  -----
-----
  6   --  -----  ---***-***-***  -----  -----
-----

      SSN  SUBSYSTEM STATUS

      ALIASA          ALIASN          ALIASI
      -----          -----          -----

CIRCULAR ROUTING INFO:
  XMIT LSN= -----  RC---
  RCV  LSN= -----
  MEMBER= ***-***-***

Exception Routes:

Command Completed.
;
```

This example shows the output when the `stat` parameter and the `ni-nc-*` or `ni-nc-***` DPC formats are specified. The output summary report includes only those destinations whose status matches the state specified.

```
rept-stat-dstn:dpc=9-4-***:stat=alminh
```

```
stdcfg1a 10-10-16 14:09:24 EST EAGLE 43.0.0
rept-stat-dstn:dpc=9-4-***:stat=alminh
Command entered at terminal #4.
Extended Processing Time may be Required
      DPCA          PST          SST          AST
009-004-006        IS-NR          Allowed     ALMINH
009-004-007        IS-NR          Allowed     ALMINH
.
.
```

```
009-004-056      IS-NR      Allowed  ALMINH
```

```
Command Completed.
```

```
;
```

This example shows the output for an ITU national point code where the `chg-stpopts:npcfnti` parameter has been set to 1-1-11:

```
rept-stat-dstn:dpcn=1-1-1-1000
```

```
stdcfgla 09-03-16 14:09:24 EST  EAGLE 41.0.0
CAUTION : Node isolated...route status out of date!
DPCN          PST          SST          AST
1-1-1-1000    OOS-MT          Prohibit    INACCESS
ALARM STATUS   = *C 0313 DPC is prohibited
RTE COST  LSN          APCA          LS STAT  NON-ADJ  ROUTE STAT
1  10  lsitu          1-1-1-1000   Prohibit  Allowed  Prohibit
2  --  -----  ---***---***  -----  -----  -----
3  --  -----  ---***---***  -----  -----  -----
4  --  -----  ---***---***  -----  -----  -----
5  --  -----  ---***---***  -----  -----  -----
6  --  -----  ---***---***  -----  -----  -----
```

```
Command Completed.
```

```
;
```

The asterisks in the space after the route numbers in the following examples indicate which route (or combined route) is carrying traffic.

```
rept-stat-dstn:dpc=1-1-1
```

```
tekelecstp 09-03-24 09:19:04 EST  EAGLE 41.0.0
DPCA          PST          SST          AST
001-001-001   IS-NR          Allowed    ACCESS
ALARM STATUS   = No Alarms.
RTE COST  LSN          APCA          LS STAT  NON-ADJ  ROUTE STAT
1* 05  lse1e1        001-001-001   Allowed  Allowed  Allowed
2* 05  lse1e2        001-002-001   Allowed  Allowed  Allowed
3  10  lse1e3        001-003-001   Allowed  Allowed  Allowed
4  --  -----  ---***---***  -----  -----  -----
5  --  -----  ---***---***  -----  -----  -----
6  --  -----  ---***---***  -----  -----  -----
```

```
Command Completed.
```

```
;
```

No asterisk appears after the route number in the following example; no routes were carrying traffic at the time.



```
rept-stat-dstn:dpc=1-1-1
```

```
stdcfg1a 09-03-16 14:09:24 EST EAGLE 41.0.0
DPCA          PST          SST          AST
001-001-001   OOS-MT          Prohibit    INACCESS
ALARM STATUS  = *C 0313 DPC is prohibited
RTE COST   LSN          APCA          LS STAT    NON-ADJ    ROUTE
STAT
  1   05   lsele1      001-001-001   Prohibit    Allowed    Prohibit
  2   05   lsele2      001-002-001   Prohibit    Allowed    Prohibit
  3   10   lsele3      001-003-001   Prohibit    Allowed    Prohibit
  4   --   -----   ***-***-***   -----   -----   -----
  5   --   -----   ***-***-***   -----   -----   -----
  6   --   -----   ***-***-***   -----   -----   -----
```

```
Command Completed.
```

```
;
```

This example shows the output when the Origin-Based MTP Routing feature is on, a specific DSTN is requested, and the *rtx* mode is specified:

```
rept-stat-dstn:dpc=9-3-*:mode=rtx
```

```
tekelecstp 09-05-01 16:21:39 EST EAGLE 41.0.0
DPCA          PST          SST          AST
009-003-*     IS-NR          Allowed    ACCESS
ALARM STATUS  = No Alarms.
RTE COST   LSN          APCA          LS STAT    NON ADJ    ROUTE STAT
1*   10   lsnstpa     042-36-23   Allowed    Allowed    Allowed
2    20   lsnstpb     092-40-03   Allowed    Allowed    Allowed
3    30   lsnstpc     128-01-22   Prohibit   Prohibit   Allowed
4    --   -----   ***-***-***   -----   -----   -----
5    --   -----   ***-***-***   -----   -----   -----
6    --   -----   ***-***-***   -----   -----   -----
```

```
Exception Routes:
```

```
OPCA          PST          SST          AST
001-001-001   IS-NR          Allowed    ACCESS
ILSN          PST          SST          AST
lsnstpy       IS-NR          Allowed    ACCESS
```

```
Command Completed.
```

```
;
```

This example shows the output when the Origin-Based MTP Routing feature is on, a specific DSTN is requested, and the *full* mode is used:

```
rept-stat-dstn:dpc=9-3-*:mode=full
```

```
stdcfg1a 09-05-16 14:09:24 EST EAGLE 41.0.0
```

```

DPCA          PST          SST          AST
009-003-006   OOS-MT         Prohibit   INACCESS
ALARM STATUS   = *C 0319 REPT-MTPLP-DET: Circ rte det(cong)
RTE COST  LSN          APCA          LS STAT   NON-ADJ   ROUTE STAT
1*  10   lsnstpa         042-036-123   Allowed   Allowed   Allowed
2   20   lsnstpb         092-240-103   Allowed   Allowed   Allowed
3   30   lsnstpc         128-101-022   Allowed   Allowed   Allowed
4   --   -----   *****-***-***   -----   -----   -----
5   --   -----   *****-***-***   -----   -----   -----
6   --   -----   *****-***-***   -----   -----   -----

```

SSN SUBSYSTEM STATUS

```

ALIASA          ALIASN          ALIASI
-----

```

```

CIRCULAR ROUTING INFO:
XMIT LSN=lsnstpb RC=20
RCV LSN=lsn01a
MEMBER =-----

```

Exception Routes:

```

OPCA          PST          SST          AST
001-001-001   IS-NR         Allowed   ACCESS

```

```

ILSN          PST          SST          AST
lsnstpy       IS-NR         Allowed   ACCESS

```

Command Completed.

;

This example shows the output when the Origin-Based MTP Routing feature is on, and the *full* mode is specified:

```
rept-stat-dstn:mode=full
```

```
tekelecstp 10-10-29 10:26:56 EST EAGLE 43.0.0
```

```
rept-stat-dstn:mode=full
```

Command entered at terminal #4.

Extended Processing Time may be Required

```

DPCA          PST          SST          AST
001-001-000   OOS-MT         Idle      INACCESS
003-001-000   OOS-MT         Idle      INACCESS
002-102-001   OOS-MT         Idle      INACCESS
001-101-001   OOS-MT         Idle      INACCESS

OPCA          PST          SST          AST
001-001-001   OOS-MT         Idle      INACCESS
002-001-000   OOS-MT         Idle      INACCESS

ILSN          PST          SST          AST
e2m1s1       OOS-MT         Idle      INACCESS

CIC  ECIC      PST          SST          AST

```

```

0      1000      OOS-MT      Idle      INACCESS
SI
3      OOS-MT      Idle      INACCESS

003-101-001      OOS-MT      Idle      INACCESS
004-101-001      OOS-MT      Idle      INACCESS
007-101-001      OOS-MT      Idle      INACCESS
100-100-*      OOS-MT      Idle      INACCESS
100-100-001      OOS-MT      Idle      INACCESS

OPCA      PST      SST      AST
001-001-001      OOS-MT      Idle      INACCESS
002-002-002      OOS-MT      Idle      INACCESS
001-102-001      OOS-MT      Idle      INACCESS
200-200-001      OOS-MT      Idle      INACCESS

DPCN      PST      SST      AST
1-010-1      OOS-MT      Idle      INACCESS
1-020-2      OOS-MT      Idle      INACCESS
1-020-3      OOS-MT      Idle      INACCESS
1-020-4      OOS-MT      Idle      INACCESS
1-050-1      OOS-MT      Idle      INACCESS

OPCA      PST      SST      AST
002-001-000      OOS-MT      Idle      INACCESS
002-101-001      OOS-MT      Idle      INACCESS

DPCN24      PST      SST      AST

DPCI      PST      SST      AST
1-030-1      OOS-MT      Idle      INACCESS
1-030-2      OOS-MT      Idle      INACCESS
1-040-4      OOS-MT      Idle      INACCESS
1-070-1      OOS-MT      Idle      INACCESS

OPCN      PST      SST      AST
1-050-1      OOS-MT      Idle      INACCESS

ILSN      PST      SST      AST
npc1      OOS-MT      Idle      INACCESS

```

Command Completed.

;

This example shows the output when the Origin-Based MTP Routing feature is on and the *rtx* mode is used:

```
rept-stat-dstn:mode=rtx
```

```

stdcfg1a 10-10-16 14:09:24 EST EAGLE 43.0.0
rept-stat-dstn:mode=rtx
Command entered at terminal #4.
Extended Processing Time may be Required

```

```

DPCA          PST          SST          AST
001-101-001  OOS-MT         Idle         INACCESS

      OPCA          PST          SST          AST
001-001-001  OOS-MT         Idle         INACCESS
002-001-000  OOS-MT         Idle         INACCESS

      ILSN          PST          SST          AST
e2m1s1       OOS-MT         Idle         INACCESS

DPCN          PST          SST          AST
1-050-1      OOS-MT         Idle         INACCESS

      OPCA          PST          SST          AST
002-001-000  OOS-MT         Idle         INACCESS
002-101-001  OOS-MT         Idle         INACCESS

DPCN24        PST          SST          AST

DPCI          PST          SST          AST
1-070-1      OOS-MT         Idle         INACCESS

      OPCN          PST          SST          AST
1-050-1      OOS-MT         Idle         INACCESS

      ILSN          PST          SST          AST
npc1         OOS-MT         Idle         INACCESS

```

Command Completed.

;

This example shows the output when the `mode=full` parameter is specified, and the Origin-Based MTP routing feature is not turned on:

```
rept-stat-dstn:mode=full
```

```
tekelecstp 10-10-29 10:26:56 EST EAGLE 43.0.0
```

```
rept-stat-dstn:mode=full
```

```
Command entered at terminal #4.
```

```
Extended Processing Time may be Required
```

```

DPCA          PST          SST          AST
001-001-001  OOS-MT         Idle         INACCESS
002-002-002  OOS-MT         Idle         INACCESS
003-003-003  OOS-MT         Idle         INACCESS
004-004-004  OOS-MT         Idle         INACCESS
005-005-005  OOS-MT         Idle         INACCESS

      SI          PST          SST          AST
3          OOS-MT         Idle         INACCESS
006-006-006  OOS-MT         Idle         INACCESS
007-007-007  OOS-MT         Idle         INACCESS
009-009-*    OOS-MT         Idle         INACCESS
008-008-*    OOS-MT         Idle         INACCESS

```

```

DPCN          PST          SST          AST
00101        OOS-MT        Idle        INACCESS
00102        OOS-MT        Idle        INACCESS
00103        OOS-MT        Idle        INACCESS
00104        OOS-MT        Idle        INACCESS
00105        OOS-MT        Idle        INACCESS
00106        OOS-MT        Idle        INACCESS
00107        OOS-MT        Idle        INACCESS

DPCN24        PST          SST          AST

DPCI          PST          SST          AST
2-100-1      OOS-MT        Idle        INACCESS
2-100-2      OOS-MT        Idle        INACCESS
2-100-3      OOS-MT        Idle        INACCESS
2-100-4      OOS-MT        Idle        INACCESS
2-100-5      OOS-MT        Idle        INACCESS
2-100-6      OOS-MT        Idle        INACCESS
2-100-7      OOS-MT        Idle        INACCESS
1-001-1      OOS-MT        Idle        INACCESS
1-001-2      OOS-MT        Idle        INACCESS

```

Command Completed.

;

This example shows the output when the `mode=rtx` parameter is specified, and the Origin-Based MTP Routing feature is not turned on:

```
rept-stat-dstn:mode=rtx
```

```

stdcfg1a 10-10-16 14:09:24 EST EAGLE 43.0.0
rept-stat-dstn:mode=rtx
Command entered at terminal #4.
Extended Processing Time may be Required

```

```

DPCA          PST          SST          AST
005-005-005  OOS-MT        Idle        INACCESS

SI            PST          SST          AST
3            OOS-MT        Idle        INACCESS

```

Command Completed.

;

This example shows the output when `dpcn16` parameter is specified.

```
rept-stat-dstn:dpcn16=1-1-1
```

```

stdcfg1a 09-03-16 14:09:24 EST EAGLE 41.0.0
DPCN16          PST          SST          AST
001-001-001    OOS-MT        Prohibit    INACCESS
ALARM STATUS   = *C 0313 DPC is prohibited
RTE COST LSN   APCN16          LS STAT    NON-ADJ    ROUTE

```

```

STAT
  1  05  lse1e1      001-001-001  Prohibit  Allowed  Prohibit
  2  05  lse1e2      001-002-001  Prohibit  Allowed  Prohibit
  3  10  lse1e3      001-003-001  Prohibit  Allowed  Prohibit
  4  --  -----      ***-***-***  -----  -----  -----
  5  --  -----      ***-***-***  -----  -----  -----
  6  --  -----      ***-***-***  -----  -----  -----

```

Command Completed.

;

### Legend

- **DPC/DPCA**—ANSI destination point code of the route
- **DPCN**—ITU-TSS national destination point code of the route
- **DPCN24**—24-bit ITU national destination point code of the route
- **DPCI**—ITU-TSS international destination point code of the route
- **OPC/OPCA**—ANSI origination point code as exception routing criterion of the exception route
- **OPCN**—ITU-TSS national origination point code as exception routing criterion of the exception route
- **OPCN24**—24-bit ITU national origination point code as exception routing criterion of the exception route
- **OPCI**—ITU-TSS international origination point code as exception routing criterion of the exception route
- **ILSN**—Originating linkset as exception routing criterion of the exception route
- **CIC**—Starting Circuit Identification Code used as the exception routing criterion for this exception route
- **ECIC**—Ending Circuit Identification Code with CIC defines the CIC range used as exception routing criterion for this exception route
- **PST**—Primary state of the subsystem. See [Possible Values for PST/SST/AST](#).
- **SST**—Secondary state of the subsystem. See [Possible Values for PST/SST/AST](#).
- **AST**—Associated state of the subsystem. See [Possible Values for PST/SST/AST](#).

### Related Topics

- [chg-dstn](#)
- [chg-rte](#)
- [dlt-dstn](#)
- [dlt-rte](#)
- [ent-dstn](#)
- [ent-rte](#)
- [rept-stat-rte](#)
- [rtv-dstn](#)
- [rtv-rte](#)

## rept-stat-e1

Use this command to display the E1 port status and signaling link status for cards with provisioned E1 ports.

### Parameters

#### **e1port (optional)**

The E1 port number. When this parameter is specified, only the information for the specified E1 port on the card in the specified card location is displayed.

#### **Range:**

1 - 8

#### **loc (optional)**

The unique identifier of a specific LIME1 card located in the STP.

#### **Range:**

1101 - 1108, 1111 - 1112, 1201 - 1208, 1211 - 1218, 1301 - 1308, 1311 - 1318,  
2101 - 2108, 2111 - 2118, 2201 - 2208, 2211 - 2218, 2301 - 2308, 2311 - 2318,  
3101 - 3108, 3111 - 3118, 3201 - 3208, 3211 - 3218, 3301 - 3308, 3311 - 3318,  
4101 - 4108, 4111 - 4118, 4201 - 4208, 4211 - 4218, 4301 - 4308, 4311 - 4318,  
5101 - 5108, 5111 - 5118, 5201 - 5208, 5211 - 5218, 5301 - 5308, 5311 - 5318,  
6101 - 6108, 6111 - 6118

#### **Default:**

Information for all LIME1 cards is reported.

### Example

```
rept-stat-e1
```

### Dependencies

No other `rept-stat-xxx` command can be in progress when this command is entered.

The `loc` parameter must be specified when the `e1port` parameter is specified.

The active TDM location cannot be specified in the `loc` parameter.

Card locations 1117 and 1118 and the MUX card locations (`xy09` and `xy10` where `x` is the frame and `y` is the shelf) cannot be specified in the `loc` parameter.

### Notes

Specifying the command without any parameters displays E1 port status for all cards with provisioned E1 ports.

If the `loc` parameter is specified, status is displayed for all E1 ports provisioned on the card in the specified location.

If the `loc` and `e1port` parameters are specified, the E1 port status summary is displayed for all E1 ports provisioned on the card in the specified location, followed by the status of all signaling links assigned to the specified E1 port on the card.

**Output**

This example shows the output when no parameters are specified:

```
rept-stat-e1
```

```
rlghncxa03w 05-01-04 07:01:08 EST EAGLE5 33.0.0
LOC  E1PORT  PST          SST          AST
1203  1        IS-NR         Avail        PARENT
1203  2        IS-NR         Avail        PAIRED
1203  3        IS-NR         Avail        -----
1203  7        OOS-MT        Unavail      -----
1207  1        IS-NR         Avail        -----
1207  2        IS-NR         Avail        -----
Command Completed.
```

```
;
```

This example shows the output when the `loc` parameter is specified:

```
rept-stat-e1:loc=1203
```

```
rlghncxa03w 05-01-04 07:01:08 EST EAGLE5 33.0.0
LOC  E1PORT  PST          SST          AST
1203  1        IS-NR         Avail        PARENT
1203  2        IS-NR         Avail        PAIRED
1203  3        IS-NR         Avail        -----
1203  7        OOS-MT        Unavail      -----
Command Completed.
```

```
;
```

This example shows the output when the `loc` and `elport` parameters are specified:

```
rept-stat-e1:loc=1203:elport=1
```

```
rlghncxa03w 05-01-04 07:01:08 EST EAGLE5 33.0.0
LOC  E1PORT  PST          SST          AST
1203  1        IS-NR         Avail        PARENT
ALARM STATUS          = No Alarms.
UNAVAIL REASON        = --
SLK  TS  PST          SST          AST
A    1  IS-NR         Avail        ---
A1   2  IS-NR         Avail        ---
Command Completed.
```

```
;
```

```
rept-stat-e1:loc=1203:elport=2
```

```
rlghncxa03w 05-01-04 07:01:08 EST EAGLE5 33.0.0
LOC  E1PORT  PST          SST          AST
```



```

1203  2      IS-NR      Avail      PAIRED
ALARM STATUS      = No Alarms.
UNAVAIL REASON    = --
Command Completed.
;

```

### Legend

- **LOC**—Card location
- **E1PORT**—Number of the E1 port provisioned on the card in the specified location.
- **PST**—Primary state of the card. See [Possible Values for PST/SST/AST](#).
- **SST**—Secondary state of the card. See [Possible Values for PST/SST/AST](#).
- **AST**—Associated state of the card. See [Possible Values for PST/SST/AST](#). The values *PARENT* and *PAIRED* refer to odd and even adjacent ports on the card that are provisioned in channel bridging mode.
- **ALARM STATUS**—Either "No Alarms" or current alarm number and text
- **UNAVAIL REASON**—Reason for the E1 port being unavailable
- **SLK**—Signaling link assigned to the E1 port
- **TS**—Timeslot assigned to the signaling link
- **PST**—Primary state of the signaling link. See [Possible Values for PST/SST/AST](#).
- **SST**—Secondary state of the signaling link. See [Possible Values for PST/SST/AST](#).
- **AST**—Associated state of the signaling link. See [Possible Values for PST/SST/AST](#).

## rept-stat-enet

Use this command to display a summary report of Ethernet status for all cards in the system that have configured Ethernet Interfaces.

### Parameters

#### **loc (optional)**

The card location as stenciled on the shelf of the system.

#### **Range:**

1101 - 1108, 1111 - 1112, 1201 - 1208, 1211 - 1218, 1301 - 1308, 1311 - 1318,  
2101 - 2108, 2111 - 2118, 2201 - 2208, 2211 - 2218, 2301 - 2308, 2311 - 2318,  
3101 - 3108, 3111 - 3118, 3201 - 3208, 3211 - 3218, 3301 - 3308, 3311 - 3318,  
4101 - 4108, 4111 - 4118, 4201 - 4208, 4211 - 4218, 4301 - 4308, 4311 - 4318,  
5101 - 5108, 5111 - 5118, 5201 - 5208, 5211 - 5218, 5301 - 5308, 5311 - 5318,  
6101 - 6108, 6111 - 6118, 1113, 1115

#### **Default:**

All ENET data for the card location is displayed.

#### **port (optional)**

Ethernet interface port ID.

**Range:***a, b, c, d***Default:**

All port data for ENET is displayed.

Ports c and d are displayed for the DEIR/SIP/ENUM applications running on the SLIC card.

**Example**

```
rept-stat-enet
rept-stat-enet:loc=1101:port=b
rept-stat-enet:loc=1201:port=c
rept-stat-enet:loc=1201:port=d
```

**Dependencies**

Another command is already in progress.

The `loc` and `port` parameters must be specified together in the command.The shelf and card must be equipped, and the card specified by the `loc` parameter must have an application of IPS, MCP, STPLAN, EROUTE, VSCCP, IPSP, IPLIM, IPLIMI, SS7IPGW, IPGWI, SIP, ENUM, or DEIR.The card in the location specified by the `loc` parameter must support the port specified by the `port` parameter.**Notes**

Interface A/D is used for ExAP connectivity, and interface B/C is used for signaling networks on SLIC cards running DEIR/SIP/ENUM application.

**Output**

This example shows the status of all configured Ethernet interfaces in the system:

```
rept-stat-enet

eagle10110 07-02-10 14:50:23 EST EAGLE 35.6.0
LOC  PORT  IPADDR          PST          SST          AST
1101  A      1.1.1.1         OOS-MT       Fault        ALMINH
1101  B      123.234.222.111 IS-ANR       Active       -----
1201  A      111.1.24.200   IS-NR       Active       -----
1201  B      2.31.234.1

OOS-MT      Fault      -----

Command Completed.
;
```

This example shows the summary for a specific card location and port when the Ethernet error count exceeds the threshold value:

```
rept-stat-enet:loc=1101:port=b

eagle10110 10-01-10 14:54:23 EST EAGLE 42.0.0
LOC  PORT IPADDR          PST          SST          AST
1101 B    123.234.222.111  IS-ANR      Active       -----
ALARM STATUS      = ** 0537 Ethernet error threshold exceeded

Command Completed.
;
```

This example shows the Ethernet interface summary for a specified card when the Ethernet interface is up, and the IP address is not assigned by the DHCP server:

```
rept-stat-enet:loc=1102:port=a

tekelecstp 10-01-17 12:54:48 MST EAGLE 42.0.0
LOC  PORT IPADDR          PST          SST          AST
1102 A    -----          IS-NR      Active       -----
ALARM STATUS      = No Alarms.

Command Completed.
```

This example shows the Ethernet interface summary for a specified card when the Ethernet interface is removed, and the DHCP lease of an assigned IP address has not expired:

```
rept-stat-enet:loc=1101:port=a

tekelecstp 10-01-17 12:54:48 MST EAGLE 42.0.0
LOC  PORT IPADDR          PST          SST          AST
1102 A    -----          IS-NR      Active       -----
ALARM STATUS      = No Alarms.

Command Completed.
```

This example shows the summary for a specified card when the Ethernet interface is up:

```
rept-stat-enet:loc=1101:port=a

tekelecstp 10-01-02 00:29:22 MST EAGLE 42.0.0
LOC  PORT IPADDR          PST          SST          AST
1101 A    192.168.63.213      IS-NR      Active       -----
ALARM STATUS      = No Alarms.

Command Completed.
;
```

## Legend

- CARD—Location of the card
- VERSION—Version number of the application loaded on the card. Dashes (- - - -) in the version column indicate one of the following conditions about the card:
  - The card is configured but is not physically present in the system.
  - The card does not run a GPL, such as TDM or MDAL cards.
  - The card is IS-ANR or is in the process of being loaded.
- TYPE—Card type entered in the database
- APPL—Application loaded on the card
- PST—Primary state of the card. See [Possible Values for PST/SST/AST](#).
- SST—Secondary state of the card. See [Possible Values for PST/SST/AST](#).
- AST—Associated state of the card. See [Possible Values for PST/SST/AST](#).

## rept-stat-enum

Use this command to display the overall status of the ENUM service on the EAGLE.

### Parameters

#### **loc (optional)**

ENUM card location for which card status and card TPS usage data is to be reported.

#### **Range:**

*1101 - 1108, 1111 - 1112, 1201 - 1208, 1211 - 1218, 1301 - 1308, 1311 - 1318, 2101 - 2108, 2111 - 2118, 2201 - 2208, 2211 - 2218, 2301 - 2308, 2311 - 2318, 3101 - 3108, 3111 - 3118, 3201 - 3208, 3211 - 3218, 3301 - 3308, 3311 - 3318, 4101 - 4108, 4111 - 4118, 4201 - 4208, 4211 - 4218, 4301 - 4308, 4311 - 4318, 5101 - 5108, 5111 - 5118, 5201 - 5208, 5211 - 5218, 5301 - 5308, 5311 - 5318, 6101 - 6108, 6111 - 6118*

#### **mode (optional)**

It will display ENUM system alarm status and per card TPS statistics.

#### **Range:**

perf

#### **Default:**

Perf

#### **peakreset (optional)**

Reset peak values to the current TPS values.

#### **Range:**

yes

### Example

```
rept-stat-enum
```

```
rept-stat-enum:peakreset=yes:loc=1101
```

```
rept-stat-enum:loc=1101
rept-stat-enum:mode=perf
```

### Dependencies

The location specified with this command should be of an ENUM card running the ENUMHC gpl.

An ENUM card running the ENUMHC application must be configured before this command can be entered.

The peakreset and loc parameters can be specified together. No other combination is allowed.

The shelf and card must be equipped, and the card specified by the loc parameter must have an application of enumhc.

The peakreset parameter should be specified with the loc parameter.

### Notes

If optional parameters are specified, only the entries that match the entered parameters are displayed.

### Output

This example displays output when no parameter is specified:

```
rept-stat-enum
```

```
Command Executed
```

```
tekelecstp 14-05-29 03:13:20 MST EST EAGLE 46.1.0
rept-stat-enum
Command entered at terminal #21.
```

```
;
```

```
Command Accepted - Processing
```

```
tekelecstp 14-05-29 03:13:20 MST EST EAGLE 46.1.0
ENUM ALARM STATUS = No Alarms
ENUM Cards Configured= 2      Cards IS-NR= 2
```

CARD	VERSION	PST	SST	AST	TPS
1207 P	045-018-002	IS-NR	Active	-----	200
1105	045-018-008	IS-NR	Active	-----	100

```
TOTAL SERVICE STATISTICS:
```

```
=====
SERVICE    SUCCESS    ERROR    TOTAL
ENUM:       300        185      485
```

```
TOTAL ERROR STATISTICS:
```

```
=====
=====
```

SERVICE	RCODE1	RCODE2	RCODE3	RCODE4	RCODE5	TOTAL
ENUM:	50	60	45	10	20	185

Command Completed.

;

This example displays output when the LOC parameter is specified:

```
rept-stat-enum:loc=1207
```

```
tekelecstp 14-05-29 04:10:20 MST EST EAGLE 46.1.0
```

```
rept-stat-enum:loc=1207
```

```
Command entered at terminal #21.
```

;

Command Accepted - Processing

```
tekelecstp 14-05-29 04:10:20 MST EST EAGLE 46.1.0
```

```
CARD VERSION TYPE PST SST AST
```

```
1207 045-018-002 DSM IS-NR Active -----
```

```
CARD ALARM STATUS = No Alarms.
```

TPS STATISTICS:

```
=====
              TPS   PEAK-TPS.   PEAKTIMESTAMP
-----
              200   250         14-05-29 04:06:21
```

Command Completed.

;

This example displays output when the MODE parameter is specified:

```
rept-stat-enum:mode=perf
```

```
tekelecstp 14-05-29 04:16:20 MST EST EAGLE 46.1.0
```

```
rept-stat-enum:mode=perf
```

```
Command entered at terminal #21.
```

;

Command Accepted - Processing

```
tekelecstp 14-05-29 04:16:20 MST EST EAGLE 46.1.0
```

```
ENUM ALARM STATUS = No Alarms
```

```
ENUM Cards Configured= 2      Cards IS-NR= 2
```

TPS STATISTICS:

```
=====
CARD  TPS   PTPS   PTIMESTAMP
-----
```

```
1207 P 200    250    14-05-29 04:06:21
1105  100    105    14-05-29 03:39:21
-----
```

Command Completed.

;

## Legend

This section defines the fields of the four `rept-stat-enum` reports:

- `rept-stat-enum`
- `rept-stat-enum:loc=1207`
- `rept-stat-enum:mode=perf`
- `rept-stat-enum:peakreset=yes:loc=1207`

A dash (-) in an output field indicates that the statistic does not apply.

- **CARD IS-NR**—Number of ENUM cards running the ENUMHC GPL that can be used by the system (status is In-Service Normal, IS-NR).
- **CARD**—Card location of the ENUM card running the ENUMHC GPL
- **P**—P indicates the primary Service Module card. The primary Service Module card provides the MPS status to the EAGLE. This indicator is displayed between the card location and the GPL version.
- **VERSION**—Version number of the ENUMHC GPL running on the ENUM card.
- **PST**—Primary state of the card. See [Possible Values for PST/SST/AST](#).
- **SST**—Secondary state of the card. See [Possible Values for PST/SST/AST](#).
- **AST**—Associate state of the card. See [Possible Values for PST/SST/AST](#).
- **TPS**—TPS (Transactions per second) indicates the number of ENUM messages which are received on the ENUM card.
- **PTPS/PEAK-TPS**—This field indicates the maximum TPS occurred on the card
- **PTIMESTAMP/PEAKTIMESTAMP**—It is the time when the maximum TPS occurred on the card.
- **ENUM ALARM STATUS**—Displays ENUM system-related alarms. If there are no system alarms present, this field displays No Alarms.
- **CARD ALARM STATUS**—Displays ENUM card-specific alarms. If there are no card alarms present, this field displays No Alarms.
- **TOTAL SERVICE STATISTICS**—System-wide view of per-service statistics. The report tracks the following information:
  - **SERVICE**—The service running on the ENUM card. Currently only the ENUM service is supported for the ENUM card.
  - **SUCCESS**—Total number of messages successfully processed by the ENUM cards.
  - **ERRORS**—Total number of messages with errors which are received or sent by the ENUM cards.
  - **TOTAL**—Total messages received. It should be the sum of (Success + Errors) messages.

- **TOTAL ERROR STATISTICS**—System-wide view of error statistics. The report tracks the following information:
  - **SERVICE**—The service running on the ENUM card. Currently only the ENUM service is supported for the ENUM card.
  - **RCODE1**—Total number of messages responded by the ENUM card for format errors.
  - **RCODE2**—Total number of messages responded by the ENUM card for server failures.
  - **RCODE3**—Total number of messages responded by the ENUM card for invalid domains.
  - **RCODE4**—Total number of messages responded by the ENUM card for requested queries which are not supported in EAGLE.
  - **RCODE5**—Total number of messages responded by the ENUM card for query types and classes which are not supported in EAGLE.
- **PER CONNECTION STATISTICS**—System-wide view of per connection statistics. The report tracks the following information:
  - **CNAME**- Name of the IP connection provisioned on ENUM card specified in LOC parameter.
  - **STATUS**- Current status of IP connection.
  - **TPS**- TPS (Transactions per second) indicates the number of ENUM messages that are received on the IP connection on a given ENUM card.
  - **PTPS**- Maximum TPS occurred on an IP connection on a given ENUM card.
  - **PTIMESTAMP**- The time when the maximum TPS occurred on an IP connection on a given card.

## rept-stat-gpl

Use this command to display the version of GPLs currently running for an application, plus the approved and trial versions of the GPL that will run if the card is restarted.

### Parameters

#### **display (optional)**

Display mode. Specifies whether the report displays only application GPL data for all cards, or both IMT and application GPL data.

#### **Range:**

*all*

#### **gp1 (optional)**

Generic program load. The GPL for which to retrieve information.

#### **Range:**

*xyyyyyyy*

1 alphabetic character followed by up to 7 alphanumeric characters. Valid GPLs are:  
*atmhc*—Used by E5-ATM-B cards to allow the card to support up to 3 signaling links



*bldc32*—Flash GPL containing a tar image with all code required on E5-MCAP cards to support VxWorks6.9 32-bit application, as in OAMHC69.

*bldc64*—Flash GPL containing a tar image with all code required on E5-SM8G-B cards for SCCP64, ENUM64, SIP64 and DEIR64 applications.

*blmcap*—Flash GPL containing a tar image with all code required on E5-MCAP, E5-E1T1-B, E5-MCPM-B, E5-ATM-B, E5-ENET-B, and E5-SM8G-B cards

*blslc32*—Flash GPL containing a tar image with all code required on SLIC cards for 32-bit application i.e. MCPHC, IPSHC etc.

*blslc64*—Flash GPL containing a tar image with all code required on SLIC cards for 64-bit application i.e. SCCP64, ENUM64, SIP64 and DEIR64.

*blsl932*—Flash GPL containing a tar image with all code required on SLIC cards for 32-bit application on VxWorks6.9, as in IPSHC69 and MCPHC69.

*deirhc*—Used by E5-SM8G-B cards to support the S13/S13' EIR feature

*enumhc*—Used by E5-SM8G-B cards to support the ENUM Mobile Number Portability and Tier One Address Resolution application

*erthc*—Used by E5-ENET-B cards for EAGLE 5 Integrated Monitoring Support functions

*hipr2*—Communication software used on the High Speed IMT Packet Router (HIPR2) card

*ipsg*—Used by E5-ENET-B cards to support the combined functionality of IPLIMx M2PA and IPGWx M3UA

*ipsg32*—Used by SLIC cards to support IPSG application with 64-bit addressing either with GTT functionality or without it.

*ipshc*—Used by E5-ENET-B cards to support the IPS application

*ipshc69*—Used by E5-ENET-B and SLIC cards to support the IPS application when running on VxWorks69.

*mcphc*—Used by E5-MCPM-B cards for the Measurements Platform feature

*mcphc69*—Used by E5-MCPM-B and SLIC cards for the Measurements Platform feature when running on VxWorks69.

*oamhc*—Used by E5-MCAP cards for enhanced OAM functions

*oamhc69*—Used by E5-MCAP cards for enhanced OAM functions, when running on VxWorks 69.

*sccphc*—Used by E5-SM8G-B cards to support EPAP-based features and the LNP ELAP Configuration feature. If no EPAP-based or LNP ELAP Configuration feature is turned on, and an E5-SM8G-B card is present, then the GPL processes normal GTT traffic.

*sfapp*—Used by SLIC cards to support the Stateful Firewall Application.

*siphc*—Used by E5-SM8G-B Cards to support the SIP application.

*ss7hc*—Application GPL used by E5-E1T1-B and SLIC cards to support **E1** and **T1** signaling links.

**Default:**

Display all

**loc (optional)**

Location. The target card address and versions of all GPLs running at the specified card location. For E5-ENET-B, or STC cards, this information includes all non-activated flash GPLs. For cards that are not STC, E5-ENET-B or E5-IPSM cards, there is no additional data: this parameter limits the report to the target card address.

**Range:**

1101 - 1108, 1111 - 1112, 1201 - 1208, 1211 - 1218, 1301 - 1308, 1311 - 1318,  
2101 - 2108, 2111 - 2118, 2201 - 2208, 2211 - 2218, 2301 - 2308, 2311 - 2318,  
3101 - 3108, 3111 - 3118, 3201 - 3208, 3211 - 3218, 3301 - 3308, 3311 - 3318,

4101 - 4108, 4111 - 4118, 4201 - 4208, 4211 - 4218, 4301 - 4308, 4311 - 4318, 5101 - 5108, 5111 - 5118, 5201 - 5208, 5211 - 5218, 5301 - 5308, 5311 - 5318, 6101 - 6108, 6111 - 6118, 1109, 1110, 1209, 1210, 1309, 1310, 2109, 2110, 2209, 2210, 2309, 2310, 3109, 3110, 3209, 3210, 3309, 3310, 4109, 4110, 4209, 4210, 4309, 4310, 5109, 5110, 5209, 5210, 5309, 5310, 6109, 6110, 1113, 1115

### Example

```
rept-stat-gpl
rept-stat-gpl:display=all
rept-stat-gpl:loc=1201
rept-stat-gpl:gpl=hipr2
rept-stat-gpl:gpl=siphc
rept-stat-gpl:gpl=enumhc
rept-stat-gpl:gpl=ipsg32
rept-stat-gpl:gpl=sfapp
```

### Dependencies

No other `rept-stat-xxxx` command can be in progress when this command is entered.

Only one of the `display=all`, `loc`, and `gpl` parameters can be specified in the command.

The value specified for the `gpl` parameter must be supported.

### Notes

To check the version of the EPAP or ELAP application, use the `rept-stat-mps` command.

When this command is entered, information is displayed only for the cards that are IS-NR or IS-ANR.

Use the `chg-gpl` command to turn auditing on and off.

Use the `rtrv-gpl` command to display the audit state.

The approved GPL is the GPL that resides on the active fixed disk and was made the approved version by specifying the GPL version number while executing the `act-gpl` command.

The trial GPL is the version of the GPL that was downloaded from the removable drive, but not activated by the `act-gpl` command.

When the `act-gpl` command is executed, the version specified becomes the approved GPL and the previously approved GPL becomes the trial GPL.

If any card is not running the active MASP system release version of a GPL, "ALM" is displayed to indicate that the card is in GPL alarm condition.

If GPL auditing is on, a minor alarm is shown, and "ALM" is displayed for each APPROVED GPL (`rtrv-gpl`) and for each RUNNING GPL (`rept-stat-gpl`) that does not match the GPL in the RELEASE column of the `rtrv-gpl` command output. If GPL auditing is off, the minor alarm is not activated, but "ALM" is displayed for each GPL that does not match the GPL in the RELEASE column.

If no `gpl` parameter is specified, the approved and trial versions for all GPLs are displayed.

If a GPL is not found, a version of "-----" is displayed. This should happen only for the OAM GPL when the plug-in USB flash drive is not inserted.

If the removable drive is inserted, an "\*" (asterisk) is displayed next to the OAM trial version. The asterisk serves as a reminder that the trial version of a GPL is loaded when the card that is running the OAM is restarted. All other cards load their approved versions of GPLs when they are restarted.

If a card is inhibited, "-----" is displayed for the running version.

When the `gpl` parameter is not specified, the default is to display all application GPLs that are running on provisioned cards. The flashable GPLs (those loaded on the card by using the `init-flash` command) are not displayed.

A plus (+) symbol in the output indicates that the flash GPL currently being run has not yet been activated on the card. See the `act-flash` or `init-flash` command for a list of flash GPLs.

When a GPL is specified in the `gpl` parameter, the specified GPL for each card connected to the IMT is displayed.

## Output

The output of the `rept-stat-gpl` command is site- and configuration-specific. The output examples show typical output for the commands that are entered; the output that is shown can differ from output that appears for a particular system.

This example shows the output when no parameters are defined. All GPLs for the card are listed:

```
rept-stat-gpl

rlghncxa03w 14-05-14 07:01:08 EST  EAGLE 46.1.0
GPL          CARD          RUNNING          APPROVED        TRIAL
ATMHC       1103          128-002-000     128-002-000    128-002-000
ATMHC       1107          128-002-000     128-002-000    128-002-000
OAMHC       1113          025-002-000     025-002-000    -----
OAMHC       1115          025-002-000     025-002-000    -----
SCCPHC      1103          026-001-000     026-001-000    026-001-000
ATMHC       1205          025-001-000     025-001-000    025-001-000
ATMHC       1211          025-001-000     025-001-000    025-001-000
SS7HC       1105          027-001-000     027-001-000    027-001-000
IPSG        1305          040-000-000     040-000-000    040-000-000
SIPHC       1101          134-035-000     134-035-000    134-035-000
ENUMHC      1111          135-020-000     135-020-000
135-020-000
Command Completed.
;
```

This example shows the output when the `display=all` parameter is specified. IMT and application GPL information is shown.

```
rept-stat-gpl:display=all
```

```
rlghncxa03w 14-05-14 10:23:93 EST EAGLE 46.1.0
```

GPL	CARD	RUNNING	APPROVED	TRIAL
ENUMHC	1111	135-020-000	135-020-000	135-020-000
	BLMCAP	135-020-000	135-020-000	135-020-003
SIPHC	1101	134-035-000	134-035-000	134-035-000
	BLMCAP	134-035-000	134-035-000	134-035-001
OAMHC	1113	027-002-000	027-002-000	-----
	BLMCAP	027-001-000	027-001-000	210-001-003
OAMHC	1115	027-002-000	027-002-000	-----
	BLMCAP	027-001-000	027-001-000	210-001-003
SCCPHC	1212	027-001-000	027-001-000	027-001-000
	BLMCAP	027-001-000	027-001-000	210-001-003
ATMHC	1203	027-001-000	027-001-000	027-001-000
	BLMCAP	027-001-000	027-001-000	210-001-003
HIPR2	1109	027-005-000	027-005-000	027-005-000
HIPR2	1110	027-005-000	027-005-000	027-005-000
HIPR2	1209	027-005-000	027-005-000	027-005-000
HIPR2	1210	027-005-000	027-005-000	027-005-000
HIPR2	1309	027-005-000	027-005-000	027-005-000
HIPR2	1310	027-005-000	027-005-000	027-005-000

Command Completed.

```
;
```

This example shows the output when the `loc` parameter is specified for other cards:

```
rept-stat-gpl:loc=1217
```

```
rlghncxa03w 07-02-01 10:23:93 EST EAGLE 37.5.0
```

```
GPL Auditing ON
```

GPL	CARD	RUNNING	APPROVED	TRIAL
ATMHC	1217	125-001-000	125-001-000	125-001-000
	BLMCAP	125-001-000	125-001-000	125-001-000

Command Completed.

```
;
```

This example includes IPSP cards. The example contains truncated output, indicated by 3 vertical dots.

```
rept-stat-gpl:display=all
```

```
tekelecstp 17-09-15 15:11:33 EST EAGLE 46.5.0.0.0-71.11.0
```

```
GPL Auditing ON
```

GPL	CARD	RUNNING	APPROVED	TRIAL
OAMHC	1113	133-051-000 ALM	028-051-000	028-051-000 *
	BLMCAP	133-051-000	133-051-000	133-051-000

```

OAMHC      1115      028-051-000      028-051-000      028-051-000
*
      BLMCAP      133-051-000      133-051-000      133-051-000
HIPR2      1109      133-051-000      133-051-000      133-051-000
HIPR2      1110      133-051-000      133-051-000      133-051-000
HIPR2      1209      133-051-000      133-051-000      133-051-000
HIPR2      6110      133-051-000      133-051-000      133-051-000
.
.
.
SCCPHC     3117      001-051-013      001-051-013      001-051-010
      BLMCAP      133-042-000      133-042-000      133-042-000
SCCPHC     3201      001-051-013      001-051-013      001-051-010
      BLMCAP      133-042-000      133-042-000      133-042-000
MCPHC      1108      133-051-000      133-051-000      133-051-000
      BLMCAP      133-042-000      133-042-000      133-042-000
MCPHC      5313      133-051-000      133-051-000      133-051-000
      BLMCAP      133-042-000      133-042-000      133-042-000
SS7HC      2201      133-051-000      133-051-000      133-051-000
      BLIXP      133-050-000      133-050-000      027-051-000
SS7HC      3307      133-051-000      133-051-000      133-051-000
      BLIXP      133-050-000      133-050-000      027-051-000
SIPHC      1101      134-035-000      134-035-000      134-035-000
      BLMCAP      134-035-000      134-035-000      134-035-001
ENUMHC     1111      135-020-000      135-020-000      135-020-000
      BLMCAP      135-020-000      135-020-000
135-020-003
.
.
.
IPSG       3116      133-051-000      133-051-000      133-051-000
      BLIXP      133-050-000      133-050-000      027-051-000
IPSG       4103      133-051-000      133-051-000      133-051-000
      BLIXP      133-050-000      133-050-000      027-051-000
Command Completed.
;

```

This example displays the output when E5-MCAP cards are used:

```
rept-stat-gpl
```

```

tekelecstp 17-09-15 15:12:33 EST EAGLE 46.5.0.0.0-71.11.0
  GPL      CARD      RUNNING      APPROVED      TRIAL
  SIPHC    1101      134-035-000      134-035-000      134-035-000
  ATMHC    1103      128-002-000      128-002-000      128-002-000
  ATMHC    1107      128-002-000      128-002-000      128-002-000
  ENUMHC   1111      135-020-000      135-020-000
135-020-000
  OAMHC    1113      030-013-000      030-013-000      030-013-000 *
  OAMHC    1115      030-013-000      030-013-000      030-013-000 *
  SCCPHC   1212      025-001-000      025-001-000      025-001-000
  ATMHC    1205      025-001-000      025-001-000      025-001-000
  ATMHC    1211      025-001-000      025-001-000      025-001-000
  SS7HC    1105      027-001-000      027-001-000      027-001-000

```

```
IPSG      1305      040-000-000      040-000-000      040-000-000
Command Completed.
;
```

This example displays the output when an E5-SM8G-B card is running the SIP application:

```
rept-stat-gpl:gpl=siphc
```

```
tekelecstp 12-07-27 14:11:48 EST EAGLE 45.0.0
rept-stat-gpl:gpl=siphc
Command entered at terminal #4.
GPL Auditing ON
```

GPL	CARD	RUNNING	APPROVED	TRIAL
SIPHC	1101	134-035-000	134-035-000	134-035-000

```
Command completed.
;
```

This example displays the output when an E5-SM8G-B card is running the S13 EIR application:

```
rept-stat-gpl:gpl=deirhc
```

```
tekelecstp 13-03-15 14:11:48 EST EAGLE 45.1.0
rept-stat-gpl:gpl=deirhc
Command entered at terminal #4.
GPL Auditing ON
```

GPL	CARD	RUNNING	APPROVED	TRIAL
DEIRHC	1104	134-060-000	134-060-000	134-060-000

```
Command Completed.
;
```

This example displays the output when an E5-SM8G-B card is running the ENUM NP application:

```
rept-stat-gpl:gpl=enumhc
```

```
tekelecstp 14-05-14 14:11:48 EST EAGLE 46.1.0
rept-stat-gpl:gpl=enumhc
Command entered at terminal #4.
GPL Auditing ON
```

GPL	CARD	RUNNING	APPROVED	TRIAL
ENUMHC	1111	135-020-000	135-020-000	135-020-000

```
Command completed.
;
```

This example displays the output when the SLIC card is running the IPSG application with data=gtt/nosccp:

```
rept-stat-gpl:gpl=ipsg32
```

```
tekelecstp 16-08-25 14:11:48 EST EAGLE 46.5.0
rept-stat-gpl:gpl=ipsg32
Command entered at terminal #4.
GPL Auditing ON
```

GPL	CARD	RUNNING	APPROVED	TRIAL
IPSG32	1101	140-012-000	140-012-000	140-012-000

```
Command completed.
```

```
;
```

This example shows the output when the display=all parameter is specified. IMT and application GPL information is shown:

```
rept-stat-gpl:display=all
```

```
tekelecstp 18-01-18 21:30:11 EST EAGLE 46.5.1.5.0-73.10.0
rept-stat-gpl:display=all
Command entered at terminal #18.
```

```
;
```

```
Command Accepted - Processing
```

```
tekelecstp 18-01-18 21:30:11 EST EAGLE 46.5.1.5.0-73.10.0
GPL Auditing ON
```

GPL	CARD	RUNNING	APPROVED	TRIAL
OAMHC	1113	033-010-001	033-010-001	-----
*				
	BLMCAP	033-010-001	033-010-001	033-010-001
OAMHC	1115	033-010-001	033-010-001	-----
*				
	BLMCAP	033-010-001	033-010-001	033-010-001
HIPR2	1109	141-003-000 ALM	143-005-000	143-005-000
HIPR2	1110	141-003-000 ALM	143-005-000	143-005-000
SFAPP	1103	009-011-001	009-011-001	033-010-000
	BLDC64	143-006-000 ALM	000-000-000	033-010-001
SS7HC	1106	033-010-000	033-010-000	033-010-000
	BLMCAP	077-005-000 ALM	033-010-001	033-010-001
IPSHC	1112	033-010-000	033-010-000	033-010-000
	BLIXP	077-005-000 ALM	033-010-001	033-010-001
SCCP64	1107	033-010-000	033-010-000	033-010-000
	BLDC64	064-011-000 ALM	000-000-000	033-010-001

```
Command Completed.
```

```
;
Command Executed
```

This example displays the output when a SLIC card is running SFAPP application:

```
rept-stat-gpl:gpl=sfapp

tekelecstp 17-11-22 07:09:00 EST  EAGLE 46.5.1.5.0-73.2.0
rept-stat-gpl:gpl=sfapp
  Command entered at terminal #17.
;

Command Accepted - Processing
tekelecstp 17-11-22 07:09:00 EST  EAGLE 46.5.1.5.0-73.2.0
  GPL Auditing  ON

      GPL          CARD          RUNNING          APPROVED          TRIAL
      SFAPP        1108          037-002-000      037-002-000      037-002-000

  Command Completed.
;
Command Executed
```

### Legend

- **GPL**—GPL associated with the cards in the display
- **CARD**—Card location
- **RUNNING**—GPL version the card is running. If the card is not running the active MASP system release GPL, ALM appears after the GPL version number in this column.
- **APPROVED**—GPL version that is the approved GPL
- **TRIAL**—GPL version that is the trial GPL
- **ACTIVE**—GPL version downloaded using the `init-flash` command and activated using the `act-flash` command
- **INACTIVE**—GPL version downloaded using the `init-flash` command but not activated
- -----(dashes)—GPL is not present at the specified location
- \*—The trial version will run if the card boots (shown to the right of the TRIAL column)
- **ALM**—Alarm indicator showing the system has an approved GPL that is not the GPL required for this software release according to the active MASP system release table.
- †—Currently running flash GPL has not been activated (shown between the RUNNING and APPROVED columns)

### Related Topics

- [act-gpl](#)
- [alw-card](#)
- [chg-gpl](#)
- [copy-gpl](#)



- [init-card](#)
- [init-sys](#)
- [rtrv-gpl](#)

## rept-stat-imt

The interprocessor message transport bus (IMT bus) is the main communications artery between all subsystems in the system. Use this command to display the primary, secondary, and associated maintenance states of the IMT bus. The primary state indicates whether the bus is normal, abnormal, or OOS for maintenance activity. The secondary state indicates the active/inhibited status of a card for a particular IMT bus.

### Parameters

#### **mode (optional)**

Use this parameter to provide additional output listing the cards that currently have IMT alarm conditions outstanding. The additional output is repeated for each IMT bus following the bus status information. If no alarms are active on a given bus, no additional output is generated.

#### **Range:**

*full*

#### **Default:**

Do not display additional information.

### Example

```
rept-stat-imt
rept-stat-imt:mode=full
```

### Dependencies

No other `rept-stat-xxx` command can be in progress when this command is entered.

### Notes

The card locations are stored only by the active MASP. The information is lost if the system switches from the active to the standby MASP.

The trouble locations are displayed sorted by card location.

### Output

```
rept-stat-imt

rlghncxa03w 10-12-17 11:58:39 EST  EAGLE 43.0.0

IMT SYSTEM
  ALARM STATUS      = No Alarms.

IMT  PST           SST           AST
```

```

A      IS-NR          Active      -----
ALARM STATUS          = No Alarms.

IMT   PST            SST          AST
B      IS-NR          Active      -----
ALARM STATUS          = No Alarms.

Command Completed.
;

rept-stat-imt:mode=full

rlghncxa03w 10-12-17 12:03:19 EST  EAGLE 43.0.0

IMT SYSTEM
ALARM STATUS          = * 0110 Failure detected on one IMT bus

IMT   PST            SST          AST
A      IS-NR          Active      -----
ALARM STATUS          = No Alarms.

IMT   PST            SST          AST
B      OOS-MT-DSBLD   Fault       -----
ALARM STATUS          = ** 0108 Major IMT failure detected.

CARDS WITH ACTIVE IMT B ALARMS:
CARD   DATE          TIME
1102   04-02-23      11:59:23
1103   04-02-23      12:01:23
1204   04-02-23      23:14:07
1205   04-02-23      23:14:07
1206   04-02-23      23:14:07
Command Completed.
;

```

### Legend

- **IMT SYSTEM**—Logical entity representing the combination of both A and B IMT busses
- **IMT**—IMT bus A or IMT bus B
- **PST**—Primary state of the subsystem. See [Possible Values for PST/SST/AST](#).
- **SST**—Secondary state of the subsystem. See [Possible Values for PST/SST/AST](#).
- **AST**—Associated state of the subsystem. See [Possible Values for PST/SST/AST](#).
- **ALARM STATUS**—List of trouble text alarm messages that have been generated for the IMT System or specified IMT bus
  - \*—Minor Alarm
  - \*\*—Major Alarm
  - \*C—Critical Alarm

The states of the IMT bus are combined from the PST, SST and AST states as shown in [IMT Bus States](#) .

**Table 4-52 IMT Bus States**

PST	SST	AST	Definition
IS-NR	Active	----	The IMT bus is operating normally.
IS-ANR	Fault	----	The IMT bus has had a failure on at least one but not all cards.
IS-ANR	Manual	----	The IMT bus is inhibited, but some cards have been connected to it.
OOS-MT	Fault	----	The IMT bus has a failure on all cards.
OOS-MT-DSBLD	Manual	----	The IMT bus is inhibited and no cards are connected to it.
OOS-MT-DSBLD	Test	FLT CHK	The IMT Bus is inhibited and undergoing Fault Isolation test.
OOS-MT-DSBLD	Test	EXT BERT	The IMT Bus is inhibited and undergoing Extended BERT.

**Related Topics**

- [clr-imt-stats](#)
- [conn-imt](#)
- [disc-imt](#)
- [rept-imt-lvl1](#)
- [rept-imt-lvl2](#)
- [rmv-imt](#)
- [rst-imt](#)

## rept-stat-ipconn

Use this command to display the dynamic status of SIP transport/ENUM/SCCP/SFAPP/IPS with SFLOG.

**Parameters**

This command has no parameters.

**Example**

```
rept-stat-ipconn
```

## Dependencies

The SIPNP Feature must be enabled before retrieving the dynamic status of SIP transport.

At least one ENUM card must be provisioned before retrieving the dynamic status of ENUM connections.

At least one IPS card with SFLOG=yes must be provisioned before entering any TCP connection information on IPS.

At least one SCCP/SFAPP card must be provisioned before entering any Visualization connection information.

A SIP/ENUM/IPS with SFLOG card running the SIPHC/ENUMHC/IPS card with SFLOG=yes application must be configured before this command can be entered.

## Notes

None

## Output

```
rept-stat-ipconn

tekelecstp 12-06-25 16:14:24 EST EAGLE 45.0.0
rept-stat-ipconn
Command entered at terminal #4.

CNAME                STATUS
-----
conn1                DOWN
conn2                UP
conn5                DOWN

Command Completed.
;
```

## Related Topics

- [chg-ip-conn](#)
- [dlt-ip-conn](#)
- [ent-ip-conn](#)
- [rtv-ip-conn](#)

# rept-stat-iptps

Use this command to display current and peak IPTPS usage for each IPSPG / IPGWx linkset in the system or for each link in the IPSPG / IPGWx linkset.

## Parameters

### history

This parameter specifies whether to report the history of IP TPS usage data on IPSPG linksets for the last 60 seconds.

**Range:**

**yes**

**no**

**Default:**

no

### link

The link on the card specified in the `loc` parameter.

**Synonym:**

*port*

**Range:**

*a, a1-a63, b, b1-b63*

Not all card types support all link parameter values.

See [Table A-1](#) for valid link parameter range values for each type of card that can have assigned signaling link ports.

### loc

The IPSPG card location for which IP TPS usage data is to be reported.

**Range:**

*1101 - 1108, 1111 - 1112, 1201 - 1208, 1211 - 1218, 1301 - 1308, 1311 - 1318,  
2101 - 2108, 2111 - 2118, 2201 - 2208, 2211 - 2218, 2301 - 2308, 2311 - 2318,  
3101 - 3108, 3111 - 3118, 3201 - 3208, 3211 - 3218, 3301 - 3308, 3311 - 3318,  
4101 - 4108, 4111 - 4118, 4201 - 4208, 4211 - 4218, 4301 - 4308, 4311 - 4318,  
5101 - 5108, 5111 - 5118, 5201 - 5208, 5211 - 5218, 5301 - 5308, 5311 - 5318,  
6101 - 6108, 6111 - 6118*

### lsn (optional)

Linkset name. The name of the linkset for which the report information is to be displayed.

**Range:**

*ayyyyyyyy*

1 alphabetic character followed by up to 9 alphanumeric characters

**Default:**

All linksets are displayed

### peakreset (optional)

Reset peak values to the current TPS values.

**Range:**

**yes**

**no**

**Default:**

*no*

**tpscost**

This parameter specifies whether to report IP TPS usage data for IPSP linksets relative to network conditions, including average MSU size, association RTT, number of links provisioned on the card, and the protocol used (M2PA or M3UA).

**Range:**

**yes**

**no**

**Default:**

*no*

**Example**

```
rept-stat-iptps
rept-stat-iptps:lsn=lsgw1101
rept-stat-iptps:peakreset=yes
rept-stat-iptps:lsn=lsm2pa1:tpscost=yes
rept-stat-iptps:loc=1305:tpscost=yes
rept-stat-iptps:loc=1305:history=yes
rept-stat-iptps:loc=1305:link=a3:history=yes
```

**Dependencies**

If the linksets are not IPGWx or IPSP, then this command cannot be entered.

The specified linkset name must exist in the database.

The `history`, `link`, `loc`, and `tpscost` parameters can be specified for only IPSP cards.

If the `history` parameter is specified, then the `loc` parameter must be specified.

If the `tpscost` parameter is specified, then the `loc` or `lsn` parameter must be specified.

If the `loc` parameter is specified, then the `tpscost`, `history`, or `peakreset` parameter must be specified.

Only one of the `history`, `tpscost`, and `peakreset` parameters can be specified in the command.

The `loc` and `lsn` parameters cannot be specified together in the command.

The specified linkset must be type IPSP.

## Notes

Traffic peak data are stored only in OAM memory and are not preserved when the card that is running the OAM boots, or in the case of an active/standby switchover.

IPSG linksets have SLKTPS linksets configured rather than IPTPS. SLKTPS configures the transactions per second for each link assigned to the IPSG linkset as opposed to IPTPS which configures the combined transactions per second for the entire IPGW linkset. For an IPSG linkset, the calculated IP TPS value (shown under the 'CONFIG' column in the report) is made up of the aggregate calculated SLKTPS of all of the provisioned links in the linkset. Non-IPSG hosted links are not counted in the calculation as they do not support SLKTPS.

If a linkset contains a mixture of IPLIMx M2PA and IPSG-M2PA links, then the command does not report any data below the TPS header or raise alarms.

For IPSG-M3UA and IPGWx-M3UA links, the `rept-stat-iptps` command also counts the received DAUD messages and transmitted SNMs in response to DAUD audits (along with the other transmitted SNMs).

The process of updating the IP TPS counts for DAUD and DAUD response SNMs is:

- Rcv IP TPS count is updated with the total number of valid DAUD messages that are successfully queued for response processing based on the combination of RCs (Routing Contexts) and APCs (Affected Point Codes) received in the M3UA DAUD message.
- In reply to DAUD, based on the response generated (DUNA or (DAVA/DRST + SCON)), Tx IP TPS counts are updated for each RC/APC combination (either the same as the Rcv counts or twice the Rcv counts respectively).
- If no RC is present, then the Tx/Rcv IP TPS is incremented for the associated link corresponding to the lowest PORT ID for IPSG-M3UA links for the same association.
- For IPGWx-M3UA links, Tx/Rcv IP TPS are always incremented on the default PORT Index (since only one link can be configured in IPGWx GPL).
- For IPGWx-M3UA links, Rcv IP TPS count are also updated with the number of valid and non discarded Deviated DAUD message received (since Deviated DAUD always contains single RC and APC combination).

All of the transmitted SNMs are pegged in IPTPS Tx counts and are considered in the TPS algorithms.

## Output

The `rept-stat-iptps` command reports on IPSG and IPGWx linkset IP TPS. The report includes the following information for the system and for each IPSG or IPGWx linkset:

- Configured IP TPS alarm threshold
- Configured IP TPS
- Current IP TPS transmit and receive usage for 15 seconds
- Peak IP TPS transmit and receive usage and timestamp for all 15 second periods since last reset

As of Release 44.0, the `rept-stat-iptps` command is enhanced to report derived IP TPS usage for IPSPG linksets.

- Current derived IP TPS transmit and receive usage over a window of 15 seconds
- Peak IP TPS transmit and receive usage and timestamp for all 15 second periods since last reset
- 60 seconds history of the IP TPS transmit and receive usage

The derived IP TPS is calculated by adding the costs for factors such as average MSU size, association round trip time, number of provisioned links on card and protocol used (M2PA or M3UA). The derived TPS has valid values if:

- The specified card location indicates an E5-ENET-B/SLIC IPSPG card or the links in the specified linkset are hosted on E5-ENET-B or SLIC card,
- the E5-ENET-B IPSPG High Throughput feature is turned ON,
- the actual traffic rate running on the IPSPG card > 6500 TPS and
- the network configuration or traffic characteristics exceeds optimal configuration limits as shown in [Table 4-53](#).

**Table 4-53 Baseline Configuration Changes for the E5-ENET-B Card**

E5-ENET-B Card Baseline Configuration	E5-ENET-B IPSPG High Throughput feature OFF	E5-ENET-B IPSPG High Throughput feature ON
TPS	6500	9500
Max RTT (ms)	120	50
Avg. MSU size (bytes)	0-272	0-120
Number of associations/links	16	4
Protocol	M2PA and M3UA	M2PA

For all other conditions, including the use instead of an E5-ENET-B card, the derived IP TPS values is invalid and is denoted by dashes (---) in the *Derived TPS* and column.

The following table shows values for Max `rsvslktps` and Max `maxslktps`:

**Table 4-54 MaxTPS Per Card**

E5-ENET-B IPSPG High Throughput FAK	Max RSVDSLKTPS			Max MAXSLKTPS		
	E5-ENET-A	E5-ENET-B	SLIC	E5-ENET-A	E5-ENET-B	SLIC
FAK is OFF	5000	6500	10000	5000	6500	10000
FAK is ON.	5000	9500	10000	5000	9500	10000

If the linkset is specified, then the command reports the same information for the individual links in the linkset.



If the `peakreset=yes` parameter is specified, then the command resets all the stored peak values to the current actual usage for each link, and recalculates linkset and system peaks before reporting usage.

If the linkset is specified with the `peakreset=yes` parameter, then the command recalculates peaks for the specified linkset and resets all the stored peak values to the current actual usage for each link contained in the linkset before reporting usage.

The peaks for transmit and receive, and for link, and linkset IP TPS may all occur at different times.

The IP TPS value shown in the command may contain one extra MSU if the linkset is specified. Because the alarm calculations are implemented using integer math, rounding may occur at each entity (link, linkset) if the IP TPS value for the entity is not evenly divisible by 15. This could occur when performing an IPTPS report for a linkset that has more than one link configured.

For mixed IPLIMx-M2PA and IPSP-M2PA linksets, the command does not report any data or raise alarms.

IPGW linksets display dashes in the *CONFIG/MAX* column.

Asterisk sign indicates that parameter (*CONFIG/RSVD* or *CONFIG/MAX*) is used to generate TPS alarm for IPSP links/linkset.

This example shows the output for an IPGW linkset:

```
rept-stat-iptps:lsn=ls1307a

eagle10212 10-04-03 09:38:48 EST EAGLE 42.0.0
IP TPS USAGE REPORT
          THRESH  CONFIG/  CONFIG/          TPS  PEAK
PEAKTIMESTAMP                RSVD    MAX

-----
---
      LSN
      ls1307a      100%    10000    --- TX:   4800   5000   03-05-05
09:49:09
                                   RCV:   4850   5000   03-05-05
09:49:09

-----
---
      LOC  LINK
      1307  A      80%    2500    ---- TX:   2399   2500   03-05-05
09:49:09
                                   RCV:   2428   2500   03-05-05
09:49:09
```

This example shows the output when IPSP and IPGW linksets are included:

rept-stat-iptps

rlghncxa03w 11-03-13 16:20:46 EST EAGLE 44.0.0  
IP TPS USAGE REPORT

PEAKTIMESTAMP	THRESH	CONFIG/ RSVD	CONFIG/ MAX		TPS	PEAK	
-----							
LSN							
00:00:00	100%	500*	500	TX:	0	0	00-00-00
00:00:00				RCV:	0	0	00-00-00
12:46:37	100%	2500*	5000	TX:	0	10	11-02-29
12:57:52				RCV:	0	10	11-02-29
00:00:00	100%	0*	0	TX:	0	0	00-00-00
00:00:00				RCV:	0	0	00-00-00
00:00:00	100%	0*	0	TX:	0	0	00-00-00
00:00:00				RCV:	0	0	00-00-00
00:00:00	100%	0*	0	TX:	0	0	00-00-00
00:00:00				RCV:	0	0	00-00-00
00:00:00	100%	0*	0	TX:	0	0	00-00-00
00:00:00				RCV:	0	0	00-00-00
12:56:07	100%	2500*	6500	TX:	0	10	11-02-29
12:58:07				RCV:	0	10	11-02-29
00:00:00	100%	100	---	TX:	0	0	00-00-00
00:00:00				RCV:	0	0	00-00-00
00:00:00	100%	4000	---	TX:	0	0	00-00-00
00:00:00				RCV:	0	0	00-00-00
00:00:00	100%	4000	---	TX:	0	0	00-00-00
00:00:00				RCV:	0	0	00-00-00

```

lgipgw      100%    4000    --- TX:      0      0  00-00-00
00:00:00
                                RCV:      0      0  00-00-00
00:00:00
lgipgw2     100%    4000    --- TX:      0      0  00-00-00
00:00:00
                                RCV:      0      0  00-00-00
00:00:00

```

```

-----
---
Command Completed.

```

This example shows the output for an IP SG M3UA linkset:

```
rept-stat-iptps:lsn=ipsgm3ua
```

```

rlghncxa03w 10-04-03 16:20:46 EST EAGLE 42.0.0
IP TPS USAGE REPORT
          THRESH CONFIG/ CONFIG/      TPS      PEAK
PEAKTIMESTAMP          RSVD      MAX
-----
----
LSN
IPSGM3UA      100%    4000    10000* TX:   3700    4000  03-05-05
09:49:19
                                RCV:   3650    4000  03-05-05
09:49:19
-----
----
LOC LINK
1101  A      80%    2000    5000* TX:   1851    2000  03-05-05
09:49:19
                                RCV:   1801    2000  03-05-05
09:49:19
1201  A      80%    2000    5000* TX:   1849    2000  03-05-05
09:49:19
                                RCV:   1799    2000  03-05-05
09:49:19
-----
----

```

This example shows the output for a mixed linkset when IP SG M2PA links are included:

```
rept-stat-iptps:lsn=ipsgm2pa
```

```
rlghncxa03w 10-04-03 16:20:46 EST EAGLE 42.0.0
```

```

IP TPS USAGE REPORT
      THRESH  CONFIG/  CONFIG/      TPS      PEAK
PEAKTIMESTAMP                RSVD      MAX
-----
      LSN
      IPSGM2PA   100%   10000*   20000 TX:   4800   5000 03-05-05
09:49:09
                                           RCV:   4850   5000 03-05-05
09:49:09
-----
      LOC  LINK
      1105  A   80%   2500*   5000 TX:   2399   2500 03-05-05
09:49:09
                                           RCV:   2428   2500 03-05-05
09:49:09
      1205  A   80%   2500*   5000 TX:   2401   2500 03-05-05
09:49:09
                                           RCV:   2422   2500 03-05-05
09:49:09
      1305  A   80%   ----   ---- TX:   ----   ----
-----
                                           RCV:   ----   ----
-----
      2105  A   80%   ----   ---- TX:   ----   ----
-----
                                           RCV:   ----   ----
-----

```

This example shows the output for an E5-ENET-B IPST card and displays TPS cost information for a specific location:

```
rept-stat-iptps:loc=1305:tpscost=yes
```

```
eagle10212 11-07-20 09:07:34 EST EAGLE 44.0.0
IP TPS USAGE REPORT
```

	Actual TPS	Derived TPS	Derived PEAK TPS	PEAKTIMESTAMP
LOC				
1305	Tx: 8000	8240	8500	11-08-03 10:00:25
	Rcv:8000	8240	8600	11-08-03 10:10:25
LSN				
lsm2pa1	A Tx: 4000	4120	4380	11-08-03 10:00:25
	Rcv:4000	4120	4120	11-08-03 10:10:25
lsm2pa2	B Tx: 4000	4120	4120	11-08-03 10:00:25

```

Rcv:4000      4120      4480      11-08-03
10:10:25

```

```

-----
---
```

Command Completed.

This example shows the output for an E5-ENET-B IPSP card and displays TPS cost information for a linkset:

```
rept-stat-iptps:lsn=lsm2pa1:tpscost=yes
```

```

eagle10212 11-07-20 09:07:34 EST EAGLE 44.0.0
IP TPS USAGE REPORT

```

```

Actual      Derived      Derived PEAK      PEAKTIMESTAMP
TPS          TPS          TPS

```

```

-----
---
```

```

LSN
lsm2pa1      Tx: 13400      14430      14675      11-08-03
10:00:25

```

```

Rcv:14200      15000      15320      11-08-03
10:10:25

```

```

-----
---
```

```

LOC  LINK
1305 A      Tx: 6800      7150      7250      11-08-03
10:00:25

```

```

Rcv:7000      7340      7550      11-08-03
10:10:25

```

```

1306 B      Tx: 6600      7280      7425      11-08-03
10:00:25

```

```

Rcv:7200      7660      7770      11-08-03
10:10:25

```

```

-----
---
```

Command Completed.

This example shows the output for an E5-ENET-B IPSP card and displays history information:

```
rept-stat-iptps:loc=1111:history=yes
```

```

eagle10212 12-01-18 09:07:34 EST EAGLE5 44.0.0
IP TPS USAGE HISTORY REPORT for Card LOC=1111

```

```

SAMPLE#  SLK      ACTUAL      DERIVED      AVG      AVG TX

```

```

AVG RX
      TX      RX      TX      RX      RTT  MSU SIZE  MSU SIZE
-----
  1    A      1702    0    2331    ---      7      292      0
      A1      3403   3403   4662   4662     14      292     292
-----
.
.
.

```

```

SAMPLE#  SLK      ACTUAL      DERIVED      AVG  AVG TX  AVG RX
          TX      RX      TX      RX      RTT  MSU SIZE  MSU SIZE
-----
  60     A      1702    0    2331    ---      7      292      0
          A1      3403   3403   4662   4662     14      292     292
-----

```

Command Completed.The following example reports

This example shows the output for history information for link A of an E5-ENET-B IPSPG card:

rept-stat-iptps:loc=1111:port=a:history=yes

```

eagle10212 12-01-18 09:07:34 EST  EAGLE5 44.0.0
IP TPS USAGE HISTORY REPORT for Card LOC=1111 PORT=A

```

```

SAMPLE#  SLK      ACTUAL      DERIVED      AVG  AVG TX  AVG RX
          TX      RX      TX      RX      RTT  MSU SIZE  MSU SIZE
-----
  1     A      3403    0    4662    ---      8      292      0
-----
.
.
.

```

```

SAMPLE#  SLK      ACTUAL      DERIVED      AVG  AVG TX  AVG RX
          TX      RX      TX      RX      RTT  MSU SIZE  MSU SIZE
-----
  60     A      3403    0    4662    ---      9      292      0
-----

```

Command Completed.

**Legend**

- **LSN**—Linkset name

- **THRESH**—Threshold at which an alarm will be generated to indicate that the actual linkset TPS is approaching the configured linkset iptps value (lsusealm value as shown in `rtrv-ls` output).
- **CONFIG/RSVD**—Reserved TPS for the linkset
- **CONFIG/MAX**—Maximum TPS for the linkset
- **TPS**—Current transmit (TX) and receive (RCV) TPS for 15 seconds
- **PEAK**—Peak transmit (TX) and receive (RCV) TPS usage for all 15 second periods since the last peak reset
- **PEAKTIMESTAMP**—Date and time that the displayed transmit and receive TPS peaks occurred
- **LOC**—Location of the card that contains a displayed link in the linkset
- **PORT**—A signaling link in the linkset
- **THRESH**—The `slkusealm` value as shown in `rtrv-ls` output
- **CONFIG/RSVD**—Reserved TPS for each link in the linkset. (-----). There is no configurable TPS for links.
- **CONFIG/MAX**—Maximum TPS for each link in the linkset. (-----). There is no configurable TPS for links.
- **TPS**—Current transmit (TX) and receive (RCV) TPS for 15 seconds
- **PEAK**—Peak transmit (TX) and receive (RCV) TPS usage for all 15 second periods since the last peak reset
- **PEAKTIMESTAMP**—Date and time that the displayed transmit and receive TPS peaks occurred
- **Derived TPS**—Derived transmit (TX) and receive (RCV) TPS for 15 seconds
- **Derived Peak TPS**—Derived peak transmit (TX) and receive (RCV) TPS usage for all 15 second periods since the last peak reset
- **Actual Tx/Rx**—Actual transmit (TX) and receive (RCV) TPS for 60 seconds
- **Derived Tx/Rx**—Actual transmit (TX) and receive (RCV) TPS for 60 seconds
- **Avg TX MSU Size**—Average transmitted MSU size
- **Avg RTT**—Average round trip time
- **Avg RX MSU Size**—Average received MSU size

#### Related Topics

- [chg-ctrl-feat](#)
- [chg-ls](#)
- [chg-sg-opts](#)
- [enable-ctrl-feat](#)
- [ent-ls](#)
- [rtrv-ctrl-feat](#)
- [rtrv-ls](#)
- [rtrv-sg-opts](#)

## rept-stat-j1

Use this command to display the J1 port status and signaling link status for cards with provisioned J1 ports.

### Parameters

#### **loc (optional)**

Card address. The unique identifier of a specific LIMT1 card located in the STP.

#### **Range:**

*1101 - 1108, 1111 - 1112, 1201 - 1208, 1211 - 1218, 1301 - 1308, 1311 - 1318, 2101 - 2108, 2111 - 2118, 2201 - 2208, 2211 - 2218, 2301 - 2308, 2311 - 2318, 3101 - 3108, 3111 - 3118, 3201 - 3208, 3211 - 3218, 3301 - 3308, 3311 - 3318, 4101 - 4108, 4111 - 4118, 4201 - 4208, 4211 - 4218, 4301 - 4308, 4311 - 4318, 5101 - 5108, 5111 - 5118, 5201 - 5208, 5211 - 5218, 5301 - 5308, 5311 - 5318, 6101 - 6108, 6111 - 6118*

#### **Default:**

Information for all LIMT1 cards having J1 interfaces is reported.

#### **j1port (optional)**

J1 port number. This parameter displays information for a J1 port on the card in the specified card location.

#### **Range:**

*1-8*

### Example

```
rept-stat-j1
rept-stat-j1:loc=1101
rept-stat-j1:loc=1101:j1port=1
```

### Dependencies

No other rept-stat-xxx command can be in progress when this command is entered.

The loc parameter must be specified when the j1port parameter is specified.

The OAM card location cannot be specified for the loc parameter.

MUX card locations (xy09 and xy10 where x is the frame and y is the shelf) cannot be specified for the loc parameter.

Card location 1118 cannot be specified.

### Notes

Specifying the command without any parameters displays J1 port status for all cards with provisioned J1 ports.

If the loc parameter is specified, status is displayed for all J1 ports provisioned on the card in the specified location.



If the `loc` and `j1port` parameters are specified, the J1 port status summary is displayed for all J1 ports provisioned on the card in the specified location, followed by the status of all signaling links assigned to the specified J1 port on the card.

### Output

This example shows the output when no parameters are specified:

```
rept-stat-j1
```

```
tekelecstp 13-12-20 13:33:09 EST 46.0.0-65.3.0
LOC   J1PORT  PST      SST      AST
1203  1        IS-NR    Avail    LINE
1203  2        IS-NR    Avail    LINE
1203  3        IS-NR    Avail    -----
1203  7        OOS-MT   Unavail  -----
1207  1        IS-NR    Avail    -----
1207  2        IS-NR    Avail    -----
Command Completed.
```

```
;
```

This example shows the output when the `loc` parameter is specified:

```
rept-stat-j1:loc=1203
```

```
tekelecstp 13-12-20 13:33:09 EST 46.0.0-65.3.0
LOC   J1PORT  PST      SST      AST
1203  1        IS-NR    Avail    LINE
1203  2        IS-NR    Avail    LINE
1203  3        IS-NR    Avail    -----
1203  7        OOS-MT   Unavail  -----
Command Completed.
```

```
;
```

These examples show the output when the `loc` and `j1port` parameters are specified:

```
rept-stat-j1:loc=1203:j1port=1
```

```
tekelecstp 13-12-20 13:33:09 EST 46.0.0-65.3.0
LOC   J1PORT  PST      SST      AST
1203  1        IS-NR    Avail    LINE
ALARM STATUS      = No Alarms.
UNAVAIL REASON    = --
SLK   TS   PST      SST      AST
A     1   IS-NR    Avail    ---
A1    2   IS-NR    Avail    ---
Command Completed.
```

```
;
```

```
rept-stat-j1:loc=1203:j1port=2

tekelecstp 13-12-20 13:33:09 EST 46.0.0-65.3.0
LOC      J1PORT    PST          SST          AST
1203    2             IS-NR        Avail        LINE
ALARM STATUS      = No Alarms.
UNAVAIL REASON    = --
Command Completed.
;
```

### Legend

- LOC-- Card location
- J1PORT--Number of the J1 port provisioned on the card in the specified location.
- ALARM STATUS--Either "No Alarms" or current alarm number and text.
- UNAVAIL REASON--Reason for the J1 port being unavailable
- SLK--Signaling link assigned to the J1 port
- TS-- Timeslot assigned to the signaling link

### Related Topics

- [chg-j1](#)
- [dlt-j1](#)
- [ent-j1](#)
- [rtrv-j1](#)
- [tst-j1](#)

## rept-stat-lfs

Use this command to generate a report of all the SS7 links that are under LFS test. Along with the link identification information, the command output lists the current LBP, the test pattern, the maximum bit-errors threshold, the bit-errors since the beginning of this test, the maximum test time, and the time elapsed since the beginning of the test.

### Parameters

#### link (optional)

The signaling link port on the card specified in the `loc` parameter.

#### Synonym:

*port*

#### Range:

*a, b, a1 - a31, b1 - b31*

Not all card types support all `link` parameter values.

See [Table A-1](#) for valid `link` parameter range values for each type of card that can have assigned signaling link ports.

**loc (optional)**

This parameter is mandatory when the `link` parameter is specified.

**Range:**

1101 - 1108, 1111 - 1112, 1201 - 1208, 1211 - 1212, 1301 - 1308, 1311 - 1318,  
2101 - 2108, 2111 - 2118, 2201 - 2208, 2211 - 2218, 2301 - 2308, 2311 - 2318,  
3101 - 3108, 3111 - 3118, 3201 - 3208, 3211 - 3218, 3301 - 3308, 3311 - 3318,  
4101 - 4108, 4111 - 4118, 4201 - 4208, 4211 - 4218, 4301 - 4308, 4311 - 4318,  
5101 - 5108, 5111 - 5118, 5201 - 5208, 5211 - 5218, 5301 - 5308, 5311 - 5318,  
6101 - 6108, 6111 - 6118

**Example**

```
rept-stat-lfs
rept-stat-lfs:loc=1201
rept-stat-lfs:loc=1201:link=a1
```

**Dependencies**

The LFS feature must be turned on before this command can be entered.

The card location specified in the `loc` parameter must be equipped.

The signaling link that is specified in the `link` parameter must be assigned to the card in the `loc` parameter location.

Card locations 1113, 1114, 1115, 1116, 1117, 1118, and all `xy09` and `xy10` locations (`x` is the frame and `y` is the shelf) cannot be specified in the `loc` parameter.

The card location (`loc` parameter) must be an E5-E1T1-B card, provisioned with the LIMT1 card type, configured with either the SS7ANSI or CCS7ITU application.

If the `link` parameter is specified, the `loc` parameter must be specified.

This command cannot be entered during upgrade.

**Notes**

This command can be canceled using the **F9** function key or the `canc-cmd` command. See `canc-cmd` for more information.

**Output**

If no parameters are specified, all links that are in LFS test are displayed.

```
rept-stat-lfs

rlghncxa03w 04-02-27 16:50:24 EST EAGLE 31.3.0
SLK      LBP  PATTERN      MAX-ERRORS  BIT_ERRORS  MAX-TIME  TEST-
TIME
1201,A   5  B0247           56           30  01:00:00  00:00:50
1202,A   3  B511            56           27  01:00:00  00:01:05
1203,A   1  OCTET           56           12  01:00:00  00:02:07
1204,A   6  ALTERNATE       56           28  01:00:00
00:04:08
1205,A   2  B0247           56           36  01:00:00
```

```
00:03:05
  1206,A    1  B0247          56          15  01:00:00  00:06:06
  1207,A    3  B0247          56          19  01:00:00  00:02:04
  1208,A    5  B0247          56          23  01:00:00  00:04:01
;

```

If only the `loc` parameter is specified, all links in LFS test on the specified card are displayed.

```
rept-stat-lfs:loc=1208
```

```
rlghncxa03w 04-02-27 16:50:24 EST  EAGLE 31.3.0
  SLK      LBP  PATTERN      MAX-ERRORS  BIT_ERRORS  MAX-TIME  TEST-TIME
  1208,A    5  B0247          56          23  01:00:00  00:04:01
  1208,B1   4  B0247          56          23  01:00:00  00:08:01
;

```

If the `loc` and `link` parameters are specified, only the specified link on the specified card is displayed.

```
rept-stat-lfs:loc=1208:link=a
```

```
rlghncxa03w 04-02-27 16:50:24 EST  EAGLE 31.3.0
  SLK      LBP  PATTERN      MAX-ERRORS  BIT_ERRORS  MAX-TIME  TEST-TIME
  1208,A    5  B0247          56          23  01:00:00  00:04:01
;

```

### Legend

- **SLK**—Signaling link identifier; same as `loc` and `link` parameters of `act-lbp` command
- **LBP**—The loopback point of this test; same as `lbp` parameter of `act-lbp` command
- **PATTERN**—Test pattern; same as `pattern` parameter of `act-lbp` command
- **MAX-ERRORS**—Bit-error threshold allowed for this LFS test; same as `maxerr` parameter of `act-lbp` command
- **BIT\_ERRORS**—Number of bit-errors since the beginning of this test
- **MAX-TIME**—Time window for testing each loop-back point; same as `time` parameter of `act-lbp` command
- **TEST-TIME**—Amount of time the test has run

### Related Topics

- [rept-stat-slk](#)

## rept-stat-lg

Use this command to display measurement and statistics of all the LG objects on Eagle node. The command class is `TKLC_INTERNAL` inheriting properties of `DEBUG` class. The Load Generator is supported on `IPSG`, `IPLHC`, `IPGHC` and `SS7HC` GPLs.

## Parameters

### **display (optional)**

Display mode of reporting the output.

#### **Range:**

##### ***brief***

Displays the summary statistics information for LG object's and its child hierarchy i.e. brief of system level stats will show only brief level of system->group->card->engine statistics

##### ***all***

Displays the detailed statistics information for LG object's and its child hierarchy i.e. system level stats will show its system->group->card->engine statistics

#### **Default:**

*brief*

### **engine (optional)**

#### **Range: ayyyyyyyyy**

Up to 10 alphanumeric characters; the first character must be a letter.

### **grp (optional)**

#### **Range: ayyyyyyyyy**

Up to 10 alphanumeric characters; the first character must be a letter

### **loc (optional)**

The card location as stenciled on the shelf of the system.

#### **Range:**

*1101 - 1108, 1111 - 1112, 1201 - 1208, 1211 - 1218, 1301 - 1308, 1311 - 1318,  
2101 - 2108, 2111 - 2118, 2201 - 2208, 2211 - 2218, 2301 - 2308, 2311 - 2318,  
3101 - 3108, 3111 - 3118, 3201 - 3208, 3211 - 3218, 3301 - 3308, 3311 - 3318,  
4101 - 4108, 4111 - 4118, 4201 - 4208, 4211 - 4218, 4301 - 4308, 4311 - 4318,  
5101 - 5108, 5111 - 5118, 5201 - 5208, 5211 - 5218, 5301 - 5308, 5311 - 5318,  
6101 - 6108, 6111 - 6118*

### **reset (optional)**

This parameter clears the statistics by setting them to zero.

#### **Range:**

##### ***Rx***

Receive Direction

##### ***Tx***

Transmit Direction

##### ***All***

Both in Tx and rx directions

**Example**

```

rept-stat-lg
rept-stat-lg:display=all
rept-stat-lg:reset=tx
rept-stat-lg:reset=all
rept-stat-lg:grp=lgroup1
rept-stat-lg:grp=lgroup1:display=brief
rept-stat-lg:grp=lgroup1:reset=tx
rept-stat-lg:loc=1101
rept-stat-lg:loc=1101:display=all
rept-stat-lg:loc=1101:reset=all
rept-stat-lg:engine=txengine1
rept-stat-lg:engine=txengine1:display=brief
rept-stat-lg:engine=txengine1:reset=all

```

**Dependencies**

The `reset` and `display` parameters cannot be specified together.

The `grp`, `loc`, and `engine` parameters cannot be specified together.

The LG group with the specified group name must exist in the system.

The card location must not be 1113-1118, orxy09 andxy10 wherexis the frame andyis the shelf.

The value specified for the `engine` parameter must already exist in the LG Engine table.

The value of `reset` parameter must be all when the engine parameter is specified.

The card location specified in the `loc` parameter must be of a provisioned LG card.

**Output**

This example shows the LG System level statistics in brief mode:

```

rept-stat-lg or rept-stat-lg:display=brief

tekelecstp 09-04-29 18:15:20 EST xx.x.x-xx.x.x
rept-stat-lg
Command entered at terminal #4.
LG System Statistics
LG System          TX: Active   RX: Active
LG Group   : lgroup1  TX: Active   RX: Active
   LG Card   : 1101    TX: Active   RX: Active
   LG Card   : 1102    TX: Active   RX: Active
LG Group   : lgroup2  TX: Active   RX: Active

```

```

      LG Card   : 1201   TX: Active   RX: Active
Command Completed.

```

```
;
```

This example displays the LG System level statistics in detailed mode:

```
rept-stat-lg:display=all
```

```

tekelecstp 09-04-29 18:15:20 EST  xx.x.x-xx.x.x
rept-stat-lg:display=all
Command entered at terminal #4.
LG System Statistics
LG System                TX: Active   RX: Active
LG Group  : lggroup1    TX: Active   RX: Active
  LG Card   : 1101      TX: Active   RX: Active
  TX Engine(s)
ENGINE      STATE      EVENT        TPS    BYTES
MSUS
txengine1   Active    isuptx1      100   22222200
222222
txengine2   Active    isuptx2      200   22222200
222222
txengine3   Inactive  isuptx3       0     0         0
RX Engine(s)
ENGINE      STATE      EVENT        TPS    BYTES
MSUS
rxengine1   Active    isuprx1      200   22222200
2222222
rxengine2   Active    isuprx2      200   22222200   2222222
DIR TPS    BYTES    MSUS
Tx  300    44444400  444444
Rx  400    44444400  444444

      LG Card   : 1102   TX: Active   RX: Active
  TX Engine(s)
ENGINE      STATE      EVENT        TPS    BYTES
MSUS
txengine4   Active    isuptx1      100   22222200
222222
txengine5   Active    isuptx2      200   22222200
222222
RX Engine(s)
ENGINE      STATE      EVENT        TPS    BYTES
MSUS
rxengine3   Active    isuprx1      200   22222200
2222222
rxengine4   Active    isuprx2      200   22222200   2222222
DIR TPS    BYTES    MSUS
Tx  300    44444400  444444
Rx  400    44444400  444444
  LG Group  : lggroup2    TX: Active   RX: Active
  LG Card   : 1201      TX: Active   RX: Active
  TX Engine(s)
ENGINE      STATE      EVENT        TPS    BYTES

```

```

MSUS
txengine1 Active isuptx1 100 22222200 222222
txengine2 Active isuptx2 200 22222200 222222
txengine3 Inactive isuptx3 0 0 0
RX Engine(s)
ENGINE STATE EVENT TPS BYTES MSUS
rxengine1 Active isuprx1 200 22222200 2222222
rxengine2 Active isuprx2 200 22222200 2222222
DIR TPS BYTES MSUS
Tx 300 44444400 444444
Rx 400 44444400 444444

```

Command Completed.

;

This example resets the LG System level statistics:

```
rept-stat-lg:reset=all
```

```

tekelecstp 09-04-29 18:15:20 EST xx.x.x-xx.x.x
rept-stat-lg:reset=all
Command entered at terminal #4.
Command Completed.

```

;

This example displays the LG Group level statistics in brief mode:

```
rept-stat-lg:grp=lgroup1
```

```

tekelecstp 09-04-29 18:15:20 EST xx.x.x-xx.x.x
rept-stat-lg:grp=lgroup1
Command entered at terminal #4.
LG Group Statistics
LG System TX: Active RX: Active
LG Group : lgroup1 TX: Active RX: Active
LG Card : 1101 TX: Active RX: Active
LG Card : 1102 TX: Active RX: Active
Command Completed.

```

;

This example shows the LG Group statistics in detailed mode:

```
rept-stat-lg:grp=lgroup1:display=all
```

```

tekelecstp 09-04-29 18:15:20 EST xx.x.x-xx.x.x
rept-stat-lg:grp=lgroup1:display=all
Command entered at terminal #4.
LG Group Statistics
LG System TX: Active RX: Active
LG Group : lgroup1 TX: Active RX: Active
LG Card : 1101 TX: Active RX: Active

```



```

TX Engine(s)
ENGINE      STATE    EVENT      TPS    BYTES
MSUS
txengine1   Active   isuptx1    100    22222200
222222
txengine2   Active   isuptx2    200    22222200
222222
txengine3   Inactive isuptx3    0       0       0
RX Engine(s)
ENGINE      STATE    EVENT      TPS    BYTES
MSUS
rxengine1   Active   isuprx1    200    22222200
2222222
rxengine2   Active   isuprx2    200    22222200    2222222
DIR TPS    BYTES    MSUS
Tx  300    44444400  444444
Rx  400    44444400  444444

LG Card   : 1102    TX: Active    RX: Active
TX Engine(s)
ENGINE      STATE    EVENT      TPS    BYTES
MSUS
txengine4   Active   isuptx1    100    22222200
222222
txengine5   Active   isuptx2    200    22222200
222222
RX Engine(s)
ENGINE      STATE    EVENT      TPS    BYTES
MSUS
rxengine3   Active   isuprx1    200    22222200
2222222
rxengine4   Active   isuprx2    200    22222200    2222222
DIR TPS    BYTES    MSUS
Tx  300    44444400  444444
Rx  400    44444400  444444
Command Completed.
;

```

This example resets LG Group statistics"

```
rept-stat-lg:grp=lgroup1:reset=all
```

```

tekelecstp 09-04-29 18:15:20 EST xx.x.x-xx.x.x
rept-stat-lg:grp=lgroup1:reset=all
Command entered at terminal #4.
Command Completed.
;

```

This example shows LG Card statistics in brief mode:

```
rept-stat-lg:loc=1101 or rept-stat-lg:loc=1101:display=brief
```

```
tekelecstp 09-04-29 18:15:20 EST xx.x.x-xx.x.x
rept-stat-lg:loc=1101
Command entered at terminal #4.
LG Card Statistics
LG System          TX: Active    RX: Active
LG Group   : lggroup1  TX: Active    RX: Active
LG Card    : 1101      TX: Active    RX: Active
DIR TPS    BYTES      MSUS          MISSEQ        CONGP        DISCARDS      RTT
Tx  300    44444400    444444        0             0            0             0
Rx  400    44444400    444444        -             -            -             -
Command Completed
```

```
;
```

This example displays the LG Card statistics in detailed mode:

```
rept-stat-lg:loc=1101:display=all
```

```
tekelecstp 09-04-29 18:15:20 EST xx.x.x-xx.x.x
rept-stat-lg:loc=1101:display=all
Command entered at terminal #4.
LG Card Statistics
LG System          TX: Active    RX: Active
LG Group   : lggroup1  TX: Active    RX: Active
LG Card    : 1101      TX: Active    RX: Active
TX Engine(s)
ENGINE          STATE      EVENT          TPS    BYTES          MSUS
                MISSEQ    CONGP          DISCARDS  RTT
txengine1      Active    isuptx1        100    22222200       222222
                0         0              0         0
txengine2      Active    isuptx2        200    22222200       222222
                0         0              0         0
txengine3      Inactive  isuptx3        0       0              0         0
                0         0              0         0
RX Engine(s)
ENGINE          STATE      EVENT          TPS    BYTES          MSUS
rxengine1      Active    isuprx1        200    22222200       222222
rxengine2      Active    isuprx2        200    22222200       222222
DIR TPS    BYTES      MSUS          MISSEQ        CONGP        DISCARDS      RTT
Tx  300    44444400    444444        0             0            0             0
Rx  400    44444400    444444        -             -            -             -
Command Completed
```

```
;
```

This example resets the LG Card statistics:

```
rept-stat-lg:loc=1101:reset=all
```

```
tekelecstp 09-04-29 18:15:20 EST xx.x.x-xx.x.x
```

```

rept-stat-lg:loc=1101:reset=all
Command entered at terminal #4.
Command Completed.
;

```

This example displays the LG Engine statistics (display level can be either brief or all output is the same):

```

rept-stat-lg:engine=txengine1 or rept-stat-
lg:engine=txengine1:display=brief or rept-stat-
lg:engine=txengine1:display=all

```

```

tekelecstp 09-04-29 18:15:20 EST xx.x.x-xx.x.x
rept-stat-lg:engine=txengine1
Command entered at terminal #4.

LG Engine Statistics
LG System           TX: Active      RX: Active
LG Group  : lgroup1 TX: Active      RX: Active
LG Card   : 1102   TX: Active      RX: Active
TX Engine(s)
ENGINE      STATE   EVENT          TPS   BYTES      MSUS
           MISSEQ  CONGP         DISCARDS  RTT
txengine1  Active  isuptx1        100   22222200   222222
           0         0             0         0

Command Completed
;

```

This example resets the LG Engine statistics:

```

rept-stat-lg:engine=txengine1:reset=all

```

```

tekelecstp 09-04-29 18:15:20 EST xx.x.x-xx.x.x
rept-stat-lg:engine=txengine1:reset=all
Command entered at terminal #4.
Command Completed.
;

```

## rept-stat-lnp

Use this command to generate a report of the local number portability (LNP) status information.

When this command is entered with no parameters, a summary of the LNP status of all equipped SCCP cards is provided. This summary includes Global Title Translation (GTT) and LNP function status for every SCCP card, as well as LNPQS system information.

When the `loc` parameter is specified, a detailed status of LNP information for the specified SCCP card is provided. These detailed reports include information for each of the following functions: Global Title Translation (GTT), LNP Message Relay (LNPMPR), LNP Query Service (LNPQS), Personal Communication Service LNP Query

Service (PLNPQS) (if the PLNP feature is turned on), Wireless LNP Query Service (WNPQS) (if the WNP feature is turned on), Triggerless LNP (TLNP) (if the TLNP feature is turned on), LRNQT (if the ITU TCAP LRN Query feature is turned on), and Automatic Call Gap (ACG).

When the `card=sccp-all` parameter is specified, a detailed status of LNP information for all SCCP cards is provided.

### Parameters

#### **card (optional)**

Specify `card=sccp-all` to display a report of the LNP status of all equipped SCCP cards.

#### **Range:**

*sccp-all*

#### **loc (optional)**

The card location as stenciled on the shelf of the system.

#### **Range:**

*1101 - 1108, 1111 - 1112, 1201 - 1208, 1211 - 1218, 1301 - 1308, 1311 - 1318, 2101 - 2108, 2111 - 2118, 2201 - 2208, 2211 - 2218, 2301 - 2308, 2311 - 2318, 3101 - 3108, 3111 - 3118, 3201 - 3208, 3211 - 3218, 3301 - 3308, 3311 - 3318, 4101 - 4108, 4111 - 4118, 4201 - 4208, 4211 - 4218, 4301 - 4308, 4311 - 4318, 5101 - 5108, 5111 - 5118, 5201 - 5208, 5211 - 5218, 5301 - 5308, 5311 - 5318, 6101 - 6108, 6111 - 6118*

#### **Default:**

A summary for all cards is displayed.

### Example

```
rept-stat-lnp
rept-stat-lnp:card=sccp-all
rept-stat-lnp:loc=1106
```

### Dependencies

The LNP feature must be turned on before this command can be entered.

The `card` and `loc` parameters cannot be specified together in the command.

The only valid value for the `card` parameter is *sccp-all*.

No other `rept-stat-xxx` command can be in progress when this command is issued.

At least one SCCP card must be configured in the system.

The value specified for the `loc` parameter must identify a Service Module card.

### Notes

The error information on this report is based on 30-second intervals. The values for number of errors and total messages are for the last 30-second period. The usage information is also updated once every 30 seconds.

When this command is entered with no parameters, a summary of the LNP subsystem status is reported, followed by a summary of the LNP status of all equipped SCCP cards. This summary includes global title translation (GTT) and LNP function status for every SCCP card,

as well as LNPQS system information. The GTT status is either ACT (active) or SWDL (software loading). The LNP status is either ACT, OFFLINE, or SWDL. LNPQS system information is then provided in the following fields:

- The ALARM STATUS displays the current alarm on the LNP Subsystem.
- The SSN STATUS and MATE SSN STATUS fields show the state of the LNP subsystems: Prohibited, Restricted, or Allowed.
- The ACG OVERLOAD LEVEL field shows the ACG node overload control level used by the system.
- The system average MIC usage is expressed as a percentage of the number of MICs sent by all cards, divided by the number of responses sent by all cards.

The `rept-stat-lnp` command also provides a summary of the following system-wide LNP statistics.

- The average GTT usage is expressed as the average percentage of GTT usage per card.
- The average LNPMPR usage is expressed as the average percentage of LNPMPR usage per card.
- The average LNPQS usage is expressed as the average percentage of LNPQS usage per card.
- The average WNPQS usage is expressed as the average percentage of WNPQS usage per card. WNPQS information is displayed only if the WNP feature is turned on.
- The average PLNPQS usage is expressed as the average percentage of PLNPQS usage per card. PLNPQS information is displayed only if the PCS 1900 Number Portability feature (PLNP) is turned on.
- The average LRNQT usage is expressed as the average percentage of LRNQT usage per card. LRNQT information is displayed only if the LRNQT feature is turned on.
- The average CPU usage is expressed as the average percentage of CPU usage per card.
- The total number of GTT, LNPMPR, LNPQS, WNPQS (if turned on), TLNP (if turned on), PLNPQS (if turned on), and LRNQT (if turned on) errors for corresponding messages received across all cards.

When the `rept-stat-lnp` command is entered for a specific card (for example, `rept-stat-lnp:loc=xxxx`), status information for the card at the specified location is provided, followed by the alarm status and detailed LNP status information and statistics for each LNP function.

- GTT STATUS, either ACT (active) or SWDL (software loading).
- GTT USAGE, expressed as a percentage of the amount of CPU used to process GTT messages during the last 30 seconds by the specified card.
- GTT ERRORS, the number of GTT errors detected for the total number of GTT messages received by the specified card.
- LNPMPR STATUS, either ACT (active), OFFLINE, or SWDL (software loading).
- LNPMPR USAGE, expressed as a percentage of the amount of CPU used to process LNP message relay messages during the last 30 seconds by the specified card.

- LNPQR ERRORS, the number of LNP message relay errors detected for the total number of LNP message relay messages received by the specified card.
- LNPQS STATUS, either ACT (active), OFFLINE, and SWDL (software loading).
- LNPQS USAGE, expressed as a percentage of the amount of CPU used to process LNP query messages during the last 30 seconds by the specified card.
- LNPQS ERRORS, the number of LNP query errors detected for the total number of LNP query messages received by the specified card.
- WNPQS STATUS, either ACT (active), OFFLINE, and SWDL (software loading).
- WNPQS USAGE, expressed as a percentage of the amount of CPU used to process WNP query messages during the last 30 seconds by the specified card.
- WNPQS ERRORS, the number of WNP query errors detected for the total number of WNP query messages received by the specified card.

 **Note:**

IS-41 LNP Queries with a TT associated with the LNPQS service are pegged as IS-41 LNP Queries with a TT associated with the WNP service under the WNPQS counter. The WNPQS STATUS, WNPQS USAGE, and WNPQS ERRORS fields are displayed only if the Wireless Number Portability feature is ON.

- PLNPQS STATUS, either ACT (active), OFFLINE, and SWDL (software loading).
- PLNPQS USAGE, expressed as the amount of CPU used to process PCS 1900 LNP Query messages over the last 30-second period by the specific card.
- PLNPQS ERRORS, the number of PCS query errors detected for the total number of PCS query messages received by the specified card.

 **Note:**

PCS 1900 LNP Queries with a TT associated with the LNPQS service are processed and pegged as IN LNP Queries under the LNPQS counter. The PLNPQS STATUS, PLNPQS USAGE, and PLNPQS ERRORS fields are displayed only if the PCS 1900 Number Portability (PLNP) feature is ON.

- TLNP STATUS, either ACT (active), OFFLINE, and SWDL (software loading).
- TLNP USAGE, expressed as a percentage of the amount of CPU used to process Triggerless LNP Encapsulated IAM messages over the last 30-second period by the specific card.
- TLNP ERRORS, the number of TLNP query errors detected for the total number of TLNP query messages received by the specified card.

 **Note:**

The TLNP STATUS, TLNP USAGE, and TLNP ERRORS fields are displayed only if the Triggerless LNP (TLNP) feature is ON.

- LRNQT STATUS, either ACT (active), OFFLINE, and SWDL (software loading).
- LRNQT USAGE, expressed as a percentage of the amount of CPU used to process LRNQT queries over the last 30-second period by the specific card.
- LRNQT ERRORS, the number of LRNQT query errors detected for the total number of LRNQT messages received by the specified card.

 **Note:**

The LRNQT STATUS, LRNQT USAGE, and LRNQT ERRORS fields are displayed only if the LRNQT feature is ON.

- ACG OVERLOAD LEVEL, the ACG node overload control level being used by the system.
- MIC USAGE, expressed as a percentage of the number of MICs sent by the specific card divided by the number of responses sent by the specified card during the last 30 seconds.
- CPU USAGE, expressed as a percentage of the amount of CPU used to process messages by the specified card during the last 30 seconds.

When the `card=sccp-all` parameter is specified, detailed information is provided about the status of all SCCP cards. The information displayed in the output is the same as that displayed for the `loc=xxxx` parameter.

## Output

This example shows the output when the WNP, PLNP, TLNP, and LRNQT features are off:

```
rept-stat-lnp
```

```
rlghncxa03w 08-11-14 10:37:22 EST EAGLE 40.0.0
LNP SUBSYSTEM REPORT OOS-MT-DSBLD Active -----
ALARM STATUS = *C 0435 LNP Subsystem is disabled

LNP Cards Configured= 3
CARD   PST           SST           GTT STATUS   LNP STATUS   CPU
USAGE
 1106   IS-NR           Active       ACT          OFFLINE
10%
 1201   IS-NR           Active       ACT          OFFLINE
12%
 1310   OOS-MT-DSBLD   Manual      -----     -----
0%

LNPQS:
SSN STATUS = Prohibited MATE SSN STATUS = Allowed
ACG: OVERLOAD LEVEL = 0 MIC UASGE = 0%

AVERAGE USAGE:
GTT = 13% LNPMT = 0% LNPQS = 0%
AVERAGE CPU USAGE = 11%
TOTAL ERRORS:
```

```
GTT:          0 out of 2000
LNPMR:       0 out of 0
LNPQS:       0 out of 0
```

## PROVISIONED TABLE QTY:

```
TN:          10 of 24000000 ( 0%)
NPA:         1 of 150000 ( 0%)
LRN:         3 of 100000 ( 0%)
```

Command Completed

;

This example shows the output when the `card=` parameter is specified:

```
rept-stat-lnp:card=sccp-all
```

```
tklcl190601 06-04-05 13:45:02 EST EAGLE5 35.0.0
CARD  VERSION      PST           SST           AST
1205  038-003-013    IS-NR        Active        DB_DIFF
ALARM STATUS      = ** 0451 RTDB reload is required
GTT:  STATUS = ACT      USAGE = 0%  ERRORS: 0 of 0
LNPMR: STATUS = ACT      USAGE = 0%  ERRORS: 0 of 0
LNPQS: STATUS = ACT      USAGE = 0%  ERRORS: 0 of 0
WNPQS: STATUS = ACT      USAGE = 0%  ERRORS: 0 of 0
TLNP:  STATUS = ACT      USAGE = 0%  ERRORS: 0 of 0
PLNPQS:STATUS = ACT      USAGE = 0%  ERRORS: 0 of 0
ACG:  OVERLOAD LEVEL = 0  MIC USAGE = 0%
CPU USAGE = 5%
```

```
CARD  VERSION      PST           SST           AST
1317  038-003-013    IS-NR        Active        DB_DIFF
ALARM STATUS      = ** 0451 RTDB reload is required
GTT:  STATUS = ACT      USAGE = 0%  ERRORS: 0 of 0
LNPMR: STATUS = ACT      USAGE = 0%  ERRORS: 0 of 0
LNPQS: STATUS = ACT      USAGE = 0%  ERRORS: 0 of 0
WNPQS: STATUS = ACT      USAGE = 0%  ERRORS: 0 of 0
TLNP:  STATUS = ACT      USAGE = 0%  ERRORS: 0 of 0
PLNPQS:STATUS = ACT      USAGE = 0%  ERRORS: 0 of 0
ACG:  OVERLOAD LEVEL = 0  MIC USAGE = 0%
CPU USAGE = 5%
```

```
CARD  VERSION      PST           SST           AST
2213  038-003-013    IS-NR        Active        DB_DIFF
ALARM STATUS      = ** 0451 RTDB reload is required
GTT:  STATUS = ACT      USAGE = 0%  ERRORS: 0 of 0
LNPMR: STATUS = ACT      USAGE = 0%  ERRORS: 0 of 0
LNPQS: STATUS = ACT      USAGE = 0%  ERRORS: 0 of 0
WNPQS: STATUS = ACT      USAGE = 0%  ERRORS: 0 of 0
TLNP:  STATUS = ACT      USAGE = 0%  ERRORS: 0 of 0
PLNPQS:STATUS = ACT      USAGE = 0%  ERRORS: 0 of 0
ACG:  OVERLOAD LEVEL = 0  MIC USAGE = 0%
CPU USAGE = 5%
```

```
CARD  VERSION      PST           SST           AST
```



```

2215 ----- OOS-MT-DSBLD Manual -----
ALARM STATUS = No Alarms.
GTT: STATUS = ----- USAGE = 0% ERRORS: 0 of 0
LNPMPR: STATUS = ----- USAGE = 0% ERRORS: 0 of 0
LNPQS: STATUS = ----- USAGE = 0% ERRORS: 0 of 0
WNPQS: STATUS = ----- USAGE = 0% ERRORS: 0 of 0
TLNP: STATUS = ----- USAGE = 0% ERRORS: 0 of 0
PLNPQS:STATUS = ----- USAGE = 0% ERRORS: 0 of 0
ACG: OVERLOAD LEVEL = 0 MIC USAGE = 0%
CPU USAGE = 0%

```

```

CARD VERSION PST SST AST
2217 038-003-013 IS-NR Active DB_DIFF
ALARM STATUS = ** 0451 RTDB reload is required
GTT: STATUS = ACT USAGE = 0% ERRORS: 0 of 0
LNPMPR: STATUS = ACT USAGE = 0% ERRORS: 0 of 0
LNPQS: STATUS = ACT USAGE = 0% ERRORS: 0 of 0
WNPQS: STATUS = ACT USAGE = 0% ERRORS: 0 of 0
TLNP: STATUS = ACT USAGE = 0% ERRORS: 0 of 0
PLNPQS:STATUS = ACT USAGE = 0% ERRORS: 0 of 0
ACG: OVERLOAD LEVEL = 0 MIC USAGE = 0%
CPU USAGE = 5%

```

```

CARD VERSION PST SST AST
2317 ----- OOS-MT Isolated -----
ALARM STATUS = ** 0013 Card is isolated from the system
GTT: STATUS = ----- USAGE = 0% ERRORS: 0 of 0
LNPMPR: STATUS = ----- USAGE = 0% ERRORS: 0 of 0
LNPQS: STATUS = ----- USAGE = 0% ERRORS: 0 of 0
WNPQS: STATUS = ----- USAGE = 0% ERRORS: 0 of 0
TLNP: STATUS = ----- USAGE = 0% ERRORS: 0 of 0
PLNPQS:STATUS = ----- USAGE = 0% ERRORS: 0 of 0
ACG: OVERLOAD LEVEL = 0 MIC USAGE = 0%
CPU USAGE = 0%

```

```

CARD VERSION PST SST AST
1105 038-003-013 IS-NR Active DB_DIFF
ALARM STATUS = ** 0451 RTDB reload is required
GTT: STATUS = ACT USAGE = 0% ERRORS: 0 of 0
LNPMPR: STATUS = ACT USAGE = 0% ERRORS: 0 of 0
LNPQS: STATUS = ACT USAGE = 1% ERRORS: 0 of 1003
WNPQS: STATUS = ACT USAGE = 0% ERRORS: 0 of 0
TLNP: STATUS = ACT USAGE = 0% ERRORS: 0 of 0
PLNPQS:STATUS = ACT USAGE = 0% ERRORS: 0 of 0
ACG: OVERLOAD LEVEL = 0 MIC USAGE = 0%
CPU USAGE = 7%

```

Command Completed.

;

This example shows the output when an LNP feature (LNP ported TNs) quantity greater than 120 million numbers is enabled, the WNP, PLNP and TLNP features are on, and the LRNQT feature is off:

rept-stat-lnp

```

Integrat40 08-11-14 10:37:22 EST EAGLE5 40.0.0
LNP SUBSYSTEM REPORT IS-ANR Active -----
ASSUMING MATE'S LOAD
ALARM STATUS = No Alarms.

LNP Cards Configured= 5
CARD PST SST GTT STATUS LNP STATUS CPU USAGE
1106 IS-NR Active ACT ACT 23%
1201 IS-ANR Standby SWDL SWDL 0%
1205 OOS-MT-DSBLD Manual ----- 0%
1302 OOS-MT FLT ----- 0%
1310 IS-ANR Standby ACT SWDL 0%
LNPQS:
SSN STATUS = Allowed MATE SSN STATUS = Prohibited
ACG: OVERLOAD LEVEL = 0 MIC USAGE = 100%

AVERAGE USAGE:
GTT = 13% LNPMT = 0% LNPQS = 0%
WNPQS = 0% TLNP = 10% PLNPQS = 0%
AVERAGE CPU USAGE = 23%
TOTAL ERRORS:
GTT: 1 out of 2000
LNPMT: 0 out of 0
LNPQS: 0 out of 0
WNPQS: 0 out of 0
PLNPQS: 0 out of 0
TLNP: 1 out of 500

PROVISIONED TABLE QTY:
TN: 76800000 of 96000000 ( 80%)
NPA: 135000 of 150000 ( 90%)
LRN: 90000 of 100000 ( 90%)
Command Completed.

```

;

This example shows the output when the WNP, PLNP, TLNP, and LRNQT features are on:

rept-stat-lnp

```

rlghncxa03w 08-10-01 08:50:14 EST EAGLE 40.0.0
LNP SUBSYSTEM REPORT IS-ANR Active -----
ASSUMING MATE'S LOAD
LNP Cards Configured= 5
CARD PST SST GTT STATUS LNP STATUS CPU USAGE
1106 IS-NR Active ACT ACT 28%
1201 IS-ANR Standby SWDL SWDL 0%
1205 OOS-MT-DSBLD Manual ----- 0%
1302 OOS-MT Fault ----- 0%
1310 IS-ANR Standby ACT SWDL 0%

LNPQS:

```

```
SSN STATUS = Allowed      MATE SSN STATUS = Prohibited
ACG: OVERLOAD LEVEL = 0   MIC USAGE = 100%
```

## AVERAGE USAGE:

```
GTT   = 13% LNPMPR = 0%   LNPQS = 0%
WNPQS = 0%  TLNP  = 10%  PLNPQS = 0%
LRNQT = 5%
```

AVERAGE CPU USAGE = 28%

## TOTAL ERRORS:

```
GTT:      1 out of 2000
LNPMPR:   0 out of   0
LNPQS:    1 out of  500
WNPQS:    0 out of   0
PLNPQS:   0 out of   0
TLNP:     1 out of  500
LRNQT:    0 out of  700
```

Command Completed.

;

This example shows the output when the WNP, PLNP, TLNP, and LRNQT features are on:

```
rept-stat-lnp:loc=1106
```

```
rlghncxa03w 08-10-01 10:37:22 EST EAGLE 40.0.0
CARD VERSION      TYPE      PST          SST          AST
1106 021-101-000 TSM       IS-NR        Active       -----
ALARM STATUS      = No Alarms.
GTT:  STATUS = ACT      USAGE = 10%  ERRORS:  1 out of 1000
LNPMPR: STATUS = ACT      USAGE = 13%  ERRORS:  0 out of 1300
LNPQS: STATUS = ACT      USAGE = 20%  ERRORS:  1 out of 2000
WNPQS: STATUS = ACT      USAGE = 0%   ERRORS:  0 out of   0
PLNPQS:STATUS = ACT      USAGE = 0%   ERRORS:  0 out of   0
TLNP:  STATUS = ACT      USAGE = 0%   ERRORS:  0 out of   0
LRNQT: STATUS = ACT      USAGE = 0%   ERRORS:  0 out of   0
ACG:  OVERLOAD LEVEL = 0   MIC USAGE = 100%
CPU USAGE = 43%
Command Completed.
```

;

**Legend**

- **CARD**—Locations of the SCCP cards
- **VERSION**—Version number of the GPL the cards are running
- **TYPE**—Type of SCCP card
- **PST**—Primary state of the card. See [Possible Values for PST/SST/AST](#).
- **SST**—Secondary state of the card. See [Possible Values for PST/SST/AST](#).
- **AST**—Associated state of the card. See [Possible Values for PST/SST/AST](#).

**Related Topics**

- [chg-th-alm](#)
- [rept-stat-sccp](#)
- [rtrv-th-alm](#)

## rept-stat-ls

Use this command to generate a report of the status of the MTP linksets. When a specific linkset is requested, the output displays a list of the links in the linkset and their secondary status. Output is generated for each of the 16 signaling link codes (SLC). If the Multiple Linksets to Single Adjacent Point Code (MLS) feature is turned on, and an adjacent destination point code is requested, then the output displays a summary status, including the secondary point codes, of the linksets that use that adjacent point code.

**Parameters****apc (optional)**

ANSI point code with subfields *network indicator-network cluster-network cluster member (ni-nc-ncm)*. The *prefix* subfield indicates a private point code (*prefix-ni-nc-ncm*).

**Range:**

*p-*, 000-255

Specify a valid value for each subfield of the point code, and separate the subfields with a dash (-).

*prefix—p-*

When `chg-sid:pctype=ansi` is specified, *ni = 000* is not valid.

When `chg-sid:pctype=ansi` is specified, *nc = 000* is not valid if *ni = 001-005*.

When `chg-sid:pctype=ansi` is specified, *nc = 000* is valid if *ni = 006-255*.

The point code *000-000-000* is not a valid point code.

**apc/apca/apci/apcn/apcn24/apcn16 (optional)**

Adjacent point code.

**apci (optional)**

ITU international point code with subfields *zone-area-id*. The *prefix* subfield indicates a spare point code, private point code, or private and spare point code (*prefix-zone-area-id*).

**Range:**

*s-*, *p-*, *ps-*, 0-255

Specify a valid value for each subfield of the point code, and separate the subfields with a dash (-).

*prefix—s-, p-, ps*

*zone—0-7*

*area—000-255*

*id—0-7*

The point code *0-000-0* is not a valid point code.

**apcn (optional)**

ITU national point code in the format of a 5-digit number (*nnnnn*); or 2, 3, or 4 numbers (*members*) separated by dashes (*m1-m2-m3-m4*) as defined by the `chg-`

`stpopts:npcfmti` flexible point code option. A group code must be specified when the ITUDUPPC feature is turned on (*nnnnn-gc, m1-m2-m3-m4-gc*). The *prefix* subfield indicates

a spare point code, private point code, or private and spare point code (*prefix-nnnnn*, *prefix-nnnnn-gc*, *prefix-m1-m2-m3-m4*, *prefix-m1-m2-m3-m4-gc*).

**Range:**

*s*-, *p*-, *ps*-, 0-16383, *aa-zz*

Specify a valid value for each subfield of the point code, and separate the subfields with a dash (-).

*prefix*—*s*-, *p*-, *ps*

*nnnnn*—0-16383

*gc*—*aa-zz*

*m1-m2-m3-m4*—0-14 for each member; values must sum to 14

**apcn24 (optional)**

24-bit ITU national point code with subfields *main signaling area-sub signaling area-signaling point* (*msa-ssa-sp*). The *prefix* indicates a private point code (*prefix-msa-ssa-sp*).

**Range:**

*p*-, 000-255

Specify a valid value for each subfield of the point code, and separate the subfields with a dash (-).

*prefix*—*p*

*msa*—000–255

*ssa*—000–255

*sp*—000–255

**apcn16 (optional)**

16-bit ITU national point code with subfields *unit number sub number area main number area* (*un-sna-mna*). The *prefix* indicates a private point code (*prefix-un-sna-mna*).

**Range:**

*p*--, 000---127

Specify a valid value for each subfield of the point code, and separate the subfields with a dash (-).

*prefix*---*p*

*un*---000---127

*sna*---000---15

*mna*---000---31

**lsn (optional)**

Linkset name. The name of the linkset for which the report information is to be displayed.

**Range:**

ayyyyyyyyy

1 alphabetic character followed by up to 9 alphanumeric characters

**Default:**

All linksets are displayed

**stat (optional)**

The primary state filter. The state of the linksets for which a report will be displayed.

**Range:*****all***

All of the primary states

***alminh***

Alarms inhibited

***anr***

In-Service-Abnormal (IS-ANR)

***dsbld***

Out-of-Service-Maintenance-Disabled (OOS-MT-DSBLD)

***mt***

Out-of-Service-Maintenance (OOS-MT)

***nr***

In-Service-Normal (IS-NR)

**Default:**

*all*

**Example**

```
rept-stat-ls
```

```
rept-stat-ls:lsn=lsnstpa
```

**Dependencies**

No other `rept-stat-xxx` command can be in progress when this command is entered.

The linkset specified by the `lsn` parameter must be equipped in the database.

The `stat` and `lsn` parameters cannot be specified together in the command.

The Multiple Linksets to a Single Adjacent Point Code (MLS) feature must be turned on before the `apc` parameter can be specified.

The `lsn`, `stat`, and `apc` parameters cannot be specified together in the command.

At least one linkset must be associated with the value of the `apc` parameter.

**Notes**

This command can be canceled using the **F9** function key or the `canc-cmd` command. See `canc-cmd` for more information.

If no link is equipped for the SLC, the output is “\_\_\_,\_\_\_ UEQ.”

In this command, only ITU-international and ITU national point codes support the spare point code subtype prefix (s-) and the private and spare point code subtype prefix (ps-). All of the point code types support the private (internal) point code subtype prefix (p-).

"ASP-STATE" is shown for only IPSPG-M3UA linksets.

**Output**

If the Proxy Point Code feature is enabled, then proxy point code information is displayed.

```
rept-stat-ls
```

```
eagle10207 08-02-23 10:09:59 EST EAGLE 38.0.0
LSN          APCA          PST          SST          AST
ls11234567   001-001-002   OOS-MT      Prohibit     GWS
ls11345678   001-001-003   OOS-MT      Prohibit     -----
ls11345679   001-001-004   OOS-MT      Idle         -----
ls1134567    001-001-005   OOS-MT      Prohibit     -----
ls113456     001-001-006   OOS-MT      Prohibit     -----
ls11345      001-001-007   OOS-MT      Prohibit     GWS
ls113467     001-001-008   OOS-MT      Prohibit     -----
ls1134       001-001-009   OOS-MT      Prohibit     -----
ls987        009-008-007   OOS-MT      Idle         -----
z            009-008-009   OOS-MT      Idle         -----
cap8        008-008-008   OOS-MT      Idle         -----

LSN          APCN          PST          SST          AST
lsnational   16383-aa      OOS-MT      Idle         -----

LSN          APCN24        PST          SST          AST

LSN          APCI          PST          SST          AST
Command Completed.
```

```
;
```

This example shows the output for a linkset when the MLS feature is not turned on or the linkset is not created with a secondary point code:

```
rept-stat-ls:lsn=lsnstpa
```

```
eagle10207 08-02-23 10:09:59 EST EAGLE 38.0.0

LSN          APCA          PST          SST          AST
lsnstpa      110-15-08     IS-NR        Allowed     -----
  SPCA = -----
  ALARM STATUS = No Alarms.
  SCRSET = ----
  GWSA = ----
  GWSM = ----
  GWSD = ----
SLC SLK      SST          SLC SLK      SST
0  1207,A Avail      8  -----,- UEQ
1  1203,A Avail      9  -----,- UEQ
2  1103,B LPBK      10 -----,- UEQ
3  -----,- UEQ      11 -----,- UEQ
4  -----,- UEQ      12 -----,- UEQ
5  -----,- UEQ      13 -----,- UEQ
```

```

6 ----,- UEQ          14 ----,- UEQ
7 ----,- UEQ          15 ----,- UEQ
Command Completed.

```

;

This example shows the output when some linksets contain spare and private adjacent point codes:

```
rept-stat-ls
```

```

tekelecstp 02-03-20 21:22:04 EST EAGLE 31.12.0
LSN          APCA          PST          SST          AST
ls11234567   001-001-002             OOS-MT       Prohibit     GWS
ls11345678   001-001-003             OOS-MT       Prohibit     -----
ls11345679   001-001-004             OOS-MT       Idle         -----
ls1134567    001-001-005             OOS-MT       Prohibit     -----
ls113456     001-001-006             OOS-MT       Prohibit     -----
ls11345      p-001-001-007           OOS-MT       Prohibit     GWS
ls113467     001-001-008             OOS-MT       Prohibit     -----
ls1134      p-001-001-009           OOS-MT       Prohibit     -----
ls987        009-008-007             OOS-MT       Idle         -----
z            009-008-009             OOS-MT       Idle         -----
cap8        008-008-008             OOS-MT       Idle         -----

```

```

LSN          APCN          PST          SST          AST
lsnational   s-09-14-05-3-ab         OOS-MT       Idle         -----

```

```

LSN          APCN24         PST          SST          AST

```

```

LSN          APCI          PST          SST          AST

```

```
Command Completed.
```

;

This example shows the output when the Multiple Linksets to a Single Adjacent Point Code (MLS) feature is turned on, and the linkset is created with a secondary point code:

```
rept-stat-ls:lsn=lsnstpa
```

```

eagle10207 08-02-23 10:09:59 EST EAGLE 38.0.0
LSN          APCA          PST          SST          AST
lsnstpa     110-15-08             IS-NR        Allowed     -----
  SPCA = 120-10-01
ALARM STATUS = No Alarms.
SCRSET = ----
GWSA = ----
GWSM = ----
GWSD = ----
SLC SLK     SST          SLC SLK     SST
0 1207,A Avail      8 ----,- UEQ
1 1203,A Avail      9 ----,- UEQ
2 1103,B LPBK       10 ----,- UEQ
3 ----,- UEQ        11 ----,- UEQ

```



```

4 ----,- UEQ      12 ----,- UEQ
5 ----,- UEQ      13 ----,- UEQ
6 ----,- UEQ      14 ----,- UEQ
7 ----,- UEQ      15 ----,- UEQ
Command Completed.

```

;

This example shows the output for an adjacent point code when the MLS feature turned on:

```
rept-stat-ls:apc=1-1-2
```

```

eagle10207 07-07-23 10:09:59 EST EAGLE 37.5.0

APCA = 001-001-002
LSN          SPCA          PST          SST          AST
ls11234567   001-005-003   OOS-MT       Prohibit     GWS
ls11345678   004-008-002   OOS-MT       Prohibit     -----
ls113456     014-012-094   OOS-MT       Prohibit     -----
Command Completed.

```

;

This example shows the output when possible duplication of adjacent point code values occurs when the MLS feature is turned on:

```
rept-stat-ls
```

```

eagle10207 07-07-23 10:09:59 EST EAGLE 37.5.0

LSN          APCA          PST          SST          AST
ls11234567   001-001-002   OOS-MT       Prohibit     GWS
ls11345678   001-001-002   OOS-MT       Prohibit     -----
ls11345679   001-001-004   OOS-MT       Idle         -----
ls1134567    001-001-005   OOS-MT       Prohibit     -----
ls113456     001-001-002   OOS-MT       Prohibit     -----
ls11345     p-001-001-007 OOS-MT       Prohibit     GWS
ls113467     001-001-008   OOS-MT       Prohibit     -----
ls1134     p-001-001-009 OOS-MT       Prohibit     -----
ls987       009-008-007   OOS-MT       Idle         -----
z          009-008-009   OOS-MT       Idle         -----
cap8       008-008-008   OOS-MT       Idle         -----
LSN          APCN          PST          SST          AST
lsnational  s-09-14-05-3-ab OOS-MT       Idle
-----
LSN          APCN24       PST          SST          AST
LSN          APCI         PST          SST          AST

```

This example shows the output when the Proxy Point Code feature is enabled:

```
rept-stat-ls:lsn=lsnstpa
```

```
tekelecstp 08-02-29 11:05:47 EST EAGLE 38.0.0
LSN          APCA          PST          SST          AST
lsnstpa     110-15-08      IS-NR        Allowed      -----
  PPCA      =    100-12-04
ALARM STATUS      = No Alarms.
SCRSET   = -----
GWSA     = -----
GWSM     = -----
GWSD     = -----
SLC SLK   SST          SLC SLK   SST
0  1207,A Avail        8  -----,- UEQ
1  1203,A Avail        9  -----,- UEQ
2  1103,B LPBK         10 -----,- UEQ
3  -----,- UEQ       11 -----,- UEQ
4  -----,- UEQ       12 -----,- UEQ
5  -----,- UEQ       13 -----,- UEQ
6  -----,- UEQ       14 -----,- UEQ
7  -----,- UEQ       15 -----,- UEQ
;
```

This example shows the output for proxy linksets using a specified adjacent point code. The MLS feature must be turned on to retrieve information for an adjacent point code.

```
rept-stat-ls:apc=1-1-2
```

```
tekelecstp 07-03-29 11:05:47 EST EAGLE 37.5.0

APCA      =    001-001-002
LSN          APCA          PST          SST          AST
ls11234567  001-005-003  OOS-MT        Prohibit     GWS
ls11345678  004-008-002  OOS-MT        Prohibit     -----
ls113456    014-012-094  OOS-MT        Prohibit     -----
;
```

This example shows the ASP state for IPSPG-M3UA linksets state when the linkset is specified:

```
rept-stat-ls:lsn=ls1305a
```

```
tekelecstp 08-01-29 18:15:20 EST EAGLE 38.0.0
LSN          APCA          PST          SST          AST
ls1305a     005-213-000  IS-NR        Allowed      -----
  SPCA      = -----
ALARM STATUS      = No Alarms.
SCRSET   = -----
GWSA     = -----
GWSM     = -----
GWSD     = -----
SLC SLK   SST          ASP STATE  SLC SLK   SST          ASP STATE
```

```

      0  1305,A  Avail  ACTIVE  8  ----,--- UEQ
-----
      1  1305,A1 Unavail DOWN   9  ----,--- UEQ
-----
      2  ----,--- UEQ  ----- 10  ----,--- UEQ
-----
      3  ----,--- UEQ  ----- 11  ----,--- UEQ
-----
      4  ----,--- UEQ  ----- 12  ----,--- UEQ
-----
      5  ----,--- UEQ  ----- 13  ----,--- UEQ
-----
      6  ----,--- UEQ  ----- 14  ----,--- UEQ
-----
      7  ----,--- UEQ  ----- 15  ----,--- UEQ
-----

```

Command Completed.

;

This example shows the output when some linksets contain adjacent point codes if J7 support feature is enabled.

```
rept-stat-ls
```

```

tekelecstp 02-03-20 21:22:04 EST  EAGLE 31.12.0
LSN          APCA          PST          SST          AST

LSN          APCN          PST          SST          AST
lsnational  s-09-14-05-3-ab  OOS-MT      Idle         -----

LSN          APCN24         PST          SST          AST

LSN          APCI          PST          SST          AST

LSN          APCN16         PST          SST          AST
lsnational  121-003-015    OOS-MT      Idle         -----

```

Command Completed.

;

### Legend

- **LSN**—Name of the linkset
- **APCA/APCI/APCN/APCN24/APCN16**—Adjacent point code of the linkset (ANSI, ITU-I, ITU-N, ITU-N 24-bit, ITU-N 16-bit)
- **SPCA/SPCI/SPCN/SPCN24**—Secondary point code of the linkset (ANSI, ITU-I, ITU-N, ITU-N 24-bit)
- **PST**—Primary state of the linkset. See [Possible Values for PST/SST/AST](#).
- **SST**—Secondary state of the linkset. See [Possible Values for PST/SST/AST](#).
- **AST**—Associated state of the linkset. See [Possible Values for PST/SST/AST](#).

- **ALARM STATUS**—List of trouble text alarm messages that have been generated for the specified card
- **SCRN**—Name of the gateway screening screen set associated with the linkset
- **GWSA**—Shows whether gateway screening is used for the specified linkset
- **GWSM**—Shows whether gateway screening messaging is turned on for the specified linkset
- **GWSD**—Shows whether discarding of MSUs that bypass the gateway screening function due to loadshedding is turned on
- **SLC**—Signaling link codes associated with the links in the specified linkset
- **SLK**—Signaling links in the linkset, shown by the card location containing the signaling link and the port on the card containing the signaling link
- **PPCA/PPCI/PPCN/PPCN24/PPCN16**—Proxy point code of the linkset (ANSI, ITU-I, ITU-N, ITU-N 24-bit, ITU-N 16-bit)
- **ASP STATE**—State of AS associated with each signaling link of the IPSPG-M3UA linkset. The states displayed are: ACTIVE, INACTIVE, or DOWN.

#### Related Topics

- [chg-ls](#)
- [dlt-ls](#)
- [ent-ls](#)
- [rtrv-ls](#)

## rept-stat-meas

Use this command to report the status of the Measurements Subsystem (Measurements Platform) or MASPs (Integrated Measurements), including card location and state, IP link status, alarm level, and subsystem state.

#### Note:

If the Integrated Measurements collection function is turned on, then the status reflects the state of the E5-OAM card(s). If the Measurements Platform collection function is turned on, then the status reflects the state of the MCPM cards.

#### Parameters

This command has no parameters.

#### Example

```
rept-stat-meas
```

#### Dependencies

At least one MCPM card must be configured in the system if the Measurements Platform feature is turned on.

No other `rept-stat-xxx` commands can be in progress when this command is issued.

The Integrated Measurements or Measurements Platform feature must be turned on before this command can be entered.

The `platformenable=on` or `oamhcmeas=on` parameter must be specified (see the `chg-measopts` command) before this command can be entered.

This command cannot be entered when CAT2 IPSM to OAM syncing is in progress.

### Notes

The card status is independent of the IP Network Link status (Port A). The card can be IS-NR even if the network link has failed.

The version of the GPL is shown in the command output if the card is in the IS-NR or IS-ANR state. The `rept-stat-card` command does not show the GPL version if the card is IS-ANR.

### Output



#### Note:

The E5-MCPM-B card is an MCPM card. The *Type* field displays MCPM.

Output example with an MCPM card isolated:

```
rept-stat-meas
```

```

MEAS SS                PST           SST           AST
IS-ANR                Active       -----
ALARM STATUS = * 0516 Degraded Mode - 1 card failed

CARD  VERSION          TYPE    PST           SST           AST
1107 P 134-000-000    MCPM    IS-NR        Active       -----
IP Link A              IS-NR        Active       -----
1109  -----          MCPM    OOS-MT        Isolated     -----
IP Link A              OOS-MT        Unavail     -----

CARD 1107 ALARM STATUS = No Alarms
CARD 1109 ALARM STATUS = Card is isolated from the system
Command Completed.
;
```

Output example when the Integrated Measurements collection function is turned on:

```
rept-stat-meas
```

```

MEAS SS                PST           SST           AST
IS-NR                Active       -----
ALARM STATUS = No Alarms

CARD  VERSION          TYPE    GPL           PST           SST
AST
```

```

1113 P 132-049-000 E5MCAP OAMHC IS-NR Active -----
      IP Link A           IS-NR Active -----
1115 132-049-000 E5MCAP OAMHC IS-NR Active -----
      IP Link A           OOS-MT Unavail -----

CARD 1113 ALARM STATUS = No Alarms
CARD 1115 ALARM STATUS = No Alarms

```

Command Completed.

;

#### Output example with both MCPM cards IS-NR:

```
rept-stat-meas
```

```

tekelec 11-03-15 20:34:15 EST EAGLE5 44.0.0
                                PST          SST          AST
MEAS SS                          IS-NR      Active      -----
      ALARM STATUS = No Alarms

```

```

CARD  VERSION          TYPE  PST          SST          AST
1106  134-000-000      MCPM IS-NR        Active      -----
      IP Link A           IS-NR Active      -----
1108  134-000-000      MCPM IS-NR        Active      -----
      IP Link A           IS-NR Active      -----

```

```

CARD 1106 ALARM STATUS = No Alarms
CARD 1108 ALARM STATUS = No Alarms

```

Command Completed.

;

#### Legend

- **VERSION**—Version number of the GPL running on the specified card. The version is shown if the card is in the IS-NR or IS-ANR state.
- **TYPE**—Type of card running the Measurements Subsystem application
- **PST**—Primary state of the Measurements Subsystem or card. See [Possible Values for PST/SST/AST](#) for more information.
- **SST**—Secondary state of the Measurements Subsystem or card. See [Possible Values for PST/SST/AST](#) for more information.
- **AST**—Associated state of the Measurements Subsystem or card. See [Possible Values for PST/SST/AST](#) for more information.
- **MEAS SS**—Measurements Subsystem application running on the card
- **ALARM STATUS**—List of trouble text alarm messages that have been generated for the card and the applications running on the card
- **CARD**—Location of the card. The card with the letter “P” to the right of its card location is the primary card. The primary card transfers scheduled measurements report files to the primary FTP server. When the primary state (PST) of the card is IS-NR, the secondary

state (SST) indicates whether the card is active or standby, and the value of the associated state (AST) remains "-----".

- **CARD XXXX ALARM STATUS**—List of trouble text alarm messages that have been generated for the card

#### Related Topics

- [rept-stat-card](#)

## rept-stat-mfc

Use this command to obtain the status of the Message Flow Control (MFC) services.

#### Parameters

##### **mode (optional)**

The amount and type of information displayed in the report.

##### **Range:**

###### ***full***

display a full report for the specified MFC service

###### ***stats***

display detailed statistics for the specified MFC service

###### ***act***

display information about the status of MFC on individual Service cards

##### **Default:**

No change to the current value

##### **reset (optional)**

This parameter resets the statistics for all sample periods for the specified service.

##### **Range:**

###### ***yes***

##### **sample (optional)**

The data sample to be used.

##### **Range:**

###### ***avg30s***

30-second average value calculated over the previous 5 minutes

###### ***tot5m***

total value summed over the previous 5 minutes

###### ***avg1h***

1-hour average value calculated over the previous 24 hours

###### ***tot24h***

total value summed over the previous 24 hours

**service (optional)**

The MFC service for which information is reported.

**Range:*****eroute***

EROUTE MFC service

***inm***

INM MFC service

***mtp3***

MTP3 MFC service

***scpdn***

SCCP DN MFC service

***scpelap***

SCCP ELAP MFC service

***scpepap***

SCCP EPAP MFC service

***scpimsi***

SCCP IMSI MFC service

***sfapp***

SFAPP MFC service

***sflog***

SFLOG MFC service

***sfr***

SFAPP response MFC service

***slan***

SLAN MFC service

***snm***

SNM MFC service

***vsccp***

VSCCP MFC service

**Example**

```
rept-stat-mfc
```

```
rept-stat-mfc:service=vsccp:mode=act
```

```
rept-stat-mfc:service=eroute
```

```
rept-stat-mfc:service=eroute:reset=yes
```

```
rept-stat-mfc:service=slan:mode=full
```

```
rept-stat-mfc:mode=stats:service=vsccp:sample=avg30s
```

```
rept-stat-mfc:mode=stats:service=scpimsi:sample=avg30s
```



```
rept-stat-mfc:service=scpepap
rept-stat-mfc:service=scpelap
rept-stat-mfc:service=sflog
rept-stat-mfc:service=sfapp
rept-stat-mfc:service=sfr
```

### Dependencies

No other command can be in progress when this command is entered.

The `mode=stats` and `sample` parameters must be specified together in the command.

If the `mode` or `reset` parameter is specified, then the `service` parameter must be specified.

If a value of `mtp3`, `snm`, or `inm` is specified for the `appl` parameter, then the `mode=act` parameter cannot be specified.

The EPAP Data Split feature must be enabled before a value of `scpdn` or `scpimsi` can be specified for the `service` parameter.

The Dual ExAP Config feature must be enabled before a value of `scpepap` or `scpelap` can be specified for the `service` parameter.

The Dual ExAP Config feature or EPAP Data Split feature must be enabled before a value of `scpepap` can be specified.

### Notes

For the SFLOG MFC service, a maximum of two servers can be provisioned in the EAGLE, and only one can be active at a time. This command will provide the basic statistics (i.e., service denied, PDU discard, PDU sent) for the SFLOG MFC service.

### Output

Abbreviated output is indicated by 3 vertical dots as shown:

```
.
.
.
```

If the card does not support thermal monitoring, and if an MFC service is hosted on that card, then `N/A` is shown in the `THERMAL` column for that card location in `rept-stat-mfc:mode=act` output.

The `UNAVL` state in the output of `rept-stat-mfc:mode=full` indicates the cards that are not in the IS-NR state.

This example shows an MFC report for all the services when EPAP Data Split feature is enabled:

```
rept-stat-mfc
```

```
epap240m 12-01-29 14:50:03 CST EAGLE 46.3.0
Service   Type      Total
-----
SLAN      SERVER    0
SLAN      CLIENT    9
SNM       SYSTEM    13
INM       SYSTEM    13
MTP3      SERVER    9
MTP3      CLIENT    13
EROUTE    SERVER    0
EROUTE    CLIENT    11
VSCCP     SERVER    4
VSCCP     CLIENT    9
SCPDN     SERVER    3
SCPDN     CLIENT    9
SCPIMSI   SERVER    3
SCPIMSI   CLIENT    9
SFLOG     SERVER    2
SFLOG     CLIENT    6
-----
```

```
Command Completed.
```

```
;
```

This example shows an MFC report for all the services when Dual ExAP Config feature is enabled:

```
rept-stat-mfc
```

```
epap240m 12-01-29 14:50:03 CST EAGLE 46.3.0
Service   Type      Total
-----
SLAN      SERVER    0
SLAN      CLIENT    9
SNM       SYSTEM    13
INM       SYSTEM    13
MTP3      SERVER    9
MTP3      CLIENT    13
EROUTE    SERVER    0
EROUTE    CLIENT    11
VSCCP     SERVER    4
VSCCP     CLIENT    9
SCPEPAP   SERVER    3
SCPEPAP   CLIENT    9
SCPELAP   SERVER    1
SCPELAP   CLIENT    0
SFLOG     SERVER    2
SFLOG     CLIENT    6
SFAPP     SERVER    3
SFAPP     CLIENT    2
SFR       SERVER    3
SFR       CLIENT    2
-----
```

```
-----
Command Completed.
```

```
;
```

This example shows a full report for the EROUTE MFC service:

```
rept-stat-mfc:service=eroute:mode=full
```

```
rlghncxa03w 11-03-04 13:46:07 EST EAGLE 44.0.0
LOC    SERVICE  STATE  SERVER  CLIENT
-----
1101   EROUTE    IS-NR           X
1103   EROUTE    UNAVL           X
1105   EROUTE    UNAVL    X
1106   EROUTE    IS-NR    X
1113   EROUTE    IS-NR           X
1115   EROUTE    UNAVL           X
-----
Totals 6          2      4
```

```
Command Completed.
```

```
;
```

This example shows the EROUTE service 30 second average data calculated over the previous 5 minutes:

```
rept-stat-mfc:service=eroute:mode=stats:sample=avg30s
```

```
rlghncxa03w 11-03-04 14:36:07 EST EAGLE 44.0.0
PER CARD EROUTE SERVER DATA, 30-SEC AVG VALUES CALCULATED OVER
PREV 5 MIN
```

```

                                SRVC_RQSTS_RCVD
NUM_APPL_ORIG
FC          MSEC  -----
EVENTS     IN FC   OUT_FC   IN_FC   DACT    DACTS
FC
-----
-----
0          0       568     0       0       0       0
CARD LOC:  1217   LAST 5 CLIENTS:  1101,1308,1308,1102,1102

0          0       0       0       0       0       0
CARD LOC:  1218   LAST 5 CLIENTS:  0 ,0 ,0 ,0 ,0

-----
-----
TOTAL SRVC RQSTS RCVD: 568
```

PER CARD EROUTE CLIENT DATA, 30-SEC AVG VALUES CALCULATED OVER PREV 5 MIN

SVC RQSTS	SVC DENIED	PDUS SENT	PDUS DSCRD	SRVR RESLCTD	ON_SHLF NOT_AVL
--------------	---------------	--------------	---------------	-----------------	--------------------

```

-----
95          0          195          0          0          0
CARD LOC:  1101  LAST 5 SERVERS: 1217,0 ,0 ,0 ,0
96          0          196          0          0          0
CARD LOC:  1102  LAST 5 SERVERS: 1217,0 ,0 ,0 ,0
96          0          96          0          0          0
CARD LOC:  1103  LAST 5 SERVERS: 1217,0 ,0 ,0 ,0
47          0          47          0          0          0
CARD LOC:  1308  LAST 5 SERVERS: 1217,0 ,0 ,0 ,0
-----

```

SYSTEM TOTALS: PDUs SENT = 1326690530, PDUs DSCRD = 94670548

Command Completed.

;

This example shows the MFC status of all the EROUTE Service Cards:

```
rept-stat-mfc:appl=eroute:mode=act
```

rlghncxa03w 11-03-04 15:26:07 EST EAGLE 44.0.0

PER CARD EROUTE SERVER ACTIVATION DATA

LOC	STATUS	THERMAL	IP LINK STATUS
1201	ACT	OK	OK
1202	ACT	N/A	OK
1204	UNAVL	---	---
2215	DACT	BAD	OK
2216	DACT	N/A	BAD
4214	ACT	OK	OK
4215	DACT	OK	BAD

Command Completed.

;

This example resets the MFC engine statistics at server side and resets application level statistics at client side, for the EROUTE service:

```
rept-stat-mfc:service=eroute:reset=yes
```

rlghncxa03w 11-03-06 13:36:07 EST EAGLE 44.0.0

Command Completed.

;

This example shows the MFC report for the EROUTE service.

```
rept-stat-mfc:service=eroute
```

```
rlghncxa03w 11-03-04 13:37:27 EST EAGLE 44.0.0
Service   Type      Total
-----
EROUTE    SERVER    2
EROUTE    CLIENT    4
-----
```

Command Completed.

;

This example shows the MFC status of all the SLAN Service Cards. This example displays abbreviated output.

```
rept-stat-mfc:service=slan:mode=act
```

```
rlghncxa03w 11-03-04 16:36:07 EST EAGLE 44.0.0
PER CARD SLAN SERVER ACTIVATION DATA
      IP LINK   IP LINK   IP LINK
LOC   STATUS    THERMAL   STATUS    CONGESTION  ACTIVATION
-----
1106  ACT         OK        OK        OK          OK
1201  ACT         OK        OK        OK          OK
1204  UNAVL       ---       ---       ---         ---
2215  DACT        N/A       OK        BAD         OK
.
.
.
4214  ACT         OK        OK        OK          OK
-----
```

Command Completed.

;

This example shows the MFC status of all the VSCCP Service Cards. This example displays abbreviated output.

```
rept-stat-mfc:service=vsccp:mode=act
```

```
rlghncxa03w 11-03-04 13:36:57 EST EAGLE 44.0.0
PER CARD VSCCP SERVER ACTIVATION DATA
      IP LINK   IP LINK   IP LINK
LOC   STATUS    THERMAL
-----
1201  ACT         OK
1204  UNAVL       ---
1217  ACT         OK
```

```

2215    ACT      N/A
.
.
.
4214    ACT      OK
-----

```

Command Completed.

;

This example shows the MTP3 service 30 second average data calculated over the previous 5 minutes: The server stats will be shown as "-" for SCCP card location.

```
rept-stat-mfc:service=mtp3:mode=stats:sample=avg30s
```

```

rlghncxa03w 11-03-04 11:36:07 EST  EAGLE 44.0.0
PER CARD MTP3 SYSTEM DATA, 30-SEC AVG VALUES CALCULATED OVER PREV 5 MIN

```

LOC	SERVER STATS			CLIENT STATS		
	FC EVENTS	MSEC IN FC	PDUS RCVD	PDUS SENT	PDUS DSCRD	SRV REQ DENIED
1101	0	0	0	0	0	0
1103	0	0	0	0	0	0
1107	0	0	0	0	0	0
1207	-	-	-	0	0	0
1208	0	0	0	0	0	0
1211	0	0	0	0	0	0
1212	0	0	0	0	0	0
1213	0	0	0	0	0	0
1214	0	0	0	0	0	0
1215	-	-	-	0	0	0
1216	-	-	-	0	0	0
1301	0	0	0	0	0	0
1305	0	0	0	0	0	0
1306	0	0	0	0	0	0
1307	0	0	0	0	0	0
1308	0	0	0	0	0	0
1311	0	0	0	0	0	0
1312	0	0	0	0	0	0
1313	0	0	0	0	0	0
1315	0	0	0	0	0	0

Command Completed.

;

This example shows a full MFC report for the SNM service:

```
rept-stat-mfc:service=snm:mode=full
```

```
rlghncxa03w 11-03-04 13:36:07 EST EAGLE 44.0.0
LOC    SERVICE  STATE   SYSTEM
-----
1101   SNM        IS-NR   X
1103   SNM        UNAVL   X
1107   SNM        IS-NR   X
1111   SNM        UNAVL   X
-----
Totals 4                4
```

Command Completed.

;

This example shows the SNM service 30 second average data calculated over the previous 5 minutes:

```
rept-stat-mfc:service=snm:mode=stats:sample=avg30s
```

```
rlghncxa03w 11-03-04 13:36:07 EST EAGLE 44.0.0
PER CARD SNM SYSTEM DATA, 30-SEC AVG VALUES CALCULATED OVER PREV 5
MIN
```

REQ LOC DENIED	SERVER STATS			CLIENT STATS		
	FC	MSEC	PDUS	PDUS	PDUS	SRV
	EVENTS	IN FC	RCVD	SENT	DSCRD	
1101	0	0	0	0	0	0
1103	0	0	0	0	0	0
1107	0	0	0	0	0	0
1207	0	0	0	0	0	0
1208	0	0	0	0	0	0
1211	0	0	0	0	0	0
1212	0	0	0	0	0	0
1213	0	0	0	0	0	0
1214	0	0	0	0	0	0
1215	0	0	0	0	0	0
1216	0	0	0	0	0	0
1301	0	0	0	0	0	0
1305	0	0	0	0	0	0
1306	0	0	0	0	0	0
1307	0	0	0	0	0	0
1308	0	0	0	0	0	0
1311	0	0	0	0	0	0
1312	0	0	0	0	0	0
1313	0	0	0	0	0	0
1315	0	0	0	0	0	0

```
-----  
Command Completed.  
;
```

This example shows an MFC report for the MTP3 service:

```
rept-stat-mfc:service=mtp3:mode=full
```

```
rlghncxa03w 11-03-04 13:06:07 EST EAGLE 44.0.0  
LOC    SERVICE  STATE  SERVER  CLIENT  
-----  
1101   MTP3      IS-NR   X       X  
1103   MTP3      UNAVL   X       X  
1107   MTP3      IS-NR           X  
1111   MTP3      UNAVL           X  
-----  
Totals 6          2       4
```

```
Command Completed.  
;
```

This example shows an MFC report for the SCPELAP service when Dual ExAP Config feature is enabled.

```
rept-stat-mfc:service=scpelap:mode=full
```

```
rlghncxa03w 11-03-04 13:06:07 EST EAGLE 45.0.0  
LOC    SERVICE  STATE  SERVER  CLIENT  
-----  
1105   SCPELAP  IS-NR   X  
-----  
Totals 1          1       0
```

```
Command Completed.  
;
```

This example shows an MFC report for the SFLOG service:

```
rept-stat-mfc:service=sflog:mode=full
```

```
tekelecstp 15-03-04 13:06:07 EST EAGLE 46.3.0  
LOC    SERVICE  STATE  SERVER  CLIENT  
-----  
1101   SFLOG    IS-NR           X  
-----  
Totals 1          0       1
```

```
Command Completed.  
;
```

This example shows an MFC report for the SFAPP service:



```
rept-stat-mfc:service=sfapp:mode=full

tklcl1110801 18-09-25 17:06:13 EST EAGLE 46.7.0.0.0-75.14.0
rept-stat-mfc:service=sfapp:mode=full
Command entered at terminal #2.
;

tklcl1110801 18-09-25 17:06:13 EST EAGLE 46.7.0.0.0-75.14.0
LOC    SERVICE  STATE   SERVER  CLIENT
-----
1101   SFAPP     IS-NR   X
1102   SFAPP     IS-NR           X
1103   SFAPP     IS-NR   X
1105   SFAPP     IS-NR   X
1217   SFAPP     IS-NR           X
-----
Totals 5                3      2

Command Completed.
;
```

This example shows an MFC report for the SFR service:

```
rept-stat-mfc:service=sfr :mode=full

Command Accepted - Processing

tklcl1110801 18-09-25 17:07:45 EST EAGLE 46.7.0.0.0-75.14.0
rept-stat-mfc:service=sfr :mode=full
Command entered at terminal #2.
;

tklcl1110801 18-09-25 17:07:45 EST EAGLE 46.7.0.0.0-75.14.0
LOC    SERVICE  STATE   SERVER  CLIENT
-----
1101   SFR       IS-NR   X
1102   SFR       IS-NR           X
1103   SFR       IS-NR   X
1105   SFR       IS-NR   X
1217   SFR       IS-NR           X
-----
Totals 5                3      2

Command Completed.
;
```

### Legend

The MFC Engine provides Server card statistics that are computed every hour (based on a Server card's timer); therefore they are typically posted an hour later. Client card statistics update continuously; current values will be observed at every invocation of the command.

## rept-stat-mon

Use this command to display the status of the Fast Copy subsystem on FC-capable cards and the EROUTE subsystem on STC cards and E5-STC cards for the EAGLE 5 Integrated Monitoring Support (E5IS) feature.

### Parameters

#### **loc (optional)**

Card location. The card location as stenciled on the shelf for an STC or E5-STC card or an FC-capable card in the system.

#### **Range:**

*1101 - 1108, 1111 - 1112, 1201 - 1208, 1211 - 1218, 1301 - 1308, 1311 - 1318, 2101 - 2108, 2111 - 2118, 2201 - 2208, 2211 - 2218, 2301 - 2308, 2311 - 2318, 3101 - 3108, 3111 - 3118, 3201 - 3208, 3211 - 3218, 3301 - 3308, 3311 - 3318, 4101 - 4108, 4111 - 4118, 4201 - 4208, 4211 - 4218, 4301 - 4308, 4311 - 4318, 5101 - 5108, 5111 - 5118, 5201 - 5208, 5211 - 5218, 5301 - 5308, 5311 - 5318, 6101 - 6108, 6111 - 6118*

#### **Default:**

Status for all STC and FC-capable cards is reported.

#### **mode (optional)**

This parameter provides extended performance information, including message flow control (MFC) messaging rates.

If the `mode=perf` parameter is specified, then only subsystem performance information is displayed.

#### **Range:**

*perf*

#### **type (optional)**

Monitoring subsystem type. The type of the subsystem for which the monitoring statistics are displayed.

#### **Range:**

*fcs*

Display the statistics for the Fast Copy subsystem

*eroute*

Display the statistics for the EROUTE subsystem

#### **Default:**

Display the statistics for both the EROUTE and FC subsystems

### Example

```
rept-stat-mon
rept-stat-mon:type=eroute
rept-stat-mon:type=fcs
rept-stat-mon:type=eroute:loc=1101
```

```
rept-stat-mon:type=fcs:loc=1104
rept-stat-mon:type=eroute:mode=perf
```

### Dependencies

No other `rept-stat-xxx` command can be in progress when this command is entered.

At least one STC card must be configured before this command can be entered.

At least one FC-capable card must be provisioned in the system before the `type=fcs` parameter can be specified.

The `loc` and `mode` parameters cannot be specified together in the command.

The `type=eroute` parameter must be specified before the `mode` parameter can be specified.

If the `loc` or `mode` parameter is specified, then the `type` parameter must be specified.

Either an STC card or an FC-capable card must be provisioned in the system.

An FC-capable card must be provisioned in the system before the `type=fcs` parameter can be specified. An STC card must be provisioned in the system before the `type=eroute` parameter can be specified.

### Notes

#### Fast Copy Cards

E5-ENET-B cards running the IPSP or IPGHC GPL are considered to be *FC-capable*. A card running the IPGHC GPL must be in the IS-NR State before the card can be considered *FC-capable*. This restriction does not apply to cards running the IPSP GPL. An *FC-capable* card is considered *FC-enabled* when Fast Copy monitoring is enabled for the respective GPL.

For a card to be FC monitored, the following two conditions must be satisfied:

1. FCMODE = FCOPY for the GPL
2. The card must have at least one (1) link with an EMP session established.

When a card is not being FC-Monitored, no FC alarm will be present on the card/port. The card's FCS state remains OFFLINE and the state of FCS ports on the card is OOS-MA/UEQ irrespective of the Ethernet cable being connected on those ports or not.

### Output

This example displays card- and system-level information for the Fast Copy and EROUTE subsystems:

```
rept-stat-mon
```

```
rlghncxa03w 11-02-04 16:35:57 IST  EAGLE 44.0.0
EROUTE SUBSYSTEM REPORT IS-NR      Active      -----
STC Cards Configured= 4  Cards IS-NR= 2
EISCOPY BIT = ON
```

```

System Threshold = 80% Total Capacity
System Peak EROUTE Load:          7080 Buffers/Sec
System Total EROUTE Capacity:     12000 Buffers/Sec

```

```
SYSTEM ALARM STATUS = No Alarms.
```

CARD	VERSION	PST	SST	AST	MESSAGE USAGE	CPU USAGE
1101	052-008-000	IS-NR	Active	-----	63%	28%
1103	052-008-001	IS-NR	Active	-----	55%	28%
1105	255-255-255	OOS-MT	Isolated	-----	0%	0%
1205	255-255-255	OOS-MT	Isolated	-----	0%	0%

```

EROUTE Service Average Messaging Capacity = 59%
Average CPU Capacity = 28%

```

```
CARDS DENIED EROUTE SERVICE:
```

```

=====
FAST COPY SUBSYSTEM REPORT IS-NR          Active    -----
FC Cards Configured= 3  Cards IS-NR= 3
SYSTEM ALARM STATUS = No Alarms.

```

```

GPL          FCMODE
-----
IPSG         FCOPY
IPGHC        FCOPY
-----

```

CARD	GPL	PST	SST	CPU	CARD FCS
1201	IPSG	IS-NR	Active	34%	ALLOWED
1202	IPSG	IS-NR	Active	55%	ALLOWED
1203	IPGHC	IS-NR	Active	10%	ALLOWED

```
Command Completed.
```

```
;
```

This example displays card- and system-level information for the EROUTE subsystem:

```
rept-stat-mon:type=eroute
```

```

rlghncxa03w 11-03-11 16:35:57 IST  EAGLE 44.0.0
EROUTE SUBSYSTEM REPORT IS-NR          Active    -----
STC Cards Configured= 4  Cards IS-NR= 2
EISCOPY BIT = ON
System Threshold = 80% Total Capacity
System Peak EROUTE Load:          7080 Buffers/Sec
System Total EROUTE Capacity:     12000 Buffers/Sec

SYSTEM ALARM STATUS = No Alarms.

```

```

      CARD   VERSION   PST           SST           AST           MESSAGE
CPU
      USAGE

```

```

-----
      1101   052-008-000 IS-NR           Active         -----        63%
28%
      1103   052-008-001 IS-NR           Active         -----        55%
28%
      1203   255-255-255 OOS-MT          Isolated       -----
0%
      1205   255-255-255 OOS-MT          Isolated       -----
0%

```

```

-----
      EROUTE Service Average Messaging Capacity = 59%
      Average CPU Capacity = 28%

```

CARDS DENIED EROUTE SERVICE:

Command Completed.

;

This example displays card- and system-level information for the Fast Copy subsystem:

```
rept-stat-mon:type=fcs
```

```

rlghncxa03w 10-02-02 16:35:57 IST EAGLE 42.0.0
FAST COPY SUBSYSTEM REPORT IS-NR           Active         -----
FC Cards Configured= 3 Cards IS-NR= 3
SYSTEM ALARM STATUS = No Alarms.

```

FAST COPY OPTIONS

```

-----
FCGPL = IPSG           FCMODE = FCOPY
FCGPL = IPGHC          FCMODE = FCOPY
-----

```

```

      CARD  GPL    PST           SST           CPU  CARD FCS
-----
      1201  IPSG   IS-NR           Active         34%  ALLOWED
      1202  IPSG   IS-NR           Active         55%  ALLOWED
      1203  IPGHC  IS-NR           Active         10%  ALLOWED
-----

```

Command Completed.

;

The following example shows status of FC ports on a FC capable card when the card is not being FC-Monitored:

```
rept-stat-mon:type=fcs:loc=1107
```

```
rlghncxa03w 10-01-09 16:35:57 IST EAGLE 42.0.0
CARD  GPL      PST      SST      CPU  CARD FCS
1107  IPGS    IS-NR    Active   21%  OFFLINE
ALARM STATUS = No Alarms.
```

```
FCS IP PORT A1:      OOS-MA      Ueq      -----
ALARM STATUS = No Alarms.
FCS IP PORT B1:      OOS-MA      Ueq      -----
ALARM STATUS = No Alarms.
```

```
IMF CONNECTION STATUS TABLE
```

```
-----
IPADDRESS          ALM ID  ASSOC NAME      PKT CNT      SERVICE MODE
-----
PORT ALARM STATUS
-----
PORT ID  ALARM ID  REASON
-----
```

```
Command Completed.
```

```
;
```

This example displays EROUTE subsystem information for the specified card:

```
rept-stat-mon:type=eroute:loc=1101
```

```
rlghncxa03w 10-01-09 16:35:57 IST EAGLE 42.0.0
CARD  VERSION    TYPE  PST      SST      AST
1101  052-008-000  STC   IS-NR    Active   -----
CARD ALARM STATUS = No Alarms.
TOTAL CPU USAGE = 28%
NTP broadcast = VALID
STC IP CONNECTION
PORT  PST      SST
A     OOS-MT   Unavail
B     OOS-MT   Unavail
```

```
Command Completed.
```

```
;
```

This example displays Fast Copy subsystem information for the specified card. (A) or (B) in the IMF CONNECTION STATUS TABLE indicates the Fast Copy A or Fast Copy B network, respectively.

```
rept-stat-mon:type=fcs:loc=1203
```

```
rlghncxa03w 10-02-02 16:35:57 IST EAGLE 42.0.0
CARD GPL PST SST CPU CARD FCS
1203 IPGHC IS-NR Active 10% ALLOWED
ALARM STATUS = No Alarms.
```

```
FCS IP PORT A1: IS-NR Active -----
ALARM STATUS = No Alarms.
FCS IP PORT B1: IS-NR Active -----
ALARM STATUS = No Alarms.
```

IMF CONNECTION STATUS TABLE

```
-----
----
IPADDRESS          ALM ID  ASSOC NAME      PKT CNT      SERVICE
MODE
-----
----
172.21.48.15      (A) 582    sg1203a21      100          Copy Rx
MSUs
172.22.48.15      (B) 582    sg1203a22      200          Copy Tx
MSUs
```

PORT ALARM STATUS

```
-----
----
PORT ID ALARM ID  REASON
-----
----
A          583      Mismatched Fast Copy Network Addresses
```

Command Completed.

;

This example displays EROUTE subsystem performance statistics:

```
rept-stat-mon:type=eroute:mode=perf
```

```
rlghncxa03w 11-03-11 16:35:57 IST EAGLE 44.0.0
EROUTE SUBSYSTEM REPORT IS-ANR Ovrflw=1 -----
STC Cards Configured= 2 Cards IS-NR= 2
EISCOPY BIT = ON
System Threshold = 80% Total Capacity
System Peak EROUTE Load: 12200 Buffers/Sec
System Total EROUTE Capacity: 12000 Buffers/Sec
```

```
SYSTEM ALARM STATUS = * 0482 Card(s) have been denied EROUTE
service
```

## STATISTICS

```
=====
CARD      CPU USAGE  MESSAGE RATE
-----
1104      55%         6200
1112      50%         6000
-----
```

```
AVERAGE MESSAGING CAPACITY = 80%
AVERAGE CPU USAGE = 27%
TOTAL MESSAGING RATE = 12200
```

```
CARDS DENIED EROUTE SERVICE: 1302, 1305
```

```
Command Completed.
```

```
;
```

This example displays output when FC-capable cards are configured, and the Fast Copy mode is turned off:

```
rept-stat-mon:type=fcs
```

```
rlghncxa03w 10-02-02 16:35:57 IST EAGLE 42.0.0
FAST COPY SUBSYSTEM REPORT OOS-MA      Ueq      -----
FC Cards Configured= 2  Cards IS-NR= 1
SYSTEM ALARM STATUS = No Alarms.
```

## FAST COPY OPTIONS

```
-----
FCGPL = IPSG      FCMODE = OFF
FCGPL = IPGHC     FCMODE = OFF
-----
```

```
-----
CARD  GPL      PST          SST          CPU  CARD FCS
-----
1105  IPSG     OOS-MT      Isolated     0%  OFFLINE
1106  IPGHC    IS-NR      Active       15%  OFFLINE
-----
```

```
Command Completed.
```

```
;
```

This example displays card- and system-level information when the Fast Copy subsystem is in the OOS-MT/Uavail state:

```
rept-stat-mon:type=fcs
```

```
rlghncxa03w 10-02-02 16:35:57 IST EAGLE 42.0.0
FAST COPY SUBSYSTEM REPORT OOS-MT      Unavail   -----
FC Cards Configured= 2  Cards IS-NR= 2
SYSTEM ALARM STATUS = * 0597 FC System is Deactivated
```



FAST COPY OPTIONS

```
-----
FCGPL = IPSG      FCMODE = FCOPY
FCGPL = IPGHC     FCMODE = FCOPY
-----
```

```
-----
CARD  GPL      PST          SST          CPU  CARD FCS
-----
1105  IPSG     IS-NR          Active       12%  DEACTIVATED
1106  IPGHC     IS-NR          Active       10%  DEACTIVATED
-----
```

Command Completed.

;

This example displays Fast Copy subsystem information for the specified card when the card is in a DEACTIVATED state:

rept-stat-mon:type=fcs:loc=1105

```
rlghncxa03w 10-02-02 16:35:57 IST  EAGLE 42.0.0
CARD  GPL      PST          SST          CPU  CARD FCS      REASON
1105  IPSG     IS-NR          Active       12%  DEACTIVATED  CPU
Thrshld Exceeded
ALARM STATUS = ** 0590 Fast Copy Application De-activated

FCS IP PORT A1:          IS-ANR          Restrict  -----
ALARM STATUS = ** 0588 FC Port De-activated
FCS IP PORT B1:          IS-ANR          Restrict  -----
ALARM STATUS = ** 0588 FC Port De-activated
```

IMF CONNECTION STATUS TABLE

```
-----
----
IPADDRESS          ALM ID  ASSOC NAME      PKT CNT      SERVICE
MODE
-----
----
172.21.48.15      (A) 582    sg1203a21      100          Copy Rx
MSUs
172.22.48.15      (B) 582    sg1203a22      200          Copy Tx
MSUs
```

PORT ALARM STATUS

```
-----
----
PORT ID ALARM ID  REASON
-----
----
```

Command Completed.  
;

## Legend

Information displayed in the EROUTE subsystem report:

- **STC Cards Configured**—Total number of STC cards and E5-STC cards configured in the system
- **Cards IS-NR**—Total number of STC cards and E5-STC cards in IS-NR state
- **EISCOPY BIT**—Indicates whether EIS copy function is turned On or Off
- **System Threshold**—% of system total capacity being used
- **System Peak EROUTE Load**—Current load in Buffers/Sec
- **System Total EROUTE Capacity**—Total capacity in Buffers/Sec
- **SYSTEM ALARM STATUS**—Either "No Alarms" or current alarm number and text
- **CARD**—Card location
- **VERSION**—Version number of the GPL loaded on the card. Dashes (- - - -) in the version column indicate one of the following conditions about the card:
  - The card does not run a GPL, such as TDM or MDAL cards.
  - The card is configured but is not physically present in the system.
  - The card is IS-ANR or is in the process of being loaded.
- **TYPE**—Card type entered in the database
- **PST**—Primary state of the card. See [Possible Values for PST/SST/AST](#).
- **SST**—Secondary state of the card. See [Possible Values for PST/SST/AST](#).
- **AST**—Associated state of the card. See [Possible Values for PST/SST/AST](#).
- **EROUTE Service Average Messaging Capacity\AVERAGE MESSAGING CAPACITY**—Average MFC Capacity in percent
- **Average CPU Capacity\Average CPU Usage**—Average CPU capacity in percent
- **Message usage**—% of system current MFC rate based on the Max MFC capacity
- **TOTAL MESSAGING RATE**—Total MFC processing rate
- **CPU usage**—% of system current CPU usage
- **STC IP PORT**—Status of the STC IP ports A and B

Information displayed in the Fast Copy subsystem report:

- **FC Cards Configured**—Total number of FC-capable cards configured in the system
- **Cards IS-NR**—Total number of FC-capable cards in IS-NR state
- **FCMODE**—Monitoring mode
- **GPL**—Application loaded on the card
- **SYSTEM ALARM STATUS**—Either "No Alarms" or current alarm number and text
- **CARD**—Card location
- **PST**—Primary state of the card. See [Possible Values for PST/SST/AST](#).

- **SST**—Secondary state of the card. See [Possible Values for PST/SST/AST](#).
- **CPU**—% of system current CPU usage
- **CARD FCS**—Fast Copy status for the card
- **REASON**—Deactivation alarm reason on Card FCS. Possible values are "CPU Thrshld Exceeded" or "Auto-Neg Fails".
- **FCS IP PORT**—status of the FCS IP ports A1 and B1
- **IPADDRESS**—IP addresses of the IMF
- **ASSOC NAME**—Association name
- **PKT CNT**—Snapshot of packets received/sent per association
- **SERVICE MODE**—Type of service granted by the DAS to FC-enabled card

## rept-stat-mps

Use this command to display the overall status of the application running on the MPS (multi-purpose server).

- If the LNP ELAP Configuration feature is turned on, the ELAP (EAGLE LNP Application Processor) subsystem status is displayed.
- If the INP/AINPQ feature is turned on, the EPAP (EAGLE Application Processor) subsystem status is displayed.
- If the G-Port (GSM mobile number portability), G-Flex (GSM flexible numbering), or PPSMS (Prepaid SMS Intercept Ph1) feature is turned on, then the GSM (Global System for Mobile Telecommunications) and EPAP status is displayed.
- If the EIR (Equipment Identity Register) feature is turned on, then the status of the EIR component on the card is displayed.
- If the V-Flex (Voice Mail Router) feature is turned on, then the status of the V-Flex component on the card is displayed.
- If the ATINP (ATI Number Portability Query) feature is enabled, then the status of the ATINPQ component on the card is displayed.

### Parameters

#### **loc (optional)**

The card location of the VSCCP card to be reported on, as stenciled on the shelf of the EAGLE.

#### **Range:**

*1101 - 1108, 1111 - 1117, 1201 - 1208, 1211 - 1218, 1301 - 1308, 1311 - 1318, 2101 - 2108, 2111 - 2118, 2201 - 2208, 2211 - 2218, 2301 - 2308, 2311 - 2318, 3101 - 3108, 3111 - 3118, 3201 - 3208, 3211 - 3218, 3301 - 3308, 3311 - 3318, 4101 - 4108, 4111 - 4118, 4201 - 4208, 4211 - 4218, 4301 - 4308, 4311 - 4318, 5101 - 5108, 5111 - 5118, 5201 - 5208, 5211 - 5218, 5301 - 5308, 5311 - 5318, 6101 - 6108, 6111 - 6118*

### Example

```
rept-stat-mps:loc=1106
```

## Dependencies

The card location specified in the `loc` parameter must contain a Service Module card.

One of the following features must be turned on, the ATINP feature must be enabled, or at least one ENUM card must be configured before this command can be entered:

- A-Port
- AINPQ
- DEIR
- G-Flex
- G-Port
- INP
- EIR
- LNP ELAP Configuration
- Prepaid SMS Intercept Ph1
- SIP NP
- V-Flex

At least one Service Module card must be configured in the system before this command can be entered.

The card location specified in the `loc` parameter must be provisioned as an SCCP card but cannot provide only GTT service.

To specify the `rept-stat-mps` command, no other `rept-stat-xxxx` command can be in progress.

The card location specified in the `loc` parameter must contain either an SCCP card, a SIP card, an ENUM card, or a DEIR card running the DEIRHC gpl.

A Service Module card running the VSCCP/SIPHC/DEIRHC/ENUMHC application must be configured before this command can be entered.

## Notes

When the MPS does not have an alarm on it, the `rept-stat-mps` report indicates in the SST field of the report which MPS is the active and which is the standby. When the MPS has an alarm on it, the SST field shows "Fault," and the Active/Standby information is displayed in the AST field as long as there is an alarm. After the alarm clears, the Active/Standby information appears in the SST field as before.

## Output



### Note:

The status for a particular feature is shown only if that feature is enabled or turned on.

This example shows the possible system response if the LNP ELAP Configuration feature is turned on:

```
rept-stat-mps
```

```
rlghncxa03w 09-01-07 10:23:93 EST EAGLE 40.0.0
          VERSION      PST          SST          AST
ELAP A          027-015-000  OOS-MT      Fault      Standby
CRITICAL PLATFORM  ALARM DATA = No Alarms
MAJOR   PLATFORM  ALARM DATA = h'0123456789ABCDEF
MINOR   PLATFORM  ALARM DATA = h'0123456789ABCDEF
CRITICAL APPLICATION ALARM DATA = No Alarms
MAJOR   APPLICATION ALARM DATA = h'0123456789ABCDEF
MINOR   APPLICATION ALARM DATA = No Alarms
          ALARM STATUS = ** 0371 Major Platform Failure(s)

          VERSION      PST          SST          AST
ELAP B          027-015-000  OOS-MT      Fault      Active
CRITICAL PLATFORM  ALARM DATA = No Alarms
MAJOR   PLATFORM  ALARM DATA = No Alarms
MINOR   PLATFORM  ALARM DATA = No Alarms
CRITICAL APPLICATION ALARM DATA = h'0123456789ABCDEF
MAJOR   APPLICATION ALARM DATA = h'0123456789ABCDEF
MINOR   APPLICATION ALARM DATA = No Alarms
          ALARM STATUS = *C 0373 Critical Application Failure(s)

CARD  PST          SST          LNP STAT
1106 P IS-NR      Active      ACT
1201  IS-ANR      Active      SWDL
1205  OOS-MT-DSBLD Manual      -----
1302  OOS-MT      Isolated   -----
1310  IS-ANR      Standby    SWDL

CARD 1106 ALARM STATUS = No Alarms
      DSM PORT A:      ALARM STATUS      = No Alarms
      DSM PORT B:      ALARM STATUS      = No Alarms
CARD 1201 ALARM STATUS = No Alarms
      DSM PORT A:      ALARM STATUS      = ** 0084 IP Connection
Unavailable
      DSM PORT B:      ALARM STATUS      = ** 0084 IP Connection
Unavailable
      CARD 1205 ALARM STATUS = No Alarms
      DSM PORT A:      ALARM STATUS      = ** 0084 IP Connection
Unavailable
      DSM PORT B:      ALARM STATUS      = ** 0084 IP Connection
Unavailable
      CARD 1302 ALARM STATUS = ** 0013 Card is isolated from the system
      DSM PORT A:      ALARM STATUS      = ** 0084 IP Connection
Unavailable
      DSM PORT B:      ALARM STATUS      = ** 0084 IP Connection
Unavailable
      CARD 1310 ALARM STATUS = No Alarms
      DSM PORT A:      ALARM STATUS      = ** 0084 IP Connection
Unavailable
```

```

        DSM PORT B:      ALARM STATUS      = ** 0084 IP Connection
Unavailable
        Command Completed.
;

```

Possible system response when a specific card is queried, and the INP or AINP feature is turned on:

```
rept-stat-mps:loc=1205
```

```

rlghncxa03w 04-01-07 10:23:93 EST  EAGLE 31.3.0
CARD  VERSION      TYPE    PST           SST           AST
1205  -----      DSM    OOS-MT-DSBLD Manual        -----
      DSM PORT A                OOS-MT        Unavail      -----
              ALARM STATUS      = ** 0084 IP Connection Unavailable
      DSM PORT B                OOS-MT        Unavail      -----
              ALARM STATUS      = ** 0084 IP Connection Unavailable
      INP STAT                  = -----
      CARD ALARM STATUS = No Alarms.
      DSM MEMORY USAGE = 0%
      Command Completed.
;

```

Possible system response when a specific card is queried, and the EIR feature and the G-Flex, G-Port, or PPSMS feature are turned on. The example also shows that DSM Port A has an IP Connection Unavailable alarm due to failed channels Dnld, TCP, and UDP. DSM Port B has an IP Connection Unavailable alarm due to failed channels Dnld and TCP.

```
rept-stat-mps:loc=1205
```

```

Integrat40 05-05-24 10:37:22 EST  EAGLE5 34.0.0
CARD  VERSION      TYPE    PST           SST           AST
1205  -----      DSM    OOS-MT-DSBLD Manual        -----
      DSM PORT A                OOS-MT        Unavail      -----
              ALARM STATUS      = ** 0084 IP Connection Unavailable
      DSM PORT B                OOS-MT        Unavail      -----
              ALARM STATUS      = ** 0084 IP Connection Unavailable
      GSM STAT                  = -----
      EIR STAT                  = -----
      CARD ALARM STATUS = No Alarms.
      DSM MEMORY USAGE = 0%
      Command Completed.
;

```

Possible system response if a specific card is queried, and the G-Flex or G-Port feature and the V-Flex feature are turned on:

```
rept-stat-mps:loc=1205
```

```

Integrat40 08-05-07 11:37:24 EST  EAGLE5 39.0.0
CARD  VERSION      TYPE    PST           SST           AST

```

```

1205 ----- DSM OOS-MT-DSBLD Manual -----
      DSM PORT A OOS-MT Unavail -----
            ALARM STATUS = ** 0084 IP Connection Unavailable
      DSM PORT B OOS-MT Unavail -----
            ALARM STATUS = ** 0084 IP Connection Unavailable
      GSM STAT = -----
      VFLEX STAT = -----
      CARD ALARM STATUS = No Alarms.
      DSM MEMORY USAGE = 0%
      Command Completed.
;

```

Possible system response if the EIR, INP or AINPQ, V-Flex, and the G-Port, G-Flex, or PPSMS features are turned on, and the ATINP feature is enabled.

rept-stat-mps

```

rlghncxa03w 09-01-07 10:23:93 EST EAGLE 40.0.0
      VERSION      PST      SST      AST
EPAP A      027-015-000 IS-NR      Active    -----
CRITICAL PLATFORM ALARM DATA = No Alarms
MAJOR PLATFORM ALARM DATA = No Alarms
MINOR PLATFORM ALARM DATA = No Alarms
CRITICAL APPLICATION ALARM DATA = No Alarms
MAJOR APPLICATION ALARM DATA = No Alarms
MINOR APPLICATION ALARM DATA = No Alarms
      ALARM STATUS = No Alarms

      VERSION      PST      SST      AST
EPAP B      027-015-000 OOS-MT      Fault     Standby
CRITICAL PLATFORM ALARM DATA = No Alarms
MAJOR PLATFORM ALARM DATA = No Alarms
MINOR PLATFORM ALARM DATA = No Alarms
CRITICAL APPLICATION ALARM DATA = No Alarms
MAJOR APPLICATION ALARM DATA = No Alarms
MINOR APPLICATION ALARM DATA = No Alarms
      ALARM STATUS = No Alarms

CARD PST      SST      GSM STAT
1106 P IS-NR      Active    ACT
1201 IS-ANR      Active    SWDL
1205 OOS-MT-DSBLD Manual    -----
1302 OOS-MT      Isolated -----
1310 IS-ANR      Standby   SWDL
CARD PST      SST      INP STAT
1106 P IS-NR      Active    ACT
1201 IS-ANR      Active    SWDL
1205 OOS-MT-DSBLD Manual    -----
1302 OOS-MT      Isolated -----
1310 IS-ANR      Standby   SWDL
CARD PST      SST      EIR STAT
1106 P IS-NR      Active    ACT
1201 IS-ANR      Active    SWDL
1205 OOS-MT-DSBLD Manual    -----

```

```

1302 OOS-MT      Isolated  -----
1310 IS-ANR     Standby  SWDL
CARD PST       SST       V-FLEX STAT
1106 P IS-NR   Active  ACT
1201 IS-ANR     Active  SWDL
1205 OOS-MT-DSBLD Manual  -----
1302 OOS-MT     Isolated  -----
1310 IS-ANR     Standby  SWDL
CARD PST       SST       ATINPQ STAT
1106 P IS-NR   Active  ACT
1201 IS-ANR     Active  SWDL
1205 OOS-MT-DSBLD Manual  -----
1302 OOS-MT     Isolated  -----
1310 IS-ANR     Standby  SWDL

```

```

CARD 1106 ALARM STATUS = No Alarms
  DSM PORT A:      ALARM STATUS      = No Alarms
  DSM PORT B:      ALARM STATUS      = No Alarms
CARD 1201 ALARM STATUS = No Alarms
  DSM PORT A:      ALARM STATUS      = No Alarms
  DSM PORT B:      ALARM STATUS      = No Alarms
CARD 1205 ALARM STATUS = No Alarms
  DSM PORT A:      ALARM STATUS      = No Alarms
  DSM PORT B:      ALARM STATUS      = No Alarms
CARD 1302 ALARM STATUS = No Alarms
  DSM PORT A:      ALARM STATUS      = No Alarms
  DSM PORT B:      ALARM STATUS      = No Alarms
CARD 1310 ALARM STATUS = No Alarms
  DSM PORT A:      ALARM STATUS      = No Alarms
  DSM PORT B:      ALARM STATUS      = No Alarms
Command Completed.

```

;

This example shows the possible system response if a SIP card is queried and the SIP NP feature is turned on:

```
rept-stat-mps:loc=1101
```

```

tekelecstp 12-07-26 14:41:09 EST EAGLE
45.0.0
rept-stat-
mps:loc=1101

```

```
Command entered at terminal #4.
```

;

```

tekelecstp 12-07-26 14:41:09 EST EAGLE 45.0.0
CARD      VERSION      TYPE  PST           SST           AST
1101     -----      DSM  OOST-MT-DSBLD MEA           -----
          DSM PORT A           OOS-MT       Unavail       -----
                  ALARM STATUS      = ** 0084 IP Connection unavailable
                              Failed Channels: Prov Dnld UDP
          CARD ALARM STATUS      = ** 0441 Incorrect MBD - CPU

```



DSM MEMORY USAGE = ---%

Command Completed.

;

The following example is when Dual ExAP Config feature is enabled and both LNP and EPAP base features turned ON:

```
exap 12-07-02 15:42:53 MST EAGLE 45.0.0-64.34.0
rept-stat-mps
Command entered at terminal #3.
```

;

```
exap 12-07-02 15:42:53 MST EAGLE 45.0.0-64.34.0
                                VERSION      PST          SST          AST
ELAP A                          009-000-000  IS-ANR       Fault        Standby
  CRITICAL PLATFORM  ALARM DATA = No Alarms
  MAJOR   PLATFORM  ALARM DATA = H'3000000000e01001
  MINOR   PLATFORM  ALARM DATA = H'5000000000000200
  CRITICAL APPLICATION ALARM DATA = No Alarms
  MAJOR   APPLICATION ALARM DATA = No Alarms
  MINOR   APPLICATION ALARM DATA = No Alarms
                                ALARM STATUS = ** 0372 Major Platform Failure(s)
```

```
                                VERSION      PST          SST          AST
ELAP B                          009-000-000  IS-ANR       Fault        Active
  CRITICAL PLATFORM  ALARM DATA = No Alarms
  MAJOR   PLATFORM  ALARM DATA = H'3000000028000900
  MINOR   PLATFORM  ALARM DATA = H'5000000000000200
  CRITICAL APPLICATION ALARM DATA = No Alarms
  MAJOR   APPLICATION ALARM DATA = No Alarms
  MINOR   APPLICATION ALARM DATA = H'6000000000000200
                                ALARM STATUS = ** 0372 Major Platform Failure(s)
```

```
CARD  PST          SST          LNP STAT
1101 P IS-NR      Active      -----
```

CARD 1101 ALARM STATUS = No Alarms.

DSM PORT A: ALARM STATUS = No Alarms.

DSM PORT B: ALARM STATUS = No Alarms.

```
                                VERSION      PST          SST          AST
EPAP A                          013-000-000  IS-ANR       Fault        Standby
  CRITICAL PLATFORM  ALARM DATA = No Alarms
  MAJOR   PLATFORM  ALARM DATA = No Alarms
  MINOR   PLATFORM  ALARM DATA = No Alarms
  CRITICAL APPLICATION ALARM DATA = No Alarms
  MAJOR   APPLICATION ALARM DATA = No Alarms
  MINOR   APPLICATION ALARM DATA = H'6000000000000008
                                ALARM STATUS = * 0375 Minor Application
```

Failure(s)

```

                VERSION      PST           SST           AST
EPAP B          013-000-000  IS-ANR        Fault         Active
  CRITICAL PLATFORM  ALARM DATA = No Alarms
  MAJOR   PLATFORM  ALARM DATA = No Alarms
  MINOR   PLATFORM  ALARM DATA = No Alarms
  CRITICAL APPLICATION ALARM DATA = No Alarms
  MAJOR   APPLICATION ALARM DATA = No Alarms
  MINOR   APPLICATION ALARM DATA = H'6000000000000008
                ALARM STATUS      = * 0375 Minor Application Failure(s)

```

```

CARD  PST           SST           GSM STAT
1111 P IS-NR        Active         ACT

```

```

CARD  PST           SST           EIR STAT
1111 P IS-NR        Active         -----

```

```

CARD 1111 ALARM STATUS = No Alarms.
  DSM PORT A:          ALARM STATUS      = No Alarms.
  DSM PORT B:          ALARM STATUS      = No Alarms.

```

Command Completed.

;

This example shows the possible system response if a DEIR card is queried and the S13/S13' EIR feature is turned ON:

```
rept-stat-mps:loc=1101
```

```

tekelecstp 13-03-14 14:41:09 EST EAGLE 45.1.0
rept-stat-mps:loc=1101
Command entered at terminal #4.

```

;

```

tekelecstp 13-03-14 14:41:09 EST EAGLE 45.1.0
CARD  VERSION      TYPE     PST           SST           AST
1101  -----      DSM     OOS-MT-DSBLD MEA           -----
  DSM PORT A                OOS-MT        Unavail       -----
                ALARM STATUS      = ** 0084 IP Connection Unavailable
                Failed Channels:  Prov Dnld UDP
CARD ALARM STATUS = ** 0441 Incorrect MBD - CPU
DSM MEMORY USAGE = ---%

```

Command Completed.

;

This example shows the possible system response if an ENUM card is queried:

```
rept-stat-mps:loc=1101
```

```
tekelecstp 14-05-14 14:41:09 EST EAGLE 46.1.0
rept-stat-mps:loc=1101
Command entered at terminal #4.
```

```
;
```

```
tekelecstp 14-05-14 14:41:09 EST EAGLE 46.1.0
CARD   VERSION      TYPE   PST           SST           AST
1101   -----      DSM   OOS-MT-DSBLD MEA           -----
      DSM PORT A           OOS-MT       Unavail       -----
      ALARM STATUS       = ** 0084 IP Connection Unavailable
      Failed Channels:  Prov Dnld UDP
      CARD ALARM STATUS = ** 0441 Incorrect MBD - CPU
      DSM MEMORY USAGE  = ---%
```

```
Command Completed.
```

```
;
```

## Legend

- **CARD**—Location of the Service Module card. The Service Module card with the designator “P” to the right of its card location is the primary Service Module card as selected by the active ELAP/EPAP. The primary Service Module card provides the ELAP/EPAP status to the OAM. When the primary state (PST) of the ELAP/EPAP is IS-NR, the secondary state (SST) indicates whether the ELAP/EPAP is active or standby.
- **VERSION**—Version number of the GPL that the specified ELAP/EPAP or card is running.
- **PST**—Primary state of the ELAP/EPAP or card. Possible values are described in [Possible Values for PST/SST/AST](#).
- **SST**—Secondary state of the ELAP/EPAP or card. Possible values are described in [Possible Values for PST/SST/AST](#).
- **AST**—Associated state of the ELAP/EPAP or card. Possible values are described in [Possible Values for PST/SST/AST](#).
- **EPAP/ELAP A/B**—Application running on the MPS (multi-purpose server) platform. If the LNP ELAP Configuration feature is turned on, the output shows ELAP A/B. If INP, G-Flex, G-Port, or V-Flex is turned on, the output shows EPAP A/B.
- **ALARM STATUS**—List of trouble text alarm messages that have been generated for the MPS and the applications running on the MPS. Each alarm is listed as a 16-character hexadecimal string where each bit represents a unique platform or application alarm. To decode the string, use the procedure in the *EPAP Administration Guide* or the *ELAP Administration and LNP Feature Activation Guide*. There are 6 categories of MPS alarms:
  - Critical platform alarm data
  - Major platform alarm data
  - Minor platform alarm data
  - Critical application alarm data

- Major application alarm data
- Minor application alarm data
- **GSM STAT**—Possible states are ACT (active) or SWDL (the GSM component on that card is inactive until the software download completes). GSM STAT information is not displayed if the G-Port, G-Flex and Prepaid SMS Intercept Ph1 features are turned off.
- **INP STAT**—Possible states include ACT (active), OFFL (offline) and SWDL (the INP component on that card is inactive until the software download completes). INP STAT information is not displayed if the INP feature is turned off.
- **LNP STAT**—Possible states include ACT (active), OFFL (offline) and SWDL (the LNP component on that card is inactive until the software download completes). LNP STAT information is not displayed if the LNP ELAP Configuration feature is turned off.
- **EIR STAT**—Possible states include ACT (active), OFFL (offline), and SWDL (the EIR component on that card is inactive until software download completes). EIR STAT information is not displayed if the EIR feature is not enabled.
- **VFLEX STAT**—Possible states include ACT (active), OFFL (offline), and SWDL (the V-Flex component on that card is inactive until software download completes). V-Flex STAT information is not displayed if the V-Flex feature is not on.
- **ATINPQ STAT**—Possible states include ACT (active), OFFL (offline), and SWDL (the ATINPQ component on that card is inactive until software download completes). ATINPQ STAT information is not displayed if the ATINP feature is not enabled.
- **DSM MEMORY USAGE**—Percentage of Service Module memory used to store the ELAP/EPAP database.  
For EPAP, the percentage of the card memory is displayed. For example, 50% of the memory on an E5-SM4G-B card means that 2GB are used.  
  
For ELAP/LNP, the percentage that is displayed depends on the enabled or default feature access key (FAK) quantity for LNP ported TNs, LNP ported LRNs, and LNP ported NPANXXs in the system (see the `rtv-ctrl-feat` command output). The percentage is the greatest of: 1) TNs provisioned divided by LNP ported TNs FAK quantity, 2) LRNs provisioned divided by LNP ported LRNs FAK quantity, or 3) NPANXXs provisioned divided by LNP ported NPANXXs FAK quantity.
- **CARD XXXX ALARM STATUS**—List of trouble text alarm messages that have been generated for the card
- **DSM Port A/B**—List of trouble text alarm messages that have been generated for the port on the Service Module card.
- **IP Connection Unavailable**—The failed channels on those ports with IP Connection Unavailable alarms. Possible channels reported are:
  - Prov—RTDB Provisioning Channel
  - Dnld—RTDB Download Channel
  - TCP—Transmission Control Protocol Channel
  - UDP—User Datagram Protocol Channel

#### Related Topics

- [rept-stat-card](#)
- [rept-stat-sccp](#)

## rept-stat-mux

Use this command to list all the MUX cards and the location and status of the cards.

### Parameters

This command has no parameters.

### Example

```
rept-stat-mux
```

### Dependencies

None

### Notes

None

### Output

```
rept-stat-mux
```

```

tekelecstp 10-02-21 11:19:03 EST EAGLE 42.0.0
CARD TYPE PST SST AST BITRATE
BITRATE BERT
(OPER)
(ACT) STATUS
-----
----
1109 HIPR2 IS-NR Active ----- HIGH
LOW PASS
1110 HIPR2 IS-NR Active ----- HIGH
LOW UNKNOWN
1209 HIPR2 IS-NR Active ----- HIGH
LOW FAIL
1210 HIPR2 IS-NR Active ----- HIGH
LOW PASS
Command Completed.
;
```

### Legend

- **CARD**—MUX card location
- **TYPE**—Type of card
- **PST**—Primary state of the card. Possible values are described in [Possible Values for PST/SST/AST](#) in Appendix A.
- **SST**—Secondary state of the card. Possible values are described in [Possible Values for PST/SST/AST](#) in Appendix A.

- **AST**—Associated state of the card. Possible values are described in [Possible Values for PST/SST/AST](#) in Appendix A.
- **BITRATE(OPER)**—Maximum operational bit rate that the Fibre-Channel ring is capable of. If the operational bit rate is HIGH, the Fibre-Channel ring can be switched between the HIGH rate and the LOW rate.
- **BITRATE(ACT)**—Bit rate currently used by the Fibre-Channel ring. This rate is determined by various parameters such as the operational bit rate of the other bus, availability of a High Rate Feature Access Key, etc.
- **BERT STATUS**—BERT (Bit Error Rate Test) status of the MUX card. BERT is a diagnostic test that is initiated by the MUX cards on the IMT Bus during Bus alignment. Possible values are:
  - **PASS**—BERT passed for the MUX card
  - **FAIL**—BERT failed for the MUX card
  - **UNKNOWN**— This value should not be seen. If it is observed, please contact My Oracle Support (MOS).

#### Related Topics

- [rept-stat-card](#)

## rept-stat-rtd

Use this command to report Run Time Diagnostics (RTD) for EAGLE cards, including the status of internal integrity checks and the RTD subsystem alarm. This display can help determine the cause when an RTD subsystem alarm occurs, or when associated issues are reported.

This command is also used to reset MSU validation statistics and clear the RTD subsystem alarm.

#### Parameters

##### **force (optional)**

This parameter is used with the `reset=yes` parameter to clear statistics for a card when the RTD subsystem alarm is present.

##### **Range:**

**yes**

##### **loc (optional)**

Location. The card location as stenciled on the shelf of the system.



##### **Note:**

This parameter can be used to either retrieve or reset statistics for a card location. To reset the statistics, the `loc` and `reset` parameters must be specified together in the command.

**Range:**

1101 - 1108, 1111 - 1112, 1201 - 1208, 1211 - 1218, 1301 - 1308, 1311 - 1318,  
2101 - 2108, 2111 - 2118, 2201 - 2208, 2211 - 2218, 2301 - 2308, 2311 - 2318,  
3101 - 3108, 3111 - 3118, 3201 - 3208, 3211 - 3218, 3301 - 3308, 3311 - 3318,  
4101 - 4108, 4111 - 4118, 4201 - 4208, 4211 - 4218, 4301 - 4308, 4311 - 4318,  
5101 - 5108, 5111 - 5118, 5201 - 5208, 5211 - 5218, 5301 - 5308, 5311 - 5318,  
6101 - 6108, 6111 - 6118

**reset (optional)**

This parameter clears the statistics by setting them to zero and resets the checksum card indicator error and RTD subsystem alarm.

**Range: yes**

Clears the statistics.

If this parameter is specified with the `loc` parameter, then statistics are cleared for the specified card. If this parameter is specified, and the `loc` parameter is not specified, then statistics are cleared for all cards in the system.

**Example**

```
rept-stat-rtd
rept-stat-rtd:loc=1107
rept-stat-rtd:reset=yes:force=yes
rept-stat-rtd:loc=1107:reset=yes
```

**Dependencies**

If the `reset=yes` parameter is specified, then the `force=yes` parameter must be specified to clear the statistics and checksum failure indicators.

The card specified by the `loc` parameter must be an IPLIMx, IPGWx, IPSG, SCCP, Service Module E5-E1T1-B, E5-ATM-B card.

The card in the location specified by the `loc` parameter must be in service.

The `reset=yes` parameter must be specified to clear the statistics.

The `force=yes` parameter must be specified.

The `loc` parameter cannot have a non-numeric value.

The following card locations are not valid for this command: 1114, 1116, 1117, 1118 (E5-TDM and E5-MDAL cards), and all xy09 and xy10 locations where x is the frame and y is the shelf (MUX cards).

The card slot must be equipped and in service.

**Notes****MSU Validation Statistics**

The statistics from internal integrity checks are displayed for all in-service LIM and SCCP cards. The reported statistics are dynamic and are not maintained when a card is re-initialized.

The displayed reports contain message validation totals since the last time the diagnostic information for the cards was reset.

The individual statistics that are reported re-start at zero after the maximum values are reached and are cleared when reset by the `rept-stat-rtd` command.

### Summary Report (rept-stat-rtd)

The report displayed shows the summary statistics or overall totals for MSU validation statistics for all LIM and SCCP cards in the system. It also includes the status for the RTD subsystem and the RTD subsystem alarm.

### Card Summary Report (rept-stat-rtd:loc=)

When the `loc` parameter is specified in the `rept-stat-rtd` command, the report displayed shows the detailed MSU validation statistics report for the specified card. The report shows statistics from integrity checks performed by the specified card on MSUs transferred to and from LIM/SCCP cards and includes the timestamp when the card last detected an error during integrity checks. The statistics are only displayed for cards with non-zero totals.

The integrity checks are performed on a subset of the MSUs transferred between cards. When card(s) report errors during the integrity checks, the RTD subsystem alarm is activated. The error statistics reported should be used along with the UIMs or alarms to help identify the source of the problem.

### RTD Subsystem Alarm

The RTD subsystem alarm is triggered when a card reports that a checksum error was detected during internal card integrity checks.

The RTD subsystem alarm remains active in the system until the statistics are reset using the `rept-stat-rtd` command, and no further indications of checksum errors are reported during internal card integrity checks.

### Output

If the `rept-stat-rtd` command is entered with no parameters, then a summary status for the RTD subsystem and alarm and summary statistics for all of the LIM/SCCP cards in the system are displayed.

If the `loc` parameter is specified in the `rept-stat-rtd` command, then detailed statistics are displayed for the specified card location. Only cards with non-zero totals are reported in the location specific report.

This example displays a summary report on the status of the RTD subsystem and RTD subsystem alarm with MSU validation statistics for all LIM/SCCP cards in the system.

```
rept-stat-rtd
```

```
eagle10110 07-02-22 20:32:58 EST EAGLE 35.6.0
Retrieving data from cards...
```

```
RTD SUBSYSTEM REPORT IS-NR Active -----
RTD ALARM STATUS = No Alarms
```

```
MSU Validation Statistics
=====
Total Rx Total Rx Total
```



CARD	Error	Validated	Tx
1101	0	275	710
1102	0	200	200
1103	0	200	1000
1105	0	1360	275
1107	0	200	100
1108	0	100	100

```
-----
---
      END OF REPORT
;
```

This example displays a detailed report for card 1101. The report indicates that the card received MSUs from several cards in the system.

```
rept-stat-rtd:loc=1101
```

```
eagle10110 07-02-22 20:32:58 EST  EAGLE 35.6.0
Retrieving data from card ...
CARD SUMMARY: 1101      Last Alarm Timestamp: -----
```

#### MSU Validation

Statistics

```
=====
SRC/DEST      Total Rx      Total Rx      Total Tx
              Error       Validated
CARD
1102           0           100           100
1103           0            0            0
1105           0            75           360
1107           0           100           200
1108           0            50            50
```

```
-----
---
      ;END OF REPORT
;
```

This example displays a summary report for cards 1101 - 1108. The report indicates that the cards received checksum errors in MSUs from other cards.

```
rept-stat-rtd
```

```
eagle10110 07-02-22 20:32:58 EST  EAGLE 35.6.0
Retrieving data from card...

RTD  SUBSYSTEM REPORT IS-ANR      Active      -----
RTD  ALARM STATUS = 541 MSU cksum error threshold exceeded
```

```

MSU Validation Statistics
=====
CARD      Total Rx   Total Rx   Total
          Error   Validated  Tx
1101      100       275       500
1102       25       200       300
1103        0       200       500
1105        0       600       125
1107       50       250       100
1108        0       100       100

```

```

-----
;END OF REPORT
;

```

This example displays a detailed report for card 1101. The report indicates that the card received MSUs with checksums from cards 1102, 1103, and 1105 and MSUs with checksum errors from card 1103.

```
rept-stat-rtd:loc=1101
```

```

eagle10110 07-02-22 20:32:58 EST EAGLE 35.6.0
Retrieving data from card ...
CARD SUMMARY: 1101      Last Alarm Timestamp: mm-dd-yy hh:mm:ss

```

```

MSU Validation Statistics
=====
SRC/DEST  Total Rx   Total Rx   Total Tx
          Error   Validated
CARD
1102        0         75       100
1103       100       100       100
1105        0       100       100
1107        0         0       100
1108        0         0       100

```

This example displays the option for resetting MSU validation statistics of all cards in the system.

```
rept-stat-rtd:reset=yes
```

```

eagle10110 07-02-22 20:32:58 EST EAGLE 35.6.0
Clear RTD Statistics command(s) issued...
Command Completed.
;

```

This example displays the option for resetting MSU validation statistics and checksum failure indicators for all cards in the system and clearing the RTD subsystem alarm.

```
rept-stat-card:reset=yes:force=yes
```

```
eagle10110 07-02-22 20:34:06 EST EAGLE 35.6  
Clear RTD Statistics command(s) issued...  
Command Completed.
```

```
eagle10110 07-02-22 20:32:58 EST EAGLE 35.6.0  
5501.0542 RTD SYSTEM MSU cksum error threshold  
cleared  
;
```

## Legend

This section defines the fields of the `rept-stat-rtd` reports.

**PST**—Possible values are described in [Possible Values for PST/SST/AST](#). For this command, IS-NR specifically means no checksum errors were found during the last reporting period; IS-ANR specifically means that a card or cards reported checksum errors during MSU integrity checks when the RTD status was previously IS-NR, and the RTD System Alarm(s) was raised.

**Total Rx Error** (for a Summary Report)—Total MSUs received with checksum errors, including MSUs with checksum errors received from all cards in the system.

**Total Rx Error** (for a Location-Specified Report)—Total MSUs with checksum errors received at the card specified by the LOC parameter from SRC/DEST CARD.

**Total Rx Validated** (for a Summary Report)—Total MSUs with checksum received and validated from all cards in the system.

**Total Rx Validated** (for a Location-Specified Report)—Total MSUs with checksum received and validated at the card specified by the LOC parameter from SRC/DEST CARD.

**Total Tx** (for a Summary Report)—Total MSUs with checksum applied and transmitted to all cards in the system.

**Total Tx** (for a Location-Specified Report)—Total MSUs with checksums transmitted from the card specified in the LOC parameter to SRC/DEST CARD.

**Last Alarm Timestamp**—Timestamp for last reported checksum error for the card specified in the LOC parameter.

**SRC/DEST CARD**—Source card transmitting MSUs with checksums received by the card specified in the LOC parameter. Destination card receiving MSUs with checksums transmitted from card specified in LOC parameter.

**RTD Subsystem**—Indicates RTD Device Status (IS-NR, etc.).

**RTD Alarm Status**—Indicates whether an alarm is present for the RTD Device.

## rept-stat-rte

Use this command to display the signaling route status for a particular destination.

## Parameters

### dpc (optional)

**Range:**

*p-*, 000-255, \*, \*\*, \*\*\*

Specify a valid value for each subfield of the point code, and separate the subfields with a dash (-).

*prefix—p-*

The asterisk values \*, \*\*, and \*\*\* are not valid for the *ni* subfield.

If \*\* or \*\*\* is specified for the *nc* subfield, either \*, \*\*, or \*\*\* must be specified for the *ncm* subfield.

When *chg-sid:pctype=ansi* is specified, *ni=000* is not valid.

When *chg-sid:pctype=ansi* is specified, *nc=000* is not valid if *ni=001-005*.

When *chg-sid:pctype=ansi* is specified, *nc=000* is valid if *ni=006-255*.

When *chg-sid:pctype=ansi* is specified, *ni-\*-\** is valid if *ni= 006-255*.

The point code 000-000-000 is not a valid point code.

### dpc/dpca/dpci/dpcn/dpcn24/dpcn16 (optional)

Destination point code.

### dpci (optional)

**Range:**

*s-*, *p-*, *ps-*, 0-255

Specify a valid value for each subfield of the point code, and separate the subfields with a dash (-).

*prefix—s-, p-, ps*

*zone—0-7*

*area—000-255*

*id—0-7*

The point code 0-000-0 is not a valid point code.

### dpcn (optional)

**Range:**

*s-*, *p-*, *ps-*, 0-16383, *aa-zz*

Specify a valid value for each subfield of the point code, and separate the subfields with a dash (-).

*prefix—s-, p-, ps*

*nnnnn—0-16383*

*gc—aa-zz*

*m1-m2-m3-m4—0-14* for each member; values must sum to 14

### dpcn24 (optional)

**Range:**

*p-*, 000-255

Specify a valid value for each subfield of the point code, and separate the subfields with a dash (-).

*prefix—p*

*msa—000-255*

*ssa—000-255*

*sp—000-255*

**dpcn16 (optional)****Range:**

*p--*, *000---127*

Specify a valid value for each subfield of the point code, and separate the subfields with a dash (-).

*prefix---p*

*un---000---127*

*sna---000---15*

*mna---000---31*

**mode (optional)**

This parameter specifies the type of display to produce.

**Range:*****full***

Comprehensive display of point code status, including *rtx*. If specified with a point code, then the status for that point code is displayed. If specified without a point code, then the status of all routes is displayed.

***rtx***

Displays exception route status, other than circular routing, if the Origin-based MTP Routing feature is on.

**Default:**

A summary report is displayed.

**stat (optional)**

The primary state filter.

**Range:*****all***

All of the primary states

***alminh***

Alarms inhibited

***anr***

In service abnormal (IS-ANR)

***dsbld***

Out of service maintenance disabled (OOS-MT-DSBLD)

***mt***

Out of service maintenance (OOS-MT)

***nr***

In service normal (IS-NR)

**Default:***all***Example**

```
rept-stat-rte
rept-stat-rte:dpc=5-25-0
rept-stat-rte:dpci=5-5-0:mode=full
rept-stat-rte:dpci=5-5-0:mode=rtx
rept-stat-rte:mode=rtx
rept-stat-rte:mode=full
rept-stat-rte:dpc=5-25-**
rept-stat-rte:dpcn16=1-2-3
```

**Dependencies**

An x-list DPC cannot be specified in the `dpc` parameter.

If the `mode=full` parameter is specified, then the `dpc/dpca/dpcn/dpci/dpcn24` parameter must be specified.

If the `dpc` parameter specifies an `ni-nc-*` format, then the `mode` parameter cannot be specified.

The `dpc` parameter must specify `anni-nc-*` format before the `stat` parameter can be specified with the `dpc` parameter.

No other `rept-stat-xxx` command can be in progress when this command is entered.

If a `dpc` parameter is specified, then the value must be the true destination point code (not an alias) and the value must be defined in the database.

The Origin-Based MTP Routing feature must be turned on before the `mode=rtx` parameter can be specified.

The destination address must be a full point code, a network destination, or a cluster point code.

The `pst` and `mode` parameters cannot be specified together in the command.

**Notes**

This command can be canceled using the **F9** function key or the `canc-cmd` command. See `canc-cmd` for more information.

This command does not report the x-list point codes. Use the `rept-stat-cluster` command for a report of x-list point codes.

If the `mode=rtx` parameter is specified with a specific DPC, additional linkset, route and exception route information associated with the specified DPC is displayed.

In this command, only ITU-international and ITU national point codes support the spare point code subtype prefix (s-) and the private and spare point code subtype prefix (ps-). All of the point code types support the private (internal) point code subtype prefix (p-).

## Summary of DPC parameter syntaxes

- `rept-stat-dstn:dpc=ni-nc-ncm` —Requests a report for fully provisioned destination *ni-nc-ncm*.
- `rept-stat-dstn:dpc= ni-***` —Requests a report for provisioned network destination with the specified network indicator. If *\** is specified in the *nc* field, *\** must be specified in the *ncm* field.
- `rept-stat-dstn:dpc= ni-***-` —Requests a report for the full network cluster for the specified *ni*.
- `rept-stat-dstn:dpc= ni-***-` — Requests a report for the full network cluster and the network cluster address (if any) for the specified *ni*.
- `rept-stat-dstn:dpc= ni-nc-*` —Requests a report for provisioned cluster destination *ni-nc-\**.
- `rept-stat-dstn:dpc= ni-nc-***` —Requests a report showing all destinations whose network (*ni*) and cluster (*nc*) components match those specified. Note, however, that the network cluster address on *ni-nc-\** (if it exists) is not reported.
- `rept-stat-dstn:dpc= ni-nc-***` —Requests a report showing all destinations whose network (*ni*) and cluster (*nc*) components match those specified. The network cluster address (if it exists) is also reported.
- `rept-stat-dstn:dpcn24=msa-ssasp` —Requests a report for fully provisioned 24-bit destination point *main signaling area-sub signaling area signaling point*.

If the `mode=rtx` parameter is specified without a specific DPC, then status is provided for all exception route sets.

If the `mode=full` parameter is specified with a specific destination point code, then additional linkset, route, and exception route information associated with the specified destination is displayed, along with information that can be used to correct circular routing. If the `mode=full` parameter is specified without a specific destination point code, then status is provided for all regular and exception route sets.

## Output

If the `dpc` parameter is not specified:

- If the `mode` parameter is not specified, then the command output lists the status of all provisioned destination point codes (DPCs) (routesets) in the system.
- If the `mode=rtx` parameter is specified, then the output lists the status of only those DPCs against which exception routes have been provisioned, and the status of the provisioned exception route sets associated with each DPCs.
- If the `mode=full` parameter is specified, then the command lists the status of all provisioned DPCs in the system, and the status of the provisioned exception route sets, if any, associated with each DPC.

If the `dpc` parameter is specified:

- If the `mode` parameter is not specified, then the output lists the status of all provisioned routes in the route set specified by that DPC.

- If the `mode=rtx` parameter is specified, then the output lists the status of all provisioned routes in the routeset specified by that DPC, and the status of all provisioned exception routesets associated with that DPC.
- If the `mode=full` parameter is specified, then the output lists the status of all provisioned routes in the routeset specified by that DPC, the status of all provisioned exception route sets associated with that DPC, any aliases associated with that DPC, and circular routing alarm information if any for that DPC.

This example shows how summary information for all provisioned cluster and noncluster DPCs is reported.

```
rept-stat-rte
```

```
tekelecstp 10-10-15 14:59:49 EST  EAGLE 43.0.0
rept-stat-rte
Command entered at terminal #4.
Extended Processing Time may be Required
  DPCA          PST          SST          AST
001-001-003    OOS-MT        Idle         INACCESS
001-001-004    OOS-MT        Idle         INACCESS
001-001-005    OOS-MT        Idle         INACCESS
001-001-006    OOS-MT        Idle         INACCESS
001-001-007    OOS-MT        Idle         INACCESS
001-001-008    OOS-MT        Idle         INACCESS
001-001-009    OOS-MT        Idle         INACCESS
001-001-010    OOS-MT        Idle         INACCESS
001-001-011    OOS-MT        Idle         INACCESS
001-001-012    OOS-MT        Idle         INACCESS
001-001-013    OOS-MT        Idle         INACCESS
001-001-014    OOS-MT        Idle         INACCESS
001-001-015    OOS-MT        Idle         INACCESS
001-001-016    OOS-MT        Idle         INACCESS
001-001-017    OOS-MT        Idle         INACCESS
001-001-018    OOS-MT        Idle         INACCESS
001-001-019    OOS-MT        Idle         INACCESS
001-001-020    OOS-MT        Idle         INACCESS
001-001-021    OOS-MT        Idle         INACCESS
001-001-022    OOS-MT        Idle         INACCESS
001-001-023    OOS-MT        Idle         INACCESS
001-001-024    OOS-MT        Idle         INACCESS
001-001-025    OOS-MT        Idle         INACCESS
001-002-003    OOS-MT        Idle         INACCESS

  DPCN          PST          SST          AST

  DPCN24        PST          SST          AST

  DPCI          PST          SST          AST

Command Completed.
```

```
;
```



This example shows how specifying a cluster destination on the `dpc` parameter shows the cluster status and routeset information. Information on cluster members (both provisioned and x-list) is not shown. Use the `rept-stat-cluster` command to obtain this information.

```
rept-stat-rte:dpc=9-3-*
```

```
rlghncxa03w 04-07-07 14:59:11 EST EAGLE 31.9.0
DPCA          PST          SST          AST
009-003-*     IS-NR          Allowed     ACCESS
ALARM STATUS   = No Alarms.
RTE COST  LSN      APCA          LS STAT  NON-ADJ  ROUTE STAT
1*  10  lsnstpa  042-036-123  Allowed  Allowed  Allowed
2   20  lsnstpb 092-240-103  Allowed  Allowed  Allowed
3   30  lsnstpc 128-101-022  Allowed  Allowed  Allowed
4   --  -----  ***-***-***  -----  -----  -----
5   --  -----  ***-***-***  -----  -----  -----
6   --  -----  ***-***-***  -----  -----  -----
;
```

This example shows how specifying an FPC or cluster destination for which circular routing has been detected, along with the `mode=full` parameter, displays the name of the linkset on which the circular routing test message was transmitted. It also displays the linkset on which the circularly routed message was received.

```
rept-stat-rte:dpc=9-3-6:mode=full
```

```
rlghncxa03w 04-01-07 14:59:11 EST EAGLE 31.3.0
DPCA          PST          SST          AST
009-003-006   OOS-MT          Prohibit    INACCESS
ALARM STATUS   = = *C xxxx Circular routing detected
RTE COST  LSN      APCA          LS STAT  NON-ADJ  ROUTE STAT
1   10  lsnstpa  042-036-123  Allowed  Allowed  Allowed
2   20  lsnstpb 092-240-103  Allowed  Allowed  Allowed
3   30  lsnstpc 128-101-022  Allowed  Allowed  Allowed
4   --  -----  ***-***-***  -----  -----  -----
5   --  -----  ***-***-***  -----  -----  -----
6   --  -----  ***-***-***  -----  -----  -----
SSN        SUBSYSTEM STATUS

ALIASA      ALIASN      ALIASI
-----
CIRCULAR ROUTING
  XMIT LSN= lsnstpb
  RCV  LSN= lsn01a
MEMBER= ***-***-***
Command Completed.
;
```

This example shows a typical report when a cluster destination and `mode=full` is specified. The interpretation of the circular routing status for cluster destinations is slightly different from the status for full point code destinations.

```
rept-stat-rte:dpc=9-3-*:mode=full
```

```
rlghncxa03w 04-01-07 14:59:11 EST EAGLE 31.3.0
  DPCA          PST          SST          AST
  009-003-*     IS-NR          Allowed    ACCESS
ALARM STATUS    = *C xxxx Circular routing detected
RTE COST  LSN      APCA          LS STAT  NON-ADJ  ROUTE STAT
  1   10  lsnstpa  042-036-123 Allowed  Allowed  Allowed
  2   20  lsnstpb  092-240-103 Allowed  Allowed  Allowed
  3   30  lsnstpc  128-101-022 Allowed  Allowed  Allowed
  4   --  -----  ***-***-*** -----  -----  -----
  5   --  -----  ***-***-*** -----  -----  -----
  6   --  -----  ***-***-*** -----  -----  -----
SSN  SUBSYSTEM STATUS
ALIASA          ALIASN          ALIASI
-----  -----  -----
CIRCULAR ROUTING INFO:
XMIT LSN=lsnstpb RC=20
RCV LSN=lsn01a
MEMBER= 009-003-006
Command Completed.
```

```
;
```

This example shows how the circular routing alarm for a cluster destination is displayed. A circular routing alarm for a cluster destination indicates that circular routing was detected for a member of the cluster, but no x-list entry could be created for that cluster. Circular routing detected on a cluster destination does not automatically force the output to display the status of the cluster as “OOS-MT Prohibit INACCESS” as it does for a full point code destination.

```
rept-stat-rte:dpc=9-3-*
```

```
rlghncxa03w 04-01-07 14:59:11 EST EAGLE 31.3.0
  DPCA          PST          SST          AST
  009-003-*     IS-NR          Allowed    ACCESS
ALARM STATUS    = *C xxxx Circular routing detected
RTE COST  LSN      APCA          LS STAT  NON-ADJ  ROUTE STAT
  1   10  lsnstpa  042-036-123 Allowed  Allowed  Allowed
  2   20  lsnstpb  092-240-103 Allowed  Allowed  Allowed
  3   30  lsnstpc  128-101-022 Allowed  Allowed  Allowed
  4   --  -----  ***-***-*** -----  -----  -----
  5   --  -----  ***-***-*** -----  -----  -----
  6   --  -----  ***-***-*** -----  -----  -----
Command Completed.
```

```
;
```

This example shows how a subsystem information header is displayed without subsystem information, as when an FPC is specified without defining any subsystems. Because aliases cannot be defined for cluster destinations, this report shows only an empty header, as when an FPC is specified without defining aliases. The circular routing information portion of the report displays “-----” for the linkset names when no circular routing condition exists for the DPC.

```
rept-stat-rte:dpc=9-3-*:mode=full
```

```
rlghncxa03w 04-07-07 14:59:11 EST EAGLE 31.9.0
  DPCA          PST          SST          AST
  009-003-*     IS-NR       Allowed    ACCESS
ALARM STATUS    = No Alarms.
RTE COST  LSN      APCA          LS STAT    NON-ADJ    ROUTE STAT
  1*  10  lsnstpa  042-036-123  Allowed    Allowed    Allowed
  2   20  lsnstpb  092-240-103  Allowed    Allowed    Allowed
  3   30  lsnstpc  128-101-022  Allowed    Allowed    Allowed
  4   --  -----  ***-***-***  -----    -----    -----
  5   --  -----  ***-***-***  -----    -----    -----
  6   --  -----  ***-***-***  -----    -----    -----
SSN  SUBSYSTEM STATUS
ALIASA      ALIASN      ALIASI
-----
CIRCULAR ROUTING
  XMIT LSN= -----
  RCV  LSN= -----
  MEMBER= ***-***-***
Command Completed.
```

```
;
```

This example shows how specifying the `stat` parameter and the `ni-nc-*` or `ni-nc-***` DPC formats causes the output summary report to include only those destinations whose status matches the state specified.

```
rept-stat-rte:dpc=9-4-***:stat=alminh
```

```
rlghncxa03w 10-10-29 13:30:00 EST EAGLE 43.0.0
rept-stat-rte:dpc=9-4-***:stat=alminh
Command entered at terminal #4.
Extended Processing Time may be Required

  DPCA          PST          SST          AST
  009-004-006    IS-NR       Allowed    ALMINH
  009-004-007    IS-NR       Allowed    ALMINH
  .
  .
  .
  009-004-056    IS-NR       Allowed    ALMINH
Command Completed.
```

```
;
```

This example shows a retrieval specifying an ITU national point code where the `chg-stpopts:npcfmti` parameter has been set to `1-1-1-11`:

```
rept-stat-rte:dpcn=1-1-1-1000
```

```
rlghncxa03w 04-02-31 13:30:00 EST EAGLE 31.3.0
CAUTION : Node isolated...route status out of date!
```

```

DPCN          PST          SST          AST
1-1-1-1000    OOS-MT        Prohibit  INACCESS
ALARM STATUS  = *C 0313 DPC is prohibited
RTE COST LSN          APCN          LS STAT  NON-ADJ  ROUTE STAT
1  10  lsitu          1-1-1-1000  Prohibit  Allowed  Prohibit
2  --  -----          ***-***-***  -----  -----  -----
3  --  -----          ***-***-***  -----  -----  -----
4  --  -----          ***-***-***  -----  -----  -----
5  --  -----          ***-***-***  -----  -----  -----
6  --  -----          ***-***-***  -----  -----  -----
Command Completed.
;

```

This example shows a private adjacent point code:

```
rept-stat-rte:mode=full:dpc=1-1-2
```

```

rlghncxa03w 05-01-07 13:30:00 EST  EAGLE 31.12.0
DPCA          PST          SST          AST
001-001-002    OOS-MT        Idle        INACCESS
ALARM STATUS  = No Alarms.
RTE COST LSN          APCA          LS STAT  NON-ADJ  ROUTE STAT
1  01  ls11234567    001-001-002  Prohibit  Allowed  Prohibit
2  02  ls12345678    p-001-001-002  Prohibit  Allowed  Prohibit
3  --  -----          ***-***-***  -----  -----  -----
4  --  -----          ***-***-***  -----  -----  -----
5  --  -----          ***-***-***  -----  -----  -----
6  --  -----          ***-***-***  -----  -----  -----
SSN  SUBSYSTEM STATUS

ALIASA        ALIASN          ALIASI
000-000-001  -----          -----
CIRCULAR ROUTING INFO:
XMIT LSN=-----  RC=---
RCV LSN=-----
MEMBER =-----
Command Completed.
;

```

This example shows how the asterisks in the space after the route numbers in the following examples indicate which route (or combined route) is carrying traffic.

```
rept-stat-rte:dpc=1-1-1
```

```

tekelecstp 04-09-24 09:19:04 EST  EAGLE 31.9.0
DPCA          PST          SST          AST
001-001-001    IS-NR        Allowed  ACCESS
ALARM STATUS  = No Alarms.
RTE COST LSN          APCA          LS STAT  NON-ADJ  ROUTE STAT
1* 05  lse1e1          001-001-001  Allowed  Allowed  Allowed
2* 05  lse1e2          001-002-001  Allowed  Allowed  Allowed
3  10  lse1e3          001-003-001  Allowed  Allowed  Allowed

```

```

      4  --  -----  ***-***-***  -----  -----
-----
      5  --  -----  ***-***-***  -----  -----
-----
      6  --  -----  ***-***-***  -----  -----
-----

```

Command Completed.

;

This example shows how no asterisk appears after the route number when no routes were carrying traffic.

```
rept-stat-rte:dpc=1-1-1
```

```

tekelecstp 06-05-24 09:19:04 EST  EAGLE 35.0.0
  DPCA          PST          SST          AST
  001-001-001   OOS-MT         Prohibit    INACCESS
ALARM STATUS    = *C 0313 DPC is prohibited
RTE COST  LSN      APCA          LS STAT  NON-ADJ  ROUTE
STAT
  1   05  lse1e1    001-001-001  Prohibit  Allowed  Prohibit
  2   05  lse1e2    001-002-001  Prohibit  Allowed  Prohibit
  3   10  lse1e3    001-003-001  Prohibit  Allowed  Prohibit
  4   --  -----  ***-***-***  -----  -----  -----
  5   --  -----  ***-***-***  -----  -----  -----
  6   --  -----  ***-***-***  -----  -----  -----

```

Command Completed.

;

This example shows the output when the primary route is not carrying traffic.

```
rept-stat-rte:dpc=1-1-1
```

```

tekelecstp 06-05-24 09:19:04 EST  EAGLE 35.0.0
  DPCA          PST          SST          AST
  001-001-001   IS-ANR         Restrict    ACCESS
ALARM STATUS    = *C 0334 DPC Subsystem is Abnormal
RTE COST  LSN      APCA          LS STAT  NON-ADJ  ROUTE
STAT
  1   05  lse1e1    001-001-001  Prohibit  Allowed  Prohibit
  2   05  lse1e2    001-002-001  Prohibit  Allowed  Prohibit
  3*  10  lse1e3    001-003-001  Allowed   Allowed  Allowed
  4   --  -----  ***-***-***  -----  -----  -----
  5   --  -----  ***-***-***  -----  -----  -----
  6   --  -----  ***-***-***  -----  -----  -----

```

Command Completed.

;

This example shows how the *rtx* mode displays all exception route sets provisioned against the specified DPC when the Origin-Based MTP Routing feature is enabled and on:

```
rept-stat-rte:dpc=9-3-*:mode=rtx
```

```
tekelecstp 09-05-01 16:21:39 EST EAGLE 41.0.0
  DPCA          PST          SST          AST
  009-003-*     IS-NR          Allowed    ACCESS
ALARM STATUS   = No Alarms.
RTE COST  LSN      APCA          LS STAT    NON ADJ    ROUTE STAT
  1   10  lsnstpa  042-36-23  Allowed    Allowed    Allowed
  2   20  lsnstpb  092-40-03  Allowed    Allowed    Allowed
  3   30  lsnstpc  128-01-22  Prohibit   Prohibit   Allowed
  4   --  -----  ***-***-***  -----  -----  -----
  5   --  -----  ***-***-***  -----  -----  -----
  6   --  -----  ***-***-***  -----  -----  -----
```

Exception Routes:

```
  OPCA          PST          SST          AST
  001-001-001   IS-NR          Allowed    ACCESS
  ILSN          PST          SST          AST
  lsnstpy       IS-NR          Allowed    ACCESS
Command Completed.
```

This example shows how all provisioned exception route sets are displayed in addition to the regular route sets when the Origin-Based MTP Routing feature is enabled and on and the *full* mode is specified.

```
rept-stat-rte:dpc=9-3-*:mode=full
```

```
tekelecstp 09-05-01 16:21:39 EST EAGLE 41.0.0
  DPCA          PST          SST          AST
  009-003-006   OOS-MT          Prohibit   INACCESS
ALARM STATUS   = = *C 0319 REPT-MTPLP-DET: Circ rte det(cong)
RTE COST  LSN      APCA          LS STAT    NON ADJ    ROUTE STAT
  1   10  lsnstpa  042-036-123 Allowed    Allowed    Allowed
  2   20  lsnstpb  092-240-103 Allowed    Allowed    Allowed
  3   30  lsnstpc  128-101-022 Allowed    Allowed    Allowed
  4   --  -----  ***-***-***  -----  -----  -----
  5   --  -----  ***-***-***  -----  -----  -----
  6   --  -----  ***-***-***  -----  -----  -----
SSN  SUBSYSTEM STATUS
```

```
  ALIASA          ALIASN          ALIASI
  -----          -----          -----
CIRCULAR ROUTING INFO:
  XMIT LSN=lsnstpb  RC=20
  RCV  LSN=lsn01a
  MEMBER =-----
```

Exception Routes:

```
  OPCA          PST          SST          AST
  001-001-001   IS-NR          Allowed    ACCESS
```

ILSN	PST	SST	AST
lsnstpy	IS-NR	Allowed	ACCESS

Command Completed.

;

This example shows how all provisioned exception route sets are displayed in addition to the regular route sets if the Origin-Based MTP Routing feature is enabled and on and the *full* mode is specified.

```
rept-stat-rte:mode=full
```

```
tekelecstp 10-10-01 14:06:10 EST EAGLE 43.0.0
rept-stat-rte:mode=full
Command entered at terminal #4.
Extended Processing Time may be Required
```

DPCA	PST	SST	AST
004-004-004	OOS-MT	Idle	INACCESS
OPCA	PST	SST	AST
001-001-001	IS-NR	Allowed	ACCESS
ILSN	PST	SST	AST
lsnstpy	IS-NR	Allowed	ACCESS
DPCN	PST	SST	AST
00001	IS-NR	Allowed	ACCESS
SI	PST	SST	AST
10	IS-NR	Allowed	ACCESS
00002	IS-NR	Allowed	ACCESS
00005	OOS-MT	Prohibit	INACCESS
00004	OOS-MT	Prohibit	INACCESS
DPCN24	PST	SST	AST
DPCI	PST	SST	AST

Command Completed.

;

This example shows how all provisioned exception routes are displayed if the Origin-Based MTP Routing feature is enabled and on and the *rtx* mode is specified.

```
rept-stat-rte:mode=rtx
```

```
tekelecstp 10-10-29 14:06:10 EST EAGLE 43.0.0
rept-stat-dstn:mode=rtx
Command entered at terminal #4.
Extended Processing Time may be Required
```

DPCA	PST	SST	AST
004-004-004	OOS-MT	Idle	INACCESS





- **ILSN**—Originating linkset as exception routing criterion of the exception route
- **CIC**—Starting Circuit Identification Code used as the exception routing criterion for this exception route
- **ECIC**—Ending Circuit Identification Code together with CIC defines the CIC range that is used as exception routing criterion for this exception route.
- **PST**—Primary state of the subsystem. See [Possible Values for PST/SST/AST](#).
- **SST**—Secondary state of the subsystem. See [Possible Values for PST/SST/AST](#).
- **AST**—Associated state of the subsystem. See [Possible Values for PST/SST/AST](#).

#### Related Topics

- [chg-dstn](#)
- [chg-rte](#)
- [dlt-dstn](#)
- [dlt-rte](#)
- [ent-dstn](#)
- [ent-rte](#)
- [rept-stat-dstn](#)
- [rtv-dstn](#)
- [rtv-rte](#)

## rept-stat-rtkey

Use this command to generate a summary report of the status of the system routing keys.

#### Parameters

This command has no parameters.

#### Example

```
rept-stat-rtkey
```

#### Dependencies

None

#### Notes

The report generated by this command contains the following information:

- The maximum of static entries (SRKQ) in the routing key table
- The current number of static routing key entries in the routing key table
- The percentage of the static routing key table entries that is provisioned

## Output

```
rept-stat-rtkey
```

```
rlghncxa03w 10-10-27 14:59:11 EST EAGLE 43.0.0
```

```
SRKQ = 250
```

```
Static Route Key table is (50 of 250) 20% full
```

```
Static Route Key Socket Association table is (80 of 4000) 2% full
```

```
;
```

## Related Topics

- [chg-appl-rtkey](#)
- [dlt-appl-rtkey](#)
- [ent-appl-rtkey](#)
- [rtrv-appl-rtkey](#)

# rept-stat-rtx

Use this command to display the signaling route status for one or more exception routes to a particular destination.

## Parameters



### Note:

See [Point Code Formats and Conversion](#) for a detailed description of point code formats, rules for specification, and examples.

### **cic** (optional)

Starting Circuit Identification Code. This parameter is used alone or together with the `ecic` parameter as exception routing criteria for the specified exception route.

#### **Range:**

0 - 16383

### **dpc** (optional)

ANSI point code with subfields *network indicator-network cluster-network cluster member* (*ni-nc-ncm*). The *prefix* subfield indicates a private point code (*prefix-ni-nc-ncm*).

#### **Synonym:**

*dpca*

#### **Range:**

*p-*, 000-255, \*, \*\*, \*\*\*

Specify a valid value for each subfield of the point code, and separate the subfields with a dash (-).

*prefix—p-*

The asterisk values \*, \*\*, and \*\*\* are not valid for the *ni* subfield.

If \*\* or \*\*\* is specified for the *nc* subfield, either \*, \*\*, or \*\*\* must be specified for the *ncm* subfield.

When *chg-sid:pctype=ansi* is specified, *ni=000* is not valid.

When *chg-sid:pctype=ansi* is specified, *nc=000* is not valid if *ni=001-005*.

When *chg-sid:pctype=ansi* is specified, *nc=000* is valid if *ni=006-255*.

When *chg-sid:pctype=ansi* is specified, *ni-\*.\** is valid if *ni= 006-255*.

The point code *000-000-000* is not a valid point code.

#### **dpc/dpca/dpci/dpcn/dpcn24/dpcn16 (optional)**

Destination point code.

#### **dpci (optional)**

ITU international destination point code with subfields *zone-area-id*. The *prefix* subfield indicates a spare point code, private point code, or private and spare point code (*prefix-zone-area-id*).

##### **Range:**

*s-, p-, ps-, 0-255*

Specify a valid value for each subfield of the point code, and separate the subfields with a dash (-).

*prefix—s-, p-, ps*

*zone—0-7*

*area—000-255*

*id—0-7*

The point code *0-000-0* is not a valid point code.

#### **dpcn (optional)**

ITU national destination point code in the format of a 5-digit number (*nnnnn*); or 2, 3, or 4 numbers (members) separated by dashes (*m1-m2-m3-m4*) as defined by the *chg-stpopts:npcfmti* flexible point code option. A group code must be specified when the ITUDUPPC feature is turned on (*nnnnn-gc,m1-m2-m3-m4-gc*). The *prefix* subfield indicates a spare point code, private point code, or private and spare point code (*prefix-nnnnn, prefix-nnnnn-gc, prefix-m1-m2-m3-m4, prefix-m1-m2-m3-m4-gc*).

##### **Range:**

*s-, p-, ps-, 0-16383, aa-zz*

Specify a valid value for each subfield of the point code, and separate the subfields with a dash (-).

*prefix—s-, p-, ps*

*nnnnn—0-16383*

*gc—aa-zz*

*m1-m2-m3-m4—0-14* for each member; values must sum to 14

#### **dpcn24 (optional)**

24-bit ITU national destination point code with subfields *main signaling area-sub signaling area-signaling point (msa-ssa-sp)*. The *prefix* subfield indicates a private point code (*prefix-msa-ssa-sp*).

##### **Range:**

*p-, 000-255*

Specify a valid value for each subfield of the point code, and separate the subfields with a dash (-).

*prefix—p*  
*msa—000—255*  
*ssa—000—255*  
*sp—000—255*

**dpcn16 (optional)**

16-bit ITU national destination point code with subfields *unit number sub number area main number area (un-sna-mna)*. The *prefix* subfield indicates a private point code (*prefix-un-sna-mna*).

**Range:**

*p-- , 000---127*

Specify a valid value for each subfield of the point code, and separate the subfields with a dash (-).

*prefix---p*  
  
*un---000---127*  
  
*sna---000---15*  
  
*mna---000---31*

**ecic (optional)**

Ending Circuit Identification Code. This parameter, together with the `cic` parameter, defines the CIC range that is used as exception routing criteria for the specified exception route.

**Range:**

*0 - 16383*

**ilsn (optional)**

Incoming Link Set Name. The name of the originating linkset. This value is used as part of the exception routing criteria for the specified exception route.

**Range:**

*ayyyyyyyy*  
1 alphabetic character followed by up to 9 alphanumeric characters.

**mode (optional)**

The type of display to produce.

**Range:*****full***

Displays routes from the associated routeset and exception route table for the specified destination point code per criteria.

**opc (optional)**

Origination point code. ANSI point code with subfields *network indicator-network cluster-network cluster member (ni-nc-ncm)*. The *prefix* subfield indicates a private point code (*prefix-ni-nc-ncm*).

**Synonym:***opca***Range:***000-255*

Specify a valid value for each subfield of the point code, and separate the subfields with a dash (-).

When *chg-sid:pctype=ansi* is specified, *ni = 000* is not valid.

When *chg-sid:pctype=ansi* is specified, *nc = 000* is not valid if *ni = 001-005*.

When *chg-sid:pctype=ansi* is specified, *nc = 000* is valid if *ni = 006-255*.

The point code *000-000-000* is not a valid point code.

**opc/opca/opci/opcn/opcn24/opcn16 (optional)**

Origination point code.

**opci (optional)**

Origination Point Code. ITU international origination point code with subfields *zone-area-id*. The *prefix* subfield indicates a spare point code, private point code, or private and spare point code (*prefix-zone-area-id*).

**Range:***s-, p-, ps-, 0-255*

Specify a valid value for each subfield of the point code, and separate the subfields with a dash (-).

*prefix—s-, p-, ps**zone—0-7**area—000-255**id—0-7*

The point code *0-000-0* is not a valid point code.

**opcn (optional)**

Origination Point Code. ITU national point code in the format of a 5-digit number (*nnnnn*); or 2, 3, or 4 numbers (members) separated by dashes (*m1-m2-m3-m4*) as defined by the *chg-stpopts:npcfmti* flexible point code option. A group code must be specified when the ITUDUPPC feature is turned on (*nnnnn-gc*, *m1-m2-m3-m4-gc*). The *prefix* subfield indicates a spare point code, private point code, or private and spare point code (*prefix-nnnnn*, *prefix-nnnnn-gc*, *prefix-m1-m2-m3-m4*, *prefix-m1-m2-m3-m4-gc*).

**Range:***s-, p-, ps-, 0-16383, aa-zz*

Specify a valid value for each subfield of the point code, and separate the subfields with a dash (-).

*prefix—s-, p-, ps**nnnnn—0-16383**gc—aa-zz**m1-m2-m3-m4—0-14* for each member; values must sum to 14**opcn24 (optional)**

Origination Point Code. 24-bit ITU national point code with subfields *main signaling area-sub signaling area-signaling point (msa-ssa-sp)*. The *prefix* indicates a private point code (*prefix-msa-ssa-sp*).

**Range:***p-*, 000-255

Specify a valid value for each subfield of the point code, and separate the subfields with a dash (-).

*prefix—p**msa—000—255**ssa—000—255**sp—000—255***opc16 (optional)**Origination Point Code. 16-bit ITU national point code with subfields *unit number sub number area main number area* (*un-sna-mna*). The *prefix* subfield indicates a private point code (*prefix-un-sna-mna*).**Range:***p--*, 000---127

Specify a valid value for each subfield of the point code, and separate the subfields with a dash (-).

*prefix---p**un---000---127**sna---000---15**mna---000---31***si (optional)**

Service Indicator. This parameter is used as part of the exception routing criteria for the specified exception route.

**Range:**

0 - 15

**Example**

```
rept-stat-rtx
```

```
rept-stat-rtx:dpc=1-101-1
```

```
rept-stat-rtx:dpc=1-101-1:opc=1-2-1
```

```
rept-stat-rtx:dpc=100-100-1:opc=1-1-1:mode=full
```

```
rept-stat-rtx:dpcn16=001-1-2
```

**Dependencies**If the `dpcn` parameter is specified, its format must match the format that was assigned with the `chg-stpopts:npcfmti` parameter.The `dpc` parameter and the class criteria parameters (`opc/ilsn/cic/si`) must be specified before the `mode` parameter can be specified.The `dpc` parameter must be specified before the class criteria parameters (`opc/ilsn/cic/si`) can be specified.

## Notes

Each exception route set can have up to 6 associated routes.

In this command, only ITU-international and ITU national point codes support the spare point code subtype prefix (s-) and the private and spare point code subtype prefix (ps-). All of the point code types support the private (internal) point code subtype prefix (p-).

This command can be cancelled using the **F9** function key or the `canc-cmd` command. See `canc-cmd` for more information.

MTT 4732 and 4735 deleted by MB

## Output

This example provides the status of all exception route sets provisioned in the system, sorted by DPC:

```
rept-stat-rtx
```

```
stdcfg2b 09-05-24 01:54:32 EST EAGLE 41.0.0
```

	DPCA	PST	SST	AST
	001-101-001	IS-NR	Allowed	ACCESS
AST	OPCA	PST	SST	
	001-002-001	IS-ANR	Restrict	ACCESS
AST	SI	PST	SST	
	10	OOS-MT	Prohibit	ACCESS
	12	OOS-MT	Prohibit	ACCESS
	DPCA	PST	SST	AST
	004-101-001	IS-NR	Allowed	ACCESS
AST	SI	PST	SST	
	10	IS-NR	Allowed	ACCESS
	DPCA	PST	SST	AST
	007-101-001	OOS-MT	Prohibit	INACCESS
AST	OPCA	PST	SST	
	003-001-020	OOS-MT	Prohibit	INACCESS

```
Command Completed.
```

This example displays the status of exception route sets provisioned against a particular DPC:

```
rept-stat-rtx:dpc=1-101-1
```

```
stdcfg2b 09-03-24 01:54:32 EST EAGLE 41.0.0
```

DPCA	PST	SST	AST
001-101-001	IS-NR	Allowed	ACCESS
OPCA	PST	SST	AST
001-002-001	IS-ANR	Restrict	ACCESS
SI	PST	SST	AST
10	OOS-MT	Prohibit	ACCESS
12	OOS-MT	Prohibit	ACCESS

```
Command Completed.
```

This example displays detailed status and alarm information for a specific exception route set provisioned against a DPC:

```
rept-stat-rtx:dpc=1-101-1:opc=1-2-1
```

```
stdcfg2b 06-03-24 02:11:31 EST EAGLE 35.0.0
```

DPCA	OPCA	PST	SST	AST		
001-101-001	001-002-001	IS-ANR	Restrict	ACCESS		
ALARM STATUS = * 0533 RTX is restricted						
RTE	COST	LSN	APCA	LS STAT	NON-ADJ	ROUTE STAT
1	09	e2e7	007-001-000	Prohibit	Allowed	Prohibit
2*	10	e2e4	004-001-000	Allowed	Allowed	Allowed
3	--	-----	*****-***-***	-----	-----	-----
4	--	-----	*****-***-***	-----	-----	-----
5	--	-----	*****-***-***	-----	-----	-----
6	--	-----	*****-***-***	-----	-----	-----

```
Command Completed.
```

```
;
```

This example displays the status of exception route sets provisioned against a particular DPC:

```
rept-stat-rtx:dpcn16=001-02-03
```

```
stdcfg2b 09-03-24 01:54:32 EST EAGLE 45.0.0
```

DPCN16	PST	SST	AST
001-02-03	IS-NR	Allowed	ACCESS
OPCI	PST	SST	AST
001-002-001	IS-ANR	Restrict	ACCESS
SI	PST	SST	AST



10	OOS-MT	Prohibit	ACCESS
12	OOS-MT	Prohibit	ACCESS

Command Completed.

### Legend

- **DPC/DPCA**—ANSI destination point code of the exception route
- **DPCN**—ITU-TSS national destination point code of the exception route
- **DPCN24**—24-bit ITU national destination point code of the exception route
- **DPCN16**—16-bit ITU national destination point code of the exception route
- **DPCI**—ITU-TSS international destination point code of the exception route
- **OPC/OPCA**—ANSI origination point code as exception routing criterion of the exception route
- **OPCN**—ITU-TSS national origination point code as exception routing criterion of the exception route
- **OPCN24**—24-bit ITU national origination point code as exception routing criterion of the exception route
- **OPCN16**—16-bit ITU national origination point code as exception routing criterion of the exception route
- **OPCI**—ITU-TSS international origination point code as exception routing criterion of the exception route
- **ILSN**—Originating linkset as exception routing criterion of the exception route
- **CIC**—Starting Circuit Identification Code used as the exception routing criterion for this exception route
- **ECIC**—Ending Circuit Identification Code together with CIC defines the CIC range that is used as exception routing criterion for this exception route.
- **SI**—Service Indicator used as the exception routing criterion for this exception route
- **PST**—Primary state of the subsystem. See [Possible Values for PST/SST/AST](#).
- **SST**—Secondary state of the subsystem. See [Possible Values for PST/SST/AST](#).
- **AST**—Associated state of the subsystem. See [Possible Values for PST/SST/AST](#).

### Related Topics

- [chg-rtx](#)
- [dlt-rtx](#)
- [ent-rtx](#)
- [rtrv-rtx](#)

## rept-stat-sccp

Use this command to display the following types of reports:

- `rept-stat-sccp` (with no parameters)—displays the status of the Service Module cards and the services executing on those cards:

- A-Port (IS41 Mobile Number Portability)
- AIQ (IS41 Analyzed Information Query)
- ATINPQ (ATI Number Portability Query)
- EIR (Equipment Identity Register)
- G-Flex (GSM Flexible Numbering)
- G-Port (GSM Mobile Number Portability)
- GTT (Global Title Translation)
- IAR (Info Analyzed Relay)
- IDP Relay (Prepaid IDP Query Relay)
- IGM (IS41 GSM Migration)
- INP (INAP-based Number Portability)
- INPMR (INP Message Relay)
- LNP (Local Number Portability)
- LNPMR (LNP Message Relay)
- LRNQT (ITU TCAP LRN Query)
- MNPSMS (Portability Check for Mobile Originated SMS)
- MO SMS B-Party Routing
- MO SMS IS41-to-GSM Migration
- MO-based GSM SMS NP
- MO-based IS41 SMS NP
- MTPRTD (MTP Routed messages serviced by the SCCP card)
- PPSMS (Prepaid SMS Intercept)
- TLNP (Triggerless LNP)
- TTR (Triggerless TCAP Relay)
- V-Flex (Voice Mail Router)
- CAT2 (Category 2 Validation)

The command also displays any cards that are denied SCCP service.

- `rept-stat-sccp:mode=perf` —targets the general SCCP traffic performance for Service Module cards. The report supplies message rates for message flow control (MFC) performance.
- `rept-stat-sccp:loc=nnnn` —provides a detailed view of the status of SCCP services provided by a specific Service Module card

 **Note:**

The `rept-stat-sccp` and `rept-stat-sccp:mode=perf` reports include the status of the Service Module cards (E5-SM8G-B and SLIC cards) but do not differentiate between the card types.

 **Note:**

To retrieve traffic statistics for the LNP feature, the `rept-stat-lnp` command can also be used.

 **Note:**

Statistics are displayed for the supported features as follows:

- AIQ—AIQ Subsystem Report and Service Statistics
- APORT, GPORT, and IGM—MNP Service Statistics
- ATINPQ—ATINPQ Subsystem Report and Service Statistics
- EIR—EIR Subsystem Report and Service Statistics
- G-Flex—GFLEX Service Statistics
- GTT—GTT Service Statistics
- IAR—IAR Service Statistics
- IDP Relay—IDPR Service Statistics
- INPQ—INP Subsystem Report and Service Statistics (includes INPQ and INPMR - AINPQ is combined with INPQ)
- INPMR-INP Message Relay Service Statistics
- LNP—LNP Subsystem Report and Service Statistics (including LNPMR, LNPQS, WNPQS, TLNP, PLNPQS and LRNQT)
- LNPMR-LNP Message Relay Service Statistics
- LNPQS-LNP Query Service Statistics
- MO SMS IS41-to-GSM Migration, MO-based GSM SMS NP, MO-based IS41 SMS NP, PPSMS—SMSMR Service Statistics
- MTPRTD-MTP Routed (MTP routed messages serviced by the SCCP card) Statistics.
- TLNP-Triggerless LNP Service Statistics
- TTR-Triggerless TCAP Relay Service Statistics
- V-Flex—VFLEX Subsystem Report and Service Statistics
- WNPQS-Wireless LNP Query Service Statistics
- CAT2- Category 2 Validation Statistics

 **Note:**

If traffic is being generated while Service Module cards are loading, then superfluous counts may be displayed in Daily and Overall Peak SCCP Loads. To correct this occurrence, reset the Peak SCCP Loads using the `rept-stat-sccp:peakreset=yes` command.

 **Note:**

It will also include the statistics of GTT-enabled LIM cards. If the system has both SCCP and GTT-enabled LIM cards, then it shows the statistics for both cards.

**Parameters****app1 (optional)**

Used to display the statistics of either SCCP cards or GTT-enabled IPSP cards.

**Range:**

*vsccp*

Display the status of the SCCP SM card

*ipsg*

Display the status of the GTT-enabled IPSP card

 **Note:**

Using `data=gtt`, the user is able to see stats of all cards configured with `data=gtt`, as in all SM GTT cards, as well as GTT-enabled IPSP cards. With the `appl` parameter, the user can either see stats of SCCP cards with GTT data or stats of GTT-enabled IPSP cards.

**data (optional)**

The subsystem data type used in the report.

**Range:**

***dn***

report on the SCCP DN subsystem

***imsi***

report on the SCCP IMSI subsystem

***epap***

report on SCCP EPAP subsystem

***elap***

report on SCCP ELAP subsystem

***gtt***

report on SCCP GTT subsystem (on both SCCP and GTT-enabled IPSP cards)

**card (optional)**

Used to display statistics of either SCCP cards or GTT-enabled LIM cards.

**Range:**

*sm*

Display the status of SCCP SM card

*lim*  
Display the status of GTT-enabled LIM card

*all*  
Display the status of all cards



**Note:**

Using `data=gtt`, the stats of all cards configured with `data=gtt`, (SM GTT cards as well as GTT-enabled LIM cards) are displayed. With the `CARD` parameter, the stats of SCCP cards or stats of GTT-enabled LIM cards are displayed.

**loc (optional)**

The location of the Service Module card to be reported on.

**Range:**

*1101 - 1108, 1111 - 1112, 1201 - 1208, 1211 - 1218, 1301 - 1308, 1311 - 1318, 2101 - 2108, 2111 - 2118, 2201 - 2208, 2211 - 2218, 2301 - 2308, 2311 - 2318, 3101 - 3108, 3111 - 3118, 3201 - 3208, 3211 - 3218, 3301 - 3308, 3311 - 3318, 4101 - 4108, 4111 - 4118, 4201 - 4208, 4211 - 4218, 4301 - 4308, 4311 - 4318, 5101 - 5108, 5111 - 5118, 5201 - 5208, 5211 - 5218, 5301 - 5308, 5311 - 5318, 6101 - 6108, 6111 - 6118*

**Default:**

Report a summary of all cards.

**mode (optional)**

Use this parameter to provide extended performance information, including output about message flow control (MFC) performance and message rates for direct assignments.

**Range:**

*perf*

**Default:**

No extended performance information is displayed.

**peakreset (optional)**

Reset all Peak values to zero.

**Range:**

*yes*

**Example**

```
rept-stat-sccp
rept-stat-sccp:mode=perf
rept-stat-sccp:loc=1106
rept-stat-sccp:data=epap
```

```
rept-stat-sccp:data=gtt:card=lim
```

### Dependencies

No other `rept-stat-xxx` command can be in progress when this command is entered.

A Service Module card running the VSCCP application must be configured before this command can be entered.

Only one optional parameter at a time can be specified in the command. The parameters DATA, LOC and CARD are mutually exclusive.

The value specified for the `loc` parameter must identify a configured Service Module card running the VSCCP application or a GTT-enabled IPSP card running the IPSP32 GPL.

The EPAP Data Split feature must be enabled before the `data` parameter can be specified.

The Dual ExAP Config feature must be enabled before specifying parameter DATA = ELAP/EPAP.

The Dual ExAP Config feature or EPAP Data Split feature must be enabled before a value of DATA=EPAP can be specified.

### Notes

In Release 46.5, with the introduction of GTT on LIM, the output format of the `rept-stat-sccp` command has been changed. The output has been divided into three parts: head, body and tail. The head of the output informs about the status report, primary state, secondary state, alarms, and other information.

The body of the output depends on whether or not an SM/GTT-enabled IPSP card is present in EAGLE. If there are only SM cards in the EAGLE, the body of the output will display only the SCCP Subsystem Report. This report will contain information including daily peak load, total system capacity, number of equipped SM cards, number of in-service SM cards, and other information. It will also contain the card list of SM cards and MSU usage, as well as CPU usage of each individual card. If there are only GTT-enabled IPSP cards in the EAGLE, the body of the output will display only the GTT on LIM Report. This report will contain information including number of equipped and in-service GTT-enabled IPSP cards, total GTT on LIM capacity, and a card list of GTT-enabled IPSP cards and MSU/CPU usage of each individual card. If both SM and GTT-enabled IPSP cards are present, the output will be a combination of an SCCP Subsystem Report and GTT on LIM report.

The tail of the output informs about the Total Service Statistics of enabled services on the EAGLE. The GTT service statistics will be a combination of GTT statistics obtained from SM cards as well as from GTT-enabled IPSP cards.

### Output

If the EIR, G-Port, INP, 1100 TPS/DSM for ITU NP, AINPQ, A-Port, IGM, Throughput Capacity, IAR, or V-Flex features are enabled, then the **ansigflex** system option is disabled.

#### Note:

Output for this command displays the status for services associated with features that are enabled and turned on. If a feature is not turned on, then the services for that feature are not displayed. The following examples display output when all possible features are turned on.

This example shows a summary report for all the features corresponding to EPAP-based services and subsystems:

rept-stat-sccp

```

tekelecstp 10-04-06 18:02:43 EST  EAGLE5 42.0.0
SCCP SUBSYSTEM REPORT  IS-ANR          Active   -----
      SCCP ALARM STATUS  = *C 0453 Exceeded Service Error
Threshold Lvl 2
GFLEX SERVICE REPORT   IS-ANR          Active   -----
      GFLEX ALARM STATUS = * 0527 Service abnormal
MNP SERVICE REPORT     IS-NR           Active   -----
      MNP ALARM STATUS   = No Alarms
INPQ SUBSYSTEM REPORT  OOS-MT          Unavail  -----
      INPQ:  SSN STATUS  = ----- MATE SSN STATUS = -----
      INP ALARM STATUS   = *C 0395 INP Subsystem is not available
EIR SUBSYSTEM REPORT   OOS-MT          Unavail  -----
      EIR:  SSN STATUS  = ----- MATE SSN STATUS = -----
      EIR ALARM STATUS   = *C 0455 EIR Subsystem is not available
VFLEX SUBSYSTEM REPORT OOS-MT          Unavail  -----
      VFLEX: SSN STATUS  = ----- MATE SSN STATUS = -----
      VFLEX ALARM STATUS = *C 0551 VFLEX Subsystem is not
available
      ATINPQ SUBSYSTEM REPORT OOS-MT          Unavail  -----
      ATINPQ: SSN STATUS = ----- MATE SSN STATUS = -----
      ATINPQ ALARM STATUS = *C 0565 ATINPQ Subsystem is not
available
      AIQ SUBSYSTEM REPORT  IS-NR           Active   -----
      AIQ:  SSN STATUS  = Allowed   MATE SSN STATUS = -----
      AIQ ALARM STATUS   = No Alarms

SCCP Cards Configured= 1      Cards IS-NR= 1
System Daily Peak SCCP Load   8      TPS 10-01-06 18:00:03
System Overall Peak SCCP Load  8      TPS 00-00-00 00:00:00
System Total SCCP Capacity    2550    TPS (2550 max SCCP
Capacity)
System SCCP Capacity Calc. Method (N)
System TPS Alarm Threshold     2040    TPS ( 80% System N SCCP
Capacity)

CARD  VERSION      PST          SST          AST          MSU  CPU
                                     USAGE USAGE
-----
1101 P 007-013-002 IS-NR          Active   -----    45%  45%
-----
SCCP Service Average MSU Capacity = 45% Average CPU Capacity
= 45%

AVERAGE CPU USAGE PER SERVICE:
      GTT   = 15% GFLEX = 5% MNP   = 10% SMSMR = 10%
IDPR   = 0%
      IAR   = 0% MTPRTD = 1%
      INPMR = 2% INPQ  = 3% EIR   = 0% VFLEX = 0%
ATINPQ = 0%

```

AIQ = 0%

TOTAL SERVICE STATISTICS:

	SERVICE	SUCCESS	ERRORS	FAIL RATIO	REROUTE\ WARNINGS	FORWARD TO GTT
TOTAL	GTT:	1995	5	0%	-	-
2000	GFLEX:	500	1	0%	4	10
515	MNP:	800	0	0%	2	3
805	SMSMR:	67	23	25%	12	14
116	IDPR:	0	0	0%	0	
0	0					
	IAR:	0	0	0%	0	
0	0					
	MTPRTD:	6	0	0%	-	
-	6					
	INPMR:	50	5	0%	0	15
70						
	INPQ:	499	1	0%	0	-
500						
	EIR:	0	0	0%	-	
-	0					
	VFLEX:	0	0	0%	-	
-	0					
	ATINPQ:	0	0	0%	-	
-	0					
	AIQ:	0	0	0%	-	
-	0					

Command Completed.

;

This example shows the output for a card location for features corresponding to EPAP-based services and subsystems:

rept-stat-sccp:loc=1101

```

tekelecstp 10-04-06 19:41:33 EST EAGLE5 42.0.0
CARD  VERSION      TYPE   PST           SST           AST
1101  127-038-000  DSM   IS-NR        Active        -----
CARD ALARM STATUS      = No Alarms
GTT:   STAT = ACT      CPU USAGE = 10%
GFLEX: STAT = ACT      CPU USAGE = 10%
MNP:   STAT = ACT      CPU USAGE = 10%
SMSMR: STAT = ACT      CPU USAGE = 20%
IDPR:  STAT = ----- CPU USAGE = 0%
IAR:   STAT = ----- CPU USAGE = 0%
MTPRTD: STAT = ACT     CPU USAGE = 10%
INPMR: STAT = ----- CPU USAGE = 0%
INPQ:  STAT = ----- CPU USAGE = 0%

```



```

EIR:    STAT = ----- CPU USAGE = 0%
VFLEX:  STAT = ----- CPU USAGE = 0%
ATINPQ: STAT = ----- CPU USAGE = 0%
AIQ:    STAT = ----- CPU USAGE = 0%
-----
TOTAL   = 50%

```

```

CARD SERVICE STATISTICS
SERVICE      SUCCESS      ERRORS      WARNINGS      FORWARD TO
GTT  TOTAL
-    GTT:          1995          5            -
2000
10   GFLEX:          500           1            4
515
10   MNP:           500           1            4
515
15   SMSMR:          50            2            3
70
0    IDPR:           0             0            0
0    IAR:            0             0            0
0    MTPRTD:         6             0            -
6
0    INPMR:          0             0            0
0    INPQ:           0             0            0
-    0
-    EIR:            0             0            -
0
-    VFLEX:          0             0            -
0
-    ATINPQ:         0             0            -
0
-    AIQ:            0             0            -
0

```

Command Completed.

;

This example shows a performance report for the EPAP-based services:

```
rept-stat-sccp:mode=perf
```

```

tekelecstp 11-03-06 17:32:58 EST EAGLE5 44.0.0
SCCP SUBSYSTEM REPORT IS-NR Active -----
SCCP ALARM STATUS = No Alarms
GFLEX SERVICE REPORT IS-NR Active -----
GFLEX ALARM STATUS = No Alarms
MNP SERVICE REPORT IS-NR Active -----
MNP ALARM STATUS = No Alarms

SCCP Cards Configured= 1 Cards IS-NR= 1
System Daily Peak SCCP Load 0 TPS 11-03-06 17:23:29

```

```

System Overall Peak SCCP Load      0      TPS 00-00-00 00:00:00
System Total SCCP Capacity        6800    TPS (6800   max SCCP Capacity)
System SCCP Capacity Calc. Method (N)
System TPS Alarm Threshold        5440    TPS ( 80% System   N SCCP
Capacity)

```

TPS STATISTICS

```

=====
CARD      CPU          TOTAL          CLASS 0          CLASS 1
          USAGE      MSU RATE      MESSAGING RATE  MESSAGING RATE
-----
1205      5%             0              0                0
-----

```

```

AVERAGE MSU USAGE = 0%
AVERAGE CPU USAGE = 5%
TOTAL MSU RATE     = 0

```

STATISTICS FOR PAST 30 SECONDS

```

=====
TOTAL MSUS:          0
TOTAL ERRORS:       0

```

HIGHEST 01 OVERALL DAILY PEAKS                      LAST 01 DAILY PEAK SCCP LOADS

```

=====
0          TPS 00-00-00 00:00:00                      0          TPS 11-03-06 17:23:29

```

Command Completed.

;

This example shows a summary report for all of the features corresponding to ELAP-based subsystems:

rept-stat-sccp

```

tekelecstp 10-04-06 18:02:43 EST  EAGLE5 42.0.0
SCCP SUBSYSTEM REPORT  IS-ANR          Active      -----
      SCCP ALARM STATUS  = *C 0453 Exceeded Service Error Threshold Lvl
2
LNP SUBSYSTEM REPORT  OOS-MT          Unavail    -----
      LNP:   SSN STATUS  = ----- MATE SSN STATUS = -----
      LNP ALARM STATUS  = *C 0424 LNP Subsystem is not available
AIQ SUBSYSTEM REPORT  IS-NR          Active      -----
      AIQ:   SSN STATUS  = Allowed   MATE SSN STATUS = -----
      AIQ ALARM STATUS  = No Alarms

SCCP Cards Configured= 1          Cards IS-NR= 1
System Daily Peak SCCP Load      8          TPS 10-01-06 18:00:03
System Overall Peak SCCP Load    8          TPS 00-00-00 00:00:00
System Total SCCP Capacity      2550    TPS (2550   max SCCP Capacity)
System SCCP Capacity Calc. Method (N)
System TPS Alarm Threshold      2040    TPS ( 80% System   N SCCP
Capacity)

```

```

CARD   VERSION   PST           SST           AST           MSU   CPU
                USAGE   USAGE
-----
1101 P 007-013-002 IS-NR           Active        -----   45%  45%
-----
SCCP Service Average MSU Capacity = 45% Average CPU Capacity
= 45%

```

```

AVERAGE CPU USAGE PER SERVICE:
GTT      = 0%
LNPMR    = 20%  LNPQS  = 15%  WNPQS  = 12%  TLNP   = 14%
PLNPQS   = 19%
LRNQT    = 23%  AIQ    = 1%

```

```

TOTAL SERVICE STATISTICS:
SERVICE  SUCCESS  ERRORS  FAIL  REROUTE\  FORWARD
GTT  TOTAL  RATIO  WARNINGS  TO
-----
GTT: 1995  5  0%  -
- 2000
LNPMR: 500  1  0%  -
- 515
LNPQS: 800  0  0%  -
- 805
WNPQS: 67  23  25%  -
- 116
TLNP: 0  0  0%  -
- 0
PLNPQS: 0  0  0%  -
- 0
LRNQT: 50  5  0%  -
- 70
AIQ: 0  0  0%  -
- 0

```

```

Command Completed.
;

```

This example shows the output for a card location for all of the features corresponding to ELAP-based subsystems:

```
rept-stat-sccp:loc=1101
```

```

tekelecstp 10-04-06 19:41:33 EST EAGLE5 42.0.0
CARD   VERSION   TYPE  PST           SST           AST
1101  127-038-000 DSM   IS-NR           Active        -----
CARD ALARM STATUS           = No Alarms
GTT:  STAT = ACT      CPU USAGE = 10%
LNPMR: STAT = ACT      CPU USAGE = 10%
LNPQS: STAT = ACT      CPU USAGE = 10%
WNPQS: STAT = ----- CPU USAGE = 0%
TLNP:  STAT = ----- CPU USAGE = 0%
PLNPQS: STAT = ----- CPU USAGE = 0%
LRNQT: STAT = ----- CPU USAGE = 0%

```

```

AIQ:    STAT = ----- CPU USAGE = 0%
                -----
                TOTAL    = 30%

```

```

CARD SERVICE STATISTICS
SERVICE      SUCCESS      ERRORS      WARNINGS      FORWARD TO GTT
TOTAL
GTT:          1995          5            -              -
2000
LNPMR:        500           15           -              -
515
LNPQS:        500           15           -              -
515
WNPQS:        0             0            -              -
-            0
TLNP:         0             0            -              -
-            0
PLNPQS:       0             0            -              -
-            0
LRNQT:        0             0            -              -
-            0
AIQ:          0             0            -              -
-            0

```

Command Completed.

;

This example shows a performance report for the ELAP-based subsystems:

rept-stat-sccp:mode=perf

```

tekelecstp 11-03-06 17:32:58 EST EAGLE5 44.0.0
SCCP SUBSYSTEM REPORT IS-NR Active -----
      SCCP ALARM STATUS = No Alarms
LNP SUBSYSTEM REPORT OOS-MT Unavail -----
      LNP:  SSN STATUS = ----- MATE SSN STATUS = -----
      LNP ALARM STATUS = *C 0424 LNP Subsystem is not available

SCCP Cards Configured= 1      Cards IS-NR= 1
System Daily Peak SCCP Load 0      TPS 11-03-06 17:23:29
System Overall Peak SCCP Load 0      TPS 00-00-00 00:00:00
System Total SCCP Capacity 6800      TPS (6800 max SCCP Capacity)
System SCCP Capacity Calc. Method (N)
System TPS Alarm Threshold 5440      TPS ( 80% System N SCCP
Capacity)

TPS STATISTICS
=====
CARD  CPU      TOTAL      CLASS 0      CLASS 1
      USAGE  MSU RATE  MESSAGING RATE  MESSAGING RATE
-----
1205  5%        0          0            0
-----
AVERAGE MSU USAGE = 0%

```

AVERAGE CPU USAGE = 5%  
TOTAL MSU RATE = 0

STATISTICS FOR PAST 30 SECONDS

TOTAL MSUS: 0  
TOTAL ERRORS: 0

HIGHEST 01 OVERALL DAILY PEAKS LAST 01 DAILY PEAK SCCP LOADS

```
=====
=====
0      TPS 00-00-00 00:00:00      0      TPS 11-03-06 17:23:29
```

Command Completed.

;

This example shows a summary report of SCCP subsystem:

rept-stat-sccp

```
tekelecstp 10-08-17 13:35:38 EDT EAGLE 42.0.0
SCCP SUBSYSTEM REPORT IS-ANR Active -----
SCCP ALARM STATUS = ** 0262 GTT Duplicate Actn processing
stopped
```

```
SCCP Cards Configured= 9 Cards IS-NR= 8
System Daily Peak SCCP Load 30147 TPS 10-08-17 13:33:36
System Overall Peak SCCP Load 30147 TPS 10-08-17 13:33:36
System Total SCCP Capacity 54400 TPS (54400 max SCCP
Capacity)
System SCCP Capacity Calc. Method (N)
System TPS Alarm Threshold 43520 TPS ( 80% System N SCCP
Capacity)
```

CARD	VERSION	PST	SST	AST	MSU USAGE	CPU USAGE
1201	036-027-001	IS-NR	Active	-----	0%	1%
1203	036-027-001	IS-NR	Active	-----	0%	3%
1205	036-027-001	IS-NR	Active	-----	0%	2%
1211	036-027-001	IS-NR	Active	-----	0%	3%
1213	036-027-001	IS-NR	Active	-----	74%	38%
1215	036-027-001	IS-NR	Active	-----	100%	42%
1217	036-027-001	IS-NR	Active	-----	100%	40%
1101	036-027-001	IS-NR	Active	-----	100%	42%
1107	-----	OOS-MT	Isolated	-----	0%	0%

SCCP Service Average MSU Capacity = 46% Average CPU Capacity = 21%

AVERAGE CPU USAGE PER SERVICE:  
GTT = 10%

```
TOTAL SERVICE STATISTICS:
      SERVICE      SUCCESS      ERRORS      FAIL      REROUTE\      FORWARD
      RATIO      WARNINGS      TO GTT
TOTAL
GTT:      898797      0      0%      -      -
898797
```

```
CARDS NOT PROCESSING GTT DUPLICATE ACTION:
      1215, 1217, 1101
```

Command Completed.

;

This example shows the output for DN data when EPAP Data Split feature is Enabled:

```
rept-stat-sccp:data=dn:mode=perf
```

```
epap240m 12-01-29 15:25:01 CST Eagle 45.0.0
SCCP DN SUBSYSTEM REPORT IS-ANR Active -----
      SCCP ALARM STATUS = No Alarms

SCCP Cards Configured= 3      Cards IS-NR= 1
System Daily Peak SCCP Load      0      TPS 12-01-29 14:44:31
System Overall Peak SCCP Load      0      TPS 00-00-00 00:00:00
System Total SCCP Capacity      850      TPS (850      max SCCP Capacity)
System SCCP Capacity Calc. Method (N)
System TPS Alarm Threshold      680      TPS ( 80% System      N SCCP
Capacity)
```

CARD	VERSION	PST	SST	AST	MSU USAGE	CPU USAGE	DATA TYPE
1101	P 099-016-000	IS-NR	Active	-----	0%	1%	DN
1105	-----	OOS-MT-DSBLD	MEA	-----	0%	0%	COMB
1107	099-016-000	IS-ANR	Standby	29%	0%	5%	COMB

```
SCCP Service Average MSU Capacity = 0%      Average CPU Capacity = 1%
```

```
HIGHEST 01 OVERALL DAILY PEAKS
=====
TPS      s%      d%      i%      DATE      TIME
-----
0      100/0      /0      00-00-00      00:00:00
```

```
LAST 01 DAILY PEAK SCCP LOADS
=====
TPS      s%      d%      i%      DATE      TIME
-----
0      100/0      /0      12-01-29      14:44:31
```

Command Completed.

;

This example shows the output when Dual ExAP Config feature is Enabled:

rept-stat-sccp:data=elap:mode=perf

```

epap240m 12-01-29 15:25:01 CST Eagle 45.0.0
SCCP ELAP SUBSYSTEM REPORT IS-ANR Active -----
      SCCP ALARM STATUS = No Alarms

SCCP Cards Configured= 3      Cards IS-NR= 1
System Daily Peak SCCP Load      0      TPS 12-01-29 14:44:31
System Overall Peak SCCP Load      0      TPS 00-00-00 00:00:00
System Total SCCP Capacity      850      TPS (850      max SCCP
Capacity)
System SCCP Capacity Calc. Method (N)
System TPS Alarm Threshold      4000      TPS ( 80% System N
SCCP Capacity)

      CARD      VERSION      PST      SST      AST      MSU      CPU
DATA
                                     USAGE USAGE
TYPE
-----
      1101 P 099-016-000 IS-NR      Active      -----      0%      1%
ELAP
      1105 ----- OOS-MT-DSBLD MEA      -----      0%      0%
ELAP
      1107 099-016-000 IS-ANR      Standby      29%      0%      5%
ELAP
-----

SCCP Service Average MSU Capacity = 0% Average CPU Capacity
= 1%

HIGHEST 01 OVERALL DAILY PEAKS
=====
TPS      sccp% epap% elap% DATE      TIME
-----
0      100      0      0      00-00-00 00:00:00

LAST      01      DAILY      PEAK      SCCP      LOADS
=====
TPS      sccp% epap% elap% DATE      TIME
-----
0      100      0      0      00-00-00 00:00:00

```

This example shows the output when both the Dual ExAP Config and the EPAP Data Split features are Enabled:

rept-stat-sccp:data=dn:mode=perf

```

epap240m 12-01-29 15:25:01 CST Eagle 45.0.0
SCCP DN SUBSYSTEM REPORT IS-ANR Active -----
      SCCP ALARM STATUS = No Alarms

```

```

SCCP Cards Configured= 3      Cards IS-NR= 1
System Daily Peak SCCP Load    0      TPS 12-01-29 14:44:31
System Overall Peak SCCP Load  0      TPS 00-00-00 00:00:00
System Total SCCP Capacity     850    TPS (850      max SCCP Capacity)
System SCCP Capacity Calc. Method (N)
System TPS Alarm Threshold     5000   TPS ( 80% System  N SCCP
Capacity)

```

CARD	VERSION	PST	SST	AST	MSU USAGE	CPU USAGE	DATA TYPE
1101	P 099-016-000	IS-NR	Active	-----	0%	1%	DN
1105	-----	OOS-MT-DSBLD	MEA	-----	0%	0%	EPAP
1107	099-016-000	IS-ANR	Standby	29%	0%	5%	EPAP

```

SCCP Service Average MSU Capacity = 0% Average CPU Capacity = 1%

```

HIGHEST 01 OVERALL DAILY PEAKS

```

=====
TPS   sccp%  dn%   imsi%  elap%  DATE      TIME
-----
0     100    0     0       0      00-00-00 00:00:00

```

LAST 01 DAILY PEAK SCCP LOADS

```

=====
TPS   sccp%  dn%   imsi%  elap%  DATE      TIME
-----
0     100    0     0       0      00-00-00 00:00:00

```

This example shows the output when both SM and GTT-enabled IPSG cards are present:

```
rept-stat-sccp
```

```
eagle10614 17-04-05 13:08:22 EST EAGLE 46.5.0.0.0-70.22.0
```

```

SCCP STATUS REPORT   IS-NR      Active      -----
SCCP ALARM STATUS   = No Alarms

```

SCCP SUBSYSTEM REPORT:

```

MNP SERVICE REPORT   OOS-MA      Ueq         -----
MNP ALARM STATUS     = No Alarms
INPQ SUBSYSTEM REPORT OOS-MA      Ueq         -----
INPQ:  SSN STATUS    = ----- MATE SSN STATUS = -----
INP ALARM STATUS     = No Alarms
EIR SUBSYSTEM REPORT OOS-MA      Ueq         -----
EIR:  SSN STATUS     = ----- MATE SSN STATUS = -----
EIR ALARM STATUS     = No Alarms
ATINPQ SUBSYSTEM REPORT OOS-MA      Ueq         -----
ATINPQ: SSN STATUS   = ----- MATE SSN STATUS = -----
ATINPQ ALARM STATUS  = No Alarms

```

```

SCCP Cards Configured= 1      Cards IS-NR= 1
System Daily Peak SCCP Load    0      TPS 17-04-05 12:48:05
System Overall Peak SCCP Load  0      TPS 00-00-00 00:00:00
System Total SCCP Capacity     5500   TPS (5500      max SCCP Capacity)

```



System SCCP Capacity Calc. Method (N)  
System TPS Alarm Threshold 4400 TPS ( 80% System N SCCP Capacity)

CARD	VERSION	PST	SST	AST	MSU	CPU
DATA					USAGE	USAGE
TYPE						

-----  
1103 073-023-009 IS-NR Active ----- 0% 1%  
GTT

-----  
SCCP Service Average MSU Capacity = 0% Average CPU Capacity = 1%

AVERAGE CPU USAGE PER SERVICE:

GTT = 0% MNP = 0%  
INPMR = 0% EIR = 0% ATINPQ = 0%

GTT on LIM REPORT:

GTT LIM Cards Configured= 1 Cards IS-NR= 1  
System Total GTT on LIM Cap. 10000 TPS

CARD	VERSION	PST	SST	AST	MSU	CPU
DATA					USAGE	USAGE
TYPE						

-----  
1101 073-025-017 IS-NR Active ----- 13% 12%  
GTT

-----  
SCCP Service Average MSU Capacity = 13% Average CPU Capacity = 12%

AVERAGE CPU USAGE PER SERVICE:

GTT = 2%

TOTAL SERVICE STATISTICS:

GTT	SERVICE TOTAL	SUCCESS	ERRORS	FAIL RATIO	REROUTE\ WARNINGS	FORWARD TO
-	GTT:	40275	0	0%	-	
0	MNP:	0	0	0%	0	
0	INPMR:	0	0	0%	0	
-	INPQ:	0	0	0%	0	
-	EIR:	0	0	0%	-	

This example shows the output for DATA GTT when both SM and GTT-enabled IPSG cards are present:

```
rept-stat-sccp:data=gtt

eagle10614 17-04-05 13:08:47 EST EAGLE 46.5.0.0-70.22.0
  SCCP GTT STATUS REPORT   IS-NR           Active      -----
      SCCP ALARM STATUS    = No Alarms

  SCCP GTT SUBSYSTEM REPORT:

  SCCP Cards Configured= 1      Cards IS-NR= 1
  System Daily Peak SCCP Load   0      TPS 17-04-05 12:48:05
  System Overall Peak SCCP Load  0      TPS 00-00-00 00:00:00
  System Total SCCP Capacity     5500   TPS (5500   max SCCP Capacity)
  System SCCP Capacity Calc. Method (N)
  System TPS Alarm Threshold     4400   TPS ( 80% System   N SCCP
Capacity)

  CARD   VERSION      PST           SST           AST           MSU   CPU   DATA
          USAGE      USAGE      TYPE
-----
1103    073-023-009   IS-NR           Active      -----      0%   1%   GTT
-----
  SCCP Service Average MSU Capacity =  0%   Average CPU Capacity =  1%

  AVERAGE CPU USAGE PER SERVICE:
    GTT   =  0%
    INPMR =  0%   EIR   =  0%   ATINPQ =  0%

  GTT on LIM REPORT:
  GTT LIM Cards Configured= 1      Cards IS-NR= 1
  System Total GTT on LIM Cap.     10000   TPS

  CARD   VERSION      PST           SST           AST           MSU   CPU   DATA
          USAGE      USAGE      TYPE
-----
1101    073-025-017   IS-NR           Active      -----      13%  12%  GTT
-----
  SCCP Service Average MSU Capacity =  13%   Average CPU Capacity =  12%

  AVERAGE CPU USAGE PER SERVICE:
    GTT   =  2%

  TOTAL SERVICE STATISTICS:

      SERVICE      SUCCESS      ERRORS      FAIL      REROUTE\      FORWARD
              RATIO      WARNINGS      TO GTT
-----
TOTAL
  GTT:           40312          0          0%          -          -
40312
```

This example shows the output for CARD SM when SM cards are present:

rept-stat-sccp:card=sm

eagle10614 17-04-05 13:08:54 EST EAGLE 46.5.0.0-70.22.0  
rept-stat-sccp:card=sm  
Command entered at terminal #23.

;

Command Accepted - Processing

eagle10614 17-04-05 13:08:55 EST EAGLE 46.5.0.0-70.22.0  
SCCP STATUS REPORT IS-NR Active -----  
SCCP ALARM STATUS = No Alarms

SCCP SUBSYSTEM REPORT:

SCCP Cards Configured= 1 Cards IS-NR= 1  
System Daily Peak SCCP Load 0 TPS 17-04-05 12:48:05  
System Overall Peak SCCP Load 0 TPS 00-00-00 00:00:00  
System Total SCCP Capacity 5500 TPS (5500 max SCCP  
Capacity)  
System SCCP Capacity Calc. Method (N)  
System TPS Alarm Threshold 4400 TPS ( 80% System N SCCP  
Capacity)

CARD	VERSION	PST	SST	AST	MSU	CPU
DATA					USAGE	USAGE
TYPE						

1103	073-023-009	IS-NR	Active	-----	0%	1%
------	-------------	-------	--------	-------	----	----

GTT

SCCP Service Average MSU Capacity = 0% Average CPU Capacity  
= 1%

AVERAGE CPU USAGE PER SERVICE:

GTT = 0% MNP = 0%  
INPMR = 0% EIR = 0% ATINPQ = 0%

TOTAL SERVICE STATISTICS:

	SERVICE	SUCCESS	ERRORS	FAIL RATIO	REROUTE\ WARNINGS	FORWARD TO
GTT	TOTAL					
-	GTT:	0	0	0%	-	
-	0					
0	MNP:	0	0	0%	0	
0	0					
0	INPMR:	0	0	0%	0	
0	0					
-	INPQ:	0	0	0%	0	
-	0					
-	EIR:	0	0	0%	-	
-	0					

This example shows the output for CARD LIM when GTT-enabled IPSG cards are present:

```
rept-stat-sccp:card=lim

eagle10614 17-04-05 13:09:02 EST EAGLE 46.5.0.0.0-70.22.0
  rept-stat-sccp:card=lim
  Command entered at terminal #23.
;

Command Accepted - Processing
eagle10614 17-04-05 13:09:02 EST EAGLE 46.5.0.0.0-70.22.0
SCCP GTT STATUS REPORT   IS-NR           Active      -----
      SCCP ALARM STATUS   = No Alarms

GTT on LIM REPORT:
GTT LIM Cards Configured= 1          Cards IS-NR= 1
System Total GTT on LIM Cap.        10000 TPS

CARD   VERSION      PST           SST           AST           MSU   CPU   DATA
      USAGE        USAGE        TYPE
-----
1101   073-025-017   IS-NR         Active        -----        13%   12%   GTT
-----
SCCP Service Average MSU Capacity = 13%   Average CPU Capacity = 12%

AVERAGE CPU USAGE PER SERVICE:
  GTT      =    2%

TOTAL SERVICE STATISTICS:

      SERVICE      SUCCESS      ERRORS      FAIL      REROUTE\      FORWARD
      SERVICE      SUCCESS      ERRORS      RATIO      WARNINGS      TO GTT
TOTAL
  GTT:           40381          0          0%          -          -
40381
```

This example shows a performance report for SCCP and GTT on LIM Subsystem when both subsystems are present:

```
rept-stat-sccp:mode=perf

eagle10614 17-04-05 13:09:09 EST EAGLE 46.5.0.0.0-70.22.0
  rept-stat-sccp:mode=perf
  Command entered at terminal #23.
;

Command Accepted - Processing
eagle10614 17-04-05 13:09:09 EST EAGLE 46.5.0.0.0-70.22.0
SCCP STATUS REPORT   IS-NR           Active      -----
      SCCP ALARM STATUS   = No Alarms

SCCP SUBSYSTEM REPORT:
MNP SERVICE REPORT   OOS-MA          Ueq          -----
      MNP ALARM STATUS   = No Alarms

SCCP Cards Configured= 1          Cards IS-NR= 1
```

```

System Daily Peak SCCP Load      0      TPS 17-04-05 12:48:05
System Overall Peak SCCP Load    0      TPS 00-00-00 00:00:00
System Total SCCP Capacity      5500   TPS (5500   max SCCP
Capacity)
System SCCP Capacity Calc. Method (N)
System TPS Alarm Threshold      4400   TPS ( 80% System  N SCCP
Capacity)

```

TPS STATISTICS

```

=====
=====

```

CARD	CPU USAGE	TOTAL MSU RATE	CLASS 0 MESSAGING RATE	CLASS 1 MESSAGING RATE	DATA TYPE
1103	1%	0	0	0	GTT

```

-----
AVERAGE MSU USAGE = 0%
AVERAGE CPU USAGE = 1%
TOTAL MSU RATE     = 0

```

STATISTICS FOR PAST 30 SECONDS

```

=====
==

```

```

TOTAL MSUS:          0
TOTAL ERRORS:        0

```

HIGHEST 01 OVERALL DAILY PEAKS

```

=====
TPS   s%  d%  i%  DATE    TIME
-----
0     0  /0  /0  00-00-00 00:00:00

```

LAST 01 DAILY PEAK SCCP LOADS

```

=====
TPS   s%  d%  i%  DATE    TIME
-----
0     0  /0  /0  17-04-05 12:48:05

```

```

GTT on LIM REPORT:
GTT LIM Cards Configured= 1      Cards IS-NR= 1
System Total GTT on LIM Cap.    10000 TPS

```

IPSG GTT TPS STATISTICS

```

=====
=====

```

CARD	CPU USAGE	TOTAL MSU RATE	CLASS 0 MESSAGING RATE	CLASS 1 MESSAGING RATE	DATA TYPE
1101	12%	1315	1315	0	GTT

```
-----
AVERAGE MSU USAGE = 13%
AVERAGE CPU USAGE = 12%
TOTAL MSU RATE     = 1341
```

This example shows a performance report for GTT on LIM Subsystem when the subsystem is present:

```
rept-stat-sccp:mode=perf:card=lim
```

```
eagle10614 17-04-05 13:09:31 EST EAGLE 46.5.0.0-70.22.0
rept-stat-sccp:mode=perf:card=lim
Command entered at terminal #23.
```

```
;
```

```
Command Accepted - Processing
```

```
eagle10614 17-04-05 13:09:32 EST EAGLE 46.5.0.0-70.22.0
SCCP GTT STATUS REPORT   IS-NR           Active      -----
      SCCP ALARM STATUS   = No Alarms
```

```
GTT on LIM REPORT:
```

```
GTT LIM Cards Configured= 1          Cards IS-NR= 1
System Total GTT on LIM Cap.         10000 TPS
```

```
IPSG GTT TPS STATISTICS
```

```
=====
CARD   CPU      TOTAL      CLASS 0      CLASS 1      DATA
      USAGE  MSU RATE  MESSAGING RATE  MESSAGING RATE  TYPE
-----
1101   12%     1335      1335          0             GTT
-----
AVERAGE MSU USAGE = 13%
AVERAGE CPU USAGE = 12%
TOTAL MSU RATE     = 1335
```

This example shows a summary report of SCCP subsystem:

```
rept-stat-sccp
```

```
Command Accepted - Processing
```

```
stpd1091301 18-07-11 08:30:50 MST EAGLE 46.7.0.0-75.4.0
rept-stat-sccp
Command entered at terminal #7.
```

```
;
```

```
stpd1091301 18-07-11 08:30:50 MST EAGLE 46.7.0.0-75.4.0
SCCP SUBSYSTEM REPORT   IS-NR           Active      -----
      SCCP ALARM STATUS   = No Alarms
GFLEX SERVICE REPORT    IS-NR           Active      -----
      GFLEX ALARM STATUS  = No Alarms
MNP SERVICE REPORT      IS-NR           Active      -----
      MNP ALARM STATUS    = No Alarms
```

```

INPQ SUBSYSTEM REPORT IS-NR Active -----
INPQ: SSN STATUS = Allowed MATE SSN STATUS = -----
INP ALARM STATUS = No Alarms
ATINPQ SUBSYSTEM REPORT IS-NR Active -----
ATINPQ: SSN STATUS = Allowed MATE SSN STATUS = -----
ATINPQ ALARM STATUS = No Alarms

```

```

SCCP Cards Configured= 6 Cards IS-NR= 6
System Daily Peak SCCP Load 361 TPS 18-07-11 04:40:13
System Overall Peak SCCP Load 361 TPS 18-07-11 04:40:13
System Total SCCP Capacity 40800 TPS (40800 max SCCP
Capacity)
System SCCP Capacity Calc. Method (N)
System TPS Alarm Threshold 32640 TPS ( 80% System N SCCP
Capacity)

```

CARD	VERSION	PST	SST	AST	MSU USAGE	CPU USAGE
2113	145-004-000	IS-NR	Active	-----	0%	2%
2201	145-004-000	IS-NR	Active	-----	0%	3%
2213	145-004-000	IS-NR	Active	-----	0%	2%
2217	145-004-000	IS-NR	Active	-----	0%	2%
2317	145-004-000	IS-NR	Active	-----	0%	2%
1111 P	145-004-000	IS-NR	Active	-----	0%	2%

```

SCCP Service Average MSU Capacity = 0% Average CPU Capacity
= 2%

```

```

AVERAGE CPU USAGE PER SERVICE:
GTT = 0% GFLEX = 0% MNP = 0% SMSMR = 0%
IDPR = 0%
MTPRTD = 0%
INPMR = 0% ATINPQ = 0%

```

```

TOTAL SERVICE STATISTICS:

```

SERVICE	SUCCESS	ERROR	FAIL RATIO	REROUTE\ WARNINGS	FORWARD TO GTT	FORWARD TO
MATE	TOTAL					
GTT:	0	0	0%	-	-	
0	0					
GFLEX:	0	0	0%	0		
0	0					
MNP:	0	0	0%	0		
0	0					
SMSMR:	0	0	0%	0		
0	0					
IDPR:	0	0	0%	0		
0	0					
MTPRTD:	0	0	0%	-		
-	0					
INPMR:	0	0	0%	0		
0	0					

```

    INPQ:          0      0      0%      0
-           0
    ATINPQ:       0      0      0%      -
-           0

```

Command Completed.

;

This example shows a performance report for SCCP:

```
rept-stat-sccp:mode=perf
```

Command Accepted - Processing

```

tekelecstp 18-06-07 09:16:15 MST EAGLE 46.7.0.0.0-75.4.0
rept-stat-sccp:mode=perf
Command entered at terminal #1.

```

;

```

tekelecstp 18-06-07 09:16:15 MST EAGLE 46.7.0.0.0-75.4.0
SCCP SUBSYSTEM REPORT IS-NR Active -----
SCCP ALARM STATUS = No Alarms

```

```

SCCP Cards Configured= 1 Cards IS-NR= 1
System Daily Peak SCCP Load 0 TPS 18-06-07 00:00:01
System Overall Peak SCCP Load 20 TPS 18-06-06 11:07:10
System Total SCCP Capacity 5500 TPS (5500 max SCCP Capacity)
System SCCP Capacity Calc. Method (N)
System TPS Alarm Threshold 4400 TPS ( 80% System N SCCP
Capacity)

```

TPS STATISTICS

```

=====
CARD   CPU      TOTAL      CLASS 0      CLASS 1
      USAGE  MSU RATE  MESSAGING RATE  MESSAGING RATE
-----
1101   1%        0          0            0
-----
AVERAGE MSU USAGE = 0%
AVERAGE CPU USAGE = 1%
TOTAL MSU RATE     = 0

```

STATISTICS FOR PAST 30 SECONDS

```

=====
TOTAL MSUS:          0
TOTAL ERRORS:        0
TOTAL MSU SEND TO MATE: 0
      HIGHEST 02 OVERALL DAILY PEAKS          LAST 02 DAILY PEAK SCCP LOADS
-----
20     TPS 18-06-06 11:07:10          0     TPS 18-06-07 00:00:01
0     TPS 00-00-00 00:00:00          20     TPS 18-06-06 11:07:10

```



```
Command Completed.
;
```

This example shows a summary report of SCCP subsystem with CAT2:

```
> rept-stat-sccp
```

```
Command Accepted - Processing
```

```
tklcl1131102 20-07-18 13:54:48 EST EAGLE 46.9.0.0.0-76.23.0
rept-stat-sccp
Command entered at terminal #3.
```

```
;
```

```
tklcl1131102 20-07-18 13:54:49 EST EAGLE 46.9.0.0.0-76.23.0
SCCP SUBSYSTEM REPORT IS-NR Active -----
SCCP ALARM STATUS = No Alarms
```

```
SCCP Cards Configured= 2 Cards IS-NR= 1
System Daily Peak SCCP Load 0 TPS 20-07-18 00:00:00
System Overall Peak SCCP Load 3361 TPS 20-07-12 00:23:07
System Total SCCP Capacity 5500 TPS (5500 max SCCP
Capacity)
System SCCP Capacity Calc. Method (N)
System TPS Alarm Threshold 4400 TPS ( 80% System N SCCP
Capacity)
```

CARD	VERSION	PST	SST	AST	MSU USAGE	CPU USAGE
1101	093-023-013	IS-NR	Active	-----	0%	2%

```
-----
SCCP Service Average MSU Capacity = 0% Average CPU Capacity
= 2%
```

```
AVERAGE CPU USAGE PER SERVICE:
GTT = 0%
```

```
TOTAL SERVICE STATISTICS:
```

SERVICE MATE	SUCCESS TOTAL	ERROR	FAIL RATIO	REROUTE\ WARNINGS	FORWARD TO GTT	FORWARD TO
GTT:	0	0	0%	-	-	
0	0					
CAT2:	0	0	0%	0	-	
0	0					

```
Command Completed.
;
```

This example shows the output for CARD SM when SM cards are present with CAT2:

```
> rept-stat-sccp:card=sm

Command Accepted - Processing

tklcl1131102 20-07-18 13:57:46 EST EAGLE 46.9.0.0.0-76.23.0
rept-stat-sccp:card=sm
Command entered at terminal #3.
;

tklcl1131102 20-07-18 13:57:46 EST EAGLE 46.9.0.0.0-76.23.0
SCCP SUBSYSTEM REPORT IS-NR Active -----
SCCP ALARM STATUS = No Alarms

SCCP Cards Configured= 2 Cards IS-NR= 1
System Daily Peak SCCP Load 0 TPS 20-07-18 00:00:00
System Overall Peak SCCP Load 3361 TPS 20-07-12 00:23:07
System Total SCCP Capacity 5500 TPS (5500 max SCCP Capacity)
System SCCP Capacity Calc. Method (N)
System TPS Alarm Threshold 4400 TPS ( 80% System N SCCP
Capacity)

CARD VERSION PST SST AST MSU CPU
USAGE USAGE
-----
1101 093-023-013 IS-NR Active ----- 0% 2%
1105 ----- OOS-MT-DSBLD MEA ----- 0% 0%
-----
SCCP Service Average MSU Capacity = 0% Average CPU Capacity = 2%

AVERAGE CPU USAGE PER SERVICE:
GTT = 0%
TOTAL SERVICE STATISTICS:

SERVICE SUCCESS ERROR FAIL REROUTE\ FORWARD FORWARD
RATIO WARNINGS TO GTT TO MATE
TOTAL
GTT: 0 0 0% - -
0
CAT2: 0 0 0% 0 -
0
Command Completed.
;
```

This example shows the output for a card location with CAT2 of SCCP subsystem:

```
> rept-stat-sccp:loc=1101

Command Accepted - Processing

tklcl1131102 20-07-18 14:07:26 EST EAGLE 46.9.0.0.0-76.23.0
rept-stat-sccp:loc=1101
Command entered at terminal #3.
;
```

```

tklc1131102 20-07-18 14:07:26 EST EAGLE 46.9.0.0-76.23.0
CARD VERSION TYPE PST SST AST
1101 093-023-013 SLIC IS-NR Active -----
CARD ALARM STATUS = No Alarms.
GTT: STAT = ACT CPU USAGE = 0%
-----
TOTAL = 0%

CARD SERVICE STATISTICS

SERVICE SUCCESS ERRORS WARNINGS FORWARD FORWARD
MATE TOTAL TO GTT TO
GTT: 0 0 - -
0 CAT2: 0 0 0 -
- 0

Command Completed.
;

```

## Legend

This section defines the fields of the three `rept-stat-sccp` reports:

- `rept-stat-sccp` with no parameters
- `rept-stat-sccp:mode=perf`
- `rept-stat-sccp:loc=nnnn`

A dash (-) in an output field indicates that the statistic does not apply.

### Note:

The ERRORS and TOTAL ERRORS fields indicate that errors have occurred for Service Module cards in the system. Refer to UIMs generated by the system for the specific errors, and refer to the *Maintenance Guide* for error explanations and recovery procedures.

*Report Type:* `rept-stat-sccp` with no parameters

- **SCCP SUBSYSTEM REPORT,GTT ON LIM REPORT, GFLEX/MNP SERVICE REPORT** and **LNP/INPQ/EIR/VFLEX/ATINPQ/AIQ SUBSYSTEM REPORT**—Summary of the SCCP subsystem status, GTT on LIM subsystem status, GFLEX and MNP service status, LNP, INPQ (INP Query), EIR, VFLEX, ATINPQ and AIQ subsystem status
- **SCCP CARDS CONFIGURED**—Number of provisioned Service Module cards running the VSCCP application
- **GTT LIM CARDS CONFIGURED**—Number of provisioned GTT-enabled LIM cards running the IP32 GPL
- **CARD IS-NR**—Number of Service Module or GTT-enabled LIM cards that can be used by the system (status is In-Service Normal, IS-NR)

- **SYSTEM PEAK SCCP LOAD**—Highest SCCP transactions-per-second (TPS) processed by the EAGLE
- **SYSTEM TOTAL SCCP CAPACITY**—Sum of the maximum capacity of all active SCCP cards
- **SYSTEM TOTAL GTT ON LIM CAPACITY**—Sum of the maximum capacity of all active GTT-enabled LIM cards
- **SYSTEM TPS ALARM THRESHOLD**—Percentage of traffic that triggers an alarm to warn that the EAGLE is approaching the total system SCCP transactions-per-second (TPS) capacity. This value is set by the `chg-th-alm` command.
- **CARD**—Card location of the cards running the VSCCP/IPSG application
- **P**—When G-Flex, GPORT, INP, APORT, EIR, V-Flex, IAR, or IGM feature is turned on, a P indicates the primary Service Module card. The primary Service Module card provides the MPS status to the EAGLE. This indicator is displayed between the card location and the GPL version.
- **VERSION**—Version number of the GPL running on the Service Module card
- **PST**—Primary state of the card. See [Possible Values for PST/SST/AST](#).
- **SST**—Secondary state of the card. See [Possible Values for PST/SST/AST](#).
- **AST**—Associated state of the card. See [Possible Values for PST/SST/AST](#).
- **MSU USAGE**—Percentage of the maximum number of MSUs received by each card during the last 30 seconds
- **CPU USAGE**—Percentage of the amount of CPU used by each card during the last 30 seconds to process messages and to handle other foreground and background tasks
- **SCCP SERVICE AVERAGE MSU CAPACITY**—Average MSU capacity used over the last 30-second interval. This field includes all services provided by the Service Module or GTT-enabled LIM cards.
- **AVERAGE CPU CAPACITY**—Average CPU capacity used over the last 30-second interval. This field includes all services provided by the Service Module or GTT-enabled LIM cards.
- **AVERAGE CPU USAGE PER SERVICE**—System-wide view of the service traffic composition.
- **TOTAL SERVICE STATISTICS**—System-wide view of per-service statistics for the last 30-second interval. An "A" in the field indicates that the statistic does not apply. The report tracks the following information:
  - **SERVICE**
  - **SUCCESS**—Total number of successful messages processed by the specified card for each service. Applies to all services.
  - **ERRORS**—Total number of messages with errors for each service. Applies to all services.
  - **WARNINGS**—Total number of messages that output UIM warnings and were forwarded to GTT by the specified card for G-Flex, MNP, SMSMR, IDPR, IAR, INPMR and INPQ services and total number of messages for which CAT2 validation has not been applied in case of CAT2.
  - **FORWARD TO GTT**—Total number of messages that could not find a match in the MPS database (did not produce any errors or warnings) and were successfully

forwarded to GTT by the specified card for G-Flex, MNP, SMSMR, IDPR, IAR and INPMR services

- **FORWARD TO MATE**— Total number of ACK messages on which GTT is performed and send to mate STP.

*Report Type:* `rept-stat-sccp:mode=perf`

This report includes the status of E5-SM8G-B and SLIC cards, but does not differentiate between these card types.

- **SCCP SUBSYSTEM REPORT, GTT ON LIM REPORT,LNP SUBSYSTEM REPORT and GFLEX/MNP SERVICE REPORT**—Summary status of the SCCP subsystem, GTT on LIM subsystem status, GFLEX and MNP services, LNP subsystem along with their corresponding Alarm Status
- **SCCP CARDS CONFIGURED**—Number of Service Module cards provisioned
- **GTT LIM CARDS CONFIGURED**—Number of provisioned GTT-enabled LIM cards running the IPSG32 GPL
- **CARD IS-NR**—Number of Service Module or GTT-enabled LIM cards that can be used by the system (status is in-service normal, IS-NR)
- **SYSTEM PEAK SCCP LOAD**—Highest SCCP TPS processed by the EAGLE
- **SYSTEM TOTAL SCCP CAPACITY**—Sum of the maximum capacity of all active Service Module cards
- **SYSTEM TOTAL GTT ON LIM CAPACITY**—Sum of the maximum capacity of all active GTT-enabled LIM cards
- **SYSTEM TPS ALARM THRESHOLD**—Percentage of traffic that triggers an alarm to warn that the EAGLE is approaching the total system SCCP TPS capacity. This value is set by the `chg-th-alm` command.
- **TPS STATISTICS**—Section of the report that provides TPS statistics on each Service Module or GTT-enabled LIM card
  - **CARD**—Card location of the cards running the VSCCP/IPSG application
  - **CPU USAGE**—Percentage of the amount of CPU used to process messages by each card during the last 30 seconds
  - **TOTAL MSU RATE**—Total number of messages processed per second. This and the other message rates are obtained from statistics maintained by the Service Module card for the last 30-second period.
  - **CLASS 0 and CLASS 1 MESSAGING RATE**—Number of messages received per second.

The next section of the `rept-stat-sccp:mode=perf` report provides system-wide SCCP traffic statistics.

#### **AVERAGE MSU USAGE**

Total of the MSU usage fields from each Service Module card divided by the number of active Service Module or GTT-enabled LIM cards

#### **AVERAGE CPU USAGE**

Total of the CPU usage fields from each Service Module card divided by the number of active Service Module or GTT-enabled LIM cards

**TOTAL MSU RATE**

Sum of all MSU rates processed by all active Service Module or GTT-enabled LIM cards

**STATISTICS FOR PAST 30 SECONDS**

Statistics that represent the last 30-second period

**TOTAL MSUS**

Sum of all transactions on all active Service Module or GTT-enabled LIM cards

**TOTAL ERRORS**

Sum of all errors on all active Service Module or GTT-enabled LIM cards

**TOTAL MSU SEND TO MATE**

Sum of all transactions that are sent to the mate STP

*Report Type:* rept-stat-sccp:loc=nnnn

- **CARD**—Card location of the card running the VSCCP/IPSG application
- **VERSION**—Version number of the GPL the card is running
- **TYPE**—Type of the card
- **PST**—Primary state of the card. See [Possible Values for PST/SST/AST](#).
- **SST**—Secondary state of the card. See [Possible Values for PST/SST/AST](#).
- **AST**—Associated state of the card. See [Possible Values for PST/SST/AST](#).
- **CARD ALARM STATUS**—If there are no card alarms present, this field displays No Alarms.

The next section of the rept-stat-sccp:loc=nnnn report supplies the status of the individual services provided by the card and the associated CPU usage for the service.

**GTT: STAT**

Possible values are ACTIVE and SWDL (software loading)

**SMSMR: STAT**

Possible values are ACTIVE and SWDL (software loading)

**IDPR: STAT**

Possible values are ACTIVE and SWDL (software loading)

**IAR: STAT**

Possible values are ACTIVE and SWDL (software loading)

**INPMR: STAT**

Possible values are ACTIVE and SWDL (software loading)

**MTPRTD: STAT**

Possible values are ACTIVE and SWDL (software loading)

**GFLEX: STAT**

Possible values are ACTIVE, OFFLINE and SWDL (software loading)

**MNP: STAT**

Possible values are ACTIVE, OFFLINE, and SWDL (software loading)

**INPQ: STAT**

Possible values are ACTIVE, OFFLINE, and SWDL (software loading)

**EIR: STAT**

Possible values are ACTIVE, OFFLINE and SWDL (software loading)

**VFLEX: STAT**

Possible values are ACTIVE, OFFLINE and SWDL (software loading)

**LNPMPR: STAT**

Possible values are ACTIVE, OFFLINE and SWDL (software loading)

**LNPQS: STAT**

Possible values are ACTIVE, OFFLINE and SWDL (software loading)

**WNPQS: STAT**

Possible values are ACTIVE, OFFLINE and SWDL (software loading)

**TLNP: STAT**

Possible values are ACTIVE, OFFLINE and SWDL (software loading)

**PLNPQS: STAT**

Possible values are ACTIVE, OFFLINE and SWDL (software loading)

**LRNQT: STAT**

Possible values are ACTIVE, OFFLINE and SWDL (software loading)

**ATINPQ: STAT**

Possible values are ACTIVE, OFFLINE and SWDL (software loading)

**AIQ: STAT**

Possible values are ACTIVE, OFFLINE and SWDL (software loading)

**TOTAL**

Sum of the CPU usage for the services running over the previous 30-second period

**CARD SERVICE STATISTICS**

Card service statistics over the previous 30-second period for the specified card. The report tracks the following:

**SERVICE**

Name of the individual service provided by the card

**SUCCESS**

Total number of successful messages processed by the specified card for each service. Applies to all services.

**ERRORS**

Total number of messages with errors for each service. Applies to all services.

**WARNINGS**

Total number of messages that output UIM warnings and were forwarded to GTT by the specified card for G-Flex, MNP, SMSMR, IDPR, IAR, INPMR and INPQ services and total number of messages for which CAT2 validation has not been applied in case of CAT2.

**FORWARD TO GTT**

Total number of messages that could not find a match in the MPS database (did not produce any errors or warnings) and were successfully forwarded to GTT by the specified card for G-Flex, MNP, SMSMR, IDPR, IAR, and INPMR services

**FORWARD TO MATE**

Total number of successful ACK messages that are send to mate STP by a specific card for GTT service only.

**TOTAL**

Total number of SUCCESS, ERRORS, WARNINGS, and FORWARD TO GTT messages

**IMEI Challenge Legend**

This section of the `rept-stat-sccp` report supplies the stats for the IMEI Challenge. The legends mean the following:

**TOTAL REQUEST**

All requests for PSI query

**VALIDATION SUCCESS**

When IMEI is received in the PSI ACK.

**VALIDATION FAILURE**

IMEI not received in PSI ACK and Purge MS is generated

**ERROR1**

Decode errors.

**ERROR2**

Encoding errors.

**Related Topics**

- [chg-th-alm](#)
- [rtrv-th-alm](#)

## rept-stat-seas

Use this command to generate a summary report of the status of the SEAS subsystem on the EAGLE. This command reports the status of the CCS MR connections if the SEAS Over IP feature is turned on. See the *Maintenance Guide* for information about the SEAS alarms.

**Parameters**

This command has no parameters.

**Example**

```
rept-stat-seas
```

**Dependencies**

No other `rept-stat-xxx` command can be in progress when this command is entered.

The SEASCFG Table must be accessible.



**Notes**

None

**Output**

This example shows output when the SEAS Over IP feature is turned on.

```
rept-stat-seas
```

```

tekelecstp 07-01-11 16:47:51 EST  EAGLE 37.5.0

      SEAS SYSTEM                                PST      SST
AST
-----
-----
                                IS-NR      Avail
-----
ALARM STATUS = No Alarms
TERM      IPADDR      PORT      PST      SST
AST
-----
-----
      18      120.30.10.11      15      IS-NR      Active
-----
ALARM STATUS = No Alarms
      40      128.30.15.12      16      IS-NR      Active
-----
ALARM STATUS = No Alarms

```

**Legend**

- **PST**—Primary state of the subsystem. Possible values are described in [Possible Values for PST/SST/AST](#).
- **SST**—Secondary state of the subsystem. Possible values are described in [Possible Values for PST/SST/AST](#).
- **AST**—Associated state of the subsystem. Possible values are described in [Possible Values for PST/SST/AST](#).
- **SEAS SYSTEM**—Overall SEAS component

**Related Topics**

- [alw-trm](#)
- [chg-trm](#)
- [inh-trm](#)
- [rept-stat-sys](#)
- [rept-stat-trbl](#)
- [rept-stat-trm](#)

## rept-stat-seculog

Use this command to display the following information about the security log on the active and standby OAMs:

- The active or standby status of each log
- The number of new (that is, not uploaded) entries in each log
- The percentage of log space used by those new entries
- Whether overflow has occurred since the last upload
- Whether a recording failure has occurred since the last upload
- The date and time of the oldest and newest records in the log
- The date and time when the last successful upload of the log occurred

### Parameters

This command has no parameters.

### Example

```
rept-stat-seculog
```

### Dependencies

No other security log command can be in progress when this command is entered.

### Notes

The %FULL field displays the amount of space in the log taken up by new (not uploaded) entries. That number is obtained by dividing the number displayed in the ENTRIES field by the overall storage capacity of the log (10,000 entries). Because the log stays full of entries at all times, new entries overwrite existing entries.

The percentage full computed is rounded up to the next integer with one exception: the value of 100 is not displayed until the log is truly 100% full.

The log capacity is 10,000 records. To determine how many more commands can be logged before an overflow condition occurs, subtract the value displayed in the ENTRIES field from 10,000.

The status of the active OAM's log is always reported first in the output report, followed by the status of the standby log; in other words, they are *not necessarily* displayed numerically by the location number.

The report displays dates in the format *yy-mm-dd*, where *yy* is the year, *mm* is the month, and *dd* is the date. The report displays times in the format of *hh:mm:ss*, where *hh* is hours, *mm* is minutes, and *ss* is seconds.

### Output

This example shows the output in the normal security log state. All un-uploaded records appear in the log on the active OAM.

rept-stat-seculog

```

rlghncxa03w 05-07-29 16:40:40 EST EAGLE 28.1.0
-- SINCE LAST UPLOAD -- OLDEST NEWEST LAST
LOC ROLE ENTRIES %FULL OFLO FAIL RECORD RECORD UPLOAD
1114 Active 8312 84 No No 96-08-12 05-07-04 05-07-16
11:23:56 15:59:06 14:02:22

1116 Standby 0 0 No No 96-09-12 05-07-30 05-07-30
11:24:12 14:00:06 14:02:13

```

;

This example shows the output when the active security log is full and has overflowed.

rept-stat-seculog

```

rlghncxa03w 05-07-29 16:40:40 EST EAGLE 28.1.0
-- SINCE LAST UPLOAD -- OLDEST NEWEST LAST
LOC ROLE ENTRIES %FULL OFLO FAIL RECORD RECORD UPLOAD
1114 Active 10000 100 Yes No 96-08-12 05-07-04 05-07-16
11:23:56 15:59:06 14:02:22

1116 Standby 0 0 No No 96-09-12 05-07-30 05-07-30
11:24:12 14:00:06 14:02:13

```

;

This example shows the output when both logs contain un-uploaded entries. The standby log on 1116 should be uploaded.

rept-stat-seculog

```

rlghncxa03w 05-07-29 16:40:40 EST EAGLE 28.1.0
-- SINCE LAST UPLOAD -- OLDEST NEWEST LAST
LOC ROLE ENTRIES %FULL OFLO FAIL RECORD RECORD UPLOAD
1114 Active 8312 84 No No 96-08-12 05-07-04 05-07-16
11:23:56 15:59:06 14:02:22

1116 Standby 693 7 No No 96-09-12 05-07-30 05-07-30
11:24:12 14:00:06 14:02:13

```

;

This example shows the output if data cannot be retrieved from the standby OAM (for example, in simplex mode).

rept-stat-seculog

```

rlghncxa03w 05-07-29 16:40:40 EST EAGLE 28.1.0
-- SINCE LAST UPLOAD -- OLDEST NEWEST LAST
LOC ROLE ENTRIES %FULL OFLO FAIL RECORD RECORD UPLOAD
1114 Active 8312 83 No No 96-08-12 05-07-04 05-07-16

```

11:23:56 15:59:06 14:02:22

```
1116 Standby -----  ---  ---  ---  -----  -----  -----
-----  -----  -----
```

;

**Legend**

- **LOC**—Address of the TDM card (with the hard disk on it) that contains the log. It is always the card at location 1114 or 1116.
- **ROLE**—Current role of the security log at that location. This value is always the same as the role of the OAM associated with the TDM card: *active* or *standby*.
- **-- SINCE LAST UPLOAD**—Applies to the four columns directly below the heading on the output. It indicates that the fields below display information obtained since the last upload.
  - **ENTRIES**—Shows how many un-uploaded commands are currently recorded in the log. This value resets to 0 (zero) when the log is uploaded using `copy-seculog`.
  - **%FULL**—Shows, as a percentage, how much space in the log the ENTRIES field value occupies
  - **OFLO**—Overflow indicator. Overflow occurs if the log is not uploaded periodically: new entries start overwriting un-uploaded entries. Displays *No* if no overflow has occurred and *Yes* if overflow has occurred
  - **FAIL**—Failed indicator. Displays *No* if no logging failure has occurred. Displays *Yes* to indicate that a logging failure has occurred that has prevented one or more entries from being recorded in the log successfully.

 **Note:**

Whether the system is able to set the logging failure flag in the security log header depends on the nature of the failure. If a `copy-disk` command is processing, the system sets the flag when the `copy-disk` command finishes processing. However, if the active fixed disk fails for some reason, or the security log happens to be in a bad sector that develops, the system is unable to set the logging failure flag.

- **OLDEST RECORD/NEWEST RECORD**—Date and time recorded in the oldest and newest record in the log. Allows the administrator to know the time period that the log covers. The log records all commands that were issued between 6/3/96 at 13:45:03 up to 8/5/96 at 06:58:55. The NEWEST RECORD for the active log is the current date, because the log will have recorded the `rept-stat-seculog` command that was just entered to produce the report.
- **LAST UPLOAD**—Date and time when the log was last uploaded successfully. That is, the `copy-seculog` command successfully copied the log to the FTA.

**Related Topics**

- [chg-attr-seculog](#)
- [rtrv-attr-seculog](#)

## rept-stat-sfapp

Use this command to display the overall status of the SFAPP Card service in the EAGLE.

### Parameters

#### **loc (optional)**

SFAPP card location for which Card status, overall card TPS and total statistics of the card is to be reported.

#### **Range:**

1101 - 1108, 1111 - 1112, 1201 - 1208, 1211 - 1218, 1301 - 1308, 1311 - 1318,  
2101 - 2108, 2111 - 2118, 2201 - 2208, 2211 - 2218, 2301 - 2308, 2311 - 2318,  
3101 - 3108, 3111 - 3118, 3201 - 3208, 3211 - 3218, 3301 - 3308, 3311 - 3318,  
4101 - 4108, 4111 - 4118, 4201 - 4208, 4211 - 4218, 4301 - 4308, 4311 - 4318,  
5101 - 5108, 5111 - 5118, 5201 - 5208, 5211 - 5218, 5301 - 5308, 5311 - 5318,  
6101 - 6108, 6111 - 6118

#### **Default:**

Report a summary of all cards

#### **peakreset (optional)**

Reset peak values to zero.

#### **Range:**

yes

### Example

```
rept-stat-sfapp
rept-stat-sfapp:peakreset=yes:loc=1101
rept-stat-sfapp:loc=1101
```

### Dependencies

Location specified should be of the SFAPP card.

### Output

This example shows a summary report for all the SFAPP cards:

```
rept-stat-sfapp

tklc1110801 18-09-25 18:01:54 EST EAGLE 46.7.0.0.0-75.14.0
rept-stat-sfapp
Command entered at terminal #2.
;

tklc1110801 18-09-25 18:01:54 EST EAGLE 46.7.0.0.0-75.14.0
SFAPP STATUS REPORT IS-NR Active -----
SFAPP ALARM STATUS = No Alarms

SFAPP Cards Configured= 3 Cards IS-NR= 3
```

System Daily Peak SFAPP Load 0 TPS 18-09-25 00:00:17  
 System Overall Peak SFAPP Load 54 TPS 18-09-24 14:50:40  
 System Total SFAPP Capacity 8000 TPS (8000 max SFAPP Capacity)  
 SFAPP Capacity Calc. Method (N)  
 System TPS Alarm Threshold 6400 TPS ( 80% System N SFAPP Capacity)

Dynamic Prof Tbl Db Level On SFAPP(P) 9  
 Dynamic Roam Tbl Db Level On SFAPP(P) 3  
 Last SYNC Between OAM and SFAPP(P) 18-09-25 17:58:26

CARD	VERSION	PST	SST	AST	CPU USAGE	MSU USAGE	TPS
1101	P 145-014-000	IS-NR	Active	-----	2%	0%	0
1103	145-014-000	IS-NR	Active	-----	3%	0%	0
1105	145-014-000	IS-NR	Active	-----	3%	0%	0

SFAPP Average MSU Capacity = 0% Average CPU Capacity = 2%

TOTAL SERVICE STATISTICS:

CARD	TOTAL REQUEST	VALIDATION SUCCESS	VALIDATION FAILED	ERROR1	ERROR2	FAIL RATIO
1101	0	0	0	0	0	0%
1103	0	0	0	0	0	0%
1105	0	0	0	0	0	0%
Total	0	0	0	0	0	0%

HIGHEST 02 OVERALL DAILY PEAKS:

TPS	GTT%	CAT3.1%	CAT3.2%	TPS SGEN%	DATE	TIME
54	0%	0%	100%	0%	18-09-24	14:50:40
0	0%	0%	0%	0%	00-00-00	00:00:00

LAST 02 DAILY PEAK SFAPP LOADS:

TPS	GTT%	CAT3.1%	CAT3.2%	TPS SGEN%	DATE	TIME
0	0%	0%	0%	0%	18-09-25	00:00:17
54	0%	0%	100%	0%	18-09-24	14:50:40

Command Completed.

;

This example displays output for a card location:

rept-stat-sfapp:loc=1105

```
tklcl1110801 18-09-25 18:03:03 EST EAGLE 46.7.0.0.0-75.14.0
rept-stat-sfapp:loc=1105
Command entered at terminal #21.
```

;

Command Accepted - Processing

```
tklcl1110801 18-09-25 18:03:03 EST EAGLE 46.7.0.0.0-75.14.0
CARD   VERSION      TYPE    PST          SST          AST
1105   145-014-000    SLIC   IS-NR        Active       -----
CARD ALARM STATUS      = No Alarms.
```

TPS STATISTICS:

```
=====
===
                TPS      PEAK-TPS    PEAKTIMESTAMP
=====
===
                0        18          18-09-24 14:50:40
-----
```

--

TOTAL SERVICE STATISTICS:

```
=====
=====
SERVICE  TOTAL      VALIDATION
VALIDATION REQUEST  SUCCESS    FAIL
ERROR2    RATIO      SUCCEEDED  FAILED     ERROR1
=====
=====
GTT:      0          0          0          0
0          0%
CAT3.1:   0          0          0          0
0          0%
CAT3.2:   0          0          0          0
0          0%
IMEI_C:   0          0          0          0
0          0%
IMEI_L:   0          0          0          0
0          0%
-----
-----
```

----

EEDB STATISTICS:

```
=====
SERVICE  QUERY      UPDATE      SUCCESSFUL  ERROR      RESPONSE
          RESPONSE  RESPONSE    RESPONSE    RESPONSE   TIMEOUT
=====
EEDB:    0          0          0          0          0
=====
```

Command Completed.

;

Output for all cards with IMEI Challenge stats included:

rept-stat-sfapp

tekelecstp 18-04-03 05:08:37 EST EAGLE 46.6.0.0.0-73.14.0

rept-stat-sfapp

Command entered at terminal #17.

;

Command Accepted - Processing

tekelecstp 18-04-03 05:08:37 EST EAGLE 46.6.0.0.0-73.14.0

SFAPP STATUS REPORT IS-NR Active -----

SFAPP ALARM STATUS = No Alarms

```
SFAPP Cards Configured= 2      Cards IS-NR= 1
System Daily Peak SFAPP Load  0      TPS 18-04-03 05:02:06
System Overall Peak SFAPP Load 0      TPS 00-00-00 00:00:00
System Total SFAPP Capacity    0      TPS (0      max SFAPP Capacity)
SFAPP Capacity Calc. Method    (N)
System TPS Alarm Threshold     0      TPS ( 80% System  N SFAPP
Capacity)
```

```
CARD  VERSION      PST          SST          AST          CPU  MSU  TPS
          USAGE  USAGE
```

```
-----
1101  -----  OOS-MT      Isolated     -----     0%  0%  0
1107  015-014-001  IS-NR      Active       -----     2%  0%  0
-----
```

SFAPP Average MSU Capacity = 0% Average CPU Capacity = 2%

TOTAL SERVICE STATISTICS:

```
=====
CARD  TOTAL  VALIDATION  VALIDATION  ERROR1  ERROR2  FAIL
      REQUEST  SUCCESS    FAILED
RATIO
=====
1101  0      0          0          0      0      0%
1107  0      0          0          0      0      0%
=====
```



```
-----
---
Total    0          0          0          0
0         0%
```

HIGHEST 01 OVERALL DAILY PEAKS:

```
=====
TPS      GTT%   CAT3.1%  CAT3.2%  IMEI_CH  DATE      TIME
=====
0         0%     0%       0%       0%       00-00-00  00:00:00
-----
```

LAST 01 DAILY PEAK SFAPP LOADS:

```
=====
TPS      GTT%   CAT3.1%  CAT3.2%  IMEI_CH  DATE      TIME
=====
0         0%     0%       0%       0%       18-04-03  05:02:06
-----
```

Command Completed.

```
;
Command Executed
```

Output for a single card with IMEI Challenge stats included:

```
rept-stat-sfapp:loc=1107
```

```
tekelecstp 18-04-03 05:10:09 EST  EAGLE 46.6.0.0.0-73.14.0
```

```
rept-stat-sfapp:loc=1107
```

```
Command entered at terminal #17.
```

```
;
```

Command Accepted - Processing

```
tekelecstp 18-04-03 05:10:10 EST  EAGLE 46.6.0.0.0-73.14.0
```

```
CARD  VERSION      TYPE    PST          SST          AST
1107  015-014-001  SLIC   IS-NR       Active       -----
CARD ALARM STATUS      = No Alarms.
```

TPS STATISTICS:

```
=====
===
                TPS      PEAK-TPS    PEAKTIMESTAMP
=====
===
                0        0           00-00-00 00:00:00
-----
```

```
--
```

TOTAL SERVICE STATISTICS:

```
=====
=====
```

```

SERVICE  TOTAL      VALIDATION  VALIDATION
FAIL
REQUEST   SUCCESS    FAILED      ERROR1      ERROR2
RATIO

-----
GTT:      0          0           0           0           0
0%
CAT3.1:   0          0           0           0           0
0%
CAT3.2:   0          0           0           0           0
0%
IMEI_CH:  0          0           0           0           0
0%
-----

Command Completed.
;
Command Executed

```

**Note:**

The `REPT-STAT-SFAPP` command reports peak of average TPS of 30 seconds intervals instead of true peak TPS.

**Related Topics**

- [chg-th-alm](#)
- [rtrv-th-alm](#)

## rept-stat-sflog

Use this command to display the overall status of the SS7 Firewall Logging subsystem on the EAGLE.

**Parameters****loc (optional)**

SFLOG card location for which card status, card TPS usage, and last log file event data is to be reported.

**Range:**

*1101 - 1108, 1111 - 1112, 1201 - 1208, 1211 - 1218, 1301 - 1308, 1311 - 1318, 2101 - 2108, 2111 - 2118, 2201 - 2208, 2211 - 2218, 2301 - 2308, 2311 - 2318, 3101 - 3108, 3111 - 3118, 3201 - 3208, 3211 - 3218, 3301 - 3308, 3311 - 3318, 4101 - 4108, 4111 - 4118, 4201 - 4208, 4211 - 4218, 4301 - 4308, 4311 - 4318, 5101 - 5108, 5111 - 5118, 5201 - 5208, 5211 - 5218, 5301 - 5308, 5311 - 5318, 6101 - 6108, 6111 - 6118*

**peakreset (optional)**

Reset peak values to the current TPS values and last log event file for primary and secondary SFLOG card.

**Range:**

yes

**Example**

```
rept-stat-sflog
rept-stat-sflog:loc=1101
rept-stat-sflog:peakreset=yes
```

**Dependencies**

At least one SCCP/SFAPP and one SFLOG card running the SCCPHC/SFAPP and IPSHC application must be configured before this command can be entered.

The `peakreset` and `loc` parameters cannot be specified together.

The location specified with this command should be the location of an SCCP or SFLOG (logging enabled) card running the SCCPHC or IPSHC GPL respectively.

The shelf and card must be equipped.

**Notes**

The `peakreset` parameter will reset the statistics on the primary and secondary card.

**Output**

This example displays output when no parameter is specified:

```
rept-stat-sflog

Command Accepted - Processing
  tekelecstp 16-02-17 10:57:44 MST  EAGLE5 46.3.0.0.0-68.11.1

SFLOG ALARM STATUS = No Alarms
SFLOG Cards Configured= 2           Cards IS-NR= 2

CARD      VERSION    PST           SST           AST           TPS
CPU USAGE
-----
---
  1201 P 021-011-007 IS-NR           Active        -----        2           2
  1101  021-011-007 IS-NR           Active        -----        0           2
-----
---

TOTAL STATISTICS:

=====
===
```

```

SERVICE          SUCCESS    DISCARD
IPSM STATS       : 60        0
SCCP STATS       : 60        0

```

```

-----
HIGHEST 01 OVERALL DAILY PEAKS
=====

```

```

TPS    DATE      TIME
-----
2      16-02-17  00:00:12

```

```

Command Completed.
;

```

This example displays output when the `loc` parameter specifies an IPS card:

```
rept-stat-sflog:loc=<IPS card>
```

```
Command Accepted - Processing
```

```

tekelecstp 15-04-22 12:28:49 MST  EAGLE5 46.3.0-66.1.0.0
CARD  VERSION      TYPE    PST          SST          AST
1101  013-011-001   IPS     IS-NR        Active       -----
CARD ALARM STATUS      = No Alarms.
CPU USAGE = 1 %

```

```
TPS STATISTICS:
```

```

=====
TPS    PEAK-TPS    PEAKTIMESTAMP
-----

```

```

101    101         02-01-02 01:16:32

```

```
LAST LOG EVENT FILE GENERATED:
```

```

=====
FILENAME                                SIZE
SERVER
-----
c11i_fw_150423_123456                    200          10.248.12.13

```

```
Command Completed.
;

```

This example displays output when the `loc` parameter specifies an SCCP card:

```
rept-stat-sflog:loc=<SCCP card>
```

```
Command Accepted - Processing
```

```

tekelecstp 15-04-22 12:28:49 MST  EAGLE5 46.3.0-66.1.0
CARD  VERSION      TYPE    PST          SST          AST

```

```

1101  013-011-001  DSM      IS-NR      Active      -----
CARD ALARM STATUS      = No Alarms.
CPU USAGE = 1 %

SCCP STATISTICS
=====
SUCCESS  DISCARD
1000    0

Command Completed.
;

```

## Legend

This section defines the fields of the three `rept-stat-sflog` reports:

- `rept-stat-sflog` with no parameters
- `rept-stat-sflog:loc=<IPS card location>`
- `rept-stat-sflog:loc=<SCCP card location>`

A dash (-) in an output field indicates that the statistic does not apply.

*Report Type:* `rept-stat-sflog` with no parameters

- **SFLOG ALARM STATUS**—Displays SFLOG system-related alarms. If there are no system alarms present, this field displays `No Alarms`.
- **SFLOG Cards Configured**—Number of cards running the IPSHC GPL that are configured for SS7 Firewall Logging.
- **CARDS IS-NR**—Number of SFLOG cards running the IPSHC GPL that can be used by the system (status is In-Service Normal, IS-NR).
- **CARD**—Card location of the SFLOG/SCCP/SFAPP card running the IPSHC/SCCPHC/SFAPP GPL respectively.
- **P**—P indicates the primary Service Module card. The primary Service Module card provides the MPS status to the EAGLE. This indicator is displayed between the card location and the GPL version.
- **VERSION**—Version number of the IPSHC/SCCPHC/SFAPP GPL running on the SFLOG/SCCP/SFAPP card.
- **PST**—Primary state of the card. See [Possible Values for PST/SST/AST](#).
- **SST**—Secondary state of the card. See [Possible Values for PST/SST/AST](#).
- **AST**—Associated state of the card. See [Possible Values for PST/SST/AST](#).
- **TPS**—Transactions Per Second; indicates the number of logging events which are received on the SFLOG card.
- **CPU USAGE**—Percentage of the amount of CPU used to process messages by each card.
- **TOTAL STATISTICS**—System-wide view of per-service statistics. The report tracks the following information:
  - **SERVICE**—SFLOG (**IPSM STATS**), **SCCP STATS** and **SFAPP STATS** statistics are displayed.

- **SUCCESS**—Total number of messages successfully processed by the SCCP, SFAPP and SFLOG cards.
- **DISCARD**—Total number of messages discarded by the SCCP and SFLOG cards.

*Report Type:* `rept-stat-sflog:loc=<IPS card location>`

- **CARD**—Card location of the SFLOG card running the IPSHC GPL.
- **VERSION**—Version number of the IPSHC GPL running on the SFLOG card.
- **TYPE**—Type of the card.
- **PST**—Primary state of the card. See [Possible Values for PST/SST/AST](#).
- **SST**—Secondary state of the card. See [Possible Values for PST/SST/AST](#).
- **AST**—Associated state of the card. See [Possible Values for PST/SST/AST](#).
- **CARD ALARM STATUS**—Displays SFLOG card-specific alarms. If there are no card alarms present, this field displays `No Alarms`.
- **CPU USAGE**—Percentage of the amount of CPU used to process messages by the card.
- **TPS STATISTICS**—System-wide view of per-service statistics. The report tracks the following information:
  - **TPS**—Transactions Per Second; indicates the number of transactions that are received on the card.
  - **PEAK-TPS**—Indicates the maximum TPS that occurred on the card
  - **PEAKTIMESTAMP**—Indicates the time when the peak TPS occurred on the card.
- **LAST LOG EVENT FILE GENERATED**—Statistics of the last log file transfer to the SFTP server. The report tracks the following information:
  - **FILENAME**—Name of the file.
  - **SIZE**—Size of the file.
  - **SERVER**—IP address of the server to which the file is transferred.

*Report Type:* `rept-stat-sflog:loc=<SCCP card location>`

- **CARD**—Card location of the SCCP card running the SCCPHC GPL.
- **VERSION**—Version number of the SCCPHC GPL running on the SCCP card.
- **TYPE**—Type of the card.
- **PST**—Primary state of the card. See [Possible Values for PST/SST/AST](#).
- **SST**—Secondary state of the card. See [Possible Values for PST/SST/AST](#).
- **AST**—Associated state of the card. See [Possible Values for PST/SST/AST](#).
- **CARD ALARM STATUS**—Displays SCCP card-specific alarms. If there are no card alarms present, this field displays `No Alarms`.
- **CPU USAGE**—Percentage of the amount of CPU used to process messages by the card.
- **SCCP STATISTICS**—Per-card logging statistics on SCCP. The report tracks the following information:
  - **SUCCESS**—Total number of messages successfully processed by the SCCP card.

- **DISCARD**—Total number of messages discarded by the SCCP card.
- **SERVER**—IP address of the server to which the file is transferred.

*Report Type:* rept-stat-sflog:loc=<SFAPP card location>

- **CARD**—Card location of the SFAPP card running the SFAPP GPL.
- **VERSION**—Version number of the SFAPP GPL running on the SFAPP card.
- **TYPE**—Type of the card.
- **PST**—Primary state of the card. See [Possible Values for PST/SST/AST](#).
- **SST**—Secondary state of the card. See [Possible Values for PST/SST/AST](#).
- **AST**—Associated state of the card. See [Possible Values for PST/SST/AST](#).
- **CARD ALARM STATUS**—Displays SFAPP card-specific alarms. If there are no card alarms present, this field displays `No Alarms`.
- **CPU USAGE**—Percentage of the amount of CPU used to process messages by the card.
- **SFAPP STATISTICS**—Per-card logging statistics on SFAPP. The report tracks the following information:
  - **SUCCESS**—Total number of messages successfully processed by the SFAPP card.
  - **DISCARD**—Total number of messages discarded by the SFAPP card.

## rept-stat-sfthrot

Use this command to display the overall status of the provisioned SS7 Firewall Throttling GTT Actions on the EAGLE.

### Parameters

This command has no parameters.

### Example

```
rept-stat-sfthrot
```

### Dependencies

An SCCP card running the SCCPHC application must be configured before this command can be entered.

### Output

Following is example output:

```
rept-stat-sfthrot
```

```
Command Executed
  tekelecstp 16-02-17 15:45:15 MST  EAGLE5 46.3.0.0-68.11.1
  rept-stat-sfthrot
  Command entered at terminal #21.
;
```

```

Command Accepted - Processing
  tekelecstp 16-02-17 15:45:15 MST  EAGLE5 46.3.0.0.0-68.11.1

  SCCP Cards Configured= 2      Cards IS-NR= 1
  Average CPU Usage = 5%

  CARD   VERSION   PST           SST           AST           TPS
-----
  1203   -----   OOS-MT-DSBLD  Manual        -----        0
  1107   004-011-004  IS-NR         Active        -----        3

  PER TA TPS STATISTICS:

=====
          CURRENT 30 SECS          PREVIOUS 30 SECS
          -----
  TA      STATUS  SUCCESS  DISCARD  SUCCESS  DISCARD
-----
  throt1  ALLOWED  94       0        95       0
  throt2  BLOCKED  101      25       100      29
  throt3  ALLOWED  96       0        95       0

  Command Completed.
;

```

## Legend

This section defines the fields of the `rept-stat-sfthrot` reports:

A dash (-) in an output field indicates that the statistic does not apply.

- **SCCP Cards Configured**—Number of cards running the SCCPHC GPL that are configured for SS7 Firewall Throttling GTT Actions.
- **CARD IS-NR**—Number of SCCP cards running the SCCPHC GPL that can be used by the system (status is In-Service Normal, IS-NR).
- **Average CPU Usage**—Average percentage of the amount of CPU used to process SS7 Firewall Throttling GTT Actions by the cards.
- **CARD**—Card location of the SCCP card running the SCCPHC GPL.
- **P**—P indicates the primary Service Module card. The primary Service Module card provides the MPS status to the EAGLE. This indicator is displayed between the card location and the GPL version.
- **VERSION**—Version number of the SCCPHC GPL running on the SCCP card.
- **PST**—Primary state of the card. See [Possible Values for PST/SST/AST](#) .
- **SST**—Secondary state of the card. See [Possible Values for PST/SST/AST](#) .
- **AST**—Associated state of the card. See [Possible Values for PST/SST/AST](#) .
- **TPS**—Transactions per second; indicates the number of SUCCESS MSUs processed by an SCCP card for all Throttling Actions (average cumulative count) for the previous window.



- **PER TA TPS STATISTICS**—System-wide view of per-TA statistics. The report tracks the following information:
  - **TA**—Throttling Actions that are provisioned in the database.
  - **STATUS**—Current state (Allowed or Blocked) of the corresponding Throttling Action for the 30-second window.
  - **CURRENT 30 SECS:**
    - \* **SUCCESS**—Number of success messages in the current 30-second window.
    - \* **DISCARD**—Number of discarded messages in the current 30-second window.
  - **PREVIOUS 30 SECS:**
    - \* **SUCCESS**—Number of success messages in the previous 30-second window.
    - \* **DISCARD**—Number of discarded messages in the previous 30-second window.

## rept-stat-sip

Use this command to display the overall status of the SIP service on the EAGLE.

### Parameters

#### **loc (optional)**

The SIP card location for which SIP TPS usage data is to be reported.

#### **Range:**

*1101 - 1108, 1111 - 1112, 1201 - 1208, 1211 - 1218, 1301 - 1308, 1311 - 1318, 2101 - 2108, 2111 - 2118, 2201 - 2208, 2211 - 2218, 2301 - 2308, 2311 - 2318, 3101 - 3108, 3111 - 3118, 3201 - 3208, 3211 - 3218, 3301 - 3308, 3311 - 3318, 4101 - 4108, 4111 - 4118, 4201 - 4208, 4211 - 4218, 4301 - 4308, 4311 - 4318, 5101 - 5108, 5111 - 5118, 5201 - 5208, 5211 - 5218, 5301 - 5308, 5311 - 5318, 6101 - 6108, 6111 - 6118*

#### **peakreset (optional)**

Reset peak values to the current TPS values.

#### **Range:**

*yes*

*no*

#### **Default:**

*no*

#### **mode (optional)**

Performance data of SIP cards and their connections.

#### **Range:**

*perf*

**Default:**  
*perf*

### Example

```
rept-stat-sip
rept-stat-sip:peakreset=yes:loc=1101
rept-stat-sip:loc=1101
rept-stat-sip:mode=perf
rept-stat-sip:mode=perf:loc=1101
```

### Dependencies

The location specified with this command should be of a SIP card.

A SIP card running the SIPHC application must be configured before this command can be entered.

Parameter peakreset should be specified with loc parameter.

### Notes

If optional parameters are specified, only the entries that match the entered parameters are displayed.

### Output

This example displays output when no parameter is specified:

```
rept-stat-sip

tekelecstp 02-03-20 05:58:25 EST EAGLE 46.0.0
rept-stat-sip

SIP ALARM STATUS = No Alarms
SIP cards Configured= 2 Cards IS-NR= 2

CARD   VERSION   PST           SST           AST           TPS
-----
1107   045-003-053 IS-ANR        Standby       100%+        0
-----

TOTAL SERVICE STATISTICS:

=====
SERVICE  SUCCESS  ERROR  WARNINGS  BYPASS  TOTAL
SIPNP:    5        2      1         2       10

Command Completed.
;
```

This example displays output when the LOC parameter is specified:

```
rept-stat-sip:loc=1107
```

Command Accepted - Processing

```
tekelecstp 02-03-20 06:00:17 EST EAGLE 46.0.0
```

```
rept-stat-sip:loc=1107
```

```

CARD   VERSION   TYPE   PST           SST           AST
1101   045-003-053  DSM   IS-NR        Active        -----
CARD ALARM STATUS = No Alarms

```

TPS STATISTICS

```

=====
====
                TPS   PEAK TPS.   PEAKTIMESTAMP
-----
                2503  2508         02-03-20 06:02:04

```

PER CONNECTION STATISTICS

```

=====
====
CNAME           STATUS TPS   INVITE  3XX   ERROR
-----
C1              DOWN   0     0     0     0
C2              DOWN   0     0     0     0
C3              UP     2503  75113  75113  0
UdpC4          UP     0     0     0     0
-----

```

Command Completed.

```
;
```

This example displays output when the MODE parameter is specified:

```
rept-stat-sip:mode=perf
```

Command Accepted - Processing

```
tekelecstp 02-03-20 06:05:55 EST EAGLE 46.0.0
```

```
rept-stat-sip:mode=perf
```

```
SIP ALARM STATUS = No Alarms
```

```
SIP Cards Configured= 2      Cards IS-NR= 2
```

TPS STATISTICS:

```
=====
```

```

===
CARD   TPS   PTPS   PTIMESTAMP
-----
1101 P 2507   2511   02-03-20 06:05:52
1107  0      0      00-00-00 00:00:00
-----

```

Command Completed.

;

This example displays output when both MODE and LOC parameters are specified:

```
rept-stat-sip:mode=perf:loc=1101
```

Command Accepted - Processing

```
tekelecstp 02-03-20 06:08:24 EST EAGLE 46.0.0
```

```
rept-stat-sip:mode=perf:loc=1101
```

```

CARD   VERSION   TYPE   PST           SST           AST
1101   045-003-053 DSM    IS-NR        Active        -----
CARD ALARM STATUS      = No Alarms

```

TPS STATISTICS:

```

=====
                TPS   PEAK TPS.   PEAKTIMESTAMP
-----
                2501  2517      02-03-20 06:06:21

```

PER CONNECTION STATISTICS:

```

=====
CNAME           TPS   PTPS   PTIMESTAMP
-----
C1                0     0      00-00-00 00:00:00
C2                0     0      00-00-00 00:00:00
C3               2501  2517   02-03-20 06:06:21
udpC4            0     0      00-00-00 00:00:00

```

Command Completed.

;

## rept-stat-slan

Use this command to generate a summary report of the status of the E5-ENET-B cards that make up the STPLAN subsystem.

## Parameters

### mode (optional)

Use this parameter to provide extended performance information, including message flow control (MFC) message rates.

#### Range:

*perf*

#### Default:

No extended performance information is displayed

## Example

```
rept-stat-slan
rept-stat-slan:mode=perf
```

## Dependencies

No other `rept-stat-xxx` commands can be in progress when this command is entered.

At least one E5-ENET-B card that makes up the STPLAN must be configured.

## Notes

The HOST Cap. field value is obtained by averaging usage percentages for data links from each E5-ENET-B card to the host.

The EAGLE Cap. field value is obtained by averaging usage percentages for E5-ENET-B traffic received from LIMs.

System level usage for host capacity (the AVERAGE USAGE per HOST CAPACITY field in the `rept-stat-slan` output) is obtained by averaging the usage percentages for the data links to the host from each E5-ENET-B card.

EAGLE level usage for E5-ENET-B card capacity (the AVERAGE USAGE per EAGLE CAPACITY field) is obtained by averaging usage percentages for E5-ENET-B traffic received from LIMs.

## Output

The following example shows output with at least one card in an IS-NR state:

```
rept-stat-slan

rlghncxa03w 04-02-27 16:53:22 EST   EAGLE 31.3.0
SLAN Subsystem Report  IS-NR           Active      -----
SLAN Cards Configured= 2          Cards IS-NR= 2
CARD  VERSION      PST           SST         AST        HOST Cap.
EAGLE Cap.

-----
1206  021-010-000  IS-NR           Active      ----
```

```

42%          16%
1104 021-010-000 IS-NR          Active  ALMINH  36%      12%

```

```
-----
AVERAGE USAGE per HOST CAPACITY = 39%
```

```
AVERAGE USAGE per EAGLE CAPACITY = 14%
```

```
CARDS DENIED SLAN SERVICE:
```

```
1101, 1204
```

```
Command Completed.
```

```
;
```

```
rept-stat-slan:mode=perf
```

```
rlghncxa03w 11-03-04 13:36:07 EST  EAGLE 44.0.0
```

```
SLAN Subsystem Report  IS-NR          Active  -----
```

```
SLAN Cards Configured= 3          Cards IS-NR= 3
```

```
CARD  HOST    EAGLE  MESSAGING
      CAP    CAP    RATE
```

```
-----
1101  50%    30%    140
```

```
1102  55%    33%    435
```

```
1103  47%    28%    435
```

```
1104  80%    32%    622
-----
```

```
AVERAGE USAGE per HOST CAPACITY = 51%
```

```
AVERAGE USAGE per EAGLE CAPACITY = 30%
```

```
CARDS DENIED SLAN SERVICE:
```

```
2103
```

```
Command Completed.
```

```
;
```

## Legend

- **SLAN Subsystem Report**—Status of the STPLAN subsystem
- **STPLAN Cards Configured**—Number of E5-ENET-B cards used by the STPLAN contained in the system.
- **Cards IS\_NR**—Number of E5-ENET-B cards contained in the system whose status is in service normal (IS-NR)
- **CARD**—Locations of the E5-ENET-B cards
- **VERSION**—Version number of the GPL running on the STPLAN card
- **PST**—Primary state of the E5-ENET-B cards. The possible values are described in [Possible Values for PST/SST/AST](#).
- **SST**—Secondary state of the E5-ENET-B cards. The possible values are described in [Possible Values for PST/SST/AST](#).
- **AST**—Associated state of the E5-ENET-B cards. The possible values are described in [Possible Values for PST/SST/AST](#).
- **HOST CAP**—Amount of traffic being sent to the host from each E5-ENET-B card, expressed as a percentage of the total amount of traffic that can be sent to the host.

- **EAGLE CAP**—Amount of traffic being sent to each E5-ENET-B card, that is received from the LIMs, expressed as a percentage of the total amount of traffic that can be sent to the E5-ENET-B card.
- **AVERAGE USAGE per HOST CAPACITY**—Amount of traffic being sent to all hosts from all E5-ENET-B cards, expressed as a percentage of the total amount of traffic that can be sent to all hosts from all E5-ENET-B cards.
- **AVERAGE USAGE per EAGLE CAPACITY**—Amount of traffic being sent to all E5-ENET-B cards that is received from the LIMs, expressed as a percentage of the total amount of traffic that can be sent to all E5-ENET-B cards.
- **CARDS DENIED SLAN SERVICE**—Card locations that cannot use the STPLAN application.
- **CARDS DISABLED COPY SERVICE**—Card locations that cannot use the stop and copy action of the gateway screening feature.

The report displayed with the `rept-stat-slan:mode=perf` command shows these fields:

- **HOST CAP**—Average of usage percentages for the TCP/IP data links to the host from each E5-ENET-B card.
- **EAGLE CAP**—Average of usage percentages for the E5-ENET-B traffic that is received from the LIMs.
- **TVG RATE**—Number of messages per second received from all SS7 links and any other group ticket voucher paced message source. Obtained from statistics maintained by the E5-ENET-B cards for the last 30-second period.
- **AVERAGE USAGE per HOST CAPACITY**—Amount of traffic being sent to all hosts from all E5-ENET-B cards, expressed as a percentage of the total amount of traffic that can be sent to all hosts from all E5-ENET-B cards.
- **AVERAGE USAGE per EAGLE CAPACITY**—Amount of traffic being sent to all E5-ENET-B cards that is received from the LIMs, expressed as a percentage of the total amount of traffic that can be sent to all E5-ENET-B cards.

#### Related Topics

- [rept-stat-alm](#)
- [rept-stat-card](#)
- [rept-stat-dlk](#)
- [rept-stat-imt](#)
- [rept-stat-sys](#)
- [rept-stat-trbl](#)

## rept-stat-slk

Use this command to generate a report of the MTP signaling links status. The secondary state (SST) indicates whether the link is available, unavailable, or manually removed from service.

Use this command to generate a separate report of status of the E1 associated with a signaling link. The status includes the location of the E1 card and the UAM text. If the E1 association is not provisioned, "E1 association unknown" is displayed. If the card is not type LIME1, no E1 output is generated.

Use this command to generate a separate report of status of the T1 associated with a signaling link. The status includes the location of the T1 card and the UAM text. If the card is not type LIMT1, no T1 output is generated.

### Parameters

#### **l2stats (optional)**

Report L2 status

##### **Range:**

###### ***align***

Display alignment data only

###### ***both***

Display alignment and service data

###### ***brief***

Display up to 10 alignment events only

###### ***no***

Do not display level 2 status information

###### ***service***

Display service data only

##### **Default:**

*no*

#### **link (optional)**

The signaling link on the card specified in the `loc` parameter. The links can be specified in any sequence or pattern.

##### **Synonym:**

*port*

##### **Range:**

*a, b, a1 - a63, b1 - b63*

Not all card types support all `link` parameter values.

See [Table A-1](#) for valid `link` parameter range values for each type of card that can have assigned signaling link ports.

##### **Default:**

Display all

#### **loc (optional)**

The card location as stenciled on the shelf of the system.

##### **Range:**

*1101 - 1108, 1111 - 1112, 1201 - 1208, 1211 - 1218, 1301 - 1308, 1311 - 1318, 2101 - 2108, 2111 - 2118, 2201 - 2208, 2211 - 2218, 2301 - 2308, 2311 - 2318, 3101 - 3108, 3111 - 3118, 3201 - 3208, 3211 - 3218, 3301 - 3308, 3311 - 3318, 4101 - 4108, 4111 - 4118, 4201 - 4208, 4211 - 4218, 4301 - 4308, 4311 - 4318, 5101 - 5108, 5111 - 5118, 5201 - 5208, 5211 - 5218, 5301 - 5308, 5311 - 5318, 6101 - 6108, 6111 - 6118*



**Default:**

All cards containing signaling links are displayed.

**stat (optional)**

A report on cards whose status is the same as the state indicated by the parameter

**Range:*****all***

All of the primary states

***alminh***

Alarms inhibited

***anr***

In-Service-Abnormal (IS-ANR)

***dsbld***

Out-of-Service-Maintenance-Disabled (OOS-MT-DSBLD)

***mt***

Out-of-Service-Maintenance (OOS-MT)

***nr***

In-Service-Normal (IS-NR)

**Default:**

Display all

**Example**

```
rept-stat-slk
```

```
rept-stat-slk:loc=1201:link=a
```

```
rept-stat-slk:stat=alminh
```

```
rept-stat-slk:loc=1203:link=b:l2stats=both
```

```
rept-stat-slk:loc=1203:link=b:l2stats=brief
```

**Dependencies**

No other `rept-stat-xxx` command can be in progress when this command is entered.

If the `loc` or `link` parameter is specified, then the `stat` parameter cannot be specified.

When the `loc` parameter is specified, the `link` parameter must be specified.

The card must be equipped and must be one of the following cards:

- E5-E1T1-B card running the SS7ANSI or CCS7ITU application
- E5-ATM-B card running the ATMANSI or ATMITU application
- E5-ENET-B card running the IPLIMI, or IPSP application
- SLIC card running the IPSP application

The location specified by the `loc` parameter cannot be one of those reserved for non-LIM or non-DCM cards.

The signaling link must be an SS7 signaling link to display level 2 statistics (`l2stats`).

On point-to-multipoint IP links (E5-ENET-B cards equipped as SS7IPGW or IPGWI links), `l2stats` output is not available.

The specified signaling link must be provisioned in the database.

A card location that is valid and defined in the database must be specified.

The card in the location specified by the `loc` parameter must be in service.

The `link=b` parameter cannot be specified for SS7IPGW links.

Neither the `stat` or `loc` and `port` parameters can be specified with this command.

An appropriate value must be specified for the `link` parameter when an ATM card is used:

- `a-a1`, `b`—E5-ATM-B card running the ATMANSI or ATMITU application

This command is not valid for IPSPG-M3UA signaling links.

### Notes

Not every card location represents a signaling link. Be sure to address a signaling link in this command.

This command can be canceled using the **F9** function key or the `canc-cmd` command. See `canc-cmd` for more information.

The *Installation Guide* provides an illustration of card locations.

### Output

```
rept-stat-slk
```

```
rlghncxa03w 04-02-27 17:00:36 EST EAGLE 31.3.0
SLK      LSN      CLLI      PST      SST      AST
1201,A   lsnssp2  -----  IS-NR    Avail    ----
1201,B   lsnstpi  -----  IS-NR    Avail    ----
1202,A   lsnstpn  -----  IS-NR    Avail    ----
1202,B   lsnstpi  -----  IS-NR    Avail    ----
1203,A   lsnstpa  -----  IS-NR    Avail    ----
1203,B   lsnscpa  -----  IS-NR    Avail    ----
1205,A   lsnscpi  -----  IS-NR    Avail    ----
1205,B   lsnssp1  -----  IS-NR    Avail    ----
1207,A   lsnstpa  -----  IS-NR    Avail    ----
1207,B   lsnssp1  -----  IS-NR    Avail    ----
1211,A   lsnstpn  -----  IS-NR    Avail    ----
1211,B   lsnssp1  -----  IS-NR    Avail    ----
Command Completed.
```

```
;
```

```
rept-stat-slk:loc=1201:link=a
```

```
rlghncxa03w 04-02-04 13:06:25 EST EAGLE 31.3.0
SLK      LSN      CLLI      PST      SST      AST
1201,A   lsnssp2  -----  OOS-MT   Unavail  ----
  ALARM STATUS      = *    0213 REPT-LKF: received SIOS
  UNAVAIL REASON    = PE NA
Command Completed.
```

```
;
```

```
rept-stat-slk:stat=alminh
```

```
rlghncxa03w 04-02-23 12:57:50 EST EAGLE 31.3.0
SLK      LSN      CLLI      PST      SST      AST
1205,A   lsnscpi  -----  IS-NR    Avail    ALMINH
1211,A   lsnstpn  -----  IS-NR    Avail    ALMINH
Command Completed.
```

```
;
```

```
rept-stat-slk:loc=1203:link=a:l2stats=both
```

```
rlghncxa03w 04-02-04 13:06:25 EST EAGLE 31.3.0
SLK      LSN      CLLI      PST      SST      AST
1203,A   lsnssp2  -----  OOS-MT-DSBLD  Unavail  ----
  ALARM STATUS      = **   0236 REPT-LKS:not aligned
  UNAVAIL REASON    = NA
Event Type      Event                               Timestamp
SSCOP State     Idle                               04-02-04
10:04:23.000
SSCOP State     Outgoing Conn. Pending            04-02-04
10:04:23.000
SSCOP State     Incoming Conn. Pending            04-02-04
10:05:31.100
SSCOP State     Outgoing Disc. Pending            04-02-04
10:05:31.100
SSCOP State     Outgoing Resync Pending           04-02-04
10:05:31.105
SSCOP State     Incoming Resync Pending           04-02-04
10:05:31.105
SSCOP State     Outgoing Recovery Pending         04-02-04
10:05:46.425
SSCOP State     Recovery Response Pending         04-02-04
10:05:46.430
SSCOP State     Incoming Recovery Pending         04-02-04
10:05:46.430
SSCOP State     Data Transfer Ready              04-02-04
10:06:02.110
SSCF State     OOS Idle                          04-02-04
10:06:02.120
SSCF State     OOS ODP                            04-02-04
10:06:02.885
```

```
SSCF State Alignment Idle 04-02-04 10:06:53.625
SSCF State Alignment OCP 04-02-04 10:07:14.000
SSCF State Alignment ODP 04-02-04 10:07:14.000
SSCF State In Service/Data Transfer Ready 04-02-04 10:08:01.760
SSCF State Proving Data Transfer Ready 04-02-04 10:08:01.760
SSCF State Aligned/Ready Data Transfer Ready 04-02-04 10:04:23.000
MAAL State OOS 04-02-04 10:04:23.000
MAAL State Alignment 04-02-04 10:05:31.100
MAAL State Proving 04-02-04 10:05:31.100
MAAL State Aligned/Ready 04-02-04 10:05:31.105
MAAL State In Service 04-02-04 10:05:31.105
SSCOP Receive BGN 04-02-04 10:05:46.425
SSCOP Receive BGAK 04-02-04 10:05:46.430
SSCOP Receive END 04-02-04 10:05:46.430
SSCOP Receive ENDAK 04-02-04 10:06:02.110
SSCOP Receive RS 04-02-04 10:06:02.120
SSCOP Receive RSAK 04-02-04 10:06:02.885
SSCOP Receive BGREJ 04-02-04 10:06:53.625
SSCOP Receive SD 04-02-04 10:07:14.000
SSCOP Transmit ER 04-02-04 10:07:14.000
SSCOP Transmit POLL 04-02-04 10:08:01.760
SSCOP Transmit STAT 04-02-04 10:08:01.760
SSCOP Transmit USTAT 04-02-04 10:04:23.000
SSCOP Transmit UD 04-02-04 10:04:23.000
SSCOP Transmit MD 04-02-04 10:05:31.100
SSCOP Transmit ERAK 04-02-04 10:05:31.100
SSCF Receive Out of Service 04-02-04 10:05:31.105
SSCF Receive Processor Outage 04-02-04 10:05:31.105
SSCF Receive In Service 04-02-04 10:05:46.425
SSCF Receive Normal 04-02-04 10:05:46.430
SSCF Receive Emergency 04-02-04 10:05:46.430
SSCF Transmit Alignment Not Successful 04-02-04 10:06:02.110
SSCF Transmit Mgmt Initiated 04-02-04 10:06:02.120
SSCF Transmit Protocol Error 04-02-04 10:06:02.885
SSCF Transmit Proving Not Successful 04-02-04 10:06:53.625
Special Event LCD 04-02-04 10:05:46.425
Special Event LCD Cleared 04-02-04 10:05:46.430
Special Event LOF 04-02-04 10:05:46.430
Special Event LOF Cleared 04-02-04 10:06:02.110
Special Event LOS 04-02-04 10:06:02.120
Special Event LOS Cleared 04-02-04 10:06:02.885
Special Event Too Many Interrupts 04-02-04 10:06:53.625

Service Event Timestamp
Timer_No_Credit expired 04-02-04 05:40:10.160
ERM link failure 04-02-04 10:02:02.125
Timer_No_Response expired 04-02-04 10:15:02.125
COO received 04-02-04 10:22:02.125
Stop Commanded 04-02-04 10:32:02.125
LPO 04-02-04 10:42:02.125
RPO 04-02-04 10:43:02.125
Remote OOS 04-02-04 10:44:02.125
Remote PE 04-02-04 10:45:02.125
Remote Mgmt Initiated 04-02-04 10:46:02.125
Failed SLT 04-02-04 10:47:02.125
```

```

LCD 04-02-04
10:48:02.125
LOS 04-02-04
10:49:02.125
LOF 04-02-04
10:52:02.125
Too many interrupts 04-02-04
10:53:02.125
In Service 04-02-04
10:54:01.760
Command Completed.
;

```

```
rept-stat-slk:loc=1203:link=b:l2stats=brief
```

```

rlghncxa03w 04-02-23 13:06:25 EST EAGLE 31.3.0
SLK      LSN      CLLI      PST      SST      AST
1203,B   lsnsspn2  -----  IS-NR      Avail     ----
ALARM STATUS      = No Alarms
UNAVAIL REASON    = --

```

```

Event Type      Event              Timestamp
Transmit        SIOS              97-10-31 10:04:23.000
State           Out of Service    97-10-31 10:04:23.000
State           Initial Align     97-10-31 10:05:31.100
State           Idle              97-10-31 10:05:31.100
Transmit        SIO               97-10-31 10:05:31.105
State           Not Aligned       97-10-31 10:05:31.105
State           T2 Expired        97-10-31 10:05:46.425
Command Completed.
;

```

This example shows the output for an E1 interface associated with a link:

```
rept-stat-slk:loc=1201:link=a
```

```

rlghncxa03w 04-02-23 13:06:25 EST EAGLE 31.3.0
SLK      LSN      CLLI      PST      SST      AST
1201,A   e5m6s4  -----  OOS-MT      Unavail     ----
ALARM STATUS      = No Alarms
UNAVAIL REASON    = --
E1 STATUS         = 1201, REPT-E1F:FAC-E1 Port 1 LOS failure
Command Completed.
;

```

This example shows the output when the E1 interface is not associated with a link:

```
rept-stat-slk:loc=1201:link=a
```

```

rlghncxa03w 04-02-23 13:06:25 EST EAGLE 31.3.0
SLK      LSN      CLLI      PST      SST      AST

```

```

1201,A   e5m6s4   ----- OOS-MT           Unavail   -----
ALARM STATUS           = No Alarms
UNAVAIL REASON         = --
E1 status              = E1 association unknown
Command Completed.
;

```

This example shows this output for a T1 interface associated with a link:

```
rept-stat-slk:loc=1201:link=a
```

```

rlghncxa03w 04-02-23 13:06:25 EST EAGLE 31.3.0
SLK      LSN      CLLI      PST      SST      AST
1201,A   e5m6s4   ----- OOS-MT           Unavail   -----
ALARM STATUS           = No Alarms
UNAVAIL REASON         = --
T1 STATUS              = 1201, REPT-E1F:FAC-T1 Port 1 LOS failure
Command Completed.
;

```

### Legend

- **SLK**—Card location and the signaling link
- **LSN**—Name of the linkset that contains the signaling link
- **CLLI**—CLLI code of the destination STP of the signaling link
- **PST**—Primary state of the signaling link. See [Possible Values for PST/SST/AST](#).
- **SST**—Secondary state of the signaling link. See [Possible Values for PST/SST/AST](#).
- **AST**—Associated state of the signaling link. See [Possible Values for PST/SST/AST](#).
- **ALARM STATUS**—Trouble text alarm message generated for the specified signaling link.
- **UNAVAIL REASON**—Reason the signaling link is unavailable. More than one unavailable reason may be listed:
  - **BSNR**—The signaling link received 2 of 3 invalid BSNs.
  - **CNGT**—The signaling link has a remote congestion time-out.
  - **COO**—A changeover order was received.
  - **FC**—The signaling link is unavailable because of false congestion restart.
  - **FE**—The signaling link is in far end loopback mode.
  - **FIBR**—The signaling link received 2 of 3 invalid FIBs.
  - **INTR**—Too many link interrupts were received.
  - **LB**—The signaling link has been blocked locally.
  - **LD**—The signaling link received incomplete data.
  - **LI**—The signaling link has been inhibited locally.
  - **NA**—The signaling link is not aligned.
  - **PF**—The signaling link failed the proving period.
  - **RB**—The signaling link has been blocked remotely.

- **RD(xx.xxx)**—The signaling link is unavailable because of a restart delay to prevent signaling link oscillation. The number in parentheses indicates the amount of time, in seconds, remaining in the restart delay period. The link is restarted automatically after this amount of time has elapsed.
- **RL**—The signaling link is in remote near end loopback mode.
- **RMI**—The signaling link has been inhibited remotely.
- **SIE**—An unexpected SIE was received.
- **SIN**—An unexpected SIN was received.
- **SIO**—An unexpected SIO was received.
- **SIOS**—An unexpected SIOS was received.
- **SLTF**—Link test failed.
- **T1NR**—The level-2 T1 (not ready) timer expired.
- **T1R**—The level-2 T1 (ready) timer expired.
- **T2**—The level-2 T2 timer expired.
- **T3**—The level-2 T3 timer expired.
- **XDA**—The signaling link did not receive an acknowledgment in time.
- **XER**—The SUERM threshold was exceeded.—
- **--**—The card is ISOLATED or the links are available.

The following are reasons that the ATM high-speed signaling link is unavailable:

- **TNC**—Timer No Credit expired - The remote node has held the node in a no-credit state for too long. The far end office should be contacted to determine the cause of the link congestion.
- **TNR**—Timer No Response expired - The far end is taking too long to acknowledge the messages sent to it by the near end. The far end office should be contacted to determine the cause for the excessive delay in acknowledging PDUs.
- **LPO**—Local Processor Outage - Indicates a spontaneous or management-initiated processor outage. The user needs to determine whether the outage was spontaneous or management-initiated on the near end.
- **RPO**—Remote Processor Outage - The far end has sent PDUs causing processor outage. The far end office should be contacted to determine the reason for the processor outage.
- **ROOS**—Remote Out of Service - The far end has sent PDUs causing a link to become out of service. The far end office should be contacted to determine the reason for taking the link out of service.
- **RPE**—Remote Protocol Error - The far end has sent PDUs declaring a protocol error. The far end office should be contacted to determine the details about the protocol error.
- **RMIR**—Remote Management Initiated Release - The far end has sent PDUs releasing the link. The far end office should be contacted to determine the reason for releasing the link.
- **LCD**—Level 1 facility outage: Loss of Cell Delineation
- **LOF**—Level 1 facility outage: Loss of Frame

- **LOS**—Level 1 facility outage: Loss of Signal

**EVENT TYPE**

The type of event being logged:

**RECEIVE**

When a signal unit is received.

**TRANSMIT**

When a signal unit is transmitted.

**STATE**

When an internal SS7 Level 2 state changes or a special event occurs that would either end alignment or cause the link to fail

**EVENT**

The specific event being logged: (1) if a signal unit is being received or transmitted, the specific signal unit is displayed; (2) if the event being logged is a state change, the new state is displayed; (3) If neither (1) nor (2) is displayed, the link or alignment failure reason is displayed.

**SERVICE EVENT**

The service activity of the link; for example, In Service. Anything other than In Service is a description of a link failure.

**TIMESTAMP**

The time event processed by the system as follows:

- **YY-MM-DD hh:mm:ss.ttt**, where
- **YY**—The last 2 digits of the year (range 00–99)
- **MM**—The month (range 01–12)
- **DD**—The day of month (range 00–31)
- **hh**—The hour of day (range 00–59)
- **mm**—The minute of the hour (range 00–59)
- **ss**—The seconds of the minute (range 00–59)
- **ttt**—Milliseconds of the second (range 000–995 in increments of 5)

**E1 STATUS**

The status of the E1 interface associated with the link; the status includes the card location and the UAM text. If the E1 association is not provisioned, “E1 association unknown” is displayed. If the card is not type LIME1, no E1 output is displayed.

**T1 STATUS**

The status of the T1 interface associated with the link; the status includes the card location and the UAM text. If the card is not type LIMT1, no T1 output is displayed.

**Related Topics**

- [act-slk](#)
- [blk-slk](#)
- [dact-slk](#)
- [dlt-slk](#)



- ent-slk
- inh-slk
- rtrv-slk
- tst-slk
- ublk-slk
- unhb-slk

## rept-stat-sys

Use this command to display a summary report of the status of the main system entities. Use this display to determine where the troubles are in the system. The display shows the number of these items that are in service (IS-NR) and how many are in another state (IS-ANR, OOS-MT, OOS-MT-DSBLD).

### Parameters

This command has no parameters.

### Example

```
rept-stat-sys
```

### Dependencies

No other `rept-stat-xxx` command can be in progress when this command is entered.

### Notes

None

### Output

The following example shows the output when no features are turned on in the system and only the cards in locations 1109-1110 and 1113-1118 are installed.

```
rept-stat-sys
```

```
tekelecstp 10-03-11 10:31:06 EST EAGLE 42.0.0
MAINTENANCE STATUS REPORT
Maintenance Baseline established.
Routing Baseline established.
SCCP Baseline established.
ALARMS:      CRIT=    2    MAJR=    2    MINR=    0    INH=    0
OAM 1113     IS-NR      Active      INH=    0
OAM 1115     IS-NR      Standby    INH=    0
LIM  CARD IS-NR=    0    Other=    0    INH=    0
SCCP  CARD IS-NR=    0    Other=    0    INH=    0
GLS  CARD IS-NR=    0    Other=    0    INH=    0
SLAN  CARD IS-NR=    0    Other=    0    INH=    0
VXWSLAN CARD IS-NR=    0    Other=    0    INH=    0
SS7IPGW CARD IS-NR=    0    Other=    0    INH=    0
IPGWI  CARD IS-NR=    0    Other=    0    INH=    0
```

```

IPLIMI  CARD IS-NR=  0  Other=      0      INH=    0
IPSG    CARD IS-NR=  0  Other=      0      INH=    0
MUX     CARD IS-NR=  2  Other=      0      INH=    0
MCPM    CARD IS-NR=  0  Other=      0      INH=    0
EROUTE  CARD IS-NR=  0  Other=      0      INH=    0
CLOCK   IS-NR=  2  Other=      0      INH=    0
IMT     IS-NR=  2  Other=      0
SLK     IS-NR=  0  Other=      0      INH=    0
DLK     IS-NR=  0  Other=      0      INH=    0
LINK SET IS-NR=  0  Other=      0      INH=    0
DSM IP LK IS-NR=  0  Other=      0      INH=    0
MCPM IP LK IS-NR=  0  Other=      0      INH=    0
APPLSOCK IS-NR=  0  Other=      0      INH=    0
SCTP ASSOC IS-NR=  0  Other=      0      INH=    0
APPL SERVER IS-NR=  0  Other=      0      INH=    0
SS7 DPC  IS-NR=  0  Other=      0      INH=    0
CLUST DPC IS-NR=  0  Other=      0      INH=    0
RTX     IS-NR=  0  Other=      0      INH=    0
XLIST DPC IS-NR=  0  Other=      0
DPC SS  Actv =  0  Other=      0
SEAS SS  IS-NR=  0  Other=      2
TERMINAL IS-NR= 16  Other=      0      INH=    0
MPS     IS-NR=  0  Other=      0
RTD SS  IS-NR=  1  Other=      0
;

```

The following example shows the output when various features are turned on in the system. (Your output will not show all of these entries; some features are mutually exclusive in the system.)

Some entries appear as follows:

- When the Measurements Platform feature is not turned on and no MCPM cards are in the IS-NR state in the system, the MCPM and MCPM IP LK values are zero and the MEAS SS entry does not appear.
- When one or more MCPM cards have been installed and allowed, the MCPM CARD entry shows the number of MCPM cards that are in each state.
- When the Measurements Platform feature is turned on and the Measurements Platform collection option is enabled, the MEAS SS entry appears.
- When the Measurements Platform collection function is enabled, the MCPM IP LK entry shows the number of links that are functioning for the MCPM cards, and the MEAS SS entry appears.
- When the Origin-Based MTP Routing (MOBR) feature is not turned on, and/or no exception routes have been provisioned, the RTX value is zero.
- When the OA&M IP Security Enhancement feature is turned on, the SECURITY SS entry appears.
- When the Equipment Identity Register (EIR) feature is turned on, the EIR SS entry appears.
- When the INAP Number Portability (INP) feature is turned on, the INP SS entry appears.
- When the ANSI41 Analyzed Information Query (ANSI41 AIQ) feature is enabled, the AIQ SS entry appears.

- When the FCMODE is FCOPY for an *FC- Capable* GPL, the FC IP LK and FCS entries appear. E5-ENET-B cards running the IPSP or IPGHC GPL are considered to be *FC- capable*. A card running the IPGHC GPL must be in the IS-NR State before the card can be considered *FC- capable*. This requirement does not apply to cards running the IPSP GPL.
- When the S13/S13' EIR feature is enabled and one or more DEIR cards have been provisioned and allowed, the DEIR CARD entry shows the number of DEIR cards that are in each state.
- When the SIP Number Portability feature is enabled and one or more SIP cards have been installed and allowed, the SIP CARD entry shows the number of SIP cards that are in each state.
- When one or more SFLOG cards have been installed and allowed, the SFLOG CARD entry shows the number of SFLOG cards that are in each state.

```
rept-stat-sys
```

```
tekelecstp 16-03-29 12:04:41 MST EAGLE5 46.3.0.0.0
```

```
MAINTENANCE STATUS REPORT
```

```
Maintenance Baseline established.
```

```
Routing Baseline being established.
```

```
SCCP Baseline established.
```

```
SIP Baseline being established.
```

```
DEIR Baseline being established.
```

```
ENUM Baseline being established.
```

```
SFLOG Baseline being established.
```

```
ALARMS:      CRIT=      8      MAJR=      12      MINR=      21
```

```
INH=      0
OAM 1113      OOS-MT      Isolated
INH=      0
OAM 1115      IS-NR      Active
INH=      0
LIM      CARD IS-NR=      1      Other=      0
INH=      0
SCCP      CARD IS-NR=      0      Other=      2
INH=      0
GLS      CARD IS-NR=      0      Other=      0
INH=      0
SLAN      CARD IS-NR=      0      Other=      0
INH=      0
SS7IPGW      CARD IS-NR=      0      Other=      0
INH=      0
IPGWI      CARD IS-NR=      0      Other=      0
INH=      0
IPLIMI      CARD IS-NR=      0      Other=      0
INH=      0
IPSG      CARD IS-NR=      0      Other=      0
INH=      0
MUX      CARD IS-NR=      2      Other=      0
INH=      0
MCPM      CARD IS-NR=      0      Other=      1
INH=      0
EROUTE      CARD IS-NR=      0      Other=      0
INH=      0
UTIL      CARD IS-NR=      0      Other=      0
```

```

INH=      0
SIP      CARD IS-NR=    0 Other=      0 INH=      0
DEIR     CARD IS-NR=    0 Other=      0 INH=      0
ENUM     CARD IS-NR=    0 Other=      0 INH=      0
SFLOG    CARD IS-NR=    1 Other=      0 INH=      1
CLOCK    IS-NR=    0 Other=      1 INH=      0
HS CLOCK IS-NR=    0 Other=      1 INH=      0
IMT      IS-NR=    1 Other=      1 INH=      0
SLK      IS-NR=    0 Other=      1 INH=      0
DLK      IS-NR=    0 Other=      0 INH=      0
LINK SET IS-NR=    0 Other=      1 INH=      0
DSM IP LK IS-NR=    1 Other=      1 INH=      0
MCPM IP LK IS-NR=    0 Other=      1 INH=      0
STC IP LK IS-NR=    0 Other=      0 INH=      0
ENET IP LK IS-NR=    2 Other=      2 INH=      0
APPLSOCK IS-NR=    0 Other=      0 INH=      0
SCTP ASSOC IS-NR=    0 Other=      0 INH=      0
APPL SERVER IS-NR=    0 Other=      0 INH=      0
SS7 DPC   IS-NR=    0 Other=      2 INH=      0
CLUST DPC IS-NR=    0 Other=      0 INH=      0
RTX       IS-NR=    0 Other=      0 INH=      0
XLIST DPC IS-NR=    0 Other=      0 INH=      0
DPC SS    Actv =    0 Other=      0
LSMS SS   IS-NR=    0 Other=      0
LSMS Conn IS-NR=    0 Other=      0 INH=      0
TERMINAL  IS-NR=    9 Other=     15 INH=      0
MPS       IS-NR=    0 Other=      2
MEAS SS   IS-NR=    0 Other=      1
E1PORT    IS-NR=    0 Other=      1 INH=      0
T1PORT    IS-NR=    0 Other=      0 INH=      0
J1PORT    IS-NR=    0 Other=      0 INH=      0
RTD SS    IS-NR=    1 Other=      0

```

Command Completed.

;

rept-stat-sys

tekelecstp 17-09-20 05:37:22 MST EAGLE5 46.6.0.0.0

MAINTENANCE STATUS REPORT

Maintenance Baseline established.

Routing Baseline being established.

SCCP Baseline established.

SIP Baseline being established.

DEIR Baseline being established.

ENUM Baseline being established.

SFLOG Baseline being established.

```

ALARMS:      CRIT=      8 MAJR=     12 MINR=     21 INH=      0
OAM 1113     OOS-MT           Isolated INH=      0
OAM 1115     IS-NR           Active   INH=      0
LIM      CARD IS-NR=    1 Other=      0 INH=      0
SCCP     CARD IS-NR=    0 Other=      2 INH=      0
IPSG     CARD IS-NR=    0 Other=      0 INH=      0
MUX      CARD IS-NR=    2 Other=      0 INH=      0

```

	MCPM	CARD	IS-NR=	0	Other=	1
INH=	0					
	EROUTE	CARD	IS-NR=	0	Other=	0
INH=	0					
	UTIL	CARD	IS-NR=	0	Other=	0
INH=	0					
	SIP	CARD	IS-NR=	0	Other=	0
INH=	0					
	DEIR	CARD	IS-NR=	0	Other=	0
INH=	0					
	ENUM	CARD	IS-NR=	0	Other=	0
INH=	0					
	SFLOG	CARD	IS-NR=	1	Other=	0
INH=	1					
	CLOCK		IS-NR=	0	Other=	1
INH=	0					
	HS CLOCK		IS-NR=	0	Other=	1
INH=	0					
	IMT		IS-NR=	1	Other=	1
	SLK		IS-NR=	0	Other=	1
INH=	0					
	DLK		IS-NR=	0	Other=	0
INH=	0					
	LINK SET		IS-NR=	0	Other=	1
INH=	0					
	DSM IP LK		IS-NR=	1	Other=	1
INH=	0					
	MCPM IP LK		IS-NR=	0	Other=	1
INH=	0					
	STC IP LK		IS-NR=	0	Other=	0
INH=	0					
	ENET IP LK		IS-NR=	2	Other=	2
INH=	0					
	APPLSOCK		IS-NR=	0	Other=	0
INH=	0					
	SCTP ASSOC		IS-NR=	0	Other=	0
INH=	0					
	APPL SERVER		IS-NR=	0	Other=	0
INH=	0					
	SS7 DPC		IS-NR=	0	Other=	2
INH=	0					
	CLUST DPC		IS-NR=	0	Other=	0
INH=	0					
	RTX		IS-NR=	0	Other=	0
INH=	0					
	XLIST DPC		IS-NR=	0	Other=	0
	DPC SS	Actv =		0	Other=	0
	LSMS SS	IS-NR=		0	Other=	0
	LSMS Conn	IS-NR=		0	Other=	0
INH=	0					
	TERMINAL		IS-NR=	9	Other=	15
INH=	0					
	MPS		IS-NR=	0	Other=	2
	MEAS SS		IS-NR=	0	Other=	1
	E1PORT		IS-NR=	0	Other=	1

```

INH=      0
          T1PORT      IS-NR=    0   Other=      0           INH=      0
          J1PORT      IS-NR=    0   Other=      0           INH=      0
          RTD SS      IS-NR=    1   Other=      0

```

Command Completed.

;

## Legend

- **INH**—Number of devices within each device type that have their alarms inhibited
- **ALARMS**—Number of critical (**CRIT**), major (**MAJR**), and minor (**MINR**) alarms on the system when the command was executed and the count of alarm inhibited (**INH**) devices for cards, links, linksets, and terminals
- **OAM**—Status of each card that is running the OAM (1113 and 1115)
- **LIMCARD**—Status of the LIM cards
- **SCCP CARD**—Status of the SCCP subsystem cards
- **VXWLAN CARD**—Status of the VXW STPLAN subsystem cards
- **MUX CARD**—Combined status of the MUX cards
- **MCPM CARD**—Status of the MCPM cards
- **EROUTE CARD**—Status of the EROUTE cards
- **CLOCK**—Status of the system clocks
- **HS CLOCK**—Status of the high-speed clocks
- **IMT**—Status of the IMT system
- **SLK**—Status of the SS7 and IPGWI signaling links in the system
- **DLK**—Status of the TCP/IP data links in the system
- **LINK SET**—Status of the linksets in the system
- **DSM IP LK**—Status of the Service Module IP linksets
- **MCPM IP LK**—Status of the MCPM IP links
- **FC IP LK**—Status of the Fast Copy IP links
- **APPLSOCK**—Status of the application sockets
- **SCTP ASSOC**—Status of the SCTP associations
- **APPL SERVER**—Status of the Application Servers
- **SS7 DPC**—Summary information for provisioned DPCs that are not in clusters
- **CLUST DPC**—Summary information for provisioned cluster DPCs
- **RTX**—Summary information for provisioned exception routes only
- **XLIST DPC**—Summary information for X-LIST DPC entries only
- **DPC SS**—Summary information for the DPC subsystem
- **SCCP SS**—Status of the SCCP subsystem
- **SEAS SS**—Status of the SEAS subsystem
- **MEAS SS**—Status of the Measurements subsystem (for Measurements Platform)

- **MPS**—Summary information on the MPS
- **TERMINAL**—Status of the terminals
- **SECURITY SS**—Status of the EAGLE OA&M IP Security subsystem
- **EIR SS**—Status of the Equipment Identity Register subsystem
- **RTD**—Status of the Run Time Diagnostic subsystem
- **VFLEX SS**—Status of the V-Flex subsystem
- **ATINPQ SS**—Status of the ATI Number Portability Query subsystem
- **INP SS**—Status of the INAP Number Portability subsystem
- **LNP SS**—Status of the Local Number Portability subsystem
- **FCS**—Status of the Fast Copy subsystem
- **AIQ SS**—Status of the ANSI41 Analyzed Information Query subsystem
- **SIP CARD**— Status of the SIP cards
- **DEIR CARD**— Status of the DEIR cards running DEIRHC GPL
- **SFLOG CARD**— Status of the SFLOG cards

#### Related Topics

- [rept-stat-alm](#)
- [rept-stat-card](#)
- [rept-stat-clk](#)
- [rept-stat-cluster](#)
- [rept-stat-dstn](#)
- [rept-stat-imt](#)
- [rept-stat-ls](#)
- [rept-stat-meas](#)
- [rept-stat-mon](#)
- [rept-stat-mps](#)
- [rept-stat-seas](#)
- [rept-stat-slk](#)
- [rept-stat-trbl](#)
- [rept-stat-xlist](#)

## rept-stat-t1

Use this command to display the T1 port status and signaling link status for cards with provisioned T1 ports.

#### Parameters

##### **loc (optional)**

Card address. The unique identifier of a specific LIMT1 card located in the STP.

**Range:**

1101 - 1108, 1111 - 1112, 1201 - 1208, 1211 - 1218, 1301 - 1308, 1311 - 1318, 2101 - 2108, 2111 - 2118, 2201 - 2208, 2211 - 2218, 2301 - 2308, 2311 - 2318, 3101 - 3108, 3111 - 3118, 3201 - 3208, 3211 - 3218, 3301 - 3308, 3311 - 3318, 4101 - 4108, 4111 - 4118, 4201 - 4208, 4211 - 4218, 4301 - 4308, 4311 - 4318, 5101 - 5108, 5111 - 5118, 5201 - 5208, 5211 - 5218, 5301 - 5308, 5311 - 5318, 6101 - 6108, 6111 - 6118

**Default:**

Information for all LIMT1 cards is reported.

**t1port (optional)**

T1 port number. This parameter displays information for a T1 port on the card in the specified card location.

**Range:**

1 - 8 .

**Example**

```
rept-stat-t1
rept-stat-t1:loc=1203
rept-stat-t1:loc=1203:t1port=1
```

**Dependencies**

No other `rept-stat-xxx` command can be in progress when this command is entered.

The `loc` parameter must be specified when the `t1port` parameter is specified.

The active TDM location cannot be specified in the `loc` parameter.

Card locations 1117 and 1118 and the MUX card locations (`xy09` and `xy10` where `x` is the frame and `y` is the shelf) cannot be specified in the `loc` parameter.

**Notes**

Specifying the command without any parameters displays T1 port status for all cards with provisioned T1 ports.

If the `loc` parameter is specified, status is displayed for all T1 ports provisioned on the card in the specified location.

If the `loc` and `t1port` parameters are specified, the T1 port status summary is displayed for all T1 ports provisioned on the card in the specified location, followed by the status of all signaling links assigned to the specified T1 port on the card.

**Output**

This example shows the output when no parameters are specified:

```
rept-stat-t1

rlghncxa03w 05-01-04 07:01:08 EST EAGLE5 33.0.0
LOC  T1PORT  PST          SST          AST
1203  1        IS-NR        Avail        BRGD MSTR
1203  2        IS-NR        Avail        BRGD SLAV
```



```

1203 3      IS-NR      Avail      -----
1203 7      OOS-MT     Unavail    -----
1207 1      IS-NR      Avail      -----
1207 2      IS-NR      Avail      -----
Command Completed.

```

;

This example shows the output when the `loc` parameter is specified:

```
rept-stat-t1:loc=1203
```

```

rlghncxa03w 05-01-04 07:01:08 EST  EAGLE5 33.0.0
LOC   T1PORT  PST      SST      AST
1203  1      IS-NR    Avail    BRGD MSTR
1203  2      IS-NR    Avail    BRGD SLAV
1203  3      IS-NR    Avail    -----
1203  7      OOS-MT   Unavail  -----
Command Completed.

```

;

This example shows the output when the `loc` and `t1port` parameters are specified:

```
rept-stat-t1:loc=1203:t1port=1
```

```

rlghncxa03w 05-01-04 07:01:08 EST  EAGLE5 33.0.0
LOC   T1PORT  PST      SST      AST
1203  1      IS-NR    Avail    BRGD MSTR
ALARM STATUS      = No Alarms.
UNAVAIL REASON    = --
SLK   TS   PST      SST      AST
A     1   IS-NR    Avail    ---
A1    2   IS-NR    Avail    ---
Command Completed.

```

;

```
rept-stat-t1:loc=1203:t1port=2
```

```

rlghncxa03w 05-01-04 07:01:08 EST  EAGLE5 33.0.0
LOC   T1PORT  PST      SST      AST
1203  2      IS-NR    Avail    BRGD SLAV
ALARM STATUS      = No Alarms.
UNAVAIL REASON    = --
Command Completed.

```

;

### Legend

- **LOC**—Card location
- **T1PORT**—Number of the T1 port provisioned on the card in the specified location.

- **PST**—Primary state of the card. See [Possible Values for PST/SST/AST](#).
- **SST**—Secondary state of the card. See [Possible Values for PST/SST/AST](#).
- **AST**—Associated state of the card. See [Possible Values for PST/SST/AST](#). The values *PARENT* and *PAIRED* refer to odd and even adjacent ports on the card that are provisioned in channel bridging mode.
- **ALARM STATUS**—Either "No Alarms" or current alarm number and text
- **UNAVAIL REASON**—Reason for the T1 port being unavailable
- **SLK**—Signaling link assigned to the T1 port
- **TS**—Timeslot assigned to the signaling link
- **PST**—Primary state of the signaling link. See [Possible Values for PST/SST/AST](#).
- **SST**—Secondary state of the signaling link. See [Possible Values for PST/SST/AST](#).
- **AST**—Associated state of the signaling link. See [Possible Values for PST/SST/AST](#).

## rept-stat-trbl

Use this command to display a summary report of all the device trouble notifications that are logged currently in the OAM's RAM storage area.

### Parameters

#### **display (optional)**

Display type of alarms to be reported.

#### **Range:**

##### ***act***

Display only active alarms

##### ***all***

Display all alarms with no timestamps

##### ***inhb***

Display only inhibited alarms

##### ***timestamp***

Display all alarms with the date and time when the alarm was logged. Timestamps appear in the output only when the `display=timestamp` parameter is specified.

#### **Default:**

*all*

#### **level (optional)**

The alarm level of the alarms to be displayed

#### **Range:**

##### ***crit***

##### ***majr***

**minr****Default:**

All alarms are displayed

**Example**

```
rept-stat-trbl
rept-stat-trbl:level=majr
rept-stat-trbl:display=inhb
```

**Dependencies**

No other `rept-stat-xxx` command can be in progress when this command is entered.

**Notes**

None

**Output**

This example lists all devices that could appear. This example is to be used as a sample only: all devices and alarms cannot coexist in the system.

```
rept-stat-trbl

tekelecstp 16-03-29 10:31:06 EST EAGLE 46.3.0.0
  SEQN UAM AL DEVICE    ELEMENT      TROUBLE TEXT
  0002.0143 * CARD 1113 OAM      System release GPL(s) not
approved
  0011.0176 * SECULOG 1116      Stdby security log - upload
required
  0002.0143 * CARD 1113 OAM      System release GPL(s) not
approved
  0011.0176 * SECULOG 1116      Stdby security log - upload
required
  2353.0022 * CARD 1107 MCP      Clock B for card failed,
Clock A normal
  3587.0048 * TERMINAL  1      Terminal failed
  0007.0110 * IMT SYSTEM      Failure detected on one IMT
bus
  2343.0002 * GPL SYSTEM BPDCM   Card is not running approved
GPL
  4321.0321 * XLIST              X-LIST occupancy threshold
exceeded
  0045.0348 * SEAS SYSTEM      SEAS is at min service limit
  0011.0176 * SECULOG 1116      Stdby security log -- upload
required
  4121.0398 * INP SYSTEM      Local Subsystem
normal, card(s) abnormal
  2354.0516 * MEAS SYSTEM      Degraded Mode - 1 card failed
  0046.0155 * DLK 1104,A1      STPLAN connection unavailable
  0050 1114 * HS CLOCK SYSTEM   Clock selection mismatch
  1088.0539 * DLK 1106,A1      Ethernet Interface Down
```

```
1089.0579 * CARD 1106 FC Network Unavailable
3700.0536 * IP7 assoc1234567890 IP Connection Excess Retransmits
0021.0318 ** LSN lsn1 REPT-LKSTO: link set prohibited
0022.0318 ** LSN lsn2 REPT-LKSTO: link set prohibited
0023.0318 ** LSN lsn3 REPT-LKSTO: link set prohibited
0024.0236 ** SLK 1315,A ls11234567 REPT-LKF: not aligned
0025.0236 ** SLK 1316,A ls11345678 REPT-LKF: not aligned
0010.0318 ** LSN lsn4 REPT-LKSTO: link set prohibited
0021.0318 ** LSN lsn1 REPT-LKSTO: link set prohibited
0022.0318 ** LSN lsn2 REPT-LKSTO: link set prohibited
0023.0318 ** LSN lsn3 REPT-LKSTO: link set prohibited
0024.0236 ** SLK 1315,A ls11234567 REPT-LKF: not aligned
0025.0236 ** SLK 1316,A ls11345678 REPT-LKF: not aligned
3540.0203 ** SLK 1201,A lsn1 REPT-LKF: lost data
3541.0203 ** SLK 1201,B lsn4 REPT-LKF: lost data
3542.0203 ** SLK 1202,A lsn2 REPT-LKF: lost data
3543.0203 ** SLK 1202,B lsn4 REPT-LKF: lost data
3544.0202 ** SLK 1203,A lsn3 REPT-LKF: HWP - too many link
interrupts
3545.0202 ** SLK 1203,B lsn4 REPT-LKF: HWP - too many link
interrupts
3589.0013 ** CARD 1103 SS7ANSI Card is isolated from the system
2358.0013 ** CARD 1111 MCP Card is isolated from the system
3590.0013 ** CARD 1115 OAM Card is isolated from the system
3590.0514 ** CARD 1115 EOAM Standby MASP is inhibited
0006.0108 ** IMT BUS A Major IMT failure detected
Card 1105, 1113, 1115
0012.0390 ** CARD 1109 HMUX Illegal Address Error
3591.0208 ** SLK 1101,A ls1 REPT-LKF: APF - lvl-2 T2 expired
3592.0208 ** SLK 1101,B ls2 REPT-LKF: APF - lvl-2 T2 expired
3593.0202 ** SLK 1102,B2 lsname489+ REPT-LKF: HWP -too many link
interrupts
3594.0236 ** SLK 1103,A ls3 REPT-LKF: not aligned
3595.0236 ** SLK 1103,B ls4 REPT-LKF: not aligned
3596.0084 ** DLK 1111,A MCP IP Connection Unavailable
0024.0236 ** SLK 1315,A ls11234567 REPT-LKF: not aligned
0025.0236 ** SLK 1316,A ls11345678 REPT-LKF: not aligned
0943.0318 ** LSN ls1 REPT-LKSTO: link set prohibited
0945.0318 ** LSN ls2 REPT-LKSTO: link set prohibited
0948.0318 ** LSN ls4 REPT-LKSTO: link set prohibited
1234.0082 ** FUSE PANEL 11xx Alarm in Fuse Panel
0134.0084 ** IP7 LONGSOCKETNAME1 IP Connection Unavailable
3537.0084 ** DLK 1215,A MCP IP Connection Unavailable
3537.0084 ** DSM 1315,A IP Connection Unavailable
5648.0382 ** E1PORT 1201,2 REPT-E1F:FAC-E1 LOF failure
0047.0392 ** SECURITY SYSTEM 1211 OA&M IP Security feature status is
OFF
1235 0114 ** IP TPS SYSTEM System IP TPS threshold exceeded
3684.0013 ** CARD 1305 SS7IPGW Card is isolated from the system
3688.0236 ** SLK 1203,A lslg2 REPT-LKF: not aligned
3692.0318 ** LSN e5e6 REPT-LKSTO: link set prohibited
1090.0576 ** FCS ALL FC Network Unavailable
3697.0539 ** ENET 1305,A Ethernet Interface Down
3698.0539 ** ENET 1305,B Ethernet Interface Down
3699.0539 ** ENET 1307,B Ethernet Interface Down
```

```
0917.0537 ** ENET 1112,B          Ethernet error threshold
exceeded
0189.0084 ** DLK 1104,A   EROUTE   IP Connection Unavailable
0150.0491 ** DCONN con1      Connection TPS exceed
0003.0313 *C DPC   s-010-010-003   DPC is prohibited
0004.0313 *C DPC   010-010-004     DPC is prohibited
0005.0313 *C DPC ps-010-010-005   DPC is prohibited
0006.0313 *C DPC   s-252-010-003   DPC is prohibited
0008.0313 *C DPC   252-010-004     DPC is prohibited
0009.0313 *C DPC   252-011-*       DPC is prohibited
0019.0236 *C T1PORT 1301,1        REPT-T1F:FAC-T1   LOS failure
0028.0313 *C DPC   252-010-001     DPC is prohibited
0029.0308 *C SYSTEM                Node isolated due to SLK

failures
0036.0455 *C EIR SYSTEM            EIR Subsystem is not available
3102.0435 *C LNP SYSTEM            LNP Subsystem is disabled
0003.0313 *C DPC   s-010-010-003   DPC is prohibited
0004.0313 *C DPC   010-010-004     DPC is prohibited
0005.0313 *C DPC ps-010-010-005   DPC is prohibited
0006.0313 *C DPC   s-252-010-003   DPC is prohibited
0008.0313 *C DPC   252-010-004     DPC is prohibited
0009.0313 *C DPC   252-011-*       DPC is prohibited
0019.0236 *C T1PORT 1301,1        REPT-T1F:FAC-T1   LOS failure
0028.0313 *C DPC   252-010-001     DPC is prohibited
0029.0308 *C SYSTEM                Node isolated due to SLK

failures
0036.0455 *C EIR SYSTEM            EIR Subsystem is not available
3102.0435 *C LNP SYSTEM            LNP Subsystem is disabled
0003.0313 *C DPC   s-010-010-003   DPC is prohibited
0004.0313 *C DPC   010-010-004     DPC is prohibited
0005.0313 *C DPC ps-010-010-005   DPC is prohibited
0028.0313 *C DPC   252-010-001     DPC is prohibited
0006.0313 *C DPC   s-252-010-003   DPC is prohibited
0008.0313 *C DPC   252-010-004     DPC is prohibited
0009.0313 *C DPC   252-011-*       DPC is prohibited
2120.0058 *C CDT   1                Critical customer trouble

detected
0029.0308 *C SYSTEM                Node isolated due to SLK

failures
0040.0128 *C CLOCK SYSTEM          All clocks have failed
2109.0331 *C SCCP SYSTEM           SCCP is not available
2110.0292 *C GLS SYSTEM            GLS is not available
1234.0153 *C SLAN SYSTEM           STPLAN not available
0009.0041 *C LSMS Connection A1    LNP DB Maintenance Required
0056.0356 *C LSMS SYSTEM           LSMS unavailable
0041.0197 *C CLOCK SYSTEM          All High Speed Clocks have

failed
0056.0356 *C LSMS SYSTEM           LSMS unavailable
0041.0197 *C CLOCK SYSTEM          All High Speed Clocks have

failed
3102.0435 *C LNP SYSTEM            LNP Subsystem is disabled
3539.0181 *C NDC SYSTEM            NDC Subsystem is not available
0036.0455 *C EIR SYSTEM            EIR Subsystem is not available
0019.0236 *C T1PORT 1301,1        REPT-T1F:FAC-T1   LOS failure
4521.0370 *C MPS A                 Critical Platform Failure(s)
```

```

0045.0469 *C EROUTE SYSTEM          All STC cards Unavailable
0036.0455 *C EIR SYSTEM              EIR Subsystem is not available
0915.0541 *C RTD SYSTEM              MSU cksum error threshold exceeded
0002.0520 *C                          Frame power usage reached LVL3
0056.0528 *C GFLEX SERVICE           Service is not available
0056.0528 *C GPORT SERVICE           Service is not available
0056.0528 *C MNP SERVICE              Service is not available
0044.0534 *C RTX      001-101-001    RTX is prohibited
0916.0565 *C ATINPQ SYSTEM           ATINPQ Subsystem is not available
0150.0483 *C DEIR SYSTEM             DEIR System is not available
0160.0120 *C ENUM SYSTEM             ENUM System is not available
7470.0630 ** TA - throt2             Throttle Threshold - exceeded

```

```
Command Completed.
```

```
;
```

```
rept-stat-trbl:display=act:level=majr
```

```

rlghncxa03w 02-03-07 09:50:17 EST  EAGLE 30.0.0
Searching devices for alarms...

```

```
;
```

```

rlghncxa03w 02-03-07 09:50:17 EST  EAGLE 30.0.0
SEQN UAM  AL DEVICE      ELEMENT      TROUBLE TEXT
3540.0203 ** SLK 1201,A  lsn1        REPT-LKF: lost data
3541.0203 ** SLK 1201,B  lsn4        REPT-LKF: lost data
3542.0203 ** SLK 1202,A  lsn2        REPT-LKF: lost data
3543.0203 ** SLK 1202,B  lsn4        REPT-LKF: lost data
3544.0202 ** SLK 1203,A  lsn3        REPT-LKF: HWP -too many link
interrupts
3545.0202 ** SLK 1203,A1 lsn4        REPT-LKF: HWP -too many link
interrupts
3545.0202 ** SLK 1203,B2 lsn4+      REPT-LKF: HWP -too many link
interrupts
0022.0318 ** LSN lsn2              REPT-LKSTO: link set prohibited
0023.0318 ** LSN lsn3              REPT-LKSTO: link set prohibited
0010.0318 ** LSN lsn4              REPT-LKSTO: link set prohibited
Command Completed.

```

```
;
```

```
rept-stat-trbl:display=inhb:level=majr
```

```

rlghncxa03w 02-03-07 09:50:17 EST  EAGLE 30.0.0
Searching devices for alarms...

```

```
;
```

```

rlghncxa03w 02-03-07 09:50:17 EST  EAGLE 30.0.0
SEQN UAM  AL DEVICE      ELEMENT      TROUBLE TEXT
0021.0318I** LSN lsn1              REPT-LKSTO: link set prohibited
Command Completed.

```

```
;
```

This example shows output when the `display=timestamp` parameter is specified.

```
rept-stat-trbl:display=timestamp
```

```
rlghncxa03w 04-04-07 09:50:17 EST EAGLE 31.6.0  
Searching devices for alarms...
```

```
;
```

```
tekelecstp 04-04-07 09:50:17 EST EAGLE 31.6.0  
SEQN UAM AL DEVICE ELEMENT TROUBLE TEXT  
0003.0048 * TERMINAL 1 Terminal failed  
04-1-27 15:19:25  
0004.0048 * TERMINAL 2 Terminal failed  
04-1-27 15:19:25  
0005.0048 * TERMINAL 4 Terminal failed  
04-1-27 15:19:25  
0006.0002 * GPL SYSTEM EOAM Card is not running approved  
GPL  
04-1-27 15:19:25  
0007.0176 * SECULOG 1116 Stdby security log -- upload  
required  
04-1-27 15:19:25  
0008.0013 ** CARD 1103 VSCCP Card is isolated from the  
system  
04-15-27 15:19:25  
0009.0438 *C SYSTEM Degraded Mode, Invalid OAM HW  
config  
04-1-27 15:19:27  
0010.0331 *C SCCP SYSTEM SCCP is not available  
04-1-27 15:19:25  
Command Completed.
```

```
;
```

```
rept-stat-trbl
```

```
eagle2 16-03-03 14:17:40 EST EAGLE5 46.3.0.0.0  
Searching devices for alarms...
```

```
;
```

```
eagle2 16-03-03 14:17:40 EST EAGLE5 46.3.0.0.0  
SEQN UAM AL DEVICE ELEMENT TROUBLE TEXT  
7374.0048 * TERMINAL 3 Terminal failed  
7375.0048 * TERMINAL 4 Terminal failed  
7376.0048 * TERMINAL 5 Terminal failed  
7377.0048 * TERMINAL 6 Terminal failed  
7378.0048 * TERMINAL 7 Terminal failed  
7379.0048 * TERMINAL 8 Terminal failed  
7380.0048 * TERMINAL 9 Terminal failed  
7381.0048 * TERMINAL 10 Terminal failed  
7382.0048 * TERMINAL 11 Terminal failed  
7383.0048 * TERMINAL 12 Terminal failed  
7384.0048 * TERMINAL 13 Terminal failed  
7385.0048 * TERMINAL 15 Terminal failed  
7386.0048 * TERMINAL 16 Terminal failed  
5088.0176 * SECULOG 1114 Stdby security log -- upload  
required
```

```

8546.0632 * TA - throt2           Alarm Threshold - exceeded
7387.0013 ** CARD 1215 IPSG       Card is isolated from the system
7388.0441 ** CARD 1105 SCCPHC     Incorrect MBD - CPU
                                HW VERIFICATION CODE: 180
7389.0084 ** DLK 1105,A   SCCP    IP Connection Unavailable
7391.0084 ** DLK 1105,B   SCCP    IP Connection Unavailable
7392.0539 ** ENET 1215,A   Ethernet Interface Down
7393.0539 ** ENET 1105,A   Ethernet Interface Down
7394.0539 ** ENET 1105,B   Ethernet Interface Down
7395.0313 *C DPC      11007     DPC is prohibited
7396.0529 *C GPORT SERVICE     Service is disabled

```

Command Completed.

;

### Legend

In the AL column:

- \*—Minor Alarm
- \*\*—Major Alarm
- \*C—Critical Alarm
- I—Inhibited Alarm

### Related Topics

- [act-alm-trns](#)
- [dact-alm-trns](#)
- [rept-stat-alm](#)
- [rept-stat-clk](#)
- [rls-alm](#)
- [rtrv-obit](#)
- [rtrv-trbl](#)

## rept-stat-trm

Use this command to display the status of the terminal ports. The device primary, secondary, and associated state information is displayed along with the terminal identification number.

### Parameters

#### **trm (optional)**

The ID of the terminal port that is to be reported.

#### **Range:**

1 - 40

#### **Default:**

Display status of all terminal ports



**Example**

```
rept-stat-trm
rept-stat-trm:trm=5
rept-stat-trm:trm=17
```

**Dependencies**

No other `rept-stat-xxx` command can be in progress when this command is entered.

**Notes**

None

**Output**

This example shows output when the IP User Interface is not turned on:

```
rept-stat-trm

tekelecstp 03-03-31 13:02:16 EST EAGLE 30.0.0
TRM  PST          SST          AST
1    IS-NR        Active      -----
2    IS-NR        Active      -----
3    IS-NR        Active      -----
4    IS-NR        Active      -----
5    IS-NR        Active      -----
6    IS-NR        Active      -----
7    IS-NR        Active      -----
8    IS-NR        Active      -----
9    IS-NR        Active      -----
10   IS-NR        Active      -----
11   IS-NR        Active      -----
12   IS-NR        Active      -----
13   IS-NR        Active      -----
14   IS-NR        Active      -----
15   IS-NR        Active      -----
16   IS-NR        Active      -----
Command Completed.
;
```

This example shows output when the IP User Interface is turned on and 3 IP SM cards are in the system:

```
rept-stat-trm

rlghncxa03w 04-01-07 09:50:17 EST EAGLE 31.3.0
TRM  PST          SST          AST
1    IS-NR        Active      -----
2    IS-NR        Active      -----
3    IS-NR        Active      ALMINH
```

```

4      IS-NR      Active      -----
5      OOS-MT-DSBLD Manual      -----
6      IS-NR      Active      -----
7      IS-NR      Active      -----
8      IS-NR      Active      -----
9      IS-NR      Active      -----
10     IS-NR      Active      -----
11     IS-NR      Active      ALMINH
12     IS-NR      Active      -----
13     IS-NR      Active      -----
14     OOS-MT      Fault       -----
15     IS-NR      Active      -----
16     IS-NR      Active      -----
17     IS-NR      Active      -----
18     IS-NR      Active      -----
19     IS-NR      Active      -----
20     OOS-MT-DSBLD Manual      -----
21     IS-NR      Idle       -----
22     IS-NR      Idle       -----
23     IS-NR      Idle       -----
24     IS-NR      Idle       -----
25     IS-NR      Active      -----
26     IS-NR      Active      -----
27     IS-NR      Active      -----
28     IS-NR      Active      -----
29     IS-NR      Active      -----
30     IS-NR      Active      -----
31     IS-NR      Active      -----
32     IS-NR      Active      -----
33     IS-NR      Active      -----
34     IS-NR      Active      -----
35     IS-NR      Active      -----
36     IS-NR      Active      -----
37     IS-NR      Active      -----
38     IS-NR      Active      -----
39     IS-NR      Active      -----
40     IS-NR      Active      -----

```

Command Completed.

;

```
rept-stat-trm:trm=5
```

```
rlghncxa03w 04-01-07 09:50:17 EST EAGLE 31.3.0
```

```
TRM  PST          SST          AST
5     IS-NR      Active      -----
```

Command Completed.

;

### Legend

- **TRM**—ID of the terminal port
- **PST**—Primary state of the terminal ports. Possible values are described in [Possible Values for PST/SST/AST](#).

- **SST**—Secondary state of the terminal ports. Possible values are described in [Possible Values for PST/SST/AST](#).
- **AST**—Associated state of the terminal ports. Possible values are described in [Possible Values for PST/SST/AST](#).

#### Related Topics

- [act-echo](#)
- [alw-trm](#)
- [chg-trm](#)
- [dact-echo](#)
- [inh-trm](#)
- [rmv-trm](#)
- [rst-trm](#)
- [rtrv-trm](#)

## rept-stat-tstslk

Use this command to generate a report of the status of the MTP signaling links currently under test.

#### Parameters

##### **link (optional)**

SS7 signaling links. The SS7 signaling link that is being tested.

##### **Synonym:**

*port*

##### **Range:**

*a, b, a1 - a3, b1 - b31*

Not all card types support all `link` parameter values.

See [Table A-1](#) for valid `link` parameter range values for each type of card that can have assigned signaling links.

##### **loc (optional)**

The card location as stenciled on the shelf of the system.

##### **Range:**

*1101 - 1108, 1111 - 1112, 1201 - 1208, 1211 - 1218, 1301 - 1308, 1311 - 1318,  
2101 - 2108, 2111 - 2118, 2201 - 2208, 2211 - 2218, 2301 - 2308, 2311 - 2318,  
3101 - 3108, 3111 - 3118, 3201 - 3208, 3211 - 3218, 3301 - 3308, 3311 - 3318,  
4101 - 4108, 4111 - 4118, 4201 - 4208, 4211 - 4218, 4301 - 4308, 4311 - 4318,  
5101 - 5108, 5111 - 5118, 5201 - 5208, 5211 - 5218, 5301 - 5308, 5311 - 5318,  
6101 - 6108, 6111 - 6118*

##### **loopback (optional)**

Loopback test type.

**Range:***sltc**lxvr**oam**line**payload***Example**

```
rept-stat-tstslk
rept-stat-tstslk:loc=1201
rept-stat-tstslk:loc=1203:link=a
rept-stat-tstslk:loopback=lxvr
```

**Dependencies**

The card location specified in the `loc` parameter must be equipped.

The signaling link specified in the `link` parameter must be equipped.

If the `link` parameter is specified, the `loc` parameter must be specified.

The signaling link specified in the `link` parameter must be an SS7 signaling link.

This command cannot be entered for E5-ENET-B cards that are running the IPGHC or IPSG application, or that have IPGHC or IPSG-M3UA links.

The card location specified in the `loc` parameter cannot be reserved by the system.

This command cannot be entered during upgrade.

**Notes**

None

**Output**

If no parameters are specified, all links in test are displayed.

If only the `loc` parameter is specified, all links in test on the specified card are displayed.

If the `loc` and `link` parameters are specified, the specified link on the specified card is displayed.

If the `loopback` parameter is specified, all links in the specified type of loopback test are displayed.

```
rept-stat-tstslk
```

```
tekelecstp 04-01-07 10:05:28 EST EAGLE 31.3.0
SLK        LOOPBACK  MAX-TIME  TEST-TIME
1102,A1    SLTC      01:00:00  00:04:01
```

```

1201,A      OAM      02:00:00   01:04:11
1203,A      LXVR     00:50:00   00:22:21
1203,B      LXVR     24:00:00   20:04:01
1208,A      PAYLOAD  01:10:00   01:05:22
1211,A      LINE     21:30:00   00:14:01
;

```

### Legend

- **SLK**—Card and signaling link that are being tested.
- **LOOPBACK**—Type of loopback test being run.
- **MAX-TIME**—Maximum length of time for the test to run, as specified in the `tst-slk` command `time` parameter.
- **TEST-TIME**—The length of time that the test has been running when this command was entered.

### Related Topics

- [tst-slk](#)

## rept-stat-user

Use this command to show which users are logged into the system. The command shows user names, terminal identification numbers, the time that the last valid command was issued, and the current state of the last command entered.

### Parameters

This command has no parameters.

### Example

```
rept-stat-user
```

### Dependencies

None

### Notes

None

### Output

```
rept-stat-user
```

```

e5oam 09-04-03 17:25:57 MST  EAGLE 41.0.0
REPT STAT USER COMPLD
USER ID          TERM #  IDLE SINCE          COMMAND
STATE
eagle            3      02-01-03 17:19:04  rept-stat-applsock
IDLE
eagle            6      02-01-03 17:25:57  rept-stat-user

```

```
PROCESSING  
REPORT COMPLETED
```

### Legend

- **USER ID**—The user ID of the users logged onto the system.
- **TERM #**—The terminal port to which the user's terminal is connected.
- **IDLE SINCE**—The date and time of day that the user last entered a command.
- **COMMAND**—The last command the user entered.
- **STATE**—The state of the command the user last entered.

### Related Topics

- [act-user](#)
- [chg-pid](#)
- [chg-user](#)
- [dact-user](#)
- [dlt-user](#)
- [ent-user](#)
- [login](#)
- [logout](#)
- [rtrv-secu-user](#)
- [rtrv-user](#)

## rept-stat-xlist

Use this command to report statistics related to the storage of x-list entries. X-list entries reside in the routing table and are dynamically created for individual members of clusters whenever one or more routes to that cluster member become more restrictive than the corresponding routes to the cluster.

The following information is reported:

- The number of routing table positions reserved for x-list entries
- The current number of x-list entries
- The percentage of space in the x-list reserved area currently in use
- The percentage of x-list space that must be in use before an alarm is issued

### Parameters

This command has no parameters.

### Example

```
rept-stat-xlist
```

## Dependencies

The Cluster Routing and Management Diversity (CRMD) feature must be turned on before using this command.

## Notes

The statistics reported by this command are those gathered during periodic polling by the maintenance subsystem. They might differ slightly from the instantaneous values at the time the command was issued.

The following rules are used to compute the *Current X-LIST occupancy* percentage value that is displayed in the output report:

- The percentage value that is displayed is computed as follows:  
 $[(\text{current x-list entries}) / (\text{allocated x-list space})] * 100$
- Non-integer percentages will be rounded up to the next highest integer (for example, 23.5% becomes 24%), with the exception of the situation described in the next rule.
- 100% is not displayed until the current *X-LIST* entries value exactly equals the allocated X-LIST space (for example, 99.1% is not rounded up to 100%).

## Output

```
rept-stat-xlist
```

```
rlghncxa03w 04-02-18 03:32:42 EST   EAGLE 31.3.0
Allocated X-LIST space      = 500
Current X-LIST entries      = 156
Current X-LIST occupancy   = 31 % (see "Notes")
X-LIST occupancy threshold = 80 %
;
```

## Related Topics

- [chg-stpopts](#)
- [rept-stat-cluster](#)
- [rtrv-stpopts](#)

# rls-alm

Use this command to silence audible alarms. Entering this command also causes the alarm status on terminals to stop blinking (though they continue showing an alarm condition).

## Parameters

### **lv1 (optional)**

The alarm level.

**Range:***crit**majr**minr***Default:**

All alarms are cleared

**Example**

```
rls-alm
rls-alm:lvl=crit
```

**Dependencies**

No other action command can be in progress when this command is entered.

**Notes**

This command has no effect on visual alarm indicators on the fuse and alarm panel (FAP) or on the cabinet side panel.

Any alarms that occur after the execution of this command activate audible alarms again.

**Output**

```
rls-alm

rlghncxa03w 04-01-07 09:27:24 EST EAGLE 31.3.0
rls-alm
Command entered at terminal #8.
;
```

**Related Topics**

- [act-alm-trns](#)
- [dact-alm-trns](#)
- [rept-stat-alm](#)
- [rept-stat-clk](#)
- [rept-stat-trbl](#)
- [rtrv-obit](#)
- [rtrv-trbl](#)

## rmv-card

Use this command to change the state of the card to Out of Service - Maintenance Disabled (OOS-MT-DSBLD), enabling a technician to test a LIM or E5-TSM card or physically remove it from the shelf.



## Parameters

### **loc (mandatory)**

The card location as stenciled on the shelf of the system.

#### **Range:**

1101 - 1108, 1111 - 1112, 1201 - 1208, 1211 - 1218, 1301 - 1308, 1311 - 1318,  
2101 - 2108, 2111 - 2118, 2201 - 2208, 2211 - 2218, 2301 - 2308, 2311 - 2318,  
3101 - 3108, 3111 - 3118, 3201 - 3208, 3211 - 3218, 3301 - 3308, 3311 - 3318,  
4101 - 4108, 4111 - 4118, 4201 - 4208, 4211 - 4218, 4301 - 4308, 4311 - 4318,  
5101 - 5108, 5111 - 5118, 5201 - 5208, 5211 - 5218, 5301 - 5308, 5311 - 5318,  
6101 - 6108, 6111 - 6118

Refer to *Installation Guide* for card location information.

### **force (optional)**

This parameter is required if the card is the last GLS or SCCP card.

#### **Range:**

**yes**

**no**

#### **Default:**

**no**

## Example

```
rmv-card:loc=1101
```

```
rmv-card:loc=1201:force=yes
```

## Dependencies

The following card locations are not valid for this command: 1113, 1114, 1115, 1116, 1117, 1118, and all xy09 and xy10 locations (where x is the frame and y is the shelf).

The shelf and card must be equipped.

If the card is a LIM, all signaling links assigned to the card must be placed out of service before the command can be entered.

The `force` parameter is required to force the last GLS (if the Integrated GLS feature is not turned ON) or SCCP card out of service.

If the card has active TCP/IP links, all TCP/IP data links assigned to it must be placed out of service.

## Notes

The function of this command is the same as the `inh-card` command.

When this command is executed, the card boots and enters the OOS-MT-DSBLD state. It has no affect if the card is already OOS-MT-DSBLD.

The command is rejected if you attempt to inhibit a LIM that has active signaling links. The links must be cancelled, using the `dact-slk` command, before the command is accepted.

Inhibiting a card running the VSCCP application affects GTT service. SCCP messages requiring global title translation are not routed, and an error message is returned to the originator.

Inhibiting an E5-TSM running the GLS application has no immediate affect on the system. These cards are used only when loading gateway screening to the LIMs.

The command is rejected if you attempt to inhibit a card that has active TCP/IP data links. The TCP/IP data links must be cancelled, using the `canc-dlk` command, before the command is accepted.

### Output

```
rmv-card:loc=1101
```

```
rlghncxa03w 04-01-07 11:11:28 EST EAGLE 31.3.0  
Card has been inhibited.
```

```
;
```

### Related Topics

- [dlt-card](#)
- [ent-card](#)
- [init-card](#)
- [rept-stat-card](#)
- [rtrv-card](#)

## rmv-imt

The interprocessor message transport bus (IMT bus) is the main communications artery between all subsystems in the system. Use this command to remove the IMT bus from service.

### Caution:

Use this command only when directed by the Customer Care Center.

### Parameters

#### **bus (mandatory)**

The IMT bus to be inhibited.

#### Range:

**a**

**b**

### Example

```
rmv-imt:bus=a
```

## Dependencies

The alternate IMT bus must be in-service normal (IS-NR) in order for the specified bus to be inhibited.

This command cannot be entered during an IMT Fault Isolation Test.

## Notes

Cards that are not connected to the other IMT bus will reinitialize.

All traffic is rerouted to the other IMT bus.

The function of this command is the same as the `inh-imt` command.

## Output

```
rmv-imt:bus=a
```

```
rlghncxa03w 04-01-07 09:22:31 EST EAGLE 31.3.0
* 0014.0203 * SLK 1205,A nc00027 slk not aligned

rlghncxa03w 04-01-07 09:22:31 EST EAGLE 31.3.0
Inhibit IMT Bus A command issued

rlghncxa03w 04-01-07 09:22:31 EST EAGLE 31.3.0
* 00120.1203 * SLK 1205,B nc00027 slk not aligned

rlghncxa21w 04-01-07 09:22:31 EST EAGLE 31.3.0
0016.0096 CARD 1205 SS7ANSI card has been reloaded

rlghncxa21w 04-01-07 09:22:31 EST EAGLE 31.3.0
0017.0236 SLK 1205,A nc00027 slk is attempting to align

rlghncxa21w 04-01-07 09:22:31 EST EAGLE 31.3.0
0018.0236 SLK 1205,B nc00027 slk is attempting to align

rlghncxa21w 04-01-07 09:22:32 est EAGLE 31.3.0
0019.0098 imt bus a imt inhibited

rlghncxa21w 04-01-07 09:22:32 est EAGLE 31.3.0
* 0020.0107 * imt bus a minor imt failure detected

rlghncxa21w 04-01-07 09:22:32 EST EAGLE 31.3.0
** 0021.0108 ** IMT BUS A major imt failure detected

rlghncxa21w 04-01-07 09:22:33 EST EAGLE 31.3.0
0022.0026 CARD 1205 SS7ANSI clocks a and b for card normal
;
```

## Related Topics

- [clr-imt-stats](#)
- [conn-imt](#)

- [disc-imt](#)
- [rept-imt-lvl1](#)
- [rept-imt-lvl2](#)
- [rept-stat-imt](#)
- [rst-imt](#)

## rmv-trm

Use this command to set the primary state of a serial port to OOS-MT-DSBLD (Out-of-Service-Maintenance-Disabled), and to set the secondary state to MANUAL. The serial port is not available to perform service functions. There is no outgoing traffic from the serial port; all incoming traffic is ignored.

### Parameters

#### **trm (mandatory)**

The ID of the serial port to be inhibited.

#### **Range:**

*1 - 40*

#### **force (optional)**

This parameter forces the removal of the terminal, even if it is the last in-service SEAS terminal available.

#### **Range:**

*yes*

*no*

#### **Default:**

*no*

### Example

```
rmv-trm:port=5
```

```
rmv-trm:trm=1:force=yes
```

### Dependencies

No other action command can be in progress when this command is entered.

The IP User Interface feature must be enabled before terminal ports 17 through 40 can be specified as values for the `trm` parameter.

The `force=yes` parameter must be specified to inhibit the last in-service SEAS terminal.

### Notes

When removing a terminal that has already been removed, a warning message is echoed to the scroll area but no action is taken.

MTT 2731 was deleted for 42.0, PR 158511.

## Output

```
rmv-trm

      rlghncxa03w 04-01-07 11:11:28 EST  EAGLE 31.3.0
      Inhibit message sent to terminal
;

rmv-trm:trm=17:force=yes

      tekelecstp 07-01-11 13:42:16 EST  EAGLE 37.5.0
      Inhibit message sent to terminal
;
```

## Related Topics

- [act-echo](#)
- [alw-trm](#)
- [canc-echo](#)
- [chg-trm](#)
- [dact-echo](#)
- [inh-trm](#)
- [rept-stat-trm](#)
- [rst-trm](#)
- [rtrv-trm](#)

# rst-dstn

Use this command to request that the circular routing status for the specified destination be reset (turned OFF). The destination that is specified can be a full point code (FPC), a cluster point code (for example, *ni-nc-\**), or an x-list point code. The system clears the circular routing status for the specified destination and then clears any outstanding circular routing alarm for the destination.

## Parameters



### Note:

See [Point Code Formats and Conversion](#) for a detailed description of point code formats, rules for specification, and examples.

**dpc (mandatory)**

ANSI destination point code with subfields *network indicator-network cluster-network cluster member (ni-nc-ncm)*. The *prefix* subfield indicates a private point code (*prefix-ni-nc-ncm*).

**Synonym:**

*dpca*

**Range:**

*p-*, *000-255*, \*

Specify a valid value for each subfield of the point code, and separate the subfields with a dash (-).

*prefix—p-*

The asterisk value (\*) is not valid for the *ni* subfield.

When *chg-sid:pctype=ansi* is specified, *ni = 000* is not valid.

When *chg-sid:pctype=ansi* is specified, *nc = 000* is not valid if *ni = 001–005*.

When *chg-sid:pctype=ansi* is specified, *nc = 000* is valid if *ni = 006–255*.

The point code *000-000-000* is not a valid point code.

**dpc/dpca/dpci/dpcn/dpcn24/dpcn16 (mandatory)****dpci (mandatory)**

ITU international destination point code with subfields *zone-area-id*. The *prefix* subfield indicates a spare point code, private point code, or private and spare point code (*prefix-zone-area-id*).

**Range:**

*s-*, *p-*, *ps-*, *0-255*

Specify a valid value for each subfield of the point code, and separate the subfields with a dash (-).

*prefix—s-*, *p-*, *ps*

*zone—0-7*

*area—000-255*

*id—0-7*

The point code *0-000-0* is not a valid point code.

**dpcn (mandatory)**

ITU national destination point code in the format of a 5-digit number (*nnnnn*); or 2, 3, or 4 numbers (*members*) separated by dashes (*m1-m2-m3-m4*) as defined by the *chg-stpopts:npcfmti* flexible point code option. A group code must be specified when the ITUDUPPC feature is turned on (*nnnnn-gc*, *m1-m2-m3-m4-gc*). The *prefix* subfield indicates a spare point code, private point code, or private and spare point code (*prefix-nnnnn*, *prefix-nnnnn-gc*, *prefix-m1-m2-m3-m4*, *prefix-m1-m2-m3-m4-gc*).

**Range:**

*s-*, *p-*, *ps-*, *0-16383*, *aa-zz*

Specify a valid value for each subfield of the point code, and separate the subfields with a dash (-).

*prefix—s-*, *p-*, *ps*

*nnnnn—0-16383*

*gc—aa-zz*

*m1-m2-m3-m4—0-14* for each member; values must sum to 14

**dpcn24 (mandatory)**

24-bit ITU national point code with subfields *main signaling area-sub signaling area-signaling point (msa-ssa-sp)*. The *prefix* subfield indicates a private point code (*prefix-msa-ssa-sp*).

**Range:***p*-, 000-255

Specify a valid value for each subfield of the point code, and separate the subfields with a dash (-).

*prefix—p**msa—000—255**ssa—000—255**sp—000—255***dpcn16 (mandatory)**16-bit ITU national point code with subfields *unit number sub number area main number area (un-sna-mna)*. The *prefix* subfield indicates a private point code (*prefix-un-sna-mna*).**Range:***p--*, 000---127

Specify a valid value for each subfield of the point code, and separate the subfields with a dash (-).

*prefix---p**un---000---127**sna---000---15**mna---000---31***force (optional)**

This parameter specifies whether to reset all dynamic data for the specified route in the Route table to the initial values.

**Range:****yes**

reset the data

**no**

do not reset the data

**Default:***no***Example**`rst-dstn:dpc=1-2-*``rst-dstn:dpc=20-2-5``rst-dstn:dpc=p-20-2-5``rst-dstn:dpc=20-2-5:force=yes``rst-dstn:dpcn16=125-2-10`**Dependencies**

The specified DPC must be either provisioned or an x-list entry.

The destination address must be a full point code or a cluster point code specified as *ni-nc-\**. A DPC as *ni-nc-\*\** or *ni-nc-\*\*\** cannot be specified.

### Notes

None.

### Output

```
rst-dstn:dpc=20-2-5:force=yes

    rlghncxa03w 09-03-29 16:40:40 EST  EAGLE 41.0.0
    Destination reset command sent to SNM (scroll area)

    rlghncxa03w 09-03-29 16:40:40 EST  EAGLE 41.0.0
    Command Completed.
;

rst-dstn:dpcn16=1-14-0

    tekelecstp 02-01-13 00:58:40 MST  UNKNOWN 45.1.0-64.69.1
    rst-dstn:dpcn16=1-14-0
    Command entered at terminal #17.
;

Command Accepted - Processing
    tekelecstp 02-01-13 00:58:40 MST  UNKNOWN 45.1.0-64.69.1
    Info: DPC is not in circular routing state.
    Reset destination command sent to all MTP cards.
;

    tekelecstp 02-01-13 00:58:40 MST  UNKNOWN 45.1.0-64.69.1
    Command Completed.
;

Command Executed
```

### Related Topics

- [chg-stpopts](#)
- [rept-stat-cluster](#)
- [rept-stat-dstn](#)
- [rtrv-stpopts](#)

## rst-imt

The interprocessor message transport bus (IMT bus) is the main communications artery between all subsystems in the system. Use this command to change the state of the specified IMT bus from OOS-MT-DSBLD (out of service maintenance disabled) to IS-NR (in service normal), if the command is successful. If the command fails, the status is IS-ANR (in service abnormal).



## Parameters

### **bus (mandatory)**

The IMT bus to be returned to service.

### **Range:**

**a**

**b**

## Example

```
rst-imt:bus=a
```

## Dependencies

None

## Notes

The function of this command is the same as the `alw-imt` command.

This command returns an inhibited IMT bus to service.

## Output

```
rst-imt:bus=a
```

```
rlghncxa03w 04-01-07 11:02:30 EST  EAGLE 31.3.0  
Allow IMT Bus A command issued.
```

```
rlghncxa03w 04-01-07 11:02:30 EST  EAGLE 31.3.0  
0100.0097   IMT   BUS A           IMT allowed
```

```
;
```

## Related Topics

- [clr-imt-stats](#)
- [conn-imt](#)
- [disc-imt](#)
- [rept-imt-lvl1](#)
- [rept-imt-lvl2](#)
- [rept-stat-imt](#)
- [rmv-imt](#)

# rst-trm

Use this command to return the specified serial port to the state IS-NR (in-service-normal) from the state OOS-MT-DSBLD (Out-of-Service-Maintenance-Disabled) if the command is successful. If the command is not successful, the terminal's state is OOS-MT (Out-of-Service-Maintenance).

## Parameters

### **trm (mandatory)**

ID of the serial port to be put into service.

#### **Range:**

1 - 40

## Example

```
rst-trm:trm=5
```

## Dependencies

No other action command can be in progress when this command is entered.

The IP User Interface feature must be enabled before terminal ports 17 through 40 can be specified in the `trm` parameter.

The terminal specified by the `trm` parameter must be equipped.

Anyone logged in to the terminal specified by this command is logged off when this command is executed. For the user to continue working on the specified terminal, the user must log on to that terminal again.

An IPSM card must be provisioned for the specified SEAS terminal before this command can be entered.

The SEAS Over IP feature must be turned on before this command can be entered for a SEAS terminal.

If the SEAS terminal is auto-inhibited, then this command cannot be entered.

The terminal specified by the `trm` parameter cannot be configured as `type=none` (see the `chg-trm` command).

## Notes

The function of this command is the same as the `alw-trm` command.

When you attempt to return to service a terminal already in service, a warning message is echoed to the scroll area but no action is taken.

## Output

```
rst-trm:trm=12
```

```
rlghncxa03w 04-01-07 11:11:28 EST EAGLE 31.3.0  
Allow message sent to terminal
```

```
rlghncxa03w 04-01-07 11:11:28 EST EAGLE 31.3.0  
1062.0046      TERMINAL      12      Terminal Enabled
```

```
;
```

## Related Topics

- [act-echo](#)

- [alw-trm](#)
- [canc-echo](#)
- [chg-trm](#)
- [dact-echo](#)
- [inh-trm](#)
- [rept-stat-trm](#)
- [rmv-trm](#)
- [rtrv-trm](#)

## rtrv-acg-mic

Use this command to display the values of ACG controls assigned to certain queries. The control can apply to all queries or to specific query services and called party digits.

### Parameters

#### **dgts (optional)**

Digits

##### **Range:**

3 digits, 6 - 10 digits

Valid values are 000-999, 000000-9999999999

#### **serv (optional)**

Query service

##### **Range:**

*ain*

*in*

#### **type (optional)**

Type of control

##### **Range:**

*all*

*sd*

### Example

Display all MICs:

```
rtrv-acg-mic
```

Display the MIC(s) that apply to particular services and digits:

```
rtrv-acg-mic:type=sd
```

Display the MIC(s) that apply to AIN queries:

```
rtrv-acg-mic:serv=ain
```

Display the MIC(s) that apply to IN queries for 919-460-xxxx:

```
rtrv-acg-mic:serv=in:dgts=919460
```

### Dependencies

If the `type=all` parameter is specified, then the `serv` and `dgts` parameters cannot be specified.

The `dgts` parameter value must be specified as 3 digits or 6-10 digits.

The LNP feature must be turned on before this command can be entered.

### Notes

None

### Output

```
rtrv-acg-mic:type=sd
```

```
rlghncxa03w 04-01-28 08:50:12 EST EAGLE 31.3.0
```

```
TYPE=ALL
```

```
ND INTVL AINTVL DRTN
```

```
6 4 7 8
```

```
TYPE=SD
```

```
DGTS SERV INTVL AINTVL DRTN
```

```
704461 AIN - 8 7
```

```
919460 IN 6 - 7
```

```
9194602132 AIN - 7 8
```

```
9194602132 IN 4 - 8
```

```
919461 IN 6 - 7
```

```
ACG MIC table is (11 of 256) 4% full of type SD
```

```
RTRV-ACG-MIC: MASP A - COMPLTD
```

```
;
```

This example shows how the memory space accounting command completion response is used for `type=all`:

```
rtrv-acg-mic:type=all
```

```
rlghncxa03w 04-01-28 08:50:12 EST EAGLE 31.3.0
```

```
TYPE=ALL
```

```
ND INTVL AINTVL DRTN
```

```
6 4 7 8
```

```
TYPE=SD
```

```
DGTS SERV INTVL AINTVL DRTN
```

```
919460 IN 6 - 7
```

```
9194602132 IN 4 - 8
```

```
ACG MIC table is (5 of 256) 2% full of type SD
```

```
RTRV-ACG-MIC: MASP A - COMPLTD  
;
```

### Legend

- **AINTVL**—New AIN interval index
- **DGTS**—Digits
- **DRTN**—New duration index
- **INTVL**—New IN interval index
- **ND**—New number of digits
- **SERV**—Query service

### Related Topics

- [chg-acg-mic](#)
- [dlt-acg-mic](#)
- [ent-acg-mic](#)
- [rept-stat-lnp](#)

## rtrv-acg-noc

Use this command to display the definitions of node overload levels. The definition is comprised of the threshold LNP query rates for node overload levels and the values for the Automatic Call Gappings (ACG) to be sent when at the overload level.

### Parameters

#### **lvl** (optional)

Overload level

#### **Range:**

1 - 10

### Example

```
rtrv-acg-noc
```

```
rtrv-acg-noc:lvl=3
```

### Dependencies

The ACG NOC table must be accessible.

The LNP feature must be turned on before this command can be entered.

### Notes

None

### Output

This example displays all defined overload levels:

```
rtrv-acg-noc
```

```
rlghncxa03w 04-01-28 08:50:12 EST EAGLE 31.3.0
LVL QR          AND  IND  INTVL  DRTN
3   600000      10   6   3      6
4   750000      6    6   5      7
10  2147483647 10   10  15     13
RTRV-ACG-NOC: MASP A - COMPLTD
```

```
;
```

This example displays overload level 3:

```
rtrv-acg-noc:lvl=3
```

```
rlghncxa03w 04-01-28 08:50:12 EST EAGLE 31.3.0
LVL QR          AND  IND  INTVL  DRTN
3   600000      10  10   3      6
RTRV-ACG-NOC: MASP A - COMPLTD
```

```
;
```

### Legend

- **LVL**—Overload level
- **QR**—Query rate
- **AND**—AIN number of digits
- **IND**—IN number of digits
- **INTVL**—Interval index
- **DRTN**—Duration index

### Related Topics

- [chg-acg-noc](#)
- [dlt-acg-noc](#)
- [ent-acg-noc](#)
- [rept-stat-lnp](#)

## rtrv-ainpopts

Use this command to retrieve AINP-specific options.

### Parameters

This command has no parameters.

### Example

```
rtrv-ainpopts
```

## Dependencies

The AINPOPTS table must be accessible.

None.

## Output

If the RNAI or RNAIV option is not provisioned, then the RNAI mnemonic default value is displayed. If the RNAI or RNAIV option is provisioned, then the RNAI mnemonic string for the option is displayed.

If the RNP or RNPV option is not provisioned, then the RNP mnemonic default value is displayed. If the RNP or RNPV option is provisioned, and the RNPV option can be set using RNP, then the RNP mnemonic string for the option is displayed. If the RNPV option cannot be provisioned using RNP, then the RNPV numerical value is displayed.

Each DIALPFX and DIALNAI option is displayed with its associated DLTPFX and SNAI option, respectively.

If the NEC option is not provisioned, then the default is displayed.

If the LNPSNAI, LNPOGLRNNAI, LNPOGDNNAI, LNPSUBDIGLEN, LNPATLDIGLEN, LNPSPORT, or LNPENTPREF option is not provisioned, then the default value is displayed.

This example shows output with default AINP options.

```
rtrv-ainpopts
```

```
rlghncxa03w 15-07-28 15:35:05 EST EAGLE 46.3.0
AINP OPTIONS
```

```

-----
NEC          = NONE
RNAI         = FRMSG
RNP          = E164
RFMT         = RNDN
SPRESTYPE   = RRWODGTS
SPORTTYPE   = NONE
DEFRN       = NONE

LNPSNAI      = INC
LNPOGLRNNAI  = INC
LNPOGDNNAI   = INC
LNPSUBDIGLEN = 7
LNPATLDIGLEN = 10
LNPSPORT     = NONE
LNPENTPREF   = RN

DIALPFX      DLTPFX
-----
DIALNAI      SNAI
-----
;

```

This example shows output with some AINP options provisioned.

```
rtrv-ainpopts
```

```
rlghncxa03w 15-07-28 15:35:05 EST EAGLE 46.3.0
AINP OPTIONS
-----
NEC          = ABC1D
RNAI         = NATL
RNP          = E212
RFMT         = CCRNDN
SPRESTYPE   = RRWDGTS
SPORTTYPE    = IS41
DEFRN       = ABC1

LNPSNAI      = INC
LNPOGLRNNAI = INC
LNPOGDNNAI   = NATL
LNPSUBDIGLEN = 7
LNPATLDIGLEN = 10
LNPSPORT     = IS41
LNPENTPREF   = GRN

DIALPFX      DLTPFX
-----      ---

DIALNAI      SNAI
---          ----
1            INTL
;
```

### Legend

- **DEFRN**—Default Routing Number
- **DIALNAI**—Dialed Party Number Nature of Address Indicator
- **DIALPFX**—Dialed Party Number Prefix
- **DLTPFX**—Delete Prefix
- **NEC**—National Escape Code
- **RFMT**—Routing Address Format
- **RNAI**—Nature of Address Indicator for the Destination Routing Address
- **RNAIV**—Nature of Address Indicator Numeric Value for the Destination Routing Address
- **RNP**—Numbering Plan for the Destination Routing Address
- **RNPV**—Numbering Plan Numeric Value for the Destination Routing Address
- **SNAI**—Service Nature of Address Indicator
- **SPORTTYPE**—Service Portability Type
- **SPRESTYPE**—AINP option to send a "Return Results with digits" message or a "Return Results without digits" message when NPREQ messages are received for AINP services, the DN digits match, and the HLR ID is present



- **LNPSNAI**—LNP Service Nature of Address Indicator
- **LNPOGLRNNAI**—LNP Outgoing LRN Nature of Address Indicator
- **LNPOGDNNAI**—LNP Outgoing DN Nature of Address Indicator
- **LNPSUBDIGLEN**—LNP Subscriber Digit Length
- **LNPATLDIGLEN**—LNP National Digit Length
- **LNPSPORT**—LNP Service Portability
- **LNPEPREF**—LNP Entity Preference

#### Related Topics

- [chg-ainpopts](#)

## rtrv-aiqopts

Use this command to retrieve AIQ specific options.

#### Parameters

This command has no parameters.

#### Example

```
rtrv-aiqopts
```

#### Dependencies

The AIQOPTS table is corrupt or cannot be found.

None

#### Output

If the `pfx=none` parameter is specified, then the corresponding TriggerType value is not displayed in the output.

This example shows output with default AIQ options.

```
rtrv-aiqopts
```

```
tekelecstp 09-12-03 07:53:46 EST EAGLE 42.0.0

AIQ OPTIONS
-----
DIGMINLEN      = 1
DIGMAXLEN      = 32
RESPAR         = rtdigits
RESFMT         = pfxdn
TCAPERR        = 138 (UnrecognizedParameterValue)

TRIGTYPE       PFX
-----
```

```
;
```

This example shows output with some AIQ options provisioned.

```
rtrv-aiqopts
```

```
tekelecstp 09-12-03 11:53:46 EST EAGLE 42.0.0
```

```
AIQ OPTIONS
```

```
-----
DIGMINLEN   = 2
DIGMAXLEN   = 10
RESPAR      = digits
RESFMT      = pfx
TCAPERR     = 138 (UnrecognizedParameterValue)
```

```
TRIGTYPE    PFX
-----
3           12434
5           789
7           534553512456784686531
```

```
;
```

### Legend

- **TRIGTYPE**—TriggerType Value
- **PFX**—Digit string associated with TriggerType
- **IGMINLEN**—Minimum Length of Digit String
- **DIGMAXLEN**—Maximum Length of Digit String
- **RESPAR**—Response Digits
- **RESFMT**—Response Format
- **TCAPERR**—TCAP Error Code.

## rtrv-appl-rtkey

Use this command to retrieve information from the Routing Key table. A routing key entry associates a routing key with up to 16 socket names with a limit of 2500 routing keys per system (if E5-ENET-B cards exist).

- DPC, SI, SSN routing keys, which are used to route SCCP messages
- DPC, SI routing keys, which are used to route non-SCCP and non-ISUP messages
- DPC, SI, CIC routing keys, which are used to route ISUP messages

### Parameters



#### Note:

See [Point Code Formats and Conversion](#) for a detailed description of point code formats, rules for specification, and examples.

**asname (optional)**

Application Server (AS) name assigned to this routing key.

**Range:**

aaaaaaaaaaaaaaaa

Up to 15 alphanumeric characters; the first character must be a letter

**cice (optional)**

The end range of circuit identification codes assigned to the routing key.

**Range:**

0 - 4294967295

See [Table A-2](#) for valid CIC values for specified SI and MSU types.

**cics (optional)**

The start range of circuit identification codes assigned to the routing key.

**Range:**

0 - 4294967295

See [Table A-2](#) for valid CIC values for specified SI and MSU types.

**display (optional)**

The type of output to display.

 **Note:**

Output includes the type of card, the data collection being audited, and a message indicating the overall status. This parameter applies only to STP databases.

**Range:**

*all*

The KEY and the ATTRIBUTE sections of the routing key are displayed

*brief*

Only the KEY section of the routing key is displayed

**Default:**

*brief*

**dpc (optional)**

ANSI destination point code with subfields *network indicator-network cluster-network cluster member (ni-nc-ncm)*.

**Synonym:**

*dpca*

**Range:**

000-255

Specify a valid value for each subfield of the point code, and separate the subfields with a dash (-).

When `chg-sid:pctype=ansi` is specified, *ni = 000* is not valid.

When `chg-sid:pctype=ansi` is specified, `nc = 000` is not valid if `ni = 001–005`.

When `chg-sid:pctype=ansi` is specified, `nc = 000` is valid if `ni = 006–255`.

The point code `000-000-000` is not a valid point code.

#### **dpc/dpca/dpci/dpcn/dpcn24/dpcn16 (optional)**

Destination point code.

#### **dpci (optional)**

ITU international destination point code with subfields *zone-area-id*. The *prefix* subfield indicates a spare point code (*prefix-zone-area-id*)

##### **Range:**

*s*-, 0-255

Specify a valid value for each subfield of the point code, and separate the subfields with a dash (-).

*prefix*—*s*

*zone*—0-7

*area*—000-255

*id*—0-7

The point code `0-000-0` is not a valid point code.

#### **dpcn (optional)**

ITU national destination point code in the format of a 5-digit number (*nnnnn*); or 2, 3, or 4 numbers (members) separated by dashes (*m1-m2-m3-m4*) as defined by the `chg-stpopts:npcfmti` flexible point code option. A group code must be specified when the ITUDUPPC feature is turned on (*nnnnn-gc*, *m1-m2-m3-m4-gc*). The *prefix* subfield indicates a spare point code (*prefix-nnnnn*, *prefix-nnnnn-gc*, *prefix-m1-m2-m3-m4*, *prefix-m1-m2-m3-m4-gc*).

##### **Range:**

*s*-, 0-16383, *aa-zz*

Specify a valid value for each subfield of the point code, and separate the subfields with a dash (-).

*prefix*—*s*-

*nnnnn*—0-16383

*gc*—*aa-zz*

*m1-m2-m3-m4*—0-14 for each member; values must sum to 14

#### **dpcn24 (optional)**

24-bit ITU national destination point code with subfields *main signaling area-sub signaling area-signaling point* (*msa-ssa-sp*).

##### **Range:**

000-255

Specify a valid value for each subfield of the point code, and separate the subfields with a dash (-).

*msa*—000–255

*ssa*—000–255

*sp*—000–255

#### **dpcn16 (optional)**

16-bit ITU national destination point code with subfields *unit number sub number area main number area* (*un-sna-mna*).

**Range:**

000---127

Specify a valid value for each subfield of the point code, and separate the subfields with a dash (-).

un---000---127

sna---000---15

mna---000---31

**num (optional)**

The number of entries to display.

**Range:**

1 - 10000

**Default:**

50

**opc (optional)**

ANSI originating point code with subfields *network indicator-network cluster-network cluster member (ni-nc-ncm)*.

**Synonym:**

opca

**Range:**

000-255

Specify a valid value for each subfield of the point code, and separate the subfields with a dash (-).

When *chg-sid:pctype=ansi* is specified, *ni = 000* is not valid.

When *chg-sid:pctype=ansi* is specified, *nc = 000* is not valid if *ni = 001-005*.

When *chg-sid:pctype=ansi* is specified, *nc = 000* is valid if *ni = 006-255*.

The point code *000-000-000* is not a valid point code.

**opc/opca/opci/opcn/opcn24/opcn16 (optional)**

Originating point code.

**opci (optional)**

ITU international originating point code with subfields *zone-area-id*. The *prefix* subfield indicates a spare point code (*prefix-zone-area-id*)

**Range:**

s-, 0-255

Specify a valid value for each subfield of the point code, and separate the subfields with a dash (-).

*prefix*—s*zone*—0-7*area*—000-255*id*—0-7

The point code *0-000-0* is not a valid point code.

**opc<sub>n</sub>** (optional)

ITU national originating point code in the format of a 5-digit number (*nnnnn*); or 2, 3, or 4 numbers (members) separated by dashes (*m1-m2-m3-m4*) as defined by the `chg-stpopts:npcfmti` flexible point code option. A group code must be specified when the ITUDUPPC feature is turned on (*nnnnn-gc,m1-m2-m3-m4-gc*). The *prefix* subfield indicates a spare point code (*prefix-nnnnn, prefix-nnnnn-gc, prefix-m1-m2-m3-m4, prefix-m1-m2-m3-m4-gc*).

**Range:**

*s-*, 0-16383, *aa-zz*

Specify a valid value for each subfield of the point code, and separate the subfields with a dash (-).

*prefix—s-*

*nnnnn—0-16383*

*gc—aa-zz*

*m1-m2-m3-m4—0-14* for each member; values must sum to 14

**opc<sub>n</sub>24** (optional)

24-bit ITU national originating point code with subfields *main signaling area-sub signaling area-signaling point* (*msa-ssa-sp*).

**Range:**

000-255

Specify a valid value for each subfield of the point code, and separate the subfields with a dash (-).

*msa—000–255*

*ssa—000–255*

*sp—000–255*

**opc<sub>n</sub>16** (optional)

16-bit ITU national originating point code with subfields *unit number sub number area main number area* (*un-sna-mna*).

**Range:**

000---127

Specify a valid value for each subfield of the point code, and separate the subfields with a dash (-).

*un---000---127*

*sna---000---15*

*mna---000---31*

**rcontext** (optional)

Routing Context. The routing key with the specified routing context.

**Range:**

0 - 4294967295

**si** (optional)

Service indicator.

**Range:**

0 - 15

The following equivalent text values can be specified:

**Number = Text—Description**

**0=snm**

Signaling network management messages

**1=regtest**

Signaling network testing and maintenance regular

**2=spltest**

Signaling network testing and maintenance special

**3=sccp**

SCCP

**4=tup**

Telephone user part

**5=isup**

ISDN user part

**13=qbicc**

**ssn (optional)**

Subsystem number.

**Range:**

0 - 255

**type (optional)**

The type of routing key.

**Range:**

*all*

*full*

*partial*

*default*

**Default:**

*all*

**Example**

```
rtrv-appl-rtkey
```

```
rtrv-appl-rtkey:dpc=123-234-255:si=3
```

```
rtrv-appl-rtkey:dpc=123-234-255
```

```
rtrv-appl-rtkey:cics=1:cice=1000:num=3
```

```
rtrv-appl-rtkey:cice=19
```

```
rtrv-appl-rtkey:opc=122-124-125
```

```
rtrv-appl-rtkey:type=partial
rtrv-appl-rtkey:display=all
rtrv-appl-rtkey:rcontext=7
rtrv-appl-rtkey:dpcn16=121-10-15
```

### Dependencies

The `ssn` parameter must be specified and is valid only when the `si=3` (*sccp*) parameter is specified.

The value specified for the `cics` parameter must be less than or equal to the value specified for the `cice` parameter.

A circuit identification code range (`cics` to `cice`) that overlaps an existing routing key cannot be specified.

The `ssn` parameter cannot be specified when `opc`, `cics`, and `cice` parameters are specified. See [Table 4-2](#) for valid parameter combinations.

When the DPC is ANSI and the `si=4` parameter is specified, a DPC/SI routing key must be specified (TUP is used only in an ITU network).

The `opc`, `cics`, and `cice` parameters can be specified with the `si` parameter only if the `si` parameter has a value of 4, 5, or 13 (or *tup*, *isup*, or *qbicc*).

[Table A-2](#) shows valid CIC values for SI types 4, 5, and 13.

The following types of partial routing keys are supported:

- The following types of partial routing keys are supported:
- DPC/SI/OPC (ignore CIC) can be used as a partial match key for CIC- based traffic.
- DPC/SI (ignore all other fields) can be used as a partial match key for CIC- based traffic or SCCP traffic.
- DPC only (ignore all other fields) can be used as a partial match for any type of traffic.
- SI only (ignore all other fields) can be used as a partial match for any type of traffic.

If the `type=default` parameter is specified, then the `dpc`, `si`, `ssn`, `opc`, `cics`, and `cice` parameters cannot be specified.

### Notes

This command can be canceled using the **F9** function key or the `cancel-cmd` command. See `cancel-cmd` for more information.

Static routing keys are stored on disk and a copy of the table is loaded to each SS7IPGW card.

Group codes are required for ITU-N point codes (DPCN/OPCN) when the Duplicate Point Code feature is turned on.

The `display=all` parameter must be specified to display the assigned routing context value for the routing key.

In this command, the point codes support only the spare point code subtype prefix (s-).



**Output**

rtrv-appl-rtkey

rlghncxa03w 08-04-11 13:17:09 EST EAGLE 38.0.0

RCONTEXT	DPC	SI	ADPTR	ASNAME	TYPE
-----	008-008-008	*	M3UA	as5	PARTIAL
-----	002-002-002	10	M3UA	as2	FULL
-----	001-001-001	*	M3UA	as11	PARTIAL
-----	001-001-001	10	M3UA	as11	FULL
-----	001-001-001	3	M3UA	as12	FULL
-----	002-002-002	9	M3UA	as14	FULL
10	002-002-002	*	M3UA	as8	PARTIAL

RCONTEXT	DPCI	SI	ADPTR	ASNAME	TYPE
-----	7-007-7	*	M3UA	as14	PARTIAL
-----	7-007-7	4	M3UA	as15	FULL

RCONTEXT	DPC	SI	ADPTR	ASNAME	TYPE
-----	*****	**	M3UA	as1	DEFAULT
-----	*****	10	M3UA	as12	PARTIAL

Route Key table is (11 of 1000) 1% full

Route Key Socket Association table is (11 of 16000) 1% full

END OF LOG REPORT

;

rtrv-appl-rtkey:asname=as11

rlghncxa03w 08-04-11 14:05:46 EST EAGLE 38.0.0

RCONTEXT	DPC	SI	ADPTR	ASNAME	TYPE
-----	001-001-001	*	M3UA	as11	PARTIAL
-----	001-001-001	10	M3UA	as11	FULL

Route Key table is (10 of 1000) 1% full

Route Key Socket Association table is (10 of 16000) 1% full

END OF LOG REPORT

;

This example shows a routing key with routing context that is assigned to an SUA Application Server and a routing key with routing context that is assigned to an M3UA Application Server.

rtrv-appl-rtkey:display=all

rlghncxa03w 08-04-11 14:13:46 EST EAGLE 38.0.0

```

RCONTEXT      DPC      SI SSN      OPC      CICS      CICE
-----
008-008-008  ** *** *****

```

```

ADPTR  TYPE      ASNAME
M3UA   PARTIAL  as5

```

```

ANAMES
assoc5

```

```

RCONTEXT      DPC      SI SSN      OPC      CICS      CICE
20            002-002-002  3 *** -----

```

```

ADPTR  TYPE      ASNAME
SUA    PARTIAL  as8

```

```

ANAMES
assoc8

```

```

Route Key table is (2 of 1000) 1% full
Route Key Socket Association table is (2 of 16000) 1% full

```

END OF LOG REPORT

;

This example shows output when the 2500 Routing Keys feature is enabled. The maximum number of routing keys allowed in the system is 2500. The maximum number of entries in the Static Route Key Socket Association table is 40,000.

rtrv-appl-rtkey

```

rlghncxa03w 08-04-11 14:03:05 EST EAGLE 38.0.0

```

```

RCONTEXT      DPC      SI  ADPTR  ASNAME      TYPE
-----
008-008-008  *  M3UA  as5        PARTIAL
002-002-002  10 M3UA  as2        FULL
001-001-001  *  M3UA  as11       PARTIAL
001-001-001  10 M3UA  as11       FULL
001-001-001  3  M3UA  as12       FULL
002-002-002  9  M3UA  as14       FULL

```

```

RCONTEXT      DPCI     SI  ADPTR  ASNAME      TYPE
-----
7-007-7       *  M3UA  as14     PARTIAL
7-007-7       4  M3UA  as15     FULL

```

```

RCONTEXT      DPC      SI  ADPTR  ASNAME      TYPE
-----
***** **  M3UA  as1        DEFAULT
***** 10  M3UA  as12       PARTIAL

```

```

Route Key table is (10 of 2500) 1% full
Route Key Socket Association table is (10 of 40000) 1% full

```

```

END OF LOG REPORT
;

rtrv-appl-rtkey

rlghncxa03w 08-04-11 13:17:09 EST EAGLE 38.0.0

RCONTEXT      DPC      SI  ADPTR  ASNAME      TYPE
-----
008-008-008  *  M3UA  as5        PARTIAL
002-002-002  10 M3UA  as2        FULL
001-001-001  *  M3UA  as11       PARTIAL
001-001-001  10 M3UA  as11       FULL
001-001-001  3  M3UA  as12       FULL
002-002-002  9  M3UA  as14       FULL
10           002-002-002 *  M3UA  as8        PARTIAL

RCONTEXT      DPCI     SI  ADPTR  ASNAME      TYPE
-----
7-007-7      *  M3UA  as14      PARTIAL
7-007-7      4  M3UA  as15      FULL

RCONTEXT      DPC      SI  ADPTR  ASNAME      TYPE
-----
*****      **  M3UA  as1        DEFAULT
*****      10 M3UA  as12      PARTIAL

RCONTEXT      DPCN16   SI  ADPTR  ASNAME      TYPE
-----
121-007-10   *  M3UA  as14      PARTIAL
121-007-11   4  M3UA  as15      FULL

Route Key table is (11 of 1000) 1% full
Route Key Socket Association table is (11 of 16000) 1% full

END OF LOG REPORT
;

```

### Related Topics

- [chg-appl-rtkey](#)
- [dlt-appl-rtkey](#)
- [ent-appl-rtkey](#)

## rtrv-as

Use this command to retrieve the characteristics of one or all Application Servers from the AS table.

### Parameters

**aname (optional)**

Name of the association.

**Range:**

ayyyyyyyyyyyyyyy

Up to 15 alphanumeric characters; the first character must be a letter

**Default:**

Retrieve all

**asname (optional)**

Name of the Application Server.

**Range:**

ayyyyyyyyyyyyyyy

Up to 15 alphanumeric characters; the first character must be a letter

**Example**

rtrv-as

rtrv-as:aname=as1

**Dependencies**

None

**Notes**

This command can be canceled using the **F9** function key or the `canc-cmd` command. See `canc-cmd` for more information.

**Output**

rtrv-as

```

rlghncxa03w 05-06-05 08:40:18 EST  EAGLE5 34.0.0
AS Name      Mode      Tr ms    Association Names
m3ua_as1     LOADSHARE 2000     m3ua_assoc1
              m3ua_assoc1
sua_as1      OVERRIDE  200      sua_assoc1
              sua_assoc2
AS Table is (2 of 250) 1% full
;
```

**Related Topics**

- [chg-as](#)
- [dlt-as](#)
- [ent-as](#)
- [rept-stat-as](#)

## rtrv-assoc

Use this command to retrieve the configuration data from the IP Socket/Association (IPAPSOCK) table.





**Range:***relaxed**match***Default:**

retrieve all associations

**Example**

```

rtrv-assoc
rtrv-assoc:aname=swbel132
rtrv-assoc:lhost=gw105.nc.tekelec.com:adapter=sua
rtrv-assoc:rhosttype=alternate:display=all
rtrv-assoc:lhost=gw105.nc.tekelec.com:adapter=diam

```

**Dependencies**

A valid value must be specified for the `host` parameter. If the host name contains a hyphen, then the host name must be enclosed within quotation marks.

**Notes**

This command can be canceled using the **F9** function key or the `canc-cmd` command. See `canc-cmd` for more information.

The IPAPSOCK table is used to associate the Local Host/Local Port to a Remote Host/Remote Port.

When the command is entered with the `aname`, `lhost`, or `alhost` parameters, the output displays SCTP buffer usage information (used and total buffer space on the card).

Heartbeat timer value is in milliseconds.

**Output**

AS names are displayed for IPGWx-M3UA and SUA linksets.

LS names are displayed for IPSG linksets.

This example shows buffer usage (used and total buffer space) and card location information:

```

rtrv-assoc:aname=ipsgm3ua05

eagle10212 10-02-10 17:21:29 EST  EAGLE 46.0.0

ANAME ipsgm3ua05
LOC      1305          IPLNK PORT A          LINK      A
ADAPTER  M3UA          VER          M3UA RFC
LHOST    e1021201.1305a
ALHOST    ---
RHOST    e1021301.1305a

```

```

ARHOST ---
LPORT 2005          RPORT 2005
ISTRMS 2           OSTRMS 2           BUFSIZE 200
RMODE  LIN         RMIN 120           RMAX 800
RTIMES 10          CWMIN 3000         UAPS 10
OPEN   NO           ALW  NO           RTXTHR 0
RHOSTVAL RELAXED   HBTIMER 500

```

```

LSN
ls1305a

```

```

IP Appl Sock/Assoc table is (7 of 4000) 1% full
Assoc Buffer Space Used (320 KB of 3200 KB) on LOC = 1307

```

```
;
```

This example shows buffer usage (used and total buffer space) and card location information:

```
rtrv-assoc:lhost=e1021201.1311a
```

```
eagle10212 10-02-10 17:21:29 EST EAGLE 46.0.0
```

```

ANAME ipl1311a
LOC 1311          IPLNK PORT A          LINK A
ADAPTER M2PA      VER M2PA RFC
LHOST e1021201.1311a
ALHOST ---
RHOST e1021301.1311a
ARHOST ---
LPORT 1311        RPORT 1311
ISTRMS 2          OSTRMS 2           BUFSIZE 200
RMODE  LIN         RMIN 120           RMAX 800
RTIMES 10          CWMIN 3000         UAPS 1
OPEN   YES         ALW  YES           RTXTHR 0
RHOSTVAL RELAXED   HBTIMER 500         M2PATSET 1

```

```

IP Appl Sock/Assoc table is (10 of 4000) 1% full
Assoc Buffer Space Used (400 KB of 1600 KB) on LOC = 1311

```

```
;
```

```
rtrv-assoc:display=brief or rtrv-assoc
```

```

CARD IPLNK
ANAME LOC PORT LINK ADAPTER LPORT RPORT OPEN ALW
a23456789012345 1305 A A M3UA 20000 30000 YES YES
b23456789012345 1305 B A M3UA 20001 30001 NO NO
c23456789012345 1307 A A SUA 20002 30002 YES YES
d23456789012345 1307 B A M3UA 20003 30003 NO NO
e23456789012345 1315 A A SUA 20004 30004 YES YES
f23456789012345 1315 A,B A M3UA 20005 30005 YES YES
g23456789012345 1317 B,A A SUA 20006 30006 YES YES

```



```

m2pa1105b3      1105  A    B3  M2PA  31105 31105 YES YES
m2pa1107a0      1107  A    --  M2PA  1107 1107 NO  NO
m2pa1107a1      1107  A    --  M2PA  11107 11107 NO  NO
m3ua1211a0      1211  A    A    M3UA  1211 1213 YES YES
m3ua1211a1      1211  A    **   M3UA  11211 11213 YES YES
m3ua1211a2      1211  A    B1   M3UA  21211 21213 YES YES
m3ua1211a3      1211  A    A3   M3UA  31211 31213 YES YES
m3ua1213a0      1213  A    A    M3UA  1213 1211 YES YES
m3ua1213a1      1213  A    A1   M3UA  11213 11211 YES YES
m3ua1213a2      1213  A    A2   M3UA  21213 21211 YES YES
m3ua1213a3      1213  A    A3   M3UA  31213 31211 YES YES
ipg1215a01      1215  A    **   M3UA  11215 1111 YES YES
ipg1215a02      1215  A    **   M3UA  11215 1112 YES YES
ipg1215a03      1215  A    --   M3UA  11215 1113 NO  NO
ipg1215a04      1215  A    --   M3UA  11215 1114 NO  NO
ipg1215a05      1215  A    --   M3UA  11215 1115 NO  NO
ipg1215a06      1215  A    --   M3UA  11215 1116 NO  NO

```

IP Appl Sock/Assoc table is (24 of 4000) 1% full

;

rtrv-assoc:adapter=m2pa

```

eagle10212 10-02-10 11:54:01 EST EAGLE 46.0.0
      CARD  IPLNK
ANAME      LOC  PORT  LINK ADAPTER LPORT RPORT OPEN ALW
ipl1301a   1301  A    A    M2PA  1301  1301 YES YES
ipl1301b   1301  A    B    M2PA  1302  1302 YES YES
sgm2pa1    1305  A    A15  M2PA  1305  1305 NO  NO
sgm2pa7    1303  A    A15  M2PA  1306  1306 YES YES
ipl1311a   1311  A    A    M2PA  1311  1311 YES YES
ipl1313a   1313  A    A    M2PA  1313  1313 YES YES

```

IP Appl Sock/Assoc ( 11 of 4000) 1%

This example shows command output for all configured associations:

rtrv-assoc:display=all

```

eagle10212 10-02-02 17:00:42 EST EAGLE 46.0.0
ANAME ipl1301a
      LOC      1301          IPLNK PORT A          LINK      A
      ADAPTER  M2PA          VER          M2PA RFC
      LHOST    e1021201.1301a
      ALHOST    ---
      RHOST    e1021301.1301a
      ARHOST    ---
      LPORT    1301          RPORT      1301
      ISTRMS   2            OSTRMS     2          BUFSIZE   200
      RMODE    LIN          RMIN       120        RMAX      800
      RTIMES   10          CWMIN      3000      UAPS      10

```

```

OPEN YES ALW YES RTXTHR 0
RHOSTVAL RELAXED HBTIMER 500 M2PATSET 1

ANAME ip11301b
LOC 1301 IPLINK PORT A LINK B
ADAPTER M2PA VER M2PA RFC
LHOST e1021201.1301a
ALHOST ---
RHOST e1021301.1301a
ARHOST ---
LPORT 1302 RPORT 1302
ISTRMS 2 OSTRMS 2 BUFSIZE 200
RMODE LIN RMIN 120 RMAX 800
RTIMES 10 CWMIN 3000 UAPS 10
OPEN YES ALW YES RTXTHR 0
RHOSTVAL RELAXED HBTIMER 500 M2PATSET

1

ANAME sg1303a
LOC 1303 IPLINK PORT A LINK A
ADAPTER M3UA VER M3UA RFC
LHOST e1021201.1303a
ALHOST ---
RHOST e1021301.1303a
ARHOST ---
LPORT 2003 RPORT 2003
ISTRMS 2 OSTRMS 2 BUFSIZE 200
RMODE LIN RMIN 120 RMAX 800
RTIMES 10 CWMIN 3000 UAPS 10
OPEN YES ALW YES RTXTHR 0
RHOSTVAL RELAXED HBTIMER 500

ANAME sg1305a
LOC 1305 IPLINK PORT A LINK A
ADAPTER M3UA VER M3UA RFC
LHOST e1021201.1305a
ALHOST ---
RHOST e1021301.1305a
ARHOST ---
LPORT 2005 RPORT 2005
ISTRMS 2 OSTRMS 2 BUFSIZE 200
RMODE LIN RMIN 120 RMAX 800
RTIMES 10 CWMIN 3000 UAPS 10
OPEN YES ALW YES RTXTHR 0
RHOSTVAL RELAXED HBTIMER 500

ANAME sg1305i
LOC 1305 IPLINK PORT A LINK B
ADAPTER M3UA VER M3UA RFC
LHOST e1021201.1305a
ALHOST ---
RHOST e1021301.1305a
ARHOST ---
LPORT 2006 RPORT 2006
ISTRMS 2 OSTRMS 2 BUFSIZE 200

```

```

RMODE    LIN           RMIN      120           RMAX      800
RTIMES   10           CWMIN    3000         UAPS      10
OPEN     NO           ALW      YES          RTXTHR   0
RHOSTVAL RELAXED     HBTIMER  500

ANAME ipg1307a1
LOC      1307           IPLNK PORT A           LINK      A
ADAPTER  M3UA           VER          M3UA RFC
LHOST    e1021201.1307a
ALHOST   ---
RHOST    e1021301.1307a
ARHOST   ---
LPORT    4001           RPORT      4001
ISTRMS   2             OSTRMS     2             BUFSIZE   16
RMODE    LIN           RMIN      120           RMAX      800
RTIMES   10           CWMIN    3000         UAPS      10
OPEN     YES          ALW      YES          RTXTHR   0
RHOSTVAL RELAXED     HBTIMER  500

ANAME ip11311a
LOC      1311           IPLNK PORT A           LINK      A
ADAPTER  M2PA           VER          M2PA RFC
LHOST    e1021201.1311a
ALHOST   ---
RHOST    e1021301.1311a
ARHOST   ---
LPORT    1311           RPORT      1311
ISTRMS   2             OSTRMS     2             BUFSIZE   200
RMODE    LIN           RMIN      120           RMAX      800
RTIMES   10           CWMIN    3000         UAPS      10
OPEN     NO           ALW      YES          RTXTHR   0
RHOSTVAL RELAXED     HBTIMER  500           M2PATSET 1

ANAME ip11313a
LOC      1313           IPLNK PORT A           LINK      A
ADAPTER  M2PA           VER          M2PA RFC
LHOST    e1021201.1313a
ALHOST   ---
RHOST    e1021301.1313a
ARHOST   ---
LPORT    1313           RPORT      1313
ISTRMS   2             OSTRMS     2             BUFSIZE   200
RMODE    LIN           RMIN      120           RMAX      800
RTIMES   10           CWMIN    3000         UAPS      3
OPEN     NO           ALW      YES          RTXTHR   0
RHOSTVAL RELAXED     HBTIMER  500           M2PATSET 1

ANAME ipg1315a1
LOC      1315           IPLNK PORT A           LINK      A
ADAPTER  M3UA           VER          M3UA RFC
LHOST    e1021201.1315a
ALHOST   ---
RHOST    e1021301.1315a
ARHOST   ---
LPORT    1315           RPORT      1315

```

```

ISTRMS 2          OSTRMS 2          BUFSIZE 16
RMODE LIN        RMIN 120         RMAX 800
RTIMES 10       CWMIN 3000       UAPS 10
OPEN NO         ALW NO          RTXTHR 0
RHOSTVAL RELAXED HBTIMER 500

ANAME ipg1317a1
LOC 1317          IPLNK PORT A          LINK A
ADAPTER M3UA      VER M3UA RFC
LHOST e1021201.1317a
ALHOST ---
RHOST e1021301.1317a
ARHOST ---
LPORT 1317       RPORT 1317
ISTRMS 2          OSTRMS 2          BUFSIZE 200
RMODE LIN        RMIN 120         RMAX 800
RTIMES 10       CWMIN 3000       UAPS 10
OPEN YES        ALW YES         RTXTHR 0
RHOSTVAL RELAXED HBTIMER 500

ANAME sg1305m
LOC 1303          IPLNK PORT A          LINK A1
ADAPTER M2PA      VER M2PA RFC
LHOST e1021201.1303a
ALHOST ---
RHOST e1021301.1303a
ARHOST ---
LPORT 1305       RPORT 1305
ISTRMS 2          OSTRMS 2          BUFSIZE 200
RMODE LIN        RMIN 120         RMAX 800
RTIMES 10       CWMIN 3000       UAPS 10
OPEN YES        ALW YES         RTXTHR 0
RHOSTVAL RELAXED HBTIMER 500 M2PATSET 1

```

IP Appl Sock/Assoc table is (11 of 4000) 1% full

;

rtrv-assoc:aname=sg1305a

eagle10212 09-03-10 17:00:42 EST EAGLE 46.0.0

```

ANAME sg1305a
LOC 1305          IPLNK PORT A          LINK A
ADAPTER M3UA      VER M3UA RFC
LHOST e1021201.1305a
ALHOST ---
RHOST e1021301.1305a
ARHOST ---
LPORT 2005       RPORT 2005
ISTRMS 2          OSTRMS 2          BUFSIZE 200
RMODE LIN        RMIN 120         RMAX 800
RTIMES 10       CWMIN 3000       UAPS 10
OPEN YES        ALW YES         RTXTHR 0

```

```

RHOSTVAL RELAXED          HBTIMER      500

LSN;

ls1305a

IP Appl Sock/Assoc table is (13 of 4000) 1% full
Assoc Buffer Space Used (600 KB of 3200 KB) on LOC = 1305
;

```

This example shows all associations with both primary and alternate remote host values configured:

```
rtrv-assoc:rhosttype=alternate:display=all
```

```

ipsig 10-02-10 17:58:37 GMT EAGLE 46.0.0

ANAME assoc12
LOC      1111          IPLNK PORT A,B          LINK      A
ADAPTER  M2PA          VER          M2PA RFC
LHOST    aricent11.com
ALHOST   aricent12.com
RHOST    tekelec11.com
ARHOST   tekelec12.com
LPORT    10003          RPORT      10001
ISTRMS   2             OSTRMS     2             BUFSIZE   200
RMODE    LIN           RMIN       120            RMAX      800
RTIMES   10            CWMIN      3000           UAPS      10
OPEN     NO             ALW        YES            RTXTHR    65535
RHOSTVAL RELAXED      HBTIMER    500            M2PATSET  1

ANAME assoc22
LOC      1201          IPLNK PORT A,B          LINK      A
ADAPTER  M2PA          VER          M2PA RFC
LHOST    aricent21.com
ALHOST   aricent22.com
RHOST    tekelec21.com
ARHOST   tekelec22.com
LPORT    10003          RPORT      10001
ISTRMS   2             OSTRMS     2             BUFSIZE   200
RMODE    LIN           RMIN       120            RMAX      800
RTIMES   10            CWMIN      3000           UAPS      1
OPEN     NO             ALW        YES            RTXTHR    65535
RHOSTVAL RELAXED      HBTIMER    500            M2PATSET  1

IP Appl Sock/Assoc table is (4 of 4000) 1% full
;

```

This example shows the associations when a primary remote host is provisioned and an alternate remote host is not provisioned:

```
rtrv-assoc:rhosttype=primary
```

```
ipsig 10-02-10 17:37:49 GMT EAGLE 46.0.0
      CARD IPLNK
ANAME      LOC  PORT  LINK ADAPTER LPORT RPORT OPEN ALW
assoc5     1101 A    A   M2PA  10002 10001 NO  YES
assoc6     1102 A    A   M3UA  30002 30002 NO  NO
assoc7     1102 B    A   SUA   20001 29011 NO  NO
```

```
IP Appl Sock/Assoc table is (4 of 4000) 1% full
```

```
;
```

```
rtrv-assoc:aname=m2pa1
```

```
ANAME m2pa1
      LOC      1305          IPLNK PORT A          LINK      B1
      ADAPTER  M2PA          VER          M2PA RFC
      LHOST    e1011001.1305a
      ALHOST    ---
      RHOST    e1011501.1305a
      ARHOST    ---
      LPORT    2005          RPORT      2005
      ISTRMS   2            OSTRMS     2            BUFSIZE   200
      RMODE    LIN          RMIN       120          RMAX      800
      RTIMES   10          CWMIN      3000        UAPS      7
      OPEN     NO           ALW        YES          RTXTHR    0
      RHOSTVAL RELAXED     HBTIMER    500         M2PATSET  1
```

```
LSN
```

```
lsm2pa05s
```

```
rtrv-assoc
```

```
ipsig 16-11-18 17:37:49 GMT EAGLE 46.5.0
      CARD IPLNK
ANAME      LOC  PORT  LINK ADAPTER LPORT RPORT OPEN ALW BUFSIZE
assoc5     1101 A    A40 M2PA  10002 10001 NO  YES  200
assoc6     1102 A    A50 M3UA  30002 30002 NO  NO   50
assoc7     1102 B    B60 M3UA  20001 29011 NO  NO   50
```

```
IP Appl Sock/Assoc table is (4 of 4000) 1% full
```

```
;
```

### Related Topics

- [chg-assoc](#)
- [dlt-assoc](#)
- [ent-assoc](#)
- [rept-stat-assoc](#)

## rtrv-atinpqopts

Use this command to retrieve the data that is used for ATI number conditioning.

### Parameters

This command has no parameters.

### Example

```
rtrv-atinpqopts
```

### Dependencies

The ATINP feature must be enabled before this command can be entered.

The EGLEOPTS table is corrupt or cannot be found.

### Output

This example shows output with default ATINPQ options:

```
rtrv-atinpqopts
```

```
tekelecstp 12-01-04 07:53:46 EST EAGLE 45.0.0
```

```
ATINPQ OPTIONS
```

```
-----
```

```
ATIACKIMSI      = NONE
ATIACKMSISDN    = MSISDN
ATIACKRN        = RN
ATIDFLTRN       = NONE
ATIDLM          = NONE
ATINPTYPE       = ANY
ENTITYLEN       = NONE
SNAI            = INTL
SPORTTYPE       = GSM
ATISUPPLOCINFO  = OFF
VLRNUMLEN      = 40
ATIACKVLRNUM    = RNSPMSISDN
```

```
;
```

This example shows output when the Location Information request is supported:

```
rtrv-atinpqopts
```

```
tekelecstp 12-01-25 12:22:38 EST EAGLE 45.0.0
```

```
ATINPQ OPTIONS
```

```
-----
```

```
ATIACKIMSI      = GRN
ATIACKMSISDN    = GRNDLMMSISDN
ATIACKRN        = GRNDLMRNSP
```

```

ATIDFLTRN      = NONE
ATIDLM         = 454555817324228
ATINPTYPE     = ANY
ENTITYLEN     = NONE
SNAI          = NAI
SPORTTYPE     = NONE
ATISUPPLOCINFO = ON
VLRNUMLEN     = 40
ATIACKVLRNUM  = RNSPMSISDN

```

```
;
```

### Legend

- **ATIACKIMSI**—IMSI parameter for ACK response message
- **ATIACKMSISDN**—MSISDN parameter for ACK response message
- **ATIACKRN**—Routing Number format
- **SNAI**—NAI of the incoming MSISDN digits
- **ATIDLM**—Outbound message delimiter
- **ATIDFLTRN**—Default Routing Number
- **ATINPTYPE**—Number Portability Type
- **SPORTTYPE**—Service Portability Type
- **GRN**—Generic Routing Number
- **ATISUPPLOCINFO**—Support ATINP query with LocationInformation request if ATINP feature is activated
- **VLRNUMLEN**—Maximum number of digits that could be encoded as VLR-number in ATI ACK response message
- **ATIACKVLRNUM**— VLR-number format

## rtrv-atm-lps

Use this command to display the parameter values for the ATM link parameter sets in the database configured with the `chg-atm-lps` command, along with the non-configurable ATM parameters.

### Parameters

#### lpset (optional)

The ATM link parameter set to be displayed.

#### Range:

1 - 30

#### Default:

All ATM link parameter sets are displayed

### Example

```
rtrv-atm-lps:lpset=5
```



rtrv-atm-lps

**Dependencies**

None

**Notes**

None

**Output****Note:**

Dashes (--) in the FC NR and FC BC fields indicate that this implementation is not supported on ATM high-speed signaling links.

rtrv-atm-lps:lpset=5

```

rlghncxa03w 04-01-04 08:40:18 EST EAGLE 31.3.0
ATM LINK PARAMETER SET TIMERS AND PARAMETERS (TIMERS IN SECONDS)
      SSCOP PARAMETERS
      TMR  TMR    TMR    TMR    TMR
LPSET  MAXCC  MAXPD  MAXSTAT  CC  KALIVE  NORSP  POLL  IDLE
5      4      500    67      0.2  0.125  1.5    0.150  0.125

      SSCF-NNI PARAMETERS
      TMRT1  TMRT2  TMRT3  N1
05.0    120.0  0.000925  64552

      SAAL PARAMETERS
      MAX  TMR  TNRNO  TMR  N  TMR
NRP  SREC  CRED  ERM  BLK  PROV
1    3600  1.5   0.125  3    0600.0

      NONCONFIGURABLE PARAMETERS
      SDU  UU      FC  FC
      SIZE  SIZE  N  NR  BC  TSUP  TLOSS  ERMSM  THRES
272    4    9  --  --  120   1.3   0.1   0.244
;

```

rtrv-atm-lps

```

rlghncxa03w 04-01-04 08:40:18 EST EAGLE 31.3.0
      SSCOP PARAMETERS
      TMR  TMR    TMR    TMR    TMR
LPSET  MAXCC  MAXPD  MAXSTAT  CC  KALIVE  NORSP  POLL  IDLE
1      4      500    67      0.2  0.125  1.5    0.150  0.125
2      4      500    67      0.2  0.125  1.5    0.150  0.125
3      4      500    67      0.2  0.125  1.5    0.150  0.125

```

4	4	500	67	0.2	0.125	1.5	0.150	0.125
5	4	500	67	0.2	0.125	1.5	0.150	0.125
6	4	500	67	0.2	0.125	1.5	0.150	0.125
7	4	500	67	0.2	0.125	1.5	0.150	0.125
8	4	500	67	0.2	0.125	1.5	0.150	0.125
9	4	500	67	0.2	0.125	1.5	0.150	0.125
10	4	500	67	0.2	0.125	1.5	0.150	0.125
11	4	500	67	0.2	0.125	1.5	0.150	0.125
12	4	500	67	0.2	0.125	1.5	0.150	0.125
13	4	500	67	0.2	0.125	1.5	0.150	0.125
14	4	500	67	0.2	0.125	1.5	0.150	0.125
15	4	500	67	0.2	0.125	1.5	0.150	0.125
16	4	500	67	0.2	0.125	1.5	0.150	0.125
17	4	500	67	0.2	0.125	1.5	0.150	0.125
18	4	500	67	0.2	0.125	1.5	0.150	0.125
19	4	500	67	0.2	0.125	1.5	0.150	0.125
20	4	500	67	0.2	0.1	1.5	0.1	0.1

SSCF-NNI PARAMETERS

LPSET	TMRT1	TMRT2	TMRT3	N1
1	05.0	015.0	0.000925	64552
2	05.0	120.0	0.000925	64552
3	05.0	120.0	0.000925	64552
4	15.0	010.0	0.000925	64552
5	05.0	120.0	0.000925	500
6	05.0	015.0	0.000925	64552
7	05.0	120.0	0.000925	64552
8	05.0	120.0	0.000925	64552
9	15.0	010.0	0.000925	64552
10	05.0	015.0	0.000925	64552
11	05.0	120.0	0.000925	64552
12	05.0	120.0	0.000925	64552
13	15.0	010.0	0.000925	64552
14	05.0	015.0	0.000925	64552
15	05.0	120.0	0.000925	64552
16	05.0	120.0	0.000925	64552
17	15.0	010.0	0.000925	64552
18	05.0	015.0	0.000925	64552
19	05.0	120.0	0.000925	64552
20	05.0	120.0	0.000925	64552

SAAL PARAMETERS

LPSET	MAX NRP	TMR SREC	TNRNO CRED	TMR ERM	N BLK	TMR PROV
1	1	3600	1.5	0.125	3	1200.0
2	1	3600	1.5	0.125	3	1000.0
3	1	60	1.5	0.125	3	0600.0
4	1	3600	1.5	0.125	3	0600.0
5	1	3600	1.5	0.125	3	0600.0
6	1	3600	1.5	0.125	3	1200.0
7	1	3600	1.5	0.125	3	1000.0
8	1	60	1.5	0.125	3	0600.0
9	1	3600	1.5	0.125	3	0600.0
10	1	3600	1.5	0.125	3	0600.0
11	1	3600	1.5	0.125	3	1200.0

```

12  1  3600  1.5  0.125  3  1000.0
13  1   60   1.5  0.125  3  0600.0
14  1  3600  1.5  0.125  3  0600.0
15  1  3600  1.5  0.125  3  0600.0
16  1  3600  1.5  0.125  3  1200.0
17  1  3600  1.5  0.125  3  1000.0
18  1   60   1.5  0.125  3  0600.0
19  1  3600  1.5  0.125  3  0600.0
20  1  3600  1.5  0.125  3  0600.0

```

NONCONFIGURABLE PARAMETERS

```

SDU  UU      FC  FC
SIZE SIZE  N  NR  BC  TSUP  TLOSS  ERMSM  THRES
272  4      9  --  --  120   1.3    0.1    0.244

```

;

rtrv-atm-lps

```

tekelecstp 04-01-05 08:40:18 EST  EAGLE 31.3.0
ATM LINK PARAMETER SET TIMERS AND PARAMETERS (TIMERS IN SECONDS)

```

SSCOP PARAMETERS

```

LPSET  MAXCC  MAXPD  MAXSTAT  TMR  TMR  TMR  TMR  TMR
        CC  KALIVE  NORSP  POLL  IDLE
1       4     500   67         0.2  0.125  1.5  0.150  0.125
.
.
20      4     500   67         0.2  0.1   1.5  0.1   0.1
21      4     500   67         0.2  0.1   1.5  0.1   0.1.
.
30      4     500   67         0.2  0.1   1.5  0.1   0.1

```

SSCF-NNI PARAMETERS

```

LPSET  TMRT1  TMRT2  TMRT3  N1
1       05.0  015.0  0.000925  64552
.
.
20      5      30   0.000925  64552
21      5     120  0.000925  1000
.
.
30      5     120  0.000925  64552

```

SAAL PARAMETERS

```

LPSET  MAX  TMR  TNRNO  TMR  N  TMR
        NRP  SREC  CRED  ERM  BLK  PROV
1       1   3600  1.5   0.125  3  1200.0
.
.
20      1   3600  1.5   0.125  3  0600.0
21      0   3600  1.5   0.125  3  1200.0
.
.

```

```
30 0 3600 1.5 0.125 3 0600.0
```

## NONCONFIGURABLE PARAMETERS

```
SDU  UU      FC  FC
SIZE SIZE  N  NR  BC  TSUP  TLOSS  ERMSM  THRES
272  4      9  --  --  120   1.3    0.1    0.244
```

```
;
```

**Legend**

- **LPSET**—Link parameter set being changed. The system default value for this parameter is 1 for ANSI and, 21 for ITU.
- **ACTION**—Copy a set of ATM signaling link parameters from one parameter set to another.
- **SCRLPSET**—ATM signaling link parameter set used as a source for the `action=copy` parameter.
- **MAXCC**—Maximum number of transmissions of a BGN, END, ER, or RS PDU
- **MAXPD**—Maximum number of SD PDUs that can be sent before a POLL is sent
- **MAXSTAT**—Maximum number of list elements in a STAT PDU
- **TMRCC**—Timer, in seconds, used during the connection phase to guard against unacknowledged BGN, END, ER or RS PDUs
- **TMRKALIVE**—Timer, in seconds, used during the transient phase when no SD PDUs are being sent to keep connection up
- **TMRNOSP**—Timer, in seconds, used to check that STAT PDUs are arriving often enough
- **TMRPOLL**—Timer, in seconds, used to guarantee that POLL PDUs are sent often enough
- **TMRIDLE**—Timer, in seconds, used during the idle phase when no SD PDUs are being sent to limit time in the idle phase
- **TMRT1**—Time, in seconds, between a link release action and the next link reestablish action during alignment
- **TMRT2**—Total time, in seconds, that SSCF will attempt alignment
- **TMRT3**—Time, in seconds, between proving PDUs
- **N1**—Number of PDUs sent during proving
- **MAXNRP**—Maximum number of retransmitted PDUs during proving
- **TMRSREC**—The timer, in seconds, used to prohibit closely spaced SSCOP recoveries from occurring.
- **TMRNOCRED**—The timer, in seconds, used when the no credit exists and PDUs are available to be sent.
- **TMRERM**—The error rate monitor interval, in seconds.
- **NBLK**—The number of monitoring intervals per block.
- **TMRPROV**—The timer, in seconds, used to monitor the status of a link after it is placed into service.
- **SDU SIZE**—The SSCOP SDU size (set to 272 octets).
- **UU SIZE**—The SCOP UU size (set to 4 octets).

- **N**—The monitoring intervals spanning a.4 second error event (set to 9).
- **FC NR**—The fixed credit increment value.
- **FC BC**—The fixed credit allocation frequency.
- **TSUP**—The superblock timer for layer management, in seconds.
- **TLOSS**—The loss timer for layer management, in seconds.
- **ERMSM**—The error rate monitor smoothing factor.
- **THRES**—The error rate monitor threshold.

#### Related Topics

- [chg-atm-lps](#)

## rtrv-atm-prm

Use this command to display system-wide non-configurable ATM layer parameters for each ATM high-speed signaling link. The data displayed includes the ATM interface parameters and the ATM traffic descriptor values.

#### Parameters

This command has no parameters.

#### Example

```
rtrv-atm-prm
```

#### Dependencies

None

#### Notes

None

#### Output

```
rtrv-atm-prm
```

```
tekelecstp 04-02-05 08:40:18 EST EAGLE 31.3.0
DS1 DS1 E1 E1 MAX MAX VCI VPI
PCR SCR PCR SCR BT CDVT QOS VPCs VCCs BITS BITS
3622 3622 4528 4528 210 100 3 0 1 16 12
```

```
;
```

#### Legend

The ATM traffic descriptors are displayed in the following fields:

- **BT**—Burst tolerance. The number of consecutive cells on the VCL permitted on the ATM interface by the enforcement process, given the PCR and the line speed.
- **CDVT**—The amount of cell delay variation for the VCL in the network ingress direction.

- **PCR**—The maximum or peak cell rate for the VCL (virtual channel link) T1 is for ANSI and E1 is for ITU.
- **QOS**—Quality of service. The performance objectives that must be met by the ATM VCL when it must discard cells during enforcement of the traffic parameters.
- **SCR**—The average or sustainable cell rate supported on the VCL. T1 is for ANSI and E1 is for ITU.
- The ATM interface parameters are displayed in the following fields:
- **MAX VCCs**—The maximum number of simultaneously active Virtual Circuit Connections (VCCs) supported.
- **MAX VPCs**—The maximum number of simultaneously active Virtual Path Connections (VPCs) supported (by the ATM interface).
- **VCI BITS**—The number of allocated VCI bits to be used in the VPIs in the ATM cells for the VCLs supported on the ATM interface.
- **VPI BITS**—The number of bits to be used in the VPIs in the ATM cells for the VPLs terminated on the ATM interface.

#### Related Topics

- [rtrv-atm-lps](#)

## rtrv-attr-seculog

Use this command to display security log attributes that were configured using the `chg-attr-seculog` command.

#### Parameters

This command has no parameters.

#### Example

```
rtrv-attr-seculog
```

#### Dependencies

None

#### Notes

None

#### Output

```
rtrv-attr-seculog
```

```
Command Accepted - Processing
```

```
stpc1081301 20-03-10 22:54:25 EST EAGLE 46.9.0.0.0-76.9.0
```

```
rtrv-attr-seculog
```

```
Command entered at terminal #1.
```

```
;
```

```
stpc1081301 20-03-10 22:54:25 EST EAGLE 46.9.0.0.0-76.9.0
```

```

Security log attributes
-----
UPLDALM      yes
UPSLG        80
PURGEPERIOD  10
;

```

### Related Topics

- [chg-attr-seculog](#)

## rtrv-bip

Use this command to show the board identification PROM (BIP) data for the main assembly at the specified card location.

The following information is displayed for the main assembly: board part number, board revision, serial number (7, 8, 11, 12, or 14 digits), manufacturing date, and the software match ID.

For main assemblies, the port A Ethernet address (if ENT01 record exists) and port B Ethernet address (if ENT02 record exists) are also displayed.

### Parameters

#### loc (mandatory)

The card location as stenciled on the shelf of the system.

#### Range:

1101 - 1108, 1111 - 1112, 1201 - 1208, 1211 - 1218, 1301 - 1308, 1311 - 1318, 2101 - 2108, 2111 - 2118, 2201 - 2208, 2211 - 2218, 2301 - 2308, 2311 - 2318, 3101 - 3108, 3111 - 3118, 3201 - 3208, 3211 - 3218, 3301 - 3308, 3311 - 3318, 4101 - 4108, 4111 - 4118, 4201 - 4208, 4211 - 4218, 4301 - 4308, 4311 - 4318, 5101 - 5108, 5111 - 5118, 5201 - 5208, 5211 - 5218, 5301 - 5308, 5311 - 5318, 6101 - 6108, 6111 - 6118, 1109, 1110, 1209, 1210, 1309, 1310, 2109, 2110, 2209, 2210, 2309, 2310, 3109, 3110, 3209, 3210, 3309, 3310, 4109, 4110, 4209, 4210, 4309, 4310, 5109, 5110, 5209, 5210, 5309, 5310, 6109, 6110, 1113, 1115

### Example

The following example displays the BIP data for the main assembly.

```
rtrv-bip:loc=1201
```

### Dependencies

The card location must be valid for the command.

### Notes

The `tst-bip` command verifies that the PROM is good by writing to and reading from the PROM. The `rtrv-bip` command shows the level of the BIP, as well as the board part number, the revision number, and the serial number. If the `rtrv-bip` command fails, this indicates that communication to the card has failed, and you might need to replace the card. Contact My Oracle Support (MOS) to find out if the card can be reprogrammed.

## Output

For main assemblies, the Max Power Rating is also displayed. If the Card Power value is not present in BIP data, then the Max Power Rating is displayed as *Undef*.

This example shows the 7-digit serial number of a main assembly card manufactured on the eleventh week of 1993):

```
rtrv-bip:loc=1201
```

```
tekelecstp 10-03-14 23:32:51 IST EAGLE 42.0.0
```

```
-----  
Location: 1201 MBD
```

```
Part Number: 850-0187-03  
Revision: G2 Week/Year: 11/1993  
Serial Number: 3110195
```

```
Software Match ID: EG - 001 Max Power Rating : Undef
```

```
-----  
END OF REPORT
```

```
;
```

This example shows the 14-digit serial number with Ethernet port A and B records, manufactured on the eleventh week of 2001:

```
rtrv-bip:loc=1201
```

```
tekelecstp 10-03-14 23:32:51 IST EAGLE 42.0.0
```

```
-----  
Location: 1201 - MBD
```

```
Part Number: 850-0187-03  
Revision: G2 Week/Year: 11/2001  
Serial Number: 102200111a0195
```

```
Software Match ID: EG - 001 Max Power Rating : Undef
```

```
Ethernet Port A Address: 00001704000C  
Ethernet Port B Address: 000017040
```

```
-----  
END OF REPORT
```

```
;
```

This example shows the BIP data for the main assembly when the Max Power Consumption value for the card is present:



```
rtrv-bip:loc=1103
```

```
tekelecstp 10-03-14 23:32:51 IST EAGLE 42.0.0
```

```
-----  
---  
Location: 1103 - MBD  
  
Part Number: 870-2212-02  
Revision: A Week/Year:  
26/2006  
Serial Number: 10206265084  
  
Software Match ID: EG - 001 Max Power Rating : 646  
mA  
-----
```

```
---  
END OF REPORT  
;
```

This example shows the BIP data for the MUX main assembly card:

```
rtrv-bip:loc=1109
```

```
tekelecstp 10-03-07 23:32:51 IST EAGLE 42.0.0
```

```
-----  
---  
Location: 1109 MBD  
Part Number: 870-2872-01  
Revision: A Week/Year:  
11/2003  
Serial Number: 10105365048  
  
Software Match ID: EG - 001 Max Power Rating : 646  
mA  
-----
```

```
---  
END OF REPORT  
;
```

### Legend

- **Location**—Card location for the BIP information
- **Part Number**—Part number of the card in the specified card location
- **Revision**—Hardware version of the card
- **Serial Number**—Serial number of the card. Serial number formats are:

- 7-digit serial number—ywwxxxx
- 8-digit serial number—yywwxxxx
- 11-digit serial number—nnnywwxxxx
- 12-digit serial number—nnnyww\*xxxx
- 14-digit serial number—nnnyyyww\*xxxx
  - \* y = year digit (0–9)
  - \* w = week digit (0–9)
  - \* n = product identifier digit (0–9)x = serial number digit (0–F hexadecimal)
  - \* \* = special character (0–9, a–z, or A–Z, alphanumeric characters)
- **Software Match ID**—Used to check hardware and board type for the BIP information.
- **Max Power Rating**—Maximum power rating of the card.
- **Week/Year**—Week (1–52) and year (4 digits) of the card. The serial number formats are:
  - 7-digit: ywwxxxx
  - 8-digit: yywwxxxx
  - 11-digit: nnnywwxxxx
  - 12-digit: nnnyww\*xxxx
  - 14-digit: nnnyyyww\*xxxx
  - where y=year, w=week, n=product identifier, x=serial number (0-F, hexadecimal), \*=special character (0–9, a–z, or A–Z)

#### Related Topics

- [chg-bip-fld](#)
- [chg-bip-rec](#)
- [disp-bip](#)
- [tst-bip](#)

## rtrv-card

Use this command to display the information about a card. The command displays the card type, the application the card is running, the linkset name, the signaling links, and the signaling link codes. If no parameter is specified, the command displays information for all cards defined by the `ent-card` command. If the `loc` parameter is specified, the command displays information for the specified card only.

#### Parameters

##### links (optional)

Links Provision Status. For the card in the location specified by the `loc` parameter, all links, only equipped links, or only unequipped links are displayed. If the parameter is not specified, only the equipped links are displayed.

**Range:*****all***

Display all possible links for the card.

***equip***

Display links that are equipped on the card.

***unequip***

Display links that are allowed but not equipped on the card.

***ipsg***

Display the SLKTPS and total card TPS used for a particular card or for all cards configured with the IPGS GPL.

**Default:**

*equip*

**loc (optional)**

The card location as stenciled on the shelf of the system.

**Range:**

1101 - 1108, 1111 - 1112, 1201 - 1208, 1211 - 1218, 1301 - 1308, 1311 - 1318,  
2101 - 2108, 2111 - 2118, 2201 - 2208, 2211 - 2218, 2301 - 2308, 2311 - 2318,  
3101 - 3108, 3111 - 3118, 3201 - 3208, 3211 - 3218, 3301 - 3308, 3311 - 3318,  
4101 - 4108, 4111 - 4118, 4201 - 4208, 4211 - 4218, 4301 - 4308, 4311 - 4318,  
5101 - 5108, 5111 - 5118, 5201 - 5208, 5211 - 5218, 5301 - 5308, 5311 - 5318,  
6101 - 6108, 6111 - 6118, 1113, 1115, 6201 - 6208, 6211 - 6218, 6301 - 6108,  
6311 - 6118

**Default:**

Retrieve all

**Example**

```
rtrv-card
rtrv-card:loc=1205
rtrv-card:links=ipsg
rtrv-card:loc=1111:links=ipsg
rtrv-card:loc=6201
```

**Dependencies**

The card location slot must be between 1 and 18 and not 9 or 10.

The card location cannot be 1114, 1116, 1117, or 1118.

The shelf location must be 11xx, 12xx, 13xx, 21xx, 22xx, 23xx, 31xx, 32xx, 33xx, 41xx, 42xx, 43xx, 51xx, 52xx, 53xx, 61xx, 62xx, or 63xx.

The specified card location must be equipped in the database.

**Notes**

Rtrv-card for a card slot provisioned for SLIC and a SLIC card inserted will show the card type as SLIC and appl as IPSG. Rtrv-card for a card slot provisioned for SLIC and a SLIC card is not inserted will show the card type as SLIC and appl as IPSG.

**Output**

```
rtrv-card
```

```
rlghncxa03w 11-03-15 16:34:56 EST EAGLE 46.0.0
  CARD   TYPE     APPL      LSET NAME      LINK SLC LSET NAME      LINK SLC
  1101   DSM       VSCCP     -----      A   -- -----      B   --
  1102   TSM       GLS       -----      A   -- -----      B   --
  1108   MCPM      MCP
  1113   E5-MCAP   OAM
  1114   TDM-A
  1115   E5-MCAP   OAM
  1116   TDM-B
  1117   MDAL
  1205   LIME1     CCS7ITU   e1lim1        A   0  -----      B   --
  -----      A1  -- -----      B1  --
  -----      A2  -- -----      B2  --
  -----      A3  -- -----      B3  --
  1207   LIME1     SS7ANSI   e1lsn1        A   0  e1jwk4        B   1
  e1lsn2        A1  2  e1jwk3        B1  2
  e1lsn3        A2  4  e1jwk2        B2  15
  -----      A3  -- e1jwk1        B3  16
  1211   LIMT1     SS7ANSI   t1lsn1        A   0  t1lsn1        B   1
  -----      A1  -- t1lsn1        B1  2
  t1lsn5        A2  0  t1lsn6        B2  6
  t1lsn7        A3  13 -----      B3  --
;
```

This example shows the output for an E5-SM4G or E5-SM8G-B card:

```
rtrv-card:loc=6111
```

```
tklcl1110501 11-03-12 17:33:25 EST EAGLE5 44.0.0
  CARD   TYPE     APPL      LSET NAME      LINK SLC LSET NAME      LINK SLC
  6111   DSM       VSCCP
;
```

This example lists unequipped links on the provisioned cards:

```
rtrv-card:links=unequip
```

```
stdcfg1a 07-05-24 14:04:54 EST EAGLE 46.0.0
  CARD   TYPE     APPL      UNEQUIPPED LINKS
  1101   LIME1     SS7ANSI   A1  B1  B3
  1102   LIME1     SS7ANSI   A1  B1  A2  B2  A3  B3
```

```

1103 LIME1      SS7ANSI      A1  A2  A3
1113 E5-MCAP     OAM
1114 TDM-A
1115 E5-MCAP     OAM
1116 TDM-B

1117 MDAL

```

```
;
```

```
rtrv-card:links=ipsg
```

```

e1001501 11-02-23 16:20:42 EST  EAGLE 44.0.0
CARD  TYPE      APPL      LSET NAME  LINK SLC  SLKTPTS
1105  ENET       IPSG      ele2sg1    A    0    410
                ele2sg1    B    4    410
                ele2sg1    A1   1    410
                ele2sg1    B1   5    410
                ele2sg1    A2   2    410
                ele2sg1    B2   6    410
                ele2sg1    A3   3    410
                ele2sg1    B3   7    410
                Total SLKTPTS is (3280 of 5000) 66%
1211  ENET       IPSG      ls1211a    A    0    500
                ls1211b    A1   0    600
                ls1211b    B1   1    600
                ls1211c    A2   0    700
                lsm3ua1    A3   0    1600
                Total SLKTPTS is (4000 of 5000) 80%
1213  ENET       IPSG      ls1213a    A    0    800
                ls1213b    A1   0    900
                ls1213c    A2   0    1000
                lsm3ua1    A3   1    1600
                Total SLKTPTS is (4300 of 6500) 66%
1215  ENETB      IPSG      m3ua01     A    0    10
                m3ua02     B    0    10
                m3ua03     A1   0    10
                m3ua04     B1   0    10
                m3ua05     A2   0    10
                m3ua06     B2   0    10
                m3ua07     A3   0    10
                m3ua08     B3   0    10
                m3ua09     A4   0    10
                m3ua10     B4   0    10
                m3ua11     A5   0    10
                m3ua12     B5   0    10
                m3ua13     A6   0    10
                m3ua14     B6   0    10
                m3ua15     A7   0    10
                m3ua16     B7   0    10
                Total SLKTPTS is (1600of 6500) 25%

```

```
;
```

```
rtrv-card:links=ipsg:loc=1105
```

```
e1001501 08-02-23 16:20:42 EST EAGLE 38.0.0
CARD   TYPE      APPL      LSET NAME   LINK SLC   SLKTPS
1105   ENET        IPSG      ele2sg1     A     0       410
        ele2sg1     B     4       410
        ele2sg1     A1    1       410
        ele2sg1     B1    5       410
        ele2sg1     A2    2       410
        ele2sg1     B2    6       410
        ele2sg1     A3    3       410
        ele2sg1     B3    7       410
Total SLKTPS is (3280 of 5000) 66%
```

```
;
```

This example includes IPSG cards:

```
rtrv-card
```

```
eagle10212 11-03-05 09:34:40 EST EAGLE 44.0.0
CARD   TYPE      APPL      LSET NAME   LINK SLC LSET NAME   LINK SLC
1303   ENET        IPSG      ls1303a     A     0     lsm2pa7     A15  0
1305   ENETB       IPSG      ls1305a     A     0     ls1305i     B     0
        ls1305a     A1    1     ls1305i     B1    1
        ls1305a     A2    2     ls1305i     B2    2
        ls1305a     A3    3     ls1305i     B3    3
```

This example shows the output when the EPAP Data Split feature is turned on:

```
rtrv-card
```

```
epap240m 12-01-05 15:48:30 CST EAGLE 45.0.0
CARD   TYPE      APPL      LSET NAME   LINK SLC LSET NAME   LINK SLC   DATA
1101   DSM         VSCCP                                DN
1103   DSM         VSCCP                                IMSI
1105   DSM         VSCCP                                COMB
1107   DSM         VSCCP                                COMB
1111   IPSM        IPS
1112   IPSM        IPS
SFLOG
1113   E5-MCAP    OAM
1114   TDM-A
1115   E5-MCAP    OAM
1116   TDM-B
1117   MDAL
1202   LIME1      CCS7ITU   lsi1       A     2
1203   LIMATM     ATMANSI   lsa1       A     3
1204   LIMT1      SS7ANSI   lsa1       A     4
1206   LIME1ATM   ATMITU    lsi1       A     6
```

This example shows the output when we have provisioned E5-APP-B cards:

```
rtrv-card

tekelecstp 12-07-12 17:06:11 EST 45.0.0-64.37.0
  rtrv-card
  Command entered at terminal #4.
  CARD   TYPE      APPL   LSET NAME  LINK SLC LSET NAME  LINK SLC
  1101   E5-APP-B  EPAP
  1103   E5-APP-B  EPAP
  1107   E5-APP-B  ELAP
  1111   E5-APP-B  ELAP
  1113   E5-MCAP   OAM
  1114   TDM-A
  1115   E5-MCAP   OAM
  1116   TDM-B
  1117   MDAL
```

The following examples show the output when we retrieve the card information with specified location of E5-APP-B card:

```
rtrv-card:loc=1101

tekelecstp 12-07-13 10:13:48 EST 45.0.0-64.37.0
  rtrv-card:loc=1101
  Command entered at terminal #4.
  CARD   TYPE      APPL   SRVNAME
  1101   E5-APP-B  EPAP   tklc1lepap

rtrv-card:loc=1107

tekelecstp 12-07-13 10:13:59 EST 45.0.0-64.37.0
  rtrv-card:loc=1107
  Command entered at terminal #4.
  CARD   TYPE      APPL   SRVNAME
  1107   E5-APP-B  ELAP   tklc1elap
```

This example shows the output when we have provisioned Telco switches:

```
rtrv-card

tekelecstp 12-09-06 11:20:45 EST 45.0.0
  rtrv-card
  Command entered at terminal #4.
  CARD   TYPE      APPL  LSET NAME  LINK SLC  LSET NAME  LINK SLC
  1113   E5-MCAP   OAM
  1114   TDM-A
  1115   E5-MCAP   OAM
  1116   TDM-B
  1117   MDAL
  6201   TELCO     SWITCH
```

```

6202  TELCO      SWITCH
6203  TELCO      SWITCH
6204  TELCO      SWITCH
6205  TELCO      SWITCH
6206  TELCO      SWITCH
;

```

The following example shows the output when we retrieve the card information with specified location of Telco Switch:

```

rtrv-card:loc=6201

tekelecstp 12-09-06 11:22:10 EST 45.0.0
rtrv-card:loc=6201
Command entered at terminal #4.
CARD   TYPE      APPL      SRVNAME
6201   TELCO      SWITCH    telcol
;

```

The following example shows the output when we retrieve the card information on Release 46.5.0 - 70.23.0:

```

rtrv-card:links=equip

tklcl061501 17-02-21 16:56:53 EST  EAGLE 46.5.0.0.0-70.23.0
  rtrv-card:links=equip
  Command entered at terminal #4.
  CARD   TYPE      APPL      DATA      LSET NAME      LINK SLC  LSET NAME      LINK
SLC
0  1101   LIMT1      SS7ANSI      ls511101      A    0    ls511102      A1
0  1102   LIME1      CCS7ITU      ls711200      A    0    ls711204      B
0                                     ls711201      A1    0    ls711205      B1
0                                     ls711202      A2    0    ls711206      B2
0                                     ls711203      A3    0    ls711207      B3
0
0  1103   DSM        VSCCP      EPAP
0  1105   SLIC      IPSPG      GTT      lsi1105m2p    A    0    lsi1105m3u    B
0
0  1107   DSM        VSCCP      GTT
0  1111   IPSPM      IPS
0  1113   E5-MCAP   OAM
0  1114   TDM-A
0  1115   E5-MCAP   OAM
0  1116   TDM-B
0  1117   MDAL
0  1208   DCM        IPGWI      lgipgwi      A    0
0  1211   DCM        IPGWI      gttlsn1b     A    0
0  1215   ENETB     IPSPG      gttlsn0b     A    0
0  1316   SLIC      IPSPG      NOSCCP      ls551        A    0

```



```

;

rtrv-card:links=unequip

tklc1061501 17-01-18 19:26:49 MST EAGLE 46.5.0.0.0-70.12.0
  rtrv-card:links=unequip
  Command entered at terminal #23.
;

Command Accepted - Processing
tklc1061501 17-01-18 19:26:49 MST EAGLE 46.5.0.0.0-70.12.0
CARD   TYPE      APPL      UNEQUIPPED LINKS
DATA
  1101  LIMT1      SS7ANSI   B  B1 A2 B2 A3 B3 A4 B4 A5
          B5 A6 B6 A7 B7 A8 B8 A9 B9
          A10 B10 A11 B11 A12 B12 A13 B13 A14
          B14 A15 B15 A16 B16 A17 B17 A18 B18
          A19 B19 A20 B20 A21 B21 A22 B22 A23
          B23 A24 B24 A25 B25 A26 B26 A27 B27
          A28 B28 A29 B29 A30 B30 A31 B31
  1102  LIME1      CCS7ITU   A4 B4 A5 B5 A6 B6 A7 B7 A8
          B8 A9 B9 A10 B10 A11 B11 A12 B12
          A13 B13 A14 B14 A15 B15 A16 B16 A17
          B17 A18 B18 A19 B19 A20 B20 A21 B21
          A22 B22 A23 B23 A24 B24 A25 B25 A26
          B26 A27 B27 A28 B28 A29 B29 A30 B30
          A31 B31
  1105  SLIC       IPSG      A1 B1 A2 B2 A3 B3 A4 B4 A5
GTT
          B5 A6 B6 A7 B7 A8 B8 A9 B9
          A10 B10 A11 B11 A12 B12 A13 B13 A14
          B14 A15 B15
  1107  DSM        VSCCP
ELAP
  1113  E5-MCAP    OAM
  1114  TDM-A
  1115  E5-MCAP    OAM
  1116  TDM-B
  1117  MDAL
  1208  DCM        IPGWI     B
  1211  DCM        IPGWI     B
  1215  ENET       IPSG      B  A1 B1 A2 B2 A3 B3 A4 B4
          A5 B5 A6 B6 A7 B7 A8 B8 A9
          B9 A10 B10 A11 B11 A12 B12 A13 B13
          A14 B14 A15 B15
  1303  MCPM      MCP       A  B
  1315  ENETB     IPSG      A  B  A1 B1 A2 B2 A3 B3 A4
          B4 A5 B5 A6 B6 A7 B7 A8 B8
          A9 B9 A10 B10 A11 B11 A12 B12 A13
          B13 A14 B14 A15 B15
  1316  SLIC       IPSG      B  A1 B1 A2 B2 A3 B3 A4 B4
NOSCCP
          A5 B5 A6 B6 A7 B7 A8 B8 A9

```

```

                                B9  A10 B10 A11 B11 A12 B12 A13 B13
                                A14 B14 A15 B15
1318   DCM       IPGWI       A   B
;
Command Executed

```

### Legend

- **CARD**—Card location as stenciled on the shelf of the system
- **TYPE**—Type of card
- **APPL**—Application associated with each card
- **LSET NAME**—Linkset name associated with the cards
- **LINK**—Signaling link associated with the linkset.
- **SLC**—Signaling link code
- **UNEQUIPPED LINKS**—Signaling links that are unequipped on the provisioned card
- **SLKTPS**—Transactions Per Second configured for signaling links provisioned on the card
- **DATA**—Type of RTDB data loaded on the card. Displayed when the EPAP Data Split feature is turned on. When an SFLOG card is configured, the DATA parameter is used to display its status.
- **SRVNAME**- Server Name of the E5-APP-B Card or Telco Switch.

### Related Topics

- [dlt-card](#)
- [ent-card](#)
- [init-card](#)
- [rept-stat-card](#)
- [rmv-card](#)

## rtrv-clkopts

Use this command to retrieve the values of the clock parameters which are maintained in the STP's option table. All values are assigned initially to system defaults during STP installation, and can be updated using this command.

### Parameters

This command has no parameters.

### Example

```
rtrv-clkopts
```

### Dependencies

None.

**Notes**

None

**Output**

rtrv-clkopts

```
e5oam 09-01-02 17:20:05 MST EAGLE 40.1.0
CLK OPTIONS
-----
```

PRIMARY

```
-----
HSCLKSRC          rs422
HSCLKLL           longhaul
```

SECONDARY

```
-----
HSCLKSRC          rs422
HSCLKLL           longhaul
```

;

rtrv-clkopts

```
e5oam 09-01-02 17:26:51 MST EAGLE 40.1.0
CLK OPTIONS
-----
```

PRIMARY

```
-----
HSCLKSRC          rs422
HSCLKLL           longhaul
```

SECONDARY

```
-----
HSCLKSRC          rs422
HSCLKLL           shorthaul
```

;

**Related Topics**

- [chg-clkopts](#)

## rtrv-cmd

Use this command to retrieve the list of command classes to which a command is assigned. You can retrieve output for one command, commands in one command class, or all commands.

## Parameters

### **class (optional)**

The command class whose attributes are to be retrieved.

#### **Range:**

*ayyyy*

One alphabetic character followed by up to 5 additional alphanumeric characters.

### **cmd (optional)**

The command whose attributes are to be retrieved.

#### **Range:**

*ZZZZZZZZZZZZZZZZZZZZ*

One alphabetic character followed by up to 19 additional alphanumeric characters, enclosed in double quotes.

## Example

```
rtrv-cmd:cmd="ent-rte"
```

```
rtrv-cmd:class=dab
```

```
rtrv-cmd
```

## Dependencies

The Command Class Management feature must be enabled before a configurable command class name can be specified in the `class` parameter.

The value of the `cmd` parameter must be a valid system command.

The CCCNAMES table is corrupt or cannot be found.

The CCMD table is corrupt or cannot be found.

The value of the `class` parameter must be a valid configurable or non-configurable command class name.

The Command Class Management feature must be enabled before CHG-CMD or CHG-CMDCLASS command can be entered.

## Notes

This command can be canceled using the **F9** function key or the `canc-cmd` command. See `canc-cmd` for more information.

## Output

This example shows the command classes to which the `rept-stat-slk` command is assigned (non-configurable class `sys` and user-configured classes `u01`, `u02`, `krb`, and `u11`):

```
rtrv-cmd:cmd="rept-stat-slk"
```

```
eagle10404 04-01-22 16:30:56 EST EAGLE 31.3.0
cmd CLASS
```

```

    rept-stat-slk      sys, u01, u02, krb, u11
;

```

This example shows the commands assigned to user-configured command class *krb*:

```
rtrv-cmd:class=krb
```

```

eagle10404 04-01-22 16:30:56 EST  EAGLE 31.3.0
CMD
rept-stat-slk      sys, u01, u02, krb, u11
act-slk           link, u09, krb
ent-user          sa, krb, abc, u23
alw-card          sys, u09 dab, krb
;

```

```
rtrv-cmd:class=link
```

```

eagle10404 10-03-06 16:30:56 EST  EAGLE 42.0.0
CMD
alw-slk           link, u11
unhb-slk          link
inh-slk           link, abc
rtrv-meas-sched  link, abc, def
act-lbp           link
act-dlk           link
act-slk           link
act-lpo           link
blk-slk           link, abc, u23, u31
dact-lbp          link
canc-dlk          link
canc-lpo          link, u01, u02, u03, u04, u05, u06, u07, u08,
u09, u10,
                  u11, u12, u13
canc-slk          link
ublk-slk          link, u01, u02, u03, u04, u05, u06, u07, u08,
u09, u10,
                  u11, u12, u13, u14, u15, u16, u17, u18, u19,
u20, u21,
                  u22, u23, u24, u25, u26, u27, u28, u29, u30,
u31, u32
rept-meas         link
chg-meas          link
tst-dlk           link, krb
tst-slk           link
;

```

```
rtrv-cmd
```

```

eagle10404 10-03-06 16:30:56 EST  EAGLE 42.0.0
CMD
CLASS

```

```

alw-slk          link, u11
ent-user        sa
unhb-slk        link
rtrv-attr-seculog sa, u31
inh-slk         link, abc
rtrv-meas-sched link, abc, def
act-lbp         link
act-dlk         link
act-slk         link
rtrv-seculog    sa, abc, def, ghi
act-lpo         link
blk-slk         link, abc, u23, u31
dact-lbp        link
canc-dlk        link
inh-card        sys
canc-lpo        link, u01, u02, u03, u04, u05, u06, u07, u08, u09,
u10,
                u11, u12, u13
canc-slk        link
ublk-slk        link, u01, u02, u03, u04, u05, u06, u07, u08, u09,
u10,
                u11, u12, u13, u14, u15, u16, u17, u18, u19, u20,
u21,
                u22, u23, u24, u25, u26, u27, u28, u29, u30, u31, u32
inh-trm         sys, krb
rept-meas       link
.
.
.
chg-meas        link
tst-dlk         link, krb
tst-slk         link
;

```

**Related Topics**

- [chg-cmd](#)

## rtrv-cmdclass

Use this command to retrieve the name and description of one command class or all command classes.

**Parameters****class (optional)**

The command class whose name and description are to be retrieved.

**Range:**

ayyyy

1 alphabetic character followed by up to 5 alphanumeric characters

**Example**

```
rtrv-cmdclass:class=krb
```

```
rtrv-cmdclass
```

### Dependencies

The Command Class Management feature must be enabled and turned on before a configurable command class name can be specified in the `class` parameter.

The CCCNAMES table is corrupt or cannot be found.

The value of the `class` parameter must be a valid configurable or non-configurable command class name.

### Notes

The Command Class Management feature must be enabled and turned on before configurable command classes will appear in the command output.

### Output

In the following examples, classes *u01*, *u03*, *u05*, and *u32* are default configurable command class names. Classes *krb* and *dab* are user-assigned configurable command class names. Default command class name *u02* was changed to *krb* and command class name *u04* was changed to *dab*. Descriptions of classes *krb* and *dab* were entered with the `descr` parameter when the class names were changed with the `chg-cmdclass` command.

```
rtrv-cmdclass:class=krb
```

```

eagle10404 04-01-22 16:30:56 EST  EAGLE 31.3.0
class          descr
krb            my command class description
;

```

```
rtrv-cmdclass
```

```

eagle10404 04-01-22 16:30:56 EST  EAGLE 31.3.0
class          descr
link          link maintenance commands
sa            security administration commands
sys          system maintenance commands
.
.
.
u01          configurable command class 1
krb          my command class description
u03          configurable command class 3
dab          your command class description
u05          configurable command class 5
.
.
.
u32          configurable command class 32
;

```

**Related Topics**

- [chg-cmdclass](#)

## rtrv-csl

Use this command to retrieve all Common Screening List (CSL) entries for a specified feature, a list of screening entries for the specified feature and screening list name, or a specific DS or PC value for a particular feature and screening list name. The Common Screening List commands are used to tailor certain types of general screening information to specific features.

**Parameters****ds (optional)**

Digit string. A unique string of digits that is used by the specified screening feature.

**Note:**

The `ds` or `pc` parameter must be specified. Both parameters cannot be specified in the same command.

**Range:**

1 - 15 hexadecimal digits. Valid digits are 0-9, a-f, A-F.

- 1-6 digits—Prepaid IDP Query Relay *ccnc* list
- 1-15 digits—Prepaid IDP Query Relay *gt* list
- 1-10 digits—Prepaid IDP Query Relay *skbcsm* list
- 4 digits—IDP Screening for Prepaid *skts* list
- 1-15 digits—IDP Screening for Prepaid *insl* list
- 1-15 digits—VFLEX *vmplx* list
- 1-6 digits—Info Analyzed Relay Base *ccnc* list
- 1-15 digits—Info Analyzed Relay Base *gt* list
- 2 digits—Info Analyzed Relay Base *trig* list
- 1-15 digits — EIR *imsipfx* list

[Table 4-23](#) lists valid hexadecimal values for the IAR Base *trig* list *ds* entries.

**feature (optional)**

Feature name. The name of the screening feature for which the command is entered.

**Note:**

The `pn` or `feature` parameter must be specified to identify the feature.





***vmpfx***  
Voice Mail Prefix List

***opcdpc***  
OPC + DPC List

The following screening lists are valid for the indicated features:

***ccnc, gt***  
Prepaid IDP Query Relay and Info Analyzed Relay Base

***imsipfx***  
EIR

***npbypass***  
SIP Number Portability

***insl, skts***  
IDP Screening for Prepaid

***skbcsm***  
Prepaid IDP Query Relay and IDP Service Key Routing

***trig***  
Info Analyzed Relay Base

***vmpfx***  
VFLEX

***opcdpc***  
Prepaid IDP Query Relay

**pc (optional)**

ANSI point code with subfields *network indicator-network cluster-network cluster member (ni-nc-ncm)*.

 **Note:**

See [Point Code Formats and Conversion](#) for a detailed description of point code formats, rules for specification, and examples.

**Synonym:**  
*pca*

**Range:**  
*000-255*

Specify a valid value for each subfield of the point code, and separate the subfields with a dash (-).

When `chg-sid:pctype=ansi` is specified, *ni = 000* is not valid.

When `chg-sid:pctype=ansi` is specified, *nc = 000* is not valid if *ni = 001–005*.

When `chg-sid:pctype=ansi` is specified, *nc = 000* is valid if *ni = 006–255*.

The point code *000-000-000* is not a valid point code.

**pc/pca/pci/pcn/pcn24 (optional)**

Point code. The `ds` or a point code parameter must be specified.

**pci (optional)**

ITU international point code with subfields *zone-area-id*.

**Range:**

*0-255*

Specify a valid value for each subfield of the point code, and separate the subfields with a dash (-).

*zone—0-7*

*area—000-255*

*id—0-7*

The point code *0-000-0* is not a valid point code.

**pcn (optional)**

ITU national destination point code in the format of a 5-digit number (*nnnnn*); or 2, 3, or 4 numbers (members) separated by dashes (*m1-m2-m3-m4*) as defined by the `chg-stpopts:npcfmt1` flexible point code option. A group code must be specified when the ITUDUPPC feature is turned on (*nnnnn-gc*, *m1-m2-m3-m4-gc*).

**Range:**

*s-*, *0-16383*, *aa-zz*

Specify a valid value for each subfield of the point code, and separate the subfields with a dash (-).

*prefix—s-*

*nnnnn—0-16383*

*gc—aa-zz*

*m1-m2-m3-m4—0-14* for each member; values must sum to 14

**pcn24 (optional)**

24-bit ITU national point code with subfields *main signaling area-sub signaling area-signaling point* (*msa-ssa-sp*).

**Range:**

*000-255*

Specify a valid value for each subfield of the point code, and separate the subfields with a dash (-).

*msa—000-255*

*ssa—000-255*

*sp—000-255*

**pn (optional)**

Part Number. The 9-digit "893xxxxx" part number of the feature for which the command is entered. The `rtv-ctrl-feat` command description shows the part number in the command output example.

 **Note:**

The `pn` or `feature` parameter must be specified to identify the feature.

**Range:**

893000000 - 893999999

The first 3 digits are 893. Do not separate the digits with dashes or spaces. The following part numbers are valid for this command:

**893012301**

EIR

**893015501**

IDP Screening for Prepaid

**893034201**

Info Analyzed Relay Base

**893016001**

Prepaid IDP Query Relay

**893016701**

VFLEX

**scpgta (optional)**

Signaling Control Point (SCP) Global Title Address (GTA).

**Note:**

The `scpgta` parameter is used only by the Prepaid IDP Query Relay feature.

**Range:**1 - 21 digits, *none*

1 - 21 hexadecimal digits. Valid digits are 0-9, a-f, A-F

**Example**

```
rtrv-csl
rtrv-csl:feature="Prepaid IDP Query Relay":list=ccnc:ds=456789
rtrv-csl:feature="Prepaid IDP Query Relay":list=ccnc
rtrv-csl:feature="IDP Screening for
Prepaid":list=insl:ds=123456789abcdEF
rtrv-csl:scpgta=12345
rtrv-csl:feature="EIR":list=imsipfx:ds=401923423
rtrv-csl:pn=893016001:list=opcdpc
```

**Dependencies**

The value specified for the `feature` parameter must be a valid feature name for a feature that uses a Common Screening List. The feature must be specified as it appears in the `rtrv-ctrl-feat` command output. Enough of the name must be specified to make the name unique when two features begin with the same word or acronym. The specified feature name must be valid for a feature that uses a Common Screening List.

The following parameters are allowed with the indicated common screening list type:

- `list=ccnc—ds` parameter
- `list=gt—ds` parameter
- `list=imsipfx---ds` parameter
- `list=insl—ds` parameter
- `list=skbcsm—ds` or `scpgta` parameter
- `list=skts—ds` parameter
- `list=trig—ds` parameter
- `list=vmpfx—ds` parameter

The Common Screening List table is corrupt or cannot be found.

Only one of the `ds`, `pc`, and `scpgta` parameters can be specified in the command.

The `pn` or `feature` parameter must be specified before the `list` parameter can be specified.

### Notes

None

### Output

This example retrieves the specified screening entry for the specified feature and screening list:

```
rtrv-csl:feature="Prepaid IDP Query Relay":list=ccnc:ds=456789
```

```
tekelecstp 05-07-12 08:45:21 EST EAGLE 34.1.0
Prepaid IDP Query Relay
CC+NC List
DS
-----
456789

CC+NC List table is (1 of 20) 5% full
;
```

This example retrieves all screening entries for the specified feature and screening list:

```
rtrv-csl:feature="Prepaid IDP Query Relay":list=ccnc
```

```
tekelecstp 05-07-12 08:44:50 EST EAGLE 35.0.0
Prepaid IDP Query Relay
CC+NC List
DS
-----
123
456789
754532
```

```
CC+NC List table is (3 of 20) 15% full
;

rtrv-csl:pn=893016701:list=vmpfx

tekelecstp 07-08-23 17:30:17 EST EAGLE 37.6.0
VFLEX
VM Prefix List
DS
-----
12
123
12345
123456789abcdef

VM Prefix List table is (4 of 100) 4% full
;
```

```
rtrv-csl:feature="Prepaid IDP Query Relay"
```

```
tekelecstp 10-10-29 12:49:31 EST EAGLE 43.0.0
Prepaid IDP Query Relay
CC+NC List
DS
-----
000015
000025
CC+NC List ( 2 of 20) 10%
Prepaid IDP Query Relay
GT List
DS          CDPN BCD
-----
1234567815  0

GT List ( 1 of 500) 1%

Prepaid IDP Query Relay
SK+BCSM List
DS          PT          IDPRCDPN  SCPGTA
-----
0000000123  prepaidno  idprcdpn  0000000014
0000000143  prepaidno  idprcdpn  0000000014
1234567815  prepaidno  idprcdpn3 1234
123456782e  prepaidno  idprcdpn  NONE
1234567890  prepaidno  idprcdpn  NONE

SK+BCSM List ( 5 of 150) 3%
;
```

rtrv-csl

tekelecstp 10-10-29 12:55:34 EST EAGLE 43.0.0  
Prepaid IDP Query Relay  
CC+NC List  
DS

-----  
000015  
000025

CC+NC List ( 2 of 20) 10%  
Prepaid IDP Query Relay  
GT List  
DS CDPN BCD

-----  
1234567815 0

GT List ( 1 of 500) 1%

Prepaid IDP Query Relay  
SK+BCSM List  
DS PT IDPRCDPN SCPGTA

-----  
0000000123 prepaidno idprcdpn 0000000014  
0000000143 prepaidno idprcdpn 0000000014  
1234567815 prepaidno idprcdpn3 1234  
123456782e prepaidno idprcdpn NONE  
1234567890 prepaidno idprcdpn NONE

SK+BCSM List ( 5 of 150) 3%

IDP Screening for Prepaid  
SK+TS List  
DS

-----  
0025  
0569  
1529

SK+TS List ( 3 of 25) 12%

IDP Screening for Prepaid  
INSL List  
DS

-----  
0029

0048  
0148

INSL List (3 of 50) 6%  
SIP Number Portability  
PFX List

DS	PFXSTRIP
-----	-----
2	NO
3	NO
02	NO
35	NO
002	NO
356	NO
0002	NO
3412	NO
00002	NO
11110	NO
12000012	NO
0000000012	NO

rtrv-csl:scpgta=0000000014

tekelecstp 10-10-29 12:57:35 EST EAGLE 43.0.0  
Prepaid IDP Query Relay  
SK+BCSM List

DS	PT	IDPRCDPN	SCPGTA
-----	-----	-----	-----
0000000123	prepaidno	idprcdpn	0000000014
0000000143	prepaidno	idprcdpn	0000000014

SK+BCSM List ( 2 of 150) 1%

;

rtrv-csl:feature="eir":ds=12313342

tekelecstp 13-10-03 11:38:55 EST 46.0.0-65.2.0  
rtrv-csl:feature="eir":ds=12313342

EIR  
PFX List

DS	TBS	RSP_LIST
-----	-----	-----
12313342	both	whitelist

PFX List ( 4 of 100000) 1%

;



```

rtrv-csl

tekelecstp 19-01-29 13:14:59 EST EAGLE 46.8.0.0-75.18.11
  Prepaid IDP Query Relay
  PC combination List
  DPC                OPC                DOMAIN
  -----
    001-003-001      001-003-002      PCN24
    001-001-005      -----          PCN24
    1-001-1          -----          PCI
    1-001-6          1-001-7          PCI
    001-01-04        -----          PCN16
    001-02-05        001-02-06        PCN16
    00114            -----          PCN
    00123            00124            PCN
  -----          002-001-005      PCN24
  -----          2-001-1          PCI
  -----          002-01-04        PCN16
  -----          00234            PCN
;

```

### Related Topics

- [chg-csl](#)
- [dlt-csl](#)
- [ent-csl](#)
- [rtrv-ctrl-feat](#)

## rtrv-cspc

Use this command to show one or more lists of concerned signaling point codes that are to be notified when subsystem-prohibited or subsystem-allowed messages are received for an associated mate application.

### Parameters

#### **grp (optional)**

Group name

#### **Range:**

ayyyyyyy

1 alphabetic character followed by up to 7 alphanumeric characters

#### **Default:**

Retrieve all.

### Example

```

rtrv-cspc

rtrv-cspc:grp=grp01

```

**Dependencies**

If specified, the group name must exist in the database.

**Notes**

If no group parameter is specified, a summary list of group names is displayed with an indication of network type and a percent full indication for each group.

**Output**

This example shows output when the ANSI/ITU SCCP Conversion feature is enabled:

```
rtrv-cspc

rlghncxa03w 04-01-07 11:43:02 EST EAGLE 31.3.0
CSPC GRP NETWORK PERCENT FULL
Grp01 ANSI 2%
Grp02 ANSI, ITU, ITU-N24 3%
Grp03 ITU 2%
;
```

This example shows output when the Spare Point Code Support feature is turned on, and the ANSI/ITU SCCP Conversion feature is enabled:

```
rtrv-cspc:grp=grp02

rlghncxa03w 05-01-07 11:43:02 EST EAGLE 31.12.0
CSPC GRP PC Type
GRP02 001-012-123 A
      001-012-124 A
      7-089-0 I
      s-2-021-4 I
      s-00789 N
;
```

This example shows output when the Spare Point Code Support feature is turned on, and the ANSI/ITU SCCP Conversion feature is not enabled:

```
rtrv-cspc:grp=groupi

rlghncxa03w 05-01-07 11:43:02 EST EAGLE 31.12.0
CSPC GRP PCI
groupi 7-089-0
      s-2-021-4
;
```

This example shows output when the Spare Point Code Support feature is turned on, and the ANSI/ITU SCCP Conversion feature is not enabled:

```
rtrv-cspc:grp=grn16
```

```
tekelecstp 13-10-18 12:27:33 EST 45.1.0-64.77.0
CSPC GRP      PCN16
Grn16        001-02-03
```

```
;
```

### Legend

- **CSPC PC TABLE IS 15% FULL**—Relative size of the CSPC point code tables
- **CSPC GRP**—Name of the CSPC broadcast group
- **NETWORK**—Network type or types associated with the point code or codes in the group. (When no parameters are specified in the command, only the groups are listed. The `grp` parameter must be specified to list the point codes in the specified group.)
- **PERCENT FULL**—Relative size of the CSPC broadcast group
- **PC**—Point codes that make up the CSPC broadcast group
- **Type**—Network type of the point code in the group. (The `grp` parameter is specified in the command to list the point codes in the specified group.)

### Related Topics

- [dlt-cspc](#)
- [ent-cspc](#)

## rtrv-ctrl-feat

Use this command to retrieve the status of feature access key controlled features that are enabled in the system.

### Parameters

#### **partnum (optional)**

The Part Number to retrieve.

#### **Range:**

893000000 - 893999999

Do not include dashes in the 9-digit number.

#### **Default:**

Retrieve all controlled features

#### **status (optional)**

Retrieve features with the specified status (On or Off).

#### **Range:**

*on*

*off*

**Default:**

Retrieve features with On and Off status

**Example**

```
rtrv-ctrl-feat
rtrv-ctrl-feat:status=on
rtrv-ctrl-feat:partnum=893005911
```

**Dependencies**

None

**Notes**

None.

**Output**

The following output examples will differ from the output shown at your terminal and might include features that are not supported in your system. You must be entitled to use a feature before you can enable the feature and turn the feature on. If you are not sure whether you are entitled to use a feature, contact your Oracle Sales Representative or Account Representative.

If a Part Number (partnum parameter) is entered that belongs to a feature associated with quantity, the output will show which quantity is currently enabled on the system, even if the specified Part Number is for a different quantity.

```
rtrv-ctrl-feat

rlghncxa03w 12-03-13 16:40:40 EST EAGLE 46.4.0
The following features have been permanently enabled:
```

Feature Name	Partnum	Status	Quantity
Command Class Management	893005801	on	----
LNP Short Message Service	893006601	on	----
Prepaid SMS Intercept Ph1	893006701	on	----
Intermed GTT Load Sharing	893006901	on	----
MNP Circ Route Prevent	893007001	on	----
XGTT Table Expansion	893006101	on	400000
XMAP Table Expansion	893007710	on	3000
Large System # Links	893005911	on	2800
Routesets	893006403	on	8000
EAGLE5 Product	893007101	on	----
Network Security Enhance	893009101	off	----
Telnet	893005701	on	----
Port Chk for MO SMS	893009301	on	----
SCCP Loop Detection	893016501	off	----
LNP ELAP Configuration	893010901	on	----
LNP ported TNs	893011036	on	384000000
LNP ported LRNs	893010501	on	200000
LNP ported NPANXXs	893009402	on	350000
15 Minute Measurements	893012101	off	----
EIR	893012301	on	----

EAGLE OA&M IP Security	893400001	off	----
SCCP Conversion	893012001	on	----
SE-HSL SLK Capacity	893013005	on	32
GSM Map Screening (GMS)	893013201	on	----
Enhanced GMS (EGMS)	893012401	on	----
MTP MAP Screening	893013501	on	----
Spare Point Code Support	893013601	on	----
GSM MAP SRI Redirect	893014001	on	----
ISUP NP with EPAP	893013801	on	----
Origin-Based MTP Routing	893014201	on	----
ITUN-ANSI SMS Conversion	893015301	on	----
Flexible GTT Load-Sharing	893015401	on	----
1100 TPS/DSM for ITU NP	893018001	off	----
IDP Screening for Prepaid	893015501	on	----
Prepaid IDP Query Relay	893016001	on	----
Origin Based SCCP Routing	893014301	on	----
GPort SRI Query for PP	893017701	off	----
Large MSU for IP Sig	893018401	off	----
Transaction Based GTT LS	893017101	on	----
Weighted GTT Loadsharing	893017001	off	----
Hex Digit Support for GTT	893018501	on	----
SEAS over IP	893018801	on	----
E5-SM4G Throughput Cap	893019102	on	6800
HIPR2 High Rate Mode	893020101	on	----
Circ Route Auto-Recovery	893017601	on	----
Enhanced Far-End Loopback	893018101	on	----
Multiple Linkset to APC	893019701	on	----
Proxy Point Code	893018710	on	100
GPORT	893017201	on	----
APOINT	893016601	on	----
IS41 GSM Migration	893017301	off	----
MTP Msgs for SCC Apps	893017401	off	----
INP	893017901	on	----
ANSI-41 INP Query	893017801	on	----
MO-based GSM SMS NP	893019401	on	----
MO-based IS41 SMS NP	893019501	on	----
MO SMS B-Party Routing	893024601	on	----
AMGTT	893021801	on	----
MT-Based GSM SMS NP	893020001	on	----
MT-Based GSM MMS NP	893024101	on	----
MT-Based IS41 SMS NP	893019901	on	----
G-Flex MAP Layer Routing	893021701	on	----
G-Flex	893021901	on	----
VFLEX	893016701	on	----
ST-HSL-A SLK Capacity	893027304	on	24
IDPR ASD	893025701	on	----
IDPR GRN	893025601	on	----
TIF ASD	893024501	on	----
TIF GRN	893025501	on	----
TIF Number Portability	893018901	on	----
TIF SCS Forwarding	893022201	on	----
TIF Simple Number Subst.	893024001	on	----
TCAP Opcode Based Routing	893027801	on	----
Flex Lset Optnl Based Rtg	893027701	on	----
MO SMS IS41-to-GSM Migr	893026201	on	----

```

ISLSBR                893026501    on    ----
ITU TCAP LRN QUERY(LRNQT) 893026301    on    ----
ATINP                 893022101    off   ----
IDP A-Party Blacklist  893033201    on    ----
IDP A-Party Routing    893033301    on    ----
IDP Service Key Routing 893033601    on    ----
TIF Number Substitution 893022501    on    ----
MO SMS ASD            893026701    on    ----
MO SMS GRN            893026601    on    ----
GTT LS ARI            893027401    off   ----
GTT Action - DISCARD   893027501    on    ----
GTT Action - DUPLICATE 893027601    on    ----
GTT Action - FORWARD   893037501    on    ----
INP Circ Route Prevention 893028501    off   ----
TOBR Opcode Quantity   893027901    on    3
VGTT with 16 GTT lengths 893024801    on    ----
6-Way LS on Routesets  893019801    on    ----
ANSI41 AIQ            893034901    on    ----
Info Analyzed Relay Base 893034201    off   ----
Info Analyzed Relay NP   893026101    off   ----
Info Analyzed Relay ASD  893035001    off   ----
Info Analyzed Relay GRN  893035101    off   ----
MTPRTD GWS Stop Action  893035601    on    ----
TIF Subscr CgPN Blacklist 893037601    on    ----
TIF Range CgPN Blacklist 893037701    on    ----
Service Portability     893034301    on    ----
S-Port Sub Dfrntiation  893037901    off   ----
LOCREQ Query Response   893038501    off   ----
Integrated Measurements 893037301    off   ----
PC & CIC Translation    893037201    on    1000
XUDT UDT Conversion     893035301    on    ----
Integrated GLS          893038901    on    ----
NPP Unlimited SDWC Chars 893039301    off   ----
EPAP Data Split         893039801    on    ----
E5-ENET-B IPSPG High TPS 893039501    on    ----
S13/S13' Int for EIR    893042401    on    ----
Dual ExAP Config        893040501    on    ----
SIPNP                   893040601    on    ----
;

```

```
rtrv-ctrl-feat:partnum=893013201
```

```

rlghncxa03w 04-07-29 16:40:40 EST EAGLE 46.3.0
The following features have been permanently enabled:
Feature Name                Partnum      Status  Quantity
GSM Map Screening (GSM)     893013201   on      ----

```

If the part number specified in the `rtrv-ctrl-feat:partnum=` command is 893400001 for "EAGLE OA&M IP Security," an additional security warning section is displayed if any or all of the following conditions are met (and the output displays all applicable issues in a detailed warning section):

- The 893400001 FAK has Status=OFF, which suppresses non-secure protocol alarms
- The security default SSH option is set to "OFF"
- Any of the FTP servers have a Security setting of "OFF"

```
rtrv-ctrl-feat:partnum=893400001
```

```
rlghncxa03w 16-10-24 13:11:12 EST EAGLE 46.5.0.0.0-70.6.0
```

```
The following features have been enabled:
```

Feature Name	Partnum	Status	Quantity
EAGLE OA&M IP Security	893400001	off	----

```
*****
*****      WARNING IP SECURITY ISSUE DETECTED      *****
*****
** EAGLE OA&M IP Security FAK is not enabled and ON      **
** The SECU_DFLT parameter SSH is set to OFF              **
** One or more of the FTP servers has SECURITY parameter to OFF **
*****
```

```
;
```

### Related Topics

- [chg-ctrl-feat](#)
- [enable-ctrl-feat](#)

## rtrv-data-rtdb

This command retrieves data from the RTDB on an active Service Module card. If the `loc` parameter is specified and the target card is an active Service Module card, the RTDB data is retrieved from that card. If the `loc` parameter is not specified, the data is retrieved on the active Service Module card that has the lowest IMT address. The RTDB status on the active Service Module card can be coherent or incoherent.

For LNP database items (TN) all Service Module cards are queried for the existence of the specified item. Either the Service Module card specified by the `loc` parameter or the Service Module card with the lowest IMT address returns full item information. Any remaining Service Module cards return either COHERENT or INCOHERENT if the item is found in the RTDB on the card.

### Parameters

#### **dn (optional)**

Dialed Number.

#### **Range:**

5 - 15 digits

#### **entity (optional)**

Network Entity.

**Range:**  
1 - 15 digits

**entitytype (optional)**  
Entity Type.

**Range:**

**sp**  
Service Provider: Any 10-digit TN

**rn**  
Routing Number: Any 10-digit TN

**vmsid**  
Voice Mail Server ID: Any 1-15 digit hexadecimal number

**grn**  
Generic Routing Number: Any 1-15 digit hexadecimal number

**imei (optional)**  
International Mobile Equipment Identity.

**Range:**  
14 digits

**imsi (optional)**  
International Mobile Subscriber Identity.

**Range:**  
5 - 15 digits

**loc (optional)**  
The card location as stenciled on the shelf of the system.

**Range:**  
*1101 - 1108, 1111 - 1117, 1201 - 1208, 1211 - 1218, 1301 - 1308, 1311 - 1318, 2101 - 2108, 2111 - 2118, 2201 - 2208, 2211 - 2218, 2301 - 2308, 2311 - 2318, 3101 - 3108, 3111 - 3118, 3201 - 3208, 3211 - 3218, 3301 - 3308, 3311 - 3318, 4101 - 4108, 4111 - 4118, 4201 - 4208, 4211 - 4218, 4301 - 4308, 4311 - 4318, 5101 - 5108, 5111 - 5118, 5201 - 5208, 5211 - 5218, 5301 - 5308, 5311 - 5318, 6101 - 6108, 6111 - 6118*

**lrn (optional)**  
Location Routing Number.

**Range:**  
10 digits

**npanxx (optional)**  
Numbering Plan Area.

**Range:**  
6 digits

**tn (optional)**  
Telephone Number.



**Range:**  
10 digits

### Example

```
rtrv-data-rtdb:tn=9194663133
```

```
rtrv-data-rtdb:npanxx=919466
```

```
rtrv-data-lrn=9194460000
```

```
rtrv-data-rtdb:imsi=12345
```

```
rtrv-data-rtdb:dn=12345
```

```
rtrv-data-rtdb:entity=abcdefabcdefabc
```

Retrieve DN information from a specific Service Module card.

```
rtrv-data-rtdb:dn=19195554444:loc=1107
```

Retrieve entity data from a specific Service Module card.

```
rtrv-data-rtdb:entity=12345:loc=1107
```

### Dependencies

The specified card location must be equipped in the database.

At least one of the `imsi`, `dn`, `entity`, `imei`, `entitytype`, `npanxx`, `lrn`, or `tn` parameters must be specified.

Only one of the `tn`, `lrn`, or `npanxx` parameters can be specified in the command.

If the `npanxx`, `lrn`, or `tn` parameter is specified, the LNP ELAP Configuration feature must be on.

If the AINPQ, EIR, G-Flex, G-Port, INP, Prepaid IDP Relay Query, Prepaid SMS Intercept Ph1 (PPSMS), or V-Flex feature is turned on, or the ATINP feature is enabled, then the `imsi`, `dn`, `entity`, `imei`, or `entitytype` parameter must be specified.

If the `imsi` parameter is specified, then the G-Flex, EIR, or S13 feature must be turned on.

The G-Flex, G-Port, or V-Flex feature must be turned on, or the ATINP feature must be enabled before the `entity` parameter can be specified.

If the `entitytype` parameter is specified, the `entity` parameter must be specified.

If the `imei` parameter is specified, the EIR or S13 feature must be turned on.

The destination specified by the `loc` parameter must correspond to a Service Module card running the VSCCP application.

The destination specified by the `loc` parameter must correspond to a Service Module card that is IS-NR.

A primary Service Module card must be provisioned.

An EPAP-related feature must be turned on before the `entity`, `entitytype`, or `dn` parameter can be specified.

The value specified by the `loc` parameter must indicate a DN or IMSI card before the `dn` or `imsi` parameter can be specified, respectively.

### Notes

For DN and DN Block entries, whichever entity is provisioned in the order of SP/RN, VMSID, GRN, will become EntIdx1.

MTT 2376 DELETED. M Buckland

### Output



#### Note:

A value of "---" in the TT column indicates that the service does not have a translation type defined in the EAGLE and that call processing will ignore the override data displayed.

This example retrieves LRN Data:

```
rtrv-data-rtdb:lrn=1111111111
```

```
tekelecstp 09-08-30 15:23:45 EST EAGLE 41.1.0
Card Loc      : 1103   Status:Coherent
Card Loc: 1103
LRN           SP
1111111111   tklc

SERV  TT  XLAT  RI  PCA          SSN  NGT  RGTA
CLASS 10  DPCSSN GT    002-002-002  2   ---  yes
WMSMC 11  DPCSSN SSN    010-010-010 10   ---  no
```

```
;
```

This example retrieves NPANXX Data:

```
rtrv-data-rtdb:npnaxx=919225
```

```
tekelecstp 09-08-30 15:37:36 EST EAGLE 41.1.0

Card Loc      : 1103   Status:Coherent
Card Loc: 1103
      NPANXX MR  LRN
      919225 yes yes LA  LI
SERV  TT  XLAT  RI  PCA          SSN  NGT  RGTA
AIN   ---  DPC   GT  -----  ---  ---  no
IN    ---  DPC   GT  -----  ---  ---  no
CLASS 10  DPCSSN SSN    007-007-007  7   ---  no
```

```
;
```

This example retrieves TN Data:

```
rtrv-data-rtdb:tn=9192252645
```

```
tekelecstp 09-08-30 15:38:56 EST EAGLE 41.1.0

Card Loc      : 1103   Status:Coherent
Card Loc: 1103
TN            SP      LRN            PTYPE
9192252645   tklc   1111111111  none  LA LI

SERV  TT  XLAT  RI  PCA            SSN  NGT  RGTA
LIDB  --- DPCSSN SSN   003-003-003  3    --- no
ISVM  --- DPCSSN SSN   004-004-004  4    --- no
```

```
;
```

This example retrieves IMSI Data:

```
rtrv-data-rtdb:imsi=12345
```

```
tekelecstp 08-05-11 07:55:28 EST EAGLE5 39.0.0
Card Loc      : 1105   Status : Coherent
  IMSI                EntIdx          IMEI Index
  12345                H'00000002      H'00000006

Entity Address  Type PC(NATL-gg) RI  SSN TT  NP NAI DA
abcdef123456abc SP   02000          SSN 122 000 00 000 prefix

SRFIMSI                NSSN  CCGT  NTT  NNP  NNAI
1234567890abcde yes   no   no   no   no

IMEI                VERSION  BLACK  GRAY  WHITE
12345678901234      0      yes   yes   yes
```

```
;
```

This example retrieves Entity data:

```
rtrv-data-rtdb:entity=abcdef123456abc
```

```
tekelecstp 09-08-30 07:53:00 EST EAGLE5 41.1.0

INFO: Default value of Entity Type is : SP
;
```

```
tekelecstp 06-03-30 07:53:00 EST EAGLE5 35.0.0

Card Loc      : 1105   Status : Coherent

Entity Address  Type PC(NATL-gg) RI  SSN TT  NP NAI DA
SRFIMSI
  abcdef123456abc SP   02000          SSN 122 000 00 000 prefix
1234567890abcde
```

```

NSSN  CCGT  NTT  NNP  NNAI
yes   no   no   no   no

```

;

This example retrieves IMEI data:

```
rtrv-data-rtdb:imei=12345678abcdef
```

```
tekelecstp 06-03-30 07:54:55 EST EAGLE5 35.0.0
```

```
Card Loc      : 1105   Status : Coherent
```

```

IMEI          VERSION  BLACK  GRAY  WHITE
12345678abcdef      0    yes   no   yes

```

;

This example retrieves data for a DN associated with two NEs:

```
rtrv-data-rtdb:dn=1111111111111111
```

```
tekelecstp 08-08-11 07:56:48 EST EAGLE5 39.1.0
```

```

Card Loc      : 1103   Status:Coherent
DN            Portability Type (255)
1111111111111111   No portability type

```

```

EntIdx1      EntIdx2
H'00000007   H'00000005

```

```

Entity Address  Type      PC(INTL  ) RI  SSN TT  NP  NAI  DA
bcda4321       RN         5-005-5   GT  000 000 00 000 none

```

```

SRFIMSI          NSSN  CCGT  NTT  NNP  NNAI
                  no   no   no   no   no

```

```

Entity Address  Type      PC(ANSI  ) RI  SSN TT  NP  NAI  DA
abcd1234       VMSID   -----  GT  000 000 00 000 none

```

```

SRFIMSI          NSSN  CCGT  NTT  NNP  NNAI
                  no   no   no   no   no

```

```
ASD Address: 1234567890
```

;

This example retrieves DN data from a specific Service Module card:

```
rtrv-data-rtdb:dn=19195554444:loc=1107
```

```
tekelecstp 08-08-26 14:03:15 EST EAGLE5 39.1.0
```

```
Card Loc      : 1107   Status:Coherent
  DN          : 19195554444   Portability Type ( 1)   Entity Index
  19195554444   Own Number ported out   H'0000513d

Entity Address Type   PC(ANSI  ) RI  SSN TT  NP NAI DA
1234           RN   -----  GT  000 000 00 000 none

SRFIMSI       NSSN  CCGT  NTT  NNP  NNAI
              no   no   no   no   no
```

```
ASD Address: 1234567890
```

```
;
```

This example retrieves DN data associated with one NE:

```
rtrv-data-rtdb:dn=12345
```

```
tekelecstp 08-08-18 07:56:48 EST EAGLE5 39.1.0
```

```
Card Loc      : 1101   Status:Coherent
  DN          : 12345   Portability Type (255)
  12345       No portability type
```

```
EntIdx1      EntIdx2
-----      -----
```

```
ASD Address: 1234567890
```

```
;
```

This example retrieves DN data when the data is non-ported:

```
rtrv-data-rtdb:dn=d1000
```

```
tklcl090203 08-10-20 10:57:33 EST EAGLE 40.0.0
```

```
Card Loc      : 1215   Status:Coherent
  DN          : d1000   Portability Type ( 36)
  d1000       Not Identified to be ported
```

```
EntIdx1      EntIdx2
-----      -----
```

```
ASD Address: abcd0
```

```
;
```

This example retrieves data for a DN associated with one NE, one ASD and one NS:

```
rtrv-data-rtdb:dn=2324567893
```

```
tekelecstp 09-04-11 07:56:48 EST EAGLE5 41.0.0

Card Loc      : 1103   Status:Coherent
DN            : 2324567893   Portability Type (255)   Category
                No portability type   Private

EntIdx
H'00000007

Entity Address Type      PC(INTL ) RI  SSN TT  NP NAI DA
bcda4321      RN        5-005-5   GT  000 000 00 000 none

SRFIMSI      NSSN  CCGT  NTT  NNP  NNAI
                no   no   no   no   no

ASD Address: 1234567890

NS Address      NS Category
2312457895     Public

;
```

This example retrieves data for a non-ported DN associated with one ASD and one NS:

```
rtrv-data-rtdb:dn=1347823456
```

```
tekelecstp 09-04-11 07:56:48 EST EAGLE5 41.0.0

Card Loc      : 1105   Status:Coherent
DN            : 1347823456   Portability Type ( 36)   Category
                Not Identified to be ported   Public

EntIdx
-----

ASD Address: 1234545367

NS Address      NS Category
1345692324     Private

;
```

This example retrieves data for a DN located in a non-ranged entry and listed as an A-Party Blacklisted private number:

```
rtrv-data-rtdb:dn=123456
```

```
tekelecstp 09-06-18 07:56:48 EST EAGLE5 41.1.0
```

```

Card Loc      : 1101   Status:Coherent
  DN
  123456
                                Portability Type (255)
                                No portability type
                                Category
                                Private
                                A-Pty Blk

```

This example retrieves data for a DN located in a ranged entry and listed as an A-Party Blacklisted public number:

```
rtrv-data-rtdb:dn=123456
```

```
tekelecstp 09-06-18 07:56:48 EST EAGLE5 41.1.0
```

```

Card Loc      : 1101   Status:Coherent
  BEG DNBLK    END DNBLK    Portability Type (255)
Category
  112233        4455667      No portability type
Public
Pty Blk

```

A-

This example retrieves NPANXX split data:

```
rtrv-data-rtdb:npanxx=919111
```

```
tekelecstp 09-08-30 15:37:36 EST EAGLE 41.1.0
```

```

Card Loc      : 1103   Status:Coherent
Card Loc: 1103
  NPANXX MR   LRN
OLD 919111 yes no  LA  LI
NEW 918111 yes yes LA  LI

```

```

Default Data
SERV  TT  XLAT  RI  PCA          SSN  NGT  RGTA
LIDB  --- DPC   GT   001-001-001  ---  ---  no

```

```
;
```

## Legend

- **Card Loc**—Location of the card that contains the retrieved information
- **Status**—RTDB database status; Coherent or Incoherent
- **IMSI**—International Mobile Subscriber Identity
- **EntIdx, EntIdx1, EntIdx2**—Hexadecimal index where the Network Entity data is stored in the Entity Bucket on the Service Module card
- **IMEI Index**—Hexadecimal index at which the IMEI data is stored in the IMEI Bucket on the Service Module card or S13 card running DEIRHC GPL.
- **Entity Address**—Hexadecimal Network Entity address

- Type—Network Entity type; Service Provider (SP), Routing Number (RN), Voice Mail Server ID (VMSID) or Generic Routing Number (GRN)
- **PC** (*type of PC*)—Point code and type of point code (ANSI; NATL - ITU National with or without group code (-gg))
- **RI**—Routing Indicator
- **SSN**—Subsystem Number
- **TT**—Translation Type
- **NP**—Numbering Plan
- **DA**—Digits action (Prefix, Suffix, or none)
- **SRFIMSI**—Signaling Relay Function IMSI
- **IMSI**—International Mobile Subscriber Identity.
- **NSSN**—New Subsystem Number (yes or no)
- **CCGT**—Cancel GT (yes or no)
- **NTT**—New Translation Type
- **NNP**—New Numbering Plan
- **NNAI**—New Nature of Address Indicator.
- **IMEI**—International Mobile Equipment Identity
- **VERSION**—IMEI data version
- **BLACK, WHITE, GRAY**—Equipment Identity Register search lists
- **DN**—Dialed Number
- **ASD Address**—Additional Subscriber Data address
- **Portability Type** (*number*)—
  - 0—Not known to be ported
  - 1—Own number ported out
  - 2—Foreign number ported to Foreign network
  - 3—Prepaid Short Message Service (PPSMS) subscriber on server #1
  - 4—PPSMS subscriber on server #2
  - 5—IS41 to GSM migrated subscriber with only GSM handset active
  - 6—PPSMS subscriber on server #3
  - 7—PPSMS subscriber on server #4
  - 8—PPSMS subscriber on server #5
  - 9—PPSMS subscriber on server #6
  - 10—PPSMS subscriber on server #7
  - 11—PPSMS subscriber on server #8
  - 12—PPSMS subscriber on server #9
  - 13—PPSMS subscriber on server #10
  - 14—PPSMS subscriber on server #11
  - 15—PPSMS subscriber on server #12



- 16—PPSMS subscriber on server #13
  - 17—PPSMS subscriber on server #14
  - 18—PPSMSsubscriber on server #15
  - 19—PPSMS subscriber on server #16
  - 20—PPSMS subscriber on server #17
  - 21—PPSMS subscriber on server #18
  - 22—PPSMS subscriber on server #19
  - 23—PPSMS subscriber on server #20
  - 24—PPSMS subscriber on server #21
  - 25—PPSMS subscriber on server #22
  - 26—PPSMS subscriber on server #23
  - 27—PPSMS subscriber on server #24
  - 28—PPSMS subscriber on server #25
  - 29—PPSMS subscriber on server #26
  - 30—PPSMS subscriber on server #27
  - 31—PPSMS subscriber on server #28
  - 32—PPSMS subscriber on server #29
  - 33—PPSMS subscriber on server #30
  - 34—PPSMS subscriber on server #31
  - 35—PPSMS subscriber on server #32
  - 36—Not Identified to be ported
  - 255—No portability type
- **NS Address**—Address of the associated DN, used for Number Substitution
  - **NS Category**—Category of the associated DN, used for Number Substitution
  - **NPA**—Number Planning Area (Area Code)
  - **NXX**—Exchange Code

## rtrv-dconn

Use this command to retrieve Diameter connection entries. The DCONN table supports the provisioning information related to the diameter connections.

### Parameters

#### **aname (optional)**

Association name configured in the association table and linked with a diameter connection.

#### **Range:**

ayyyyyyyyyyyyyyy

A string of alphanumeric characters, beginning with a letter and up to 15 characters in length. Valid values are a..z, A..Z, 0..9.

**Default:**

No change to the current value

**System Default:**

*null*

**dcname (optional)**

Diameter connection name. This parameter specifies the unique logical name assigned to each diameter connection.

**Range:**

aaaaaaaaaaaaaaaa

A string of alphanumeric characters, beginning with a letter and up to 15 characters in length. Valid values are a..z, A..Z, 0..9.

**Default:**

No change to the current value

**System Default:**

*null*

**loc (optional)**

The card location as stenciled on the shelf of the system.

**Range:**

1101 - 1108, 1111 - 1112, 1201 - 1208, 1211 - 1218, 1301 - 1308, 2101 - 2108, 2111 - 2118, 2201 - 2208, 2211 - 2218, 2301 - 2308, 2311 - 2318, 3101 - 3108, 3111 - 3118, 3201 - 3208, 3211 - 3218, 3301 - 3308, 3311 - 3318, 4101 - 4108, 4111 - 4118, 4201 - 4208, 4211 - 4218, 4301 - 4308, 4311 - 4318, 5101 - 5108, 5111 - 5118, 5201 - 5208, 5211 - 5218, 5301 - 5308, 5311 - 5318, 6101 - 6108, 6111 - 6118

**Example**

```
rtrv-dconn
rtrv-dconn:dcname=connection1
rtrv-dconn:aname=assoc12d
rtrv-dconn:loc=1103
```

**Dependencies**

The S13/S13' EIR feature must be enabled before retrieving any diameter connection entry.

The DCONN table should be accessible.

The specified card location must be equipped.

A DEIR card must be present at the specified location.

DCNAME must be present in DCONN table.

The value specified for the ANAME parameter must be present in the IPAPSOCK table and referred by a diameter connection.

Multiple combinations of optional parameters are not allowed.

### Notes

Multiple combinations of optional parameters are not allowed.

If optional parameters are specified, only the entries that match the entered parameters are displayed.

### Output

This example displays output when no parameter is specified:

```
rtrv-dconn

tekelecstp 14-03-21 02:59:22 EAGLE 46.0.0 65.11.0
rtrv-dconn
Command entered at terminal #19.
;

Command Accepted - Processing
tekelecstp 14-03-21 02:59:22 MST EAGLE 46.0.0 65.11.0

DCNAME          ANAME          LOC   RSVDTPS  MAXTPS  Tw(s)
Td(s)
-----
d1              a1              1101  250      8000    6      3
d2              a2              1101  250      8000    6      3
d31             a31             1101  250      8000    6      3
d41             a41             1101  250      8000    6      3
d3              a3              1101  250      8000    6      3
d4              a4              1101  250      8000    6      3
dd10            aa10            1101  250      8000    6      3
b1              b1              1103  250      8000    6      3
b2              b2              1103  250      8000    6      3
b31             b31             1103  250      8000    6      3
b41             b41             1103  250      8000    6      3
b3              b3              1103  250      8000    6      3
b4              b4              1103  1500    8000    7      5
b10             b10             1103  250      8000    6      3
aasw234edf56tgr x1              1105  250      8000    6
3

DCONN table is (15 of 512) 3% full.
;
```

This example displays output when the DCNAME parameter is specified:

```
rtrv-dconn:dcname=d1

tekelecstp 14-03-21 03:01:22 MST EAGLE 46.0.0 65.11.0
rtrv-dconn:dcname=d1
```

```

Command entered at terminal #19.
;

Command Accepted - Processing
tekelecstp 14-03-21 03:01:22 MST EAGLE 46.0.0 65.11.0

DCNAME          ANAME          LOC   RSVDTPS   MAXTPS   Tw(s)   Td(s)
-----
d1              a1              1101  250       8000     6        3
;

```

This example displays output when the ANAME parameter is specified:

```
rtrv-dconn:aname=a1
```

```

tekelecstp 14-03-21 03:03:24 MST EAGLE 46.0.0 65.11.0
rtrv-dconn:aname=a1
Command entered at terminal #19.
;

```

```

Command Accepted - Processing
tekelecstp 14-03-21 03:03:24 MST EAGLE 46.0.0 65.11.0

DCNAME          ANAME          LOC   RSVDTPS   MAXTPS   Tw(s)   Td(s)
-----
d1              a1              1101  250       8000     6        3

```

This example displays output when the LOC parameter is specified:

```
rtrv-dconn:loc=1101
```

```

tekelecstp 14-03-21 03:06:01 MST EAGLE 46.0.0-65.11.0
rtrv-dconn:loc=1101
Command entered at terminal #19.
;

```

```

Command Accepted - Processing
tekelecstp 14-03-21 03:06:01 MST EAGLE 46.0.0-65.11.0

DCNAME          ANAME          LOC   RSVDTPS   MAXTPS   Tw(s)   Td(s)
-----
d1              a1              1101  250       8000     6        3
d2              a2              1101  250       8000     6        3
d31             a31             1101  250       8000     6        3
d41             a41             1101  250       8000     6        3
d3              a3              1101  250       8000     6        3
d4              a4              1101  250       8000     6        3

```

```
dd10          aa10          1101  250          8000   6          3
```

```
DCONN table is (15 of 512) 3% full.
```

```
;
```

### Legend

This section defines the fields used in the `rtrv-dconn` command output:

- **DCNAME** --- Diameter connection name.
- **ANAME** --- Association name configured in IPAPSOCK table which is associated with the diameter connection.
- **LOC** --- Specifies the DEIR card location on which the particular diameter connection is configured.
- **RSVDTPS** --- This (Reserved TPS) is the guaranteed TPS for a diameter connection.
- **MAXTPS** --- This is the maximum TPS for a diameter connection.
- **Tw** --- This (Diameter Watchdog Timer) timer is used to control how long the S13 process will wait for a DWA (Diameter Watchdog Answer) response before sending a DWR (Diameter Watchdog Request).
- **Td** --- This (Diameter Peer Disconnect Timer) is used to control how long the S13 process will wait for a DPA (Disconnect Peer Answer) response before sending a DPR (Disconnect Peer Request).

### Related Topics

- [chg-dconn](#)
- [dlt-dconn](#)
- [ent-dconn](#)

## rtrv-deiropts

Use this command to retrieve S13/S13' diameter EIR configuration options.

### Parameters

This command has no input parameters.

### Example

```
rtrv-deiropts
```

### Dependencies

The S13/S13' EIR Feature must be enabled before retrieving Diameter EIR configuration options.

The DEIROPTS table should be accessible.

### Output

This example shows output with default DEIR options.

```
rtrv-deiropts
```

```
tekelecstp 13-03-16 11:43:52 EST EAGLE 45.1
rtrv-deiropts
Command entered at terminal #4.
  DEIRGRSP      = off          DEIRRSPTYPE    = type1
  DEIRIMSICHK   = off          CONGERR        = 3004
  VENDID        = 0           APPLID         = 16777252
  PRODUCT       = none        DPR Cause      = Do not want to
talk(2)
  DEIRIMSISCRN  = off          DEIRLOGWL     = off
  DEIRDFLTIMSISCRN = off      DEIRDFLTIMSILKUP = range
  DEIRDFLTIMSIRESP = whitelist
```

This example shows output with provisioned DEIR options.

```
rtrv-deiropts
```

```
tekelecstp 13-03-16 11:43:52 EST EAGLE 45.1
rtrv-deiropts
Command entered at terminal #4.
  DEIRGRSP      = off          DEIRRSPTYPE    = type1
  DEIRIMSICHK   = off          CONGERR        = 3004
  VENDID        = 4004        APPLID         = 16777252
  PRODUCT       = abc         DPR Cause      = Busy(1)
  DEIRIMSISCRN  = off          DEIRLOGWL     = off
  DEIRDFLTIMSISCRN = off      DEIRDFLTIMSILKUP = both
  DEIRDFLTIMSIRESP = blacklist
```

### Legend

- **DEIRGRSP** -- S13/S13' EIR Global Response Type. The Global Response Type is used to override the response that is sent back to the MME.
- **DEIRRSPTYPE** -- S13/S13' EIR Response Type. The Response Type is used to determine how the lists are to be searched.
- **DEIRIMSICHK** -- Indicates whether IMSI will be used when determining if an IMEI is to be "black" listed or not.
- **CONGERR** -- It displays the diameter response to be sent by DEIRHC card at the time of card congestion.
- **VENDID** -- S13 local Vendor ID. All the outgoing messages that require Vendor ID in Vendor-Specific-Application-ID AVP will use this configured value.
- **APPLID** -- Authentication Application ID. The application ID configured should match with the Auth-Application-Id (AVP Code 258) value in Vendor-Specific-Application-ID AVP. This application ID is fixed and cannot be changed.
- **PRODUCT** -- It contains the vendor-assigned name for the product. All the outgoing messages that require Product name AVP will use this configured value.
- **DPR Cause** -- It is a Disconnect Cause in DPR (Disconnect Peer Request) message sent by the DEIRHC card.

- **DEIRIMSISCRN** -- Indicates whether the IMSI Screening for Diameter Equipment Identity Register (EIR) will be done before the IMEI check.
- **DEIRLOGWL** -- Indicates whether the white list logging for Diameter Equipment Identity Register (EIR) will be on.
- **DEIRDFLTIMSISCRN** -- Indicates whether the default IMSI Screening for Diameter Equipment Identity Register (EIR) will be on.
- **DEIRDFLTIMSILKUP** -- Indicates the order of IMEI table lookup for default IMSI screening.
- **DEIRDFLTIMSIRESP** -- Indicates the default IMEI status for default IMSI screening.

### Related Topics

- [chg-deiropts](#)

## rtrv-dlk

Use this command to show the parameters of a TCP/IP data link.

### Parameters

#### **ipaddr (optional)**

The TCP/IP data link's IP address. This is a TCP/IP address expressed in standard dot notation. IP addresses consist of the system's network number and the machine's unique host number. An example IP address is 192.126.100.5, where *192.126.100* is the network number and *5* is the machine's host number.

#### **Range:**

*1-223, 0-255*  
4 numbers separated by dots  
*1-223*—first number  
*0-255*—the other three numbers

#### **Default:**

Display all.

#### **loc (optional)**

The card location as stenciled on the shelf of the system.

#### **Range:**

*1101 - 1108, 1111 - 1112, 1201 - 1208, 1211 - 1218, 1301 - 1308, 1311 - 1318, 2101 - 2108, 2111 - 2118, 2201 - 2208, 2211 - 2218, 2301 - 2308, 2311 - 2318, 3101 - 3108, 3111 - 3118, 3201 - 3208, 3211 - 3218, 3301 - 3308, 3311 - 3318, 4101 - 4108, 4111 - 4118, 4201 - 4208, 4211 - 4218, 4301 - 4308, 4311 - 4318, 5101 - 5108, 5111 - 5118, 5201 - 5208, 5211 - 5218, 5301 - 5308, 5311 - 5318, 6101 - 6108, 6111 - 6118*

#### **Default:**

All TCP/IP data links are shown.

### Example

```
rtrv-dlk
```

```
rtrv-dlk:loc=1201
```

```
rtrv-dlk:ipaddr=193.4.201.34
```

### Dependencies

The `loc` and `ipaddr` parameters cannot be specified in the same command.

The shelf and card must be equipped.

The specified card must have a TCP/IP data link assigned to it.

### Notes

None

### Output

In this example, cards at locations 1201 and 1203 are E5-ENET-B cards running the STPLAN application. For these cards, the value of the `auto` parameter is defaulted to `no`, and the value of the `duplex` parameter is defaulted to `half`.

The cards at locations 1101, 1103 and 1107 are E5-ENET-B cards running the STPLAN application. For these cards, if the `auto=yes` parameter is specified, then the values of `speed` and `duplex` parameters are not shown.

```
rtrv-dlk
```

```
tekelecstp 07-02-06 11:12:47 EST EAGLE 37.0.0
LOC  IPADDR          LINK SPEED  DUPLEX  AUTO
1101 192.168.63.34    100Mbit  FULL    NO
1103 192.168.63.11    10Mbit   HALF    NO
1107 192.168.63.12    -----  ----    YES
1201 192.168.63.13    10Mbit   HALF    NO
1203 192.168.63.14    10Mbit   HALF    NO
```

```
;
```

```
rtrv-dlk:loc=1101
```

```
tekelecstp 07-02-01 14:09:13 EST EAGLE 37.0.0
LOC  IPADDR          LINK SPEED  DUPLEX  AUTO
1101 192.168.63.34    100Mbit  FULL    NO
```

```
;
```

```
rtrv-dlk:ipaddr=192.168.63.11
```

```
tekelecstp 07-02-01 14:19:14 EST EAGLE 37.0.0
LOC  IPADDR          LINK SPEED  DUPLEX  AUTO
1103 192.168.63.11    10Mbit   HALF    NO
```

```
;
```

This example shows the output when the specified IP address is not assigned to a TCP/IP data link:



```
rtrv-dlk:ipaddr=193.4.201.28
```

```
tekelecstp 07-02-01 14:19:14 EST EAGLE 37.0.0
LOC IPADDR LINK SPEED DUPLEX AUTO
IPADDR not assigned to a TCP/IP Link.
;
```

This example shows the output when there are no TCP/IP data links in the database.

```
rtrv-dlk
```

```
tekelecstp 07-02-02 14:19:14 EST EAGLE 37.0.0
LOC IPADDR LINK SPEED DUPLEX AUTO
No TCP/IP Links are defined in the database.
;
```

This example shows the output when the specified IP address is assigned to a TCP/IP node instead of a TCP/IP data link:

```
rtrv-dlk:ipaddr=193.4.201.63
```

```
tekelecstp 07-02-01 12:12:10 EST EAGLE 37.0.0
LOC IPADDR LINK SPEED DUPLEX AUTO
IPADDR assigned to a TCP/IP Node.
;
```

### Legend

- **IPADDR**—IP address associated with the interface on the data link
- **LOC**—Card location containing the data link
- **LINK SPEED**—Bandwidth for the interface in megabits per second, **10** or **100**
- **AUTO**—Whether or not to automatically determine duplex and speed. If the value is *yes*, then duplex and speed are automatically determined. If the value is *no*, then duplex and speed are not automatically determined.
- **DUPLEX**—Mode of operation of the interface

### Related Topics

- [act-dlk](#)
- [canc-dlk](#)
- [dlt-dlk](#)
- [ent-dlk](#)
- [rept-stat-dlk](#)
- [tst-dlk](#)

## rtrv-dstn

Use this command to show the destination point code entries in the Destination point code table.

### Parameters



#### Note:

See [Point Code Formats and Conversion](#) for a detailed description of point code formats, rules for specification, and examples.

#### **aliasa (optional)**

ANSI alias point code with subfields *network indicator-network cluster-network cluster member (ni-nc-ncm)*.

##### **Range:**

0-255, \*

Specify a valid value for each subfield of the point code, and separate the subfields with a dash (-).

The asterisk (\*) value is not valid for the *ni* subfield.

When *chg-sid:pctype=ansi* is specified, *ni=000* is not valid.

When *chg-sid:pctype=ansi* is specified, *nc = 000* is not valid if *ni=001-005*.

When *chg-sid:pctype=ansi* is specified, *nc=000* is valid if *ni=006-255*.

When *chg-sid:pctype=ansi* is specified, *ni-\*.\** is valid if *ni =006-255*.

The point code *000-000-000* is not a valid point code.

#### **aliasa/aliasi/aliasn/aliasn24/aliasn16 (optional)**

Alias point code.

#### **aliasi (optional)**

ITU international alias point code with subfields *zone-area-id*. The *prefix* subfield indicates a spare point code (*prefix-zone-area-id*). If this parameter is specified with an ITU international destination (*dpci*) point code, the prefix subfields cannot be the same, i.e., both spare or both non-spare.

If an ITU international destination (*dpci*) point code is entered, then the *dpci* and *aliasi prefix* subfields cannot be the same (both spare or both non-spare). Up to 2 comma-delimited entries can be entered in the point code list.

##### **Range:**

s-, 0-255

Specify a valid value for each subfield of the point code, and separate the subfields with a dash (-).

*prefix*—s

*zone*—0-7

*area*—000-255

*id*—0-7

The point code *0-000-0* is not a valid point code.

**aliasn (optional)**

ITU national alias point code in the format of a 5-digit number (*nnnnn*); or 2, 3, or 4 numbers (members) separated by dashes (*m1-m2-m3-m4*) as defined by the `chg-stpopts:npcfmti` flexible point code option. A group code must be specified when the ITUDUPPC feature is turned on (*nnnnn-gc*, *m1-m2-m3-m4-gc*). The *prefix* subfield indicates a spare point code (*prefix-nnnnn*, *prefix-nnnnn-gc*, *prefix-m1-m2-m3-m4*, *prefix-m1-m2-m3-m4-gc*). If this parameter is specified with an ITU national destination (*dpcn*) point code, the prefix subfields cannot be the same, i.e., both spare or both non-spare.

If an ITU national destination (*dpcn*) point code is entered, then the *dpcn* and *aliasn* *prefix* subfields cannot be the same (both spare or both non-spare). Up to 2 comma-delimited entries can be entered in the point code list.

**Range:**

*s*-, 0-16383, *aa-zz*

Specify a valid value for each subfield of the point code, and separate the subfields with a dash (-).

*prefix*—*s*-

*nnnnn*—0-16383

*gc*—*aa-zz*

*m1-m2-m3-m4*—0-14 for each member; values must sum to 14

**aliasn24 (optional)**

24-bit ITU national destination point code with subfields *main signaling area-sub signaling area-signaling point* (*msa-ssa-sp*).

**Range:**

000-255

Specify a valid value for each subfield of the point code, and separate the subfields with a dash (-).

*msa*—000–255

*ssa*—000–255

*sp*—000–255

**aliasn16 (optional)**

16-bit ITU national point code with subfields *unit number-sub number area-main number area* (*un-sna-mna*).

**Range:**

000---127

Specify a valid value for each subfield of the point code, and separate the subfields with a dash (-).

*un*---000---127

*sna*---000---15

*mna*---000---31

**c11i (optional)**

Common Language Location Identifier. The Common Language Location Identifier assigned to the link.

**Range:**

ayyyyyyyyyy

1 alphabetic character followed by 10 alphanumeric characters

**Default:**

none

**dpc (optional)**ANSI destination point code with subfields *network indicator-network cluster-network cluster member (ni-nc-ncm)*. The *prefix* subfield indicates a private point code (*prefix-ni-nc-ncm*).**Synonym:**

dpca

**Range:**

p-, 000-255, \*, \*\*, \*\*\*

Specify a valid value for each subfield of the point code, and separate the subfields with a dash (-).

*prefix—p-*The asterisk values \*, \*\*, and \*\*\* are not valid for the *ni* subfield.If \*\* or \*\*\* is specified for the *nc* subfield, either \*, \*\*, or \*\*\* must be specified for the *ncm* subfield.When *chg-sid:pctype=ansi* is specified, *ni=000* is not valid.When *chg-sid:pctype=ansi* is specified, *nc=000* is not valid if *ni=001-005*.When *chg-sid:pctype=ansi* is specified, *nc=000* is valid if *ni=006-255*.When *chg-sid:pctype=ansi* is specified, *ni-\*.\** is valid if *ni= 006-255*.The point code *000-000-000* is not a valid point code.**dpc/dpca/dpci/dpcn/dpcn24/dpcn16 (optional)**

Destination point code.

**dpci (optional)**ITU international destination point code with subfields *zone-area-id*. The *prefix* subfield indicates a spare point code, private point code, or private and spare point code (*prefix-zone-area-id*).**Range:**

s-, p-, ps-, 0-255

Specify a valid value for each subfield of the point code, and separate the subfields with a dash (-).

*prefix—s-, p-, ps**zone—0-7**area—000-255**id—0-7*The point code *0-000-0* is not a valid point code.**dpcn (optional)**ITU national destination point code in the format of a 5-digit number (*nnnnn*); or 2, 3, or 4 numbers (members) separated by dashes (*m1-m2-m3-m4*) as defined by the *chg-stpopts:npcfmti* flexible point code option. A group code must be specified when the ITUDUPPC feature is turned on (*nnnnn-gc, m1-m2-m3-m4-gc*). The *prefix* subfield indicates a spare point code, private point code, or private and spare point code (*prefix-nnnnn, prefix-nnnnn-gc, prefix-m1-m2-m3-m4, prefix-m1-m2-m3-m4-gc*).

**Range:**

*s*-, *p*-, *ps*, 0-16383, *aa-zz*, \*

Specify a valid value for each subfield of the point code, and separate the subfields with a dash (-).

An asterisk (\*) can be specified for the node (*nnnnn* or every member of a flexible point code) or for the group code (*gc*) only when group codes are present in the point codes.

An asterisk (\*) can be specified either for the node or for the group code, but not both.

*prefix*—*s*-, *p*-, *ps*-

*nnnnn*—0-16383, \*

*gc*—*aa-zz*, \*

*m1-m2-m3-m4*—0-14 for each member; values must sum to 14; or *\*-\*-\** when the point code includes a group code.

**dpcn24 (optional)**

24-bit ITU national destination point code with subfields *main signaling area-sub signaling area-signaling point* (*msa-ssa-sp*). The *prefix* subfield indicates a private point code (*prefix-msa-ssa-sp*).

**Range:**

*p*-, 000-255

Specify a valid value for each subfield of the point code, and separate the subfields with a dash (-).

*prefix*—*p*

*msa*—000-255

*ssa*—000-255

*sp*—000-255

**dpcn16 (optional)**

16-bit ITU national point code with subfields *unit number-sub number area-main number area* (*un-sna-mna*). The *prefix* subfield indicates a private point code (*prefix-un-sna-mna*).

**Range:**

*p*--, 000---127

Specify a valid value for each subfield of the point code, and separate the subfields with a dash (-).

*prefix*---*p*

*un*---000---127

*sna*---000---15

*mna*---000---31

**homescp (optional)**

This parameter displays all destination point codes (DPCs) that have the internal Home SCP flag set to the specified value.

**Range:****yes**

the DPC is considered a Home SCP for messages with no Global Title Address Digits

**no**

the DPC is not considered a Home SCP for messages with no Global Title Address Digits

**homesmsc (optional)**

This parameter displays all destination point codes (DPCs) that have the internal Home SMSC flag set to the specified value.

**Range:****yes**

the DPC is considered a Home SMSC for messages with no Global Title Address Digits

**no**

the DPC is not considered a Home SMSC for messages with no Global Title Address Digits

**msar (optional)**

Memory space accounting report. When the NRT feature or the CRMD feature, or both, is turned on, this parameter specifies whether summary or detail destination table memory space accounting information is displayed. The *summary* or *detail* report appears following the destination information that is requested by entering the command with or without other parameters. The *only* parameter value displays a detail destination table memory space accounting report without any other destination information. If neither feature is on, only the summary report information is displayed; the detail report information cannot be displayed.

**Range:****detail****only****summary****Default:****detail**

if `rtrv-dstn` is entered with no parameters

**summary**

if `rtrv-dstn` is entered with parameters

**ncai (optional)**

Nested cluster allowed indicator. This parameter specifies whether the route to the cluster point code can be different for provisioned members of the cluster and whether clusters with nested cluster point codes, or clusters that do not allow nested cluster point codes are displayed.

**Range:**

***yes***

Display clusters with NCAI set to *yes*

***no***

Display clusters with the NCAI set to *no*

**nprst (optional)**

NM bits reset. This parameter displays all entries with the specified value of the `nprst` option.

**Range:**

***off***

Display entries with an NPRST value of *off*

***on***

Display entries with an NPRST value of *on*

**pcst (optional)**

Point code subtype. This parameter displays point codes with the specified subtype.

**Range:**

***none***

Display only point codes without subtype prefixes

***p***

Display only private point codes

***ps***

Display only private and spare point codes

***s***

Display only spare point codes

**pctype (optional)**

Point code domain. This parameter displays point codes of the specified domain type.

**Range:**

***ansi***

Display only ANSI point codes

***itui***

Display only ITU International point codes

***itun***

Display only ITU National point codes

***itun24***

Display only 24-bit ITU National point codes

***itun16***

Display only 16-bit ITU National point codes

**ppc (optional)**

ANSI proxy point code with subfields *network indicator-network cluster-network cluster member (ni-nc-ncm)*.

The proxy point code must be a full point code.

**Range:**

000-255

Specify a valid value for each subfield of the point code, and separate the subfields with a dash (-).

When `chg-sid:pctype=ansi` is specified, *ni = 000* is not valid.

When `chg-sid:pctype=ansi` is specified, *nc = 000* is not valid if *ni = 001-005*.

When `chg-sid:pctype=ansi` is specified, *nc = 000* is valid if *ni = 006-255*.

The point code *000-000-000* is not a valid point code.

**ppc/ppca/ppci/ppcn/ppcn24/ppcn16 (optional)**

Proxy Point Code.

The proxy point code must be a full point code.

**ppci (optional)**

ITU international proxy point code with subfields *zone-area-id*. The *prefix* subfield indicates a spare point code (*prefix-zone-area-id*).

**Range:**

s-, 0-255

Specify a valid value for each subfield of the point code, and separate the subfields with a dash (-).

*prefix*—s

*zone*—0-7

*area*—000-255

*id*—0-7

The point code *0-000-0* is not a valid point code.

**ppcn (optional)**

ITU national proxy point code in the format of a 5-digit number (*nnnnn*); or 2, 3, or 4 numbers (*members*) separated by dashes (*m1-m2-m3-m4*) as defined by the `chg-stpopts:npcfmti` flexible point code option. A group code must be specified when the ITUDUPPC feature is turned on (*nnnnn-gc*, *m1-m2-m3-m4-gc*). The *prefix* subfield indicates a spare point code (*prefix-nnnnn*, *prefix-nnnnn-gc*, *prefix-m1-m2-m3-m4*, *prefix-m1-m2-m3-m4-gc*).

**Range:**

s-, 0-16383, aa-zz

Specify a valid value for each subfield of the point code, and separate the subfields with a dash (-).

*prefix*—s-

*nnnnn*—0-16383

*gc*—aa-zz

*m1-m2-m3-m4*—0-14 for each member; values must sum to 14

**ppcn24 (optional)**

24-bit ITU national point code with subfields *main signaling area-sub signaling area-signaling point (msa-ssa-sp)*.



**Range:***000-255*

Specify a valid value for each subfield of the point code, and separate the subfields with a dash (-).

*msa—000–255**ssa—000–255**sp—000–255***ppcn16 (optional)**16-bit ITU national point code with subfields *unit number-sub number area-main number area (un-sna-mna)*.**Range:***000---127*

Specify a valid value for each subfield of the point code, and separate the subfields with a dash (-).

*un---000---127**sna---000---15**mna---000---31***prx (optional)**

Proxy point code indicator.

**Range:****yes**

Will be used as a proxy point code

**no**

Will not be used a proxy point code.

**sccpmsgcnv (optional)**

SCCP UDT(S)/XUDT(S) Message Conversion Indicator. The type of conversion performed on messages for the specified destination.

**Range:****none**

conversion is not required on messages for the destination

**udt2xudt**

convert all UDT(S) messages for the destination to XUDT(S) messages

**xudt2udt**

convert all non-segmented XUDT(S) messages for the destination to UDT(S) messages

**sxudt2udt**

convert all segmented and non-segmented XUDT(S) messages for the destination to UDT(S) messages

**spc (optional)**

ANSI secondary point code with subfields *network indicator-network cluster-network cluster member (ni-nc-ncm)*. The *prefix* subfield indicates a private point code (*prefix-ni-nc-ncm*).

**Synonym:**

*spca*

**Range:**

*p-*, 000-255

Specify a valid value for each subfield of the point code, and separate the subfields with a dash (-).

*prefix—p-*

When *chg-sid:pctype=ansi* is specified, *ni = 000* is not valid.

When *chg-sid:pctype=ansi* is specified, *nc = 000* is not valid if *ni = 001-005*.

When *chg-sid:pctype=ansi* is specified, *nc = 000* is valid if *ni = 006-255*.

The point code *000-000-000* is not a valid point code.

**spc/spca/spci/spcn/spcn24/spcn16 (optional)**

Secondary point code.

**spci (optional)**

ITU international secondary point code with subfields *zone-area-id*. The *prefix* subfield indicates a spare point code, private point code, or private and spare point code (*prefix-zone-area-id*).

**Range:**

*s-*, *p-*, *ps-*, 0-255

Specify a valid value for each subfield of the point code, and separate the subfields with a dash (-).

*prefix—s-*, *p-*, *ps*

*zone—0-7*

*area—000-255*

*id—0-7*

The point code *0-000-0* is not a valid point code.

**spcn (optional)**

ITU national secondary point code in the format of a 5-digit number (*nnnnn*); or 2, 3, or 4 numbers (members) separated by dashes (*m1-m2-m3-m4*) as defined by the *chg-stpopts:npcfmti* flexible point code option. A group code must be specified when the ITUDUPPC feature is turned on (*nnnnn-gc*, *m1-m2-m3-m4-gc*). The *prefix* subfield indicates a spare point code, private point code, or private and spare point code (*prefix-nnnnn*, *prefix-nnnnn-gc*, *prefix-m1-m2-m3-m4*, *prefix-m1-m2-m3-m4-gc*).

**Range:**

*s-*, *p-*, *ps-*, 0-16383, *aa-zz*

Specify a valid value for each subfield of the point code, and separate the subfields with a dash (-).

*prefix—s-*, *p-*, *ps*

*nnnnn—0-16383*

*gc—aa-zz*

*m1-m2-m3-m4—0-14* for each member; values must sum to 14

**spcn24 (optional)**

24-bit ITU national secondary point code with subfields *main signaling area-sub signaling area-signaling point (msa-ssa-sp)*. The *prefix* subfield indicates a private point code (*prefix-msa-ssa-sp*).

**Range:**

*p-*, 000-255

Specify a valid value for each subfield of the point code, and separate the subfields with a dash (-).

*prefix—p*

*msa—000—255*

*ssa—000—255*

*sp—000—255*

**spcn16 (optional)**

16-bit ITU national point code with subfields *unit number-sub number area-main number area (un-sna-mna)*. The *prefix* subfield indicates a private point code (*prefix-un-sna-mna*).

**Range:**

*p--*, 000---127

Specify a valid value for each subfield of the point code, and separate the subfields with a dash (-).

*prefix---p*

*un---000---127*

*sna---000---15*

*mna---000---31*

**splitiam (optional)**

IAM/SAM split. This parameter displays all entries with the specified `splitiam` parameter value.

**Range:**

15 - 31, none

**Example**

This example displays all encountered destination point codes that are members of network cluster 20-2 as well as the cluster address:

```
rtrv-dstn:dpca=20-2-***
```

This example displays the destination with an ANSI alias of 222-200-200:

```
rtrv-dstn:aliasa=222-200-200
```

This example displays all encountered ANSI alias destination point codes that have a network indicator of 222 and a network cluster of 200:

```
rtrv-dstn:aliasa=222-200-**
```

This example displays the destination with a CLLI of rlghncbb001:

```
rtrv-dstn:clli=rlghncbb001
```

This example displays the secondary point code 6:

```
rtrv-dstn:spc=6-6-6
```

This example displays a single cluster (the NRT feature must be turned on):

```
rtrv-dstn:dpc=010-*-*
```

This example displays a single ITU national destination (the ITUDUPPC feature must be turned on):

```
rtrv-dstn:dpcn=3-15-15-15-fr:spc=1-15-15-15-fr
```

This example displays all ITU national group codes by duplicate point code:

```
rtrv-dstn:dpcn=2050-*
```

This example displays all ITU national point codes within a group code:

```
rtrv-dstn:dpcn=*-fr
```

This example displays 24-bit ITU national point code 15-100-10:

```
rtrv-dstn:dpcn24=15-100-10
```

This example displays 24-bit ITU national alias point code 4:

```
rtrv-dstn:aliasn24=4-4-4
```

This example displays a private point code:

```
rtrv-dstn:dpcn=p-12-12-12
```

This example displays a private and spare point code:

```
rtrv-dstn:dpci=ps-1-234-1
```

This example displays all ANSI private point codes:

```
rtrv-dstn:pctype=ansi:pcst=p
```

This example displays all ITU national private and spare point codes:

```
rtrv-dstn:pctype=itun:pcst=ps
```

This example displays all ANSI point codes that do not have point code subtype prefixes:

```
rtrv-dstn:pctype=ansi
```

This example displays all point codes that do not have point code subtype prefixes:

```
rtrv-dstn:pcst=none
```

This example displays all private point codes:

```
rtrv-dstn:pcst=p
```

This example displays all spare point codes:

```
rtrv-dstn:pcst=s
```

This example displays all proxy destinations:

```
rtrv-dstn:prx=yes
```

This example displays all destinations using a specified proxy point code:

```
rtrv-dstn:ppc=1-1-1
```

This example displays full DPCs when the `homescp=yes` parameter is specified:

```
rtrv-dstn:homescp=yes
```

This example displays all point codes where the `sccpmsgcnv=udt2xudt` parameter is specified:

```
rtrv-dstn:sccpmsgcnv=udt2xudt
```

This example displays 16-bit ITU national point code 125-2-25:

```
rtrv-dstn:dpcn16=125-2-25
```

This example displays a 16-bit ITU national alias point code:

```
rtrv-dstn:aliasn16=2-3-4
```

## Dependencies



### Note:

A full point code contains numerical values for all three segments of the point code.

Only one destination point code parameter, or one alias point code parameter, or one CLLI parameter can be specified in the command; these parameters cannot be specified together in the command.

If the `dpcn` or `aliasn` parameter is specified, the format must match the format that was assigned with the `chg-stpopts:npfmti` parameter.

If specified (except when `spc=none`), the secondary point code must be a full point code.

Cluster destinations are allowed only if the Cluster Routing Management and Diversity (CRMD) feature is turned on.

Alias point codes must be specified as full point codes.

When the `msar=only` parameter is specified, no other parameters can be specified in the command.

Network routing is valid only if the Network Routing (NRT) feature is turned on.

The `pcst` parameter value `s` or `ps` cannot be specified when the `pctype` value `ansi` or `itun24` or `itun16` is specified.

The `pctype` and `pcst` parameters cannot be specified in the same command with the destination point code, alias point code, secondary point code, `clli`, `msar=only`, and `ncai` parameters.

The `clli=none` parameter cannot be specified.

The Route table is corrupt or cannot be found.

The site identification table is corrupt or cannot be found.

The Proxy Point Code feature must be enabled before the `prx` parameter can be specified.

The Proxy Point Code feature must be enabled before the `ppc` parameter can be specified.

The `prx` parameter can be specified with only the `pctype`, `pcst`, or `msar` parameter.

The `ppc` parameter can be specified with only the `msar` parameter.

A valid value must be specified for the `prx` parameter.

The point code specified by the `ppc` parameter must be a full point code.

Proxy point codes, as specified by the `ppc` parameter, cannot be private.

PRX point codes cannot be private.

The XUDT UDT Conversion feature must be turned on before the `sccpmsgcnv` parameter can be specified.

### Notes

This command can be canceled using the **F9** function key or the `canc-cmd` command. See `canc-cmd` for more information.

In this command, only ITU-international and ITU national point codes and aliases support the spare point code subtype prefix (s-). Only ITU-international and ITU national point codes support the private and spare point code subtype prefix (ps-). All of the point code types support the private (internal) point code subtype prefix (p-). Aliases do not support the private (internal) point code prefix.

Summary description of the reports that are produced by the various DPC parameter syntaxes is shown:

- `rtrv-dstn:dpc=ni-nc-ncm` —Report for fully provisioned destination *ni-nc-ncm*
- `rtrv-dstn:dpc=ni-***` —Report for provisioned network destination with the specified network indicator. If \* is specified in the *nc* field, \* must be specified in the *ncm* field.
- `rtrv-dstn:dpc=ni-***` —Report for the full network cluster for the specified *ni*
- `rtrv-dstn:dpc=ni-****` —Report for the full network cluster and the network cluster address (if any) for the specified *ni*
- `rtrv-dstn:dpc=ni-nc-*` —Report for provisioned cluster destination *ni-nc-\**
- `rtrv-dstn:dpc=ni-nc-**` —Report showing all destinations whose network (*ni*) and cluster (*nc*) components match those specified. The network cluster address *ni-nc-\** (if it exists) is not reported.
- `rtrv-dstn:dpc=ni-nc-***` —Report showing all destinations whose network (*ni*) and cluster (*nc*) components match those specified. The network cluster address *ni-nc-\** (if it exists) is also reported.
- `rtrv-dstn:dpcn24=msa-ssa-sp` —Report for fully provisioned 24-bit destination *main signaling area-sub signaling area-signaling point*

### Asterisks in ANSI Point Codes

Two asterisks in the *ncm* subfield of a cluster point code produces a summary report that shows all point code destinations residing in the given cluster (for example, *20-2-\*\**). This does not include the specified cluster point code (for example, *20-2-\**).

Three asterisks in the *ncm* subfield of a cluster point code (for example, *20-2-\*\*\**) produces a summary report that shows all point code destinations residing in the given network cluster. The specified cluster point code is also displayed if it exists.

If the linkset name is specified (`lsn` parameter) and the `dpc/dpca` parameter's *ncm* subfield is specified with asterisks, all route entries are displayed that have the specified linkset and that match the specified `dpc/dpca` parameter's subfield values.

### Asterisks in ITU-N Duplicate Point Codes and Flexible Format Point Codes

When the ITU Duplicate Point Code (ITUDUPPC) feature is on,

- An asterisk (\*) can be specified for the group code of an ITU-N duplicate point code to display all ITU-N point codes that have the specified node value (for example, *10101-\**).
- An asterisk (\*) can be specified for the node of an ITU-N duplicate point code to display all ITU-N point codes that have the specified group code value (for example, *\*-ab*).

When the ITUDUPPC feature is on and the STP flexible point code option (`npcfmti`) is used to change the ITU-N point format to four members (*m1-m2-m3-m4-gc*)

- An asterisk (\*) can be specified for the group code of an ITU-N flexible point code to display all ITU-N point codes that have the specified point code value (for example, *15*)
- An asterisk (\*) can be specified for every member of the ITU-N flexible point code to display all ITU-N flexible point codes that have the same group code (for example, *\**, *\*-15-\*-\*-ab* is not valid).

If the Proxy Point Code feature is enabled, then the values specified for the `ppc` and `dpc` parameters must be full point codes. Cluster point codes and private point codes are not supported.

## Output

### ***Destination Table Memory Space Accounting Information***

Each output example for this command shows the display of destination table memory space accounting information. The `msar` parameter value and the NCR, NRT, CRMD, and Origin-based MTP Routing feature settings determine whether a summary report or a detail report is displayed.

#### *Summary Report*

When the NCR, NRT, CRMD, and Origin-based MTP Routing features are off, the summary report is displayed when the command is entered with and without parameters specified and for all of the `msar` parameter values. The detail report cannot be displayed. The summary information appears at the end of the requested destination information, or appears without any other destination information when the `msar=only` parameter is specified.

When one or more of the NCR, NRT, CRMD, and Origin-based MTP Routing features are on, the summary report is displayed:

- When the command is entered with one or more parameters to select the specific destination information to be displayed. The summary information appears at the end of the requested destination information. (The `msar=summary` parameter is the default in this case.)
- When the command is entered with only the `msar=summary` parameter specified. The summary information appears at the end of the destination information.

The maximum number of destinations that can be provisioned depends on the Routes and Routesets quantity features that are on in the system (see the `rtrv-feat dstn5000` entry and the `rtrv-ctrl-feat Routesets` entry). The `chg-stpopts` command's `mtpdpcq` parameter must be set to the value of the Routes or Routesets quantity feature to allow the maximum number of destinations to be provisioned.

The number currently provisioned is the value *x*, the allowed maximum is the value *y*, and the table percent full is the value *z* shown in the following first line of the summary report:

```
Destination table is (x of y) z% full
```

- When no Routes or Routesets quantity features are on in the system, a maximum of 2000 destinations can be provisioned.
- When the DSTN5000 (5000 Routes) feature bit is on, a maximum of 5000 destinations can be provisioned.
- When the 6000, 7000, 8000, or 10,000 Routesets quantity feature is enabled, a maximum of the corresponding number of destinations can be provisioned.

The maximum number of aliases that can be provisioned depends on the quantity features that are on in the system (see the `rtrv-feat dstn5000` entry and the `rtrv-ctrl-feat Routesets` entry). The number currently provisioned is the *x* value, the allowed maximum is the *y* value, and the table percent full is the *z* value shown in the following second line of the summary report:

```
Alias table is (x of y) z% full
```

- When no Routes or Routesets quantity features are on in the system, a maximum of 12000 aliases can be provisioned.
- When the DSTN5000 feature bit is on, a maximum of 12000 aliases can be provisioned.
- When the 6000 Routesets feature quantity is enabled, a maximum of 12000 aliases can be provisioned.
- When the 7000 or 8000 Routesets quantity feature is enabled, a maximum of 8000 aliases can be provisioned.
- When the 10000 Routesets quantity feature is enabled, a maximum of 10000 aliases can be provisioned.

#### *Detail Report*

When the NCR, NRT, CRMD, and Origin-based MTP Routing features are off, the detail report cannot be displayed.

When one or more of the NCR, NRT, CRMD, or Origin-based MTP Routing features are on, the detail report is displayed:

- When the command is entered with no parameters. The detail report appears at the end of the destination information. (The `msar=detail` parameter value is the default in this case.)
- When the `msar=detail` parameter is specified with one or more other parameters to select the specific destination information to be displayed. The detail report appears at the end of the requested destination information.
- When the `msar=only` parameter is specified. The detail report appears with no other destination information.

The maximum number of destinations that can be provisioned depends on the Routes and Routesets quantity features that are on in the system (see the `rtrv-feat dstn5000` entry and the `rtrv-ctrl-feat Routesets` entry). The `chg-stpopts` command's `mtpdpcq` parameter must be set to the value of the quantity feature to allow the maximum number of



destinations to be provisioned. The possible maximum numbers of destinations are described in the *Summary Report* section.

In the example of the detail report, the allowed maximum number of destinations is the DESTINATION ENTRIES ALLOCATED value. The list of values under the allocated value includes the TOTAL DPCs currently provisioned and the Destination table CAPACITY (% FULL).

The allowed maximum number of aliases is the ALIASES ALLOCATED value. The list of values under the allocated value include the current number of ALIASES USED and the Aliases table CAPACITY (% FULL). The possible maximum numbers of aliases are described in the *Summary Report* section.

The output for the `rtrv-dstn` command does not change when the Proxy Point Code feature is on.

Abbreviated output is indicated by 3 vertical dots as shown:

```
.
.
.
```

This example shows destination table memory space accounting information contained in a summary report. In the example, the NCR, NRT, CRMD, and Origin-based MTP Routing features are all off. The Summary Report information appears without any other destination information.

```
rtrv-dstn:msar=only

rlghncxa03w 06-06-01 16:02:05 EST EAGLE 35.0.0
Destination table is (0 of 2000) 0% full
Alias table is (0 of 12000) 0% full
RTRV-DSTN: MASP A - COMPLTD
;
```

This example shows the output for a detail report. One or more of the NCR, NRT, CRMD or Origin-based MTP Routing features are on. The Detail Report information appears without any other destination information.

```
rtrv-dstn:msar=only

eagle10115 08-12-09 10:00:37 EST EAGLE 40.1.0
DESTINATION ENTRIES ALLOCATED: 2000
  FULL DPC(s): 178
  EXCEPTION DPC(s): 17
  NETWORK DPC(s): 0
  CLUSTER DPC(s): 4
  TOTAL DPC(s): 199
  CAPACITY (% FULL): 10%
ALIASES ALLOCATED: 12000
  ALIASES USED: 206
  CAPACITY (% FULL): 2%
```

```

X-LIST ENTRIES ALLOCATED:      500
;

```

This example shows the output when the NCR, NRT, and CRMD features are off, and no Routes or Routesets quantity features are on:

```
rtrv-dstn
```

```

tekelecstp 08-01-21 10:31:06 EST  EAGLE 38.0.0

No destinations meeting the requested criteria were found

Destination table is (0 of 2000) 0% full
Alias table is (0 of 12000) 0% full
;

```

This example shows the output when one or more of the NCR, NRT, or CRMD features are on and no Routes or Routesets features are on:

```
rtrv-dstn
```

```

tekelecstp 08-01-21 10:31:06 EST  EAGLE 38.0.0

No destinations meeting the requested criteria were found

DESTINATION ENTRIES ALLOCATED:  2000
  FULL DPC(s):                   0
  NETWORK DPC(s):                0
  CLUSTER DPC(s):                0
  TOTAL DPC(s):                  0
  CAPACITY (% FULL):             0%
ALIASES ALLOCATED:               12000
  ALIASES USED:                   0
  CAPACITY (% FULL):             0%
X-LIST ENTRIES ALLOCATED:       500
;

```

This example shows all provisioned destinations. The example contains abbreviated output.

```
rtrv-dstn
```

```

tekelecstp 10-10-15 14:46:12 EST  EAGLE 43.0.0
rtrv-dstn
Command entered at terminal #4.
Extended Processing Time may be Required
  DPCA          CLLI          BEI ELEI  ALIASI          ALIASN/N24
DMN
  001-001-000  stp1          no  --- -----
SS7
  003-001-000  mstp         no  --- -----
SS7

```

```

          004-001-000  stp4      no  --- -----
-----          SS7
.
.
.
          200-200-*    cluster2  yes no -----
-----          SS7
          005-006-001  ----- no  --- -----
005-006-001  SS7
          001-001-001  dstn01   no  --- -----
-----          SS7
          p-001-001-001  dstn01p  no  --- -----
-----          SS7
          001-001-002  dstn02   no  ---  1-001-2
-----          SS7
          p-001-001-002  dstn02p  no  ---  1-011-2
-----          SS7
          001-001-003  dstn03   no  ---  s-1-001-3
-----          SS7
          p-001-001-003  dstn03p  no  ---  s-1-011-3
-----          SS7
          001-001-004  dstn04   no  --- -----
02060          SS7
          p-001-001-004  dstn04p  no  --- -----
01060          SS7
          001-070-001  tgtansi001 no  --- -----
-----          SS7
          001-001-005  dstn05   no  --- -----
s-02061          SS7
          p-001-001-005  dstn05p  no  --- -----
s-01061          SS7
.
.
.
          DPCI          CLI          BEI  ELEI  ALIASA
ALIASN/N24  DMN
          s-4-002-0    ----- no  ---  010-001-001
s-08228          SS7
          2-010-0      dstn13   no  --- -----
-----          SS7
          p-2-010-0    dstn13p  no  --- -----
-----          SS7
          2-010-1      dstn14   no  ---  002-010-001
-----          SS7
          p-2-010-1    dstn14p  no  ---  002-100-001
-----          SS7
          2-010-2      dstn15   no  --- -----
04178          SS7
          p-2-010-2    dstn15p  no  --- -----
08178          SS7
          2-010-3      dstn16   no  --- -----
s-04179          SS7
          p-2-010-3    dstn16p  no  --- -----
s-08179          SS7

```

```

.
.
.
    s-2-020-0      dstn21      no --- -----
SS7
ps-2-020-0      dstn21p     no --- -----
SS7
    s-2-020-1      dstn22      no --- 002-020-001 -----
SS7
ps-2-020-1      dstn22p     no --- 002-200-001 -----
SS7
    s-2-020-2      dstn23      no --- ----- 04258
SS7
ps-2-020-2      dstn23p     no --- ----- 08258
SS7
    s-2-020-3      dstn24      no --- ----- s-04259
SS7
ps-2-020-3      dstn24p     no --- ----- s-08259
SS7
    s-2-070-3      tgtitui003 no --- -----
SS7
.
.
.
    s-2-029-6      rtxroute002 no --- 002-029-006 s-04269
SS7
    DPCI          CLLI          BEI ELEI  ALIASI          ALIASN/N24
DMN
    3-030-0      dstn29      no --- s-3-030-0 -----
SS7
p-3-030-0      dstn29p     no --- s-3-031-0 -----
SS7
    3-030-1      dstn30      no --- s-3-030-1 06385
SS7
p-3-030-1      dstn30p     no --- s-3-031-1 07385
SS7
.
.
.
    DPCI          CLLI          BEI ELEI  ALIASN          ALIASN
DMN
    3-030-4      dstn33      no --- s-06388 06388
SS7
p-3-030-4      dstn33p     no --- s-07388 07388
SS7
    3-030-5      dstn34      no --- 06389 s-06389
SS7
p-3-030-5      dstn34p     no --- 07389 s-07389
SS7
    s-3-040-6      dstn39      no --- s-06471 06471
SS7
ps-3-040-6      dstn39p     no --- s-07471 07471
SS7
    s-3-040-7      dstn40      no --- 06472 s-06472

```

```

SS7
  ps-3-040-7      dstn40p    no --- 07472
s-07472          SS7

          DPCN          CLLI          BEI ELEI  ALIASA
ALIASI          DMN
  06157          ----- no --- 020-005-002
----- SS7
  08192          dstn41      no --- -----
----- SS7
  p-08192        dstn41p     no --- -----
----- SS7
  08193          dstn42      no --- 004-000-001
----- SS7
  p-08193        dstn42p     no --- 004-200-001
----- SS7
  08194          dstn43      no --- -----
4-000-2          SS7
  p-08194        dstn43p     no --- -----
4-040-2          SS7
  08195          dstn44      no --- -----
s-4-000-3        SS7
  p-08195        dstn44p     no --- -----
s-4-040-3        SS7
  08753          tgtitun001 no --- -----
----- SS7
.
.
.

          DPCN          CLLI          BEI ELEI  ALIASI
ALIASI          DMN
  08198          dstn47      no --- s-4-000-6
4-000-6          SS7
  p-08198        dstn47p     no --- s-4-040-6
4-040-6          SS7
  08199          dstn48      no --- 4-000-7
s-4-000-7        SS7
  p-08199        dstn48p     no --- 4-040-7
s-4-040-7        SS7
  s-08278        dstn55      no --- s-4-010-6
4-010-6          SS7
  ps-08278       dstn55p     no --- s-4-050-6
4-050-6          SS7
  s-08279        dstn56      no --- 4-010-7
s-4-010-7        SS7
  ps-08279       dstn56p     no --- 4-050-7
s-4-050-7        SS7
  s-08379        rtxroute003 no --- s-4-058-7
4-058-7          SS7

          DPCN          CLLI          BEI ELEI  ALIASN
ALIASI          DMN
  12688          dstn57      no --- s-12688
----- SS7

```

SS7	p-12688	dstn57p	no	---	s-13688	-----
SS7	12689	dstn58	no	---	s-12689	6-050-1
SS7	p-12689	dstn58p	no	---	s-13689	6-060-1
SS7	12690	dstn59	no	---	s-12690	s-6-050-2
SS7	p-12690	dstn59p	no	---	s-13690	s-6-060-2
SS7	s-12691	dstn60	no	---	12691	-----
SS7	ps-12691	dstn60p	no	---	13691	-----
SS7	s-12692	dstn61	no	---	12692	6-050-4
SS7	ps-12692	dstn61p	no	---	13692	6-060-4
SS7	s-12693	dstn62	no	---	12693	s-6-050-5
SS7	ps-12693	dstn62p	no	---	13693	s-6-060-5
DMN	DPCN24	CLLI	BEI	ELEI	ALIASA	ALIASI
SS7	003-003-004	-----	no	---	003-003-003	3-003-4
SS7	006-005-001	dstn63	no	---	-----	-----
SS7	p-006-005-001	dstn63p	no	---	-----	-----
SS7	006-005-002	dstn64	no	---	006-005-002	-----
SS7	p-006-005-002	dstn64p	no	---	006-005-020	-----
SS7	006-005-003	dstn65	no	---	-----	6-005-3
SS7	p-006-005-003	dstn65p	no	---	-----	6-050-3
SS7	006-070-001	tgtitun24a	no	---	-----	-----
SS7	006-005-004	dstn66	no	---	-----	s-6-005-4
SS7	p-006-005-004	dstn66p	no	---	-----	s-6-050-4
SS7	006-005-005	dstn67	no	---	006-005-005	6-005-5
SS7	p-006-005-005	dstn67p	no	---	006-005-050	6-050-5
SS7	006-070-002	tgtitun24b	no	---	-----	-----
DESTINATION ENTRIES ALLOCATED:				2000		
FULL DPC(s) :				178		
EXCEPTION DPC(s) :				17		

```

NETWORK DPC(s) :           0
CLUSTER DPC(s) :           4
TOTAL DPC(s) :             199
CAPACITY (% FULL) :        10%
ALIASES ALLOCATED:         12000
ALIASES USED:               206
CAPACITY (% FULL) :         2%
X-LIST ENTRIES ALLOCATED:   500

```

```
;
```

This example shows the 24-bit ITUN Destination Point Code(s) assigned to a specified 24-bit ITUN Secondary Point Code:

```
rtrv-dstn:spcn24=6-5-0
```

```

eagle10115 10-10-29 10:00:37 EST EAGLE 43.0.0
rtrv-dstn:spcn24=6-5-0
Command entered at terminal #4.
Extended Processing Time may be Required

```

```
SPCN24= 006-005-000
```

ALIASES	DPCN24	CLLI	BEI	ELEI	ALIASA
DMN	003-003-004	-----	no	---	003-003-003
3-003-4	SS7				
	006-005-001	dstn63	no	---	-----
	SS7				
	p-006-005-001	dstn63p	no	---	-----
	SS7				
	006-005-002	dstn64	no	---	006-005-002
	SS7				
	p-006-005-002	dstn64p	no	---	006-005-020
	SS7				
	006-005-003	dstn65	no	---	-----
6-005-3	SS7				
	p-006-005-003	dstn65p	no	---	-----
6-050-3	SS7				
	006-070-001	tgtitun24a	no	---	-----
	SS7				
	006-005-004	dstn66	no	---	-----
s-6-005-4	SS7				
	p-006-005-004	dstn66p	no	---	-----
s-6-050-4	SS7				
	006-005-005	dstn67	no	---	006-005-005
6-005-5	SS7				
	p-006-005-005	dstn67p	no	---	006-005-050
6-050-5	SS7				
	006-070-002	tgtitun24b	no	---	-----
	SS7				

```

Destination table is (199 of 2000) 10% full
Alias table is (206 of 12000) 2% full

```

;

This example shows the output when the `ncai=yes` parameter is specified:

```
rtrv-dstn:ncai=yes
```

```
eagle10115 10-10-09 10:00:37 EST EAGLE 43.0.0
rtrv-dstn:ncai=yes
Command entered at terminal #4.
Extended Processing Time may be Required
```

```
NCAI= yes
```

	DPCA	CLLI	BEI	ELEI	ALIASI	ALIASN/N24
DMN	100-100-*	cluster1	no	no	-----	-----
SS7	200-200-*	cluster2	yes	no	-----	-----
SS7						

```
Destination table is (199 of 2000) 10% full
Alias table is (206 of 12000) 2% full
```

;

This example shows the retrieval of a single cluster:

```
rtrv-dstn:dpc=200-200-*
```

```
eagle10115 10-08-12 10:00:37 EST EAGLE 43.0.0
```

	DPCA	CLLI	BEI	ELEI	ALIASI	ALIASN/N24		
DMN	200-200-*	cluster2	yes	no	-----	-----		
SS7								
SCCPMSGCNV	SPCA	NCAI	RCAUSE	NPRST	SPLITIAM	HMSMSC	HMSCP	
	-----	yes	none	off	none	no	no	none

```
Destination table is (197 of 2000) 10% full
Alias table is (206 of 12000) 2% full
```

;

This example shows when the `ncai=no` parameter is specified:

```
rtrv-dstn:ncai=no
```

```
eagle10115 10-10-09 10:00:37 EST EAGLE 43.0.0
rtrv-dstn:ncai=no
Command entered at terminal #4.
```



Extended Processing Time may be Required

NCAI= no

DPCA	CLLI	BEI	ELEI	ALIASI
ALIASN/N24 DMN				
040-001-*	myncaibeno	no	no	-----
-----	SS7			
040-010-*	myncaibeno2	no	no	-----
-----	SS7			

Destination table is (199 of 2000) 10% full

Alias table is (206 of 12000) 2% full

;

This example shows a single cluster with the NRT feature turned on:

rtrv-dstn:dpc=010-\*-\*

eagle10115 10-08-12 10:00:37 EST EAGLE 43.0.0

DPCA	CLLI	BEI	ELEI	ALIASI
ALIASN/N24 DMN				
010-*-*	-----	---	---	-----
-----	SS7			

SPCA	NCAI	RCAUSE	NPRST	SPLITIAM	HMSMSC	HMSCP
SCCPMSGCNV						
-----	----	none	off	none	no	no
none						

Destination table is (200 of 2000) 10% full

Alias table is (206 of 12000) 2% full

;

This example shows a single ITU national destination with the ITUDUPPC (ITU Duplicate Point Code) feature turned on:

rtrv-dstn:dpcn=08199-tk

eagle10115 10-08-12 10:00:37 EST EAGLE 43.0.0

DPCN	CLLI	BEI	ELEI	ALIASA
ALIASI DMN				
08199-tk	dstn48dupTk	no	---	-----
4-006-2	SS7			

SPCN	NCAI	RCAUSE	NPRST	SPLITIAM	HMSMSC	HMSCP
SCCPMSGCNV						
-----	----	none	off	none	no	no

none

Destination table is (207 of 2000) 10% full  
Alias table is (215 of 12000) 2% full

;

This example shows all ITU national group codes by duplicate point code:

rtrv-dstn:dpcn=8198-\*

eagle10115 08-12-09 10:00:37 EST EAGLE 40.1.0

	DPCN	CLLI	BEI	ELEI	ALIASA	ALIASI
DMN	08198-nz	dstn47dupnz	no	---	-----	-----
SS7						

	DPCN	CLLI	BEI	ELEI	ALIASI	ALIASI
DMN	08198-aa	dstn47	no	---	s-4-000-6	4-000-6
SS7						
SS7	08198-fr	dstn47dupfr	no	---	s-4-005-7	4-005-7
SS7	08198-tk	dstn47dupTk	no	---	4-006-0	s-4-006-0

Destination table is (207 of 2000) 10% full  
Alias table is (215 of 12000) 2% full

;

This example shows a single cluster when the NRT and DSTN5000 features are turned on:

rtrv-dstn:dpc=010-\*\*-\*

eagle10115 10-08-12 10:00:37 EST EAGLE 43.0.0

	DPCI	CLLI	BEI	ELEI	ALIASA	ALIASN/N24
DMN	010-**-*	-----	no	no	-----	-----
SS7						

	SPCI	NCAI	RCAUSE	NPRST	SPLITIAM	HMSMSC	HMSCP
SCCPMSGCNV	-----	----	none	off	none	no	no
							udt2xudt

Destination table is (3 of 6000) 1% full  
Alias table is (4 of 12000) 1% full

;

This example shows the output when the 6000 Routesets and CRMD features are turned on:

rtrv-dstn

tekelecstp 10-10-15 14:46:12 EST EAGLE 43.0.0

rtrv-dstn

Command entered at terminal #4.

Extended Processing Time may be Required

DPCA	CLLI	BEI	ELEI	ALIASI
ALIASN/N24 DMN				
003-003-003	-----	no	---	-----
----- SS7				
004-004-004	-----	no	---	-----
----- SS7				
005-005-005	-----	no	---	-----
----- SS7				
008-001-*	-----	no	no	-----
----- SS7				

```

DESTINATION ENTRIES ALLOCATED: 6000
FULL DPC(s) : 3
NETWORK DPC(s) : 0
CLUSTER DPC(s) : 1
TOTAL DPC(s) : 4
CAPACITY (% FULL) : 1%
ALIASES ALLOCATED: 12000
ALIASES USED: 0
CAPACITY (% FULL) : 0%
X-LIST ENTRIES ALLOCATED: 500

```

;

This example shows the output for a specific DPC when the 6000 Routesets and the CRMD features are on:

rtrv-dstn:dpc=8-1-\*

eagle10115 10-08-12 10:00:37 EST EAGLE 43.0.0

DPCA	CLLI	BEI	ELEI	ALIASI
ALIASN/N24 DMN				
008-001-*	-----	no	no	-----
----- SS7				

SPCA	NCAI	RCAUSE	NPRST	SPLITIAM	HMSMSC	HMSCP
SCCPMSGCNV						
-----	no	none	off	none	no	no
none						

Destination table is (4 of 6000) 1% full

Alias table is (0 of 12000) 0% full

;

This example shows the output for a 24-bit ITU-N destination point code with an assigned 24-bit ITU-N secondary point code:

```
rtrv-dstn:dpcn24=6-5-2
```

```

eagle10115 10-08-12 10:00:37 EST EAGLE 43.0.0
      DPCN24      CLLI      BEI ELEI  ALIASA      ALIASI
DMN
      006-005-002  dstn64      no  ---  006-005-002  -----
SS7

      SPCN24      NCAI      RCAUSE NPRST SPLITIAM HMSMSC HMSCP
SCCPMSGCNV
      -----  ----      none  off  none  no  no  none

```

```
Destination table is (208 of 2000) 10% full
```

```
Alias table is (216 of 12000) 2% full
```

```
;
```

This example shows a specific 24-bit ITU-N alias point code:

```
rtrv-dstn:aliasn24=3-41-5
```

```

eagle10115 10-08-12 10:00:37 EST EAGLE 43.0.0
      DPCI      CLLI      BEI ELEI  ALIASI      ALIASN/N24
DMN
      ps-3-040-5  dstn38p      no  ---  3-041-5      003-041-005
SS7

      SPCI      NCAI      RCAUSE NPRST SPLITIAM HMSMSC HMSCP
SCCPMSGCNV
      -----  ----      none  off  none  no  no  none

```

```
Destination table is (208 of 2000) 10% full
```

```
Alias table is (216 of 12000) 2% full
```

```
;
```

This example shows the output for a linkset that contains a private point code:

```
rtrv-dstn:dpci=ps-3-40-3
```

```

eagle10115 10-08-12 10:00:37 EST EAGLE 43.0.0
      DPCI      CLLI      BEI ELEI  ALIASI      ALIASN/N24
DMN
      ps-3-040-3  dstn36p      no  ---  3-041-3      07467-aa
SS7

      SPCI      NCAI      RCAUSE NPRST SPLITIAM HMSMSC HMSCP

```

```

SCCPMSGCNV
----- ---- none off none no no
none

```

```

Destination table is (208 of 2000) 10% full
Alias table is (216 of 12000) 2% full

```

```
;
```

This example shows ANSI point codes with the private point code subtype prefix (p-):

```
rtrv-dstn:pctype=ansi:pcst=p
```

```

eagle10115 10-10-29 10:00:37 EST EAGLE 43.0.0
rtrv-dstn:pctype=ansi:pcst=p
Command entered at terminal #4.
Extended Processing Time may be Required

```

DPCN	CLLI	BEI	ELEI	ALIASI
ALIASN/N24 DMN				
p-001-001-001	dstn01p	no	---	-----
----- SS7				
p-001-001-002	dstn02p	no	---	1-011-2
----- SS7				
p-001-001-003	dstn03p	no	---	s-1-011-3
----- SS7				
p-001-001-004	dstn04p	no	---	-----
aa SS7				01060-
p-001-001-005	dstn05p	no	---	-----
aa SS7				s-01061-
p-001-001-006	dstn06p	no	---	-----
001-011-006 SS7				
p-001-001-007	dstn07p	no	---	1-011-7
aa SS7				01063-
p-001-002-000	dstn08p	no	---	1-012-0
aa SS7				s-01064-
p-001-002-001	dstn09p	no	---	s-1-012-1
aa SS7				01065-
p-001-002-002	dstn10p	no	---	s-1-012-2
aa SS7				s-01066-
p-001-002-003	dstn11p	no	---	1-012-3
001-012-003 SS7				
p-001-002-004	dstn12p	no	---	s-1-012-4
001-012-004 SS7				

```

Destination table is (208 of 2000) 10% full
Alias table is (216 of 12000) 2% full

```

```
;
```

This example shows ITU-I point codes with the spare point code subtype prefix (s-):

rtrv-dstn:pctype=itui:pcst=s

eagle10115 10-10-29 10:00:37 EST EAGLE 43.0.0

rtrv-dstn:pctype=itui:pcst=s

Command entered at terminal #4.

Extended Processing Time may be Required

	DPCI	CLLI	BEI	ELEI	ALIASA	ALIASN/N24
DMN	s-4-002-0	-----	no	---	010-001-001	s-08228-aa
SS7	s-2-020-0	dstn21	no	---	-----	-----
SS7	s-2-020-1	dstn22	no	---	002-020-001	-----
SS7	s-2-020-2	dstn23	no	---	-----	04258-aa
SS7	s-2-020-3	dstn24	no	---	-----	s-04259-aa
SS7	s-2-070-3	tgtitui003	no	---	-----	-----
SS7	s-2-020-4	dstn25	no	---	-----	002-020-004
SS7	s-2-020-5	dstn26	no	---	002-020-005	04261-aa
SS7	s-2-020-6	dstn27	no	---	002-020-006	s-04262-aa
SS7	s-2-020-7	dstn28	no	---	002-020-007	002-020-007
SS7	s-2-070-4	tgtitui004	no	---	-----	-----
SS7	s-3-070-3	tgtitui007	no	---	-----	-----
SS7	s-3-070-4	tgtitui008	no	---	-----	-----
SS7	s-2-029-6	rtxroute002	no	---	002-029-006	s-04269-aa
	DPCI	CLLI	BEI	ELEI	ALIASI	ALIASN/N24
DMN	s-3-040-2	dstn35	no	---	3-040-2	-----
SS7	s-3-040-3	dstn36	no	---	3-040-3	06467-aa
SS7	s-3-040-4	dstn37	no	---	3-040-4	s-06468-aa
SS7	s-3-040-5	dstn38	no	---	3-040-5	003-040-005
	DPCI	CLLI	BEI	ELEI	ALIASN	ALIASN
DMN	s-3-040-6	dstn39	no	---	s-06471-aa	06471-aa
SS7	s-3-040-7	dstn40	no	---	06472-aa	s-06472-aa

SS7

Destination table is (208 of 2000) 10% full  
Alias table is (216 of 12000) 2% full

;

This example shows ITU-N point codes with the private point code subtype prefix (p-):

rtrv-dstn:pctype=itun:pcst=p

eagle10115 10-10-29 10:00:37 EST EAGLE 43.0.0  
rtrv-dstn:pctype=itun:pcst=p  
Command entered at terminal #4.  
Extended Processing Time may be Required

DPCN	CLLI	BEI	ELEI	ALIASA
ALIASI DMN				
p-08192-aa	dstn41p	no	---	-----
-----	SS7			
p-08193-aa	dstn42p	no	---	004-200-001
-----	SS7			
p-08194-aa	dstn43p	no	---	-----
4-040-2	SS7			
p-08195-aa	dstn44p	no	---	-----
s-4-040-3	SS7			
p-08196-aa	dstn45p	no	---	004-200-004
4-040-4	SS7			
p-08197-aa	dstn46p	no	---	004-200-005
s-4-040-5	SS7			

DPCN	CLLI	BEI	ELEI	ALIASI
ALIASI DMN				
p-08198-aa	dstn47p	no	---	s-4-040-6
4-040-6	SS7			
p-08199-aa	dstn48p	no	---	4-040-7
s-4-040-7	SS7			

DPCN	CLLI	BEI	ELEI	ALIASN
ALIASI DMN				
p-12688-aa	dstn57p	no	---	s-13688-aa
-----	SS7			
p-12689-aa	dstn58p	no	---	s-13689-aa
6-060-1	SS7			
p-12690-aa	dstn59p	no	---	s-13690-aa
s-6-060-2	SS7			

Destination table is (208 of 2000) 10% full  
Alias table is (216 of 12000) 2% full

;

This example shows ITU-N point codes with the private and spare point code subtype prefix (ps-):

```
rtrv-dstn:pctype=itun:pcst=ps
```

```
eagle10115 10-10-29 10:00:37 EST EAGLE 43.0.0
```

```
rtrv-dstn:pctype=itun:pcst=ps
```

```
Command entered at terminal #4.
```

```
Extended Processing Time may be Required
```

	DPCN	CLLI	BEI	ELEI	ALIASA	ALIASI
DMN	ps-08272-aa	dstn49p	no	---	-----	-----
SS7	ps-08273-aa	dstn50p	no	---	004-200-010	-----
SS7	ps-08274-aa	dstn51p	no	---	-----	4-050-2
SS7	ps-08275-aa	dstn52p	no	---	-----	s-4-050-3
SS7	ps-08276-aa	dstn53p	no	---	004-200-040	4-050-4
SS7	ps-08277-aa	dstn54p	no	---	004-200-050	s-4-050-5

	DPCN	CLLI	BEI	ELEI	ALIASI	ALIASI
DMN	ps-08278-aa	dstn55p	no	---	s-4-050-6	4-050-6
SS7	ps-08279-aa	dstn56p	no	---	4-050-7	s-4-050-7

	DPCN	CLLI	BEI	ELEI	ALIASN	ALIASI
DMN	ps-12691-aa	dstn60p	no	---	13691-aa	-----
SS7	ps-12692-aa	dstn61p	no	---	13692-aa	6-060-4
SS7	ps-12693-aa	dstn62p	no	---	13693-aa	s-6-060-5

```
Destination table is (208 of 2000) 10% full
```

```
Alias table is (216 of 12000) 2% full
```

```
;
```

This example displays ANSI point codes. The example displays abbreviated output.

```
rtrv-dstn:pctype=ansi
```

```
eagle10115 10-10-29 10:00:37 EST EAGLE 43.0.0
```

```
rtrv-dstn:pctype=ansi
```

```
Command entered at terminal #4.
```

```
Extended Processing Time may be Required
```

	DPCA	CLLI	BEI	ELEI	ALIASI	ALIASN/N24
--	------	------	-----	------	--------	------------



```

DMN
    001-001-000  stp1          no  ---  -----
-----          SS7
    003-001-000  mstp         no  ---  -----
-----          SS7
.
.
.
    100-100-*    cluster1     no  no  -----
-----          SS7
    100-100-001  -----         no  ---  -----
-----          SS7
    200-200-*    cluster2     yes no  -----
-----          SS7
    005-006-001  -----         no  ---  -----
005-006-001  SS7
    001-001-001  dstn01         no  ---  -----
-----          SS7
    p-001-001-001 dstn01p       no  ---  -----
-----          SS7
    001-001-002  dstn02         no  ---  1-001-2
-----          SS7
    p-001-001-002 dstn02p       no  ---  1-011-2
-----          SS7
    001-001-003  dstn03         no  ---  s-1-001-3
-----          SS7
    p-001-001-003 dstn03p       no  ---  s-1-011-3
-----          SS7
    001-001-004  dstn04         no  ---  -----
aa          SS7
    p-001-001-004 dstn04p       no  ---  -----
aa          SS7
    001-070-001  tgtansi001     no  ---  -----
-----          SS7
    001-001-005  dstn05         no  ---  -----
aa          SS7
    p-001-001-005 dstn05p       no  ---  -----
aa          SS7
    001-001-006  dstn06         no  ---  -----
001-001-006  SS7
    p-001-001-006 dstn06p       no  ---  -----
001-011-006  SS7
    001-001-007  dstn07         no  ---  1-001-7      02063-
aa          SS7
    p-001-001-007 dstn07p       no  ---  1-011-7      01063-
aa          SS7
    001-002-000  dstn08         no  ---  1-002-0      s-02064-
aa          SS7
    p-001-002-000 dstn08p       no  ---  1-012-0      s-01064-
aa          SS7
    001-070-002  tgtansi002     no  ---  -----
-----          SS7
    001-002-001  dstn09         no  ---  s-1-002-1    02065-
aa          SS7
    p-001-002-001 dstn09p       no  ---  s-1-012-1    01065-

```

```

aa      SS7
        001-002-002  dstn10    no --- s-1-002-2    s-02066-aa
SS7
        p-001-002-002  dstn10p  no --- s-1-012-2    s-01066-aa
SS7
        001-002-003  dstn11    no --- 1-002-3    001-002-003
SS7
        p-001-002-003  dstn11p  no --- 1-012-3    001-012-003
SS7
        001-002-004  dstn12    no --- s-1-002-4    001-002-004
SS7
        p-001-002-004  dstn12p  no --- s-1-012-4    001-012-004
SS7
        001-070-003  tgtansi003 no --- -----
SS7
        200-002-001  rtxroute001 no --- -----
SS7
        040-001-*    myncaibeno no no -----
SS7
        040-010-*    myncaibeno2 no no -----
SS7
        010-*-*      ----- --- --- -----
SS7

```

```

Destination table is (208 of 2000) 10% full
Alias table is (216 of 12000) 2% full

```

```
;
```

This example shows ITU-I point codes:

```
rtrv-dstn:pctype=itui
```

```

eagle10115 10-10-29 10:00:37 EST EAGLE 43.0.0
rtrv-dstn:pctype=itui
Command entered at terminal #4.
Extended Processing Time may be Required

```

```

          DPCI          CLLI          BEI ELEI  ALIASA          ALIASN/N24
DMN
        s-4-002-0      ----- no --- 010-001-001    s-08228-aa
SS7
          2-010-0      dstn13    no --- -----
SS7
        p-2-010-0      dstn13p  no --- -----
SS7
          2-010-1      dstn14    no --- 002-010-001    -----
SS7
        p-2-010-1      dstn14p  no --- 002-100-001    -----
SS7
          2-010-2      dstn15    no --- -----          04178-aa
SS7
        p-2-010-2      dstn15p  no --- -----          08178-aa
SS7
          2-010-3      dstn16    no --- -----          s-04179-aa

```

```

SS7
  p-2-010-3      dstn16p    no --- ----- s-08179-
aa   SS7
     2-070-1      tgtitui001 no --- -----
----- SS7
     2-010-4      dstn17     no --- -----
002-010-004 SS7
  p-2-010-4      dstn17p    no --- -----
002-100-004 SS7
  2-010-5        dstn18     no --- 002-010-005 04181-
aa   SS7
  p-2-010-5      dstn18p    no --- 002-100-005 08181-
aa   SS7
  2-010-6        dstn19     no --- 002-010-006 s-04182-
aa   SS7
  p-2-010-6      dstn19p    no --- 002-100-006 s-08182-
aa   SS7
  2-010-7        dstn20     no --- 002-010-007
002-010-007 SS7
  p-2-010-7      dstn20p    no --- 002-100-007
002-100-007 SS7
  2-070-2        tgtitui002 no --- -----
----- SS7
  s-2-020-0      dstn21     no --- -----
----- SS7
  ps-2-020-0     dstn21p    no --- -----
----- SS7
  s-2-020-1      dstn22     no --- 002-020-001
----- SS7
  ps-2-020-1     dstn22p    no --- 002-200-001
----- SS7
  s-2-020-2      dstn23     no --- ----- 04258-
aa   SS7
  ps-2-020-2     dstn23p    no --- ----- 08258-
aa   SS7
  s-2-020-3      dstn24     no --- ----- s-04259-
aa   SS7
  ps-2-020-3     dstn24p    no --- ----- s-08259-
aa   SS7
  s-2-070-3      tgtitui003 no --- -----
----- SS7
  s-2-020-4      dstn25     no --- -----
002-020-004 SS7
  ps-2-020-4     dstn25p    no --- -----
002-200-004 SS7
  s-2-020-5      dstn26     no --- 002-020-005 04261-
aa   SS7
  ps-2-020-5     dstn26p    no --- -----
----- SS7
  s-2-020-6      dstn27     no --- 002-020-006 s-04262-
aa   SS7
  ps-2-020-6     dstn27p    no --- 002-200-005 08261-
aa   SS7
  s-2-020-7      dstn28     no --- 002-020-007
002-020-007 SS7

```

SS7	ps-2-020-7	dstn28p	no	---	002-200-007	002-200-007
SS7	s-2-070-4	tgtitui004	no	---	-----	-----
SS7	s-3-070-3	tgtitui007	no	---	-----	-----
SS7	s-3-070-4	tgtitui008	no	---	-----	-----
SS7	s-2-029-6	rtxroute002	no	---	002-029-006	s-04269-aa
DMN	DPCI	CLLI	BEI	ELEI	ALIASI	ALIASN/N24
SS7	3-030-0	dstn29	no	---	s-3-030-0	-----
SS7	p-3-030-0	dstn29p	no	---	s-3-031-0	-----
SS7	3-030-1	dstn30	no	---	s-3-030-1	06385-aa
SS7	p-3-030-1	dstn30p	no	---	s-3-031-1	07385-aa
SS7	3-030-2	dstn31	no	---	s-3-030-2	s-06386-aa
SS7	p-3-030-2	dstn31p	no	---	s-3-031-2	s-07386-aa
SS7	3-070-1	tgtitui005	no	---	s-3-070-1	-----
SS7	3-030-3	dstn32	no	---	s-3-030-3	003-030-003
SS7	p-3-030-3	dstn32p	no	---	s-3-031-3	003-031-003
SS7	3-070-2	tgtitui006	no	---	s-3-070-2	-----
SS7	s-3-040-2	dstn35	no	---	3-040-2	-----
SS7	ps-3-040-2	dstn35p	no	---	3-041-2	-----
SS7	s-3-040-3	dstn36	no	---	3-040-3	06467-aa
SS7	ps-3-040-3	dstn36p	no	---	3-041-3	07467-aa
SS7	s-3-040-4	dstn37	no	---	3-040-4	s-06468-aa
SS7	ps-3-040-4	dstn37p	no	---	3-041-4	s-07468-aa
SS7	s-3-040-5	dstn38	no	---	3-040-5	003-040-005
SS7	ps-3-040-5	dstn38p	no	---	3-041-5	003-041-005
DMN	DPCI	CLLI	BEI	ELEI	ALIASN	ALIASN
SS7	3-030-4	dstn33	no	---	s-06388-aa	06388-aa
SS7	p-3-030-4	dstn33p	no	---	s-07388-aa	07388-aa

```

SS7
    3-030-5      dstn34      no --- 06389-aa      s-06389-
aa      SS7
    p-3-030-5    dstn34p     no --- 07389-aa      s-07389-
aa      SS7
    s-3-040-6    dstn39      no --- s-06471-aa      06471-
aa      SS7
    ps-3-040-6   dstn39p     no --- s-07471-aa      07471-
aa      SS7
    s-3-040-7    dstn40      no --- 06472-aa      s-06472-
aa      SS7
    ps-3-040-7   dstn40p     no --- 07472-aa      s-07472-
aa      SS7

```

Destination table is (208 of 2000) 10% full

Alias table is (216 of 12000) 2% full

;

This example shows ITU-N point codes:

```
rtrv-dstn:pctype=itun
```

```
eagle10115 10-10-29 10:00:37 EST EAGLE 43.0.0
```

```
rtrv-dstn:pctype=itun
```

```
Command entered at terminal #4.
```

```
Extended Processing Time may be Required
```

```

          DPCN          CLLI          BEI ELEI  ALIASA
ALIASI          DMN
          06157-aa      ----- no --- 020-005-002
-----          SS7
          08192-aa      dstn41      no --- -----
-----          SS7
          p-08192-aa    dstn41p     no --- -----
-----          SS7
          08193-aa      dstn42      no --- 004-000-001
-----          SS7
          p-08193-aa    dstn42p     no --- 004-200-001
-----          SS7
          08194-aa      dstn43      no --- -----
4-000-2          SS7
          p-08194-aa    dstn43p     no --- -----
4-040-2          SS7
          08195-aa      dstn44      no --- -----
s-4-000-3        SS7
          p-08195-aa    dstn44p     no --- -----
s-4-040-3        SS7
          08753-aa      tgtitun001 no --- -----
-----          SS7
          08196-aa      dstn45      no --- 004-000-004
4-000-4          SS7
          p-08196-aa    dstn45p     no --- 004-200-004
4-040-4          SS7
          08197-aa      dstn46      no --- 004-000-005

```

s-4-000-5	SS7					
p-08197-aa		dstn46p	no	---	004-200-005	s-4-040-5
SS7						
08754-aa		tgtitun002	no	---	-----	-----
SS7						
s-08272-aa		dstn49	no	---	-----	-----
SS7						
ps-08272-aa		dstn49p	no	---	-----	-----
SS7						
s-08273-aa		dstn50	no	---	004-010-001	-----
SS7						
ps-08273-aa		dstn50p	no	---	004-200-010	-----
SS7						
s-08274-aa		dstn51	no	---	-----	4-010-2
SS7						
ps-08274-aa		dstn51p	no	---	-----	4-050-2
SS7						
s-08275-aa		dstn52	no	---	-----	s-4-010-3
SS7						
ps-08275-aa		dstn52p	no	---	-----	s-4-050-3
SS7						
s-08755-aa		tgtitun003	no	---	-----	-----
SS7						
s-08276-aa		dstn53	no	---	004-010-004	4-010-4
SS7						
ps-08276-aa		dstn53p	no	---	004-200-040	4-050-4
SS7						
s-08277-aa		dstn54	no	---	004-010-005	s-4-010-5
SS7						
ps-08277-aa		dstn54p	no	---	004-200-050	s-4-050-5
SS7						
s-08756-aa		tgtitun004	no	---	-----	-----
SS7						
08757-aa		tgtitun005	no	---	-----	-----
SS7						
s-08758-aa		tgtitun006	no	---	-----	-----
SS7						
08199-fr		dstn48dupfr	no	---	-----	s-4-006-1
SS7						
08199-tk		dstn48dupTk	no	---	-----	4-006-2
SS7						
08198-nz		dstn47dupnz	no	---	-----	-----
SS7						
s-08273-fr		dstn50dupfr	no	---	-----	4-006-3
SS7						
		DPCN	CLLI	BEI	ELEI	ALIASI
DMN						
08198-aa		dstn47	no	---	s-4-000-6	4-000-6
SS7						
p-08198-aa		dstn47p	no	---	s-4-040-6	4-040-6
SS7						
08199-aa		dstn48	no	---	4-000-7	s-4-000-7
SS7						
p-08199-aa		dstn48p	no	---	4-040-7	s-4-040-7

```

SS7
  s-08278-aa      dstn55      no --- s-4-010-6
4-010-6          SS7
  ps-08278-aa     dstn55p     no --- s-4-050-6
4-050-6          SS7
  s-08279-aa      dstn56      no --- 4-010-7
s-4-010-7        SS7
  ps-08279-aa     dstn56p     no --- 4-050-7
s-4-050-7        SS7
  s-08379-aa      rtxroute003 no --- s-4-058-7
4-058-7          SS7
  08198-fr        dstn47dupfr no --- s-4-005-7
4-005-7          SS7
  08198-tk        dstn47dupTk no --- 4-006-0
s-4-006-0        SS7

          DPCN          CLLI          BEI ELEI  ALIASN
ALIASI      DMN
  12688-aa    dstn57      no --- s-12688-aa
-----      SS7
  p-12688-aa  dstn57p     no --- s-13688-aa
-----      SS7
  12689-aa    dstn58      no --- s-12689-aa
6-050-1      SS7
  p-12689-aa  dstn58p     no --- s-13689-aa
6-060-1      SS7
  12690-aa    dstn59      no --- s-12690-aa
s-6-050-2    SS7
  p-12690-aa  dstn59p     no --- s-13690-aa
s-6-060-2    SS7
  s-12691-aa  dstn60      no --- 12691-aa
-----      SS7
  ps-12691-aa dstn60p     no --- 13691-aa
-----      SS7
  s-12692-aa  dstn61      no --- 12692-aa
6-050-4      SS7
  ps-12692-aa dstn61p     no --- 13692-aa
6-060-4      SS7
  s-12693-aa  dstn62      no --- 12693-aa
s-6-050-5    SS7
  ps-12693-aa dstn62p     no --- 13693-aa
s-6-060-5    SS7
  s-08272-fr  dstn49dupfr no --- 08300-fr
-----      SS7
  s-08272-tk  dstn49dupTk no --- 08300-tk
4-006-7      SS7

```

Destination table is (208 of 2000) 10% full

Alias table is (216 of 12000) 2% full

;

This example shows point codes that have no point code subtype prefix. The example contains abbreviated output.

rtrv-dstn:pcst=none

eagle10115 10-10-29 10:00:37 EST EAGLE 43.0.0

rtrv-dstn:pcst=none

Command entered at terminal #4.

Extended Processing Time may be Required

	DPCA	CLLI	BEI	ELEI	ALIASI	ALIASN/N24
DMN	001-001-000	stp1	no	---	-----	-----
SS7	003-001-000	mstp	no	---	-----	-----
SS7						
.						
.						
.						
SS7	200-200-*	cluster2	yes	no	-----	-----
SS7	005-006-001	-----	no	---	-----	005-006-001
SS7	001-001-001	dstn01	no	---	-----	-----
SS7	001-001-002	dstn02	no	---	1-001-2	-----
SS7	001-001-003	dstn03	no	---	s-1-001-3	-----
SS7	001-001-004	dstn04	no	---	-----	02060-aa
SS7	001-070-001	tgtansi001	no	---	-----	-----
SS7	001-001-005	dstn05	no	---	-----	s-02061-aa
SS7	001-001-006	dstn06	no	---	-----	001-001-006
SS7	001-001-007	dstn07	no	---	1-001-7	02063-aa
SS7	001-002-000	dstn08	no	---	1-002-0	s-02064-aa
SS7	001-070-002	tgtansi002	no	---	-----	-----
SS7	001-002-001	dstn09	no	---	s-1-002-1	02065-aa
SS7	001-002-002	dstn10	no	---	s-1-002-2	s-02066-aa
SS7	001-002-003	dstn11	no	---	1-002-3	001-002-003
SS7	001-002-004	dstn12	no	---	s-1-002-4	001-002-004
SS7	001-070-003	tgtansi003	no	---	-----	-----
SS7	200-002-001	rtxroute001	no	---	-----	-----
SS7	040-001-*	myncaibeno	no	no	-----	-----



```

          040-010-*   myncaibeno2 no no -----
-----          SS7
          010-*-*   -----
-----          SS7

          DPCI      CLLI      BEI ELEI  ALIASA
ALIASN/N24  DMN
          2-010-0   dstn13     no  --- -----
-----          SS7
          2-010-1   dstn14     no  --- 002-010-001
-----          SS7
          2-010-2   dstn15     no  --- ----- 04178-
aa          SS7
          2-010-3   dstn16     no  --- ----- s-04179-
aa          SS7
          2-070-1   tgtitui001 no  --- -----
-----          SS7
          2-010-4   dstn17     no  --- -----
002-010-004  SS7
          2-010-5   dstn18     no  --- 002-010-005 04181-
aa          SS7
          2-010-6   dstn19     no  --- 002-010-006 s-04182-
aa          SS7
          2-010-7   dstn20     no  --- 002-010-007
002-010-007  SS7
          2-070-2   tgtitui002 no  --- -----
-----          SS7

          DPCI      CLLI      BEI ELEI  ALIASI
ALIASN/N24  DMN
          3-030-0   dstn29     no  --- s-3-030-0
-----          SS7
          3-030-1   dstn30     no  --- s-3-030-1 06385-
aa          SS7
          3-030-2   dstn31     no  --- s-3-030-2 s-06386-
aa          SS7
          3-070-1   tgtitui005 no  --- s-3-070-1
-----          SS7
          3-030-3   dstn32     no  --- s-3-030-3
003-030-003  SS7
          3-070-2   tgtitui006 no  --- s-3-070-2
-----          SS7

          DPCI      CLLI      BEI ELEI  ALIASN
ALIASN      DMN
          3-030-4   dstn33     no  --- s-06388-aa 06388-
aa          SS7
          3-030-5   dstn34     no  --- 06389-aa s-06389-
aa          SS7

          DPCN      CLLI      BEI ELEI  ALIASA
ALIASI      DMN
          06157-aa  ----- no  --- 020-005-002
-----          SS7
          08192-aa  dstn41     no  --- -----

```

```

----- SS7
      08193-aa      dstn42      no --- 004-000-001 -----
SS7
      08194-aa      dstn43      no --- ----- 4-000-2
SS7
      08195-aa      dstn44      no --- ----- s-4-000-3
SS7
      08753-aa      tgttitun001 no --- -----
SS7
      08196-aa      dstn45      no --- 004-000-004 4-000-4
SS7
      08197-aa      dstn46      no --- 004-000-005 s-4-000-5
SS7
      08754-aa      tgttitun002 no --- -----
SS7
      08757-aa      tgttitun005 no --- -----
SS7
      08199-fr      dstn48dupfr no --- ----- s-4-006-1
SS7
      08199-tk      dstn48dupTk no --- ----- 4-006-2
SS7
      08198-nz      dstn47dupnz no --- -----
SS7

      DPCN          CLLI          BEI ELEI  ALIASI          ALIASI
DMN
      08198-aa      dstn47      no --- s-4-000-6      4-000-6
SS7
      08199-aa      dstn48      no --- 4-000-7        s-4-000-7
SS7
      08198-fr      dstn47dupfr no --- s-4-005-7      4-005-7
SS7
      08198-tk      dstn47dupTk no --- 4-006-0        s-4-006-0
SS7

      DPCN          CLLI          BEI ELEI  ALIASN          ALIASI
DMN
      12688-aa      dstn57      no --- s-12688-aa     -----
SS7
      12689-aa      dstn58      no --- s-12689-aa     6-050-1
SS7
      12690-aa      dstn59      no --- s-12690-aa     s-6-050-2
SS7

      DPCN24        CLLI          BEI ELEI  ALIASA          ALIASI
DMN
      003-003-004   ----- no --- 003-003-003    3-003-4
SS7
      006-005-001   dstn63      no --- -----
SS7
      006-005-002   dstn64      no --- 006-005-002  -----
SS7
      006-005-003   dstn65      no --- ----- 6-005-3
SS7
      006-070-001   tgttitun24a no --- -----

```

```

SS7
      006-005-004  dstn66      no --- -----
s-6-005-4      SS7
      006-005-005  dstn67      no ---   006-005-005
6-005-5      SS7
      006-070-002  tgttitun24b no --- -----
-----      SS7

```

Destination table is (208 of 2000) 10% full

Alias table is (216 of 12000) 2% full

;

This example shows point codes with the spare point code subtype prefix (s-):

```
rtrv-dstn:pcst=s
```

```
eagle10115 10-10-29 10:00:37 EST EAGLE 43.0.0
```

```
rtrv-dstn:pcst=s
```

```
Command entered at terminal #4.
```

```
Extended Processing Time may be Required
```

```

          DPCI          CLLI          BEI ELEI  ALIASA
ALIASN/N24  DMN
      s-4-002-0          ----- no ---   010-001-001  s-08228-
aa      SS7
      s-2-020-0          dstn21      no --- -----
-----      SS7
      s-2-020-1          dstn22      no ---   002-020-001
-----      SS7
      s-2-020-2          dstn23      no --- -----          04258-
aa      SS7
      s-2-020-3          dstn24      no --- -----          s-04259-
aa      SS7
      s-2-070-3          tgttitui003 no --- -----
-----      SS7
      s-2-020-4          dstn25      no --- -----
002-020-004  SS7
      s-2-020-5          dstn26      no ---   002-020-005  04261-
aa      SS7
      s-2-020-6          dstn27      no ---   002-020-006  s-04262-
aa      SS7
      s-2-020-7          dstn28      no ---   002-020-007
002-020-007  SS7
      s-2-070-4          tgttitui004 no --- -----
-----      SS7
      s-3-070-3          tgttitui007 no --- -----
-----      SS7
      s-3-070-4          tgttitui008 no --- -----
-----      SS7
      s-2-029-6          rtxroute002 no ---   002-029-006  s-04269-
aa      SS7

```

```

          DPCI          CLLI          BEI ELEI  ALIASI
ALIASN/N24  DMN

```

SS7	s-3-040-2	dstn35	no	---	3-040-2	-----
SS7	s-3-040-3	dstn36	no	---	3-040-3	06467-aa
SS7	s-3-040-4	dstn37	no	---	3-040-4	s-06468-aa
SS7	s-3-040-5	dstn38	no	---	3-040-5	003-040-005
DMN	DPCI	CLLI	BEI	ELEI	ALIASN	ALIASN
SS7	s-3-040-6	dstn39	no	---	s-06471-aa	06471-aa
SS7	s-3-040-7	dstn40	no	---	06472-aa	s-06472-aa
DMN	DPCN	CLLI	BEI	ELEI	ALIASA	ALIASI
SS7	s-08272-aa	dstn49	no	---	-----	-----
SS7	s-08273-aa	dstn50	no	---	004-010-001	-----
SS7	s-08274-aa	dstn51	no	---	-----	4-010-2
SS7	s-08275-aa	dstn52	no	---	-----	s-4-010-3
SS7	s-08755-aa	tgtitun003	no	---	-----	-----
SS7	s-08276-aa	dstn53	no	---	004-010-004	4-010-4
SS7	s-08277-aa	dstn54	no	---	004-010-005	s-4-010-5
SS7	s-08756-aa	tgtitun004	no	---	-----	-----
SS7	s-08758-aa	tgtitun006	no	---	-----	-----
SS7	s-08273-fr	dstn50dupfr	no	---	-----	4-006-3
DMN	DPCN	CLLI	BEI	ELEI	ALIASI	ALIASI
SS7	s-08278-aa	dstn55	no	---	s-4-010-6	4-010-6
SS7	s-08279-aa	dstn56	no	---	4-010-7	s-4-010-7
SS7	s-08379-aa	rtxroute003	no	---	s-4-058-7	4-058-7
DMN	DPCN	CLLI	BEI	ELEI	ALIASN	ALIASI
SS7	s-12691-aa	dstn60	no	---	12691-aa	-----
SS7	s-12692-aa	dstn61	no	---	12692-aa	6-050-4
SS7	s-12693-aa	dstn62	no	---	12693-aa	s-6-050-5

```

SS7
   s-08272-fr      dstn49dupfr no --- 08300-fr
-----          SS7
   s-08272-tk      dstn49dupTk no --- 08300-tk
4-006-7          SS7

```

Destination table is (208 of 2000) 10% full

Alias table is (216 of 12000) 2% full

;

This example shows point codes with the private point code subtype prefix (p-):

```
rtrv-dstn:pcst=p
```

```
eagle10115 10-10-29 10:00:37 EST EAGLE 43.0.0
```

```
rtrv-dstn:pcst=p
```

```
Command entered at terminal #4.
```

```
Extended Processing Time may be Required
```

```

          DPCA          CLLI          BEI ELEI  ALIASI
ALIASN/N24  DMN
   p-001-001-001  dstn01p    no --- -----
-----          SS7
   p-001-001-002  dstn02p    no --- 1-011-2
-----          SS7
   p-001-001-003  dstn03p    no --- s-1-011-3
-----          SS7
   p-001-001-004  dstn04p    no --- -----          01060-
aa          SS7
   p-001-001-005  dstn05p    no --- -----          s-01061-
aa          SS7
   p-001-001-006  dstn06p    no --- -----
001-011-006  SS7
   p-001-001-007  dstn07p    no --- 1-011-7          01063-
aa          SS7
   p-001-002-000  dstn08p    no --- 1-012-0          s-01064-
aa          SS7
   p-001-002-001  dstn09p    no --- s-1-012-1          01065-
aa          SS7
   p-001-002-002  dstn10p    no --- s-1-012-2          s-01066-
aa          SS7
   p-001-002-003  dstn11p    no --- 1-012-3
001-012-003  SS7
   p-001-002-004  dstn12p    no --- s-1-012-4
001-012-004  SS7

          DPCI          CLLI          BEI ELEI  ALIASA
ALIASN/N24  DMN
   p-2-010-0      dstn13p    no --- -----
-----          SS7
   p-2-010-1      dstn14p    no --- 002-100-001
-----          SS7
   p-2-010-2      dstn15p    no --- -----          08178-
aa          SS7

```

SS7	p-2-010-3	dstn16p	no	---	-----	s-08179-aa
SS7	p-2-010-4	dstn17p	no	---	-----	002-100-004
SS7	p-2-010-5	dstn18p	no	---	002-100-005	08181-aa
SS7	p-2-010-6	dstn19p	no	---	002-100-006	s-08182-aa
SS7	p-2-010-7	dstn20p	no	---	002-100-007	002-100-007
DMN	DPCI	CLLI	BEI	ELEI	ALIASI	ALIASN/N24
SS7	p-3-030-0	dstn29p	no	---	s-3-031-0	-----
SS7	p-3-030-1	dstn30p	no	---	s-3-031-1	07385-aa
SS7	p-3-030-2	dstn31p	no	---	s-3-031-2	s-07386-aa
SS7	p-3-030-3	dstn32p	no	---	s-3-031-3	003-031-003
DMN	DPCI	CLLI	BEI	ELEI	ALIASN	ALIASN
SS7	p-3-030-4	dstn33p	no	---	s-07388-aa	07388-aa
SS7	p-3-030-5	dstn34p	no	---	07389-aa	s-07389-aa
DMN	DPCN	CLLI	BEI	ELEI	ALIASA	ALIASI
SS7	p-08192-aa	dstn41p	no	---	-----	-----
SS7	p-08193-aa	dstn42p	no	---	004-200-001	-----
SS7	p-08194-aa	dstn43p	no	---	-----	4-040-2
SS7	p-08195-aa	dstn44p	no	---	-----	s-4-040-3
SS7	p-08196-aa	dstn45p	no	---	004-200-004	4-040-4
SS7	p-08197-aa	dstn46p	no	---	004-200-005	s-4-040-5
DMN	DPCN	CLLI	BEI	ELEI	ALIASI	ALIASI
SS7	p-08198-aa	dstn47p	no	---	s-4-040-6	4-040-6
SS7	p-08199-aa	dstn48p	no	---	4-040-7	s-4-040-7
DMN	DPCN	CLLI	BEI	ELEI	ALIASN	ALIASI
SS7	p-12688-aa	dstn57p	no	---	s-13688-aa	-----

```

        p-12689-aa      dstn58p      no --- s-13689-aa
6-060-1          SS7
        p-12690-aa      dstn59p      no --- s-13690-aa
s-6-060-2          SS7

        DPCN24          CLLI          BEI ELEI  ALIASA
ALIASI          DMN
        p-006-005-001  dstn63p      no --- -----
-----          SS7
        p-006-005-002  dstn64p      no --- 006-005-020
-----          SS7
        p-006-005-003  dstn65p      no --- -----
6-050-3          SS7
        p-006-005-004  dstn66p      no --- -----
s-6-050-4          SS7
        p-006-005-005  dstn67p      no --- 006-005-050
6-050-5          SS7

```

```

Destination table is (208 of 2000) 10% full
Alias table is (216 of 12000) 2% full

```

```
;
```

This example shows point codes with the private and spare point code subtype prefix (ps-):

```
rtrv-dstn:pcst=ps
```

```

eagle10115 10-10-29 10:00:37 EST EAGLE 43.0.0
rtrv-dstn:pcst=ps
Command entered at terminal #4.
Extended Processing Time may be Required

```

```

        DPCI          CLLI          BEI ELEI  ALIASA
ALIASN/N24      DMN
        ps-2-020-0      dstn21p      no --- -----
-----          SS7
        ps-2-020-1      dstn22p      no --- 002-200-001
-----          SS7
        ps-2-020-2      dstn23p      no --- ----- 08258-
aa          SS7
        ps-2-020-3      dstn24p      no --- ----- s-08259-
aa          SS7
        ps-2-020-4      dstn25p      no --- -----
002-200-004      SS7
        ps-2-020-5      dstn26p      no --- -----
-----          SS7
        ps-2-020-6      dstn27p      no --- 002-200-005 08261-
aa          SS7
        ps-2-020-7      dstn28p      no --- 002-200-007
002-200-007      SS7

        DPCI          CLLI          BEI ELEI  ALIASI
ALIASN/N24      DMN
        ps-3-040-2      dstn35p      no --- 3-041-2

```

```

----- SS7
ps-3-040-3      dstn36p   no --- 3-041-3      07467-aa
SS7
ps-3-040-4      dstn37p   no --- 3-041-4      s-07468-aa
SS7
ps-3-040-5      dstn38p   no --- 3-041-5      003-041-005
SS7

          DPCI          CLLI          BEI ELEI    ALIASN          ALIASN
DMN
ps-3-040-6      dstn39p   no --- s-07471-aa    07471-aa
SS7
ps-3-040-7      dstn40p   no --- 07472-aa      s-07472-aa
SS7

          DPCN          CLLI          BEI ELEI    ALIASA          ALIASI
DMN
ps-08272-aa     dstn49p   no --- -----
SS7
ps-08273-aa     dstn50p   no --- 004-200-010  -----
SS7
ps-08274-aa     dstn51p   no --- ----- 4-050-2
SS7
ps-08275-aa     dstn52p   no --- ----- s-4-050-3
SS7
ps-08276-aa     dstn53p   no --- 004-200-040 4-050-4
SS7
ps-08277-aa     dstn54p   no --- 004-200-050 s-4-050-5
SS7

          DPCN          CLLI          BEI ELEI    ALIASI          ALIASI
DMN
ps-08278-aa     dstn55p   no --- s-4-050-6    4-050-6
SS7
ps-08279-aa     dstn56p   no --- 4-050-7      s-4-050-7
SS7

          DPCN          CLLI          BEI ELEI    ALIASN          ALIASI
DMN
ps-12691-aa     dstn60p   no --- 13691-aa     -----
SS7
ps-12692-aa     dstn61p   no --- 13692-aa     6-060-4
SS7
ps-12693-aa     dstn62p   no --- 13693-aa     s-6-060-5
SS7

```

```

Destination table is (208 of 2000) 10% full
Alias table is (216 of 12000) 2% full

```

```
;
```

This example shows the output for an ANSI destination point code with a single SPC:



```
rtrv-dstn:dpca=1-56-5
```

```

eagle10115 10-08-12 10:00:37 EST EAGLE 43.0.0
      DPCA          CLLI          BEI ELEI  ALIASI
ALIASN/N24  DMN
      001-056-005  ----- no  ---  1-056-2
16000      SS7
      SPC          NCAI          RCAUSE NPRST SPLITIAM HMSMSC HMSCP
SCCPMSGCNV
      ----- no          none  off  none  no  no
sxudt2udt

```

```
Destination table is (12 of 2000) 1% full
```

```
Alias table is (4 of 12000) 1% full
```

```
;
```

This example shows the 24-bit ITU-N destination point code(s) assigned to the 24-bit ITU-N secondary point code:

```
rtrv-dstn:spcn24=6-5-0
```

```

eagle10115 10-10-29 10:00:37 EST EAGLE 43.0.0
rtrv-dstn:spcn24=6-5-0
Command entered at terminal #4.
Extended Processing Time may be Required

SPCN24= 006-005-000

      DPCN24          CLLI          BEI ELEI  ALIASA
ALIASI          DMN
      003-003-004  ----- no  ---  003-003-003
3-003-4          SS7
      006-005-001  dstn63      no  ---  -----
-----          SS7
      p-006-005-001  dstn63p     no  ---  -----
-----          SS7
      006-005-002  dstn64      no  ---  006-005-002
-----          SS7
      p-006-005-002  dstn64p     no  ---  006-005-020
-----          SS7
      006-005-003  dstn65      no  ---  -----
6-005-3          SS7
      p-006-005-003  dstn65p     no  ---  -----
6-050-3          SS7
      006-070-001  tgtitun24a  no  ---  -----
-----          SS7
      006-005-004  dstn66      no  ---  -----
s-6-005-4          SS7
      p-006-005-004  dstn66p     no  ---  -----
s-6-050-4          SS7
      006-005-005  dstn67      no  ---  006-005-005
6-005-5          SS7
      p-006-005-005  dstn67p     no  ---  006-005-050

```

```

6-050-5      SS7
              006-070-002  tgtitun24b  no  --- -----
SS7

Destination table is (208 of 2000) 10% full
Alias table is (216 of 12000) 2% full
;

```

This example shows a summary report for all point code destinations that are members of the given network. This does not include the specified network routing point code 40-\*\*-\*

```
rtrv-dstn:dpc=40-**-*
```

```

eagle10115 10-10-09 10:00:37 EST  EAGLE 43.0.0
rtrv-dstn:dpc=40-**-*
Command entered at terminal #4.
Extended Processing Time may be Required

      DPCA          CLLI          BEI ELEI  ALIASI          ALIASN/N24
DMN
      040-001-*      myncaibeno  no  no  -----
SS7
      040-010-*      myncaibeno2 no  no  -----
SS7
      040-001-001    noncluster1 no  --- -----
SS7
      040-001-002    noncluster2 no  --- -----
SS7

Destination table is (211 of 2000) 11% full
Alias table is (216 of 12000) 2% full
;

```

This example shows summary output when proxy point code destinations are present:

```
rtrv-dstn
```

```

tekelecstp 10-10-15 14:46:12 EST  EAGLE 43.0.0
rtrv-dstn
Command entered at terminal #4.
Extended Processing Time may be Required

      DPCA          CLLI          BEI ELEI  ALIASI          ALIASN/N24
DMN
      002-002-002    ----- no  --- -----
SS7
      001-001-001    ----- no  --- -----
SS7
      001-001-002    ----- no  --- -----
SS7
      001-001-003    ----- no  --- -----
SS7

```

```

001-001-004 ----- no --- -----
----- SS7
001-001-005 ----- no --- -----
----- SS7
001-001-006 ----- no --- -----
----- SS7
001-001-007 ----- no --- -----
----- SS7
001-001-008 ----- no --- -----
----- SS7
001-001-009 ----- no --- -----
----- SS7
001-001-010 ----- no --- -----
----- SS7

```

```

Destination table is (11 of 2000) 1% full
Alias table is (0 of 12000) 0% full
PPC table is (1 of 10) 10% full

```

```
;
```

This example shows the output for a destination that references a proxy point code:

```
rtrv-dstn:dpc=1-1-1
```

```

eagle10115 10-08-12 10:00:37 EST EAGLE 43.0.0
DPCA          CLLI          BEI ELEI  ALIASI
ALIASN/N24    DMN
001-001-001 ----- no --- -----
----- SS7

PPCA          NCAI PRX      RCAUSE NPRST SPLITIAM HMSMSC HMSCP
SCCPMSGCNV
002-002-002 ---- no      none  off  none  no   no
none

```

```

Destination table is (30 of 2000) 2% full
Alias table is (0 of 12000) 0% full
PPC table is (1 of 100) 10% full

```

```
;
```

This example shows summary information for all destinations using a specified proxy point code:

```
rtrv-dstn:ppc=2-2-2
```

```

eagle10115 10-10-09 10:00:37 EST EAGLE 43.0.0
rtrv-dstn:ppc=2-2-2
Command entered at terminal #4.
Extended Processing Time may be Required

PPCA=      002-002-002

```

	DPCA	CLLI	BEI	ELEI	ALIASI	ALIASN/N24
DMN	001-001-001	-----	no	---	-----	-----
SS7	001-001-002	-----	no	---	-----	-----
SS7	001-001-003	-----	no	---	-----	-----
SS7	001-001-004	-----	no	---	-----	-----
SS7	001-001-005	-----	no	---	-----	-----
SS7	001-001-006	-----	no	---	-----	-----
SS7	001-001-007	-----	no	---	-----	-----
SS7	001-001-008	-----	no	---	-----	-----
SS7	001-001-009	-----	no	---	-----	-----
SS7	001-001-010	-----	no	---	-----	-----

Destination table is (11 of 2000) 1% full

Alias table is (0 of 12000) 0% full

PPC table is (1 of 10) 10% full

;

This example shows summary information for all proxy destinations:

rtrv-dstn:prx=yes

eagle10115 10-10-09 10:00:37 EST EAGLE 43.0.0

rtrv-dstn:prx=yes

Command entered at terminal #4.

Extended Processing Time may be Required

PRX= yes

	DPCA	CLLI	BEI	ELEI	ALIASI	ALIASN/N24
DMN	001-001-001	-----	no	---	-----	-----
SS7	001-001-002	-----	no	---	-----	-----
SS7	001-001-003	-----	no	---	-----	-----
SS7	001-001-004	-----	no	---	-----	-----

Destination table is (17 of 2000) 1% full

Alias table is (0 of 12000) 0% full

```

    PPC table is (4 of 10) 40% full
;

```

This example shows the output for a specific destination point code when the Proxy Point Code feature is turned on and the DPC refers to a secondary point code. The *homesmsc* and *homescp* flags are provisioned.

```
rtrv-dstn:dpc=3-3-3
```

```

    eagle10115 10-08-12 10:00:37 EST  EAGLE 43.0.0
          DPCA          CLLI          BEI ELEI  ALIASI
ALIASN/N24  DMN
          003-003-003  ----- no  --- -----
----- SS7
          SPCA          NCAI PRX      RCAUSE NPRST SPLITIAM HMSMSC HMSCP
SCCPMSGCNV
          009-009-009  ---- no      none  off  none    yes    yes
none
    Destination table is (4 of 2000) 1% full
    Alias table is (0 of 12000) 0% full
    PPC table is (2 of 10) 20% full
;

```

This example shows the ITUN destination point code(s) within a spare group code when the ITUDUPPC feature is on and the STP flexible point code option (*npcfmti*) is set to the 4-member ITUN point format to (*m1-m2-m3-m4-gc*):

```
rtrv-dstn:dpcn=s-*-***-*-fr
```

```

    eagle10115 10-10-09 10:00:37 EST  EAGLE 43.0.0
    rtrv-dstn:dpcn=s-*-***-*-fr
    Command entered at terminal #4.
    Extended Processing Time may be Required

          DPCN          CLLI          BEI ELEI  ALIASA
ALIASI          DMN
          s-1034-0-0-1-fr dstn50dupfr no  --- -----
4-006-3          SS7

          DPCN          CLLI          BEI ELEI  ALIASN
ALIASI          DMN
          s-1034-0-0-0-fr dstn49dupfr no  ---  1037-1-0-0-fr
----- SS7

    Destination table is (208 of 2000) 10% full
    Alias table is (216 of 12000) 2% full
;

```

This example shows the output when the *rcause* and *nprst* parameters are provisioned:

```
rtrv-dstn:dpci=1-1-1
```

```

eagle10115 10-08-12 10:00:37 EST EAGLE 43.0.0

      DPCI          CLLI          BEI ELEI  ALIASA          ALIASN/N24
DMN   1-001-1      ----- no   ---   001-001-001    16000
SS7

      SPCI          NCAI          RCAUSE NPRST SPLITIAM HMSMSC HMSCP
SCCPMSGCNV
      ----- no          5       on   none    no    no    none

Destination table is (12 of 2000) 1% full
Alias table is (4 of 12000) 1% full

```

```
;
```

This example shows the output when IAM/SAM splitting is provisioned:

```
rtrv-dstn:splitiam=20
```

```

tklc1191001 10-10-28 07:25:13 EST EAGLE5 43.0.0
rtrv-dstn:splitiam=20
Command entered at terminal #4.
Extended Processing Time may be Required

      DPCA          CLLI          BEI ELEI  ALIASI          ALIASN/N24
DMN

      DPCI          CLLI          BEI ELEI  ALIASA          ALIASN/N24
DMN   1-001-1      ----- no   ---   001-001-001    -----
SS7

      DPCN          CLLI          BEI ELEI  ALIASA          ALIASI
DMN

      DPCN24        CLLI          BEI ELEI  ALIASA          ALIASI
DMN

DESTINATION ENTRIES ALLOCATED:  8000
  FULL DPC(s) :                  864
  EXCEPTION DPC(s) :             5184
  NETWORK DPC(s) :                  0
  CLUSTER DPC(s) :                  0
  TOTAL DPC(s) :                 6048
  CAPACITY (% FULL) :             76%
ALIASES ALLOCATED:              8000
  ALIASES USED:                  1511
  CAPACITY (% FULL) :             19%
X-LIST ENTRIES ALLOCATED:       500

```

```
;
```

This example shows summary information for all the destinations with  
sccpmsgcnv=udt2xudt:

```
rtrv-dstn:sccpmsgcnv=udt2xudt
```

```

eagle10115 10-11-22 10:00:36 EST  EAGLE 43.0.0

      DPCA          CLLI          BEI ELEI  ALIASI
ALIASN/N24  DMN
      009-009-009  ----- no  --- -----
----- SS7

      DPCI          CLLI          BEI ELEI  ALIASA
ALIASN/N24  DMN

      DPCN          CLLI          BEI ELEI  ALIASA
ALIASI      DMN
      01234        ----- no  --- -----
----- SS7

      DPCN24        CLLI          BEI ELEI  ALIASA
ALIASI      DMN

Destination table is (5 of 2000) 1% full
Alias table is (0 of 12000) 0% full

```

```
;
```

This example shows the output when the NCR, NRT, and CRMD features are  
on, and the 10,000 Routesets feature is enabled:

```
rtrv-dstn
```

```

rlghncxa03w 10-08-17 08:29:15 EST  EAGLE 43.0.0
      DPCA          CLLI          BEI ELEI  ALIASI
ALIASN/N24  DMN
      003-003-003  ----- no  --- -----
----- SS7
      004-004-004  ----- no  --- -----
----- SS7
      005-005-005  ----- no  --- -----
----- SS7
      008-001-*    ----- no  no  -----
----- SS7

DESTINATION ENTRIES ALLOCATED: 10000
FULL DPC(s) : 9
NETWORK DPC(s) : 0
CLUSTER DPC(s) : 1
TOTAL DPC(s) : 10
CAPACITY (% FULL) : 1%
ALIASES ALLOCATED: 10000
ALIASES USED: 0

```

```

          CAPACITY (% FULL):                0%
X-LIST ENTRIES ALLOCATED:                500
;

```

This example shows the output when the CRMD, NCR, NRT features are off and the 10,000 Routesets feature is enabled. If the route table is not empty, the provisioned DSTP is also displayed:

```

rtrv-dstn

      rlghncxa03w 10-08-17 08:29:15 EST  EAGLE 43.0.0
Destination table is (10 of 10000) 1% full
Alias table is (8 of 10000) 1% full
RTRV-DSTN: MASP A - COMPLTD
;

```

This example shows the output when the J7 Support feature is enabled:

```

rtrv-dstn:pctype=itun16

      tekelecstp 13-02-27 15:13:41 EST  45.0.0-64.56.0
rtrv-dstn:pctype=ansi
Command entered at terminal #4.
Extended Processing Time may be Required

      DPCN16          CLLI          BEI  ELEI   ALIASI
ALIASN              DMN
      001-002-006   ----- no   ---   001-002-005
-----
                      SS7

      Destination table is (2 of 2000) 1% full
      Alias table is (2 of 12000) 1% full
;

```

### Legend

- **DPC/DPCA/DPCI/DPCN/DPCN24**—Destination point code
- **CLLI**—Command Language Location Indicator
- **BEI**—Broadcast Exception Indicator
- **ELEI**—Cluster Exception-List Exclusion Indicator
- **NCAI**—Nested Cluster Allowed Indicator
- **ALIASA/ALIASI/ALIASN/ALIASN24**—Alias point code
- **SPC**—Secondary point code
- **DMN**—Destination Entity Domain
- **PPC**—Proxy Point Code
- **PRX**—Proxy Point Code Indicator



- **RCAUSE**—Release Cause
- **NPRST**—NM Bits Reset
- **SPLITIAM**—IAM/SAM Split
- **HOMESMSC**—Home SMSC
- **HOMESCP**—Home SCP
- **SCCPMSGCNV**—SCCP Message Conversion Indicator

#### Related Topics

- [chg-dstn](#)
- [chg-rte](#)
- [dlt-dstn](#)
- [dlt-rte](#)
- [ent-dstn](#)
- [ent-rte](#)
- [rept-stat-dstn](#)
- [rept-stat-rte](#)
- [rtrv-rte](#)

## rtrv-e1

Use this command to retrieve information for a specified E1 interface or for all E1 interfaces that have been defined by the `ent-e1` command for an E5-E1T1-B card used as an E1 or SE-HSL card.

#### Parameters

##### **e1port (optional)**

E1 port number

The value must be an E1 port that has already been configured with an E1 interface on the specified E1 card (`loc` parameter).

##### **Range:**

1 - 8

##### **Default:**

If not specified, all E1 ports are listed.

##### **loc (optional)**

The card location as stenciled on the shelf of the system.

##### **Range:**

1101 - 1108, 1111 - 1112, 1201 - 1208, 1211 - 1218, 1301 - 1308, 1311 - 1318,  
2101 - 2108, 2111 - 2118, 2201 - 2208, 2211 - 2218, 2301 - 2308, 2311 - 2318,  
3101 - 3108, 3111 - 3118, 3201 - 3208, 3211 - 3218, 3301 - 3308, 3311 - 3318,  
4101 - 4108, 4111 - 4118, 4201 - 4208, 4211 - 4218, 4301 - 4308, 4311 - 4318,  
5101 - 5108, 5111 - 5118, 5201 - 5208, 5211 - 5218, 5301 - 5308, 5311 - 5318,  
6101 - 6108, 6111 - 6118

**Default:**

If not specified, all E1 card locations are listed.

**Example**

```
rtrv-e1
rtrv-e1:loc=1307:elport=2
rtrv-e1:loc=1311:elport=1
```

**Dependencies**

The `loc` and `elport` parameters must be specified together in the command.

The E1 interface of the E1 card specified by the `loc` parameter must already be defined (see the `ent-e1` command) before this command can be entered.

The card specified by the `loc` parameter must be a LIME1 card type.

The Card (IMT) table must be accessible.

The E1/T1 table must be accessible.

An E1 interface must already be defined on the port specified by the `elport` parameter before this command can be entered.

The following card locations (`loc` parameter) are not valid for this command: 1113 through 1118 and all `xy09` and `xy10` locations (where `x` is the frame and `y` is the shelf).

**Notes**

None.

**Output****Legend**

- **LOC**—E1 card location
- **E1PORT**—E1 port number on an E1 card
- **CRC4**—CRC4 indicator
- **ENCODE**—Indicator for use of HDB3 or AMI encoding/decoding
- **SI**—Value of two Spare International bits of NFAS data
- **SN**—Value of five Spare National bits of NFAS data
- **MINSURATE**—Minimum number of signaling units present on a link uniformly distributed. A value appears in this field only when the LINKCLASS field value is UNCHAN.
- **TSx**—Timeslot

**Related Topics**

- [chg-e1](#)
- [dlt-e1](#)
- [ent-e1](#)
- [tst-e1](#)

## rtrv-eisopts

Use this command to retrieve the status of the copy functions for the EAGLE 5 Integrated Monitoring Support (E5IS) feature.

### Parameters

This command has no parameters.

### Example

```
rtrv-eisopts
```

### Dependencies

The NETOPTS table must be accessible.

The EAGLE 5 Integrated Monitoring Support (E5IS) feature must be turned on before this command can be entered.

### Notes

None

### Output

```
rtrv-eisopts

rlghncxa03w 17-08-21 11:12:15 EST  EAGLE 46.6.0
  EIS OPTIONS
  -----
  EISCOPY = ON

  FAST COPY OPTIONS
  -----
  FCGPL = IPSG      FCMODE = FCOPY
  -----
;
```

### Related Topics

- [chg-eisopts](#)

## rtrv-enum-acl

Use this command to retrieve an entry from the ENUM Access Control List (ACL) Table. The ENUM ACL Table supports the provisioning information related to the allowed IP addresses for the ENUM application.

## Parameters

### ipaddr (optional)

This is a TCP/IP address expressed in standard dot notation. It specifies allowed IP addresses for the ENUM application.

#### Range:

Four numbers separated by dots, with each number in the range of 0-255, \*.

#### Note:

It also supports wildcard characters as follows:

```
xxx.xxx.xxx.*
```

```
xxx.xxx.*.*
```

```
xxx.*.*.*
```

where xxx can be any number in range of 0-255.

#### System Default:

0.0.0.0

## Example

```
rtrv-enum-acl
rtrv-enum-acl:ipaddr=10.248.13.9
rtrv-enum-acl:ipaddr=10.248.13.*
rtrv-enum-acl:ipaddr=10.248.*.*
rtrv-enum-acl:ipaddr=10.*.*.*
```

## Dependencies

The ENUM ACL Table should be accessible.

The IP address specified by the IPADDR parameter should be provisioned in the ENUM ACL Table.

The IP address specified by the IPADDR parameter must be a valid IP address.

## Notes

Wildcard IP addresses are allowed to support the ranges of IP addresses.

## Output

This example displays output when the IPADDR parameter is not specified:

```
rtrv-enum-acl

tekelecstp 14-05-28 15:04:28 EST EAGLE 46.1.0
  rtrv-enum-acl
  Command entered at terminal #4.
  RTRV-ENUM-ACL: MASP A - COMPLTD
```

```
;
  IP Address
  -----
  10.248.13.4
  10.245.13.*
  12.*.*.*

rtrv-enum-acl:ipaddr=10.248.13.9

tekelecstp 14-05-28 15:04:28 EST EAGLE 46.1.0
  rtrv-enum-acl:ipaddr=10.248.13.9
  Command entered at terminal #4.
  RTRV-ENUM-ACL: MASP A - COMPLTD

;
  IP Address
  -----
  10.248.13.9
```

### Related Topics

- [dlt-enum-acl](#)
- [ent-enum-acl](#)

## rtrv-enumopts

Use this command to retrieve the parameters from the ENUMOPTS table.

### Parameters

This command has no input parameters.

### Example

```
rtrv-enumopts
```

### Dependencies

The ENUMOPTS table should be accessible.

### Output

This example shows output with default ENUM options in EAGLE Release 46.1.0.

```
rtrv-enumopts

tekelecstp 14-06-02 11:43:52 EST EAGLE 46.1.0
rtrv-enumopts
Command entered at terminal #4.

MAXDNDIGS = 10
CONGLVL1  = 40
CONGLVL2  = 80
```

```
CNGNTFY = no
CNGRCODE = ENUM QRY REFUSED(5)
```

```
;
```

This example shows output with default ENUM options in EAGLE Release 46.5.0.

```
rtrv-enumopts
```

```
Command Accepted - Processing
```

```
tekelecstp 17-03-16 13:44:43 EST EAGLE 46.5.0.0.0-70.22.0
rtrv-enumopts
Command entered at terminal #2.
```

```
ENUM OPTIONS TABLE
```

```
-----
```

```
MAXDNDIGS = 15
CONGLVL1 = 40
CONGLVL2 = 80
CNGNTFY = no
CNGRCODE = ENUM QRY REFUSED(5)
EXCLUDESP = no
RNCONTEXT = no
```

```
;
```

This example shows output with default ENUM options in EAGLE Release 46.8.0.

```
rtrv-enumopts
```

```
Command Accepted - Processing
```

```
tekelecstp 19-05-03 16:59:46 MST EAGLE 46.8.0.0.0-75.18.14
rtrv-enumopts
Command entered at terminal #3.
```

```
tekelecstp 19-05-03 16:59:46 MST EAGLE 46.8.0.0.0-75.18.14
```

```
ENUM OPTIONS TABLE
```

```
-----
```

```
MAXDNDIGS = 15
CONGLVL1 = 40
CONGLVL2 = 80
CNGNTFY = no
CNGRCODE = ENUM QRY REFUSED(5)
EXCLUDESP = no
RNCONTEXT = no
INCPREFIX = no
```

```
;
```

## Related Topics

- [chg-enumopts](#)

## rtrv-enum-prof

Use this command to retrieve the existing profile entry which has data to generate the ENUM response for three supported resource record formats such as NAPTR, NS and CNAME. The ENUM Profile Table stores the profile entry.

### Parameters

#### **prn (optional)**

Profile name. This parameter specifies the unique logical name assigned to the profile entry used to generate the ENUM response.

##### **Range:**

*ZZZZZZZZZZ*

A string of alphanumeric characters, beginning with a letter and up to 10 characters in length. Valid values are a..z, A..Z, 0..9.

#### **rtrtype (optional)**

Response type. This parameter specifies the response type for the profile. It identifies the profile used to generate the ENUM response for each resource record type.

##### **Range:**

*naptr*

*cname*

*ns*

##### **Default:**

No change to the current value

##### **System Default:**

*naptr*

#### **sparm (optional)**

Service parameter. This parameter specifies the supported ENUM services. The ENUM application shall only support two ENUM Services.

##### **Range:**

*pstntel*

*pstnsip*

*sip*

##### **Default:**

No change to the current value

##### **System Default:**

*pstntel*

**prefix (optional)**

This parameter specifies the prefix digits to be appended as routed number (RN) in NAPTR regex response. This parameter is only valid for NAPTR response type.

**Range:**

0 - ffff

Upto 5 hexa-decimal digits allowed.

*sip*

**Default:**

No change to the current value

**System Default:**

*None*

**Example**

```
rtrv-enum-prof:prn=pr1
rtrv-enum-prof:sparm=pstntel
rtrv-enum-prof:rtype=ns
rtrv-enum-prof:rtype=naptr:sparm=sip
rtrv-enum-prof:rtype=naptr:sparm=pstnsip
rtrv-enum-prof:prefix=1234
```

**Dependencies**

The ENUM Profile Table should be accessible.

The Profile name parameter cannot be specified with any other parameter.

The Profile name must be present in the ENUM Profile Table.

Either provide the SPARM parameter alone or with the RTYPE=NAPTR parameter.

**Notes**

The requirement of using PREFIX in the regular expression is only for PSTN-SIP (NAPTR query). As such, PREFIX will not be applied for PSTN-TEL and SIP (NAPTR queries).

PREFIX can be configured for PSTN-TEL and SIP profiles, but it will not be used.

**Output**

The example shows the output of a profile having RTYPE = NAPTR.

```
> rtrv-enum-prof:prn=pr1

tekelecstp 18-05-29 04:55:20 MST EST EAGLE 46.1.0
rtrv-enum-prof:prn=pr1

PROFILE NAME: pr1
RTYPE      : naptr      SPARM      : sip
```



```
PREF      : yes          RRDOMAIN : abc.oracle.com
RPDOMAIN  : ---
;
```

The example shows the output of a profile having RTYPE = NS.

```
> rtrv-enum-prof:prn=pr2
```

```
tekelecstp 18-05-29 04:57:20 MST EST EAGLE 46.1.0
rtrv-enum-prof:prn=pr2

PROFILE NAME: ns
RTYPE       : ns          SPARM    : ---          PREF   : ---
RRDOMAIN    : ---
RPDOMAIN    : def.oracle.com
;
```

The example shows the output of a NAPTR type profile in which replacement domain name is not provisioned.

```
> rtrv-enum-prof:prn=pr3
```

```
tekelecstp 18-05-29 04:58:20 MST EST EAGLE 46.1.0
rtrv-enum-prof:prn=pr3

PROFILE NAME: pr3
RTYPE       : naptr      SPARM    : pstnsip
PREF       : yes        RRDOMAIN  : abc1.oracle.com
RPDOMAIN    : ---
;
```

The example shows the output of `rtrv-enum-prof` without any parameter.

```
rtrv-enum-prof
```

```
tekelecstp 18-05-29 04:59:20 MST EST EAGLE 46.1.0
rtrv-enum-prof

PROFILE NAME: default
RTYPE       : ns          SPARM    : ---          PREF   : ---
RRDOMAIN    : ---
RPDOMAIN    : abc.com

PROFILE NAME: ns
RTYPE       : ns          SPARM    : ---          PREF   : ---
RRDOMAIN    : ---
RPDOMAIN    : def.oracle.com
```

```
PROFILE NAME: cname
RTYPE      : cname      SPARM   : ---      PREF   : ---
RRDOMAIN   : ---
RPDOMAIN   : def.oracle.com

PROFILE NAME: nap_prof
RTYPE      : naptr      SPARM   : pstntel  PREF   : no
RRDOMAIN   : ---
RPDOMAIN   : ---

ENUMPROF table is (4 of 1024) 1% full.

;
```

The example shows the output of rtrv-enum-prof with prefix parameter:

```
rtrv-enum-prof

>

tekelecstp 19-02-01 14:33:21 EST  EAGLE 46.8.0.0.0-75.18.11
rtrv-enum-prof:prefix=1234
Command entered at terminal #2.

;

tekelecstp 19-02-01 14:33:21 EST  EAGLE 46.8.0.0.0-75.18.11

PROFILE NAME: pr1
RTYPE      : naptr      SPARM   : sip      PREF   : yes
RRDOMAIN   : abc.oracle.com
RPDOMAIN   : ---
PREFIX     : 1234

PROFILE NAME: pr4
RTYPE      : naptr      SPARM   : pstnsip  PREF   : no
RRDOMAIN   : abc2.oracle.com
RPDOMAIN   : ---
PREFIX     : 1234

ENUMPROF table is (6 of 2048) 1% full.

;
```

### Related Topics

- [chg-enum-prof](#)
- [dlt-enum-prof](#)
- [ent-enum-prof](#)

## rtrv-enum-profsel

Use this command to retrieve an entry from the ENUM Profile Selection Table or the ENUM DN Block Table. The ENUM Profile Selection Table supports the provisioning information related to mapping the Entity Id to the Profile Selection Id. The ENUM DN Block table supports the provisioning information related to mapping the DN Block to the Profile Selection Id.

### Parameters

**edn (optional)**

End Dialed Number

**Range:**

5-15 digits

**entityid (optional)**

Network Entity

**Range:**

1-15 digits

**sdn (optional)**

Start Dialed Number

**Range:**

5-15 digits

### Example

```
rtrv-enum-profsel:entityid=12345
```

```
rtrv-enum-profsel:sdn=11223344
```

```
rtrv-enum-profsel:edn=1324566
```

```
rtrv-enum-profsel
```

### Dependencies

The value specified for the EntityId, SDN, or EDN parameters must already exist in the ENUM Profile Selection Table or the ENUM DN Block Table respectively.

The ENUM Profile Selection Table should be accessible.

The ENUM DN Block Table should be accessible.

Entity Id cannot be specified with SDN or EDN.

### Notes

None

### Output

This example displays output when entity Id is specified:

```
rtrv-enum-profsel:entityid=1234
```

```
tekelecstp 14-05-28 15:04:28 EST EAGLE 46.1.0
rtrv-enum-profsel:entityid=1234
Command entered at terminal #4.
RTRV-ENUM-PROFSEL: MASP A - COMPLTD
```

```
;
```

Entity ID	PRN1	PRN2	PRN3	PRN4
1234	---	cname	---	naptr

This example displays output when SDN is specified:

```
rtrv-enum-profsel:sdn=1234567
```

```
tekelecstp 14-05-28 15:04:28 EST EAGLE 46.1.0
rtrv-enum-profsel:sdn=1234567
Command entered at terminal #4.
RTRV-ENUM-PROFSEL: MASP A - COMPLTD
```

```
;
```

SDN	EDN	PRN1	PRN2	PRN3	PRN4
1234567	1235555	prof1	prof2	Prof3	Prof4

This example displays output when EDN is specified:

```
rtrv-enum-profsel:edn=1235555
```

```
tekelecstp 14-05-28 15:04:28 EST EAGLE 46.1.0
rtrv-enum-profsel:edn=1235555
Command entered at terminal #4.
RTRV-ENUM-PROFSEL: MASP A - COMPLTD
```

```
;
```

SDN	EDN	PRN1	PRN2	PRN3	PRN4
1234567	1235555	prof1	prof2	Prof3	Prof4

This example displays output of `rtrv-enum-profsel` without any parameters specified:

```
rtrv-enum-profsel
```

```
tekelecstp 14-05-28 15:04:28 EST EAGLE 46.1.0
rtrv-enum-profsel
Command entered at terminal #4.
RTRV-ENUM-PROFSEL: MASP A - COMPLTD
```

```

;

Entity ID          PRN1          PRN2          PRN3          PRN4
-----
1234              ---          cname        ---          naptr
12345            ns1          ---          naptr        ---
12346            ---          ---          ---          naptr

SDN              EDN              PRN1          PRN2          PRN3          PRN4
-----
1234567          1235555          prof1         prof2         Prof3         Prof4

ENUMPRID table is (3 of 1024) 1% full.

ENUMDNBK table is (1 of 1024) 1% full.

```

**Related Topics**

- [chg-enum-profsel](#)
- [dlt-enum-profsel](#)
- [ent-enum-profsel](#)

## rtrv-feat

Use this command to show the status of optional features in the system that are controlled with the `chg-feat` command.

**Parameters**

This command has no parameters.

**Example**

```
rtrv-feat
```

**Dependencies**

The MAS configuration table must be accessible.

The database cannot be accessed. There is a severe database failure.

None

**Notes**

This command is not allowed in upgrade mode.

## Output

### ▲ Caution:

The following output example may differ from the output shown at your terminal and may include unsupported features. Some optional features must be purchased before you turn the feature on. If you are not sure whether you are entitled to turn a feature on, contact your Oracle Sales Representative or Account Representative. After you turn on a feature with the `chg-feat` command, you cannot turn it off.

```
rtrv-feat
```

```
tekelecstp 10-03-10 16:50:04 EST EAGLE 42.0.0
EAGLE FEATURE LIST
GTT      = off      GWS      = off      NRT      = off
LAN      = off      CRMD     = off      SEAS     = off
LFS      = off      MTPRS   = off      FAN      = off
DSTN5000 = off      WNP     = off      CNCF     = off
TLNP     = off      SCCPCNV = off      TCAPCNV = off
IPISUP   = off      PLNP    = off      NCR      = off
ITUMTPRS = off      SLSOCB  = off      EGTT     = off
VGTT     = off      MPC     = off      ITUDUPPC = off
MEASPLAT = off      TSCSYNC = off      E5IS     = off
```

```
;
```

## Legend

- **GTT**—Global Title Translation feature
- **GWS**—Gateway Screening feature
- **NRT**—Network Routing feature
- **LAN**—STPLAN feature
- **CRMD**—Cluster Routing and Management Diversity feature
- **LFS**—Link Fault Sectionalization feature
- **MTPRS**—ANSI MTP Restart feature
- **FAN**—Cooling Fan feature
- **DSTN5000**—DSTN5000 (5000 Routes) feature
- **WNP**—Wireless Number Portability feature
- **CNCF**—Calling Name Conversion Facility with Redirect Capability feature
- **TLNP**—Triggerless Local Number Portability feature
- **IPISUP**—ISUP Routing over IP feature
- **SEAS**—SEAS feature
- **SCCPCNV**—SCCP Conversion feature
- **TCAPCNV**—TCAP Conversion feature

- **PLNP**—PCS 1900 Number Portability feature
- **NCR**—Nested Cluster Routing feature
- **ITUMTPRS**—ITU MTP Restart feature
- **SLSOCB**—Other CIC Bit Used feature
- **EGTT**—Enhanced Global Title Translation feature
- **VGTT**—Variable Length GTT feature
- **MPC**—Multiple Point Code feature
- **ITUDUPPC**—ITU National Duplicate Point Code feature
- **TSCSYNC**—Time Slot Counter Synchronization (TSC) feature
- **E5IS**—EAGLE 5 Integrated Monitoring Support feature
- **MEASPLAT**—Measurements Platform feature

#### Related Topics

- [chg-feat](#)

## rtrv-frm-pwr

Use this command to retrieve a list of entries for all provisioned frames or the entry for the specified frame from the Frame Power Threshold (FPT) table. The command displays only provisioned entries for provisioned frames.

#### Parameters

##### **frm (optional)**

Frame ID. This parameter displays the FPT table entry for the specified provisioned frame.

##### **Range:**

###### **cf00**

Control frame

###### **ef00**

First extension frame

###### **ef01**

Second extension frame

###### **ef02**

Third extension frame

###### **ef03**

Fourth extension frame

###### **ef04**

Fifth extension frame

#### Example

Retrieve all provisioned Frame Power Threshold table entries.

```
rtrv-frm-pwr
```

Retrieve Frame Power Threshold table entries for the control frame (`frm=cf00`).

```
rtrv-frm-pwr:frm=cf00
```

### Dependencies

The following values are valid for the `frm` parameter: *CF00, EF00, EF01, EF02, EF03, EF04*.

The `frm` parameter value must specify a provisioned frame.

The Frame Power Threshold (FPT) table must be accessible.

The `frm` parameter value must specify a frame that has a Frame Power Threshold entry provisioned in the FPT table.

### Notes

If no parameter is specified in the command, all provisioned FPT table entries are displayed.

If the `frm` parameter is specified, the FPT entry corresponding to the specified frame is displayed.

### Output

This example retrieves all Frame Power Threshold table entries:

```
rtrv-frm-pwr
```

```
tekelecstp 06-04-11 12:38:01 EST EAGLE 35.0.0
```

Frame	Power Threshold (Amps)
-----	-----
cf00	56
ef00	36
ef01	40

```
FRAME POWER THRESHOLD table is (3 of 10) 30% full;  
RTRV-FRM-PWR: MASP A - COMPLTD
```

```
;
```

This example Retrieve the Frame Power Threshold table entry for the control shelf:

```
rtrv-frm-pwr:frm=cf00
```

```
tekelecstp 06-04-11 12:38:01 EST EAGLE 35.0.0
```

Frame	Power Threshold (Amps)
-----	-----
cf00	56

```
FRAME POWER THRESHOLD table is (3 of 10) 30% full;  
RTRV-FRM-PWR: MASP A - COMPLTD
```

```
;
```



**Related Topics**

- [chg-frm-pwr](#)
- [dlt-frm-pwr](#)
- [ent-frm-pwr](#)
- [rtrv-stp](#)

## rtrv-ftp-serv

Use this command to retrieve an entry for an FTP server from the FTP Server table or all entries in the FTP Server table.

**Parameters****app (optional)**

Application. This parameter specifies the FTP Client application that interfaces with the FTP Server.

**Range:*****db***

Database Backup\Restore application

***dist***

EAGLE Software Release Distribution application

***meas***

Measurements Platform application

***sflog***

SS7 Firewall Logging application

***user***

FTP-based Table Retrieve Application (FTRA)

**ipaddr (optional)**

IP Address of the FTP Server.

**Range:**

4 numbers separated by dots, with each number in the range of 0-255.

**mode (optional)**

Full or brief report indicator.

**Range:*****full******brief*****Default:**

*brief*

**Example**

```
rtrv-ftp-serv
```

```

rtrv-ftp-serv:app=meas:ipaddr=1.255.0.100
rtrv-ftp-serv:mode=brief
rtrv-ftp-serv:app=meas
rtrv-ftp-serv:ipaddr=1.255.0.100
rtrv-ftp-serv:mode=full
rtrv-ftp-serv:app=sflog

```

### Dependencies

The `app` parameter must specify an application that uses the FTP Support feature.

The `ipaddr` parameter must specify a valid IP address for the FTP server.

The `mode` parameter allows you to display either the full 100 characters of the path string for each entry (`mode=full`), or the first 29 characters of the path string for each entry (`mode=brief`).

### Notes

The LOGIN and PATH are displayed in mixed case.

### Output

```
rtrv-ftp-serv
```

```

tekelecstp 12-09-19 15:15:04 EST 45.0.0-64.42.0
rtrv-ftp-serv
Command entered at terminal #4.

```

APP	IPADDR	LOGIN	SECU	PRIO	PATH
-----	-----	-----	----	----	----
meas	10.248.13.9	root	ON	8	/root
db	10.248.13.10	root	OFF	4	/root
user	10.248.13.100	root	ON	4	/root

```
FTP SERV table is (3 of 10) 30% full
```

```
;
```

```
rtrv-ftp-serv:app=sflog
```

```

tekelecstp 15-05-27 15:55:00 EST Eagle 46.3.0
rtrv-ftp-serv:app=sflog
Command entered at terminal #4.

```

APP	IPADDR	LOGIN	SECU	PRIO	PATH
-----	-----	-----	----	----	----
sflog	10.248.13.9	root	ON	1	data

```
FTP SERV table is (1 of 10) 10% full
```

```
;
```

**Related Topics**

- [chg-ftp-serv](#)
- [dlt-ftp-serv](#)
- [ent-ftp-serv](#)

## rtrv-gpl

Use this command to show the version numbers of the GPLs stored on each fixed disk or drive and the system release table stored on each fixed disk.

**Parameters****gp1 (optional)**

Generic program load. The GPL for which to retrieve information.

**Range:**

xyyyyyyy

1 alphabetic character followed by up to 7 alphanumeric characters. Valid GPLs are:

*atmhc*—Used by E5-ATM-B cards to allow the card to support up to 3 signaling links

*bldc32*—Flash GPL containing a tar image with all code required on E5-MCAP cards to support VxWorks6.9 32-bit application, as in OAMHC69.

*bldc64*—Flash GPL containing a tar image with all code required on E5-SM8G-B cards for SCCP64, ENUM64, SIP64 and DEIR64 applications.

*blmcap*—Flash GPL containing a tar image with all code required on E5-MCAP, E5-E1T1-B, E5-MCPM-B, E5-ATM-B, E5-ENET-B, and E5-SM8G-B cards

*blslc32*—Flash GPL containing a tar image with all code required on SLIC cards for 32-bit application i.e. MCPHC, IPSHC etc.

*blslc64*—Flash GPL containing a tar image with all code required on SLIC cards for 64-bit application i.e. SCCP64, ENUM64, SIP64 and DEIR64.

*blsl932*—Flash GPL containing a tar image with all code required on SLIC cards for 32-bit application on VxWorks6.9, as in IPSHC69 and MCPHC69.

*deirhc*—Used by E5-SM8G-B cards to support the S13/S13' EIR feature

*enumhc*—Used by E5-SM8G-B cards to support the ENUM Mobile Number Portability and Tier One Address Resolution application

*erthc*—Used by E5-ENET-B cards for EAGLE 5 Integrated Monitoring Support functions

*hipr2*—Communication software used on the High Speed IMT Packet Router (HIPR2) card

*ipsg*—Used by E5-ENET-B cards to support the combined functionality of IPLIMx M2PA and IPGWx M3UA

*ipsg32*—Used by SLIC cards to support IPSG application with 64-bit addressing either with GTT functionality or without it.

*ipshc*—Used by E5-ENET-B cards to support the IPS application

*ipshc69*—Used by E5-ENET-B and SLIC cards to support the IPS application when running on VxWorks69.

*mcphc*—Used by E5-MCPM-B cards for the Measurements Platform feature

*mcphc69*—Used by E5-MCPM-B and SLIC cards for the Measurements Platform feature when running on VxWorks69.

*oamhc*—Used by E5-MCAP cards for enhanced OAM functions

*oamhc69*—Used by E5-MCAP cards for enhanced OAM functions, when running on VxWorks 69.

*sccphc*—Used by E5-SM8G-B cards to support EPAP-based features and the LNP ELAP Configuration feature. If no EPAP-based or LNP ELAP Configuration feature is turned on, and an E5-SM8G-B card is present, then the GPL processes normal GTT traffic.

*sfapp*—Used by SLIC cards to support the Stateful Firewall Application.

*siphc*—Used by E5-SM8G-B Cards to support the SIP application.

*ss7hc*—Application GPL used by E5-E1T1-B and SLIC cards to support **E1** and **T1** signaling links.

**Default:**  
Display all

### Example

```
rtrv-gpl
rtrv-gpl:gpl=hipr2
```

### Dependencies

No other activate, change, copy, or retrieve GPL command can be in progress when this command is entered.

The value specified for the *gpl* parameter must be supported.

### Notes

To check the version of the EPAP or ELAP application, use the *rept-stat-mps* command.

If no application is specified, the approved and trial versions for all GPLs are shown, as well as the release table and removable GPL.

The approved GPL is the GPL that resides on the fixed disk and was made the approved version by specifying the GPL version number while executing the *act-gpl* command.

The trial GPL is the version of the GPL that was downloaded from the removable drive, but not activated by the *act-gpl* command.

When the *act-gpl* command is executed, the version specified in the command becomes the approved GPL and the previously approved GPL becomes the trial GPL.

If a GPL is not found, a version of "-----" is shown. This should happen only for the OAM GPL trial version on the fixed disk and for all GPLs on the plug-in USB flash drive when the drive is not inserted.

If the approved GPL version does not match the GPL version shown in the ACTIVE MASP RELEASE column, an alarm is activated.

A minor alarm is shown, and ALM is displayed for each APPROVED GPL (*rtrv-gpl*) and for each RUNNING GPL (*rept-stat-gpl*) that does not match the GPL in the RELEASE column of the *rtrv-gpl* output. The minor alarm is not activated, but ALM is displayed for each GPL that does not match the GPL in the RELEASE column.

ALM is always displayed when the approved version does not match the release version. You cannot turn off *fixed disk auditing*. The auditing state shown here is for the *rept-stat-gpl* command. You can turn on and off *running version auditing*.

A GPL audit cannot be in progress when this command is entered.

### Output

This example lists all possible GPLs that can be shown in the output when no GPL is specified. All of these GPLs will not appear in the output for your system, because all GPLs are not valid in the same system.

```
rtrv-gpl
```

```
tekelecstp 18-01-18 21:23:11 EST EAGLE 46.5.1.5.0-73.10.0
```

```
  rtrv-gpl
```

```
  Command entered at terminal #18.
```

```
;
```

```
Command Accepted - Processing
```

```
  tekelecstp 18-01-18 21:23:11 EST EAGLE 46.5.1.5.0-73.10.0
```

```
  GPL Auditing ON
```

GPL	CARD	RELEASE	APPROVED	TRIAL	REMOVE
TRIAL					
OAMHC	1114	143-010-000	143-010-000	ALM	-----
-----					
OAMHC	1116	143-010-000	143-010-000	ALM	-----
-----					
OAMHC	1115	-----	-----		-----
-----					
OAMHC69	1114	143-010-000	143-010-000	ALM	-----
-----					
OAMHC69	1116	143-010-000	143-010-000	ALM	-----
-----					
OAMHC69	1115	-----	-----		-----
-----					
IPSG32	1114	143-010-000	143-010-000		143-010-000
-----					
IPSG32	1116	143-010-000	143-010-000		143-010-000
-----					
IPSG32	1115	-----	-----		-----
-----					
BLMCAP	1114	143-010-000	143-010-000		143-010-000
-----					
BLMCAP	1116	143-010-000	143-010-000		143-010-000
-----					
BLMCAP	1115	-----	-----		-----
-----					
HIPR2	1114	143-010-000	143-010-000		143-010-000
-----					
HIPR2	1116	143-010-000	143-010-000		143-010-000
-----					
HIPR2	1115	-----	-----		-----
-----					
SFAPP	1114	143-010-000	143-010-000	ALM	143-010-000
-----					
SFAPP	1116	143-010-000	143-010-000	ALM	143-010-000
-----					
SFAPP	1115	-----	-----		-----

```

-----
SS7HC      1114  143-010-000  143-010-000      143-010-000  -----
SS7HC      1116  143-010-000  143-010-000      143-010-000  -----
SS7HC      1115  -----
SCCPHC     1114  143-010-000  143-010-000      143-010-000  -----
SCCPHC     1116  143-010-000  143-010-000      143-010-000  -----
SCCPHC     1115  -----
ERTHC      1114  143-010-000  143-010-000      143-010-000  -----
ERTHC      1116  143-010-000  143-010-000      143-010-000  -----
ERTHC      1115  -----
IPSHC      1114  143-010-000  143-010-000      143-010-000  -----
IPSHC      1116  143-010-000  143-010-000      143-010-000  -----
IPSHC      1115  -----
ATMHC      1114  143-010-000  143-010-000      143-010-000  -----
ATMHC      1116  143-010-000  143-010-000      143-010-000  -----
ATMHC      1115  -----
IPSG       1114  143-010-000  143-010-000      143-010-000  -----
IPSG       1116  143-010-000  143-010-000      143-010-000  -----
IPSG       1115  -----
PKTGHC     1114  143-010-000  143-010-000      -----
PKTGHC     1116  143-010-000  143-010-000      -----
PKTGHC     1115  -----
BLIXP      1114  143-010-000  143-010-000      143-010-000  -----
BLIXP      1116  143-010-000  143-010-000      143-010-000  -----
BLIXP      1115  -----
MCPHC      1114  143-010-000  143-010-000      143-010-000  -----
MCPHC      1116  143-010-000  143-010-000      143-010-000  -----
MCPHC      1115  -----
SIPHC      1114  143-010-000  143-010-000      143-010-000  -----
SIPHC      1116  143-010-000  143-010-000      143-010-000  -----
SIPHC      1115  -----
DEIRHC     1114  143-010-000  143-010-000      143-010-000  -----
DEIRHC     1116  143-010-000  143-010-000      143-010-000  -----
DEIRHC     1115  -----
ENUMHC     1114  143-010-000  143-010-000      143-010-000  -----
ENUMHC     1116  143-010-000  143-010-000      143-010-000  -----
ENUMHC     1115  -----
PKTG64     1114  143-010-000  143-010-000      -----
PKTG64     1116  143-010-000  143-010-000      -----
PKTG64     1115  -----
BLDC64     1114  143-010-000  -----          143-010-000  -----
BLDC64     1116  143-010-000  000-000-000 ALM  143-010-000  -----
BLDC64     1115  -----
SCCP64     1114  143-010-000  143-010-000      143-010-000  -----
SCCP64     1116  143-010-000  143-010-000      143-010-000  -----
SCCP64     1115  -----
BLSLC32    1114  143-010-000  143-010-000      143-010-000  -----
BLSLC32    1116  143-010-000  143-010-000      143-010-000  -----
BLSLC32    1115  -----
BLSLC64    1114  143-010-000  143-010-000      143-010-000  -----
BLSLC64    1116  143-010-000  143-010-000      143-010-000  -----
BLSLC64    1115  -----
SIP64      1114  143-010-000  143-010-000      143-010-000  -----
SIP64      1116  143-010-000  143-010-000      143-010-000  -----
SIP64      1115  -----

```

```

DEIR64 1114 143-010-000 143-010-000 143-010-000
-----
DEIR64 1116 143-010-000 143-010-000 143-010-000
-----
DEIR64 1115 -----
-----
ENUM64 1114 143-010-000 143-010-000 143-010-000
-----
ENUM64 1116 143-010-000 143-010-000 143-010-000
-----
ENUM64 1115 -----
-----
BLDC32 1114 143-010-000 ----- 143-010-000
-----
BLDC32 1116 143-010-000 ----- 143-010-000
-----
BLDC32 1115 -----
-----
MCPHC69 1114 143-010-000 143-010-000 143-010-000
-----
MCPHC69 1116 143-010-000 143-010-000 143-010-000
-----
MCPHC69 1115 -----
-----
IPSHC69 1114 143-010-000 143-010-000 143-010-000
-----
IPSHC69 1116 143-010-000 143-010-000 143-010-000
-----
IPSHC69 1115 -----
-----
BLSL932 1114 143-010-000 143-010-000 143-010-000
-----
BLSL932 1116 143-010-000 143-010-000 143-010-000
-----
BLSL932 1115 -----
-----

```

```

;
Command Executed

```

This example shows the output with the E5-based control cards feature. A removable drive is in the latched USB port and a plug-in flash drive is in the flush-mounted USB port of the active OAM. A removable drive is not present in the latched USB port of the standby OAM.

```
rtrv-gpl:gpl=oamhc
```

```

tekelecstp 18-01-19 15:49:30 EST EAGLE 46.5.1.5.0-73.10.0
  rtrv-gpl:gpl=oamhc
  Command entered at terminal #17.

```

```
;
```

```

Command Accepted - Processing
  tekelecstp 18-01-19 15:49:30 EST EAGLE 46.5.1.5.0-73.10.0

```

```
GPL Auditing ON
```

GPL	CARD	RELEASE	APPROVED	TRIAL	REMOVE TRIAL
OAMHC	1114	143-010-000	143-010-000	ALM	-----
OAMHC	1116	033-010-000	143-010-000	ALM	-----
OAMHC	1115	-----	-----	-----	-----

```
;  
Command Executed
```

This example shows the output for E5-based control cards. Version information is displayed for three removable drives that are inserted, including the removable drive in the latched USB port of the active OAM, the plug-in flash drive in the flush-mounted USB port of the active OAM, and the removable drive in the latched USB port of the standby OAM.

```
rtrv-gpl
```

```
tekelecstp 18-01-18 22:23:11 EST EAGLE 46.5.1.5.0-73.10.0  
rtrv-gpl  
Command entered at terminal #18.  
;
```

```
Command Accepted - Processing  
tekelecstp 18-01-18 21:23:11 EST EAGLE 46.5.1.5.0-73.10.0  
GPL Auditing ON
```

GPL	CARD	RELEASE	APPROVED	TRIAL	REMOVE TRIAL
OAMHC	1114	143-010-000	143-010-000	ALM	----- 143-010-000
OAMHC	1116	143-010-000	143-010-000	ALM	----- 143-010-000
OAMHC	1115	-----	-----	-----	-----
OAMHC69	1114	143-010-000	143-010-000	ALM	----- 143-010-000
OAMHC69	1116	143-010-000	143-010-000	ALM	----- 143-010-000
OAMHC69	1115	-----	-----	-----	-----
IPSG32	1114	143-010-000	143-010-000	143-010-000	143-010-000
IPSG32	1116	143-010-000	143-010-000	143-010-000	143-010-000
IPSG32	1115	-----	-----	-----	-----
BLMCAP	1114	143-010-000	143-010-000	143-010-000	143-010-000
BLMCAP	1116	143-010-000	143-010-000	143-010-000	143-010-000
BLMCAP	1115	-----	-----	-----	-----
HIPR2	1114	143-010-000	143-010-000	143-010-000	143-010-000
HIPR2	1116	143-010-000	143-010-000	143-010-000	143-010-000
HIPR2	1115	-----	-----	-----	-----
SFAPP	1114	143-010-000	143-010-000	ALM	143-010-000 143-010-000
SFAPP	1116	143-010-000	143-010-000	ALM	143-010-000 143-010-000
SFAPP	1115	-----	-----	-----	-----
SS7HC	1114	143-010-000	143-010-000	143-010-000	143-010-000
SS7HC	1116	143-010-000	143-010-000	143-010-000	143-010-000
SS7HC	1115	-----	-----	-----	-----
SCCPHC	1114	143-010-000	143-010-000	143-010-000	143-010-000
SCCPHC	1116	143-010-000	143-010-000	143-010-000	143-010-000
SCCPHC	1115	-----	-----	-----	-----
ERTHC	1114	143-010-000	143-010-000	143-010-000	143-010-000
ERTHC	1116	143-010-000	143-010-000	143-010-000	143-010-000
ERTHC	1115	-----	-----	-----	-----



IPSHC	1114	143-010-000	143-010-000	143-010-000
143-010-000				
IPSHC	1116	143-010-000	143-010-000	143-010-000
143-010-000				
IPSHC	1115	-----	-----	-----
-----				
ATMHC	1114	143-010-000	143-010-000	143-010-000
143-010-000				
ATMHC	1116	143-010-000	143-010-000	143-010-000
143-010-000				
ATMHC	1115	-----	-----	-----
-----				
IPSG	1114	143-010-000	143-010-000	143-010-000
143-010-000				
IPSG	1116	143-010-000	143-010-000	143-010-000
143-010-000				
IPSG	1115	-----	-----	-----
-----				
PKTGHC	1114	143-010-000	143-010-000	-----
-----				
PKTGHC	1116	143-010-000	143-010-000	-----
-----				
PKTGHC	1115	-----	-----	-----
-----				
BLIXP	1114	143-010-000	143-010-000	143-010-000
143-010-000				
BLIXP	1116	143-010-000	143-010-000	143-010-000
143-010-000				
BLIXP	1115	-----	-----	-----
-----				
MCPHC	1114	143-010-000	143-010-000	143-010-000
143-010-000				
MCPHC	1116	143-010-000	143-010-000	143-010-000
143-010-000				
MCPHC	1115	-----	-----	-----
-----				
SIPHC	1114	143-010-000	143-010-000	143-010-000
143-010-000				
SIPHC	1116	143-010-000	143-010-000	143-010-000
143-010-000				
SIPHC	1115	-----	-----	-----
-----				
DEIRHC	1114	143-010-000	143-010-000	143-010-000
143-010-000				
DEIRHC	1116	143-010-000	143-010-000	143-010-000
143-010-000				
DEIRHC	1115	-----	-----	-----
-----				
ENUMHC	1114	143-010-000	143-010-000	143-010-000
143-010-000				
ENUMHC	1116	143-010-000	143-010-000	143-010-000
143-010-000				
ENUMHC	1115	-----	-----	-----
-----				
PKTG64	1114	143-010-000	143-010-000	-----

```

-----
PKTG64 1116 143-010-000 143-010-000 -----
PKTG64 1115 -----
BLDC64 1114 143-010-000 ----- 143-010-000 143-010-000
BLDC64 1116 143-010-000 000-000-000 ALM 143-010-000 143-010-000
BLDC64 1115 -----
SCCP64 1114 143-010-000 143-010-000 143-010-000 143-010-000
SCCP64 1116 143-010-000 143-010-000 143-010-000 143-010-000
SCCP64 1115 -----
BLSLC32 1114 143-010-000 143-010-000 143-010-000 143-010-000
BLSLC32 1116 143-010-000 143-010-000 143-010-000 143-010-000
BLSLC32 1115 -----
BLSLC64 1114 143-010-000 143-010-000 143-010-000 143-010-000
BLSLC64 1116 143-010-000 143-010-000 143-010-000 143-010-000
BLSLC64 1115 -----
SIP64 1114 143-010-000 143-010-000 143-010-000 143-010-000
SIP64 1116 143-010-000 143-010-000 143-010-000 143-010-000
SIP64 1115 -----
DEIR64 1114 143-010-000 143-010-000 143-010-000 143-010-000
DEIR64 1116 143-010-000 143-010-000 143-010-000 143-010-000
DEIR64 1115 -----
ENUM64 1114 143-010-000 143-010-000 143-010-000 143-010-000
ENUM64 1116 143-010-000 143-010-000 143-010-000 143-010-000
ENUM64 1115 -----
BLDC32 1114 143-010-000 ----- 143-010-000 143-010-000
BLDC32 1116 143-010-000 ----- 143-010-000 143-010-000
BLDC32 1115 -----
MCPHC69 1114 143-010-000 143-010-000 143-010-000 143-010-000
MCPHC69 1116 143-010-000 143-010-000 143-010-000 143-010-000
MCPHC69 1115 -----
IPSHC69 1114 143-010-000 143-010-000 143-010-000 143-010-000
IPSHC69 1116 143-010-000 143-010-000 143-010-000 143-010-000
IPSHC69 1115 -----
BLSL932 1114 143-010-000 143-010-000 143-010-000 143-010-000
BLSL932 1116 143-010-000 143-010-000 143-010-000 143-010-000
BLSL932 1115 -----

```

```

;
Command Executed

```

```
rtrv-gpl
```

```

tekelecstp 17-09-15 15:10:33 EST EAGLE 46.5.0.0.0-71.11.0
  GPL Auditing ON
  GPL      CARD  RELEASE      APPROVED      TRIAL      REMOVE TRIAL
  EOAM     1114  134-000-000  134-000-000  134-000-000  134-000-000
  EOAM     1116  134-000-000  134-000-000  134-000-000  134-000-000
  EOAM     1113  -----      -----      -----      -----
  CDU      1114  134-000-000  134-000-000  134-000-000  134-000-000
  CDU      1116  134-000-000  134-000-000  134-000-000  134-000-000
  CDU      1113  -----      -----      -----      -----
  IMT      1114  134-000-000  134-000-000  134-000-000  134-000-000
  IMT      1116  134-000-000  134-000-000  134-000-000  134-000-000

```

IMT	1113	-----	-----	-----
-----				
ATMANSI	1114	134-000-000	134-000-000	134-000-000
134-000-000				
ATMANSI	1116	134-000-000	134-000-000	134-000-000
134-000-000				
ATMANSI	1113	-----	-----	-----
-----				
BPHCAP	1114	134-000-000	134-000-000	134-000-000
134-000-000				
BPHCAP	1116	134-000-000	134-000-000	134-000-000
134-000-000				
BPHCAP	1113	-----	-----	-----
-----				
BPDCM	1114	134-000-000	134-000-000	134-000-000
134-000-000				
BPDCM	1116	134-000-000	134-000-000	134-000-000
134-000-000				
BPDCM	1113	-----	-----	-----
-----				
BLMCAP	1114	134-000-000	134-000-000	134-000-000
134-000-000				
BLMCAP	1116	134-000-000	134-000-000	134-000-000
134-000-000				
BLMCAP	1113	-----	-----	-----
-----				
OAMHC	1114	134-000-000	134-000-000	134-000-000
134-000-000				
OAMHC	1116	134-000-000	134-000-000	134-000-000
134-000-000				
OAMHC	1113	-----	-----	-----
-----				
HIPR2	1114	134-000-000	134-000-000	134-000-000
134-000-000				
HIPR2	1116	134-000-000	134-000-000	134-000-000
134-000-000				
HIPR2	1113	-----	-----	-----
-----				
VXWSLAN	1114	134-000-000	134-000-000	134-000-000
134-000-000				
VXWSLAN	1116	134-000-000	134-000-000	134-000-000
134-000-000				
VXWSLAN	1113	-----	-----	-----
-----				
VSCCP	1114	134-000-000	134-000-000	134-000-000
134-000-000				
VSCCP	1116	134-000-000	134-000-000	134-000-000
134-000-000				
VSCCP	1113	-----	-----	-----
-----				
ATMITU	1114	134-000-000	134-000-000	134-000-000
134-000-000				
ATMITU	1116	134-000-000	134-000-000	134-000-000
134-000-000				
ATMITU	1113	-----	-----	-----

```
-----
VCDU      1114  134-000-000  134-000-000  134-000-000  134-000-000
VCDU      1116  134-000-000  134-000-000  134-000-000  134-000-000
VCDU      1113  -----
BPMPPL    1114  134-000-000  134-000-000  134-000-000  134-000-000
BPMPPL    1116  134-000-000  134-000-000  134-000-000  134-000-000
BPMPPL    1113  -----
SS7ML     1114  134-000-000  134-000-000  134-000-000  134-000-000
SS7ML     1116  134-000-000  134-000-000  134-000-000  134-000-000
SS7ML     1113  -----
BPHMUX    1114  134-000-000  134-000-000  134-000-000  134-000-000
BPHMUX    1116  134-000-000  134-000-000  134-000-000  134-000-000
BPHMUX    1113  -----
BPD2CM    1114  134-000-000  134-000-000  134-000-000  134-000-000
BPD2CM    1116  134-000-000  134-000-000  134-000-000  134-000-000
BPD2CM    1113  -----
EROUTE    1114  134-000-000  134-000-000  134-000-000  134-000-000
EROUTE    1116  134-000-000  134-000-000  134-000-000  134-000-000
EROUTE    1113  -----
BPMPPLT   1114  134-000-000  134-000-000  134-000-000  134-000-000
BPMPPLT   1116  134-000-000  134-000-000  134-000-000  134-000-000
BPMPPLT   1113  -----
MCP       1114  134-000-000  134-000-000  134-000-000  134-000-000
MCP       1116  134-000-000  134-000-000  134-000-000  134-000-000
MCP       1113  -----
BPHCAPT   1114  134-000-000  134-000-000  134-000-000  134-000-000
BPHCAPT   1116  134-000-000  134-000-000  134-000-000  134-000-000
BPHCAPT   1113  -----
MPLG      1114  134-000-000  134-000-000  134-000-000  134-000-000
MPLG      1116  134-000-000  134-000-000  134-000-000  134-000-000
MPLG      1113  -----
SS7HC     1114  134-000-000  134-000-000  134-000-000  134-000-000
SS7HC     1116  134-000-000  134-000-000  134-000-000  134-000-000
SS7HC     1113  -----
BLBIOS    1114  134-000-000  134-000-000  134-000-000  134-000-000
BLBIOS    1116  134-000-000  134-000-000  134-000-000  134-000-000
BLBIOS    1113  -----
BLCPLD    1114  134-000-000  134-000-000  134-000-000  134-000-000
BLCPLD    1116  134-000-000  134-000-000  134-000-000  134-000-000
BLCPLD    1113  -----
BLDIAG    1114  131-002-000  131-002-000  131-002-000  131-002-000
BLDIAG    1116  131-002-000  131-002-000  131-002-000  131-002-000
BLDIAG    1113  -----
IMTPCI    1114  134-000-000  134-000-000  134-000-000  134-000-000
IMTPCI    1116  134-000-000  134-000-000  134-000-000  134-000-000
IMTPCI    1113  -----
BLVXW     1114  131-006-000  131-006-000  131-006-000  131-006-000
BLVXW     1116  131-006-000  131-006-000  131-006-000  131-006-000
BLVXW     1113  -----
PLDPMC1   1114  134-000-000  134-000-000  134-000-000  134-000-000
PLDPMC1   1116  134-000-000  134-000-000  134-000-000  134-000-000
PLDPMC1   1113  -----
SS7EPM    1114  130-029-000  130-029-000  130-029-000  130-029-000
SS7EPM    1116  130-029-000  130-029-000  130-029-000  130-029-000
SS7EPM    1113  -----
```

BLBEPM	1114	134-000-000	134-000-000	134-000-000
134-000-000				
BLBEPM	1116	134-000-000	134-000-000	134-000-000
134-000-000				
BLBEPM	1113	-----	-----	-----
-----				
BLVXW6	1114	134-000-000	134-000-000	134-000-000
134-000-000				
BLVXW6	1116	134-000-000	134-000-000	134-000-000
134-000-000				
BLVXW6	1113	-----	-----	-----
-----				
BLDIAG6	1114	134-000-000	134-000-000	134-000-000
134-000-000				
BLDIAG6	1116	134-000-000	134-000-000	134-000-000
134-000-000				
BLDIAG6	1113	-----	-----	-----
-----				
PKTGEN	1114	134-000-000	134-000-000	134-000-000
134-000-000				
PKTGEN	1116	134-000-000	134-000-000	134-000-000
134-000-000				
PKTGEN	1113	-----	-----	-----
-----				
SCCPHC	1114	134-000-000	134-000-000	134-000-000
134-000-000				
SCCPHC	1116	134-000-000	134-000-000	134-000-000
134-000-000				
SCCPHC	1113	-----	-----	-----
-----				
BLBSMG	1114	134-000-000	134-000-000	134-000-000
134-000-000				
BLBSMG	1116	134-000-000	134-000-000	134-000-000
134-000-000				
BLBSMG	1113	-----	-----	-----
-----				
ERTHC	1114	134-000-000	134-000-000	134-000-000
134-000-000				
ERTHC	1116	134-000-000	134-000-000	134-000-000
134-000-000				
ERTHC	1113	-----	-----	-----
-----				
IPSHC	1114	134-000-000	134-000-000	134-000-000
134-000-000				
IPSHC	1116	134-000-000	134-000-000	134-000-000
134-000-000				
IPSHC	1113	-----	-----	-----
-----				
ATMHC	1114	134-000-000	134-000-000	134-000-000
134-000-000				
ATMHC	1116	134-000-000	134-000-000	134-000-000
134-000-000				
ATMHC	1113	-----	-----	-----
-----				
IPSG	1114	134-000-000	134-000-000	134-000-000

```

134-000-000
IPSG      1116  134-000-000  134-000-000      134-000-000  134-000-000
IPSG      1113  -----
BLROM1    1114  134-000-000  134-000-000      134-000-000  134-000-000
BLROM1    1116  134-000-000  134-000-000      134-000-000  134-000-000
BLROM1    1113  -----
PKTGHC    1114  134-000-000  134-000-000      134-000-000  134-000-000
PKTGHC    1116  134-000-000  134-000-000      134-000-000  134-000-000
PKTGHC    1113  -----
BLIXP     1114  134-000-000  134-000-000      134-000-000  134-000-000
BLIXP     1116  134-000-000  134-000-000      134-000-000  134-000-000
BLIXP     1113  -----
MCPHC     1114  134-000-000  134-000-000      134-000-000  134-000-000
MCPHC     1116  134-000-000  134-000-000      134-000-000  134-000-000
MCPHC     1113  -----
SIPHC     1114  134-000-000  134-000-000      134-000-000  134-000-000
SIPHC     1116  134-000-000  134-000-000      134-000-000  134-000-000
SIPHC     1113  -----
DEIRHC    1114  134-000-000  134-000-000      134-000-000  134-000-000
DEIRHC    1116  134-000-000  134-000-000      134-000-000  134-000-000
DEIRHC    1113  -----
ENUMHC    1114  135-000-000  135-000-000      135-000-000  135-000-000
ENUMHC    1116  135-000-000  135-000-000      135-000-000  135-000-000
ENUMHC    1113  -----
IPSG32    1114  140-000-000  140-000-000      140-000-000  -----
IPSG32    1116  140-000-000  140-000-000      140-000-000
-----

```

;

This example shows the output for SFAPP cards. Version information is displayed for three removable drives that are inserted, including the removable drive in the latched USB port of the active OAM, the plug-in flash drive in the flush-mounted USB port of the active OAM, and the removable drive in the latched USB port of the standby OAM:

```
rtrv-gpl:gpl=sfapp
```

```
tekelecstp 17-11-22 06:57:22 EST EAGLE 46.5.1.5.0-73.2.0
```

```
  rtrv-gpl:gpl=sfapp
```

```
  Command entered at terminal #17.
```

;

```
Command Accepted - Processing
```

```
  tekelecstp 17-11-22 06:57:23 EST EAGLE 46.5.1.5.0-73.2.0
```

```
  GPL Auditing ON
```

```

GPL      CARD  RELEASE      APPROVED      TRIAL      REMOVE TRIAL
SFAPP    1114  037-002-000  037-002-000  037-002-000  -----
SFAPP    1116  037-002-000  037-002-000  037-002-000  -----
SFAPP    1115  -----

```

;

```
Command Executed
```

### Legend

- **GPL**—GPL associated with each card in the display
- **APPROVED**—GPL version that is the approved GPL.
- **CARD**—Card location.
- **RELEASE**—Version number of each GPL that is required to be installed and approved for a specific release of software for the system.
- **REMOVE TRIAL**—GPL version that is on the removable drive.
- **TRIAL**—GPL version that is the trial GPL.
- -----—GPL is not present at the specified location.
- **ALM**—Alarm indicator showing that the system has an approved GPL that is not the GPL required for this software release according to the active MASP system release table.
- **CORRUPTED**—Data audit has determined that the GPL is corrupted.

### Related Topics

- [act-gpl](#)
- [chg-gpl](#)
- [copy-gpl](#)
- [rept-stat-gpl](#)

## rtrv-gserv-data

Use this command to display all values in the GSERV table or to display specific translation type, originating point code, or global title address data. These values are used to determine whether a Send Routing Information (SRI) request should receive G-Port SRI Query for Prepaid service or normal G-Port service.

### Parameters



#### Note:

See [Point Code Formats and Conversion](#) for a detailed description of point code formats, rules for specification, and examples.

### **display (optional)**

Use this parameter to display a specified category of entries in the GSERV table.

#### **Range:**

##### ***all***

Display all entries in the GSERV table.

##### ***gta***

Display all calling party (CgPA) global title addresses in the GSERV table.

**opc**

Display all message transfer part (MTP) originating point codes in the GSERV table.

**tt**

Display all called party (CdPA) translation types in the GSERV table.

**gta (optional)**

Global title address. Use this parameter to specify a CgPA global title address.

**Range:**

1 - 21 digits

**opc (optional)**

ANSI originating point code in the form of *network indicator-network cluster-network cluster member (ni-nc-ncm)*. The *prefix* subfield indicates a private point code (*prefix-ni-nc-ncm*).

**Synonym:**

*opca*

**Range:**

*p-*, *000-255*

Specify a valid value for each subfield of the point code, and separate the subfields with a dash (-).

*prefix—p-*

When *chg-sid:pctype=ansi* is specified, *ni = 000* is not valid.

When *chg-sid:pctype=ansi* is specified, *nc = 000* is not valid if *ni = 001-005*.

When *chg-sid:pctype=ansi* is specified, *nc = 000* is valid if *ni = 006-255*.

The point code *000-000-000* is not a valid point code.

**opc/opca/opci/opcn/opcn24 (optional)**

Originating point code. Use these parameters to specify MTP originating point codes.

**opci (optional)**

ITU international originating point code with subfields *zone-area-id*.

**Range:**

*s-*, *p-*, *ps-*, *0-255*

Specify a valid value for each subfield of the point code, and separate the subfields with a dash (-).

*prefix—s-*, *p-*, *ps*

*zone—0-7*

*area—000-255*

*id—0-7*

The point code *0-000-0* is not a valid point code.

**opcn (optional)**

ITU national originating point code in the format of a 5-digit number (*nnnnn*); or 2, 3, or 4 numbers (members) separated by dashes (*m1-m2-m3-m4*) as defined by the *chg-stpopts:npcfmti* flexible point code option. A group code must be specified when the ITUDUPPC feature is turned on (*nnnnn-gc*, *m1-m2-m3-m4-gc*).

**Range:**

*s-*, *p-*, *ps-*, *0-16383*, *aa-zz*



Specify a valid value for each subfield of the point code, and separate the subfields with a dash (-).

*prefix*—*s*, *p*, *ps*

*nnnnn*—0-16383

*gc*—*aa-zz*

*m1-m2-m3-m4*—0-14 for each member; values must sum to 14

#### **opc24 (optional)**

24-bit ITU national originating point code with subfields *main signaling area-sub signaling area-signaling point (msa-ssa-sp)*.

##### **Range:**

*p*-, 000-255

Specify a valid value for each subfield of the point code, and separate the subfields with a dash (-).

*prefix*—*p*

*msa*—000–255

*ssa*—000–255

*sp*—000–255

#### **tt (optional)**

Translation type. Use this parameter to specify a CdPA translation type.

**Range: 0 - 255**

#### **Example**

```
rtrv-gserv-data:display=all
```

```
rtrv-gserv-data:tt=26
```

```
rtrv-gserv-data:display=opc
```

#### **Dependencies**

The system is busy, or the GSERV table is corrupted.

The G-Port SRI Query for Prepaid feature must be enabled before this command can be entered.

The G-Port feature must be on before this command can be entered.

The *gta*, *opc/opca/opci/opcn/opcn24*, *tt*, or *display* parameter must be specified.

The *display*, *tt*, *opc*, and *gta* parameters cannot be specified together in the command.

#### **Output**

```
rtrv-gserv-data:display=all
```

```
mystp 06-07-27 20:32:46 EST EAGLE 35.2.0
  TT      OPC                      GTA
=====
    0
    25
```

```
26
TT      OPC                      GTA
=====
          02057                    (ITUN)
          002-002-002              (ANSI)
          5-005-5                  (ITUI)
          001-001-001              (ANSI)
          006-000-001              (ANSI)
TT      OPC                      GTA
=====
                                     9194605500
```

```
num of tt entries is (3 of 256)
num of opc entries is (5 of 50)
num of gta entries is (1 of 50)
```

```
GSERV table is (9 of 356) 3% full
```

```
;
```

```
rtrv-gserv-data:tt=26
```

```
mystp 06-07-27 20:35:57 EST EAGLE 35.2.0
TT      OPC                      GTA
=====
26
```

```
;
```

```
rtrv-gserv-data:display=opc
```

```
mystp 06-07-27 20:32:46 EST EAGLE 35.2.0
TT      OPC                      GTA
=====
          02057                    (ITUN)
          002-002-002              (ANSI)
          5-005-5                  (ITUI)
          001-001-001              (ANSI)
          006-000-001              (ANSI)
```

```
GSERV table is (5 of 50) 10% full
```

```
;
```

### Related Topics

- [dlt-gserv-data](#)
- [ent-gserv-data](#)

## rtrv-gsm-msg

Use this command to display the configured GSM test message parameter values.

### Parameters

#### **msgn (mandatory)**

Message number. The test message number that is retrieved.

#### **Range:**

1 - 10

### Example

```
rtrv-gsm-msg:msgn=5
```

### Dependencies

The TSTMSG table is corrupt or cannot be found.

None

### Output

```
rtrv-gsm-msg:msgn=1
```

```
tekelecstp 08-12-02 10:46:51 EST EAGLE 40.1.0  
MSG = 1 ACTIVE = YES
```

```
CGPA_GT = 2  
CGPA_GT_NAI = 4 CGPA = 919818000001  
CDPA_GT = 2
```

```
CDPA_GT_NAI = 4 CDPA = 919818000002
```

```
CGPN_NAI = 1  
CGPN_NP = 2 CGPN = 919818000007
```

```
CDPN_NAI = 1  
CDPN_NP = 2 CDPN = 919818000008
```

```
rtrv-gsm-msg:msgn=2
```

```
tekelecstp 11-10-05 11:33:46 EST EAGLE 44.0.0  
MSG = 2 ACTIVE = YES
```

```
CGPA_GT = 4  
CGPA_GT_NAI = 4 CGPA = 919818000009
```

```
CDPA_GT = 4  
CDPA_GT_NAI = 4 CDPA = 919818000008
```

```
CGPN_NAI = 4
```

```
CGPN_NP = 1      CGPN = none
CDPN_NAI = 4
CDPN_NP = 1      CDPN = 919876543201
```

### Related Topics

- [chg-gsm-msg](#)
- [tst-msg](#)

## rtrv-gsmmap-scrn

Use this command to retrieve the GSM (Global System for Mobile Telecommunication) MAP (Mobile Application Part) Screening CgPA and CdPA entries and their attributes from the active system database.

### Parameters

#### **opname (mandatory)**

User-defined name for the operation code. This value references the operation code defined with the `ent-gsms-opcode` command.

#### **Range:**

*ayyyyyyy*  
Up to 8 alphanumeric characters

#### **action (optional)**

Screening action to take if a message is forbidden as defined by the *forbid* parameter.

#### **Range:**

##### ***pass***

Route the message as normal to the destination.

##### ***discard***

Discard the MSU.

##### ***atierr***

Generate an ATI reject message. This option is only valid for ATI MAP operation codes.

##### ***route***

Route the message as normal to the original destination node; no UIM will be generated. The original destination is the node to which normal GTT would be sent if no GSM MAP actions are taken.

##### ***forward***

Route the original message to the forward node. The original message will not be sent to the original node. If, however, the forward node is not available for routing, the MSU is routed to the original node.

**duplicate**

Route the message as normal to the original destination and route a copy of the original message to the duplicate node. If the MSU fails to route to the duplicate node, a UIM is generated indicating the duplicate routing failure.

**dupdisc**

Route the original message to the duplicate node. The original message will not be sent to the original node. If, however, the duplicate node is not available for routing, the MSU is routed to the original node.

**Default:**

Display all screening actions

**cdsr (optional)**

CdPA Screening Reference.

**Range:**

*ayyy*

1 alphabetic character followed by up to 3 optional alphanumeric characters

**cgsr (optional)**

CgPA Screening Reference.

**Range:**

*ayyy*

1 alphabetic character followed by up to 3 optional alphanumeric characters

**eaddr (optional)**

Ending origination address, in association with `npv` and `naiv` for the CGPA address to be screened.

**Range:**

1–15 hexadecimal digits. Valid digits are 0–9, *a-f*, *A-F*

**forbid (optional)**

Forbidden parameter value. Indicates a forbidden parameter for the entered address. If a forbidden parameter is detected the message is rejected by the action defined by the `action` parameter.

**Range:*****all***

All parameters are forbidden. Take the specified screening action defined by the `action` parameter for messages arriving at the system.

***location***

Take the specified screening action defined by the `action` parameter for messages arriving at the system that contain `location` as the forbidden parameter value for the entered address/operation code combination. This value is valid only for GSM ATI messages.

***none***

None of the parameters are forbidden. Route the message to its destination.

**state**

Take the specified screening action defined by the `action` parameter for messages arriving at the system that contain `state` as the forbidden parameter value for the entered address/operation code combination. This value is valid only for GSM ATI messages.

**Default:**

Display all forbidden parameter values

**mapset (optional)**

MAP set ID.

**Range:**

1 - 36000, *dflt*  
*dflt* —Default MAP set

**naiv (optional)**

Nature of Address value for the address or range of CgPA and CdPA addresses.

**Range:**

0 - 127, \*

**npv (optional)**

Numbering Plan value for the address or range of CgPA and CdPA addresses.

**Range:**

0 - 15, \*

**ri (optional)**

Routing indicator. This parameter specifies whether a subsequent global title translation is required.

**Range:**

*gt*

*ssn*

**saddr (optional)**

Starting origination address in association with `npv` and `naiv` for the single entry or range of entries of the CGPA address to be screened.

**Range:**

1 - 15 digits, \*  
1–15 hexadecimal digits. Valid digits are 0–9, a-f, A-F

**Default:**

\*

**tt (optional)**

Translation type. This parameter specifies the value that the CdPA translation type is set to as the result of Enhanced GSM Map Screening.

**Range:**

0 - 255, *none*

**Default:**  
Display all translation types

### Example

The following example retrieves all CgPA entries for the specified OPNAME:

```
rtrv-gsmmap-scrn:opname=e
```

The following example retrieves the specified CgPA range entry for the specified OPNAME:

```
rtrv-gsmmap-  
scrn:opname=ati:saddr=91946200000000:eaddr=91946300000000
```

The following example retrieves all CdPA entries for the specified CGSR:

```
rtrv-gsmmap-scrn:opname=xyz:cgsr=fela
```

The following example retrieves the specified CDSR entry for the specified CGSR:

```
rtrv-gsmmap-scrn:opname=xyz:cgsr=fela:cdsr=cal4
```

The following examples retrieves the specified RI for the specified OPNAME:

```
rtrv-gsmmap-scrn:opname=e:ri=ssn
```

```
rtrv-gsmmap-scrn:opname=e:mapset=dfmt:ri=gt
```

```
rtrv-gsmmap-scrn:opname=rr:cgsr=au:cdsr=aj
```

```
rtrv-gsmmap-scrn:opname=test4:tt=12
```

### Dependencies

The GSM Map Screening feature must be enabled before this command can be entered.

The Enhanced GSM Map Screening (EGMS) feature must be enabled before:

- The `cgsr` parameter can be specified.
- The `cdsr` parameter can be specified.
- The `saddr=*` parameter can be specified.
- The `saddr` and `eaddr` parameters can contain hexadecimal digits.

The specified `opname` parameter value must exist in the GSM Map Op-Code table.

If the `eaddr` parameter is specified, its value must contain the same number of digits as the `saddr` parameter value.

If the `eaddr` parameter is specified, its value must be greater than the `saddr` parameter value.

If the `eaddr` parameter is specified, the `saddr` parameter must be specified.

If the `saddr=*` parameter is specified, then the `eaddr` parameter cannot be specified.

If the `saddr` parameter is specified, the `cgsr` and `cdsr` parameters cannot be specified.

The `saddr`, `npv`, and `naiv` parameters must be specified together in the command.

If any of the `saddr/eaddr/npv/naiv` and `cdsr` parameters are specified, then the `forbid` and `action` parameters cannot be specified.

A value of `state` or `location` cannot be specified for the `forbid` parameter unless the operation code referenced by the `opname` parameter is 71. The `forbid` option is only valid for ATI MAP operation codes, and the `opcode=71` parameter signifies an ATI MAP operation code.

The `action=atierr` parameter cannot be specified unless the operation code referenced by the `opname` parameter is 71. The `atierr` option is only valid for ATI MAP operation codes, and the `opcode=71` parameter signifies an ATI MAP operation code.

The GSM Map Op-Code table must be accessible.

The GSM Map Screening table must be accessible.

If the `cdsr` parameter is specified, then the `cgscr` parameter must be specified.

The specified `cgscr` parameter value must exist in the database.

The specified `cdsr` parameter value must exist in the database.

The `opname` parameter must consist of alphanumeric characters.

The `opname` parameter must be entered.

The `cgscr` and `cdsr` parameters must each begin with an alphabetic character.

The `cgscr` and `cdsr` parameters must each consist of 1-4 alphanumeric characters.

The Flexible GTT Load Sharing feature must be enabled before the `mapset` parameter can be specified.

The specified MAP set must exist.

## Notes

None

## Output

GSM MAP Screening single entries and range entries shown in separate sections of the output. All single entries are shown first in a summary report; all range entries follow.

```
rtrv-gsmmap-scrn:opname=e
```

```
tekelecstp 08-08-22 00:33:10 EST EAGLE 39.2.0
```

```
Single CgPA Entries for OPNAME: e
```

```
-----
```

SADDR	NP	NAI	FORBD	ACT	PCA	SSN	CGSR	RI	TT
1111	2	3	all	fwd	001-001-002	12	ad	gt	11
SADDR	NP	NAI	FORBD	ACT	PCI	SSN	CGSR	RI	TT



```

SADDR      NP NAI FORBD ACT      PCN      SSN CGSR
RI      TT

```

```

SADDR      NP NAI FORBD ACT      PCN24     SSN CGSR
RI      TT

```

```

SADDR      NP NAI FORBD ACT  CGSR

```

Range CgPA Entries for OPNAME: e

-----

```

SADDR      EADDR      NP NAI FORBD ACT
PCA      SSN CGSR
1234      3452      * * all fwd
001-001-002  12 as
RI=gt TT=11

```

```

SADDR      EADDR      NP NAI FORBD ACT
PCI      SSN CGSR

```

```

SADDR      EADDR      NP NAI FORBD ACT
PCN      SSN CGSR

```

```

SADDR      EADDR      NP NAI FORBD ACT
PCN24     SSN CGSR

```

```

SADDR      EADDR      NP NAI FORBD ACT  CGSR

```

GSM MAP Screening Table (8 of 4000) is 1% full

;

The following example shows the output when the Flexible GTT Load Sharing feature is on. rtrv-gsmmap-scrn:opname=dd

tekelecstp 08-08-22 00:45:11 EST EAGLE 39.2.0

Single CgPA Entries for OPNAME: dd

-----

```

SADDR      NP NAI FORBD ACT      PCA      SSN CGSR
MAPSET  RI

```

```

SADDR      NP NAI FORBD ACT      PCI      SSN CGSR
MAPSET  RI
*      * * all fwd      1-221-2      13 ab
DFLT      gt
TT=11

```

```

SADDR      NP NAI FORBD ACT      PCN      SSN CGSR
MAPSET  RI

```

```

SADDR      NP NAI FORBD ACT      PCN24     SSN CGSR

```

```

MAPSET  RI

      SADDR          NP NAI FORBD ACT  CGSR

Range CgPA Entries for OPNAME: dd
-----

      SADDR          EADDR          NP NAI FORBD ACT    PCA          SSN
CGSR

      SADDR          EADDR          NP NAI FORBD ACT    PCI          SSN
CGSR
1234          3452          * *  all  fwd      1-221-2      13
ak
MAPSET=DFLT RI=gt  TT=11

      SADDR          EADDR          NP NAI FORBD ACT    PCN          SSN
CGSR

      SADDR          EADDR          NP NAI FORBD ACT    PCN24        SSN
CGSR

      SADDR          EADDR          NP NAI FORBD ACT    CGSR

GSM MAP Screening Table (14 of 4000) is 1% full
;

```

This example shows the output for a specific MAP set. The Flexible GTT Load Sharing feature is on.

```
rtrv-gsmmap-scrn:opname=rr:mapset=1
```

```

tekelecstp 08-01-22 00:59:18 EST  EAGLE 38.0.0

Single CgPA Entries for OPNAME: rr
-----

      SADDR          NP NAI FORBD ACT    PCA          SSN CGSR  MAPSET
RI

      SADDR          NP NAI FORBD ACT    PCI          SSN CGSR  MAPSET
RI

      SADDR          NP NAI FORBD ACT    PCN          SSN CGSR  MAPSET
RI

      SADDR          NP NAI FORBD ACT    PCN24        SSN CGSR  MAPSET
RI

Range CgPA Entries for OPNAME: rr
-----

      SADDR          EADDR          NP NAI FORBD ACT    PCA          SSN
CGSR

```

```

1234          3452          * * all fwd
001-001-002  12 au
MAPSET=1 RI=gt TT=11

```

```

SADDR          EADDR          NP NAI FORBD ACT
PCI           SSN CGSR

```

```

SADDR          EADDR          NP NAI FORBD ACT
PCN           SSN CGSR

```

```

SADDR          EADDR          NP NAI FORBD ACT
PCN24         SSN CGSR

```

```

GSM MAP Screening Table (26 of 4000) is 1% full
;
```

This example shows the output for the subsystem number routing indicator.

```
rtrv-gsmmap-scrn:opname=e:ri=ssn
```

```
tekelecstp 08-08-21 15:40:00 EST EAGLE 39.2.0
```

```
Single CgPA Entries for OPNAME: e
```

```

-----
SADDR          NP NAI FORBD ACT      PCA          SSN CGSR
RI      TT
*              * * all fwd      001-001-002  12 ad
ssn    11

SADDR          NP NAI FORBD ACT      PCI          SSN CGSR
RI      TT

SADDR          NP NAI FORBD ACT      PCN          SSN CGSR
RI      TT

SADDR          NP NAI FORBD ACT      PCN24        SSN CGSR
RI      TT

```

```
Range CgPA Entries for OPNAME: e
```

```

-----
SADDR          EADDR          NP NAI FORBD ACT
PCA           SSN CGSR
*              *              * * all fwd
001-001-002  12 d
RI=ssn TT=11

SADDR          EADDR          NP NAI FORBD ACT
PCI           SSN CGSR

SADDR          EADDR          NP NAI FORBD ACT
PCN           SSN CGSR

```

```

SADDR          EADDR          NP NAI FORBD ACT      PCN24          SSN
CSGR

SADDR          EADDR          NP NAI FORBD ACT      CGSR

GSM MAP Screening Table (4 of 4000) is 1% full
;

```

This example shows the output for the global translation routing indicator and a specified mapset:

```
rtrv-gsmmap-scrn:opname=e:mapset=dflt:ri=gt
```

```
tekelecstp 08-08-22 00:57:57 EST EAGLE 39.2.0
```

```
Single CgPA Entries for OPNAME: e
```

```

-----
SADDR          NP NAI FORBD ACT      PCA          SSN CGSR      MAPSET
RI
1111          2 3  all  fwd      001-001-002  12 ad         DFLT
gt
TT=11

SADDR          NP NAI FORBD ACT      PCI          SSN CGSR      MAPSET
RI

SADDR          NP NAI FORBD ACT      PCN          SSN CGSR      MAPSET
RI

SADDR          NP NAI FORBD ACT      PCN24        SSN CGSR      MAPSET
RI

```

```
Range CgPA Entries for OPNAME: e
```

```

-----
SADDR          EADDR          NP NAI FORBD ACT      PCA          SSN
CSGR
1234          3452          * *  all  fwd      001-001-002  12
as
MAPSET=DFLT RI=gt  TT=11

SADDR          EADDR          NP NAI FORBD ACT      PCI          SSN
CSGR

SADDR          EADDR          NP NAI FORBD ACT      PCN          SSN
CSGR

SADDR          EADDR          NP NAI FORBD ACT      PCN24        SSN
CSGR

```

```

GSM MAP Screening Table (26 of 4000) is 1% full
;

```

This example shows the output for called and calling party screening references:

```
rtrv-gsmmap-scrn:opname=rr:cgsr=au:cdsr=aj

tekelecstp 08-08-22 00:58:55 EST EAGLE 39.2.0
SADDR          EADDR          NP NAI FORBD ACT
PCA            SSN CDSR
1234           3452           * * all fwd
001-001-002   12 aj
MAPSET=1 RI=gt TT=11
GSM MAP Screening Table (26 of 4000) is 1% full
;
```

This example shows the output for a calling party screening reference.

```
rtrv-gsmmap-scrn:opname=dd:cgsr=ak

tekelecstp 08-08-22 00:44:34 EST EAGLE 39.2.0

Single CdPA Entries for OPNAME: dd and CGSR: ak
-----

RI      SADDR          NP NAI FORBD ACT      PCA          SSN CDSR
      TT

RI      SADDR          NP NAI FORBD ACT      PCI          SSN CDSR
3476   * * all fwd      1-221-2      13 gu
gt      11

RI      SADDR          NP NAI FORBD ACT      PCN          SSN CDSR
      TT

RI      SADDR          NP NAI FORBD ACT      PCN24        SSN CDSR
      TT

SADDR          NP NAI FORBD ACT      CDSR

Range CdPA Entries for OPNAME: dd and CGSR: ak
-----

PCA      SADDR          EADDR          NP NAI FORBD ACT
      SSN CDSR

PCI      SADDR          EADDR          NP NAI FORBD ACT
1234    3452           * * all fwd
1-221-2  13 gh
      RI=gt TT=11

PCN      SADDR          EADDR          NP NAI FORBD ACT
      SSN CDSR
```

```

SADDR          EADDR          NP NAI FORBD ACT      PCN24          SSN
CDSR

SADDR          EADDR          NP NAI FORBD ACT      CDSR

GSM MAP Screening Table (14 of 4000) is 1% full
;

```

This example shows the output for a specified translation type.

```
rtrv-gsmmap-scrn:opname=test4:tt=12
```

```
tekelecstp 08-08-18 17:26:42 EST EAGLE 39.2.0
```

```
Single CgPA Entries for OPNAME: test4
```

```

-----
SADDR          NP NAI FORBD ACT      PCA          SSN CGSR      RI      TT
*              * * all fwd          001-001-002  12 ad         ssn     12

SADDR          NP NAI FORBD ACT      PCI          SSN CGSR      RI      TT

SADDR          NP NAI FORBD ACT      PCN          SSN CGSR      RI      TT

SADDR          NP NAI FORBD ACT      PCN24        SSN CGSR      RI      TT

SADDR          NP NAI FORBD ACT      CGSR

```

```
Range CgPA Entries for OPNAME: test4
```

```

-----
SADDR          EADDR          NP NAI FORBD ACT      PCA          SSN
CGSR
*              *              * * all fwd          001-001-002  -
d
RI=ssn TT=12

SADDR          EADDR          NP NAI FORBD ACT      PCI          SSN
CGSR

SADDR          EADDR          NP NAI FORBD ACT      PCN          SSN
CGSR

SADDR          EADDR          NP NAI FORBD ACT      PCN24        SSN
CGSR

SADDR          EADDR          NP NAI FORBD ACT      CGSR

GSM MAP Screening Table (4 of 4000) is 1% full
;

```

This example shows the output for a specified translation type and a specified mapset.

rtrv-gsmmap-scrn:opname=e:mapset=dflt:tt=12

tekelecstp 08-01-22 00:57:57 EST EAGLE 39.2.0

Single CgPA Entries for OPNAME: e

```

-----
      SADDR          NP NAI FORBD ACT      PCA          SSN CGSR
MAPSET  RI
      1111          2 3  all  fwd      001-001-002  12  ad
DFLT    ssn
      TT=12

      SADDR          NP NAI FORBD ACT      PCI          SSN CGSR
MAPSET  RI

      SADDR          NP NAI FORBD ACT      PCN          SSN CGSR
MAPSET  RI

      SADDR          NP NAI FORBD ACT      PCN24         SSN CGSR
MAPSET  RI

```

Range CgPA Entries for OPNAME: e

```

-----
      SADDR          EADDR          NP NAI FORBD ACT
PCA          SSN CGSR
      1234          3452          * *  all  fwd
001-001-002  12  as
      MAPSET=DFLT RI=ssn TT=12

      SADDR          EADDR          NP NAI FORBD ACT
PCI          SSN CGSR

      SADDR          EADDR          NP NAI FORBD ACT
PCN          SSN CGSR

      SADDR          EADDR          NP NAI FORBD ACT
PCN24         SSN CSGR

```

GSM MAP Screening Table (26 of 4000) is 1% full

;

### Legend

- **Single Entries/Range Entries**—GSM MAP screening single entries and range entries are output in separate sections of the retrieval report. All single entries are output first during a summary report and then all range entries follow.
- **CgPA**—Calling Party Address entry
- **CdPA**—Called Party Address entry
- **OPNAME**—User-defined MAP operation code name.
- **SADDR**—Start origination address.

- **EADDR**—End origination address. This column is displayed for range entries only.
- **NPV**—Numbering plan value.
- **NAIV**—Nature of address indicator value.
- **FORBID** or **FORBD**—Indicates a forbidden parameter for the entered address. If a forbidden parameter is detected the message is rejected by the action defined by the *action* parameter. (Some values are abbreviated; for example, *locat* means *location* .)
- **ACTION** or **ACT**—Screening action, if forbidden. Possible actions are pass, discard (disc), atterr, route, forward, duplicate (dupl), and dupdisc.
- **PC** or **PCA**—ANSI Point Code
- **PCI**—ITU International Point Code
- **PCN**—ITU National Point Code
- **PCN24**—24-bit ITU National Point Code
- **SSN**—Subsystem Number
- **CGSR**—CgPA Screening Reference
- **CDSR**—CdPA Screening Reference
- **MAPSET**—MAP set
- **RI**—Routing Indicator
- **TT**—Translation Type

#### Related Topics

- [chg-gsmmap-scrn](#)
- [dlt-gsmmap-scrn](#)
- [ent-gsmmap-scrn](#)

## rtrv-gsmopts

Use this command to display all GSM (Global System for Mobile Telecommunication) system options from the database.

#### Parameters

This command has no parameters.

#### Example

```
rtrv-gsmopts
```

#### Dependencies

The EGLEOPTS table is corrupt or cannot be found.

None

#### Notes

None



## Output

rtrv-gsmopts

tekelecstp 14-05-30 16:51:49 EST EAGLE 46.1.0

GSM OPTIONS

```

-----
MULTCC          = NONE          MULTCC          = NONE
MULTCC          = NONE          MULTCC          = NONE
MULTCC          = NONE          MULTCC          = NONE
MULTCC          = NONE          MULTCC          = NONE
MULTCC          = NONE          MULTCC          = NONE
DEFMAPVR        = 1

DEFMCC          = NONE          DEFMNC          = NONE
CCNC            = NONE          MCCMNC         = NONE
CCNC            = NONE          MCCMNC         = NONE
CCNC            = NONE          MCCMNC         = NONE
CCNC            = NONE          MCCMNC         = NONE
CCNC            = NONE          MCCMNC         = NONE
CCNC            = NONE          MCCMNC         = NONE
CCNC            = NONE          MCCMNC         = NONE
CCNC            = NONE          MCCMNC         = NONE
CCNC            = NONE          MCCMNC         = NONE
CCNC            = NONE          MCCMNC         = NONE
CCNC            = NONE          MCCMNC         = NONE
CCNC            = NONE          MCCMNC         = NONE
CCNC            = NONE          MCCMNC         = NONE

SRIDN           = TCAP          SRIDNNOTFOUND  = GTT
CRPTT           = NONE          SRISMGTTTRTG   = OFF
MSRNDIG         = RN           MSRNNAI         = 0
MSRNNP          = 0            MSISDNTRUNC    = 0
SRFADDR         = NONE          SRFNAI         = 0
SRFNP           = 0            MSRNLEN        = 30

SERVERPFX       = NONE          GSM2IS41       = NONE
MIGRPFX         = SINGLE       IS412GSM       = NONE

SPORTTYPE       = NONE          DFLTRN         = NONE

EIRGRSP         = OFF          EIRRSPTYPE     = TYPE1
EIRIMSICLK      = OFF          EIRIMSISCRN    = OFF
EIRLOGWL        = OFF          EIRDFLTIMSISCRN = OFF
EIRDFLTIMSILKUP = RANGE       EIRDFLTIMSIRESP = WHITELIST

ENCODECUG       = OFF          ENCODENPS      = ON
ENCDNPSPTNONE  = OFF          ENCDNPSDNNOTFOUND = OFF

SRIRDCTENT      = GRN

OWNNETWORKSETNAME = NONE

G-Flex MLR OPTIONS :
  GFLEXMAPLAYERRTG = NONE

```

```

REGSS          = OFF  ACTSS          = OFF  DACTSS        = OFF
INTSS          = OFF  AUTHFAILRPT = OFF  RSTDATA       = OFF
PROCUNSTRQT   = OFF  RDYFORSM      = OFF  PURGMOBSS     = OFF
SRILOC        = OFF

```

```
;
```

### Related Topics

- [chg-gsmopts](#)
- [chg-gsmsmsopts](#)
- [rtrv-gsmsmsopts](#)

## rtrv-gsms-opcode

Use this command to retrieve the concerned GSM (Global System for Mobile Telecommunication) MAP (Mobile Application Part) screening operation codes and the default screening action for the operation code. This command allows the craftsperson to verify a list of all operation codes or a single operation code that the system uses in performing GSM Map Screening.

### Parameters

#### **mapset (optional)**

MAP set ID.

##### **Range:**

*1 - 36000, dflt*  
*dflt* —Default MAP set

#### **opcode (optional)**

MAP operation code.

##### **Range:**

*0 - 255, \**

##### **Default:**

Display all MAP operation codes

#### **opname (optional)**

User-defined name for the operation code. This value is defined with the `ent-gsms-opcode` command.

##### **Range:**

*ayyyyyyy*  
Up to 8 alphanumeric characters

##### **Default:**

Display all operation code names

#### **ri (optional)**

Routing indicator. This parameter specifies whether a subsequent global title translation is required.

**Range:***gt**ssn***tt (optional)**

Translation type. The value the CdPA TT is set to as the result of Enhanced GSM Map Screening.

**Range:***0 - 255***Default:**

Display all translation types

**Example**

```
rtrv-gsms-opcode
rtrv-gsms-opcode:opname=ati
rtrv-gsms-opcode:ri=gt
rtrv-gsms-opcode:tt=11
```

**Dependencies**

The GSM Map Screening feature must be enabled before this command can be entered.

The EGMS feature must be enabled and turned on before:

- The `opcode=*` parameter can be specified.
- An `opname` parameter can be specified that refers to an `opcode=*` parameter.

The GSM Map Op-Code table must be accessible.

The `opcode` and `opname` parameters cannot be specified together in the command.

The value of the `opcode` parameter must be between 0 - 255 or \* .

The specified `opname` parameter must exist in the GSM MAP Op-Code table.

If the `opname` parameter is specified, then it must be alphanumeric.

The `opname` parameter must be no more than 8 characters in length.

The Flexible GTT Load Sharing feature must be enabled before the `mapset` parameter can be specified.

The specified MAP set must exist.

**Notes**

None

**Output**

rtrv-gsms-opcode

tekelecstp 08-08-22 00:32:17 EST EAGLE 39.2.0

OPCODE	OPNAME	DFLTACT	PCA	SSN	RI	TT
15	d	fwd	001-001-002	12	ssn	11
16	e	fwd	001-001-002	12	gt	21
19	f	fwd	001-001-002	12	gt	14
20	h	fwd	001-001-002	-	gt	11

OPCODE	OPNAME	DFLTACT	PCI	SSN	RI	TT
17	dd	fwd	1-221-2	13	gt	244

OPCODE	OPNAME	DFLTACT	PCN	SSN	RI	TT

OPCODE	OPNAME	DFLTACT	PCN24	SSN	RI	TT

OPCODE	OPNAME	DFLTACT
12	a	disc
13	b	disc

GSMMS OPCODE Table (9 of 257) is 4% full

;

rtrv-gsms-opcode:opname=e

tekelecstp 08-08-22 00:32:45 EST EAGLE 39.2.0

OPCODE	OPNAME	DFLTACT	PCA	SSN	RI	TT
16	e	fwd	001-001-002	12	gt	21

GSMMS OPCODE Table (9 of 257) is 4% full

;

**This example includes a spare point code:**

rtrv-gsms-opcode

tekelecstp 08-08-22 00:54:42 EST EAGLE 39.2.0

OPCODE	OPNAME	DFLTACT	PCA	SSN	RI	TT
15	d	fwd	001-001-002	12	ssn	11
16	e	fwd	001-001-002	12	gt	21
19	f	fwd	001-001-002	12	gt	14
20	h	fwd	001-001-002	-	gt	11
21	k	fwd	001-001-002	12	gt	11
22	t	fwd	001-001-002	-	gt	128
23	u	fwd	001-001-002	12	ssn	11

```

39      rr      fwd      001-001-002      12      ssn      11

OPCODE OPNAME  DFLTACT  PCI          SSN  RI      TT
17      dd      fwd      1-221-2      13      gt      244
31      kk      fwd      1-221-2      13      ssn      11
44      rf      fwd      1-221-2      13      gt      11

OPCODE OPNAME  DFLTACT  PCN          SSN  RI      TT

OPCODE OPNAME  DFLTACT  PCN24       SSN  RI      TT

OPCODE OPNAME  DFLTACT
12      a      disc
13      b      disc

```

GSMSMMS OPCODE Table (13 of 257) is 5% full

;

This example shows output when the Flexible GTT Load Sharing feature is on.

rtrv-gsms-opcode

tekelecstp 08-08-22 00:54:42 EST EAGLE 39.2.0

```

OPCODE OPNAME  DFLTACT  PCA          SSN  MAPSET
RI      TT
15      d      fwd      001-001-002  12  DFLT
ssn    11
16      e      fwd      001-001-002  12  DFLT
gt     21
19      f      fwd      001-001-002  12  DFLT
gt     14
20      h      fwd      001-001-002  -   DFLT
gt     11
21      k      fwd      001-001-002  12  DFLT
gt     11
22      t      fwd      001-001-002  -   DFLT
gt     128
23      u      fwd      001-001-002  12  DFLT
ssn    11
39      rr      fwd      001-001-002  12  1
ssn    11

OPCODE OPNAME  DFLTACT  PCI          SSN  MAPSET
RI      TT
17      dd      fwd      1-221-2      13  DFLT
gt     244
31      kk      fwd      1-221-2      13  DFLT
ssn    11
44      rf      fwd      1-221-2      13  2
gt     11

OPCODE OPNAME  DFLTACT  PCN          SSN  MAPSET
RI      TT

```

```

OPCODE  OPNAME      DFLTACT      PCN24          SSN  MAPSET RI      TT
OPCODE  OPNAME      DFLTACT
12      a           disc
13      b           disc

```

GSMMS OPCODE Table (13 of 257) is 5% full

;

This example shows output for a specific MAP set. The Flexible GTT Load Sharing feature is on.

```
rtrv-gsms-opcode:mapset=2
```

```
tekelecstp 08-08-22 00:56:01 EST EAGLE 39.2.0
```

```

OPCODE  OPNAME      DFLTACT      PCA          SSN  MAPSET RI      TT
OPCODE  OPNAME      DFLTACT      PCI          SSN  MAPSET RI      TT
44      rf          fwd          1-221-2     13   2      gt      11
OPCODE  OPNAME      DFLTACT      PCN          SSN  MAPSET RI      TT
OPCODE  OPNAME      DFLTACT      PCN24       SSN  MAPSET RI      TT

```

GSMMS OPCODE Table (13 of 257) is 5% full

;

This example shows the output for the global translation routing indicator.

```
rtrv-gsms-opcode:ri=gt
```

```
tekelecstp 08-08-22 00:54:53 EST EAGLE 39.2.0
```

```

OPCODE  OPNAME      DFLTACT      PCA          SSN  RI      TT
16      e           fwd          001-001-002 12   gt      21
19      f           fwd          001-001-002 12   gt      14
20      h           fwd          001-001-002 -    gt      11
21      k           fwd          001-001-002 12   gt      11
22      t           fwd          001-001-002 -    gt      128
OPCODE  OPNAME      DFLTACT      PCI          SSN  RI      TT
17      dd          fwd          1-221-2     13   gt      244
44      rf          fwd          1-221-2     13   gt      11
OPCODE  OPNAME      DFLTACT      PCN          SSN  RI      TT
OPCODE  OPNAME      DFLTACT      PCN24       SSN  RI      TT

```

GSMMS OPCODE Table (13 of 257) is 5% full

;

This example shows the output for the subsystem number routing indicator. The FGTTLS feature is enabled.

```
rtrv-gsms-opcode:ri=ssn
```

```
tekelecstp 08-08-22 00:55:03 EST EAGLE 39.2.0

  OPCODE  OPNAME      DFLTACT      PCA          SSN  MAPSET
RI      TT
  15      d          fwd          001-001-002  12  DFLT
ssn    11
  23      u          fwd          001-001-002  12  DFLT
ssn    11
  39      rr         fwd          001-001-002  12  1
ssn    11

  OPCODE  OPNAME      DFLTACT      PCI          SSN  MAPSET
RI      TT
  31      kk         fwd          1-221-2      13  DFLT
ssn    11

  OPCODE  OPNAME      DFLTACT      PCN          SSN  MAPSET
RI      TT

  OPCODE  OPNAME      DFLTACT      PCN24        SSN  MAPSET
RI      TT

  GSMMS OPCODE Table (13 of 257) is 5% full
;
```

This example shows the output for a specified translation type.

```
rtrv-gsms-opcode:tt=11
```

```
tekelecstp 08-08-22 00:54:53 EST EAGLE 39.2.0

  OPCODE  OPNAME      DFLTACT      PCA          SSN  RI  TT
  15      d          fwd          001-001-002  12  ssn 11
  20      h          fwd          001-001-002  -   gt  11
  21      k          fwd          001-001-002  12  gt  11
  22      t          fwd          001-001-002  -   gt  11
  23      u          fwd          001-001-002  12  ssn 11
  39      rr         fwd          001-001-002  12  ssn 11

  OPCODE  OPNAME      DFLTACT      PCI          SSN  RI  TT
  31      kk         fwd          1-221-2      13  ssn 11
  44      rf         fwd          1-221-2      13  gt  11

  OPCODE  OPNAME      DFLTACT      PCN          SSN  RI  TT

  OPCODE  OPNAME      DFLTACT      PCN24        SSN  RI  TT
```

```
GSMMS OPCODE Table (13 of 257) is 5% full  
;
```

### Legend

- **OPCODE**—MAP operation code
- **OPNAME**—User-defined name of operation code
- **DFLTACT**—Default screening action
- **PCA**—ANSI Point Code
- **PCI**—ITU International Point Code
- **PCN**—ITU National Point Code
- **PCN24**—24-bit ITU National Point Code
- **SSN**—Subsystem Number
- **MAPSET**—MAP set
- **RI**—Routing Indicator
- **TT**—Translation Type

### Related Topics

- [chg-gsms-opcode](#)
- [dlt-gsms-opcode](#)
- [ent-gsms-opcode](#)

## rtrv-gsmsmsopts

Use this command to display all GSM SMS options from the database.

### Parameters

**This command has no parameters.**

### Example

```
rtrv-gsmsmsopts
```

### Dependencies

The EGLEOPTS table is corrupt or cannot be found.

None.

### Notes

None

### Output

```
rtrv-gsmsmsopts
```

```
tekelecstp 10-09-23 11:27:38 EST EAGLE5 43.0.0
```



## GSM SMS OPTIONS

```

-----
BPARTYGTTSN = NONE           MOSMSGTTDIG = SCCPCDPA
MOSMSTYPE   = SPRN           MOSMSNAI    = INTL
MOSMSSA     = NO             MOSMSFWD    = NO
MOSMSACLEN  = 0              MOSMSGTA    = NONE
MOSMSTCAPSEG = OFF           MOSMSDIGMAT = EXACT
SPORTTYPE   = NONE           SPFILL      = OFF
DEFRN       = NONE

MTSMSIMSI   = MCCRNDN        MTSMSNNI    = RN
MTSMSTYPE   = RN             MTSMSACKN   = ACK
MTSMSDLTR   = NO             MTSMSDLTRV  = NONE
MTSMSNAKERR = 1              MTSMSCHKSRC = NO
MTMMSTYPE   = RN             SRISMDN     = SCCP

MTMMSGTA    = NONE
MTMMSACKN   = ACK            MTMMSENTYLEN = NONE
MTMMSLEN    = NONE

IGSMSRELAY  = NO              DEFIS41SMSC = NONE
IS41SMSCGTTSN= NONE

```

**Related Topics**

- [chg-gsmopts](#)
- [chg-gsmssmsopts](#)
- [rtrv-gsmopts](#)

## rtrv-gsmssn-scrn

Use this command to retrieve all or single subsystem numbers in the GSM SSN screening table.

**Parameters****ssn (optional)**

Subsystem number.

**Range:**

000 - 255

**Default:**

Display all

**type (optional)**

Subsystem type.

**Range:****orig**

Origination SSN

**dest**  
Destination SSN

**Default:**  
Display all

### Example

```
rtrv-gsmssn-scrn
rtrv-gsmssn-scrn:ssn=0:type=dest
```

### Dependencies

The GSM Map Screening feature must be enabled before this command can be entered.

The SSN Map Screening table is corrupt or cannot be found.

A valid value must be specified for the `ssn` parameter.

A valid value must be specified for the `type` parameter.

### Notes

If specified, the `ssn/type` parameter combination must exist in the GSM SSN screening table. If the value does not exist, the following message is displayed:

```
SSN ORIG DEST
```

No matching entries with the specified criteria found.

### Output

```
rtrv-gsmssn-scrn:ssn=10:type=orig

rlghncxa03w 04-02-20 09:07:58 EST EAGLE 31.3.0
SSN ORIG DEST
010 Yes Yes
GSMMS SSN table is (256 of 512) 50% full
RTRV-GSMSSN-SCRN: MASP A - COMPLTD
;

rtrv-gsmssn-scrn

rlghncxa03w 04-02-20 09:07:58 EST EAGLE 31.3.0
SSN ORIG DEST
002 Yes No
010 Yes Yes
GSMMS SSN table is (2 of 512) 1% full
RTRV-GSMSSN-SCRN: MASP A - COMPLTD
;
```

**Legend**

- **SSN**—Subsystem number
- **ORIG**—Specifies whether the subsystem type is origination
- **DEST**—Specifies whether the subsystem type is destination

**Related Topics**

- [dlt-gsmssn-scrn](#)
- [ent-gsmssn-scrn](#)

## rtrv-gta

Use this command to display a list of the GTA (global title address) information applicable to the specified GTT set. This list can be filtered using a number of parameters. The report that is displayed contains two records (the percentage full and number-of-cells-used field) that give the total entries in the GTT table without regard to the selector specified.

This command obtains the routing object (destination address and subsystem number), relative cost, and routing indicator assigned to that object for specified GTAs (global title addresses) or ranges of GTAs with a given GTT set.

**Note:**

If the EGTT feature is turned on, then the GTT Selector (`ent/chg/dlt/rtrvgtttsel`), GTT Set (`ent/dlt/rtrv-gttset`), and GTA (`ent/chg/dlt/rtrvgta`) commands replace the Translation Type (`ent/dlt/rtrv-tt`) and Global Title Translation (`ent/chg/dlt/rtrv-gtt`) commands. It is not recommended to run `ent/dlt/rtrv-tt & ent/chg/dlt/rtrv-gtt` commands as it may cause the advance GTA fields of GTT entry to be reset to the default values.

**Parameters****Note:**

See [Point Code Formats and Conversion](#) for a detailed description of point code formats, rules for specification, and examples.

**gttsn (mandatory)**

GTT set name. A GTT set is an entity to which global title addresses and selectors are assigned.

**Range:**

ayyyyyyy

1 leading alphabetic and up to 8 following alphanumeric characters

**acn (optional)**

Application context name. The ITU TCAP *acn* field in the incoming MSU.

**Range:**

0 - 255, \*, *none*

The *acn* field supports up to 7 subfields separated by a dash (e.g., 1-202-33-104-54-26-007).

\*—any valid value in the ITU TCAP *acn* field in the incoming MSU

*none*—there is no ITU TCAP *acn* field in the incoming MSU

**actsn (optional)**

GTT Action Set Name.

**Range:**

ayyyyyyyy, *none*

1 leading alphabetic character and up to 8 following alphanumeric characters

**cdssn (optional)**

Starting CdPA subsystem number.

**Range:**

0 - 255

**cggtmod (optional)**

Calling party global title modification indicator. This parameter displays all translation entries that have the specified value of the calling party GT modification indicator.

**Range:**

*yes*

*no*

**cgpc (optional)**

ANSI CgPA point code with subfields *network indicator-network cluster-network cluster member (ni-nc-ncm)*.

**Synonym:**

*cgpca*

**Range:**

0-255, \*

Specify a valid value for each subfield of the point code, and separate the subfields with a dash (-).

The asterisk (\*) value is not valid for the *ni* subfield.

When *chg-sid:pctype=ansi* is specified, *ni=000* is not valid.

When *chg-sid:pctype=ansi* is specified, *nc = 000* is not valid if *ni=001–005*.

When *chg-sid:pctype=ansi* is specified, *nc=000* is valid if *ni=006–255*.

When *chg-sid:pctype=ansi* is specified, *ni-\*-\** is valid if *ni =006–255*.

The point code *000-000-000* is not a valid point code.

**cgpci (optional)**

ITU international CgPA point code with subfields *zone-area-id*. The *prefix* subfield indicates a spare point code (*prefix-zone-area-id*).

**Range:***s-*, 0-255

Specify a valid value for each subfield of the point code, and separate the subfields with a dash (-).

*prefix*—*s**zone*—0-7*area*—000-255*id*—0-7

The point code 0-000-0 is not a valid point code.

**cgpcn (optional)**ITU national CgPA point code in the format of a 5-digit number (*nnnnn*); or 2, 3, or 4 numbers (members) separated by dashes (*m1-m2-m3-m4*) as defined by the `chg-stpopts:npcfmti` flexible point code option. A group code must be specified when the ITUDUPPC feature is turned on (*nnnnn-gc*, *m1-m2-m3-m4-gc*). The *prefix* subfield indicates a spare point code (*prefix-nnnnn*, *prefix-nnnnn-gc*, *prefix-m1-m2-m3-m4*, *prefix-m1-m2-m3-m4-gc*).**Range:***s-*, 0-16383, *aa-zz*

Specify a valid value for each subfield of the point code, and separate the subfields with a dash (-).

*prefix*—*s-**nnnnn*—0-16383*gc*—*aa-zz**m1-m2-m3-m4*—0-14 for each member; values must sum to 14**cgpcn24 (optional)**24-bit ITU national CgPA point code with subfields *main signaling area-sub signaling area-signaling point* (*msa-ssa-sp*).**Range:**

000-255

Specify a valid value for each subfield of the point code, and separate the subfields with a dash (-).

*msa*—000-255*ssa*—000-255*sp*—000-255**cgpcn16 (optional)**16-bit ITU national CgPA point code with subfields *unit number-sub number area-main number area* (*un-sna-mna*).**Range:**

000---127

Specify a valid value for each subfield of the point code, and separate the subfields with a dash (-).

*un*---000---127*sna*---000---15*mna*---000---31

**cgpcaction (optional)**

This parameter is used to provide the required abilities, indicating what any particular translation needs to do with CgPA PC.

**Range:**

*dflt*

protocol will be allowed to perform all the required processing/conversion with CGPC.

*ignore*

CGPC will be left as it was in incoming MSU.

*remove*

CGPC will be removed from outgoing MSU.

**Default:**

*dflt*

**cgssn (optional)**

Starting CgPA subsystem number.

**Range: 0 - 255**

**defmapvr (optional)**

Default MAP version for MBR opcodes. This parameter is used to provide the default MAP version for supported MBR opcodes if the Application Context Name (ACN) is not present in an incoming MAP message.

**Range:**

*v1*

*v2*

*v3*

**dpcc (optional)**

ANSI destination point code with subfields *network indicator-network cluster-network cluster member (ni-nc-ncm)*.

**Synonym:**

*dpca*

**Range:**

*0-255, \**

Specify a valid value for each subfield of the point code, and separate the subfields with a dash (-).

The asterisk (\*) value is not valid for the *ni* subfield.

When *chg-sid:pctype=ansi* is specified, *ni=000* is not valid.

When *chg-sid:pctype=ansi* is specified, *nc = 000* is not valid if *ni=001-005*.

When *chg-sid:pctype=ansi* is specified, *nc=000* is valid if *ni=006-255*.

When *chg-sid:pctype=ansi* is specified, *ni-\*-\** is valid if *ni =006-255*.

The point code *000-000-000* is not a valid point code.

**dpc/dpca/dpci/dpcn/dpcn24/dpcn16 (optional)**

Point Code.

**dpci (optional)**

ITU international destination point code with subfields *zone-area-id*. The *prefix* subfield indicates a spare point code (*prefix-zone-area-id*).

**Range:**

*s*-, 0-255

Specify a valid value for each subfield of the point code, and separate the subfields with a dash (-).

*prefix*—*s*

*zone*—0-7

*area*—000-255

*id*—0-7

The point code 0-000-0 is not a valid point code.

**dpcn (optional)**

ITU destination point code in the format of a 5-digit number (*nnnnn*); or 2, 3, or 4 numbers (members) separated by dashes (*m1-m2-m3-m4*) as defined by the `chg-stpopts:npcfmti` flexible point code option. A group code must be specified when the ITUDUPPC feature is turned on (*nnnnn-gc*, *m1-m2-m3-m4-gc*). The *prefix* subfield indicates a spare point code (*prefix-nnnnn*, *prefix-nnnnn-gc*, *prefix-m1-m2-m3-m4*, *prefix-m1-m2-m3-m4-gc*).

**Range:**

*s*-, 0-16383, *aa-zz*

Specify a valid value for each subfield of the point code, and separate the subfields with a dash (-).

*prefix*—*s*-

*nnnnn*—0-16383

*gc*—*aa-zz*

*m1-m2-m3-m4*—0-14 for each member; values must sum to 14

**dpcn24 (optional)**

24-bit ITU national destination point code with subfields *main signaling area-sub signaling area-signaling point* (*msa-ssa-sp*).

**Range:**

000-255

Specify a valid value for each subfield of the point code, and separate the subfields with a dash (-).

*msa*—000-255

*ssa*—000-255

*sp*—000-255

**dpcn16 (optional)**

16-bit ITU national destination point code with subfields *unit number-sub number area-main number area* (*un-sna-mna*).

**Range:**

000---127

Specify a valid value for each subfield of the point code, and separate the subfields with a dash (-).

*un---000---127*

*sna---000---15*

*mna---000---31*

**eaddr (optional)**

End Address (Similar to EGTA). This parameter specifies the end of a range of MAP digits (IMEI/IMSI/MSISDN/VLRNB/SMRPOA/SMRPDA).

**Range:**

1 - 21 digits

If the Hex Digit Support for GTT feature is not enabled, the range is 1 - 21 decimal digits; valid digits are 0-9.

If the Hex Digit Support for GTT feature is enabled and on, the range is 1 - 21 hexadecimal digits; valid digits are 0-9, a-f, A-F.

**Default:**

Same as the specified SADDR value.

**ecdssn (optional)**

Ending CdPA subsystem number.

**Range:**

0 - 255

**ecgssn (optional)**

Ending CgPA subsystem number.

**Range:**

0 - 255

**egta (optional)**

End global title address. The end of a range of global title digits.

**Range:**

1 - 21 digits

If the Hex Digit Support for GTT feature is not enabled and on, the range is 1 - 21 decimal digits; valid digits are 0-9.

If the Hex Digit Support for GTT feature is enabled and on, the range is 1 - 21 hexadecimal digits; valid digits are 0-9, a-f, A-F.

**Default:**

The first *gta* entry for the given GTT selector

**family (optional)**

The ANSI TCAP *family* field in the incoming MSU.

**Range:**

0 - 255, \*, none



\*

any valid value in the ANSI TCAP *family* field in the incoming MSU

**none**

there is no value in the ANSI TCAP *family* field in the incoming MSU

**force (optional)**

Display more than 1000 entries.

**Range:**

**yes**

**no**

**Default:**

*no*

**gta (optional)**

Global title address. The beginning of a range of global title digits.

**Range:**

1 - 21 digits

If the Hex Digit Support for GTT feature is not enabled and on, the range is 1 - 21 decimal digits; valid digits are 0-9.

If the Hex Digit Support for GTT feature is enabled and on, the range is 1 - 21 hexadecimal digits; valid digits are 0-9, a-f, A-F.

**Default:**

The first *gta* entry for the given GTT selector

**gtmodid (optional)**

Global title modification identifier.

**Range:**

*ayyyyyyy*

1 leading alphabetic character followed by up to 8 alphanumeric characters

**Default:**

displays all GT Modification Indicators for the GTA

**loopset (optional)**

SCCP loopset name. This parameter retrieves translation entries associated with the specified loopset.

**Range:**

*ayyyyyyy, none*

1 alphabetic character followed by up to 7 alphanumeric characters.

*none* —Translation entries with no association to any loopset.

**mapset (optional)**

MAP set ID. This parameter retrieves GTA information for a specified Mated Application set.

**Range:**

1 - 36000, *dflt*

*dflt* —Default MAP set

**Default:**

Retrieves GTA information for the default MAP set.

**mrnset (optional)**

MRN set ID. This parameter retrieves GTA information for a specified Mated Relay Node set.

**Range:**

1 - 3000, *dflt*, *none*

*dflt* —Default MRN set

*none* —The GTA translation does not participate in any loadsharing.

**num (optional)**

Number of entries to display.

**Range:**

1 - 1000000

**Default:**

1 —if *gta* is specified

20 —if *gta* is not specified

**opc (optional)**

ANSI originating point code with subfields *network indicator-network cluster-network cluster member (ni-nc-ncm)*.

**Synonym:**

*opca*

**Range:**

0-255, \*

Specify a valid value for each subfield of the point code, and separate the subfields with a dash (-).

The asterisk (\*) value is not valid for the *ni* subfield.

When *chg-sid:pctype=ansi* is specified, *ni=000* is not valid.

When *chg-sid:pctype=ansi* is specified, *nc = 000* is not valid if *ni=001–005*.

When *chg-sid:pctype=ansi* is specified, *nc=000* is valid if *ni=006–255*.

When *chg-sid:pctype=ansi* is specified, *ni-\*-\** is valid if *ni =006–255*.

The point code *000-000-000* is not a valid point code.

**opci (optional)**

ITU international originating point code with subfields *zone-area-id*. The *prefix* subfield indicates a spare point code (*prefix-zone-area-id*).

**Range:**

s-, 0-255

Specify a valid value for each subfield of the point code, and separate the subfields with a dash (-).

*prefix*—s

*zone*—0-7

*area*—000-255

*id*—0-7

The point code *0-000-0* is not a valid point code.

**opcn (optional)**

ITU national originating point code in the format of a 5-digit number (*nnnnn*); or 2, 3, or 4 numbers (members) separated by dashes (*m1-m2-m3-m4*) as defined by the `chg-stpopts:npcfmti` flexible point code option. A group code must be specified when the ITUDUPPC feature is turned on (*nnnnn-gc*, *m1-m2-m3-m4-gc*). The *prefix* subfield indicates a spare point code (*prefix-nnnnn*, *prefix-nnnnn-gc*, *prefix-m1-m2-m3-m4*, *prefix-m1-m2-m3-m4-gc*).

**Range:**

*s*-, 0-16383, *aa-zz*

Specify a valid value for each subfield of the point code, and separate the subfields with a dash (-).

*prefix*—*s*-

*nnnnn*—0-16383

*gc*—*aa-zz*

*m1-m2-m3-m4*—0-14 for each member; values must sum to 14

**opcn24 (optional)**

24-bit ITU originating point code with subfields *main signaling area-sub signaling area-signaling point* (*msa-ssa-sp*).

**Range:**

000-255

Specify a valid value for each subfield of the point code, and separate the subfields with a dash (-).

*msa*—000-255

*ssa*—000-255

*sp*—000-255

**opcn16 (optional)**

16-bit ITU originating point code with subfields *unit number-sub number area-main number area* (*un-sna-mna*).

**Range:**

000---127

Specify a valid value for each subfield of the point code, and separate the subfields with a dash (-).

*un*---000---127

*sna*---000---15

*mna*---000---31

**opcode (optional)**

The TCAP *opcode* field in the incoming MSU.

**Range:**

0 - 255, \*, *none*

\*—any valid value in the TCAP *opcode* field in the incoming MSU

*none*—there is no value in the TCAP *opcode* field in the incoming MSU

**pc (optional)**

ANSI point code in the form of *network indicator-network cluster-network cluster member (ni-nc-ncm)*. The *prefix* subfield indicates a private point code (*prefix-ni-nc-ncm*).

**Synonym:**

*pca*

**Range:**

*p-*, 000-255

Specify a valid value for each subfield of the point code, and separate the subfields with a dash (-).

*prefix—p-*

When *chg-sid:pctype=ansi* is specified, *ni = 000* is not valid.

When *chg-sid:pctype=ansi* is specified, *nc = 000* is not valid if *ni = 001-005*.

When *chg-sid:pctype=ansi* is specified, *nc = 000* is valid if *ni = 006-255*.

The point code *000-000-000* is not a valid point code.

**pci (optional)**

ITU international point code in the form of *zone-area-id*. The *prefix* subfield indicates a spare point code, private point code, or private and spare point code (*prefix-zone-area-id*).

**Range:**

*s-*, *p-*, *ps-*, 0-255

Specify a valid value for each subfield of the point code, and separate the subfields with a dash (-).

*prefix—s-*, *p-*, *ps*

*zone—0-7*

*area—000-255*

*id—0-7*

The point code *0-000-0* is not a valid point code.

**pcn (optional)**

ITU national point code in the format of a 5-digit number (*nnnnn*); or 2, 3, or 4 numbers (members) separated by dashes (*m1-m2-m3-m4*) as defined by the *chg-stpopts:npcfmti* flexible point code option. A group code must be specified when the ITUDUPPC feature is turned on (*nnnnn-gc*, *m1-m2-m3-m4-gc*). The *prefix* subfield indicates a spare point code, private point code, or private and spare point code (*prefix-nnnnn*, *prefix-nnnnn-gc*, *prefix-m1-m2-m3-m4*, *prefix-m1-m2-m3-m4-gc*).

**Range:**

*s-*, *p-*, *ps-*, 0-16383, *aa-zz*

Specify a valid value for each subfield of the point code, and separate the subfields with a dash (-).

*prefix—s-*, *p-*, *ps*

*nnnnn—0-16383*

*gc—aa-zz*

*m1-m2-m3-m4—0-14* for each member; values must sum to 14

**pcn24 (optional)**

24-bit ITU national point code with subfields *main signaling area-sub signaling area-signaling point (msa-ssa-sp)*. The *prefix* subfield indicates a private point code (*prefix-msa-ssa-sp*).

**Range:**

*p-*, 000-255

Specify a valid value for each subfield of the point code, and separate the subfields with a dash (-).

*prefix—p*  
*msa—000–255*  
*ssa—000–255*  
*sp—000–255*

**pcn16 (optional)**

16-bit ITU national point code with subfields *unit number-sub number area-main number area (un-sna-mna)*. The *prefix* subfield indicates a private point code (*prefix-un-sna-mna*).

**Range:**

*p--*, *000---127*

Specify a valid value for each subfield of the point code, and separate the subfields with a dash (-).

*prefix---p*  
*un---000---127*  
*sna---000---15*  
*mna---000---31*

**pctype (optional)**

Point code type. This parameter retrieves a single type of point code among mixed types of point code provisioned for a Translation Type.

**Range:**

*ansi*  
*itui*  
*itun*  
*itun16*  
*itun24*  
*ituis*  
*ituns*

**Default:**

Display all point code types

**pkgtype (optional)**

Package type. The ANSI TCAP and ITU TCAP package type.

**Range:**

*ansiuni*  
ANSI unidirectional

**qwp**  
Query with Permission

**qwop**  
Query with out Permission

**resp**  
Response

**cwp**  
Conversation with Permission

**cwop**  
Conversation with out Permission

**ansiabort**  
ANSI abort

**any**  
Wildcard value

**bgn**  
Begin

**end**  
End

**cnt**  
Continue

**ituabort**  
ITU abort

**ituuni**  
ITU unidirectional

**ANSI TCAP PKGTYPE**  
*ansiuni, qwp, qwop, resp, cwp, cwop, ansiabort, any*

**ITU TCAP PKGTYPE**  
*bgn, ituabort, ituuni, any, end, cnt*

**ppmeasreqd (optional)**  
Per Path Measurement required.

**Range:**

**yes**

**no**

**refgttsn (optional)**  
Referred GTT set name. The GTT Set Name referred in the GT Translation Entry by the *optsn*, *opcsn*, and *cgcnsn* parameters.

**Range:***ayyyyyyy*

1 leading alphabetic and up to 8 following alphanumeric characters

**saddr (optional)**

Start Address (Similar to GTA). This parameter specifies the beginning of a range of MAP digits (IMEI/MSI/MSISDN/VLRNB/SMRPOA/SMRPDA).

**Range:**

1 - 21 digits

If the Hex Digit Support for GTT feature is not enabled, the range is 1 - 21 decimal digits; valid digits are 0-9.

If the Hex Digit Support for GTT feature is enabled and on, the range is 1 - 21 hexadecimal digits; valid digits are 0-9, a-f, A-F.

**ssn (optional)**

Subsystem number.

**Range:***002 - 255***Default:**

Display all

**testmode (optional)**Test mode. This parameter displays all translation entries that have a specified value of the `testmode` parameter.**Range:***on**off***Default:***off***xlat (optional)**

Translate indicator. This parameter specifies translation actions and routing actions.

**Range:***dpc**dpcngt**dpcssn**none***Example**

```
rtrv-gta:gttsn=t800:num=65535:force=yes
```

```
rtrv-gta:gttsn=t800:pc=8-1-1:ssn=222:gta=9195551212
```

```
rtrv-
```

```
gta:gttsn=t800:ssn=222:gta=9000000000:egta=9762429999:num=65535  
:force=yes
```

```
rtrv-gta:gttsn=ntoa23:pctype=ansi
rtrv-gta:gttsn=setnat003:pcn=s-129-aa
rtrv-gta:gttsn=setnat003:gta=987658321198765432101:pcn=s-128-aa
rtrv-gta:gttsn=tbla
rtrv-gta:gttsn=tbla:pc=1-1-1
rtrv-gta:gttsn=setssn:mapset=6
rtrv-gta:gttsn=setans006:mrnset=1
rtrv-gta:gttsn=setans004:actsn=asetudts1
rtrv-gta:gttsn=setcdgta:testmode=on
rtrv-gta:gttsn=setcdssn:cdssn=15:ecdssn=25
rtrv-gta:gttsn=setcdgta:xlat=none
rtrv-gta:gttsn=setdpc:dpci=1-101-1
rtrv-gta:gttsn=setcdgta:xlat=dpcssn:ssn=10
rtrv-gta:gtmodid=set1
rtrv-gta:gttsn=setcggta:refgttsn=setcgpc
rtrv-gta:gttsn=setcdgta:ppmeasreqd=yes
rtrv-gta:gttsn=setcdgta:xlat=none:mrnset=1:mapset=6
rtrv-gta:gttsn=gtt1:cgpcaction=df1t
rtrv-gta:gttsn=setimsil:saddr=123456789
rtrv-gta:gttsn=setimsil:defmapvr=v2
rtrv-gta:gttsn=opc:opcode=57
rtrv-gta:gttsn=opcset1:opcode=57:pkgtype=bgn
rtrv-gta:gttsn=opcset1:pkgtype=end
rtrv-gta:gttsn=opc:opcode=57:acn=4-0-0-1-0-1-2
rtrv-gta:gttsn=opc:pkgtype=bgn:acn=none
```

### Dependencies

The EGTT feature must be turned on before this command can be entered.

The ANSI/ITU SCCP Conversion feature must be enabled before the `pctype` parameter can be specified.

The `gttsn` parameter must be specified, cannot have a value of *none*, and must match an existing `gttsn`.

The `pc/pca/pci/pcn/pcn24/pcn16`, `cgpc/cgpca/cgpci/cgpcn/cgpcn24/cgpcn16`, `opc/opca/opci/opcn/opcn24/opcn16`, and `dpc/dpca/dpci/dpcn/dpcn24/dpcn16` parameters must have valid values within the range for each subfield.



The ANSI/ITU SCCP Conversion feature must be enabled before a translated point code that is of a different domain than the GTT set specified by the `gttsn` parameter can be specified.

If the `egta/eaddr` parameter is specified, the `gta/saddr` parameter must be specified. The `gta/saddr` and `egta/eaddr` parameters must be the same length, and the value for the `egta/eaddr` parameter must be greater than the value for the `gta/saddr` parameter.

If the specified `num` parameter value is greater than 1000, the `force=yes` parameter must be specified.

The number of digits in the specified `gta/saddr` parameter must be at least the number of digits provisioned for the GTT set specified by the `gttsn` parameter. If the VGTT feature is turned on, then up to 10 GTA/SADDR lengths can exist per GTT set. If the Support for 16 GTT Lengths in VGTT feature is turned on, then up to 16 GTA/SADDR lengths can exist per GTT set.

If the Flexible GTT Load Sharing feature is not enabled, then the `mapset` parameter cannot be specified.

At least one entry must be provisioned in the specified MAP set in the MAP table.

If the `ecgssn/ecdssn` parameter is specified, the `cgssn/cdssn` parameter must be specified.

If the `ecgssn/ecdssn` parameter is specified, the `cgssn/cdssn` parameter must be specified, and the `ecgssn/ecdssn` parameter must be greater than the `cgssn/cdssn` parameter.

The OBSR feature must be enabled before the `cgpc/cgpca/cgpci/cgpcn/cgpcn24/cgpcn16`, `opc/opca/opci/opcn/opcn24/opcn16`, `cgssn`, or `ecgssn` parameter can be specified.

The range specified by the `cgssn/ecgssn` or the `cdssn/ecdssn` parameters must exist for the specified GTT set.

The Hex Digit Support for GTT feature must be enabled and on before hexadecimal digits can be specified for the `gta/saddr` and `egta/eaddr` parameters.

The SCCP Loop Detection feature must be enabled before the `loopset` parameter can be specified.

The value of the `loopset` parameter must already exist in the database.

The Loopset table is corrupt or cannot be found.

At least one entry must be provisioned in the MRN table for the MRN set that is specified by the `mrnset` parameter.

The Flexible GTT Load Sharing feature must be enabled before the `mrnset` parameter can be specified.

The AMGTT feature or the AMGTT CgPA Upgrade feature must be turned on before the `cgtmod` parameter can be specified.

The `xlat=none` parameter must be specified before the `mapset` and `mrnset` parameters can be specified together in the command.

A TOBR quantity feature must be turned on before the `opcode`, `pkgtype`, `acn`, `family`, `saddr`, `eaddr`, or `defmapvr` parameter can be specified.

The `opcode`, `pkgtype`, and `family` parameters must be specified together for ANSI TCAP translations. The `opcode`, `pkgtype`, and `acn` parameters must be specified together for ITU TCAP translations.

The `acn` and `family` parameters cannot be specified together in the command.

If the `family` parameter is specified, then a value of `ansiuni`, `qwp`, `qwop`, `resp`, `cwp`, `cwop`, `ansiabort`, or `any` must be specified for the `pkgtype` parameter.

If the `acn` parameter is specified, then a value of `bgn`, `ituabort`, `ituuni`, `any`, `end`, or `cnt` must be specified for the `pkgtype` parameter.

If the `pkgtype=ituabort` parameter is specified, then a value of `none` must be specified for the `acn` and `opcode` parameters.

If the `pkgtype=ansiabort` parameter is specified, then a value of `none` must be specified for the `family` and `opcode` parameters.

The `cgpc`, `cgssn`, `gta`, `opc`, `cdssn`, `opcode`, `acn`, `pkgtype`, `family`, and `saddr` parameters cannot be specified together in the command.

If the `cgssn` and `cdssn` parameters are both specified in the same command (in any order), then only the value for the last of the two parameters specified is used during processing.

Failure while reading the GTT Action Set table.

The value specified by the `actsn` parameter must already exist in the database.

The FLOBR feature must be turned on before the `dpc`, `cdssn`, or `ecdssn` parameter can be specified.

The specified point code must be a full point code.

The value specified for the `gtmodid` parameter must already exist in the GTMOD table.

The GTMOD table is corrupt or cannot be found.

A value of `none` cannot be specified for the `gttsn` and `refgttsn` parameters.

If the `xlat=none` parameter is specified, then the `pc/pca/pci/pcn/pcn24/pcn16`, `force`, `ssn`, and `ccgt` parameters cannot be specified.

The specified GTT set must have a set type of `opcode` (see the `ent-gttset` command) before the `opcode/acn/pkgtype` or `opcode/family/pkgtype/family` parameters can be specified. The specified GTT set must have a set type of `cdssn`, `cgssn`, `cdgta/cgta`, `opc`, or `cgpc` before the `cdssn`, `cgssn`, `gta`, `opc`, or `cgpc` parameter, respectively, can be specified.

If the `cgssn` parameter is specified, then the `ecdssn` parameter cannot be specified. If the `cdssn` parameter is specified, then the `ecgssn` parameter cannot be specified.

If the `opc` or `dpc` parameter is specified, then the `(e)gta`, `(e)cgssn`, `(e)cdssn`, `acn`, `pkgtype`, `family`, and `opcode` parameters cannot be specified.

The specified GTT set must have a set type of `opcode` (see the `ent-gttset` command) before the `defmapvr` parameter can be specified.

The `SADDR` parameter must be specified if the `EADDR` parameter is specified in the command.

### Notes

The percentage full and number of cells used report that is provided with the `rtrv-gta` command reflects the total entries in the GTA table without regard to the selector specified.

This command can be canceled using the **F9** function key or the `canc-cmd` command. See `canc-cmd` for more information.

If the `rtrv-gta` command is entered with only the `gta` parameter, a match would be an entry containing the same number of digits, or more digits, for the GTT set. For example, if `gta=8005556666` is specified, the six-digit GTT set `800555` would be a match. If the VGTT feature is turned on and the `egta` parameter is specified, all matching entries regardless of length are displayed.

In this command, only ITU-international and ITU national point codes support the spare point code subtype prefix (s-) and the private and spare point code subtype prefix (ps-). All of the point code types support the private (internal) point code subtype prefix (p-).

The point code domain translation types for EGTT are handled by the EAGLE protocol processing as either ANSI or ITU; therefore, ITU applies to ITU-I, ITU-I Spare, ITU-N, and ITU-N Spare. ITU-I includes ITU-I Spare, and ITU-N includes ITU-N Spare.

When the Origin-based SCCP Routing feature is enabled, its parameters are displayed. If no data is provisioned for these parameters, they are displayed as dashes.

### Output



#### Note:

The Start GTA (`gta`) and End GTA (`egta`) fields are sized according to the `ndgt` parameter value. Because all GTAs for a GTT Set are the same size, this helps the appearance of the display. If all 21 digits are used, an entry will not fit on a single line. If two lines per entry are used, the size of the report would double, being inefficient for large reports. It is not anticipated that more than 15 digits will be used in the immediate future, but displaying GTAs longer than 19 digits will cause the line to wrap around to the next line.

This example retrieves all GTAs for the specified GTT Set:

```
rtrv-gta:gttsn=t800:num=65535:force=yes
```

```
tekelecstp 10-02-04 08:31:05 EST EAGLE 42.0.0
```

```
GTTSN      NETDOM  NDGT
t800      ansi    10
```

```
GTA table is (17 of 269999) 1% full.
```

```

;
tekelecstp 10-02-04 08:31:06 EST EAGLE 42.0.0

START GTA  END GTA  XLAT  RI  PCA
8005550000 8005551999 DPCSSN SSN 001-254-255
      SSN=255 CCGT=no
      GTMODID=----- TESTMODE=off
      ACTSN=----- PPMEASREQD= NO
8005552000 8005553999 DPC  GT 001-254-255
      SSN=255 CCGT=no
      GTMODID=gtmodset1 TESTMODE=off
      ACTSN=----- PPMEASREQD= NO
8005554000 8005555999 DPCNGT GT 001-254-255
      SSN=255 CCGT=no
      GTMODID=gtmodset2 TESTMODE=off
      ACTSN=----- PPMEASREQD= NO
8005556000 8005557999 DPCSSN SSN 001-254-255
      SSN=255 CCGT=no
      GTMODID=----- TESTMODE=off
      ACTSN=----- PPMEASREQD= NO
8005558000 8005559999 DPCSSN SSN 001-254-255
      SSN=255 CCGT=yes
      GTMODID=----- TESTMODE=off
      ACTSN=----- PPMEASREQD= NO
9195551212 9195551212 DPCSSN SSN 008-001-001
      SSN=222 CCGT=no
      GTMODID=----- TESTMODE=off
      ACTSN=----- PPMEASREQD= NO
9762428487 9762428487 DPCSSN SSN 001-254-255
      SSN=222 CCGT=no
      GTMODID=----- TESTMODE=off
      ACTSN=----- PPMEASREQD= NO
9766423277 9766423277 DPCSSN SSN 001-254-255
      SSN=222 CCGT=no
      GTMODID=----- TESTMODE=off
      ACTSN=----- PPMEASREQD= NO
9769388928 9769388928 DPCSSN SSN 001-254-255
      SSN=222 CCGT=no
      GTMODID=gtmodset3 TESTMODE=off
      ACTSN=----- PPMEASREQD= NO

Command Retrieved 9 Entries
;

```

This example retrieves the specific GTAs containing the specified PC/SSN/GTA combination for the specified GTT Set:

```
rtrv-gta:gttsn=t800:pc=8-1-1:ssn=222:gta=9195551212
```

```

tekelecstp 10-02-24 08:29:15 EST EAGLE 42.0.0

GTTSN      NETDOM  NDGT
t800      ansi    10

```

```

GTA table is (17 of 269999) 1% full.
;
tekelecstp 10-02-24 08:29:16 EST EAGLE 42.0.0

START GTA  END GTA  XLAT  RI  PCA
9195551212 9195551212 DPCSSN SSN  008-001-001
      SSN=222 CCGT=no
      GTMODID=----- TESTMODE=off
      ACTSN=----- PPMEASREQD= NO

Command Retrieved 1 Entries
;

```

This example retrieves all GTAs containing the specified SSN and within the specified GTA range for the specified GTT Set:

```

rtrv-
gta:gttsn=t800:ssn=222:gta=9000000000:egta=9762429999:num=65535
:force=yes

```

```

tekelecstp 10-02-24 08:29:15 EST EAGLE 42.0.0

GTTSN      NETDOM  NDGT
t800      ansi    10
GTA table is (17 of 269999) 1% full.
;
tekelecstp 10-02-24 08:29:16 EST EAGLE 42.0.0

START GTA  END GTA  XLAT  RI  PCA
9195551212 9195551212 DPCSSN SSN  008-001-001
      SSN=222 CCGT=no
      GTMODID=----- TESTMODE=off
      ACTSN=----- PPMEASREQD= NO
9762428487 9762428487 DPCSSN SSN  001-254-255
      SSN=222 CCGT=no
      GTMODID=----- TESTMODE=off
      ACTSN=----- PPMEASREQD= NO

Command Retrieved 2 Entries
;

```

This example retrieves all GTAs for the specified GTT Set when the VGTT feature is turned on:

```

rtrv-gta:gttsn=t800:num=65535:force=yes

```

```

tekelecstp 10-02-04 08:31:05 EST EAGLE 42.0.0

GTTSN      NETDOM  NDGT
t800      ansi    10
GTA table is (17 of 269999) 1% full.
;

```

```
tekelecstp 10-02-04 08:31:06 EST EAGLE 42.0.0

START GTA  END GTA  XLAT  RI  PCA
8005550000 8005551999 DPCSSN SSN 001-254-255
      SSN=255 CCGT=no
      GTMODID=----- TESTMODE=off
      ACTSN=----- PPMEASREQD= NO
8005552000 8005553999 DPC  GT 001-254-255
      SSN=255 CCGT=no
      GTMODID=----- TESTMODE=off
      ACTSN=----- PPMEASREQD= NO
8005554000 8005555999 DPCNGT GT 001-254-255
      SSN=255 CCGT=no
      GTMODID=gtmodset3 TESTMODE=off
      ACTSN=----- PPMEASREQD= NO
8005556000 8005557999 DPCSSN SSN 001-254-255
      SSN=255 CCGT=no
      GTMODID=gtmodset1 TESTMODE=off
      ACTSN=----- PPMEASREQD= NO
8005558000 8005559999 DPCSSN SSN 001-254-255
      SSN=255 CCGT=yes
      GTMODID=----- TESTMODE=off
      ACTSN=----- PPMEASREQD= NO
9195551212 9195551212 DPCSSN SSN 008-001-001
      SSN=222 CCGT=no
      GTMODID=----- TESTMODE=off
      ACTSN=----- PPMEASREQD= NO
9762428487 9195551212 DPCSSN SSN 001-254-255
      SSN=222 CCGT=no
      GTMODID=gtmodset4 TESTMODE=off
      ACTSN=----- PPMEASREQD= NO
9766423277 9195551212 DPCSSN SSN 001-254-255
      SSN=222 CCGT=no
      GTMODID=----- TESTMODE=off
      ACTSN=----- PPMEASREQD= NO
9769388928 9195551212 DPCSSN SSN 001-254-255
      SSN=222 CCGT=no
      GTMODID=----- TESTMODE=off
      ACTSN=----- PPMEASREQD= NO
```

Command Retrieved 9 Entries

;

This example shows output containing GTMODID values:

```
rtrv-gta:gttsn=ansi:gtmodid=aset32
```

```
tekelecstp 10-02-04 08:29:15 EST EAGLE 42.0.0
GTTSN      NETDOM  NDGT
ansi      ansi    10

GTA table is (17 of 1000000) 1% full.
```

;

```

tekelecstp 10-02-04 08:29:16 EST EAGLE 42.0.0

START GTA  END GTA  XLAT  RI  PCA
8005550000 8005551999 DPCSSN SSN 001-254-255
      SSN=255 CCGT=no
      GTMODID=aset32 TESTMODE=off
      ACTSN=----- PPMEASREQD= NO
8005552000 8005553999 DPCNGT GT 001-254-255
      SSN=255 CCGT=no
      GTMODID=aset32 TESTMODE=off
      ACTSN=----- PPMEASREQD= NO
8005554000 8005555999 DPCNGT GT 001-254-255
      SSN=255 CCGT=no
      GTMODID=aset32 TESTMODE=off
      ACTSN=----- PPMEASREQD= NO
8005558000 8005559999 DPCSSN SSN 001-254-255
      SSN=255 CCGT=yes
      GTMODID=aset32 TESTMODE=off
      ACTSN=----- PPMEASREQD= NO
9195551212 9195551212 DPCSSN SSN 008-001-001
      SSN=222 CCGT=no
      GTMODID=aset32 TESTMODE=off
      ACTSN=----- PPMEASREQD= NO
9762428487 9762428487 DPCNGT GT 001-254-255
      SSN=222 CCGT=no
      GTMODID=aset32 TESTMODE=off
      ACTSN=----- PPMEASREQD= NO
9766423277 9766423277 DPCSSN SSN 001-254-255
      SSN=222 CCGT=no
      GTMODID=aset32 TESTMODE=off
      ACTSN=----- PPMEASREQD= NO

```

Command Retrieved 7 Entries

;

This example shows output when the GTT table can contain up to 1,000,000 entries:

```
rtrv-gta:gttsn=ansi
```

```

tekelecstp 10-02-04 08:29:15 EST EAGLE 42.0.0
GTTSN      NETDOM  NDGT
ansi      ansi    10

```

GTA table is (17 of 1000000) 1% full.

;

```

tekelecstp 10-02-04 08:29:16 EST EAGLE 42.0.0

START GTA  END GTA  XLAT  RI  PCA
8005550000 8005551999 DPCSSN SSN 001-254-255
      SSN=255 CCGT=no
      GTMODID=gtmodset9 TESTMODE=off
      ACTSN=----- PPMEASREQD= NO
8005552000 8005553999 DPCNGT GT 001-254-255

```

```

      SSN=255 CCGT=no
      GTMODID=----- TESTMODE=off
      ACTSN=----- PPMEASREQD= NO
8005554000 8005555999 DPCNGT GT      001-254-255
      SSN=255 CCGT=no
      GTMODID=gtmodset6 TESTMODE=off
      ACTSN=----- PPMEASREQD= NO
8005558000 8005559999 DPCSSN SSN    001-254-255
      SSN=255 CCGT=yes
      GTMODID=----- TESTMODE=off
      ACTSN=----- PPMEASREQD= NO
9195551212 9195551212 DPCSSN SSN    008-001-001
      SSN=222 CCGT=no
      GTMODID=----- TESTMODE=off
      ACTSN=----- PPMEASREQD= NO
9762428487 9762428487 DPCNGT GT      001-254-255
      SSN=222 CCGT=no
      GTMODID=gtmodset4 TESTMODE=off
      ACTSN=----- PPMEASREQD= NO
9766423277 9766423277 DPCSSN SSN    001-254-255
      SSN=222 CCGT=no
      GTMODID=----- TESTMODE=off
      ACTSN=----- PPMEASREQD= NO

```

Command Retrieved 7 Entries

;

This example shows output when the ANSI/ITU SCCP Conversion feature is enabled and the PCTYPE parameter has a value of ANSI:

```
rtrv-gta:gttsn=ntoa23:pctype=ansi
```

```
tekelecstp 10-02-24 08:29:15 EST EAGLE 42.0.0
```

```
GTTSN      NETDOM  NDGT
ntoa23     itu      4
```

GTA table is (36 of 269999) 1% full.

;

```
tekelecstp 10-02-24 08:29:16 EST EAGLE 42.0.0
```

```
START GTA END GTA XLAT  RI    PC
1899      1899    DPCNGT GT      010-002-002
      SSN=--- CCGT=no
      GTMODID=gmansiset TESTMODE=off
      ACTSN=----- PPMEASREQD= NO
```

Command Retrieved 1 Entries

;

This example shows output when the ANSI/ITU SCCP Conversion feature is enabled and the PCTYPE parameter has a value of ITUI:



```
rtrv-gta:gttsn=atoi22:pctype=itui
```

```

tekelecstp 10-02-24 08:29:15 EST  EAGLE 42.0.0

GTTSN      NETDOM  NDGT
atoi22    ansi     9

GTA table is (36 of 269999) 1% full.
;
tekelecstp 10-02-24 08:29:16 EST  EAGLE 42.0.0

START GTA END GTA  XLAT  RI      ITUI PC
991001200 991001300 DPCNGT GT      7-001-4
      SSN=--- CCGT=no
      GTMODID=asetitu2  TESTMODE=off
      ACTSN=----- PPMEASREQD= NO

Command Retrieved 1 Entries
;
```

This example shows output when the ANSI/ITU SCCP Conversion feature is enabled and the PCTYPE parameter has a value of ITUN:

```
rtrv-gta:gttsn=aton21:pctype=itun
```

```

tekelecstp 10-02-24 08:29:15 EST  EAGLE 42.0.0

GTTSN      NETDOM  NDGT
aton21     ansi     2

GTA table is (36 of 269999) 1% full.
;
tekelecstp 10-02-24 08:29:16 EST  EAGLE 42.0.0

START GTA END GTA XLAT  RI      ITUN PC
80      89      DPCSSN SSN    15441
      SSN=45 CCGT=no
      GTMODID=----- TESTMODE=off
      ACTSN=----- PPMEASREQD= NO

Command Retrieved 1 Entries
;
```

This example shows output when the ANSI/ITU SCCP Conversion feature is enabled and the PCTYPE parameter has a value of ITUN24:

```
rtrv-gta:gttsn=ntin24:pctype=itun24
```

```

tekelecstp 10-02-24 08:30:15 EST  EAGLE 42.0.0

GTTSN      NETDOM  NDGT
```

```

ntin24   itu      10

GTA table is (36 of 269999) 1% full.
;
tekelecstp 10-02-24 08:30:16 EST  EAGLE 42.0.0

START GTA   END GTA   XLAT   RI      ITUN24 PC
8006550000 8006551999 DPCSSN SSN    100-120-003
          SSN=255 CCGT=no
          GTMODID=asetitu24  TESTMODE=off
          ACTSN=----- PPMEASREQD= NO

Command Retrieved 1 Entries
;

rtrv-gta:gttsn=setnat003

tekelecstp 10-02-24 08:29:15 EST  EAGLE 42.0.0

GTTSN      NETDOM  NDGT
setnat003  itu      6,11,21

GTA table is (10 of 269999) 1% full.
;
tekelecstp 10-02-24 08:29:16 EST  EAGLE 42.0.0

START GTA           END GTA           XLAT   RI      PC
123456             123456             DPCSSN GT    s-00128-aa
          SSN=10 CCGT=no
          GTMODID=asetnat6  TESTMODE=off
          ACTSN=----- PPMEASREQD= NO
234567             234567             DPCNGT GT    s-00124-aa
          SSN=--- CCGT=no
          GTMODID=asetnat3  TESTMODE=off
          ACTSN=----- PPMEASREQD= NO
234568             234568             DPC    GT    s-00124-aa
          SSN=--- CCGT=no
          GTMODID=asetnat7  TESTMODE=off
          ACTSN=----- PPMEASREQD= NO
234569             234569             DPC    GT    s-00124-aa
          SSN=--- CCGT=no
          GTMODID=-----  TESTMODE=off
          ACTSN=----- PPMEASREQD= NO
12345678901       23456789012       DPCSSN SSN   s-00124-aa
          SSN=10 CCGT=no
          GTMODID=asetnat4  TESTMODE=off
          ACTSN=----- PPMEASREQD= NO
334569467213456789012 334569478932012345678 DPC    GT    s-00124-aa
          SSN=--- CCGT=no
          GTMODID=asetnat4  TESTMODE=off
          ACTSN=----- PPMEASREQD= NO
987656789012345678901 987657321098765432101 DPCNGT GT    s-00124-aa
          SSN=--- CCGT=no

```

```
GTMODID=asetnat9 TESTMODE=off
ACTSN=----- PPMEASREQD= NO
987658321198765432101 987658321198765432101 DPCNGT GT s-00128-aa
SSN=--- CCGT=no
GTMODID=----- TESTMODE=off
ACTSN=----- PPMEASREQD= NO
987658321198765432102 990123456789012345678 DPCNGT GT s-00124-aa
SSN=--- CCGT=no
GTMODID=asetnat1 TESTMODE=off
ACTSN=----- PPMEASREQD= NO
```

Command Retrieved 9 Entries

;

rtrv-gta:gttsn=setnat003:pcn=s-129-aa:gtmodid=id5

tekelecstp 10-02-24 08:29:15 EST EAGLE 42.0.0

```
GTTSN NETDOM NDGT
setnat003 itu 6,11,21
```

GTA table is (11 of 269999) 1% full.

;

tekelecstp 10-02-24 08:29:16 EST EAGLE 42.0.0

```
START GTA END GTA XLAT RI PC
987658321198765432102 987658321198765432102 DPCNGT GT s-00129-aa
SSN=--- CCGT=no
GTMODID=setntt21 TESTMODE=off
ACTSN=----- PPMEASREQD= NO
```

Command Retrieved 1 Entries

;

rtrv-gta:gttsn=setnat003:ssn=10

tekelecstp 10-02-24 08:29:15 EST EAGLE 42.0.0

```
GTTSN NETDOM NDGT
setnat003 itu 6,11,21
```

GTA table is (11 of 269999) 1% full.

;

tekelecstp 10-02-24 08:29:16 EST EAGLE 42.0.0

```
START GTA END GTA XLAT RI PC
123456 123456 DPCSSN GT s-00128-aa
SSN=10 CCGT=no
GTMODID=gtmod21 TESTMODE=off
ACTSN=----- PPMEASREQD= NO
12345678901 23456789012 DPCSSN SSN s-00124-aa
```

```

SSN=10 CCGT=no
GTMODID=----- TESTMODE=off
ACTSN=----- PPMEASREQD= NO

```

Command Retrieved 2 Entries

```

;

rtrv-gta:gttsn=setnat003:gta=987658321198765432101:pcn=s-128-aa

```

```

tekelecstp 10-02-24 08:29:15 EST EAGLE 42.0.0

```

```

GTTSN      NETDOM  NDGT
setnat003  itu      6,11,21

```

GTA table is (11 of 269999) 1% full.

```

;

tekelecstp 10-02-24 08:29:16 EST EAGLE 42.0.0

```

```

START GTA          END GTA          XLAT  RI    PC
987658321198765432101 987658321198765432101 DPCNGT GT  s-00128-aa
      SSN=--- CCGT=no
      GTMODID=asetnat3 TESTMODE=off
      ACTSN=----- PPMEASREQD= NO

```

Command Retrieved 1 Entries

```
;
```

This example shows an MRN set. The Flexible GTT Load-Sharing and Intermediate GTT Load Sharing features are on and the GTT Action - Discard feature or GTT Action - Duplicate feature is enabled.

```
rtrv-gta:gttsn=setssnn
```

```

tekelecstp 10-02-104 09:49:42 EST EAGLE 42.0.0

```

```

GTTSN      NETDOM  NDGT
setssnn    ansi    10

```

GTA table is (1 of 269999) 1% full.

```

;

tekelecstp 10-02-104 09:49:43 EST EAGLE 42.0.0

```

```

START GTA  END GTA    XLAT  RI    PCA
1111111111 1111111111 DPC   GT    001-001-003
      MRNSET=1      SSN=--- CCGT=no
      GTMODID=asetans1 TESTMODE=off
      ACTSN=----- PPMEASREQD= NO

```

Command Retrieved 1 Entries

```
;
```

This example shows a MAP set. The Flexible GTT Load Sharing feature is enabled.

```
rtrv-gta:gttsn=tbla

tekelecstp 10-02-04 14:51:59 EST EAGLE 42.0.0

GTTSN      NETDOM  NDGT
tbla       ansi    6,10

GTA table is (3 of 269999) 1% full.
;
tekelecstp 10-02-04 14:52:00 EST EAGLE 42.0.0

START GTA  END GTA   XLAT   RI     PCA
234567    234567    DPCSSN GT    001-001-001
          MRNSET=DFLT  SSN=10  CCGT=no
          GTMODID=-----  TESTMODE=off
          ACTSN=-----  PPMEASREQD= NO
9810012345 9850012345 DPCSSN SSN    001-001-001
          MAPSET=DFLT  SSN=10  CCGT=no
          GTMODID=-----  TESTMODE=off
          ACTSN=-----  PPMEASREQD= NO

Command Retrieved 2 Entries
;
```

This example retrieves a CdPA GTA entry and an Advanced CdPA GTA entry when the OBSR feature is enabled.

```
rtrv-gta:gttsn=setcdpa

tekelecstp 10-03-10 09:49:42 EST EAGLE 42.0.0

GTTSN      NETDOM  SETTYPE  NDGT
setcdpa    itu     CDGTA    6
GTA table is (15 of 269999) 1% full.
;
tekelecstp 10-02-04 09:49:42 EST EAGLE 42.0.0

START GTA  END GTA  XLAT   RI     PC
106399    106489  DPCNGT GT    1-200-1
          SSN=---  CCGT=no
          GTMODID=modset1  TESTMODE=off
          OPTSN=SETCG1  CGSELID=-----  OPCSN=-----
          ACTSN=-----  PPMEASREQD= NO
306399    306489  DPCNGT GT    1-200-1
          SSN=---  CCGT=no
          GTMODID=modset3  TESTMODE=off
          OPTSN=CGPCSET01  CGSELID=-----  OPCSN=OPCSET001
          ACTSN=-----  PPMEASREQD= NO
400000    406489  NONE
          GTMODID=-----  TESTMODE=off
```

```

OPTSN=----- CGSELID=----- OPCS=-----
ACTSN=asetudts PPMEASREQD= NO
500000 506489 NONE
GTMODID=----- TESTMODE=off
OPTSN=----- CGSELID=----- OPCS=-----
ACTSN=asetdisc PPMEASREQD= NO
600001 600009 DPCSSN SSN -----
SSN=125 CCGT=no
GTMODID=modset5 TESTMODE=off
OPTSN=----- CGSELID=65500 OPCS=OPCSET001
ACTSN=----- PPMEASREQD= NO

```

Command Retrieved 5 Entries

;

This example retrieves a CgPA GTA entry when the OBSR feature is enabled.

```
rtrv-gta:gttsn=setcgpa
```

```
tekelecstp 10-03-10 09:49:42 EST EAGLE 42.0.0
```

```
GTTSN      NETDOM  SETTYPE  NDGT
setcgpa   itu      CGGTA    6
GTA table is (15 of 269999) 1% full.
```

;

```
tekelecstp 10-02-04 09:49:43 EST EAGLE 42.0.0
```

```
START GTA END GTA XLAT  RI  PC
406399  406489 DPCNGT  GT   1-200-1
      SSN=--- CCGT=no
      GTMODID=acdset3 TESTMODE=off
      OPTSN=setcgssn1 CGSELID=-----
      ACTSN=----- PPMEASREQD= NO
906399  906489 NONE
      GTMODID=----- TESTMODE=off
      OPTSN=----- CGSELID=-----
      ACTSN=asetdisc PPMEASREQD= NO

```

Command Retrieved 2 Entries

;

This example retrieves a CgPA PC entry when the Origin Based SCCP Routing feature is enabled:

```
rtrv-gta:gttsn=setcgpc
```

```
tekelecstp 10-03-10 09:49:42 EST EAGLE 42.0.0
```

```
GTTSN      NETDOM  SETTYPE  NDGT
setcgpc   ansi     CGPC    -
GTA table is (5 of 269999) 1% full.
```

```

;
tekelecstp 10-02-24 09:49:42 EST EAGLE 42.0.0

CgPA PC                XLAT  RI    PC
001-012-255           DPCNGT GT  1-200-1
  SSN=--- CCGT=no
  GTMODID=acgset3     TESTMODE=off
  OPTSN=setcgssn2     CGSELID=-----
  ACTSN=----- PPMEASREQD= NO
101-*-*              DPCNGT GT  1-200-1
  SSN=--- CCGT=no
  GTMODID=acgset3     TESTMODE=off
  OPTSN=setcgssn2     CGSELID=-----
  ACTSN=----- PPMEASREQD= NO

Command Retrieved 2 Entries
;

```

This example retrieves an OPC entry when the OBSR feature is enabled:

```
rtrv-gta:gttsn=setopc
```

```

eagle1 10-05-10 11:14:52 EST EAGLE 42.0.0

GTTSN      NETDOM  SETTYPE  NDGT
setopc     ansi    OPC       -

GTA table is (3 of 269999) 1% full.

OPCA                XLAT  RI    PCA
001-001-001        DPC   GT    001-001-001
  SSN=--- CCGT=no
  GTMODID=set1      TESTMODE=off
  OPTSN=----- CGSELID=-----
  ACTSN=----- PPMEASREQD= NO

Command Retrieved 1 Entries
;

```

This example retrieves a CgPA SSN entry when the OBSR feature is enabled and an ITU Point Code is used:

```
rtrv-gta:gttsn=setssnn
```

```

eagle1 10-05-10 12:01:08 EST EAGLE 42.0.0

GTTSN      NETDOM  SETTYPE  NDGT
setcgssn2  itu     CGSSN    -

GTA table is (5 of 269999) 1% full.

```

```

START SSN          END SSN          XLAT  RI      ITU PC
9                9                DPCNGT GT    2-002-2
  SSN=--- CCGT=no
  GTMODID=----- TESTMODE=off
  OPTSN=----- CGSELID=-----
  ACTSN=----- PPMEASREQD= NO

```

Command Retrieved 1 Entries

;

This example shows output when the network domain is set to cross:

```
rtrv-gta:gttsn=ansiset1
```

```
tekelecstp 10-02-04 15:22:08 EST EAGLE 42.0.0
```

```
GTTSN      NETDOM  NDGT
ansiset1   cross   6
```

GTA table is (1 of 269999) 1% full.

;

```
tekelecstp 10-02-04 15:22:09 EST EAGLE 42.0.0
```

```

START GTA END GTA  XLAT  RI      PC
123456   123456   DPCSSN SSN    001-001-002
  SSN=110 CCGT=no
  GTMODID=----- TESTMODE=off
  ACTSN=----- PPMEASREQD= NO

```

Command Retrieved 1 Entries

;

This example shows output when the Flexible GTT Load Sharing feature is enabled:

```
rtrv-gta:gttsn=tblb
```

```
tekelecstp 10-02-04 15:22:08 EST EAGLE 42.0.0
```

```
GTTSN      NETDOM  NDGT
tblb       ansi    6
```

GTA table is (6 of 269999) 1% full.

;

```
tekelecstp 10-02-04 15:22:09 EST EAGLE 42.0.0
```

```

START GTA END GTA  XLAT  RI      PCA
123456   123456   DPC   GT    003-003-003
  MRNSET=DFLT SSN=--- CCGT=no
  GTMODID=gtmodset1 TESTMODE=off
  ACTSN=----- PPMEASREQD= NO
123457   123457   DPCSSN SSN    003-003-003
  MAPSET=DFLT SSN=2   CCGT=no

```



```

GTMODID=----- TESTMODE=off
ACTSN=----- PPMEASREQD= NO

```

```
Command Retrieved 2 Entries
```

```
;
```

This example shows output when the Hex Digit Support for GTT feature is turned on and hexadecimal digits are provisioned in GTA values:

```
rtrv-gta:gttsn=setnat201
```

```
tekelecstp 10-02-24 13:39:28 EST EAGLE 42.0.0
```

```

GTTSN      NETDOM  NDGT
setnat201  itu      6,21

```

```
GTA table is (5 of 269999) 1% full.
```

```
;
```

```
tekelecstp 10-02-24 13:39:29 EST EAGLE 42.0.0
```

```

START GTA          END GTA          XLAT  RI    PC
100000             10000d          DPC   GT   00101
  SSN=--- CCGT=no
  GTMODID=anatset2 TESTMODE=off
  ACTSN=----- PPMEASREQD= NO
10000e             10000f          DPC   GT   00101
  SSN=--- CCGT=no
  GTMODID=----- TESTMODE=off
  ACTSN=----- PPMEASREQD= NO
100010             200000          DPC   GT   00101
  SSN=--- CCGT=no
  GTMODID=anatset4 TESTMODE=off
  ACTSN=----- PPMEASREQD= NO
abcdef0123456789abcdef  abcde01234567890afff DPCSSN SSN  00103
  SSN=10 CCGT=no
  GTMODID=----- TESTMODE=off
  ACTSN=----- PPMEASREQD= NO
fbcdef0123456789abcdef  ffbfde01234567890aaff DPCSSN SSN  00103
  SSN=10 CCGT=no
  GTMODID=anatset5 TESTMODE=off
  ACTSN=----- PPMEASREQD= NO

```

```
Command Retrieved 5 Entries
```

```
;
```

This example shows output when the SCCP Loop Detection feature is enabled and an associated loopset exists:

```
rtrv-gta:gttsn=setssn:mapset=6
```

```
tekelecstp 10-02-04 09:50:42 EST EAGLE 42.0.0
```

```
GTTSN      NETDOM  NDGT
setssnn    ansi    10

GTA table is (42 of 269999) 1% full.
;
tekelecstp 10-02-04 09:50:42 EST  EAGLE 42.0.0

START GTA  END GTA    XLAT  RI    PCA
111111111 1111111122 DPCSSN SSN    001-001-003
      MAPSET=6      SSN=2    CCGT=no
      GTMODID=----- TESTMODE=off
      LOOPSET = loop1
      ACTSN=----- PPMEASREQD= NO

Command Retrieved 1 Entries
;
```

This example shows output for a specified MRN set when the Flexible GTT Load Sharing feature is enabled:

```
rtrv-gta:gttsn=setans006:mrnset=1
```

```
tekelecstp 10-02-04 13:03:16 EST  EAGLE 42.0.0

GTTSN      NETDOM  NDGT
setans006  ansi    10

GTA table is (8 of 269999) 1% full.
;
tekelecstp 10-02-04 13:03:16 EST  EAGLE 42.0.0

START GTA  END GTA    XLAT  RI    PCA
1818510090 1918511241 DPC    GT    001-001-003
      MRNSET=1      SSN=---- CCGT=no
      GTMODID=----- TESTMODE=off
      ACTSN=----- PPMEASREQD= NO

Command Retrieved 1 Entries
;
```

This example shows output when calling party GT modification is requested for a GTT set:

```
rtrv-gta:gttsn=setans004:cggmod=yes
```

```
tekelecstp 10-02-24 16:57:00 EST  EAGLE 42.0.0

GTTSN      NETDOM  NDGT
setans004  ansi    6

GTA table is (1 of 269999) 1% full.
```

```
;
tekelecstp 10-02-24 16:57:01 EST EAGLE 42.0.0

START GTA END GTA XLAT RI PC
981234 981234 DPCNGT GT 001-001-001
MRNSET=DFLT SSN=--- CCGT=no CGGTMOD=yes
GTMODID=aansset4 TESTMODE=off
ACTSN=----- PPMEASREQD= NO

Command Retrieved 1 Entries
```

```
;

rtrv-gta:gttsn=setans001
```

```
rtrv-gta:gttsn=setans001
e1040501 10-02-24 14:25:15 EST EAGLE 42.0.0

GTTSN NETDOM SETTYPE NDGT
setans001 ansi CDGTA 3,6

GTA table is (61 of 269999) 1% full.
```

```
;
e1040501 10-02-04 14:25:16 EST EAGLE 39.2.0

START GTA END GTA XLAT RI PCA
100 100 DPCSSN SSN 001-001-002
MAPSET=DFLT SSN=10 CCGT=no CGGTMOD=NO
GTMODID=gtmodset3 TESTMODE=off
ACTSN=----- PPMEASREQD= NO
101 101 DPCSSN SSN 001-001-003
MAPSET=DFLT SSN=10 CCGT=no CGGTMOD=NO
GTMODID=----- TESTMODE=off
ACTSN=----- PPMEASREQD= NO
104 104 DPCSSN SSN 001-001-003
MAPSET=DFLT SSN=10 CCGT=no CGGTMOD=NO
GTMODID=gtmodset1 TESTMODE=off
ACTSN=----- PPMEASREQD= NO
105 105 DPCSSN SSN 001-001-003
MAPSET=1 SSN=14 CCGT=no CGGTMOD=NO
GTMODID=gtmodsetn TESTMODE=off
ACTSN=----- PPMEASREQD= NO
115 115 DPCSSN SSN 001-001-002
MAPSET=2 SSN=15 CCGT=no CGGTMOD=NO
GTMODID=gtmodset2 TESTMODE=off
ACTSN=----- PPMEASREQD= NO
111111 111111 DPC GT 001-001-002
MRNSET=DFLT SSN=--- CCGT=no CGGTMOD=NO
GTMODID=----- TESTMODE=off
ACTSN=----- PPMEASREQD= NO
111112 111112 DPC GT 001-001-002
MRNSET=DFLT SSN=--- CCGT=no CGGTMOD=NO
GTMODID=gtmodseti TESTMODE=off
```

```
ACTSN=----- PPMEASREQD= NO
111113 111113 DPC GT 001-001-002
MRNSET=DFLT SSN=--- CCGT=no CGGTMOD=NO
GTMODID=----- TESTMODE=off
ACTSN=----- PPMEASREQD= NO
111114 111114 DPC GT 001-001-002
MRNSET=DFLT SSN=--- CCGT=no CGGTMOD=NO
GTMODID=gtmodset4 TESTMODE=off
ACTSN=----- PPMEASREQD= NO
111115 111115 DPC GT 001-001-002
MRNSET=DFLT SSN=--- CCGT=no CGGTMOD=NO
GTMODID=----- TESTMODE=off
ACTSN=----- PPMEASREQD= NO
111116 111116 DPC GT 001-001-002
MRNSET=DFLT SSN=--- CCGT=no CGGTMOD=NO
GTMODID=----- TESTMODE=off
ACTSN=----- PPMEASREQD= NO
111117 111117 DPC GT 001-001-002
MRNSET=DFLT SSN=--- CCGT=no CGGTMOD=NO
GTMODID=----- TESTMODE=off
ACTSN=----- PPMEASREQD= NO
111118 111118 DPC GT 001-001-002
MRNSET=DFLT SSN=--- CCGT=no CGGTMOD=NO
GTMODID=gtmodseti TESTMODE=off
ACTSN=----- PPMEASREQD= NO
111119 111119 DPC GT 001-001-002
MRNSET=DFLT SSN=--- CCGT=no CGGTMOD=NO
GTMODID=----- TESTMODE=off
ACTSN=----- PPMEASREQD= NO
111120 111120 DPC GT 001-001-002
MRNSET=DFLT SSN=--- CCGT=no CGGTMOD=NO
GTMODID=----- TESTMODE=off
ACTSN=----- PPMEASREQD= NO
111121 111121 DPC GT 001-001-002
MRNSET=DFLT SSN=--- CCGT=no CGGTMOD=NO
GTMODID=----- TESTMODE=off
ACTSN=----- PPMEASREQD= NO
111122 111122 DPC GT 001-001-002
MRNSET=DFLT SSN=--- CCGT=no CGGTMOD=NO
GTMODID=----- TESTMODE=off
ACTSN=----- PPMEASREQD= NO
111123 111123 DPC GT 001-001-002
MRNSET=DFLT SSN=--- CCGT=no CGGTMOD=NO
GTMODID=----- TESTMODE=off
ACTSN=----- PPMEASREQD= NO
111124 111124 DPC GT 001-001-002
MRNSET=DFLT SSN=--- CCGT=no CGGTMOD=NO
GTMODID=----- TESTMODE=off
ACTSN=----- PPMEASREQD= NO
111125 111125 DPC GT 001-001-002
MRNSET=DFLT SSN=--- CCGT=no CGGTMOD=NO
GTMODID=----- TESTMODE=off
ACTSN=----- PPMEASREQD= NO
```

```
Command Retrieved 20 Entries
;

rtrv-gta:gttsn=setans001:pc=1-1-3

e1040501 10-02-04 14:25:57 EST EAGLE 42.0.0

GTTSN      NETDOM  SETTYPE  NDGT
setans001  ansi    CDGTA   3,6

GTA table is (61 of 269999) 1% full.

;

e1040501 10-02-04 14:25:58 EST EAGLE 42.0.0

START GTA END GTA  XLAT  RI    PCA
101      101      DPCSSN SSN    001-001-003
MAPSET=DFLT SSN=10 CCGT=no CGGTMOD=NO
GTMODID=----- TESTMODE=off
ACTSN=----- PPMEASREQD= NO
104      104      DPCSSN SSN    001-001-003
MAPSET=DFLT SSN=10 CCGT=no CGGTMOD=NO
GTMODID=gtmodset5 TESTMODE=off
ACTSN=----- PPMEASREQD= NO
105      105      DPCSSN SSN    001-001-003
MAPSET=1     SSN=14 CCGT=no CGGTMOD=NO
GTMODID=gtmodset4 TESTMODE=off
ACTSN=----- PPMEASREQD= NO
111260   111260   DPCSSN SSN    001-001-003
MAPSET=DFLT SSN=12 CCGT=no CGGTMOD=NO
GTMODID=----- TESTMODE=off
ACTSN=----- PPMEASREQD= NO
111261   111261   DPCSSN SSN    001-001-003
MAPSET=DFLT SSN=12 CCGT=no CGGTMOD=NO
GTMODID=gtmodset4 TESTMODE=off
ACTSN=----- PPMEASREQD= NO
111262   111262   DPCSSN SSN    001-001-003
MAPSET=DFLT SSN=12 CCGT=no CGGTMOD=NO
GTMODID=----- TESTMODE=off
ACTSN=----- PPMEASREQD= NO
111263   111263   DPCSSN SSN    001-001-003
MAPSET=DFLT SSN=12 CCGT=no CGGTMOD=NO
GTMODID=----- TESTMODE=off
ACTSN=----- PPMEASREQD= NO
111264   111264   DPCSSN SSN    001-001-003
MAPSET=DFLT SSN=12 CCGT=no CGGTMOD=NO
GTMODID=gtmodset7 TESTMODE=off
ACTSN=----- PPMEASREQD= NO
111265   111265   DPCNGT GT    001-001-003
MRNSET=DFLT SSN=--- CCGT=no CGGTMOD=NO
GTMODID=----- TESTMODE=off
ACTSN=----- PPMEASREQD= NO
```

```
111266 111266 DPCNGT GT 001-001-003
MRNSET=DFLT SSN=--- CCGT=no CGGTMOD=NO
GTMODID=----- TESTMODE=off
ACTSN=----- PPMEASREQD= NO
111267 111267 DPCNGT GT 001-001-003
MRNSET=DFLT SSN=--- CCGT=no CGGTMOD=NO
GTMODID=----- TESTMODE=off
ACTSN=----- PPMEASREQD= NO
```

Command Retrieved 11 Entries

;

```
rtrv-gta:gttsn=setans002:ssn=10
```

```
e1040501 10-02-04 14:25:57 EST EAGLE 42.0.0
```

```
GTTSN      NETDOM  SETTYPE  NDGT
setans002  ansi    CDGTA    6
```

GTA table is (61 of 269999) 1% full.

;

```
e1040501 10-02-04 14:25:58 EST EAGLE 42.0.0
```

```
START GTA END GTA  XLAT  RI    PCA
222222 222229 DPCSSN SSN 001-001-002
MAPSET=DFLT SSN=10 CCGT=no CGGTMOD=NO
GTMODID=----- TESTMODE=off
OPTSN=----- CGSELID=----- CDSELID=-----
ACTSN=----- PPMEASREQD= NO
222232 222239 DPCSSN SSN 001-001-002
MAPSET=DFLT SSN=10 CCGT=no CGGTMOD=NO
GTMODID=----- TESTMODE=off
OPTSN=----- CGSELID=----- CDSELID=-----
ACTSN=----- PPMEASREQD= NO
222242 222249 DPCSSN SSN 001-001-002
MAPSET=DFLT SSN=10 CCGT=no CGGTMOD=NO
GTMODID=----- TESTMODE=off
OPTSN=----- CGSELID=----- CDSELID=-----
ACTSN=----- PPMEASREQD= NO
```

Command Retrieved 3 Entries

;

```
rtrv-gta:gttsn=cgssnset1
```

```
e1040501 10-02-04 14:10:41 EST EAGLE 42.0.0
```

```
GTTSN      NETDOM  SETTYPE  NDGT
cgssnset1  ansi    CGSSN    -
```

GTA table is (50 of 269999) 1% full.

;

e1040501 10-02-04 14:10:42 EST EAGLE 42.0.0

START SSN	END SSN	XLAT	RI	PCA
1	1	DPC	SSN	
001-001-002				
MAPSET=2 SSN=0 CCGT=no CGGTMOD=NO				
GTMODID=----- TESTMODE=off				
ACTSN=----- PPMEASREQD= NO				
34	34	DPC	SSN	
001-001-002				
MAPSET=2 SSN=0 CCGT=no CGGTMOD=NO				
GTMODID=----- TESTMODE=off				
ACTSN=----- PPMEASREQD= NO				
100	100	DPC	SSN	
001-001-002				
MAPSET=2 SSN=0 CCGT=no CGGTMOD=NO				
GTMODID=----- TESTMODE=off				
ACTSN=----- PPMEASREQD= NO				
101	101	DPC	SSN	
001-001-002				
MAPSET=2 SSN=0 CCGT=no CGGTMOD=NO				
ACTSN=----- PPMEASREQD= NO				
GTMODID=----- TESTMODE=off				
102	102	DPC	SSN	
001-001-002				
MAPSET=2 SSN=0 CCGT=no CGGTMOD=NO				
GTMODID=----- TESTMODE=off				
ACTSN=----- PPMEASREQD= NO				
103	103	NONE		
MAPSET=2 MRNSET=DFLT				
CGGTMOD=NO				
GTMODID=----- TESTMODE=off				
ACTSN=actudts1 PPMEASREQD= YES				
104	104	NONE		
MAPSET=2 MRNSET=DFLT				
CGGTMOD=NO				
GTMODID=----- TESTMODE=off				
ACTSN=actdisc1 PPMEASREQD= NO				

Command Retrieved 7 Entries

;

rtrv-gta:gttsn=cgssnset2:actsn=asetdisc1

e1040501 10-02-04 14:11:37 EST EAGLE 42.0.0

GTTSN NETDOM SETTYPE NDGT

```

cgssnset2 ansi CGSSN -
GTA table is (51 of 269999) 1% full.
;
e1040501 10-02-04 14:11:38 EST EAGLE 42.0.0

START SSN          END SSN          XLAT  RI    PCA
105              105              NONE
MAPSET=2          MRNSET=DFLT
CGGTMOD=NO
GTMODID=----- TESTMODE=off
ACTSN=actdisc1  PPMEASREQD= NO

Command Retrieved 1 Entries
;

rtrv-gta:gttsn=cgssnset3

e1040501 10-02-04 14:25:57 EST EAGLE 42.0.0

GTTSN  NETDOM  SETTYPE  NDGT
cgssnset3 ansi CGSSN -

GTA table is (51 of 269999) 1% full.
;
e1040501 10-02-04 14:25:57 EST EAGLE 42.0.0

START SSN          END SSN          XLAT  RI    PCA
Command Retrieved no Entries
;

```

This example shows output when the OBSR feature is enabled and the FLOBR feature is turned on:

```

rtrv-gta:gttsn=setans006

tekelecstp 10-02-04 16:20:44 EST EAGLE 42.0.0

GTTSN  NETDOM  SETTYPE  NDGT
setans006 ansi CDGTA 6

GTT TABLE IS 1 % FULL (3 of 269999)
;
tekelecstp 10-02-04 16:20:45 EST EAGLE 42.0.0

START GTA END GTA XLAT RI PCA

```



```

123456 123456 DPC GT 001-001-002
MRNSET=NONE SSN=--- CCGT=no CCGTMOD=NO
GTMODID=gtmod3 TESTMODE=on
LOOPSET = none FALLBACK=Yes
OPTSN=----- CGSELID=456 CDSELID=----- OPCS=setopc001
ACTSN=----- PPMEASREQD= NO
;

```

This example retrieves a CdPA SSN entry when the FLOBR feature is enabled:

```
rtrv-gta:gttsn=setcdssn
```

```

tekelecstp 10-03-10 09:49:42 EST EAGLE 42.0.0

GTTSN      NETDOM  SETTYPE  NDGT
setcdssn  itu      CDSSN    -

GTT TABLE IS 1 % FULL (5 of 269999)
;

tekelecstp 10-03-10 09:49:42 EST EAGLE 42.0.0

START SSN          END SSN          XLAT  RI  PC
100                200              DPCNGT GT  1-200-1
      SSN=0  CCGT=no
      GTMODID=gtmod3  TESTMODE=on
      FALLBACK=sysdflt  CGCNVSN=-----
      OPTSN=-----  CGSELID=-----  CDSELID=-----
      ACTSN=-----  PPMEASREQD= NO

Command Retrieved 1 Entries
;

```

This example retrieves an OPCODE entry when the TOBR feature is turned on:

```
rtrv-gta:gttsn=opcode2
```

```

tekelecstp 16-11-07 14:13:13 MST EAGLE 46.5.0.0.0-70.5.0

GTTSN      NETDOM  SETTYPE  NPSN  CHECKMULCOMP  NDGT
opcode2    itu      OPCODE   -----  YES            -

GTA table is (3 of 269999) 1% full.

FAMILY          OPCODE          PKGTYPE          XLAT  RI  PC
ACN              OPCODE          PKGTYPE          XLAT  RI  PC
1-2-3           5                cnt              DPC   GT  3-003-3
      SSN=0  CCGT=no
      GTMODID=-----  TESTMODE=off
      FALLBACK=sysdflt  CGCNVSN=-----

```

```

OPTSN=----- CGSELID=----- CDSELID=----- OPCS=-----
ACTSN=----- PPMEASREQD= NO
CGPCACTION=dflt
DEFMAPVR=v3
PRIO=1024

```

Command Retrieved 1 Entries

;

This example retrieves an OPCODE entry when the TOBR feature is turned on:

```
rtrv-gta:gttsn=opcode1
```

```
tekelecstp 16-11-07 14:13:13 MST EAGLE 46.5.0.0.0-70.5.0
```

GTTSN	NETDOM	SETTYPE	NPSN	CHECKMULCOMP	NDGT
opcode1	ansi	OPCODE	-----	YES	-

GTA table is (2 of 269999) 1% full.

FAMILY	OPCODE	PKGTYPE	XLAT	RI	PC
7	4	qwp	DPC	GT	002-002-002

```

SSN=0 CCGT=no
GTMODID=----- TESTMODE=off
FALLBACK=sysdflt
OPTSN=----- CGSELID=----- CDSELID=----- OPCS=-----
ACTSN=----- PPMEASREQD= NO
CGPCACTION=dflt
DEFMAPVR=v3
PRIO=1024

```

ACN	OPCODE	PKGTYPE	XLAT	RI	PC
-----	--------	---------	------	----	----

Command Retrieved 1 Entries

;

This example retrieves a DPC entry when the FLOBR feature is turned on:

```
rtrv-gta:gttsn=setdpc1
```

```
tekelecstp 10-03-08 11:23:49 EST EAGLE 42.0.0
```

GTTSN	NETDOM	SETTYPE	NDGT
setdpc1	ansi	DPC	-

GTA table is (2 of 269999) 1% full.

DPCA	XLAT	RI	PCA
001-001-001	DPC	GT	001-001-001

```

SSN=--- CCGT=no
GTMODID=----- TESTMODE=off

```

```
FALLBACK=sysdflt
OPTSN=----- CGSELID=----- CDSELID=-----
ACTSN=----- PPMEASREQD= NO
```

Command Retrieved 1 Entries

```
;
rtrv-gta:gttsn=setcdgta:xlat=none:gtmodid=gttid1
```

```
e1040501 10-02-04 14:25:57 EST EAGLE 42.0.0
```

```
GTTSN      NETDOM  NDGT
setcdgta   ansi    6
```

GTA table is (1 of 269999) 1% full.

```
;
e1040501 10-02-04 14:25:57 EST EAGLE 42.0.0
```

```
START GTA END GTA  XLAT  RI    PC
981234   981234  NONE
      CGGTMOD=YES
      GTMODID=gttid1    TESTMODE=off
      LOOPSET = none
      ACTSN=actudts1  PPMEASREQD= YES
```

Command Retrieved 1 Entries

```
rtrv-gta:gttsn=setcdgta:mapset=1:mrnset=2:xlat=none
```

```
tekelecstp 10-05-04 14:25:57 EST EAGLE 42.0.0
```

```
GTTSN      NETDOM  NDGT
setcdgta   ansi    6
```

GTA table is (1 of 269999) 1% full.

```
;
tekelecstp 10-05-04 14:25:57 EST EAGLE 42.0.0
```

```
START GTA END GTA  XLAT  RI    PC
981234   981234  NONE
      MAPSET=1    MRNSET=2
      CGGTMOD=NO
      GTMODID=gttid1    TESTMODE=off
      LOOPSET = none
      ACTSN=actudts1  PPMEASREQD= YES
```

Command Retrieved 1 Entries

This entry retrieves the 16 bit PC entries and `cgpcaction` parameter added.

```
rtrv-gta:gttsn=abc:cgpcaction=dfld
```

```
tekelecstp 13-07-02 13:10:20 EST 45.0.0-64.69.0
rtrv-gta:gttsn=abc:cgpcaction=dfld
Command entered at terminal #4.
```

```
GTTSN      NETDOM  SETTYPE  NDGT
abc        itu      CGPC     -
```

```
GTA table is (1 of 269999) 1% full.
```

```
CGPC (ITU)          XLAT  RI    ITU PC
001-01-01          dpc   ssn   001-02-03
MAPSET=dfld  SSN=--- CCGT=no
GTMODID=----- TESTMODE=off
OPTSN=----- CGSELID=-----
ACTSN=----- PPMEASREQD= no
CGPCACTION=dfld
```

```
Command Retrieved 1 Entries
```

```
;
```

The following output shows a GTA entry for a SETTYPE of IMSI:

```
rtrv-gta:gttsn=setimsi
```

```
tekelecstp 15-11-06 17:51:27 EST EAGLE5 46.3.0.0.0-66.14.0
rtrv-gta:gttsn=setimsi
Command entered at terminal #17.
```

```
;
```

```
Command Accepted - Processing
```

```
tekelecstp 15-11-06 17:51:27 EST EAGLE5 46.3.0.0.0-66.14.0
```

```
GTTSN      NETDOM  SETTYPE  NPSN      NDGT
setimsi    itu      IMSI     -----   6
```

```
GTA table is (17 of 269999) 1% full.
```

```
;
```

```
tekelecstp 15-11-06 17:51:27 EST EAGLE5 46.3.0.0.0-66.14.0
```

```
SADDR      EADDR      XLAT  RI    ITU PC
123456     123456     dpc   gt    1-001-6
SSN=--- CCGT=no
GTMODID=----- TESTMODE=off
FALLBACK=sysdfld
OPTSN=setop      CGSELID=----- CDSELID=-----
ACTSN=----- PPMEASREQD= no
CGPCACTION=dfld
```

```
Command Retrieved 1 Entries
```

;

The following output shows a GTA entry for a SETTYPE of VLRNB:

```
rtrv-gta:gttsn=setvlr
```

```
tekelecstp 15-11-06 18:01:48 EST EAGLE5 46.3.0.0.0-66.14.0
rtrv-gta:gttsn=setvlr
Command entered at terminal #17.
```

;

```
Command Accepted - Processing
```

```
tekelecstp 15-11-06 18:01:48 EST EAGLE5 46.3.0.0.0-66.14.0
```

GTTSN	NETDOM	SETTYPE	NPSN	NDGT
setvlr	itu	VLRNB	-----	6

```
GTA table is (17 of 269999) 1% full.
```

;

```
tekelecstp 15-11-06 18:01:48 EST EAGLE5 46.3.0.0.0-66.14.0
```

SADDR	EADDR	XLAT	RI	ITU PC
987654	987654	dpc	gt	1-001-7

```
SSN=--- CCGT=no
GTMODID=----- TESTMODE=off
FALLBACK=sysdflt
OPTSN=setcgssn CGSELID=----- CDSELID=-----
ACTSN=----- PPMEASREQD= no
CGPCACTION=dflt
```

```
Command Retrieved 1 Entries
```

;

The following output shows a GTA entry for a SETTYPE of SMRPOA:

```
rtrv-gta:gttsn=setsmrpo
```

```
tekelecstp 15-11-06 18:02:58 EST EAGLE5 46.3.0.0.0-66.14.0
rtrv-gta:gttsn=setsmrpo
Command entered at terminal #17.
```

;

```
Command Accepted - Processing
```

```
tekelecstp 15-11-06 18:02:58 EST EAGLE5 46.3.0.0.0-66.14.0
```

GTTSN	NETDOM	SETTYPE	NPSN	NDGT
setsmrpo	itu	SMRPOA	-----	6

```
GTA table is (17 of 269999) 1% full.
```

```

;
tekelecstp 15-11-06 18:02:58 EST EAGLE5 46.3.0.0.0-66.14.0

SADDR      EADDR      XLAT  RI      ITU PC
132456     132456     dpc   gt      1-001-6
          SSN=--- CCGT=no
          GTMODID=----- TESTMODE=off
          FALLBACK=sysdflt
          OPTSN=----- CGSELID=----- CDSELID=-----
          ACTSN=----- PPMEASREQD= no
          CGPCACTION=dflt

Command Retrieved 1 Entries

```

The following output shows a GTA entry for a SETTYPE of IMEI:

```
rtrv-gta:gttsn=imei1
```

```
tekelecstp 17-06-21 11:21:24 MST EAGLE 46.6
rtrv-gta:gttsn=imei1
Command entered at terminal #17.
```

GTTSN	NETDOM	SETTYPE	NPSN	CHECKMUL COMP	SETIDX	GTTSET MEASRQD	SXUDT	NDGT
imei1	itu	IMEI	-----	---	1	no	-	6

GTA table is (4 of 269999) 1% full.

```

;
tekelecstp 17-06-21 11:21:24 MST EAGLE 46.6

SADDR      EADDR      XLAT  RI      ITU PC
123456     123456     dpcsn gt      5-005-1
          SSN=5  CCGT=no
          GTMODID=----- TESTMODE=off
          FALLBACK=sysdflt
          OPTSN=----- CGSELID=----- CDSELID=-----
          ACTSN=----- PPMEASREQD=no TRANSMEASRQD=no
          CGPCACTION=dflt

Command Retrieved 1 Entries

```

This example shows different combination of PKGTYPE, ACN, FAMILY AND OPCODE:

```
r trv-gta:gttsn=opc:pkgtype=bgn
```

```
tekelecstp 17-05-09 05:01:25 EST EAGLE 46.6
rtrv-gta:gttsn=opc:pkgtype=bgn
Command entered at terminal #4.
```

```

          GTTSN      NETDOM  SETTYPE  NPSN      CHECKMUL      GTTSET
          SXUDT NDGT      COMP      SETIDX  MEASRQD
opc      ansi      OPCODE  -----  off      15      trans
yes      -

```

GTA table is (3 of 269999) 1% full.

```

FAMILY                                OPCODE  PKGTYPE  XLAT  RI  PCA
ACN                                OPCODE  PKGTYPE  XLAT  RI  PCA
4-0-0-1-0-1-2                      57      bgn      none
GTMODID=-----  TESTMODE=off
FALLBACK=sysdflt
OPTSN=-----  CGSELID=-----  CDSELID=-----  OPCSN=-----
ACTSN=-----  PPMEASREQD= no  TRANSMEASRQD=no
CGPCACTION=dfmt
DEFMAPVR=v3
PRIO = 1024

```

```

4-0-0-1-0-1-3                      2      bgn      none
GTMODID=-----  TESTMODE=off
FALLBACK=sysdflt
OPTSN=-----  CGSELID=-----  CDSELID=-----  OPCSN=-----
ACTSN=-----  PPMEASREQD= no  TRANSMEASRQD=yes
CGPCACTION=dfmt
DEFMAPVR=v3
PRIO = 1024

```

```

Any                                45      bgn      none
GTMODID=-----  TESTMODE=off
FALLBACK=sysdflt
OPTSN=-----  CGSELID=-----  CDSELID=-----  OPCSN=-----
ACTSN=-----  PPMEASREQD= no  TRANSMEASRQD=no
CGPCACTION=dfmt
DEFMAPVR=v3
PRIO = 2

```

Command Retrieved 3 Entries

;

rtrv-gta:gttsn=opc:opcode=57

```

tekelecstp 17-05-09 05:02:07 EST  EAGLE 46.6
rtrv-gta:gttsn=opc:opcode=57
Command entered at terminal #4.

```

```

          GTTSN      NETDOM  SETTYPE  NPSN      CHECKMUL      GTTSET
          SXUDT NDGT      COMP      SETIDX  MEASRQD
opc      itu      OPCODE  -----  off      2      yes

```

no -

GTA table is (3 of 269999) 1% full.

FAMILY	OPCODE	PKGTYPE	XLAT	RI	PCI
5	57	any	none		
GTMODID=----- TESTMODE=off FALLBACK=sysdflt OPTSN=----- CGSELID=----- CDSELID=----- OPCSN=----- ACTSN=----- PPMEASREQD= no TRANSMEASRQD=yes CGPCACTION=dflt DEFMAPVR=v3 PRIO = 1024					
ACN	OPCODE	PKGTYPE	XLAT	RI	PCI
any	57	none	none		
GTMODID=----- TESTMODE=off FALLBACK=sysdflt OPTSN=----- CGSELID=----- CDSELID=----- OPCSN=----- ACTSN=----- PPMEASREQD= no TRANSMEASRQD=yes CGPCACTION=dflt DEFMAPVR=v3 PRIO = 5					
4-9	57	end	dpc	GT	2-1-1
GTMODID=----- TESTMODE=off FALLBACK=sysdflt OPTSN=----- CGSELID=----- CDSELID=----- OPCSN=----- ACTSN=----- PPMEASREQD= no TRANSMEASRQD=no CGPCACTION=dflt DEFMAPVR=v3 PRIO = 1024					
any	57	cnt	none		
GTMODID=----- TESTMODE=off FALLBACK=sysdflt OPTSN=----- CGSELID=----- CDSELID=----- OPCSN=----- ACTSN=----- PPMEASREQD= no TRANSMEASRQD=yes CGPCACTION=dflt DEFMAPVR=v3 PRIO = 5					

Command Retrieved 4 Entries

;

rtrv-gta:gttsn=opc:acn=\*:opcode=57

tekelecstp 17-05-09 05:02:39 EST EAGLE 46.6

rtrv-gta:gttsn=opc:acn=\*:opcode=57

Command entered at terminal #4.

CHECKMUL

GTTSET



```

      GTTSN      NETDOM  SETTYPE  NPSN      COMP      SETIDX  MEASRQD
SXUDT  NDGT
opc     itu      OPCODE  -----  off       3       yes
yes    -

```

GTA table is (3 of 269999) 1% full.

```

      FAMILY
      ACN
any
      OPCODE  PKGTYPE  XLAT  RI  PCA
      57      none   none
      GTMODID=-----  TESTMODE=off
      FALLBACK=sysdflt
      OPTSN=-----  CGSELID=-----  CDSELID=-----  OPCSN=-----
      ACTSN=-----  PPMEASREQD= no  TRANSMEASRQD=yes
      CGPCACTION=dflt
      DEFMAPVR=v3
      PRIO = 5

```

```

any
      OPCODE  PKGTYPE  XLAT  RI  PCA
      57      cnt    none
      GTMODID=-----  TESTMODE=off
      FALLBACK=sysdflt
      OPTSN=-----  CGSELID=-----  CDSELID=-----  OPCSN=-----
      ACTSN=-----  PPMEASREQD= no  TRANSMEASRQD=yes
      CGPCACTION=dflt
      DEFMAPVR=v3
      PRIO = 5

```

Command Retrieved 2 Entries

;

### Legend

- **GTTSN**—GTT set name. A GTT set is an entity to which global title addresses and selectors are assigned.
- **NETDOM**—The network domain.
- **NDGT**—The number of digits required for GTAs associated with this set.
- **START GTA**—The start global title address.
- **END GTA**—The end global title address.
- **XLAT**—The translate indicator.
- **RI**—The routing indicator.
- **PC, PCA, ITU PC, ITUI PC, ITUN PC, ITUN24, ITUN16 PC**—Translated point code.
- **SSN**—The translated subsystem number.
- **CCGT**—The cancel called global title indicator.
- **MRN**—Mated Relay Node
- **MRNSET**—MRN set ID

- **MAPSET**—MAP set ID
- **CGGTMOD**—Calling Party Global Title Modification Indicator
- **ACTSN**—GTT Action Set Name
- **GTMODID**—Global Title Modification Identifier
- **PPMEASREQD**—Per Path Measurement Required
- **OPCODE**—TCAP opcode field
- **ACN**—Application context name. ITU TCAP *acn* field.
- **PKGTYPE**—TCAP package type
- **FAMILY**—ANSI TCAP *family* field
- **TESTMODE**—Invokes a Test Tool to debug the FLOBR/TOBR rules
- **DPC**—Destination point code
- **CGPC**—CgPa point code
- **OPC**—Originating point code
- **NPSN**—Not present set name
- **SADDR**—Start of MAP digits (IMEI/IMSI/MSISDN/VLRNB/SMRPOA/SMRPDA)
- **EADDR**—End of MAP digits (IMEI/IMSI/MSISDN/VLRNB/SMRPOA/SMRPDA)
- **DEFMAPVR**—Default MAP version
- **PRIO**—Priority of each translation of the type OPCODE GTTSET
- **TRANSMEASRQD**—Per GTT Translation Measurement Required

#### Related Topics

- [chg-gta](#)
- [dlt-gta](#)
- [ent-gta](#)

## rtrv-gtcnv

Use this command to display entries in the Default Global Title Conversion table.

#### Parameters

##### **dir** (optional)

Direction of conversion.

##### **Range:**

###### ***atoi***

ANSI to ITU conversion

###### ***itoa***

ITU to ANSI conversion

**both**

Conversion in both directions

**gtixlat (optional)**

Global title indicator conversion. This parameter is expressed in the form of the ANSI GTI and the ITU GTI.

**Range:****22**

Converts an incoming ANSI GTI 2 to an outgoing ITU GTI 2 or an incoming ITU GTI 2 to an outgoing ANSI GTI 2

**24**

Converts an incoming ANSI GTI 2 to an outgoing ITU GTI 4 or an incoming ITU GTI 4 to an outgoing ANSI GTI 2

**nai (optional)**

Nature of address indicator.

**Range:**

0 - 63, \*

**np (optional)**

Numbering plan.

**Range:**

0 - 15, \*

**tta (optional)**

ANSI translation type.

**Range:**

0 - 255, \*

**tti (optional)**

ITU translation type.

**Range:**

0 - 255, \*

**Example**

```
rtrv-gtcnv
```

**Dependencies**

The ANSI/ITU SCCP Conversion feature must be enabled before the command can be entered.

**Notes**

None

**Output**

This example displays output containing decimal global title digits:

```
rtrv-gtcnv
```

```
tekelecstp 06-11-07 13:44:12 EST EAGLE 35.3.0
```

```
DIR  GTIXLAT  TTA  TTI  NP  NAI  DEL  POS  ADD
atoi  22    10  5   --- ---  10  pfx  123
```

```
GTCNV  table is (1 of 1000) 1% full.
```

```
;
```

This example shows output containing hexadecimal global title digits:

```
rtrv-gtcnv
```

```
tekelecstp 06-11-07 11:52:58 EST EAGLE 35.3.0
```

```
DIR  GTIXLAT  TTA  TTI  NP  NAI  DEL  POS  ADD
atoi  22    1  3   --- ---  ---  pfx  abcdef0123456789abcdef
itoa  24    5  6   2  1   ---  sfx  abcdef0123456789abcef
```

```
GTCNV  table is (2 of 1000) 1% full.
```

```
;
```

### Legend

- **DIR**—Direction of the translation: ANSI to ITU or ITU to ANSI
- **GTIXLAT**—GTI translation
- **TTA**—ANSI translation type
- **TTI**—ITU translation type
- **NP**—Numbering plan
- **NAI**—Nature of address indicator
- **DEL**—Deletion status, listing the number of incoming MSUs that will be deleted prior to translation
- **POS**—Prefix or Suffix
- **ADD**—Global title address

### Related Topics

- [chg-gtcnv](#)
- [dlt-gtcnv](#)
- [ent-gtcnv](#)

## rtrv-gtmod

Use this command to display entries from the GTMOD table. A GTMOD entry consists of a GTMOD ID and GTMOD specific data.

## Parameters



### Note:

Definitions for the feature options specified by the `on` and `off` parameters are located in the Notes section.

### **cgpassn (optional)**

Calling Party Subsystem number. The calling party subsystem address that receives the message.

**Range:**

*002 - 255*

### **gtmodid (optional)**

GT Modification Identifier.

**Range:**

*ayyyyyyy*

1 leading alphabetic character followed by up to 8 alphanumeric characters

### **ngti (optional)**

New Global Title Indicator. This parameter specifies whether a new GTI translation format is type 2 or type 4.

**Range:**

*2*

*4*

*none*

### **nnai (optional)**

New nature of address indicator. The value used to replace the received NNAI.

**Range:**

*0 - 127, none*

### **nnp (optional)**

New numbering plan. The value used to replace the received numbering plan.

**Range:**

*0 - 15, none*

### **npdd (optional)**

Number of prefix digits to be deleted. The number of digits to be deleted from the prefix of the received GT address.

**Range:**

*1 - 21, none*

**npds (optional)**

New prefix digits string. The digits to be prefixed to the received GT address.

**Range:**

1 - 21 digits, *none*

If the Hex Digit Support for GTT feature is not enabled, the range is 1 - 21 decimal digits; valid digits are 0-9 .

If the Hex Digit Support for GTT feature is enabled and on, the range is 1 - 21 hexadecimal digits; valid digits are 0-9, a-f, A-F .

**Default:**

Display all

**nsdd (optional)**

Number of suffix digits to be deleted. The number of digits to be deleted from the suffix of the received GT address.

**Range:**

1 - 21, *none*

**nsds (optional)**

New suffix digits string. The digits to be suffixed to the received GT address.

**Range:**

1-21 digits, *none*

If the Hex Digit Support for GTT feature is not enabled, the range is 1 - 21 decimal digits; valid digits are 0-9 .

If the Hex Digit Support for GTT feature is enabled and on, the range is 1 - 21 hexadecimal digits; valid digits are 0-9, a-f, A-F .

**ntt (optional)**

New Translation Type. The value that is used to replace the received Translation Type.

**Range:**

0 - 255, *none*

**off (optional)**

Disables or turns off the specified feature options. A comma-separated list of feature options that are requested to be turned off. Up to 8 feature options can be specified in the list.

**Range:**

*gt0fill*

**on (optional)**

Enables or turns on the specified feature options. A comma-separated list of feature options that are requested to be turned on. Up to 8 feature options can be specified in the list.

**Range:**

*gt0fill*

*refcnt*

**precd (optional)**

Precedence. This parameter specifies whether the prefix or suffix takes precedence when modifying the received GT address

**Range:***pfx**sfx***Example**

```
rtrv-gtmod:gtmodid=id2
rtrv-gtmod:npdd=5:on=refcnt
rtrv-gtmod:nsdd=10:precd=sfx:nnai=2:nnp=5
rtrv-gtmod:ngti=4:on=gt0fill:cgpasnn=12
```

**Dependencies**

The GTMOD table is corrupt or cannot be found.

The Hex Digit Support for GTT feature must be turned on before hexadecimal digits can be specified for the *npds* and *nsds* parameters.

The *gtmodid=none* parameter cannot be specified.

If the *gtmodid* parameter is specified, then the *on=refcnt* parameter is the only other parameter that can be specified.

The value specified for the *gtmodid* parameter must already exist in the GTMOD table.

The same value cannot be specified for the *on* and *off* parameters.

**Notes****on/off options**

- *gt0fill* —GT zero fill. Specifies whether the last 0 of the GTA is treated as a valid digit (OFF) or as filler (ON) during GT Modification for the *gti(x)=2* to *gti(x)=4* scenario.
- *refcnt* —Reference count. Specifies the number of entries in the GTT Table that references the GTMOD entry. This option is ON only.

**Output**

```
rtrv-gtmod
```

```
tekelecstp 10-02-10 14:43:31 EST EAGLE 42.0.0
```

GTMODID	NTT	NGTI	GT0FILL	NNP	NNAI	NPDD	NSDD	PRECD	CGPASSN
set1	--	--	OFF	0	--	--	--	AFX	254
	NPDS=		NSDS=						
set2	--	4	ON	12	3	3	11	SFX	--
	NPDS=01234567890			NSDS=0987654321					

```

GTMOD table is (2 of 100000) 1% full.
;

rtrv-gtmod:on=refcnt

tekelecstp 10-02-10 14:43:31 EST EAGLE 42.0.0
GTMODID NTT NGTI GT0FILL NNP NNAI NPDD NSDD PRECD CGPASSN
REFCNT
set1 5 4 OFF 0 -- -- -- PFX
254 5
NPDS= NSDS=
set2 -- 4 ON 12 3 3 11
SFX 0
NPDS=01234567890 NSDS=0987654321

GTMOD table is (2 of 100000) 1% full.
;

```

```
rtrv-gtmod:on=gt0fill,refcnt
```

```

tekelecstp 10-02-18 14:43:31 EST 42.0.0
GTMODID NTT NGTI GT0FILL NNP NNAI NPDD NSDD PRECD CGPASSN
REFCNT
id1 -- -- ON 0 -- -- --
PFX 0
NPDS= NSDS=

GTMOD TABLE IS ( 1 of 100000) 1 % FULL
;

```

### Legend

**AMGTT**—Advanced GT Modification

**GT0FILL**—Indicates whether a trailing 0 in the GTA is considered as a valid digit or a filler

**NGTI**—New Global Title Indicator

**NNP**—New Numbering Plan

**NNAI**—New Nature of Address Indicator

**NPDD**—New Prefix Digits to be Deleted

**NPDS**—New Prefix Digits String

**NSDD**—New Suffix Digits to be Deleted

**NSDS**—New Suffix Digits String

**PC**—Point Code



**Related Topics**

- [chg-gtmod](#)
- [dlt-gtmod](#)
- [ent-gtmod](#)

## rtrv-gtt

Use this command to show one or more entries from the GTT Data and the Translation Type tables. The report contains two records (the percentage full and number-of-cells-used field) that give the total entries in the GTT table without regard to the *type* parameter specified.

 **Note:**

If the EGTT feature is turned on, then the GTT Selector (`ent/chg/dlt/rtrvgttssel`), GTT Set (`ent/dlt/rtrv-gttset`), and GTA (`ent/chg/dlt/rtrvgta`) commands replace the Translation Type (`ent/dlt/rtrv-tt`) and Global Title Translation (`ent/chg/dlt/rtrv-gtt`) commands. It is not recommended to run `ent/dlt/rtrv-tt & ent/chg/dlt/rtrv-gtt` commands as it may cause the advance GTA fields of GTT entry to be reset to the default values.

**Parameters** **Note:**

See [Point Code Formats and Conversion](#) for a detailed description of point code formats, rules for specification, and examples.

**cggtmod (optional)**

Calling party global title modification indicator. This parameter displays all translation entries that have the specified value of the calling party GT modification indicator.

**Range:**

*yes*

*no*

**egta (optional)**

End global title address. This parameter specifies the end of a range of global title digits.

**Range:**

1-21 digits

If the Hex Digit Support for GTT feature is not enabled and on, the range is 1 - 21 decimal digits; valid digits are 0-9.

If the Hex Digit Support for GTT feature is enabled and on, the range is 1 - 21 hexadecimal digits; valid digits are 0-9, a-f, A-F.

**Default:**

If the `gta` parameter is specified, the `egta` parameter default value is the specified `gta` parameter value.

**force (optional)**

This parameter allows the user to display more than 1000 entries. This parameter is used to prevent inadvertent displays of extremely large amounts of information, which could take many hours.

**Range:**

*yes*

*no*

**Default:**

*no*

**gta (optional)**

Global title start address. The beginning of a range of global title digits.

**Range:**

1-21 digits

If the Hex Digit Support for GTT feature is not enabled and on, the range is 1 - 21 decimal digits; valid digits are 0-9.

If the Hex Digit Support for GTT feature is enabled and on, the range is 1 - 21 hexadecimal digits; valid digits are 0-9, a-f, A-F.

**Default:**

The first GTT entry for the given translation type.

**gtmodid (optional)**

Global Title Modification Identifier.

**Range:**

*ayyyyyyy*

1 leading alphabetic character followed by up to 8 alphanumeric characters

**loopset (optional)**

SCCP loopset name. This parameter retrieves translation entries that are associated with the specified loopset.

**Range:**

*ayyyyyyy*

1 alphabetic character followed by up to 7 alphanumeric characters.

*none* —Translation entries with no association to any loopset.

**mapset (optional)**

MAP set ID.

**Range:**

*1 - 36000, dflt*

*dflt* —Default MAP set

**mrnset (optional)**

MRN set ID. This parameter retrieves GTT information for a specified Mated Relay Node set.

**Range:**

1 - 3000, *dflt*, *none*

*dflt* —Default MRN set

*none* —The GTA translation does not participate in any loadsharing.

**num (optional)**

The number of entries to be shown.

**Range:**

1 - 1000000

1-1000 —if *force=yes* is not specified

1-1000000 —if *force=yes* is specified

**Default:**

1 —if *gta* is specified

20 —if *gta* is not specified

**pc (optional)**

ANSI point code with subfields *network indicator-network cluster-network cluster member (ni-nc-ncm)*. The *prefix* subfield indicates a private point code (*prefix-ni-nc-ncm*).

**Synonym:**

*pca*

**Range:**

*p-*, 000-255

Specify a valid value for each subfield of the point code, and separate the subfields with a dash (-).

*prefix*—*p-*

When *chg-sid:pctype=ansi* is specified, *ni = 000* is not valid.

When *chg-sid:pctype=ansi* is specified, *nc = 000* is not valid if *ni = 001-005*.

When *chg-sid:pctype=ansi* is specified, *nc = 000* is valid if *ni = 006-255*.

The point code 000-000-000 is not a valid point code.

**Default:**

Display all

**pc/pca/pci/pcn/pcn24 (optional)**

Point code.

**pci (optional)**

ITU international point code with subfields *zone-area-id*. The *prefix* subfield indicates a spare point code, private point code, or private and spare point code (*prefix-zone-area-id*).

**Range:**

*s-*, *p-*, *ps-*, 0-255

Specify a valid value for each subfield of the point code, and separate the subfields with a dash (-).

*prefix*—*s*-, *p*-, *ps*  
*zone*—*0-7*  
*area*—*000-255*  
*id*—*0-7*

The point code *0-000-0* is not a valid point code.

**Default:**

Display all

**pcn (optional)**

ITU national point code in the format of a 5-digit number (*nnnnn*); or 2, 3, or 4 numbers (members) separated by dashes (*m1-m2-m3-m4*) as defined by the `chg-stpopts:npcfmti` flexible point code option. A group code must be specified when the ITUDUPPC feature is turned on (*nnnnn-gc*, *m1-m2-m3-m4-gc*). The *prefix* subfield indicates a spare point code, private point code, or private and spare point code (*prefix-nnnnn*, *prefix-nnnnn-gc*, *prefix-m1-m2-m3-m4*, *prefix-m1-m2-m3-m4-gc*).

**Range:**

*s*-, *p*-, *ps*-, *0-16383*, *aa-zz*

Specify a valid value for each subfield of the point code, and separate the subfields with a dash (-).

*prefix*—*s*-, *p*-, *ps*  
*nnnnn*—*0-16383*  
*gc*—*aa-zz*  
*m1-m2-m3-m4*—*0-14* for each member; values must sum to 14

**Default:**

Display all

**pcn24 (optional)**

24-bit ITU national point code with subfields *main signaling area-sub signaling area-signaling point* (*msa-ssa-sp*). The *prefix* subfield indicates a private point code (*prefix-msa-ssa-sp*).

**Range:**

*p*-, *000-255*

Specify a valid value for each subfield of the point code, and separate the subfields with a dash (-).

*prefix*—*p*  
*msa*—*000-255*  
*ssa*—*000-255*  
*sp*—*000-255*

**Default:**

Display all

**pctype (optional)**

Point code type. This parameter retrieves a single type of point code among mixed types of point code provisioned for a Translation Type.

**Range:**

*ansi*

*itui**itun**itun24**ituis**ituns***Default:**

Display all

**ssn (optional)**

Subsystem number. The subsystem address that is to receive the message.

**Range:**

002 - 255

**Default:**

Display all

**ttn (optional)**

Translation name.

**Range:**

ayyyyyyy

1 alphabetic character followed by up to 8 alphanumeric characters

**Default:**

None given

**type/typeea/typeei/typen/typen24/typeis/typens (optional)**

Translation type identifies the translation type and network type. This parameter is the decimal representation of the 1-byte field used in SS7.

The *type* and *typeea* parameters specify an ANSI network.The *typei* parameter specifies an ITU-international network.The *typen* parameter specifies an ITU-national network.The *typen24* parameter specifies a 24-bit ITU-national network.The *typeis* parameter specifies an ITU-international spare network.The *typens* parameter specifies an ITU-national spare network.A translation type numeric value may be entered as ANSI type (*type* or *typeea*) and as an ITU type (*typei/typen/typen24/typeis/typens*). However, they are separate entities.

The point code domain translation types for GTT are handled by the EAGLE protocol processing as either ANSI or ITU; therefore, ITU applies to ITU-I, ITU-I spare, ITU-N, ITU-N spare, and ITU-N24.

**Range:**

0 - 255

**Default:**

None given

**Example**

rtrv-gtt:type=5:ttn=lidb1:gta=919555

```
rtrv-gtt:type=5:gta=919555
rtrv-gtt:type=5:gta=919555:num=2500:force=yes
rtrv-gtt:typen24=0
rtrv-gtt:typei=7:pctype=ansi
rtrv-gtt:typen=106:pctype=itui
rtrv-gtt:type=55:pctype=itun
rtrv-gtt:type=9:pctype=itun24
rtrv-gtt:typei=4:pci=s-1-24-1
rtrv-gtt:typen=3:pcn=s-124
rtrv-gtt:ttn=tbla
rtrv-gtt:ttn=tbla:mapset=1
rtrv-gtt:type=4:cggmod=yes
rtrv-gtt:ttn=ituset:gtmodid=set1
rtrv-gtt:typens=5:gta=123456
rtrv-gtt:typeis=5:gta=123456
```

### Dependencies

The ANSI/ITU SCCP Conversion feature must be enabled before the `pctype` parameter can be specified.

If the `pcn` parameter is specified, its format must match the format that was assigned with the `chg-stpopts:npcfmti` parameter.

The first character of the translation name must be a letter.

The value of the `tt` parameter must exist in the Translation Type table.

The value specified for the `tt` parameter must correspond to a value of the `type/typea/typei/typen/typen24/typeis/typens` parameter (see the `ent/chg-gtt` command).

If the value of the `num` parameter exceeds 1000, then the `force=yes` parameter must be specified.

The `type` or `ttn` parameter must be specified.

The value of the `pc/pca/pci/pcn/pcn24` parameter must be a full point code.

If the `egta` parameter is specified, the `gta` parameter must be specified.

If the system is defined as an ANSI system, the `pc/pca` parameter must be specified as a valid ANSI point code.

The ANSI/ITU SCCP Conversion feature must be enabled before a translated point code and a translation type in different network types can be specified.

The number of digits in the specified `gta` parameter must be at least the number of digits provisioned for the given translation type. If the VGTT (variable length GTT) feature is turned on, there can be up to 10 GTA lengths per translation type. When the `ent-gtt` command is

entered to create entries, the software keeps track of the lengths and allows only ten different lengths.

The value of the `tt` parameter must not be defined as an alias.

The Flexible GTT Load Sharing feature must be enabled before the `mapset` parameter can be specified.

The specified MAP set must exist in the database.

The Hex Digit Support for GTT feature must be enabled and on before hexadecimal digits can be specified for the `gta` and `egta` parameters.

The value of the `num` parameter must not exceed the maximum table size.

The length of the `egta` parameter must equal the length of the `gta` parameter.

The value of the `egta` parameter must be greater than the value of the `gta` parameter.

If the `tt` parameter is not specified, then the value of the `ttn` parameter must match the value of a `tt` parameter in the STP database.

The value of the `gta` parameter must exist.

The SCCP Loop Detection feature must be enabled before the `loopset` parameter can be specified.

The value of the `loopset` parameter must already exist in the database.

The Loopset table is corrupt or cannot be found.

The Flexible GTT Load Sharing feature must be enabled before the `mrnset` parameter can be specified.

At least one entry must be provisioned in the MRN table for the MRN set that is specified by the `mrnset` parameter.

The AMGTT feature or the AMGTT CgPA Upgrade feature must be turned on before the `cggtmod` parameter can be specified.

The `mapset` and `mrnset` parameters cannot be specified together in the command.

The GTT set associated with the translation type specified by the `ttn` parameter must have a set type of `cdgta` (see the `ent-gttset` command).

The value specified for the `gtmodid` parameter must already exist in the GTMOD table.

The GTMOD table is corrupt or cannot be found.

The `ttn=none` parameter cannot be specified.

The network domain of the translation type specified by the `ttn` parameter cannot be CROSS (see the `ent-gttset` command).

## Notes

If the `rtrv-gtt` command is entered with only the `gta` parameter, a match would be an entry containing the same number of digits, or more digits, for the translation type. For example, if `gta=8005556666` is specified, the six-digit translation type `800555`

would be a match. If the VGTT feature is turned on and the `egta` parameter is specified, all matching entries regardless of length are displayed.

This command can be canceled using the **F9** function key or the `canc-cmd` command. See `canc-cmd` for more information.

If you do not know either the translation type or the translation type name, use the `rtv-tt` command to obtain type and name.

Due to the size of these tables (up to 270,000 possible entries), a limit (65,535) is placed on the number of entries that can be printed at one time.

In this command, only ITU-international and ITU national point codes support the spare point code subtype prefix (s-) and the private and spare point code subtype prefix (ps-). All of the point code types support the private (internal) point code subtype prefix (p-).

The number of entries to be shown (the `num` parameter) can be specified for any valid combination of parameters.

If the `gta` parameter is not specified, then the first entry in the global title translation table that corresponds to the translation type is the first entry shown.

If the `num` and `gta` parameters are not specified, then up to 20 entries are shown.

If the `gta` parameter is specified, but the `num` parameter is not specified, then only one entry is shown.

If the `num` parameter is specified, then the number of entries shown is the lesser of the number of entries in the table from the defined starting point to the end, or the value of the `num` parameter.

If the `gta` and `egta` parameters are specified, then the entry that matches the `gta` parameter, or is the nearest entry below the `gta` parameter, is the first entry shown for the specified range.

The `rtv-gtt` command can retrieve only CdGTA entries that were provisioned through GTA commands when the OBSR or FLOBR feature is turned on.

## Output

```
rtv-gtt:type=10:num=65535:force=yes
```

```
tekelecstp 10-02-04 11:43:04 EST EAGLE 42.0.0
```

```
TYPEA   TTN       NDGT
   3     c800     10
```

```
GTT table is (9 of 269999) 1% full.
```

START GTA	END GTA	XLAT	RI	PCA
9195551212	9195551212	DPCSSN	SSN	008-001-001
SSN=222	GTMODID=setntt1			
8005550000	8005551999	DPCSSN	SSN	001-254-255
SSN=255	GTMODID=-----			
8005552000	8005553999	DPC	GT	001-254-255
SSN=255	GTMODID=setntt2			
8005554000	8005555999	DPCNGT	GT	001-254-255
SSN=255	GTMODID=-----			



```
      8005556000          8005557999          DPCSSN SSN
001-254-255
      SSN=255  GTMODID=-----
      8005558000          8005559999          DPCSSN SSN
001-254-255
      SSN=255  GTMODID=-----
      9762428487          9762428487          DPCSSN SSN
001-254-255
      SSN=222  GTMODID=-----
      9766423277          9766423277          DPCSSN SSN
001-254-255
      SSN=222  GTMODID=-----
      9769388928          9769388928          DPCSSN SSN
001-254-255
      SSN=222  GTMODID=-----
```

Command Retrieved 9 Entries

;

```
rtrv-gtt:type=10:dpc=8-1-1:ssn=222:gta=9195551212
```

```
tekelecstp 10-02-24 11:43:04 EST  EAGLE 42.0.0
TYPEA      TTN          NDGT
  3         c800         10
```

GTT table is (9 of 269999) 1% full.

```
START GTA          END GTA          XLAT  RI
PCA
  9195551212        9195551212        DPCSSN SSN
008-001-001
      SSN=222  GTMODID=-----
```

Command Retrieved 1 Entries

;

```
rtrv-gtt:typen=10
```

```
tekelecstp 10-02-24 11:44:04 EST  EAGLE 42.0.0
TYPEN      TTN          NDGT
  10        -----         6
```

GTT table is (9 of 269999) 1% full.

```
START GTA          END GTA          XLAT  RI      ITU
PC
  123456          123456          DPC   GT
0500-1-0-1
      SSN=----  GTMODID=-----
```

Command Retrieved 1 Entries

;

This example shows a retrieval of all GTTs for a specified translation when the VGTT feature is turned on:

```
rtrv-gtt:type=10:num=65535:force=yes
```

```
tekelecstp 10-02-24 11:44:04 EST EAGLE 42.0.0
```

```
TYPEA   TTN      NDGT
  10     c800     6, 8, 10
```

GTT table is (17 of 269999) 1% full.

START GTA	END GTA	XLAT	RI	PCA
976242	976242	DPCSSN	SSN	001-254-255
SSN=222	GTMODID=-----			
976642	976642	DPCSSN	SSN	001-254-255
SSN=222	GTMODID=-----			
976938	976938	DPCSSN	SSN	001-254-255
SSN=222	GTMODID=-----			
80055500	80055519	DPCSSN	SSN	001-254-255
SSN=255	GTMODID=-----			
80055520	80055539	DPC	GT	001-254-255
SSN=255	GTMODID=-----			
80055540	80055559	DPCNGT	GT	001-254-255
SSN=255	GTMODID=-----			
80055560	80055579	DPCSSN	SSN	001-254-255
SSN=255	GTMODID=-----			
80055580	80055599	DPCSSN	SSN	001-254-255
SSN=255	GTMODID=-----			
9195551212	9195551212	DPCSSN	SSN	008-001-001
SSN=222	GTMODID=-----			
8005550000	8005551999	DPCSSN	SSN	001-254-255
SSN=255	GTMODID=-----			
8005552000	8005553999	DPC	GT	001-254-255
SSN=255	GTMODID=-----			
8005554000	8005555999	DPCNGT	GT	001-254-255
SSN=255	GTMODID=-----			
8005556000	8005557999	DPCSSN	SSN	001-254-255
SSN=255	GTMODID=-----			
8005558000	8005559999	DPCSSN	SSN	001-254-255
SSN=255	GTMODID=-----			
9762428487	9762428487	DPCSSN	SSN	001-254-255
SSN=222	GTMODID=-----			
9766423277	9766423277	DPCSSN	SSN	001-254-255
SSN=222	GTMODID=-----			
9769388928	9769388928	DPCSSN	SSN	001-254-255
SSN=222	GTMODID=-----			

Command Retrieved 17 Entries

;

rtrv-gtt:type=7:gtmodid=asetansi5

tekelecstp 10-02-24 11:43:04 EST EAGLE 42.0.0

TYPEA	TTN	NDGT
7	isvm	3,6,7,10

GTT table is (17 of 269999) 1% full.

START GTA	END GTA	XLAT	RI	PCA
564	564	DPCSSN	SSN	
248-006-015				
SSN=245	GTMODID=asetansi5			
641	641	DPCSSN	SSN	
248-006-015				
SSN=245	GTMODID=asetansi5			
589234	598744	DPCSSN	SSN	
248-006-015				
SSN=245	GTMODID=asetansi5			
648392	659832	DPCSSN	SSN	
248-006-015				
SSN=245	GTMODID=asetansi5			

Command Retrieved 4 Entries

;

This example shows output when the GTT table can contain up to 1,000,000 entries:

rtrv-gtt:type=7

tekelecstp 10-02-04 11:43:04 EST EAGLE 42.0.0

TYPEA	TTN	NDGT
7	isvm	3,6,7,10

GTT table is (17 of 1000000) 1% full.

START GTA	END GTA	XLAT	RI
564	564	DPCNGT	GT
248-006-015			
SSN=245	GTMODID=asetansi4		
641	641	DPCNGT	GT
248-006-015			
SSN=245	GTMODID=-----		
589234	598744	DPCNGT	GT
248-006-015			
SSN=245	GTMODID=asetansi4		
648392	659832	DPCSSN	SSN
248-006-015			
SSN=245	GTMODID=-----		

```
Command Retrieved 4 Entries
;
```

This example shows output for a 24-bit ITU-N point code translation type of 4:

```
rtrv-gtt:typen24=4
```

```
tekelecstp 10-02-24 11:43:04 EST EAGLE 42.0.0
TYPEN24 TTN NDGT
4 ----- 6
```

```
GTT table is (1 of 269999) 1% full.
```

```
START GTA          END GTA          XLAT  RI      ITU PC
919833             919833             DPCSSN SSN    008-008-008
          SSN=20  GTMODID=-----
```

```
Command Retrieved 1 Entries
;
```

This example shows output when the ANSI/ITU SCCP Conversion feature is enabled and the `pctype=ansi` parameter is specified:

```
rtrv-gtt:typei=7:pctype=ansi
```

```
tekelecstp 10-02-04 11:43:04 EST EAGLE 42.0.0
TYPEI  TTN      NDGT
7      isvm    3,6,7,10
```

```
GTT table is (17 of 1000000) 1% full.
```

```
START GTA          END GTA          XLAT  RI      PCA
564                564                DPCNGT GT    002-136-005
          SSN=245  GTMODID=aseti43  CGGTMOD = NO
648392             659832             DPCSSN SSN    007-006-005
          SSN=245  GTMODID=-----  CGGTMOD = NO
```

```
Command Retrieved 2 Entries
;
```

This example shows output when the ANSI/ITU SCCP Conversion feature is enabled and the `pctype=itui` parameter is specified:

```
rtrv-gtt:typen=106:pctype=itui:gtmodid=id12
```

```
tekelecstp 10-02-24 11:43:04 EST EAGLE 42.0.0
TYPEN  TTN      NDGT
106    ntoi43   6
```

GTT table is (17 of 1000000) 1% full.

START GTA	END GTA	XLAT	RI	ITUI
300006	300006	DPCNGT	GT	

PC  
6-002-3  
SSN=--- GTMODID=id12

Command Retrieved 1 Entries

;

This example shows output when the ANSI/ITU SCCP Conversion feature is enabled and the `pctype=itun` parameter is specified:

```
rtrv-gtt:type=55:pctype=itun
```

```
tekelecstp 10-02-24 11:43:04 EST EAGLE 42.0.0
TYPEA      TTN      NDGT
55         aton44    7
```

GTT table is (17 of 1000000) 1% full.

START GTA	END GTA	XLAT	RI	ITUN
6543210	6543210	DPCNGT	GT	

PC  
12341  
SSN=--- GTMODID=amseta4

Command Retrieved 1 Entries

;

This example shows output when the ANSI/ITU SCCP Conversion feature is enabled and the `pctype=itun24` parameter is specified:

```
rtrv-gtt:type=9:pctype=itun24
```

```
tekelecstp 10-02-04 11:43:04 EST EAGLE 42.0.0
TYPE      TTN      NDGT
7         isvm     3,6,7,10
```

GTT table is (17 of 1000000) 1% full.

START GTA	END GTA	XLAT	RI	ITUN24
764	864	DPCNGT	GT	

PC  
002-136-005  
SSN=245 GTMODID=amitu43 CGGTMOD = NO  
668392 689832 DPCSSN SSN  
007-006-005

```
SSN=245 GTMODID=----- CGGTMOD = NO
```

```
Command Retrieved 2 Entries
```

```
;
```

```
rtrv-gtt:typen=3
```

```
tekelecstp 10-02-24 11:43:04 EST EAGLE 42.0.0
```

```
TYPEN   TTN       NDGT  
3       - - - - - 6,21
```

```
GTT table is (6 of 269999) 1% full.
```

START GTA	END GTA	XLAT	RI	ITU PC
123456	123456	DPCSSN	GT	s-00124-aa
SSN=10	GTMODID=amnat34			
234567	234567	DPCNGT	GT	s-00124-aa
SSN=---	GTMODID=-----			
234568	234568	DPC	GT	s-00124-aa
SSN=---	GTMODID=-----			
234569	234569	DPC	GT	s-00124-aa
SSN=---	GTMODID=amnat22			
334569467213456789012	334569478932012345678	DPC	GT	s-00124-aa
SSN=---	GTMODID=amnat10			

```
Command Retrieved 5 Entries
```

```
;
```

```
rtrv-gtt:typen=3:pcn=s-124-aa
```

```
tekelecstp 10-02-24 11:43:04 EST EAGLE 42.0.0
```

```
TYPEN   TTN       NDGT  
3       - - - - - 6,21
```

```
GTT table is (6 of 269999) 1% full.
```

START GTA	END GTA	XLAT	RI	ITU PC
123456	123456	DPCSSN	GT	s-00124-aa
SSN=10	GTMODID=amsetnat1	CGGTMOD = YES		
234567	234567	DPCNGT	GT	s-00124-aa
SSN=---	GTMODID=-----	CGGTMOD = NO		
234568	234568	DPC	GT	s-00124-aa
SSN=---	GTMODID=-----	CGGTMOD = NO		
234569	234569	DPC	GT	s-00124-aa
SSN=---	GTMODID=amsetnat2	CGGTMOD = YES		
334569467213456789012	334569478932012345678	DPC	GT	s-00124-aa
SSN=---	GTMODID=amsetnat3	CGGTMOD = NO		

```
Command Retrieved 5 Entries
```

;

rtrv-gtt:typen=3:ssn=104

```
tekelecstp 10-02-24 11:43:04 EST EAGLE 42.0.0
TYPEN      TTN      NDGT
3          - - - - - 6
```

GTT table is (5 of 269999) 1% full.

```
START GTA          END GTA          XLAT  RI      ITU PC
123456            123456          DPCSSN GT    s-00124-aa
      SSN=10      GTMODID=asetnal3
```

Command Retrieved 1 Entries

;

This example shows output when the Flexible GTT Load Sharing feature is not on:

rtrv-gtt:ttn=tbla

```
tekelecstp 10-02-24 15:50:49 EST EAGLE 42.0.0
TYPEA      TTN      NDGT
10         tbla      6
```

GTT table is (2 of 269999) 1% full.

```
START GTA          END GTA          XLAT  RI      PCA
123456            123456          DPC   GT
001-001-001
      SSN=---      GTMODID=-----
234567            234567          DPCSSN SSN
001-001-001
      SSN=2        GTMODID=-----
```

Command Retrieved 2 Entries

;

This example shows an MRN set value of NONE. The Flexible GTT Load-Sharing feature and the Intermediate GTT Load Sharing feature are on.

rtrv-gtt:ttn=tbl1

```
tekelecstp 10-02-24 13:54:32 EST EAGLE 42.0.0
TYPEA      TTN      NDGT
1          tbl1      10
```

GTT table is (1 of 269999) 1% full.

```

START GTA          END GTA          XLAT  RI    PCA
1234567890        1234567890        DPC   GT   001-001-002
      MRNSET=NONE  SSN=----  GTMODID=mod3

```

Command Retrieved 1 Entries

;

This example shows output when the Flexible GTT Load Sharing feature and the Origin-based SCCP feature are on:

```
rtrv-gtt:ttn=tbla
```

```

tekelecstp 10-02-24 14:51:59 EST  EAGLE 42.0.0
TYPEA      TTN          NDGT
 6          tbla        6,10

```

```

GTA table is (61 of 269999) 1% full
e1040501 10-02-24 13:33:10 EST  EAGLE 42.0.0

```

```

START GTA          END GTA          XLAT  RI    ITU PC
123456            123456          DPC   GT   1-101-1
      MRNSET=DFLT  SSN=----  GTMODID=-----  CGGTMOD = NO

```

Command Retrieved 1 Entries

;

This example shows output when the Hex Digit Support for GTT feature is turned on and hexadecimal digits are included in GTA values:

```
rtrv-gtt:typen=201
```

```

tekelecstp 10-02-24 13:36:23 EST  EAGLE 42.0.0
TYPEN      TTN          NDGT
201        -----  6,21

```

```
GTT table is (5 of 269999) 1% full.
```

```

START GTA          END GTA          XLAT  RI    PC
100000            10000d          DPC   GT   00101
      SSN=----  GTMODID=-----
10000e            10000f          DPC   GT   00101
      SSN=----  GTMODID=-----
100010            200000          DPC   GT   00101
      SSN=----  GTMODID=-----
abcdef0123456789abcdef  abcde01234567890afff  DPCSSN  SSN  00103
      SSN=10   GTMODID=-----
fbcdef0123456789abcdef  fbfde01234567890aaff  DPCSSN  SSN  00103
      SSN=10   GTMODID=asetnal33

```



Command Retrieved 5 Entries

;

This example shows output when the SCCP Loop Detection feature is enabled and an associated loopset entry exists:

```
rtrv-gtt:ttn=setssn:mapset=6
```

```
tekelecstp 10-02-24 12:41:25 EST EAGLE 42.0.0
TYPEA    TTN      NDGT
  2      setssn   10
```

GTT table is (4 of 269999) 1% full.

```
START GTA          END GTA          XLAT  RI    PCA
2133              2133              DPC   GT
001-001-003
      MAPSET=6     SSN=----  GTMODID=asetans  CGGTMOD = NO
```

Command Retrieved 1 Entries

;

This example shows output for a specified MRN set when the Flexible GTT Load Sharing feature is enabled:

```
rtrv-gtt:ttn=tbla:mrnset=1
```

```
tekelecstp 10-02-24 12:41:25 EST EAGLE 42.0.0
TYPEA    TTN      NDGT
  2      tbla    4
```

GTT table is (4 of 269999) 1% full.

```
START GTA          END GTA          XLAT  RI    PCA
2133              2133              DPC   GT
001-001-003
      MRNSET=1     SSN=----  GTMODID=asetans  CGGTMOD = NO
```

Command Retrieved 1 Entries

;

This example retrieves all examples of translation type 4 where calling party global title modification is requested:

```
rtrv-gtt:type=4:cggmod=yes
```

```
tekelecstp 10-02-24 16:21:15 EST EAGLE 42.0.0
TYPEA    TTN      NDGT
```

4           -----       6

GTT table is (1 of 269999) 1% full.

START GTA	END GTA	XLAT	RI	PCA
981234	981234	DPC	GT	001-001-001
MRNSET=DFLT SSN=---- GTMODID=asetans CGGTMOD = YES				
LOOPSET = none				

Command Retrieved 1 Entries

;

rtrv-gtt:type=1:num=22

e1040501 10-02-24 13:14:49 EST EAGLE 42.0.0

TYPEA	TTN	NDGT
1	-----	6

GTT table is (22 of 269999) 1% full.

START GTA	END GTA	XLAT	RI	PCA
111111	111111	DPC	GT	001-001-002
SSN=---- GTMODID=-----				
111112	111112	DPC	GT	001-001-002
SSN=---- GTMODID=gtmo10				
111113	111113	DPC	GT	001-001-002
SSN=---- GTMODID=-----				
111114	111114	DPC	GT	001-001-002
SSN=---- GTMODID=gtmo12				
111115	111115	DPC	GT	001-001-002
SSN=---- GTMODID=-----				
111116	111116	DPC	GT	001-001-002
SSN=---- GTMODID=-----				
111117	111117	DPC	GT	001-001-002
SSN=---- GTMODID=-----				
111118	111118	DPC	GT	001-001-002
SSN=---- GTMODID=-----				
111119	111119	DPC	GT	001-001-002
SSN=---- GTMODID=-----				
111120	111120	DPC	GT	001-001-002
SSN=---- GTMODID=gtmo11				
111121	111121	DPC	GT	001-001-002
SSN=---- GTMODID=gtmo122				
111122	111122	DPC	GT	001-001-002
SSN=---- GTMODID=-----				
111123	111123	DPC	GT	001-001-002
SSN=---- GTMODID=-----				
111124	111124	DPC	GT	001-001-002
SSN=---- GTMODID=-----				
111125	111125	DPC	GT	001-001-002
SSN=---- GTMODID=-----				
111126	111126	DPC	GT	001-001-002

```

          SSN=--- GTMODID=-----
111127          111127          DPC   GT
001-001-002
          SSN=--- GTMODID=gtmo121
111128          111128          DPC   GT
001-001-002
          SSN=--- GTMODID=-----
111129          111129          DPC   GT
001-001-002
          SSN=--- GTMODID=-----
111130          111130          DPC   GT
001-001-002
          SSN=--- GTMODID=-----
111131          111131          DPC   GT
001-001-002
          SSN=--- GTMODID=gtmo34

```

Command Retrieved 21 Entries

;

rtrv-gtt:type=2

```

e1040501 10-02-24 13:15:11 EST EAGLE 42.0.0
TYPEA   TTN       NDGT
  2     - - - - -  6

```

GTT table is (22 of 269999) 1% full.

```

START GTA          END GTA          XLAT  RI      PCA
222222          222229          DPCSSN SSN
001-001-002
          SSN=10  GTMODID=-----

```

Command Retrieved 1 Entries

;

rtrv-gtt:type=1:gta=111268:egta=222259

```

tekelecstp 10-02-24 13:31:05 EST EAGLE 42.0.0
TYPEA   TTN       NDGT
  1     - - - - -  6

```

GTT table is (37 of 269999) 1% full.

```

START GTA          END GTA          XLAT  RI      PCA
111268          111268          DPCNGT GT
001-001-002
          SSN=--- GTMODID=-----  CGGTMOD = NO
111269          111269          DPCNGT GT
001-001-002

```

```

          SSN=--- GTMODID=asetans3  CGGTMOD = YES
111270          111270          DPCNGT GT      001-001-002
          SSN=--- GTMODID=asetans4  CGGTMOD = NO
222252          222259          DPCSSN SSN    001-001-002
          SSN=12  GTMODID=-----  CGGTMOD = YES

```

Command Retrieved 4 Entries

;

rtrv-gtt:type=1:mapset=1

```

e1040501 10-02-24 13:38:25 EST  EAGLE 42.0.0
TYPEA    TTN          NDGT
 1        -----    3,6

```

GTT table is (41 of 269999) 1% full.

```

START GTA          END GTA          XLAT  RI      PCA
105              105              DPCSSN SSN    001-001-003
          MAPSET=1  SSN=14  GTMODID=-----  CGGTMOD = NO

```

Command Retrieved 1 Entries

;

rtrv-gtt:type=1:ssn=10

```

e1040501 10-02-24 13:33:10 EST  EAGLE 42.0.0
TYPEA    TTN          NDGT
 1        -----    3,6

```

GTT table is (40 of 269999) 1% full.

```

START GTA          END GTA          XLAT  RI      PCA
100              100              DPCSSN SSN    001-001-002
          SSN=10  GTMODID=-----  CGGTMOD = NO
101              101              DPCSSN SSN    001-001-003
          SSN=10  GTMODID=mod3      CGGTMOD = NO
104              104              DPCSSN SSN    001-001-003
          SSN=10  GTMODID=-----  CGGTMOD = NO

```

Command Retrieved 3 Entries

;

This example retrieves all CdGTA translations which have been provisioned by GTA commands:

```
rtrv-gtt:type=3
```

```
tekelecstp 10-03-02 13:15:11 EST EAGLE 42.0.0
```

```
TYPEA   TTN       NDGT  
3       setans003  6
```

```
GTT table is (6 of 269999) 1% full.
```

```
;
```

```
tekelecstp 10-03-02 13:15:11 EST EAGLE 42.0.0
```

```
START GTA           END GTA           XLAT  RI    PCA  
345678             345680           DPC   GT  
001-001-002  
      SSN=--- NGT=---
```

```
Command Retrieved 1 Entries
```

```
rtrv-gtt:typeis=5
```

```
tekelecstp 10-05-01 04:39:18 EST EAGLE 42.0.0
```

```
TYPEIS  TTN       NDGT  
5       ------  6
```

```
GTT table is (12 of 269999) 1% full.
```

```
;
```

```
tekelecstp 10-05-01 04:39:18 EST EAGLE 42.0.0
```

```
START GTA           END GTA           XLAT  RI    ITU PC  
123456             123456           DPC   GT    s-1-001-4  
      SSN=--- NGT=---
```

```
Command Retrieved 1 Entries
```

```
;
```

```
rtrv-gtt:typens=5
```

```
tekelecstp 10-05-01 04:40:38 EST EAGLE 42.0.0
```

```
TYPENS  TTN       NDGT  
5       ------  6
```

```
GTT table is (20 of 269999) 1% full.
```

```
;
```

```
tekelecstp 10-05-01 04:40:38 EST EAGLE 42.0.0
```

```

START GTA          END GTA          XLAT  RI    ITU PC
123456             123456           DPC   GT    s-00111
      SSN=---- NGT=----

```

Command Retrieved 1 Entries

;

### Legend

- **type/typea/typeei/typen/typen24/typeis/typens**—Translation type
- **TTN**—Translation name
- **NDGT**—Number of digits
- **GTT TABLE IS 10% FULL**—Relative size of the GTT table
- **x of y**—Number of entries in the table (x) and the maximum number of entries configured for the table (y)
- **START GTA**—Global title start address
- **END GTA**—Global title end address
- **XLAT**—Translate indicator
- **RI**—Route indicator
- **PC, PCA, ITU PC, ITUI PC, ITUN PC, ITUN24 PC**—Point code
- **SSN**—Subsystem number
- **MRN**—Mated Relay Node
- **MRNSET**—MRN set ID
- **MAPSET**—MAP set ID
- **CGGTMOD**—Calling Party GT Modification Indicator
- **GTMODID**—Global Title Modification Identifier

### Related Topics

- [chg-gtt](#)
- [dlt-gtt](#)
- [ent-gtt](#)

## rtrv-gttact

Use this command to display entries from the Global Title Translations (GTT) Action table.

### Parameters



#### Note:

Definitions for the feature options specified by the `on` and `off` parameters are located in the Notes section.

**act (optional)**

Action. The action applied to the message.

**Range:*****disc***

discard message with no return error

***dup***

route a copy of the message to a specified duplicate node

***fwd***

route the original message to a specified forward node instead of the destination indicated by the GTT/ DB data

***scpval***

perform the SCCP MAP validation on MO/MT-FSM messages

***sflog***

send a copy of the original message to the SFLOG card

***sfthrot***

discard message if threshold exceeded

***srvc***

apply service (GPORT/GFLEX/SMSMR) on the message.

***tcaperr***

discard message that has a specified TCAP error

***udts***

discard message and send udts/xudts

***sfapp***

route message to SFAPP card

**actid (optional)**

GTT Action Id.

**Range:**

ayyyyyyy

1 leading alphabetic followed by up to 8 alphanumeric characters

**atcaperr (optional)**

ANSI TCAP Error Cause. The reason for discarding the message containing the ANSI TCAP portion that is associated with the TCAPERR GTT Action.

**Range:**

0 - 255

**atirescmodid (optional)**

Calling party global title modification identifier for ATI. The GTMOD ID to be associated with the calling party of a SFAPP GTT Action entry.

**Range:**

ayyyyyyy

1 leading alphabetic character followed by up to 8 alphanumeric characters

**Default:**

None

**cdgtmodid (optional)**

Called party global title modification identifier.

**Range:**

ayyyyyyy

1 leading alphabetic character followed by up to 8 alphanumeric characters

**cggtmodid (optional)**

Calling party global title modification identifier.

**Range:**

ayyyyyyy

1 leading alphabetic character followed by up to 8 alphanumeric characters

**cgpc (optional)**ANSI point code with subfields *network indicator-network cluster-network cluster member (ni-nc-ncm)*. The *prefix* subfield indicates a private point code (*prefix-ni-nc-ncm*).**Synonym:**

cgpca

**Range:**

p-, 000-255

Specify a valid value for each subfield of the point code, and separate the subfields with a dash (-).

*prefix—p-*When *chg-sid:pctype=ansi* is specified, *ni = 000* is not valid.When *chg-sid:pctype=ansi* is specified, *nc = 000* is not valid if *ni = 001-005*.When *chg-sid:pctype=ansi* is specified, *nc = 000* is valid if *ni = 006-255*.The point code *000-000-000* is not a valid point code.**cgpci (optional)**ITU international destination point code with subfields *zone-area-id*. The *prefix* subfield indicates a spare point code, private point code, or private and spare point code (*prefix-zone-area-id*).**Range:**

s-, p-, ps-, 0-255

Specify a valid value for each subfield of the point code, and separate the subfields with a dash (-).

*prefix—s-, p-, ps**zone—0-7**area—000-255**id—0-7*The point code *0-000-0* is not a valid point code.**cgpcn (optional)**ITU national point code in the format of a 5-digit number (*nnnnn*); or 2, 3, or 4 numbers (members) separated by dashes (*m1-m2-m3-m4*) as defined by the *chg-stpopts:npcfmti* flexible point code option. A group code must be specified when the ITUDUPPC feature is turned on (*nnnnn-gc, m1-m2-m3-m4-gc*). The *prefix* subfield indicates



a spare point code, private point code, or private and spare point code (*prefix-nnnnn*, *prefix-nnnnn-gc*, *prefix-m1-m2-m3-m4*, *prefix-m1-m2-m3-m4-gc*).

**Range:**

*s*-, *p*-, *ps*-, 0-16383, *aa-zz*

Specify a valid value for each subfield of the point code, and separate the subfields with a dash (-).

*prefix*—*s*-, *p*-, *ps*

*nnnnn*—0-16383

*gc*—*aa-zz*

*m1-m2-m3-m4*—0-14 for each member; values must sum to 14

**cgpcn24 (optional)**

24-bit ITU national point code with subfields *main signaling area-sub signaling area-signaling point* (*msa-ssa-sp*). The *prefix* subfield indicates a private point code (*prefix-msa-ssa-sp*).

**Range:**

*p*-, 000-255

Specify a valid value for each subfield of the point code, and separate the subfields with a dash (-).

*prefix*—*p*

*msa*—000–255

*ssa*—000–255

*sp*—000–255

**cgpcn16 (optional)**

16-bit ITU national point code with subfields *unit number-sub number area-main number area* (*un-sna-mna*). The *prefix* subfield indicates a private point code (*prefix-un-sna-mna*).

**Range:**

*p*--, 000---127

Specify a valid value for each subfield of the point code, and separate the subfields with a dash (-).

*prefix*---*p*

*un*---000---127

*sna*---000---15

*mna*---000---31

**cgpcogmsg (optional)**

The data that is used as the Calling Party Point Code in the outgoing message.

**Range:****cgpcicmsg**

CgPA PC data from the incoming MSU

**dflt**

Default. The standard Global Title Translation process provides the CgPA PC.

**opcicmsg**

OPC data from the incoming MSU

**provcgpc**

provisioned CGPC/CGPCA/CGPCI/CGPCN/CGPCN24 data in the GTT Action

**remove**

CGPC will be removed from the outgoing MSU

**defactid (optional)**

Default Action ID. The Action ID associated with the Forward/SCPVAL/SFTHROT action.

**Range:****disc**

GTT Action ID of type *disc*

**udts**

GTT Action ID of type *udts*

**tcaperr**

GTT Action ID of type *tcaperr*

**fallback**

The MSU is routed using routing data in the incoming MSU when action is  *fwd* .  
When action is set to *scpval/sfthrot*, the MSU is discarded.

**failactid (optional)**

Fail Action ID. The default action that is performed to route the message when the VLR Validation fails on Stateful App.

**Range:**

ayyyyyyy

1 leading alphabetic character followed by 8 alphanumeric characters

The *failactid* parameter can take one of the following values:

- GTT Action ID with a GTT Action of *disc*, *udts* or *tcaperr* (see the *act* parameter). This value must already be defined in the GTT Action table.
- *fallback* -The MSU is discarded.

**Default:**

*fallback*

**fdggtt (optional)**

Forward GTT. The forward GTT Action ID that is to be used to route the MSU.

**Range:**

ayyyyyyy

**hlraddr (optional)**

It is used to address the HLR for the ATI message.

**Range:**

*USECDPA* --- Use the CDPA GTA from the query message

*TCAPPARM* --- GTT translation shall be performed on MAP Parameter. MAP parameter will be used in SCCP CDPA for GTT translation

*FWDACT* --- Route the message to a specified forward node indicated in FWD GTT Action ID

**Default:**  
*USECDPA*

**itcaperr (optional)**

ITU TCAP Error Cause. The reason for discarding the message containing the ITU TCAP portion that is associated with the TCAPERR GTT Action.

**Range:**  
*0 - 255*

**loopset (optional)**

SCCP loopset name. This parameter retrieves action entries that are associated with the specified loopset.

**Range:**  
*ayyyyyyy*  
One alphabetic character followed by up to 7 alphanumeric characters.  
*none* —Action entries with no association to any loopset.

**mapset (optional)**

MAP Set ID. The Mated Application Set ID.

**Range:**  
*1 - 36000, dflt*  
*dflt* —Default MAP set

**mrnset (optional)**

MRN Set ID. The Mated Relay Node Set ID.

**Range:**  
*1 - 3000, dflt*

***dflt***  
Default MRN Set ID

***none***  
The GTT Action table entry with no association to any mrnset.

**off (optional)**

Disables or turns off the specified feature options. A comma-separated list of feature options that are requested to be turned off. Up to 8 feature options can be specified in the list.

**Range:**  
*uimreqd*  
*useicmsg*  
*handlresp*

**on (optional)**

Enables or turns on the specified feature options. A comma-separated list of feature options that are requested to be turned on. Up to 8 feature options can be specified in the list.

**Range:***refcnt**uimreqd**useicmsg**handlresp***pc (optional)**

ANSI point code in the form of *network indicator-network cluster-network cluster member (ni-nc-ncm)*. The value "none" indicates that the Origin Point Code (OPC) field in the message will be used in place of CGPC.

**Synonym:***pca***Range:***p-, 000-255*

Specify a valid value for each subfield of the point code, and separate the subfields with a dash (-).

*prefix—p-*

When *chg-sid:pctype=ansi* is specified, *ni = 000* is not valid.

When *chg-sid:pctype=ansi* is specified, *nc = 000* is not valid if *ni = 001-005*.

When *chg-sid:pctype=ansi* is specified, *nc = 000* is valid if *ni = 006-255*.

The point code *000-000-000* is not a valid point code.

**pci (optional)**

ITU international destination point code with subfields *zone-area-id*. The *prefix* subfield indicates a spare point code, private point code, or private and spare point code (*prefix-zone-area-id*).

**Range:***s-, p-, ps-, 0-255*

Specify a valid value for each subfield of the point code, and separate the subfields with a dash (-).

*prefix—s-, p-, ps**zone—0-7**area—000-255**id—0-7*

The point code *0-000-0* is not a valid point code.

**pcn (optional)**

ITU national point code in the format of a 5-digit number (*nnnnn*); or 2, 3, or 4 numbers (members) separated by dashes (*m1-m2-m3-m4*) as defined by the *chg-stpopts:npcfmti* flexible point code option. A group code must be specified when the ITUDUPPC feature is turned on (*nnnnn-gc*, *m1-m2-m3-m4-gc*). The *prefix* subfield indicates a spare point code, private point code, or private and spare point code (*prefix-nnnnn*, *prefix-nnnnn-gc*, *prefix-m1-m2-m3-m4*, *prefix-m1-m2-m3-m4-gc*).

**Range:***s-, p-, ps-, 0-16383, aa-zz*

Specify a valid value for each subfield of the point code, and separate the subfields with a dash (-).

*prefix—s-, p-, ps**nnnnn—0-16383**gc—aa-zz**m1-m2-m3-m4—0-14* for each member; values must sum to 14**pcn16 (optional)**16-bit ITU national point code with subfields *unit number-sub number area-main number area (un-sna-mna)*. The *prefix* subfield indicates a private point code (*prefix-un-sna-mna*).**Range:***p--, 000---127*

Specify a valid value for each subfield of the point code, and separate the subfields with a dash (-).

*prefix---p**un---000---127**sna---000---15**mna---000---31***pcn24 (optional)**24-bit ITU national point code with subfields *main signaling area-sub signaling area-signaling point (msa-ssa-sp)*. The *prefix* subfield indicates a private point code (*prefix-msa-ssa-sp*).**Range:***p-, 000-255*

Specify a valid value for each subfield of the point code, and separate the subfields with a dash (-).

*prefix—p**msa—000—255**ssa—000—255**sp—000—255***psirescgmodid (optional)**

Calling party global title modification identifier for PSI. The GTMOD ID to be associated with the calling party of a SFAPP GTT Action entry.

**Range:***ayyyyyyy*

1 leading alphabetic character followed by up to 8 alphanumeric characters

**Default:**

None

**ri (optional)**

Routing indicator.

**Range:**

*gt*

*ssn*

**snai (optional)**

The service nature of address indicator.

**Range:**

*ccrndn*

Country code, routing number, and national directory number

*intl*

International number

*Natl*

National significant number

*rnidn*

Routing number prefix and international dialed/directory number

*rnndn*

Routing number prefix and national dialed/directory number

*rnsdn*

Routing number prefix and subscriber dialed/directory number

*Sub*

Subscriber number

**snp (optional)**

The service numbering plan.

**Range:**

*e164*

E.164 numbering plan

*e212*

E.212 numbering plan

*e214*

E.214 numbering plan

**sprm (optional)**

SCCP Parameter. This parameter is used to decide whether the SCCP GTA, NP, and NAI (if GTI=4 and NP/NAI are present) will be picked up from CDPA or CGPA for comparison.

**Range:**

*CDPA*

SCCP CDPA GTA, NP, and NAI (if GTI=4 and NP/NAI are present) will be used for comparison

**CGPA**

SCCP CGPA GTA, NP, and NAI (if GTI=4 and NP/NAI are present) will be used for comparison

**svccerr (optional)**

The action to be taken when the Service triggered by the GTT Action Service fails. The MSU can be processed by either applying the results of the pre-Service GTT, or continuing with the specific Service error processing.

**Range:****SRVC**

Continue with specific service error

**GTT**

Apply the result of pre-GTT service

**Default:**

SRVC

**svcname (optional)**

Service to be applied on the MSU when `act` is set to `svrc`.

**Range:**

*GFLEX, GPORT, SMSMR*

**ssn (optional)**

Subsystem number.

**Range:**

*2 - 255, none*

**tprm (optional)**

TCAP Parameter. This parameter is used to decide whether the MAP digits, NP, and NON (if NP and NON are present) will be picked up from SMRPDA or SMRPOA for comparison.

**Range:****SMRPDA**

MAP digits, NP, and NON (if NP and NON are present) from SMRPDA will be used for comparison

**SMRPOA**

MAP digits, NP, and NON (if NP and NON are present) from SMRPOA will be used for comparison

**udtserr (optional)**

UDTS error cause. This parameter specifies the reason for discarding the message that is associated with UDTs GTT Action.

**Range:**

*0 - 255*

**valtype (optional)**

Validation Type. This parameter is used to decide whether SCCP/TCAP parameter should be used for the validation of the MSU or IR21.xml file data should be used for the validation of the MSU. This parameter can only be set for act=scpval.

**Range:**

*sccptotcap*

*ir21totcap*

**Example**

```
rtrv-gttact:actid=disc1
rtrv-gttact:cggtmodid=idda1
rtrv-gttact:cggtmodid=cggt1:cdgtmodid=cdgt2
rtrv-gttact:defactid=fallback
rtrv-gttact:pcn16=1-14-0
rtrv-gttact:act=srvc
rtrv-gttact:svcname=gflex
rtrv-gttact:tprm=smrpda
rtrv-gttact:hlraddr=usecdpa:failactid=sfapp8
rtrv-gttact:hlraddr=fwdact
rtrv-gttact:hlraddr=tcapparm
rtrv-gttact:atirescgmodid=set1
rtrv-gttact:psirescgmodid=set5
rtrv-gttact:valtype=sccptotcap
```

**Dependencies**

The GTT Action table is corrupt or cannot be found.

The specified GTT Action entry must already exist in the database.

If the Flexible GTT Load Sharing feature is not enabled, then the `mapset` parameter cannot be specified.

The value specified for the `pc/pca/pci/pcn/pcn24/pcn16` and `cgpc/cgpca/cgpci/cgpcn/cgpcn24/cgpcn16` parameters must be a full point code and must have a valid value within the range for each subfield.

The Flexible GTT Load Sharing feature must be enabled before the `mrnset` parameter can be specified.

The `mapset` and `mrnset` parameters cannot be specified together in the command.

A value of *none* or *fallback* cannot be specified for the `actid` parameter.

A value of *disc*, *udts*, *tcaperr*, *scpval*, or *sfapp* must be specified for the `act` parameter before a value of *umreqd* can be specified for the `on` or `off` parameter.



A value of *dup* or *fwd* must be specified for the *act* parameter before the *pc*, *ssn*, *ri*, *mrnset*, *mapset*, *loopset*, *cgpc*, *cgpcogmsg*, *cggtmodid* or *cdgtmodid* parameters can be specified.

A value of *dup*, *fwd*, *scpval*, or *sfthrot* must be specified for the *act* parameter before a value of *useicmsg* can be specified for the *on* or *off* parameter.

The *act=fwd/scpval/sfthrot* parameter must be specified before the *defactid* parameter can be specified.

The *pc*, *ssn*, *ri*, *mrnset*, *mapset*, *loopset*, *cgpc*, *cgpcogmsg*, *defactid*, *tprm*, and *sprm* parameters cannot be specified in the same command as the *atcaperr*, *itcaperr*, or *udtserr* parameters.

Values of *useicmsg* and *uimreqd* cannot be specified for the *on* or *off* parameters in the same command.

If the *actid* parameter is specified, then the *ri*, *pc*, *ssn*, *mrnset*, *mapset*, *loopset*, *on*, *off*, *atcaperr*, *itcaperr*, *udtserr*, *act*, *cgpc*, *cgpcogmsg*, *defactid*, *cggtmodid*, *cdgtmodid*, *snp snai*, *svccerr*, *svcname*, *sprm*, and *tprm* parameters cannot be specified.

The *act=tcaperr* parameter must be specified before the *atcaperr* or *itcaperr* parameter can be specified.

The *act=udts* parameter must be specified before the *udtserr* parameter can be specified.

The *udtserr* and *svccerr* parameters cannot be specified in the same command.

The *atcaperr* and *itcaperr* parameters cannot be specified in the same command.

The *pc*, *ri*, *ssn*, *mrnset*, *mapset*, *loopset*, *cdgtmodid*, *defactid*, *cgpc*, *cgpcogmsg*, and *cggtmodid* parameters cannot be specified in the same command with the *atcaperr*, *itcaperr*, and *udtserr* parameters.

The *svcname*, *snp*, *snai* and *svccerr* parameters can only be specified when *act* is set to *svc*.

The *sprm* and *tprm* parameters can be specified only when *act* is set to *scpval*.

The *scfaddr*, *hlraddr*, *tt*, *failactid* and *fwdggt* parameters can only be specified if action type is *sfapp*.

The point code specified for the *pc/pci/pcn/pcn24/pcn16* and *cgpc/cgpci/cgpcn/cgpcn24/cgpcn16* parameters must be a full point code.

The SCCP Loop Detection feature must be enabled before the *loopset* parameter can be specified.

The value specified for the *loopset* parameter must already exist in the database.

The Loopset table is corrupt or cannot be found.

The value specified for the *cdgtmodid* or *cggtmodid* parameter must already exist in the GTMOD table.

The GTMOD table is corrupt or cannot be found.

The `defactid=none` or `failactid=none` parameter cannot be specified.

The value specified for the `pc/pca/pci/pcn/pcn24/pcn16` and `cgpc/cgpca/cgpci/cgpcn/cgpcn24/cgpcn16` parameters must have the same domain.

The same value cannot be specified for the `on` and `off` parameters.

The specified MAP set must already exist in the MAP table.

The specified MRN set must already exist in the MRN table.

A value of `fwd`, `dup`, or `scpval` must be specified for the `act` parameter before a value of `useicmsg` can be specified for the `on` or `off` parameter.

The value specified for the `atirescgmodid` and `psirescgmodid` parameters must already exist in the GTMOD table.

## Notes

### on/off options

- `uimreqd` —UIM required. Specifies whether a UIM should be generated.
- `useicmsg` —Use Incoming Message. Specifies whether to apply GTT Action data to the message as the message was received (OFF) or after any EPAP or GTT translation/modification data has been applied (ON).
- `handlresp` —Specifies whether the ATI/PSI response will be sent to the SFAPP card or not.

## Output

```
rtrv-gttact:on=refcnt
```

```
tekelecstp 15-05-29 18:21:01 EST EAGLE 46.3.0
```

ACTID	ACTION	ATCAPERR	ITCAPERR	UDTSERR	UIMREQD	REFCNT
act2	disc	---	---	---	off	0
none1	disc	---	---	---	off	0

ACTID	ACTION	PCA	RI	SSN	MRNSET	MAPSET	REFCNT
actdup1	dup	001-001-001	gt	---	DFLT	-----	2
		CDGTMODID = -----			CGGTMODID = -----		
		LOOPSET = None					
		USEICMSG = off			CGPCOGMSG = dflt	CGPCA = ---	
actfwd1	fwd	001-001-001	gt	---	DFLT	-----	2
		CDGTMODID = -----			CGGTMODID = -----		
		LOOPSET = None			DEFACTID = Fallback		
		USEICMSG = off			CGPCOGMSG = dflt	CGPCA = ---	

ACTID	ACTION	PCI	RI	SSN	MRNSET	MAPSET	REFCNT
-------	--------	-----	----	-----	--------	--------	--------

```

      ACTID      ACTION      PCN          RI  SSN MRNSET  MAPSET  REFCNT
-----
-----
      ACTID      ACTION      PCN24        RI  SSN MRNSET  MAPSET  REFCNT
-----
-----
      ACTID      ACTION      VALTYPE      NDGT   UIMREQD  USEICMSG
DEFACTID REFCNT
-----
-----
      scpval1    scpval    ir21totcap  ALL     off     off
DISCARD  0

      scpval2    scpval    sccptotcap  15     off     off
DISCARD  0
          TPRM = smrpda  SPRM = cdpa

```

GTT-ACT table is (2 of 2000) 1% full.

;

rtrv-gttact:cggmodid=set1

tekelecstp 10-02-04 18:21:01 EST EAGLE 42.0.0

```

      ACTID      ACTION PCI          RI  SSN MRNSET  MAPSET
-----
-----
      actdup2    DUP      002-002-002    GT  ---  2000    -----
          CDGTMODID = set2      CGGTMODID = set1

      ACTID      ACTION PCN24        RI  SSN MRNSET  MAPSET
-----
-----
      actdup6    DUP      111-222-333    SSN 100  ----  3000
          CDGTMODID = id9      CGGTMODID = set1

```

GTT Action table is (8 of 2000) 1% full

;

rtrv-gttact:pcn16=1-2-3

tekelecstp 13-07-02 15:04:36 EST 45.0.0-64.69.0

```
rtrv-gttact:pcn16=1-2-3
Command entered at terminal #4.
```

ACTID	ACTION	PCN16	RI	SSN	MRNSET	MAPSET
actfwd5	fwd	001-02-03	gt	---	DFLT	-----
		CDGTMODID = -----	CGGTMODID = -----			
DEFACTID = Fallback						
USEICMSG = off		CGPCOGMSG = dflt		CGPCN16 = ---		

```
GTT-ACT table is (1 of 2000) 1% full.
```

```
;
```

```
rtrv-gttact:svrname=smsmr:act=svrc
```

```
eagle1 13-10-27 18:10:25 EST EAGLE 46.0.0
```

ACTID	ACTION	SRVCNAME	SRVCERR	SNP	SNAI
actsvrc1	svrc	GFLEX	SRVC	E212	SUB
actsvrc4	svrc	GPORT	SRVC	E164	INTL
actsvrc5	svrc	GPORT	GTT	E164	RNNDN
actsvrc6	svrc	SMSMR	SRVC	E164	INTL
actsvrc7	svrc	SMSMR	GTT	E164	RNNDN

```
;
```

```
rtrv-gttact:act=scpval
```

```
tekelecstp 15-05-29 18:21:01 EST EAGLE 46.9.0
```

ACTID	ACTION	VALTYPE	NDGT	UIMREQD	USEICMSG
DEFACID					
scpval1	scpval	ir21totcap	ALL	off	off
DISCARD					DISCARD
scpval2	scpval	sccptotcap	15	off	off
DISCARD					DISCARD
TPRM = smrpda SPRM = cdpa					

```
GTT-ACT table is (2 of 2000) 1% full.
```

```
;
```

```
rtrv-gttact:act=sfthrot
```

```
tekelecstp 15-05-29 18:21:01 EST EAGLE 46.3.0
```

ACTID	ACTION	THRESHOLD	BURSTS	DEFACTID
act1	sfthrot	1	0	disc1
act2	sfthrot	1	2	disc2
act3	sfthrot	1	1	disc3
act4	sfthrot	20	0	disc4

GTT-ACT table is (4 of 2000) 1% full.

;

rtrv-gttact:hlraddr=usecdpa

tekelecstp 17-11-22 14:55:02 EST EAGLE 46.5.1.5.0-73.2.0  
 rtrv-gttact:hlraddr=usecdpa  
 Command entered at terminal #17.

;

Command Accepted - Processing

tekelecstp 17-11-22 14:55:02 EST EAGLE 46.5.1.5.0-73.2.0

ACTID	ACTION	DEFACTID	USEICMSG	NDGT	UIMREQD
sfapp1	sfapp	FALLBACK	off	ALL	off
	SCFADDR = 18			FAILACTID = DISCARD	
	HLRADDR = USECDPA				
sfapp8	sfapp	FALLBACK	off	ALL	off
	SCFADDR = 19			FAILACTID = DISCARD	
	HLRADDR = USECDPA				
sfapp9	sfapp	FALLBACK	off	ALL	off
	SCFADDR = 19			FAILACTID = DISCARD	
	HLRADDR = USECDPA				
sfapp10	sfapp	FALLBACK	off	ALL	off
	SCFADDR = 19			FAILACTID = DISCARD	
	HLRADDR = USECDPA				
sfapp13	sfapp	FALLBACK	off	ALL	off
	SCFADDR = 16			FAILACTID = DISCARD	
	HLRADDR = USECDPA				

GTT-ACT table is (11 of 2000) 1% full.

;

Command Executed

rtrv-gttact:failactid=fallback

tekelecstp 17-11-22 14:56:30 EST EAGLE 46.5.1.5.0-73.2.0  
 rtrv-gttact:failactid=fallback  
 Command entered at terminal #17.

;

Command Accepted - Processing

tekelecstp 17-11-22 14:56:30 EST EAGLE 46.5.1.5.0-73.2.0

ACTID	ACTION	DEFACTID	USEICMSG	NDGT	UIMREQD
-------	--------	----------	----------	------	---------

```

-----
sfapp1      sfapp      FALLBACK  off      ALL      off
            SCFADDR = 18                FAILACTID = DISCARD
            HLRADDR = USECDPA
sfapp8      sfapp      FALLBACK  off      ALL      off
            SCFADDR = 19                FAILACTID = DISCARD
            HLRADDR = USECDPA
sfapp9      sfapp      FALLBACK  off      ALL      off
            SCFADDR = 19                FAILACTID = DISCARD
            HLRADDR = USECDPA
sfapp10     sfapp      FALLBACK  off      ALL      off
            SCFADDR = 19                FAILACTID = DISCARD
            HLRADDR = USECDPA
sfapp13     sfapp      FALLBACK  off      ALL      off
            SCFADDR = 16                FAILACTID = DISCARD
            HLRADDR = USECDPA

```

GTT-ACT table is (11 of 2000) 1% full.

```

;
Command Executed

```

```
rtrv-gttact:atirescgmodid=set1
```

```

tekelecstp 18-05-07 10:48:35 EST  EAGLE 46.7.0.0.0-74.5.0
rtrv-gttact:atirescgmodid=set1
Command entered at terminal #4.

```

```

ACTID      ACTION      DEFACTID      NDGT      UIMREQD
-----
sfapp10     sfapp      FALLBACK      ALL      off
            SCFADDR = 19                FAILACTID = DISCARD
            HLRADDR = USECDPA
            ATIRESCGMODID = set1      PSIRESCGMODID = -----
            HANDLRESP = ON

```

GTT-ACT table is (3 of 2000) 1% full.

```

;
rtrv-gttact:psirescgmodid=set5

```

```

tekelecstp 18-05-07 10:48:35 EST  EAGLE 46.7.0.0.0-74.5.0
rtrv-gttact:atirescgmodid=set5
Command entered at terminal #4.

```

```

ACTID      ACTION      DEFACTID      NDGT      UIMREQD
-----
sfapp10     sfapp      FALLBACK      ALL      off
            SCFADDR = 19                FAILACTID = DISCARD

```

```

HLRADDR = USECDPA
ATIRESCGMODID = ----- PSIRESCGMODID = set5
HANDLRESP = ON

GTT-ACT table is (3 of 2000) 1% full.

;

rtrv-gttact:valtype=ir21totcap

tklcl1131001 20-01-29 02:18:02 HST EAGLE 46.9

ACTID      ACTION  VALTYPE  NDGT  UIMREQD  USEICMSG
DEFACTID
-----
scpvall    scpval   ir21totcap ALL    off       off
DISCARD

GTT-ACT table is (2 of 2000) 1% full.

;

```

**Related Topics**

- [chg-gttact](#)
- [dlt-gttact](#)
- [ent-gttact](#)

## rtrv-gttapath

Use this command to retrieve a GTT Action path entry. A GTT Action path consists of pairs of "setname + value" for Opcode/CgGTA/CdGTA. Each "setname + value" pair must already be defined in the GTT translation table.

**Parameters****acn (optional)**

Application context name. The ITU TCAP *acn* field in the incoming MSU.

**Range:**

0 - 255, none

none—there is no ITU TCAP *acn* field in the incoming MSU

**cdgta (optional)**

Called Party Global Title Address.

**Range:**

1-21 digits

If the Hex Digit Support for GTT feature is not enabled, the range is 1 - 21 decimal digits; valid digits are 0-9.

If the Hex Digit Support for GTT feature is enabled and on, the range is 1 - 21 hexadecimal digits; valid digits are 0-9, a-f, A-F.

**cdgttsn (optional)**

GTT set name (CDPA type).

**Range:**

ayyyyyyy

1 leading alphabetic and up to 8 following alphanumeric characters

**cggta (optional)**

Calling Party Global Title Address.

**Range:**

1-21 digits

If the Hex Digit Support for GTT feature is not enabled, the range is 1 - 21 decimal digits; valid digits are 0-9.

If the Hex Digit Support for GTT feature is enabled and on, the range is 1 - 21 hexadecimal digits; valid digits are 0-9, a-f, A-F.

**cggtsn (optional)**

GTT set name (CGPA type).

**Range:**

ayyyyyyy

1 leading alphabetic and up to 8 following alphanumeric characters.

**family (optional)**

The ANSI TCAP*family* field in the incoming MSU.

**Range:**

0 - 255, \*, none

*none* —there is no value in the ANSI TCAP *family* field in the incoming MSU

**gttprn (optional)**

GTT Path name.

**Range:**

ayyyy

1 leading alphabetic character and up to 4 following alphanumeric characters.

**opcode (optional)**

The TCAP*opcode* field in the incoming MSU.

**Range:**

0 - 255, \*, none

*none* —there is no value in the TCAP *opcode* field in the incoming MSU

**opgttsn (optional)**

GTT set name (Opcode type).



**Range:***ayyyyyyy*

1 leading alphabetic and up to 8 following alphanumeric characters.

**pkgtype (optional)**

The ANSI and ITU TCAP package type.

**Range:*****ituuni***

ITU unidirectional

***qwp***

Query with Permission

***qwop***

Query without Permission

***resp***

Response

***cwp***

Conversation with Permission

***cwop***

Conversation without Permission

***any***

Wildcard value

***bgn***

Begin

***end***

End

***cnt***

Continue

***ituabort***

ITU abort

***ansiabort***

ANSI abort

***ansiuni***

ANSI unidirectional

ANSI TCAP Package Types—*ansiuni*, *qwp*, *qwop*, *resp*, *cwp*, *cwop*, *ansiabort*,*any*ITU TCAP Package Types—*bgn*, *ituabort*, *ituuni*, *any*, *end*, *cnt***Example**

```
rtrv-  
gttapath:opgttsn=opsn2:pkgtype=ansiuni:opcode=124:family=2:cgg  
tsn=cgsn3:cggta=987654:cdgttsn=cdsn1:cdgta=123456
```

```
rtrv-gttapath:opgttsn=opsn2:pkgtype=ansiuni:opcode=124:family=2
rtrv-gttapath
```

### Dependencies

The `acn` and `family` parameters cannot be specified together in the command.

The GTA table is corrupt or cannot be found.

The GTT DBMM table is corrupt or cannot be found.

The GTT Action - DISCARD, GTT Action - FORWARD, or GTT Action - DUPLICATE feature must be enabled before this command can be entered.

The GTT Set table must be accessible.

A value of *none* cannot be specified for the `opgttsn`, `cgttsn`, and `cdgttsn` parameter(s).

The `opcode`, `pkgtype`, and `family` parameters must be specified together for ANSI TCAP translations. The `opcode`, `pkgtype`, and `acn` parameters must be specified together for ITU TCAP translations.

If the `family` parameter is specified, then a value of *ansiuni*, *qwp*, *qwop*, *resp*, *cwp*, *cwop*, *ansiabort*, or *any* must be specified for the `pkgtype` parameter.

If the `acn` parameter is specified, then a value of *bgn*, *ituabort*, *ituuni*, *any*, *end*, or *cnt* must be specified for the `pkgtype` parameter.

If the `pkgtype=ituabort`, then a value of *none* must be specified for the `acn` and `opcode` parameters.

If the `pkgtype=ansiabort` is specified then a value of *none* must be specified for the `family` and `opcode` parameters.

If the `family` and `opcode` parameters are specified in the command, then either both parameters must have a value of *none* or neither parameter can have a value of *none*.

The GTT Action Path table is corrupt or cannot be found.

At least one GTT set-value combination must be specified.

The value specified for the `gttpn` parameter must already exist in the database.

Both Path name and set-value combination(s) cannot be specified together.

The value specified for the `gttpn` parameter cannot be a reserved word.

### Output

```
rtrv-gttapath:gttpn=path3
```

```
tekelecstp 10-02-04 18:29:41 EST EAGLE 42.0.0
```

GTPN	OPGTTSN	CGGTTSN	CDGTTSN
path3	opsn2	cgsn3	cdsn1
	OPCODE = 124	PKGTYPE = ansiuni	FAMILY = 2
	CGGTA = 987654		ECGGTA = 999999

```
CDGTA = 123456                                ECDGTA = 234567

GTT Action Path table is (3 of 10000) 1% full

Command Completed.
;

rtrv-gttapath:opgttsn=opsn2:pkgtype=ansiuni:opcode=124:family=2
```

```
tekelecstp 10-02-04 18:29:41 EST EAGLE 42.0.0
```

GTPPN	OPGTTSN	CGGTTSN	CDGTTSN
-----			
path2	opsn2	cgsn2	-----
	OPCODE = 124	PKGTYPE = ansiuni	FAMILY = 2
	CGGTA = 45673		ECGGTA = 45673
path3	opsn2	cgsn3	cdsn1
	OPCODE = 124	PKGTYPE = ansiuni	FAMILY = 2
	CGGTA = 987654		ECGGTA = 999999
	CDGTA = 123456		ECDGTA = 234567

```
GTT Action Path table is (3 of 10000) 1% full
```

```
Command Completed.
```

```
;
```

```
rtrv-gttapath
```

```
tekelecstp 10-02-04 18:29:41 EST EAGLE 42.0.0
```

GTPPN	OPGTTSN	CGGTTSN	CDGTTSN
-----			
path1	opsn1	-----	cdsn1
	OPCODE = 123	PKGTYPE = ituuni	ACN =
111-111-111-111-111-111-111			
	CGGTA = 7654		ECGGTA = 7654
path2	opsn2	cgsn2	-----
	OPCODE = 124	PKGTYPE = ansiuni	FAMILY = 2
	CGGTA = 45673		ECGGTA = 45673
path3	opsn2	cgsn3	cdsn1
	OPCODE = 124	PKGTYPE = ansiuni	FAMILY = 2
	CGGTA = 987654		ECGGTA = 999999
	CDGTA = 123456		ECDGTA = 234567

```
GTT Action Path table is (3 of 10000) 1% full
```

```
Command Completed.
```

```
;
```

**Related Topics**

- [chg-gttapath](#)
- [dlt-gttapath](#)
- [ent-gttapath](#)

## rtrv-gttaset

Use this command to display entries from the Global Title Translations (GTT) Action Set table.

**Parameters** **Note:**

Definitions for the feature options specified by the `on` and `off` parameters are located in the Notes section.

**actid1 (optional)**

GTT Action ID 1. This parameter specifies the first action ID associated with the GTT action set.

**Range:**

ayyyyyyy

1 leading alphabetic character and up to 8 following alphanumeric characters

**actid2 (optional)**

GTT Action ID 2. This parameter specifies the second action ID associated with the GTT action set.

**Range:**

ayyyyyyy

1 leading alphabetic character and up to 8 following alphanumeric characters

**actid3 (optional)**

GTT Action ID 3. This parameter specifies the third action ID associated with the GTT action set.

**Range:**

ayyyyyyy

1 leading alphabetic character and up to 8 following alphanumeric characters

**actid4 (optional)**

GTT Action ID 4. This parameter specifies the fourth action ID associated with the GTT action set.

**Range:**

ayyyyyyy

1 leading alphabetic character and up to 8 following alphanumeric characters

**actid5 (optional)**

GTT Action ID 5. This parameter specifies the fifth action ID associated with the GTT action set.

**Range:**

ayyyyyyy

1 leading alphabetic character and up to 8 following alphanumeric characters

**actid6 (optional)**

GTT Action ID 6. This parameter specifies the sixth action ID associated with the GTT action set.

**Range:**

ayyyyyyy

1 leading alphabetic character and up to 8 following alphanumeric characters

**actsn (optional)**

GTT Action Set Name.

**Range:**

ayyyyyyy

1 leading alphabetic character and up to 8 following alphanumeric characters

**off (optional)**

Disables or turns off the specified feature options. This parameter specifies a comma-separated list of feature options that are requested to be turned off. Up to 8 feature options can be specified in the list.

**Range:**

*testmode*

**on (optional)**

Enables or turns on the specified feature options. This parameter specifies a comma-separated list of feature options that are requested to be turned on. Up to 8 feature options can be specified in the list.

**Range:**

*testmode*

*refcnt*

**Example**

```
rtrv-gttaset:actid1=disc1
```

```
rtrv-gttaset:actsn=asetdisc1:on=refcnt
```

```
rtrv-gttaset:on=testmode
```

**Dependencies**

The GTT Action Set table is corrupt or cannot be found.

The specified GTT Action Set must already exist in the database.

The `actsn=none` parameter cannot be specified.

If the `actsn` parameter is specified, then the `on=refcnt` parameter is the only other parameter that can be specified.

A value of `fallback` or `none` cannot be specified for the `actid1/actid2/actid3/actid4/actid5/actid6` parameters.

The EGTT feature must be on before this command can be entered.

The action ID specified by the `actid1/actid2/actid3/actid4/actid5/actid6` parameter(s) must already exist in the GTT Action table.

The `actid1/actid2/actid3/actid4/actid5/actid6` parameters must each specify a unique GTT Action ID in the command.

Only one Action ID with an action of `disc`, `udts`, `tcaperr` or `srvc` can be specified.

If an Action ID with an act of `fwd` is specified, then no other Action ID in the Action Set with an act of `disc`, `udts`, `tcaperr`, `fwd` or `srvc` can be specified.

If an Action ID associated with an action of `srvc` is specified, then no other Action ID in the same Action Set can be associated with an act of `fwd`, `disc`, `udts`, `tcaperr`, or `srvc`.

If 5 Action IDs with an act of `dup` are specified then the remaining Action ID with an act of `dup` cannot be specified.

The same value cannot be specified for the `on` and `off` parameters.

## Notes

When only the `actidX` (where X=1, 2, 3, 4, 5, 6) parameter is specified, and its value matches any action set, then all such matches will be displayed.

## on/off options

- `testmode` —Invokes a field-safe Test Tool in order to debug the GTT Action Set rules.
- `refcnt` —Reference Count. Displays the number of GTTs that reference the GTT Action Set. This feature option is ON only.

## Output

```
rtrv-gttaset
```

```

tekelecstp 10-02-04 18:21:01 EST EAGLE 42.0.0
ACTSN      REFCNT    TEST  ActIds
          MODE
-----
aset1      1         on   dup1    (DUP) , dup2    (DUP) , dup3
(DUP) ,
          disc1    (DISC) , -----, -----
aset2      5         off  dup2    (DUP) , dup1    (DUP) , -----,
-----, -----, -----
aset3      10        on   fwd1    FWD) , dup4    (DUP) , -----,
-----, -----, -----
aset4      0         off  udts1   (UDTS) , -----, -----,
-----, -----, -----

```

```

-----,-----,-----
aset5      0      off  -----,tcaperr1 (TCAPERR),-----,
-----,-----,-----

GTT Action Set table is (5 of 20000) 1% full

;

```

```
rtrv-gttaset:actid2=disc2
```

```

tekelecstp 14-03-13 10:53:02 EST  EAGLE 46.0.0
ACTSN      TEST  ActIds
          MODE
-----
aset3      off  -----,disc2 (DISC),-----,
-----,-----,-----
aset4      off  disc2 (DISC),-----,-----,
-----,-----,-----
aset6      off  -----,-----,-----,
-----,-----,disc2 (DISC)

```

```
GTT-ASET table is (3 of 20000) 1% full.
```

```
;
```

```
rtrv-gttaset
```

```

tekelecstp 13-10-28 17:34:05 EST  46.0.0
ACTSN  REFCNT  TEST  ActIds
          MODE
-----
actn1  2      off  srvcl (SRVC),-----,-----,
-----,-----,-----,

```

```
GTT-ASET table is (1 of 20000) 1% full.
```

```
;
```

### Related Topics

- [chg-gttaset](#)
- [dlt-gttaset](#)
- [ent-gttaset](#)

## rtrv-gttset

Use this command to display a list of administered global title selector combinations required for a global title entry. The list can be filtered by using various parameter combinations.

### Note:

If the EGTT feature is turned on, then the GTT Selector (`ent/chg/dlt/rtrvgttset`), GTT Set (`ent/dlt/rtrv-gttset`), and GTA (`ent/chg/dlt/rtrvgta`) commands replace the Translation Type (`ent/dlt/rtrv-tt`) and Global Title Translation (`ent/chg/dlt/rtrv-gtt`) commands. It is not recommended to run `ent/dlt/rtrv-tt & ent/chg/dlt/rtrv-gtt` commands as it may cause the advance GTA fields of GTT entry to be reset to the default values.

### Parameters

### Note:

The nature of address indicator parameters (`naiv` or `nai`) can be specified using a mnemonic or an explicit value. Either value can be specified: however, both values cannot be specified at the same time for the same parameter. [Table 58: NAIV/NAI Mapping](#) shows the mapping between the `naiv` and the `nai` parameter values.

### Note:

The numbering plan parameters (`npv` or `np`) can be specified using a mnemonic or an explicit value. Either value can be specified: however, both values cannot be specified at the same time for the same parameter. [Table 59: NPV/NP Mapping](#) shows the mapping between the `npv` and `np` parameter values.

#### **cdgtasn (optional)**

CdPA GTA GTT set name.

#### **Range:**

ayyyyyyy

1 leading alphabetic character and up to 8 following alphanumeric characters.

#### **cdgttsn (optional)**

CdPA GTT set.

#### **Range:**

ayyyyyyy

1 leading alphabetic and up to 8 following alphanumeric characters.

#### **cggtasn (optional)**

CgPA GTA GTT set name.



**Range:***ayyyyyyy*

1 leading alphabetic character and up to 8 following alphanumeric characters.

**cggttsn (optional)**

CgPA GTT set.

**Range:***ayyyyyyy*

1 leading alphabetic and up to 8 following alphanumeric characters.

**cgpcsn (optional)**

CgPA PC GTT set name.

**Range:***ayyyyyyy*

1 leading alphabetic character and up to 8 following alphanumeric characters.

**cgssn (optional)**

CgPA subsystem number.

**Range:***0 - 255***eaglegen (optional)**

This parameter specifies whether the selector is used by EAGLE generated messages.

**Range:****yes**

The selector is used by EAGLE generated messages

**gti/gtia/gtii/gtin/gtin24/gtiis/gtins/gtin16 (optional)**

Global title indicator.

For all EGTT selector commands, the domain is defined as GTI and GTIA (ANSI), GTII (ITU international), GTIN (ITU national), GTIN24 (24-bit ITU national), GTIIS (ITU international spare), and GTINS (ITU national spare) and GTIN16 (16-bit ITU National).

For the selector commands, GTI and GTIA are equivalent. GTT selectors can be provisioned for the same translation type (TT) with different ITU domains. For example, if an entry with *gtii=2* and *tt=4* already exists, an entry with *gtin=2* and *tt=4* can be specified.**Range:***0, 2, 4*Supported value for ANSI: *gti=0, 2* and *gtia=0, 2*Supported values for ITU: *gtii/gtin/gtin24/gtiis/gtins/gtin16=0, 2, 4***Default:**display all *gti(x)* parameter values**gttsn (optional)**

GTT set name. A GTT set is an entity to which global title addresses and selectors are assigned.

**Range:**

ayyyyyyy

1 leading alphabetic and up to 8 following alphanumeric characters.

**Default:**

Display all

**lsn (optional)**

Linkset name.

**Range:**

ayyyyyyy

1 alphabetic character followed by up to 9 alphanumeric characters

**msgtype (optional)**

SCCP message type.

Allow one or more SCCP message types (UDT/UDTS/XUDT/XUDTS) for every GTT Selector entry. This will help in screening different message types differently.

**Range:**

*sub*

*u*

*us*

*x*

*xs*

*all*

**Default**

*all*

**nai (optional)**

Nature of Address indicator.

**Range:**

*sub*

*rsvd*

*natl*

*intl*

*dflt*

**Default:**

Display all

**naiv (optional)**

Nature of Address indicator value.

**Range:**

*0 - 127*

**Default:**

Display all

**np (optional)**

Numbering Plan.

**Range:**

*e164*

*generic*

*x121*

*f69*

*e210*

*e212*

*e214*

*private*

*dflt*

**Default:**

Display all

**npv (optional)**

Numbering Plan value.

**Range:**

*0 - 15*

**Default:**

Display all

**ovrlapd (optional)**

Overlapped GTT Selectors.

**Range:**

*yes*

**Default:**

*no*

**selid (optional)**

Selector ID.

**Range:**

*0 - 65534, none*

**tt (optional)**

Translation type.

**Range:**

0 - 255

**Default:**

Display all

**Example**

```

rtrv-gtttsel
rtrv-gtttsel:gtii=2
rtrv-gtttsel:tt=0:np=e164
rtrv-gtttsel:gti=2:tt=10
rtrv-gtttsel:gttsn=setint000

rtrv-
gttsel:gtia=2:tt=21:cggtsn=setcgpc:cdgtsn=setcdgta:cgssn=20:selid=
1: lsn=ls10

rtrv-gtttsel:gtia=2:tt=2:lsn=ls1010
rtrv-gtttsel:gtia=2:eaglegen=yes
rtrv-gtttsel:cdgtsn=setdpc
rtrv-gtttsel:ovrlapd=yes
rtrv-gtttsel:gtin16=2
rtrv-gtttsel:msgtype=u
rtrv-gtttsel:msgtype=u,us

```

**Dependencies**

The EGTT feature must be turned on before this command can be entered.

Only entries that exactly match all specified parameters will be displayed. If no match is found, the following message is displayed in the Scroll Area of the terminal: "No GTT Selectors matching the specified criteria were found."

The `np` and `npv` parameters cannot be specified together in the same command.

The `nai` and `naiv` parameters cannot be specified together in the same command.

The `gti/gtia=4`, `gti(x)=1`, and `gti(x)=3` parameters cannot be specified.

If the `gti/gtia/gtii/gtin/gtin24/gtiis/gtins/gtin16=2` parameter is specified, then the `np/npv` and `nai/naiv` parameters cannot be specified.

If a full GTT selector key is specified by the `gti(x)`, `tt`, `np/npv`, `nai/naiv`, `cgssn`, `selid`, and `lsn` parameters, then the GTT set specified by the `cgpcsn`, `cggtasn`, or `cggtsn` parameters cannot be specified.

The OBSR feature must be enabled before the `cggtasn`, `cgpcsn`, `cgssn`, or `cdgtasn` parameters can be specified.

The GTT set specified by the `cggtasn` or `cgpcsn` parameter must exist in the database before it is assigned to a GTT selector.

The set type of the `cggtasn` or `cgpcsn` parameter must match the set type of the corresponding entry in the GTT set table. For example, the `cggtasn` parameter should have a set type of `cggt`, and the `cgpcsn` parameter should have a set type of `cgpc`.

The SSNSELID table must be accessible.

The FLOBR feature must be turned on before the `lsn`, `eaglegen`, `cdgttsn`, or `cggttsn` parameter can be specified.

If the `eaglegen=yes` parameter is specified, then the `msgtype`, `lsn`, `selid`, `gttsn`, `cdgtasn`, `cgssn`, `cggttsn`, `cggtasn`, and `cgpcsn` parameters cannot be specified.

The value specified for the `cdgtasn` or `gttsn` parameter must match the name of an existing GTT set.

The GTT set specified by the `cdgtasn` or `gttsn` parameter must have a set type of `cdgt` (see the `ent-gttset` command).

If the OBSR feature is enabled or the FLOBR feature is turned on, then the `gttsn` parameter cannot be specified.

The GTT Set table is corrupt or cannot be found.

The GTT Selector table is corrupt or cannot be found.

The GTTDBMM table is corrupt or cannot be found.

The linkset specified by the `lsn` parameter must already exist in the Linkset table.

The CdPA GTT Set specified by the `gttsn`, `cdgtasn`, or `cdgttsn` parameter must already exist in the GTT Set table.

A value of `dflt` must be specified for the `np` and `nai` parameters, or neither value can be `dflt`.

The Linkset table is corrupt or cannot be found.

If a full GTT selector key is specified by the `gti(x)`, `tt`, `np/npv`, `nai/naiv`, `selid`, and `lsn` parameters, then the GTT set specified by the `gttsn`, `cdgtasn`, or `cdgttsn` parameters cannot be specified.

If the `lsn` parameter is specified, then the `cdgttsn` or `cggttsn` parameter must be specified.

The `cggtasn`, `cgpcsn`, and `cggttsn` parameters cannot be specified together in the command.

The `gttsn`, `cdgtasn`, and `cdgttsn` parameters cannot be specified together in the command.

If the `gttsn`, `cdgttsn`, or `cdgtasn` parameter is specified, then the `cgssn` parameter cannot be specified.

If the `eaglegen=yes` parameter is specified, then the `lsn`, `selid`, `gttsn`, `cdgtasn`, `cgssn`, `cggttsn`, `cggtasn`, or `cgpcsn` parameters cannot be specified.

If the FLOBR feature is turned on, then the `cdgtasn`, `cggtasn`, and `cgpcsn` parameters cannot be specified.

If a value of `dflt` is specified for the `np` and `nai` parameters, then the `cggtasn`, `cgpcsn`, `cgssn`, `selid`, `lsn`, `cggttsn`, and `eaglegen` parameters cannot be specified.

A value of `none` cannot be specified for the `gttsn`, `cdgtasn`, `cdgttsn`, `cggttsn`, `cggtasn`, and `cgpcsn` parameters.

If the `gti(x)=0` parameter is specified, then the `eaglegen`, `tt`, `np/npv`, and `nai/naiV` parameters cannot be specified.

## Notes

There is no J7 FAK dependency on the GTIA/GTIN16/GTIN24 parameters. The command can be entered successfully whether the J7 FAK is enabled or not enabled.

GTT Selector entries configured using GTIN24/GTIN16 parameters shall be treated as ITU-N24 entries if the J7 FAK is disabled and shall be treated as ITU-N16 entries if the J7 FAK is enabled.

Also, if the J7 Support feature is enabled, the `rtrv-gttssel` output displays the GTIN16 header and if the J7 feature is not enabled, the `rtrv-gttssel` output displays the GTIN24 header.

When `msgtype` is specified in the `rtrv-gttssel` command, the best match for the specified `msgtype` is shown in the output. For example, say there are two GTT Selector entries provisioned with `msgtype=u`, `us` and `msgtype=us` for different GTI(x), TT, NP and NAI combination. The command `rtrv-gttssel:msgtype=us` will display both selectors in the output.

## Output

This example retrieves all GTT selectors when EGTT is ON:

```
rtrv-gttssel
```

```
tekelecstp 10-04-15 13:54:13 EST EAGLE 42.0.0
GTIA   TT   NP   NAI  SELID GTTSN
2      2    --   --- none setans002
2      5    --   --- none setans005

GTII   TT   NP   NAI  SELID GTTSN
2      4    --   --- none setint004
4      4    dflt dflt none setint004

GTIN   TT   NP   NAI  SELID GTTSN
2      6    --   --- none setnat006
4      6    dflt dflt none setnat006

GTIN24 TT   NP   NAI  SELID GTTSN

GTIIS  TT   NP   NAI  SELID GTTSN
```

```

2      10    --      --- none  setins010
4      10    dflt    dflt none  setins010

GTINS  TT    NP      NAI  SELID GTTSN
;

```

This example retrieves all GTT Selectors when the OBSR feature is enabled or the FLOBR feature is turned on:

```
rtrv-gttset
```

```

sccprte 10-04-15 14:31:52 EST EAGLE 42.0.0
GTI          CG          CDPA          CGPA
ANSI TT NP      NAI  SSN SELID LSN      GTTSET      GTTSET
2      5  --      --- any none  lsa03      opc1      (opc )
cgssn2      (cgssn)
2      5  --      --- 202 1234 any      -----      (--- )
cggtal1      (cggtal)
2      5  --      --- any none  any      cdgtal1      (cdgta)
cggtal1      (cggtal)
2      15 --      --- --- none  Eagle-Gen cdgtal2      (cdgta)
-----      (--- )
2      15 --      --- 202 1234 lsa02      -----      (--- )
cgssn1      (cgssn)
2      101 --      --- --- none  any      setans101(cdgta)
-----      (--- )
2      102 --      --- --- none  any      a102      (cdgta)
-----      (--- )
2      202 --      --- --- none  any      a102      (cdgta)
-----      (--- )

GTI          CG          CDPA          CGPA
INTL TT NP      NAI  SSN SELID LSN      GTTSET      GTTSET
2      17 --      --- --- none  Eagle-Gen icdgtal1      (cdgta)
-----      (--- )
2      101 --      --- --- none  any      setint101(cdgta)
-----      (--- )
2      102 --      --- --- none  any      int102      (cdgta)
-----      (--- )
2      222 --      --- --- none  any      int102      (cdgta)
-----      (--- )
4      101 dflt    dflt --- none  any      setint101(cdgta)
-----      (--- )
4      102 dflt    dflt --- none  any      int102      (cdgta)
-----      (--- )
4      222 dflt    dflt --- none  any      int102      (cdgta)
-----      (--- )
4      253 11      126 102 5678 any      -----      (--- )
icgpc2      (cgpc )
4      253 11      15  any 5678 lsint02      icgssn2      (cgssn)
iopc2      (opc )

GTI          CG          CDPA          CGPA
NATL TT NP      NAI  SSN SELID LSN      GTTSET      GTTSET

```

```

    2    103 --      --- --- none any      setnat103(cdgta) -----
(--- )
    2    104 --      --- --- none any      n104      (cdgta) -----
(--- )
    2    204 --      --- --- none any      n104      (cdgta) -----
(--- )
    4    18  f69    5    --- none Eagle-Gen icdgta1 (cdgta) -----
(--- )
    4    103 dflt   dflt --- none any      setnat103(cdgta) -----
(--- )
    4    104 dflt   dflt --- none any      n104      (cdgta) -----
(--- )
    4    204 dflt   dflt --- none any      n104      (cdgta) -----
(--- )

      GTI                CG                CDDPA                CGPA
      N24 TT NP          NAI SSN SELID LSN      GTTSET                GTTSET
    2    2  --          --- --- none any      n24      (cdgta) -----
(--- )
    2    124 --        --- --- none any      n24      (cdgta) -----
(--- )
    2    224 --        --- --- none any      set24n224(cdgta) -----
(--- )
    4    2  dflt       dflt --- none any      n24      (cdgta) -----
(--- )
    4    19  f69    5    --- none Eagle-Gen icdgta1 (cdgta) -----
(--- )
    4    124 dflt     dflt --- none any      n24      (cdgta) -----
(--- )
    4    224 dflt     dflt --- none any      set24n224(cdgta) -----
(--- )

      GTI                CG                CDDPA                CGPA
      INTS TT NP        NAI SSN SELID LSN      GTTSET                GTTSET
    2    5  --          --- --- none any      setins005(cdgta) -----
(--- )
    2    7  --          --- --- none any      ituis7   (cdgta) -----
(--- )
    4    5  dflt       dflt --- none any      setins005(cdgta) -----
(--- )
    4    7  dflt       dflt --- none any      ituis7   (cdgta) -----
(--- )

      GTI                CG                CDDPA                CGPA
      NATS TT NP        NAI SSN SELID LSN      GTTSET                GTTSET
    2    5  --          --- --- none any      setnas005(cdgta) -----
(--- )
    2    7  --          --- --- none any      ituns7   (cdgta) -----
(--- )
    4    5  dflt       dflt --- none any      setnas005(cdgta) -----
(--- )
    4    7  dflt       dflt --- none any      ituns7   (cdgta) -----
(--- )
;

```



The following example illustrates rtrv-gttset output after introduction of MSGTYPE as a GTT Selector key:

```
rtrv-gttset
```

```
tekelecstp 17-04-15 14:31:52 EST EAGLE 46.6.0
      GTI                      CG                      CDPA
CGPA
  MSGTYPE ANSI TT  NP      NAI  SSN SELID LSN      GTTSET
GTTSET
  xs      2   17  --      ---  --- none  any      acdgtal
-----
      (--- )
                                     (cdgta)

      GTI                      CG                      CDPA
CGPA
  MSGTYPE INTL TT  NP      NAI  SSN SELID LSN      GTTSET
GTTSET
  u,us    2   17  --      ---  --- none  any      icdgtal
-----
      (--- )
      xs    2   17  --      ---  --- none  any      setint101
-----
      (--- )
      us,x  2   21  --      ---  --- 15   any      setint104
-----
      (--- )
      u,us,x 2   23  --      ---  --- 15   any      setint109
-----
      (--- )
      us    2  102  --      ---  --- none  any      setint102
-----
      (--- )
      all   2  103  --      ---  --- 15   any      setint103
-----
      (--- )

      GTI                      CG                      CDPA
CGPA
  MSGTYPE NATL TT  NP      NAI  SSN SELID LSN      GTTSET
GTTSET

      GTI                      CG                      CDPA
CGPA
  MSGTYPE N24 TT  NP      NAI  SSN SELID LSN      GTTSET
GTTSET

      GTI                      CG                      CDPA
```

```

CGPA
MSGTYPE INTS TT NP      NAI  SSN SELID LSN      GTTSET      GTTSET

      GTI
MSGTYPE NATS TT NP      NAI  SSN SELID LSN      GTTSET      CGPA
      GTTSET

```

The following example illustrates `rtrv-gttset` output when a single `msgtype` value is mentioned in the `msgtype` parameter.

```
rtrv-gttset:msgtype=us
```

```

tekelecstp 17-04-15 14:31:53 EST  EAGLE 46.6.0
      GTI
MSGTYPE ANSI TT NP      NAI  SSN SELID LSN      GTTSET      CGPA
      GTTSET

      GTI
MSGTYPE INTL TT NP      NAI  SSN SELID LSN      GTTSET      CGPA
u,us    2    17  --      ---  --- none  any      icdgta      ----
      (cdgta)      (--- )
us,x    2    21  --      ---  --- 15   any      setint104   ----
      (cdgta)      (--- )
u,us,x  2    23  --      ---  --- 15   any      setint109   ----
      (cdgta)      (--- )
us      2    102 --      ---  --- none  any      setint102   ----
      (cdgta)      (--- )
all     2    103 --      ---  --- 15   any      setint103   ----
      (cdgta)      (--- )

      GTI
MSGTYPE NATL TT NP      NAI  SSN SELID LSN      GTTSET      CGPA
      GTTSET

      GTI
MSGTYPE N24 TT NP      NAI  SSN SELID LSN      GTTSET      CGPA
      GTTSET

      GTI
MSGTYPE INTS TT NP      NAI  SSN SELID LSN      GTTSET      CGPA
      GTTSET

      GTI
MSGTYPE NATS TT NP      NAI  SSN SELID LSN      GTTSET      CGPA
      GTTSET

```

The following example illustrates `rtrv-gttset` output when a `msgtype=all` is provided in command.

```
rtrv-gttset:msgtype=all
```

```

tekelecstp 17-04-15 14:31:53 EST  EAGLE 46.6.0
      GTI
MSGTYPE ANSI TT NP      NAI  SSN SELID LSN      GTTSET      CGPA
      GTTSET

      GTI
MSGTYPE INTL TT NP      NAI  SSN SELID LSN      GTTSET      CGPA
all     2    103 --      ---  --- 15   any      setint103   ----

```

```

                                (cdgta)
(--- )
      GTI                      CG                      CDPA
CGPA
  MSGTYPE NATL TT  NP          NAI  SSN  SELID  LSN          GTTSET
GTTSET

      GTI                      CG                      CDPA
CGPA
  MSGTYPE N24  TT  NP          NAI  SSN  SELID  LSN          GTTSET
GTTSET

      GTI                      CG                      CDPA
CGPA
  MSGTYPE INTS TT  NP          NAI  SSN  SELID  LSN          GTTSET
GTTSET

      GTI                      CG                      CDPA
CGPA
  MSGTYPE NATS TT  NP          NAI  SSN  SELID  LSN          GTTSET
GTTSET

```

The following example illustrates `rtrv-gttset` output when two `msgtype` values are mentioned in the `msgtype` parameter:

```
rtrv-gttset:msgtype=u,x
```

```

tekelecstp 17-04-15 14:31:52 EST  EAGLE 46.6.0
      GTI                      CG                      CDPA
CGPA
  MSGTYPE ANSI TT  NP          NAI  SSN  SELID  LSN          GTTSET
GTTSET

      GTI                      CG                      CDPA
CGPA
  MSGTYPE INTL TT  NP          NAI  SSN  SELID  LSN          GTTSET
GTTSET
  u,us    2    17  --          ---  ---  none  any          icdgtal
-----
                                (cdgta)
(--- )
  us,x    2    21  --          ---  ---  15   any          setint104
-----
                                (cdgta)
(--- )
  u,us,x  2    23  --          ---  ---  15   any          setint109
-----
                                (cdgta)
(--- )
  all     2    103 --          ---  ---  15   any          setint103
-----
                                (cdgta)
(--- )

```

```

          GTI          CG          CDPA          CGPA
MSGTYPE NATL TT NP      NAI SSN SELID LSN      GTTSET      GTTSET

          GTI          CG          CDPA          CGPA
MSGTYPE N24 TT NP      NAI SSN SELID LSN      GTTSET      GTTSET

          GTI          CG          CDPA          CGPA
MSGTYPE INTS TT NP      NAI SSN SELID LSN      GTTSET      GTTSET

          GTI          CG          CDPA          CGPA
MSGTYPE NATS TT NP      NAI SSN SELID LSN      GTTSET      GTTSET

```

The below example illustrates `rtrv-gttset` output when three `msgtype` values are mentioned in the `msgtype` parameter. No more than three `msgtype` values can be mentioned in `msgtype` parameter.

```
rtrv-gttset:msgtype=u,x,xs
```

```

tekelecstp 17-04-15 14:31:52 EST EAGLE 46.6.0
          GTI          CG          CDPA          CGPA
MSGTYPE ANSI TT NP      NAI SSN SELID LSN      GTTSET      GTTSET
xs      2      17  --      --- --- none any      acdgtal      ----
          (cdgta)      (--- )

          GTI          CG          CDPA          CGPA
MSGTYPE INTL TT NP      NAI SSN SELID LSN      GTTSET      GTTSET
u,us    2      17  --      --- --- none any      icdgtal      ----
          (cdgta)      (--- )
xs      2      17  --      --- --- none any      setint101    ----
          (cdgta)      (--- )
u,x     2      21  --      --- --- 15  any      setint104    ----
          (cdgta)      (--- )
u,u,x   2      23  --      --- --- 15  any      setint109    ----
          (cdgta)      (--- )
all     2      103 --      --- --- 15  any      setint103    ----
          (cdgta)      (--- )

          GTI          CG          CDPA          CGPA
MSGTYPE NATL TT NP      NAI SSN SELID LSN      GTTSET      GTTSET

          GTI          CG          CDPA          CGPA
MSGTYPE N24 TT NP      NAI SSN SELID LSN      GTTSET      GTTSET

          GTI          CG          CDPA          CGPA
MSGTYPE INTS TT NP      NAI SSN SELID LSN      GTTSET      GTTSET

          GTI          CG          CDPA          CGPA
MSGTYPE NATS TT NP      NAI SSN SELID LSN      GTTSET      GTTSET

```

The below example illustrates `rtrv-gttset` output when the `msgtype` parameter is mentioned with the `tt` parameter. No more than three `msgtype` values can be mentioned in the `msgtype` parameter

```
rtrv-gttset:msgtype=xs:tt=17
```

```
tekelecstp 17-04-15 14:31:52 EST EAGLE 46.6.0
          GTI                      CG                      CDPA
CGPA
  MSGTYPE ANSI TT  NP      NAI  SSN SELID LSN      GTTSET
GTTSET
  xs      2   17  --      ---  --- none  any      acdgtal
-----
          (--- )
          GTI                      CG                      CDPA
CGPA
  MSGTYPE INTL TT  NP      NAI  SSN SELID LSN      GTTSET
GTTSET
  xs      2   17  --      ---  --- none  any      setint101
-----
          (--- )
          GTI                      CG                      CDPA
CGPA
  MSGTYPE NATL TT  NP      NAI  SSN SELID LSN      GTTSET
GTTSET
          GTI                      CG                      CDPA
CGPA
  MSGTYPE N24  TT  NP      NAI  SSN SELID LSN      GTTSET
GTTSET
          GTI                      CG                      CDPA
CGPA
  MSGTYPE INTS TT  NP      NAI  SSN SELID LSN      GTTSET
GTTSET
          GTI                      CG                      CDPA
CGPA
  MSGTYPE NATS TT  NP      NAI  SSN SELID LSN      GTTSET
GTTSET
```

### Legend

- **GTI/GTIA/GTII/GTIN/GTIN24/GTIN16**—Global title indicator
- **TT**—Translation type
- **NP**—Number plan
- **NAI**—Nature of address indicator
- **GTTSN**—GTT set name. A GTT set is an entity to which global title addresses and selectors are assigned.

- **MSGTYPE**—SCCP message type

#### Related Topics

- [chg-gttset](#)
- [dlt-gttset](#)
- [ent-gttset](#)

## rtrv-gttset

Use this command to display a list of administered GTT sets. This list can be filtered by using the parameters shown.

#### Note:

If the EGTT feature is turned on, then the **GTT Selector** (`ent/chg/dlt/rtrvgttset`), **GTT Set** (`ent/dlt/rtrv-gttset`), and **GTA** (`ent/chg/dlt/rtrvgta`) commands replace the **Translation Type** (`ent/dlt/rtrv-tt`) and **Global Title Translation** (`ent/chg/dlt/rtrv-gtt`) commands. It is not recommended to run `ent/dlt/rtrv-tt & ent/chg/dlt/rtrv-gtt` commands as it may cause the advance GTA fields of GTT entry to be reset to the default values.

#### Parameters

##### **actsn (optional)**

GTT Action Set Name.

##### **Range:**

ayyyyyyy

1 leading alphabetic and up to 8 following alphanumeric characters.

##### **gtmodid (optional)**

Global title modification identifier.

##### **Range:**

ayyyyyyy

##### **Default:**

Display all

##### **gttsn (optional)**

GTT set name. A GTT set is an entity to which global title addresses and selectors are assigned.

##### **Range:**

ayyyyyyy

1 leading alphabetic and up to 8 following alphanumeric characters.

**netdom (optional)**

Network domain. This command does not distinguish between ITU National or ITU International because the Enhanced Global Title Translation feature does not discriminate between the ITU-I and ITU-N translations.

**Range:**

*ansi*

*itu*

*cross*

**Default:**

Display all

**npsn (optional)**

GTT set name (Not Present Set Name). This parameter can have the IMEI/IMSI/MSISDN/VLRNB/SMRPOA/SMRPDA GTT set types.

**Range:**

*ayyyyyyy*

1 leading alphabetic and up to 8 following alphanumeric characters.

**refcnt (optional)**

GTT set reference count. The count of GTT set being referred in GTT Selectors, GTA Translations, BPARTYGTTSN and IS41SMSCGTTSN options in GSMSMSOPTS table and BPARTYGTTSN option in IS41SMSOPTS table.

**Range:**

*yes*

**setidx (optional)**

GTT set index.

 **Note:**

A comma-separated setidx list that allow GTT set information to be retrieved based on the GTT index number. Up to 7 setidx can be specified in the list.

**Range:**

*0 - 9999*

**settype (optional)**

GTT set type.

**Range:**

*cdgta*

*cdssn*

*cggta*

**cgpc**

**cgssn**

**dpc**

**imei**

**imsi**

**msisdn**

**opc**

**opcode**

**smrpda**

**smrpoa**

**vlrnb**

**Default:**

Display all

**sxudt (optional)**

Segmented XUDT. This parameter specifies whether TOBR will support the processing of segmented XUDT message.

**Range:**

**yes**

perform decoding of segmented XUDT message

**no**

do not perform decoding of segmented XUDT message

**Default:**

*no*

**Example**

```
rtrv-gttset
rtrv-gttset:netdom=ansi
rtrv-gttset:gttsn=t800
rtrv-gttset:netdom=ansi:settype=cdssn
rtrv-gttset:settype=opcode
rtrv-gttset:setidx=1
rtrv-gttset:actsn=actdiscl
rtrv-gttset:refcnt=yes
rtrv-gttset:gtmodid=set1
rtrv-gttset:npsn=imsi1
```



```
rtrv-gttset:setidx=3,7,65,22
```

```
rtrv-gttset:sxudt=yes
```

### Dependencies

The EGTT feature must be turned on before this command can be entered.

If the `gttsn` parameter is specified, it cannot have a value of *none*, and must match an existing `gttsn`.

If the `netdom` parameter is specified, at least one entry must exist that exactly matches the specified value. Otherwise, the following error message appears in the scroll area:

No GTT Sets matching the specified criteria were found.

The `netdom=cross` parameter is valid if the `settype=cdgta/imei/imsi/msisdn/vlrnb/smrpoa/smrpda` parameter is specified.

If the `gttsn` parameter is specified then the `settype`, `netdom`, `actsn`, and `gtmodid` parameters cannot be specified.

The Origin-based SCCP Routing feature must be enabled if the value of the `settype` parameter is *cggtta*, *cgssn*, *opc*, or *cgpc*.

The ANSI/ITU SCCP Conversion feature must be enabled before the `netdom=cross` parameter can be specified.

The TOBR feature must be turned on before the `opcode=settype` parameter can be specified.

If the `setidx` parameter is specified, then no other parameter can be specified in the command.

The FLOBR feature must be turned on before a value of *cdssn* or *dpc* can be specified for the `settype` parameter.

The value specified for the `gtmodid` parameter must already exist in the GTMOD table.

The value specified for the `npsn` parameter must match the name of an existing GTT Set of IMEI/IMSI/MSISDN/VLRNB/SMRPOA/SMRPDA type.

The SXUDT parameter must be specified with the OP CODE GTT set type only.

Duplicate values cannot be specified for the SETIDX parameter.

### Notes

When the Origin-based SCCP Routing feature is turned on, the `settype` parameter is displayed regardless of feature key status. If the feature key is not enabled, the `settype=cdgta` parameter (default value) is displayed.

Only entries that match the `setidx` values specified in the command will be displayed. If no GTTSet is found for a particular `setidx`, the following message is displayed in the Scroll Area of the terminal: "No Entry found." along with the `setidx` for which GTTSet was not found.

## Output

This example retrieves all GTT sets:

```
rtrv-gttset

tekelecstp 10-05-04 12:57:51 EST EAGLE 42.0.0
GTTSN      NETDOM      NDGT
lidx       ansi         10
t800       ansi         6
s_i000     itu           15
imsi       itu           15
abcd1234   itu           12
setins005  itu           6
ituis7     itu           6
setnas005  itu           6
ituns7     itu           6

GTT-SET table is (5 of 2000) 1% full.
;
```

This example retrieves a specific GTT set:

```
rtrv-gttset:gttsn=t800

tekelecstp 09-08-14 13:46:14 EST EAGLE 41.1.0
GTTSN      NETDOM      NDGT
t800       ansi         6

GTT-SET table is (3 of 2000) 1% full.
;
```

This example retrieves all GTT sets when the VGTT feature is turned on:

```
rtrv-gttset

tekelecstp 09-08-14 13:46:56 EST EAGLE 41.1.0
GTTSN      NETDOM      NDGT
lidx       ansi         3,7,10
t800       ansi         4,6
s_i000     itu           10,15
imsi       itu           10,15
abcd1234   itu           12

GTT-SET table is (5 of 2000) 1% full.
;
```

This example retrieves GTT sets for a specified GTT set type when the Origin-based SCCP Routing feature is turned on:

```
rtrv-gttset:settype=cgpc
```

```
tekelecstp 09-08-14 12:59:19 EST EAGLE 41.1.0
GTTSN      NETDOM  SETTYPE  NDGT
pc00      ansi    CGPC     -
pc01      ansi    CGPC     -
pc02      itu     CGPC     -
pc03      ansi    CGPC     -
pc04      ansi    CGPC     -
pc05      ansi    CGPC     -
```

```
GTT-SET table is (8 of 2000) 1% full.
```

```
;
```

This example retrieves all GTT sets when the Origin-based SCCP Routing feature is turned on.

```
rtrv-gttset
```

```
rlghncxa03w 09-08-14 08:10:20 EST EAGLE 41.1.0
GTTSN      NETDOM  SETTYPE  NDGT
Pc10      cross  CDGTA    6,8,10,17
Pc11      ansi    CGGTA    10
Pc12      itu     CGPC     -
Pc13      itu     CGSSN    -
Pc14      ansi    OPC      -
Pc15      ansi    CGPC     -
```

```
GTT-SET table is (6 of 2000) 1% full.
```

```
;
```

Retrieve all GTT sets when the ANSI/ITU SCCP Conversion feature is enabled:

```
rtrv-gttset
```

```
rlghncxa03w 09-08-13 08:29:15 EST EAGLE 41.1.0
GTTSN      NETDOM  NDGT
lidx       ansi    10
t800       ansi    6
s_i000     itu     15
imsi       itu     15
abcd1234   cross  12
```

```
GTT-SET table is (5 of 2000) 1% full.
```

```
;
```

This example retrieves all GTT sets when the Support for 16 GTT Lengths in VGTT feature is turned on:

```
rtrv-gttset
```

```
rlghncxa03w 09-08-13 08:16:15 EST EAGLE 41.1.0
GTTSN      NETDOM  NDGT
lidb       ansi    1,3,5,6,7,8,9,10,11,12,13,14,18,21
t800       ansi    4,6
s_i000     itu     10,15
```

```
GTT-SET table is (3 of 2000) 1% full.
```

```
;
```

This example retrieves all GTT sets when the TOBR feature is turned on:

```
rtrv-gttset
```

```
tekelecstp 16-10-10 13:54:11 MST EAGLE 46.5.0.0.0-70.5.0
GTTSN      NETDOM  SETTYPE  NPSN    CHECKMULCOMP  NDGT
Pc10       cross  CDGTA    -----  -----  6,8,10,17
Pc11       ansi   CGGTA    -----  -----  10
Pc12       itu    CGPC     -----  -----  -
Pc13       itu    CGSSN    -----  -----  -
Pc14       ansi   OPC      -----  -----  -
Pc15       ansi   CGPC     -----  -----  -
Pc16       itu    CDSSN    -----  -----  -
Pc17       -      OPCODE   -----  YES      -
```

```
GTT-SET table is (8 of 2000) 1% full.
```

```
;
```

This example retrieves the GTT set entry on the basis of set index:

```
rtrv-gttset:setidx=1
```

```
tekelecstp 09-08-13 10:57:14 EST EAGLE 41.1.0
Command entered at terminal #4.
```

```
GTTSN      NETDOM  SETTYPE  NDGT
setcggta   ansi    CGGTA    0
```

```
GTT-SET table is (3 of 2000) 1% full.
```

```
;
```

This example retrieves GTT sets for DPC set type when the FLOBR feature is turned on:

```
rtrv-gttset:settype=dpc
```

```
tekelecstp 10-03-14 08:10:20 EST EAGLE 42.0.0
GTTSN      NETDOM  SETTYPE  NDGT
Setdpc     ansi    DPC      -
```

```
Setdpc1  ansi  DPC  -

GTT-SET table is (8 of 2000) 1% full.
```

```
;
```

This example retrieves GTT set entries and the corresponding reference counts:

```
rtrv-gttset:refcnt=yes
```

```
tekelecstp 10-05-04 12:11:59 EST Eagle 42.0.0
GTTSN      NETDOM  REFCNT  NDGT
l1db       ansi    0       10
t800       ansi    2       6
s_i000     itu     1       15
imsi       itu     1       15
abcd1234   itu     0       12
```

```
GTT-SET table is (5 of 2000) 1% full.
```

```
;
```

```
rtrv-gttset:gtmodid=set1
```

```
tekelecstp 10-01-10 12:13:21 EST EAGLE 42.0.0
```

```
GTTSN      NETDOM  NDGT
abc         ansi    6
```

```
GTT-SET table is (1 of 2000) 1% full.
```

```
;
```

This example retrieves GTT set entries after the NPSN parameter is added:

```
rtrv-gttset:settype=msisdn
```

```
tekelecstp 15-05-24 08:10:20 EST EAGLE 46.3.0
GTTSN      NETDOM  SETTYPE  NPSN    NDGT
Imsi1     ansi    MSISDN  imsi2   10
Msisdn3   itu     MSISDN  imsi3   -
```

```
GTT-SET table is (10 of 2000) 1% full.
```

```
;
```

```
rtrv-gttset
```

```
tekelecstp 15-05-24 08:10:20 EST EAGLE 46.3.0
GTTSN      NETDOM  SETTYPE  NPSN    NDGT
Pc10       cross  CDGTA   --      6,8,10,17 --
Pc11       ansi   CCGTA   --      10
```

```

Imsi1   ansi   MSISDN   imsi2   10
Imsi2   itu    IMSI     msisdn3 -
Msisdn3 itu    MSISDN   imsi3   -
Imsi3   ansi   IMSI     -        -

```

GTT-SET table is (6 of 2000) 1% full.

;

This example retrieves all GTT sets with new column SETIDX:

```
rtrv-gttset
```

```
tekelecstp 17-06-07 09:38:07 MST EAGLE 46.6
```

GTTSN	NETDOM	SETTYPE	NPSN	CHECKMUL		GTTSET		
				COMP	SETIDX	MEASRQD	SXUDT	NDGT
op1	itu	OPCODE	-----	---	0	no	yes	8
cdset2	itu	CDGTA	-----	---	1	yes	-	6
cdset3	itu	CDGTA	-----	---	2	no	-	8
resdata	itu	OPCODE	-----	off	3	trans	no	-
imsi1	itu	IMSI	-----	---	4	yes	-	6
vlrnb1	itu	VLRNB	imsi1	---	5	no	-	6

GTT-SET table is (6 of 10000) 1% full.;

This example retrieves the GTT set entry on the basis comma separated set index:

```
rtrv-gttset:setidx=3,44,2,90,106
```

```
tekelecstp 17-06-21 12:20:26 MST EAGLE 46.6
```

GTTSN	NETDOM	SETTYPE	NPSN	CHECKMUL		GTTSET		
				COMP	SETIDX	MEASRQD	SXUDT	NDGT
resdata	itu	OPCODE	-----	off	3	trans	no	-
No Entry found						44		
cdset3	itu	CDGTA	-----	---	2	no	-	8
No Entry found						90		
No Entry found						106		

GTT-SET table is (6 of 10000) 1% full.

This example retrieves GTT set entries on the basis of sxudt:

```
rtrv-gttset:sxudt=yes
```

```
tekelecstp 17-07-15 15:22:26 MST EAGLE 46.6
```

GTTSN	NETDOM	SETTYPE	NPSN	CHECKMUL		GTTSET		
				COMP	SETIDX	MEASRQD	SXUDT	NDGT
op1	itu	OPCODE	-----	off	3	no	yes	-
op2	itu	OPCODE	-----	---	2	yes	yes	8

GTT-SET table is (6 of 10000) 1% full.

**Legend**

- **GTTSN**—GTT set name
- **NETDOM**—Network domain
- **SETTYPE**—GTT set type
- **REFCNT**—Reference count
- **NDGT**—Number of digits required for GTAs associated with this set
- **NPSN**—Not present GTT set name
- **CHECKMULCOMP**—Decode multiple components of a TCAP Message
- **GTTSETMEASRQD**—Per GTTSET Measurement Required
- **SETIDX**—GTT set index
- **SXUDT**—Segmented XUDT

**Related Topics**

- [chg-gttset](#)
- [dlt-gttset](#)
- [ent-gttset](#)

## rtrv-gtw-stp

Use this command to display the level 3 ANSI transfer control status (TFCSTAT) parameter. This value is the level 3 control status used on a TFC message received from an ITU node destined for an ANSI node.

**Parameters**

This command has no parameters.

**Example**

```
rtrv-gtw-stp
```

**Dependencies**

None

**Notes**

None

**Output**

```
rtrv-gtw-stp
```

```
rlghncxa03w 03-03-11 11:34:04 EST EAGLE 31.3.0
TFCSTAT
1
;
```

**Related Topics**

- [chg-gtw-stp](#)

## rtrv-gtwy-acthresh

Use this command to display the current values for the SS7 message rejection thresholds occurring because of the gateway screening process.

**Parameters****lsn (optional)**

Linkset name.

**Range:**

ayyyyyyyyy

1 alphabetic character followed by up to 9 alphanumeric characters

**Default:**

Display all

**Example**

```
rtrv-gtwy-acthresh:lsn=wy644368
```

```
rtrv-gtwy-acthresh
```

**Dependencies**

The Extended Linkset table must be accessible.

The specified linkset must exist in the gateway linkset entity set of the requesting system.

The Linkset table must be accessible.

The linkset specified must exist in the active database.

At least one optional parameter must be specified.

**Notes**

None

**Output**

This example shows the thresholds of all linksets:

```
rtrv-gtwy-acthresh

rlghncxa03w 04-02-18 08:50:12 EST EAGLE 31.3.0
LSN          REJ    RECV   INTRVL
WY644368    10     1000   10
WY234456    25     2000   20
LN123445    -      -       -
LN123556    25     2500   30
OP239900    -      5       5
;
```



This example shows linkset WY644368 rejection thresholds:

```
rtrv-gtwy-acthresh:lsn=wy644368
```

```
rlghncxa03w 04-02-18 08:50:12 EST EAGLE 31.3.0
LSN          REJ      RECV     INTRVL
wy644368    10       1000     10
:
```

### Legend

- **LSN**—Linkset name
- **REJ**—Reject threshold
- **RECV**—Received message threshold
- **INTRVL**—Monitor interval

### Related Topics

- [set-gtwy-acthresh](#)

## rtrv-gtwy-prmtrs

Use this command to display the STP values that limit the display of certain notification messages that could become excessive. Only the values set by the `set-scrrej-prmtrs` command are displayed.

### Parameters

This command has no parameters.

### Example

```
rtrv-gtwy-prmtrs
```

### Dependencies

The Extended STP Options table must be accessible.

None

### Notes

None

### Output

```
rtrv-gtwy-prmtrs
```

```
rlghncxa03w 04-02-18 08:50:12 EST EAGLE 31.3.0
LIMIT INTRVL
1000 15
;
```

### Legend

- **LIMIT**—The threshold not to be exceeded.
- **INTRVL**—Monitor interval. The examination period, in minutes, during which the gateway screening activity thresholds are to be tested.

### Related Topics

- [set-scrrej-prmtrs](#)

## rtrv-gws-actset

Use this command to display the values defined for gateway screening stop actions.

### Parameters

#### **actid (optional)**

The identification number of the gateway screening stop action.

**Range:**

4 - 16

**Default:**

Display all

#### **actname (optional)**

The name of the gateway screening stop action set.

**Range:**

ayyyy

One alphabetic character followed by up to five alphanumeric characters.

**Default:**

Display all

### Example

```
rtrv-gws-actset
rtrv-gws-actset:actname=cr
rtrv-gws-actset:actid=6
```

### Dependencies

Either `actname` or `actid` can be specified, but not both.

### Notes

If neither `actname` nor `actid` are specified, all gateway screening stop actions are displayed.

**Output**

rtrv-gws-actset:actname=cr

```

tekelecstp 13-10-24 12:05:05 EST 46.0.0-65.3.0
rtrv-gws-actset:actname=cr
Command entered at terminal #4.
ACT ACT ACT ACT ACT ACT ACT ACT ACT ACT ACT
ACT
ID NAME 1 2 3 4 5 6 7 8 9
10
-- -----
-----
3 cr copy rdct -----
-----

```

GWS action set table is (6 of 16) 38% full

;

rtrv-gws-actset

```

tekelecstp 13-10-24 11:56:11 EST 46.0.0-65.3.0
rtrv-gws-actset
Command entered at terminal #4.
ACT ACT ACT ACT ACT ACT ACT ACT ACT ACT ACT
ACT
ID NAME 1 2 3 4 5 6 7 8 9
10
-- -----
-----
1 copy copy -----
-----
2 rdct rdct -----
-----
3 cr copy rdct -----
-----
4 dup1 dup rdct -----
-----
5 dup2 copy dup -----
-----
6 strip strip -----
-----

```

GWS action set table is (6 of 16) 38% full

;

```
rtrv-gws-actset:actname=dup1
```

```
tekelecstp 13-10-24 12:04:21 EST 46.0.0-65.3.0
rtrv-gws-actset:actname=dup1
Command entered at terminal #4.
ACT  ACT    ACT    ACT    ACT    ACT    ACT    ACT    ACT    ACT    ACT    ACT
ID   NAME    1      2      3      4      5      6      7      8      9      10
--   -----
4   dup1    dup    ----- rdct -----

```

GWS action set table is (6 of 16) 38% full

```
;
```

### Related Topics

- [chg-gws-actset](#)

## rtrv-gws-redirect

Use this command to display the provisioning data for the redirect function. The parameters and values that are retrieved using this command are stored in the Redirect table, and they are used to set the variable fields of the MSUs being redirected.

### Parameters

**This command has no parameters.**

### Example

```
rtrv-gws-redirect
```

### Dependencies

None

### Notes

None

### Output

The second column in the output displays the type of point code used:

- ANSI—DPCA
- International—DPCI
- ITU National—DPCN
- ITU National 24—DPCN24
- ITU National 16---DPCN16

```
rtrv-gws-redirect
```

```
rlghncxa03w 09-04-10 11:43:04 EST EAGLE 41.0.0
```

```

ENABLED   DPCA           RI  SSN  TT  GTA
off       003-033-003   GT  0    0   1
;

```

This example shows output when the gateway screening redirect function is not enabled:

```
rtrv-gws-redirect
```

```

rlghncxa03w 09-04-10 11:43:04 EST EAGLE 41.0.0
ENABLED   DPCA           RI  SSN  TT  GTA
Redirect function data is not provisioned
;

```

```
rtrv-gws-redirect
```

```

tekelecstp 13-07-02 15:48:55 EST 45.0.0-64.69.0
rtrv-gws-redirect
Command entered at terminal #4.
ENABLED   DPCN16        RI  SSN  TT  GTA
on        001-02-03    GT  10  100 5
;

```

### Related Topics

- [chg-gws-actset](#)

## rtrv-home-smsc

Use this command to retrieve HOME SMSC specific addresses currently used to identify Short Message Service Centers in the database. This command reads the HOME SMSCADDR table.

### Parameters

#### **force (optional)**

Display more than 50 entries.

#### **Range:**

**yes**

**no**

#### **Default:**

*no*

#### **num (optional)**

Number of entries to display. The *force* parameter must also be specified to display more than 50 entries.

**Range:**

1 - 500

**Default:**

50

**smsc (optional)**

Short Message Service Center address.

**Range:**

1-21 hexadecimal digits

**Example**

```
rtrv-home-smsc
rtrv-home-smsc:smsc=552611646
rtrv-home-smsc:num=100:force=yes
```

**Dependencies**

One of the following features must be enabled

- MO SMS IS41-to-GSM Migration
- MO-based GSM SMS NP
- MO-based IS41 SMS NP
- MT-Based GSM SMS NP
- MT-Based IS41 SMS NP
- Portability Check for Mobile Originated SMS

When the specified `num` parameter value is greater than 50, the `force=yes` parameter must also be specified.

The HOME SMSCADDR table must be accessible.

The GSM DBMM table must be accessible.

**Notes**

None

**Output**

```
rtrv-home-smsc

rlghncxa03w 03-03-28 08:50:12 EST  EAGLE 31.3.0
SMSC ADDRESS

13214564894498
55231465465434
5465455655656456

HOME SMSC ADDRESS TABLE IS  1 % FULL  (3 of 500)
```

;

**Related Topics**

- [dlt-home-smsc](#)
- [ent-home-smsc](#)

## rtrv-homern

Use this command to retrieve a list of routing number prefixes that belong to the operating network.

**Parameters**

This command has no parameters.

**Example**

```
rtrv-homern
```

**Dependencies**

The HOMERN table must be accessible.

**Notes**

None

**Output**

```
rtrv-homern
```

```
rlghncxa03w 03-03-28 08:50:12 EST EAGLE 31.3.0
RN
-----
216780909087654
76345098
abc
abc1234
c10234567
cabade
```

```
HOMERN table is (6 of 100) 6% full
```

;

**Legend**

- **RN**—Routing Number

**Related Topics**

- [dlt-homern](#)
- [ent-homern](#)

## rtrv-inpopts

Use this command to retrieve INP-specific options.

### Parameters

This command has no parameters.

### Example

```
rtrv-inpopts
```

### Dependencies

None.

The INPOPTS table must be accessible.

### Notes

If no DRANAI value or DRANAIV value has been provisioned, the command output displays the DRANAIV default value of 126.

If either the DRANAI value or DRANAIV value has been provisioned, the DRANAI mnemonic string for the provisioned value is displayed.

If no DRANP value or DRANPV value has been provisioned, the command output displays the DRANP default mnemonic value of E164.

If either the DRANP value or DRANPV value has been provisioned, the DRANP mnemonic string for the provisioned value is displayed.

The command output displays each CDPNPFEX value with its associated DLTPFX setting.

The command output displays each CDPNNAI value with its associated SNAI value.

If no NEC value has been provisioned, a value of *none* is displayed.

If a RELCAUSE value was not provisioned, then the default value of 31 is displayed.

### Output

This example shows output with default INP options:

```
rtrv-inpopts
```

```
rlghncxa03w 10-03-17 15:35:05 EST  EAGLE 42.0.0
INP OPTIONS
-----
NEC          = NONE
DRANAIV      = 126
DRANP        = E164
DRA          = RNDN
SPRESTYPE    = CONTINUE
RELCAUSE     = 31
SPORTTYPE    = NONE
DEFRN        = NONE
```



```

CUTNPASTE = OFF

CDPNPFX          DLTPFX
-----          ---

CDPNNAI          SNAI
---            ----

;

```

This example shows output with some INP options provisioned.

```
rtrv-inpopts
```

```

rlghncxa03w 10-03-17 15:35:05 EST EAGLE 42.0.0
INP OPTIONS
-----
NEC          = abc1d
DRANAIV      = 126
DRANP        = E164
DRA          = CCRNDN
SPRESTYPE    = CONTINUE
RELCAUSE     = 30
SPORTTYPE    = ALL
DEFRN        = 99887
CUTNPASTE    = ON

CDPNPFX          DLTPFX
-----          ---

CDPNNAI          SNAI
---            ----
127              unknown

;

```

### Legend

- **ASD**—Additional Subscriber Data
- **CDPNNAI**—Called Party Number Nature of Address Indicator
- **CDPNPFX**—Called Party Number Prefix
- **DLTPFX**—Delete Prefix
- **DRA**—Destination Routing Address.
- **DRANAI**—Nature of Address Indicator for the Destination Routing Address
- **DRANPV**—Numbering Plan Value for the Destination Routing Address
- **GRN**—Generic Routing Number.
- **NEC**—National Escape Code
- **SNAI**—Service Nature of Address Indicator

- **SPRESTYPE**—INP option to send a "Connect" message or a "Continue" message when IDP messages are received for INP services, the DN digits match, and the HLR ID is present
- **SPORTTYPE**—Service Portability Type
- **DEFNRN**—Default Routing Number
- **RELCAUSE**—INP CRP option, specifying the reason for releasing the call when an INP Circular Route is detected
- **CUTNPASTE**—Specifies whether the CutAndPaste parameter is included in an INP CONNECT response message

#### Related Topics

- [chg-inpopts](#)

## rtrv-ip-card

Use this command to retrieve IP networking parameters for a given card.

#### Parameters

##### loc (optional)

Card location. The unique identifier of a specific application subsystem located in the system.

##### Range:

1101 - 1108, 1111 - 1112, 1201 - 1208, 1211 - 1218, 1301 - 1308, 1311 - 1318, 2101 - 2108, 2111 - 2118, 2201 - 2208, 2211 - 2218, 2301 - 2308, 2311 - 2318, 3101 - 3108, 3111 - 3118, 3201 - 3208, 3211 - 3218, 3301 - 3308, 3311 - 3318, 4101 - 4108, 4111 - 4118, 4201 - 4208, 4211 - 4218, 4301 - 4308, 4311 - 4318, 5101 - 5108, 5111 - 5118, 5201 - 5208, 5211 - 5218, 5301 - 5308, 5311 - 5318, 6101 - 6108, 6111 - 6118, 1113, 1115

#### Example

```
rtrv-ip-card:loc=1211  
rtrv-ip-card
```

#### Dependencies

The value specified for the `loc` parameter must correspond to the location of a card that can run an IP application (other than the EROUTE application, which is not supported by this command).

#### Notes

None

#### Output

```
rtrv-ip-card:loc=1211  
  
rlghncxa03w 13-09-24 15:35:05 EST EAGLE 46.0.0  
  LOC 1211  
    SRCHORDR LOCAL
```

```
      DNSA      150.123.123.123
      DNSB      -----
      DEFROUTER -----
      DOMAIN    NC.TEKELEC.COM
      SCTPCSUM  adler32
      DSCP      4

;

rtrv-ip-card

rlghncxa03w 13-09-24 15:35:05 EST EAGLE 46.0.0
  LOC 1211
    SRCHORDR  LOCAL
    DNSA      150.1.1.1
    DNSB      -----
    DEFROUTER -----
    DOMAIN    NC.TEKELEC.COM
    SCTPCSUM  adler32
    DSCP      9

  LOC 1213
    SRCHORDR  LOCAL
    DNSA      150.1.1.1
    DNSB      -----
    DEFROUTER 150.1.1.25
    DOMAIN    NC.TEKELEC.COM
    SCTPCSUM  adler32
    DSCP      15

  LOC 1301
    SRCHORDR  SRVROONLY
    DNSA      150.1.1.10
    DNSB      150.1.1.28
    DEFROUTER -----
    DOMAIN    NC.TEKELEC.COM
    SCTPCSUM  adler32
    DSCP      20

;
```

This example displays the output when an E5-SM4G or E5-SM8G-B card is used:

```
rtrv-ip-card

rlghncxa03w 13-09-24 22:12:42 EST EAGLE 46.0.0
  LOC 1105
    SRCHORDR  LOCAL
    DNSA      -----
    DNSB      -----
    DEFROUTER -----
```

```

DOMAIN -----
SCTPCSUM  crc32c
BPIPADDR  192.168.124.2
BPSUBMASK 255.255.255.0
DSCP      9

LOC 1107
SRCHORDR  LOCAL
DNSA -----
DNSB -----
DEFROUTER -----
DOMAIN -----
SCTPCSUM  crc32c
BPIPADDR  192.168.124.4
BPSUBMASK 255.255.255.0
DSCP      8

LOC 1111
SRCHORDR  LOCAL
DNSA -----
DNSB -----
DEFROUTER -----
DOMAIN -----
SCTPCSUM  crc32c
BPIPADDR  192.168.124.3
BPSUBMASK 255.255.255.0
DSCP      15

```

### Legend

- **LOC**—Card location
- **SRCHORDR**—Host table search order. LOCAL indicates that the Local Host table is searched first. SRVR indicates that the Domain server is searched first. SRVRONLY indicates that only the Domain server is searched.
- **DNSA**—IP address of Domain Server A
- **DNSB**—IP address of Domain Server B
- **DEFROUTER**—IP address for the default router
- **DOMAIN**—TDomain name of the Domain server
- **SCTPCSUM**—SCTP checksum algorithm type
- **BPADDR**—Bonded port IPv6 address
- **BPSUBMASK**—Bonded port IP submask
- **DSCP**—Subfield in IP header. Applicable to SIGTRAN-based cards only

### Related Topics

- [chg-ip-card](#)



*no*

SIP/ENUM/SCCP/SFAPP/IPS with SFLOG connection is not allowed to receive SIP/ENUM/SCCP/SFAPP/IPS with SFLOG traffic.

**prot (optional)**

Underlying SIP/ENUM/SCCP/SFAPP/IPS with SFLOG connection protocol.

**Range:**

*tcp*

Transmission Control Protocol.

*udp*

User Datagram Protocol.



**Note:**

For ENUMHC, only *udp* is supported.

For IPS with SFLOG, only *tcp* is supported.

**Example**

```
rtrv-ip-conn
rtrv-ip-conn:cname=conn1101a
rtrv-ip-conn:loc=1101
rtrv-ip-conn:prot=tcp
rtrv-ip-conn:lhost=lss1
rtrv-ip-conn:open=yes
```

**Dependencies**

SIPNP Feature must be enabled before retrieving any SIP connection entry.

At least one ENUM card must be provisioned before entering any ENUM connection information.

At least one IPS card with SFLOG=yes must be provisioned before entering any TCP connection information on IPS.

At least one SCCP/SFAPP card must be provisioned before entering any Visualization connection information.

IPCONN table should be accessible.

The value specified for the HOST parameter must begin with an alphabetic character and can contain a..z, A..Z, 0..9, - (hyphen), or . (period).

The specified card location must be equipped.

The location specified with this command should be of a SIP/ENUM/IPS with SFLOG card.

**Notes**

If optional parameters are specified, only the entries that match the entered parameters are displayed.

If the host name contains a hyphen, then the host name must be enclosed within quotation marks.

**Output**

This example displays output when no parameter is specified:

```
rtrv-ip-conn
```

```
tekelecstp 16-10-28 01:15:18 EST EAGLE 46.4.0.0.0-69.15.0
rtrv-ip-conn
Command entered at terminal #4.
```

CNAME	PROT	LPORT	RPORT	OPEN
connection1	TCP	1555	1555	No
connection2	TCP	1234	1234	Yes
connection3	TCP	1202	----	No
connection4	TCP	1203	1203	No
connection5	TCP	1569	----	No
sipudpipv4	UDP	4900	----	No
sipudpipv4c	UDP	4800	----	No

```
;
```

This example displays the output when CNAME parameter is specified:

```
rtrv-ip-conn:cname=sipudpipv4
```

```
tekelecstp 16-10-28 01:17:26 EST EAGLE 46.4.0.0.0-69.15.0
rtrv-ip-conn:cname=sipudpipv4
Command entered at terminal #4.
```

```
CNAME  sipudpipv4
PROT   UDP
LHOST  sipb1103
RHOST  ----
LPORT  4900          RPORT  ----
OPEN   No
```

```
;
```

```
rtrv-ip-conn:cname=connection3
```

```
tekelecstp 16-10-28 01:17:26 EST EAGLE 46.4.0.0.0-69.15.0
rtrv-ip-conn:cname=connection3
Command entered at terminal #4.
```

```
CNAME  connection3
```

```

          PROT    TCP
          LHOST   hss3
          RHOST   ----
          LPORT   1202          RPORT   ----
          OPEN    No
;

```

This example displays the output when PROT parameter is specified:

```
rtrv-ip-conn:prot=udp
```

```

tekelecstp 16-10-28 01:18:56 EST EAGLE 46.4.0.0-69.15.0
rtrv-ip-conn:prot=udp
Command entered at terminal #4.
CNAME          PROT    LPORT    RPORT    OPEN
-----
sipudpipv4     UDP     4900     ----     No
sipudpipv4c   UDP     4800     ----
No
;

```

```
rtrv-ip-conn:prot=tcp
```

```

tekelecstp 12-09-24 17:24:32 EST EAGLE 45.0.0
rtrv-ip-conn:prot=tcp
Command entered at terminal #4.

```

```

CNAME          PROT    LPORT    RPORT    OPEN
-----
conn7          TCP     2022     2023     No
conn5          TCP     2021     2021     No
;

```

This example displays the output when LOC parameter is specified:

```
rtrv-ip-conn:loc=1101
```

```

tekelecstp 12-09-24 17:25:14 EST EAGLE 45.0.0
rtrv-ip-conn:loc=1101
Command entered at terminal #4.

```

```

CNAME          PROT    LPORT    RPORT    OPEN
-----
conn7          TCP     2022     2023     No
conn5          TCP     2021     2021     No
conn1          TCP     1555     ----     No
conn2          TCP     1555     1567     No
conn3          TCP     1107     ----     No
;

```

This example displays the output when LHOST parameter is specified:



```
rtrv-ip-conn:lhost=lss1
```

```
tekelecstp 12-09-24 17:26:00 EST EAGLE 45.0.0
rtrv-ip-conn:lhost=lss1
Command entered at terminal #4.
```

CNAME	PROT	LPORT	RPORT	OPEN
conn7	TCP	2022	2023	No
conn5	TCP	2021	2021	No
conn1	TCP	1555	----	No
conn2	TCP	1555	1567	No
conn3	TCP	1107	----	No

```
;
```

This example displays the output when OPEN parameter is specified:

```
rtrv-ip-conn:open=no
```

```
tekelecstp 16-10-28 01:18:56 EST EAGLE 46.4.0.0.0-69.15.0
rtrv-ip-conn:open=no
Command entered at terminal #4.
```

CNAME	PROT	LPORT	RPORT	OPEN
conn7	TCP	2022	2023	No
conn5	TCP	2021	2021	No
conn1	TCP	1555	----	No
conn2	TCP	1555	1567	No
conn3	TCP	1107	----	No
sipudpipv4	UDP	4900	----	No
sipudpipv4c	UDP	4800	----	No

```
;
```

### Related Topics

- [dlt-ip-conn](#)
- [ent-ip-conn](#)
- [chg-ip-conn](#)

## rtrv-ip-host

Use this command to retrieve the IP Host table. The IP Host table defines local host names for IP addresses.



**Range:*****local***

host name and address of the IP card for the local system

***remote***

host name and address of the IP card for a remote system

**Example**

```
rtrv-ip-host:host=gw100-nc.tekelec.com:ipaddr=150.1.1.1
rtrv-ip-host:host=gw100.nc.tekelec.com
rtrv-ip-host:ipaddr=150.1.1.1
rtrv-ip-host
rtrv-ip-host:display=all
rtrv-ip-host:num=10
rtrv-ip-host:type=local:num=3
rtrv-ip-host:display=detail
rtrv-ip-host:realm=abc.com
```

**Dependencies**

A valid value must be specified for the `host` parameter. If the host name contains a hyphen, then the host name must be enclosed within quotation marks.

A valid value must be specified for the `realm` parameter. If the realm contains a hyphen, then the host name must be enclosed within quotation marks.

`Display=all` and `realm` parameter must not be specified together.

**Notes**

If optional parameters are specified, only the entries that match the entered parameters are retrieved.

Realm is mandatory for all the IP hosts associated with diameter connections.

**Output**

If this command is entered without any parameters, then the command displays up to a maximum of 50 entries. The `display=all` parameter must be specified to display all entries in the IP Host table.

This example displays output when no other parameter is specified:

```
rtrv-ip-host

tekelecstp 12-07-24 10:22:08 EST  EAGLE 45.0.0
LOCAL IPADDR      LOCAL HOST
192.168.63.51     tekelecdmz11.com
192.168.63.115   tekelecdmz5.com
192.168.73.116   tekelecdmz7.com
192.168.63.52     tekelecdmz13.com
```

```
192.168.63.54 tekelecdmz14.com
192.168.63.55 hss4
```

```
REMOTE IPADDR REMOTE HOST
192.168.63.235 tekelecdmz21.com
127.1.1.1 tekelec0.com
192.168.63.245 client
192.168.63.57 tekelec1.com
192.168.63.58 tekelec2.com
192.168.63.59 tekelec3.com
192.168.63.60 tekelec4.com
192.168.63.61 tekelec5.com
192.168.63.62 tekelec6.com
192.168.63.63 tekelec7.com
192.168.63.64 tekelec8.com
192.168.63.65 tekelec9.com
192.168.63.66 tekelec10.com
192.168.63.67 tekelec11.com
192.168.63.68 tekelec12.com
192.168.63.69 tekelec13.com
192.168.63.70 tekelec14.com
192.168.63.71 tekelec15.com
192.168.63.72 tekelec16.com
192.168.63.73 tekelec17.com
192.168.63.74 tekelec18.com
192.168.63.75 tekelec19.com
192.168.63.76 tekelec20.com
192.168.63.77 tekelec21.com
192.168.63.78 tekelec22.com
192.168.63.79 tekelec23.com
192.168.63.80 tekelec24.com
192.168.63.81 tekelec25.com
192.168.63.82 tekelec26.com
192.168.63.83 tekelec27.com
192.168.63.84 tekelec28.com
192.168.63.85 tekelec29.com
192.168.63.86 tekelec30.com
192.168.63.87 tekelec31.com
192.168.63.88 tekelec32.com
192.168.63.89 tekelec33.com
192.168.63.90 tekelec34.com
192.168.63.91 tekelec35.com
192.168.63.92 tekelec36.com
192.168.63.93 tekelec37.com
192.168.63.94 tekelec38.com
192.168.63.95 tekelec39.com
192.168.63.96 tekelec40.com
192.168.63.97 tekelec41.com
```

```
IP-HOST table is (68 of 4096) 2% full.
```

```
;
```

This example displays the output when the output is filtered:

```
rtrv-ip-host:type=local:num=3

tekelecstp 12-07-24 10:22:09 EST EAGLE 45.0.0
LOCAL IPADDR      LOCAL HOST
192.168.63.51     tekelecdmz11.com
192.168.63.115   tekelecdmz5.com
192.168.73.116   tekelecdmz7.com

IP-HOST table is (68 of 4096) 2% full.

;
```

This example displays the output when all entries are requested:

```
rtrv-ip-host:display=all

tekelecstp 12-07-24 10:22:09 EST EAGLE 45.0.0
LOCAL IPADDR      LOCAL HOST
192.168.63.51     tekelecdmz11.com
192.168.63.115   tekelecdmz5.com
192.168.73.116   tekelecdmz7.com
192.168.63.52     tekelecdmz13.com
192.168.63.54     tekelecdmz14.com
192.168.63.55     hss4

REMOTE IPADDR     REMOTE HOST
192.168.63.235    tekelecdmz21.com
127.1.1.1         tekelec0.com
192.168.63.245    client
192.168.63.57     tekelec1.com
192.168.63.58     tekelec2.com
192.168.63.59     tekelec3.com
192.168.63.60     tekelec4.com
192.168.63.61     tekelec5.com
192.168.63.62     tekelec6.com
192.168.63.63     tekelec7.com
192.168.63.64     tekelec8.com
192.168.63.65     tekelec9.com
192.168.63.66     tekelec10.com
192.168.63.67     tekelec11.com
192.168.63.68     tekelec12.com
192.168.63.69     tekelec13.com
192.168.63.70     tekelec14.com
192.168.63.71     tekelec15.com
192.168.63.72     tekelec16.com
192.168.63.73     tekelec17.com
192.168.63.74     tekelec18.com
192.168.63.75     tekelec19.com
192.168.63.76     tekelec20.com
192.168.63.77     tekelec21.com
192.168.63.78     tekelec22.com
192.168.63.79     tekelec23.com
192.168.63.80     tekelec24.com
```

```
192.168.63.81 tekelec25.com
192.168.63.82 tekelec26.com
192.168.63.83 tekelec27.com
192.168.63.84 tekelec28.com
192.168.63.85 tekelec29.com
192.168.63.86 tekelec30.com
192.168.63.87 tekelec31.com
192.168.63.88 tekelec32.com
192.168.63.89 tekelec33.com
192.168.63.90 tekelec34.com
192.168.63.91 tekelec35.com
192.168.63.92 tekelec36.com
192.168.63.93 tekelec37.com
192.168.63.94 tekelec38.com
192.168.63.95 tekelec39.com
192.168.63.96 tekelec40.com
192.168.63.97 tekelec41.com
192.168.63.98 tekelec42.com
192.168.63.99 tekelec43.com
192.168.63.20 tekelec44.com
192.168.63.21 tekelec45.com
192.168.63.22 tekelec46.com
192.168.63.23 tekelec47.com
192.168.63.24 tekelec48.com
192.168.63.25 tekelec49.com
192.168.63.26 tekelec50.com
192.168.63.27 tekelec51.com
192.168.63.28 tekelec52.com
192.168.63.29 tekelec53.com
192.168.63.30 tekelec54.com
192.168.63.31 tekelec55.com
192.168.63.32 tekelec56.com
192.168.63.33 tekelec57.com
192.168.63.34 tekelec58.com
192.168.63.35 tekelec59.com
```

```
IP-HOST table is (68 of 4096) 2% full.
```

```
;
```

This example displays the output when the `display=detail` parameter is specified:

```
rtrv-ip-host:display=detail
```

```
tekelecstp 13-03-12 10:22:09 EST EAGLE 45.1
```

REMOTE IPADDR	REMOTE HOST REALM
1.1.1.13	a13 abc.com
1.1.1.12	a12
1.1.1.14	a14

```
                                abc.com

LOCAL IPADDR      LOCAL HOST
                  REALM
10.248.141.165    local11
                  xyz.com

IP-HOST table is (68 of 2048) 3% full.

;
```

This example displays the output when the `realm` parameter is specified:

```
rtrv-ip-host:realm=abc.com

tekelecstp 13-03-12 10:22:09 EST  EAGLE 45.1

REMOTE IPADDR      REMOTE HOST
1.1.1.13           a13
1.1.1.14           a14

IP-HOST  table is (68 of 2048) 3% full.

;
```

This example displays the output when the `ipaddr` parameter is specified:

```
rtrv-ip-host:ipaddr=1.1.1.13

tekelecstp 13-03-12 10:22:09 EST  EAGLE 45.1

REMOTE IPADDR      REMOTE HOST
                  REALM
1.1.1.13           a13
                  abc.com

IP-HOST table is (68 of 2048) 3% full.

;
```

This example displays the output when the `host` parameter is specified:

```
rtrv-ip-host:host=a13

tekelecstp 13-03-12 10:22:09 EST  EAGLE 45.1

REMOTE IPADDR      REMOTE HOST
                  REALM
1.1.1.13           a13
                  abc.aricent.com

IP-HOST  table is (68 of 2048) 3% full.
```

;

This example displays the output when the output is filtered:

```
rtrv-ip-host:type=local:num=3

tekelecstp 13-03-25 10:22:09 EST  EAGLE 45.1.0
LOCAL IPADDR      LOCAL HOST
                   REALM
192.168.63.51     tekelecdmz11.com

192.168.63.115    tekelecdmz5.com
                   test.com

192.168.73.116    tekelecdmz7.com

IP-HOST table is (68 of 2048) 3% full.

;
```

### Related Topics

- [dlt-ip-host](#)
- [ent-ip-host](#)

## rtrv-ip-lnk

Use this command to retrieve the IP link table.

### Parameters

#### **loc (optional)**

Card location. The unique identifier of a specific application subsystem located in the system.

#### **Range:**

*1101 - 1108, 1111 - 1112, 1201 - 1208, 1211 - 1218, 1301 - 1308, 1311 - 1318, 2101 - 2108, 2111 - 2118, 2201 - 2208, 2211 - 2218, 2301 - 2308, 2311 - 2318, 3101 - 3108, 3111 - 3118, 3201 - 3208, 3211 - 3218, 3301 - 3308, 3311 - 3318, 4101 - 4108, 4111 - 4118, 4201 - 4208, 4211 - 4218, 4301 - 4308, 4311 - 4318, 5101 - 5108, 5111 - 5118, 5201 - 5208, 5211 - 5218, 5301 - 5308, 5311 - 5318, 6101 - 6108, 6111 - 6118, 1113, 1115*

#### **Default:**

All card location link data are displayed.

#### **port (optional)**

Ethernet interface port ID.

#### **Range:**

*a, b, c, d*



**Default:**

All IP link port data associated with all ports on the card are displayed.

**Example**

```
rtrv-ip-lnk:loc=1211:port=a
rtrv-ip-lnk:loc=1211
rtrv-ip-lnk
rtrv-ip-lnk:loc=1211:port=c
```

**Dependencies**

The value specified for the `loc` parameter must correspond to the location of a card that can run an IP application (other than the EROUTE application, which is not supported by this command).

The card in the location specified by the `loc` parameter must support the port specified by the `port` parameter.

**Notes**

Interface A/D is used for ExAP connectivity, and interface B/C is used for signaling network on SLIC cards running the DEIR/SIP/ENUM applications.

**Output**

```
rtrv-ip-lnk

tekelecstp 14-06-05 11:18:06 MST EAGLE5 46.0.0-65.20.0
  LOC  PORT IPADDR          SUBMASK          DUPLEX  SPEED  MACTYPE
AUTO MCAST
  1102  A    10.255.1.2      255.255.255.0    ----   ---   DIX
YES  NO
  1102  B    -----        -----        FULL   100   DIX
NO  NO
  1103  A    192.168.53.52  255.255.255.0    ----   ---   DIX
YES  NO
  1103  B    -----        -----        FULL   100   DIX
NO  NO
  1106  A    192.168.53.50  255.255.255.0    FULL   100   DIX
NO  YES
  1106  B    -----        -----        HALF   10    DIX
NO  NO
  1107  A    192.168.120.2  255.255.255.0    HALF   100   DIX
NO  YES
  1107  B    192.168.121.2  255.255.255.0    HALF   10    DIX
NO  YES
  1111  A    192.168.120.1  255.255.255.0    HALF   100   DIX
NO  YES
  1111  B    192.168.121.1  255.255.255.0    HALF   10    DIX
NO  YES
  1113  A    192.168.53.92  255.255.255.0    ----   ---   DIX
YES  NO
  1115  A    192.168.53.93  255.255.255.0    ----   ---   DIX
```

YES NO

IP-LNK table is (12 of 512) 2% full.

;

rtrv-ip-lnk:loc=1211

rlghncxa03w 04-02-17 15:35:05 EST EAGLE 31.3.0

LOC	PORT	IPADDR	SUBMASK	DUPLEX	SPEED	MACTYPE	AUTO
MCAST							
1211	A	150.123.123.123	255.255.255.0	HALF	10	DIX	NO NO
1211	B	150.123.123.124	255.255.255.0	HALF	10	DIX	NO NO

;

rtrv-ip-lnk:loc=1211:port=a

rlghncxa03w 04-02-17 15:35:05 EST EAGLE 31.3.0

LOC	PORT	IPADDR	SUBMASK	DUPLEX	SPEED	MACTYPE	AUTO
MCAST							
1211	A	150.123.123.123	255.255.255.0	HALF	10	DIX	NO NO

;

rtrv-ip-lnk:loc=1113

rlghncxa03w 10-04-01 21:20:37 GMT EAGLE5 42.0.0

LOC	PORT	IPADDR	SUBMASK	DUPLEX	SPEED	MACTYPE	AUTO
MCAST							
1113	A	150.1.1.1	255.255.255.0	FULL	100	DIX	NO YES
1113	B	-----	-----	FULL	10	DIX	NO NO

;

rtrv-ip-lnk:loc=1115

rlghncxa03w 10-04-01 21:20:37 GMT EAGLE5 42.0.0

LOC	PORT	IPADDR	SUBMASK	DUPLEX	SPEED	MACTYPE	AUTO
MCAST							
1115	A	150.1.2.2	255.255.255.0	FULL	100	DIX	NO YES
1115	B	-----	-----	FULL	10	DIX	NO NO

;.0-69.1.0

rtrv-ip-lnk:loc=1106

Command entered at terminal #4.

LOC PORT

1106 A DUPLEX = FULL SPEED = 100 MACTYPE = DIX AUTO = NO MCAST = NO  
IPADDR = 1.2.3.4 SUBMASK = 255.255.255.0

## Legend

- **LOC**—Card location
- **PORT**—Ethernet interface port ID
- **IPADDR**—IPv4 address for the specified port
- **SUBMASK**—Subnet mask of the IPv4 interface
- **DUPLEX**—Mode of operation of the interface
- **SPEED**—Bandwidth for the interface in megabits per second
- **MACTYPE**—Media Access Control Type of the interface. 802.3 indicates the IEEE standard number 802.3 for Ethernet 1, and DIX indicates the Digital/Inter/Xerox de facto standard for Ethernet 2.
- **AUTO**—Whether to automatically determine duplex and speed. If YES, duplex and speed are automatically determined. If NO, duplex and speed are not automatically determined.
- **MCAST**—Multicast Control. Enables or disables multicast support for the interface. This parameter is necessary for INP, G-Port, and G-Flex to establish the connection from the Service Module card to the MPS system.

## Related Topics

- [chg-ip-lnk](#)

# rtrv-ip-node

Use this command to display one or more nodes that are directly connected to a IP data link. This command can display a connection, an application on a node, or an entire node. No parameters are required to display an entire node. An application can be specified by giving either the application name or its IP port on the node.

## Parameters

### **ipaddr (optional)**

Remote host IP address. This address is expressed in standard dot notation. IP addresses consist of the system's network number and the machine's unique host number. An example IP address is 192.126.100.5, where *192.126.100* is the network number and *5* is the machine's host number.

#### **Range:**

*1-223, 0-255*

4 numbers separated by dots

*1-223*—first number

*0-255*—the other three numbers

#### **Default:**

Display all

### **ipapp1 (optional)**

IP application supported by the node.

**Range:***stplan***ipport (optional)**

Logical IP port that addresses the application on the node.

**Range: 1024 - 5000****Default:**

Display all

**iprte (optional)**

Default router IP address. This address is expressed in standard dot notation. IP addresses consist of the system's network number and the machine's unique host number. An example IP address is *192.126.100.5*, where *192.126.100* is the network number and *5* is the machine's host number.

**Range:***1-223, 0-255*

4 numbers, separated by dots

*1-223*-first number*0-255*-the other three numbers**Default:**

Display all

**loc (optional)**

The card location as stenciled on the shelf of the system that contains the link that will be directly connected to the node.

**Range:**

*1101 - 1108, 1111 - 1112, 1201 - 1208, 1211 - 1218, 1301 - 1308, 1311 - 1318, 2101 - 2108, 2111 - 2118, 2201 - 2208, 2211 - 2218, 2301 - 2308, 2311 - 2318, 3101 - 3108, 3111 - 3118, 3201 - 3208, 3211 - 3218, 3301 - 3308, 3311 - 3318, 4101 - 4108, 4111 - 4118, 4201 - 4208, 4211 - 4218, 4301 - 4308, 4311 - 4318, 5101 - 5108, 5111 - 5118, 5201 - 5208, 5211 - 5218, 5301 - 5308, 5311 - 5318, 6101 - 6108, 6111 - 6118*

**Default:**

Display all

**Example**

```
rtrv-ip-node
```

```
rtrv-ip-node:ipappl=stplan
```

```
rtrv-ip-node:ipaddr=193.4.201.50
```

```
rtrv-ip-node:ipaddr=193.4.201.50:ipport=1024
```

```
rtrv-ip-node:loc=1201
```

**Dependencies**

Only one of the `ipappl`, `ipport`, or `loc` parameters can be specified in the command.

The `ipaddr` parameter must be specified before the `ipport` parameter can be specified.

The shelf and card must be equipped.

If the `loc` parameter is specified, the card location must be equipped with an IP data link.

If the `iprte` parameter is not specified, then all IP nodes meeting the display criteria are displayed. If the IP node has no IP router assigned to it, dashes are displayed in the `IPRTE` field.

### Notes

None

### Output

```
rtrv-ip-node
```

```
rlghncxa03w 04-02-04 21:16:43 EST EAGLE 31.3.0
IPADDR      IPPORT  IPAPPL  LOC   CAP  IPRTE
193.4.201.50 1024   stplan 1201 10%  --
193.4.201.50 1024   stplan 1202 10%  --
193.4.201.50 1024   stplan 1203 20%  --
193.4.202.30 2000   stplan 1204 40%  193.4.201.1
194.5.198.74 3000   stplan 1205 40%  193.4.201.1
197.4.217.39 4000   stplan 1206 40%  197.4.216.1
;
```

```
rtrv-ip-node:ipappl=stplan
```

```
rlghncxa03w 04-02-04 21:16:43 EST EAGLE 31.3.0
IPADDR      IPPORT  IPAPPL  LOC   CAP  IPRTE
193.4.201.50 1024   stplan 1201 10%  --
193.4.201.50 1024   stplan 1202 10%  --
193.4.201.50 1024   stplan 1203 20%  --
193.4.202.30 2000   stplan 1204 40%  193.4.201.1
194.5.198.74 3000   stplan 1205 40%  193.4.201.1
197.4.217.39 4000   stplan 1206 40%  197.4.216.1
;
```

```
rtrv-ip-node:ipaddr=193.4.201.50
```

```
rlghncxa03w 04-02-04 21:16:43 EST EAGLE 31.3.0
IPADDR      IPPORT  IPAPPL  LOC   CAP  IPRTE
193.4.201.50 1024   stplan 1201 10%  --
193.4.201.50 1024   stplan 1202 10%  --
193.4.201.50 1024   stplan 1203 20%  --
;
```

```
rtrv-ip-node:ipaddr=193.4.201.50:ipport=1024
```

```
rlghncxa03w 04-02-04 21:16:43 EST EAGLE 31.3.0
IPADDR          IPPORT  IPAPPL  LOC   CAP  IPRTE
193.4.201.50    1024   stplan 1201  10%  --
193.4.201.50    1024   stplan 1202  10%  --
193.4.201.50    1024   stplan 1203  20%  --
```

```
;
```

```
rtrv-ip-node:loc=1201
```

```
rlghncxa03w 04-02-04 21:16:43 EST EAGLE 31.3.0
IPADDR          IPPORT  IPAPPL  LOC   CAP  IPRTE
193.4.201.50    1024   stplan 1201  10%  --
```

```
;
```

```
rtrv-ip-node:ipaddr=193.4.201.50:ipport=1022
```

```
rlghncxa03w 04-02-04 21:16:43 EST EAGLE 31.3.0
IPADDR          IPPORT  IPAPPL  LOC   CAP  IPRTE
IPPORT on Node not connected to any TCP/IP link.
```

```
;
```

```
rtrv-ip-node:ipaddr=193.4.111.55
```

```
rlghncxa03w 04-02-04 21:16:43 EST EAGLE 31.3.0
IPADDR          IPPORT  IPAPPL  LOC   CAP  IPRTE
IPADDR not connected to any TCP/IP Link.
```

```
;
```

## Legend

- **IPADDR**—Remote host's IP address
- **IPPORT**—Logical IP port to address the application on the node
- **IPAPPL**—IP application supported by the node
- **LOC**—Card location as stenciled on the shelf of the system that contains the TCP/IP link that will be directly connected to the node
- **CAP**—Maximum percentage of ethernet capacity for this node connection
- **IPRTE**—Default router's IP address

## Related Topics

- [dlt-ip-node](#)
- [ent-ip-node](#)

## rtrv-ip-rte

Use this command to display all static IP route entries in the Static IP Route table, entries for a specific card, entries for a specific destination IP address, or entries for a specific gateway IP address.

### Parameters

#### **dest (optional)**

Destination IP Address. The IP Address of a remote destination host or network.

#### **gtwy (optional)**

Gateway IP Address. The IP address assigned to the gateway router that will properly forward IP datagrams with the destination IP address (dest) to the next-hop gateway router or final destination host.

#### **Range:**

4 numbers separated by dots, with each number in the range of 0-255.  
The IP address 0.0.0.0 is not valid.

#### **loc (optional)**

Card location. The unique identifier of a specific IP card in the system.

#### **Range:**

1101 - 1108, 1111 - 1112, 1201 - 1208, 1211 - 1218, 1301 - 1308, 1311 - 1318,  
2101 - 2108, 2111 - 2118, 2201 - 2208, 2211 - 2218, 2301 - 2308, 2311 - 2318,  
3101 - 3108, 3111 - 3118, 3201 - 3208, 3211 - 3218, 3301 - 3308, 3311 - 3318,  
4101 - 4108, 4111 - 4118, 4201 - 4208, 4211 - 4218, 4301 - 4308, 4311 - 4318,  
5101 - 5108, 5111 - 5118, 5201 - 5208, 5211 - 5218, 5301 - 5308, 5311 - 5318,  
6101 - 6108, 6111 - 6118

#### **num (optional)**

Number of IP route entries to be retrieved.

#### **Range:**

1 - 2048

#### **Default:**

2048

### Example

```
rtrv-ip-rte
rtrv-ip-rte:loc=1301
rtrv-ip-rte:dest=128.252.10.5
rtrv-ip-rte:gtwy=140.190.15.3
```

### Dependencies

Only one of the `dest`, `gtwy`, or `loc` optional parameters can be specified in a single command.

The value specified for the `loc` parameter must not correspond to an E5 TDM-A or TDM-B

The specified destination IP address (`dest` parameter):

- Must not be the default route (`0.0.0.0`)
- Must not correspond to any loopback address (i.e. `127.X.X.X`)

The specified gateway IP address (`gtwy` parameter):

- Must not be the default route (`0.0.0.0`)
- Must not correspond to any loopback address (i.e. `127.X.X.X`)

### Notes

None

### Output

```
rtrv-ip-rte
```

```
rlghncxa03w 12-07-23 09:50:17 EST EAGLE 45.0.0
LOC  DEST          SUBMASK          GTWY
1301 128.252.10.5    255.255.255.255 140.188.13.33
1301 128.252.0.0     255.255.0.0     140.188.13.34
1301 150.10.1.1      255.255.255.255 140.190.15.3
1303 192.168.10.1    255.255.255.255 150.190.15.23
1303 192.168.0.0     255.255.0.0     150.190.15.24
```

```
IP Rte (5 of 2048) 1%
```

```
;
```

```
rtrv-ip-rte:loc=1301
```

```
rlghncxa03w 12-07-23 09:50:17 EST EAGLE 45.0.0
LOC  DEST          SUBMASK          GTWY
1301 128.252.10.5    255.255.255.255 140.188.13.33
1301 128.252.0.0     255.255.0.0     140.188.13.34
1301 150.10.1.1      255.255.255.255 140.190.15.3
```

```
IP Rte (5 of 2048) 1%
```

```
;
```

Command Executed

### Notes

### Legend

- **LOC**—Card location
- **DEST**—Destination IP Address. Can be either IPv4 or IPv6 address
- **GTWY**—Gateway IP Address. Can be either IPv4 or IPv6 address
- **SUBMASK**—Subnet mask of the IP interface.



## Related Topics

- [ent-ip-rte](#)

# rtrv-is41-msg

Use this command to display the configured IS41 test message parameter values.

## Parameters

### **msgn (mandatory)**

Message number. The test message number that is retrieved.

### **Range:**

1 - 10

## Example

```
rtrv-is41-msg:msgn=5
```

## Dependencies

The TSTMSG table is corrupt or cannot be found.

None.

## Output

```
rtrv-is41-msg:msgn=1
```

```
tekelecstp 08-12-02 10:47:51 EST EAGLE 40.1.0  
MSG = 1 ACTIVE = YES
```

```
CGPA_GT = 2  
CGPA_GT_NAI = 4 CGPA = 919818000001
```

```
CDPA_GT = 2  
CDPA_GT_NAI = 4 CDPA = 919818000002
```

```
CGPN_NAI = 1 CGPN_NP = 2  
CGPN_ES = 1 CGPN = 919818000007
```

```
CDPN_NAI = 1 CDPN_NP = 2  
CDPN_ES = 1 CDPN = 919818000008
```

```
rtrv-is41-msg:msgn=2
```

```
tekelecstp 11-10-05 11:48:46 EST EAGLE 44.0.0  
MSG = 2 ACTIVE = YES
```

```
CGPA_GT = 4  
CGPA_GT_NAI = 4 CGPA = 919818000009
```

```
CDPA_GT = 4  
CDPA_GT_NAI = 4 CDPA = 919818000005
```

```

CGPN_NAI = 1      CGPN_NP = 2
CGPN_ES = 1      CGPN = none

CDPN_NAI = 1      CDPN_NP = 2
CDPN_ES = 1      CDPN = 919818000003

```

**Related Topics**

- [chg-is41-msg](#)
- [tst-msg](#)

## rtrv-is41opts

Use this command to retrieve the IS41 option indicators maintained in the IS41OPTS table.

**Parameters**

This command has no parameters.

**Example**

```
rtrv-is41opts
```

**Dependencies**

The APORT or IGM feature must be enabled before this command can be entered.

**Output**

```
rtrv-is41opts
```

```
tekelecstp 10-03-15 12:49:20 EST EAGLE 42.0.0
```

```
IS41 OPTIONS
```

```

-----
SMSREQBYPASS      = NO
LOCREQDN          = SCCP
IEC               = NONE
NEC               = NONE
RSPCGPARI         = FRMSG
RSPCGPAPCP       = FRMSG
RSPCDPARI        = FRMSG
RSPCDPAPCP       = OFF
RSPCGPANAI       = NONE
RSPCGPANP        = NONE
RSPCGPAT         = NONE
MTPLOCREQNAI     = FRMSG
RSPPARM          = TLIST
RSPDIG           = RNDN
RSPNON           = NONE
RSPNP            = 2
RSPMIN           = HOMERN
MSCMKTID         = 0

```

```

MSCSWITCH          = 0
ESNMFG             = 0
ESNSN              = 0
RSPDIGTYPE         = 6
LOCREQRMHRN        = NO
TCAPSNAI           = FRMSG
MTPLOCREQLEN       = 15
SPORTTYPE          = IS41
DFLTRN             = 3
LOCREQRSPND        = OFF

```

```
;
```

### Related Topics

- [chg-is41opts](#)
- [chg-is41smsopts](#)
- [rtrv-is41smsopts](#)

## rtrv-is41smsopts

Use this command to display all IS41 SMS options from the database.

### Parameters

**This command has no parameters.**

### Example

```
rtrv-is41smsopts
```

### Dependencies

The EGLEOPTS table is corrupt or cannot be found.

None.

### Notes

None

### Output

```
rtrv-is41smsopts
```

```

tekelecstp 09-06-20 11:49:00 EST  EAGLE 41.1.0
IS41 SMS OPTIONS
-----
BPARTYGTTSN       = NONE           MODAPARAM         = DA
MOIGMPFX          = IS412GSM      MOSMSACLEN        = 0
MOSMSDIGMAT       = EXACT          MOSMSNAI          = NAT
MOSMSGTTDIG       = SCCPCDPA      MOSMSTYPE         = ALL
SPORTTYPE         = GSM           SPFILL            = ON
DEFRN             = abcdef123456789

```

```

MTSMSACKN      = ACK          MTSMSCHKSRC    = NO
MTSMSDNFMT     = RN           MTSMSDLTR      = NO
MTSMSDLTRV     = NONE        MTSMSDIGTYPE   = 6
MTSMSNAKERR    = 5           MTSMSPARM      = DIGIT
MTSMSESN       = NO          MTSMSSSN       = 6
MTSMSTYPE      = RN

```

```
;
```

### Related Topics

- [chg-is41opts](#)
- [chg-is41smsopts](#)
- [rtrv-is41opts](#)

## rtrv-isup-msg

Use this command to display one ISUP test message or all ISUP test messages from the TESTMSG table. The TIF Test Tool processes ISUP test messages to verify the TIF and NPP provisioned configuration in the system.

### Parameters

#### **msgn (optional)**

ISUP Test Message number. The ISUP test message number for which parameter values are displayed.

#### **Range:**

1 - 10

### Dependencies

None.

### Example

```
rtrv-isup-msg
```

### Output

```
rtrv-isup-msg
```

```

tekelecstp 08-10-30 14:55:45 EST  EAGLE 40.0.0
MSG = 1          ACTIVE = NO
  CGPN_NAI = 4          CGPN = 01234567890abcdef
  CDPN_NAI = 4          CDPN = 01234567890abcdef

  CGPN_CAT = 0

  NMBITS = 0
MSG = 2          ACTIVE = YES
  CGPN_NAI = 4          CGPN = 01234567890abcdef

```

```
      CDPN_NAI = 4          CDPN = 01234567890abcdef

      CGPN_CAT = 0

      NMBITS = 0
MSG = 3          ACTIVE = NO
      CGPN_NAI = 4          CGPN = 01234567890abcdef
      CDPN_NAI = 4          CDPN = 01234567890abcdef
      CGPN_CAT = 0
      NMBITS = 0
MSG = 4          ACTIVE = NO
      CGPN_NAI = 4          CGPN = 01234567890abcdef
      CDPN_NAI = 4          CDPN = 01234567890abcdef

      CGPN_CAT = 0

      NMBITS = 0
MSG = 5          ACTIVE = NO
      CGPN_NAI = 4          CGPN = 01234567890abcdef
      CDPN_NAI = 4          CDPN = 01234567890abcdef

      CGPN_CAT = 0

      NMBITS = 0
MSG = 6          ACTIVE = NO
      CGPN_NAI = 4          CGPN = 01234567890abcdef
      CDPN_NAI = 4          CDPN = 01234567890abcdef

      CGPN_CAT = 0

      NMBITS = 0
MSG = 7          ACTIVE = NO
      CGPN_NAI = 4          CGPN = 01234567890abcdef
      CDPN_NAI = 4          CDPN = 01234567890abcdef

      CGPN_CAT = 0

      NMBITS = 0
MSG = 8          ACTIVE = NO
      CGPN_NAI = 4          CGPN = 01234567890abcdef
      CDPN_NAI = 4          CDPN = 01234567890abcdef

      CGPN_CAT = 0

      NMBITS = 0
MSG = 9          ACTIVE = NO
      CGPN_NAI = 4          CGPN = 01234567890abcdef
      CDPN_NAI = 4          CDPN = 01234567890abcdef

      CGPN_CAT = 0

      NMBITS = 0
MSG = 10         ACTIVE = NO
      CGPN_NAI = 4          CGPN = 01234567890abcdef
      CDPN_NAI = 4          CDPN = 01234567890abcdef
```

```

CGPN_CAT = 0

NMBITS = 0
;

rtrv-isup-msg:msgn=10

tekelecstp 08-10-30 14:57:07 EST EAGLE 40.0.0
MSG = 10          ACTIVE = NO
  CGPN_NAI = 4      CGPN = 01234567890abcdef
  CDPN_NAI = 4      CDPN = 01234567890abcdef

  CGPN_CAT = 0

  NMBITS = 0
;

```

**Legend****MSG**—ISUP Test Message number**ACTIVE**—Indicates whether the ISUP test message will be sent to the network card in the test (0=NO, 1=YES)**CGPN\_NAI**—Calling Party Number Nature of Address Indicator**CGPN\_CAT**—CgPN Category**CGPN**—Calling Party Number Digits**CDPN\_NAI**—Called Party Number Nature of Address Indicator**CDPN**—Called Party Number Digits**NMBITS**—Nm Bits that indicate whether a number portability lookup has already been performed in the network**Related Topics**

- [chg-isup-msg](#)
- [tst-msg](#)

## rtrv-j1

Use this command to retrieve information for a specified J1 interface or for all J1 interfaces that have been defined by the ent-j1 command.

**Parameters****loc (optional)**

The card location as stenciled on the shelf of the system.

**Range:**

1101 - 1108, 1111 - 1112, 1201 - 1208, 1211 - 1218, 1301 - 1308, 1311 - 1318,  
2101 - 2108, 2111 - 2118, 2201 - 2208, 2211 - 2218, 2301 - 2308, 2311 - 2318,  
3101 - 3108, 3111 - 3118, 3201 - 3208, 3211 - 3218, 3301 - 3308, 3311 - 3318,  
4101 - 4108, 4111 - 4118, 4201 - 4208, 4211 - 4218, 4301 - 4308, 4311 - 4318,  
5101 - 5108, 5111 - 5118, 5201 - 5208, 5211 - 5218, 5301 - 5308, 5311 - 5318,  
6101 - 6108, 6111 - 6118

**Default:**

All T1 card locations having J1 interfaces configured are listed.

**j1port (optional)**

J1 port number. The value must be a J1 port that has already been configured with a J1 interface on the specified J1 card having application as CCS7ITU.

**Range:**

1-8

**Default:**

If not specified, all T1 card locations having J1 interfaces configured are listed.

**Example**

```
rtrv-j1  
rtrv-j1:loc=1101:j1port=1
```

**Dependencies**

The `loc` and `j1port` parameters must be specified together, if any parameters are specified for the command.

The J1 interface of the J1 card specified by the `loc` parameter must already be defined before this command can be entered.

The card specified by the `loc` parameter must be a LIMT1 card type and the application must be CCS7ITU.

The Card (IMT) table must be accessible.

The J1 table must be accessible.

The port specified by the `j1port` parameter on the card specified by the `loc` parameter must already be equipped with a J1 interface.

The following card locations (`loc` parameter) are not valid for this command: 1113 - 1118 and all `xy09` and `xy10` locations (where `x` is the frame and `y` is the shelf).

The `j1port` parameter must be in the range from 1 to 8.

**Notes**

None.

**Output**

rtrv-j1

tekelecstp 13-12-20 13:16:13 EST 46.0.0-65.3.0

rtrv-j1

J1

LOC	PORT	ENCODE	J1TSEL	LL
1101	3	B8ZS	LINE	133
1102	1	B8ZS	LINE	133
1102	2	B8ZS	LINE	133
1102	3	B8ZS	LINE	133

;

rtrv-j1:loc=1101:j1port=1

tekelecstp 13-12-20 13:16:13 EST 46.0.0-65.3.0

rtrv-j1

J1

LOC	PORT	ENCODE	J1TSEL	LL
1101	3	B8ZS	LINE	133

TS1	1101,A	TS9	1101,B	TS17	-----
TS2	1101,A1	TS10	-----	TS18	-----
TS3	1101,B1	TS11	-----	TS19	-----
TS4	1101,B3	TS12	1102,B3	TS20	-----
TS5	1102,A	TS13	-----	TS21	-----
TS6	-----	TS14	-----	TS22	-----
TS7	1103.A	TS15	-----	TS23	-----
TS8	1104.A	TS16	-----	TS24	-----

;

**Legend**

- LOC-- J1 card location in the shelf.
- J1PORT--Number of the J1 port provisioned on the card in the specified location.
- ENCODE--Indicator for use of B8ZS or AMI encoding/decoding.
- J1TSEL-- J1 timing source indicator (external = master timing source, line= slave timing source).

**Related Topics**

- [chg-j1](#)
- [dlt-j1](#)
- [ent-j1](#)
- [tst-j1](#)



## rtrv-l2t

Use this command to display the values of the SS7 MTP Level 2 timers. The timers are organized in 40 timer sets of 10 timer values each. The timer sets are grouped and system default values are initialized by specification (ANSI, ITU, High Speed for China, High Speed for Q.703 Annex A, JT Q703, and High Speed for Unchannelized T1). Each timer set is administered individually by the `chg-l2t` command. The `ent-slk` command is used to assign an SS7 signaling link to any of the timer sets. Each assigned link is associated with a timer set.

### Parameters

#### l2tset (optional)

Level 2 timer set identifier, or timer set number. Up to 40 different SS7 MTP Level 2 timer sets can be defined.

**Range:**

1 - 40

**Default:**

Displays all timer sets

### Example

```
rtrv-l2t
rtrv-l2t:l2tset=36
```

### Dependencies

The Level 2 Timer Set table is corrupt or cannot be found.

None.

### Notes

The timer values are shown in the output for this command in seconds, even though they were specified in milliseconds in the `chg-l2t` command.

### Output

The timer values are shown in the output for this command in seconds.

```
rtrv-l2t

tekelecstp 02-01-02 18:39:27 MST  EAGLE 46.0.0-65.9.0
rtrv-l2t
Command entered at terminal #3.
;

tekelecstp 02-01-02 18:39:27 MST  EAGLE 46.0.0-65.9.0
LEVEL 2 TIMERS (IN SECONDS)
L2TSET  T1      T2      T3      T4NPP  T4EPP   T5      T6      T7      NODATA  TE
1        9.0     9.0     9.0     2.3    0.60   0.09    4.0    0.3    0.10   --
```

```

2      13.0  11.5  11.5  2.3  0.60  0.10  4.0  1.5  0.10  --
3      13.0  11.5  11.5  2.3  0.60  0.10  4.0  1.5  0.10  --
4      13.0  11.5  11.5  2.3  0.60  0.10  4.0  1.5  0.10  --
5       9.0   9.0   9.0  2.3  0.60  0.10  4.0  0.3  0.10  --
6      13.0  11.5  11.5  2.3  0.60  0.10  4.0  1.5  0.10  --
7      13.0  11.5  11.5  2.3  0.60  0.10  4.0  1.5  0.10  --
8      13.0  11.5  11.5  2.3  0.60  0.10  4.0  1.5  0.10  --
9       9.0   9.0   9.0  2.3  0.60  0.10  4.0  0.3  0.10  --
10     13.0  11.5  11.5  2.3  0.60  0.10  4.0  1.5  0.10  --
11     40.0  30.0   2.0  8.2  0.50  0.10  4.0  1.5  0.10  --
12     49.0  49.0   2.0  8.2  0.50  0.10  4.0  2.0  0.10  --
13     40.0  30.0   2.0  8.2  0.50  0.10  4.0  1.5  0.10  --
14     40.0  30.0   2.0  8.2  0.50  0.10  4.0  1.5  0.10  --
15     40.0  30.0   2.0  8.2  0.50  0.10  4.0  1.5  0.10  --
16     40.0  30.0   2.0  8.2  0.50  0.10  4.0  1.5  0.10  --
17     40.0  30.0   2.0  8.2  0.50  0.10  4.0  1.5  0.10  --
18     40.0  30.0   2.0  8.2  0.50  0.10  4.0  1.5  0.10  --
19     40.0  30.0   2.0  8.2  0.50  0.10  4.0  1.5  0.10  --
20     40.0  30.0   2.0  8.2  0.50  0.10  4.0  1.5  0.10  --
21    150.0 130.0   1.0 30.0  0.50  0.10  5.0  0.8  0.10  --
22     90.0  90.0   2.0 30.0  0.50  0.10  5.0  2.0  0.10  --
23    150.0 130.0   1.0 30.0  0.50  0.10  5.0  0.8  0.10  --
24    150.0 130.0   1.0 30.0  0.50  0.10  5.0  0.8  0.10  --
25    150.0 130.0   1.0 30.0  0.50  0.10  5.0  0.8  0.10  --
26    300.0 130.0   1.0 30.0  0.50  0.10  5.0  0.8  0.10  --
27    300.0 130.0   1.0 30.0  0.50  0.10  5.0  0.8  0.10  --
28    300.0 130.0   1.0 30.0  0.50  0.10  5.0  0.8  0.10  --
29    300.0 130.0   1.0 30.0  0.50  0.10  5.0  0.8  0.10  --
30    300.0 130.0   1.0 30.0  0.50  0.10  5.0  0.8  0.10  --
31    151.0  14.0  14.0 30.0  3.00  0.08  3.0  0.5  0.10  --
32    151.0  14.0  14.0 30.0  3.00  0.08  3.0  0.5  0.10  --
33    151.0  14.0  14.0 30.0  3.00  0.08  3.0  0.5  0.10  --
34    151.0  14.0  14.0 30.0  3.00  0.08  3.0  0.5  0.10  --
35     70.0   7.0   7.0 30.0  3.00  0.12  3.0  2.0  0.10  --
36     15.0   5.0   3.0  --    3.00  0.20  5.0  2.0  0.10  0.024
37     15.0   5.0   3.0  --    3.00  0.20  5.0  2.0  0.10  0.024
38     15.0   5.0   3.0  --    3.00  0.20  5.0  2.0  0.10  0.024
39     15.0   5.0   3.0  --    3.00  0.20  5.0  2.0  0.10  0.024
40     15.0   5.0   3.0  --    3.00  0.20  5.0  3.0  0.10  0.024

```

;

This example displays timer values for a specified timer set:

```
rtrv-l2t:l2tset=36
```

```

tekelecstp 02-01-02 18:42:26 MST  EAGLE 46.0.0-65.9.0
LEVEL 2 TIMERS (IN SECONDS)
L2TSET  T1      T2      T3      T4NPP  T4EPP   T5      T6      T7  NODATA  TE
36      15.0    5.0    3.0    --     3.00  0.20   5.0    2.0  0.10  0.024

```

### Legend

- **L2TSET**—SS7 MTP Level 2 timer set identifier or number

- **T1**—Aligned ready
- **T2**—Not aligned
- **T3**—Aligned
- **T4NPP**—Proving period normal
- **T4EPP**—Proving period Emergency
- **T5**—Sending SIB
- **T6**—Remote congestion
- **T7**—Excessive delay of acknowledgment
- **NODATA**—Amount of time with no data
- **TE**— Error rate monitoring

#### Related Topics

- [chg-l2t](#)
- [ent-slk](#)
- [rtrv-slk](#)

## rtrv-l3t

Use this command to show values of the SS7 level 3 timers. The timers are grouped into sets that are assigned to linksets.

#### Parameters

##### **13tset (optional)**

Level 3 timer set table. Only one level 3 timer set table can be defined. The timer set can then be assigned to a linkset using the `ent-ls` or `chg-l3t` command.

**Range:**

*1*

**Default:**

Display table

#### Example

```
rtrv-l3t:13tset=1
```

#### Dependencies

Only one timer set is supported in this release.

#### Notes

The timer output for this command is in seconds, even though it could have been entered in milliseconds in the `chg-l3t` command.

**Output**

rtrv-l3t:l3tset=1

```

rlghncxa03w 04-02-17 16:03:12 EST EAGLE 31.3.0
LEVEL 3 TIMERS (IN SECONDS)
      L3TSET   T1      T2      T3      T4      T5      T6      T7
          1     0.8     1.4     0.8     0.8     0.8     0.8     1.0

              T8      T9      T10     T11     T12     T13     T14
              0.8     --     30.0    30.0    0.8     0.8     2.0

              T15     T16     T17     T18     IT18     T19     IT19
              3.0     1.4     0.8     10.0    19.0    480.0    67.0

      T20/IT22  IT20    T21/IT23 IT21     T22     T23     T24
              90.0    59.0    90.0    63.0    10.0    10.0    10.0

              T25     T26     T27     T28     T29     T30     T31
              30.0    12.0    --     3.0     60.0    30.0    60.0

              T32
              60.0

```

;

**Legend**

- **L3TSET**—Level 3 timer set table.
- **T1**—Delay, in seconds, to avoid message missequencing on changeover. Also used as the ITU MTP restart isolation timer.
- **T2**—Amount of time, in seconds, to wait for changeover acknowledgment
- **T3**—Time controlled diversion – the delay, in seconds, to avoid missequencing on changeback
- **T4**—Amount of time, in seconds, to wait for changeback acknowledgment, first attempt
- **T5**—Amount of time, in seconds, to wait for changeback acknowledgment, second attempt
- **T6**—Delay, in seconds, to avoid message missequencing on controlled rerouting
- **T7**—Amount of time, in seconds, to wait for signaling data link connection acknowledgment
- **T8**—Transfer-prohibited inhibited timer (transient solution)
- **T10**—Amount of time, in seconds, to wait before repeating the signaling-route-set-test message
- **T11**—Transfer-restricted timer
- **T12**—Amount of time, in seconds, to wait for uninhibit acknowledgment
- **T13**—Amount of time, in seconds, to wait for force uninhibit
- **T14**—The amount of time, in seconds, to wait for inhibition acknowledgment

- **T15**—Amount of time, in seconds, to wait before repeating the signaling-route-set-congestion test
- **T16**—Amount of time, in seconds, to wait for route-set-congestion status update
- **T17**—Delay, in seconds, to avoid oscillation of initial alignment failure and link restart
- **T18**—Repeat TFR once by response method timers
- **IT18**—Timer within an STP whose MTP restarts to supervise the receipt of routing information and the activation of the link and link set. The amount of time, in seconds, to wait for links to align and to receive TRAs from all adjacent nodes.
- **T19**—Failed link craft referral timer
- **IT19**—Amount of time, in seconds, for the supervision timer to wait during MTP restart to avoid ping-pong of TFP, TFR1, and TRA messages
- **T20/IT22**—Amount of time, in seconds, to wait before repeating the local inhibit test
- **IT20**—Amount of time, in seconds, to wait overall for the MTP restart at the signaling point whose MTP restarts
- **T21/IT23**—Amount of time, in seconds, to wait before repeating the remote inhibit test
- **IT21**—Overall MTP restart timer at a signaling point adjacent to one whose MTP restarts
- **T22**—Timer at the restarting STP. The amount of time, in seconds, to wait for signaling links to become available
- **T23**—Timer at the restarting STP. Starting after T22, the amount of time, in seconds, to wait to receive all TRA messages.
- **T24**—Timer at the restarting STP with transfer function. Starting after T23, the amount of time, in seconds, to wait to broadcast all TRA messages.
- **T25**—Timer at the adjacent and restarting STPs. The amount of time, in seconds, to wait for a TRA message (may be started at level 2).
- **T26**—Timer at the restarting STP. The amount of time, in seconds, to wait to repeat a TRW message.
- **T28**—Timer at the STP adjacent to the restarting STP. The amount of time, in seconds, to wait for a TRW message.
- **T29**—Timer started when a TRA message is sent in response to an unexpected TRA or TRW. Also, the timer started when traffic is resumed without receipt of a TRA message.
- **T30**—Timer used to limit the sending of TFPS/TFRs in response to an unexpected TRA or TRW message
- **T31**—False link congestion detection timer
- **T32**—Link oscillation timer—Procedure A

#### Related Topics

- [chg-l2t](#)
- [chg-l3t](#)
- [ent-ls](#)

- [rtrv-l2t](#)
- [rtrv-ls](#)

## rtrv-lbp

Use this command to retrieve the current value of a far-end loopback point maintained in the link fault sectionalization table.

### Parameters

#### **lbp (optional)**

Loopback point ID. A far-end loopback point that lies along an SS7 signaling link path between the STP and the target device (up to and including the target device).

**Range:**

1 - 32

**Default:**

Display all

#### **link (optional)**

SS7 signaling link. The SS7 signaling link that is to be tested.

**Synonym:**

*port*

**Range:**

*a, b, a1 - a31, b1 - b31*

Not all card types support all link parameter values.

See [Table A-1](#) for valid link parameter range values for each type of card that can have assigned signaling links.

**Default:**

Display all

#### **loc (optional)**

Card location. The unique identifier of a specific application subsystem located in the STP.

**Range:**

*1101 - 1108, 1111 - 1112, 1201 - 1208, 1211 - 1218, 1301 - 1308, 1311 - 1318, 2101 - 2108, 2111 - 2118, 2201 - 2208, 2211 - 2218, 2301 - 2308, 2311 - 2318, 3101 - 3108, 3111 - 3118, 3201 - 3208, 3211 - 3218, 3301 - 3308, 3311 - 3318, 4101 - 4108, 4111 - 4118, 4201 - 4208, 4211 - 4218, 4301 - 4308, 4311 - 4318, 5101 - 5108, 5111 - 5118, 5201 - 5208, 5211 - 5218, 5301 - 5308, 5311 - 531, 6101 - 6108, 6111 - 6118*

**Default:**

All card locations.

### Example

```
rtrv-lbp
rtrv-lbp:loc=1202
rtrv-lbp:loc=1202:link=a
rtrv-lbp:loc=1202:link=a:lbp=3
```

## Dependencies

The Link Fault Sectionalization (LFS) feature must be on before this command can be entered.

The card location specified in the `loc` parameter cannot be reserved by the system.

If the `link` parameter is specified, the `loc` parameter must be specified. If the `lbp` parameter is specified, the `loc` and `link` parameters must be specified.

The card location (`loc` parameter) must identify a provisioned E5-E1T1-B card, provisioned with the LIMT1 card type, configured with either the SS7ANSI or CCS7ITU application.

The card location specified in the `loc` parameter must be equipped.

The Link Fault Sectionalization table containing the Loopback Point (LBP) database must be accessible.

## Notes

This command can be canceled using the **F9** function key or the `canc-cmd` command. See `canc-cmd` for more information.

## Output

This example displays the attributes for the loopback points for SS7 links assigned to the STP:

```
rtrv-lbp
```

```
rlghncxa03w 04-02-17 16:02:05 EST EAGLE 31.3.0
LOC  PORTLINK  LBP  RLE  REP  CLLI  LFSST
1101  A         1   DS0  0  -----  LLT
          7   OCU  0  -----  NLT
          9   NEI  0  -----  LLT

1102  A         2   DS0  0  -----  LLT
          3   DS0  4  -----  LLT
          4   NEI  0  -----  LLT

1102  B         1   DS0  0  -----  LLT
          6   NEI  0  -----  LLT

1215  A         1   DS0  0  -----  LLT
          3   DS0  4  -----  LLT
          5   DS0  5  -----  LLT
          7   DS0  8  -----  LLT
          9   NEI  0  -----  LLT
```

```
;
```

This example displays the attributes for the loopback points for the SS7 links A and B of the LIM card residing in the first frame, first shelf, and second slot of the STP:

```
rtrv-lbp:loc=1102
```

```

rlghncxa03w 04-02-17 16:02:05 EST EAGLE 31.3.0
LOC  LINK  LBP  RLE  REP  CLLI  LFST
1102  A     2   DS0  0   -----  LLT
      3   DS0  4   -----  LLT
      4   NEI  0   -----  LLT

1102  B     1   DS0  0   -----  LLT
      6   NEI  0   -----  LLT
;

```

This example displays the attributes for the loopback points for the SS7 link A of the LIM card residing in the first frame, first shelf, and second slot of the STP:

```
rtrv-lbp:loc=1102:link=a
```

```

rlghncxa03w 04-02-17 16:02:05 EST EAGLE 31.3.0
LOC  LINK  LBP  RLE  REP  CLLI  LFST
1102  A     2   DS0  0   -----  LLT
      3   DS0  4   -----  LLT
      4   NEI  0   -----  LLT
;

```

This example displays the attributes for loopback point 3 for the SS7 link A of the LIM card residing in the first frame, first shelf, and second slot of the STP:

```
rtrv-lbp:loc=1102:link=a:lbp=3
```

```

rlghncxa03w 04-02-17 16:02:05 EST EAGLE 31.3.0
LOC  LINK  LBP  RLE  REP  CLLI  LFST
1102  A     3   DS0  4   -----  LLT
;

```

This example displays the attributes for the loopback points for the SS7 link A of the LIM card residing in the first frame, first shelf, and second slot of the STP. No loopback points have been provisioned.

```
rtrv-lbp:loc=1102:link=a
```

```

rlghncxa03w 04-02-17 16:02:05 EST EAGLE 31.3.0
LOC  LINK  LBP  RLE  REP  CLLI  LFST

No loopback points meeting the requested criteria were found
;

```

## Related Topics

- [act-lbp](#)



- [chg-lbp](#)
- [dact-lbp](#)
- [dlt-lbp](#)
- [ent-lbp](#)

## rtrv-lg-card

Use this command to retrieve and display LG card provisioning.

The command class is TKLC\_INTERNAL inheriting properties of DEBUG class.

The Load Generator is supported on IPSG, IPLHC, IPGHC and SS7HC GPLs.

### Parameters

#### loc (mandatory)

The card location as stenciled on the shelf of the system.

#### Range:

1101 - 1108, 1111 - 1112, 1201 - 1208, 1211 - 1218, 1301 - 1308, 1311 - 1318,  
2101 - 2108, 2111 - 2118, 2201 - 2208, 2211 - 2218, 2301 - 2308, 2311 - 2318,  
3101 - 3108, 3111 - 3118, 3201 - 3208, 3211 - 3218, 3301 - 3308, 3311 - 3318,  
4101 - 4108, 4111 - 4118, 4201 - 4208, 4211 - 4218, 4301 - 4308, 4311 - 4318,  
5101 - 5108, 5111 - 5118, 5201 - 5208, 5211 - 5218, 5301 - 5308, 5311 - 5318,  
6101 - 6108, 6111 - 6118

### Example

```
rtrv-lg-card:loc=1302
```

### Dependencies

The card location must not be 1113-1118, or xy09 and xy10 where x is the frame and y is the shelf.

The LG Card table is corrupt or cannot be found.

Loc is mandatory

The card location specified in the loc parameter must be of a provisioned LG card.

### Output

```
rtrv-lg-card:loc=1302
```

```
tekelecstp 09-04-29 18:15:20 EST xx.x.x-xx.x.x
LG Card Configuration
LG Card Loc: 1302    LG Group: lggroup1
5 of 64 Engines (TX - 3, RX - 2), TX - 300 MSUs/sec
```

```
TX Engine(s)

ENGINE      EVENT      ENGINE      EVENT
ENGINE      EVENT      PORT RATE  ACTION RXENGINE  DIR TYPE
CLASS
txengine1   isuptx1    A    100    NONE    -          TX  MSU  INT
```

```

txengine2  isuptx1    A1  100  NONE  -      TX  MSU  INT
txengine3  isuptx1    A2  100  NONE  -      TX  MSU  INT
RX Engine(s)
ENGINE          EVENT          PORT RATE  ACTION RXENGINE  DIR TYPE CLASS
rxengine1      isuprx1        ---  ---   SNK    -      RX  MSU  ---
rxengine2      isuprx2        ---  ---   SNK    -      RX  MSU  ---

```

LG Card table is (1 of 250) 1% full

Command Completed.

;

### Related Topics

- [act-lg-card](#)
- [chg-lg-card](#)
- [dact-lg-card](#)
- [dlt-lg-card](#)
- [ent-lg-card](#)
- [rept-stat-lg](#)

## rtrv-lg-engine

Use this command to retrieve and display LG engine provisioning, as well as the total number of engines configured. The command class is TKLC\_INTERNAL inheriting properties of DEBUG class. The Load Generator is supported on IPSG, IPLHC, IPGHC and SS7HC GPLs.

### Parameters

#### **engine (optional)**

LG Engine name

#### **Range:**

aaaaaaaaaa

Up to 10 alphanumeric characters; the first character must be a letter.

### Example

```
rtrv-lg-engine
```

```
rtrv-lg-engine:engine=rxengine1
```

### Dependencies

The value specified for the `engine` parameter must already exist in the LG Engine table.

The LG Engine table is corrupt or cannot be found.

## Output

```
rtrv-lg-engine
```

```

tekelecstp 09-04-29 18:15:20 EST xx.x.x-xx.x.x
LG Engine Configuration
TX Engine(s)

```

ENGINE	LOC	EVENT	ENGINE	PORT	RATE	ACTION	RXENGINE	EVENT	DIR	TYPE
txengine1	1302	isuptx1	A	100	NONE	-		TX	MSU	INT
rxengine1	1302	isuprx1	-	-	SNK	-		RX	MSU	-

```

RX Engine(s)

```

ENGINE	LOC	EVENT	ENGINE	PORT	RATE	ACTION	RXENGINE	EVENT	DIR	TYPE
rxengine2	1304	isuprx2	-	-	SNK	-		RX	MSU	-
rxengine3	1305	isuprx2	-	-	SNK	-		RX	MSU	-

```

LG Engine table is (4 of 2048) 1% full
Command Completed.
;

```

This example displays the output for a specified LG Engine.

```
rtrv-lg-engine:engine=rxengine1
```

```

tekelecstp 09-04-29 18:15:20 EST xx.x.x-xx.x.x
LG Engine Configuration

```

ENGINE	LOC	EVENT	ENGINE	PORT	RATE	ACTION	RXENGINE	EVENT	DIR	TYPE
rxengine1	1302	isuprx1	-	-	SNK	-		RX	MSU	-

```

LG Engine table is (4 of 2048) 1% full
Command Completed
;

```

## Related Topics

- [act-lg-engine](#)
- [chg-lg-engine](#)
- [dact-lg-engine](#)
- [dlt-lg-engine](#)
- [ent-lg-engine](#)
- [rept-stat-lg](#)

## rtrv-lg-event

Use this command to display an LG event provisioning. The command class is TKLC\_INTERNAL inheriting properties of DEBUG class. The Load Generator is supported on IPSP, IPLHC, IPGHC and SS7HC GPLs.

### Parameters

#### **dir (optional)**

Direction of Event generation or reception.

#### **Range:**

***Tx***  
Transmit Event

***Rx***  
Receive Event

#### **event (optional)**

The name of the LG event.

#### **Range:**

*ayyyyyyyy*

Up to 10 alphanumeric characters; the first character must be a letter

### Example

```
rtrv-lg-event
rtrv-lg-event:event=txisup1
rtrv-lg-event:event=txsnm1
rtrv-lg-event:dir=rx
```

### Dependencies

When failed to read LG Event table.

The value specified for the `event` parameter must already exist in the table.

The `dir` or `event` parameter must be specified.

The value specified for the `event` parameter cannot be an Eagle reserved name

### Output

```
rtrv-lg-event
```

```
tekelecstp 09-04-29 18:15:20 EST xx.x.x-xx.x.x
LG Event Configuration
```

```
TX Event(s)
```

```
EVENT          DIR TYPE CLASS CARD ENGINE          PORT RATE  ACTN RXENGINE
```

```

txisup1      TX  MSU  INT   1302 txengine1  A   100  NONE  -
              1304 txengine10 A1   10  NONE  -
txisup2      TX  MSU  INT   1302 txengine2  B   20  NONE  -
              1304 txengine20 B1   50  NONE  -
txsccp1      TX  MSU  INT   1305 txengine2  B   20  NONE  -
              1306 txengine20 B1   50  NONE  -
txisup3      TX  MSU  INT   ----  -----  ---  -----  -
txsnm1       TX  MSU  INT   1305 txsnmevent1 A   10  NONE  -
txsccp       TX  MSU  INT   1304 txengine5   ---  -----  -
txtest      TX  MSU  INT   1304 txengine15 A    0  NONE  -
RX Event(s)
EVENT        DIR  TYPE  CLASS  CARD  ENGINE      PORT  RATE  ACTN
RXENGINE
rxisup1     RX  MSU  -      1302 rxengine1   ---  -----  SNK  -
LG Event table is (8 of 256) 3% full
Command Completed.
;

```

rtrv-lg-event:event=txisup1

```

tekelecstp 09-04-29 18:15:20 EST xx.x.x-xx.x.x
LG Event Configuration
EVENT        DIR  TYPE  CLASS  CARD  ENGINE      PORT  RATE  ACTION
RXENGINE
txisup1     TX  MSU  INT   1302 txengine1  A   100  NONE  -
              1304 txengine10 A1   10  NONE  -
SIF
  MINSIZE:           MAXSIZE:
MTP LAYER
  SI: 5      DPC :   1-1-1      OPC :   2-2-2
  PRIORITY: 0  MINSLS: 0          MAXSLS: 255
ISUP LAYER
  MINCIC: 0          MAXCIC: 4294967295
LG Event table is (8 of 256) 3% full
Command Completed.
;

```

rtrv-lg-event:event=txsnm1

```

tekelecstp 09-04-29 18:15:20 EST xx.x.x-xx.x.x
LG Event Configuration
EVENT        DIR  TYPE  CLASS  CARD  ENGINE      PORT  RATE  ACTION
RXENGINE
txsnm1     TX  MSU  INT   1305 txsnmevent1 A   10  NONE  -
SIF
  MINSIZE:           MAXSIZE:
MTP LAYER
  SI: 0      DPC :   1-1-1      OPC :   2-2-2
SNM Information
  MINSLS: 0  MAXSLS: 255          CPC :   -
  CNGLVL: 0  CAUSE: 0  USRID: 0  HOH1: TFA
LG Event table is (8 of 256) 3% full

```

```
Command Completed.
;

rtrv-lg-event:dir=rx

tekelecstp 09-04-29 18:15:20 EST xx.x.x-xx.x.x
LG Event Configuration
EVENT      DIR TYPE CLASS CARD ENGINE      PORT RATE ACTION RXENGINE
rxisup1    RX  MSU  -    1302 rxengine1  -    -    SNK    -
LG Event table is (8 of 256) 3% full
Command Completed.
;

rtrv-lg-event:event=txsccp

tekelecstp 09-04-29 18:15:20 EST xx.x.x-xx.x.x
LG Event Configuration
EVENT      DIR TYPE CLASS CARD ENGINE      PORT RATE ACTN RXENGINE
txsccp     TX  MSU  INT  1304 txengine5  ---  -----  -    -
SIF
  MINSIZE: 60    MAXSIZE: 60
MTP LAYER
  SI: 3    DPC :    001-001-001    OPC :    001-001-002
  PRIORITY: 0    MINSLS: 0    MAXSLS: 255
SCCP LAYER
  CLASS: 15    RI: SSN    TT: 100    SSN: 10
  START GTA: -    END GTA: -
LG Event table is (8 of 256) 3% full.
;

rtrv-lg-event:event=txttest

tekelecstp 09-04-29 18:15:20 EST xx.x.x-xx.x.x
LG Event Configuration
EVENT      DIR TYPE CLASS CARD ENGINE      PORT RATE ACTN RXENGINE
txttest    TX  MSU  INT  1304 txengine15  A    0    NONE  -
SIF
  MINSIZE: 40    MAXSIZE: 40
MTP LAYER
  SI: 2    DPC :    001-004-007    OPC :    001-001-003
  PRIORITY: 0    MINSLS: 0    MAXSLS: 255
LG Event table is (8 of 256) 3% full.
;
```

### Related Topics

- [chg-lg-event](#)
- [dlt-lg-event](#)
- [ent-lg-event](#)

- [rept-stat-lg](#)

## rtrv-lg-grp

Use this command to retrieve and display LG card groups. The command class is TKLC\_INTERNAL inheriting properties of DEBUG class. The Load Generator is supported on IPSG, IPLHC, IPGHC and SS7HC GPLs.

### Parameters

#### **grp (optional)**

LG group name

#### **Range:**

aaaaaaaaaa

Up to 10 alphanumeric characters; the first character must be a letter

### Example

```
rtrv-lg-grp
rtrv-lg-grp:grp=lgroup1
```

### Dependencies

The value specified for the `grp` parameter must already exist in the LG Group table.

The LG Group table is corrupt or cannot be found.

### Output

```
rtrv-lg-grp

tekelecstp 09-04-29 18:15:20 EST xx.x.x-xx.x.x
rtrv-lg-grp
Command entered at terminal #4.
LG Group Configuration
Group Name      NUM  LOC
lgroup1         12   1301, 1302, 1304, 1305, 1306, 1307, 1308,
1311,
                1312, 1313, 1314, 1315
lgroup2         1    1304
lgroup3         0    ----
LG Group table is (3 of 16) 19% full
Command Completed.
;
```

```
rtrv-lg-grp:grp=lgroup2

tekelecstp 09-04-29 18:15:20 EST xx.x.x-xx.x.x
rtrv-lg-group:grp=lgroup2
Command entered at terminal #4.
LG Group Configuration
```

```

Group Name      NUM  LOC
lggroup2        1   1304
LG Group table is (3 of 16) 19% full
Command Completed.
;

```

### Related Topics

- [act-lg-grp](#)
- [dact-lg-grp](#)
- [dlt-lg-grp](#)
- [ent-lg-grp](#)
- [rept-stat-lg](#)

## rtrv-lg-sys

Use this command to display and retrieve all LG groups, cards, engines and events provisioning in the system.

The command class is TKLC\_INTERNAL inheriting properties of DEBUG class. The Load Generator is supported on IPSTG, IPLHC, IPGHC and SS7HC GPLs.

### Parameters

No Parameters

### Example

```
rtrv-lg-sys
```

### Dependencies

The LG System table is corrupt or cannot be found.

The LG Engine table is corrupt or cannot be found.

The LG Group table is corrupt or cannot be found.

The LG Card table is corrupt or cannot be found.

When failed to read LG Event table.

### Output

```
rtrv-lg-sys
```

```

tekelecstp 09-04-29 18:15:20 EST xx.x.x-xx.x.x
rtrv-lg-sys
Command entered at terminal #4.
LG System Configuration
DIR      GROUPS   CARDS    ENGINES   EVENTS
TX       -        -        20        30
RX       -        -        10        20
Total    5        10       30        50

```



```
Command Completed.
```

```
;
```

### Related Topics

- [act-lg-sys](#)
- [dact-lg-sys](#)
- [rept-stat-lg](#)

## rtrv-lnp-serv

Use this command to retrieve all LNP services. This command displays the assigned translation type, translation type name, service type, LNP digit validity indication, and TT aliases.

### Parameters

This command has no parameters.

### Example

```
rtrv-lnp-serv
```

### Dependencies

The LNP TT SERV table is corrupt or cannot be found.

The LNP feature must be turned on before this command can be entered.

The LNP database is corrupt or cannot be found.

The GTT Action table is corrupt or cannot be found.

### Notes

None

### Output

This example shows output when EGTT is ON.

```
rtrv-lnp-serv
```

```
rlghncxa03w 10-11-11 13:45:15 EST EAGLE 43.0.0
SERV  TT  TTN      DV   ALIAS  GTTRQD  SELID  DFLTACT
CNAM  1    cnam1    SCCP ---    On     10     fallback
      8     On     20     discact
LIDB  2    lidb1    SCCP ---    Off    None   discact
      19    On     None   falltogtt
AIN   3    ain      TCAP ---    Off    None   fallback
UDF1  22   udf1     TCAP ---    ---    ---    ---
```

```
LNP-SERV TABLE IS 2% FULL (6 of 256)
```

```
;
```

```
rtrv-lnp-serv
```

```
rlghncxa03w 10-11-11 14:42:38 EST EAGLE 43.0.0
SERV TT TTN DV ALIAS GTTRQD SELID DFLTACT
AIN 15 AINGTE TCAP --- On None discact
LIDB 20 LIDB SCCP --- Off None fallback
                    5 On 10 discact
WNP 22 WNP TCAP --- Off 20 fallback
LNPQS 11 LNPQS TCAP --- On None fallback
PCS 12 PCS TCAP --- On 54 discact
CLASS 25 CLASSGTE SCCP --- Off 88 falltogtt
UDF1 201 UDF1 SCCP --- --- --- ---
```

```
LNP-SERV TABLE IS 3% FULL (8 of 256)
```

```
;
```

This example shows output when the LNP SMS feature is turned on and provisioned:

```
rtrv-lnp-serv
```

```
rlghncxa03w 10-11-11 14:42:38 EST EAGLE 43.0.0
SERV TT TTN DV ALIAS GTTRQD SELID DFLTACT
AIN 15 AINGTE TCAP --- On None fallback
                    236 Off None discudts
LIDB 20 LIDB SCCP --- On 10 discact
WNP 22 WNP TCAP --- On 87 fallback
LNPQS 11 LNPQS TCAP --- On 100 fallback
PCS 12 PCS TCAP --- Off None discudts
CLASS 25 CLASSGTE SCCP --- On 34 falltogtt
WSMSC 55 WSMSC SCCP --- On 52 discudts
UDF1 201 UDF1 SCCP --- --- --- ---
```

```
LNP-SERV TABLE IS 3% FULL (9 of 256)
```

```
;
```

This example shows output when the LNP SMS feature is not turned on but is provisioned:

```
rtrv-lnp-serv
```

```
rlghncxa03w 10-11-11 14:42:38 EST EAGLE 43.0.0
SERV TT TTN DV ALIAS GTTRQD SELID DFLTACT
AIN 15 AINGTE TCAP --- Off None discudts
                    236 On None fallback
LIDB 20 LIDB SCCP --- On 10 discact
WNP 22 WNP TCAP --- Off 105 fallback
LNPQS 11 LNPQS TCAP --- On None discact
CLASS 25 CLASSGTE SCCP --- On 30 discudts
WSMSC* 55 WSMSC SCCP --- Off None fallback
UDF1 201 UDF1 SCCP --- --- --- ---
                    235 --- --- ---
```

```

LNP-SERV TABLE IS 3% FULL (9 of 256)
;

```

This example shows output when an entry is provisioned for the LRNQT feature.

```
rtrv-lnp-serv
```

```

rlghncxa03w 10-11-11 14:42:38 EST EAGLE 43.0.0
SERV  TT  TTN      DV   ALIAS  GTTRQD  SELID  DFLTACT
LNPQS  11  LNPQS    TCAP ---    Off    None   falltogtt
PCS    12  PCS      TCAP ---    On     33     discact
AIN    15  AINGTE   TCAP ---    On     None   fallback
                236  Off    39     discact
LIDB   20  LIDB     SCCP ---    On     20     falltogtt
WNP    22  WNP      TCAP ---    Off    None   fallback
CLASS  25  CLASSGTE SCCP ---    On     50     discact
UDF1   201  UDF1     SCCP ---    ---    ---    ---
LRNQT  239  LRNQT    TCAP ---    On     None   fallback

```

```

LNP-SERV TABLE IS 3% FULL (9 of 256)
;

```

This example shows output when Dual ExAP Config is enabled.

```

exap 12-07-10 18:33:00 MST EAGLE 45.0.0-64.37.0
SERV  TT  TTN      DV   ALIAS  RQDTBLNOP  GTTRQD  SELID  DFLTACT
LIDB  1   lidb    SCCP  -----  DISC
                4       UDTS
                225    DISC

```

```

LNP-SERV table is 1% full (3 of 256)
;

```

### Legend

- **SERV**—Reserved service type name
- **TT**—Translation type
- **TTN**—Translation type name
- **DV**—Digits valid
- **ALIAS**—Alias translation type
- **SELID**—GTT Selector ID
- **GTTRQD**—GTT Required
- **DFLTACT**—Default GTT Action ID

### Related Topics

- [chg-lnp-serv](#)
- [dlt-lnp-serv](#)
- [ent-lnp-serv](#)

## rtrv-lnpopts

Use this command to display all the LNP-specific system options from the database.

### Parameters

This command has no parameters.

### Example

```
rtrv-lnpopts
```

### Dependencies

The LNP feature or AINPQ feature must be turned on before this command can be entered.

The LNP Options table must be accessible.

The LNP database must be accessible.

### Notes

None

### Output

The JIPPROV and JIPDIGITS fields appear in the output only when the Triggerless LNP feature is turned on.

```
rtrv-lnpopts

      AMASLPID      = 123456789
      INCSLP        = yes
      AMACTYPE      = 003
      AMAFEATID     = 010
      CIC           = 1369
      AUD           = on
      SP            = a123
      ADMHIPRI      = yes
      GTWYSTP       = yes
      JIPPROV       = yes
      JIPDIGITS     = 919460
      CCP           = no
      SERVPORT      = no
      WQREDRCT      = off
      WSMSC10DIG    = yes
;
```

### Legend

- **AMASLPID**—AMA slip ID
- **INCSLP**—Whether the AMA slip ID included in the response
- **AMACTYPE**—AMA call type

- **AMAFEATID**—AMA feature ID
- **CIC**—Carrier identification code
- **AUD**—Audit indicator
- **SP**—Service provider ID
- **FRCSMPLX**—Allow simplex database updates indicator
- **ADMHIPRI**—LNP database administration has the highest priority of all administration
- **GTWYSTP**—LNP system is configured as a Gateway STP
- **JIPPROV**—Add a Jurisdictional Information Parameter value to the IAM
- **JIPDIGITS**—Jurisdictional Information Parameter value
- **CCP**—Copy Charge Parameters
- **SERVPORT**—Service Portability
- **WQREDRCT**—Wireless queries directed to default GTT
- **WSMS10DIG**—SCCP GTA length indicator for 10 or 11 digits

#### Related Topics

- [chg-lnpopts](#)

## rtrv-log

Use this command to retrieve records from the active or standby Alarm and UIM logs generated by the Maintenance system. This command selects these records based on a span of time or a specific log file index.

#### Parameters

##### **dir (optional)**

Direction in which to obtain entries from within the log (forward or backward) for displaying. See the Dependencies and Notes sections for usage information.

##### **Range:**

###### ***fwd***

Display entries from nearer the beginning of the log toward entries at the end of the log

###### ***bkwd***

Display entries from nearer the end of the log toward entries at the beginning of the log

##### **Default:**

*fwd*

##### **edate (optional)**

End date. Report only log entries that were created on or before the specified date (*dir=fwd*), or only log entries that were created on or after the specified date (*dir=bkwd*). See the Notes section for usage information.

**Range:**

000101 - 991231

(in the form *yymmdd*, where *yy* is year, *mm* is month, and *dd* is day)**Default:**

Report log entries regardless of their creation date

**enum (optional)**

Ending Message Reference Number (MRN) for which to display entries. The ending Alarm or UIM number if specifying a range.

**Range:**

1 - 1999

1-999 —Alarms (UAMs)

1000-1999 —UIMs

**Default:**If *enum* is not specified and:If *snum* is specified, the default *enum* value is the same as the specified *snum* value.If *snum* is not specified and *type* is *alarm* or not specified, the default *enum* value is 999.If *snum* is not specified and *type* is *all* or *uim*, the default *enum* value is 1999.**etime (optional)**End time. Report only log entries that were created on or before the specified time (*dir=fwd*), or only log entries that were created on or after the specified time (*dir=bkwd*). See the Notes section for usage information.**Range:**

000000 - 235959

(in the form *hhmmss*, where *hh*=hours (00-23), *mm*=minutes (00-59), *ss*=seconds (00-59)) *y*)

The time must be specified with 6 digits in a 24-hour format. For example, enter 1:05:03 P.M. as 130503.

**Default:**

Report log entries regardless of their creation time

**mode (optional)**

Log display mode; display all information or just summary information from each log entry.

**Note:**

If the entry is only one line, the same information (one line) is displayed in brief and full mode for that entry.

**Range:*****brief***

Display only the first “Summary” line of the log entry

***full***

Display all information available in the log entry

**Default:**

*full*

**next (optional)**

Number of additional records to display using the same direction (*dir*) and filtering criteria of *outgrp*, *type*, *slog*, and *mode* that were used for the previous successful *rtrv-log* command at the same terminal.

**Range:**

1 - 65500

**num (optional)**

Number of records that can be displayed before the report is stopped.

**Range:**

1 - 65500

**Default:**

15

**outgrp (optional)**

Output Group to sort or filter the Alarms (UAMs) and/or UIMs on.

**Range:**

***all***

Retrieve information for all Output Groups

***appserv***

Application Server

***appss***

Application Subsystem

***card***

Card

***clk***

Clock

***db***

Database

***dbg***

Debug

***gtt***

GTT Maintenance

***gws***

GWS Maintenance

***link***

Link Maintenance

**meas**  
Measurements Maintenance

**mon**  
Monitoring (Sentinel or IMF) Maintenance

**mps**  
MPS Maintenance

**pu**  
Program Update

**sa**  
System Administration

**seas**  
SEAS (Sentinel or IMF)

**slan**  
SLAN Maintenance

**sys**  
System Maintenance

**traf**  
Traffic

**Default:**

If the `next` parameter is not specified, the default is *all*.

If the `next` parameter is specified, the output is the same as the immediately previous successful `rtrv-log` command that was entered at the same terminal (and no `rtrv-log` command was entered at another terminal).

**sdate (optional)**

Start date. Report only log entries that were created on or after the specified date (`dir=fwd`), or only log entries that were created on or before the specified date (`dir=bkwd`). See the Notes section for usage information.

**Range:**

000101 - 991231

(in the form *yymmdd*, where *yy* is year, *mm* is month, and *dd* is day)

**Default:**

Report log entries regardless of their creation date

**slog (optional)**

Source of log. The OAM Maintenance log to access.

**Range:**

**act**  
Active OAM

**stb**  
Standby OAM



**Default:***act***snum (optional)**

A single Alarm or UIM Message Reference Number (MRN), or the starting Alarm or UIM MRN if specifying a range. This parameter cannot be specified when the *outgrp* parameter is specified.

**Range:***1 - 1999**1-999* —Alarms (UAMs)*1000-1999* —UIMs**Default:**

All entries for the specified *type* are displayed.

If *type=all*, *alarm*, or not specified, the default value is *1*.

If *type=uim*, the default value is *1000*.

**stime (optional)**

Start time. Report only log entries that were created on or after the specified time (*dir=fwd*), or only log entries that were created on or before the specified time (*dir=bkwd*). See the Notes section for usage information.

**Range:***000000 - 235959*

(in the form *hhmmss*, where *hh*=hours (00-23), *mm*=minutes (00-59), *ss*=seconds (00-59))

The time must be specified with 6 digits in a 24-hour format. For example, enter 1:05:03 P.M. as *130503*.

**Default:**

Report log entries regardless of their creation time

**type (optional)**

Type of Maintenance log to access for the report.

**Range:***all*

UAMs and UIMs

*alarm*

UAMs

*uim*

UIMs

**Default:***alarm***Example**

```
rtrv-log:sdate=960715:stime=220000:num=50
```

```
rtrv-log:sdate=960715:stime=220000:num=50:snum=106
```

```
rtrv-log:sdate=960715:stime=220000:num=50:snum=106:enum=350
```

```
rtrv-log:sdate=960715:stime=220000:num=50:outgrp=slan:type=all  
rtrv-log:next=100
```

### Dependencies

No other `rtrv-log` command can already be in progress on the same OAM.

The initialization of the ELOG and UIM logs must be complete in the system before the `rtrv-log` command can be entered.

If the `sdate` and `edate` parameters are specified:

- In the forward direction, the `sdate` value must be less than or equal to the `edate` value.
- In the backward direction, the `sdate` value must be greater than or equal to the `edate` value.

The month component of the `sdate` and `edate` parameters must be in the range 1–12.

The day component of the `sdate` and `edate` parameters must be in the range 1–31 and must accurately reflect the number of days in the month and year indicated (see Notes section).

The seconds component of the `stime` and `etime` parameters must be in the range 00–59.

The minutes component of the `stime` and `etime` parameters must be in the range 00–59.

If the `sdate` parameter value is equal to the `edate` parameter value,

- In the forward direction, the `stime` value must be less than or equal to the `etime` value.
- In the backward direction, the `stime` value must be greater than or equal to the `etime` value.

The `sdate` parameter value plus the `stime` parameter value must be less than the current time and date combination.

If `dir=bkwd` is specified with a date and time range, `sdate/stime` must be greater than `edate/etime`.

When the `enum` parameter is specified, the `snum` parameter must be specified with a value less than or equal to the specified `enum` value.

The specified `enum` parameter value and the specified `snum` value must be within the same range: 1-999 for Alarms (UAMs) and 1000-1999 for UIMs.

The `type` parameter and the `snum/enum` parameters cannot be specified together in the command.

The `rtrv-log:next=` command must be entered on the same terminal where the previous successful `rtrv-log` command was entered in the system. No other parameters can be entered with the `next` parameter in the command.

The `rtrv-log:next=` command cannot be entered following a `rtrv-log` command that contained the `type=all` parameter. A `rtrv-log` command without the `type=all` parameter must be entered before the `rtrv-log:next=` command can be entered.

Because entries can be overwritten between the entry of a `rtrv-log` command without the `next` parameter and the entry of a `rtrv-log:next=` command, the `rtrv-log:next:`

command might not execute successfully. Another `rtrv-log` command without the `next` parameter must be entered before the `rtrv-log:next:` command can be entered again,

The values specified for the `edate` with the `stime` parameter combination must be valid.

The values specified for the `edate` with `stime` and `etime` parameter combination must be valid.

When an `enum` parameter is specified, it requires an `snum` as its mated parameter.

No other parameters can be entered with the `next` parameter in the command.

The selected log must be accessible and free of errors.

The standby OAM is corrupt or cannot be found.

When the `snum` parameter is specified, it must be within the valid range: 1-999 for Alarms (UAMs) and 1000-1999 for UIMs.

When the `enum` parameter is specified, it must be within the valid range: 1-999 for Alarms (UAMs) and 1000-1999 for UIMs.

## Notes

This command can be canceled using the **F9** function key or the `canc-cmd` command. See `canc-cmd` for more information.

To accommodate the year 2000 and beyond, the two-digit year portion of dates is interpreted to be in the indicated century as follows:

- years 95–99 = 1995 through 1999
- years 00–94 = 2000 through 2094

This means that date 000101 (Jan. 1, 2000) is greater than 991231 (Dec. 31, 1999).

The day portion of any `sdate/edate` value entered must be in agreement with the month and year. The system issues error message E2252 if the day is found to be not valid (for example, 960631 is not a valid date). The system software and date/time hardware properly handle leap years and leap centuries. The year 2000 is a leap year.

When no date or time parameters are specified, the log display depends on the specified or default values of the `num` and `dir` parameters. The `num` parameter determines the maximum number of entries to display, and the `dir` parameter determines whether entries are displayed from the oldest end (`dir=fwd` or not specified) or the newest end (`dir=bkwd`).

When `sdate` is specified and `edate` is not specified in the forward direction, `edate` is defaulted to be the end of the log.

When `edate` is specified and `sdate` is not specified in the forward direction, `sdate` is defaulted to be the beginning of the log.

When `sdate` is specified and `edate` is not specified in the backward direction, `edate` is defaulted to be the beginning of the log.

When `edate` is specified and `sdate` is not specified in the backward direction, `sdate` is defaulted to be the end of the log.

When `stime` is specified and `etime` is not specified in the forward direction, `etime` is defaulted to 235959.

When `etime` is specified and `stime` is not specified in the forward direction, `stime` is defaulted to 000000.

When `stime` is specified and `etime` is not specified in the backward direction, `rtime` is defaulted to 000000.

When `etime` is specified and `stime` is not specified in the backward direction, `stime` is defaulted to 235959.

When `stime` or `etime` is specified but neither the `sdate` or `edate` parameters are specified, `sdate` and `edate` are each defaulted to the value *today*.

The `num` parameter is used to control the maximum number of entries to be displayed by one command.

The `dir` parameter is used to control whether preceding (older) or following (newer) records are displayed. In either output format, records are displayed in time order regardless of the retrieval control of the `dir` parameter.

Because logging does not stop while records are displaying, old records that were displayed can be overwritten before they are accessed again.

After the date or time is changed in the system, output records can show anomalies in the date-time stamp. An example of this occurs when the time is changed back—in this case records may show that an earlier time follows a later time in the log.

When no Output Group (`outgrp`) is specified, no sorting based on Output Groups and no additional Alarm/UIM breakdown into Output Group categories is done for the report. The log entries will be shown only in the forward or reverse chronological ordering of the logs.

When a unique Output Group is specified, the report is separated into Alarm and UIM categories, and the entries for the specified Output Group are shown in each category.

When `outgrp=all` is specified, the report is separated into Alarm and UIM categories, and the available entries in each category are listed by Output Group.

The `next` parameter is used to display a specified number of additional log records after the previous `rtrv-log` entry at the terminal. New records that are logged after the previous `rtrv-log` command was entered will not be displayed when the `rtrv-log:next=` command is entered. The `next` parameter is valid only under the following conditions:

- The `rtrv-log:next=` command is entered at the same terminal from which the previous `rtrv-log` command was entered. The previous `rtrv-log` command must not include the `type=all` parameter.
- No other terminal has issued a `rtrv-log` command after the `rtrv-log` command entered at the terminal from which the `rtrv-log:next=` command is entered.
- The `next` parameter is the only parameter specified in the `rtrv-log` command.
- There are still logs present that match the conditions (except `time/date/num`) specified in the previous `rtrv-log` command.

When either a single `snum` or range of `snum/enum` is specified, only those Alarms or UIMs within the specified range are displayed.

When `snum` is specified and `enum` is not specified, the `enum` value defaults to the specified `snum` value.

When `enum` is specified, an `snum` value must be specified that is less than or equal to the specified `enum` value.

If an `snum` is specified within the range 1-999, its corresponding `enum` must be greater than or equal to the `snum` and also within the range of 1-999.

If an `snum` is specified within the range 1000-1999, its corresponding `enum` must be greater than or equal to the `snum` and also within the range of 1000-1999.

When `enum` is not specified and the specified `snum` Alarm or UIM does not exist (is not currently used in the system), a scroll area message indicates that the `snum` value is out of range.

If `snum` and `enum` are specified and one or both specified Alarms and/or UIMs do not exist (are not currently used in the system), the report lists all existing Alarms and/or UIMs that exist within the specified range.

The Alarm log only stores minimal information about each alarm. Only a few alarms support multiple-line formats that would be displayed when `mode=full` is used. The majority of alarms display the same information when either `mode=full` or `mode=brief` is used.

## Output

In this example, the sequence numbers that are replaced by the dashes (- - -) represent the UIMs that were discarded due to the UIM thresholding feature:

```
rtrv-log:type=uim:sdate=960715:stime=220000:num=50
```

```
rlghncxa03w 04-02-16 10:15:29 EST EAGLE 31.3.0
Card 1113; SYS REL= Rel 31.3.0; STP CLLI= ncralstp0001; Timezone=
EST
```

```
**** Logged 99-07-16 01:03:09****
0001.1005 CARD 1105,B INFO GWS rcvd OPC that is not allowed
          SIO=01 OPC=001-001-001 DPC=002-002-002
          H0H1=000 AFTPC=003-003-003
          TEST MODE
          SR=scrib LSN=A1234567
          Report Date: 99-07-16 Time: 01:00:01
**** Logged 99-07-16 01:03:34****
----.1004 CARD 1205,B INFO MTP rcvd unknown DPC
          SIO=07 OPC=001-001-001 DPC=002-002-002
          LSN=A1234567
          Report Date: 99-07-16 Time: 01:01:00
**** Logged 99-07-16 01:03:55****
0014.1019 CARD 1103 INFO SCCP rcvd invalid UDTS msg
          SIO=03 OPC=001-001-001 DPC=002-002-002
          CDPA: SSN=005 TT=250
          CGPA: SSN=000 TT=000
          RETURN CAUSE=001
          DATA=26 80 03 09 0e 06 09 00 fe 08 50 55
                43 00
```

LSN=A1234567  
Report Date: 99-07-16 Time: 01:00:05

;

This example shows the records in the log created after 15 July 2003 at 10 PM up to a maximum of 50 records:

rtrv-log:sdate=030715:stime=220000:num=50

```
ncralstp00001 10-03-16 10:15:29 EST EAGLE 42.0.0
Card 1113; SYS REL= 31.3.0; STP CLLI= ncralstp00001; Timezone= EST

****03-07-15 22:03:09****
3159.0013 ** CARD 1207 CCS7ITU      Card is isolated from the system
****03-07-15 22:03:11****
3160.0046  TERMINAL 10             Terminal enabled
****03-07-16 00:23:55****
3161.0200  SLK 1103,B              RCVRY-LKF: link available
****03-07-16 01:42:18****
3162.0155 * DLK 2117,A             STPLAN Connection unavailable
****03-07-16 01:43:51****
3163.0317  LSET A123456789         RCVRY-LKSTO: linkset allowed
****03-07-16 02:35:16****
3164.0082 * FUSE PANEL 11xx        Alarm in fuse panel
****03-07-16 03:00:23****
3165.0108 ** IMT BUS A             Major IMT fault detected
****03-07-16 03:37:59****
3166.0292 *C GLS SYSTEM            GLS is not available
****03-07-16 07:22:06****
3167.0313 *C DPC 021-005-000       DPC is prohibited
****03-07-16 09:33:17****
3168.0348 * SEAS SYSTEM            SEAS is at minimum service
****03-07-16 09:34:01****
3169.0112 * IMT SYSTEM             Major Failures detected on both
****03-07-16 09:35:07****
3170.0160 * CLOCK SYSTEM           1116-S clock failed
****03-07-16 09:36:34****
3171.0160 * CARD 1116 OAM          1116-S clock failed
****03-07-16 09:37:23****
3172.0065 * CLOCK                  Minor holdover clock trouble detected
****03-07-16 09:38:12****
3173.0308 *C SYSTEM                Node isolated due to SLK failure
****03-07-16 09:39:56****
3174.0331 *C SCCP SYSTEM            SCCP is not available
****03-07-16 09:40:15****
3175.0002 * GPL SYSTEM OAM         Card is not running approved GP
****03-07-16 09:41:34****
3176.0153 *C SLAN SYSTEM            STPLAN not available
****03-07-16 09:42:45****
3177.0060 * CDT 9                  Minor customer trouble
detected
****03-07-16 09:45:29****
3180.0321 * XLIST                   X-LIST occupancy threshold Exceeded
****03-07-16 09:48:48****
```

```

3181.0175 * SECURITY 1114          LOGBUFROVL-SECULOG - upload
required
****03-07-16 10:23:47****
0259.0084 ** DSM 1101,B          IP Connection Unavailable
Failed Channels: Prov Dnld TCP UDP
****03-07-16 10:25:41****
0069.0084 ** STC 1105,B          IP Connection Unavailable
ERROR STATUS: DHCP Lease. Physical Link.
;

UAM Report terminated - end of log reached.
END OF ALARM LOG REPORT.
;

```

This example shows the records in the log created after 15 July 2003 at 10 PM for Alarm (UAM) 160:

```

rtrv-log:sdate=030715:stime=220000:num=50:snum=160

ncralstp00001 03-07-16 10:15:29 EST EAGLE 31.3.0
Card 1113; SYS REL= 31.3.0; STP CLLI= ncralstp00001; Timezone= EST

****03-07-16 09:35:07****
3170.0160 * CLOCK SYSTEM          1116-S clock failed
****03-07-16 09:36:34****
3171.0160 * CARD 1116 OAM          1116-S clock failed
;

UAM Report terminated - end of log reached.
END OF LOG REPORT.
;

```

This example shows the records in the log created after 15 July 2003 at 10 PM that include Alarms (UAMs) 106 - 350:

```

rtrv-log:sdate=030715:stime=220000:num=50:snum=106:enum=350

ncralstp00001 10-03-16 10:15:29 EST EAGLE 42.0.0
Card 1113; SYS REL= 31.3.0; STP CLLI= ncralstp00001; Timezone= EST

****03-07-16 00:23:55****
3161.0200 SLK 1103,B          RCVRV-LKF: link available
****03-07-16 01:42:18****
3162.0155 * DLK 2117,A          STPLAN Exceededn unavailable
****03-07-16 01:43:51****
3163.0317 LSET A123456789      RCVRV-LKSTO: linkset
allowed
****03-07-16 03:00:23****
3165.0108 ** IMT BUS A          Major IMT fault detected
****03-07-16 03:37:59****
3166.0292 *C GLS SYSTEM          GLS is not available
****03-07-16 07:22:06****

```

```

3167.0313 *C DPC 021-005-000      DPC is prohibited
****03-07-16 09:33:17****
3168.0348 * SEAS SYSTEM          SEAS is at minimum service
****03-07-16 09:34:01****
3169.0112 * IMT SYSTEM           Major Failures detected on both
****03-07-16 09:35:07****
3170.0160 * CLOCK SYSTEM         1116-S clock failed
****03-07-16 09:36:34****
3171.0160 * CARD 1116 OAM        1116-S clock failed
****03-07-16 09:38:12****
3173.0308 *C SYSTEM             Node isolated due to SLK failure
****03-07-16 09:39:56****
3174.0331 *C SCCP SYSTEM         SCCP is not available
****03-07-16 09:41:34****
3176.0153 *C SLAN SYSTEM        STPLAN not available
****03-07-16 09:45:29****
3180.0321 * XLIST                X-LIST occupancy threshold Exceeded
****03-07-16 09:48:48****
3181.0175 * SECURITY 1114        LOGBUFROVL-SECULOG - upload required
;

UAM Report terminated - end of log reached.
END OF LOG REPORT.
;

```

This example shows the records in the log created after 15 July 2003 at 10 PM for Alarms (UAMs) and UIMs in the SLAN Output Group:

```
rtrv-log:sdate=030715:stime=220000:num=50:outgrp=slan:type=all
```

```

ncralstp00001 03-07-16 10:15:29 EST  EAGLE 31.3.0
Card 1113; SYS REL= 31.3.0; STP CLLI= ncralstp00001; Timezone= EST

Alarm Output Group - SLAN
****03-07-16 09:41:34****
3176.0153 *C SLAN SYSTEM          STPLAN not available

UIM Output Group - SLAN
**** Logged 03-07-16 01:03:09****
0001.1005  CARD 1105,B  INFO  GWS rcvd OPC that is not allowed
          SIO=01  OPC=001-001-001  DPC=002-002-002
          H0H1=000  AFTPC=003-003-003
          TEST MODE
          SR=scrib  LSN=A1234567
          Report Date: 03-07-16  Time: 01:00:01
;

Report terminated - end of log reached.
END OF LOG REPORT.
;

```

This example shows the records in the log in the backward direction that were created between 12 June 2003 at 4:48:27 PM and 11 June 2003 at 10:00:45 PM for Alarms (UAMs):



```
rtrv-
log:dir=bkwd:stime=044827:sdate=030612:etime=100045:edate=03061
1
```

```
tekelecstp 03-06-23 04:10:12 EST EAGLE 31.3.0
Card 1115; SYS REL= 31.3.0. STP CLLI= tekelecstp; Timezone= EST
```

```
Report Initiated - extended processing time required
```

```
****03-06-12 04:48:27****
5001.0009 CARD 1115 EOAM MASP became active
****03-06-11 13:38:55****
5003.0002 * GPL SYSTEM BPHMUX Card is not running approved
GPL
****03-06-11 13:38:55****
5002.0002 * GPL SYSTEM BPDCM Card is not running approved
GPL
****03-06-11 13:36:04****
5001.0009 CARD 1115 EOAM MASP became active
****03-06-11 12:15:29****
5001.0009 CARD 1115 EOAM MASP became active
****03-06-11 11:19:51****
5001.0009 CARD 1115 EOAM MASP became active
****03-06-11 10:00:46****
5019.0109 IMT SYSTEM All IMT System level alarms
cleared
****03-06-11 10:00:45****
5018.0106 IMT BUS B IMT Bus alarm cleared
****03-06-11 10:00:45****
5017.0106 IMT BUS A IMT Bus alarm cleared
****03-06-11 10:00:45****
5016.0014 CARD 1107 SS7ANSI Card is present
ASSY SN: 10200301518
****03-06-11 10:00:45****
5015.0111 ** IMT SYSTEM Failure on both IMT A and IMT
B
UAM Report terminated - 11 records displayed
END OF LOG REPORT.
;
```

This example shows all the records in the log in the backward direction (UAMs and UIMs):

```
rtrv-log:type=all
```

```
tekelecstp 06-01-06 09:16:20 EST EAGLE 35.0.0
Card 1113; SYS REL= 35.0.0; STP CLLI= tekelecstp; Timezone= ****
```

```
****06-01-06 09:06:49****
0002.0009 CARD 1113 EOAM MASP became active
****06-01-06 09:11:16****
0004.0143 * CARD 1113 EOAM System release GPL(s) not
approved
```

```

****06-01-06 09:13:54****
0005.0048 * TERMINAL 4 Terminal failed
****06-01-06 09:13:59****
0006.0046 TERMINAL 2 Terminal enabled
UAM Report terminated - end of log reached
;

tekelecstp 06-01-06 09:16:22 **** EST EAGLE 35.0.0
Card 1113; SYS REL= 35.0.0; STP CLLI= tekelecstp; Timezone= ****

****Logged 06-01-06 09:10:43****
0003.1083 SYSTEM INFO REPT COND: system alive
Report Date:06-01-06 Time:09:10:43
****Logged 06-01-06 09:15:43****
0007.1083 SYSTEM INFO REPT COND: system alive
Report Date:06-01-06 Time:09:15:43
UIM Report terminated - end of log reached
END OF LOG REPORT.
;

```

This example shows the log records in the backward direction that include Alarms (UAMs) 937 and 938 for the RTD System:

```
rtrv-log:dir=bkwd:num=10
```

```

stdcfg1b 13-06-23 00:05:42 WET EAGLE 35.6.0
Card 1113; SYS REL= 35.6.0; STP CLLI= stdcfg1b; Timezone= WET

****13-06-23 00:03:42****
0936.0542 RTD SYSTEM MSU cksum error threshold cleared
****13-06-22 23:15:12****
0915.0541 *C RTD SYSTEM MSU cksum error threshold exceeded
****13-06-21 21:50:24****
0144.0542 RTD SYSTEM MSU cksum error threshold cleared
****13-06-21 21:48:47****
0142.0541 *C RTD SYSTEM MSU cksum error threshold exceeded
****13-06-21 21:32:03****
0138.0096 CARD 1101 SS7ML Card has been reloaded
****13-06-21 21:31:40****
0137.0002 * GPL SYSTEM SS7ML Card is not running approved GPL
****13-06-21 21:31:28****
0136.0109 IMT SYSTEM All IMT System level alarms cleared
Outstanding IMT BUS A failure for card 1111, 1113
****13-06-21 21:31:28****
0135.0106 IMT BUS B IMT Bus alarm cleared
UAM Report terminated - max. or num= count reached
END OF LOG REPORT.
;

```

## rtrv-loopset

Use this command to retrieve loopset data from the database.

## Parameters

### **disp (optional)**

Display method. The manner in which the retrieved data is displayed.

#### **Range:**

##### ***detail***

Provides detailed information for a loopset entry.

##### ***list***

Provides a list of loopset entries.

#### **Default:**

*detail*

### **force (optional)**

#### **Range:**

***yes***

### **mode (optional)**

Mode of operation. Retrieves loopset entries that have been assigned the specified mode.

#### **Range:**

##### ***notify***

Generates a UIM without discarding the message.

##### ***discard***

Generates a UIM and discards the message.

### **name (optional)**

Loopset name.

#### **Range:**

*ayyyyyyy*

1 alphabetic and up to 7 alphanumeric characters.

### **num (optional)**

The number of entries to be retrieved.

#### **Range:**

*1 - 1000*

#### **Default:**

*50*

## Example

This example provides detailed information for the first 50 valid loopset entries in the loopset table.

```
rtrv-loopset
```

This example provides detailed information for the loopset entry RTP1.

```
rtrv-loopset:name=rtp1
```

This example provides detailed information for the first 100 valid loopset entries in the loopset table.

```
rtrv-loopset:num=100:force=yes
```

This example provides a list of the first 100 valid loopset entries in the loopset table.

```
rtrv-loopset:force=yes:num=100:disp=list
```

This example provides detailed information for the first 100 valid loopset entries set to *discard* mode in the loopset table.

```
rtrv-loopset:force=yes:num=100:mode=discard
```

This example provides a list of the first 100 valid loopset entries set to *notify* mode in the loopset table.

```
rtrv-loopset:force=yes:num=100:mode=notify:disp=list
```

### Dependencies

If the value of the `num` parameter is greater than 50, then the `force=yes` parameter must be specified.

The value of the `name` parameter must already exist in the database.

The SCCP Loop Detection feature must be enabled before this command can be entered.

The GTT feature must be turned on before this command can be entered.

The Loopset table must be accessible.

The `name=none` parameter cannot be specified.

If the `name` parameter is specified, then the `disp=list` parameter cannot be specified.

### Output

This example displays loopset entry details for loopset RTP1:

```
rtrv-loopset:name=rtp1
```

```
rlghncxa03w 07-02-10 08:52:38 EST EAGLE Rel 35.6.0
```

```

LoopSet   Mode      Point Codes
=====
RTP1      Discard  005-005-005      007-007-007      (ANSI)
          003-007-003      005-007-005
          005-004-005

```

```
;
```

This example displays details for up to 100 loopset entries:

```
rtrv-loopset:num=100:force=yes
```

```
rlghncxa03w 07-02-10 08:59:18 EST EAGLE Rel 35.6.0
```

```

LoopSet   Mode      Point Codes
=====
Cary2     Notify   005-015-005      007-007-007      (ANSI)

```

```

                                033-007-003      005-027-005
Cary4      Notify  005-012-005      007-026-007      (ANSI)
                                033-002-003      005-008-055

Apex3      Discard 005-017-008      007-017-009      (ANSI)
005-014-005      005-017-005
                                033-002-043      005-038-005
033-003-043      005-012-005

Apex4      Discard 005-007-008      027-007-009      (ANSI)
005-004-055      027-001-007
                                033-007-003      005-003-055

RAL5       Notify  005-005-005      007-007-007      (ANSI)
003-001-003      005-007-005
                                003-002-003      005-008-005
003-003-003      005-002-005

RAL6       Notify  005-007-008      007-007-009      (ANSI)
003-007-003

DUNN1     Discard  005-002-055      007-051-007      (ANSI)

RTP9      Discard  005-002-005      007-001-007      (ANSI)
003-007-003      005-003-005
                                005-004-005

RTP5      Discard  005-007-008      007-007-009      (ANSI)

RTP1      Discard  005-005-005      007-007-007      (ANSI)
003-007-003      005-007-005
005-004-005

RTP2      Notify  005-007-008      007-007-009      (ANSI)
;

```

This example displays the names and modes of up to 100 loopset entries:

```
rtrv-loopset:force=yes:num=100:disp=list
```

```

rlghncxa03w 07-02-10 09:03:27 EST EAGLE Rel 35.6.0

LoopSet  Mode      || LoopSet  Mode      || LoopSet  Mode
=====
Cary2    Notify  || Cary4    Notify  || Apex3    Discard
Apex4    Discard || RAL5     Notify  || RAL6     Notify
DUNN1    Discard || RTP9     Discard || RTP5     Discard
RTP1     Discard || RTP2     Notify
;

```

This example displays a list of up to 100 loopset entries that contain the `mode=notify` parameter:

```
rtrv-loopset:force=yes:num=100:mode=notify:disp=list
```

```
rlghncxa03w 07-02-10 09:10:07 EST EAGLE Rel 35.6.0
```

```
LoopSet  Mode      || LoopSet  Mode      || LoopSet  Mode
=====
Cary2    Notify   || Cary4    Notify   || RAL5     Notify
RAL6     Notify   || RTP2     Notify
```

```
;
```

### Related Topics

- [chg-loopset](#)
- [dlt-loopset](#)
- [ent-loopset](#)

## rtrv-ls

Use this command to show the linkset information.

### Parameters

#### **apc (optional)**

ANSI point code with subfields *network indicator-network cluster-network cluster member (ni-nc-ncm)*. The prefix subfield indicates a private point code (*prefix-ni-nc-ncm*).

#### **Range:**

*p-*, 000-255

Specify a valid value for each subfield of the point code, and separate the subfields with a dash (-).

*prefix—p-*

When `chg-sid:pctype=ansi` is specified, *ni = 000* is not valid.

When `chg-sid:pctype=ansi` is specified, *nc = 000* is not valid if *ni = 001-005*.

When `chg-sid:pctype=ansi` is specified, *nc = 000* is valid if *ni = 006-255*.

The point code *000-000-000* is not a valid point code.

#### **apc/apca/apci/apcn/apcn24/apcn16 (optional)**

Adjacent point code.

#### **apci (optional)**

ITU international point code with subfields *zone-area-id*. The *prefix* subfield indicates a spare point code, private point code, or private and spare point code (*prefix-zone-area-id*).

#### **Range:**

*s-*, *p-*, *ps-*, 0-255

Specify a valid value for each subfield of the point code, and separate the subfields with a dash (-).

*prefix—s-*, *p-*, *ps*

zone—0-7  
 area—000-255  
 id—0-7

The point code 0-000-0 is not a valid point code.

#### **apcn (optional)**

ITU national point code in the format of a 5-digit number (*nnnnn*); or 2, 3, or 4 numbers (*members*) separated by dashes (*m1-m2-m3-m4*) as defined by the `chg-stpopts:npcfmti` flexible point code option. A group code must be specified when the ITUDUPPC feature is turned on (*nnnnn-gc*, *m1-m2-m3-m4-gc*). The prefix subfield indicates a spare point code, private point code, or private and spare point code (*prefix-nnnnn*, *prefix-nnnnn-gc*, *prefix-m1-m2-m3-m4*, *prefix-m1-m2-m3-m4-gc*).

#### **Range:**

*s*-, *p*-, *ps*-, 0-16383, *aa-zz*

Specify a valid value for each subfield of the point code, and separate the subfields with a dash (-).

*prefix*—*s*-, *p*-, *ps*

*nnnnn*—0-16383

*gc*—*aa-zz*

*m1-m2-m3-m4*—0-14 for each member; values must sum to 14

#### **apcn24 (optional)**

24-bit ITU national point code with subfields *main signaling area-sub signaling area-signaling point* (*msa-ssa-sp*). The prefix indicates a private point code (*prefix-msa-ssa-sp*).

#### **Range:**

*p*-, 000-255

Specify a valid value for each subfield of the point code, and separate the subfields with a dash (-).

*prefix*—*p*

*msa*—000-255

*ssa*—000-255

*sp*—000-255

#### **apcn16 (optional)**

16-bit ITU national point code with subfields *unit number sub number area main number area* (*un-sna-mna*). The *prefix* indicates a private point code (*prefix-un-sna-mna*).

#### **Range:**

*p*--, 000---127

Specify a valid value for each subfield of the point code, and separate the subfields with a dash (-).

*prefix*---*p*

*un*---000---127

*sna*---000---15

*mna*---000---31

**cggtmod (optional)**

Calling party GT modification indicator. This parameter displays the linksets that have the specified value of the calling party GT modification indicator.

**Range:**

*yes*

*no*

**islrsrb (optional)**

Incoming rotated signaling link selection (SLS) bit. This parameter displays the linksets with the specified rotated bit.

**Range:**

*1 - 8*

ITU linksets— *1-4*

ANSI linksets— *1-8*

**Default:**

Display all link sets

**itutfr (optional)**

ITU TFR (Transfer Restricted) procedure indicator. This parameter displays the linksets that have the specified value of the *itutfr* parameter.

This parameter is valid for ITU national linksets only.

**Range:**

*on*

*off*

**Default:**

Display all link sets

**lsn (optional)**

Linkset name

**Range:**

*ayyyyyyyy*

1 alphabetic character followed by up to 9 alphanumeric characters

**Default:**

Display all link sets

**lst (optional)**

Linkset type. This parameter specifies whether to display proxy links.

This parameter can be specified only when the Proxy Point Code feature is enabled.

**Range:**

*prx*

Display proxy links.



**mtprese (optional)**

ANSI or ITU MTP Restart equipped. This parameter specifies whether the node adjacent to the linkset is equipped with MTP Restart.

**Range:**

**yes**  
equipped

**no**  
not equipped

**Default:**

Display all link sets

**pct (optional)**

This parameter displays the linksets where the Point Code and CIC Translation has the specified status.

**Range:**

**on**

**off**

**ppc (optional)**

ANSI proxy point code with subfields *network indicator-network cluster-network cluster member (ni-nc-ncm)*.

The proxy point code must be a full point code.

**Synonym:**

*ppca*

**Range:**

*000-255*

Specify a valid value for each subfield of the point code, and separate the subfields with a dash (-).

When *chg-sid:pctype=ansi* is specified, *ni = 000* is not valid.

When *chg-sid:pctype=ansi* is specified, *nc = 000* is not valid if *ni = 001-005*.

When *chg-sid:pctype=ansi* is specified, *nc = 000* is valid if *ni = 006-255*.

The point code *000-000-000* is not a valid point code.

**ppc/ppca/ppci/ppcn/ppcn24/ppcn16 (optional)**

Proxy Point Code.

The proxy point code must be a full point code.

**ppci (optional)**

ITU international proxy point code with subfields *zone-area-id*. The *prefix* subfield indicates a spare point code (*prefix-zone-area-id*).

**Range:**

*s-, 0-255*

Specify a valid value for each subfield of the point code, and separate the subfields with a dash (-).

*prefix—s*

zone—0-7  
 area—000-255  
 id—0-7

The point code 0-000-0 is not a valid point code.

#### **ppcn (optional)**

ITU national proxy point code in the format of a 5-digit number (*nnnnn*); or 2, 3, or 4 numbers (members) separated by dashes (*m1-m2-m3-m4*) as defined by the `chg-stpopts:npcfmti` flexible point code option. A group code must be specified when the ITUDUPPC feature is turned on (*nnnnn-gc*, *m1-m2-m3-m4-gc*). The prefix subfield indicates a spare point code (*prefix-nnnnn*, *prefix-nnnnn-gc*, *prefix-m1-m2-m3-m4*, *prefix-m1-m2-m3-m4-gc*).

#### **Range:**

*s-*, 0-16383, *aa-zz*

Specify a valid value for each subfield of the point code, and separate the subfields with a dash (-).

*prefix—s-*  
*nnnnn—0-16383*

*gc—aa-zz*

*m1-m2-m3-m4—0-14* for each member; values must sum to 14

#### **ppcn24 (optional)**

24-bit ITU national point code with subfields *main signaling area-sub signaling area-signaling point* (*msa-ssa-sp*).

#### **Range:**

000-255

Specify a valid value for each subfield of the point code, and separate the subfields with a dash (-).

*msa—000–255*

*ssa—000–255*

*sp—000–255*

#### **ppcn16 (optional)**

16-bit ITU national point code with subfields *unit number-sub number area-main number area* (*un-sna-mna*).

#### **Range:**

000---127

Specify a valid value for each subfield of the point code, and separate the subfields with a dash (-).

*un---000---127*

*sna---000---15*

*mna---000---31*

#### **rands1s (optional)**

Random SLS (signaling link selection). This parameter displays linksets that have the specified value of the `rands1s` parameter.

**Range:****off**

Displays all linksets where random SLS is disabled.

**class0**

Displays linksets where random SLS generation for Class0 SCCP traffic is enabled.

**all**

Displays ITU linksets where random SLS generation for Class0 and Class1 SCCP traffic is enabled and ANSI linksets where random SLS generation for Class0 and ISUP traffic is enabled.

**Default:**

*off*

**s1socbit (optional)**

Other CIC (Circuit Identification Code) Bit. This parameter displays the linksets that have the `s1socbit` parameter set to a value from 5 - 16.

**Range:\***

\*

Specifies all possible values (5-16)

**Default:**

Display all link sets

**s1srsb (optional)**

Rotated SLS (Signaling Link Selection) Bit. This parameter displays the linksets with the specified rotated bit.

**Range:**

1 - 4

**Default:**

Display all link sets

**spc (optional)**

ANSI secondary point code with subfields *network indicator-network cluster-network cluster member (ni-nc-ncm)*.

**Range:**

000-255

Specify a valid value for each subfield of the point code, and separate the subfields with a dash (-).

When `chg-sid:pctype=ansi` is specified, *ni = 000* is not valid.

When `chg-sid:pctype=ansi` is specified, *nc = 000* is not valid if *ni = 001-005*.

When `chg-sid:pctype=ansi` is specified, *nc = 000* is valid if *ni = 006-255*.

The point code *000-000-000* is not a valid point code.

**spc/spca/spci/spcn/spcn24/spcn16 (optional)**

Secondary point code.

**spci (optional)**

ITU international secondary point code with subfields *zone-area-id*. The *prefix* subfield indicates a spare point code (*prefix-zone-area-id*).

**Range:**

*s*-, 0-255

Specify a valid value for each subfield of the point code, and separate the subfields with a dash (-).

*prefix*—*s*

*zone*—0-7

*area*—000-255

*id*—0-7

The point code 0-000-0 is not a valid point code.

**spcn (optional)**

ITU national secondary point code in the format of a 5-digit number (*nnnnn*); or 2, 3, or 4 numbers (members) separated by dashes (*m1-m2-m3-m4*) as defined by the `chg-stpopts:npcfmti` flexible point code option. A group code must be specified when the ITUDUPPC feature is turned on (*nnnnn-gc*, *m1-m2-m3-m4-gc*). The *prefix* subfield indicates a spare point code (*prefix-nnnnn*, *prefix-nnnnn-gc*, *prefix-m1-m2-m3-m4*, *prefix-m1-m2-m3-m4-gc*).

**Range:**

*s*-, 0-16383, *aa-zz*

Specify a valid value for each subfield of the point code, and separate the subfields with a dash (-).

*prefix*—*s*-

*nnnnn*—0-16383

*gc*—*aa-zz*

*m1-m2-m3-m4*—0-14 for each member; values must sum to 14

**spcn24 (optional)**

24-bit ITU national secondary point code with subfields *main signaling area-sub signaling area-signaling point* (*msa-ssa-sp*).

**Range:**

000-255

Specify a valid value for each subfield of the point code, and separate the subfields with a dash (-).

*msa*—000-255

*ssa*—000-255

*sp*—000-255

**spcn16 (optional)**

16-bit ITU national point code with subfields *unit number sub number area main number area* (*un-sna-mna*).

**Range:**

000---127

Specify a valid value for each subfield of the point code, and separate the subfields with a dash (-).

*un*---000---127

```
sna---000---15
```

```
mna---000---31
```

### Example

Display all linksets having the parameter `pct=on`:

```
rtrv-ls:pct=on
```

Display the attributes of all link sets:

```
rtrv-ls
```

Retrieve linkset LS1:

```
rtrv-ls:lsn=ls1
```

Retrieve all link sets with the `mtprse=yes` parameter:

```
rtrv-ls:mtprse=yes
```

Retrieve all link sets that use the `slsocbit` parameter with a value from 5 - 16:

```
rtrv-ls:slsocbit=*
```

Display an ITU linkset to view the settings for the `slsrsb` or `slsocbit` parameters:

```
rtrv-ls:lsn=lsitu
```

Retrieve all ITU national linksets that have the `itutfr` parameter set to `on`:

```
rtrv-ls:itutfr=on
```

Retrieve the specified ITU national linkset and display its setting for the `itutfr` parameter:

```
rtrv-ls:lsn=lsitun
```

Retrieve all linksets where random SLS generation is enabled for SCCP ITU traffic and Class0 ANSI traffic:

```
rtrv-ls:randsls=class0
```

Display all proxy linksets:

```
rtrv-ls:lst=prx
```

Display all linksets using a specified proxy point code:

```
rtrv-ls:ppc=11-11-11
```

Display all linksets using a specified secondary point code:

```
rtrv-ls:spc=2-2-2
```

Display all linksets using a specified adjacent point code:

```
rtrv-ls:apc=1-1-2
```

Retrieves all linksets where calling party global title modification is requested:

```
rtrv-ls:cggtmod=yes
```

Retrieves all link sets with the ISLSRSB value 6:

```
rtrv-ls:islsrsb=6
```

Display all linksets using a specified adjacent point code:

```
rtrv-ls:apcn16=121-10-15
```

## Dependencies

A PCT quantity feature must be enabled before the `pct` parameter can be specified.

The specified linkset must be in the database.

The Linkset table is corrupt or cannot be found.

All optional parameters, except for the combination of the `slsocbit` and `slsrsb` parameters, can only be used individually. Any combination of 2 or more of the optional parameters, other than the specified exception, is invalid.

If the `apcn` parameter is specified as the Adjacent Point Code, then the format of the `apcn` parameter must match the format dictated by the `chg-stpopts:npcfmti` parameter.

The SLSOCB feature must be enabled before the `slsocbit` parameter can be specified.

The Multiple Linksets to Single Adjacent PC (MLS) feature must be turned on before the `apc` and `spc` parameters can be specified.

A NULL pointer was sent into a function. An ATH will also be issued.

The Signaling Link table is corrupt or cannot be found.

The extended link table is corrupt or cannot be found.

The STPOPTS table is corrupt or cannot be found.

At least one linkset must be associated with the value of the `apc` parameter.

The Proxy Point Code feature must be enabled before the `lst=prx` parameter can be specified.

The Proxy Point Code feature must be enabled before the `ppc` parameter can be specified.

The value specified for the `ppc` parameter must be a full point code.

The value specified for the `ppc` parameter must already exist in the Destination table, and the `prx=yes` parameter must have been specified.

The value specified for the `apc` parameter must be a full point code.

The value specified for the `spc` parameter must be a full point code.

The AMGTT feature or the AMGTT CgPA Upgrade feature must be turned on before the `cggtmod` parameter can be specified.

The ISLSRSB feature must be enabled before the `islsbr` parameter can be specified.

The PPC specified must not be a private point code.

## Notes

This command can be canceled using the **F9** function key or the `canc-cmd` command. See `canc-cmd` for more information.

The CLLI, TFATCABMLQ, MTPRSE, and ASL8 fields are displayed only when a specific linkset is specified. The SLSOCBIT and SLSRSB fields are displayed only when a specific linkset is specified, and the linkset must be an ITU linkset.

If the `tfatcabmlq` parameter database value is 0 for a linkset, then the value displayed is one-half (rounded-up) of the number of links assigned to the given linkset (or 1 if there are 2 or fewer links in the linkset).

If the `tfatcabmlq` parameter database value is 0, then the TFA/TCA broadcast minimum link quantity is calculated by the EAGLE to be a minimum of 1 for linksets containing 2 or fewer links, or half (rounded-up) of the number of links configured in the linkset for linksets containing more than 2 links. The calculated value is displayed in the `rtrv-ls` command output.

If the `tfatcabmlq` parameter value is set to a specific value greater than 0, then the EAGLE does not calculate a TFA/TCA broadcast minimum link quantity. The provisioned value is displayed in the `rtrv-ls` command output.

The EAGLE `ent-ls` command allows 10-character linkset names, but entering a linkset name through SEAS is still restricted to 8 characters. In SEAS, a specific linkset with a name greater than 8 characters (entered using the EAGLE command) cannot be retrieved by name. If an asterisk is used for the linkset name in the SEAS `vfy-ls` command, all linksets will be shown; however, the linkset names that are more than 8 characters will have only the first 8 characters shown. Therefore it may appear that there are duplicate linkset names in SEAS `vfy-ls` output, but all linkset names are actually unique.

In this command, only ITU-international and ITU national point codes support the spare point code subtype prefix (s-) and the private and spare point code subtype prefix (ps-). All of the point code types support the private (internal) point code subtype prefix (p-).

The value specified for the `ppc` parameter must be a full point code. Cluster point codes and private point codes are not supported.

The ICNIMAP and OGNIMAP fields are displayed only if the linkset name is specified in the command, the ITU Spare Point Code feature is enabled, and an ITUN or ITUI point code is associated with the linkset.

IPSG linksets have SLKTPS configured. SLKTPS configures the transactions per second for each link assigned to the IPSG linkset. For an IPSG linkset, the calculated IP TPS value (shown under the 'CONFIG' column in the report) is made up of the aggregate calculated SLKTPS of all of the provisioned links in the linkset. Non-IPSG hosted links are not counted in the calculation as they do not support SLKTPS.

If a linkset contains a mixture of IPLIMx M2PA and IPSG-M2PA links, then the command does not report any data below the TPS header or raise alarms.

## Output

The Multiple Linksets to Single Adjacent PC (MLS) feature must be turned on before information can be retrieved for an adjacent point code or a secondary point code.

The Proxy Point Code feature must be enabled before information can be retrieved by proxy point code or proxy linkset.

If information is requested for a linkset, then the secondary point code field is displayed in the output. If the MLS feature is not enabled, or if the linkset was not created with a secondary point code, the field contains dashes.

Headings for unequipped cards are not displayed.

This example shows all linksets where random SLS generation is enabled for Class0 and Class1 SCCP traffic for ITU linksets and Class0 and ISUP traffic for ANSI linksets:

```
rtrv-ls:randsls=all
```

```
tekelecstp 10-03-06 19:36:00 EST EAGLE 42.0.0

      L3T SLT          GWS GWS GWS
LSN      APCA  (SS7)  SCRN SET SET BEI LST LNKS ACT MES DIS SLSCI
NIS
lsa111   001-001-001  none 1  1  no  B  0  off off off no
off

      L3T SLT          GWS GWS GWS
LSN      APCI  (SS7)  SCRN SET SET BEI LST LNKS ACT MES DIS SLSCI
NIS
lsi111   1-001-1      none 1  2  no  B  0  off off off no
off

Link set table is (2 of 1024) 1% full.

;
```

This example shows detailed linkset configuration for linkset LSI111. Random SLS generation is enabled for Class0 and Class1 SCCP traffic:

```
rtrv-ls:lsn=lsi111
```

```
tekelecstp 18-01-22 05:29:51 EST EAGLE 46.6.0.0.0-71.21.0

      L3T SLT          GWS GWS GWS
LSN      APCI  (SS7)  SCRN SET SET BEI LST LNKS ACT MES DIS SLSCI
NIS
lsi111   1-000-1      none 1  2  no  A  0  off off off no
off

      SPCI          CLLI          TFATCABMLQ MTPRSE ASL8
      -----          -----          1          ---  ---

SLSRSB RANDSLS ITUTFR
1      all      off

IPSG  GTTMODE          CGGTMOD
no    CdPA            no

Link set table is (1 of 1024) 1% full.

;
```

This example shows detailed linkset configuration for linkset LS4. Random SLS generation is enabled for SCCP Class0 traffic, and the SLSOCB and the ITUDUPPC features are turned on:



```
rtrv-ls:lsn=ls4
```

```

tekelecstp 18-01-22 05:30:11 EST EAGLE 46.6.0.0.0-71.21.0

      LSN          APCI  (SS7)  SCRN  L3T SLT          GWS GWS GWS
SLSCI NIS
  ls4          1-007-4      none  1  2   no  A   4   off off off
---  off

      SPCA          CLLI          TFATCABMLQ MTPRSE ASL8
GSMSCRN
-----
SLSOCBIT SLSRSB RANDSLS MULTGC ITUTFR
none     1      class0 no     off

IPSG  GTTMODE          CGGTMOD
no    CdPA            no

      L2T          PCR PCR  E1
E1
      LOC  LINK  SLC  TYPE  SET  BPS  ECM  N1  N2  LOC
PORT TS
1    5      1202 B    0  LIME1  11  56000 BASIC ---  ----- 1202
1    6      1202 B1   1  LIME1  11  56000 BASIC ---  ----- 1202
1    7      1202 B2   2  LIME1  11  56000 BASIC ---  ----- 1202
1    8      1202 B3   3  LIME1  11  56000 BASIC ---  ----- 1202

Link set table is (167 of 1024) 16% full.

;
```

This example displays the attributes of all linksets.

 **Note:**

If the `mtpmse` or `slsocibit` parameters are specified, then the output appears the same as the `rtrv-ls` command's output. The command filters the output to display only the linksets that have the specified value of the parameter.

```
rtrv-ls
```

```
tekelecstp 08-02-26 20:11:43 EST EAGLE 38.0.0
```

```

                L3T SLT                GWS GWS GWS
      LSN        APCA  (SS7)  SCRN SET SET BEI LST LNKS ACT MES DIS SLSCI
NIS
lsa1111         011-001-001  none 1  1  no  A  1  off off off no
off
lsa1112         011-001-002  none 1  1  no  A  1  off off off no
off
lsa1121         011-002-001  none 1  1  no  A  1  off off off no
off
lsa1122         011-002-002  none 1  1  no  A  1  off off off no
off
lsa111111      011-011-011  none 1  1  no  A  1  off off off no
off

```

```

                L3T SLT                GWS GWS GWS
      LSN        APCI  (SS7)  SCRN SET SET BEI LST LNKS ACT MES DIS SLSCI
NIS
lsi311         3-001-1      none 1  2  no  A  0  off off off ---
off

```

```

                L3T SLT                GWS GWS GWS
      LSN        APCN24 (SS7) SCRN SET SET BEI LST LNKS ACT MES DIS SLSCI
NIS
lsn24         024-024-024  none 1  2  no  A  0  off off off ---
off

```

Link set table is (7 of 1024) 1% full.

;

In this example:

- The TFATCABMLQ and MTPRSE fields are displayed only when a linkset is specified. The FE-PC of this link set has no CLLI; therefore the CLLI is shown as "-----".
- The SLSOCBIT and SLSRSB fields are not displayed for ANSI linksets.
- RANDSLS information is displayed for an ANSI linkset.

```
rtrv-ls:lsn=ls1
```

```
tekelecstp 18-01-22 05:31:51 EST EAGLE 46.6.0.0-71.21.0
```

```

                L3T SLT                GWS GWS GWS
      LSN        APCA  (SS7)  SCRN SET SET BEI LST LNKS ACT MES DIS SLSCI
NIS
ls1           003-003-003  gws1 1  1  no  A  15  on  on  on  yes
off

```

```

                SPCA          CLLI          TFATCABMLQ MTPRSE ASL8
-----
              7              no          no

```

```
RANDSLS
off
```

```

IPSG GTTMODE          CGGTMOD
no   CdPA             no

LOC LINK SLC TYPE      LP      ATM
1102 A  2  LIMATM     1  1.544M EXTERNAL 5  0  0

LOC LINK SLC TYPE      IPLIML2

L2T                      PCR  PCR

E1  E1
LOC PORT TS
1205 1  1
1205 A  6  LIME1     1  56000 BASIC --- -----

L2T                      PCR  PCR

T1  T1
LOC PORT TS
1206 1  1
1206 A 10  LIMT1     1  56000 BASIC --- -----

```

Link set table is (7 of 1024) 1% full.

;

This example shows output that includes an E1 card.

rtrv-ls:lsn=ls1

```

tekelecstp 18-01-22 05:33:55 EST EAGLE 46.6.0.0.0-71.21.0

LSN          APCA (SS7)  SCRN  L3T SLT          GWS GWS GWS
SLSCI NIS
ls1          003-003-003  none  1  1  no  A  14  off off off
no  off

```

```

          SPCA          CLLI          TFATCABMLQ MTPRSE ASL8
-----
          1          no  no

```

RANDSLS  
off

```

IPSG GTTMODE          CGGTMOD
no   CdPA             no

LOC LINK SLC TYPE      LP      ATM
1103 A  3  LIMATM     1  1.544M EXTERNAL 5  0  0

LOC LINK SLC TYPE      IPLIML2

```

```

                L2T                PCR PCR  E1  E1
                SET BPS      ECM  N1  N2  LOC  PORT TS
1205 A1    7  LIME1  1    56000  BASIC ---  ----- 1205 1    2

```

Link set table is (7 of 1024) 1% full.

;

This example includes an IPLIMx to 8 Points card. The PCT feature is turned on.

```
rtrv-ls:lsn=ls1
```

```
tekelecstp 18-01-22 05:38:00 EST  EAGLE 46.6.0.0.0-71.21.0
```

```

                L3T SLT                GWS GWS GWS
                SET SET BEI LST LNKS ACT MES DIS SLSCI
NIS
ls1          APCA  (SS7)  SCRN  1  1  no  A  15  on  on  on  yes
off

```

```

                SPCA                CLLI                TFATCABMLQ MTPRSE ASL8
                -----  -----  1                no    no

```

```
RANDSLS
off
```

```
IPSG  GTTMODE                CGGTMOD  PCT
no    CdPA                    no      off
```

```

                LP                ATM
                SET BPS      TSEL      VCI  VPI  LL
1102 A    2  LIMATM  1  1.544M  LINE    5    0    0

```

```
LOC  PORT SLC TYPE  IPLIML2
```

```

                L2T                PCR PCR  E1  E1
                SET BPS      ECM  N1  N2  LOC  PORT
TS
1205 A    6  LIME1  1    56000  BASIC ---  ----- 1205 1
1

```

```

                L2T                PCR PCR  T1  T1
                SET BPS      ECM  N1  N2  LOC  PORT
TS
1206 A    10 LIMT1  1    56000  BASIC ---  ----- 1206 1
1

```

Link set table is (7 of 1024) 1% full.

;

This example includes adjacent spare point codes (s-), adjacent private point codes (p-), and adjacent private and spare point codes (ps-):

rtrv-ls

tekelecstp 08-03-05 10:12:31 EST EAGLE 38.0.0

LSN	APCA	(SS7)	SCRN	L3T SET	SLT SET	BEI	LST	LNKS	GWS ACT	GWS MES	GWS DIS
SLSCI NIS											
lsa1	001-001-002		none	1	1	no	A	0	off	off	off
no off											
lsa2	p-001-002-004		none	1	1	no	A	0	off	off	off
no off											
lsa3	p-001-002-005		none	1	1	no	A	0	off	off	off
no off											

LSN	APCI	(SS7)	SCRN	L3T SET	SLT SET	BEI	LST	LNKS	GWS ACT	GWS MES	GWS DIS
SLSCI NIS											
lsn1	s-1-002-3		none	1	2	no	A	1	off	off	off
--- off											
lsn2	s-2-002-2		none	1	2	no	A	1	off	off	off
--- off											
lsn3	s-2-100-1		none	1	2	no	A	1	off	off	off
--- off											
lsn4	s-2-012-1		none	1	2	no	A	1	off	off	off
--- off											
lsn5	2-100-1		none	1	2	no	A	1	off	off	off
--- off											
lsn6	s-3-134-1		none	1	2	no	A	1	off	off	off
--- off											

LSN	APCN	(SS7)	SCRN	L3T SET	SLT SET	BEI	LST	LNKS	GWS ACT	GWS MES	GWS DIS
SLSCI NIS											
lsn410234	ps-1-1-1-2047-aa		none	1	2	no	B	0	off	off	off
--- off											
lsn410235	p-1-1-1-0059-aa		none	1	2	no	B	0	off	off	off
--- off											
lsn4102356	ps-1-1-1-0234-aa		none	1	2	no	B	0	off	off	off
--- off											

Link set table is (12 of 1024) 1% full.

;

This example displays linksets using a specified adjacent point code. The MLS feature must be turned on before information can be retrieved for an adjacent point code:

rtrv-ls:apc=1-1-2

tekelecstp 07-07-26 12:49:06 EST EAGLE 37.5.0

APCA = 001-001-002

L3T SET	SLT SET	GWS ACT	GWS MES	GWS DIS
---------	---------	---------	---------	---------

```

      LSN          SPCA          SCRN SET SET BEI LST LNKS ACT MES DIS SLSCI
NIS
  lsa1          002-002-002    none 1  1  no  A  0   off off off no
off
  rtp4          001-002-005    none 1  1  no  A  0   off off off no
off
  dur16        002-007-042    none 1  1  no  A  0   off off off no
off
  morv12       012-009-005    none 1  1  no  A  0   off off off no
off
  lsa22        004-002-022    none 1  1  no  A  0   off off off no
off

```

Link set table is (12 of 1024) 1% full.

This example displays all linksets when the MLS feature is turned on. The MLS feature allows multiple linksets to have the same adjacent point code.

rtrv-ls

```

      LSN          APCA  (SS7)          L3T SLT          GWS GWS GWS
      SCRN SET SET BEI LST LNKS ACT MES DIS SLSCI
NIS
  lsa1          001-001-002    none 1  1  no  A  0   off off off no
off
  lsa2          p-001-002-004    none 1  1  no  A  0   off off off no
off
  lsa3          p-001-002-005    none 1  1  no  A  0   off off off no
off
  rtp4          001-001-002    none 1  1  no  A  0   off off off no
off
  dur16        001-001-002    none 1  1  no  A  0   off off off no
off
  morv12       001-001-002    none 1  1  no  A  0   off off off no
off
  lsa22        001-001-002    none 1  1  no  A  0   off off off no
off

```

```

      LSN          APCI  (SS7)          L3T SLT          GWS GWS GWS
      SCRN SET SET BEI LST LNKS ACT MES DIS SLSCI
NIS
  lsn1          s-1-002-3          none 1  2  no  A  1   off off off ---
off
  lsn2          2-100-1          none 1  2  no  A  1   off off off ---
off
  lsn3          s-3-134-1        none 1  2  no  A  1   off off off ---
off

```

```

      LSN          APCN  (SS7)          L3T SLT          GWS GWS GWS
      SCRN SET SET BEI LST LNKS ACT MES DIS SLSCI
NIS
  lsn410234    ps-1-1-1-2047-aa none 1  2  no  B  0   off off off ---
off
  lsn410235    p-1-1-1-0059-aa none 1  2  no  B  0   off off off ---

```

off

Link set table is (12 of 1024) 1% full.

This example displays all linksets when the Proxy Point Code feature is enabled.  
Proxy point codes used by the linksets are displayed:

rtrv-ls

homenetwork 08-03-19 17:03:37 EST EAGLE 38.0.0

LSN	APCA	(SS7)	SCRN	L3T SET	SLT SET	BEI	LST	LNKS	GWS ACT	GWS MES	GWS DIS
SLSCI NIS											
x1	001-001-001		none	1	1	no	PRX	0	off	off	off
no off											
x2	001-001-002		none	1	1	no	PRX	0	off	off	off
no off											
x3	001-001-003		none	1	1	no	PRX	0	off	off	off
no off											
x4	001-001-004		none	1	1	no	PRX	0	off	off	off
no off											
x5	001-001-005		none	1	1	no	PRX	0	off	off	off
no off											
x6	001-001-006		none	1	1	no	PRX	0	off	off	off
no off											
x7	001-001-007		none	1	1	no	PRX	0	off	off	off
no off											
x8	001-001-008		none	1	1	no	PRX	0	off	off	off
no off											
x9	001-001-009		none	1	1	no	PRX	0	off	off	off
no off											
x10	001-001-010		none	1	1	no	PRX	0	off	off	off
no off											
y	002-002-002		none	1	1	no	A	0	off	off	off
no off											

Link set table is (11 of 1024) 1% full.

;

This example displays linksets using a specified proxy point code:

rtrv-ls:ppc=2-2-2

homenetwork 07-05-19 17:05:04 EST EAGLE 37.5.0

PPCA = 002-002-002

LSN	APCA	(SS7)	SCRN	L3T SET	SLT SET	BEI	LST	LNKS	GWS ACT	GWS MES	GWS DIS
SLSCI NIS											
x1	001-001-001		none	1	1	no	PRX	0	off	off	off

```

no    off
x2    001-001-002  none 1  1  no PRX 0  off off off no
off
x3    001-001-003  none 1  1  no PRX 0  off off off no
off
x4    001-001-004  none 1  1  no PRX 0  off off off no
off
x5    001-001-005  none 1  1  no PRX 0  off off off no
off
x6    001-001-006  none 1  1  no PRX 0  off off off no
off
x7    001-001-007  none 1  1  no PRX 0  off off off no
off
x8    001-001-008  none 1  1  no PRX 0  off off off no
off
x9    001-001-009  none 1  1  no PRX 0  off off off no
off
x10   001-001-010  none 1  1  no PRX 0  off off off no
off

```

Link set table is (11 of 1024) 1% full.

;

The following example displays all proxy linksets.

```
rtrv-ls:lst=prx
```

```
homenetwork 08-03-19 17:05:40 EST EAGLE 38.0.0
```

```

LSN          APCA  (SS7)  L3T SLT          GWS GWS GWS
SCRN SET SET BEI LST LNKS ACT MES DIS SLSCI
NIS
x1           001-001-001  none 1  1  no PRX 0  off off off no
off
x2           001-001-002  none 1  1  no PRX 0  off off off no
off
x3           001-001-003  none 1  1  no PRX 0  off off off no
off
x4           001-001-004  none 1  1  no PRX 0  off off off no
off
x5           001-001-005  none 1  1  no PRX 0  off off off no
off
x6           001-001-006  none 1  1  no PRX 0  off off off no
off
x7           001-001-007  none 1  1  no PRX 0  off off off no
off
x8           001-001-008  none 1  1  no PRX 0  off off off no
off
x9           001-001-009  none 1  1  no PRX 0  off off off no
off
x10          001-001-010  none 1  1  no PRX 0  off off off no
off

```



Link set table is (11 of 1024) 1% full.

;

This example displays information for a specified linkset when the Proxy Point Code feature is enabled:

rtrv-ls:lsn=x1

```
tekelecstp 18-01-22 05:39:15 EST EAGLE 46.6.0.0-71.21.0

      LSN          APCA   (SS7)   L3T SLT          GWS GWS GWS
SLSCI NIS
      x1           001-001-001  none  1   1   no  PRX  0   on  on  on
yes   off

      PPCA          CLLI          TFATCABMLQ MTPRSE ASL8
      002-002-002  -----  7          ---   no

RANDSLS
off

MATELSN          LSUSEALM SLKUSEALM GTTMODE
-----  ---   ---   CdPA
```

Link set table is (11 of 1024) 1% full.

;

This example displays proxy linksets using a specified adjacent point code when the MLS feature is turned on and the Proxy Point Code feature is enabled:

rtrv-ls:apc=1-1-1

```
tekelecstp 07-03-05 17:32:59 EST EAGLE 37.5.0

APCA   =   001-001-001

      LSN          PPCA          L3T SLT          GWS GWS GWS
SLSCI NIS
      x1           002-002-002  none  1   1   no  PRX  0   off off off
no     off
```

Link set table is (11 of 1024) 1% full.

;

This example displays linksets using a specified secondary point code when the MLS feature is turned on:

```
rtrv-ls:spc=2-2-2
```

```
homenetwork 07-05-19 17:05:04 EST EAGLE 37.5.0
```

```
SPCA = 002-002-002
```

LSN	APCA	(SS7)	SCRN	L3T SET	SLT SET	BEI	LST	LNKS	GWS ACT	GWS MES	GWS DIS	SLSCI
NIS	lsa1	001-001-002	none	1	1	no	A	0	off	off	off	no
off	lsa2	p-001-002-004	none	1	1	no	A	0	off	off	off	no
off												

```
Link set table is (12 of 1024) 1% full.
```

```
;
```

This example displays information for a specific linkset when the MLS feature is turned on:

```
rtrv-ls:lsn=lsa1
```

```
tekelecstp 18-01-22 05:40:51 EST EAGLE 46.6.0.0.0-71.21.0
```

LSN	APCA	(SS7)	SCRN	L3T SET	SLT SET	BEI	LST	LNKS	GWS ACT	GWS MES	GWS DIS	SLSCI
NIS	lsa1	001-001-002	gws1	1	1	no	A	4	on	on	on	yes
off												

```
SPCA          CLLI          TFATCABMLQ MTPRSE ASL8
```

```
002-002-002 ----- 2          --- no
```

```
RANDSLS
```

```
off
```

```
IPSG GTTMODE          CGGTMOD
```

```
no CdPA          no
```

LOC	LINK	SLC	TYPE	LP SET	BPS	ATM TSEL	VCI	VPI	LL
1102	A	2	LIMATM	1	1.544M	EXTERNAL	5	0	0

```
LOC LINK SLC TYPE IPLIML2
```

LOC	LINK	SLC	TYPE	L2T SET	BPS	ECM	PCR N1	PCR N2	E1 LOC	E1
1205	A	6	LIME1	1	56000	BASIC	----	-----	1205	

```
PORT TS
```

```
1 1
```

LOC	LINK	SLC	TYPE	L2T SET	BPS	ECM	PCR N1	PCR N2	T1 LOC	T1 PORT

```

TS
          1206 A      10 LIMT1      1      56000 BASIC --- -----
1206 1      1

```

Link set table is (1 of 1024) 1% full.

;

This example displays output for a specified linkset when calling party GT modification is requested:

```
rtrv-ls:lsn=ls3
```

```

tekelecstp 18-01-22 05:41:01 EST EAGLE 46.6.0.0.0-71.21.0

          L3T SLT                      GWS GWS GWS
LSN      APCA  (SS7)  SCRN SET SET BEI LST LNKS ACT MES DIS
SLSCI NIS
  ls3    002-002-003  none 1   1   no  A   0   off off off
no      off

          SPCA          CLLI          TFATCABMLQ MTPRSE ASL8
GSMSCRN
-----
RANDSLS
off

          IPSG  GTTMODE          CGGTMOD
no      AdvCdPA,CdPA,CgPA  yes

```

Link set table is (1 of 1024) 1% full.

;

This example displays all of the linksets where calling party global title modification is requested.

```
rtrv-ls:cggmod=yes
```

```

tekelecstp 08-02-27 11:56:50 EST EAGLE 38.0.0

          L3T SLT                      GWS GWS GWS
LSN      APCA  (SS7)  SCRN SET SET BEI LST LNKS ACT MES DIS
SLSCI NIS
  abc14368 330-020-000  SEAS 1   1   yes a   2   off off off
no      off
  abc34589 330-030-000  scr1 1   2   no  c   3   on  on  on
yes

          L3T SLT                      GWS GWS GWS
LSN      APCA  (SS7)  SCRN SET SET BEI LST LNKS ACT MES DIS
SLSCI NIS

```

```

      abc32261      330-044-000      scr1  1  1  yes a  1  off off off  ---
off
                                     L3T SLT                                     GWS GWS GWS
      LSN          APCA  (SS7)  SCRN  SET SET BEI LST LNKS ACT MES DIS SLSCI
NIS
                                     L3T SLT                                     GWS GWS GWS
      LSN          APCA  (SS7)  SCRN  SET SET BEI LST LNKS ACT MES DIS SLSCI
NIS

      Link set table is (114 of 1024) 12% full
;

```

This example displays output for an IPSG-M2PA linkset:

```
rtrv-ls:lsn=m2pa12132
```

```

      tekelecstp 18-01-22 05:42:02 EST  EAGLE 46.6.0.0-71.21.0

                                     L3T SLT                                     GWS GWS GWS
      LSN          APCA  (SS7)  SCRN  SET SET BEI LST LNKS ACT MES DIS SLSCI
NIS
      m2pa12132    001-213-002  none  1  1  no  A  1  off off off no
off

      SPCA          CLLI          TFATCABMLQ MTPRSE ASL8
      -----
      RANDSLS
      off

      IPSG          GTTMODE          CGGTMOD
      yes           CdPA             no

      ADAPTER       RSVDSLKTPS      MAXSLKTPS
      m2pa          1000             5000

      TPSALM        LSUSEALM        SLKUSEALM
      maxslktps    100%             80%

      LOC  LINK  SLC  TYPE          ANAME
      1303 A    0    IPSG          m2pa1303a

      Link set table is (20 of 1024) 2% full.
;

```

This example displays the output for an IPSG-M3UA linkset. If value of the `numslk` threshold parameter is provisioned to 0, and the value is recalculated as per the provisioned links within the linkset, then an indication marker "\*" is printed as a superscript to the value of the corresponding parameter.

```
rtrv-ls:lsn=ipsgm3ua
```

```
tekelecstp 18-01-22 05:43:50 EST EAGLE 46.6.0.0.0-71.21.00

      L3T SLT          GWS GWS GWS
LSN      APCA  (SS7)  SCRN SET SET BEI LST LNKS ACT MES DIS
SLSCI NIS
  ipsgm3ua  008-008-004  none 1  1  no  A  3  off off off
no      off

      SPCA          CLLI          TFATCABMLQ MTPRSE ASL8
-----

RANDSLS
off

IPSG  GTTMODE          CGGTMOD
yes   CdPA             no

ADAPTER  RSVDSLKTPS  MAXSLKTPS
m3ua     100          100

TPSALM   LSUSEALM    SLKUSEALM
rsvdslktps 80%      80%

RCONTEXT ASNOTIF      NUMSLKALW  NUMSLKRSTR  NUMSLKPROH
1234567890 yes       2*         1           1

LOC  LINK SLC TYPE    ANAME
1102 A2  0  IPG     ipsgm3ua1102
1202 A3  1  IPG     ipsgm3ua1202
1302 A4  2  IPG     ipsgm3ua1302
```

Link set table is (1 of 1024) 1% full.

```
;
```

This example displays linkset information when the ITU National and International Spare Point Code Support feature is enabled:

```
rtrv-ls:lsn=lsnp1
```

```
tekelecstp 18-01-22 05:44:16 EST EAGLE 46.6.0.0.0-71.21.00

      L3T SLT          GWS GWS GWS
LSN      APCI  (SS7)  SCRN SET SET BEI LST LNKS ACT MES DIS
SLSCI NIS
  lsnp1   1-002-1    none 1  2  no  A  3  off off off
no      off

      SPCI          CLLI          TFATCABMLQ MTPRSE ASL8
-----
                        2          ---  ---
```

```

SLRSRB RANDSLS ITUTFR ICNIMAP      OGNIMAP
1      off      off      itui2ituis  ituis2itui

IPSG  GTTMODE      CGGTMOD
no    CdPA          no

LOC  LINK SLC TYPE      LP      ATM      E1ATM
SET BPS  TSEL  VCI  VPI  CRC4 SI
SN
1104 A  0  LIME1ATM 21  2.048M LINE  5  0  ON  3
0
1105 A  1  LIME1ATM 21  2.048M LINE  5  0  ON  3
0
1106 A  2  LIME1ATM 21  2.048M LINE  5  0  ON  3
0

```

Link set table is (1 of 1024) 1% full.

;

This example displays output for an IPGWx linkset.

```
rtrv-ls:lsn=ls1315a
```

```

tekelecstp 18-01-22 05:46:00 EST  EAGLE 46.6.0.0.0-71.21.0

LSN          APCA  (SS7)  SCRN SET SET BEI LST LNKS ACT MES DIS SLSCI
NIS
ls1315a      000-015-000  none 1  1  no  A  1  off off off no
off

          SPCA          CLLI          TFATCABMLQ MTPRSE ASL8
          -----  -----  1          no  no

RANDSLS
off

IPSG  GTTMODE      CGGTMOD
no    CdPA          no

MATELSN      LSUSEALM  SLKUSEALM
-----  100%    80%

LOC  LINK SLC TYPE
1315 A  0  SS7IPGW

```

Link set table is (18 of 1024) 2% full.

;

This example displays linkset information for an ANSI linkset when the Incoming SLS Bit Rotation feature is enabled:

```
rtrv-ls:lsn=ls6
```

```
tekelecstp 18-01-22 05:47:41 EST EAGLE 46.6.0.0.0-71.21.0
```

```

          L3T SLT          GWS GWS GWS
LSN      APCA  (SS7)  SCRN SET SET BEI LST LNKS ACT MES DIS
SLSCI NIS
  ls06    002-007-008  scr4 1  4  no  a  0  on  off off
no      on

```

```

          SPCA          CLLI          TFATCABMLQ MTPRSE ASL8
-----
          ls06clli          1          no  no

```

```
RANDSLS
off
```

```
ISLSRSB RSL8
1      no
```

```
IPSG GTTMODE          CGGTMOD
no   CdPA          no
```

```
Link set table is ( 20 of 1024) 2% full
```

```
;
```

This example displays linkset information for an ITU linkset when the Incoming SLS Bit Rotation feature is enabled:

```
rtrv-ls:lsn=lsi111
```

```
tekelecstp 18-01-22 05:48:03 EST EAGLE 46.6.0.0.0-71.21.0
```

```

          L3T SLT          GWS GWS GWS
LSN      APCI  (SS7)  SCRN SET SET BEI LST LNKS ACT MES DIS
SLSCI NIS
  lsi111  1-001-1    none 1  2  no  A  0  off off off
no      off

```

```

          SPCI          CLLI          TFATCABMLQ MTPRSE ASL8
-----
          1          ---  ---

```

```
SLSOCSBIT SLRSRSB RANDSLS ITUTFR
none      1      off  off
```

```
ISLSRSB
1
```

```
IPSG GTTMODE          CGGTMOD
no   CdPA          no
```

```
Link set table is (1 of 1024) 1% full.
```

This example displays the output when information for linksets with a specified ISLSRB filter is requested:

```
rtrv-ls:islsrsb=4

tekelecstp 08-10-21 09:46:52 EST EAGLE 40.0.0

                L3T SLT                GWS GWS GWS
LSN            APCI  (SS7)  SCRN SET SET BEI LST LNKS ACT MES DIS SLSCI
NIS
  lsi616        6-001-6      none 1  2  no  B  0   off off off no
off
  lsi747        7-014-7      none 1  2  no  A  0   off off off no
off

Link set table is (16 of 1024) 2% full.

;
```

This example displays linkset information for a specific linkset when the Flexible Linkset Optional Based Routing feature is turned on:

```
rtrv-ls:lsn=ls8

tekelecstp 18-01-22 05:49:51 EST EAGLE 46.6.0.0.0-71.21.0

                L3T SLT                GWS GWS GWS
LSN            APCA  (SS7)  SCRN SET SET BEI LST LNKS ACT MES DIS SLSCI
NIS
  ls8           001-001-001  none 1  1  no  A  0   off off off no
off

                SPCA          CLLI          TFATCABMLQ MTPRSE ASL8
                -----
                1          ---          no

RANDSLS
off

IPSG  GTTMODE          CGGTMOD          PCT
no    FLCdPA,FLCgPA    no          off

Link set table is (2 of 1024) 1% full.

;
```

This example displays linkset information for an ANSI linkset when the Incoming SLS Bit Rotation feature is enabled and the `islsrsb=6` parameter was specified:

```
rtrv-ls:lsn=lsa

tekelecstp 18-01-22 05:49:51 EST EAGLE 46.6.0.0.0-71.21.0
```



```

          L3T SLT          GWS GWS GWS
LSN      APCA  (SS7)  SCRN SET SET BEI LST LNKS ACT MES DIS
SLSCI NIS
  lsa    001-001-001  none 1  1  no  A  0  off off off
no      off

          SPCA          CLLI          TFATCABMLQ MTPRSE ASL8
-----
RANDSLS
off

ISLSRSB RSL8
6      yes

IPSG  GTTMODE          CGGTMOD
no    CdPA            no

```

Link set table is (1 of 1024) 1% full.

This example displays linkset information for an ITU link set, when the MPC, ITUDUPPC, Spare Point Code, SLSOCB and ISLSBR features are enabled:

```
rtrv-ls:lsn=lsi
```

```
tekelecstp 18-01-22 05:50:11 EST EAGLE 46.6.0.0-71.21.0
```

```

          L3T SLT          GWS GWS GWS
LSN      APCN  (SS7)  SCRN SET SET BEI LST LNKS ACT MES DIS
SLSCI NIS
  lsi    01001-aa    none 1  2  no  A  0  off off off
no      off

          SPCN          CLLI          TFATCABMLQ MTPRSE ASL8
-----
SLSOCBIT SLSRSB RANDSLS MULTGC ITUTFR ICNIMAP
OGNIMAP
none     1      off    no    off    none      none

ISLSRSB
1

IPSG  GTTMODE          CGGTMOD
no    CdPA            no

```

Link set table is (4 of 1024) 1% full.

```
;
```

This example displays linkset information when all linksets are in SLT Reflect mode:

rtrv-ls

tekelecstp 11-10-13 15:55:42 EST EAGLE 44.0.0

NIS	LSN	APCA (SS7)	SCRN	L3T SLT			LST	LNKS	GWS	GWS	GWS	SLSCI
				SET	SET	BEI			ACT	MES	DIS	
	ls1	001-001-001	none	1	RFT	no	A	0	off	off	off	no
off												
	ls2	002-002-002	none	1	RFT	no	A	0	off	off	off	no
off												
	ls3	003-003-003	none	1	RFT	no	A	0	off	off	off	no
off												

Link set table is (3 of 1024) 1% full.

This example displays linkset information for a specified linkset in SLT Reflect mode:

rtrv-ls:lsn=ls1

tekelecstp 18-01-22 05:51:51 EST EAGLE 46.6.0.0.0-71.21.0

NIS	LSN	APCA (SS7)	SCRN	L3T SLT			LST	LNKS	GWS	GWS	GWS	SLSCI
				SET	SET	BEI			ACT	MES	DIS	
	ls1	001-001-001	none	1	RFT	no	A	0	off	off	off	no
off												

SPCA	CLLI	TFATCABMLQ	MTPRSE	ASL8
-----	-----	1	---	no

RANDSLS  
off

IPSG	GTTMODE	CGGTMOD	PCT
no	CdPA	no	off

Link set table is (3 of 1024) 1% full.

Example with J1 links.

rtrv-ls:lsn=ls2

tekelecstp 18-01-22 05:52:51 EST EAGLE 46.6.0.0.0-71.21.0

rtrv-ls:lsn=ls2

Command entered at terminal #4.

NIS	LSN	APCN16 (SS7)	SCRN	L3T SLT			LST	LNKS	GWS	GWS	GWS	SLSCI
				SET	SET	BEI			ACT	MES	DIS	
	ls2	001-02-03	none	1	RFT	no	A	3	off	off	off	no

off

```

          SPCN16          CLLI          TFATCABMLQ MTPRSE ASL8
          -----          -
          2              ---      ---

SLSRSB RANDSL S ITUTFR
1      off      off

IPSG  GTTMODE          CGGTMOD  PCT
no    SysDflt          no        off

          L2T          PCR PCR  J1
          SET  BPS      ECM  N1  N2

PORT TS
1      11          1102 A    11  LIMT1  11  64000  BASIC  ----  -----
1      11          1102 A1   10  LIMT1  11  64000  BASIC  ----  -----
1      20          1102 A2   5   LIMT1  11  64000  BASIC  ----  -----

```

Link set table is (2 of 1024) 1% full.

;

This example displays a linkset entry with the CHGMTP3OPC parameter.

rtrv-ls:lsn=ls112

```

tekelecstp 18-01-22 05:55:54 EST  EAGLE 46.6.0.0.0-71.21.0
rtrv-ls:lsn=ls112
Command entered at terminal #4.

```

```

          L3T SLT          GWS GWS GWS
          SET SET BEI LST LNKS ACT MES DIS
LSN      APCI  (SS7)  SCRN
SLSCI NIS
ls112    1-001-2      none 1  2  no  A  0  off off off
no      off

```

```

          SPCI          CLLI          TFATCABMLQ MTPRSE ASL8
          -----          -
          2              ---      ---

SLSRSB RANDSL S ITUTFR
1      off      off

IPSG  GTTMODE          CGGTMOD  PCT  CHGMTP3OPC
yes   SysDflt          no        off  on

ADAPTER  RSVDSLKTPS  MAXSLKTPS
m3ua     1000        1000

TPSALM   LSUSEALM    SLKUSEALM
rsvdslktps 100%      80%

```

```

RCONTEXT  ASNOTIF  NUMSLKALW  NUMSLKRSTR  NUMSLKPROH
none      yes       1          1           1

```

Link set table is (1 of 1024) 1% full.

```

;
Command Executed

```

This example displays a linkset entry with the GNAMESET and CGPNBLSET parameter.

```
rtrv-ls:lsn=ls1104
```

```
Searching link set table on disk - please wait...
```

```
Command Accepted - Processing
```

```
tekelecstp 19-11-12 23:28:53 EST EAGLE 46.9.0.0.0-76.1.0
```

```
rtrv-ls:lsn=ls1104
```

```
Command entered at terminal #1.
```

```
;
```

```
tekelecstp 19-11-12 23:28:53 EST EAGLE 46.9.0.0.0-76.1.0
```

```

                                L3T SLT                      GWS GWS GWS
SLSCI NIS      LSN          APCA  (SS7)  SCR N SET SET BEI LST LNKS ACT MES DIS
no   off      ls1104      001-001-004  scr1 1  1  no  A  1  on  on  on
                                SPCA          CLLI          TFATCABMLQ MTPRSE ASL8
                                -----
                                RANDSLS
                                off
                                IPSG  GTTMODE          CGGTMOD  PCT  CHGMTP3OPC
GNAMESET      yes  SysDflt          no      off  on          SetA
                                ADAPTER  RSVDSLKTPS  MAXSLKTPS  CGPNBLSET
                                m3ua     5000       5000       2
                                TPSALM   LSUSEALM   SLKUSEALM
                                rsvdslktps 100%     80%
                                RCONTEXT  ASNOTIF   NUMSLKALW  NUMSLKRSTR  NUMSLKPROH
                                10        yes       1          1           1
                                LOC  LINK SLC TYPE      ANAME
                                1104 A  0  IPSG  assoc1104

```

Link set table is (1 of 1024) 1% full.

```
;
```

## Legend

- **LSN**—Name of the linkset. When CHINA appears after the LSN heading, each linkset that is listed under the heading was defined with the `apctype=itunchina` parameter specified.
- **APC/APCII/APCN/APCN24/APCN16**—Adjacent DPC of the linkset
- **SPC/SPCII/SPCN/SPCN24/SPCN16**—Secondary PC of the linkset
- **SCRN**—Screen set assigned to the linkset
- **L3TSET**—Level 3 timer set value assigned to the linkset
- **SLTSET**—SLTM record associated with the linkset
- **BEI**—Broadcast exception indicator. Indicates whether TFP (transfer prohibited) messages can be broadcast on the linkset.
- **LST**—Type of links in the linkset (access links, bridge links, etc.)
- **LNKS**—Number of links in the linkset
- **GWSA**—Shows whether gateway screening is used on the specified linkset
- **GWSM**—Shows whether the display of messages generated for each screened message is turned on or off
- **GWSD**—Shows whether the gateway screening message discard function is turned on or off
- **SLSCI**—Shows whether the 5-to-8-bit SLS conversion feature is to be used to select links for outgoing messages directed to the given linkset
- **NIS**—Shows whether the Network Indicator Spare option is on or off for the specified linkset
- **CLLI**—The far end Common Language Location Identifier (CLLI)
- **TFATCABMLQ**—the minimum number of links in the given linkset (or in the combined linkset in which it resides) that must be available to user-part messages traffic in order for the STP to consider the first-choice ordered routes using that linkset as allowed rather than restricted
- **MTPRSE**—Shows whether the adjacent node is equipped with MTP restart
- **ASL8**—Shows whether the adjacent node is sending MSUs with 8-bit SLSs
- **MULTGC**—Shows whether multiple group codes are allowed
- **MATELSN**—Name of the mate IP Gateway linkset
- **LSUSEALM**—Percent of the linkset TPS (IPTPS) at which an alarm is generated to indicate that the actual linkset TPS is approaching the configured IPTPS value for the linkset
- **SLKUSEALM**—Percent of the link "fair share" TPS at which an alarm is generated to indicate that the actual link TPS is approaching the link's "fair share" of its linkset's configured IPTPS. The "fair share" of the linkset TPS for a link is the configured linkset TPS divided by the number of in-service links in the linkset.
- **LOC**—Location of the card containing the signaling links that make up the linkset
- **PORT**—Port on the card containing the signaling link
- **SLSOCBIT**—Setting of the Other CIC (Circuit Identification Code) Bit

- **SLRSRB**—Setting of the Rotated SLS (Signaling Link Selection) Bit
- **ISLRSRB**—setting of the Incoming Rotated SLS (Signaling Link Selection) Bit
- **GSMSCRN**—Shows whether the GSM MAP screening indicator is turned on or off
- **ITUTFR**—Shows whether the ITU TFR procedure indicator is turned on or off
- **L2TSET**—Level 2 timer set value associated with the signaling link
- **SLC**—Signaling link code of the signaling link
- **TYPE**—Type of card
- **BPS**—Transmission rate for the link in bits per second
- **E1PORT**—E1 port with the E1 interface that services the link
- **E1LOC**—Card location of the E1 card with the E1 interface that services the link
- **T1PORT**—T1 port with the T1 interface that services the link
- **T1LOC**—Card location of the T1 card with the T1 interface that services the link
- **TS**—Timeslot assigned to the link that is serviced by the E1 or T1 interface
- **E1ATMCRC4**—Indicator of whether CRC4 multi-frame structure is enabled or disabled
- **E1ATMSI**—Value of two Spare International bits of NFAS data
- **E1ATMSN**—Value of five Spare National bits of NFAS data
- **RANDSLS**—The setting of linkset for Random SLS generation
- **ADAPTER**—Shows whether the linkset is IPSP M2PA or IPSP M3UA linkset
- **RSVDSLKTPS**—Guaranteed SLKTPS for an IPSP linkset
- **MAXSLKTPS**—Maximum SLKTPS for an IPSP linkset
- **RCONTEXT**—Routing context ID of IPSP M3UA linkset
- **ASNOTIF**—Shows whether AS notifications will be generated for IPSP M3UA linkset
- **ANAME**—Association name configured for signaling link of IPSP linkset
- **SLKTPS**—Provisioned TPS for concerned signaling link of the specified IPSP linkset
- **CGGTMOD**—Shows whether calling party global title modification indicator is yes or no for the linkset
- **PPC/PPCI/PPCN/PPCN24/PPCN16**—The proxy point code of the linkset
- **NUMSLKALW**—Threshold value for IPSP M3UA linkset used to transition to Allowed state from Restricted or Prohibited state
- **NUMSLKRSTR**—Threshold value for IPSP M3UA linkset used to transition to Restricted state from Allowed state
- **NUMSLKPROH**—Threshold value for IPSP M3UA linkset used to transition to Prohibited state from Restricted or Allowed state
- **ICNIMAP**—Incoming NI Map
- **OGNIMAP**—Outgoing NI Map
- **RSL8**—Shows whether the incoming SLS is rotated by 8 bits
- **PCT**—Shows whether the Point Code & CIC Translation (PCT) feature is applied to messages coming in or going out on links of a particular link set
- **RFT**—Shows whether the linkset is in SLT Reflect mode

- **J1PORT**—J1 port with the J1 interface that services the link
- **CHGMTP3OPC**—Shows whether OPC is going to be replaced by SPC.
- **GNAMESET**—Shows the Generic name Set.
- **CGPNBLSET**—Shows the Calling Party Blacklist Set.
- **VISUALIZEDATA**—Linkset based visualization options.

#### Related Topics

- [chg-ls](#)
- [chg-lsopts](#)
- [dlt-ls](#)
- [ent-ls](#)
- [rept-stat-ls](#)

## rtrv-m2pa-tset

Use this command to retrieve either one M2PA timer set or all M2PA timer sets.

#### Parameters

##### **tset (optional)**

The name of the M2PA timer set to be retrieved.

##### **Range:**

*1 - 20*

##### **ver (optional)**

The M2PA version supported by the association.

##### **Range:**

*d6*

*rfc*

#### Example

```
rtrv-m2pa-tset
```

```
rtrv-m2pa-tset:tset=1
```

#### Dependencies

None

#### Notes

If a timer set is not specified in the command, all timer sets are retrieved.

**Output**

```
rtrv-m2pa-tset:tset=1:ver=d6
```

```
rlghncxa03w 06-01-18 08:16:14 EST EAGLE 34.3.0
```

```
M2PA Draft 6 Timers (in msec, T16 in microsec)
```

TSET	T1	T2	T3	T4N	T4E	T5	T6	T7	T16	T17	T18
1	10000	-----	10000	10000	500	1000	3000	1200	200000	250	1000

```
;
```

```
rtrv-m2pa-tset:tset=1:ver=rfc
```

```
rlghncxa03w 06-01-18 08:16:14 EST EAGLE 34.3.0
```

```
M2PA RFC Timers (in msec, T16 in microsec)
```

TSET	T1	T2	T3	T4N	T4E	T5	T6	T7	T16	T17	T18
1	300000	20000	2000	30000	500	100	3000	1200	200000	250	1000

```
;
```

```
rtrv-m2pa-tset:tset=1
```

```
rlghncxa03w 06-01-18 08:16:14 EST EAGLE 34.3.0
```

```
M2PA Draft 6 Timers (in msec, T16 in microsec)
```

TSET	T1	T2	T3	T4N	T4E	T5	T6	T7	T16	T17	T18
1	10000	-----	10000	10000	500	1000	3000	1200	200000	250	1000

```
M2PA RFC Timers (in msec, T16 in microsec)
```

TSET	T1	T2	T3	T4N	T4E	T5	T6	T7	T16	T17	T18
1	300000	20000	2000	30000	500	100	3000	1200	200000	250	1000

```
;
```

```
rtrv-m2pa-tset:ver=d6
```

```
rlghncxa03w 06-01-18 08:16:14 EST EAGLE 34.3.0
```

```
M2PA Draft 6 Timers (in msec, T16 in microsec)
```

TSET	T1	T2	T3	T4N	T4E	T5	T6	T7	T16	T17	T18
1	10000	-----	10000	10000	500	1000	3000	1200	200000	250	1000
2	10000	-----	10000	10000	500	1000	3000	1200	200000	250	1000
3	10000	-----	10000	10000	500	1000	3000	1200	200000	250	1000
4	10000	-----	10000	10000	500	1000	3000	1200	200000	250	1000
5	10000	-----	10000	10000	500	1000	3000	1200	200000	250	1000



```

6      10000  ----- 10000 10000 500  1000  3000 1200  200000 250
1000
7      10000  ----- 10000 10000 500  1000  3000 1200  200000 250
1000
8      10000  ----- 10000 10000 500  1000  3000 1200  200000 250
1000
9      10000  ----- 10000 10000 500  1000  3000 1200  200000 250
1000
10     10000  ----- 10000 10000 500  1000  3000 1200  200000 250
1000
11     10000  ----- 10000 10000 500  1000  3000 1200  200000 250
1000
12     10000  ----- 10000 10000 500  1000  3000 1200  200000 250
1000
13     10000  ----- 10000 10000 500  1000  3000 1200  200000 250
1000
14     10000  ----- 10000 10000 500  1000  3000 1200  200000 250
1000
15     10000  ----- 10000 10000 500  1000  3000 1200  200000 250
1000
16     10000  ----- 10000 10000 500  1000  3000 1200  200000 250
1000
17     10000  ----- 10000 10000 500  1000  3000 1200  200000 250
1000
18     10000  ----- 10000 10000 500  1000  3000 1200  200000 250
1000
19     10000  ----- 10000 10000 500  1000  3000 1200  200000 250
1000
20     10000  ----- 10000 10000 500  1000  3000 1200  200000 250
1000

```

;

rtrv-m2pa-tset:ver=rfc

```

rlghncxa03w 06-01-18 08:16:14 EST  EAGLE 34.3.0
M2PA RFC Timers (in msec, T16 in microsec)

```

TSET	T1	T2	T3	T4N	T4E	T5	T6	T7	T16	T17
T18										
1	300000	20000	2000	30000	500	100	3000	1200	200000	250
1000										
2	300000	20000	2000	30000	500	100	3000	1200	200000	250
1000										
3	300000	20000	2000	30000	500	100	3000	1200	200000	250
1000										
4	300000	20000	2000	30000	500	100	3000	1200	200000	250
1000										
5	300000	20000	2000	30000	500	100	3000	1200	200000	250
1000										
6	300000	20000	2000	30000	500	100	3000	1200	200000	250
1000										
7	300000	20000	2000	30000	500	100	3000	1200	200000	250

```

1000
 8  30000 20000 2000 30000 500 100 3000 1200 200000 250 1000
 9  30000 20000 2000 30000 500 100 3000 1200 200000 250 1000
10  30000 20000 2000 30000 500 100 3000 1200 200000 250 1000
11  30000 20000 2000 30000 500 100 3000 1200 200000 250 1000
12  30000 20000 2000 30000 500 100 3000 1200 200000 250 1000
13  30000 20000 2000 30000 500 100 3000 1200 200000 250 1000
14  30000 20000 2000 30000 500 100 3000 1200 200000 250 1000
15  30000 20000 2000 30000 500 100 3000 1200 200000 250 1000
16  30000 20000 2000 30000 500 100 3000 1200 200000 250 1000
17  30000 20000 2000 30000 500 100 3000 1200 200000 250 1000
18  30000 20000 2000 30000 500 100 3000 1200 200000 250 1000
19  30000 20000 2000 30000 500 100 3000 1200 200000 250 1000
20  30000 20000 2000 30000 500 100 3000 1200 200000 250 1000

```

```
;
```

```
rtrv-m2pa-tset
```

```

rlghncxa03w 06-01-18 08:16:14 EST EAGLE 34.3.0
M2PA Draft 6 Timers (in msec)

```

TSET	T1	T2	T3	T4N	T4E	T5	T6	T7	T16	T17	T18
1	10000	-----	10000	10000	500	1000	3000	1200	200000	250	1000
2	10000	-----	10000	10000	500	1000	3000	1200	200000	250	1000
3	10000	-----	10000	10000	500	1000	3000	1200	200000	250	1000
4	10000	-----	10000	10000	500	1000	3000	1200	200000	250	1000
5	10000	-----	10000	10000	500	1000	3000	1200	200000	250	1000
6	10000	-----	10000	10000	500	1000	3000	1200	200000	250	1000
7	10000	-----	10000	10000	500	1000	3000	1200	200000	250	1000
8	10000	-----	10000	10000	500	1000	3000	1200	200000	250	1000
9	10000	-----	10000	10000	500	1000	3000	1200	200000	250	1000
10	10000	-----	10000	10000	500	1000	3000	1200	200000	250	1000
11	10000	-----	10000	10000	500	1000	3000	1200	200000	250	1000
12	10000	-----	10000	10000	500	1000	3000	1200	200000	250	1000
13	10000	-----	10000	10000	500	1000	3000	1200	200000	250	1000
14	10000	-----	10000	10000	500	1000	3000	1200	200000	250	1000
15	10000	-----	10000	10000	500	1000	3000	1200	200000	250	1000
16	10000	-----	10000	10000	500	1000	3000	1200	200000	250	1000
17	10000	-----	10000	10000	500	1000	3000	1200	200000	250	1000
18	10000	-----	10000	10000	500	1000	3000	1200	200000	250	1000
19	10000	-----	10000	10000	500	1000	3000	1200	200000	250	1000
20	10000	-----	10000	10000	500	1000	3000	1200	200000	250	1000

```
M2PA RFC Timers (in msec, T16 in microsec)
```

TSET	T1	T2	T3	T4N	T4E	T5	T6	T7	T16	T17	T18
1	300000	20000	2000	30000	500	100	3000	1200	200000	250	1000
2	300000	20000	2000	30000	500	100	3000	1200	200000	250	1000
3	300000	20000	2000	30000	500	100	3000	1200	200000	250	1000
4	300000	20000	2000	30000	500	100	3000	1200	200000	250	1000
5	300000	20000	2000	30000	500	100	3000	1200	200000	250	1000
6	300000	20000	2000	30000	500	100	3000	1200	200000	250	1000

```

7 300000 20000 2000 30000 500 100 3000 1200 200000 250
1000
8 300000 20000 2000 30000 500 100 3000 1200 200000 250
1000
9 300000 20000 2000 30000 500 100 3000 1200 200000 250
1000
10 300000 20000 2000 30000 500 100 3000 1200 200000 250
1000
11 300000 20000 2000 30000 500 100 3000 1200 200000 250
1000
12 300000 20000 2000 30000 500 100 3000 1200 200000 250
1000
13 300000 20000 2000 30000 500 100 3000 1200 200000 250
1000
14 300000 20000 2000 30000 500 100 3000 1200 200000 250
1000
15 300000 20000 2000 30000 500 100 3000 1200 200000 250
1000
16 300000 20000 2000 30000 500 100 3000 1200 200000 250
1000
17 300000 20000 2000 30000 500 100 3000 1200 200000 250
1000
18 300000 20000 2000 30000 500 100 3000 1200 200000 250
1000
19 300000 20000 2000 30000 500 100 3000 1200 200000 250
1000
20 300000 20000 2000 30000 500 100 3000 1200 200000 250
1000
;

```

**Related Topics**

- [chg-m2pa-tset](#)

## rtrv-map

Use this command to show the mated application relationship information and Alternate RI Mate information maintained by the system. The GTT Load Sharing with Alternate Routing Indicator (GTT LS ARI) feature must be enabled to view Alternate RI Mate information. This information is used to support the routing of SCCP management SSP/SSA messages.

**Parameters****Note:**

See [Point Code Formats and Conversion](#) for a detailed description of point code formats, rules for specification, and examples.

**Note:**

Definitions for the feature options specified by the `on` parameter are located in the Notes section.

**mapset (optional)**

MAP set ID.

**Range:**

1 - 36000, *dflt*  
*dflt* —Default MAP set

**Default:**

*dflt*

The default value is *dflt* only when the Flexible GTT Load Sharing feature is not enabled.

**on (optional)**

Enables or turns on the specified options. A comma-separated list of options that are requested to be turned on. Up to 8 options can be specified in the list.

**Range:**

*refcnt*

**pc (optional)**

ANSI point code in the form of *network indicator-network cluster-network cluster member (ni-nc-ncm)*.

**Synonym:**

*pca*

**Range:**

000-255

Specify a valid value for each subfield of the point code, and separate the subfields with a dash (-).

When `chg-sid:pctype=ansi` is specified, *ni = 000* is not valid.

When `chg-sid:pctype=ansi` is specified, *nc = 000* is not valid if *ni = 001–005*.

When `chg-sid:pctype=ansi` is specified, *nc = 000* is valid if *ni = 006–255*.

The point code *000-000-000* is not a valid point code.

**pc/pca/pci/pcn/pcn24/pcn16 (optional)**

Point code.

**pci (optional)**

ITU international point code in the form of *zone-area-id*.

**Range:**

*s-*, 0-255

Specify a valid value for each subfield of the point code, and separate the subfields with a dash (-).

*prefix*—*s*

*zone*—0-7

*area—000-255*

*id—0-7*

The point code *0-000-0* is not a valid point code.

**pcn (optional)**

ITU national point code in the format of a 5-digit number (*nnnnn*); or 2, 3, or 4 numbers (members) separated by dashes (*m1-m2-m3-m4*) as defined by the `chg-stpopts:npcfmti` flexible point code option. A group code must be specified when the ITUDUPPC feature is turned on (*nnnnn-gc*, *m1-m2-m3-m4-gc*). The *prefix* subfield indicates a spare point code (*prefix-nnnnn*, *prefix-nnnnn-gc*, *prefix-m1-m2-m3-m4*, *prefix-m1-m2-m3-m4-gc*).

**Range:**

*s-*, *0-16383*, *aa-zz*

Specify a valid value for each subfield of the point code, and separate the subfields with a dash (-).

*prefix—s-*

*nnnnn—0-16383*

*gc—aa-zz*

*m1-m2-m3-m4—0-14* for each member; values must sum to 14

**pcn24 (optional)**

24-bit ITU national point code in the form of *main signaling area-sub signaling area-signaling point*.

**Range:**

*000-255*

Specify a valid value for each subfield of the point code, and separate the subfields with a dash (-).

*msa—000-255*

*ssa—000-255*

*sp—000-255*

**pcn16 (optional)**

16-bit ITU national point code in the form of *unit number-sub number area-main number area* (*un-sna-mna*).

**Range:**

*000---127*

Specify a valid value for each subfield of the point code, and separate the subfields with a dash (-).

*un---000---127*

*sna---000---15*

*mna---000---31*

**ssn (optional)**

Subsystem number

**Range:**

*2 - 255*

**Default:**

All subsystem numbers and their mates are shown for the given point code.

**Example**

```
rtrv-map
rtrv-map:pc=2-2-2
rtrv-map:pca=1-1-4:ssn=15
rtrv-map:mapset=2
rtrv-map:mapset=df1t:pcn=s-10155-ab
rtrv-map:pcn=1001:on=refcnt
rtrv-map:pcn16=1-2-3
```

**Dependencies**

The value of the `pc/pca/pci/pcn/pcn24/pcn16` parameter must already exist in the MAP entity set. All subsystem numbers for the specified PC and mate are displayed.

The remote PC must be specified as a full PC.

Asterisk entries are not allowed.

If an SSN is specified, the PC/SSN pair must exist in the MAP table. The PC/SSN entry and its mate are shown.

The DPC of the primary subsystem must be a full PC.

If the SSN is specified, then the remote PC must be specified.

The Site Identification table is corrupt or cannot be found.

The Flexible GTT Load Sharing feature must be enabled before the `mapset` parameter can be specified.

The specified MAP set must exist in the database.

If the PC and MAP set are specified, and the SSN is not specified, then at least one entry for that PC/MAP set must exist in the MAP table.

If the PC, SSN, and MAP set are specified, then they must already be provisioned in the MAP table.

The MAP table is corrupt or cannot be found.

**Notes**

This command can be canceled using the **F9** function key or the `canc-cmd` command. See the `canc-cmd` command for more information.

In this command, only ITU-international and ITU national point codes support the spare point code subtype prefix (`s-`).

If the Flexible GTT Load Sharing feature is enabled, then the retrieved MAP examples contain the MAPSET ID for each MAP set. MAP sets that were configured before the Flexible GTT Load Sharing feature was enabled are shown as MAPSET ID=DFLT after the Flexible GTT Load Sharing feature is enabled.

The `pc/pca/pci/pcn/pcn24/pcn16`, `ssn`, and `mapset` parameters can be used to screen the output of all MAP sets. These parameters allow retrieval of only those MAP sets that contain the desired parameters.

A MAP set can contain one primary entry and up to 31 mated entries.

If no parameters are entered, all defined mated point codes (up to 36,000) are shown.

If the Flexible Final GTT Loadsharing feature is not enabled, then the number of entries in the MAP table is based on unique point codes. Point codes that are duplicated in MRN sets using different SSNs are counted only once in the number of entries.

If the Flexible Final GTT Loadsharing feature is enabled, then the number of entries in the MAP table is based on unique point code and SSN combinations. Point codes that are duplicated in MRN sets are counted in the number of entries).

When the GTT LS ARI feature is enabled, the Alternate RI Mate, identified by the MRNSET and MRNPC fields, is displayed for all MAP Sets. When the GTT LS ARI feature is not enabled, the Alternate RI Mate is not displayed, and the display is unchanged.

### on option

`refcnt`—displays the MAPSET, MAPSET/PC, and MAPSET/PC/SSN reference counts

### Output

All subsystem numbers for the specified point code and its mates are shown.

The NET column is shown only when a MAP set contains mixed network point code types. Addition of the NET column realigns all remaining columns in the output. The re-alignment is constant even if the NET column is not shown.

If an MRC value is preceded with an "\*", then the MRC value is not applicable for the current multiplicity mode (MULT field). The MRC value is only valid when MULT is *DOM*.

If an SRM value is preceded with an "\*", then the SRM value is not applicable for the current multiplicity mode (MULT field). The SRM value is only valid when MULT is *DOM* or *COM*.

If an SSN REFCNT value is preceded with an "\*", then the entry can be deleted if any other entry with the same point code exists in that MAP set.

This example retrieves an ANSI MAP set for a specified point code:

```
rtrv-map:pc=2-2-2
```

```
flexgtoff 09-08-09 12:05:28 EST EAGLE 41.1.0
  PCA           Mate PCA           SSN RC MULT SRM MRC GRP NAME SSO
  002-002-002           10 10 SHR *Y *Y ----- OFF
           002-002-003           20 10 SHR *Y *Y ----- OFF
```

```
MAP table is (8 of 1024) 1% full.
```

This example includes MAP sets with a Concerned Signaling Point Code group name and spare point codes, (s-). The ITUDUPPC (ITU National Duplicate Point Code) feature is on, and the Flexible ITU National Point Code STP option is set to 4.

rtrv-map

```

spareduppc 09-08-09 12:05:28 EST EAGLE 41.1.0
  PCA           Mate PCA       SSN RC MULT SRM MRC GRP NAME SSO
  002-002-002           10 10 SHR *Y *Y ----- OFF
                        002-002-003 20 10 SHR *Y *Y ----- OFF

  PCA           Mate PCA       SSN RC MULT SRM MRC GRP NAME SSO
  003-101-001           10 30 DOM YES YES abcdefg OFF
                        003-001-000 10 40 DOM YES YES abcdefg OFF

  PCI           NET Mate PC     SSN RC MULT SRM MRC GRP NAME SSO
  1-109-0           I   1-110-0   90 20 COM NO *N ----- OFF
                        N   00-01-7-3-aa 90 20 COM NO *N ----- OFF
                        N   01-03-2-2-aa 90 30 COM NO *N ----- OFF

  PCN           Mate PCN       SSN RC MULT SRM MRC GRP NAME SSO
  03-00-1-2-aa           55 10 DOM NO NO ----- OFF
                        s-09-14-5-3-ab 45 99 DOM NO NO ----- OFF

  PCN           Mate PCN       SSN RC MULT SRM MRC GRP NAME SSO
  12-00-7-1-aa           5 10 DOM NO NO ----- OFF
                        12-00-7-3-aa 5 20 DOM NO NO ----- OFF

  PCI           Mate PCI       SSN RC MULT SRM MRC GRP NAME SSO
  s-1-128-6           55 10 SOL *N *N ----- OFF

```

MAP table is (13 of 1024) 1% full.

This example includes a Flexible ITU National Point Code STP option of 3-8-3-0:

rtrv-map

```

spareduppc 09-08-09 12:05:28 EST EAGLE 41.1.0
  PCA           Mate PCA       SSN RC MULT SRM MRC GRP NAME SSO
  001-001-001           10 25 SHR *Y *Y ----- OFF
                        001-001-004 20 25 SHR *Y *Y ----- OFF

  PCA           Mate PCA       SSN RC MULT SRM MRC GRP NAME SSO
  001-001-002           55 5  DOM YES YES ----- OFF
                        001-001-002 15 15 DOM YES YES ----- ON
                        001-001-003 25 20 DOM YES YES ----- ON
                        001-001-002 40 35 DOM YES YES ----- OFF

  PCA           Mate PCA       SSN RC MULT SRM MRC GRP NAME SSO
  001-001-003           30 10 COM NO *N ----- OFF
                        001-010-010 30 30 COM NO *N ----- OFF
                        001-001-004 15 30 COM YES *Y ----- OFF

```



PCA	Mate PCA	SSN	RC	MULT	SRM	MRC	GRP	NAME	SSO	
001-001-004		5	25	SHR	*Y	*Y	-----		OFF	
	001-001-001	50	25	SHR	*Y	*Y	-----		OFF	
PCA	Mate PCA	SSN	RC	MULT	SRM	MRC	GRP	NAME	SSO	
001-001-004		25	10	DOM	YES	YES	-----		OFF	
	001-001-004	10	15	DOM	YES	YES	-----		OFF	
PCA	Mate PCA	SSN	RC	MULT	SRM	MRC	GRP	NAME	SSO	
001-102-001		110	5	SHR	*Y	*Y	-----		OFF	
	002-001-000	110	5	SHR	*Y	*Y	-----		OFF	
	003-001-000	110	5	SHR	*Y	*Y	-----		OFF	
PCA	Mate PCA	SSN	RC	MULT	SRM	MRC	GRP	NAME	SSO	
002-001-000		10	20	SOL	*Y	*Y	-----		OFF	
PCA	Mate PCA	SSN	RC	MULT	SRM	MRC	GRP	NAME	SSO	
002-002-002		10	10	SHR	*Y	*Y	-----		OFF	
	002-002-003	20	10	SHR	*Y	*Y	-----		OFF	
PCA	Mate PCA	SSN	RC	MULT	SRM	MRC	GRP	NAME	SSO	
003-101-001		10	30	DOM	YES	YES	abcdefg		OFF	
	003-001-000	10	40	DOM	YES	YES	abcdefg		OFF	
PCA	Mate PCA	SSN	RC	MULT	SRM	MRC	GRP	NAME	SSO	
007-101-001		254	10	SOL	*Y	*Y	-----		OFF	
PCA	Mate PCA	SSN	RC	MULT	SRM	MRC	GRP	NAME	SSO	
007-101-001		255	10	COM	YES	*Y	-----		OFF	
	007-001-000	251	10	COM	YES	*Y	-----		OFF	
	007-001-000	249	10	COM	YES	*Y	-----		OFF	
	007-001-000	253	15	COM	YES	*Y	-----		OFF	
PCI	Mate PCI	SSN	RC	MULT	SRM	MRC	GRP	NAME	SSO	
1-101-0		10	10	SHR	*N	*N	-----		OFF	
	1-102-0	10	10	SHR	*N	*N	-----		OFF	
	1-103-0	30	10	SHR	*N	*N	-----		OFF	
	1-104-0	40	10	SHR	*N	*N	-----		OFF	
	1-105-0	50	10	SHR	*N	*N	-----		OFF	
	1-106-0	60	10	SHR	*N	*N	-----		OFF	
	1-107-0	70	10	SHR	*N	*N	-----		OFF	
	1-108-0	80	10	SHR	*N	*N	-----		OFF	
PCI	NET	Mate PC	SSN	RC	MULT	SRM	MRC	GRP	NAME	SSO
1-109-0			90	10	COM	NO	*N	-----	OFF	
	I	1-110-0	90	20	COM	NO	*N	-----	OFF	
	N	0-015-3-aa	90	20	COM	NO	*N	-----	OFF	
	N	0-154-2-aa	90	30	COM	NO	*N	-----	OFF	
PCN	Mate PCN	SSN	RC	MULT	SRM	MRC	GRP	NAME	SSO	
1-129-2-aa		55	10	DOM	NO	NO	-----		OFF	
	s-4-245-3-ab	45	99	DOM	NO	NO	-----		OFF	
PCN	Mate PCN	SSN	RC	MULT	SRM	MRC	GRP	NAME	SSO	

```

6-007-1-aa                5 10  DOM NO  NO  ----- OFF
                           6-007-3-aa  5 20  DOM NO  NO  ----- OFF

PCI          Mate PCI     SSN RC MULT SRM MRC GRP NAME SSO
s-1-128-6   55 10  SOL *N *N  ----- OFF

```

MAP table is (30 of 1024) 3% full.

This example retrieves all MAP sets containing a specified ANSI point code:

```
rtrv-map:pca=1-1-4
```

```

spareduppc 09-08-09 12:05:28 EST  EAGLE 41.1.0
PCA          Mate PCA     SSN RC MULT SRM MRC GRP NAME SSO
001-001-004  5 25  SHR *Y *Y  ----- OFF
                           001-001-001  50 25  SHR *Y *Y  ----- OFF

PCA          Mate PCA     SSN RC MULT SRM MRC GRP NAME SSO
001-001-004  10 15  DOM YES YES ----- OFF
                           25 10  DOM YES YES ----- OFF

PCA          Mate PCA     SSN RC MULT SRM MRC GRP NAME SSO
001-001-003  15 30  COM YES *Y ----- OFF
                           30 10  COM NO *N ----- OFF
                           001-010-010  30 30  COM NO *N ----- OFF

PCA          Mate PCA     SSN RC MULT SRM MRC GRP NAME SSO
001-001-001  20 25  SHR *Y *Y  ----- OFF
                           10 25  SHR *Y *Y  ----- OFF

PCA          Mate PCA     SSN RC MULT SRM MRC GRP NAME SSO
001-001-004  25 10  DOM YES YES ----- OFF
                           001-001-004  10 15  DOM YES YES ----- OFF

```

MAP table is (30 of 1024) 3% full.

This example retrieves a unique ANSI point code and SSN combination:

```
rtrv-map:pca=1-1-4:ssn=15
```

```

spareduppc 09-08-09 12:05:28 EST  EAGLE 41.1.0
PCA          Mate PCA     SSN RC MULT SRM MRC GRP NAME SSO
                           001-001-004  15 30  COM YES *Y ----- OFF
001-001-003  30 10  COM NO *N ----- OFF
                           001-010-010  30 30  COM NO *N ----- OFF

```

MAP table is (30 of 1024) 3% full.

This example shows output when the Flexible Final GTT Loadsharing feature is enabled:

```
rtrv-map:mapset=2
```

```
flexgton 08-12-09 12:05:28 EST EAGLE 40.1.0
```

```
MAPSET ID=2
```

PCA	Mate PCA	SSN	RC	MULT	SRM	MRC	GRP	NAME	SSO
001-001-002		50	5	DOM	YES	YES	-----		OFF
	001-001-002	10	15	DOM	YES	YES	-----		ON
	001-001-003	20	20	DOM	YES	YES	-----		ON
	001-001-002	40	35	DOM	YES	YES	-----		OFF

```
MAP table is (49 of 36000) 1% full.
```

```
rtrv-map:mapset=dfmt:pcn=s-10155-ab
```

```
flexgton 08-12-10 12:01:04 EST EAGLE 40.1.0
```

```
MAPSET ID=DFLT
```

PCN	Mate PCN	SSN	RC	MULT	SRM	MRC	GRP	NAME	SSO
03082-aa		55	10	DOM	NO	NO	-----		OFF
	s-10155-ab	45	99	DOM	NO	NO	-----		OFF

```
MAP table is (49 of 36000) 1% full.
```

This example shows output when the Weighted GTT Loadsharing feature is enabled, and the Flexible Final GTT Loadsharing feature is not enabled:

```
rtrv-map:pci=1-110-0
```

```
wgtonflxoff 09-08-10 12:03:44 EST EAGLE 41.1.0
```

WT	%WT	THR	PCI	NET	Mate PC	SSN	RC	MULT	SRM	MRC	GRP	NAME	SSO
			1-110-0			90	20	COM	NO	*N	-----		OFF
10	20	60		I	1-109-0	90	20	COM	NO	*N	-----		OFF
20	40	60		N	00123	90	20	COM	NO	*N	-----		OFF
20	40	60		N	01234	90	30	COM	NO	*N	-----		OFF
30	100	60											

```
MAP table is (14 of 1024) 1% full.
```

This example shows a Flexible ITU National Point Code STP option of 3-8-3-0. The Weighted GTT Loadsharing and Flexible Final GTT Loadsharing features are enabled:

```
rtrv-map:pcn=6-7-1
```

```
npcfmti3830 08-12-10 12:03:44 EST EAGLE 40.1.0
```

```

MAPSET ID=DFLT
PCN           Mate PCN           SSN RC MULT SRM MRC GRP NAME SSO WT %WT
THR
6-007-1
---
           6-007-3           5 20  DOM NO  NO  ----- OFF -- ---
---

```

MAP table is (19 of 36000) 1% full.

This example shows a PCN24 point code. The Weighted GTT Loadsharing and Flexible Final GTT Loadsharing features are not enabled.

rtrv-map

```

wgttgflxoff 09-08-10 15:00:37 EST EAGLE 41.1.0
PCA           Mate PCA           SSN RC MULT SRM MRC GRP NAME SSO
001-001-001           001-001-002           10 10  SHR *Y  *Y  ----- ON
           001-001-002           20 10  SHR *Y  *Y  ----- OFF

PCI           Mate PCI           SSN RC MULT SRM MRC GRP NAME SSO
1-101-0           1-102-0           10 10  SHR *N  *N  ----- OFF
           1-102-0           10 10  SHR *N  *N  ----- OFF

PCN24         Mate PCN24           SSN RC MULT SRM MRC GRP NAME SSO
000-000-001           000-001-002           5 30  SHR *N  *N  ----- OFF
           000-001-002           5 30  SHR *N  *N  ----- OFF

```

MAP table is (6 of 1024) 1% full.

This example shows weighted MAP sets:

rtrv-map

```

wgttonflxoff 09-08-08 15:00:37 EST EAGLE 41.1.0
PCA           Mate PCA           SSN RC MULT SRM MRC GRP NAME SSO WT %WT
THR
50 001-001-001           10 10  SHR *Y  *Y  ----- ON 20 67
           001-001-002           20 10  SHR *Y  *Y  ----- OFF 10 33
50
THR PCI           Mate PCI           SSN RC MULT SRM MRC GRP NAME SSO WT %WT
33 1 1-101-0           10 10  SHR *N  *N  ----- OFF 10
           1-102-0           10 10  SHR *N  *N  ----- OFF 20
67 1
THR PCN24         Mate PCN24           SSN RC MULT SRM MRC GRP NAME SSO WT %WT
80 000-000-001           5 30  SHR *N  *N  ----- OFF 50 91

```

```

                    000-001-002      5 30 SHR *N *N ----- OFF
5   9  80

MAP table is (6 of 1024) 1% full.

```

This example shows output when the Flexible Final GTT Loadsharing feature is enabled:

```
rtrv-map:pcn24=0-1-2
```

```

wgtonflxoff 09-08-10 15:00:37 EST EAGLE 41.1.0

MAPSET ID=DFLT
PCN24      Mate PCN24      SSN RC MULT SRM MRC GRP NAME SSO
WT %WT THR
000-000-001      5 30 SHR *N *N ----- OFF
50  91  80
000-001-002      5 30 SHR *N *N ----- OFF
5   9  80

MAP table is (6 of 36000) 1% full.

```

This example shows output when the Flexible GTT Load Sharing and GTT LS ARI features are enabled and the Weighted GTT Load Sharing feature is turned off:

```
rtrv-map
```

```

tekelecstp 09-08-22 13:36:31 EST EAGLE 41.1.0
MAPSET ID=DFLT MRNSET ID=---- MRNPC=-----
PCI      Mate PCI      SSN RC MULT SRM MRC GRP NAME SSO
1-101-1      11 10 SHR *N *N itugrp OFF
1-101-2      12 10 SHR *N *N itugrp OFF

MAPSET ID=1      MRNSET ID=---- MRNPC=-----
PCN      Mate PCN      SSN RC MULT SRM MRC GRP NAME SSO
s-02001      21 10 SHR *N *N ----- OFF
s-02002      22 10 SHR *N *N ----- OFF

MAP table is (4 of 36000) 1% full.
;

```

This example shows output when the Flexible GTT Load Sharing and GTT LS ARI features are enabled, ARI Mates are provisioned, and the Weighted GTT Load Sharing feature is turned off:

```
rtrv-map
```

```

tekelecstp 09-08-22 13:36:31 EST EAGLE 41.1.0
MAPSET ID=DFLT MRNSET ID=DFLT MRNPC= 001-001-004
PCA      Mate PCA      SSN RC MULT SRM MRC GRP NAME SSO
001-001-001      11 10 SHR *Y *Y ----- OFF

```

```

                                001-001-002    12 10  SHR *Y *Y  ----- OFF
MAPSET ID=2      MRNSET ID=DFLT  MRNPC=    001-001-003
PCA             Mate PCA        SSN RC MULT SRM MRC GRP NAME SSO
001-001-005     001-001-006     11 20  SHR *Y *Y  ----- OFF
                                10 20  SHR *Y *Y  ----- OFF

MAPSET ID=DFLT  MRNSET ID=-----  MRNPC=-----
PCI             Mate PCI        SSN RC MULT SRM MRC GRP NAME SSO
1-101-1        1-101-2         11 10  SHR *N *N  itugrp  OFF
                                12 10  SHR *N *N  itugrp  OFF

MAPSET ID=5      MRNSET ID=DFLT  MRNPC=    1-101-3
PCI             NET  Mate PC     SSN RC MULT SRM MRC GRP NAME SSO
1-101-1        I   s-2-202-1    11 10  SHR *N *N  itugrp  OFF
                N   01002       12 10  SHR *N *N  ----- OFF

MAPSET ID=3      MRNSET ID=1      MRNPC=    01003
PCN             Mate PCN        SSN RC MULT SRM MRC GRP NAME SSO
01001          01002           11 10  SHR *N *N  ----- OFF
                                12 10  SHR *N *N  ----- OFF

MAPSET ID=4      MRNSET ID=2      MRNPC=    s-2-202-3
PCI             Mate PCI        SSN RC MULT SRM MRC GRP NAME SSO
s-2-202-1     s-2-202-2       21 10  SHR *N *N  ----- OFF
                                22 10  SHR *N *N  ----- OFF

MAPSET ID=1      MRNSET ID=-----  MRNPC=-----
PCN             Mate PCN        SSN RC MULT SRM MRC GRP NAME SSO
s-02001      s-02002          21 10  SHR *N *N  ----- OFF
                                22 10  SHR *N *N  ----- OFF

```

MAP table is (15 of 36000) 1% full.

;

This example shows output for a specific point code. The Flexible GTT Load Sharing and GTT LS ARI features are enabled, and the Weighted GTT Load Sharing feature is turned off.

```
rtrv-map:pcn=1001
```

```
eaglestp 09-08-22 18:41:14 EST EAGLE 41.1.0
```

```

MAPSET ID=3      MRNSET ID=1      MRNPC=    01003
PCN             Mate PCN        SSN RC MULT SRM MRC GRP NAME SSO
01001          01002           11 10  SHR *N *N  ----- OFF
                                12 10  SHR *N *N  ----- OFF

```

MAP table is (15 of 36000) 1% full.

;

This example shows output for a specific point code and subsystem number. The Flexible GTT Load Sharing and GTT LS ARI features are enabled. The Weighted GTT Load Sharing feature is turned off.

```
rtrv-map:pcn=1002:ssn=12
```

```
eaglestp 09-08-12 18:41:20 EST EAGLE 41.1.0

MAPSET ID=3      MRNSET ID=1      MRNPC=  01003
PCN              Mate PCN      SSN RC MULT SRM MRC GRP NAME SSO
01001           01002          11 10  SHR *N *N  ----- OFF
                   12 10  SHR *N *N  ----- OFF

MAPSET ID=5      MRNSET ID=DFLT  MRNPC=  1-101-3
PCN      NET  Mate PC      SSN RC MULT SRM MRC GRP NAME SSO
1-101-1  I   s-2-202-1      11 10  SHR *N *N itugrp  OFF
                   N   01002          12 10  SHR *N *N  ----- OFF
                   N   01002          12 10  SHR *N *N  ----- OFF

MAP table is (15 of 36000) 1% full.
;
```

This example shows output when the Flexible GTT Load Sharing and GTT LS ARI features are enabled, and the Weighted GTT Load Sharing feature is turned on:

```
rtrv-map
```

```
eaglestp 09-08-12 18:43:29 EST EAGLE 41.1.0
MAPSET ID=DFLT  MRNSET ID=DFLT  MRNPC=  001-001-004
PCA              Mate PCA      SSN RC MULT SRM MRC GRP NAME SSO
WT %WT THR
001-001-001          11 10  SHR *Y *Y  ----- OFF
-- --- ---
                   001-001-002  12 10  SHR *Y *Y  ----- OFF
-- --- ---

MAPSET ID=2      MRNSET ID=DFLT  MRNPC=  001-001-003
PCA              Mate PCA      SSN RC MULT SRM MRC GRP NAME SSO
WT %WT THR
001-001-005          11 20  SHR *Y *Y  ----- OFF
20 67 50
                   001-001-006  10 20  SHR *Y *Y  ----- OFF
10 33 50

MAPSET ID=DFLT  MRNSET ID=----  MRNPC=-----
PCI              Mate PCI      SSN RC MULT SRM MRC GRP NAME SSO
WT %WT THR
1-101-1          11 10  SHR *N *N itugrp  OFF
-- --- ---
                   1-101-2          12 10  SHR *N *N itugrp  OFF
-- --- ---

MAPSET ID=5      MRNSET ID=DFLT  MRNPC=  1-101-3
```

```

      PCI      NET  Mate PC      SSN RC MULT SRM MRC GRP NAME SSO WT %WT
THR
1-101-1      11 10  SHR *N *N  itugrp  OFF 30
33 1
      I  s-2-202-1      12 10  SHR *N *N  ----- OFF 30
33 1
      N    01002      12 10  SHR *N *N  ----- OFF 30
33 1

      MAPSET ID=3      MRNSET ID=1      MRNPC= 01003
      PCN      Mate PCN      SSN RC MULT SRM MRC GRP NAME SSO WT %WT
THR
01001      11 10  SHR *N *N  ----- OFF 40
67 1
      01002      12 10  SHR *N *N  ----- OFF 20
33 1

      MAPSET ID=4      MRNSET ID=2      MRNPC= s-2-202-3
      PCI      Mate PCI      SSN RC MULT SRM MRC GRP NAME SSO WT %WT
THR
s-2-202-1      21 10  SHR *N *N  ----- OFF -- ---
---
      s-2-202-2      22 10  SHR *N *N  ----- OFF -- ---
---

      MAPSET ID=1      MRNSET ID=----- MRNPC=-----
      PCN      Mate PCN      SSN RC MULT SRM MRC GRP NAME SSO WT %WT
THR
s-02001      21 10  SHR *N *N  ----- OFF -- ---
---
      s-02002      22 10  SHR *N *N  ----- OFF -- ---
---
```

MAP table is (15 of 36000) 1% full.

;

This example shows output for a specific point code. The Flexible GTT Load Sharing and GTT LS ARI features are enabled, and the Weighted GTT Load Sharing feature is turned on.

```
rtrv-map:pcn=1001
```

```

eaglestp 09-08-12 18:43:34 EST EAGLE 41.1.0
      MAPSET ID=3      MRNSET ID=1      MRNPC= 01003
      PCN      Mate PCN      SSN RC MULT SRM MRC GRP NAME SSO WT %WT
THR
01001      11 10  SHR *N *N  ----- OFF 40
67 1
      01002      12 10  SHR *N *N  ----- OFF 20
33 1
```

MAP table is (15 of 36000) 1% full.

;



This example shows output for a specific point code and subsystem number. The Flexible GTT Load Sharing and GTT LS ARI features are enabled, and the Weighted GTT Load Sharing feature is turned on.

```
rtrv-map:pcn=1002:ssn=12
```

```
eaglestp 09-08-12 18:43:39 EST EAGLE 41.1.0
  MAPSET ID=3      MRNSET ID=1      MRNPC= 01003
  PCN              Mate PCN          SSN RC MULT SRM MRC GRP NAME SSO
WT %WT THR
01001
40 67 1
                01002          12 10 SHR *N *N ----- OFF
20 33 1

  MAPSET ID=5      MRNSET ID=DFLT  MRNPC= 1-101-3
  PCN              NET Mate PC       SSN RC MULT SRM MRC GRP NAME SSO
WT %WT THR
1-101-1
30 33 1
                I s-2-202-1      12 10 SHR *N *N ----- OFF
30 33 1
                N 01002          12 10 SHR *N *N ----- OFF
30 33 1

  MAP table is (15 of 36000) 1% full.
;
```

This example shows output for a specific point code. The GTT LS ARI feature is enabled, the Weighted GTT Load Sharing feature is turned on, and `on=refcnt` is specified.

```
rtrv-map:pcn=1001:on=refcnt
```

```
eaglestp 11-03-17 16:23:34 EST EAGLE 44.0.0
  MAPSET ID=3      MRNSET ID=1      MRNPC= 01003
  MAPSET REFCNT=1
  PCN              Mate PCN          SSN RC MULT SRM MRC GRP NAME SSO
WT %WT THR
01001
40 67 1
  MAPSETPCSSN REFCNT=2      MAPSETPC REFCNT=1
                01002          12 10 SHR *N *N ----- OFF
20 33 1
  MAPSETPCSSN REFCNT=0      MAPSETPC REFCNT=*1

  MAP table is (15 of 36000) 1% full.
;
```

Output for 16 bit PC map entry.

```
rtrv-map:pcn16=1-2-3
```

```
tekelecstp 13-07-02 16:13:30 EST 45.0.0-64.69.0
```

```
rtrv-map:pcn16=1-2-3
```

```
Command entered at terminal #4.
```

```

MAPSET ID=DFLT
PCN16      Mate PCN16      SSN RC MULT SRM MRC GRP NAME SSO WT %WT
THR
001-02-03          10 10  SOL *N  *N  ----- OFF -- ---
---
```

```
MAP table is (2 of 36000) 1% full.
```

```
;
```

### Legend

- **MAPSET ID**—MAP set number or DFLT when numbered MAP sets are allowed
- **PCA/PCI/PCN/PCN24/PCN16**—Point code of the SCP where the primary application resides
- **NET**—Mate network type of the point code when an ITU MAP set contains both ITU-I and ITU-N point codes. The field can show I if the MATE PC is an ITU-I point code or N if the MATE PC is an ITU-N point code.
- **MATE PC/PCA/PCI/PCN/PCN24/PCN16**—Point code of the SCP where the mate application resides
- **SSN**—Applications subsystem number
- **RC**—Relative cost of the point code/subsystem
- **MULT**—Multiplicity mode SOL (Solitary), DOM (Dominant), SHR (Shared), or COM (Combined - Shared and Dominant) Load sharing. See the "Notes" section in the `ent-map` command description for an explanation of multiplicity modes.
- **SRM**—Specifies whether subsystem routing messages are transmitted is on (YES), off (NO), not applicable (\*Y) but would be YES if applicable, or not applicable (\*N) but would be NO if applicable. See the "Notes" section in the command description for SRM non applicable Load sharing modes.
- **MRC**—Specifies whether message routing under congestion is on (YES), off (NO), not applicable (\*Y) but would be YES if applicable, or not applicable (\*N) but would be NO if applicable. See the "Notes" section in the `rtrv-map` command for MRC non applicable Load sharing modes.
- **GRP NAME**—Name of a group of point codes (broadcast list group name) to be notified of the subsystem status
- **SSO**—Subsystem Status Option. Subsystem status (ON=prohibited or OFF=allowed) for PC/SSN MAP entries.
- **WT**—Weight assigned to the PC
- **%WT**—Relative percentage, according to weight, of an in-service PC within an RC group

- **THR**—Service threshold. If the relative percentage, according to weight, of in-service PCs within an RC group falls below the in-service threshold, that RC group is considered out-of-service and traffic is routed to the next lowest RC group.
- **MRNSET**—Alternate RI Mate MRN Set ID
- **MRNPC**—Alternate RI Mate point code
- **MAPSET REFCNT**—Count of GTT Translation table entries with XLAT=NONE that refer to the corresponding MAP set
- **MAPSETPCSSN REFCNT**—Count of entries from MRN, GSM MAP Screening, GSM MAP Opcode, GTT Translation and GTT Action tables that refer a MAP entry with a MAPSET/PC/SSN combination
- **MAPSETPC REFCNT**—Count of entries from MRN, GTT Translation, GSM MAP Screening, GSM MAP Opcode and Prepaid SMS Options tables that refer a MAP entry with a MAPSET/PC combination

### Related Topics

- [chg-map](#)
- [dlt-map](#)
- [ent-map](#)

## rtrv-mate-stp

Use this command to see point codes configured in mate stp table.

### Parameters

This command has no parameters

### Example

```
rtrv-mate-stp
```

### Dependencies

This command cannot be entered while in upgrade mode.

### Output

```
rtrv-mate-stp
```

```
Command Accepted - Processing
```

```
tekelecstp 18-05-29 11:19:05 MST EAGLE 46.6.2.0.0-73.19.0
```

```
  rtrv-mate-stp
```

```
    Command entered at terminal #2.
```

```
tekelecstp 18-05-29 11:19:05 MST EAGLE 46.6.2.0.0-73.19.0
```

```
STP POINT CODE (PCI)
```

```
-----
```

```
  1-001-1
```

```
  3-003-1
```

```
Mate Stp table is (2 of 16) 13% full.  
;
```

### Related Topics

- [ent-mate-stp](#)
- [dlt-mate-stp](#)

## rtrv-meas-sched

Use this command to retrieve the list of measurement reports currently scheduled to be dumped to the UI, and the collection settings for OAM based measurements.

This command provides no information on Measurements Platform (MCP) scheduled FTP reports or on the status of MCP measurements (see `rtrv-measopts`).

Refer to the *Measurements Manual* for specific details on measurement reports.

### Parameters

This command has no parameters.

### Example

```
rtrv-meas-sched
```

### Dependencies

None

### Notes

None

### Output

Output with measurement collection on.

```
rtrv-meas-sched
```

```
rlghncxa03w 04-02-27 07:19:51 EST EAGLE 31.3.0  
COLLECT          = on  
GTWYLSFLTR      = both  
-----  
SYSTOT-STP      = on  
SYSTOT-TT       = off  
SYSTOT-STPLAN   = off  
COMP-LNKSET     = on  
COMP-LINK       = on  
GTWY-STP        = on  
GTWY-LNKSET     = on  
MTCD-STP        = on  
MTCD-LINK       = on  
MTCD-STPLAN     = on
```

```

    MTC-D-LNKSET      = on
;

```

Output with measurement collection off. The parentheses () indicate that a setting is not in effect because collection is turned off.

```
rtrv-meas-sched
```

```

rlghncxa03w 04-02-27 07:19:51 EST  EAGLE 31.3.0
COLLECT      = off
GTWYLSFLTR   = (both)
-----
SYSTOT-STP   = (off)
SYSTOT-TT    = (off)
SYSTOT-STPLAN = (off)
COMP-LNKSET  = (off)
COMP-LINK    = (off)
GTWY-STP     = (off)
GTWY-LNKSET  = (off)
MTC-D-STP    = (on)
MTC-D-LINK   = (on)
MTC-D-STPLAN = (on)
MTC-D-LNKSET = (on)
;

```

### Legend

- **COLLECT**—Shows whether measurement collection is on or off.
- **GTWYLSFLTR**—Shows the setting that filters the linksets included in the GTWY report. The settings are as follows:
  - *both*—Only gateway linksets are included in the report to the terminal and SEAS.
  - *stp*—Only gateway linksets are included in the report to the terminal. All defined linksets are included in the report to SEAS.
  - *seas*—All defined linksets are included in the report to the terminal. Only gateway linksets are included in the report to SEAS.
  - *none*—All defined linksets are included in the report to the terminal and SEAS.
- **SYSTOT-STP**—System total–STP measurement collection is on or off.
- **SYSTOT-TT**—System total–translation type measurement collection is on or off.
- **SYSTOT-STPLAN**—System total–STP LAN measurement collection is on or off.
- **COMP-LNKSET**—Component–linkset measurement collection is on or off.
- **COMP-LINK**—Component–link measurement collection is on or off.
- **GTWY-STP**—Gateway administration–STP measurement report is on or off.
- **GTWY-LNKSET**—Gateway administration–LNKSET measurement report is on or off.
- **MTC-D-STP**—Maintenance daily–STP measurement collection is on or off.
- **MTC-D-LINK**—Maintenance daily–link measurement collection is on or off.

- **MTCD-STPLAN**—Maintenance daily—STP LAN measurement collection is on or off.
- **MTCD-LNKSET**—Maintenance daily—LNKSET measurement report is on or off.

### Related Topics

- [chg-meas](#)
- [rept-meas](#)
- [rtrv-measopts](#)

## rtrv-measopts

Use this command show the status of:

- All FTP scheduled measurements reports
- the Measurements Platform collection function (PLATFORMENABLE setting)
- the 15 Minute Measurements collection function (COLLECT15MIN setting)
- the CLI-based report file name option (CLLIBASEDNAME setting)
- the Integrated Measurements collection function (OAMHCMEAS setting)
- the unchannelized link label function (UNCHLINKLABEL setting)

### Parameters

This command has no parameters.

### Example

```
rtrv-measopts
```

### Dependencies

This command cannot be entered while in upgrade mode.

### Notes

None

### Output

```
rtrv-measopts
```

```
e1061001 12-01-13 00:03:37 EST EAGLE5 45.0.0
PLATFORMENABLE = off
COLLECT15MIN   = off
CLLIBASEDNAME  = off
OAMHCMEAS     = on
UNCHLINKLABEL  = on
-----
SYSTOTSTP     = off
SYSTOTT       = off
SYSTOTIDPR    = off
SYSTOTSIP     = off
SYSTOTSFTHROT = off
COMPLINK      = off
```

```

COMPLNKSET      = on
COMPSCPASOC     = off
COMPSCPACARD    = off
COMPUA          = off
GTWYSTP         = off
GTWYLNKSET      = off
GTWYORIGNI      = off
GTWYORIGNINC    = off
GTWYLSORIGNI    = off
GTWYLSDESTNI    = off
GTWYLSONISMT    = off
NMSTP           = off
NMLINK          = off
NMLNKSET        = on
AVLLINK         = off
AVLDLINK        = off

```

;

### Legend

- **PLATFORMENABLE**—status of the Measurements Collection function
- **COLLECT15MIN**—status of the 15 Minute Measurements collection function
- **OAMHCMEAS**—Indicates the status of the Integrated Measurements collection function on an E5-OAM card
- **UNCHLINKLABEL**—status of the unchannelized link label for high-speed MTP2 links
- **CLLIBASEDNAME**—indicates whether the CLLI-based file name option is turned on or off
- **SYSTOTSTP**—System Total measurements report for the entire STP
- **SYSTOTTT**—System Total report for Translation Type measurements
- **SYSTOTIDPR**—System Total measurements report for the entire IDPR Measurements
- **SYSTOTSIP**—System Total measurements report for the entire SIP Measurements
- **SYSTOTSFTHROT**—System Total measurements report for SFTHROT GTT Action Measurements
- **COMPLINK**—Component measurements report for links
- **COMPLNKSET**—Component measurements report for link sets
- **COMPSCPASOC**—Component measurements report for SCTP associations
- **COMPSCPACARD**—Component measurements report for SCTP cards
- **COMPUA**—Component measurements report for M3UA and SUA application server/association pairs
- **GTWYORIGNI**—Gateway Administration measurements report per originating network (large network uniquely identified by NI only)
- **GTWYORIGNINC**—Gateway Administration measurements report per originating network (small network identified by NI-NC)

- **GTWYLSORIGNI**—Gateway Administration measurements report per link set and originating network
- **GTWYLSDESTNI**—Gateway Administration measurements report per link set and destination network
- **GTWYLSONISMT**—Gateway Administration measurements report per link set, per originating network, per ISUP message type
- **NMLINK**—Network Management measurements report for links
- **NMLNKSET**—Network Management measurements report for link sets
- **NMSTP**—Network Management measurements report for the entire STP
- **AVLINK**—Hourly Availability report for links
- **AVLDLINK**—Daily Availability report for links

#### Related Topics

- [chg-measopts](#)
- [chg-mtc-measopts](#)
- [rtrv-mtc-measopts](#)

## rtrv-mrn

Use this command to display the Mated Relay Node application relationship information maintained by the EAGLE. This information is used to support the routing of SCCP management SSP/SSA messages.

If the Intermediate GTT Load-Sharing feature is on and the Flexible GTT Load-Sharing feature is enabled, then use this command to retrieve MRN set information.

If the GTT Load Sharing with Alternate Routing Indicator (GTT LS ARI) feature is enabled, then use this command to display Alternate RI Mate information.

#### Parameters

**Note:**

See [Point Code Formats and Conversion](#) for a detailed description of point code formats, rules for specification, and examples.

**Note:**

Definitions for the feature options specified by the `on` parameter are located in the Notes section.

**mrnset (optional)**

MRN set ID.



**Range:**

1 - 3000, *dflt*  
*dflt* —Default MRN set

**on (optional)**

Enables or turns on the specified options. A comma-separated list of options that are requested to be turned on. Up to 8 options can be specified in the list.

**Range:**

*refcnt*

**pc (optional)**

ANSI point code in the form of *network indicator-network cluster-network cluster member (ni-nc-ncm)*.

**Synonym:**

*pca*

**Range:**

000-255

Specify a valid value for each subfield of the point code, and separate the subfields with a dash (-).

When *chg-sid:pctype=ansi* is specified, *ni = 000* is not valid.

When *chg-sid:pctype=ansi* is specified, *nc = 000* is not valid if *ni = 001–005*.

When *chg-sid:pctype=ansi* is specified, *nc = 000* is valid if *ni = 006–255*.

The point code *000-000-000* is not a valid point code.

**pc/pca/pci/pcn/pcn24/pcn16 (optional)**

Post-GTT-translated point code.

**pci (optional)**

ITU international point code with subfields *zone-area-id*. The *prefix* subfield indicates a spare point code (*prefix-zone-area-id*).

**Range:**

*s-*, 0-255

Specify a valid value for each subfield of the point code, and separate the subfields with a dash (-).

*prefix*—*s*

*zone*—0-7

*area*—000-255

*id*—0-7

The point code *0-000-0* is not a valid point code.

**pcn (optional)**

ITU national point code in the format of a 5-digit number (*nnnnn*); or 2, 3, or 4 numbers (members) separated by dashes (*m1-m2-m3-m4*) as defined by the *chg-stpopts:npcfmti* flexible point code option. A group code must be specified when the ITUDUPPC feature is turned on (*nnnnn-gc*, *m1-m2-m3-m4-gc*). The *prefix* subfield indicates a spare point code (*prefix-nnnnn*, *prefix-nnnnn-gc*, *prefix-m1-m2-m3-m4*, *prefix-m1-m2-m3-m4-gc*).

**Range:***s*-, 0-16383, *aa-zz*

Specify a valid value for each subfield of the point code, and separate the subfields with a dash (-).

*prefix*—*s*-*nnnnn*—0-16383*gc*—*aa-zz**m1-m2-m3-m4*—0-14 for each member; values must sum to 14**pcn24 (optional)**24-bit ITU national point code with subfields *main signaling area-sub signaling area-signaling point (msa-ssa-sp)*.**Range:**

000-255

Specify a valid value for each subfield of the point code, and separate the subfields with a dash (-).

*msa*—000–255*ssa*—000–255*sp*—000–255**pcn16 (optional)**16-bit ITU national point code with subfields *unit number-sub number area-main number area (un-sna-mna)*.**Range:**

000---127

Specify a valid value for each subfield of the point code, and separate the subfields with a dash (-).

*un*---000---127*sna*---000---15*mna*---000---31**Example**`rtrv-mrn``rtrv-mrn:pc=1-1-2``rtrv-mrn:pcn=s-1-1-1-123-aa``rtrv-mrn:pci=1-55-1:mrnset=2``rtrv-mrn:pcn=1001:mrnset=dflt:on=refcnt``rtrv-mrn:pcn16=1-2-3:mrnset=dflt`**Dependencies**

A point code that is specified in the command must already exist in the MRN table.

The `mrnset` parameter can only be specified when the Flexible GTT Load-Sharing feature is enabled.

If the Flexible GTT Load Sharing feature is ON, then the PC and MRN set must be specified together.

The specified MRN set must already exist in the MRN table.

If the Flexible GTT Load Sharing feature is enabled, then the specified PC must already exist in the specified MRN set.

The Intermediate Global Title Translation Load Sharing (IGTTLS) feature must be turned on before this command can be entered.

### Notes

This command can be canceled using the **F9** function key or the `canc-cmd` command. See `canc-cmd` for more information.

In this command, only ITU-international and ITU national point codes support the spare point code subtype prefix (s-).

If any entries are provisioned in the SCCP-SERV table, then the maximum number of entries shown for the MRN table are reduced by that amount.

When the GTT LS ARI feature is enabled, the Alternate RI Mate, identified by the MAPSET, MAPPC, and MAPSSN fields, is displayed for all MRN Sets. When the GTT LS ARI feature is not enabled, the Alternate RI Mate is not displayed, and the display is unchanged.

### on options

*refcnt* —displays the MRNSET and MRNSET/PC reference counts

### Output

The NET column is shown only when an MRN set contains mixed network point code types. Addition of the NET column realigns all remaining columns in the output. The re-alignment is constant even if the NET column is not shown.

```
rtrv-mrn
```

```
spareduppc 08-12-13 11:35:12 EST EAGLE 40.1.0
```

PC	RC
001-001-000	5
001-001-001	10
001-001-002	20
001-001-003	30
001-001-004	40
PC	RC
001-002-001	20
001-001-007	25
001-001-008	30
001-003-002	30
PCI	RC
s-2-100-1	10
s-2-002-1	10

```
s-2-002-2      10
```

```
PCN           RC
s-1-1-1-0123-aa  1
s-1-1-1-0235-aa  2
s-1-1-1-0555-aa  3
```

MRN table is (15 of 3000) 1% full.

```
rtrv-mrn:pc=1-1-2
```

```
spareduppc 08-12-13 11:35:12 EST  EAGLE 40.1.0
```

```
PC           RC
001-001-000  5
001-001-001  10
001-001-002  20
001-001-003  30
001-001-004  40
```

MRN table is (15 of 3000) 1% full.

```
rtrv-mrn:pci=s-2-2-1
```

```
spareduppc 08-12-13 11:35:12 EST  EAGLE 40.1.0
```

```
PCI          RC
s-2-100-1    10
s-2-002-1    10
s-2-002-2    10
```

MRN table is (15 of 3000) 1% full.

```
rtrv-mrn:pcn=s-1-1-1-123-aa
```

```
spareduppc 08-12-13 11:35:12 EST  EAGLE 40.1.0
```

```
PCN           RC
s-1-1-1-0123-aa  1
s-1-1-1-0235-aa  2
s-1-1-1-0555-aa  3
```

MRN table is (15 of 3000) 1% full.

This example shows output when the Weighted GTT Load Sharing feature is on, and weights are added to an existing MRN set:

```
rtrv-mrn:pci=s-2-2-2
```

```
weighton 08-12-13 11:35:12 EST EAGLE 40.1.0
```

PCI	RC	WT	%WT	THR
s-2-002-1	10	5	17	50
s-2-002-2	10	10	33	50
s-2-100-1	10	15	50	50

```
MRN table is (15 of 3000) 1% full.
```

This example shows output when the Flexible Final GTT Load Sharing feature is enabled, and the first new ANSI MRN set is added:

```
rtrv-mrn
```

```
gflexon 08-12-13 11:35:12 EST EAGLE 40.1.0
```

MRNSET	PC	RC	WT	%WT	THR
DFLT	001-001-000	5	--	---	---
	001-001-001	10	--	---	---
	001-001-002	20	--	---	---
	001-001-003	30	--	---	---
	001-001-004	40	--	---	---

MRNSET	PC	RC	WT	%WT	THR
DFLT	001-002-001	20	--	---	---
	001-001-007	25	--	---	---
	001-001-008	30	--	---	---
	001-003-002	30	--	---	---

MRNSET	PCI	RC	WT	%WT	THR
DFLT	s-2-100-1	10	15	50	50
	s-2-002-1	10	5	17	50
	s-2-002-2	10	10	33	50

MRNSET	PCN	RC	WT	%WT	THR
DFLT	s-1-1-1-0123-aa	1	--	---	---
	s-1-1-1-0235-aa	2	--	---	---
	s-1-1-1-0555-aa	3	--	---	---

MRNSET	PC	RC	WT	%WT	THR
1	001-003-001	10	--	---	---
	001-003-002	10	--	---	---
	001-003-003	30	--	---	---
	001-003-004	30	--	---	---
	001-003-006	60	--	---	---
	001-003-007	60	--	---	---
	001-003-008	80	--	---	---
	001-003-009	80	--	---	---

```
MRN table is (23 of 6000) 1% full.
```

This example shows output when a mixed ITU network weighted MRN set is used:

```
rtrv-mrn:pci=1-55-1:mrnset=2
```

```
gflexon 08-12-13 11:35:12 EST EAGLE 40.1.0
```

MRNSET	NET	PC	RC	WT	%WT	THR
2	N	s-1-1-1-0235-aa	30	20	20	1
	I	1-055-1	30	20	20	1
	I	s-2-002-1	30	20	20	1
	I	s-2-002-2	30	20	20	1
	N	1-1-1-0444-bb	30	20	20	1

MRN table is (28 of 6000) 1% full.

This example shows output when the Flexible GTT Loadsharing and GTT LS ARI features are enabled, and the Weighted GTT Loadsharing feature is not turned on:

```
rtrv-mrn
```

```
eaglestp 08-12-22 19:03:49 EST EAGLE 40.1.0
```

MRNSET	MAPSET	MAPPEN	MAPPSSN	PCN	RC
DFLT	DFLT	01003	10	01002	10
				01001	10

MRNSET	MAPSET	MAPPEN	MAPPSSN	PC	RC
1	-----	-----	---	001-001-002	10
				001-001-001	10

MRNSET	MAPSET	MAPPEN	MAPPSSN	PCI	RC
2	1	1-101-3	10	1-101-2	10
				1-101-1	10

MRNSET	MAPSET	MAPPEN	MAPPSSN	PCI	RC
3	2	s-2-202-3	*	s-2-202-2	10
				s-2-202-1	10

MRNSET	MAPSET	MAPPEN	MAPPSSN	PCN	RC
4	DFLT	s-02003	*	s-02002	20
				s-02001	20

MRNSET	MAPSET	MAPPEN	MAPPSSN	NET	PC	RC
5	DFLT	01004	20	I	1-101-1	10
				N	01001	10
				I	s-2-202-1	30

MRN table is (13 of 6000) 1% full.

```
;
```

This example shows output when the Flexible GTT Loadsharing and GTT LS ARI features are enabled, and the Weighted GTT LS feature is turned on:

rtrv-mrn

```

eaglestp 08-12-22 19:04:42 EST EAGLE 40.1.0
MRNSET MAPSET MAPPCN MAPSSN PCN RC WT
%WT THR
50 1 DFLT DFLT 01003 10 01002 10 5
50 1 01001 10 5

MRNSET MAPSET MAPPC MAPSSN PC RC WT
%WT THR
67 20 1 ----- 1001-001-002 10 20
33 20 001-001-001 10 10

MRNSET MAPSET MAPPCI MAPSSN PCI RC WT
%WT THR
57 1 2 1 1-101-3 10 1-101-2 10 40
43 1 1-101-1 10 30

MRNSET MAPSET MAPPCI MAPSSN PCI RC WT
%WT THR
50 1 3 2 s-2-202-3 * s-2-202-2 10 50
50 1 s-2-202-1 10 50

MRNSET MAPSET MAPPCN MAPSSN PCN RC WT
%WT THR
--- --- 4 DFLT s-02003 * s-02002 20 --
--- --- s-02001 20 --

MRNSET MAPSET MAPPCN MAPSSN NET PC RC WT
%WT THR
50 1 5 DFLT 01004 20 I 1-101-1 10 20
50 1 N 01001 10 20
100 1 I s-2-202-1 30 20

```

MRN table is (13 of 6000) 1% full.

;

This example shows output for a specific point code and MRN Set. The Flexible GTT Loadsharing and GTT LS ARI features are enabled, and the Weighted GTT Loadsharing feature is turned off.

```
rtrv-mrn:pcn=1001:mrnset=dflt
```

```
eaglestp 08-12-22 19:03:53 EST EAGLE 40.1.0
```

MRNSET	MAPSET	MAPPCN	MAPSSN	PCN	RC
DFLT	DFLT	01003	10	01002	10
				01001	10

```
MRN table is (13 of 6000) 1% full.
```

```
;
```

This example shows output for a specific point code and MRN Set. The Flexible GTT Loadsharing and GTT LS ARI features are enabled, and the Weighted GTT Loadsharing feature is turned on.

```
rtrv-mrn:pcn=1001:mrnset=dflt
```

```
eaglestp 08-12-22 19:04:47 EST EAGLE 40.1.0
```

MRNSET	MAPSET	MAPPCN	MAPSSN	PCN	RC	WT	%WT	THR
DFLT	DFLT	01003	10	01002	10	5	50	1
				01001	10	5	50	1

```
MRN table is (13 of 6000) 1% full.
```

```
;
```

This example shows output for a specific point code and MRN set. The GTT LS ARI feature is enabled, the Weighted GTT Loadsharing feature is turned on, and `on=refcnt` is specified.

```
rtrv-mrn:pcn=1001:mrnset=dflt:on=refcnt
```

```
eaglestp 11-03-17 14:24:37 EST EAGLE 44.0.0
```

```
MRNSET REFCNT=1
MRNSET MAPSET MAPPCN MAPSSN PCN RC WT %WT THR
DFLT DFLT 01003 10 01002 10 5 50 1
MRNSETPC REFCNT=2
01001 10 5 50 1
MRNSETPC REFCNT=1
```

```
MRN table is (13 of 6000) 1% full.
```

```
;
```

```
16 bit PC MRN entry output.
```



```
rtrv-mrn:pcn16=1-2-3:mrnset=dflt
```

```
tekelecstp 13-07-02 16:18:09 EST 45.0.0-64.69.0
rtrv-mrn:pcn16=1-2-3:mrnset=dflt
Command entered at terminal #4.
```

MRNSET	PCN16	RC	WT	%WT	THR
DFLT	002-02-02	10	10	25	1
	001-02-03	10	30	75	1

```
MRN table is (2 of 6000) 1% full.
```

### Legend

- **MRNSET**—MRN set ID
- **NET**—Mmated network type of the point code when an ITU MRN set contains both ITU-I and ITU-N point codes. The field can show I if the PC is an ITU-I point code or N if the PC is an ITU-N point code.
- **PC/PCI/PCN/PCN24/PCN16**—Point Code
- **RC**—Relative Cost
- **WT**—PC Weight
- **%WT**—Relative percentage, according to weight, of an in-service PC within an RC group
- **THR**—Service threshold. If the relative percentage, according to weight, of in-service PCs within a RC group falls below the in-service threshold, that RC group is considered out-of-service, and traffic is routed to the next lowest RC group.
- **MAPSET**—Secondary mate MAP Set
- **MAPPCN**—Alternate RI Mate point code
- **MAPSSN**—Alternate RI Mate subsystem number
- **MRNSET REFCNT**—Count of GTA table entries with XLAT=NONE that refer to the corresponding MRN set
- **MRNSETPC REFCNT**—Count of entries from the MAP, GTT Translation, GTT Action, and Prepaid SMS Options tables that refer to the corresponding MRN entry with an MRNSET/PC combination

### Related Topics

- [chg-mrn](#)
- [dlt-mrn](#)
- [ent-mrn](#)

## rtrv-mtc-measopts

Use this command to show the enabled/disabled status of all hourly and daily scheduled maintenance measurements reports.

**Parameters**

This command has no parameters.

**Example**

```
rtrv-mtc-measopts
```

**Dependencies**

This command cannot be entered while in upgrade mode.

**Notes**

None

**Output**

```
rtrv-mtc-measopts
```

```
tekelecstp 17-05-13 16:31:40 EST EAGLE 45.1.0
```

```

MTCHLNP           = off
MTCHNP            = off
MTCHMAP           = off
MTCHEIR           = off
MTCHENUM          = on
MTCHVFLEX         = on
MTCHATINPQ       = off
MTCHGTTAPATH     = off
                   MTCHGTTSET      = off
MTCHAIQ           = off
MTCDSTP           = off
MTCDLINK          = off
MTCDLNKSET        = off
MTCDLNP           = off
MTCDNP            = off
MTCDMAP           = off
MTCDEIR           = off
MTCDENUM          = on
MTCDVFLEX         = on
MTCDATINPQ       = off
MTCDSCTPASOC     = off
MTCDSCTPCARD     = off
MTCDUA            = off
MTCDGTTAPATH     = off
                   MTCDGTTSET      = off
MTCDAIQ           = off
MTCDSFTHROT      = off
MTCDSSIP         = off
MTCHDEIR         = off
MTCDEIR          = off

```

;

**Legend**

- **MTCHEIR**—Maintenance Hourly (marginal) measurements report for Equipment Identity Register
- **MTCHENUM**—Maintenance Hourly measurements report for ENUM Mobile Number Portability and Tier One Address Resolution
- **MTCHVFLEX**—Maintenance Hourly (marginal) measurements report for V-Flex (Voice Mail Router)
- **MTCHATINPQ**—Maintenance Hourly (marginal) measurements report for ATINP Query
- **MTCHNP**—Maintenance Hourly (marginal) measurements report for INP, INP CRP, and G-Port
- **MTCHLNP**—Maintenance Hourly (marginal) measurements report for LNP
- **MTCHAIQ**—Maintenance Hourly (marginal) measurements report for ANSI41 AIQ
- **MTCHMAP**—Maintenance Hourly (marginal) measurements report for GSM Map Screening
- **MTCHGTTAPATH**—Maintenance Hourly (marginal) measurements report for GTT Action Per-Path.
- **MTCHGTTSET**—Maintenance Hourly measurements report per GTTSET
- **MTCDEIR**—Maintenance Daily measurements report for Equipment Identity Register
- **MTCDENUM**—Maintenance Daily measurements report for ENUM Mobile Number Portability and Tier One Address Resolution
- **MTCDFLEX**—Maintenance Daily measurements report for V-Flex (Voice Mail Router)
- **MTCdstp**—Maintenance Daily measurements report for STP
- **MTCdlNK**—Maintenance Daily measurements report for links
- **MTCdlNKSET**—Maintenance Daily measurements report for linksets
- **MTCdlNP**—Maintenance Daily measurements report for LNP
- **MTCdNP**—Maintenance Daily measurements report for INP/AINPQ, INP CRP, and G-Port
- **MTCdMAP**—Maintenance Daily measurements report for GSM Map Screening
- **MTCdsCTPASOC**—Maintenance Daily measurements report for SCTP associations
- **MTCdsCTPCARD**—Maintenance Daily measurements report for SCTP cards
- **MTCdUA**—Maintenance Daily measurements report for UA associations
- **MTCdGTTAPATH**—Maintenance Daily measurements report for GTT Action Per-Path.
- **MTCdGTTSET**—Maintenance Daily measurements report per GTTSET
- **MTCdAIQ**—Maintenance Daily measurements report for ANSI41 AIQ

- **MTCDSFTHROT**—Maintenance Daily measurement report for SFTHROT GTT Actions.
- **MTCDSIP**— Maintenance Daily measurement report for SIP
- **MTCHDEIR**— Maintenance Hourly measurements report for S13/S13' Diameter Equipment Identity Register
- **MTCDDEIR**—Maintenance Daily measurements report for S13/S13' Diameter Equipment Identity Register

#### Related Topics

- [chg-measopts](#)
- [chg-mtc-measopts](#)
- [chg-netopts](#)
- [rtrv-measopts](#)
- [rtrv-netopts](#)

## rtrv-na

Use this command to display the configured network appearances.

#### Parameters

This command has no parameters.

#### Example

```
rtrv-na
```

#### Dependencies

None

#### Notes

None

#### Output

```
rtrv-na
```

```
rlghncxa03w 05-01-20 09:07:58 EST EAGLE 31.12.0
TYPE      GC          NA
ANSI      --             0
ITUI      --             1
ITUN      aa             2
ITUN24    --             3
ITUIS     --             4
ITUNS     bb             5
```

```
;
```

#### Related Topics

- [dlt-na](#)

- [ent-na](#)

## rtrv-netopts

Use this command to retrieve the user-specified options for the IP and Fast Copy (FC) networks used by the EAGLE. This command displays the PVN IP address, PVN subnet mask, and FC Network parameters.

### Parameters

This command has no parameters.

### Example

```
rtrv-netopts
```

### Dependencies

The NETOPTS table must be accessible.

The EAGLE 5 Integrated Monitoring Support (E5IS) feature must be turned on before this command can be entered.

### Notes

None

### Output

```
rtrv-netopts
```

```
rlghncxa03w 08-12-11 16:35:57 IST EAGLE 40.1.0
NETWORK OPTIONS
-----
PVN          = 170.120.50.1
PVNMASK     = 255.255.252.0
FCNA        = 170.21.96.0
FCNAMASK    = 255.255.254.0
FCNB        = 170.22.96.0
FCNBMASK    = 255.255.254.0
```

```
;
```

### Related Topics

- [chg-netopts](#)

## rtrv-npp-as

Use this command to display a Numbering Plan Processor (NPP) Action Set (AS) entry.

## Parameters

### asn (optional)

Action set name. The name of the AS.

#### Range:

*ayyyyyyyy*

1 alphabetic character followed by up to 9 alphanumeric characters

### mode (optional)

This parameter allows the command to display Service Action optional numerical and digit string data values.

#### Range:

*full*

## Example

```
rtrv-npp-as
rtrv-npp-as:asn=asn6
rtrv-npp-as:mode=full
```

## Dependencies

None

## Output



### Note:

The `asn` or `mode=full` parameter must be specified before FA list information is displayed in the `rtrv-npp-as` output.

This example displays all AS entries:

```
rtrv-npp-as

tekelecstp 11-03-05 15:37:41 EMS EAGLE 44.0.0

ASN          CA          SA          FA          OFNAI  REFS
-----
asn1         znx         asdlkup     asd         inc     0
asn2         znx         grnlkup     grn         inc     0
asn3         znx         cgpnasdrqd zn          inc     0
              nprls
asn4         znx         cgpnasdrqd grn         inc     0
              cgpngrnrqd
              nprelay
```

```

asn5      ac8      rtdbtrn   sn          inc    0
          sn8      rtdbtsp   ac
          cc3      rtdbtrnsp cc
          cdial
asn6      cc3      nscdpn    cc          intl   0
          ac8      nscgpn    ac
          sn8      sn

```

NPP-AS table is (6 of 1024) 1% full.

;

This example displays a specific AS entry that contains TIF Number Substitution Service Actions:

```
rtrv-npp-as:asn=asn6
```

```
tekelecstp 12-02-05 15:37:41 EMS EAGLE 45.0.0
```

ASN	CA	SA	FA	OFNAI	REFS
asn6	cc3	nscdpn	cc	intl	0
	ac8	nscgpn	ac		
	sn8		sn		
FANE	: none				
FANF	: none				
FARN	: none				
FASP	: none				
FASCRCD	: none				
FASCRCG	: none				

NPP-AS table is (6 of 1024) 1% full.

;

```
rtrv-npp-as:mode=full
```

```
tekelecstp 12-02-05 15:37:41 EMS EAGLE 45.0.0
```

ASN	CA	SA	SA DATA	FA
asn6	cc3	nscdpn		cc
intl	1			
	ac8	nscgpn		ac
	sn8			sn
FANE	: none			
FANF	: none			
FARN	: none			
FASP	: none			
FASCRCD	: none			

```

FASCRCG : none

tifcgpn1  cc2      blrls      val1 =12    cc      intl  1
           dnx                      val2 =45    dn
           blnfndrls  val1 =56
           grnlkup      val2 =78

FANE      : none
FANF      : none
FARN      : none
FASP      : none
FASCRCG   : none
FASCRCG   : none

tifcgpn2  cc2      asdlkup    cc      intl  1
           dnx                      dn

FANE      : none
FANF      : none
FARN      : none
FASP      : none
FASCRCG   : none
FASCRCG   : none

tif1      znx      selscr    dlma    intl  1
           zn

FANE      : none
FANF      : none
FARN      : none
FASP      : none
FASCRCG   : cc, ac, rn, sn
FASCRCG   : dlmd

```

NPP-AS table is (3 of 1024) 1% full.

;

This example displays full information for a specific AS entry.

rtrv-npp-as:mode=full:asn=idpin1

tekelecstp 12-02-11 15:37:41 EMS EAGLE 45.0.0

```

ASN      CA      SA      SA DATA      FA      OFNAI
REFS
-----
----
idpin1   cc3      inprtg    cc      intl  1
         ac4      cdpnp     ac
         sn8      asdlkup   sn
         grnlkup

FANE      : cc, ac, grn, sn
FANF      : dlma, cc, ac, sn
FARN      : cc, ac, rn, sn
FASP      : none
FASCRCG   : none

```



```
FASCRCG      : none
```

```
NPP-AS      table is (1 of 1024) 1% full.
```

```
;
```

### Legend

- **ASN**—Action Set Name
- **CA**—Conditioning Action
- **SA**—Service Action
- **SA DATA**—Service Action Data
- **FA**—Formatting Action
- **OFNAI**—Outgoing Filter Nature of Address Indicator
- **REFS**—NPP Rule References
- **FANE**—Formatting Action List when the SP and RN entities are not associated with the DN in the RTDB
- **FANF**—Formatting Action when the DN is not present in the RTDB
- **FARN**—Formatting Action List when the RN network entity is associated with the DN in the RTDB
- **FASP**—Formatting Action List when the SP network entity is associated with the DN in the RTDB
- **FASCRC**D— Formatting Action List to format ISUP CdPN digits when CdPN is Screened and SA(X)VAL is none.
- **FASCRC**G— Formatting Action List to format ISUP CgPN digits when CdPN is Screened and SA(X)VAL is none.

### Related Topics

- [chg-npp-as](#)
- [ent-npp-as](#)

## rtrv-npp-serv

Use this command to display a Numbering Plan Processor (NPP) Service Data entry.

### Parameters

#### **mode (optional)**

This parameter allows the command to display NAI and delimiter values.

#### **Range:**

*full*

#### **srvn (optional)**

Service name. The name of the NPP Service.

**Range:**

***nppt***  
NPP Test Service

***idprcdpn***  
IDPRCDPN Service

***idprcgpn***  
IDPRCGPN Service

***tif***  
TIF Service

***tif2***  
TIF2 Service

***tif3***  
TIF3 Service

***mosmsicgpn***  
MOSMSICGPN service

***mosmsicdpn***  
MOSMSICDPN Service

***mosmsgcgpn***  
MOSMSGCGPN Service

***mosmsgcdpn***  
MOSMSGCDPN Service

***iarcdpn***  
IARCDPN Service

***iarcgpn***  
IARCGN Service

***idprcdpn2***  
IDPRCDPN2 Service

***idprcdpn3***  
IDPRCDPN3 Service

***idprcdpn4***  
IDPRCDPN4 Service

***tifcgpn***  
TIFCGPN Service

***tifcgpn2***  
TIFCGPN2 Service

***tifcgpn3***  
TIFCGPN3 Service

**Example**

```
rtrv-npp-serv:svrn=tif:mode=full
```

```
rtrv-npp-serv:svrn=tif
```

**Dependencies**

None

**Output**

This example displays all NPP Service table entries:

```
rtrv-npp-serv
```

```
tekelecstp 12-07-05 19:09:11 EST EAGLE 45.0.0
```

SERVICE	STATUS	SA	PRECEDENCE
nppt	off	rtdbtrnsp	100
		rtdbtrn	50
		rtdbtsp	50
		cdial	10

SERVICE	STATUS	SA	PRECEDENCE
tif	off	cdial	10
		fwdscs	5
		crp	92
		npnrls	91
		nprelay	80
		npnrls	80
		sncgpn	75
		cgpnsvcrqd	80
		asdlkup	90
		grnlkup	90
		cgpnasdrqd	90
		cgpngrnrqd	90
		nscdpn	80
		nscgpn	75
		nocgpnrls	80
		fpfxrls	92
		blrls	91
blnfndrls	91		
selscr	91		

SERVICE	STATUS	SA	PRECEDENCE
tif2	off	cdial	10
		fwdscs	5
		crp	92
		npnrls	91
		nprelay	80
		npnrls	80
sncgpn	75		

cgpnsvcrqd	80
asdlkup	90
grnlkup	90
cgpnasdrqd	90
cgpngrnrqd	90
nscdpn	80
nscgpn	75
nocgpnrls	80
fpfxrls	92
blrls	91
blnfndrls	91
selscr	91

SERVICE	STATUS	SA	PRECEDENCE
-----			
tif3	off	cdial	10
		fwdscs	5
		crp	92
		npnrls	91
		nprelay	80
		npnrls	80
		sncgpn	75
		cgpnsvcrqd	80
		asdlkup	90
		grnlkup	90
		cgpnasdrqd	90
		cgpngrnrqd	90
		nscdpn	80
		nscgpn	75
		nocgpnrls	80
		fpfxrls	92
		blrls	91
		blnfndrls	91
		selscr	91

SERVICE	STATUS	SA	PRECEDENCE
-----			
idprcdpn	off	cdial	10
		ccncchk	100
		cdpnp	80
		lacck	60
		cgpnsvcrqd	60
		asdlkup	50
		grnlkup	50
		cgpnasdrqd	50
		cgpngrnrqd	50
		inprtq	95
		skgtartg	50

SERVICE	STATUS	SA	PRECEDENCE
-----			
idprcgp	off	cdial	10
		cgpnp	80
		asdlkup	50
		grnlkup	50

blklstqry	90
blklstrly	90
cgpnrty	70
inprty	95

SERVICE	STATUS	SA	PRECEDENCE
mosmsicdpn	off	cdial	10
		cdpnp	60
		asdlkup	50
		grnlkup	50
		cgpnasdrqd	50
		cgpngrnrqd	50
		migrate	70

SERVICE	STATUS	SA	PRECEDENCE
mosmsicgpn	off	cdial	10
		asdlkup	50
		grnlkup	50

SERVICE	STATUS	SA	PRECEDENCE
mosmsgcdpn	off	cdial	10
		cdpnp	60
		asdlkup	50
		grnlkup	50
		cgpnasdrqd	50
		cgpngrnrqd	50
		pprelay	80

SERVICE	STATUS	SA	PRECEDENCE
mosmsgcgpn	off	cdial	10
		asdlkup	50
		grnlkup	50
		pprelay	80
		fraudchk	90

SERVICE	STATUS	SA	PRECEDENCE
iarcdpn	off	cdial	10
		ccncchk	100
		cdpnp	80
		cgpnsvcrqd	60
		asdlkup	50
		grnlkup	50
		cgpnasdrqd	50
		cgpngrnrqd	50

SERVICE	STATUS	SA	PRECEDENCE
iarcgpn	off	cdial	10
		cgpnp	80
		asdlkup	50

grnlkup 50

SERVICE	STATUS	SA	PRECEDENCE
idprcdpn2	off	cdial	10
		ccncchk	100
		cdpnp	80
		lacck	60
		cgpnsvrqd	60
		asdlkup	50
		grnlkup	50
		cgpnasdrqd	50
		cgpngrnrqd	50
		inprtq	95
		skgtartg	50

SERVICE	STATUS	SA	PRECEDENCE
idprcdpn3	off	cdial	10
		ccncchk	100
		cdpnp	80
		lacck	60
		cgpnsvrqd	60
		asdlkup	50
		grnlkup	50
		cgpnasdrqd	50
		cgpngrnrqd	50
		inprtq	95
		skgtartg	50

SERVICE	STATUS	SA	PRECEDENCE
idprcdpn4	off	cdial	10
		ccncchk	100
		cdpnp	80
		lacck	60
		cgpnsvrqd	60
		asdlkup	50
		grnlkup	50
		cgpnasdrqd	50
		cgpngrnrqd	50
		inprtq	95
		skgtartg	50

SERVICE	STATUS	SA	PRECEDENCE
tifcgp	off	cdial	10
		sncgpn	75
		cgpnp	80
		asdlkup	90
		grnlkup	90
		nscgpn	75
		fpfxrls	92
		blrls	91
		blnfndrls	91

SERVICE	STATUS	SA	PRECEDENCE
tifcgpn2	off	cdial	10
		sncgpn	75
		cgpnnp	80
		asdlkup	90
		grnlkup	90
		nscgpn	75
		fpfxrls	92
		blrls	91
		blnfndrls	91

SERVICE	STATUS	SA	PRECEDENCE
tifcgpn3	off	cdial	10
		sncgpn	75
		cgpnnp	80
		asdlkup	90
		grnlkup	90
		nscgpn	75
		fpfxrls	92
		blrls	91
		blnfndrls	91

;

This example displays NPP Service table data for a specific Service:

```
rtrv-npp-serv:svrn=tif
```

```
tekelecstp 12-07-05 19:09:11 EST EAGLE 45.0.0
```

SERVICE	STATUS	SA	PRECEDENCE
tif	off	crp	92
		npnrls	91
		nprelay	90
		npnrls	90
		cgpnsvcrqd	90
		sncgpn	80
		cdial	10
		fwdses	5
		nprelay	80
		npnrls	80
		sncgpn	75
		cgpnnpnrd	80
		asdlkup	90
		grnlkup	90
		cgpnasdrqd	90
		cgpngrnrqd	90
		nscdpn	80
		nscgpn	75
		nocgpnrls	80
		fpfxrls	92

```

blrls      91
blnfndrls  91
selscr     91

```

```
;
```

This example displays all NPP Service data for a specified Service when `mode=full` is specified:

```
rtrv-npp-serv:svrn=tif:mode=full
```

```
tekelecstp 11-02-02 08:46:52 EST EAGLE 44.0.0
```

SERVICE	STATUS	SA	PRECEDENCE	FNAI	NAI
tif	off	cdial	10	unkn	0
		fwdscs	5	intl	4
		crp	92	natl	3
		npnrls	91	nail	none
		nprelay	90	nai2	none
		npnrls	90	nai3	none
		snsccpn	80		
		cgpnnprqd	80		
		asdlkup	90		
		grnlkup	90		
		cgpnasdrqd	90		
		cgpngrnrqd	90		
		nscdpn	80		
		nscgpn	75		
		nocgpnrsl	80		
		fpfxrls	92		
		blrls	91		
		blnfndrls	91		
		selscr	91		

#### DELIMITERS

```

dlma=1234567890abcdef  dlmb=aaaaabbbbcccccd  dlmc=1020304050607080
dlmd=d0d0              dlme=e0e0              dlmf=f0f0
dlmg=9010              dlmh=9020              dlmi=9030
dlmj=9040              dlmk=9050              dlml=9050
dlmm=9060              dlmn=9070              dlmo=9080
dlmp=9090

```

```
;
```

#### Related Topics

- [chg-npp-serv](#)
- [chg-npp-srs](#)
- [dlt-npp-srs](#)
- [ent-npp-srs](#)



## rtrv-npp-srs

Use this command to display a Numbering Plan Processor (NPP) Service Rule Set entry.

### Parameters

#### **asn (optional)**

Action set name.

##### **Range:**

*aaaaaaaa*

1 alphabetic character followed by up to 9 alphanumeric characters

#### **fdl (optional)**

Filter digit length. The number of digits on the incoming digit string that is filtered by the NPP.

##### **Range:**

*1 - 32, \**

\*—multiple lengths of digit strings can be filtered

#### **fna i (optional)**

Filter nature of address indicator. This parameter specifies the filter Nature of Address Indicator (NAI) class.

##### **Range:**

*intl, natl, nai1, nai2, nai3, unkn*

*intl*—filter messages with NAI=INTL

*natl*—filter messages with NAI=NATL

*nai1*—filter messages with NAI=NAI1

*nai2*—filter messages with NAI=NAI2

*nai3*—filter messages with NAI=NAI3

*unkn*—filter messages with NAI=UNKN

The `chg-npp-serv` command is used to assign values to the various FNAI classes.

#### **fpfx (optional)**

Filter prefix. The prefix used to filter incoming digit strings.

##### **Range:**

1 - 16 hexadecimal digits inclusive of single digit wildcard (?); or wildcard (\*) matching the entire digit string; Valid digits are ?, \*, 0-9, a-f, A-F.

#### **srvn (optional)**

Service name.

##### **Range:**

*nppt*

NPP Test Service

***idprcdpn***  
IDPRCDPN Service

***idprcgpn***  
IDPRCGPN Service

***tif***  
TIF Service

***tif2***  
TIF2 Service

***tif3***  
TIF3 Service

***mosmsicgpn***  
MOSMSICGPN Service

***mosmsicdpn***  
MOSMSICDPN Service

***mosmsgcgpn***  
MOSMSGCGPN Service

***mosmsgcdpn***  
MOSMSGCDPN Service

***iarcdpn***  
IARCDPN Service

***iarcgpn***  
IARCGPN Service

***idprcdpn2***  
IDPRCDPN2 Service

***idprcdpn3***  
IDPRCDPN3 Service

***idprcdpn4***  
IDPRCDPN4 Service

***tifcgpn***  
TIFCGPN Service

***tifcgpn2***  
TIFCGPN2 Service

***tifcgpn3***  
TIFCGPN3 Service

### Example

Display all NPP Service Rule Set table entries for a given service.

```
rtrv-npp-srs
```

Display NPP Service Rule Set table entries for a specified digit length.

```
rtrv-npp-srs:fdl=*
```

Display NPP Service Rule Set table entries for a specified filter prefix and filter digit length.

```
rtrv-npp-srs:fpfx=91:fdl=16
```

### Dependencies

The value specified for the `fpfx` parameter cannot have a `?` as the final character.

### Output

```
rtrv-npp-srs
```

```
tekelecstp 11-02-28 16:41:44 EST EAGLE 44.0.0
```

SRVN	FPFX	FDL	FNAI	ASN	INVKSERV
nppt	a	10	intl	asn2	none
nppt	a	16	intl	asn3	none
tif2	b	12	natl	asn5	tifcgp2
idprcdpn	91	12	intl	cdset1	none
idprcdpn2	91	10	natl	cdset2	none
idprcdpn3	*	*	intl	cdset3	none
idprcdpn4	98	9	intl	cdset2	none

```
NPP-SRS table is (7 of 8192) 1% full.
```

```
;
```

### Legend

- **SRVN**—Service Name
- **FPFX**—Filter Prefix
- **FDL**—Filter Digit Length
- **FNAI**—Filter Nature of Address Indicator
- **ASN**—Action Set Name
- **INVKSERV**—Invoke Service Name

### Related Topics

- [chg-npp-serv](#)
- [chg-npp-srs](#)
- [dlt-npp-srs](#)
- [ent-npp-srs](#)

## rtrv-obit

Use this command to show the obituaries that were most recently logged in the system. The report shows the obituaries from either the active or standby OAM, and the report indicates which card and processor generated the obituary.

An obituary is a set of data that describes the status of the system just before a processor restarted due to a fault in hardware or software. The data includes a register and stack dump of the processor, card location, reporting module number, software code location, and class of the fault detected.

### Parameters

#### **loc (mandatory)**

The address of the card that is running the OAM from which the obituary information is to be retrieved.

##### **Range:**

*1113, 1115*

#### **mode (optional)**

Display mode

##### **Range:**

##### **c**

Continuous mode; shows obituaries already logged and new obituaries as they occur.

##### **m**

Manual mode; shows obituaries on demand only, when this command is entered.

##### **Default:**

*c*

#### **num (optional)**

The number of obituaries to display.

##### **Range:**

*1 - 512*

##### **Default:**

*150*

### Example

```
rtrv-obit:loc=1115:num=2
```

### Dependencies

The obituary log on the specified OAM must contain at least one obituary; otherwise, the command is rejected.

If the `mode` parameter is specified without the `num` parameter, the entire log is displayed.

Only one `rtrv-obit` or `rtrv-trbl` command at a time can be in progress throughout the entire system.

The card location specified by the `loc` parameter must be either 1113 or 1115.

If the `loc` parameter specifies the card that is running the standby OAM, that card must be available.

The `num` parameter value must be between 1 - 512.

## Notes

This command can be canceled using the **F9** function key or the `canc-cmd` command when the command is entered for the active OAM. See `canc-cmd` for more information.

In most situations, obituary reports are generated automatically when a card is reset. Automatic report generation can be turned off by selecting the `mode=m` parameter for manual mode.

The obituary from a 186 processor displays the register dump and a 16-word stack dump.

The obituary from a 486 processor is different from 186 because the register set is larger. Also, only 12 words of the stack are dumped for the 486.

The obituary from an IXP-based processor card (which includes MUX card) contains significantly more information than an obituary from an X86-based processor card. The data in an IXP obituary is spread over multiple system buffers, where each buffer is logged and printed as an independent obituary. Sequence numbers are displayed in the output so that it is clear which buffers comprise a given obituary. There is an overall sequence number, and a sequence number within each class (such as IXP register set or user data) of information.

## Output

This example shows output for two obituaries from an x86-based card:

```
rtrv-obit:loc=1115:num=2
```

```
rlghncxa03w 03-03-30 08:43:14 EST EAGLE 31.3.0
```

```
-----
STH: Received a BOOT 286-obituary reply for 1 restart(s)
Primary: Card 1203 Module 4608 Mod_loc 1 Class 0080
```

```
Register Dump :
```

```
FL=338e CS=4a9c IP=01c0
AX=0000 CX=0100 DX=21c1 BX=078a
SP=01a6 BP=01a6 SI=0fe4 DI=3ece
DS=dce8 ES=21c1 SS=336b
```

```
Stack Dump :
```

```
[SP+1E]=3ece [SP+16]=46cc [SP+0E]=0001 [SP+06]=0246
[SP+1C]=078a [SP+14]=dce8 [SP+0C]=4608 [SP+04]=338e
[SP+1A]=078a [SP+12]=078a [SP+0A]=0001 [SP+02]=4a9c
[SP+18]=0100 [SP+10]=336b [SP+08]=0080 [SP+00]=01c0
```

```
STH: Received a BOOT 486-obituary reply for 1 restart(s)
Primary: Card 1213 Module 0047 Mod_loc 5 Class 0241
```

```
Register Dump :
```

```
EFL=00000000 CS =0208 EIP=0003e75f SS =0060
EAX=0009a90b ECX=0009a915 EDX=00000000
EBX=00000000
ESP=000ddaf2 EBP=000ddb6c ESI=00090241
EDI=00141df8
DS =0060 ES =0060 FS =0060 GS =0060
```

```
Stack Dump :
```

```

[ESP+2E]=0009    [ESP+28]=1df8    [ESP+22]=0000    [ESP+1C]=a915
[ESP+2C]=a90b    [ESP+26]=0009    [ESP+20]=0000    [ESP+1A]=0009
[ESP+2A]=0014    [ESP+24]=a8c0    [ESP+1E]=0009    [ESP+18]=a90b
User Data Dump :
    0a 06 00 00 46 01 08 04 00 00 00          ....F.....
Report Date:03-03-04  Time:09:19:59
-----
;

```

This example shows output for six obituaries from an IXP-based card:

```
rtrv-obit:loc=1113:num=6
```

```

rlghncxa03w 03-01-23 08:43:14 EST  EAGLE 30.0.0
-----
STH: Received a BOOT IMT-obituary reply for 1 restart(s)
Card 1209  Module TKS_SBFR.C  Line 728  Class 01cc
StrongARM Core Register Dump (1 of 1):  [Overall: 1 of 6]
    r0 =00008b22    r1 =00004e72    r2 =0003e75f    r3 =0060024a
    r4 =0004a92b    r5 =000019c5    r6 =0000a57c    r7 =00005521
    r8 =0000b1f7    r9 =0000836c    r10=0000e251    r11=00141d42
    r12=006055a3    sp =0000727c    lr =0000003f    pc =00006429
Report Date:03-01-23  Time:12:20:45
-----

```

```

rlghncxa03w 03-01-23 08:43:14 EST  EAGLE 30.0.0
-----
STH: Received a BOOT IMT-obituary reply for 1 restart(s)
Card 1209  Module TKS_SBFR.C  Line 728  Class 01cc
StrongARM Core Stack Dump (1 of 1):  [Overall: 2 of 6]
System Mode Stack:
    0000  15a3a816  0012be0a  06000046  01080400  ..
.....
    0010  00a2342c  07f7b83a  15729dd2  05580601  ..
.....
    0020  1a22a616  7072b91a  46304a44  06887400  ..
.....
    0030  25a33b12  01a4ba22  17e03026  11483402  ..
.....
    0040  00130811  0033a30a  14008149  0cab6130  ..
.....
    0050  00000000  00000000  00000000  00000000  ..
.....
    0060  15a3a816  0012be0a  06000046  01080400  ..
.....
    0070  00a2342c  07f7b83a  15729dd2  05580601  ..
.....
    0080  1a22a616  7072b91a  46304a44  06887400  ..
.....
Abort Mode Stack:
    0000  25a33b12  01a4ba22  17e03026  11483402  ..
.....
    0010  00130811  0033a30a  14008149  0cab6130  ..
.....

```

```

06887400      0020  1a22a616  7072b91a  46304a44
              .....
11483402      0030  25a33b12  01a4ba22  17e03026
              .....
0cab6130      0040  00130811  0033a30a  14008149
              .....
00000000      0050  00000000  00000000  00000000
              .....
01080400      0060  15a3a816  0012be0a  06000046
              .....

```

Report Date:03-01-23 Time:12:20:45

-----

rlghncxa03w 03-01-23 08:43:14 EST EAGLE 30.0.0

-----

STH: Received a BOOT IMT-obituary reply for 1 restart(s)

Card 1209 Module TKS\_SBFRC Line 728 Class 01cc

IXP Register Dump (1 of 2): [Overall: 3 of 6]

\*\*\*\*\* FBI Registers: \*\*\*\*\*

```

IREG =00000000          SOP_SEQ1=00000000
SOP_SEQ2=0003e75f      ENQUEUE_SEQ1=0060024a
ENQUEUE_SEQ2=0060024a  THREAD_DONE_REG0=00600231
THREAD_DONE_REG1=00600231  RCV_RDY_CNT=000012d4
RCV_RDY_HI =0009a90b    RCV_RDY_LO=00000000
RCV_RDY_CTL=0009a915    RCV_CNTL=00000000
REC_FASTPORT_CTL =000ddaf2  FLOWCTL_MASK =000ddb6c
RDYBUS_SYN_CNT_DEF=00090241  SELF_DESTRUCT=00141df8
HASH_MULTIPLIER_64_HI=006011a3
HASH_MULTIPLIER_64_LO=00000000
HASH_MULTIPLIER_48_HI=006011a3
HASH_MULTIPLIER_48_LO=00000000
GET_CMD=00000000        XMIT_RDY_LO=00000000
XMIT_RDY_HI=00000000    XMIT_RDY_CTL=00000000
XMIT_PTR =0003e75f

```

\*\*\*\*\* SDRAM Registers: \*\*\*\*\*

```

SDRAM_CSR=0060024a
SDRAM_MEMCTL0=0060024a
SDRAM_MEMCTL1=00600231  DRAM_MEMINIT=00600231

```

\*\*\*\*\* StrongARM System Registers: \*\*\*\*\*

```

PLL_CFG=0060024a      GPIO_EN=0060024a
GPIO_DATA=00600231    RTC_DIV=00600231
RTC_INIT=000012d4     RTC_TVAL=0009a90b
RTC_CNTR=00000000     RTC_ALM=0009a915
UART_SR=0009a915      UART_CR=00000000
UART_DR=00090241      TIMER_1_LOAD=000ddb6c
TIMER_2_LOAD=00090241  TIMER_3_LOAD=00141df8
TIMER_4_LOAD=00000000  TIMER_1_VALUE=00000000
TIMER_2_VALUE=006011a3  TIMER_3_VALUE=00000000
TIMER_4_VALUE=00090241  TIMER_1_CONTROL=00141df8
TIMER_2_CONTROL=00000000  TIMER_3_CONTROL=00000000

```

```

TIMER_4_CONTROL=006011a3      FIQ=00000000
IRQ=00000000
***** PCI Configuration Space Registers: *****
PCI_VEN_DEV_ID=0060024a      PCI_CMD_STAT=0060024a
PCI_REV_CLASS=00600231      PCI_CACHE_LAT_HDR_BIST=00600231
PCI_MEM_BAR=000012d4        PCI_IO_BAR=0009a90b
PCI_DRAM_BAR=00000000        PCI_SUBSYS=0009a915
PCI_INT_LAT=0009a915
***** PCI Shared Control Registers: *****
CAP_PTR_EXT=00090241          PWR_MGMT=000ddb6c
IXP1200_RESET=00090241      PCI_OUT_INT_MASK=00141df8
I20_INB_FIFO=00000000      I20_OUTB_FIFO=00000000
MAILBOX_0=006011a3          MAILBOX_1=00000000
MAILBOX_2=006011a3          MAILBOX_3=00000000
DOORBELL=006011a3          DOORBELL_SETUP=00000000
***** PCI Control Registers: *****
CHAN_1_BYTE_COUNT=0060024a  CHAN_2_BYTE_COUNT=0060024a
CHAN_1_PCI_BAR=00600231     CHAN_2_PCI_BAR=00600231
CHAN_1_DRAM_ADDR=000012d4   CHAN_2_DRAM_ADDR=0009a90b
CHAN_1_DESC_PTR=00000000    CHAN_2_DESC_PTR=0009a915
CHAN_1_CONTROL=0009a915     CHAN_2_CONTROL=00000000
DMA_INF_MODE=00090241       CSR_BASE_ADDR_MASK=000ddb6c
DRAM_BASE_ADDR_MASK=000ac14c I20_INB_FLIST_HPTR=00141df8
I20_INB_PLIST_TPTR=006011a3 I20_OUTB_PLIST_HPTR =00000000
I20_OUTB_FLIST_TPTR =00000000 I20_INB_FLIST_CNT=00000000
I20_OUTB_PLIST_CNT =006011a3 I20_INB_PLIST_CNT =00000000
SA_CONTROL=00090241         PCI_ADDR_EXT=000ddb6c
DBELL_PCI_MASK=00090241     DBELL_SA_MASK=00141df8
IRQ_STATUS=00000000         FIQ_STATUS=00000000
IRQ_RAW_STATUS=006011a3     FIQ_RAW_STATUS=00000000
IRQ_ENABLE=006011a3         FIQ_ENABLE=00000000
***** Coprocessor 15 Registers: *****
ID_CHIP=0060024a            CONTROL_CP15=0060024a
TRANSLATION_TAB_BASE=00600231 DOMAIN_ACCESS_CONTROL=00600231
FAULT_STATUS=000012d4       FAULT_ADDRESS=0009a90b
CACHE_CONTROL_OPER=00000000 READ_BUFFER_OPER=0009a915
PROC_ID_VIRT_ADDR_MAP=00000000
DATA_BREAKPT_CONTROL_REG=0009a915
Report Date:03-01-23 Time:12:20:45

```

```
-----
rlghncxa03w 03-01-23 08:43:14 EST EAGLE 30.0.0
-----
```

STH: Received a BOOT IMT-obituary reply for 1 restart(s)

Card 1209 Module TKS\_SBFRC Line 728 Class 01cc

IXP Register Dump (2 of 2): [Overall: 4 of 6]

\*\*\*\*\* SRAM Registers: \*\*\*\*\*

```

SRAM_CSR=0060024a          SRAM_AUTO_BASE=0060024a
SRAM_AUTO_PTR=00600231     SRAM_AUTO_END=00600231
SRAM_TEST_MOD=000012d4     SRAM_SLOW_CONFIG=0009a90b
SRAM_BOOT_CONFIG=00000000  SRAM_SLOWPORT_CONFIG=0009a915

```

\*\*\*\*\* Microengine 0 Registers: \*\*\*\*\*

```

USTORE_DATA=0060024a       ALU_OUTPUT=0060024a
CTX_ENABLES=000012d4       CC_ENABLE=0009a90b
CTX_0_SIG_EVENTS=00090241  CTX_1_SIG_EVENTS=000ddb6c

```



```

        CTX_2_SIG_EVENTS=00090241
CTX_3_SIG_EVENTS=00141df8
        CTX_0_WAKEUP_EVENTS=00000000
CTX_1_WAKEUP_EVENTS=00000000
        CTX_2_WAKEUP_EVENTS=006011a3
CTX_3_WAKEUP_EVENTS=00000000
        CTX_ARB_CNTL=00600231
ACTIVE_CTX_STS:  SEG=1    ACNO=1    AB=0    ACTXPC: 38
CTX_0_STS:       SEG=1    ACNO=2    RR=0    CTX_PC:
245
        CTX_1_STS:       SEG=0    ACNO=1    RR=1    CTX_PC:
15
        CTX_2_STS:       SEG=0    ACNO=0    RR=0    CTX_PC:
75
        CTX_3_STS:       SEG=1    ACNO=3    RR=1    CTX_PC:
132
***** Microengine 1 Registers: *****
        USTORE_DATA=0060024a          ALU_OUTPUT=0060024a
        CTX_ENABLES=000012d4          CC_ENABLE=0009a90b
        CTX_0_SIG_EVENTS=00090241
CTX_1_SIG_EVENTS=000ddb6c
        CTX_2_SIG_EVENTS=00090241
CTX_3_SIG_EVENTS=00141df8
        CTX_0_WAKEUP_EVENTS=00000000
CTX_1_WAKEUP_EVENTS=00000000
        CTX_2_WAKEUP_EVENTS=006011a3
CTX_3_WAKEUP_EVENTS=00000000
        CTX_ARB_CNTL=00600231
ACTIVE_CTX_STS:  SEG=1    ACNO=1    AB=0    ACTXPC: 38
CTX_0_STS:       SEG=1    ACNO=2    RR=0    CTX_PC:
245
        CTX_1_STS:       SEG=0    ACNO=1    RR=1    CTX_PC:
15
        CTX_2_STS:       SEG=0    ACNO=0    RR=0    CTX_PC:
128
        CTX_3_STS:       SEG=1    ACNO=3    RR=1    CTX_PC:
72
***** Microengine 2 Registers: *****
        USTORE_DATA=0060024a          ALU_OUTPUT=0060024a
        CTX_ENABLES=000012d4          CC_ENABLE=0009a90b
        CTX_0_SIG_EVENTS=00090241
CTX_1_SIG_EVENTS=000ddb6c
        CTX_2_SIG_EVENTS=00090241
CTX_3_SIG_EVENTS=00141df8
        CTX_0_WAKEUP_EVENTS=00000000
CTX_1_WAKEUP_EVENTS=00000000
        CTX_2_WAKEUP_EVENTS=006011a3
CTX_3_WAKEUP_EVENTS=00000000
        CTX_ARB_CNTL=00600231
ACTIVE_CTX_STS:  SEG=1    ACNO=1    AB=0    ACTXPC: 38
CTX_0_STS:       SEG=1    ACNO=2    RR=0    CTX_PC:
245
        CTX_1_STS:       SEG=0    ACNO=1    RR=1    CTX_PC:
125
        CTX_2_STS:       SEG=0    ACNO=0    RR=0    CTX_PC:
```

```
75          CTX_3_STS:          SEG=1      ACNO=3      RR=1      CTX_PC:
62
***** Microengine 3 Registers: *****
USTORE_DATA=0060024a          ALU_OUTPUT=0060024a
CTX_ENABLES=000012d4          CC_ENABLE=0009a90b
CTX_0_SIG_EVENTS=00090241      CTX_1_SIG_EVENTS=000ddb6c
CTX_2_SIG_EVENTS=00090241      CTX_3_SIG_EVENTS=00141df8
CTX_0_WAKEUP_EVENTS=00000000    CTX_1_WAKEUP_EVENTS=00000000
CTX_2_WAKEUP_EVENTS=006011a3    CTX_3_WAKEUP_EVENTS=00000000
CTX_ARB_CNTL=00600231
ACTIVE_CTX_STS:  SEG=1      ACNO=1      AB=0      ACTXPC: 38
CTX_0_STS:       SEG=1      ACNO=2      RR=0      CTX_PC:
245
CTX_1_STS:       SEG=0      ACNO=1      RR=1      CTX_PC:
125
CTX_2_STS:       SEG=0      ACNO=0      RR=0      CTX_PC:
75
CTX_3_STS:       SEG=1      ACNO=3      RR=1      CTX_PC:
62
***** Microengine 4 Registers: *****
USTORE_DATA=0060024a          ALU_OUTPUT=0060024a
CTX_ENABLES=000012d4          CC_ENABLE=0009a90b
CTX_0_SIG_EVENTS=00090241      CTX_1_SIG_EVENTS=000ddb6c
CTX_2_SIG_EVENTS=00090241      CTX_3_SIG_EVENTS=00141df8
CTX_0_WAKEUP_EVENTS=00000000    CTX_1_WAKEUP_EVENTS=00000000
CTX_2_WAKEUP_EVENTS=006011a3    CTX_3_WAKEUP_EVENTS=00000000
CTX_ARB_CNTL=00600231
ACTIVE_CTX_STS:  SEG=1      ACNO=1      AB=0      ACTXPC: 38
CTX_0_STS:       SEG=1      ACNO=2      RR=0      CTX_PC:
245
CTX_1_STS:       SEG=0      ACNO=1      RR=1      CTX_PC:
15
CTX_2_STS:       SEG=0      ACNO=0      RR=0      CTX_PC:
75
CTX_3_STS:       SEG=1      ACNO=3      RR=1      CTX_PC:
132
***** Microengine 5 Registers: *****
USTORE_DATA=0060024a          ALU_OUTPUT=0060024a
CTX_ENABLES=000012d4          CC_ENABLE=0009a90b
CTX_0_SIG_EVENTS=00090241      CTX_1_SIG_EVENTS=000ddb6c
CTX_2_SIG_EVENTS=00090241      CTX_3_SIG_EVENTS=00141df8
CTX_0_WAKEUP_EVENTS=00000000    CTX_1_WAKEUP_EVENTS=00000000
CTX_2_WAKEUP_EVENTS=006011a3    CTX_3_WAKEUP_EVENTS=00000000
CTX_ARB_CNTL=00600231
ACTIVE_CTX_STS:  SEG=1      ACNO=1      AB=0      ACTXPC: 38
CTX_0_STS:       SEG=1      ACNO=2      RR=0      CTX_PC:
245
CTX_1_STS:       SEG=0      ACNO=1      RR=1      CTX_PC:
15
CTX_2_STS:       SEG=0      ACNO=0      RR=0      CTX_PC:
75
CTX_3_STS:       SEG=1      ACNO=3      RR=1      CTX_PC:
132
```

Report Date:03-01-23 Time:12:20:45

-----  
rlghncxa03w 03-01-23 08:43:14 EST EAGLE 30.0.0  
-----

-  
STH: Received a BOOT IMT-obituary reply for 1 restart(s)

Card 1209 Module TKS\_SBFR.C Line 728 Class 01cc

User Data Dump (1 of 2): [Overall: 5 of 6]

01080400	0000	15a3a816	0012be0a	06000046
		.....		
	0010	00a2342c	07f7b83a	15729dd2
05580601		.....		
	0020	1a22a616	7072b91a	46304a44
06887400		.....		
	0030	25a33b12	01a4ba22	17e03026
11483402		.....		
	0040	00130811	0033a30a	14008149
0cab6130		.....		
	0050	00000000	00000000	00000000
00000000		.....		
	0060	15a3a816	0012be0a	06000046
01080400		.....		
	0070	00a2342c	07f7b83a	15729dd2
05580601		.....		
	0080	1a22a616	7072b91a	46304a44
06887400		.....		
	0090	25a33b12	01a4ba22	17e03026
11483402		.....		
	00a0	00130811	0033a30a	14008149
0cab6130		.....		
	00b0	1a22a616	7072b91a	46304a44
06887400		.....		
	00c0	25a33b12	01a4ba22	17e03026
11483402		.....		
	00d0	00130811	0033a30a	14008149
0cab6130		.....		
	00e0	00000000	00000000	00000000
00000000		.....		
	00f0	15a3a816	0012be0a	06000046
01080400		.....		
	0100	00a2342c	07f7b83a	15729dd2
05580601		.....		
	0110	1a22a616	7072b91a	46304a44
06887400		.....		
	0120	25a33b12	01a4ba22	17e03026
11483402		.....		
	0130	25a33b12	01a4ba22	17e03026
11483402		.....		
	0140	00130811	0033a30a	14008149
0cab6130		.....		
	0150	00000000	00000000	00000000
00000000		.....		
	0160	15a3a816	0012be0a	06000046

```

01080400      .....
              0170  00a2342c  07f7b83a  15729dd2  05580601      ..
.....
              0180  1a22a616  7072b91a  46304a44  06887400      ..
.....
              0190  25a33b12  01a4ba22  17e03026  11483402      ..
.....
              01a0  00130811  0033a30a  14008149  0cab6130      ..
.....
              01b0  1a22a616  7072b91a  46304a44  06887400      ..
.....
              01c0  25a33b12  01a4ba22  17e03026  11483402      ..
.....

```

Report Date:03-01-23 Time:12:20:45

-----  
rlghncxa03w 03-01-23 08:43:14 EST EAGLE 30.0.0  
-----

STH: Received a BOOT IMT-obituary reply for 1 restart(s)

Card 1209 Module TKS\_SBFR.C Line 728 Class 01cc

User Data Dump (2 of 2): [Overall: 6 of 6]

```

              0000  15a3a816  0012be0a  06000046  01080400      ..
.....
              0010  00a2342c  07f7b83a  15729dd2  05580601      ..
.....
              0020  1a22a616  7072b91a  46304a44  06887400      ..
.....
              0030  25a33b12  01a4ba22  17e03026  11483402      ..
.....
              0040  00130811  0033a30a  14008149  0cab6130      ..
.....
              0050  00000000  00000000  00000000  00000000      ..
.....
              0060  15a3a816  0012be0a  06000046  01080400      ..
.....
              0070  00a2342c  07f7b83a  15729dd2  05580601      ..
.....
              0080  1a22a616  7072b91a  46304a44  06887400      ..
.....
              0090  25a33b12  01a4ba22  17e03026  11483402      ..
.....
              00a0  00130811  0033a30a  14008149  0cab6130      ..
.....
              00b0  1a22a616  7072b91a  46304a44  06887400      ..
.....
              00c0  25a33b12  01a4ba22  17e03026  11483402      ..
.....
              00d0  00130811  0033a30a  14008149  0cab6130      ..
.....
              00e0  00000000  00000000  00000000  00000000      ..
.....
              00f0  15a3a816  0012be0a  06000046  01080400      ..
.....
              0100  00a2342c  07f7b83a  15729dd2  05580601      ..
.....

```

```
0110 1a22a616 7072b91a 46304a44
06887400 .....
0120 25a33b12 01a4ba22 17e03026
11483402 .....
Report Date:03-01-23 Time:12:20:45
```

-----

;

```
rtrv-obit:loc=1115
```

```
Command Accepted - Processing
```

```
stdcfg1b 05-06-13 16:32:30 EST EAGLE 34.0.0
NOTICE: Only 7 obit(s) to retrieve in the log.
```

;

```
stdcfg1b 05-06-13 16:32:30 EST EAGLE 34.0.0
```

-----

-

```
STH: Received a BOOT IMT-Obituary reply for restart
Card 1103 Module ATH_386A.ASM Line 988 Class 0400
```

```
Register Dump :
```

```
EFL=00000246 CS =0058 EIP=0041cf03 SS =0060
EAX=00000046 ECX=00000000 EDX=005245d9
EBX=00000001
ESP=00483f80 EBP=00483f88 ESI=00000000
EDI=00000000
DS =0060 ES =0060 FS =0060 GS =0060
```

```
Stack Dump :
```

```
[SP+1E]=0048 [SP+16]=0000 [SP+0E]=0041 [SP+06]=0000
[SP+1C]=3fd0 [SP+14]=0001 [SP+0C]=cecc [SP+04]=0000
[SP+1A]=0048 [SP+12]=0000 [SP+0A]=0048 [SP+02]=0041
[SP+18]=3fbc [SP+10]=0a0a [SP+08]=3f9c [SP+00]=e600
```

```
Report Date:05-06-10 Time:19:20:55
```

-----

-

;

```
stdcfg1b 05-06-13 16:32:31 EST EAGLE 34.0.0
```

-----

-

```
STH: Received a BOOT IMT-Obituary reply for restart
Card 1209 Module sds_arm_send Line 356 Class 0001
StrongARM Core Register Dump (1 of 1): [Overall: 1 of 6]
```

```
SYSTEM MODE REGISTERS:
```

```
r0 = 00116bd4 r1 = 00000164 r2 = 00000001 r3 =
```

```
00000003
   r4 = 00f5f3f0    r5 = 00000000    r6 = 0000001f    r7 = 001251a0
   r8 = 00177be0    r9 = 10ffbfcc    r10= 00118b74    r11= 00000000
   r12= 642b0002    sp = 000cffa8    lr = 00116b88    pc = 00102424
   cpsr=400000df
```

Register Dump 2 is empty

Report Date:05-06-13 Time:16:30:42

;

```
-----
stdcfg1b 05-06-13 16:32:33 EST EAGLE 34.0.0
-----
```

```
STH: Received a BOOT IMT-Obituary reply for restart
      Card 1209  Module sds_arm_send Line 356 Class 0001
      StrongARM Core Stack Dump (1 of 1):  [Overall: 2 of 6]
```

```
SYSTEM MODE STACK (Length=192):
0000 00e00000 00000007 00e00000 00102ab0 .....*..
0010 00178698 00000000 000000f8 000cff08 .....
0020 00000001 00116bd4 00000164 00000001 ....k.d.....
0030 000cff68 00000000 00000000 0000001f h.....
0040 001251a0 00177be0 10ffbfcc 00118b74 .Q...{.....t...
0050 00000000 00102468 00000000 00000000 ....h$.
0060 000cffa8 00116bd4 00000164 00000001 ....k.d.....
0070 00000003 00f5f3f0 00000000 0000001f .....
0080 001251a0 00177be0 10ffbfcc 00118b74 .Q...{.....t...
0090 00000000 642b0002 00116b88 00102424 .....+d.k..$.
00a0 00000000 00000000 0000001f 00115e10 .....^..
00b0 00177c4c 00177bf0 0000001f 00125268 L|...{.....hR..
```

;

```
stdcfg1b 05-06-13 16:32:34 EST EAGLE 34.0.0
```

Stack Dump 2 is empty

Report Date:05-06-13 Time:16:30:42

;

```
-----
stdcfg1b 05-06-13 16:32:35 EST EAGLE 34.0.0
-----
```

```
STH: Received a BOOT IMT-Obituary reply for restart
      Card 1209  Module sds_arm_send Line 356 Class 0001
      User Data Dump (1 of 1):  [Overall: 3 of 6]
```

User Data is empty

Report Date:05-06-13 Time:16:30:42

;

```
-----
stdcfg1b 05-06-13 16:32:36 EST EAGLE 34.0.0
-----
```

```
STH: Received a BOOT IMT-Obituary reply for restart
      Card 1209  Module sds_arm_send Line 356 Class 0001
```

EP9312 Register Dump (1 of 2): [Overall: 4 of 6]

## \*\*\*\*\* DMA Registers \*\*\*\*\*

```
DMA_CTRL_M2M0=      0608d40c   DMA_INTR_STAT_M2M0=
00000000
DMA_STAT_M2M0=      00000000   DMA_BCR0_M2M0=
0608d40c
DMA_BASE_SRC0_M2M0= 00000000   DMA_CRNT_SRC0_M2M0=
00000000
DMA_BASE_DSTN0_M2M0= 00000000   DMA_CRNT_DSTN0_M2M0=
00000000
DMA_BCR1_M2M0=      000001fc   DMA_BASE_SRC1_M2M0=
00000000
DMA_CRNT_SRC1_M2M0= 00000000   DMA_BASE_DSTN1_M2M0=
00000000
DMA_CRNT_DSTN1_M2M0= 00000000
DMA_CTRL_M2M1=      0608d40c   DMA_INTR_STAT_M2M1=
00000000
DMA_STAT_M2M1=      00000000   DMA_BCR0_M2M1=
00000000
DMA_BASE_SRC0_M2M1= 00000000   DMA_CRNT_SRC0_M2M1=
00000000
DMA_BASE_DSTN0_M2M1= 00000000   DMA_CRNT_DSTN0_M2M1=
00000000
DMA_BCR1_M2M1=      00000000   DMA_BASE_SRC1_M2M1=
00000000
DMA_CRNT_SRC1_M2M1= 00000000   DMA_BASE_DSTN1_M2M1=
00000000
DMA_CRNT_DSTN1_M2M1= 00000000
DMA_ACTIVE_INTR=    00000000
```

## \*\*\*\*\* TIMER Registers \*\*\*\*\*

```
TMR1_CURR_VALUE=    00000000   TMR1_CTRL_REG=
00000000
TMR1_LOAD_REG=      00000000   TMR2_CURR_VALUE=
00000000
TMR2_CTRL_REG=      00000000   TMR2_LOAD_REG=
00000000
TMR3_CURR_VALUE=    00000001   TMR3_CTRL_REG=
000000d5
TMR3_LOAD_REG=      00000001   TMR4_VALUE_LOW=
413c60f3
TMR4_VALUE_HI=      0000015f
```

## \*\*\*\*\* SYSCON Registers \*\*\*\*\*

```
PWRSTS=             4320ace3   PWRCNT=
0c000000
CLKSET1=            00a5a127   CLKSET2=
0003c317
SCRATCH0=           00000040   SCRATCH1=
00000000
DEVCFG=             6902090e   CHIP_ID=
34009213
SYSCFG=             340000d6   APB_WAIT=
00000001
```

```

ARB_REG=          00000000    VID_REG=          00000000
MIR_REG=          00000000    I2S_REG=         00000000
TCH_REG=          00000000

```

```
***** GPIO Registers *****
```

```

PADR=            0000007f    PBDR=            000000e9
PCDR=            000000c0    PDDR=            000000c4
PEDR=            00000000    PFDR=            000000ff
PGDR=            00000002    PHDR=            0000007f
PADDR=            00000000    PBDDR=           00000009
PCDDR=            000000fb    PDDDR=           000000fb
PEDDR=            00000003    PFDDR=           00000000
PGDDR=            0000000c    PHDDR=           00000007
PA_TYPE1=         00000000    PB_TYPE1=         00000080
PF_TYPE1=         00000000    PA_TYPE2=         00000000
PB_TYPE2=         00000000    PF_TYPE2=         00000000
PA_INT_EN=        00000000    PB_INT_EN=        00000080
PF_INT_EN=        00000000    PA_RAW_STAT=      00000080
PB_RAW_STAT=      0000001f    PF_RAW_STAT=      00000000
PA_INT_STAT=      00000000    PB_INT_STAT=      00000000
PF_INT_STAT=      00000000    PA_DB=            00000000
PB_DB=            00000000    PF_DB=            00000000
EE_REG=           00000000

```

```
***** Coprocessor 15 Registers *
```

```

ID_CODE_CP15_0=   41129200    CACHE_CODE_CP15_0= 0d172172
CONTROL_CP15_1=   c000107d    TRANS_BASE_TBL_CP15_2=10ffc000
DOMAIN_ACCESS_CP15_3= ffffffff    FAULT_STATUS_CP15_5= 0000000d
FAULT_PREFETCH_CP15_5=000000fa    FAULT_ADDR_CP15_6=   d3b765e8
CACHE_OPER_CP15_7= 00000000    TLB_OPER_CP15_8=     00000000
DCACHE_LOCKDN_CP15_9= 00000000    ICACHE_LOCKDN_CP15_9= 00000000
D_TLB_LOCKDN_CP15_10= 00b00000    I_TLB_LOCKDN_CP15_10= 00200000
FCSE_PID_CP15_13= 00000000

```

```
Report Date:05-06-13 Time:16:30:42
```

```
;
```

```
stdcfg1b 05-06-13 16:32:40 EST EAGLE 34.0.0
```

```

STH: Received a BOOT IMT-Obituary reply for restart
Card 1209 Module sds_arm_send Line 356 Class 0001
EP9312 Register Dump (2 of 2): [Overall: 5 of 6]

```

```
***** VIC Registers *****
```

```

VIC_1_IRQ_STATUS= 00000000    VIC_1_FIQ_STATUS= 00000000
VIC_1_RAW_INTR=   25000008    VIC_1_INT_SELECT= 00000000
VIC_1_INT_ENABLE= 00060000    VIC_1_SOFT_INT=    00000000
VIC_1_SOFT_INT_CLEAR= 00000000
VIC_2_IRQ_STATUS= 00000000    VIC_2_FIQ_STATUS= 00000000
VIC_2_RAW_INTR=   0000021b    VIC_2_INT_SELECT= 00080000
VIC_2_INT_ENABLE= 08080004    VIC_2_SOFT_INT=    00000000
VIC_2_SOFT_INT_CLEAR= 00000000

```

```
***** SMC Registers *****
```



```
BANK_CONFIG0=          70001c80   BANK_CONFIG1=
70001420
BANK_CONFIG2=          40001480   BANK_CONFIG3=
70000400
BANK_CONFIG6=          70001440   BANK_CONFIG7=
70001440
```

```
***** UART3 Registers *****
LINE_CTRL_LOW=         00000003   LINE_CTRL_MID=
00000000
LINE_CTRL_HIGH=        00000074   CTRL_REG=
00000001
STATUS_REG=            00000000   FLAGS_REG=
00000090
DATA_REG=              00000020
```

```
***** Watchdog Registers *****
WDOG_REG=              00806c69
```

Report Date:05-06-13 Time:16:30:42

-----  
-  
;

stdcfg1b 05-06-13 16:32:42 EST EAGLE 34.0.0

-----  
-

STH: Received a BOOT IMT-Obituary reply for restart  
Card 1209 Module sds\_arm\_send Line 356 Class 0001  
SIFB Register Dump (1 of 1): [Overall: 6 of 6]

```
***** BCM5630 Switch0 Registers *****
Switch0 Port0 Status= 00c06c00   Switch0 Port1 Status=
00c06c00
Switch0 Port2 Status= 00806c00   Switch0 Port3 Status=
00806c00
Switch0 Port4 Status= 00806c00   Switch0 Port5 Status=
00806c00
Switch0 Port6 Status= 00806c00   Switch0 Port7 Status=
00800000
Switch0 Port12 Status=00806c00
```

```
***** BCM5630 Switch1 Registers *****
Switch1 Port0 Status= 00806c00   Switch1 Port1 Status=
00806c00
Switch1 Port2 Status= 00806c00   Switch1 Port3 Status=
00806c00
Switch1 Port4 Status= 00806c00   Switch1 Port5 Status=
00806c00
Switch1 Port6 Status= 00806c00   Switch1 Port7 Status=
00806c00
Switch1 Port8 Status= 00806c00   Switch1 Port9 Status=
00806c00
```

```
Switch1 Port10 Status=00806c00   Switch1 Port11 Status=00800000
Switch1 Port12 Status=aaaaaa00
```

```
Report Date:05-06-13   Time:16:30:43
```

```
;
```

This example shows output for seven obituaries from an IXP2350-based card:

```
rtrv-obit:loc=1113
```

```
tekelecstp 09-06-12 08:40:04 GMT   EAGLE 41.1.0
```

```
-----
STH: Received a BOOT IXP2350-Obituary reply for restart
Card 1109   Module hiprop_init.   Line 489   Class 0001
StrongARM Core Register Dump (1 of 1):   [Overall: 1 of 7]
```

```
SYSTEM MODE REGISTERS:
```

```
r0= 00607964   r1= 000001e9   r2= 00000001   r3= 00000003
r4= 003dffec   r5= 00000000   r6= 42000360   r7= 0002c498
r8= 0000006f   r9= 90003c00   r10= 00606e54   r11= 00000000
r12= 00000000   sp= 003dff78   lr= 006079f4   pc= 00601ae4
cpsr=400000df
```

```
Register Dump 2 is empty
```

```
Report Date:09-06-12   Time:08:40:04
```

```
;
```

```
tekelecstp 09-06-12 08:40:05 GMT   EAGLE 41.1.0
0007.0106   IMT BUS A               IMT Bus alarm cleared
```

```
;
```

```
tekelecstp 09-06-12 08:40:07 GMT   EAGLE 41.1.0
```

```
-----
STH: Received a BOOT IXP2350-Obituary reply for restart
Card 1109   Module hiprop_init.   Line 489   Class 0001
StrongARM Core Stack Dump (1 of 1):   [Overall: 2 of 7]
```

```
SYSTEM MODE STACK (Length=132):
```

```
0000 00000000 00000000 00000001 003d0000 .....=.
0010 003dffec 00615b98 00000001 00606f00 ..=..[a.....o`.
0020 00000000 00000000 00000000 00000000 .....
0030 00000000 00000000 00000000 00000000 .....
0040 00000000 00000000 00000000 00000000 .....
0050 00000000 00000000 00000000 00000000 .....
0060 00000000 00000000 00000000 00000000 .....
0070 00000000 00000001 00000001 00000000 .....
0080 00000000 .....
....
```

```
;
```

```
tekelecstp 09-06-12 08:40:09 GMT   EAGLE 41.1.0
Stack Dump 2 is empty
```

Report Date:09-06-12 Time:08:40:04

-----  
-  
;  
  
tekelecstp 09-06-12 08:40:10 GMT EAGLE 41.1.0

-----  
-  
STH: Received a BOOT IXP2350-Obituary reply for restart  
Card 1109 Module hiprop\_init. Line 489 Class 0001  
User Data Dump (1 of 1): [Overall: 3 of 7]

User Data is empty

Report Date:09-06-12 Time:08:40:04

-----  
-  
;  
  
tekelecstp 09-06-12 08:40:12 GMT EAGLE 41.1.0

-----  
-  
STH: Received a BOOT IXP2350-Obituary reply for restart  
Card 1109 Module hiprop\_init. Line 489 Class 0001  
IXP Register Dump (1 of 3): [Overall: 4 of 7]

\*\*\*\*\* XSI SDRAM Registers \*\*\*\*\*  
SDIR= 00730000 SDCR=  
06553100  
ESDCR= 93005001 SDBR=  
008000b6  
SBR0= 02000000 SBR1=  
02000000  
ECC= 0f000000 ELOC0=  
00000000  
ELOC1= 00000000 ECAR\_0=  
00000000  
ECAR\_1= 00000000 ECTST=  
00000000  
MCISR= 00000000 MPTCR=  
1c000000  
MPCR= 00000000 RFR=  
8a000000  
SDPR0= 01008002 SDPR1=  
00000070  
SDPR2= 0000ffa0 SDPR3=  
0000fff8  
SDPR4= 000000b0 SDPR5=  
00000000  
SDPR6= 00000000 SDPR7=

```
00000000
DDR_RCOMP_SETUP_CTRL=          60000000 PMOS_RCOMP_MEAS=          8f000000
NMOS_RCOMP_MEAS=              8f000005 PMOS_RCOMP_OVRD_REG_1=    00000016
NMOS_RCOMP_OVRD_REG_1=        00000000 PMOS_NMOS_SCOMP_OVRD_REG_1=002d0000
SLEW_RATE_INDEX_SEL=          39009b00 CTL_PMOS_PULL_UP_OFST=    0100005b
CTL_PMOS_PULL_DW_OFST=        01000000 CKE_PMOS_PULL_UP_OFST=    01000000
CKE_PMOS_PULL_DW_OFST=        01000000 CK_PMOS_PULL_UP_OFST=    01000000
CK_PMOS_PULL_DW_OFST=         01000000 DQ_PMOS_PULL_UP_OFST=    01000000
DQ_PMOS_PULL_DW_OFST=         01000000 PMOS_NMOS_RCOMP_OVRD_REG_1=00000000
PMOS_RCOMP_OVRD_REG_2=        00000000 NMOS_RCOMP_OVRD_REG_2=    00000000
PMOS_RCOMP_OVRD_REG_3=        00000000 NMOS_RCOMP_OVRD_REG_3=    00000000
PMOS_RCOMP_OVRD_REG_4=        00000000 NMOS_RCOMP_OVRD_REG_4=    00000000
PMOS_NMOS_SCOMP_OVRD_2=       00000000 CS_PMOS_PULL_UP_OFST=    01000000
CS_NMOS_PULL_DW_OFST=         01000000 RCVEN_PMOS_PULL_UP_OFST= 01000000
RCVEN_NMOS_PULL_DW_OFST=      01000000 GMII_PMOS_PULL_UP_OFST=    00000000
GMII_NMOS_PULL_DW_OFST=       00000000 SLEW_RATE_IDX_SEL_REG_2= 06000000
SETUP_AND_CTRL_REG=           00000000 DDR_ACIO_RX_DDL_SETTINGS= 13000000
DDR_RX_DESKEW=                13000013 DDR_RDDLSELE_RECVEN=    13000000
```

## \*\*\*\*\* MSG SDRAM Registers \*\*\*\*\*

```
SRAM_CONTROL=                 00000000 SRAM_PARITY_STATUS_1=    00000028
SRAM_PARITY_STATUS_2=         00001f00 MSG_STAT=              00000000
MSG_RET_STAT=                 00000000 MSG_OVFL_INT_ENB=        00000000
```

## \*\*\*\*\* COPROCESSOR Registers \*\*\*\*\*

```
ID_CHIP=                      05040500 CONTROL_CP15=          fd030066
TRANSLATION_TBL_BASE=         00ffff10 DOMAIN_ACCESS_CONTROL=  fd00ff80
FAULT_STATUS=                 066000ff FAULT_ADDRESS=        c7000e04
PROC_ID_VIRTUAL_ADDR_MAPPING=000000eb
```

Report Date:09-06-12 Time:08:40:04

;

tekelecstp 09-06-12 08:40:19 GMT EAGLE 41.1.0

STH: Received a BOOT IXP2350-Obituary reply for restart  
Card 1109 Module hiprop\_init. Line 489 Class 0001  
IXP Register Dump (2 of 3): [Overall: 5 of 7]

## \*\*\*\*\* Microengine 0 Registers \*\*\*\*\*

```
USTORE_ERROR_STATUS=         02020202 ALU_OUTPUT=          02020202
CTX_ARB_CNTL=                02020202 CTX_ENABLES=          02020202
CC_ENABLE=                    02020202
INDIRECT_CTX_STS0:           SEG=0 ACNO=02 RR=0 CTX_PC=0064
INDIRECT_CTX_STS1:           SEG=0 ACNO=02 RR=0 CTX_PC=0064
INDIRECT_CTX_STS2:           SEG=0 ACNO=02 RR=0 CTX_PC=0064
INDIRECT_CTX_STS3:           SEG=0 ACNO=02 RR=0 CTX_PC=0064
INDIRECT_CTX_STS4:           SEG=0 ACNO=02 RR=0 CTX_PC=0064
INDIRECT_CTX_STS5:           SEG=0 ACNO=02 RR=0 CTX_PC=0064
INDIRECT_CTX_STS6:           SEG=0 ACNO=02 RR=0 CTX_PC=0064
INDIRECT_CTX_STS7:           SEG=0 ACNO=02 RR=0 CTX_PC=0064
ACTIVE_CTX_STS: SEG=0 ACNO=02 AB=0 ACTXPC=0064
INDIRECT_CTX_0_SIG_EVNT=     02020202 INDIRECT_CTX_1_SIG_EVNT= 02020202
INDIRECT_CTX_2_SIG_EVNT=     02020202 INDIRECT_CTX_3_SIG_EVNT= 02020202
```

```
    INDIRECT_CTX_4_SIG_EVNT= 02020202 INDIRECT_CTX_5_SIG_EVNT=
02020202
    INDIRECT_CTX_6_SIG_EVNT= 02020202 INDIRECT_CTX_7_SIG_EVNT=
02020202
    ACTIVE_CTX_SIG_EVNT=      02020202
INDIRECT_CTX_0_WAKEUP_EVNT=02020202
    INDIRECT_CTX_1_WKEUP_EVNT= 02020202
INDIRECT_CTX_2_WAKEUP_EVNT=02020202
    INDIRECT_CTX_3_WAKEUP_EVNT=02020202
INDIRECT_CTX_4_WAKEUP_EVNT=02020202
    INDIRECT_CTX_5_WAKEUP_EVNT=02020202
INDIRECT_CTX_6_WAKEUP_EVNT=02020202
    INDIRECT_CTX_7_WAKEUP_EVNT=02020202 ACTIVE_CTX_WAKEUP_EVNT=
02020202
```

## \*\*\*\*\* Microengine 1 Registers \*\*\*\*\*

```
    USTORE_ERROR_STATUS=      02020202 ALU_OUTPUT=
02020202
    CTX_ARB_CNTL=              02020202 CTX_ENABLES=
02020202
    CC_ENABLE=                  02020202
INDIRECT_CTX_STS0:            SEG=0  ACNO=02  RR=0  CTX_PC=0064
INDIRECT_CTX_STS1:            SEG=0  ACNO=02  RR=0  CTX_PC=0064
INDIRECT_CTX_STS2:            SEG=0  ACNO=02  RR=0  CTX_PC=0064
INDIRECT_CTX_STS3:            SEG=0  ACNO=02  RR=0  CTX_PC=0064
INDIRECT_CTX_STS4:            SEG=0  ACNO=02  RR=0  CTX_PC=0064
INDIRECT_CTX_STS5:            SEG=0  ACNO=02  RR=0  CTX_PC=0064
INDIRECT_CTX_STS6:            SEG=0  ACNO=02  RR=0  CTX_PC=0064
INDIRECT_CTX_STS7:            SEG=0  ACNO=02  RR=0  CTX_PC=0064
    ACTIVE_CTX_STS: SEG=0  ACNO=02  AB=0  ACTXPC=0064
INDIRECT_CTX_0_SIG_EVNT=      02020202 INDIRECT_CTX_1_SIG_EVNT=
02020202
    INDIRECT_CTX_2_SIG_EVNT=      02020202 INDIRECT_CTX_3_SIG_EVNT=
02020202
    INDIRECT_CTX_4_SIG_EVNT=      02020202 INDIRECT_CTX_5_SIG_EVNT=
02020202
    INDIRECT_CTX_6_SIG_EVNT=      02020202 INDIRECT_CTX_7_SIG_EVNT=
02020202
    ACTIVE_CTX_SIG_EVNT=      02020202
INDIRECT_CTX_0_WAKEUP_EVNT=02020202
    INDIRECT_CTX_1_WKEUP_EVNT= 02020202
INDIRECT_CTX_2_WAKEUP_EVNT=02020202
    INDIRECT_CTX_3_WAKEUP_EVNT=02020202
INDIRECT_CTX_4_WAKEUP_EVNT=02020202
    INDIRECT_CTX_5_WAKEUP_EVNT=02020202
INDIRECT_CTX_6_WAKEUP_EVNT=02020202
    INDIRECT_CTX_7_WAKEUP_EVNT=02020202 ACTIVE_CTX_WAKEUP_EVNT=
02020202
```

## \*\*\*\*\* Microengine 2 Registers \*\*\*\*\*

```
    USTORE_ERROR_STATUS=      02020202 ALU_OUTPUT=
02020202
    CTX_ARB_CNTL=              02020202 CTX_ENABLES=
02020202
    CC_ENABLE=                  02020202
```

```
INDIRECT_CTX_STS0:      SEG=0  ACNO=02  RR=0  CTX_PC=0064
INDIRECT_CTX_STS1:      SEG=0  ACNO=02  RR=0  CTX_PC=0064
INDIRECT_CTX_STS2:      SEG=0  ACNO=02  RR=0  CTX_PC=0064
INDIRECT_CTX_STS3:      SEG=0  ACNO=02  RR=0  CTX_PC=0064
INDIRECT_CTX_STS4:      SEG=0  ACNO=02  RR=0  CTX_PC=0064
INDIRECT_CTX_STS5:      SEG=0  ACNO=02  RR=0  CTX_PC=0064
INDIRECT_CTX_STS6:      SEG=0  ACNO=02  RR=0  CTX_PC=0064
INDIRECT_CTX_STS7:      SEG=0  ACNO=02  RR=0  CTX_PC=0064
ACTIVE_CTX_STS:  SEG=0  ACNO=02  AB=0  ACTXPC=0064
INDIRECT_CTX_0_SIG_EVNT= 02020202  INDIRECT_CTX_1_SIG_EVNT= 02020202
INDIRECT_CTX_2_SIG_EVNT= 02020202  INDIRECT_CTX_3_SIG_EVNT= 02020202
INDIRECT_CTX_4_SIG_EVNT= 02020202  INDIRECT_CTX_5_SIG_EVNT= 02020202
INDIRECT_CTX_6_SIG_EVNT= 02020202  INDIRECT_CTX_7_SIG_EVNT= 02020202
ACTIVE_CTX_SIG_EVNT=      02020202  INDIRECT_CTX_0_WAKEUP_EVNT=02020202
INDIRECT_CTX_1_WKEUP_EVNT= 02020202  INDIRECT_CTX_2_WAKEUP_EVNT=02020202
INDIRECT_CTX_3_WAKEUP_EVNT=02020202  INDIRECT_CTX_4_WAKEUP_EVNT=02020202
INDIRECT_CTX_5_WAKEUP_EVNT=02020202  INDIRECT_CTX_6_WAKEUP_EVNT=cc000002
INDIRECT_CTX_7_WAKEUP_EVNT=cc0000cc  ACTIVE_CTX_WAKEUP_EVNT=      cc0001cc
IXP Register Dump (2 of 2):      [Overall: 2 of 2]
```

Report Date:09-06-12 Time:08:40:04

-----  
;
tekelecstp 09-06-12 08:40:31 GMT EAGLE 41.1.0

-----  
STH: Received a BOOT IXP2350-Obituary reply for restart  
Card 1109 Module hiprop\_init. Line 489 Class 0001  
IXP Register Dump (3 of 3): [Overall: 6 of 7]

```
***** Microengine 3 Registers *****
USTORE_ERROR_STATUS=      02020202  ALU_OUTPUT=      02020202
CTX_ARB_CNTL=             02020202  CTX_ENABLES=      02020202
CC_ENABLE=                02020202
INDIRECT_CTX_STS0:      SEG=0  ACNO=02  RR=0  CTX_PC=0064
INDIRECT_CTX_STS1:      SEG=0  ACNO=02  RR=0  CTX_PC=0064
INDIRECT_CTX_STS2:      SEG=0  ACNO=02  RR=0  CTX_PC=0064
INDIRECT_CTX_STS3:      SEG=0  ACNO=02  RR=0  CTX_PC=0064
INDIRECT_CTX_STS4:      SEG=0  ACNO=02  RR=0  CTX_PC=0064
INDIRECT_CTX_STS5:      SEG=0  ACNO=02  RR=0  CTX_PC=0064
INDIRECT_CTX_STS6:      SEG=0  ACNO=02  RR=0  CTX_PC=0064
INDIRECT_CTX_STS7:      SEG=0  ACNO=02  RR=0  CTX_PC=0064
ACTIVE_CTX_STS:  SEG=0  ACNO=02  AB=0  ACTXPC=0064
INDIRECT_CTX_0_SIG_EVNT= 02020202  INDIRECT_CTX_1_SIG_EVNT= 02020202
INDIRECT_CTX_2_SIG_EVNT= 02020202  INDIRECT_CTX_3_SIG_EVNT= 02020202
INDIRECT_CTX_4_SIG_EVNT= 02020202  INDIRECT_CTX_5_SIG_EVNT= 02020202
INDIRECT_CTX_6_SIG_EVNT= 02020202  INDIRECT_CTX_7_SIG_EVNT= 02020202
ACTIVE_CTX_SIG_EVNT=      02020202  INDIRECT_CTX_0_WAKEUP_EVNT=02020202
INDIRECT_CTX_1_WKEUP_EVNT= 02020202  INDIRECT_CTX_2_WAKEUP_EVNT=02020202
INDIRECT_CTX_3_WAKEUP_EVNT=02020202  INDIRECT_CTX_4_WAKEUP_EVNT=02020202
INDIRECT_CTX_5_WAKEUP_EVNT=02020202  INDIRECT_CTX_6_WAKEUP_EVNT=02020202
INDIRECT_CTX_7_WAKEUP_EVNT=02020202  ACTIVE_CTX_WAKEUP_EVNT=      02020202

***** DDR SDRAM Registers *****
DU_CONTROL=              04031000  DU_ERROR_STATUS_1=      20018544
```

```
DU_ERROR_STATUS_2=          a3003426 DU_ECC_TEST=
00000000
DU_INIT=                     00000100 DU_CNTR_2=
38000000
DDR_RCOMP_CSR=              60000000 PMOS_RCOMP_MEAS=
8f000000
NMOS_RCOMP_MEAS=            9f000005 PMOS_RCOMP_OVRD_REG_1=
00000016
NMOS_RCOMP_OVRD_REG_1=      00000000 PMOS_NMOS_SCOMP_OVRD_1=
002d0000
SLEW_RATE_IDX_SEL_REG_1=    39009c00 CTL_PMOS_PULL_UP_OFST=
010000db
CTL_PMOS_PULL_DW_OFST=      01000000 CKE_PMOS_PULL_UP_OFST=
01000000
CKE_NMOS_PULL_DW_OFST=      01000000 CK_PMOS_PULL_UP_OFST=
01000000
CK_NMOS_PULL_DW_OFST=       01000000 DQ_PMOS_PULL_UP_OFST=
01000000
DQ_NMOS_PULL_DW_OFST=       01000000 PMOS_NMOS_RCOMP_OVRD=
00000000
PMOS_RCOMP_OVRD_REG_2=      00000000 NMOS_RCOMP_OVRD_REG_2=
00000000
PMOS_RCOMP_OVRD_REG_3=      00000000 NMOS_RCOMP_OVRD_REG_3=
00000000
PMOS_RCOMP_OVRD_REG_4=      00000000 NMOS_RCOMP_OVRD_REG_4=
00000000
PMOS_NMOS_SCOMP_OVRD_2=     00000000 RCVEN_PMOS_PULL_UP_OFST=
01000000
RCVEN_NMOS_PULL_DW_OFST=    01000000 GMII_PMOS_PULL_UP_OFST=
01000000
GMII_NMOS_PULL_DW_OFST=     01000000 SLEW_RATE_IDX_SEL_REG_2=
06000000
SETUP_AND_CTRL_REG=         00000000 DDR_ACIO_RX_DDL_SETTINGS=
13000000
DDR_RX_DESKEW=              13000013 DDR_RDDLSELE_RECVEN=
13000000
```

Report Date:09-06-12 Time:08:40:04

-----  
-  
;

tekelecstp 09-06-12 08:40:31 GMT EAGLE 41.1.0

-----  
-

STH: Received a BOOT IXP2350-Obituary reply for restart  
Card 1109 Module hiprop\_init. Line 489 Class 0001  
Instruction Trace Dump (1 of 1): [Overall: 7 of 7]

Length: 415  
0000 02 02 02 02 02 02 02 02 02 02 02 02 02 02  
02 .....  
0010 02 02 02 02 02 02 02 02 02 02 02 02 02 02

```

02 .....
0020 02 02 02 02 02 02 02 02 02 02 02 02 02 02 02 .....
0030 02 02 02 02 02 02 02 02 02 02 02 02 02 02 02 .....
0040 02 02 02 02 02 02 02 02 02 02 02 02 02 02 02 .....
0050 02 02 02 02 02 02 02 02 02 02 02 02 02 02 02 .....
0060 02 02 02 02 02 02 02 02 02 02 02 02 02 02 02 .....
0070 02 02 02 02 02 02 02 02 02 02 02 02 02 02 02 .....
0080 02 02 02 02 02 02 02 02 02 02 02 02 02 02 02 .....
0090 02 02 02 02 02 02 02 02 02 02 02 02 02 02 02 .....
00a0 02 02 02 02 02 02 02 02 02 02 02 02 02 02 02 .....
00b0 02 02 02 02 02 02 02 02 02 02 02 02 02 02 02 .....
00c0 02 02 02 02 02 02 02 02 02 02 02 02 02 02 02 .....
00d0 02 02 02 02 02 02 02 02 02 02 02 02 02 02 02 .....
00e0 02 02 02 02 02 02 02 02 02 02 02 02 02 02 02 .....
00f0 02 02 02 02 02 02 02 02 02 02 02 02 02 02 02 .....
0100 02 02 02 02 02 02 02 02 02 02 02 02 02 02 02 .....
0110 02 02 02 02 02 02 02 02 02 02 02 02 02 02 02 .....
0120 02 02 02 02 02 02 02 02 02 02 02 02 02 02 02 .....
0130 02 02 02 02 02 02 02 02 02 02 02 02 02 02 02 .....
0140 02 02 02 02 02 02 02 02 02 02 02 02 02 02 02 .....
0150 02 02 02 02 02 02 02 02 02 02 02 02 02 02 02 .....
0160 02 02 02 02 02 02 02 02 02 02 02 02 02 02 02 .....
0170 02 00 00 cc cc 00 00 cc cc 01 00 cc cc 00 00 cc .....
0180 cc 00 00 cc cc 58 fa 12 00 0a b8 6d 00 6c fd 12 .....X.....m.l..
0190 00 fa 00 00 00 00 70 fd 7f cc cc cc cc cc cc .....p.....

```

Report Date:09-06-12 Time:08:40:04

;

### Related Topics

- [act-alm-trns](#)
- [dact-alm-trns](#)
- [rept-stat-clk](#)
- [rept-stat-trbl](#)
- [rls-alm](#)
- [rtrv-trbl](#)

## rtrv-pct

Use this command to display Point Code and CIC Translations.

### Parameters

#### **ecice (optional)**

The end of the Emulated Circuit Identification Code range.

#### **Range:**

0 - 4294967295, \*



- 0-4095 —ITU TUP/ISUP
- 0-16383 —ANSI ISUP
- 0-4294967295 —ANSI Q.BICC

**Default:**

\*

**ecics (optional)**

The start of the Emulated Circuit Identification Code range.

**Range:**

0 - 4294967295, \*

- 0-4095 —ITU TUP/ISUP
- 0-16383 —ANSI ISUP
- 0-4294967295 —ANSI Q.BICC

**Default:**

\*

**epc (optional)**

ANSI point code with subfields *network indicator-network cluster-network cluster member (ni-nc-ncm)*.

**Synonym:**

*epca*

**Range:**

000-255

Specify a valid value for each subfield of the point code, and separate the subfields with a dash (-).

When `chg-sid:pctype=ansi` is specified, *ni = 000* is not valid.

When `chg-sid:pctype=ansi` is specified, *nc = 000* is not valid if *ni = 001–005*.

When `chg-sid:pctype=ansi` is specified, *nc = 000* is valid if *ni = 006–255*.

The point code *000-000-000* is not a valid point code.

**epci (optional)**

ITU international destination point code with subfields *zone-area-id*.

**Range:**

0-255

Specify a valid value for each subfield of the point code, and separate the subfields with a dash (-).

*zone—0–7*

*area—000–255*

*id—0–7*

The point code *0-000-0* is not a valid point code.

**epcn (optional)**

ITU national point code in the format of a 5-digit number (*nnnnn*); or 2, 3, or 4 numbers (members) separated by dashes (*m1-m2-m3-m4*) as defined by the `chg-stpopts:npcfmti` flexible point code option. A group code must be specified when the ITUDUPPC feature is turned on (*nnnnn-gc, m1-m2-m3-m4-gc*).

**Range:***0-16383, aa-zz*

Specify a valid value for each subfield of the point code, and separate the subfields with a dash (-).

*nnnnn—0-16383**gc—aa-zz**m1-m2-m3-m4—0-14* for each member; values must sum to 14**filtpc (optional)**ANSI point code with subfields *network indicator-network cluster-network cluster member (ni-nc-ncm)*.**Synonym:***filtpca***Range:***0-255, \**

Specify a valid value for each subfield of the point code, and separate the subfields with a dash (-).

The asterisk (\*) value is not valid for the *ni* subfield.When *chg-sid:pctype=ansi* is specified, *ni=000* is not valid.When *chg-sid:pctype=ansi* is specified, *nc = 000* is not valid if *ni=001–005*.When *chg-sid:pctype=ansi* is specified, *nc=000* is valid if *ni=006–255*.When *chg-sid:pctype=ansi* is specified, *ni-\*. \** is valid if *ni =006–255*.The point code *000-000-000* is not a valid point code.**filtpci (optional)**ITU international destination point code with subfields *zone-area-id*.**Range:***0-255, \**

Specify a valid value for each subfield of the point code, and separate the subfields with a dash (-).

*zone—0-7**area—000-255**id—0-7*The point code *0-000-0* is not a valid point code.**filtpcn (optional)**ITU national point code in the format of a 5-digit number (*nnnnn*); or 2, 3, or 4 numbers (members) separated by dashes (*m1-m2-m3-m4*) as defined by the *chg-stpopts:npcfmti* flexible point code option. A group code must be specified when the ITUDUPPC feature is turned on (*nnnnn-gc, m1-m2-m3-m4-gc*).**Range:***16363, aa-zz, \**

Specify a valid value for each subfield of the point code, and separate the subfields with a dash (-).

*nnnnn—0-16383**gc—aa-zz**m1-m2-m3-m4—0-14* for each member; values must sum to 14**rcice (optional)**

The end of the Real Circuit Identification Code range.

**Range:**

0 - 4294967295, \*

- 0-4095 —ITU TUP/ISUP
- 0-16383 —ANSI ISUP
- 0-4294967295 —ANSI Q.BICC

**Default:**

\*

**rcics (optional)**

The start of the Real Circuit Identification Code range.

**Range:**

0 - 4294967295, \*

- 0-4095 —ITU TUP/ISUP
- 0-16383 —ANSI ISUP
- 0-4294967295 —ANSI Q.BICC

**Default:**

\*

**realpc (optional)**ANSI point code with subfields *network indicator-network cluster-network cluster member (ni-nc-ncm)*.**Range:**

000-255

Specify a valid value for each subfield of the point code, and separate the subfields with a dash (-).

When `chg-sid:pctype=ansi` is specified, `ni = 000` is not valid.When `chg-sid:pctype=ansi` is specified, `nc = 000` is not valid if `ni = 001-005`.When `chg-sid:pctype=ansi` is specified, `nc = 000` is valid if `ni = 006-255`.The point code `000-000-000` is not a valid point code.**Range:****realpci (optional)**ITU international destination point code with subfields *zone-area-id*.**Range:**

0-255

Specify a valid value for each subfield of the point code, and separate the subfields with a dash (-).

*zone*—0-7*area*—000-255*id*—0-7The point code `0-000-0` is not a valid point code.**realpcn (optional)**ITU national point code in the format of a 5-digit number (*nnnnn*); or 2, 3, or 4 numbers (members) separated by dashes (*m1-m2-m3-m4*) as defined by the `chg-`

`stpopts:npcfmti` flexible point code option. A group code must be specified when the ITUDUPPC feature is turned on (*nnnnn-gc, m1-m2-m3-m4-gc*).

**Range:**

*0-16383, aa-zz*

Specify a valid value for each subfield of the point code, and separate the subfields with a dash (-).

*nnnnn—0-16383*

*gc—aa-zz*

*m1-m2-m3-m4—0-14* for each member; values must sum to 14

**relcause (optional)**

Release Cause

**Range:**

*0 - 127*

**Default:**

*0*

**si (optional)**

Service Indicator

**Range:**

**0**

NM

**3**

SCCP

**5**

ISUP

**4**

TUP

**13**

ANSI Q. BICC

\*

**Default:**

\*

**ssn (optional)**

SCCP Subsystem number

**Range:**

*0 - 255, \**

**Default:**

\*

**Example**

`rtrv-pct:epc=1-1-1`

```
rtrv-pct:realpc=2-2-2
```

### Dependencies

If the `ssn` or `ecics` parameter is specified, then the `si` parameter must be specified.

A full point code must be specified as the value for the `realpc/realpca/realpci/realpcn` and `epc/epca/epci/epcn` parameters.

The value specified for the `ecice/rcice` parameter must be equal to or greater than the value specified for the `ecics/rcics` parameter, respectively.

The values specified for the `epc/epca/epci/epcn`, `filtpc/filtpca/filtpci/filtpcn`, and `realpc/realpca/realpci/realpcn` parameters must have the same domain.

The PCT table is corrupt or cannot be found.

The values specified for the `realpc/realpca/realpci/realpcn` and `filtpc/filtpca/filtpci/filtpcn` parameters must have at least one route for each value defined in the Route table.

If a groupcode is specified then the values specified for the `realpc`, `filtpc`, and `epc` parameters must have the same group code.

A spare point code cannot be specified as a value for the `epci/epcn`, `filtpci/filtpcn`, and `realpci/realpcn` parameters.

The `ecics` or `rcics` parameter must be specified before the `relcause` parameter can be specified.

The `si=3` parameter must be specified before the `ssn` parameter can be specified.

If the `ecice` or `rcice` parameter is specified, then the `ecics` or `rcics` parameter must be specified, respectively.

If the `ecics`, `ecice`, and `rcics` parameters are specified, then the `rcice` parameter must be specified.

A value of 4, 5, or 13 must be specified for the `si` parameter before the `ecice/ecics` and `rcice/rcics` parameters can be specified.

The values specified for the `epc/epca/epci/epcn`, `filtpc/filtpca/filtpci/filtpcn`, and `realpc/realpca/realpci/realpcn` parameters cannot be same as the STP point code.

The values specified for the `epc/epca/epci/epcn`, `filtpc/filtpca/filtpci/filtpcn`, and `realpc/realpca/realpci/realpcn` parameters cannot be same as the STP capability point code.

The `epc/epca/epci/epcn` or `realpc/realpca/realpci/realpcn` parameter must be specified if any other optional parameter is specified.

The values specified for the `ecics/ecice` and `rcics/rcice` parameters must be within the range specified by the parameter definition.

The difference between the values specified for the `ecice` and `ecics` parameters must be equal to the difference between the values specified for the `rcice` and `rcics` parameters.

A value of 5 or 13 must be specified for the `si` parameter before the `relcause` parameters can be specified.

The values specified for the `realpc/realpca/realpci/realpcn` and `filtpc/filtpca/filtpci/filtpcn` parameters must already exist in the Route table.

The `ssn` and `cic` parameters cannot be specified together in the command.

If the `ecics`, `rcics`, and `rcice` parameters are specified, then the `ecice` parameter must be specified.

If the same value is specified for the `epc` and `realpc` parameters, then the values specified for the `ecics/ecice` and `rcics/rcice` parameters cannot indicate the same range.

Only one of the `filtpc/filtpca/filtpci/filtpcn` parameters can be specified in the command.

The value specified for the `epc/epci/epcn` parameter cannot be the same as a secondary point code.

## Output

```
rtrv-pct
```

```
tekelecstp 10-08-26 11:31:14 EST EAGLE 43.0.0
```

```

EPCA          FILTPCA          REALPCA      SI  SSN  RELCAUSE
001-001-001   *                002-002-002  4  ---  10

```

```

ECICS = 10          ECICE = 20
RCICS = 30          RCICE = 40

```

```

EPCI          FILTPCI          REALPCI      SI  SSN  RELCAUSE
1-001-2       2-002-2          2-002-2      3  10  ---

```

```

ECICS = -----  ECICE = -----
RCICS = -----  RCICE = -----

```

```

EPCN          FILTPCN          REALPCN      SI  SSN  RELCAUSE
00300         *                00200        *  ---  ---

```

```

ECICS = -----  ECICE = -----
RCICS = -----  RCICE = -----

```

```

Unique EPC    is 3 of 250
Unique RealPC is 3 of 250

```

```
PCT table is (3 of 1000) 1% full.
```

```
;
```

## Related Topics

- [dlt-pct](#)
- [ent-pct](#)

## rtrv-ppsopts

Use this command to display Prepaid Short Message Service options from the PPSOPTS table.

### Parameters

#### **ppt (optional)**

Prepaid portability type. An IN platform.

#### **Range:**

1 - 32

### Example

```
rtrv-ppsopts
rtrv-ppsopts:ppt=2
```

### Dependencies

The Prepaid SMS Intercept Ph1, IDP A-Party Routing, or IDP Service Key Routing feature must be enabled and turned on before this command can be entered.

The Prepaid SMS Options Table must be available.

### Output

Set ID values are displayed only if the Flexible GTT Load Sharing (FGTTLs) feature is enabled.

This example displays Prepaid SMS options for a specific Prepaid Type:

```
rtrv-ppsopts:ppt=1

tekelecstp 08-12-17 15:07:01 EST EAGLE 40.1.0

Prepaid SMS Options
-----
BPARTYCHK          = OFF
PPT      PCA/PCI/PCN      SSN      RI
---      -
1        PCI:    1-001-1      1        GT
;

```

This example displays Prepaid SMS options for all Prepaid Types:

```
rtrv-ppsopts

tekelecstp 08-12-17 15:11:22 EST EAGLE 40.1.0

Prepaid SMS Options

```

```

-----
BPARTYCHK      = OFF
PPT            PCA/PCI/PCN          SSN   RI
-----
1             PCI:      1-001-1          1     GT
2             PCI:      1-001-2          1     SSN
3             -----          NONE  GT
4             -----          NONE  GT
5             -----          NONE  GT
6             -----          NONE  GT
7             -----          NONE  GT
8             -----          NONE  GT
9             -----          NONE  GT
10            -----          NONE  GT
11            -----          NONE  GT
12            -----          NONE  GT
13            -----          NONE  GT
14            -----          NONE  GT
15            -----          NONE  GT
16            -----          NONE  GT
17            -----          NONE  GT
18            -----          NONE  GT
19            -----          NONE  GT
20            -----          NONE  GT
21            -----          NONE  GT
22            -----          NONE  GT
23            -----          NONE  GT
24            -----          NONE  GT
25            -----          NONE  GT
26            -----          NONE  GT
27            -----          NONE  GT
28            -----          NONE  GT
29            -----          NONE  GT
30            -----          NONE  GT
31            -----          NONE  GT
32            -----          NONE  GT

```

```

GTA
---
1110
1111
NONE
NONE
NONE
NONE
NONE
NONE
NONE
NONE
NONE
NONE
NONE
NONE
NONE
NONE
NONE
NONE
NONE
NONE
NONE
NONE

```





6	-----	NONE	GT	DFLT
7	-----	NONE	GT	DFLT
8	-----	NONE	GT	DFLT
9	-----	NONE	GT	DFLT
10	-----	NONE	GT	DFLT
11	-----	NONE	GT	DFLT
12	-----	NONE	GT	DFLT
13	-----	NONE	GT	DFLT
14	-----	NONE	GT	DFLT
15	-----	NONE	GT	DFLT
16	-----	NONE	GT	DFLT
17	-----	NONE	GT	DFLT
18	-----	NONE	GT	DFLT
19	-----	NONE	GT	DFLT
20	-----	NONE	GT	DFLT
21	-----	NONE	GT	DFLT
22	-----	NONE	GT	DFLT
23	-----	NONE	GT	DFLT
24	-----	NONE	GT	DFLT
25	-----	NONE	GT	DFLT
26	-----	NONE	GT	DFLT
27	-----	NONE	GT	DFLT
28	-----	NONE	GT	DFLT
29	-----	NONE	GT	DFLT
30	-----	NONE	GT	DFLT
31	-----	NONE	GT	DFLT
32	-----	NONE	GT	DFLT

GTA

---

1122

NONE

NONE

NONE

NONE

NONE

NONE

NONE

NONE

NONE

NONE

NONE

NONE

NONE

NONE

NONE

NONE

NONE

NONE

NONE

NONE

NONE

NONE

NONE



- GSM MAP SRI Redirect
- ISUP NP for EPAP

### Example

Retrieve provisioned prefix information for all supported features.

```
rtrv-prefix
```

Retrieve prefix information for the GSM MAP SRI Redirect feature.

```
rtrv-prefix:feature="GSM MAP SRI Redirect"
```

### Dependencies

The feature name must be the name of an enabled controlled feature as it is displayed in the `rtrv-ctrl-feat` command output. The following controlled features are supported by this command:

- GSM MAP SRI Redirect
- ISUP NP for EPAP

The FEATPFX table is corrupt or cannot be found by the system.

### Notes

None

### Output

This example retrieves the provisioned prefix information for all features. Additional information is displayed in the function column for prefix numbers 6 and 7 of the “ISUP NP with EPAP” feature.

```
rtrv-prefix
```

```
rlghncxa03w 14-09-20 09:04:14 EST EAGLE 46.1.0
```

Feature	NUM	Prefix	Function
GSM MAP SRI Redirect	1	1a1a	
GSM MAP SRI Redirect	2	ffff	
GSM MAP SRI Redirect	3	1234	
GSM MAP SRI Redirect	26	1224	
ISUP NP with EPAP	1	3b4c	
ISUP NP with EPAP	6	886	Insertion Country Code
ISUP NP with EPAP	7	0	Deletion Condition

```
FEATPFX table is (7 of 256) 2% full
```

```
;
```

This example retrieves provisioned prefix information for the “GSM MAP SRI Redirect” feature. The table capacity for the total number of entries in use is reported, not just the number of entries displayed. No additional information is displayed in the Function column for this feature.

```
rtrv-prefix:feature="GSM MAP SRI Redirect"
```

```
rlghncxa03w 14-09-20 09:04:14 EST EAGLE 46.1.0
```

Feature	NUM	Prefix	Function
---------	-----	--------	----------

GSM MAP SRI Redirect	1	1a1a	
GSM MAP SRI Redirect	2	ffff	
GSM MAP SRI Redirect	3	1234	
GSM MAP SRI Redirect	26	1224	
GSM MAP SRI Redirect	32	1204	

```
FEATPFX table is (6 of 256) 2% full
```

```
;
```

### Related Topics

- [chg-prefix](#)
- [dlt-prefix](#)
- [rtrv-ctrl-feat](#)

## rtrv-rmt-appl

Use this command to retrieve a list of remote application assignments.

### Parameters

This command has no parameters.

### Example

```
rtrv-rmt-appl
```

### Dependencies

None

### Notes

None

### Output

```
rtrv-rmt-appl
```

```
rlghncxa03w 05-01-07 12:05:33 EST EAGLE 31.12.0
```

IPCA	SI SSN
003-003-003	3 100, 110-119, 200
	5

IPCI	SI SSN
3-003-3	3 5, 50-100, 250

```

                                     5
IPCN          SI SSN
16380        3 250
                                     5
IPCN24       SI SSN
100-200-100 5
;

rtrv-rmt-appl

rlghncxa03w 05-01-07 12:05:33 EST  EAGLE 31.12.0
  IPCA          SI SSN
p-001-001-001 3 5-102
  IPCI          SI SSN
ps-2-002-2    5
  IPCN          SI SSN
s-16380       3 250
  IPCN24       SI SSN
;

rtrv-rmt-appl

tekelecstp 13-07-02 15:53:27 EST  45.0.0-64.69.0
rtrv-rmt-appl
Command entered at terminal #4.

  IPCA          SI SSN

  IPCI          SI SSN

  IPCN          SI SSN

  IPCN24       SI SSN

  IPCN16       SI SSN
001-02-03    5
;

```

### Legend

- **IPC/IPCA/IPCI/PCN/PCN24/PCN16**—End node's internal point code.
- **SI**—Service indicator value that designates which user part is assigned to the IPC.
- **SSN**—SCCP subsystem number.
- Point code subtype prefixes—

- s- Spare point code
- p- Private point code
- ps- Private and spare point code

### Related Topics

- [dlt-rmt-appl](#)
- [ent-rmt-appl](#)

## rtrv-rte

This command is used to display the parameter information for the route entries in the database.

Asterisks can be specified to select and display only point codes that have the same point code subfields. See the "Notes" section for this command for details.

### Parameters



#### Note:

See [Point Code Formats and Conversion](#) for a detailed description of point code formats, rules for specification, and examples.

#### **c11i (optional)**

Common Language Location Identifier. This parameter specifies the Common Language Location Identifier assigned to the link.

##### **Range:**

ayyyyyyyyyyy

1 alphabetic character followed by 10 alphanumeric characters

##### **Default:**

No value given

#### **dpc (optional)**

ANSI destination point code with subfields network indicator-network cluster-network cluster member (*ni-nc-ncm*). The *prefix* subfield indicates a private point code (*prefix-ni-nc-ncm*).

##### **Synonym:**

*dpca*

##### **Range:**

*p-*, 000-255, \*, \*\*, \*\*\*

Specify a valid value for each subfield of the point code, and separate the subfields with a dash (-).

*prefix—p-*

The asterisk values \*, \*\*, and \*\*\* are not valid for the *ni* subfield.

If \*\* or \*\*\* is specified for the *nc* subfield, either \*, \*\*, or \*\*\* must be specified for the *ncm* subfield.

When `chg-sid:pctype=ansi` is specified, `ni=000` is not valid.  
 When `chg-sid:pctype=ansi` is specified, `nc=000` is not valid if `ni=001-005`.  
 When `chg-sid:pctype=ansi` is specified, `nc=000` is valid if `ni=006-255`.  
 When `chg-sid:pctype=ansi` is specified, `ni-*.*` is valid if `ni= 006-255`.  
 The point code `000-000-000` is not a valid point code.

**dpc/dpca/dpci/dpcn/dpcn24/dpcn16 (optional)**

Destination point code.

**dpci (optional)**

ITU international point code with subfields *zone-area-id*. The *prefix* subfield indicates a spare point code, private point code, or private and spare point code (*prefix-zone-area-id*).

**Range:**

*s-, p-, ps-, 0-255*

Specify a valid value for each subfield of the point code, and separate the subfields with a dash (-).

*prefix—s-, p-, ps*

*zone—0-7*

*area—000-255*

*id—0-7*

The point code `0-000-0` is not a valid point code.

**dpcn (optional)**

ITU national point code in the format of a 5-digit number (*nnnnn*); or 2, 3, or 4 numbers (members) separated by dashes (*m1-m2-m3-m4*) as defined by the `chg-stpopts:npcfmti` flexible point code option. A group code must be specified when the ITUDUPPC feature is turned on (*nnnnn-gc, m1-m2-m3-m4-gc*). The *prefix* subfield indicates a spare point code, private point code, or private and spare point code (*prefix-nnnnn, prefix-nnnnn-gc, prefix-m1-m2-m3-m4, prefix-m1-m2-m3-m4-gc*).

**Range:**

*s-, p-, ps-, 0-16383, aa-zz, \**

Specify a valid value for each subfield of the point code, and separate the subfields with a dash (-).

An asterisk (\*) can be specified for the node (*nnnnn* or every member of a flexible point code) or for the group code (*gc*) only when group codes are present in the point codes.

An asterisk (\*) can be specified either for the node or for the group code, but not both.

*prefix—s-, p-, ps-*

*nnnnn—0-16383, \**

*gc—aa-zz, \**

*m1-m2-m3-m4—0-14* for each member; values must sum to 14; or *\*-\*-\*-\** when the point code includes a group code.

**dpcn24 (optional)**

24-bit ITU national point code with subfields *main signaling area-sub signaling area-signaling point* (*msa-ssa-sp*). The *prefix* indicates a private point code (*prefix-msa-ssa-sp*).

**Range:**

*p-, 000-255*

Specify a valid value for each subfield of the point code, and separate the subfields with a dash (-).

*prefix—p*

*msa—000-255*



ssa—000–255  
sp—000–255

**dpcn16 (optional)**

16-bit ITU national point code with subfields *unit number sub number area main number area* (*un-sna-mna*). The *prefix* indicates a private point code (*prefix-un-sna-mna*).

**Range:**

*p--*, 000---127

Specify a valid value for each subfield of the point code, and separate the subfields with a dash (-).

*prefix---**p*

*un---*000---127

*sna---*000---15

*mna---*000---31

**lsn (optional)**

Linkset name

**Range:**

*ayyyyyyyyy*

1 alphabetic character followed by up to 9 alphanumeric characters

**Default:**

Display all

**mode (optional)**

The method used to display the output report.

**Range:**

*full*

**pcst (optional)**

Point code subtype. If selected, this parameter causes the command to display only the point codes that have no subtype prefix, or display only the point codes that have the specified subtype prefix.

**Range:**

*none*

Display all point codes that do not have subtype prefixes

*s*

Display only spare point codes

*p*

Display only private point codes

**ps**

Display only private and spare point codes

**pctype (optional)**

Point code domain. This parameter displays the point codes of the specified domain type.

**Range:****ansi****itui****itun****itun24****Example**

```
rtrv-rte
rtrv-rte:dpc=240-012-004:lsn=ls000001
rtrv-rte:clli=dp1:lsn=ls000001
rtrv-rte:dpc=140-012-008
rtrv-rte:clli=dp1rtrv-rte
rtrv-rte:dpcn=3-15-15-15-fr
rtrv-rte:lsn=elm3itun
rtrv-rte:dpcn24=10-100-14
rtrv-rte:pcst=s
rtrv-rte:pcst=none
rtrv-rte:pctype=ansi
rtrv-rte:pctype=itun24:pcst=none
rtrv-rte:dpc=1-1-**
rtrv-rte:dpc=1-1-***
rtrv-rte:dpc=1-**-*
rtrv-rte:dpc=1-***-*
rtrv-rte:dpc=1-***-*:lsn=ab64
rtrv-rte:dpc=1-***-*:lsn=xx64
rtrv-rte:dpcn=1000-*
rtrv-rte:dpcn=1000-*:lsn=dpcn64
rtrv-rte:dpcn=p-*aa
rtrv-rte:dpcn=s-9000-*
rtrv-rte:pctype=itun16:pcst=none
```

## Dependencies

The value of the `dpc/dpca/dpci/dpcn/dpcn24/dpcn16` parameter must exist in the Destination Point Code table.

The value specified for the `lsn` parameter must exist in the routeset of the destination if the `dpc` parameter is specified.

If the `dpcn` parameter is specified, its format must match the format that was assigned with the `chg-stpopts` command `npcfmti` parameter.

If the `pctype` parameter has a value of `ansi` or `itun24`, then the `pcst` parameter cannot have a value of `s` or `ps`.

The `pctype` and `pcst` parameters cannot be specified in the same command with the destination point code, alias point code, secondary point code, `clli`, `msar=only`, and `ncai` parameters.

When using network routing, if the destination point code has a value of `*` in the `nc` field, the `ncm` field must also be `*` (for example, `dpc=21--*`).

The value of the `dpc/dpca/dpci/dpcn/dpcn24/dpcn16` parameter must be a valid point code.

If the `clli` parameter is specified, then the value must exist in the Route table.

All link sets currently assigned to a route set must still be equipped.

All link sets must be defined in the route set.

The Linkset table is corrupt or cannot be found.

The Route table is corrupt or cannot be found.

The Site ID table is corrupt or cannot be found.

The database must be consistent.

The value specified for the `lsn` parameter must already be assigned to the specified routeset.

## Notes

This command can be canceled using the **F9** function key or the `canc-cmd` command. See `canc-cmd` for more information.

In this command, only ITU-international and ITU national point codes support the spare point code subtype prefix (`s-`) and the private and spare point code subtype prefix (`ps-`). All of the point code types support the private (internal) point code subtype prefix (`p-`).

## Asterisks in ANSI Point Codes

Two asterisks in the `ncm` subfield of a cluster point code produces a summary report that shows all point code destinations residing in the given cluster (for example, `20-2-**`). This does not include the specified cluster point code (for example, `20-2-*`).

Three asterisks in the `ncm` subfield of a cluster point code (for example, `20-2-***`) produces a summary report that shows all point code destinations residing in the given network cluster. The specified cluster point code is also displayed if it exists.

If the linkset name is specified and the `dpc/dpca` parameter `ncm` subfield is specified with asterisks, all route entries are displayed that have the specified linkset and that match the specified `dpc/dpca` parameter subfield values.

### Asterisks in ITU-N Duplicate Point Codes and Flexible Format Point Codes

When the ITU Duplicate Point Code (ITUDUPPC) feature is on,

- An asterisk (\*) can be specified for the group code of an ITU-N duplicate point code to display all ITU-N point codes that have the specified node value (for example, `10101-*`).
- An asterisk (\*) can be specified for the node of an ITU-N duplicate point code to display all ITU-N point codes that have the specified group code value (for example, `*-ab`).

When the ITUDUPPC feature is on and the STP flexible point code option (`npcfmt1`) is used to change the ITU-N point format to four members (`m1-m2-m3-m4-gc`),

- An asterisk (\*) can be specified for the group code of an ITU-N flexible point code to display all ITU-N point codes that have the specified point code value (for example, `15`).
- An asterisk (\*) can be specified for every member of the ITU-N flexible point code to display all ITU-N flexible point codes that have the same group code (for example, `*`, `*-15-*-*-*ab` is not valid).

### Output

In these command output examples, the point code prefixes `s-`, `p-`, and `ps-` indicate that the point code is a spare point code, a private point code, or a private and spare point, respectively.

Abbreviated output is indicated by 3 vertical dots as shown:

```
.
.
.
```

This example displays output when the Route table is provisioned. The example displays abbreviated output.

```
rtrv-rte
```

```
tekelecstp 10-10-15 14:52:32 EST EAGLE 43.0.0
rtrv-rte
Command entered at terminal #4.
Extended Processing Time may be Required
```

DPCA	ALIASI	ALIASN/N24 LSN	RTX RC	CLLI APCA
001-001-000	-----	-----	No	stp1
		e2e1	10	001-001-000
003-001-000	-----	-----	No	mstp
		e2e3	10	003-001-000
004-001-000	-----	-----	No	stp4
		e2e4	10	004-001-000
007-001-000	-----	-----	No	stp7
		e2e7	10	007-001-000
002-101-001	-----	-----	No	ssp201

002-101-001		e2m1s1	10	
		e2e3	20	
003-001-000				
002-102-001	-----	-----	No	ssp202
		e2m1s2	10	
002-102-001		e2e3	20	
003-001-000				
001-101-001	-----	-----	No	ssp101
		e2e1	10	
001-001-000				
		e2e4	20	
004-001-000				
		e2e3	30	
003-001-000				
.				
.				
.				
200-200-*	-----	-----	No	cluster2
005-006-001	-----	005-006-001	No	
-----				
001-001-001	-----	-----	No	dstn01
		lsn01	10	
001-001-001				
p-001-001-001	-----	-----	No	dstn01p
001-001-002	1-001-2	-----	No	dstn02
		lsn02	10	
001-001-002				
p-001-001-002	1-011-2	-----	No	dstn02p
001-001-003	s-1-001-3	-----	No	dstn03
		lsn03	10	
001-001-003				
p-001-001-003	s-1-011-3	-----	No	dstn03p
001-001-004	-----	02060-aa	No	dstn04
		lsn04	10	
001-001-004				
p-001-001-004	-----	01060-aa	No	dstn04p
001-070-001	-----	-----	No	tgtansi001
		lsn01	10	
001-001-001				
		lsn02	20	
001-001-002				
		lsn03	30	
001-001-003				
		lsn04	40	
001-001-004				
.				
.				
.				
200-002-001	-----	-----	Yes	
rtroute001		lsn12	10	
001-002-004				
040-001-*	-----	-----	No	myncaibeno

040-010-*	-----	-----	No	myncaibeno2
010-*-*	-----	-----	No	-----
040-*-*	-----	-----	No	-----
040-001-001	-----	-----	No	noncluster1
040-001-002	-----	-----	No	noncluster2
DPCI	ALIASA	ALIASN/N24	RTX	CLLI
		LSN	RC	APCI
s-4-002-0	010-001-001	s-08228-aa	No	-----
2-010-0	-----	-----	No	dstn13
		lsn13	10	2-010-0
p-2-010-0	-----	-----	No	dstn13p
2-010-1	002-010-001	-----	No	dstn14
		lsn14	10	2-010-1
p-2-010-1	002-100-001	-----	No	dstn14p
2-010-2	-----	04178-aa	No	dstn15
		lsn15	10	2-010-2
p-2-010-2	-----	08178-aa	No	dstn15p
2-010-3	-----	s-04179-aa	No	dstn16
		lsn16	10	2-010-3
p-2-010-3	-----	s-08179-aa	No	dstn16p
2-070-1	-----	-----	No	tgtitui001
		lsn13	10	2-010-0
		lsn14	20	2-010-1
		lsn15	30	2-010-2
		lsn16	40	2-010-3
2-010-4	-----	002-010-004	No	dstn17
		lsn17	10	2-010-4
p-2-010-4	-----	002-100-004	No	dstn17p
.				
.				
.				
s-2-020-0	-----	-----	No	dstn21
		lsn21	10	s-2-020-0
ps-2-020-0	-----	-----	No	dstn21p
s-2-020-1	002-020-001	-----	No	dstn22
		lsn22	10	s-2-020-1
ps-2-020-1	002-200-001	-----	No	dstn22p
s-2-020-2	-----	04258-aa	No	dstn23
		lsn23	10	s-2-020-2
ps-2-020-2	-----	08258-aa	No	dstn23p
s-2-020-3	-----	s-04259-aa	No	dstn24
		lsn24	10	s-2-020-3
ps-2-020-3	-----	s-08259-aa	No	dstn24p
s-2-070-3	-----	-----	No	tgtitui003
		lsn21	10	s-2-020-0
		lsn22	20	s-2-020-1
		lsn23	30	s-2-020-2
		lsn24	40	s-2-020-3
.				
.				
.				
DPCI	ALIASI	ALIASN/N24	RTX	CLLI
		LSN	RC	APCI

3-030-0	s-3-030-0	-----	No	dstn29
		lsn29	10	3-030-0
p-3-030-0	s-3-031-0	-----	No	dstn29p
3-030-1	s-3-030-1	06385-aa	No	dstn30
		lsn30	10	3-030-1
p-3-030-1	s-3-031-1	07385-aa	No	dstn30p
3-030-2	s-3-030-2	s-06386-aa	No	dstn31
		lsn31	10	3-030-2
p-3-030-2	s-3-031-2	s-07386-aa	No	dstn31p
3-070-1	s-3-070-1	-----	No	tgtitui005
		lsn29	10	3-030-0
		lsn30	20	3-030-1
		lsn31	30	3-030-2
3-030-3	s-3-030-3	003-030-003	No	dstn32
		lsn32	10	3-030-3
p-3-030-3	s-3-031-3	003-031-003	No	dstn32p
3-070-2	s-3-070-2	-----	No	tgtitui006
		lsn32	10	3-030-3
		lsn33	20	3-030-4
		lsn34	30	3-030-5
s-3-040-2	3-040-2	-----	No	dstn35
		lsn35	10	s-3-040-2
ps-3-040-2	3-041-2	-----	No	dstn35p
s-3-040-3	3-040-3	06467-aa	No	dstn36
		lsn36	10	s-3-040-3
ps-3-040-3	3-041-3	07467-aa	No	dstn36p
s-3-040-4	3-040-4	s-06468-aa	No	dstn37
		lsn37	10	s-3-040-4
ps-3-040-4	3-041-4	s-07468-aa	No	dstn37p
s-3-040-5	3-040-5	003-040-005	No	dstn38
		lsn38	10	s-3-040-5
ps-3-040-5	3-041-5	003-041-005	No	dstn38p
DPCI	ALIASN	ALIASN	RTX	CLLI
		LSN	RC	APCI
3-030-4	s-06388-aa	06388-aa	No	dstn33
		lsn33	10	3-030-4
p-3-030-4	s-07388-aa	07388-aa	No	dstn33p
3-030-5	06389-aa	s-06389-aa	No	dstn34
		lsn34	10	3-030-5
p-3-030-5	07389-aa	s-07389-aa	No	dstn34p
s-3-040-6	s-06471-aa	06471-aa	No	dstn39
		lsn39	10	s-3-040-6
ps-3-040-6	s-07471-aa	07471-aa	No	dstn39p
s-3-040-7	06472-aa	s-06472-aa	No	dstn40
		lsn40	10	s-3-040-7
ps-3-040-7	07472-aa	s-07472-aa	No	dstn40p
DPCN	ALIASA	ALIASI	RTX	CLLI
		LSN	RC	APCN
06157-aa	020-005-002	-----	No	
-----				
08192-aa	-----	-----	No	dstn41
		lsn41	10	08192-aa
p-08192-aa	-----	-----	No	dstn41p

08193-aa	004-000-001	-----	No	dstn42
		lsn42	10	08193-aa
p-08193-aa	004-200-001	-----	No	dstn42p
08194-aa	-----	4-000-2	No	dstn43
		lsn43	10	08194-aa
p-08194-aa	-----	4-040-2	No	dstn43p
08195-aa	-----	s-4-000-3	No	dstn44
		lsn44	10	08195-aa
p-08195-aa	-----	s-4-040-3	No	dstn44p
08753-aa	-----	-----	No	tgtitun001
		lsn41	10	08192-aa
		lsn42	20	08193-aa
		lsn43	30	08194-aa
		lsn44	30	08195-aa
08196-aa	004-000-004	4-000-4	No	dstn45
		lsn45	10	08196-aa
p-08196-aa	004-200-004	4-040-4	No	dstn45p
08197-aa	004-000-005	s-4-000-5	No	dstn46
		lsn46	10	08197-aa
p-08197-aa	004-200-005	s-4-040-5	No	dstn46p
08754-aa	-----	-----	No	tgtitun002
		lsn45	10	08196-aa
		lsn46	20	08197-aa
		lsn47	30	08198-aa
		lsn48	30	08199-aa
s-08272-aa	-----	-----	No	dstn49
		lsn49	10	s-08272-aa
ps-08272-aa	-----	-----	No	dstn49p
s-08273-aa	004-010-001	-----	No	dstn50
		lsn50	10	s-08273-aa
ps-08273-aa	004-200-010	-----	No	dstn50p
s-08274-aa	-----	4-010-2	No	dstn51
		lsn51	10	s-08274-aa
ps-08274-aa	-----	4-050-2	No	dstn51p
s-08275-aa	-----	s-4-010-3	No	dstn52
		lsn52	10	s-08275-aa
ps-08275-aa	-----	s-4-050-3	No	dstn52p
.				
.				
.				
DPCN	ALIASI	ALIASI	RTX	CLLI
		LSN	RC	APCN
08198-aa	s-4-000-6	4-000-6	No	dstn47
		lsn47	10	08198-aa
p-08198-aa	s-4-040-6	4-040-6	No	dstn47p
08199-aa	4-000-7	s-4-000-7	No	dstn48
		lsn48	10	08199-aa
p-08199-aa	4-040-7	s-4-040-7	No	dstn48p
s-08278-aa	s-4-010-6	4-010-6	No	dstn55
		lsn55	10	s-08278-aa
ps-08278-aa	s-4-050-6	4-050-6	No	dstn55p
s-08279-aa	4-010-7	s-4-010-7	No	dstn56
		lsn56	10	s-08279-aa
ps-08279-aa	4-050-7	s-4-050-7	No	dstn56p



s-08379-aa rtxroute003	s-4-058-7	4-058-7	Yes	
		lsn55	80	s-08278-aa
08198-fr dstn47dupfr	s-4-005-7	4-005-7	No	
08198-tk dstn47dupTk	4-006-0	s-4-006-0	No	
DPCN	ALIASN	ALIASI	RTX	CLLI
12688-aa	s-12688-aa	----- lsn57	RC No 10	APCN dstn57 12688-aa
p-12688-aa	s-13688-aa	-----	No	dstn57p
12689-aa	s-12689-aa	6-050-1 lsn58	No 10	dstn58 12689-aa
p-12689-aa	s-13689-aa	6-060-1	No	dstn58p
12690-aa	s-12690-aa	s-6-050-2 lsn59	No 10	dstn59 12690-aa
p-12690-aa	s-13690-aa	s-6-060-2	No	dstn59p
s-12691-aa	12691-aa	----- lsn60	No 10	dstn60 s-12691-aa
ps-12691-aa	13691-aa	-----	No	dstn60p
s-12692-aa	12692-aa	6-050-4 lsn61	No 10	dstn61 s-12692-aa
ps-12692-aa	13692-aa	6-060-4	No	dstn61p
s-12693-aa	12693-aa	s-6-050-5 lsn62	No 10	dstn62 s-12693-aa
ps-12693-aa	13693-aa	s-6-060-5	No	dstn62p
s-08272-fr dstn49dupfr	08300-fr	-----	No	
s-08272-tk dstn49dupTk	08300-tk	4-006-7	No	
DPCN24	ALIASA	ALIASI	RTX	CLLI
003-003-004	003-003-003	LSN 3-003-4	RC No	APCN24
----- 006-005-001	-----	----- lsn63	No 10	dstn63
006-005-001				
p-006-005-001	-----	-----	No	dstn63p
006-005-002	006-005-002	----- lsn64	No 10	dstn64
006-005-002				
p-006-005-002	006-005-020	-----	No	dstn64p
006-005-003	-----	6-005-3 lsn65	No 10	dstn65
006-005-003				
p-006-005-003	-----	6-050-3	No	dstn65p
006-070-001	-----	----- lsn63	No 10	tgtitun24a
006-005-001				
		lsn64	20	
006-005-002				
		lsn65	30	
006-005-003				

```

006-005-004 ----- s-6-005-4 No dstn66
                                lsn66 10 006-005-004
p-006-005-004 ----- s-6-050-4 No dstn66p
006-005-005 006-005-005 6-005-5 No dstn67
                                lsn67 10 006-005-005
p-006-005-005 006-005-050 6-050-5 No dstn67p
006-070-002 ----- ----- No tgtitun24b
                                lsn66 10 006-005-004
                                lsn67 20 006-005-005

```

;

This example displays the output when the Route table is empty:

```
rtrv-rte
```

```
tekelecstp 08-01-01 12:31:35 EST EAGLE 38.0.0
```

```
rtrv-rte
```

```
Command entered at terminal #4.
```

```
No routes meeting the requested criteria were found
```

;

This example retrieves a route by linkset name:

```
rtrv-rte:lsn=e2e1
```

```
eagle10115 10-10-09 10:00:37 EST EAGLE 43.0.0
```

```
rtrv-rte:lsn=e2e1
```

```
Command entered at terminal #4.
```

```
Extended Processing Time may be Required
```

LSN	DPCA	RC
e2e1	001-001-000	10
	001-101-001	10
	004-101-001	20
	100-100-*	10
	100-100-001	10

;

This example retrieves a route by linkset name and destination point code:

```
rtrv-rte:dpc=4-101-1:lsn=e2e1
```

```
eagle10115 08-12-09 10:00:37 EST EAGLE 40.1.0
```

```
LSN DPCA RC
```

```
e2e1 004-101-001 20
```

;

In this example, the `chg-stpopts:npcfmti` value is set to 7-4-3:

```
rtrv-rte:dpcn=127-15-7
```

```
eagle10115 08-12-09 10:00:37 EST EAGLE 40.1.0

      DPCN          ALIASA          ALIASI          LSN          RC
APCN
      127-15-7      -----
100-10-2
                                           RTX: No      CLLI:
-----
;
```

In this example, the `chg-stpopts:npcfmti` value is set to 11-1-1-1 and the ITUDUPPC feature is on:

```
rtrv-rte:lsn=ls3
```

```
eagle10115 10-10-09 10:00:37 EST EAGLE 43.0.0
rtrv-rte:lsn=ls3
Command entered at terminal #4.
Extended Processing Time may be Required

LSN          DPCN          RC
lsn47        1024-1-1-0-aa 10
              1094-0-1-0-aa 30

;
```

In this example, the `chg-stpopts:npcfmti` value is set to 2-4-4-4 and the ITUDUPPC feature is on:

```
rtrv-rte:dpcn=s-2-00-05-00-tk
```

```
eagle10115 08-12-09 10:00:37 EST EAGLE 40.1.0

      DPCN          ALIASN          ALIASI          RTX    CLLI
              LSN          RC          APCN
s-2-00-05-00-tk  2-00-06-12-tk  4-006-7      No
dstn49dupTk

;
```

In this example, the `chg-stpopts:npcfmti` value is set to 11-1-1-1 and the ITUDUPPC feature is on:

```
rtrv-rte:lsn=elm3itun
```

```
eagle10115 10-10-09 10:00:37 EST EAGLE 43.0.0
```

```
rtrv-rte:lsn=elm3itun
Command entered at terminal #4.
Extended Processing Time may be Required
```

```
LSN          DPCN          RC
elm3itun     2047-1-1-1-pe 10
```

```
;
```

This example contains a route with 24-bit ITU-N point codes:

```
rtrv-rte:lsn=lsn66
```

```
eagle10115 10-10-09 10:00:37 EST EAGLE 43.0.0
rtrv-rte:lsn=lsn66
Command entered at terminal #4.
Extended Processing Time may be Required
```

```
LSN          DPCN24        RC
lsn66        006-005-004   10
              006-070-002   10
```

```
;
```

This example displays ANSI point codes:

```
rtrv-rte:pctype=ansi
```

```
eagle10115 10-10-29 10:00:37 EST EAGLE 43.0.0
rtrv-rte:pctype=ansi
Command entered at terminal #4.
Extended Processing Time may be Required
```

DPCA	ALIASI	ALIASN/N24 LSN	RTX RC	CLLI APCA
001-001-000	-----	----- e2e1	No 10	stp1 001-001-000
003-001-000	-----	----- e2e3	No 10	mstp 003-001-000
004-001-000	-----	----- e2e4	No 10	stp4 004-001-000
007-001-000	-----	----- e2e7	No 10	stp7 007-001-000
002-101-001	-----	----- e2m1s1 e2e3	No 10 20	ssp201 002-101-001 003-001-000
002-102-001	-----	----- e2m1s2 e2e3	No 10 20	ssp202 002-102-001 003-001-000
001-101-001	-----	----- e2e1 e2e4	No 10 20	ssp101 001-001-000 004-001-000

			e2e3	30	
003-001-000					
003-101-001	-----	-----		No	ssp301
			e2m1s3	10	
003-101-001					
			e2e3	20	
003-001-000					
004-101-001	-----	-----		No	ssp401
			e2e4	10	
004-001-000					
			e2e1	20	
001-001-000					
007-101-001	-----	-----		No	ssp701
			e2e7	10	
007-001-000					
100-100-*	-----	-----		No	cluster1
			e2e1	10	
001-001-000					
			e2e3	20	
003-001-000					
100-100-001	-----	-----		No	
-----					
			e2e1	10	
001-001-000					
200-200-*	-----	-----		No	cluster2
005-006-001	-----	005-006-001		No	
-----					
001-001-001	-----	-----		No	dstn01
			lsn01	10	
001-001-001					
p-001-001-001	-----	-----		No	dstn01p
001-001-002	1-001-2	-----		No	dstn02
			lsn02	10	
001-001-002					
p-001-001-002	1-011-2	-----		No	dstn02p
001-001-003	s-1-001-3	-----		No	dstn03
			lsn03	10	
001-001-003					
p-001-001-003	s-1-011-3	-----		No	dstn03p
001-001-004	-----	0257-1-0-0-aa		No	dstn04
			lsn04	10	
001-001-004					
p-001-001-004	-----	0132-1-0-0-aa		No	dstn04p
001-070-001	-----	-----		No	tgtansi001
			lsn01	10	
001-001-001					
			lsn02	20	
001-001-002					
			lsn03	30	
001-001-003					
			lsn04	40	
001-001-004					
001-001-005	-----	s-0257-1-0-1-aa		No	dstn05
			lsn05	10	
001-001-005					

```

p-001-001-005 ----- s-0132-1-0-1-aa No dstn05p
  001-001-006 ----- 001-001-006 No dstn06
                                lsn06 10 001-001-006
p-001-001-006 ----- 001-011-006 No dstn06p
  001-001-007 1-001-7 0257-1-1-1-aa No dstn07
                                lsn07 10 001-001-007
p-001-001-007 1-011-7 0132-1-1-1-aa No dstn07p
  001-002-000 1-002-0 s-0258-0-0-0-aa No dstn08
                                lsn08 10 001-002-000
p-001-002-000 1-012-0 s-0133-0-0-0-aa No dstn08p
  001-070-002 ----- ----- No tgtansi002
                                lsn05 10 001-001-005
                                lsn06 20 001-001-006
                                lsn07 30 001-001-007
                                lsn08 40 001-002-000
  001-002-001 s-1-002-1 0258-0-0-1-aa No dstn09
                                lsn09 10 001-002-001
p-001-002-001 s-1-012-1 0133-0-0-1-aa No dstn09p
  001-002-002 s-1-002-2 s-0258-0-1-0-aa No dstn10
                                lsn10 10 001-002-002
p-001-002-002 s-1-012-2 s-0133-0-1-0-aa No dstn10p
  001-002-003 1-002-3 001-002-003 No dstn11
                                lsn11 10 001-002-003
p-001-002-003 1-012-3 001-012-003 No dstn11p
  001-002-004 s-1-002-4 001-002-004 No dstn12
                                lsn12 10 001-002-004
p-001-002-004 s-1-012-4 001-012-004 No dstn12p
  001-070-003 ----- ----- No tgtansi003
                                lsn09 10 001-002-001
                                lsn10 20 001-002-002
                                lsn11 30 001-002-003
                                lsn12 40 001-002-004
200-002-001 ----- ----- Yes rtxroute001
040-001-* ----- ----- No myncaibeno
040-010-* ----- ----- No myncaibeno2
010-*-* ----- ----- No -----
040-*-* ----- ----- No -----
040-001-001 ----- ----- No noncluster1
040-001-002 ----- ----- No noncluster2

```

;

This example displays ITU-I point codes:

```
rtrv-rte:pctype=itui
```

```

eagle10115 10-10-29 10:00:37 EST EAGLE 43.0.0
rtrv-rte:pctype=itui
Command entered at terminal #4.
Extended Processing Time may be Required

```

```

DPCI          ALIASA          ALIASN/N24    RTX    CLLI
s-4-002-0     010-001-001    s-1028-1-0-0-aa No     -----
                                LSN          RC          APCI

```

2-010-0	-----	-----	No	dstn13
		lsn13	10	2-010-0
p-2-010-0	-----	-----	No	dstn13p
2-010-1	002-010-001	-----	No	dstn14
		lsn14	10	2-010-1
p-2-010-1	002-100-001	-----	No	dstn14p
2-010-2	-----	0522-0-1-0-aa	No	dstn15
		lsn15	10	2-010-2
p-2-010-2	-----	1022-0-1-0-aa	No	dstn15p
2-010-3	-----	s-0522-0-1-1-aa	No	dstn16
		lsn16	10	2-010-3
p-2-010-3	-----	s-1022-0-1-1-aa	No	dstn16p
2-070-1	-----	-----	No	tgtitui001
		lsn13	10	2-010-0
		lsn14	20	2-010-1
		lsn15	30	2-010-2
		lsn16	40	2-010-3
2-010-4	-----	002-010-004	No	dstn17
		lsn17	10	2-010-4
p-2-010-4	-----	002-100-004	No	dstn17p
2-010-5	002-010-005	0522-1-0-1-aa	No	dstn18
		lsn18	10	2-010-5
p-2-010-5	002-100-005	1022-1-0-1-aa	No	dstn18p
2-010-6	002-010-006	s-0522-1-1-0-aa	No	dstn19
		lsn19	10	2-010-6
p-2-010-6	002-100-006	s-1022-1-1-0-aa	No	dstn19p
2-010-7	002-010-007	002-010-007	No	dstn20
		lsn20	10	2-010-7
p-2-010-7	002-100-007	002-100-007	No	dstn20p
2-070-2	-----	-----	No	tgtitui002
		lsn17	10	2-010-4
		lsn18	20	2-010-5
		lsn19	30	2-010-6
		lsn20	40	2-010-7
s-2-020-0	-----	-----	No	dstn21
		lsn21	10	s-2-020-0
ps-2-020-0	-----	-----	No	dstn21p
s-2-020-1	002-020-001	-----	No	dstn22
		lsn22	10	s-2-020-1
ps-2-020-1	002-200-001	-----	No	dstn22p
s-2-020-2	-----	0532-0-1-0-aa	No	dstn23
		lsn23	10	s-2-020-2
ps-2-020-2	-----	1032-0-1-0-aa	No	dstn23p
s-2-020-3	-----	s-0532-0-1-1-aa	No	dstn24
		lsn24	10	s-2-020-3
ps-2-020-3	-----	s-1032-0-1-1-aa	No	dstn24p
s-2-070-3	-----	-----	No	tgtitui003
		lsn21	10	s-2-020-0
		lsn22	20	s-2-020-1
		lsn23	30	s-2-020-2
		lsn24	40	s-2-020-3
s-2-020-4	-----	002-020-004	No	dstn25
		lsn25	10	s-2-020-4
ps-2-020-4	-----	002-200-004	No	dstn25p
s-2-020-5	002-020-005	0532-1-0-1-aa	No	dstn26

		lsn26	10	s-2-020-5
ps-2-020-5	-----	-----	No	dstn26p
s-2-020-6	002-020-006	s-0532-1-1-0-aa	No	dstn27
		lsn27	10	s-2-020-6
ps-2-020-6	002-200-005	1032-1-0-1-aa	No	dstn27p
s-2-020-7	002-020-007	002-020-007	No	dstn28
		lsn28	10	s-2-020-7
ps-2-020-7	002-200-007	002-200-007	No	dstn28p
s-2-070-4	-----	-----	No	tgtitui004
		lsn25	10	s-2-020-4
		lsn26	20	s-2-020-5
		lsn27	30	s-2-020-6
		lsn28	40	s-2-020-7
s-3-070-3	-----	-----	No	tgtitui007
		lsn35	10	s-3-040-2
		lsn36	20	s-3-040-3
		lsn37	30	s-3-040-4
s-3-070-4	-----	-----	No	tgtitui008
		lsn38	10	s-3-040-5
		lsn39	20	s-3-040-6
		lsn40	30	s-3-040-7
s-2-029-6	002-029-006	s-0533-1-0-1-aa	Yes	rtxroute002
		lsn26	5	s-2-020-5
DPCI	ALIASI	ALIASN/N24	RTX	CLLI
		LSN	RC	APCI
3-030-0	s-3-030-0	-----	No	dstn29
		lsn29	10	3-030-0
p-3-030-0	s-3-031-0	-----	No	dstn29p
3-030-1	s-3-030-1	0798-0-0-1-aa	No	dstn30
		lsn30	10	3-030-1
p-3-030-1	s-3-031-1	0923-0-0-1-aa	No	dstn30p
3-030-2	s-3-030-2	s-0798-0-1-0-aa	No	dstn31
		lsn31	10	3-030-2
p-3-030-2	s-3-031-2	s-0923-0-1-0-aa	No	dstn31p
3-070-1	s-3-070-1	-----	No	tgtitui005
		lsn29	10	3-030-0
		lsn30	20	3-030-1
		lsn31	30	3-030-2
3-030-3	s-3-030-3	003-030-003	No	dstn32
		lsn32	10	3-030-3
p-3-030-3	s-3-031-3	003-031-003	No	dstn32p
3-070-2	s-3-070-2	-----	No	tgtitui006
		lsn32	10	3-030-3
		lsn33	20	3-030-4
		lsn34	30	3-030-5
s-3-040-2	3-040-2	-----	No	dstn35
		lsn35	10	s-3-040-2
ps-3-040-2	3-041-2	-----	No	dstn35p
s-3-040-3	3-040-3	0808-0-1-1-aa	No	dstn36
		lsn36	10	s-3-040-3
ps-3-040-3	3-041-3	0933-0-1-1-aa	No	dstn36p
s-3-040-4	3-040-4	s-0808-1-0-0-aa	No	dstn37
		lsn37	10	s-3-040-4
ps-3-040-4	3-041-4	s-0933-1-0-0-aa	No	dstn37p



```

s-3-040-5          3-040-5          003-040-005 No   dstn38
                  lsn38          10   s-3-040-5
ps-3-040-5        3-041-5          003-041-005 No   dstn38p

DPCI              ALIASN              ALIASN              RTX   CLLI
                  LSN              RC
3-030-4          s-0798-1-0-0-aa   0798-1-0-0-aa No   dstn33
                  lsn33          10   3-030-4
p-3-030-4        s-0923-1-0-0-aa   0923-1-0-0-aa No   dstn33p
3-030-5          0798-1-0-1-aa   s-0798-1-0-1-aa No   dstn34
                  lsn34          10   3-030-5
p-3-030-5        0923-1-0-1-aa   s-0923-1-0-1-aa No   dstn34p
s-3-040-6        s-0808-1-1-1-aa   0808-1-1-1-aa No   dstn39
                  lsn39          10   s-3-040-6
ps-3-040-6       s-0933-1-1-1-aa   0933-1-1-1-aa No   dstn39p
s-3-040-7        0809-0-0-0-aa   s-0809-0-0-0-aa No   dstn40
                  lsn40          10   s-3-040-7
ps-3-040-7       0934-0-0-0-aa   s-0934-0-0-0-aa No   dstn40p

```

;

This example displays ITU-N point codes:

```
rtrv-rte:pctype=itun
```

```

eagle10115 10-10-29 10:00:37 EST EAGLE 43.0.0
rtrv-rte:pctype=itun
Command entered at terminal #4.
Extended Processing Time may be Required

```

```

DPCN              ALIASA              ALIASI              RTX   CLLI
                  LSN              RC   APCN
06157-aa          020-005-002   -----
-----
08192-aa          -----
                  lsn41          10   dstn41
p-08192-aa       -----
08193-aa          004-000-001   -----
                  lsn42          10   dstn41p
p-08193-aa       004-200-001   -----
08194-aa          -----
                  4-000-2       10   dstn42
p-08194-aa       -----
                  lsn43          10   dstn42p
08195-aa          -----
                  4-040-2       10   dstn43
p-08195-aa       -----
                  s-4-000-3     No   dstn43p
08196-aa          -----
                  lsn44          10   dstn44
p-08196-aa       -----
                  s-4-040-3     No   dstn44p
08753-aa          -----
                  lsn41          10   tgtitun001
                  lsn42          20   08192-aa
                  lsn43          30   08193-aa
                  lsn44          30   08194-aa
08197-aa          004-000-004   4-000-4       No   08195-aa
p-08197-aa       004-200-004   4-040-4       10   dstn45
                  lsn45          10   08196-aa
                  4-040-4       No   dstn45p

```

08197-aa	004-000-005	s-4-000-5	No	dstn46
		lsn46	10	08197-aa
p-08197-aa	004-200-005	s-4-040-5	No	dstn46p
08754-aa	-----	-----	No	tgtitun002
		lsn45	10	08196-aa
		lsn46	20	08197-aa
		lsn47	30	08198-aa
		lsn48	30	08199-aa
s-08272-aa	-----	-----	No	dstn49
		lsn49	10	s-08272-aa
ps-08272-aa	-----	-----	No	dstn49p
s-08273-aa	004-010-001	-----	No	dstn50
		lsn50	10	s-08273-aa
ps-08273-aa	004-200-010	-----	No	dstn50p
s-08274-aa	-----	4-010-2	No	dstn51
		lsn51	10	s-08274-aa
ps-08274-aa	-----	4-050-2	No	dstn51p
s-08275-aa	-----	s-4-010-3	No	dstn52
		lsn52	10	s-08275-aa
ps-08275-aa	-----	s-4-050-3	No	dstn52p
s-08755-aa	-----	-----	No	tgtitun003
		lsn49	10	s-08272-aa
		lsn50	20	s-08273-aa
		lsn51	30	s-08274-aa
		lsn52	30	s-08275-aa
s-08276-aa	004-010-004	4-010-4	No	dstn53
		lsn53	10	s-08276-aa
ps-08276-aa	004-200-040	4-050-4	No	dstn53p
s-08277-aa	004-010-005	s-4-010-5	No	dstn54
		lsn54	10	s-08277-aa
ps-08277-aa	004-200-050	s-4-050-5	No	dstn54p
s-08756-aa	-----	-----	No	tgtitun004
		lsn53	10	s-08276-aa
		lsn54	20	s-08277-aa
		lsn55	30	s-08278-aa
		lsn56	30	s-08279-aa
08757-aa	-----	-----	No	tgtitun005
		lsn57	10	12688-aa
		lsn58	20	12689-aa
		lsn59	30	12690-aa
s-08758-aa	-----	-----	No	tgtitun006
		lsn60	10	s-12691-aa
		lsn61	20	s-12692-aa
		lsn62	30	s-12693-aa
08199-fr	-----	s-4-006-1	No	dstn48dupfr
08199-tk	-----	4-006-2	No	dstn48dupTk
08198-nz	-----	-----	No	dstn47dupnz
s-08273-fr	-----	4-006-3	No	dstn50dupfr
DPCN	ALIASI	ALIASI	RTX	CLLI
		LSN	RC	APCN
08198-aa	s-4-000-6	4-000-6	No	dstn47
		lsn47	10	08198-aa
p-08198-aa	s-4-040-6	4-040-6	No	dstn47p
08199-aa	4-000-7	s-4-000-7	No	dstn48

```

                lsn48          10    08199-aa
p-08199-aa      4-040-7        s-4-040-7        No    dstn48p
s-08278-aa      s-4-010-6        4-010-6          No    dstn55
                lsn55          10    s-08278-aa
ps-08278-aa     s-4-050-6        4-050-6          No    dstn55p
s-08279-aa      4-010-7          s-4-010-7        No    dstn56
                lsn56          10    s-08279-aa
ps-08279-aa     4-050-7          s-4-050-7        No    dstn56p
s-08379-aa      s-4-058-7        4-058-7          Yes
rtxroute003
                lsn55          80    s-08278-aa
    08198-fr     s-4-005-7        4-005-7          No
dstn47dupfr
    08198-tk     4-006-0          s-4-006-0        No
dstn47dupTk

    DPCN          ALIASN          ALIASI          RTX    CLLI
                LSN
    12688-aa      s-12688-aa      -----
                lsn57          10    12688-aa
p-12688-aa      s-13688-aa      -----
    12689-aa      s-12689-aa      6-050-1          No    dstn57p
                lsn58          10    12689-aa
p-12689-aa      s-13689-aa      6-060-1          No    dstn58p
    12690-aa      s-12690-aa      s-6-050-2        No    dstn59
                lsn59          10    12690-aa
p-12690-aa      s-13690-aa      s-6-060-2        No    dstn59p
s-12691-aa      12691-aa      -----
                lsn60          10    s-12691-aa
ps-12691-aa     13691-aa      -----
s-12692-aa      12692-aa      6-050-4          No    dstn60p
                lsn61          10    s-12692-aa
ps-12692-aa     13692-aa      6-060-4          No    dstn61p
s-12693-aa      12693-aa      s-6-050-5        No    dstn62
                lsn62          10    s-12693-aa
ps-12693-aa     13693-aa      s-6-060-5        No    dstn62p
s-08272-fr     08300-fr      -----
dstn49dupfr
s-08272-tk     08300-tk      4-006-7          No
dstn49dupTk
;

```

This example displays ANSI point codes that have the private point code subtype prefix (p-):

```
rtrv-rte:pctype=ansi:pcst=p
```

```

eagle10115 10-10-09 10:00:37 EST EAGLE 43.0.0
rtrv-rte:pctype=ansi:pcst=p
Command entered at terminal #4.
Extended Processing Time may be Required

```

```

    DPCA          ALIASI          ALIASN/N24      RTX    CLLI
                LSN          RC          APCA

```

```

p-001-001-001 ----- ----- No dstn01p
p-001-001-002      1-011-2 ----- No dstn02p
p-001-001-003      s-1-011-3 ----- No dstn03p
p-001-001-004 -----          01060-aa No dstn04p
p-001-001-005 -----          s-01061-aa No dstn05p
p-001-001-006 -----          001-011-006 No dstn06p
p-001-001-007      1-011-7          01063-aa No dstn07p
p-001-002-000      1-012-0          s-01064-aa No dstn08p
p-001-002-001      s-1-012-1          01065-aa No dstn09p
p-001-002-002      s-1-012-2          s-01066-aa No dstn10p
p-001-002-003      1-012-3          001-012-003 No dstn11p
p-001-002-004      s-1-012-4          001-012-004 No dstn12p

```

;

This example displays ITU-I point codes that have the private and spare point code subtype prefix (ps-):

```
rtrv-rte:pctype=itui:pcst=ps
```

```

eagle10115 10-10-09 10:00:37 EST EAGLE 43.0.0
rtrv-rte:pctype=itui:pcst=ps
Command entered at terminal #4.
Extended Processing Time may be Required

```

DPCI	ALIASA	ALIASN/N24 LSN	RTX RC	CLLI APCI
ps-2-020-0	-----	-----	No	dstn21p
ps-2-020-1	002-200-001	-----	No	dstn22p
ps-2-020-2	-----	08258-aa	No	dstn23p
ps-2-020-3	-----	s-08259-aa	No	dstn24p
ps-2-020-4	-----	002-200-004	No	dstn25p
ps-2-020-5	-----	-----	No	dstn26p
ps-2-020-6	002-200-005	08261-aa	No	dstn27p
ps-2-020-7	002-200-007	002-200-007	No	dstn28p

DPCI	ALIASI	ALIASN/N24 LSN	RTX RC	CLLI APCI
ps-3-040-2	3-041-2	-----	No	dstn35p
ps-3-040-3	3-041-3	07467-aa	No	dstn36p
ps-3-040-4	3-041-4	s-07468-aa	No	dstn37p
ps-3-040-5	3-041-5	003-041-005	No	dstn38p

DPCI	ALIASN	ALIASN LSN	RTX RC	CLLI APCI
ps-3-040-6	s-07471-aa	07471-aa	No	dstn39p
ps-3-040-7	07472-aa	s-07472-aa	No	dstn40p

;

This example displays ITU-N point codes that have the spare point code subtype prefix (s-):

rtrv-rte:pctype=itun:pcst=s

eagle10115 10-10-09 10:00:37 EST EAGLE 43.0.0

rtrv-rte:pctype=itun:pcst=s

Command entered at terminal #4.

Extended Processing Time may be Required

DPCN	ALIASA	ALIASI LSN	RTX RC	CLLI APCN
s-08272-aa	-----	-----	No	dstn49
		lsn49	10	s-08272-aa
s-08273-aa	004-010-001	-----	No	dstn50
		lsn50	10	s-08273-aa
s-08274-aa	-----	4-010-2	No	dstn51
		lsn51	10	s-08274-aa
s-08275-aa	-----	s-4-010-3	No	dstn52
		lsn52	10	s-08275-aa
s-08755-aa	-----	-----	No	tgtitun003
		lsn49	10	s-08272-aa
		lsn50	20	s-08273-aa
		lsn51	30	s-08274-aa
		lsn52	30	s-08275-aa
s-08276-aa	004-010-004	4-010-4	No	dstn53
		lsn53	10	s-08276-aa
s-08277-aa	004-010-005	s-4-010-5	No	dstn54
		lsn54	10	s-08277-aa
s-08756-aa	-----	-----	No	tgtitun004
		lsn53	10	s-08276-aa
		lsn54	20	s-08277-aa
		lsn55	30	s-08278-aa
		lsn56	30	s-08279-aa
s-08758-aa	-----	-----	No	tgtitun006
		lsn60	10	s-12691-aa
		lsn61	20	s-12692-aa
		lsn62	30	s-12693-aa
s-08273-fr	-----	4-006-3	No	
dstn50dupfr				

DPCN	ALIASI	ALIASI LSN	RTX RC	CLLI APCN
s-08278-aa	s-4-010-6	4-010-6	No	dstn55
		lsn55	10	s-08278-aa
s-08279-aa	4-010-7	s-4-010-7	No	dstn56
		lsn56	10	s-08279-aa
s-08379-aa	s-4-058-7	4-058-7	Yes	
rtxrout003				
		lsn55	80	s-08278-aa

DPCN	ALIASN	ALIASI LSN	RTX RC	CLLI APCN
s-12691-aa	12691-aa	-----	No	dstn60
		lsn60	10	s-12691-aa
s-12692-aa	12692-aa	6-050-4	No	dstn61
		lsn61	10	s-12692-aa

```

s-12693-aa      12693-aa      s-6-050-5      No   dstn62
                lsn62          10 s-12693-aa
s-08272-fr      08300-fr      -----        No   dstn49dupfr
s-08272-tk      08300-tk      4-006-7        No   dstn49dupTk

```

;

This example displays point codes that have no point code subtype prefix. This example displays abbreviated output.

```
rtrv-rte:pcst=none
```

```
eagle10115 10-10-09 10:00:37 EST EAGLE 43.0.0
```

```
rtrv-rte:pcst=none
```

```
Command entered at terminal #4.
```

```
Extended Processing Time may be Required
```

DPCA	ALIASI	ALIASN/N24 LSN	RTX RC	CLLI APCA
001-001-000	-----	-----	No	stp1
		e2e1	10	001-001-000
003-001-000	-----	-----	No	mstp
		e2e3	10	003-001-000
004-001-000	-----	-----	No	stp4
		e2e4	10	004-001-000
007-001-000	-----	-----	No	stp7
		e2e7	10	007-001-000
002-101-001	-----	-----	No	ssp201
		e2m1s1	10	002-101-001
		e2e3	20	003-001-000
.				
.				
.				
200-200-*	-----	-----	No	cluster2
005-006-001	-----	005-006-001	No	-----
001-001-001	-----	-----	No	dstn01
		lsn01	10	001-001-001
001-001-002	1-001-2	-----	No	dstn02
		lsn02	10	001-001-002
001-001-003	s-1-001-3	-----	No	dstn03
		lsn03	10	001-001-003
001-001-004	-----	02060	No	dstn04
		lsn04	10	001-001-004
001-070-001	-----	-----	No	tgtansi001
		lsn01	10	001-001-001
		lsn02	20	001-001-002
		lsn03	30	001-001-003
		lsn04	40	001-001-004
001-001-005	-----	s-02061	No	dstn05
		lsn05	10	001-001-005
.				
.				
.				
010-*-*	-----	-----	No	dstnrtison

DPCI	ALIASA	ALIASN/N24 LSN	RTX RC	CLLI APCI
2-010-0	-----	----- lsn13	No 10	dstn13 2-010-0
2-010-1	002-010-001	----- lsn14	No 10	dstn14 2-010-1
2-010-2	-----	04178 lsn15	No 10	dstn15 2-010-2
2-010-3	-----	s-04179 lsn16	No 10	dstn16 2-010-3
2-070-1	-----	----- lsn13 lsn14 lsn15 lsn16	No 10 20 30 40	tgtitui001 2-010-0 2-010-1 2-010-2 2-010-3
2-010-4	-----	002-010-004 lsn17	No 10	dstn17 2-010-4
.				
.				
.				
DPCI	ALIASI	ALIASN/N24 LSN	RTX RC	CLLI APCI
3-030-0	s-3-030-0	----- lsn29	No 10	dstn29 3-030-0
3-030-1	s-3-030-1	06385 lsn30	No 10	dstn30 3-030-1
3-030-2	s-3-030-2	s-06386 lsn31	No 10	dstn31 3-030-2
3-070-1	s-3-070-1	----- lsn29 lsn30 lsn31	No 10 20 30	tgtitui005 3-030-0 3-030-1 3-030-2
3-030-3	s-3-030-3	003-030-003 lsn32	No 10	dstn32 3-030-3
3-070-2	s-3-070-2	----- lsn32 lsn33 lsn34	No 10 20 30	tgtitui006 3-030-3 3-030-4 3-030-5
DPCI	ALIASN	ALIASN LSN	RTX RC	CLLI APCI
3-030-4	s-06388	06388 lsn33	No 10	dstn33 3-030-4
3-030-5	06389	s-06389 lsn34	No 10	dstn34 3-030-5
DPCN	ALIASA	ALIASI LSN	RTX RC	CLLI APCN
06157	020-005-002	-----	No	
----- 08192	-----	----- lsn41	No 10	dstn41 08192
08193	004-000-001	----- lsn42	No 10	dstn42 08193

```

08194      -----      4-000-2      No      dstn43
              lsn43      10      08194
08195      -----      s-4-000-3      No      dstn44
              lsn44      10      08195
08753      -----      -----      No      tgtitun001
              lsn41      10      08192
              lsn42      20      08193
              lsn43      30      08194
              lsn44      30      08195
.
.
.

DPCN      ALIASI      ALIASI      RTX      CLLI
              LSN      RC      APCN
08198      s-4-000-6      4-000-6      No      dstn47
              lsn47      10      08198
08199      4-000-7      s-4-000-7      No      dstn48
              lsn48      10      08199
DPCN      ALIASN      ALIASI      RTX      CLLI
              LSN      RC      APCN
12688      s-12688      -----      No      dstn57
              lsn57      10      12688
12689      s-12689      6-050-1      No      dstn58
              lsn58      10      12689
12690      s-12690      s-6-050-2      No      dstn59
              lsn59      10      12690

DPCN24      ALIASA      ALIASI      RTX      CLLI
              LSN      RC      APCN24
003-003-004      003-003-003      3-003-4      No      -----
006-005-001      -----      -----      No      dstn63
              lsn63      10      006-005-001
006-005-002      006-005-002      -----      No      dstn64
              lsn64      10      006-005-002
006-005-003      -----      6-005-3      No      dstn65
              lsn65      10      006-005-003
006-070-001      -----      -----      No      tgtitun24a
              lsn63      10      006-005-001
              lsn64      20      006-005-002
              lsn65      30      006-005-003
006-005-004      -----      s-6-005-4      No      dstn66
              lsn66      10      006-005-004
006-005-005      006-005-005      6-005-5      No      dstn67
              lsn67      10      006-005-005
006-070-002      -----      -----      No      tgtitun24b
              lsn66      10      006-005-004
              lsn67      20      006-005-005

```

;

This example displays point codes that have the private point code subtype prefix (p-):



rtrv-rte:pcst=p

eagle10115 10-10-09 10:00:37 EST EAGLE 43.0.0

rtrv-rte:pcst=p

Command entered at terminal #4.

Extended Processing Time may be Required

DPCA	ALIASI	ALIASN/N24 LSN	RTX RC	CLLI APCA
p-001-001-001	-----	-----	No	dstn01p
p-001-001-002	1-011-2	-----	No	dstn02p
p-001-001-003	s-1-011-3	-----	No	dstn03p
p-001-001-004	-----	01060-aa	No	dstn04p
p-001-001-005	-----	s-01061-aa	No	dstn05p
p-001-001-006	-----	001-011-006	No	dstn06p
p-001-001-007	1-011-7	01063-aa	No	dstn07p
p-001-002-000	1-012-0	s-01064-aa	No	dstn08p
p-001-002-001	s-1-012-1	01065-aa	No	dstn09p
p-001-002-002	s-1-012-2	s-01066-aa	No	dstn10p
p-001-002-003	1-012-3	001-012-003	No	dstn11p
p-001-002-004	s-1-012-4	001-012-004	No	dstn12p

DPCI	ALIASA	ALIASN/N24 LSN	RTX RC	CLLI APCI
p-2-010-0	-----	-----	No	dstn13p
p-2-010-1	002-100-001	-----	No	dstn14p
p-2-010-2	-----	08178-aa	No	dstn15p
p-2-010-3	-----	s-08179-aa	No	dstn16p
p-2-010-4	-----	002-100-004	No	dstn17p
p-2-010-5	002-100-005	08181-aa	No	dstn18p
p-2-010-6	002-100-006	s-08182-aa	No	dstn19p
p-2-010-7	002-100-007	002-100-007	No	dstn20p

DPCI	ALIASI	ALIASN/N24 LSN	RTX RC	CLLI APCI
p-3-030-0	s-3-031-0	-----	No	dstn29p
p-3-030-1	s-3-031-1	07385-aa	No	dstn30p
p-3-030-2	s-3-031-2	s-07386-aa	No	dstn31p
p-3-030-3	s-3-031-3	003-031-003	No	dstn32p

DPCI	ALIASN	ALIASN LSN	RTX RC	CLLI APCI
p-3-030-4	s-07388-aa	07388-aa	No	dstn33p
p-3-030-5	07389-aa	s-07389-aa	No	dstn34p

DPCN	ALIASA	ALIASI LSN	RTX RC	CLLI APCN
p-08192-aa	-----	-----	No	dstn41p
p-08193-aa	004-200-001	-----	No	dstn42p
p-08194-aa	-----	4-040-2	No	dstn43p
p-08195-aa	-----	s-4-040-3	No	dstn44p
p-08196-aa	004-200-004	4-040-4	No	dstn45p
p-08197-aa	004-200-005	s-4-040-5	No	dstn46p

```

DPCN          ALIASI          ALIASI          RTX  CLLI
              ALIASI          LSN            RC    APCN
p-08198-aa    s-4-040-6          4-040-6        No   dstn47p
p-08199-aa    4-040-7            s-4-040-7      No   dstn48p

DPCN          ALIASN          ALIASI          RTX  CLLI
              ALIASN          LSN            RC    APCN
p-12688-aa    s-13688-aa         -----        No   dstn57p
p-12689-aa    s-13689-aa         6-060-1        No   dstn58p
p-12690-aa    s-13690-aa         s-6-060-2      No   dstn59p

DPCN24        ALIASA          ALIASI          RTX  CLLI
              ALIASA          LSN            RC    APCN24
p-006-005-001 -----          -----        No   dstn63p
p-006-005-002 006-005-020 -----        No   dstn64p
p-006-005-003 -----          6-050-3        No   dstn65p
p-006-005-004 -----          s-6-050-4      No   dstn66p
p-006-005-005 006-005-050 6-050-5        No   dstn67p

```

;

This example displays point codes that have the spare point code subtype prefix (s-):

```
rtrv-rte:pcst=s
```

```

eagle10115 10-10-09 10:00:37 EST EAGLE 43.0.0
rtrv-rte:pcst=s
Command entered at terminal #4.
Extended Processing Time may be Required

```

```

DPCI          ALIASA          ALIASN/N24      RTX  CLLI
              ALIASA          LSN            RC    APCI
s-4-002-0     010-001-001    s-08228-aa     No   -----
s-2-020-0     -----          -----        No   dstn21
              -----          lsn21          10   s-2-020-0
s-2-020-1     002-020-001    -----        No   dstn22
              -----          lsn22          10   s-2-020-1
s-2-020-2     -----          04258-aa      No   dstn23
              -----          lsn23          10   s-2-020-2
s-2-020-3     -----          s-04259-aa    No   dstn24
              -----          lsn24          10   s-2-020-3
s-2-070-3     -----          -----        No   tgtitui003
              -----          lsn21          10   s-2-020-0
              -----          lsn22          20   s-2-020-1
              -----          lsn23          30   s-2-020-2
              -----          lsn24          40   s-2-020-3
s-2-020-4     -----          002-020-004   No   dstn25
              -----          lsn25          10   s-2-020-4
s-2-020-5     002-020-005    04261-aa      No   dstn26
              -----          lsn26          10   s-2-020-5
s-2-020-6     002-020-006    s-04262-aa    No   dstn27
              -----          lsn27          10   s-2-020-6
s-2-020-7     002-020-007    002-020-007   No   dstn28
              -----          lsn28          10   s-2-020-7

```

s-2-070-4	-----	-----	No	tgtitui004
		lsn25	10	s-2-020-4
		lsn26	20	s-2-020-5
		lsn27	30	s-2-020-6
		lsn28	40	s-2-020-7
s-3-070-3	-----	-----	No	tgtitui007
		lsn35	10	s-3-040-2
		lsn36	20	s-3-040-3
		lsn37	30	s-3-040-4
s-3-070-4	-----	-----	No	tgtitui008
		lsn38	10	s-3-040-5
		lsn39	20	s-3-040-6
		lsn40	30	s-3-040-7
s-2-029-6 rtxroute002	002-029-006	s-04269-aa	Yes	
		lsn26	5	s-2-020-5
DPCI	ALIASI	ALIASN/N24 LSN	RTX RC	CLLI APCI
s-3-040-2	3-040-2	-----	No	dstn35
		lsn35	10	s-3-040-2
s-3-040-3	3-040-3	06467-aa	No	dstn36
		lsn36	10	s-3-040-3
s-3-040-4	3-040-4	s-06468-aa	No	dstn37
		lsn37	10	s-3-040-4
s-3-040-5	3-040-5	003-040-005	No	dstn38
		lsn38	10	s-3-040-5
DPCI	ALIASN	ALIASN LSN	RTX RC	CLLI APCI
s-3-040-6	s-06471-aa	06471-aa	No	dstn39
		lsn39	10	s-3-040-6
s-3-040-7	06472-aa	s-06472-aa	No	dstn40
		lsn40	10	s-3-040-7
DPCN	ALIASA	ALIASI LSN	RTX RC	CLLI APCN
s-08272-aa	-----	-----	No	dstn49
		lsn49	10	s-08272-aa
s-08273-aa	004-010-001	-----	No	dstn50
		lsn50	10	s-08273-aa
s-08274-aa	-----	4-010-2	No	dstn51
		lsn51	10	s-08274-aa
s-08275-aa	-----	s-4-010-3	No	dstn52
		lsn52	10	s-08275-aa
s-08755-aa	-----	-----	No	tgtitun003
		lsn49	10	s-08272-aa
		lsn50	20	s-08273-aa
		lsn51	30	s-08274-aa
		lsn52	30	s-08275-aa
s-08276-aa	004-010-004	4-010-4	No	dstn53
		lsn53	10	s-08276-aa
s-08277-aa	004-010-005	s-4-010-5	No	dstn54
		lsn54	10	s-08277-aa
s-08756-aa	-----	-----	No	tgtitun004

```

                lsn53          10 s-08276-aa
                lsn54          20 s-08277-aa
                lsn55          30 s-08278-aa
                lsn56          30 s-08279-aa
s-08758-aa      -----
                -----      No   tgtitun006
                lsn60          10 s-12691-aa
                lsn61          20 s-12692-aa
                lsn62          30 s-12693-aa
s-08273-fr      -----
                4-006-3       No   dstn50dupfr

                DPCN          ALIASI          ALIASI          RTX   CLLI
                s-08278-aa    s-4-010-6    4-010-6         RC    APCN
                lsn55          10 s-08278-aa
s-08279-aa      4-010-7    s-4-010-7       No   dstn56
                lsn56          10 s-08279-aa
s-08379-aa      s-4-058-7    4-058-7         Yes  rtxroute003
                lsn55          80 s-08278-aa

                DPCN          ALIASN          ALIASI          RTX   CLLI
                s-12691-aa    12691-aa     -----
                lsn60          10 s-12691-aa
s-12692-aa      12692-aa     6-050-4         No   dstn61
                lsn61          10 s-12692-aa
s-12693-aa      12693-aa     s-6-050-5       No   dstn62
                lsn62          10 s-12693-aa
s-08272-fr      08300-fr     -----
s-08272-tk      08300-tk     4-006-7         No   dstn49dupfr
                ;

```

This example displays point codes that have the private and spare point code subtype prefix (ps-):

```
rtrv-rte:pcst=ps
```

```

eagle10115 10-10-09 10:00:37 EST EAGLE 43.0.0
rtrv-rte:pcst=ps
Command entered at terminal #4.
Extended Processing Time may be Required

```

```

                DPCI          ALIASA          ALIASN/N24      RTX   CLLI
                ps-2-020-0    -----
                ps-2-020-1    002-200-001    -----      No   dstn21p
                ps-2-020-2    -----          08258-aa      No   dstn22p
                ps-2-020-3    -----          s-08259-aa    No   dstn23p
                ps-2-020-4    -----          002-200-004   No   dstn24p
                ps-2-020-5    -----
                ps-2-020-6    002-200-005    08261-aa      No   dstn25p
                ps-2-020-7    002-200-007    002-200-007   No   dstn26p
                DPCI          ALIASI          ALIASN/N24      RTX   CLLI
                ps-2-020-0    -----
                ps-2-020-1    002-200-001    -----      No   dstn27p
                ps-2-020-2    -----          08258-aa      No   dstn28p
                ps-2-020-3    -----          s-08259-aa    No
                ps-2-020-4    -----          002-200-004   No
                ps-2-020-5    -----
                ps-2-020-6    002-200-005    08261-aa      No
                ps-2-020-7    002-200-007    002-200-007   No

```

```

ps-3-040-2      3-041-2      -----      No      dstn35p
ps-3-040-3      3-041-3      07467-aa     No      dstn36p
ps-3-040-4      3-041-4      s-07468-aa   No      dstn37p
ps-3-040-5      3-041-5      003-041-005 No      dstn38p

      DPCI      ALIASN      ALIASN      RTX      CLLI
      LSN      LSN      RC      APCI
ps-3-040-6      s-07471-aa   07471-aa     No      dstn39p
ps-3-040-7      07472-aa     s-07472-aa   No      dstn40p

      DPCN      ALIASA      ALIASI      RTX      CLLI
      LSN      LSN      RC      APCN
ps-08272-aa     -----      -----      No      dstn49p
ps-08273-aa     004-200-010 -----      No      dstn50p
ps-08274-aa     -----      4-050-2      No      dstn51p
ps-08275-aa     -----      s-4-050-3    No      dstn52p
ps-08276-aa     004-200-040 4-050-4      No      dstn53p
ps-08277-aa     004-200-050 s-4-050-5    No      dstn54p

      DPCN      ALIASI      ALIASI      RTX      CLLI
      LSN      LSN      RC      APCN
ps-08278-aa     s-4-050-6   4-050-6      No      dstn55p
ps-08279-aa     4-050-7     s-4-050-7    No      dstn56p

      DPCN      ALIASN      ALIASI      RTX      CLLI
      LSN      LSN      RC      APCN
ps-12691-aa     13691-aa    -----      No      dstn60p
ps-12692-aa     13692-aa    6-060-4      No      dstn61p
ps-12693-aa     13693-aa    s-6-060-5    No      dstn62p

```

;

rtrv-rte:dpc=40-1-\*\*\*

```

eagle10115 10-10-09 10:00:37 EST EAGLE 43.0.0
rtrv-rte:dpc=40-1-***
Command entered at terminal #4.
Extended Processing Time may be Required

```

```

      DPCA      ALIASI      ALIASN/N24      RTX      CLLI
      LSN      LSN      RC      APCA
      040-001-* ----- -----      No      myncaibeno
      lsn01      10
001-001-001
      040-001-001 ----- -----      No
noncluster1
      lsn01      10
001-001-001
      040-001-002 ----- -----      No
noncluster2
      lsn01      10
001-001-001

```

;

rtrv-rte:dpc=40-\*\*\*-\*:lsn=lsn01

eagle10115 10-10-09 10:00:37 EST EAGLE 43.0.0  
 rtrv-rte:dpc=40-\*\*\*-\*:lsn=lsn01  
 Command entered at terminal #4.  
 Extended Processing Time may be Required

LSN	DPCA	RC
lsn01	040-001-*	10
	040-001-001	10
	040-001-002	10

;

rtrv-rte:dpcn=8199-\*

eagle10115 10-10-09 10:00:37 EST EAGLE 43.0.0  
 rtrv-rte:dpcn=8199-  
 Command entered at terminal #4.  
 Extended Processing Time may be Required

DPCN	ALIASA	ALIASI LSN	RTX RC	CLLI APCN
08199-fr	-----	s-4-006-1	No	dstn48dupfr
08199-tk	-----	4-006-2	No	dstn48duptk

DPCN	ALIASI	ALIASI LSN	RTX RC	CLLI APCN
08199-aa	4-000-7	s-4-000-7 lsn48	No 10	dstn48 08199-aa

;

rtrv-rte:dpcn=8199-\*:lsn=lsn48

eagle10115 08-12-09 10:00:37 EST EAGLE 40.1.0

LSN	DPCN	RC
lsn48	08199-aa	10

;

rtrv-rte:dpcn=p-\*aa

eagle10115 10-10-09 10:00:37 EST EAGLE 43.0.0

```
rtrv-rte:dpcn=p-*-aa
Command entered at terminal #4.
Extended Processing Time may be Required
```

DPCN	ALIASA	ALIASI LSN	RTX RC	CLLI APCN
p-08192-aa	-----	-----	No	dstn41p
p-08193-aa	004-200-001	-----	No	dstn42p
p-08194-aa	-----	4-040-2	No	dstn43p
p-08195-aa	-----	s-4-040-3	No	dstn44p
p-08196-aa	004-200-004	4-040-4	No	dstn45p
p-08197-aa	004-200-005	s-4-040-5	No	dstn46p

DPCN	ALIASI	ALIASI LSN	RTX RC	CLLI APCN
p-08198-aa	s-4-040-6	4-040-6	No	dstn47p
p-08199-aa	4-040-7	s-4-040-7	No	dstn48p

DPCN	ALIASN	ALIASI LSN	RTX RC	CLLI APCN
p-12688-aa	s-13688-aa	-----	No	dstn57p
p-12689-aa	s-13689-aa	6-060-1	No	dstn58p
p-12690-aa	s-13690-aa	s-6-060-2	No	dstn59p

```
;
```

```
rtrv-rte:dpcn=s-9000-*
```

```
eagle10115 10-10-09 10:00:37 EST EAGLE 43.0.0
rtrv-rte:dpcn=s-9000-*
Command entered at terminal #4.
Extended Processing Time may be Required
```

DPCN	ALIASA	ALIASI LSN	RTX RC	CLLI APCN
09000-fr	-----	s-4-007-1	No	dstn9xfr
09000-tk	-----	4-007-2	No	dstn9xtk

DPCN	ALIASI	ALIASI LSN	RTX RC	CLLI APCN
09000-aa	4-001-7	s-4-000-7 lsn9x	No 10	dstn9x 09000-aa

```
;
```

This example displays output when the *full* mode is requested. This example displays abbreviated output.

```
rtrv-rte:mode=full
```

```
eagle10115 10-10-29 10:00:37 EST EAGLE 43.0.0
rtrv-rte:mode=full
```

Command entered at terminal #4.  
Extended Processing Time may be Required

DPCA	ALIASI	ALIASN/N24 LSN	RTX	CLLI
001-001-000	-----	-----	No	stp1
		e2e1	10	001-001-000
003-001-000	-----	-----	No	mstp
		e2e3	10	003-001-000
004-001-000	-----	-----	No	stp4
		e2e4	10	004-001-000
007-001-000	-----	-----	No	stp7
		e2e7	10	007-001-000
002-101-001	-----	-----	No	ssp201
		e2m1s1	10	002-101-001
		e2e3	20	003-001-000
.				
.				
.				
200-200-*	-----	-----	No	cluster2
005-006-001	-----	005-006-001	No	-----
001-001-001	-----	-----	No	dstn01
		lsn01	10	001-001-001
p-001-001-001	-----	-----	No	dstn01p
001-001-002	1-001-2	-----	No	dstn02
		lsn02	10	001-001-002
p-001-001-002	1-011-2	-----	No	dstn02p
001-001-003	s-1-001-3	-----	No	dstn03
		lsn03	10	001-001-003
p-001-001-003	s-1-011-3	-----	No	dstn03p
001-001-004	-----	02060-aa	No	dstn04
		lsn04	10	001-001-004
p-001-001-004	-----	01060-aa	No	dstn04p
001-070-001	-----	-----	No	tgtansi001
		lsn01	10	001-001-001
		lsn02	20	001-001-002
		lsn03	30	001-001-003
		lsn04	40	001-001-004
001-001-005	-----	s-02061-aa	No	dstn05
		lsn05	10	001-001-005
p-001-001-005	-----	s-01061-aa	No	dstn05p
001-001-006	-----	001-001-006	No	dstn06
		lsn06	10	001-001-006
.				
.				
.				
200-002-001	-----	-----	Yes	rtxroute001
		lsn12	10	001-002-004
	OPCA			
	001-001-001	lsn11	15	001-002-003
	001-002-001	lsn10	99	001-002-002
	CIC - ECIC			
	0 9	lsn10	1	001-002-002
	10 16383	lsn10	2	001-002-002
	SI			



001-002-004	3	lsn12	1	
001-002-004	9	lsn12	21	
001-002-004	11	lsn12	9	
.				
.				
.				
DPCI	ALIASA	ALIASN/N24	RTX	CLLI
s-4-002-0	010-001-001	LSN s-08228-aa	RC	APCI
-----				
2-010-0	-----	-----	No	dstn13
		lsn13	10	2-010-0
p-2-010-0	-----	-----	No	dstn13p
2-010-1	002-010-001	-----	No	dstn14
		lsn14	10	2-010-1
p-2-010-1	002-100-001	-----	No	dstn14p
2-010-2	-----	04178-aa	No	dstn15
		lsn15	10	2-010-2
p-2-010-2	-----	08178-aa	No	dstn15p
2-010-3	-----	s-04179-aa	No	dstn16
		lsn16	10	2-010-3
p-2-010-3	-----	s-08179-aa	No	dstn16p
2-070-1	-----	-----	No	tgtitui001
		lsn13	10	2-010-0
		lsn14	20	2-010-1
		lsn15	30	2-010-2
		lsn16	40	2-010-3
2-010-4	-----	002-010-004	No	dstn17
		lsn17	10	2-010-4
.				
.				
.				
s-2-020-0	-----	-----	No	dstn21
		lsn21	10	s-2-020-0
ps-2-020-0	-----	-----	No	dstn21p
s-2-020-1	002-020-001	-----	No	dstn22
		lsn22	10	s-2-020-1
ps-2-020-1	002-200-001	-----	No	dstn22p
s-2-020-2	-----	04258-aa	No	dstn23
		lsn23	10	s-2-020-2
ps-2-020-2	-----	08258-aa	No	dstn23p
s-2-020-3	-----	s-04259-aa	No	dstn24
		lsn24	10	s-2-020-3
ps-2-020-3	-----	s-08259-aa	No	dstn24p
s-2-070-3	-----	-----	No	tgtitui003
		lsn21	10	s-2-020-0
		lsn22	20	s-2-020-1
		lsn23	30	s-2-020-2
		lsn24	40	s-2-020-3
.				
.				

s-2-029-6	002-029-006	s-04269-aa lsn26	Yes 5	rtxroute002 s-2-020-5
	OPCI			
	3-030-0	lsn27	28	s-2-020-6
	CIC - ECIC			
	34 44	lsn27	6	s-2-020-6
	45 55	lsn27	16	s-2-020-6
	SI			
	3	lsn27	7	s-2-020-6
	15	lsn27	14	s-2-020-6
DPCI	ALIASI	ALIASN/N24 LSN	RTX RC	CLLI APCI
3-030-0	s-3-030-0	----- lsn29	No 10	dstn29 3-030-0
p-3-030-0	s-3-031-0	-----	No	dstn29p
3-030-1	s-3-030-1	06385-aa lsn30	No 10	dstn30 3-030-1
p-3-030-1	s-3-031-1	07385-aa	No	dstn30p
3-030-2	s-3-030-2	s-06386-aa lsn31	No 10	dstn31 3-030-2
p-3-030-2	s-3-031-2	s-07386-aa	No	dstn31p
3-070-1	s-3-070-1	----- lsn29	No 10	tgtitui005 3-030-0
		lsn30	20	3-030-1
		lsn31	30	3-030-2
3-030-3	s-3-030-3	003-030-003 lsn32	No 10	dstn32 3-030-3
p-3-030-3	s-3-031-3	003-031-003	No	dstn32p
3-070-2	s-3-070-2	----- lsn32	No 10	tgtitui006 3-030-3
		lsn33	20	3-030-4
		lsn34	30	3-030-5
s-3-040-2	3-040-2	----- lsn35	No 10	dstn35 s-3-040-2
ps-3-040-2	3-041-2	-----	No	dstn35p
s-3-040-3	3-040-3	06467-aa lsn36	No 10	dstn36 s-3-040-3
ps-3-040-3	3-041-3	07467-aa	No	dstn36p
s-3-040-4	3-040-4	s-06468-aa lsn37	No 10	dstn37 s-3-040-4
ps-3-040-4	3-041-4	s-07468-aa	No	dstn37p
s-3-040-5	3-040-5	003-040-005 lsn38	No 10	dstn38 s-3-040-5
ps-3-040-5	3-041-5	003-041-005	No	dstn38p
DPCI	ALIASN	ALIASN LSN	RTX RC	CLLI APCI
3-030-4	s-06388-aa	06388-aa lsn33	No 10	dstn33 3-030-4
p-3-030-4	s-07388-aa	07388-aa	No	dstn33p
3-030-5	06389-aa	s-06389-aa lsn34	No 10	dstn34 3-030-5
p-3-030-5	07389-aa	s-07389-aa	No	dstn34p

s-3-040-6	s-06471-aa	06471-aa	No	dstn39
		lsn39	10	s-3-040-6
ps-3-040-6	s-07471-aa	07471-aa	No	dstn39p
s-3-040-7	06472-aa	s-06472-aa	No	dstn40
		lsn40	10	s-3-040-7
ps-3-040-7	07472-aa	s-07472-aa	No	dstn40p
DPCN	ALIASA	ALIASI	RTX	CLLI
		LSN	RC	APCN
06157-aa	020-005-002	-----	No	
-----				
08192-aa	-----	-----	No	dstn41
		lsn41	10	08192-aa
p-08192-aa	-----	-----	No	dstn41p
08193-aa	004-000-001	-----	No	dstn42
		lsn42	10	08193-aa
p-08193-aa	004-200-001	-----	No	dstn42p
08194-aa	-----	4-000-2	No	dstn43
		lsn43	10	08194-aa
p-08194-aa	-----	4-040-2	No	dstn43p
08195-aa	-----	s-4-000-3	No	dstn44
		lsn44	10	08195-aa
p-08195-aa	-----	s-4-040-3	No	dstn44p
08753-aa	-----	-----	No	tgtitun001
		lsn41	10	08192-aa
		lsn42	20	08193-aa
		lsn43	30	08194-aa
		lsn44	30	08195-aa
08196-aa	004-000-004	4-000-4	No	dstn45
		lsn45	10	08196-aa
p-08196-aa	004-200-004	4-040-4	No	dstn45p
08197-aa	004-000-005	s-4-000-5	No	dstn46
		lsn46	10	08197-aa
p-08197-aa	004-200-005	s-4-040-5	No	dstn46p
08754-aa	-----	-----	No	tgtitun002
		lsn45	10	08196-aa
		lsn46	20	08197-aa
		lsn47	30	08198-aa
		lsn48	30	08199-aa
s-08272-aa	-----	-----	No	dstn49
		lsn49	10	s-08272-aa
ps-08272-aa	-----	-----	No	dstn49p
s-08273-aa	004-010-001	-----	No	dstn50
		lsn50	10	s-08273-aa
ps-08273-aa	004-200-010	-----	No	dstn50p
s-08274-aa	-----	4-010-2	No	dstn51
		lsn51	10	s-08274-aa
ps-08274-aa	-----	4-050-2	No	dstn51p
s-08275-aa	-----	s-4-010-3	No	dstn52
		lsn52	10	s-08275-aa
ps-08275-aa	-----	s-4-050-3	No	dstn52p
s-08755-aa	-----	-----	No	tgtitun003
		lsn49	10	s-08272-aa
		lsn50	20	s-08273-aa
		lsn51	30	s-08274-aa

```

lsn52          30 s-08275-aa
.
.
.
DPCN          ALIASI          ALIASI          RTX  CLI
              LSN
08198-aa      s-4-000-6          4-000-6          No  dstn47
              lsn47
p-08198-aa    s-4-040-6          4-040-6          No  dstn47p
08199-aa      4-000-7          s-4-000-7          No  dstn48
              lsn48
p-08199-aa    4-040-7          s-4-040-7          No  dstn48p
s-08278-aa    s-4-010-6          4-010-6          No  dstn55
              lsn55
ps-08278-aa   s-4-050-6          4-050-6          No  dstn55p
s-08279-aa    4-010-7          s-4-010-7          No  dstn56
              lsn56
ps-08279-aa   4-050-7          s-4-050-7          No  dstn56p
s-08379-aa    s-4-058-7          4-058-7          Yes rtxroute003
              lsn55
              80 s-08278-aa
              OPCN
              s-08278-aa          lsn62          8  s-12693-aa
              CIC - ECIC
              99  100          lsn62          9  s-12693-aa
              999  1989          lsn62          99 s-12693-aa
              SI
              4          lsn56          29 s-08279-aa
              14          lsn56          44 s-08279-aa
08198-fr      s-4-005-7          4-005-7          No  dstn47dupfr
08198-tk      4-006-0          s-4-006-0          No  dstn47dupTk
DPCN          ALIASN          ALIASI          RTX  CLI
              LSN
12688-aa      s-12688-aa          -----          No  dstn57
              lsn57
p-12688-aa    s-13688-aa          -----          No  dstn57p
.
.
.
DPCN24        ALIASA          ALIASI          RTX  CLI
              LSN
003-003-004   003-003-003          3-003-4          No  -----
006-005-001   -----          -----          No  dstn63
              lsn63
p-006-005-001 -----          -----          No  006-005-001
              dstn63p
.
.
.
;
```

This example contains a route with 16-bit ITU-N point codes:

```

rtrv-rte:lsn=lsn66

tekelecstp 10-10-09 10:00:37 EST EAGLE 45.1.0
rtrv-rte:lsn=lsn66
Command entered at terminal #4.
Extended Processing Time may be Required

LSN          DPCN16      RC
lsn66        006-005-004 10
              006-004-002 10

;

```

### Legend

- **DPC, DPCA, DPCI, DPCN, DPCN24, DPCN16**—Destination point code to be reached through this route
- **ALIAS, ALIASA, ALIASI, ALIASN/N24, ALIASN16**—Alias associated with the route
- **CLLI**—CLLI associated with the route
- **LSN**—Name of the linkset assigned to this route
- **RC**—Relative cost (priority) assigned to the route
- **APC, APCA, APCI, APCN, APCN24, APCN16**—Point code of the STP or SSP that is directly adjacent to the linkset. The point code may or may not be the same as the destination point code assigned to this route.

### Related Topics

- [chg-dstn](#)
- [chg-rte](#)
- [dlt-dstn](#)
- [dlt-rte](#)
- [ent-dstn](#)
- [ent-rte](#)
- [rept-stat-dstn](#)
- [rept-stat-rte](#)
- [rtrv-dstn](#)

## rtrv-rtx

Use this command to retrieve one or more exception route entries. Because all parameters are optional, the retrieve examines the entire Route table to find all entries that match the specified parameters. Entries with CIC-ECIC range values that fall in the range specified by the `cic` and `ecic` parameters are displayed.

## Parameters

### **cic (optional)**

Starting Circuit Identification Code. This parameter is used alone or together with the `ecic` parameter as exception routing criteria for the specified exception route.

**Range:**

0 - 16383

### **class (optional)**

Exception routing class. This parameter displays all exception route sets provisioned for the specified class.

**Range:**

*opc*

*ilsn*

*cic*

*si*

### **dpc (optional)**

ANSI destination point code with subfields *network indicator-network cluster-network cluster member (ni-nc-ncm)*. The *prefix* subfield indicates a private point code (*prefix-ni-nc-ncm*).

**Synonym:**

*dpca*

**Range:**

*p-*, 000-255, \*, \*\*, \*\*\*

Specify a valid value for each subfield of the point code, and separate the subfields with a dash (-).

*prefix—p-*

The asterisk values \*, \*\*, and \*\*\* are not valid for the *ni* subfield.

If \*\* or \*\*\* is specified for the *nc* subfield, either \*, \*\*, or \*\*\* must be specified for the *ncm* subfield.

When `chg-sid:pctype=ansi` is specified, *ni=000* is not valid.

When `chg-sid:pctype=ansi` is specified, *nc=000* is not valid if *ni=001-005*.

When `chg-sid:pctype=ansi` is specified, *nc=000* is valid if *ni=006-255*.

When `chg-sid:pctype=ansi` is specified, *ni-\*-\** is valid if *ni= 006-255*.

The point code 000-000-000 is not a valid point code.

### **dpci (optional)**

Destination Point Code. ITU international point code with subfields *zone-area-id*. The *prefix* subfield indicates a spare point code, private point code, or private and spare point code (*prefix-zone-area-id*).

**Range:**

*s-*, *p-*, *ps-*, 0-255

Specify a valid value for each subfield of the point code, and separate the subfields with a dash (-).

*prefix—s-*, *p-*, *ps*

zone—0-7  
 area—000-255  
 id—0-7

The point code 0-000-0 is not a valid point code.

#### **dpcn (optional)**

ITU national point code in the format of a 5-digit number (*nnnnn*); or 2, 3, or 4 numbers (members) separated by dashes (*m1-m2-m3-m4*) as defined by the `chg-stpopts:npcfmti` flexible point code option. A group code must be specified when the ITUDUPPC feature is turned on (*nnnnn-gc*, *m1-m2-m3-m4-gc*). The *prefix* subfield indicates a spare point code, private point code, or private and spare point code (*prefix-nnnnn*, *prefix-nnnnn-gc*, *prefix-m1-m2-m3-m4*, *prefix-m1-m2-m3-m4-gc*).

#### **Range:**

*s-*, *p-*, *ps*, 0-16383, *aa-zz*, \*

Specify a valid value for each subfield of the point code, and separate the subfields with a dash (-).

An asterisk (\*) can be specified for the node (*nnnnn* or every member of a flexible point code) or for the group code (*gc*) only when group codes are present in the point codes.

An asterisk (\*) can be specified either for the node or for the group code, but not both.

*prefix*—*s-*, *p-*, *ps-*

*nnnnn*—0-16383, \*

*gc*—*aa-zz*, \*

*m1-m2-m3-m4*—0-14 for each member; values must sum to 14; or *\*-\*-\** when the point code includes a group code.

#### **dpcn24 (optional)**

24-bit ITU national point code with subfields *main signaling area-sub signaling area-signaling point* (*msa-ssa-sp*). The *prefix* subfield indicates a private point code (*prefix-msa-ssa-sp*).

#### **Range:**

*p-*, 000-255

Specify a valid value for each subfield of the point code, and separate the subfields with a dash (-).

*prefix*—*p*

*msa*—000-255

*ssa*—000-255

*sp*—000-255

#### **dpcn16 (optional)**

16-bit ITU national point code with subfields *unit number-sub number area-main number area* (*un-sna-mna*). The *prefix* subfield indicates a private point code (*prefix-un-sna-mna*).

#### **Range:**

*p--*, 000---127

Specify a valid value for each subfield of the point code, and separate the subfields with a dash (-).

*prefix---**p*

*un---000---127*

*sna---000---15*

*mna---000---31*

**ecic (optional)**

Ending Circuit Identification Code. This parameter, together with the `cic` parameter, defines the CIC range that is used as exception routing criteria for the specified exception route.

**Range:**

*0 - 16383*

**ilsn (optional)**

Incoming Link Set Name. The parameter value is used as part of the exception routing criteria for the specified exception route.

**Range:**

*aaaaaaaa*

1 alphabetic character followed by up to 9 alphanumeric characters.

**lsn (optional)**

Link Set Name. The linkset associated with the specified exception route.

**Range:**

*aaaaaaaa*

1 alphabetic character followed by up to 9 alphanumeric characters.

**opc (optional)**

ANSI origination point code with subfields *network indicator-network cluster-network cluster member* (*ni-nc-ncm*). The *prefix* subfield indicates a private point code (*prefix-ni-nc-ncm*).

**Range:**

*p-, 000-255, \*, \*\*, \*\*\**

Specify a valid value for each subfield of the point code, and separate the subfields with a dash (-).

*prefix—p-*

The asterisk values *\**, *\*\**, and *\*\*\** are not valid for the *ni* subfield.

If *\*\** or *\*\*\** is specified for the *nc* subfield, either *\**, *\*\**, or *\*\*\** must be specified for the *ncm* subfield.

When `chg-sid:pctype=ansi` is specified, *ni=000* is not valid.

When `chg-sid:pctype=ansi` is specified, *nc=000* is not valid if *ni=001-005*.

When `chg-sid:pctype=ansi` is specified, *nc=000* is valid if *ni=006-255*.

When `chg-sid:pctype=ansi` is specified, *ni-\*-\** is valid if *ni= 006-255*.

The point code *000-000-000* is not a valid point code.

**opci (optional)**

ITU international point code with subfields *zone-area-id*. The *prefix* subfield indicates a spare point code, private point code, or private and spare point code (*prefix-zone-area-id*).

**Range:**

*s-, p-, ps-, 0-255*

Specify a valid value for each subfield of the point code, and separate the subfields with a dash (-).



*prefix*—*s*-, *p*-, *ps*  
*zone*—0-7  
*area*—000-255  
*id*—0-7

The point code 0-000-0 is not a valid point code.

#### **opc<sub>n</sub>** (optional)

ITU national point code in the format of a 5-digit number (*nnnnn*); or 2, 3, or 4 numbers (members) separated by dashes (*m1-m2-m3-m4*) as defined by the `chg-stpopts:npcfmti` flexible point code option. A group code must be specified when the ITUDUPPC feature is turned on (*nnnnn-gc*, *m1-m2-m3-m4-gc*). The *prefix* subfield indicates a spare point code, private point code, or private and spare point code (*prefix-nnnnn*, *prefix-nnnnn-gc*, *prefix-m1-m2-m3-m4*, *prefix-m1-m2-m3-m4-gc*).

#### **Range:**

*s*-, *p*-, *ps*, 0-16383, *aa-zz*, \*

Specify a valid value for each subfield of the point code, and separate the subfields with a dash (-).

An asterisk (\*) can be specified for the node (*nnnnn* or every member of a flexible point code) or for the group code (*gc*) only when group codes are present in the point codes.

An asterisk (\*) can be specified either for the node or for the group code, but not both.

*prefix*—*s*-, *p*-, *ps*-  
*nnnnn*—0-16383, \*  
*gc*—*aa-zz*, \*

*m1-m2-m3-m4*—0-14 for each member; values must sum to 14; or *\*-\*-\** when the point code includes a group code.

#### **opc<sub>n24</sub>** (optional)

24-bit ITU national point code with subfields *main signaling area-sub signaling area-signaling point* (*msa-ssa-sp*). The *prefix* subfield indicates a private point code (*prefix-msa-ssa-sp*).

#### **Range:**

*p*-, 000-255

Specify a valid value for each subfield of the point code, and separate the subfields with a dash (-).

*prefix*—*p*  
*msa*—000-255  
*ssa*—000-255  
*sp*—000-255

#### **opc<sub>n16</sub>** (optional)

16-bit ITU national point code with subfields *unit number-sub number area-main number area* (*un-sna-mna*). The *prefix* subfield indicates a private point code (*prefix-un-sna-mna*).

#### **Range:**

*p*--, 000---127

Specify a valid value for each subfield of the point code, and separate the subfields with a dash (-).

*prefix---p*

*un---000---127*

*sna---000---15*

*mna---000---31*

**si (optional)**

Service Indicator. This parameter is used as part of the exception routing criteria for the specified exception route.

**Range:**

3 - 15

**Example**

```
rtrv-rtx:dpc=1-1-1
```

```
rtrv-rtx:opca=6-**-*
```

```
rtrv-rtx:ilsn=1set4
```

```
rtrv-rtx:si=5
```

```
rtrv-rtx:cic=0:ecic=16383
```

```
rtrv-rtx:dpcn16=121-10-25
```

**Dependencies**

Only one of the `opc`, `ilsn`, `cic`, `si`, or `class` parameters can be specified.

If the `ecic` parameter is specified, the `cic` parameter must also be specified.

The `ecic` parameter value cannot be less than the `cic` parameter value.

The Origin-Based MTP Routing feature must be enabled and turned on before this command can be entered.

The linkset name, as defined by the `ilsn` or `lsn` parameter, must exist.

The Linkset table is corrupt or cannot be found.

The Route table is corrupt or cannot be found.

The Route Exception table is corrupt or cannot be found.

The value specified for the destination point code must be a full point code and not a cluster or network point code.

**Notes**

\*\* can be used in the network cluster member (*ncm*) subfield of `dpc/dpca` and `opc/opca` parameters to retrieve all point codes residing in (members of) a given network cluster (*ni-nc*).

\*\* can be used in the network cluster (*nc*) subfield of `dpc/dpca` and `opc/opca` parameters to retrieve all point codes residing in (members of) a given network (*ni*).

\*\*\* can be used in the network cluster member (*ncm*) subfield of *dpc/dpca/opc/opca* parameters to retrieve all point codes residing in (members of) a given network cluster (*ni-nc*), and the network cluster address (if any).

\*\*\* can be used in the network cluster (*nc*) subfield of *dpc/dpca* and *opc/opca* parameters to retrieve all point codes residing in (members of) a given network (*ni*), and the network address (if any).

\* is allowed only for retrieves (for example, *rtrv-rtx:dpcn=-aa* or *rtrv-rtx:opc=-xy* ) on ITU-N DPCs and ITU-N OPCs if the ITUDUPPC feature is on. \*\* and \*\*\* are not allowed for ITU-N DPCs and OPCs (for example, *dpcn=-\*-xy* is rejected). The node and group code cannot both be \* (*dpcn=-\*-\** is rejected).

## Output

This example retrieves all provisioned exception routes:

```
rtrv-rtx
```

```
eagle10115 08-12-09 10:00:37 EST EAGLE 40.1.0
```

DPCA	RTX-CRITERIA	LSN	RC	APC
200-002-001	OPCA			
001-002-003	001-001-001	lsn11	15	
001-002-002	001-002-001	lsn10	99	
	CIC - ECIC			
001-002-002	0 9	lsn10	1	
001-002-002	10 16383	lsn10	2	
	SI			
001-002-004	3	lsn12	1	
001-002-004	9	lsn12	21	
001-002-004	11	lsn12	9	
DPCI	RTX-CRITERIA	LSN	RC	APC
s-2-029-6	OPCI			
	3-030-0	lsn27	28	s-2-020-6
	CIC - ECIC			
	34 44	lsn27	6	s-2-020-6
	45 55	lsn27	16	s-2-020-6
	SI			
	3	lsn27	7	s-2-020-6
	15	lsn27	14	s-2-020-6

DPCN	RTX-CRITERIA	LSN	RC	APC
s-08379-aa	OPCN s-08278-aa	lsn62	8	s-12693-aa
	CIC - ECIC 99 100 999 1989	lsn62 lsn62	9 99	s-12693-aa s-12693-aa
	SI 4 14	lsn56 lsn56	29 44	s-08279-aa s-08279-aa
DESTINATION ENTRIES ALLOCATED:		2000		
FULL DPC(s):		188		
EXCEPTION DPC(s):		17		
NETWORK DPC(s):		2		
CLUSTER DPC(s):		4		
TOTAL DPC(s):		211		
CAPACITY (% FULL):		11%		
ALIASES ALLOCATED:		12000		
ALIASES USED:		216		
CAPACITY (% FULL):		2%		
X-LIST ENTRIES ALLOCATED:		500		

;

This example retrieves all exception routes provisioned for a specific DPC:

```
rtrv-rtx:dpcn=s-08379-aa
```

```
eagle10115 08-12-09 10:00:37 EST EAGLE 40.1.0
```

DPCN	RTX-CRITERIA	LSN	RC	APC
s-08379-aa	OPCN s-08278-aa	lsn62	8	s-12693-aa
	CIC - ECIC 99 100 999 1989	lsn62 lsn62	9 99	s-12693-aa s-12693-aa
	SI 4 14	lsn56 lsn56	29 44	s-08279-aa s-08279-aa
DESTINATION ENTRIES ALLOCATED:		2000		
FULL DPC(s):		188		
EXCEPTION DPC(s):		17		
NETWORK DPC(s):		2		
CLUSTER DPC(s):		4		
TOTAL DPC(s):		211		
CAPACITY (% FULL):		11%		
ALIASES ALLOCATED:		12000		
ALIASES USED:		216		

```

CAPACITY (% FULL):          2%
X-LIST ENTRIES ALLOCATED:  500

```

;

This example retrieves all provisioned exception routes for a specific exception criteria:

```
rtrv-rtx:dpcn=s-08379-aa:opcn=s-08278-aa
```

```
eagle10115 08-12-09 10:00:37 EST EAGLE 40.1.0
```

DPCN	RTX-CRITERIA	LSN	RC	APC
s-08379-aa	OPCN s-08278-aa	lsn62	8	s-12693-aa

```

DESTINATION ENTRIES ALLOCATED:  2000
FULL DPC(s) :                    188
EXCEPTION DPC(s) :                17
NETWORK DPC(s) :                   2
CLUSTER DPC(s) :                   4
TOTAL DPC(s) :                     211
CAPACITY (% FULL) :                11%
ALIASES ALLOCATED:                 12000
ALIASES USED:                       216
CAPACITY (% FULL) :                 2%
X-LIST ENTRIES ALLOCATED:          500

```

;

This example retrieves all provisioned exception routes for a specific exception criteria:

```
rtrv-rtx:dpci=s-2-029-6:cic=45:ecic=55
```

```
eagle10115 08-12-09 10:00:37 EST EAGLE 40.1.0
```

DPCI	RTX-CRITERIA	LSN	RC	APC
s-2-029-6	CIC - ECIC 45 55	lsn27	16	s-2-020-6

```

DESTINATION ENTRIES ALLOCATED:  2000
FULL DPC(s) :                    188
EXCEPTION DPC(s) :                17
NETWORK DPC(s) :                   2
CLUSTER DPC(s) :                   4
TOTAL DPC(s) :                     211
CAPACITY (% FULL) :                11%
ALIASES ALLOCATED:                 12000
ALIASES USED:                       216
CAPACITY (% FULL) :                 2%
X-LIST ENTRIES ALLOCATED:          500

```

;

This example retrieves exception routes for a specific class:

```
rtrv-rtx:opc=1-1-1
```

```
eagle10115 08-12-09 10:00:37 EST EAGLE 40.1.0

      DPCA          RTX-CRITERIA      LSN          RC      APC
      200-002-001      OPCA
                          001-001-001      lsn11        15      001-002-003

DESTINATION ENTRIES ALLOCATED:  2000
  FULL DPC(s) :                  188
  EXCEPTION DPC(s) :              17
  NETWORK DPC(s) :                 2
  CLUSTER DPC(s) :                 4
  TOTAL DPC(s) :                  211
  CAPACITY (% FULL) :             11%
ALIASES ALLOCATED:              12000
  ALIASES USED:                   216
  CAPACITY (% FULL) :              2%
X-LIST ENTRIES ALLOCATED:        500
```

;

This example retrieves exception routes for a specific linkset:

```
rtrv-rtx:lsn=lsn27
```

```
eagle10115 08-12-09 10:00:37 EST EAGLE 40.1.0

      DPCI          RTX-CRITERIA      LSN          RC      APC
      s-2-029-6      OPCI
                          3-030-0          lsn27        28      s-2-020-6

                          CIC - ECIC
                          34   44          lsn27        6      s-2-020-6
                          45   55          lsn27        16     s-2-020-6

                          SI
                          3           lsn27        7      s-2-020-6
                          15          lsn27        14     s-2-020-6

DESTINATION ENTRIES ALLOCATED:  2000
  FULL DPC(s) :                  188
  EXCEPTION DPC(s) :              17
  NETWORK DPC(s) :                 2
  CLUSTER DPC(s) :                 4
  TOTAL DPC(s) :                  211
```

```

CAPACITY (% FULL):          11%
ALIASES ALLOCATED:          12000
ALIASES USED:                216
CAPACITY (% FULL):          2%
X-LIST ENTRIES ALLOCATED:    500

```

```
;
```

This example retrieves exception routes for the network cluster members of an OPC:

```
rtrv-rtx:opc=40-**-*
```

```

eagle10115 08-12-09 10:00:37 EST EAGLE 40.1.0

DPCA          RTX-CRITERIA    LSN          RC          APC
002-002-003   OPCA
040-001-001   bd1          10
002-002-002   040-001-002  bd1          15
002-002-002   040-001-*    bd1          5
002-002-002

DESTINATION ENTRIES ALLOCATED:  2000
FULL DPC(s) :                    190
EXCEPTION DPC(s) :                21
NETWORK DPC(s) :                   2
CLUSTER DPC(s) :                   4
TOTAL DPC(s) :                    217
CAPACITY (% FULL) :                11%
ALIASES ALLOCATED:                12000
ALIASES USED:                      216
CAPACITY (% FULL) :                 2%
X-LIST ENTRIES ALLOCATED:          500

```

```
;
```

This example retrieves exception routes for all cluster member plus itself of an OPC:

```
rtrv-rtx:opc=40-***-*
```

```

eagle10115 08-12-09 10:00:37 EST EAGLE 40.1.0

DPCA          RTX-CRITERIA    LSN          RC          APC
002-002-003   OPCA
040-001-001   bd1          10
002-002-002   040-001-002  bd1          15
002-002-002   040-**-*     bd1          0
002-002-002

```

```

                                040-001-*          bd1          5          002-002-002

DESTINATION ENTRIES ALLOCATED:  2000
  FULL DPC(s) :                  190
  EXCEPTION DPC(s) :             21
  NETWORK DPC(s) :                2
  CLUSTER DPC(s) :               4
  TOTAL DPC(s) :                 217
  CAPACITY (% FULL) :            11%
ALIASES ALLOCATED:              12000
  ALIASES USED:                  216
  CAPACITY (% FULL) :            2%
X-LIST ENTRIES ALLOCATED:       500

```

;

This example retrieves route exceptions by criteria class:

```
rtrv-rtx:class=cic
```

```

eagle10115 08-12-09 10:00:37 EST EAGLE 40.1.0

  DPCA          RTX-CRITERIA    LSN          RC      APC
  200-002-001  CIC - ECIC
                0      9      lsn10        1      001-002-002
                10   16383  lsn10        2      001-002-002

  DPCI          RTX-CRITERIA    LSN          RC      APC
  s-2-029-6    CIC - ECIC
                34   44      lsn27        6      s-2-020-6
                45   55      lsn27       16      s-2-020-6

  DPCN          RTX-CRITERIA    LSN          RC      APC
  s-08379-aa   CIC - ECIC
                99   100    lsn62        9      s-12693-aa
                999 1989    lsn62       99      s-12693-aa

```

```

DESTINATION ENTRIES ALLOCATED:  2000
  FULL DPC(s) :                  188
  EXCEPTION DPC(s) :             17
  NETWORK DPC(s) :                2
  CLUSTER DPC(s) :               4
  TOTAL DPC(s) :                 211
  CAPACITY (% FULL) :            11%
ALIASES ALLOCATED:              12000
  ALIASES USED:                  216
  CAPACITY (% FULL) :            2%
X-LIST ENTRIES ALLOCATED:       500

```

;



This example retrieves exception routes for a specific class:

```
rtrv-rtx:opcn16=121-10-15
```

```
eagle10115 08-12-13 10:00:37 EST EAGLE 45.1.0

      DPCN16          RTX-CRITERIA      LSN          RC      APC
      200-002-001    OPCN16          121-010-015  lsn11   15
001-002-003

DESTINATION ENTRIES ALLOCATED:  2000
FULL DPC(s) :                   188
EXCEPTION DPC(s) :               17
NETWORK DPC(s) :                  2
CLUSTER DPC(s) :                  4
TOTAL DPC(s) :                   211
CAPACITY (% FULL) :              11%
ALIASES ALLOCATED:              12000
ALIASES USED:                    216
CAPACITY (% FULL) :               2%
X-LIST ENTRIES ALLOCATED:        500

;
```

### Related Topics

- [chg-rtx](#)
- [dlt-rtx](#)
- [ent-rtx](#)
- [rept-stat-rtx](#)

## rtrv-sccp-msg

Use this command to display the configured SCCP message parameter values.

### Parameters

#### **msgn (optional)**

Message number. The number of the SCCP message.

**Range:**  
1 - 10

### Example

```
rtrv-sccp-msg:msgn=1
```

### Dependencies

The TSTMSG table is corrupt or could not be found.

The GTT feature must be turned on before this command can be entered.

**Notes**

None

**Output**

rtrv-sccp-msg:msgn=1

tekelecstp 16-10-03 14:18:10 MST EAGLE 46.5.0.0.0

```
MSG = 1
ACTIVE = YES
OPC = 010-010-010
DPC = 010-010-001
SELID = 6

CDPA_GTI = 2
CDPA_TT = 0
CDPA_SSN = 6
CDPC = 010-010-010
CDPA_NP = 1 ( e164 )
CDPA_NAI = 1 ( sub )
CDPA_GTA = 1234567890
```

```
CGPA_GTI = 2
CGPA_TT = 0
CGPA_SSN = 8
CGPC = 020-020-020
CGPA_NP = 1 ( e164 )
CGPA_NAI = 1 ( sub )
CGPA_GTA = 1234567890
```

```
LSN = 1s111
EAGLEGEN = NO
```

TCAP\_FAMILY = 67

TCAP\_FAMILY2 = 44

TCAP\_FAMILY3 = 32

TCAP\_OPCODE = 32

TCAP\_OPCODE2 = 35

TCAP\_OPCODE3 = 100

TCAP\_PACKAGE = bgn (0x62)

TCAP\_ACN = 6-7-8-9-3

MAP Parameters Present in Test Message:

```
--Imsi
--Smrpoa
--Smrpda
```

```
IMSI DGTS = 12345

MSISDN NP = 1 ( e164 )
MSISDN DGTS = 1234567890

VLR NP = 15 ( unknown )
VLR DGTS = 1234567890

SMRPOA NP = 1 ( e164 )
SMRPOA DGTS = 1234567890

SMRPDA NP = 15 ( unknown )
SMRPDA DGTS = 987654321
```

;

### Related Topics

- [chg-sccp-msg](#)
- [tst-msg](#)

## rtrv-sccp-serv

Use this command to display the SCCP Service application relationship information maintained by the EAGLE.

### Parameters

#### **serv (optional)**

Name of the service to be retrieved.

#### **Range:**

##### ***gflex***

G-Flex (GSM Flexible Numbering)

##### ***gport***

G-Port (GSM Mobile Number Portability)

##### ***mnport***

Mobile Number Portability

### Dependencies

The A-Port or IGM feature must be enabled before the `serv=mnport` parameter can be specified.

The G-Flex feature must be enabled before the `serv=gflex` parameter can be specified.

The G-Port feature must be enabled before the `serv=gport` parameter can be specified.

Failed reading the MRN table.

Failed reading the SCCP Service table.

## Notes

The `rtrv-sccp-serv` command is cancelable using the **F9** key or the `canc-cmd` command. Please refer to [8] for details and an example of a command abort in KSR mode. The `canc-cmd` command and F9 are not applicable for pure SEAS commands.

In this command, only ITU-international and ITU national point codes support the spare point code subtype prefix (s-).

Point codes are grouped by service in the output.

## Output

The number of entries reported in use for the SCCPSRV table includes an entry for each point code network type. This entry is not displayed with the point code entries in the output. For example, if 3 ANSI point codes are used, the reported number of ANSI entries is 4.

This example displays output when no supporting features are turned on, and the SCCP Service table is empty:

```
rtrv-sccp-serv

tekelecstp 06-10-30 09:26:14 EST  EAGLE 36.0.0
No Entries Found.

;
```

This example displays output when the G-Port feature is turned on, and the SCCP Service table is empty:

```
rtrv-sccp-serv

tekelecstp 06-10-30 09:26:14 EST  EAGLE 36.0.0

-----
Service      : GPORT
State       : Offline
GTT Option  : Yes
-----

SCCPSRV table is (0 of 384) 0% full.

;
```

This example displays output when the G-Port and G-Flex features are turned on, and the SCCP Service table is empty:

```
rtrv-sccp-serv

tekelecstp 06-10-30 09:26:47 EST  EAGLE 36.0.0
```

```
-----  
Service      : GFLEX  
State        : Offline  
GTT Option   : Yes  
-----  
  
-----  
Service      : GPORT  
State        : Offline  
GTT Option   : Yes  
-----  
SCCPSRV table is (0 of 384) 0% full.  
;
```

This example displays output when the G-Port and G-Flex features are turned on, and the service set contains ANSI point codes:

```
rtrv-sccp-serv  
  
tekelecstp 06-10-30 09:30:02 EST EAGLE 36.0.0  
  
-----  
Service      : GFLEX  
State        : Offline  
GTT Option   : Yes  
-----  
  
-----  
Service      : GPORT  
State        : Offline  
GTT Option   : Yes  
-----  
  
ANSI PC      RC  
001-001-001 01  
001-001-002 01  
001-001-003 01  
  
SCCPSRV table is (4 of 384) 1% full.  
;
```

This example displays output when the G-Port and G-Flex services are turned on, and the service set contains ANSI and ITU-I point codes:

```
rtrv-sccp-serv  
  
tekelecstp 06-10-30 09:32:30 EST EAGLE 36.0.0  
  
-----  
Service      : GFLEX  
State        : Offline  
GTT Option   : Yes
```

```
-----  
-----  
Service      : GPORT  
State        : Offline  
GTT Option   : Yes  
-----
```

```
ANSI PC      RC  
001-001-001 01  
001-001-002 01  
001-001-003 01
```

```
ITUI PC      RC  
2-001-1      02  
2-001-2      02  
2-001-3      02
```

SCCPSRV table is (8 of 384) 2% full.

;

This example displays output when the GPORT and GFLEX services are ONLINE, and the service set contains ANSI, ITU, and ITU-N point codes:

rtrv-sccp-serv

tekelecstp 06-10-30 09:37:03 EST EAGLE 36.0.0

```
-----  
Service      : GFLEX  
State        : Online  
GTT Option   : Yes  
-----
```

```
ITUN PC      RC  
00001        02
```

```
-----  
Service      : GPORT  
State        : Online  
GTT Option   : Yes  
-----
```

```
ANSI PC      RC  
001-001-001 01  
001-001-002 01  
001-001-003 01
```

```
ITUI PC      RC  
2-001-1      02  
2-001-2      02  
2-001-3      02
```

SCCPSRV table is (10 of 384) 3% full.

;

This example displays output when the A-Port or IGM feature is enabled, and the MNP and GFLEX services are ONLINE. This example also displays spare point codes:

rtrv-sccp-serv

tekelecstp 06-10-30 09:37:03 EST EAGLE 36.0.0

```
-----  
Service      : GFLEX  
State        : Online  
GTT Option   : Yes  
-----
```

```
ITUN PC      RC  
00001       02
```

```
-----  
Service      : MNP  
State        : Online  
GTT Option   : Yes  
-----
```

```
ANSI PC      RC  
001-001-001 01  
001-001-002 01  
001-001-003 01
```

```
ITUI PC      RC  
2-001-1     02  
2-001-2     02  
2-01-3      02
```

```
ITUI SPARE   RC  
s-4-201-0   10  
s-4-201-1   10
```

```
ITUN SPARE   RC  
s-2-102-0-aa 10  
s-2-102-1-aa 10
```

SCCPSRV table is (16 of 384) 4% full.

;

### Related Topics

- [chg-sccp-serv](#)
- [dlt-sccp-serv](#)

## rtrv-sccpopts

Use this command to display the current value of one or more of the SCCP option indicators maintained in the STP options table.

### Parameters

This command has no parameters.

### Example

```
rtrv-sccpopts
```

### Dependencies

The STP Options table is corrupt or cannot be found.

The GTTSET table is corrupt or cannot be found.

None.

### Notes

None.

### Output

This example displays output when the Origin-based MTP Routing feature is turned on.

```
rtrv-sccpopts
```

```
tekelecstp 10-02-15 14:07:11 EST EAGLE 42.0.0
```

SCCP	OPTIONS
CLASS1SEQ	off
CCLLEN	1
ACLEN	3
INTLUNKNNAI	no
SUBDFRN	off
MOBRSCCPOPC	MTP
DFLTGTTMODE	CdPA

```
;
```

The example displays output when the Transaction-based GTT Loadsharing feature is enabled. `rtrv-sccpopts`

```
tekelecstp 10-02-15 14:07:11 EST EAGLE 42.0.0
```

SCCP	OPTIONS
CLASS1SEQ	on
CCLLEN	1



```

ACLEN                3
INTLUNKNNAI         no
SUBDFRN             off
TGTT0               NONE
TGTT1               NONE
TGTTUDTKEY          MTP
TGTTXUDTKEY         MTP

```

```
;
```

This example displays output when the GSM MAP Screening feature is turned on, and GSM MAP Screening is enabled for TCAP\_Continue and TCAP\_End messages.

```
rtrv-sccpopts
```

```
tekelecstp 10-02-15 14:07:11 EST EAGLE 42.0.0
```

```

SCCP                OPTIONS
-----
CLASS1SEQ           off
CCLEN               1
ACLEN               3
INTLUNKNNAI        yes
SUBDFRN            off
DFLTGTTMODE        CdPA
GMSTCAPCE          on

```

```
;
```

This example displays output when the ANSI/ITU SCCP Conversion feature is enabled. rtrv-sccpopts

```
tekelecstp 09-06-15 14:07:11 EST EAGLE 41.1.0
```

```

SCCP                OPTIONS
-----
CLASS1SEQ           on
CCLEN               1
ACLEN               3
INTLUNKNNAI        no
SUBDFRN            off
DFLTGTTMODE        CdPA
CNVAINAT            1
TGTT0               NONE
TGTT1               UDT,XUDT
TGTTUDTKEY          MTP
TGTTXUDTKEY         MTP

```

```
;
```

This example displays output when the FLOBR feature is turned on.

```
rtrv-sccpopts

tekelecstp 10-04-04 05:46:41 EST EAGLE 41.0.0

SCCP                                OPTIONS
-----
CLASS1SEQ                            off
DFLTGTTMODE    FLOBRCdPA, FLOBRCgPA
DFLTFALLBACK                            yes

;
```

```
rtrv-sccpopts

tekelecstp 10-04-06 15:11:29 EST Eagle 42.0.0

SCCP                                OPTIONS
-----
CLASS1SEQ                            off
CCLEN                                0
ACLEN                                0
INTLUNKNNAI                          no
DFLTGTTMODE                            CdPA
MTPRGTT                                off
MTPRGTTFALLBK                          mtproute
UNQGTTSEL                              bestmatch

;
```

This example displays output when the ANSI/ITU SCCP Conversion feature is turned ON.

```
rtrv-sccpopts

tekelecstp 12-05-18 14:26:24 EST EAGLE 45.0.0

SCCP                                OPTIONS
-----
CLASS1SEQ                            off
CCLEN                                0
ACLEN                                0
INTLUNKNNAI                          no
SUBDFRN                                off
DFLTGTTMODE                            CdPA
CNVAINAT                              1
MTPRGTT                                off
MTPRGTTFALLBK                          mtproute
UNQGTTSEL                              bestmatch
DELCCPREFIX                            pfxwcc
CNVCLGITU                              off

;
```

This example displays output when EPAP Data Split feature enabled.

## rtrv-sccpopts

```
tekelecstp 12-07-11 14:51:24 EST EAGLE 45.0.0
rtrv-sccpopts
Command entered at terminal #4.
```

SCCP	OPTIONS
-----	
CLASS1SEQ	off
CCLEN	0
ACLEN	0
INTLUNKNNAI	no
SUBDFRN	off
DFLTGTTMODE	CdPA
CNVAINAT	1
MOBRSCCPOPC	MTP
TGTT0	NONE
TGTT1	NONE
TGTTUDTKEY	MTP
TGTTXUDTKEY	MTP
GMSTCAPCE	off
DFLTFALLBACK	no
MTPRGTT	off
MTPRGTTFALLBK	mtproute
UNQGTSEL	bestmatch
DELCCPREFIX	pfxwcc
GTTDIST	dn

```
;
```

This example displays output when Dual ExAP Config feature enabled.

## rtrv-sccpopts

```
tekelecstp 12-07-11 14:52:24 EST EAGLE 45.0.0
rtrv-sccpopts
Command entered at terminal #4.
```

SCCP	OPTIONS
-----	
CLASS1SEQ	off
CCLEN	0
ACLEN	0
INTLUNKNNAI	no
SUBDFRN	off
DFLTGTTMODE	CdPA
CNVAINAT	1
MOBRSCCPOPC	MTP
TGTT0	NONE
TGTT1	NONE
TGTTUDTKEY	MTP
TGTTXUDTKEY	MTP
GMSTCAPCE	off
DFLTFALLBACK	no
MTPRGTT	off

MTPRGTTFALLBK	mtproute
UNQGTTSEL	bestmatch
DELCCPREFIX	pfxwcc
GTTDIST	elap

;

**Related Topics**

- [chg-sccpopts](#)

## rtrv-scr-aftpc

Use this command to show the allowed affected point code (AFTPC) screening references in the AFTPC entity set.

**Parameters****actname (optional)**

The name of the gateway screening stop action set. Stop actions must be administered using this parameter in conjunction with the gateway screening stop action table (see `chg-gws-actset` and `rtrv-gws-actset`).

**Range:**

ayyyyy

1 alphabetic character followed by up to 5 alphanumeric characters.

*none* —Display gateway screening rules that do not have an assigned gateway screening stop action set

**a11 (optional)**

Displays all AFTPC screening references.

**Range:**

yes

no

**Default:**

no

**area (optional)**

ITU international area. The *area* in the point code represented by *zone-area-id*.

**Range:**

000 - 255, \*

\*the full range of values from 000–255

**id (optional)**

ITU international ID. The ID in the point code represented by *zone-area-id*.

**Range:**

0 - 7, \*

\* —the full range of values from 0–7

**mna (optional)**

16-bit ITU national main number area. The *mna* in the point code represented by *un-sna-mna*.

**Range:**

0 -- 31, \*

\* —the full range of values from 0–31

**msa (optional)**

24-bit ITU national main signaling area. The main signaling area in the point code represented by *msa-ssa-sp*.

**Range:**

000 - 255, \*

\* —the full range of values from 000-255

**nc (optional)**

Network cluster identifier value. This parameter displays entries containing the specific cluster of the point code represented by *ni-nc-ncm*.

**Range:**

0 - 255, \*

\* —the full range of values from 000-255

**Default:**

Display all

**ncm (optional)**

Network cluster member identifier value. This parameter displays entries containing this specific cluster member of the point code represented by *ni-nc-ncm*.

**Range:**

0 - 255, \*

\* —the full range of values from 000-255

**Default:**

Display all

**ni (optional)**

Network identifier value. This parameter displays entries containing this specific network of the point code represented by *ni-nc-ncm*.

**Range:**

0 - 255, \*

\* —the full range of values from 000-255

**Default:**

Display all

**npc (optional)**

ITU national point code.

 **Note:**

Gateway screening allows the ITU national point code to be displayed and entered in the database only as a single number. If you are using multiple-part ITU national point codes, see [Converting ITU National Point Code Formats](#) in Appendix A.

**Range:**

00000 - 16383, \*

\* —the full range of values from 00000–16383

**nsfi (optional)**

This parameter specifies the next screening category that is used in the gateway screening process, or it indicates that the gateway screening process should stop.

**Range:**

*stop*—The gateway screening process ends and the message proceeds through normal routing.

**Default:**

Display all

**nsr (optional)**

The next screening reference parameter indicates which screening reference in the specified screening category (*nsfi*) is to be used in the screening process.

**Range:**

*ayyy*

1 alphabetic character followed by up to 3 alphanumeric characters

**Default:**

Display all

**pcst (optional)**

Point code subtype. This parameter indicates whether the specified ITU international or ITU national point code has no subtype prefix or has the spare point code prefix (s-).

**Range:**

*none*

*s*

**Default:**

*none*

**sna (optional)**

16-bit ITU national main number area. The *sna* in the point code represented by *un-sna-mna*.

**Range:**

0 -- 15, \*

\* —the full range of values from 0–15

**sp (optional)**

24-bit ITU national signaling point. The signaling point in the point code represented by *msa-ssa-sp*.

**Range:**

000 - 255, \*

\* —the full range of values from 000-255

**sr (optional)**

The AFTPC screening reference name

**Range:**

ayyy

1 alphabetic character followed by up to 3 alphanumeric characters

**Default:**

Display all

**ssa (optional)**

24-bit ITU national sub signaling area. The ssa specified in the point code represented by *msa-ssa-sp*.

**Range:**

0 - 255, \*

\* —the full range of values from 000-255

**ssn (optional)**

Subsystem number.

**Range:**

0 - 255, \*

\* —the full range of values from 0–255

**Default:**

Display all.

**un (optional)**

16-bit ITU-national unit number. The *un* of the point code represented by *un-sna-mna*.

**Range:**

0 -- 127, \*

\* —the full range of values from 0–127

**zone (optional)**

ITU international zone. The zone in the point code represented by *zone-area-id*.

**Range:**

0 - 7, \*

\* —the full range of values from 0–7

**Example**

```
rtrv-scr-aftpc
```

```
rtrv-scr-aftpc:sr=iec:ni=240:nc=001:ncm=010&&014:ssn=012
```

```
rtrv-scr-aftpc:sr=iec
```

```
rtrv-scr-aftpc:all=yes  
rtrv-scr-aftpc:sr=iec:ni=240:nc=001:ncm=010:ssn=012:actname=copy  
rtrv-scr-aftpc:sr=aft1  
rtrv-scr-aftpc:sr=aft1:zone=1:area=2:id=3:nsfi=stop:ssn=1:pcst=s  
rtrv-scr-aftpc:sr=aft2:un=1:sna=2:mna=3
```

### Dependencies

If the `nsfi` parameter is specified, the parameter value must be `stop`.

ANSI point code value 000-000-000 and ITU-International point code value 0-000-0 are not allowed.

If `nc=*` is specified, `ncm=*` must be specified.

If `ni=*` is specified, `nc=*` and `ncm=*` must be specified.

If `zone=*` is specified, `area=*` and `id=*` must be specified.

If `area=*` is specified, `id=*` must be specified.

If `msa=*` is specified, `ssa=*` and `sp=*` must be specified.

If `ssa=*` is specified, `sp=*` must be specified.

If `un=*` is specified, `sna=*` and `mna=*` must be specified.

If `sna=*` is specified, `mna=*` must be specified.

The character `c` is not a valid value for the `ni`, `nc`, `ncm`, `zone`, `area`, `id`, `msa`, `ssa`, `sp`, `un`, `sna`, `mna`, and `npc` parameters.

The `nsr` parameter cannot be specified if the `actname` parameter is specified.

The `nsr` parameter cannot be specified if the `nsfi=stop` parameter is specified.

The value of the `actname` parameter must be defined in the gateway screening stop action table with the `chg-gws-actset` command. These values are shown in the ACT NAME field of the `rtrv-gws-actset` command output.

If the `actname` parameter is specified with the `sr` parameter, the specified value for the `actname` parameter must be assigned to that screening reference name.

If specified, the `sr` parameter value must exist in the AFTPC screen entity set.

The Spare Point Code Support feature must be enabled before the `pcst` parameter can be specified.

The spare point code subtype prefix (s-) is not supported for ANSI point codes (parameters `ni`, `nc`, `ncm`) or for 24-bit ITU national point codes (parameters `msa`, `ssa`, `sp`) or for 16-bit ITU national point codes (parameters `un`, `sna`, `mna`). The `pcst` parameter cannot be specified for ANSI, ITU-N16, and ITU-N24 point codes.

Any specified `ni`, `nc`, `ncm`, `zone`, `area`, `id`, `msa`, `ssa`, `sp`, `un`, `sna`, `mna`, `ncp`, `nsfi`, and `nsr` parameters must already exist in the AFTPC entity for the screening reference.



If the `pcst` parameter is specified, point codes with the specified subtype prefix (no prefix or s-) must exist in the database.

If the `nc` parameter is specified as a single value or a range, a single value must be specified for the `ni` parameter.

If the `nc` parameter is specified as a range, the `ncm` parameter must be specified as an asterisk or as the full range 000 – 255.

The Gateway Screening Stop Action table must be accessible.

The GWSOA parameter combination should be known and valid.

## Notes

This command can be canceled using the **F9** function key or the `canc-cmd` command. See `canc-cmd` for more information.

An asterisk as a parameter value in this command displays only entries that have an asterisk as the same parameter value in the entry.

A range of values is defined by separating the values that define the range by two ampersands (&&) for example, `ni=025&&100` specifies all network indicators for ANSI point codes from 25 - 100.

If no parameters are specified, a list of allowed AFTPC references is produced indicating whether they are referenced or not.

If only the `all=yes` parameter is specified, detailed information for every rule in every allowed AFTPC screening table is displayed.

If the `all` parameter is specified and other parameters are also specified, the `all` parameter is ignored.

The spare point code subtype prefix (s-) is supported only for ITU international and ITU national point codes. The `pcst` parameter indicates whether the specified point code has no subtype prefix or has the spare point code prefix.

## Output

```
rtrv-scr-aftpc
```

```
rlghncxa03w 03-03-13 13:12:38 EST EAGLE 31.3.0
SCREEN = ALLOWED AFTPC
SR    REF  RULES
IEC   YES   2
WRD2  YES   1
WRD3  NO    4
WRD4  YES   9
```

```
;
```

```
rtrv-scr-
aftpc:sr=iec:ni=240:nc=001:ncm=010&&014:ssn=012:actname=copy
```

```
rlghncxa03w 03-03-14 15:23:18 EST EAGLE 31.3.0
SCREEN = ALLOWED AFTPC
```

```

SR      NI      NC      NCM      SSN      NSFI      NSR/ACT
IEC     240     001     010&&012  012     STOP     COPY
;

rtrv-scr-aftpc:sr=aft1:zone=1:area=2:id=3:nsfi=stop:ssn=1:pcst=s

```

```

tekelecstp 05-01-05 10:19:51 EST EAGLE 31.12.0
SCREEN = ALLOWED AFTPC
SR      ZONE     AREA     ID      SSN      NSFI      NSR/ACT
aft1    s-1      002     3       1       STOP     -----
;

```

```
rtrv-scr-aftpc:sr=aft1
```

```

tekelecstp 05-01-05 10:19:51 EST EAGLE 31.12.0
SCREEN = ALLOWED AFTPC
SR      ZONE     AREA     ID      SSN      NSFI      NSR/ACT
aft1    s-2      002     3       1       STOP     -----

SR      NPC
aft1    s-00128
;

```

```
rtrv-scr-aftpc:sr=aft2
```

```

eaglestp 28-02-13 10:19:51 EST EAGLE 45.1.0
SCREEN = ALLOWED AFTPC
SR      UN      SNA     MNA     SSN      NSFI      NSR/ACT
aft2    001     02     01     1       STOP     -----
;

```

## Legend

For a summary report:

- **REF**—Indicates whether a screen is referenced by another screen. If NO, the screen is not used. If you need a more detailed output, use the `rtrv-scr-blkdpq:all=yes` command, or specify the specific screening reference.
- **RULES**—Number of screening rules in that screening table

For a detailed report:

- **SCREEN = ALLOWED AFTPC**—Screen type
- **SR**—Identifies the various screen sets being used. It can be up to four characters in length
- **NI-NC-NCM**—Point code referenced within the screen. For international point codes, these columns are ZONE - AREA - ID. For 24-bit ITU national point codes, these columns are MSA - SSA - SP. For 16-bit ITU national point codes, these columns are UN - SNA - MNA. For national point codes, these columns become the single column NPC.

- **SSN**—Subsystem number associated with the point code identified by *ni-nc-ncm*
- **NSFI**—Next screening category to be used
- **NSR/ACT**—Name of the next screening reference (NSR –up to four characters) or action to be taken (ACT –up to six characters), if the message passes this screen

#### Related Topics

- [chg-scr-aftpc](#)
- [dlt-scr-aftpc](#)
- [ent-scr-aftpc](#)

## rtrv-scr-blkdpc

Use this command to show the blocked destination point code (BLKDPC) screening references in the BLKDPC entity set.

#### Parameters

##### **actname (optional)**

The name of the gateway screening stop action set. Stop actions must be administered using this parameter in conjunction with the gateway screening stop action table (see `chg-gws-actset` and `rtrv-gws-actset`).

##### **Range:**

*ayyyyy*

1 alphabetic character followed by up to 5 alphanumeric characters.

*none* —Display gateway screening rules that do not have an assigned gateway screening stop action set

##### **a11 (optional)**

Displays all blocked DPC screening references.

##### **Range:**

*yes*

*no*

##### **Default:**

*no*

##### **area (optional)**

ITU international area. The area in the point code specified by *zone-area-id*.

##### **Range:**

*000 - 255, \**

\* —the full range of values from 000–255

##### **id (optional)**

ITU international ID. The ID in the point code represented by *zone-area-id*.

##### **Range:**

*0 - 7, \**

\* —the full range of values from 0–7

**mna (optional)**

16-bit ITU national main number area. The *mna* in the point code represented by *un-sna-mna*.

**Range:**

0 -- 31, \*

\* —the full range of values from 0–31

**msa (optional)**

24-bit ITU national main signaling area. The main signaling area in the point code represented by *msa-ssa-sp*.

**Range:**

000 - 255, \*

\* —the full range of values from 000-255

**nc (optional)**

Network cluster identifier value. This parameter displays entries containing the specific cluster of the point code represented by *ni-nc-ncm*.

**Range:**

0 - 255, \*

\* —the full range of values from 0–255

**Default:**

Display all

**ncm (optional)**

Network cluster member identifier value. This parameter displays entries containing the specific cluster member of the point code represented by *ni-nc-ncm*.

**Range:**

0 - 255, \*

\* —the full range of values from 0–255

**Default:**

Display all

**ni (optional)**

Network identifier value. This parameter displays entries containing the specific network of the point code represented by *ni-nc-ncm*.

**Range:**

0 - 255, \*

\* —the full range of values from 0–255.

**Default:**

Display all

**npc (optional)**

ITU national point code.

 **Note:**

Gateway screening allows the ITU national point code to be displayed and entered in the database only as a single number. If you are using multiple-part ITU national point codes, see [Converting ITU National Point Code Formats](#) in Appendix A.

**Range:**

00000 - 16383, \*

\* —the full range of values from 00000–16383

**nsfi (optional)**

This parameter specifies the next screening category used in the gateway screening process, or it indicates that the gateway screening process should stop.

**Range:*****cgpa***

Allowed calling party address is the next screening category

***destfld***

Allowed destination field (DESTFLD) is the next screening category

***fail***

The received message should be discarded.

***isup***

ISUP message type (ISUP) is the next screening category

***stop***

The gateway screening process ends and the message proceeds through normal routing

**Default:**

Display all

**nsr (optional)**

The next screening reference parameter indicates which screening reference in the specified screening category (*nsfi*) is to be used in the screening process. This parameter is mandatory if *nsfi* is other than *stop* or *fail* and cannot be entered if *nsfi* is *stop* or *fail*, or the *copy=yes* parameter is specified.

**Range:**

ayyy 1 alphabetic character followed by up to 3 alphanumeric characters

**Default:**

Display all

**pcst (optional)**

Point code subtype. This parameter specifies whether the specified ITU international or ITU national point code has no subtype prefix or has the spare point code prefix (S-).

**Range:***none**s***Default:***none***sna (optional)**

16-bit ITU national main number area. The *sna* in the point code represented by *un-sna-mna*.

**Range:***0 -- 15, \**

\* —the full range of values from 0–15

**sp (optional)**

24-bit ITU national signaling point. This parameter specifies the signaling point in the point code represented by *msa-ssa-sp*.

**Range:***000 - 255, \**

\* —the full range of values from 000-255

**sr (optional)**

The BLKDPC screening reference name

**Range:***ayyy*

1 alphabetic character followed by up to 3 alphanumeric characters

**Default:**

Display all.

**ssa (optional)**

24-bit ITU national sub signaling area. The sub signaling area specified in the point code represented by *msa-ssa-sp*.

**Range:***0 - 255, \**

\* —the full range of values from 000-255

**un (optional)**

16-bit ITU-national unit number. The *un* of the point code represented by *un-sna-mna*.

**Range:***0 -- 127, \**

\* —the full range of values from 0–127

**zone (optional)**

ITU international zone. The zone in the point code represented by *zone-area-id*.

**Range:***0 - 7, \**

\* —the full range of values from 0–7

### Example

```
rtrv-scr-blkdpc  
  
rtrv-scr-  
blkdpc:sr=iec:ni=240:nc=001:ncm=010&&018:nsfi=stop:actname=rdct  
  
rtrv-scr-blkdpc:sr=iec  
  
rtrv-scr-blkdpc:all=yes  
  
rtrv-scr-blkdpc:sr=bdp1:npc=128:nsfi=fail:pcst=s  
  
rtrv-scr-blkdpc:sr=bl01:un=1:sna=2:mna=3
```

### Dependencies

A complete point code must be specified, and must be one and only one of the five point code parameter combinations: `ni-nc-ncm`, `zone-area-id`, `msa-ssa-sp`, `un-sna-mna`, or `npc`, except in the special case of entering `c` for "continue."

If the `ni=c` parameter is specified, then the `nc` and the `ncm` parameters must have a value of `c` or must not be specified. If the `ni=c` parameter is specified, and the `nc` and the `ncm` parameters are not specified, then the `nc` and `ncm` parameters default to a value of `c`.

If the `zone=c` parameter is specified, then the `area` and `id` parameters must have a value of `c` or must not be specified. If the `zone=c` parameter is specified, and the `area` and the `id` parameters are not specified, then the `area` and `id` parameters default to a value of `c`.

If the `msa=c` parameter is specified, then the `ssa` and `sp` parameters must have a value of `c` or must not be specified. If the `msa=c` parameter is specified, and the `ssa` and the `sp` parameters are not specified, then the `ssa` and `sp` parameters default to a value of `c`.

If the `un=c` parameter is specified, then the `sna` and `mna` parameters must have a value of `c` or must not be specified. If the `un=c` parameter is specified, and the `sna` and the `mna` parameters are not specified, then the `sna` and `mna` parameters default to a value of `c`.

ANSI point code value 000-000-000 and ITU-International point code value 0-000-0 are not allowed.

If the `area=*` parameter is specified, then the `id=*` parameter must be specified.

If the value of the `nsfi` parameter is `stop` or `fail`, then the `nsr` parameter cannot be specified.

If the `actname` parameter is specified, the `nsr` parameter cannot be specified.

If the `actname` parameter is specified, then the `nsfi=stop` parameter must be specified.

If the `actname` parameter is specified with the `sr` parameter, the specified value for the `actname` parameter must be assigned to that screening reference name.

The value of the `actname` parameter must already be defined in the Gateway Screening Stop Action table with the `chg-gws-actset` command. These values are shown in the ACT NAME field of the `rtrv-gws-actset` command output.

If the `ni` parameter is specified as an asterisk (`ni=*`) or as a range, the `nc` and `ncm` parameters must be specified as an asterisk or as the full range 000 – 255.

If the `nc` parameter is specified as a single value or a range, a single value must be specified for the `ni` parameter.

If the `nc` parameter is specified as a range, the `ncm` parameter must be specified as an asterisk or as the full range 000 – 255.

If the `ncm` parameter is specified as a single value, or a range other than the full range of 000 – 255, the `ni` and the `nc` parameters must be specified with a single value.

The value of the `sr` parameter must already exist in the BLKDPC entity set.

The Spare Point Code Support feature must be enabled before the `pcst` parameter can be specified.

The spare point code subtype prefix (s-) is not supported for ANSI point codes (parameters `ni`, `nc`, `ncm`) or for 24-bit ITU national point codes (parameters `msa`, `ssa`, `sp`) or for 16-bit ITU national point codes (parameters `un`, `sna`, `mna`). The `pcst` parameter cannot be specified for ANSI, ITU-N16 or ITU-N24 point codes.

Any specified `id`, `mna` or `sp` parameter must already exist in the database.

If the `pcst` parameter is specified, point codes with the specified subtype prefix (no prefix or s-) must exist in the database.

Any specified `nc` parameter must already exist in the database

Any specified `ncm` parameter must already exist in the database

Any specified `zone`, `un` or `msa` parameter must already exist in the database.

Any specified `ni` parameter must already exist in the database

Any specified `nsr` parameter must already exist in the database

Any specified `nsfi` parameter must already exist in the database

Any specified `npc` parameter must already exist in the database

Any specified `area`, `sna`, or `ssa` parameter must already exist in the database.

Any specified `pcst` parameter must already exist in the database

The Gateway Screening Stop Action table must be accessible.

If the `zone=*` parameter is specified, then the `area=*` and `id=*` parameters must be specified.

If the `msa=*` parameter is specified, then the `ssa=*` and the `sp=*` parameters must be specified.

If the `ssa=*` parameter is specified, then the `sp=*` parameter must be specified.

If the `un=*` parameter is specified, then the `sna=*` and the `mna=*` parameters must be specified.



If the `sna=*` parameter is specified, then the `mna=*` parameter must be specified.

The GWSOA parameter combination should be known and valid.

### Notes

This command can be canceled using the **F9** function key or the `canc-cmd` command. See `canc-cmd` for more information.

If no parameters are specified, a list of blocked DPC screening references is displayed indicating whether they are referenced or not.

If only the `all=yes` parameter is specified, detailed information for every rule in every blocked DPC screening table is output.

If the `all` parameter is specified and other parameters are also specified, the `all` parameter is ignored.

An asterisk as a parameter value in this command displays only entries that have an asterisk as the same parameter value in the entry.

A range of values is specified by separating the values that define the range by two ampersands (&&); for example, `ni=025&&100` specifies all network indicators for ANSI point codes from 25 - 100.

The character `c` is used in the blocked DPC screens to allow the screening process to continue for messages with point codes that do not match any point codes in the blocked DPC screens. When screening for a blocked DPC and the point code being screened does not match any of the point codes in the blocked DPC screens, the message is not rejected and the screening process continues. There must be an entry in the blocked DPC screens to allow the screening process to continue. This entry consists of a screening reference, point code, `nsfi`, and `nsr`. The point code has the value `c`.

If the character `c` is specified for any subfield of a three-subfield point code, all three subfields must have the value `c`. No other values can be used. For example, a point code `c` is not allowed. The point code must be `c`. The asterisk (\*) value cannot be used with the character `c` (for example, a point code `c` is not allowed).

In all cases, if `c` for "continue" is entered for the first subfield in the point code, the other subfields default to `c` in the database.

When the point code does not match any entries in the blocked DPC screens, the screening process is directed to the screening reference with the point code `c`. The `nsfi` and `nsr` in this entry are examined to determine the next step in the screening process.

The spare point code subtype prefix `s-` is supported only for ITU international and ITU national point codes. The `pcst` parameter indicates whether the specified point code has no subtype prefix or has the spare point code prefix.

### Output

```
rtrv-scr-blkdpc
```

```
rlghncxa03w 03-03-13 13:12:38 EST EAGLE 31.3.0
SCREEN = BLOCKED DPC
SR      REF  RULES
```

```

IEC  YES  2
WRD2 YES  1
WRD3 NO   4
WRD4 YES  9
;

rtrv-scr-blkdpc:sr=iec:ni=240:nc=001:ncm=010&&018

```

```

rlghncxa03w 03-03-13 13:13:21 EST  EAGLE 31.3.0
SCREEN = BLOCKED DPC
SR  NI      NC      NCM      NSFI     NSR/ACT
IEC 240     001     010&&020 STOP    -----
;

```

```
rtrv-scr-blkdpc:actname=rdct
```

```

rlghncxa03w 03-03-13 13:13:21 EST  EAGLE 31.3.0
SCREEN = BLOCKED DPC
SR  NI      NC      NCM      NSFI     NSR/ACT
IEC C       C       C       STOP    RDCT
;

```

```
rtrv-scr-blkdpc:nsr=is02
```

```

tekelecstp 02-08-30 09:25:54 EST  EAGLE 30.0.0
rtrv-scr-blkdpc:nsr=is02
Command entered at terminal #4.
SCREEN = BLOCKED DPC
SR  NI      NC      NCM      NSFI     NSR/ACT
bdp3 C       C       C       ISUP    is02
;

```

```
rtrv-scr-blkdpc:sr=bdp1:npc=128:nsfi=fail
```

```

tekelecstp 05-01-25 15:57:51 EST  EAGLE 31.12.0
SCREEN = BLOCKED DPC
SR  NPC      NSFI     NSR/ACT
bdp1 s-00128  FAIL    -----
;

```

```
rtrv-scr-blkdpc:sr=b101
```

```

tekelecstp 13-07-05 16:48:31 EST  45.0.0-64.69.0
rtrv-scr-blkdpc:sr=b101
Command entered at terminal #4.
SCREEN = BLOCKED DPC
SR  UN      SNA      MNA      NSFI     NSR/ACT

```

```

b101    004    05    06    FAIL    -----
b101    C      C      C      STOP    -----

```

```
;
```

### Legend

For a summary report:

- **REF**—Indicates whether a screen is referenced by another screen. If NO, the screen is not used. For more detailed output, use the `rtrv-scr-blkopc:all=yes` command, or specify the specific screening reference.
- **RULES**—Number of screening rules in that screening table

For a detailed report:

- **SCREEN = BLOCKED DPC**—Screen type
- **SR**—Identifies the screen sets being used. It can be up to four characters in length.
- **NI - NC - NCM**—Point code referenced within the screen. For international point codes, columns are ZONE - AREA - ID. For 24-bit ITU national point codes, columns are MSA-SSA-SP. For 16-bit ITU national point codes, columns are UN-SNA-MNA. For national point codes, columns become the single column NPC.
- **NSFI**—Next screening category to be used
- **NSR/ACT**—Name of the next screening reference (NSR - up to four characters) or action to be taken (ACT - up to six characters), if the message passes this screen.

### Related Topics

- [chg-scr-blkopc](#)
- [dlt-scr-blkopc](#)
- [ent-scr-blkopc](#)

## rtrv-scr-blkopc

Use this command to show the blocked originating point code (BLKOPC) screening references in the BLKOPC entity set.

### Parameters

#### **actname (optional)**

The name of the gateway screening stop action set. Stop actions must be administered using this parameter in conjunction with the gateway screening stop action table (see `chg-gws-actset` and `rtrv-gws-actset`).

#### **Range:**

*ayyyy*

1 alphabetic character followed by up to 5 alphanumeric characters.

*none*—Display gateway screening rules that do not have an assigned gateway screening stop action set

**a11 (optional)**

Displays all blocked OPC screening references.

**Range:**

*yes*

*no*

**Default:**

*no*

**area (optional)**

ITU international area. The area in the point code represented by *zone-area-id*.

**Range:**

*000 - 255, \**

\*— the full range of values from 000–255

**id (optional)**

ITU international ID. The ID in the point code represented by *zone-area-id*.

**Range:**

*0 - 7, \**

\*—the full range of values from 0–7

**mna (optional)**

16-bit ITU national main number area. The *mna* in the point code represented by *un-sna-mna*.

**Range:**

*0 -- 31, \**

\*—the full range of values from 0–31

**msa (optional)**

24-bit ITU national main signaling area. The main signaling area in the point code represented by *msa-ssa-sp*.

**Range:**

*000 - 255, \**

\*—the full range of values from 000-255

**nc (optional)**

Network cluster identifier value. This parameter displays entries containing this specific cluster of the point code represented by *ni-nc-ncm*.

**Range:**

*0 - 255*

\*—the full range of values from 0–255

**Default:**

Display all

**ncm (optional)**

Network cluster member identifier value. This parameter displays entries containing this specific cluster member of the point code represented by *ni-nc-ncm*.

**Range:**

0 - 255, \*

\* —the full range of values from 0–255

**Default:**

Display all

**ni (optional)**

Network identifier value. This parameter displays entries containing this specific network of the point code represented by *ni-nc-ncm*.

**Range:**

0 - 255, \*

\* —the full range of values from 0–255

**Default:**

Display all

**npc (optional)**

ITU national point code.

 **Note:**

Gateway screening allows the ITU national point code to be displayed and entered in the database only as a single number. If you are using multiple-part ITU national point codes, see [Converting ITU National Point Code Formats](#) in Appendix A.

**Range:**

00000 - 16383, \*

\* —the full range of values from 00000–16383

**nsfi (optional)**

This parameter specifies the next screening category that is used in the gateway screening process, or it indicates that the gateway screening process should stop.

**Range:*****cgpa***

Allowed calling party address is the next screening category

***stop***

The gateway screening process ends and the message proceeds through normal routing.

***fail***

The received message should be discarded.

***sio***

Allowed SIO is the next screening category.

***dpc***

Allowed DPC is the next screening category.

**blkdpc**

Blocked DPC is the next screening category.

**Default:**

Display all

**nsr (optional)**

The next screening reference parameter indicates which screening reference in the specified screening category (*nsfi*) is to be used in the screening process. This parameter is mandatory if *nsfi* is other than *stop* or *fail*. The *nsr* parameter cannot be entered if *nsfi* is *stop* or *fail*, or the *copy=yes* parameter is specified.

**Range:**

*ayyy*

1 alphabetic character followed by up to 3 alphanumeric characters

**Default:**

Display all

**pcst (optional)**

Point code subtype. This parameter indicates whether the specified ITU international or ITU national point code has no subtype prefix or has the spare point code prefix (s-).

**Range:**

*none*

*s*

**Default:**

*none*

**sna (optional)**

16-bit ITU national main number area. The *sna* in the point code represented by *un-sna-mna*.

**Range:**

*0 -- 15, \**

\* —the full range of values from 0–15

**sp (optional)**

24-bit ITU national signaling point. The signaling point in the point code represented by *msa-ssa-sp*.

**Range:**

*000 - 255, \**

\* —the full range of values from 000-255

**sr (optional)**

The BLKOPC screening reference name

**Range:**

*ayyy*

1 alphabetic character followed by up to 3 alphanumeric characters

**Default:**  
Display all.

**ssa (optional)**

24-bit ITU national sub signaling area. The sub signaling area is specified in the point code represented by *msa-ssa-sp*.

**Range:**  
0 - 255, \*  
\*—the full range of values from 000-255

**un (optional)**

16-bit ITU-national unit number. The *un* of the point code represented by *un-sna-mna*.

**Range:**  
0 -- 127, \*  
\*—the full range of values from 0–127

**zone (optional)**

ITU international zone. The zone in the point code represented by *zone-area-id*.

**Range:**  
0 - 7, \*  
\*—the full range of values from 0–7

**Example**

```
rtrv-scr-blkopc
rtrv-scr-blkopc:sr=iec:ni=240:nc=001:ncm=010&&018:actname=copy
rtrv-scr-blkopc:sr=iec
rtrv-scr-blkopc:all=yes
rtrv-scr-blkopc:sr=bop1:npc=128:nsfi=fail
rtrv-scr-blkopc:sr=bop1:zone=2:area=2:id=3:nsfi=fail:pcst=s
rtrv-scr-blkopc:sr=bop1:un=121:sna=10:mna=17:nsfi=fail:pcst=s
```

**Dependencies**

ANSI point code value 000-000-000 and ITU-International point code value 0-000-0 are not allowed.

Any specified *ni*, *nc*, *ncm*, *zone*, *area*, *id*, *msa*, *ssa*, *sp*, *ncp*, *nsfi*, *un*, *sna*, *mna*, and *nsr* parameters must already exist in the database.

If the *pcst* parameter is specified, point codes with the specified subtype prefix (no prefix or *s-*) must exist in the database.

If the *area=\** parameter is specified, then the *id=\** parameter must be specified.

If the *nsr* parameter is specified, then the *actname* parameter cannot be specified.

If the value of the *nsfi* parameter is *stop* or *fail*, then the *nsr* parameter cannot be specified.

If the `actname` parameter is specified, the `nsfi=stop` parameter must be specified.

If the value `c` is specified for any subfield of a three-subfield point code, then all three subfields must have a value of `c` (`c-c-c`). No other values, including asterisks can be used.

If the value of the first subfield is `c`, then the other subfields default to `c` in the database.

The value of the `actname` parameter must already be defined in the Gateway Screening Stop Action table with the `chg-gws-actset` command. These values are shown in the ACT NAME field of the `rtrv-gws-actset` command output.

If the `actname` parameter is specified with the screening reference name parameter, the specified value for the `actname` parameter must be assigned to that screening reference name.

The Spare Point Code Support feature must be enabled before the `pcst` parameter can be specified.

The spare point code subtype prefix (s-) is not supported for ANSI point codes (parameters `ni`, `nc`, `ncm`) or for 24-bit ITU national point codes (parameters `msa`, `ssa`, `sp`) or for 16-bit ITU national point codes (parameters `un`, `sna`, `mna`). The `pcst` parameter cannot be specified for ANSI, ITU-N16 or ITU-N24 point codes.

If the `nc=*`  parameter is specified, then the `ncm=*`  parameter must be specified.

The Gateway Screening Stop Action table must be accessible.

If the `ni=*`  parameter is specified, then the `nc=*`  and `ncm=*`  parameters must be specified.

If the `zone=*`  parameter is specified, then the `area=*`  and `id=*`  parameters must be specified.

If the `msa=*`  parameter is specified, then the `ssa=*`  and `sp=*`  parameters must be specified.

If the `un=*`  parameter is specified, then the `sna=*`  and `mna=*`  parameters must be specified.

If the `ssa=*`  parameter is specified, then the `sp=*`  parameter must be specified.

If the `sna=*`  parameter is specified, then the `mna=*`  parameter must be specified.

The GWSOA parameter combination should be known and valid.

## Notes

This command can be canceled using the **F9** function key or the `canc-cmd` command. See `canc-cmd` for more information.

An asterisk as a parameter value in this command displays only entries that have an asterisk as the same parameter value in the entry.

If no parameters are specified, a list of blocked OPC references is displayed indicating whether they are referenced or not.

If only the `all=yes` parameter is specified, detailed information for every rule in every blocked OPC screening table is displayed.

If the `all` parameter is specified and other parameters are also specified, the `all` parameter is ignored.



A range of values is specified by separating the values that define the range by two ampersands (&&); for example, `ni=025&&100` specifies all network indicators for ANSI point codes from 25 - 100.

For point codes with three subfields, the value `c` (continue) is used as a place holder. If the point code is not found in this screen set, the continue value points to the `nsfi` and `nsr` to be applied next.

The character `c` is used in the blocked OPC screens to allow the screening process to continue for messages with point codes that do not match any point codes in the blocked OPC screens. When screening for a blocked OPC and the point code being screened does not match any of the point codes in the blocked OPC screens, the message is not rejected and the screening process continues. There must be an entry in the blocked OPC screens to allow the screening process to continue. This entry consists of a screening reference, point code, `nsfi`, and `nsr`. The point code `c`.

When the point code does not match any entries in the blocked OPC screens, the screening process is directed to the screening reference with the point code `c`. The `nsfi` and `nsr` in this entry are examined to determine the next step in the screening process.

The spare point code subtype prefix `s-` is supported only for ITU international and ITU national point codes. The `pcst` parameter indicates whether the specified point code has no subtype prefix or has the spare point code prefix.

## Output

```
rtrv-scr-blkopc
```

```
rlghncxa03w 03-03-13 13:12:38 EST EAGLE 31.3.0
SCREEN = BLOCKED OPC
SR   REF  RULES
IEC  YES   2
WRD2 YES   1
WRD3 NO    4
WRD4 YES   9
```

```
;
```

```
rtrv-scr-blkopc:sr=iec:ni=240:nc=001:ncm=010&&018
```

```
rlghncxa03w 03-03-13 13:13:21 EST EAGLE 31.3.0
SCREEN = BLOCKED OPC
SR   NI      NC      NCM      NSFI      NSR/ACT
IEC  240     001     010&&020 FAIL     -----
```

```
;
```

```
rtrv-scr-blkopc:actname=cncf
```

```
rlghncxa03w 03-03-13 10:34:07 EST EAGLE 31.3.0
SCREEN = BLOCKED OPC
SR   NI      NC      NCM      NSFI      NSR/ACT
```

```
IEC C C C STOP CNCF
;
```

```
rtrv-scr-blkopc:all=yes
```

```
rlghncxa03w 03-03-13 10:34:07 EST EAGLE 31.3.0
SCREEN = BLOCKED OPC
SR NI NC NCM NSFI NSR/ACT
IEC 240 001 010 FAIL -----
IEC 241 010 * FAIL -----

SR ZONE AREA ID NSFI NSR/ACT
IEC 1 003 4 FAIL -----
IEC 1 003 5 FAIL -----

SR NI NC NCM NSFI NSR/ACT
IEC C C C STOP CRNCF

SR NI NC NCM NSFI NSR/ACT
WRD2 243 015 001 FAIL -----
WRD2 243 105 002 FAIL -----
WRD2 C C C STOP CNCF
;
```

```
rtrv-scr-blkopc:sr=bo01:nsfi=sio:nsr=si01:msa=c:ssa=c:sp=c
```

```
tekelecstp 03-03-25 15:57:07 EST EAGLE 31.0.0
SCREEN = BLOCKED OPC
SR MSA SSA SP NSFI NSR/ACT
bo01 C C C SIO si01
;
```

```
rtrv-scr-blkopc:sr=bop1
```

```
tekelecstp 05-01-25 15:57:07 EST EAGLE 31.12.0
SCREEN = BLOCKED OPC
SR ZONE AREA ID NSFI NSR/ACT
bop1 s-2 002 3 FAIL -----

SR NPC NSFI NSR/ACT
bop1 s-00128 FAIL -----

SR ZONE AREA ID NSFI NSR/ACT
bop1 C C C STOP -----
;
```

```
rtrv-scr-blkopc:sr=iec:un=120:sna=10:mna=15
```

```
rlghncxa03w 03-03-13 13:13:21 EST EAGLE 45.0.0
SCREEN = BLOCKED OPC
SR      UN      SNA      MNA      NSFI      NSR/ACT
IEC    120      10      15      FAIL      -----
```

```
;
```

## Legend

For a summary report:

- **REF**—Indicates whether a screen is referenced by another screen. If NO, the screen is not used. If you need a more detailed output, use the `rtrv-scr-blkopc:all=yes` command, or specify the specific screening reference.
- **RULES**—Number of screening rules in that screening table.

For a detailed report:

- **SCREEN = BLOCKED OPC**—Screen type
- **SR**—Identifies the various screen sets being used. It can be up to four characters in length.
- **NI - NC - NCM**—Point code referenced within the screen. For international point codes, these columns are ZONE - AREA - ID. For 24-bit ITU national point codes, these columns are MSA-SSA-SP. For the 16-bit ITU national point codes, these columns are UN-SNA-MNA. For national point codes, these columns become the single column NPC .
- **NSFI**—Next screening category to be used
- **NSR/ACT**—Name of the next screening reference ( NSR - up to four characters) or action to be taken ( ACT - up to six characters), if the message passes this screen

## Related Topics

- [chg-scr-blkopc](#)
- [dlt-scr-blkopc](#)
- [ent-scr-blkopc](#)

## rtrv-scr-cdpa

Use this command to show the allowed called party address (CDPA) screening references in the CDPA entity set.

### Parameters

#### **actname (optional)**

The name of the gateway screening stop action set. Stop actions must be administered using this parameter in conjunction with the gateway screening stop action table (see `chg-gws-actset` and `rtrv-gws-actset`).

**Range:***ayyyy*

1 alphabetic character followed by up to 5 alphanumeric characters.

*none*—Display gateway screening rules that do not have an assigned gateway screening stop action set**a11 (optional)**

Displays all allowed CDPA screening references.

**Range:***yes**no***Default:***no***area (optional)**ITU international area. The area in the point code represented by *zone-area-id*.**Range:***000 - 255, \***\**—the full range of values from 000–255**id (optional)**ITU international ID. The ID in the point code represented by *zone-area-id*.**Range:***0 - 7, \***\** —the full range of values from 0–7**mna (optional)**16-bit ITU national main number area. The *mna* in the point code represented by *un-sna-mna*.**Range:***0 -- 31, \***\** —the full range of values from 0–31**msa (optional)**24-bit ITU national main signaling area. The main signaling area specified in the point code represented by *msa-ssa-sp*.**Range:***000 - 255, \***\** — the full range of values from 000-255**nc (optional)**Network cluster identifier value. This parameter displays entries containing this specific cluster of the point code represented by *ni-nc-ncm*.**Range:***0 - 255, \***\** —the full range of values from 0–255

**Default:**  
Display all

**ncm (optional)**

Network cluster member identifier value. This parameter displays entries containing this specific cluster member of the point code represented by *ni-nc-ncm*.

**Range:**  
0 - 255, \*  
\* —the full range of values from 0–255

**Default:**  
Display all

**ni (optional)**

Network identifier value. This parameter displays entries containing this specific network of the point code represented by *ni-nc-ncm*.

**Range:**  
0 - 255, \*  
\* —the full range of values from 0–255

**Default:**  
Display all

**npc (optional)**

ITU national point code.



**Note:**

Gateway screening allows the ITU national point code to be displayed and entered in the database only as a single number. If you are using multiple-part ITU national point codes, see [Converting ITU National Point Code Formats](#) in Appendix A.

**Range:**  
00000 - 16383, \*  
\* —the full range of values from 00000–16383

**nsfi (optional)**

This parameter specifies the next screening category that is used in the gateway screening process, or it indicates that the gateway screening process should stop.

**Range:**

***aftpc***

Allowed affected point code is the next screening category

***stop***

The gateway screening process ends and the message proceeds through normal routing

**Default:**  
Display all

**nsr (optional)**

The next screening reference parameter indicates which screening reference in the specified screening category (*nsfi*) is to be used in the screening process. This parameter is mandatory if *nsfi* is other than *stop* or *fail*. This parameter cannot be entered if *nsfi* is *stop* or *fail*, or the *copy=yes* parameter is specified.

**Range:**

*ayyy*

1 alphabetic character followed by up to 3 alphanumeric characters

**Default:**

Display all

**pcst (optional)**

Point code subtype indicator. This parameter indicates whether the ITU international or ITU national point codes to be displayed must have the spare point code prefix (s-).

**Range:**

*none*

No spare point code prefix required

*s*

Spare point code prefix required

**Default:**

none

**scmgfid (optional)**

SCCP management (SCMG) format ID, which consists of a 1-octet field and uniquely defines the function and format of each SCMG message. The following SCCP message types are screened against the Allowed CDPA table and all others are passed: UDT, UDTS, XUUDT, XUUDTS

**Range:**

*1 - 255, \**

\*—the full range of values from 1-255

**Default:**

All SCMG format IDs are shown.

**sna (optional)**

16-bit ITU national sub number area. The *sna* in the point code represented by *un-sna-mna*.

**Range:**

*0 -- 15, \**

\*—the full range of values from 0–15

**sp (optional)**

24-bit ITU national signaling point. The signaling point in the point code represented by *msa-ssa-sp*.

**Range:**

*000 - 255, \**

\*—the full range of values from 000-255

**sr (optional)**

Displays all allowed CDPA screening references.

**Range:**

*ayyy*

1 alphabetic character followed by up to 3 alphanumeric characters

**Default:**

Display all.

**ssa (optional)**

24-bit ITU national sub signaling area. The sub signaling area specified in the point code represented by *msa-ssa-sp*.

**Range:**

*0 - 255, \**

\*—the full range of values from 000-255

**ssn (optional)**

Subsystem number.

**Range:**

*0 - 255, \**

\* — the full range of values from 0–255

**Default:**

Display all.

**un (optional)**

16-bit ITU-national unit number. The *un* of the point code represented by *un-sna-mna*.

**Range:**

*0 -- 127, \**

\*—the full range of values from 0–127

**zone (optional)**

ITU international zone. The zone in the point code represented by *zone-area-id*.

**Range:**

*0 - 7, \**

\*—the full range of values from 0–7

**Example**

```
rtrv-scr-cdpa
```

```
rtrv-scr-cdpa:sr=iec:ni=240:nc=001:ncm=010:ssn=001
```

```
rtrv-scr-cdpa:sr=iec:ni=240:nc=001:ssn=002&&005
```

```
rtrv-scr-cdpa:sr=iec
```

```
rtrv-scr-cdpa:sr=iec:actname=copy
```

```
rtrv-scr-
```

```
cdpa:sr=cdp1:zone=1:area=2:id=3:ssn=1:nsfi=stop:scmgfid=1:pcst=
```

```
s
```

```
rtrv-scr-cdpa:sr=cdp1
```

```
rtrv-scr-cdpa:sr=cdp2:un=1:sna=2:mna=3
```

### Dependencies

If the `actname` parameter is specified, the `nsr` parameter cannot be specified.

If the `actname` parameter is specified, the `nsfi=stop` parameter must be specified.

The `nsr` parameter cannot be specified when `nsfi=stop`.

If `zone=*` is specified, `area=*` and `id=*` must be specified.

If `area` is specified or respecified as an asterisk, `id` must also be an asterisk.

If `msa=*` is specified, `ssa=*` and `sp=*` must be specified.

If `ssa=*` is specified, `sp=*` must be specified.

If `un=*` is specified, `sna=*` and `mna=*` must be specified.

If `sna=*` is specified, `mna=*` must be specified.

If the `ni` parameter is specified as an asterisk or as a range, the `nc` and `ncm` parameters must be specified as an asterisk or as the full range 000 – 255.

If the `nc` parameter is specified as an asterisk, the `ncm` parameter must be specified as an asterisk or as the full range 000 – 255.

If the `nc` parameter is specified as a single value or a range, a single value must be specified for the `ni` parameter.

If the `nc` parameter is specified as a range, the `ncm` parameter must be specified as an asterisk or as the full range 000 – 255.

If the `ncm` parameter is specified as a single value, or a range other than the full range of 000 – 255, the `ni` and the `nc` parameters must be specified with a single value.

ANSI point code value 000-000-000 and ITU-International point code value 0-000-0 are not allowed.

If the `actname` parameter is specified with the screening reference name parameter, the specified value for the `actname` parameter must be assigned to that screening reference name.

The value of the `actname` parameter must already be defined in the Gateway Screening Stop Action table with the `chg-gws-actset` command. These values are shown in the ACT NAME field of the `rtrv-gws-actset` command output.

The Spare Point Code Support feature must be enabled before the `pcst` parameter can be specified.

The spare point code subtype prefix (s-) is not supported for ANSI point codes (parameters `ni`, `nc`, `ncm`) or for 24-bit ITU national point codes (parameters `msa`, `ssa`, `sp`) or for 16-bit ITU national point codes (parameters `un`, `sna`, `mna`). The `pcst` parameter cannot be specified for ANSI, ITU-N16 or ITU-N24 point codes.

Any specified `ni`, `nc`, `ncm`, `zone`, `area`, `id`, `msa`, `ssa`, `sp`, `un`, `sna`, `mna`, `ncp`, `nsfi`, `ri`, `ssn`, and `nsr` parameters must already exist in the CGPA entity for the screening reference.



If the `pcst` parameter is specified, point codes with the specified subtype prefix (no prefix or `s-`) must exist in the database.

The specified screening function identifier (`nsfi`) must be in the allowed CDPA entity set.

The Gateway Screening Stop Action table must be accessible.

If specified, the `sr` parameter value must exist in the AFTPC screen entity set.

The GWSOA parameter combination should be known and valid.

## Notes

This command can be canceled using the **F9** function key or the `canc-cmd` command. See `canc-cmd` for more information.

If no parameters are specified, the system displays a summary output.

If only the `all=yes` parameter is specified, the system displays a detailed output.

If the `all` parameter and any point code parameter are specified, the `all` parameter is ignored.

The REF column of the output of this command displays *YES* when the screen is referenced by another screen; otherwise, it displays *NO*.

An asterisk as a parameter value in this command displays only entries that have an asterisk as the same parameter value in the entry.

A range of values is specified by separating the values that define the range by two ampersands (`&&`); for example, `ni=025&&100` specifies all network indicators for ANSI point codes from 25 - 100.

The spare point code subtype prefix (`s-`) is supported only for ITU international and ITU national point codes. The `pcst` parameter indicates whether the specified point code has no subtype prefix or has the spare point code prefix.

## Output

```
rtrv-scr-cdpa:sr=iec:ni=240:nc=001:ncm=010:ssn=001
```

```
rlghncxa03w 03-03-07 12:05:33 EST EAGLE 31.3.0
SCREEN = ALLOWED CDPA
SR   NI      NC      NCM      SSN      SCMGFID  NSFI  NSR/ACT
IEC  240      001      010      001      002&&003 STOP  -----
;
```

```
rtrv-scr-cdpa:sr=iec:ni=240:nc=001:ssn=002&&005
```

```
rlghncxa03w 03-03-07 12:05:33 EST EAGLE 31.3.0
SCREEN = ALLOWED CDPA
SR   NI      NC      NCM      SSN      SCMGFID  NSFI  NSR/ACT
IEC  240      001      010      002      ----- STOP  -----
```

```
IEC 240 001 011 002&&003 ----- STOP -----  
;
```

```
rtrv-scr-cdpa:sr=iec
```

```
rlghncxa03w 03-03-07 12:05:33 EST EAGLE 31.3.0  
SCREEN = ALLOWED CDPA  
SR NI NC NCM SSN SCMGFID NSFI NSR/ACT  
IEC 240 001 010 12 ----- STOP -----  
IEC 241 010 * * ----- AFTPC IAFT  
;
```

```
rtrv-scr-cdpa
```

```
rlghncxa03w 03-03-07 12:05:33 EST EAGLE 31.3.0  
SCREEN = ALLOWED CDPA  
SR REF RULES  
IEC YES 2  
WRD2 YES 1  
WRD4 YES 4  
;
```

```
rtrv-scr-cdpa:sr=iec:actname=copy
```

```
rlghncxa03w 03-03-07 12:05:33 EST EAGLE 31.3.0  
SCREEN = ALLOWED CDPA  
SR NI NC NCM SSN SCMGFID NSFI NSR/ACT  
IEC 245 001 010 001 002&&003 STOP COPY  
IEC 246 001 010 001 002&&003 STOP COPY  
  
U0 - CNCF  
;
```

```
rtrv-scr-  
cdpa:sr=cdp1:zone=1:area=2:id=3:ssn=1:nsfi=stop:scmgfid=1:pcst=s
```

```
rlghncxa03w 05-01-07 12:05:33 EST EAGLE 31.12.0  
SCREEN = ALLOWED CDPA  
SR ZONE AREA ID SSN SCMGFID NSFI NSR/ACT  
cdp1 s-1 002 3 1 1 STOP -----  
;
```

```
rtrv-scr-cdpa:sr=cdp1
```

```
rlghncxa03w 05-01-07 12:05:33 EST EAGLE 31.12.0  
SCREEN = ALLOWED CDPA  
SR ZONE AREA ID SSN SCMGFID NSFI NSR/ACT
```

```

cdp1 s-2      002      3      1      1      STOP      -----
SR      NPC
cdp1 s-00128      1      1      STOP      -----
;

rtrv-scr-cdpa:sr=cdp2:

```

```

eaglestp 28-02-13 12:05:33 EST EAGLE 45.1.0
SCREEN = ALLOWED CDPA
SR      UN      SNA      MNA      SSN      SCMGFID      NSFI      NSR/ACT
cdp2    001    02      01      1      1      STOP      -----
;

```

## Legend

For a summary report:

- **REF**—Indicates whether a screen is referenced by another screen. If NO, the screen is not used. For more detailed output, use the `rtrv-scr-cdpa:all=yes` command, or specify the specific screening reference.
- **RULES**—Number of screening rules in that screening table

For a detailed report:

- **SCREEN = ALLOWED CDPA**—Screen type
- **SR**—Screen sets being used. It can be up to four characters in length.
- **NI - NC - NCM**—Point code referenced within the screen. For international point codes, these columns are ZONE - AREA - ID . For 24-bit national point codes, these columns are MSA - SSA - SP. For 16-bit ITU national point codes, these columns are UN - SNA - MNA. For national point codes, these columns become the single column NPC.
- **SSN**—Subsystem number associated with the point code identified by the *ni-nc-ncm*.
- **SCMGFID**—SCMGFID format ID
- **NSFI**—Next screening category to be used
- **NSR/ACT**—Name of the next screening reference ( NSR - up to four characters) or action to be taken ( ACT - up to six characters), if the message passes this screen.

## Related Topics

- [chg-scr-cdpa](#)
- [dlt-scr-cdpa](#)
- [ent-scr-cdpa](#)

# rtrv-scr-cgpa

Use this command to show the allowed calling party address (CGPA) screening references in the CGPA entity set.

## Parameters

 **Note:**

The `nc`, `ncm`, and `ni` parameters can be specified as a single value, range of values, or an asterisk (\*). An \* value indicates the full range of values. The `area`, `id`, `msa`, `ni`, `nsr`, `ri`, `sp`, `ssa`, `ssn`, `un`, `sna`, `mna`, and `zone` parameters can be specified as a single value or as an \*.

### **actname (optional)**

The name of the gateway screening stop action set. Stop actions must be administered using this parameter in conjunction with the gateway screening stop action table (see `chg-gws-actset` and `rtrv-gws-actset`).

**Range:**

*ayyyyy*

1 alphabetic character followed by up to 5 alphanumeric characters.

*none* —Display gateway screening rules that do not have an assigned gateway screening stop action set

### **a11 (optional)**

Displays all allowed CGPA screening references.

**Range:**

*yes*

*no*

**Default:**

*no*

### **area (optional)**

ITU international area. The area in the point code represented by *zone-area-id*.

**Range:**

*000 - 255, \**

\* —the full range of values from 000–255

### **id (optional)**

ITU international ID. The ID in the point code represented by *zone-area-id*.

**Range:**

*0 - 7, \**

\* —the full range of values from 0–7

### **mna (optional)**

16-bit ITU national main number area. The *mna* in the point code represented by *un-sna-mna*.

**Range:**

*0 -- 31, \**

\* —the full range of values from 0–31

**msa (optional)**

24-bit ITU national main signaling area. The main signaling area specified in the point code represented by *msa-ssa-sp*.

**Range:**

000 - 255, \*

\* —the full range of values from 000-255

**nc (optional)**

Network cluster identifier value. This parameter displays entries containing this specific cluster of the point code represented by *ni-nc-ncm*.

**Range:**

0 - 255, \*

\* — the full range of values from 0–255

**Default:**

Display all

**ncm (optional)**

Network cluster member identifier value. This parameter display entries containing this specific cluster member of the point code represented by *ni-nc-ncm*.

**Range:**

0 - 255, \*

\* —the full range of values from 0–255

**Default:**

Display all

**ni (optional)**

Network identifier value. This parameter displays entries containing this specific network of the point code represented by *ni-nc-ncm*.

**Range:**

0 - 255, \*

\* — the full range of values from 0–255

**Default:**

Display all

**npc (optional)**

ITU national point code.

**Note:**

Gateway screening allows the ITU national point code to be displayed and entered in the database only as a single number. If you are using multiple-part ITU national point codes, see [Converting ITU National Point Code Formats](#) in Appendix A.

**Range:**

00000 - 16383, \*

\* —the full range of values from 00000–16383

**nsfi (optional)**

This parameter specifies the next screening category that is used in the gateway screening process, or it indicates that the gateway screening process should stop.

**Range: *cdpa, stop, tt***

*cdpa* —Allowed called party address point code is the next screening category.

*stop* —The gateway screening process ends and the message proceeds through normal routing.

*tt* —Allowed translation type point code is the next screening category.

**Default:**

Display all

**nsr (optional)**

The next screening reference parameter indicates which screening reference in the specified screening category (*nsfi*) is to be used in the screening process. This parameter is mandatory if *nsfi* is other than *stop* or *fail*. This parameter cannot be entered if *nsfi* is *stop* or *fail*, or the *copy=yes* parameter is specified.

**Range:**

*ayyy*

1 alphabetic character followed by up to 3 alphanumeric characters

**Default:**

Display all

**pcst (optional)**

Point code subtype indicator. This parameter indicates whether the ITU international or ITU national point codes to be displayed must have the spare point code prefix (s-).

**Range:**

*none*

No spare point code prefix required.

*s*

Spare point code prefix required.

**Default:**

*none*

**ri (optional)**

Routing indicator. Routing instructions to the receiving signaling point. In gateway screening, messages may be screened based on the value of the routing indicator.

**Range:**

*gt*

Allow a called party address with a routing indicator value of "global title."

*dpc*

Allow a called party address with a routing indicator value of "DPC/SSN."

*\**

Allow both routing indicator values.

**Default:**  
Display all

**sccpmt (optional)**  
SCCP message type.

**Range:**

**9**  
UDT

**10**  
UDTS

**17**  
XUDT

**18**  
XUDTS

**\***  
All possible allowed values (9, 10, 17, 18)

**Default:**  
Display all SCCP message types

**sna (optional)**  
16-bit ITU national main number area. The *sna* in the point code represented by *un-sna-mna*.

**Range:**  
*0 -- 15, \**  
\* —the full range of values from 0–15

**sp (optional)**  
24-bit ITU national signaling point. The signaling point in the point code represented by *msa-ssa-sp*.

**Range:**  
*000 - 255, \**  
\* —the full range of values from 000-255

**sr (optional)**  
The CGPA screening reference name

**Range:**  
*ayyy*  
1 alphabetic character followed by up to 3 alphanumeric characters

**Default:**  
Display all.

**ssa (optional)**  
24-bit ITU national sub signaling area. The sub signaling area specified in the point code. represented by *msa-ssa-sp*.

**Range:**

0 - 255, \*

\* — the full range of values from 000-255

**ssn (optional)**

Subsystem number.

**Range:**

0 - 255, \*

\* — the full range of values from 0–255

**Default:**

Display all.

**un (optional)**16-bit ITU-national unit number. The *un* of the point code represented by *un-sna-mna*.**Range:**

0 -- 127, \*

\* — the full range of values from 0–127

**zone (optional)**ITU international zone. The zone in the point code represented by *zone-area-id*.**Range:**

0 - 7, \*

\* — the full range of values from 0–7

**Example**

```
rtrv-scr-cgpa:sr=iec:ni=240:nc=001:ncm=010:ssn=012
```

```
rtrv-scr-cgpa:sr=iec:ni=240:nc=001:ncm=010:actname=copy
```

```
rtrv-scr-cgpa:sr=cgp1
```

```
rtrv-scr-
```

```
cgpa:sr=cgpa:zone=1:area=2:id=3:ssn=1:sccpmt=9:ri=*:nsfi=stop:pcst=s
```

```
rtrv-scr-cgpa:sr=cgp1:un=1:sna=2:mna=1:ssn=1:sccpmt=9:nsfi=stop:ri=*
```

**Dependencies**

If the *ni* parameter is specified as an asterisk or as a range, the *nc* and *ncm* parameters must be specified as an asterisk or as the full range 000 – 255.

If the *nc* parameter is specified as an asterisk, the *ncm* parameter must be specified as an asterisk or as the full range 000 – 255.

If the *nc* parameter is specified as a single value or a range, a single value must be specified for the *ni* parameter.

If the *nc* parameter is specified as a range, the *ncm* parameter must be specified as an asterisk or as the full range 000 – 255.

If the *ncm* parameter is specified as a single value, or a range other than the full range of 000 – 255, the *ni* and the *nc* parameters must be specified with a single value.

If the *actname* parameter is specified, the *nsr* parameter cannot be specified.



If the `actname` parameter is specified, the `nsfi=stop` parameter must be specified.

If the `actname` parameter is specified with the screening reference name parameter, the specified value for the `actname` parameter must be assigned to that screening reference name.

ANSI point code value 000-000-000 and ITU-International point code value 0-000-0 are not allowed.

If `zone=*` is specified, `area=*` and `id=*` must be specified.

If `area=*` is specified, `id=*` must be specified.

If `msa=*` is specified, `ssa=*` and `sp=*` must be specified.

If `ssa=*` is specified or re-specified, `sp=*` must also be specified.

If `un=*` is specified, `sna=*` and `mna=*` must be specified.

If `sna=*` is specified, `mna=*` must be specified.

The Spare Point Code Support feature must be enabled before the `pcst` parameter can be specified.

Any specified `ni`, `nc`, `ncm`, `zone`, `area`, `id`, `msa`, `ssa`, `sp`, `un`, `sna`, `mna`, `nep`, `nsfi`, `ri`, `ssn`, and `nsr` parameters must already exist in the CGPA entity for the screening reference.

If the `pcst` parameter is specified, point codes with the specified subtype prefix (no prefix or s-) must exist in the database.

The specified screening reference (`sr`) must be in the allowed CGPA entity set.

If the `nsfi=stop` parameter is specified, the `nsr` parameter cannot be specified.

The spare point code subtype prefix (s-) is not supported for ANSI point codes (parameters `ni`, `nc`, `ncm`) or for 24-bit ITU national point codes (parameters `msa`, `ssa`, `sp`) or for 16-bit ITU national point codes (parameters `un`, `sna`, `mna`). The `pcst` and `npcst` parameters cannot be specified for ANSI, ITU-N16 or ITU-N24 point codes.

The value of the `actname` parameter must already be defined in the Gateway Screening Stop Action table with the `chg-gws-actset` command. These values are shown in the *ACT NAME* field of the `rtrv-gws-actset` command output.

The Gateway Screening Stop Action table must be accessible.

The GWSOA parameter combination should be known and valid.

## Notes

This command can be canceled using the **F9** function key or the `canc-cmd` command. See `canc-cmd` for more information.

If no parameters are specified, the system displays a summary output.

If only the `all=yes` parameter is specified, the system displays a detailed output.

If the `all` parameter and any point code parameter are specified, the `all` parameter is ignored.

An asterisk as a parameter value in this command displays only entries that have an asterisk as the same parameter value in the entry.

A range of values is specified by separating the values that define the range by two ampersands (&&); for example, `ni=025&&100` specifies all network indicators for ANSI point codes from 25 - 100.

The spare point code subtype prefix `s-` is supported only for ITU international and ITU national point codes. The `pcst` parameter indicates whether the specified point code has no subtype prefix or has the spare point code prefix.

## Output

```
rtrv-scr-cgpa:sr=iec:ni=240:nc=001:ncm=010:ssn=012
```

```
rlghncxa03w 03-03-14 15:58:16 EST EAGLE 31.3.0
SCREEN = ALLOWED CGPA
SR   NI      NC      NCM      SSN      RI      SCCPMT  NSF1     NSR/ACT
IEC  240     001     010     012     DPC    009&&010 STOP     -----
```

```
;
```

```
rtrv-scr-cgpa:sr=iec:ni=240:nc=001-004:ri=dpc:sccpmt=000&&010
```

```
rlghncxa03w 03-03-14 15:58:16 EST EAGLE 31.3.0
SCREEN = ALLOWED CGPA
SR   NI      NC      NCM      SSN      RI      SCCPMT  NSF1     NSR/ACT
IEC  240     001     010     012     DPC    017&&018 STOP     -----
IEC  240     002&&003 *      004     DPC    009      STOP     -----
```

```
;
```

```
rtrv-scr-cgpa:actname=none
```

```
rlghncxa03w 03-03-14 15:58:16 EST EAGLE 31.3.0
SCREEN = ALLOWED CGPA
SR   NI      NC      NCM      SSN      RI      SCCPMT  NSF1     NSR/ACT
IEC  240     001     010     012     DPC    017      STOP     -----
IEC  240     001     010     014     GT     *        STOP     -----
IEC  241     002     011     014     GT     *        CDPA     CDP1
```

```
;
```

```
rtrv-scr-
cgpa:sr=cg01:nsfi=tt:nsr=tt01:ri=gt:ssn=1:sccpmt=9:msa=255:ssa=255:s
p=255
```

```
tekelecstp 03-03-05 14:41:37 EST EAGLE 31.0.0
SCREEN = ALLOWED CGPA
SR   MSA     SSA     SP      NSF1     NSR/ACT
cg01 255     255     255     1        GT     9        TT      tt01
```

```
;
```

```
rtrv-scr-
cgpa:sr=cgpa:zone=1:area=2:id=3:ssn=1:sccpmt=9:ri=*:nsfi=stop:p
cst=s
```

```
tekelecstp 05-01-05 14:41:37 EST EAGLE 31.12.0
SCREEN = ALLOWED CGPA
SR      ZONE  AREA   ID      SSN      RI  SCCPMT  NSFI
NSR/ACT
cgpa  s-1    002    3       1        *    9       STOP
-----
;
```

```
rtrv-scr-cgpa:sr=cgp1
```

```
tekelecstp 05-01-05 14:41:37 EST EAGLE 31.12.0
SCREEN = ALLOWED CGPA
SR      ZONE  AREA   ID      SSN      RI  SCCPMT  NSFI
NSR/ACT
cgp1  s-2    002    3       1        *    *       STOP
-----

SR      NPC
NSR/ACT
cgp1  s-00128
-----
;
```

```
rtrv-scr-cgpa:sr=cgp1:
```

```
eaglestp 28-02-13 14:41:37 EST EAGLE 45.1.0
SCREEN = ALLOWED CGPA
SR      UN   SNA   MNA     SSN      RI  SCCPMT  NSFI
NSR/ACT
cgp1  001  02    01      1        *    9       STOP
-----
;
```

### Legend

For a summary report:

- **REF**—Indicates whether a screen is referenced by another screen. If NO, the screen is not used. If you need a more detailed output, use the `rtrv-scr-cgpa:all=yes` command, or specify the specific screening reference.
- **RULES**—The number of screening rules in that screening table.

For a detailed report:

- **SCREEN = ALLOWED CGPA**—Screen type

- **SR**—Identifies the screen sets being used. It can be up to four characters in length.
- **NI - NC - NCM**—Point code referenced within the screen. For international point codes, these columns are ZONE - AREA - ID. For 24-bit ITU national point codes, these columns are MSA-SSA-SP. For 16-bit ITU national point codes, these columns are UN - SNA - MNA. For national point codes, these columns become the single column NPC.
- **SSN**—Subsystem number associated with the point code identified by the *ni-nc-ncm*
- **RI**—Routing indicator in the called party address
- **SCCPMT**—SCCP message type
- **NSFI**—Next screening category to be used
- **NSR/ACT**—Name of the next screening reference (NSR - up to four characters) or action to be taken (ACT - up to six characters), if the message passes this screen.

#### Related Topics

- [chg-scr-cgpa](#)
- [dlt-scr-cgpa](#)
- [ent-scr-cgpa](#)

## rtrv-scr-destfld

Use this command to show the attributes of one or more allowed affected destination field (DESTFLD) screening references and associated attributes (destination point code, next screening function identifier, next screening function reference) that are allowed to receive SS7 messages from another network.

#### Parameters

##### **actname (optional)**

The name of the gateway screening stop action set. Stop actions must be administered using this parameter with the gateway screening stop action table (see [chg-gws-actset](#) and [rtrv-gws-actset](#)).

##### **Range:**

*ayyyy*

1 alphabetic character followed by up to 5 alphanumeric characters.

*none*—Display gateway screening rules that do not have an assigned gateway screening stop action set

##### **a11 (optional)**

Displays all allowed DPC screening references.

##### **Range:**

*yes*

*no*

##### **Default:**

*no*

**area (optional)**

ITU international area. The area in the point code represented by *zone-area-id*.

**Range:**

000 - 255, \*

\* —the full range of values from 000–255

**Default:**

Display all

**id (optional)**

ITU international ID. The ID in the point code represented by *zone-area-id*.

**Range:**

0 - 7, \*

\* —the full range of values from 0–7

**Default:**

Display all

**mna (optional)**

16-bit ITU national main number area. The *mna* in the point code represented by *un-sna-mna*.

**Range:**

0 -- 31, \*

\* —the full range of values from 0–31

**msa (optional)**

24-bit ITU national main signaling area. The main signaling area in the point code represented by *msa-ssa-sp*.

**Range:**

000 - 255, \*

\* —the full range of values from 000-255

**nc (optional)**

Network cluster identifier value. This parameter displays entries containing the specific cluster of the point code represented by *ni-nc-ncm*.

**Range:**

0 - 255, \*

\* —the full range of values from 0–255

**Default:**

Display all

**ncm (optional)**

Network cluster member identifier value. This parameter displays entries containing the specific cluster member of the point code represented by *ni-nc-ncm*.

**Range:**

0 - 255, \*

\* — the full range of values from 0–255

**Default:**  
Display all

**ni (optional)**

Network identifier value. This parameter displays entries containing the specific network of the point code represented by *ni-nc-ncm*.

**Range:**  
0 - 255, \*  
\* —the full range of values from 0–255

**Default:**  
Display all

**npc (optional)**

ITU national point code.

 **Note:**

Gateway screening allows the ITU national point code to be displayed and entered in the database only as a single number. For multiple-part ITU national point codes, see [Converting ITU National Point Code Formats](#) in Appendix A.

**Range:**  
00000 - 16383  
\* —the full range of values from 00000–16383

**nsfi (optional)**

This parameter indicates that the gateway screening process should stop.

**Range:**

**stop**  
the gateway screening process ends and the message proceeds through normal routing

**Default:**  
Display all screening references

**nsr (optional)**

Next screening reference. This parameter indicates which screening reference in the specified screening category (*nsfi*) is to be used in the screening process.

**Range:**  
ayyy  
1 alphabetic character followed by up to 3 alphanumeric characters

**Default:**  
Display all

**pcst (optional)**

Point code subtype. This parameter indicates whether the specified ITU international or ITU national point code has no subtype prefix or has the spare point code prefix (s-).

**Range:**

*none*

*s*

**Default:**

*none*

**sna (optional)**

16-bit ITU national main number area. The *sna* in the point code represented by *un-sna-mna*.

**Range:**

*0 -- 15, \**

\* —the full range of values from 0–15

**sp (optional)**

24-bit ITU national signaling point. The signaling point in the point code represented by *msa-ssa-sp*.

**Range:**

*000 - 255, \**

\* —the full range of values from 000-255

**sr (optional)**

The name of the individual DESTFLD screen to be displayed.

**Range:**

*ayyy*

1 alphabetic character followed by up to 3 alphanumeric characters

**Default:**

Display all.

**ssa (optional)**

24-bit ITU national sub signaling area. The sub signaling area in the point code represented by *msa-ssa-sp*.

**Range:**

*0 - 255, \**

\* —the full range of values from 000-255.

**un (optional)**

16-bit ITU-national unit number. The *un* of the point code represented by *un-sna-mna*.

**Range:**

*0 -- 127, \**

\* —the full range of values from 0–127

**zone (optional)**

ITU international zone. The zone in the point code represented by *zone-area-id*.

**Range: 0 - 7, \***

*0 - 255, \**

\* — the full range of values from 0–7

### Example

```
rtrv-scr-destfld
rtrv-scr-destfld:sr=iec:ni=240:nc=001:ncm=010&&018
rtrv-scr-destfld:sr=iec:id=4:actname=cncf
rtrv-scr-destfld:all=yes
rtrv-scr-destfld:sr=dst1:zone=1:area=2:id=3:nsfi=stop:pcst=s
rtrv-scr-destfld:sr=dst1
rtrv-scr-destfld:sr=iec:un=125:sna=1:mna=10
```

### Dependencies

If the `actname` parameter is specified, the `nsfi=stop` parameter must be specified.

The `nsfi=stop` parameter must be specified.

The `nsr` parameter cannot be specified in the command if the `nsfi` parameter has a value of *stop* or *fail*.

If the `actname` parameter is specified, the `nsr` parameter cannot be specified.

The value of the `actname` parameter must already be defined in the Gateway Screening Stop Action table with the `chg-gws-actset` command. These values are shown in the ACT NAME field of the `rtrv-gws-actset` command output.

If the `actname` parameter is specified with the screening reference name parameter, the specified value for the `actname` parameter must be assigned to that screening reference name.

If the `ni` parameter is specified as an asterisk or as a range, the `nc` and `ncm` parameters must be specified as an asterisk or as the full range 000 – 255.

If the `nc` parameter is specified as an asterisk, the `ncm` parameter must be specified as an asterisk or as the full range 000 – 255.

If the `nc` parameter is specified as a single value or a range, a single value must be specified for the `ni` parameter.

If the `nc` parameter is specified as a range, the `ncm` parameter must be specified as an asterisk or as the full range 000 – 255.

If the `ncm` parameter is specified as a single value, or a range other than the full range of 000 – 255, the `ni` and `nc` parameters must be specified with a single value.

ANSI point code value 000-000-000 and ITU-International point code value 0-000-0 are not allowed.

If the `zone=*` parameter is specified, then the `area=*` and the `id=*` parameters must be specified.

If the `area=*` parameter is specified, then the `id=*` parameter must be specified.

If the `msa=*` parameter is specified, then the `ssa=*` and the `sp=*` parameters must be specified.



If the `un=*` parameter is specified, then the `sna=*` and the `mna=*` parameters must be specified.

If the `ssa=*` parameter is specified, then the `sp=*` parameter must be specified.

If the `sna=*` parameter is specified, then the `mna=*` parameter must be specified.

The specified screening reference (`sr`) must be in the allowed DESTFLD entity set.

The Spare Point Code Support feature must be enabled before the `pcst` parameter can be specified.

The spare point code subtype prefix (s-) is not supported for ANSI point codes (parameters `ni`, `nc`, `ncm`) or for 24-bit ITU national point codes (parameters `msa`, `ssa`, `sp`) or for 16-bit ITU national point codes (parameters `na`, `sna`, `mna`). The `pcst` parameter cannot be specified for ANSI, ITU-N16 or ITU-N24 point codes.

If the `pcst` parameter is specified, point codes with the specified subtype prefix (no prefix or s-) must exist in the database.

Any specified `area`, `sna` or `ssa` parameter must already exist in the database.

Any specified `id`, `sp` or `mna` parameter must already exist in the database.

Any specified `zone`, `un` or `msa` parameter must already exist in the database.

Any specified `nc` parameter must already exist in the database.

Any specified `ncm` parameter must already exist in the database.

Any specified `ni` parameter must already exist in the database.

Any specified `npc` parameter must already exist in the database.

Any specified `nsfi` parameter must already exist in the database.

Any specified `nsr` parameter must already exist in the database.

Any specified `pcst` parameter must already exist in the database.

If the `nsfi=fail` parameter is specified, then the `nni`, `nc`, `ncm`, `narea`, `nzone`, `nid`, `nmsa`, `nssa`, `nsp`, `nun`, `nsna`, `nmna`, and `npc` parameters cannot have a value of `c`.

The Gateway Screening Stop Action table must be accessible.

The GWSOA parameter combination should be known and valid.

## Notes

This command can be canceled using the **F9** function key or the `canc-cmd` command. See `canc-cmd` for more information.

If no parameters are specified, the system displays a summary output.

If only the `all=yes` parameter is specified, the system displays a detailed output.

If the `all` parameter and any point code parameter are specified, the `all` parameter is ignored.

The REF column of the output of this command displays *YES* when the screen is referenced by another screen; otherwise, it displays *NO*.

An asterisk as a parameter value in this command displays only entries that have an asterisk as the same parameter value in the entry.

A range of values is specified by separating the values that define the range by two ampersands (&&); for example, `ni=025&&100` specifies all network indicators for ANSI point codes from 25 - 100.

The spare point code subtype prefix (s-) is supported only for ITU international and ITU national point codes. The `pcst` parameter indicates whether the specified point code has no subtype prefix or has the spare point code prefix.

## Output

```
rtrv-scr-destfld
```

```
rlghncxa03w 03-03-13 13:12:38 EST EAGLE 31.3.0
SCREEN = ALLOWED DESTFLD
SR   REF  RULES
IEC  YES   2
WRD2 YES   1
WRD3 NO    4
WRD4 YES   9
```

```
;
```

```
rtrv-scr-destfld:sr=iec:ni=240:nc=001:ncm=010&&018
```

```
rlghncxa03w 03-03-13 13:13:21 EST EAGLE 31.3.0
SCREEN = ALLOWED DESTFLD
SR   NI      NC      NCM      NSFI  NSR/ACT
IEC  240     001     010&&020 STOP  -----
```

```
;
```

```
rtrv-scr-destfld:sr=iec:id=4:actname=cncf
```

```
rlghncxa03w 03-03-13 13:13:56 EST EAGLE 31.3.0
SCREEN = ALLOWED DESTFLD
SR   ZONE   AREA   ID      NSFI  NSR/ACT
IEC  1       003    4       STOP  CNCF
```

```
;
```

```
rtrv-scr-destfld:all=yes
```

```
rlghncxa03w 03-03-13 13:14:18 EST EAGLE 31.3.0
SCREEN = ALLOWED DESTFLD
SR   NI      NC      NCM      NSFI  NSR/ACT
IEC  240     001     010     STOP  CNCF
IEC  241     010     *       STOP  -----

SR   ZONE   AREA   ID      NSFI  NSR/ACT
IEC  1       003    4       STOP  -----
```

```

IEC 1          003      5          STOP  CR

SR   NPC
IEC  00235
IEC  00240          STOP  -----
;

rtrv-scr-destfld:sr=dst1:zone=1:area=2:id=3:nsfi=stop:pcst=s

```

```

tekelecstp 05-01-06 11:40:26 EST  EAGLE 31.12.0
SCREEN = ALLOWED DESTFLD
SR      ZONE  AREA  ID      NSFI  NSR/ACT
dst1   s-1   002   3      STOP  -----
;

```

```
rtrv-scr-destfld:sr=dst1
```

```

tekelecstp 05-01-06 11:40:26 EST  EAGLE 31.12.0
SCREEN = ALLOWED DESTFLD
SR      ZONE  AREA  ID      NSFI  NSR/ACT
dst1   s-1   002   3      STOP  -----

SR      NPC
dst1   s-00128          STOP  -----
;

```

```
rtrv-scr-destfld:sr=ds01
```

```

tekelecstp 13-07-05 16:27:55 EST  45.0.0-64.69.0
rtrv-scr-destfld:sr=ds01
Command entered at terminal #4.
SCREEN = ALLOWED DESTFLD
SR      UN      SNA  MNA  NSFI  NSR/ACT
ds01   001     14   01   STOP  -----
;

```

## Legend

For a summary report:

- **REF**—Indicates whether a screen is referenced by another screen. If NO, the screen is not used. If you need a more detailed output, use the `rtrv-scr-destfld:all=yes` command, or specify the specific screening reference.
- **RULES**—Number of screening rules in that screening table.

For a detailed report:

- **SCREEN = ALLOWED DESTFLD**—Screen type

- **SR**—Identifies the various screen sets being used. It can be up to four characters in length.
- **NI - NC - NCM**—Point code referenced within the screen. For international point codes, these columns are ZONE - AREA - ID. For 24-bit ITU national point codes, these columns are MSA-SSA-SP. For 16-bit ITU national point codes, these columns are UN-SNA-MNA. For national point codes, these columns become the single column NPC.
- **NSFI**—Next screening category to be used
- **NSR/ACT**—Name of the next screening reference (NSR - up to four characters) or action to be taken (ACT - up to six characters), if the message passes this screen.

#### Related Topics

- [chg-gws-actset](#)
- [chg-scr-destfld](#)
- [dlt-scr-destfld](#)
- [ent-scr-destfld](#)
- [rtrv-gws-actset](#)

## rtrv-scr-dpc

Use this command to show the attributes of one or more allowed DPC screening references and associated attributes (destination point code, next screening function identifier, next screening function reference) that are allowed to receive SS7 messages from another network.

#### Parameters

##### **actname (optional)**

The name of the gateway screening stop action set. Stop actions must be administered using this parameter with the gateway screening stop action table (see [chg-gws-actset](#) and [rtrv-gws-actset](#)).

##### **Range:**

*ayyyy*

1 alphabetic character followed by up to 5 alphanumeric characters.

*none* —Display gateway screening rules that do not have an assigned gateway screening stop action set

##### **a11 (optional)**

Displays all allowed DPC screening references.

##### **Range:**

*yes*

*no*

##### **Default:**

*no*

##### **area (optional)**

ITU international area. The area in the point code represented by *zone-area-id*.

**Range:**

000 - 255, \*

\*—the full range of values from 000–255

**id (optional)**ITU international ID. The ID in the point code represented by *zone-area-id*.**Range:**

0 - 7, \*

\*—the full range of values from 0–7

**mna (optional)**16-bit ITU national main number area. The *mna* in the point code represented by *un-sna-mna*.**Range:**

0 -- 31, \*

\*—the full range of values from 0–31

**msa (optional)**24-bit ITU national main signaling area. The main signaling area specified in the point code represented by *msa-ssa-sp*.**Range:**

000 - 255

\* — the full range of values from 000-255

**nc (optional)**Network cluster identifier value. This parameter displays entries containing the specific cluster of the point code represented by *ni-nc-ncm*.**Range:**

0 - 255, \*

\*—the full range of values from 0–255

**Default:**

Display all

**ncm (optional)**Network cluster member identifier value. This parameter displays entries containing this specific cluster member of the point code represented by *ni-nc-ncm*.**Range:**

0 - 255, \*

\*—the full range of values from 0–255

**Default:**

Display all

**ni (optional)**Network identifier value. This parameter displays entries containing this specific network of the point code represented by *ni-nc-ncm*.**Range:**

0 - 255, \*

\*—the full range of values from 0–255

**Default:**  
Display all

**npc (optional)**  
ITU national point code.



**Note:**

Gateway screening allows the ITU national point code to be displayed and entered in the database only as a single number. For multiple-part ITU national point codes, see [Converting ITU National Point Code Formats](#).

**Range:**  
00000 - 16383, \*  
\*—the full range of values from 00000–16383

**nsfi (optional)**  
This parameter specifies the next screening category that is used in the gateway screening process, or it indicates that the gateway screening process should stop.

**Range:**

***blkdpc***

Blocked DPC is the next screening category

***cgpa***

Allowed calling party address is the next screening category.

***destfld***

Allowed destination field (DESTFLD) is the next screening category.

***isup***

ISUP message type (ISUP) is the next screening category.

***stop***

The gateway screening process ends and the message proceeds through normal routing.

**Default:**  
Display all screening references

**nsr (optional)**  
Next screening reference parameter indicates which screening reference in the specified screening category (*nsfi*) is to be used in the screening process. This parameter is mandatory if *nsfi* is other than *stop* or *fail*. The *nsr* parameter cannot be entered if *nsfi* is *stop* or *fail*, or the *copy=yes* parameter is specified.

**Range:**  
*ayyy*  
1 alphabetic character followed by up to 3 alphanumeric characters

**Default:**  
Display all

**pcst (optional)**

Point code subtype. This parameter indicates whether the specified ITU international or ITU national point code has no subtype prefix or has the spare point code prefix (S-).

**Range:**

*none*

*s*

**Default:**

*none*

**sna (optional)**

16-bit ITU national main number area. The *sna* in the point code represented by *un-sna-mna*.

**Range:**

*0 -- 15, \**

\* —the full range of values from 0–15

**sp (optional)**

24-bit ITU national signaling point. The signaling point in the point code represented by *msa-ssa-sp*.

**Range:**

*000 - 255, \**

\* —the full range of values from 000-255

**sr (optional)**

The allowed DPC screening reference name

**Range:**

*ayyy*

1 alphabetic character followed by up to 3 alphanumeric characters

**Default:**

Display all.

**ssa (optional)**

24-bit ITU national sub signaling area. The sub signaling area in the point code represented by *msa-ssa-sp*.

**Range:**

*0 - 255, \**

\* — the full range of values from 000-255

**un (optional)**

16-bit ITU-national unit number. The *un* of the point code represented by *un-sna-mna*.

**Range:**

*0 -- 127, \**

\* —the full range of values from 0–127

**zone (optional)**

ITU international zone. The zone in the point code represented by *zone-area-id*.

**Range:**

0 - 7, \*

\* — the full range of values from 0–7

**Example**

```
rtrv-scr-dpc
rtrv-scr-dpc:sr=iec:ni=240:nc=001:ncm=010&&018
rtrv-scr-dpc:sr=iec:id=4
rtrv-scr-dpc:all=yes
rtrv-scr-dpc:all=yes:actname=cncf
rtrv-scr-dpc:sr=dpc1:npc=128:nsfi=stop:pcst=s
rtrv-scr-dpc:sr=dpc2:un=1:sna=2:mna=3
```

**Dependencies**

ANSI point code value 000-000-000 and ITU-International point code value 0-000-0 are not allowed.

The specified screening reference (*sr*) must be in the allowed DPC entity set.

Any specified *ni* parameter must already exist in the allowed DPC entity for the screening reference.

The Spare Point Code Support feature must be enabled before the *pcst* parameter can be specified.

The spare point code subtype prefix (s-) is not supported for ANSI point codes (parameters *ni*, *nc*, *ncm*) or for 24-bit ITU national point codes (parameters *msa*, *ssa*, *sp*) or for 16-bit ITU national point codes (parameters *un*, *sna*, *mna*). The *pcst* parameter cannot be specified for ANSI, ITU-N16 or ITU-N24 point codes.

If the *pcst* parameter is specified, point codes with the specified subtype prefix (no prefix or s-) must exist in the database.

If the *ni=\** parameter is specified, then the *nc=\** and *ncm=\** parameters must be specified.

If the *nc=\** parameter is specified, then the *ncm=\** parameter must be specified.

If the *zone=\** parameter is specified, then the *area=\** and the *id=\** parameters must be specified.

If the *area=\** parameter is specified, then the *id=\** parameter must be specified.

If the *msa=\** parameter is specified, then the *ssa=\** and the *sp=\** parameters must be specified.

If the *un=\** parameter is specified, then the *sna=\** and the *mna=\** parameters must be specified.

If the *ssa=\** parameter is specified, then the *sp=\** parameter must be specified.



If the `sna=*` parameter is specified, then the `mna=*` parameter must be specified.

If the value of the `nsfi=stop` parameter is specified, then the `nsr` parameter cannot be specified.

If the `nsr` parameter is specified, then the `actname` parameter cannot be specified.

If the `actname` parameter is specified, then the `nsfi=stop` parameter must be specified.

The value of the `actname` parameter must already be defined in the Gateway Screening Stop Action table with the `chg-gws-actset` command. These values are shown in the ACT NAME field of the `rtrv-gws-actset` command output.

If the `actname` parameter is specified with the screening reference name parameter, the specified value for the `actname` parameter must be assigned to that screening reference name.

Any specified `npc` parameter must already exist in the allowed DPC entity for the screening reference.

Any specified `ncm` parameter must already exist in the allowed DPC entity for the screening reference.

Any specified `nc` parameter must already exist in the allowed DPC entity for the screening reference.

Any specified `nsfi` parameter must already exist in the allowed DPC entity for the screening reference.

Any specified `nsr` parameter must already exist in the allowed DPC entity for the screening reference.

Any specified `pcst` parameter must already exist in the allowed DPC entity for the screening reference.

Any specified `area`, `sna` or `ssa` parameter must already exist in the allowed DPC entity for the screening reference.

Any specified `id`, `mna` or `sp` parameter must already exist in the allowed DPC entity for the screening reference.

Any specified `zone`, `un` or `msa` parameter must already exist in the allowed DPC entity for the screening reference.

If the `nsfi=fail` parameter is specified, then the `ni`, `nc`, `ncm`, `area`, `zone`, `nid`, `msa`, `ssa`, `sp`, `un`, `sna`, `mna`, and `npc` parameters cannot have a value of `c`.

The Gateway Screening Stop Action table must be accessible.

The GWSOA parameter combination should be known and valid.

## Notes

This command can be canceled using the **F9** function key or the `canc-cmd` command. See `canc-cmd` for more information.

If no parameters are specified, a list of allowed DPC references is displayed indicating whether they are referenced or not.

If a single allowed DPC screening reference is specified, the specified entity set requested is shown.

If `all=yes` and no other parameter is specified, detailed information for all of the screening reference entities in the allowed DPC entity set are shown.

If the `all` parameter is specified and other parameters are also specified, the `all` parameter is ignored.

An asterisk as a parameter value in this command displays only entries that have an asterisk as the same parameter value in the entry.

A range of values is specified by separating the values that define the range by two ampersands (&&); for example, `ni=025&&100` specifies all network indicators for ANSI point codes from 25 - 100 .

The spare point code subtype prefix (s-) is supported only for ITU international and ITU national point codes. The `pcst` parameter indicates whether the specified point code has no subtype prefix or has the spare point code prefix.

## Output

```
rtrv-scr-dpc
```

```
rlghncxa03w 03-03-13 13:12:38 EST EAGLE 31.3.0
SCREEN = ALLOWED DPC
SR   REF  RULES
IEC  YES   2
WRD2 YES   1
WRD3 NO    4
WRD4 YES   9
```

```
;
```

```
rtrv-scr-dpc:sr=iec:ni=240:nc=001:ncm=010&&018
```

```
rlghncxa03w 03-03-13 13:13:21 EST EAGLE 31.3.0
SCREEN = ALLOWED DPC
SR  NI      NC      NCM      NSFI     NSR/ACT
IEC 240      001     010&&020 STOP     -----
```

```
;
```

```
rtrv-scr-dpc:sr=iec:id=4
```

```
rlghncxa03w 03-03-13 13:13:56 EST EAGLE 31.3.0
SCREEN = ALLOWED DPC
SR   ZONE   AREA   ID      NSFI     NSR/ACT
IEC  1       003    4       BLKOPC  blk1
```

```
;
```

```
rtrv-scr-dpc:all=yes
```

```
rlghncxa03w 03-03-13 13:14:18 EST EAGLE 31.3.0
SCREEN = ALLOWED DPC
SR   NI      NC      NCM      NSF1     NSR/ACT
IEC  240     001     010     STOP     -----
IEC  241     010     *       CGPA     cg04

SR   ZONE    AREA    ID       NSF1     NSR/ACT
IEC  1       003     4       BLKDPC  blk1
IEC  1       003     5       STOP     -----

SR   NPC
IEC  00235
IEC  00240
NSF1     CGPA     cg04
NSF1     CGPA     cg01
```

```
;
```

```
rtrv-scr-dpc:sr=dpc1:actname=copy
```

```
rlghncxa03w 03-03-13 13:16:13 EST EAGLE 31.3.0
SCREEN = ALLOWED DPC
SR   NI      NC      NCM      NSF1     NSR/ACT
dpc1 010     010     010     STOP     COPY
dpc1 010     010     012     STOP     COPY
```

```
;
```

```
rtrv-scr-dpc:sr=dpc1:npc=128:pcst=s
```

```
tekelecstp 05-01-06 11:29:11 EST EAGLE 31.12.0
SCREEN = ALLOWED DPC
SR   NPC
dpc1 s-00128
NSF1     STOP     -----
```

```
;
```

```
rtrv-scr-dpc:sr=dpc1
```

```
tekelecstp 05-01-06 11:29:11 EST EAGLE 31.12.0
SCREEN = ALLOWED DPC
SR   ZONE    AREA    ID       NSF1     NSR/ACT
dpc1 s-1       002     3       STOP     -----

SR   NPC
dpc1 s-00128
NSF1     STOP     -----
```

```
;
```

```
dlt-scr-dpc:sr=dpc2:

eaglestp 28-02-13 13:13:56 EST EAGLE 45.1.0
  SCREEN = ALLOWED DPC
  SR      UN      SNA      MNA      NSFI      NSR/ACT
  dpc2    001      02      01      STOP      -----
;
```

### Legend

For a summary report:

- **REF**—Indicates whether a screen is referenced by another screen. If NO, the screen is not used. For more detailed output, use the `rtv-scr-dpc:all=yes` command, or specify the specific screening reference.
- **RULES**—Number of screening rules in that screening table

For a detailed report:

- **SCREEN = ALLOWED DPC**—Screen type
- **SR**—Identifies the screen sets being used. It can be up to four characters in length.
- **NI-NC-NCM**—Point code referenced within the screen. For international point codes, these columns are ZONE-AREA-ID. For 24-bit ITU national point codes, these columns are MSA-SSA-SP. For 16-bit ITU national point codes, these columns are UN-SNA-MNA. For national point codes, these columns become the single column NPC.
- **NSFI**—Next screening category to be used
- **NSR/ACT**—Name of the next screening reference (NSR - up to four characters) or action to be taken (ACT - up to six characters), if the message passes this screen.

### Related Topics

- [chg-scr-dpc](#)
- [chg-gws-actset](#)
- [dlt-scr-dpc](#)
- [ent-scr-dpc](#)
- [rtv-gws-actset](#)

## rtv-scr-isup

Use this command to display one allowed ISUP screening reference or all allowed ISUP screening references in the Allowed ISUP entity set.

### Parameters

#### **actname (optional)**

The name of the gateway screening stop action set. Stop actions must be administered using this parameter with the gateway screening stop action table (see `chg-gws-actset` and `rtv-gws-actset`).

**Range:***ayyyy*

1 alphabetic character followed by up to 5 alphanumeric characters.

**a11 (optional)**

This parameter displays all allowed ISUP screening references in the Allowed ISUP entity set.

**Range:***yes**no***Default:***no***isupmt/tupmt (optional)**ISUP message type or TUP message type in the specified entry. The *tupmt* parameter is not valid for SEAS. A single value or range of values can be entered.**Range:***000 - 255, \**

\*—the entire range of 0-255

**nsfi (optional)**

This parameter specifies the next screening category that is used in the gateway screening process.

**Range: stop ,***stop* —The gateway screening process ends and the message proceeds through normal routing.**nsr (optional)**

Next screening reference.

**Range:***ayyy*

1 alphabetic character followed by up to 3 alphanumeric characters

**Default:**

No value given

**sr (optional)**

The individual ISUP screen to be displayed.

**Range:***ayyy*

1 alphabetic character followed by up to 3 alphanumeric characters

**Example**

```
rtrv-scr-isup:sr=iec:isupmt=1:nisupmt=1&&2
```

```
rtrv-scr-isup:sr=tu01:tupmt=0&&255
```

## Dependencies

If the `nsfi` parameter is specified, the value must be `stop`.

The `nsr` parameter cannot be specified if the `actname` parameter is specified.

The `nsr` parameter cannot be specified if the `nsfi=stop` parameter is specified.

If `sr` is specified, the value must exist in the database.

The value of the `actname` parameter must be defined in the gateway screening stop action table with the `chg-gws-actset` command. These values are shown in the ACT NAME field of the `rtrv-gws-actset` command output.

The GWSOA parameter combination should be known and valid.

## Notes

This command can be canceled using the **F9** function key or the `canc-cmd` command. See `canc-cmd` for more information.

A range of values for the `isupmt` or `tupmt` parameter can be specified by separating the values that define the range by two ampersands (&&); for example, `isupmt=025&&100` specifies all ISUP message types from 25 - 100. The value to the left of the && must be less than the value to the right of the && in the range.

An asterisk can be used for a parameter value in the `chg/dlt/rtrv-scr-isup` commands only if that parameter value was specified as an asterisk in the `ent-scr-isup` command to define the parameter value.

If no parameters are specified, a list of allowed ISUP references is produced indicating whether they are referenced or not.

## Output

```
rtrv-scr-isup
```

```
tekelecstp 02-09-02 11:10:38 EST EAGLE 30.0.0
SCREEN = ALLOWED ISUP
SR    REF  RULES
iall  NO    1
ibig  NO    1
iec   NO    2
is01  YES    1
is02  YES    1
isu   NO    1
isu1  NO    1
isu2  NO    1
isw1  NO    1
```

```
;
```

```
rtrv-scr-isup:sr=iall
```

```
tekelecstp 02-09-02 11:13:25 EST EAGLE 30.0.0
SCREEN = ALLOWED ISUP
SR  ISUPMT  NSFI  NSR/ACT
iall *      STOP  -----
```

```
;
```

```
rtrv-scr-isup:sr=iec:isupmt=1&&9
```

```
tekelecstp 02-09-02 11:13:25 EST EAGLE 30.0.0
SCREEN = ALLOWED ISUP
SR  ISUPMT  NSFI  NSR/ACT
iec 001&&002 STOP  -----
iec 009      STOP  -----
```

```
;
```

```
rtrv-scr-isup:isupmt=*
```

```
tekelecstp 02-09-02 11:13:25 EST EAGLE 30.0.0
SCREEN = ALLOWED ISUP
SR  ISUPMT  NSFI  NSR/ACT
iall *      STOP  -----
isu2 *      STOP  -----
isw1 *      STOP  -----
```

```
;
```

```
rtrv-scr-isup:sr=tu01:tupmt=0&&255
```

```
tekelecstp 03-11-13 13:10:02 EST EAGLE 31.4.0
SCREEN = ALLOWED ISUP
SR  ISUPMT  NSFI  NSR/ACT
    TUPMT/
tu01 002    STOP  -----
```

```
;
```

```
rtrv-scr-isup:all=yes
```

```
tekelecstp 02-09-13 13:10:02 EST EAGLE 30.0.0
SCREEN = ALLOWED ISUP
SR  ISUPMT  NSFI  NSR/ACT
is01 001    STOP  -----
is02 001&&010 STOP  -----
```

```

is03 *          STOP  -----
;

```

### Legend

- **REF**—Indicates whether a screen is referenced by another screen. If NO, the screen is not used. For more detailed output, use the `rtrv-scr-isup:all=yes` command, or specify the specific screening reference.
- **RULES**—Number of screening rules in that screening table

For a detailed report:

- **SCREEN = ALLOWED ISUP**—Screen type
- **SR**—Identifies the various screen sets being used. It can be up to four characters in length.
- **ISUPMT/TUPMT**—ISUP or TUP Message type in the entry
- **NSFI**—Next screening category to be used
- **NSR/ACT**—Name of the next screening reference (NSR - up to four characters) or action to be taken (ACT - up to six characters), if the message passes this screen.

### Related Topics

- [chg-scr-isup](#)
- [dlt-scr-isup](#)
- [ent-scr-isup](#)

## rtrv-scr-opc

Use this command to show an allowed OPC screening reference and associated attributes (originating point code, next screening function identifier, next screening function reference).

### Parameters

#### **actname (optional)**

Name of the gateway screening stop action set. Stop actions must be administered using this parameter with the gateway screening stop action table (see `chg-gws-actset` and `rtrv-gws-actset` ).

#### **Range:**

*ayyyy*

1 alphabetic character followed by up to 5 alphanumeric characters.

*none* —Display gateway screening rules that do not have an assigned gateway screening stop action set

#### **a11 (optional)**

Displays all allowed OPC screening references.

#### **Range:**

*yes*



**no**

**Default:**  
Display all

**area (optional)**

ITU international area. The area in the point code represented by *zone-area-id*.

**Range:**  
000 - 255, \*  
\* —the full range of values from 000–255

**id (optional)**

ITU international ID. The ID in the point code represented by *zone-area-id*.

**Range:**  
0 - 7, \*  
\* —the full range of values from 0–7

**mna (optional)**

16-bit ITU national main number area. The *mna* in the point code represented by *un-sna-mna*.

**Range:**  
0 -- 31, \*  
\* —the full range of values from 0–31

**msa (optional)**

24-bit ITU national main signaling area. The main signaling area in the point code represented by *msa-ssa-sp*.

**Range:**  
000 - 255, \*  
\* —the full range of values from 000-255

**nc (optional)**

Network cluster identifier value. This parameter displays entries containing this specific cluster of the point code represented by *ni-nc-ncm*.

**Range:**  
0 - 255, \*  
\* —the full range of values from 0–255

**Default:**  
Display all

**ncm (optional)**

Network cluster member identifier value. This parameter displays entries containing this specific cluster member of the point code represented by *ni-nc-ncm*.

**Range:**  
0 - 255, \*  
\* —the full range of values from 0–255

**Default:**  
Display all

**ni (optional)**

Network identifier value. This parameter displays entries containing this specific network of the point code represented by *ni-nc-ncm*.

**Range:**

0 - 255

\* —the full range of values from 0–255

**Default:**

Display all

**npc (optional)**

ITU national point code.

 **Note:**

Gateway screening allows the ITU national point code to be displayed and entered in the database only as a single number. If you are using multiple-part ITU national point codes, see [Converting ITU National Point Code Formats](#) in Appendix A.

**Range:**

00000 - 16383, \*

\* —the full range of values from 00000–16383

**nsfi (optional)**

This parameter specifies the next screening category that is used in the gateway screening process, or it indicates that the gateway screening process should stop.

**Range:*****blkopc***

Blocked OPC is the next screening category.

***sio***

Allowed SIO is the next screening category

***dpc***

Allowed DPC is the next screening category.

***blkdpc***

Blocked DPC is the next screening category

***cgpa***

Allowed calling party address is the next screening category.

***stop***

The gateway screening process ends and the message proceeds through normal routing.

**Default:**

Display all screening references

**nsr (optional)**

Next Screening Reference. This parameter indicates which screening reference in the specified screening category (*nsfi*) is to be used in the screening process. This parameter is mandatory if *nsfi* is other than *stop* or *fail*. This parameter cannot be specified if *nsfi* is *stop* or *fail*, or the *copy=yes* parameter is specified.

**Range:**

*ayyy*

1 alphabetic character followed by up to 3 alphanumeric characters

**Default:**

Display all

**pcst (optional)**

Point code subtype. This parameter indicates whether the specified ITU international or ITU national point code has no subtype prefix or has the spare point code prefix (S-).

**Range:**

*none*

*s*

**Default:**

*none*

**sna (optional)**

16-bit ITU national sub number area. The *sna* in the point code represented by *un-sna-mna*.

**Range:**

*0 -- 15, \**

\* —the full range of values from 0–15

**sp (optional)**

24-bit ITU national signaling point. The signaling point in the point code represented by *msa-ssa-sp*.

**Range:**

*000 - 255, \**

\* —the full range of values from 000-255

**sr (optional)**

The allowed OPC screening reference name

**Range:**

*ayyy*

1 alphabetic character followed by up to 3 alphanumeric characters

**Default:**

Display all.

**ssa (optional)**

24-bit ITU national sub signaling area. The sub signaling area *i* in the point code represented by *msa-ssa-sp*.

**Range:**

0 - 255, \*

\* — the full range of values from 000-255

**un (optional)**16-bit ITU-national unit number. The *un* of the point code represented by *un-sna-mna*.**Range:**

0 -- 127, \*

\* —the full range of values from 0–127

**zone (optional)**ITU international zone. The zone in the point code represented by *zone-area-id*.**Range:**

0 - 7, \*

\* —the full range of values from 0–7

**Example**

```

rtrv-scr-opc
rtrv-scr-opc:sr=iec:ni=240:nc=001:ncm=010&&018
rtrv-scr-opc:sr=iec:id=4
rtrv-scr-opc:all=yes
rtrv-scr-opc:sr=opc1:actname=cr
rtrv-scr-opc:sr=opc1:npc=128:nsfi=fail:pcst=s
rtrv-scr-opc:sr=opc2:un=1:sna=2:mna=3

```

**Dependencies**

ANSI point code value 000-000-000 and ITU-International point code value 0-000-0 are not allowed.

If the *ni=\** parameter is specified, the *nc=\** and *ncm=\** parameters must be specified.

If the *nc=\** parameter is specified, then the *ncm=\** parameter must be specified.

If the *zone=\** parameter is specified, then the *area=\** and *id=\** parameters must be specified.

If the *area=\** parameter is specified, then the *id=\** parameter must be specified.

If the *msa=\** parameter is specified, then the *ssa=\** and *sp=\** parameters must be specified.

If the *ssa=\** parameter is specified, then the *sp=\** parameter must be specified.

If the *un=\** parameter is specified, then the *sna=\** and the *mna=\** must be specified.

If the *sna=\** parameter is specified, then the *mna=\** parameter must be specified.

If the *ni* parameter is specified as an asterisk or as a range, the *nc* and *ncm* parameters must be specified as an asterisk or as the full range 000 – 255.

If the *nc* parameter is specified as an asterisk, the *ncm* parameter must be specified as an asterisk or as the full range 000 – 255.

If the `nc` parameter is specified as a single value or a range, a single value must be specified for the `ni` parameter.

If the `nc` parameter is specified as a range, the `ncm` parameter must be specified as an asterisk or as the full range 000 – 255.

If the `ncm` parameter is specified as a single value, or a range other than the full range of 000 – 255, the `ni` and `nc` parameters must be specified with a single value.

If the `nsr` parameter is specified, then the `actname` parameter cannot be specified.

If the `actname` parameter is specified, the `nsfi=stop` parameter must be specified.

If the `nsfi=stop` parameter is specified, then the `nsr` parameter cannot be specified.

The value of the `actname` parameter must already be defined in the Gateway Screening Stop Action table with the `chg-gws-actset` command. These values are shown in the ACT NAME field of the `rtrv-gws-actset` command output.

If the `actname` parameter is specified with the screening reference name parameter, the specified value for the `actname` parameter must be assigned to that screening reference name.

The specified screening reference must be in the allowed OPC entity set.

The Spare Point Code Support feature must be enabled before the `pcst` parameter can be specified.

The spare point code subtype prefix (s-) is not supported for ANSI point codes (parameters `ni`, `nc`, `ncm`) or for 24-bit ITU national point codes (parameters `msa`, `ssa`, `sp`) for 16-bit ITU national point codes (parameters `un`, `sna`, `mna`). The `pcst` parameter cannot be specified for ANSI, ITU-N16 or ITU-N24 point codes.

If the `pcst` parameter is specified, point codes with the specified subtype prefix (no prefix or s-) must exist in the database.

Any specified `ni` parameter must already exist in the allowed OPC entity for the screening reference.

Any specified `nc` parameter must already exist in the allowed OPC entity for the screening reference.

Any specified `ncm` parameter must already exist in the allowed OPC entity for the screening reference.

Any specified `npc` parameter must already exist in the allowed OPC entity for the screening reference.

Any specified `nsfi` parameter must already exist in the allowed OPC entity for the screening reference.

Any specified `nsr` parameter must already exist in the allowed OPC entity for the screening reference.

Any specified `pcst` parameter must already exist in the allowed OPC entity for the screening reference.

Any specified `area`, `sna` or `ssa` parameter must already exist in the allowed OPC entity for the screening reference.

Any specified `id`, `mna` or `sp` parameter must already exist in the allowed OPC entity for the screening reference.

Any specified `zone`, `un` or `msa` parameter must already exist in the allowed OPC entity for the screening reference.

If the `nsfi=fail` parameter is specified, then the `ni`, `nc`, `ncm`, `area`, `zone`, `id`, `msa`, `ssa`, `sp`, `un`, `sna`, `mna`, and `npc` parameters cannot have a value of `c`.

The Gateway Screening Stop Action table must be accessible.

The GWSOA parameter combination should be known and valid.

## Notes

This command can be canceled using the **F9** function key or the `canc-cmd` command. See `canc-cmd` for more information.

If no parameters are specified, a list of allowed OPC references is produced indicating whether they are referenced or not.

If a single allowed OPC screening reference is specified, the specified entity set requested is shown.

If `all=yes` and no other parameter is specified, detailed information for all of the screening reference entities in the allowed OPC entity set are shown.

If `all` is specified and other parameters are also specified, the `all` parameter is ignored.

An asterisk specified as a parameter value in this command displays only entries that have an asterisk as the same parameter value in the entry.

A range of values is specified by separating the values that define the range by two ampersands (`&&`); for example, `ni=025&&100` specifies all network indicators for ANSI point codes from 25 - 100.

The spare point code subtype prefix `s-` is supported only for ITU international and ITU national point codes. The `pcst` parameter indicates whether the specified point code has no subtype prefix or has the spare point code prefix.

## Output

```
rtrv-scr-opc
```

```
rlghncxa03w 03-03-13 13:12:38 EST EAGLE 31.3.0
SCREEN = ALLOWED OPC
SR   REF  RULES
IEC  YES   2
WRD2 YES   1
WRD3 NO    4
WRD4 YES   9
```

```
;
```

```
rtrv-scr-opc:sr=iec:ni=240:nc=001:ncm=010&&018
```

```
rlghncxa03w 03-03-13 13:13:21 EST EAGLE 31.3.0
```

```
SCREEN = ALLOWED OPC
SR   NI      NC      NCM      NSFI      NSR/ACT
IEC  240     001     010&&020 STOP    -----
;
```

```
rtrv-scr-opc:sr=iec:id=4
```

```
rlghncxa03w 03-03-13 13:13:56 EST  EAGLE 31.3.0
SCREEN = ALLOWED OPC
SR   ZONE     AREA     ID      NSFI      NSR/ACT
IEC  1        003      4       BLKOPC   blk1
;
```

```
rtrv-scr-opc:all=yes
```

```
rlghncxa03w 03-03-13 13:14:18 EST  EAGLE 31.3.0
SCREEN = ALLOWED OPC
SR   NI      NC      NCM      NSFI      NSR/ACT
IEC  240     001     010     STOP    -----
IEC  241     010     *       CGPA    cg04

SR   ZONE     AREA     ID      NSFI      NSR/ACT
IEC  1        003      4       BLKOPC   blk1
IEC  1        003      5       STOP    -----

SR   NPC                      NSFI      NSR/ACT
IEC  00235                   CGPA    cg04
IEC  00240                   CGPA    cg01

SR   NI      NC      NCM      NSFI      NSR/ACT
WRD2 243     015     001     STOP    -----
WRD3 243     105     002     CGPA    WRD4
;
```

```
rtrv-scr-opc:sr=opc1:actname=cr
```

```
rlghncxa03w 03-03-13 13:16:13 EST  EAGLE 31.3.0
SCREEN = ALLOWED OPC
SR   NI      NC      NCM      NSFI      NSR/ACT
opc1 010     010     010     STOP    CR
opc1 010     010     012     STOP    CR
;
```

```
rtrv-scr-opc:sr=op55
```

```
tekelecstp 03-03-06 11:30:42 EST  EAGLE 31.0.0
SR   MSA      SSA      SP      NSFI      NSR/ACT
```

```

    op55  007      077      007      BLKOPC  bo55
;

rtrv-scr-opc:sr=opc1:npc=128:nsfi=fail

    tekelecstp 05-01-06 11:30:42 EST  EAGLE  31.12.0
SR      NPC                      NSFI   NSR/ACT
opc1   s-00128                    FAIL   -----
;

rtrv-scr-opc:sr=opc2:

    eaglestp 28-02-13 13:13:56 EST  EAGLE  45.1.0
SCREEN = ALLOWED OPC
SR      UN      SNA      MNA      NSFI   NSR/ACT
opc2   001      02      01      STOP   -----
;

```

## Legend

For a summary report:

- **REF**—Indicates whether a screen is referenced by another screen. If NO, the screen is not used. For more detailed output, use the `rtrv-scr-opc:all=yes` command, or specify the specific screening reference.
- **RULES**—Number of screening rules in that screening table

For a detailed report:

- **SCREEN = ALLOWED OPC**—Screen type
- **SR**—Identifies the various screen sets being used. It can be up to four characters in length
- **NI - NC - NCM**—Point code referenced within the screen. For international point codes, these columns are ZONE-AREA-ID. For 24-bit ITU national point codes, these columns are MSA-SSA-SP. For 16-bit ITU national point codes, these columns are UN-SNA-MNA. For national point codes, these columns become the single column NPC.
- **NSFI**—Next screening category to be used
- **NSR/ACT**—Name of the next screening reference (NSR - up to four characters) or action to be taken (ACT - up to six characters), if the message passes this screen.

## Related Topics

- [chg-scr-opc](#)
- [chg-gws-actset](#)
- [dlt-scr-opc](#)
- [ent-scr-opc](#)
- [rtrv-gws-actset](#)



## rtrv-scr-sio

Use this command to show the attributes of one or more `nic/si/h0/h1` combinations that are allowed for SS7 messages from another network.

### Parameters

#### **actname (optional)**

Name of the gateway screening stop action set. Stop actions must be administered using this parameter with the gateway screening stop action table (see `chg-gws-actset` and `rtrv-gws-actset`).

#### **Range:**

*ayyyy*

1 alphabetic character followed by up to 5 alphanumeric characters.

*none* —Display gateway screening rules that do not have an assigned gateway screening stop action set

#### **a11 (optional)**

Displays all allowed SIO screening references.

#### **Range:**

*yes*

*no*

#### **Default:**

*no*

#### **h0 (optional)**

H0 heading code. A single value or a range of values can be specified.

#### **Range:**

*0 - 15, \**

*\** — all possible values from 0–15

#### **Default:**

Display all

#### **h1 (optional)**

H1 heading code. A single value or a range of values can be specified.

#### **Range:**

*0 - 15, \**

*\** —all possible values from 0–15

#### **Default:**

Display all

#### **nic (optional)**

Network indicator code.

**Range:**

0 - 3, \*

\* — all possible values from 0–3

**Default:**

Display all

**nsfi (optional)**

This parameter specifies the next screening category that is used in the gateway screening process, or it indicates that the gateway screening process should stop.

**Range:*****blkdpc***

Blocked DPC is the next screening category.

***cgpa***

Allowed calling party address is the next screening category.

***cdpa***

Allowed called party address is the next screening category.

***destfld***

Allowed destination field (DESTFLD) is the next screening category.

***dpc***

Allowed DPC is the next screening category.

***isup***

ISUP message type (ISUP) is the next screening category.

***stop***

The gateway screening process ends and the message proceeds through normal routing.

**Default:**

Display all screening references

**nsr (optional)**

Next screening reference. This parameter indicates which screening reference in the specified screening category (*nsfi*) is to be used in the screening process.

This parameter is mandatory if *nsfi* is other than *stop*; cannot be entered if *nsfi=stop*.

**Range:***ayyy*

1 alphabetic character followed by up to 3 alphanumeric characters

**Default:**

Display all

**pri (optional)**

Message priority. A single value or a range of values can be specified.

**Range:**

0 - 3

\* —all possible values from 0–3

**Default:**  
Display all

**si (optional)**  
Service indicator.

**Range:**  
0 - 15, \*  
\*—all possible values from 0–15

**Default:**  
Display all

**sr (optional)**  
Allowed SIO screening reference name

**Range:**  
ayyy  
1 alphabetic character followed by up to 3 alphanumeric characters

**Default:**  
Display all

### Example

```
rtrv-scr-sio
rtrv-scr-sio:sr=iec:nic=1:si=3:pri=2&&3
rtrv-scr-sio:sr=sio1:nic=1:si=1
rtrv-scr-sio:sr=sio1:nic=1:si=1:h0=1:h1=*
rtrv-scr-sio:sr=sio1:si=1:h0=1:h1=1
rtrv-scr-sio:all=yes
rtrv-scr-sio:sr=iec:nic=1:si=1:actname=crncf
```

### Dependencies

If the `si` parameter is not equal to 00, 01, or 02, the `h0` and `h1` parameters cannot be specified.

If the `nic`, `si`, and `h0/h1` parameters are specified, the SIO screening reference must be in the allowed SIO entity set.

The `nic` parameter must be specified if the `si` parameter is specified.

The `nic` and `si` parameters must be specified if the `h0` and `h1` parameters are specified.

If an asterisk value is specified for the `h0` parameter, the `h1` parameter cannot be specified.

If the `nsfi=stop` parameter is specified, then the `nsr` parameter cannot be specified.

If the `actname` parameter is specified, then the `nsfi=stop` parameter must be specified.

If the `nsr` parameter is specified, then the `actname` parameter cannot be specified.

If the `actname` parameter is specified with the screening reference name parameter, the specified value for the `actname` parameter must be assigned to that screening reference name.

The value of the `actname` parameter must be defined in the gateway screening stop action table with the `chg-gws-actset` command. These values are shown in the ACT NAME field of the `rtrv-gws-actset` command output.

If the `sr` parameters are specified, the SIO screening reference must be in the allowed SIO entity set.

The Gateway Screening Stop Action table must be accessible.

Valid `nsfi` parameter combinations must be specified.

The GWSOA parameter combination should be known and valid.

For SEAS commands, the `pri` parameter specified must be in the range 0-3, \*.

For SEAS commands, the `h0` parameter specified must be in the range 0-15, \*.

For SEAS commands, the `h1` parameter specified must be in the range 0-15, \*.

### Notes

This command can be canceled using the **F9** function key or the `canc-cmd` command. See `canc-cmd` for more information.

An asterisk as a parameter value in this command displays only entries that have an asterisk as the same parameter value in the entry.

If no parameters are specified, a list of allowed SIO references is output indicating whether they are referenced or not.

If only the `all=yes` parameter is specified, detailed information for every rule in every allowed SIO screening table is displayed.

If the `all` parameter is specified and other parameters are also specified, the `all` parameter is ignored.

### Output

```
rtrv-scr-sio
```

```
SCREEN = ALLOWED SIO
SR    REF  RULES
s     NO   1
s999 NO   1
si    NO   1
si01  NO   1
si1   NO   1
sio1  NO   3
swl1  NO   1
swl2  NO   1
;
```

```
rtrv-scr-sio:sr=iec:nic=1:si=3:pri=2&&3
```

```
rlghncxa03w 03-03-15 08:36:43 EST EAGLE 31.3.0
SCREEN = ALLOWED SIO
SR   NIC PRI   SI  H0    H1    NSFI   NSR/ACT
IEC  1   0&&2 3   --    --    BLKDPC WDB2
IEC  1   3    3   --    --    DPC    ABC2
```

```
;
```

```
rtrv-scr-
sio:sr=sio1:nic=1:si=1:h1=1:pri=1:h0=15:nsfi=blkdpc:nsr=bdp1
```

```
rlghncxa03w 03-03-07 12:05:33 EST EAGLE 31.3.0
SCREEN = ALLOWED SIO
SR   NIC PRI   SI  H0    H1    NSFI   NSR/ACT
sio1 1   1    1  15    01    BLKDPC bdp1
```

```
;
```

```
rtrv-scr-sio:sr=sio1:h0=1:h1=1
```

```
rlghncxa03w 03-03-07 12:05:33 EST EAGLE 31.3.0
SCREEN = ALLOWED SIO
SR   NIC PRI   SI  H0    H1    NSFI   NSR/ACT
sio1 1   1    1  01    *    STOP   -----
sio1 2   1    1  01    *    STOP   -----
```

```
;
```

```
rtrv-scr-sio:sr=sio1:nic=1:si=1
```

```
rlghncxa03w 03-03-07 12:05:33 EST EAGLE 31.3.0
SCREEN = ALLOWED SIO
SR   NIC PRI   SI  H0    H1    NSFI   NSR/ACT
sio1 1   1    1  01    *    STOP   -----
sio1 1   1    1  02    01    STOP   -----
```

```
;
```

```
rtrv-scr-sio:sr=sio1:nic=1:si=1:h0=1:h1=*
```

```
rlghncxa03w 03-03-07 12:05:33 EST EAGLE 31.3.0
SCREEN = ALLOWED SIO
SR   NIC PRI   SI  H0    H1    NSFI   NSR/ACT
sio1 1   1    1  01    *    STOP   -----
```

```
;
```

```
rtrv-scr-sio:sr=iec:nic=1:si=1:actname=crncf
```

```
rlghncxa03w 03-03-19 21:16:37 EST EAGLE 31.3.0
SCREEN = ALLOWED SIO
SR   NIC  PRI   SI  H0    H1    NSFI   NSR/ACT
iec  1    1    1   15    01    STOP   CRNCF
```

```
;
```

```
rtrv-scr-sio:si=5
```

```
tekelecstp 02-08-28 16:47:06 EST EAGLE 30.0.0
SCREEN = ALLOWED SIO
SR   NIC  PRI   SI  H0    H1    NSFI   NSR/ACT
si01 1    1    5  --    --    STOP   -----
si02 1    1    5  --    --    ISUP   is01
```

```
;
```

## Legend

For a summary report:

- **SR**—The screen sets being used
- **REF**—Indicates whether a screen is referenced by another screen. If NO, the screen is not used. For more detailed output, use the `rtrv-scr-sio:all=yes` command, or specify the specific screening reference.
- **RULES**—Number of screening rules in that screening table

For a detailed report:

- **SCREEN = ALLOWED SIO**—Screen type
- **SR**—The screen sets being used
- **NIC**—Network indicator code in the service information octet
- **PRI**—Priority of a single message or the beginning message priority in a range of priorities in the service information octet
- **SI**—Service indicator for the service information octet, which are the last two bits of the subservice field
- **H0**—H0 heading code
- **H1**—H1 heading code
- **NSFI**—Next screening category to be used
- **NSR/ACT**—Name of the next screening reference (NSR - up to four characters) or action to be taken (ACT - up to six characters), if the message passes this screen.

## Related Topics

- [chg-scr-sio](#)
- [dlt-scr-sio](#)
- [ent-scr-sio](#)

## rtrv-scr-tt

Use this command to show the allowed translation type (TT) screening reference in the TT entity set.

### Parameters

#### **actname (optional)**

Name of the gateway screening stop action set. Stop actions must be administered using this parameter with the gateway screening stop action table (see `chg-gws-actset` and `rtrv-gws-actset`).

#### **Range:**

*ayyyy*

1 alphabetic character followed by up to 5 alphanumeric characters.

*none* —Display gateway screening rules that do not have an assigned gateway screening stop action set

#### **a11 (optional)**

Displays all allowed TT screening references.

#### **Range:**

*yes*

*no*

#### **Default:**

*no*

#### **nsfi (optional)**

This parameter specifies the next screening category that is used in the gateway screening process, or it indicates that the gateway screening process should stop.

#### **Range: *cdpa, stop***

##### ***cdpa***

Allowed called party address is the next screening category.

##### ***stop***

The gateway screening process ends and the message proceeds through normal routing.

#### **Default:**

Display all screening references

#### **nsr (optional)**

The next screening reference parameter indicates which screening reference in the specified screening category (*nsfi*) is to be used in the screening process. This parameter is mandatory if *nsfi* is other than *stop*. The *nsr* parameter cannot be entered if *nsfi* is *stop*, or the `copy=yes` parameter is specified.

**Range:**

ayyy

1 alphabetic character followed by up to 3 alphanumeric characters

**Default:**

Display all

**sr (optional)**

The TT screening reference name

**Range:**

ayyy

1 alphabetic character followed by up to 3 alphanumeric characters

**Default:**

Display all

**type (optional)**

Translation type. The global title translation type value in the called party address. This value is the decimal representation of the 1-byte field used in SS7.

**Range:**

0 - 255, \*

\* —the full range of values from 0–255

**Default:**

Display all.

**Example**

```
rtrv-scr-tt
```

```
rtrv-scr-tt:sr=iec
```

```
rtrv-scr-tt:all=yes
```

**Dependencies**

If the `nsr` parameter is specified, `nsfi=stop` cannot be specified.

If the `actname` parameter is specified, the value specified for `nsfi` must be `stop`.

The value of the `actname` parameter must be defined in the gateway screening stop action table with the `chg-gws-actset` command. These values are shown in the ACT NAME field of the `rtrv-gws-actset` command output.

The `nsr` parameter cannot be specified if the `actname` parameter is specified.

If the `actname` parameter is specified with the screening reference name parameter, the specified value for the `actname` parameter must be assigned to that screening reference name.

Stop actions must be administered using the `actname` parameter in conjunction with the gateway screening stop action table (see `chg-gws-actset` and `rtrv-gws-actset`).

The specified value for the `nsfi` parameter is not valid for TT screen.



The `actname` parameter value must already be defined in the Gateway Screening Stop Action table with the `chg-gws-actset` command. These values are shown in the ACT NAME field of the `rtrv-gws-actset` command output.

The Gateway Screening Stop Action table must be accessible.

The screening reference and translation type for which the attributes are to be retrieved must exist.

The value specified for the `type` parameter must be within the allowed range.

The GWSOA parameter combination should be known and valid.

## Notes

This command can be canceled using the **F9** function key or the `canc-cmd` command. See `canc-cmd` for more information.

An asterisk as a parameter value in this command displays only entries that have an asterisk as the same parameter value in the entry.

If no parameters are specified, a list of allowed TT references is produced indicating whether they are referenced or not.

If only the `all=yes` parameter is specified, detailed information for every rule in every allowed TT screening table is displayed.

If the `all` parameter is specified and other parameters are also specified, the `all` parameter is ignored.

## Output

```
rtrv-scr-tt
```

```
rlghncxa03w 03-03-07 12:05:33 EST EAGLE 31.3.0
SCREEN = ALLOWED TT
SR   REF  RULES
IEC  YES   2
WRD2 YES   1
WRD4 YES   4
```

```
;
```

```
rtrv-scr-tt:sr=iec
```

```
rlghncxa03w 03-03-07 12:05:33 EST EAGLE 31.3.0
SCREEN = ALLOWED TT
SR   TYPE   NSFI   NSR/ACT
IEC  005&&010 STOP  -----
IEC  012     STOP  -----
IEC  016     CDPA  IEC
```

```
;
```

```
rtrv-scr-tt:all=yes
```

```
rlghncxa03w 03-03-07 12:05:33 EST EAGLE 31.3.0
SCREEN = ALLOWED TT
SR   TYPE      NSFI      NSR/ACT
IEC  005&&010  STOP      -----
IEC  012        STOP      -----
IEC  016        CDPA      IEC
WRD2 243        STOP      -----
WRD4 *          STOP      -----
```

```
;
```

```
rtrv-scr-tt:sr=iec:type=1&&15:actname=copy
```

```
rlghncxa03w 03-03-15 08:54:35 EST EAGLE 31.3.0
SCREEN = ALLOWED TT
SR   TYPE      NSFI      NSR/ACT
IEC  005&&010  STOP      COPY
IEC  012        STOP      COPY
```

```
;
```

### Legend

- **SCREEN = ALLOWED TT**—Screen type
- **SR**—Identifies the screen sets being used. It can be up to four characters in length.
- **REF**—Indicates whether a screen is referenced by another screen. If NO, the screen is not used. for a more detailed output, used the the `rtrv-scr-tt:all=yes` command, or specify the specific screening reference.
- **TYPE**—Translation type that is allowed for global title translation
- **NSFI**—Next screening category to be used
- **NSR/ACT**—Name of the next screening reference (NSR - up to four characters) or action to be taken (ACT - up to six characters), if the message passes this screen.

### Related Topics

- [chg-scr-tt](#)
- [dlt-scr-tt](#)
- [ent-scr-tt](#)

## rtrv-scrset

Use this command to show the attributes of one or more screen sets in the screen set entity set.

## Parameters

### **actname (optional)**

Name of the gateway screening stop action set. Stop actions must be administered using this parameter with the gateway screening stop action table (see `chg-gws-actset` and `rtrv-gws-actset`).

#### **Range:**

*ayyyyy*

1 alphabetic character followed by up to 5 alphanumeric characters.

*none* —Display gateway screening rules that do not have an assigned gateway screening stop action set

### **a11 (optional)**

Displays all screen sets (except “placeholder” screen sets that contain only one rule with `nsfi=stop` specified in the rule).

#### **Range:**

*yes*

*no*

#### **Default:**

*no*

### **destfld (optional)**

This parameter displays the indicator that specifies whether to apply the automatic allowed affected destination screening for network management messages against the routing table, self point codes, and capability point codes. When this parameter is on in the screen set rule, the automatic screening is applied at the end of the provisioned screen set.

#### **Range:**

*yes*

*no*

#### **Default:**

Display all

### **nsfi (optional)**

This parameter indicates the next screening category that is used in the gateway screening process, or that the gateway screening process should stop. In this command, information is displayed for one or more screen sets containing rules with the specified `nsfi` parameter value.

 **Note:**

When `nsfi=stop` is specified, the command displays only the “placeholder” screen sets that have only one rule, with `nsfi=stop` specified in the rule. This is a way to locate those “placeholder” screen sets, so that you can add or change the rules to accomplish appropriate screening.

**Range:*****opc***

Display rules with Allowed OPC as the next screening category.

***blkopc***

Display rules with Blocked OPC as the next screening category.

***sio***

Display rules with Allowed SIO as the next screening category.

***dpc***

Display rules with Allowed DPC as the next screening category.

***blkdpc***

Display rules with Blocked DPC as the next screening category.

***stop***

Display only “placeholder” screen sets that have only one rule in the screen set, with `nsfi=stop` specified as the next screening category.

**Default:**

Display all

***nsr* (optional)**

Next screening reference. This parameter indicates which screening reference in the specified screening category (`nsfi`) is to be used in the screening process. This parameter is used to display information for one or more screen sets with rules that have the specified `nsr` parameter value.

**Range:**

*ayyy*

1 alphabetic character followed by up to 3 alphanumeric characters

**Default:**

Display all

***scrn* (optional)**

Screen set name.

**Range:**

*ayyy*

1 alphabetic character followed by up to 3 alphanumeric characters

**Default:**

Display all

### Example

```
rtrv-scrset  
  
rtrv-scrset:scrn=scr1  
  
rtrv-scrset:nsr=opc4  
  
rtrv-scrset:nsfi=dpc  
  
rtrv-scrset:actname=copy
```

### Dependencies

The screen set name must already exist.

The `nsfi=stop` parameter must be specified before the `actname` parameter can be specified.

The `nsr` parameter cannot be specified if the `actname` parameter is specified.

If the `actname` parameter is specified with the screen set name parameter, the specified value for the `actname` parameter must be assigned to that screen set name.

The `nsfi` parameter must be valid for the SCRSET entity.

If the `nsfi=stop` parameter is not specified, then the `nsr` parameter must be specified.

The `nsr` parameter cannot be entered if the `nsfi` parameter value equals `stop`.

The GWSOA parameter combination should be known and valid.

### Notes

This command can be canceled using the **F9** function key or the `canc-cmd` command. See `canc-cmd` for more information.

If no parameters are specified for the `rtrv-scrset` command, the output shows all the screen sets, the screening function identifier of the root screening table, the screening reference of the root screening table, the memory usage (percentage), the number of entries in the screen set and the overall gateway screening statistics, followed by a summary of statistics for each screen set.

For the `rtrv-scrset:all=yes` command, the output consists of every screen set and every screening reference in each screen set (except "placeholder" screen sets that have only one rule with `nsfi=stop` specified in the rule). The `all=yes` and `nsfi=stop` parameters cannot be specified in the same command.

If the `scrn`, `nsfi`, or `nsr` parameter is entered, summary information for all screens that match the specified parameters is shown.

When the % FULL is over 100%, the screen is inaccessible. A screenset over 100% capacity size will not bind correctly. A screenset can become provisioned over capacity when linking one screen reference to another causes the size to become too large. To reduce a screenset that is over 100% capacity, screen rules must be deleted (see the `dlt-scr-xxx` commands)

**Output**

```
rtrv-scrset:nsfi=opc
```

```
rlghncxa03w 03-03-14 16:37:54 EST EAGLE 31.3.0
SCRN  NSFI      NSR/ACT  RULES  DESTFLD
att1  OPC       att1     111    Y
atx1  OPC       atx1     2      Y
bam1  OPC       bam1     3      Y
ctt1  OPC       ctt1     1      Y
ctw1  OPC       ctw      39     Y
mci1  OPC       mci1     3      Y
wt11  OPC       wt11    339    Y
```

```
;
```

```
rtrv-scrset:nsr=dpc3
```

```
rlghncxa03w 03-03-14 16:38:28 EST EAGLE 31.3.0
SCRN  NSFI      NSR/ACT  RULES
ss01  DPC       dpc3     3
ss02  DPC       dpc3     3
ss03  DPC       dpc3     3
ss04  DPC       dpc3     3
ss05  DPC       dpc3     3
```

```
;
```

```
rtrv-scrset:scrn=ss53
```

```
rlghncxa03w 03-03-14 16:39:04 EST EAGLE 31.3.0
SCRN  NSFI      NSR/ACT  RULES  DESTFLD
ss53  BLKDPC  bkd2     2      Y
      CGPA    cgp1     3
      TT     tt1      3
      TT     tt2      3
      TT     tt3      4
      CDPA   cdp1     3
      CDPA   cdp2     3
      CDPA   cdp3     4
      AFTPC  end1     9
```

```
;
```

```
rtrv-scrset:scrn=gws1
```

```
e1070402 02-07-22 10:06:09 EST EAGLE 30.0.0
rtrv-scrset:scrn=gws1
Command entered at terminal #4.
SCRN  NSFI      NSR/ACT  RULES  DESTFLD
gws1  OPC       opc1     17     Y
```

```

BLKOPC bop1 1812
SIO sio1 80
DPC dpc1 17
BLKDPC bdp1 1812
CGPA cga1 34
TT tt01 256
CDPA cda1 17
CDPA cdb1 6
AFTPC apc1 17
ISUP isu1 17

```

```
;
```

The number of screen sets has increased from 255 to 1023. In the following example, the % full is over 100% and the screen is inaccessible.

```
rtrv-scrset
```

```

tekelecstp 02-01-04 23:34:41 MST UNKNOWN 46.1.0-65.14.0
ENTIRE GWS DATABASE IS 1% FULL
CDPA + AFTPC TABLES ARE 0% FULL
SCREEN SET TABLE IS (4 OF 1023) 1% FULL
THERE ARE 0 SEAS SCREEN SETS USED (prefix 00nn)
THERE ARE 4 EAGLE SCREEN SETS USED

```

```
THE FOLLOWING ARE OVER 80% FULL:
```

SCRN	NSFI	NSR/ACT	FULL	RULES	TABLES	DESTFLD
s1	OPC	op1	101%	8192	3	Y
set1	OPC	op10	97%	7894	6	Y

SCRN	NSFI	NSR/ACT	FULL	RULES	TABLES	DESTFLD
a600	SIO	si1	1%	16	1	Y
a610	SIO	si1	1%	16	1	Y
s1	OPC	op1	101%	8192	3	Y
set1	OPC	op10	97%	7894	6	Y

### Legend

- **SCRN**—Name of the screen set
- **NSFI**—Next screening category to be used
- **NSR/ACT**—Name of the next screening reference (NSR - up to four characters) or action to be taken (ACT - up to six characters), if the message passes this screen
- **FULL**—Capacity of allowed memory a given screen set occupies, expressed as a percentage
- **RULES**—Number of entries in the screen set
- **TABLES**—Number of tables in the screen set
- **DESTFLD**—Displays whether to apply the automatic allowed affected destination screening for network management messages against the routing table, self point codes, and capability point codes. When this parameter is on, the automatic screening is applied at the end of the provisioned screen set.

**Related Topics**

- [chg-scrset](#)
- [dlt-scrset](#)
- [ent-scrset](#)

## rtrv-seas-config

Use this command to retrieve configuration information for the CCS Message Router (CCS MR) and the name of the EAGLE source node for the SEAS Over IP interface.

**Parameters**

This command has no parameters.

**Example**

```
rtrv-seas-config
```

**Dependencies**

The SEAS Over IP feature must be enabled before this command can be entered.

The SEASCFG Table must be accessible.

**Output**

```
rtrv-seas-config
```

```
tekelecstp 07-01-23 18:46:01 EST  EAGLE 37.5.0
SEASCLLI      AUTHMODE
-----
DEVEAGLE001  Password

      CONN      TERM  IPADDR          PORT  LOGIN
HNAME
-----
      IPMR1      25   128.96.75.45   4010  ccscor
tcpipmr1
      IPMR2      33   128.96.75.46   4011  ccscor          tcpipmr2
```

**Related Topics**

- [chg-seas-config](#)

## rtrv-secu-dflt

Use this command to display the current values of the various security-related parameters that have been configured with the `chg-secu-dflt` command.



## Parameters

### msg (optional)

Use this parameter to specify whether the text of the login warning message is to be displayed also.

#### Range:

*yes*

*no*

#### Default:

*no*

## Example

```
rtrv-secu-dflt
rtrv-secu-dflt:msg=yes
```

## Dependencies

None

## Notes

None

## Output

```
rtrv-secu-dflt:msg=yes
```

```
rlghncxa03w 13-06-16 21:49:14 EDT  EAGLE 45.0.0
SECURITY DEFAULTS
-----
PAGE             60
UOUT             90
MULTLOG         NO
MINLEN           8
ALPHA            1
NUM              1
PUNC             1
MININTRVL       1
PNOTIFY         7
PGRACE          3
PREUSE          5
PCHREUSE        4
SSH             ON
```

```
rlghncxa03w 13-06-16 21:49:14 EDT  EAGLE 45.0.0
WARNING MESSAGE
-----
```

```
1:"*****"
2:"*  NOTICE: This is a private computer system.  *"
```

```

3:"* Unauthorized Access or use may lead to      *"
4:"* prosecution.                               *"
5:"* 13-06-01 Notice!!! Eagle will be upgraded between *"
6:"*                the hours of 2am-3am on 13-07-15.  *"
7:"*                *"
8:"* Today's happy message: Go with Tekelec!!    *"
9:"*****"
10:" "
11:""
12:""
13:""
14:""
15:""
16:""
17:""
18:""
19:""
20:""
;

rtrv-secu-dflt

```

```

tekelecstp 12-09-18 10:07:57 EST 45.0.0-64.42.0
rtrv-secu-dflt
Command entered at terminal #4.
SECURITY DEFAULTS
-----
PAGE          90
UOUT          90
MULTLOG       NO
MINLEN        8
ALPHA         1
NUM           1
PUNC          1
MININTRVL    1
PNOTIFY       7
PGRACE        3
PREUSE        5
PCHREUSE      4
SSH           ON
;

```

### Legend

- **PAGE**—Default password aging interval for newly created user IDs
- **UOUT**—number of successive days a user ID can go unused (no successful login) before the system denies login
- **MULTLOG**—Indicates whether users can users be logged on to multiple terminals at the same time
- **MINLEN**—Minimum password length
- **ALPHA**—Minimum number of alphabetic characters (a–z) required in a new password

- **NUM**—Minimum number of numeric characters (0–9) required in a new password
- **PUNC**—Minimum number of punctuation characters required in a new password. A punctuation character is any character that is not an alphabetic or numeric character.
- **MININTRVL**—Minimum number of days before a password can be changed again
- **PNOTIFY**—Number of days prior to password expiration in which the user will be notified about upcoming expiration
- **PGRACE**—Number of days after password expiration in which the user is allowed to login without requiring a password change
- **PREUSE**—Number of passwords in the password history that must be unique
- **PCHREUSE**—Number of characters that cannot be reused from the existing password when setting a new password
- **WARNING MESSAGE**—Message displayed when a user has successfully logged in
- **SSH**— Together with OAM IP security feature it indicates whether the telnet connections are secure or not

#### Related Topics

- [chg-pid](#)
- [chg-secu-dflt](#)

## rtrv-secu-trm

Use this command to display the access rights for a terminal. Only a user with system security administration authority can change a terminal's access rights. Access rights determine whether a terminal or port has command access to the system.

#### Parameters

##### **trm (optional)**

Specifies the port about which information will be displayed.

**Range:**

1 - 16

**Default:**

Display all

#### Example

```
rtrv-secu-trm
```

```
rtrv-secu-trm:trm=9
```

#### Dependencies

The CCCNAMES table is corrupt or cannot be found.

The Terminal table is corrupt or cannot be found.

None

**Notes**

None

**Output**

This example shows attributes of all terminals when the Command Class Management feature is off:

```
rtrv-secu-trm
```

```
e5oam 08-12-01 23:40:14 EST EAGLE 40.1.0
TRM   LINK SA  SYS  PU   DB   DBG
1     YES  *** YES  YES  YES  YES
2     YES  *** YES  YES  YES  YES
3     YES  YES  YES  YES  YES  YES
4     YES  YES  YES  YES  YES  YES
5     YES  YES  YES  YES  YES  YES
6     YES  YES  YES  YES  YES  YES
7     NO   *** NO   NO   NO   NO
8     YES  *** YES  YES  YES  YES
9     YES  *** YES  YES  YES  YES
10    YES  *** YES  YES  YES  YES
11    YES  *** YES  YES  YES  YES
12    NO   *** NO   NO   NO   NO
13    NO   *** NO   NO   NO   NO
14    NO   *** NO   NO   NO   NO
15    NO   YES NO   NO   NO   NO
16    NO   *** NO   NO   NO   NO
;
```

This example shows attributes of all terminals when the Command Class Management feature is on:

```
rtrv-secu-trm
```

```
rlghncxa03w 08-12-01 12:30:07 EST EAGLE 40.1.0

trm   link sa  sys pu  db  dbg
1     NO  NO  YES NO  YES NO
2     NO  YES NO  NO  NO  NO
3     YES *** YES YES YES YES
4     NO  NO  NO  NO  NO  NO
5     YES *** YES NO  YES YES
6     NO  NO  NO  NO  NO  NO
.
.
.
16    NO  YES NO  NO  YES YES YES

trm   U01 U02 U03 U04 U05 U06 U07 U08 U09 U10 U11 U12 U13 U14 U15 U16
1     NO  NO  YES NO  YES NO  YES YES NO  YES NO  NO  NO  NO  YES NO
2     NO  YES NO  NO  NO  NO  YES NO  NO  NO  YES NO  YES NO  YES NO
```

```

3      YES NO  YES YES YES YES YES NO  NO  YES NO  NO  NO  YES NO
YES
4      NO  NO  NO  NO  NO  NO  YES NO  YES NO  YES NO  YES NO  YES
NO
5      YES YES YES NO  YES YES YES YES YES YES NO  NO  NO  YES NO
YES
6      NO  NO  NO  NO  NO  NO  YES YES YES NO  YES NO  YES NO  YES
NO
.
.
.
16     NO  YES NO  NO  YES YES YES YES YES YES YES YES NO  YES NO
YES

trm    U17 U18 U19 U20 U21 U22 U23 U24 U25 U26 U27 U28 U29 U30 U31
U32
1      NO  NO  YES NO  YES NO  YES YES NO  YES NO  NO  NO  YES NO
YES
2      NO  NO  NO  NO  NO  NO  YES NO  YES NO  YES NO  YES NO  YES
NO
3      YES YES YES NO  YES YES YES YES YES YES NO  NO  NO  YES NO
YES
4      NO  NO  NO  NO  NO  NO  YES YES YES NO  YES NO  YES NO  YES
NO
5      NO  NO  YES NO  YES NO  YES YES NO  YES NO  NO  NO  NO  YES
NO
6      NO YES  NO  NO  NO  NO  YES NO  NO  NO  YES NO  YES NO  YES
NO
.
.
.
16     NO  YES NO  NO  YES YES YES YES NO  YES NO  YES NO  YES NO
YES
;

```

This example shows attributes of terminal 9 when the Command Class Management feature is off:

```

rtrv-secu-trm:trm=9

rlghncxa03w 08-12-01 12:30:07 EST  EAGLE 40.1.0

TRM    LINK SA  SYS  PU   DB   DBG
9      NO   NO  YES  NO   YES  NO
;

```

This example shows attributes of terminal 9 when the Command Class Management feature is on:

```

rtrv-secu-trm:trm=9

rlghncxa03w 08-12-01 12:30:07 EST  EAGLE 40.1.0

```

```

TRM   LINK SA  SYS  PU   DB   DBG
9     NO  NO  YES  NO   YES  NO

trm   U01 U02 U03 U04 U05 U06 U07 U08 U09 U10 U11 U12 U13 U14 U15 U16
9     NO  NO  YES NO   YES NO   YES YES YES YES NO   YES NO   YES NO   YES

trm   U17 U18 U19 U20 U21 U22 U23 U24 U25 U26 U27 U28 U29 U30 U31 U32
9     NO  NO  YES YES YES YES YES YES YES YES YES YES NO   YES NO   NO
;

```

### Legend

- **TRM**—ID number of the terminal whose characteristics are to be changed
- **LINK**—Shows whether the Link Maintenance class of commands is allowed for this terminal
- **SA**—Shows whether the Security Administration class of commands is allowed for this terminal
- **SYS**—Shows whether the System Maintenance class of commands is allowed for this terminal
- **PU**—Shows whether the Program Update class of commands is allowed for this terminal
- **DB**—Shows whether the Database class of commands is allowed for this terminal
- **DBG**—Shows whether the Debug class of commands is allowed for this terminal
- **\*\*\***—Denotes a Security Administration port whose port type has been configured with a value of *none* or *printer*. These terminal types do not allow you to enter commands.
- **U01 - U32**—Configurable command class default names. (If configured with a user-specified name, that name appears.)

### Related Topics

- [chg-secu-trm](#)

## rtrv-secu-user

Use this command to show the security information for all users in the system.

### Parameters

#### uid (optional)

User ID

#### Range:

*azzzzzzzzzzzzzzzzz*

1 alphabetic character followed by up to 15 alphanumeric characters

#### Default:

Display all

### Example

```
rtrv-secu-user:uid=rogers
```

## Dependencies

The CCCNAMES table is corrupt or cannot be found.

If a user ID is specified, the user ID must exist in the UserID table.

## Notes

Only the system administrator should have access to this command.

Passwords cannot be shown.

This command can be canceled using the **F9** function key or the `canc-cmd` command. See `canc-cmd` for more information.

## Output

This example shows a display when the Command Class Management feature is not enabled:

```
rtrv-secu-user
```

```
rlghncxa03w 08-12-01 09:50:17 EST EAGLE 40.1.0
```

user id	age	page	uout	rev	link	sa	sys	pu	db	dbg
eagle1longname16	750	0	0	NO	YES	YES	YES	YES	YES	YES

user id	age	page	uout	rev	link	sa	sys	pu	db	dbg
manny	36	60	60	NO	YES	YES	YES	YES	YES	YES

user id	age	page	uout	rev	link	sa	sys	pu	db	dbg
moe	100	30	60	YES	YES	YES	YES	YES	YES	YES

user id	age	page	uout	rev	link	sa	sys	pu	db	dbg
jack	10	30	30	NO	YES	YES	YES	YES	YES	YES

```
;
```

This example shows a display when the Command Class Management feature is enabled:

```
rtrv-secu-user
```

```
rlghncxa03w 08-12-01 09:50:17 EST EAGLE 40.1.0
```

user id	age	page	uout	rev	link	sa	sys	pu	db	dbg
eagle1longname16	750	0	0	NO	YES	YES	YES	YES	YES	YES

			u01	u02	u03	u04	u05	u06	u07	u08	u09	u10	u11	u12	u13
u14	u15	u16													
			YES	YES	YES	YES	YES	YES	YES	YES	YES	YES	YES	YES	YES
YES	YES	NO													

			u17	u18	u19	u20	u21	u22	u23	u24	u25	u26	u27	u28	u29
u30	u31	u32													

```

YES YES YES YES YES YES YES YES YES YES YES YES NO NO NO NO
YES
    user id          age page uout rev link sa  sys pu  db  dbg
    manny           36  60  60   NO  YES  YES  YES  YES  YES  YES  YES
u01 u02 u03 u04 u05 u06 u07 u08 u09 u10 u11 u12 u13 u14 u15
u16
NO NO NO NO YES YES YES YES YES YES YES YES YES YES YES YES
YES
    u17 u18 u19 u20 u21 u22 u23 u24 u25 u26 u27 u28 u29 u30 u31
u32
YES YES YES YES YES YES YES YES YES YES YES YES NO NO NO NO
YES
    user id          age page uout rev link sa  sys pu  db  dbg
    moe             100 30  60   YES YES  YES  YES  YES  YES  YES
u01 u02 u03 u04 u05 u06 u07 u08 u09 u10 u11 u12 u13 u14 u15
u16
YES YES YES YES YES YES YES YES YES YES YES YES YES YES YES YES
NO
    u17 u18 u19 u20 u21 u22 u23 u24 u25 u26 u27 u28 u29 u30 u31
u32
YES YES YES YES YES YES YES YES YES YES YES YES YES YES NO NO
NO
    user id          age page uout rev link sa  sys pu  db  dbg
    jack           10  30  30   NO  YES  YES  YES  YES  YES  YES  YES
u01 u02 u03 u04 u05 u06 u07 u08 u09 u10 u11 u12 u13 u14 u15
u16
YES YES YES YES YES YES YES YES YES YES YES YES YES YES YES YES
YES
    u17 u18 u19 u20 u21 u22 u23 u24 u25 u26 u27 u28 u29 u30 u31
u32
YES YES YES YES YES YES NO NO NO NO YES YES YES YES YES YES
NO
;

```

### Legend

- **USER-ID**—Name of the user
- **AGE**—Current age, in days, of the password associated with this user ID. If the password age is greater than 999 days, the value 999 is displayed.
- **PAGE**—Maximum password age established for the user ID. When AGE becomes greater than PAGE, the system forces the user to change the password at the next login. An asterisk (\*) displayed after the value indicates that the system-wide default page parameter value, as configured on the `chg-secu-dflt` command, is in effect for the user ID.



- **UOUT**—User ID aging interval, in days. If the user ID is not used (that is, no successful login) for longer than this interval, the system does not allow a login. An asterisk (\*) displayed after the value indicates that the system-wide default, `uout` parameter value, as configured on the `chg-secu-dflt` command, is in effect for the user ID.
- **REV**—Shows whether the user ID is denied login (revoked). YES indicates that the user ID is revoked, NO indicates that the user ID is not revoked.
- **LINK**—Shows whether the user has access to all commands in the Link Maintenance command class
- **SA**—Shows whether the user has access to all commands in the Security Administration command class
- **SYS**—Shows whether the user has access to all commands in the System Maintenance command class
- **PU**—Shows whether the user has access to all commands in the Program Update command class
- **DB**—Shows whether the user has access to all commands in the Database Administration command class
- **DBG**—Shows whether the user has access to all commands in the Debug command class

If the Command Class Management feature is enabled, the following fields appear:

- **U01 - U32**—Default configurable command class names. If user-defined names have been provisioned, they will appear instead of the default names.

#### Related Topics

- [act-user](#)
- [chg-pid](#)
- [chg-user](#)
- [dact-user](#)
- [dlt-user](#)
- [ent-user](#)
- [login](#)
- [logout](#)
- [rept-stat-user](#)
- [rtrv-user](#)

## rtrv-seculog

Use this command to retrieve the contents of a security log and display it to the user in the scroll area. Various reports can be produced by varying the values of the command parameters. By default, the report is generated from the log on the active fixed disk, although the `slog` parameter can be used to generate the report from the log on the standby fixed disk.

## Parameters

### **edate (optional)**

End date. This parameter displays log entries that were created on or before the specified date. If the `sdate` parameter is specified, log entries created for the period specified by the `sdate` and `edate` combination are displayed.

#### **Range:**

*000101 - 991231*

(in the form *yymmdd*, where *yy* is year, *mm* is month, and *dd* is day)

The date must be specified with 6 digits. For example, enter 1/1/96 as 960101.

#### **Default:**

Report log entries regardless of their creation date

### **etime (optional)**

End time. This parameter displays log entries created between midnight (00:00:00) and the time specified by this parameter. If the `stime` parameter is specified, log entries created in the time period specified by the `stime` and `etime` combination are displayed.

#### **Range:**

*000000 - 235959*

(in the form *hhmmss*, where *hh*=hours (00-23), *mm*=minutes (00-59), *ss*=seconds (00-59))

The time must be specified with 6 digits in a 24-hour format. For example, enter 1:05:03 P.M. as *130503*.

#### **Default:**

Report log entries regardless of their creation time

### **mode (optional)**

Use this parameter to produce a either full log report or an abbreviated log report.

#### **Range:**

##### ***brief***

Causes only one line of output to be generated for each log entry reported. Some information in each reported log entry is not shown.

##### ***full***

Produces a report showing multiple lines of output for each log record that is reported. This report displays more information from each log record (including the entire command) than the `mode=brief` report.

#### **Default:**

*brief*

### **num (optional)**

Number of records to be displayed before the report is terminated.

#### **Range:**

*1 - 50000*

**Default:**

500 —if `mode=brief` is specified  
250 —if `mode=full` is not specified

**rectype (optional)**

This parameter specifies whether to consider all records in the log for reporting or only new (un-uploaded) records.

**Range: *new, both******new***

The report generator scans un-uploaded records when generating the report. Old records are not considered for reporting, even if they match the reporting criteria.

***both***

All records in the log are considered for reporting.

**Default:**

*new*

**sdate (optional)**

Start date. This parameter displays log entries created on or after the specified date. If the `edate` parameter is also specified, log entries created for the period specified by the `sdate/edate` combination are displayed.

**Range:**

000101 - 991231

(in the form *yymdd*, where *yy* is year, *mm* is month, and *dd* is day)

The date must be specified with 6 digits. For example, enter 1/1/96 as 960101.

**Default:**

Report log entries regardless of their creation date

**slog (optional)**

Source log indicator. The log to be copied to the FTA.

**Range:*****act***

produces the report from the log on the active MASP

***stb***

produces the report from the log on the standby MASP

**Default:**

*act*

**stime (optional)**

Start time. This parameter displays log entries created between the time specified by this parameter and the end of the day (23:59:59) inclusive. If the `etime` parameter is specified, log entries created in the time period specified by the `stime/etime` combination are displayed.

**Range:**

000000 - 235959

(in the form *hhmmss*, where *hh*=hours (00-23), *mm*=minutes (00-59), *ss*=seconds (00-59))

The time must be specified with 6 digits in a 24-hour format (*hhmmss*). For example, enter 1:05:03 p.m. as *130503*.

**Default:**

Report log entries regardless of their creation time

**trm (optional)**

Terminal ID. Use this parameter to report only those log entries created by the specified terminal.

**Range:**

1 - 16

**Default:**

Report log entries regardless of the associated terminal

**uid (optional)**

User ID. This parameter displays log entries created by the specified user ID. Specify `uid=seas` to display commands received on a SEAS terminal. Specify `uid=none` to display commands not associated with a user ID (for example, commands issued prior to login).

**Range:**

*azzzzzzzzzzzzzzzzz*

1 alphabetic character followed by up to 15 alphanumeric characters

**Default:**

Display all

**Example**

```
rtrv-seculog:sdate=960214:edate=960215:num=7
```

```
rtrv-seculog:mode=full:sdate=960214:edate=960214:stime=062900:etime=063200
```

**Dependencies**

If the `sdate` and `edate` parameters are specified, the date specified for the `sdate` parameter must be earlier than or equal to the date specified for the `edate` parameter.

If the `stime` and `etime` parameters are specified, the time specified for the `stime` parameter must be earlier than or equal to the time specified for the `etime` parameter.

The month component of the `sdate` and `edate` parameter combination must be specified in the range 1–12.

The day component of `sdate` and `edate` parameter combination must be specified in the range 1–31. This value must accurately reflect the number of days in the month and year indicated. For example, `sdate=960631` is not a valid parameter value because June has only 30 days.

The second component of the `stime` and `etime` parameter combination must be specified in the range 00–59.

The minute component of the `stime` and `etime` parameter combination must be specified in the range 00–59.

No other security log command can be in progress when this command is entered.

This command cannot be entered at a telnet terminal (terminal ID 17-40).

### Notes

To accommodate the year 2000 and beyond, the two-digit year portion of dates is interpreted to be in the indicated century as follows:

- years 95–99 = 1995 through 1999
- years 00–36 = 2000 through 2036

A consequence of this is that date 000101 (Jan 1, 2000) is greater than 991231 (December 31, 1999).

If the `mode=brief` parameter is specified and the output report has a plus (+) symbol appearing at the end of the command, the plus symbol indicates that more command characters are available to be displayed. Specify the `mode=full` parameter to see these additional characters.

In the `mode=full` output report, a plus (+) symbol appearing at the end of the command indicates the command is longer than 150 characters. Note that even in the uploaded log, each record in the log has room to record only 150 characters of the entered command. If the command is longer than 150 characters, then only the first 149 characters of the command and the plus symbol (to indicate that truncation has occurred) are recorded.

Security log size is limited to 50,000 records. Data from a query that exceeds the size limit of the security log cannot be displayed.

The system checks to ensure that the day portion of any `sdate/edate` value entered is in agreement with the month and year. It issues error message E2252 if the day is found to be invalid (for example, 960631 is not a valid date). The system software and date/time hardware properly handle leap years and leap centuries.

The system uses the `sdate/edate` and `stime/etime` parameters to select log records for reporting as follows:

- If the date on which the log record was created is not in the date range specified by the `sdate/edate` parameters, the record is not reported. The default `sdate` is the date of the oldest record in the log, and the default `edate` is the current date.
- If the time of day at which the log record was created is not in the time range specified by the `stime/etime` parameters, the record is not reported. The default `stime` is 00:00:00 (midnight), and the default `etime` is 23:59:59.
- Otherwise, the log record is reported, unless it is disqualified by other parameters such as `uid` or `trm`.

As an example, if the following command is entered, records are displayed for October 10, 1996 from 2:00 p.m. until 4:00 p.m., for October 11, 1996, from 2:00 p.m. until 4:00 p.m., and for October 12, 1996, from 2:00 p.m. until 4:00 p.m.

```
rtrv-  
seculog:sdate=961010:edate=961012:stime=140000:etime=160000
```

It takes the system approximately one minute to display 500 lines of data in the scroll area. To output a complete `mode=full` report (150,000 lines maximum) takes approximately 300 minutes. For this reason, the `num` parameter defaults to 125 (`mode=full`) or 500 (`mode=brief`) to prevent an excessively long process time, unless you deliberately choose a longer report.

This command can be canceled using the **F9** function key or the `canc-cmd` command. See `canc-cmd` for more information.

The following message appears in the scroll area if the `slog=stb` parameter is specified (either explicitly or by default) and the standby fixed disk is not available (for example, simplex mode).

```
Command Failed - unable to read security log
```

When the `rtrv-seculog` command is entered, one of the first things that the reporting function does is to examine the log overflow and logging failure flags in the header of the specified log. Depending on the nature of the information found, one of the following notices is displayed in the output:

```
Notice: Log overflow has occurred -- report may be incomplete.
```

```
Notice: Logging failure -- report may be incomplete.
```

## Output

This example shows output for records in the log created between 2/14/96 and 2/15/96 are displayed, up to a maximum of 9 records:

```
rtrv-seculog:sdate=960214:edate=960215:num=9
```

```
rlghncxa03w 96-02-14 06:32:20 EST EAGLE Release 34.0
Notice: Log overflow has occurred -- report may be incomplete.
```

```
Reporting parameters:
```

```
  sdate   = 960214
  edate   = 960215
  num     = 9
```

uid	trm	date	time	st	cmd
NONE	03	960214	063000	OK	login:uid=johnlamb
SEAS	15	960214	063010	OK	CHG-SLK::LSN123-03:123456:50,RCH::S+
johnlamb	03	960214	063021	OK	rept-stat-trbl
SEAS	15	960214	063032	OK	CHG-RTE::LSNABC-001001001:123456:55+
johnlamb	05	960215	064524	RJ	ent-card:loc=1201:type=limel:appl=+
johnlamb	05	960215	064528	OK	ent-card:loc=1201:type=limel:appl=+
johnlamb	03	960215	063030	AB	rept-stat-card
johnlamb	03	960215	063031	OK	canc-cmd
johnlamb	05	960215	064533	OK	logout

```
Report terminated -- output length limitation (NUM=) reached.
9 records reported of 5613 records scanned.
END OF SECURITY LOG REPORT.
```

```
;
```

This example shows all records in the log created on 2/14/96 between the hours of 06:29:00 and 06:32:00:

```
rtrv-
seculog:mode=full:sdate=960214:edate=960214:stime=062900:etime=
063200
```

```
rlghncxa03w 96-02-14 06:32:20 EST EAGLE Release 34.0
```

```
Reporting parameters:
```

```
    sdate   = 960214
    edate   = 960214
    stime   = 062900
    etime   = 063200
```

```
uid          trm date   time    result
-----
NONE         05 960214 062912 E1234
Cmd: login:uid=eagle
johnlamb     03 960214 063000 OK
Cmd: rept-stat-card
SEAS         16 960214 063123 OK
```

```
Cmd:CHG-
```

```
SLK::LSN12345-12:123456:50,RCH::OOS:::D,PRV123456-106-12,96-02-14-06-3
1-22;
```

```
Johnlamb     03 960214 063128 OK
```

```
Cmd:chg-lnp-lrn:lrn=1234567890:nmrgt1=255-255-255-255-255-dpcssn-
ssn-255-   yes:nmrgt2=255-255-255-255-dpcssn-ssn-255-
yes:mrrgt3=255-255-255-255-255-   dpcssn+
```

```
3 records reported of 50000 records scanned.
END OF SECURITY LOG REPORT.
```

```
;
```

This example displays a maximum of 10 records (SEAS commands) in the log when the SEAS Over IP feature is turned on and SEAS commands are issued through the SEAS terminals:

```
rtrv-seculog:uid=seas:num=10
```

```
tekelecstp 07-03-09 11:57:50 IST EAGLE 37.5.0
```

```
Reporting parameters:
```

```
    uid     = seas
    num     = 10
```

```
uid          trm date   time    st cmd
```

```

-----
SEAS          17  070902 124846 RJ ASGN-
SLK::LS111-00:AJP6OD:50,SOM::1+
SEAS          17  070902 124856 OK ASGN-
SLK::LS111-02:AJP6OD:50,SOM::1+
SEAS          17  070902 124944 OK ASGN-
SLK::LS111-03:AJP6OD:50,SOM::1+
SEAS          17  070902 125238 OK ASGN-
SLK::LS111-11:AJP6OD:50,SOM::1+
SEAS          17  070902 125245 OK ASGN-
SLK::LS111-05:AJP6OD:50,SOM::1+
SEAS          17  070902 125257 OK ASGN-
SLK::LS111-13:AJP6OD:50,SOM::1+
SEAS          17  070902 130331 OK ASGN-
SLK::LS111-02:AJP6OD:50,SOM::1+
SEAS          17  070902 130539 OK ASGN-
SLK::LS111-02:AJP6OD:50,SOM::1+
SEAS          25  070902 131327 OK ASGN-
SLK::LS111-03:AJP6OD:50,SOM::1+
SEAS          25  070902 184758 OK ASGN-
SLK::LS111-02:AJP6OD:50,SOM::1+

```

Report terminated -- output length limitation (NUM=) reached

10 records reported of 240 records scanned.  
END OF SECURITY LOG REPORT.

## Legend

- **uid**—User ID that issued the command. The value SEAS appears if the command was received on a SEAS port. The value NONE appears if no user ID was associated with the port at the time the command was logged.
- **trm**—Terminal ID of the terminal where the command was received
- **date**—Date the log entry was made; that is, the date on which the command was received for execution
- **time**—Time the log entry was made; that is, the time the command was received for execution. A 24-hour time format is used (for example, 1:00 p.m. = 130000).
- **st**—Two-letter shorthand notation of the command's status. The complete status can be obtained by re-entering the `rtrv-seculog` command and specifying the `mode=full` parameter. The status abbreviations are:
  - **AB**—Command aborted. Displayed when the `canc-cmd:trm` command is issued to abort the following commands: `rept-stat-card`, `rept-stat-dstn`, `rept-stat-ls`, `rept-stat-slk`, `rtrv-dstn`, `rtrv-gta`, `rtrv-gtt`, `rtrv-ls`, `rtrv-map`, `rtrv-rte`, `rtrv-seculog`, and `rtrv-slk`. An AB status indicates that processing and output of the command have been halted. This status is also displayed for SEAS flow-thru commands that are canceled with the `canc-cmd` (without the `trm` parameter).
  - **RJ**—Command rejected. Displayed whenever the results value that would be displayed in the `mode=full` report would be one of the following:
    - \* Edddd



- \* FAILED
- \* rrrrrr/mmmm
- **RL**—Retry later. The system is busy.
- **IP**—In Progress
- **OK**—Command successfully executed
- **TO**—Timed out.
- **cmd**—Command that was recorded. In the `mode=brief` report, if the length of the recorded command is greater than or equal to 35 characters (as this much as can be displayed on a single line of the output report), then only the first 34 characters of the command are displayed, and the 35th character is displayed as a plus symbol (+) to indicate that more information is available in the log. Re-enter the `rtrv-seculog` command with the `mode=full` parameter to see the additional information. In the `mode=full` report, a plus symbol at the end of a command indicates that the command is longer than 150 characters.

## rtrv-serial-num

Use this command to retrieve the NT serial number for the system.

### Parameters

This command has no parameters.

### Example

```
rtrv-serial-num
```

### Dependencies

None

### Notes

None

### Output

Dashes appear if the serial number has not yet been entered into the database.

```
rtrv-serial-num
```

```
rlghncxa03w 03-03-29 16:40:40 EST EAGLE 31.3.0  
System serial number = nt00001231
```

```
System serial number is locked.
```

```
rlghncxa03w 03-03-29 16:40:40 EST EAGLE 31.3.0  
Command Completed
```

```
;
```

**Related Topics**

- [ent-serial-num](#)

## rtrv-sfappopts

Use this command to retrieve the parameters from the SFAPPOPTS table.

**Parameters**

This command has no input parameters.

**Example**

```
rtrv-sfappopts
```

**Dependencies**

The SFAPP table should be accessible.

**Output**

This example shows output with default SFAPP options in Eagle Rel 46.7.0:

```
rtrv-sfappopts
```

```
tekelecstp 18-09-13 01:26:30 EST EAGLE 46.7.0.0.0-75.10.0
rtrv-sfappopts
Command entered at terminal #17.
;
```

```
Command Accepted - Processing
```

```
tekelecstp 18-09-13 01:26:30 EST EAGLE 46.7.0.0.0-75.10.0
SFAPP OPTIONS TABLE
-----
VLRIMEICHALLENGE = no
MODE               = active
SUCCTH             = none
FAILTH             = none
VELTH              = none
AGETIME            = none
```

**Legend**

- **VLRIMEICHALLENGE** - Enables/Disables the VLR IMEI challenge for CAT3.2 messages
- **MODE**- Provides option to turn off dynamic learning, test the learning algorithm, and move the system in operation using various modes
  - **OFF**- Turn off the dynamic learning. Delete all the dynamic entries

- *LEARN* - Only learn about new VLRs, no challenges are performed (newly learned VLRs are considered as Whitelisted). Delete dynamic entries without parent in static when switch from ACTIVE or TEST mode
- *ACTIVE* - Challenges are performed. Status of dynamically learned VLRs are changed to Whitelisted or Blacklisted if they meet criteria
- *TEST* - Challenges are performed. However, learned VLRs remain Grey listed
- **SUCCTH** If system-wide success threshold is 0 i.e., None, then do not transition any VLR to whitelist
- **VELTH** - In case VELTH is set to None, all dynamic VLR roaming entries will always be in LEARNING phase and will never be used for VLR validation
- **AGETIME** - In case agetime is set to None, ageing will not perform

## rtrv-sg-opts

Use this command to retrieve information about the currently chosen IP<sup>7</sup> Secure Gateway protocol options.

### Parameters

This command has no parameters.

### Example

```
rtrv-sg-opts
```

### Dependencies

None

### Notes

None

### Output

```
rtrv-sg-opts
```

```
rlghncxa03w 13-09-24 09:50:17 EST EAGLE 46.0.0
SRKQ:                250
SNMPCONT:            john doe 555-123-4567
GETCOMM:             public
SETCOMM:             private
TRAPCOMM:            public
SCTPCSUM:            adler32
IPGWABATE:           NO
UAMEASUSEDFTAS:     YES
DSCP                  20
```

```
;
```

## Legend

- **SRKQ**—Static routing key quantity. Maximum number of routing key entries in the Static Routing Key table.
- **SNMPCONT**—System contact information for each E5-ENET-B SNMP agent
- **GETCOMM**—Community name used for messages sent by SS7IPGW cards (SNMP Get and GetNext request validations)
- **SETCOMM**—Community name used for SNMP set request validation. This value applies for each E5-ENET-B SNMP agent in the system.
- **TRAPCOMM**—Community name used when SNMP traps are generated. This value applies for each E5-ENET-B SNMP agent in the system.
- **SCTPCSUM**—SCTP checksum algorithm type
- **IPGWABATE**—IPGWx SS7 congestion abatement procedures
- **UAMEASUSEDFTAS**—UA measurements are generated
- **DSCP**--- Subfield in IP header. Applicable to SIGTRAN based cards only.

## Related Topics

- [chg-sg-opts](#)
- [rtrv-appl-rtkey](#)

# rtrv-shlf

Use this command to display the frames and shelves that are currently provisioned in the system. The type of shelf is also shown.

## Parameters

### loc (optional)

The shelf location.

#### Range:

1100, 1200, 1300, 2100, 2200, 2300, 3100, 3200, 3300, 4100, 4200, 4300, 5100, 5200, 5300, 6100, 6200, 6300

#### Default:

Display all configured locations

## Example

```
rtrv-shlf
rtrv-shlf:loc=1300
rtrv-shlf:loc=6200
```

## Dependencies

The frame and shelf values of the shelf location parameter (`loc`) must be within the valid range (`xyzz`, where `x`=frame and `y`=shelf; `zz` is always 00 for this command).

The Shelf table is corrupt or cannot be found by the system.

**Notes**

None

**Output**

This example displays all configured STP equipment shelves:

rtrv-shlf

```

tekelecstp 09-03-12 12:24:48 EST 45.0.0
SHELF DISPLAY
FRAME SHELF      TYPE
   1      1      CONTROL
   1      2      EXTENSION
   6      1      EXTENSION
   6      2      FPB
;

```

This example displays a specific STP equipment shelf:

rtrv-shlf:loc=1300

```

rlghncxa03w 12-05-07 09:50:17 EST EAGLE 45.0.0
SHELF DISPLAY LOCATION=1300 FRMID: CF00
FRAME SHELF      TYPE
   1      3      EXTENSION
CARD  TYPE      APPL      LSET NAME      PORT SLC  LSET NAME      PORT SLC
1301  LIME1     SS7ANSI  -----      --  --  -----      --  --
1302  LIME1     SS7ANSI  -----      --  --  -----      --  --
1303  LIME1     SS7ANSI  -----      --  --  -----      --  --
1304  LIME1     SS7ANSI  -----      --  --  -----      --  --
1305  LIME1     SS7ANSI  -----      --  --  -----      --  --
;

```

This example displays a specific STP equipment shelf that is not configured (unequipped):

rtrv-shlf:loc=2100

```

rlghncxa03w 12-05-07 09:50:17 EST EAGLE 45.0.0
SHELF DISPLAY LOCATION=2100 FRMID: EF00
FRAME SHELF      TYPE

This shelf is UNEQUIPPED in the database.
;

```

This example displays a specific FPB shelf.

```

rtrv-shlf:loc=6300

tekelecstp 12-09-05 11:03:45 EST 45.0.0
rtrv-shlf:loc=6300
Command entered at terminal #4.
SHELF DISPLAY LOCATION=6300
FRAME          SHELF          TYPE          FAN
6              3              FPB          OFF
CARD          TYPE          APPL          SRVNAME
6301          TELCO          SWITCH        telco1
6302          TELCO          SWITCH        telco2
;

```

### Legend

- **FRAME ID**—Frame power designation identifier
- **FRAME**—Frame location of the shelf
- **SHELF** —Location of the shelf within the frame
- **TYPE** —Type of shelf
- **CARD**—Card location in the specified shelf
- **TYPE**—Card type
- **APPL**—Application running on the card
- **LSET NAME**—Linkset name for the port on the card
- **PORT**—Port used by the linkset defined on the card
- **SLC**—Signaling link code for the linkset
- **FPB** - Frame Power Budget
- **SRVNAME**- Server Name

### Related Topics

- [dlt-shlf](#)
- [ent-shlf](#)

## rtrv-sid

Use this command to retrieve site identification characteristics of the system. It shows the point code assigned to this system, the CLLI code of the system, the capability code of the STP, and the type of point codes supported by the system.

### Parameters

#### Note:

See [Point Code Formats and Conversion](#) for a detailed description of point code formats, rules for specification, and examples.

**cpc (optional)**

ANSI capability point code in the form of *network indicator-network cluster-network cluster member (ni-nc-ncm)*.

**Synonym:**

*cpc*

**Range:**

*000-255*

Specify a valid value for each subfield of the point code, and separate the subfields with a dash (-).

When *chg-sid:pctype=ansi* is specified, *ni = 000* is not valid.

When *chg-sid:pctype=ansi* is specified, *nc = 000* is not valid if *ni = 001-005*.

When *chg-sid:pctype=ansi* is specified, *nc = 000* is valid if *ni = 006-255*.

The point code *000-000-000* is not a valid point code.

**Default:**

Display all

**cpc/cpca/cpci/cpcn/cpcn24/cpcn16 (optional)**

Capability point code. The code used by the SS7 protocol to identify a group of functionally related STPs in the signaling network to which the STP belongs.

**cpci (optional)**

ITU international point code with subfields *zone-area-id*. The *prefix* subfield indicates a spare point code (*prefix-zone-area-id*).

**Range:**

*s-, 0-255*

Specify a valid value for each subfield of the point code, and separate the subfields with a dash (-).

*prefix—s*

*zone—0-7*

*area—000-255*

*id—0-7*

The point code *0-000-0* is not a valid point code.

**Default:**

Display all

**cpcn (optional)**

ITU national point code in the format of a 5-digit number (*nnnnn*); or 2, 3, or 4 numbers (members) separated by dashes (*m1-m2-m3-m4*) as defined by the *chg-stpopts:npcfmt1* flexible point code option. A group code must be specified when the ITUDUPPC feature is turned on (*nnnnn-gc, m1-m2-m3-m4-gc*). The *prefix* subfield indicates a spare point code (*prefix-nnnnn, prefix-nnnnn-gc, prefix-m1-m2-m3-m4, prefix-m1-m2-m3-m4-gc*).

**Range:**

*s-, 0-16383, aa-zz*

Specify a valid value for each subfield of the point code, and separate the subfields with a dash (-).

*prefix—s-*

*nnnnn—0-16383*

*gc—aa-zz*  
*m1-m2-m3-m4—0-14* for each member; values must sum to 14

**Default:**  
Display all

**cpcn24 (optional)**

24-bit ITU national point code with subfields *main signaling area-sub signaling area-signaling point (msa-ssa-sp)*.

**Range:**  
*000-255*  
Specify a valid value for each subfield of the point code, and separate the subfields with a dash (-).  
*msa—000–255*  
*ssa—000–255*  
*sp—000–255*

**Default:**  
Display all

**cpcn16 (optional)**

16-bit ITU national point code with subfields *unit number sub number area main number area (un-sna-mna)*.

**Range:**  
*000---127*

Specify a valid value for each subfield of the point code, and separate the subfields with a dash (-).

*un---000---127*

*sna---000---15*

*mna---000---31*

**Default:**  
Display all

**cpctype (optional)**

Capability point code type. This parameter displays the CPCs that are provisioned for the specified service.

**Range:**

*stp*

*lnp*

*inp*

*eir*

*gport*



***gflex***

***mnp***

***atinpq***

***vflex***

***aiq***

**Default:**

*stp*

### Example

```
rtrv-sid
rtrv-sid:cpc=3-3-3
rtrv-sid:cyctype=inp
rtrv-sid:cpcn=s-00456
rtrv-sid:cpcn16=1-2-3
```

### Dependencies

The STP destination point codes and capability point codes can be specified only as full point codes.

The ANSI point code 0-0-0 and the ITU-I point code 0-000-0 are invalid for STP capability point codes.

The LNP feature must be turned on before the `cpctype=lnp` parameter can be specified.

The INP feature must be turned on before the `cpctype=inp` parameter can be specified.

The EIR feature must be turned on before the `cpctype=eir` parameter can be specified.

The Spare Point Code Support feature must be enabled before an ITU-I or ITU-N spare point code can be retrieved.

The STP MAS Configuration table is corrupt or cannot be found.

If the `cpcn` parameter is specified, the format of the specified point code must match the format that was assigned with the `chg-stpopts:npcfmit` command.

The STP Site Identification table is corrupt or cannot be found.

The ATINP feature must be enabled before the `cpctype=atinpq` parameter can be specified.

The V-Flex feature must be turned on before the `cpctype=vflex` parameter can be specified.

The A-Port or the IS41 GSM Migration (IGM) feature must be enabled, before the `cpctype=mnp` parameter can be specified.

The ANSI41 AIQ feature must be enabled before the `cpctype=aiq` parameter can be specified.

### Notes

If the `cpc/cpca/cpci/cpcn/cpcn24/cpcn16` parameter is not specified, all site identification characteristics are displayed.

If the STP capability point code is specified and not provisioned, the report contains only the PCA, PCI, PCN, PCN16, PCN24, CLLI, and PCTYPE fields, with the message:

```
Capability Point Code specified is not provisioned.
```

In this command, only ITU-international and ITU national point codes support the spare point code subtype prefix (s-).

### Output

The `rtrv-sid` command CPC output is sorted using three sort keys.

- The first sort key is by the `cpctype` service, ordered by: `aiq`, `eir`, `gflex`, `inp`, `stp` (own STP, unlabeled), and `gport` or `mnp` depending on whether A-Port, ATINP, G-Port or V-Flex is enabled.
- The second sort key is by network type, ordered by: ANSI, ITU-I, ITU-N, then ITU-N24.
- The third sort key is by point code value, ordered low to high.

In the following output examples:

- When a 24-bit ITU-N site identification STP point code is configured, the PCN header is changed to PCN24.
- The s- point code prefix indicates an ITU national or international spare point code or spare capability point code.
- ANSI41 AIQ, EIR, G-Flex, G-Port, INP, LNP and V-Flex capability point codes are indicated in parentheses after the capability point code header.
- STP capability point codes have no parentheses after the header.

This example shows all site identification characteristics provisioned in the system at the time the command was entered. The output includes spare point codes.

```
rtrv-sid
```

```
tekelecstp 04-06-14 15:18:11 EST EAGLE 31.12.0
PCA          PCI          PCN          CLLI
PCTYPE
005-067-000  1-023-4      01234       tekelecstp   ANSI
              s-1-023-4    s-01234
CPCI
s-4-056-0
CPCN
s-00456
```

;

This example shows an STP capability point code:

```
rtrv-sid:cpc=5-5-4
```

```

      rlghncxa03w 03-03-18 09:33:58 EST  EAGLE 31.3.0
      PCA          PCI          PCN          CLLI
PCTYPE
      008-013-008  -----          -----          tklcstn14
OTHER
      CPCA
      005-005-004

```

;

This example shows an LNP capability point code:

```
rtrv-sid:cpc=3-3-3
```

```

      rlghncxa03w 03-03-10 09:33:58 EST  EAGLE 31.3.0
      PCA          PCI          PCN          CLLI
PCTYPE
      008-013-008  -----          -----          tklcstn14
OTHER
      CPCA (LNP)
      003-003-003

```

;

This example shows output when no match for the specified capability point code is found in the Site ID table:

```
rtrv-sid:cpc=100-100-100
```

```

      rlghncxa03w 03-03-18 09:33:58 EST  EAGLE 31.3.0
      PCA          PCI          PCN          CLLI
PCTYPE
      008-013-008  -----          -----          tklcstn14
OTHER

```

```
      Capability Point Code specified is not provisioned.
```

;

This example shows a display of a site identification STP point code with a group code (the ITUDUPPC feature must be on):

```
rtrv-sid
```

```
rlghncxa03w 03-03-18 09:33:58 EST EAGLE 31.3.0
PCA          PCI          PCN          CLLI          PCTYPE
008-013-008  -----  128-15-1-1-si tklcstn14    OTHER
```

```
;
```

This example shows all provisioned INP capability point codes:

```
rtrv-sid:cpctype=inp
```

```
rlghncxa03w 03-03-18 09:33:58 EST EAGLE 31.3.0
PCA          PCI          PCN          CLLI          PCTYPE
-----      2-150-4      12345        tklcstn14    OTHER
```

```
CPCN (INP)
1234 34567
```

```
CPCI (INP)
3-050-2      4-100-3
```

```
;
```

This example shows a specific 24-bit ITU-N capability point code:

```
rtrv-sid:cpcn24=33-33-33
```

```
rlghncxa03w 02-03-18 09:33:58 EST EAGLE 31.0.0
PCA          PCI          PCN24        CLLI          PCTYPE
001-001-001  -----      011-011-011 tekelecstp   ANSI
```

```
CPCN24
033-033-033
```

```
;
```

This example contains capability point codes provisioned with cpctype=gflex, cpctype=gport, and cpctype=aiq:

```
rtrv-sid
```

```
tekelecstp 09-12-09 15:46:50 EST EAGLE 42.0.0
PCA          PCI          PCN          CLLI
PCTYPE
001-001-001  2-002-2      00333        tekelecstp   ANSI
```

```
CPCI (GFLEX)
2-002-3      2-002-4
```

```
CPCA (AIQ)
001-002-003  001-002-004
```

```

      CPCA (GPORT)
      001-001-002      001-001-003
;

rtrv-sid

      tekelecstp 04-06-14 15:18:11 EST  EAGLE 31.12.0
      PCA          PCI          PCN          CLLI
PCTYPE
      008-013-008      -----      -----      tklcstn14
OTHER

      CPCA
      005-005-002      005-005-004      005-005-005

      CPCA (LNP)
      005-005-002      005-005-004      005-005-005
;

```

This example retrieves a specific spare ITU-N capability point code:

```
rtrv-sid:cpcn=s-00456
```

```

      rlghncxa03w 05-01-07-18 09:33:58 EST  EAGLE 31.12.0
      PCA          PCI          PCN
CLLI          PCTYPE
      005-067-000      1-023-4      01234
tekelecstp    ANSI
              s-1-023-4      s-01234

      CPCN
      s-00456

      CPCN (EIR)
      s-123
;

```

This example shows all site identification characteristics provisioned in the system at the time the command was entered when the J7 feature is enabled. The output includes spare point codes.

```

rtrv-sid

      tekelecstp 13-08-13 15:36:39 EST  EAGLE 45.1.0-64.71.0
rtrv-sid
Command entered at terminal #4.
      PCN16          PCI          PCN
CLLI          PCTYPE
      001-01-01      2-002-2      12345
tekelecstp    ANSI
              s-2-003-1      s-12341

```

```

CPCI
3-004-5

CPCN
03203

CPCN16
003-04-01          003-04-03

```

;

### Legend

- **PCA**—ANSI point code of the STP.
- **PCI**—ITU-TSS international point code of the STP.
- **PCN**—ITU-TSS national point code of the STP.
- **PCN16**—16-bit ITU national point code of the STP.
- **PCN24**—24-bit ITU national point code of the STP.
- **CPCA**—ANSI capability point code used by the SS7 protocol to identify a group of functionally related STPs in the signaling network
- **CPCN**—ITU-TSS national capability point code used by the SS7 protocol to identify a group of functionally related STPs in the signaling network.
- **CPCI**—ITU-TSS international capability point code used by the SS7 protocol to identify a group of functionally related STPs in the signaling network.
- **CPCN24**—ITU-TSS 24-bit national capability point code used by the SS7 protocol to identify a group of functionally related STPs in the signaling network.
- **CPCN16**—ITU-TSS 16-bit national capability point code used by the SS7 protocol to identify a group of functionally related STPs in the signaling network.
- **(EIR)**—Equipment Identity Register (EIR) point code.
- **(INP)**—INAP Number Portability (INP) point code.
- **(LNP)**—Local number portability (LNP) point code.
- **(GFLEX)**—G-Flex (GFLEX) point code.
- **(GPORT)**—G-Port (GPORT) point code.
- **(MNP)**—MNP point code.
- **(VFLEX)**—V-Flex (VFLEX) point code.
- **(ATINP)**—ATINP feature (ATINPQ) point code.
- **(AIQ)**—ANSI41 AIQ feature (AIQ) point code.
- **CLLI**—Common language location identifier of the STP
- **PCTYPE**—Type of point code used by the STP. There are two types of point codes that the EAGLE STP can use, ANSI and OTHER. The value ANSI means the EAGLE STP supports point codes that meet the ANSI standard. The value OTHER means that the EAGLE STP supports point codes that do not meet the ANSI standard.



**Notes**

If optional parameters are specified, only the entries that match the entered parameters are displayed.

**Output**

This example displays output when no other parameter is specified:

```
rtrv-sip-npp

tekelecstp 12-07-09 19:08:19 EST EAGLE 45.0.0
rtrv-sip-npp
Command entered at terminal #4.
PHONE-CTXT          PFX          NPDD          NPDS
-----
xyz.com              121          0             NONE
abc.com              12           0             NONE
mart.com             43321        0
NONE                 233          0
NONE                 232          0
NONE                 231          0
NONE                 11           0
NONE                 1            0             NONE

PHCTXTID table is (3 of 101) 3% full.

;
```

The below two examples display the output when PHCTXT parameter is specified:

```
rtrv-sip-npp:phctxt=abc.com

tekelecstp 12-07-09 19:09:08 EST EAGLE 45.0.0
rtrv-sip-npp:phctxt=abc.com
Command entered at terminal #4.
PHONE-CTXT          PFX          NPDD          NPDS
-----
-----
abc.com              12           0             NONE

PHCTXTID table is (3 of 101) 3% full.
```



```

;

rtrv-sip-npp:phctxt=dfmt

tekelecstp 12-07-09 19:09:08 EST EAGLE 45.0.0
rtrv-sip-npp:phctxt=dfmt
Command entered at terminal #4.
PHONE-CTXT                PFX                NPDD                NPDS
-----
dfmt                        15                  0                    NONE

PHCTXTID table is (4 of 101) 4% full.

;

```

This example displays the output when PFX parameter is specified:

```

rtrv-sip-npp:phctxt=user@mart.com:pfm=91+

tekelecstp 12-07-09 19:09:08 EST EAGLE 45.0.0
rtrv-sip-npp:phctxt=user@mart.com:pfm=91+
Command entered at terminal #4.
PHONE-CTXT                PFX                NPDD                NPDS
-----
user@mart.com              91+                  0                    NONE

PHCTXTID table is (3 of 101) 3% full.

;

```

### Related Topics

- [dlt-sip-npp](#)
- [ent-sip-npp](#)
- [chg-sip-npp](#)

## rtrv-sipopts

Use this command to retrieve SIP-configuration options.

### Parameters

This command has no input parameters.

**Example**

```
rtrv-sipopts
```

**Dependencies**

SIPNP Feature must be enabled before retrieving SIP configuration-options.

SIPOPTS table should be accessible.

**Output**

This example shows output with default SIP options.

```
rtrv-sipopts
```

```
tekelecstp 12-06-25 11:43:52 EST EAGLE 45.0.0
rtrv-sipopts
Command entered at terminal #4.
NPRSPFMT      = RNDN
INCLUDENPDI   = on
INCLUDERN     = on
RNFMT         = RN
NPLKUPFAIL    = 404
RNCONTEXT     = null
```

```
;
```

This example shows output with SIP options provisioned.

```
rtrv-sipopts
```

```
tekelecstp 12-06-25 11:54:02 EST EAGLE 45.0.0
rtrv-sipopts
Command entered at terminal #4.
NPRSPFMT      = RN
INCLUDENPDI   = off
INCLUDERN     = off
RNFMT         = RNASD
NPLKUPFAIL    = 302
RNCONTEXT     = xyz
```

```
;
```

**Legend**

- NPRSPFMT— Defines format of URI in Contact header, when INCLUDERN is OFF.
- INCLUDENPDI— Indicates whether to include "npdi" parameter in the response in cases where the RTDB dip is successfully performed.
- INCLUDERN— Indicates whether to include "rn" parameter in the response in cases where the RTDB dip is successfully performed.
- RNFMT— Defines format of Routing Number in the 302 response.

- NPLKUPFAIL— Indicates whether 302 or 404 response is sent, when DN is not found in RTDB lookup.
- RNCONTEXT— Describes how the "rn" parameter value should be interpreted (global or local).

### Related Topics

- [chg-sipopts](#)

## rtrv-slk

Use this command to show the parameters for low-speed signaling links, ATM high-speed signaling links, or both.

### Parameters

#### **aname (optional)**

Association name. The name of the association assigned to the links to be displayed.

#### **Range:**

aaaaaaaaaaaaaaaa

Up to 15 alphanumeric characters; the first character must be a letter

#### **link (optional)**

The signaling link on the card specified in the `loc` parameter. The links can be specified in any sequence or pattern.

#### **Synonym:**

*port*

#### **Range:**

*a, b, a1 - a63, b1 - b63*

Not all card types support all link parameter values.

See [Table A-1](#) for valid `link` parameter range values for each type of card that can have assigned signaling links.

#### **Default:**

Display all

#### **loc (optional)**

The card location as stenciled on the shelf of the system.

#### **Range:**

*1101 - 1108, 1111 - 1112, 1201 - 1208, 1211 - 1218, 1301 - 1308, 1311 - 1318, 2101 - 2108, 2111 - 2118, 2201 - 2208, 2211 - 2218, 2301 - 2308, 2311 - 2318, 3101 - 3108, 3111 - 3118, 3201 - 3208, 3211 - 3218, 3301 - 3308, 3311 - 3318, 4101 - 4108, 4111 - 4118, 4201 - 4208, 4211 - 4218, 4301 - 4308, 4311 - 4318, 5101 - 5108, 5111 - 5118, 5201 - 5208, 5211 - 5218, 5301 - 5308, 5311 - 5318, 6101 - 6108, 6111 - 6118*

#### **Default:**

All signaling links are shown.

#### **type (optional)**

Link type. This parameter specifies to display a sub-set of links.

**Range:*****e1***

Display signaling links for E1 cards. Includes low speed E1 and SE-HSL links.

***ipgw***

Display signaling links configured for IPGW linksets

***ipsg***

Display signaling links configured for IPSG linksets

***j1***

Display signaling links for J1 cards. Includes low speed J1 links.

***mtp2***

Display low-speed signaling links

***saal***

Display ATM high-speed signaling links

***t1***

Display signaling links for T1 cards. Includes low speed T1 and ST-HSL-A links.

**Default:**

Display all signaling links

**Example**

```
rtrv-slk:loc=1302:link=a
rtrv-slk:loc=1302:link=b2
rtrv-slk:loc=1303:link=a31
rtrv-slk:aname=asocm2pa
rtrv-slk:loc=1305
rtrv-slk:type=j1
```

**Dependencies**

If the `link` parameter is specified, the `loc` parameter must be specified. The `loc` parameter can be specified without the `link` parameter.

The `loc` parameter or the `class` parameter, but not both, can be specified in the command.

The slot portion of the specified `loc` parameter must be 01 - 18, except 09 and 10 cannot be specified (`loc=xyss`, where `x` is the frame, `y` is the shelf, and `ss` is the slot).

Card locations 1113 - 1118 cannot be specified for the `loc` parameter.

The LIMATM, LIME1ATM, LIME1, LIMT1, DCM, and ENET/ENETB card types are the only valid card types for this command.

The card must be an E5-ATM-B, E5-E1T1-B, E5-ENET-B.

The specified card location must be equipped.

The IMT (Card) table must be accessible.

The Link table must be accessible.

The Linkset table must be accessible.

If an E5-ATM-B card is used, then a value of A, B, or A1 must be specified for the `link` parameter. A 3 Links per Card feature quantity must be enabled before the `link=a1` parameter can be specified.

### Notes

This command can be canceled using the **F9** function key or the `canc-cmd` command. See `canc-cmd` for more information.

Not every card location represents a signaling link. Be sure to address a signaling link in this command.

The *Installation Guide* provides an illustration of the card locations.

### Output

```
rtrv-slk
```

```
tekelecstp 09-12-17 13:54:32 EST EAGLE 42.0.0
```

```
rtrv-slk
```

```
Command entered at terminal #4.
```

LOC	LINK	LSN	SLC	TYPE	LP SET BPS	ATM TSEL	VCI	VPI	LL
1208	A	e3e4	4	LIMATM	1 1.544M	LINE	5	0	0
1218	A	e3e4	5	LIMATM	1 1.544M	LINE	5	0	0

LOC	LINK	LSN	SLC	TYPE	ANAME	SLKTPS
1303	A	m2pa12132	0	IPSG	m2pa1303a	1000
1303	B	m3ua333a	0	IPSG	m3ua1303b	500
1303	A1	m3ua323a	0	IPSG	m3ua1303a	1000
1303	B1	m3ua333i	0	IPSG	m3ua1303b	500
1303	B2	m3ua333n	0	IPSG	m3ua1303b	500
1305	A	ls1305a	0	IPSG	sg1305a	1000
1305	B	ls1305i	0	IPSG	sg1305i	500
1305	A1	ls1305a	1	IPSG	a1	1000
1305	B1	ls1305i	1	IPSG	a1	500
1305	B14	lsitunbb	0	IPSG	a1	1000
1305	B15	lsitunaa	0	IPSG	a1	1000

LOC	LINK	LSN	SLC	TYPE
1313	A	e3e4i	0	IPLIMI

LOC	LINK	LSN	SLC	TYPE
1307	A	ls1307a	0	SS7IPGW
1315	A	ls1315a	0	SS7IPGW
1317	A	ls1317i	0	IPGWI

```
SLK table is (20 of 1200) 2% full.
```

```
;
```

This example shows the link information for an LIMATM card:

```
rtrv-slk:loc=1304:link=a
```

```
tekelecstp 09-12-14 12:17:00 EST EAGLE 42.0.0
                                LP          ATM
LOC  LINK LSN          SLC TYPE   SET BPS   TSEL     VCI  VPI  LL
1304 A   ls1          3  LIMATM   1  1.544M LINE  5    0    0
```

This example shows the link information for an IPSG card:

```
rtrv-slk:loc=1301
```

```
e1001501 10-04-03 16:20:45 EST EAGLE 42.0.0

LOC  LINK LSN          SLC TYPE   ANAME          SLKTPS/
MAXSLKTPS
                                RSVDSLKTPS
1301 A   SCS1          0  IPSG   sg1301a        500          5000
1301 B   SCS2          0  IPSG   sg1301b        1000         5000
1301 A1  MGC1          0  IPSG   sg1301a1       700          5000
1301 B1  MGC2          0  IPSG   sg1301b1       1200         5000

IPTPS for LOC = 1301 is (3400 of 5000) 68%
;
```

This example shows link information for signaling links configured for a specified association:

```
rtrv-slk:aname=m3ua1211a1
```

```
e1001501 10-04-03 16:20:45 EST EAGLE 42.0.0

LOC  LINK LSN          SLC TYPE   ANAME          SLKTPS/
MAXSLKTPS
                                RSVDSLKTPS
1211 A1  ls1211b       0  IPSG   m3ua1211a1     600          5000
1211 A2  ls1211c       0  IPSG   m3ua1211a1     700          5000
;
```

This example shows the link information for an E5-ATM-B card:

```
rtrv-slk:loc=1305
```

```
tekelecstp 11-03-14 12:17:00 EST EAGLE 44.0.0
                                LP          ATM
LOC  LINK LSN          SLC TYPE   SET BPS   TSEL     VCI  VPI  LL
1305 A   ls1          0  LIMATM   1  1.544M LINE  5    0    0
1305 B   ls1          1  LIMATM   1  1.544M LINE  5    0    0
```

This example shows the link B information for an E5-ATM-B card:

```
rtrv-slk:loc=1305:link=b
```

```
tekelecstp 11-03-14 12:17:00 EST EAGLE 44.0.0
LP ATM
LOC LINK LSN SLC TYPE SET BPS TSEL VCI VPI LL
1305 B ls1 1 LIMATM 1 1.544M LINE 5 0 0
```

This example shows ATM (ANSI & ITU) and E1/T1 (HSL & LSL) links:

```
rtrv-slk
```

```
tekelecstp 09-12-17 17:09:54 EST 42.0.0
LP ATM
LOC LINK LSN SLC TYPE SET BPS TSEL VCI VPI LL
1101 A ls333 0 LIMATM 1 1.544M LINE 5 0 0

LP
ATM E1ATM
LOC LINK LSN SLC TYPE SET BPS TSEL VCI VPI
CRC4 SI SN
1201 A lsi333 1 LIME1ATM 21 2.048M EXTERNAL 5 0
ON 3 0

L2T PCR PCR
E1 E1

LOC LINK LSN SLC TYPE SET BPS ECM N1 N2
LOC PORT TS
1204 A lsi111 0 LIME1 26 1.984M BASIC ---- -
1204 5 1
1205 A1 lsi222 0 LIME1 11 56000 BASIC ---- -
1205 1 3

L2T PCR PCR
T1 T1

LOC LINK LSN SLC TYPE SET BPS ECM N1 N2
LOC PORT TS
1104 A ls111 0 LIMT1 31 1.536M BASIC ---- -
1104 5 1
1105 A1 ls222 0 LIMT1 1 56000 BASIC ---- -
1105 1 2
```

```
SLK table is (6 of 1200) 1% full.
```

```
;
```

This example shows link A1 information for an E5-ATM-B card:

```
rtrv-slk:loc=1306:link=a1
```

```
tekelecstp 11-03-18 12:17:00 EST EAGLE 44.0.0
LP ATM
```

```

LOC LINK LSN          SLC TYPE      SET BPS      TSEL      VCI  VPI  LL
1306 A1   ls1          1  LIMATM     1  1.544M LINE  5    0    0

```

This example shows link information for an E5-ENET-B card:

```
rtrv-slk:loc=1301
```

```

tekelecstp 11-03-14 16:22:25 EST  EAGLE5 44.0.0
LOC LINK LSN          SLC TYPE      ANAME          SLKTPS/
MAXSLKTPS
RSVDSLKTPS
1301 A    SCS1          0  IPSPG     sg1301a        500           6500
1301 B    SCS2          0  IPSPG     sg1301b        1000          6500
1301 A1   MGC1          0  ISPG     sg1301a1       700           6500
1301 B1   MGC2          0  IPSPG     sg1301b1      1200          6500

```

RSVDSLKTPS for LOC = 1301 is (3400 of 6500) 52%.

SLK table is (4 of 1200) 1% full.

This example shows link information for a J1 link:

```
rtrv-slk:type=j1
```

```

tekelecstp 13-12-19 19:02:51 EST  46.0.0-65.3.0
rtrv-slk:type=j1
Command entered at terminal #4.

LOC LINK LSN          SLC TYPE      L2T          PCR  PCR  J1
SET BPS      ECM  N1  N2  PORT TS
1102 A    ls2          11  LIMT1     11  64000 BASIC  ----  -----  1  11
1102 A1   ls2          10  LIMT1     11  64000 BASIC  ----  -----  1  11
1102 A2   ls2           5  LIMT1     11  64000 BASIC  ----  -----  1  25

```

SLK table is (7 of 1200) 1% full.

```
;
```

This example shows the link information for a SLIC card running the IPSPG application:

```
rtrv-slk:loc=1301
```

```

e1001501 16-05-27 16:20:45 EST  EAGLE 46.4.0

LOC LINK LSN          SLC TYPE      ANAME          SLKTPS/
RSVDSLKTPS
MAXSLKTPS
1301 A30  SCS1          0  IPSPG     sg1301a        500           9500
1301 B35  SCS2          0  IPSPG     sg1301b        1000          9500
1301 A50  MGC1          0  ISPG     sg1301a1       700           9500
1301 B55  MGC2          0  IPSPG     sg1301b1      1200          9500

```



IPTPS for LOC = 1301 is (3400 of 9500) 35%

;

### Legend

- **LOC**—Location of the card containing the signaling link
- **LINK**—Signaling link assigned to the card
- **LSN**—Name of the linkset containing the signaling link
- **SLC**—Signaling link code of the signaling link
- **TYPE**—Type of card
- **ANAME**—Association name
- **SLKTPS/RSVDSLKTPS**—SLKTPS guaranteed for an IPSP link
- **MAXSLKTPS**—Maximum SLKTPS allowed for an IPSP link
- **L2TSET**—Number of the level 2 timer set associated with the signaling link
- **BPS**—Transmission rate of the signaling link in bits per second
- **ECM**—Basic of PC for transmission
- **PCRN1**—MSU number
- **PCRN2**—Octet number
- **LPSET**—ATM link parameter set identifier
- **ATMTSEL**—ATM timing selector. Possible values are as follows:
  - **Internal**—Derived from an internal clock source operating at 1.544 MHz  $\pm$  200 Hz (ANSI) or 2.048 MHz  $\pm$  103 Hz (ITU).
  - **External**—Derived from the High-Speed Master Clock (T1 or E1)
  - **Line**—Derived from its received data stream, if present
- **VCI**—ATM virtual channel identifier
- **VPI**—ATM virtual path identifier
- **LL**—ATM line length
- **E1PORT**—E1 card port that has an E1 interface assigned to it.
- **T1PORT**—T1 card port that has a T1 interface assigned to it
- **TS**—Timeslot associated with the signaling link that is serviced by the E1 or T1 interface
- **E1ATMCRC4**—E1 ATM card CRC4 multi-frame structure enable/disable indicator
- **E1ATMSI**—Value of two Spare International bits of NFAS data for the E1 ATM card
- **E1ATMSN**—Value of five Spare National bits of NFAS data for the E1 ATM card
- **J1PORT**— J1 card port that has a J1 interface assigned to it.

### Related Topics

- [act-slk](#)
- [blk-slk](#)

- [dact-slk](#)
- [dlt-slk](#)
- [ent-slk](#)
- [inh-slk](#)
- [rept-stat-slk](#)
- [tst-slk](#)
- [ublk-slk](#)
- [unhb-slk](#)

## rtrv-slt

Use this command to display the fields of an SLTM (signaling link test message) record in the SLTM table.

### Parameters

#### **enabled (optional)**

Displays the SLTM records that are either enabled or disabled ( *off* ).

#### **Range:**

***on***  
display enabled records

***off***  
display disabled records

#### **Default:**

All SLTM records with the specified value for the enabled parameter are shown.

#### **sltset (optional)**

The signaling link test message (SLTM) record number in the SLTM table.

#### **Range:**

*1 - 20*

#### **Default:**

Display all

### Example

```
rtrv-slt
rtrv-slt:sltset=1
rtrv-slt:enabled=off
```

### Dependencies

None

### Notes

None

**Output**

```
rtrv-slt
```

```
rlghncxa03w 03-03-07 00:21:24 EST EAGLE 31.3.0
SLTM PARAMETERS
SLTSET  T1   T2   MODE   ENABLED PATTERN
1       9.0  60.0 SPECIAL ON    AA2233445566778899AABBCCDDEEFF
2       12.0 30.0 SPECIAL OFF   F01234BCDE
3       4.0  50.0 REGULAR ON    CC2233445566778899AABBCCDDEEFF
4       6.0  90.0 SPECIAL OFF   BB23446789BCABEFG
5       6.0  90.0 SPECIAL OFF   BB23446789BCABEFG
6       6.0  90.0 SPECIAL OFF   BB23446789BCABEFG
7       6.0  90.0 SPECIAL OFF   BB23446789BCABEFG
8       6.0  90.0 SPECIAL OFF   BB23446789BCABEFG
9       6.0  90.0 REGULAR OFF   BB23446789BCABEFG
10      6.0  90.0 REGULAR OFF   BB23446789BCABEFG
11      6.0  90.0 REGULAR OFF   BB23446789BCABEFG
12      4.0  50.0 SPECIAL ON    FFEEDDCCBAA998877665544332211
13      4.0  50.0 SPECIAL ON    EE22334455
14      6.0  90.0 SPECIAL ON    AABCCDD
15      6.0  90.0 REGULAR ON    AABCCDD
16      6.0  90.0 REGULAR ON    AABCCDD
17      6.0  90.0 REGULAR ON    AABCCDD
18      6.0  90.0 SPECIAL ON    AABCCDD
19      6.0  90.0 SPECIAL ON    AABCCDD
20      6.0  90.0 SPECIAL ON    AABCCDD
```

```
;
```

```
rtrv-slt:sltset=1
```

```
rlghncxa03w 03-03-07 00:21:24 EST EAGLE 31.3.0
SLTM PARAMETERS
SLTSET  T1   T2   MODE   ENABLED PATTERN
1       9.0  60.0 SPECIAL ON    112233445566778899AABBCCDDEEFF
```

```
;
```

```
rtrv-slt:enabled=off
```

```
rlghncxa03w 03-03-07 00:21:24 EST EAGLE 31.3.0
SLTM PARAMETERS
SLTSET  T1   T2   MODE   ENABLED PATTERN
2       12.0 30.0 SPECIAL OFF   F01234BCDE
4       6.0  90.0 SPECIAL OFF   0123446789BCABEFG
5       6.0  90.0 SPECIAL OFF   0123446789BCABEFG
6       6.0  90.0 SPECIAL OFF   0123446789BCABEFG
7       6.0  90.0 SPECIAL OFF   0123446789BCABEFG
8       6.0  90.0 SPECIAL OFF   0123446789BCABEFG
9       6.0  90.0 REGULAR OFF   0123446789BCABEFG
10      6.0  90.0 REGULAR OFF   0123446789BCABEFG
```

```
11      6.0  90.0  REGULAR  OFF      0123446789BCABEFG  
;
```

### Legend

- **SLTSET**—Signaling link test message record number in the SLTM table
- **T1**—T1 timer value for the SLTM record. The amount of time, in seconds, to wait before running the SLTM test again after an SLTM test fails.
- **T2**—T2 timer value for the SLTM record. The amount of time, in seconds, to wait between running SLTM tests for a normally functioning signaling link.
- **MODE**—SLTM mode to be used when sending test messages
- **ENABLED**—Indicates whether the signaling link test message is enabled.
- **PATTERN**—Test pattern to be sent with a signaling link test message

### Related Topics

- [chg-l3t](#)
- [chg-slt](#)
- [ent-ls](#)
- [rtrv-ls](#)

## rtrv-snmp-host

Use this command to show the configuration parameters of the provisioned SNMP hosts.

### Parameters

This command has no parameters.

### Example

```
rtrv-snmp-host
```

### Dependencies

This command cannot be entered while in upgrade mode.

### Notes

None

### Output

```
rtrv-snmp-host  
  
tekelecstp 12-06-13 14:37:55 EST 45.0.0-64.66.0  
rtrv-snmp-host  
Command entered at terminal #4.  
IPADDR      192.168.54.100  
HOST        snmphost1  
CMDPORT     161  
TRAPPORT    162  
HB          60
```

```
TRAPCOMM public
SNMP HOST table is (1 of 2) 50% full
;
```

### Legend

- IPADDR - IP address of the SNMP Manager device
- HOST - Host name of the Manager device
- CMDPORT - SNMP command interface port ID
- TRAPPORT - SNMP trap interface port ID
- HB - Heartbeat notification interval
- TRAPCOMM - Trap community string

### Related Topics

- [ent-snmp-host](#)
- [chg-snmp-host](#)
- [dlt-snmp-host](#)

## rtrv-snmptpts

Use this command to display the system-wide SNMP Options

### Parameters

This command has no parameters.

### Example

```
rtrv-snmptpts
```

### Dependencies

This command cannot be entered while in upgrade mode.

### Notes

None.

### Output

```
rtrv-snmptpts
```

```
tekelecstp 13-06-13 15:27:39 EST 45.0.0-64.66.0
```

```
rtrv-snmptpts
```

```
Command entered at terminal #4.
```

```
SNMP      OPTIONS
```

```
-----
SNMPUIM   on
GETCOMM   my.getcomm.str
SETCOMM   setcomm-pwd
;
```

**Legend**

- SNMPUIIM - UIM trap enable/disable
- GETCOMM - Get community string
- SETCOMM - Trap community string

**Related Topics**

- [chg-snmppopts](#)

## rtrv-spc

Use this command to retrieve an SPC (secondary point code) from the active database.

**Parameters****Note:**

See [Point Code Formats and Conversion](#) for a detailed description of point code formats, rules for specification, and examples.

**spc (optional)**

ANSI point code in the form of *network indicator-network cluster-network cluster member (ni-nc-ncm)*.

**Synonym:**

*spca*

**Range:**

*000-255*

Specify a valid value for each subfield of the point code, and separate the subfields with a dash (-).

When *chg-sid:pctype=ansi* is specified, *ni = 000* is not valid.

When *chg-sid:pctype=ansi* is specified, *nc = 000* is not valid if *ni = 001-005*.

When *chg-sid:pctype=ansi* is specified, *nc = 000* is valid if *ni = 006-255*.

The point code *000-000-000* is not a valid point code.

**spc/spca/spci/spcn/spcn24/spcn16 (optional)**

The secondary point code.

**spci (optional)**

ITU international secondary point code with subfields *zone-area-id*. The *prefix* subfield indicates a spare point code (*prefix-zone-area-id*).

**Range:**

*s-, 0-255*

Specify a valid value for each subfield of the point code, and separate the subfields with a dash (-).

*prefix—s*

*zone—0-7*

*area—000-255*

*id—0-7*

The point code *0-000-0* is not a valid point code.

#### **spcn (optional)**

ITU national point code in the format of a 5-digit number (*nnnnn*); or 2, 3, or 4 numbers (members) separated by dashes (*m1-m2-m3-m4*) as defined by the `chg-stpopts:npcfmti` flexible point code option. A group code must be specified when the ITUDUPPC feature is turned on (*nnnnn-gc*, *m1-m2-m3-m4-gc*). The *prefix* subfield indicates a spare point code (*prefix-nnnnn*, *prefix-nnnnn-gc*, *prefix-m1-m2-m3-m4*, *prefix-m1-m2-m3-m4-gc*).

#### **Range:**

*s-*, *0-16383*, *aa-zz*

Specify a valid value for each subfield of the point code, and separate the subfields with a dash (-).

*prefix—s-*

*nnnnn—0-16383*

*gc—aa-zz*

*m1-m2-m3-m4—0-14* for each member; values must sum to 14

#### **spcn24 (optional)**

24-bit ITU national point code with subfields *main signaling area-sub signaling area-signaling point* (*msa-ssa-sp*).

#### **Range:**

*000-255*

Specify a valid value for each subfield of the point code, and separate the subfields with a dash (-).

*msa—000-255*

*ssa—000-255*

*sp—000-255*

#### **spcn16 (optional)**

16-bit ITU national point code with subfields *unit number sub number area main number area* (*un-sna-mna*).

#### **Range:**

*000---127*

Specify a valid value for each subfield of the point code, and separate the subfields with a dash (-).

*un---000---127*

*sna---000---15*

*mna---000---31*

#### **Example**

```
rtrv-spc
```

```
rtrv-spc:spc=5-3-3
```

```
rtrv-spc:spcn24=98-98-98
```

```
rtrv-spc:spcn=s-00345
rtrv-spc:spcn16:121-10-30
```

### Dependencies

The MPC feature must be turned on before this command can be entered.

The SPC table must be accessible.

The value of the `spc` parameter must be a full point code.

### Notes

In this command, only ITU-international and ITU national point codes support the spare point code subtype prefix (s-).

### Output

This example shows output for all provisioned secondary point codes. SPC-N is a flexible point code format as defined with the `chg-stpopts:npcfmti` parameter.

```
rtrv-spc

rlghncxa03w 03-03-18 08:50:12 EST  EAGLE 31.0.0
SPC (Secondary Point Codes)

SPCA
    001-010-010
    002-010-010
    003-010-010

SPC-I
    01-253-05
    02-254-06
    03-255-07

SPC-N
    120-01-0-1
    100-02-1-0

SPC-N24
    099-099-099

Secondary Point Code table is (9 of 40) 25% full

;
```

This example shows output for all provisioned secondary point codes. Spare point codes are included.

```
rtrv-spc

rlghncxa03w 05-01-18 08:50:12 EST  EAGLE 31.12.0
SPC (Secondary Point Codes)
```



```
SPCA
  001-001-001
  001-123-003
```

```
SPC-I
  1-001-1
  s-1-001-1
  2-003-4
  s-4-003-4
```

```
SPC-N
  00234
  s-00345
```

```
SPC-N24
  011-011-011
```

Secondary Point Code table is (9 of 40) 22% full.

;

This example shows the only provisioned secondary point code:

```
rtrv-spc
```

```
rlghncxa03w 05-03-18 08:50:12 EST EAGLE 31.0.0
SPC (Secondary Point Codes)
```

```
SPCA
none
```

```
SPC-I
none
```

```
SPC-N
none
```

```
SPC-N24
  099-099-099
```

Secondary Point Code table is (1 of 40) 2% full.

;

This example shows output for a specific ANSI secondary point code:

```
rtrv-spc:spc=5-3-3
```

```
rlghncxa03w 03-03-18 08:50:12 EST EAGLE 31.3.0
SPC (Secondary Point Codes)
  005-003-003
```

```
Secondary Point Code table is (8 of 40) 25% full.
```

```
;
```

This example shows output when the specified secondary point code is not provisioned:

```
rtrv-spc:spc=5-3-1
```

```
rlghncxa03w 03-03-18 08:50:12 EST EAGLE 31.3.0  
SPC (Secondary Point Codes)
```

```
Secondary Point Code specified is not provisioned
```

```
Secondary Point Code table is (3 of 40) 8% full.
```

```
;
```

This example shows information for a specific ITU-N secondary spare point code:

```
rtrv-spc:spcn=s-00345
```

```
rlghncxa03w 03-03-18 08:50:12 EST EAGLE 31.12.0  
SPC (Secondary Point Codes)  
s-00345
```

```
Secondary Point Code table is (2 of 40) 5% full.
```

```
;
```

This example shows output for a specific 24-bit ITU-N secondary point code:

```
rtrv-spc:spcn24=98-98-98
```

```
rlghncxa03w 03-03-18 08:50:12 EST EAGLE 31.0.0  
SPC (Secondary Point Codes)  
098-098-098
```

```
Secondary Point Code table is (2 of 40) 5% full.
```

```
;
```

This example shows output for a specific 16-bit ITU-N point code:

```
rtrv-spc:spcn16=121-10-15
```

```
rlghncxa03w 03-03-18 08:50:12 EST EAGLE 31.0.0  
SPC (Secondary Point Codes)  
098-098-098
```

```
Secondary Point Code table is (2 of 40) 5% full.
```

```
;
```

### Legend

- **SPC**—Secondary point code
- **SPCA**—ANSI secondary point code
- **SPC-I**—ITU international secondary point code
- **SPC-N**—ITU national secondary point code
- **SPC-N24**—24-bit ITU national secondary point code
- **SPC-N16**—16-bit ITU national secondary point code

### Related Topics

- [dlt-spc](#)
- [ent-spc](#)

## rtrv-srvsel

Use this command to display a list of administered service selector combinations. The list can be filtered using various parameter combinations.



### Note:

The `rtrv-srvsel` operation may be lengthy because the service selector table can contain over 1,000 entries.

### Parameters



### Note:

Definitions for the feature options specified by the `on` and `off` parameters are located in the Notes section.

### **df1tact** (optional)

The default action ID associated with the service selector entry.

#### Range:

ayyyyyyy

1 alphabetic character followed by up to 8 alphanumeric characters

This parameter can take one of the following values:

- a valid GTT Action ID of type **disc/udts/tcaperr** that must already exist in the GTT Action table

- *fallback* —Fallback to the Relay data. The Relayed MSU is routed as per routing data provided by the service.
- *falltogtt* —Fallback to GTT. If the *gttselid* parameter has a value other than *none*, and the GTT selector search fails, then the GTT selector search is performed again using *gttselid=none*.

**force (optional)**

The *force=yes* parameter must be specified when a *num* parameter value greater than 50 is specified to display more than 50 entries.

**Range:**

*yes*

*no*

**Default:**

*no*

**gti/gtia/gtii/gtin/gtin24 (optional)**

Global title indicator. For all service selector commands, the domain is defined as GTI and GTIA (ANSI), GTII (ITU international), GTIN (ITU national) and GTIN24 (24-bit ITU national). For the service selector commands, GTI and GTIA are equivalent.

**Range:**

Supported value for ANSI: *gti/gtia=2*

Supported values for ITU: *gtii/gtin/gtin24=0, 2, 4*

**Default:**

Display all

**nai (optional)**

Nature of Address indicator.

**Range:**

*sub*

*rsvd*

*natl*

*intl*

**Default:**

Display all

**naiv (optional)**

Nature of Address indicator value.

**Range:**

*0 - 127*

**Default:**

Display all

**np (optional)**

Numbering Plan.

**Range:***e164**generic**x121**f69**e210**e212**e214**private***Default:**

Display all

**npv (optional)**

Numbering Plan value.

**Range:***0 - 15***Default:**

Display all

**num (optional)**Number of entries to display. The *force=yes* parameter is required when this parameter value is specified greater than 50 entries.**Range:***1 - 20992***Default:***50***off (optional)**

Disables or turns off the specified feature options. A comma-separated list of feature options that are requested to be turned off. Up to 10 feature options can be specified in the list.

**Range:***gttrqd**force*

**on (optional)**

Enables or turns on the specified feature options. A comma-separated list of feature options that are requested to be turned on. Up to 10 feature options can be specified in the list.

**Range:**

***gttrqd***

***force***

**serv (optional)**

The Service Module card service.

**Range:**

***eir***

Equipment Identity Register

***gflex***

GSM flexible numbering

***gport***

GSM number portability

***inpq***

INP query

***inpmr***

INP message relay

***smsmr***

Prepaid SMS Intercept Phase 1, Portability Check for Mobile Originated SMS, MO SMS GSM NP, MO SMS IS41 NP, MO SMS IS41-to-GSM Migration, MO SMS ASD, MO SMS GRN, MO SMS B-Party routing.

***idps***

IDP Screening for Prepaid

***idpr***

Prepaid IDP Query Relay

***mnp***

mobile number portability

***vflex***

Voice Mail Router

***atinp***

ATI Number Portability Query (ATINP)

***ttr***

Triggerless TCAP Relay

***aiq***

ANSI41 Analyzed Information Query

**Default:**  
Display all

**snai (optional)**  
Service nature of address indicator.

**Range:**

**sub**  
Subscriber number

**natl**  
National significant number

**intl**  
International number

**rnidn**  
Routing number prefix and international dialed/directory number

**rnndn**  
Routing number prefix and national dialed/directory number

**rnsdn**  
Routing number prefix and subscriber dialed/directory number

**ccrndn**  
Country code, routing number, and national directory number

**Default:**  
Display all

**snp (optional)**  
Service numbering plan.

**Range:**

**e164**  
E.164 numbering plan

**e212**  
E.212 numbering plan

**e214**  
E.214 numbering plan

**Default:**  
Display all

**ssn (optional)**  
Subsystem number.

**Range:**  
0 - 255, \*

**tt (optional)**  
Translation type.

**Range:**

0 - 255

**Default:**

Display all

**Example**

```
rtrv-srvsel
rtrv-srvsel:gtii=2
rtrv-srvsel:tt=0:np=e164
rtrv-srvsel:serv=vflex
rtrv-srvsel:serv=aiq
rtrv-srvsel:on=gttrqd
rtrv-srvsel:gtii=0:serv=idpr
```

**Dependencies**

The INP or AINPQ feature must be turned on before the `serv=inpvr` or `serv=inpq` parameter can be specified.

The G-Flex feature must be turned on before the `serv=gflex` parameter can be specified.

The G-Port feature must be turned on before the `serv=gport` parameter can be specified.

The `np` and `npv` parameters cannot be specified together in the command.

The `nai` and `naiV` parameters cannot be specified together in the command.

The values 1 and 3 are not valid for the `gti/gtia/gtii/gtin/gtin24` parameters.

The value 0, 4 is not valid for the `gti/gtia` parameters.

If the `gti/gtia/gtii/gtin/gtin24=0, 2` parameter is specified, then no `np(v)` and `nai(v)` parameter combinations can be specified.

If the `serv` parameter has a value of `inpvr`, `inpq`, `gport`, or `eir`, then the `gtia` and `gti` parameters cannot be specified.

If the `serv=inpvr` parameter is specified, then the value of the `snp` parameter must be `e164` if specified.

If the value specified for the `snaI` parameter is `rnidn`, `rnndn`, or `rnsdn`, then the value of the `serv` parameter must be `inpvr`, `gport`, or `smsmr` if it is specified.

If the `serv=inpq` parameter is specified, then the `gtii` parameter cannot be specified.

If the value specified for the `snaI` parameter is `rnidn`, `rnndn`, or `rnsdn`, then the `serv=gflex` parameter cannot be specified.

If a value of `aiq`, `eir`, `inpq`, or `vflex` is specified for the `serv` parameter then the `snp` and `snaI` parameters cannot be specified.

If the `snaI=ccrndn` parameter is specified, then the value specified for the `serv` parameter must be `gport` or `smsmr`.



If the value specified for the `num` parameter is greater than 50, then the `force=yes` parameter must be specified.

The Prepaid IDP Query Relay feature must be turned on or the IAR Base feature must be enabled before the `serv=ttr` parameter can be specified.

If a value of `idpr` or `ttr` is specified for the `serv` parameter, then the parameters `NAIV`, `NPV`, `SNP`, or `SNAI` must not be specified.

The IDP Screening for Prepaid feature must be turned on before the `serv=idps` parameter can be specified.

The V-flex feature must be turned on before the `serv=vflex` parameter can be specified.

The Portability Check for Mobile Originated SMS or the PPSMS feature must be turned on, or the MO SMS ASD, MO SMS B-Party Routing, MO SMS GRN, MO SMS IS41-to-GSM Migration, MO-based GSM SMS NP, or MO-based IS41 SMS NP feature must be enabled before the `serv=smsmr` parameter can be specified.

The ATINP feature must be enabled before the `serv=atinp` parameter can be specified.

If a value of `aiq`, `atinp`, or `eir` is specified for the `serv` parameter, then the `gtin24` parameter cannot be specified.

The Prepaid IDP Query Relay feature must be turned on before the `serv=idpr` parameter can be specified.

The ANSI41 AIQ feature must be enabled before the `serv=aiq` parameter can be specified.

If a DSM4G card is active in the system, then the `on=gttrqd` parameter cannot be specified.

The GTT Action table is corrupt or cannot be found.

If a GTT Action ID is specified as the value for the `dfltact` parameter, then the Action ID must already exist in the GTT Action table.

The same values cannot be specified for the `on` and `off` parameters.

The `dfltact=none` parameter cannot be specified.

The EGTT feature must be turned on before the `dfltact` parameter can be specified.

The GSM DBMM table must be accessible.

The `defactid=none` parameter cannot be specified.

Only for IDP Relay feature, `gtii/gtin/gtin24=0` can be specified.

## Notes

### on/off options

- `gttrqd` —GTT required. Specifies whether GTT is required after service execution is complete and the message is relayed by the service. This option is supported for the IDPR, MNP, TTR, GPORT, SMSMR, GFLEX, and INPMR services.

- *force* —Must be specified to display more than 50 entries

### Output

This example shows all service selectors containing the specified GTI value:

```
rtrv-srvsel:gtii=2
```

```
rlghncxa03w 10-03-29 16:40:40 EST EAGLE 42.0.0
GTII TT NP NAI SSN SNP SNAI SERV GTTRQD
2 0 -- --- 7 e164 intl gflex on
DFLTACT=act123456 GTTSELID=20
2 18 -- --- 7 e164 rnidn inpmr off
DFLTACT=act1 GTTSELID=2
;
```

This example includes a GTIN24 entry:

```
rtrv-srvsel
```

```
rlghncxa03w 10-03-09 16:40:40 EST EAGLE 42.0.0
GTIN TT NP NAI SSN SNP SNAI SERV GTTRQD
4 4 e164 intl 8 e164 intl gport off
DFLTACT=fallback GTTSELID=none

GTIN24 TT NP NAI SSN SNP SNAI SERV GTTRQD
4 4 e164 intl 2 e164 intl gport off
DFLTACT=act123456 GTTSELID=2

SRV SELECTOR table is (2 of 20992) 1 % full
;
```

```
rtrv-srvsel:ssn=3
```

```
tekelecstp 10-03-08 15:43:22 EST EAGLE5 42.0.0
GTII TT NP NAI SSN SNP SNAI SERV GTTRQD
4 1 e214 intl 3 --- --- eir ---
DFLTACT=----- GTTSELID=-----

SRV SELECTOR table is (4 of 20992) 1 % full
;
```

This example shows all provisioned service selectors:

```
rtrv-srvsel
```

```
tekelecstp 10-03-16 17:09:08 EST EAGLE 42.0.0
GTIA TT NP NAI SSN SNP SNAI SERV GTTRQD
2 9 -- --- * e212 intl gflex off
DFLTACT=act123 GTTSELID=9
```

```

2      10  --      ---  3   e164  intl  gflex  off
DFLTACT=act123456 GTTSELID=75
2      253 --      ---  4   e214  natl  gflex  off
DFLTACT=actt1     GTTSELID=80

GTII  TT  NP      NAI  SSN  SNP  SNAI  SERV  GTTRQD
2      0  --      ---  2   e164  intl  gflex  off
DFLTACT=act12345 GTTSELID=56
2      18  --      ---  *   e164  rnsdn inpmr  on
DFLTACT=act123   GTTSELID=80
4      0  e214  sub  *   e214  sub  gflex  off
DFLTACT=act123456 GTTSELID=98

GTIN  TT  NP      NAI  SSN  SNP  SNAI  SERV  GTTRQD
2      2  --      ---  3   e164  intl  gflex  off
DFLTACT=act1234  GTTSELID=8
2      9  --      --   *   ---   ---  inpq   ---
DFLTACT=----- GTTSELID=-----
4      2  e164  natl *   e164  rnndn inpmr  on
DFLTACT=act1234  GTTSELID=432
4      9  ---   ---  4   ---   ---  inpq   ---
DFLTACT=----- GTTSELID=-----
;

```

```
rtrv-srvsel:serv=vflex
```

```

tekelecstp 10-03-08 16:35:22 EST  EAGLE 42.0.0
GTII  TT  NP      NAI  SSN  SNP  SNAI  SERV  GTTRQD
4      1  e164  intl  3   ---   ---  vflex  ---
DFLTACT=----- GTTSELID=-----
4      2  e164  intl  *   ---   ---  vflex  ---
DFLTACT=----- GTTSELID=-----

GTIN  TT  NP      NAI  SSN  SNP  SNAI  SERV  GTTRQD
4      4  e164  natl  4   ---   ---  vflex  ---
DFLTACT=----- GTTSELID=-----

SRV SELECTOR table is (3 of 20992)  1 % full
;

```

This example shows the output when no service selectors are provisioned:

```
rtrv-srvsel
```

```

tekelecstp 10-03-04 13:28:13 EST  EAGLE 42.0.0

GTIA  TT  NP      NAI  SSN  SNP  SNAI  SERV  GTTRQD
No SRV Selector found in range
;

```

```
rtrv-srvsel: serv=aiq
```

```
tekelecstp 09-12-03 15:43:22 EST EAGLE5 42.0.0
GTII TT NP NAI SSN SNP SNAI SERV
4 0 e214 intl 10 --- --- aiq
```

```
SRV SELECTOR table is (4 of 20992) 1 % full
```

```
;
```

This example shows all service selectors for the GPORT service:

```
rtrv-srvsel: serv=gport
```

```
tekelecstp 10-03-04 13:28:13 EST EAGLE 42.0.0
```

```
GTII TT NP NAI SSN SNP SNAI SERV GTTRQD
2 4 -- ---- 12 e164 sub gport on
DFLTACT=act123456 GTTSELID=20
2 6 -- ---- 15 e164 sub gport on
DFLTACT=fallback GTTSELID=246
```

```
;
```

This example shows the output when the EPAP Data Split feature is turned on:

```
rtrv-srvsel
```

```
tekelecstp 12-01-12 15:24:04 EST EAGLE5 44.0.0
```

```
GTII TT NP NAI SSN SNP SNAI SERV RQDTBLNOP GTTRQD
4 1 e164 sub 2 e164 sub gflex uds off
DFLTACT=fallback GTTSELID=none
4 2 e164 sub 3 e164 sub gflex gtt off
DFLTACT=fallback GTTSELID=none
4 2 e164 sub 4 e164 sub gflex disc off
DFLTACT=fallback GTTSELID=none
4 2 e164 sub 5 e164 sub gflex uds off
DFLTACT=fallback GTTSELID=none
4 5 e164 sub 2 e164 sub mnp uds off
DFLTACT=fallback GTTSELID=none
4 5 e164 sub 3 e164 sub mnp disc off
DFLTACT=fallback GTTSELID=none
4 5 e164 sub 4 e164 sub mnp gtt off
DFLTACT=fallback GTTSELID=none
4 5 e164 sub 5 e164 sub mnp uds off
DFLTACT=fallback GTTSELID=none
4 6 e164 sub 2 e164 sub smsmr uds off
DFLTACT=fallback GTTSELID=none
4 6 e164 sub 3 e164 sub smsmr disc off
DFLTACT=fallback GTTSELID=none
4 6 e164 sub 4 e164 sub smsmr gtt off
DFLTACT=fallback GTTSELID=none
4 6 e164 sub 5 e164 sub smsmr uds off
```

```

DFLTACT=fallback GTTSELID=none
4      7      e164      sub  2  ----  -----  eir  udts  ---
DFLTACT=----- GTTSELID=-----
4      7      e164      sub  3  ----  -----  eir  disc  ---
DFLTACT=----- GTTSELID=-----
4      7      e164      sub  5  ----  -----  eir  udts  ---
DFLTACT=----- GTTSELID=-----
4      9      e164      sub  2  ----  -----  idps udts  ---
DFLTACT=----- GTTSELID=-----
4      9      e164      sub  3  ----  -----  idps disc  ---
DFLTACT=----- GTTSELID=-----
4      9      e164      sub  4  ----  -----  idps gtt   ---
DFLTACT=----- GTTSELID=-----
4      9      e164      sub  5  ----  -----  idps udts  ---
DFLTACT=----- GTTSELID=-----
4      10     e164      sub  2  e164  sub  mnp  udts  off
DFLTACT=fallback GTTSELID=none
4      10     e164      sub  3  e164  sub  mnp  disc  off
DFLTACT=fallback GTTSELID=none
4      10     e164      sub  4  e164  sub  mnp  gtt   off
DFLTACT=fallback GTTSELID=none
4      10     e164      sub  5  e164  sub  mnp  udts  off
DFLTACT=fallback GTTSELID=none
4      11     e164      sub  2  e164  sub  tati gtt   ---
DFLTACT=----- GTTSELID=-----
4      11     e164      sub  3  e164  sub  tati disc  ---
DFLTACT=----- GTTSELID=-----
4      11     e164      sub  4  e164  sub  tati gtt   ---
DFLTACT=----- GTTSELID=-----
4      11     e164      sub  5  e164  sub  tati udts  ---
DFLTACT=----- GTTSELID=-----

GTIN   TT   NP       NAI  SSN  SNP  SNAI  SERV  RQDTBLNOP
GTRQD
2      3   --       ----  2   ----  -----  inpq  udts  ---
DFLTACT=----- GTTSELID=-----
2      4   --       ----  2   e164  sub  inpmr  udts  off
DFLTACT=fallback GTTSELID=none
2      4   --       ----  3   ----  -----  inpq  disc  ---
DFLTACT=----- GTTSELID=-----
2      4   --       ----  4   e164  sub  inpmr  gtt   off
DFLTACT=fallback GTTSELID=none
2      4   --       ----  5   ----  -----  inpq  udts  ---
DFLTACT=----- GTTSELID=-----

```

SRV SELECTOR table is (32 of 20992) 1 % full

;

### Legend

- **GTI/GTIA/GTII/GTIN/GTIN24**—Global title indicator
- **TT**—Translation type
- **NP**—Numbering plan

- **NAI**—Nature of address indicator
- **NPV**—Numbering plan value.
- **NAIV**—Nature of address indicator value
- **SSN**—Subsystem number
- **SNP**—Service numbering plan
- **SNAI**—Service nature of address indicator
- **SERV**—Service Module card service
- **GTTRQD**—GTT Required Indicator
- **GTTSELID**—Selector ID
- **DFLACT**—Default action ID
- **RQDTBLNOP**—Required table not present

**Related Topics**

- [chg-srvsel](#)
- [dlt-srvsel](#)
- [ent-srvsel](#)

## rtrv-ss-appl

Use this command to retrieve information for all provisioned subsystem applications from the database. The command displays the application type, subsystem number, and application status.

**Parameters**

This command has no parameters.

**Example**

```
rtrv-ss-appl
```

**Dependencies**

The ANSI41 AIQ, EIR, LNP, or V-Flex feature must be enabled, or the AINPQ or INP feature must be turned on before this command can be entered.

The SS-APPL table is corrupt or cannot be found.

The LNP feature must be turned on before the WNP or PLNP feature can be turned on and before LNP information or measurements can be reported on.

A severe system fault has occurred and the command was rejected.

The LNP TT SS-APPL table is corrupt or cannot be found.

**Notes**

None

## Output

```
rtrv-ss-appl
```

```
tekelecstp 09-12-03 14:42:38 EST EAGLE 42.0.0
APPL  SSN  STAT
AIQ   12  online
ATINPQ 10  online
```

```
SS-APPL TABLE IS 33% FULL (2 OF 6)
```

```
;
```

This example shows the output when the EPAP Data Split feature is turned on:

```
rtrv-ss-appl
```

```
tekelecstp 12-01-12 15:08:04 EST EAGLE 45.0.0
```

```
APPL  SSN  STAT  RQDTBLNOP
INP   11  offline disc
AIQ   12  online  udts
```

```
SS-APPL table is (2 of 6) 33% full.
```

```
;
```

## Legend

- **APPL**—Application type
- **SSN**—Subsystem number
- **STAT**—Status:online or offline
- **RQDTBLNOP**—Required table not present

## Related Topics

- [chg-ss-appl](#)
- [dlt-ss-appl](#)
- [ent-ss-appl](#)

# rtrv-ss7opts

This command retrieves the current values of the SS7 option indicators maintained in the STP options table. SS7 options can modify normal handling of SS7 traffic.

## Parameters

This command has no parameters.

## Example

```
rtrv-ss7opts
```

**Dependencies**

None

**Notes**

None

**Output**

rtrv-ss7opts

```
tekelecstp 09-05-10 03:59:31 EST EAGLE 41.0.0
```

```
SS7 OPTIONS
```

```
-----  
LSRESTRICT      off  
DISCARDTFCI     off  
DISCARDTFCN     off  
SLSREPLACE      yes  
SLANCPORGOPC   off  
DDBAUDTIMER     10  
SLANLSN         off  
MSGPRI2ITUI     3  
MSGPRI2ITUN     0
```

```
;
```

**Related Topics**

- [chg-ss7opts](#)

## rtrv-stp

Use this command to retrieve information related to the STP at which the command is entered.

The command can retrieve frame and card power consumption and threshold values (in Amps or milliamps and Watts) for all provisioned frames or for a specified frame. (See the `ent-frm-pwr` command.)

The command can retrieve hardware configuration information (card location, board part number, revision, serial number, card type, card memory, APPL, and GPL version):

- For all provisioned STP frames and shelves
- For a specific provisioned frame
- For a specific provisioned shelf
- For a specific equipped card
- For all cards of the specified card type
- For all cards that contain the specified Board Part Number
- For all cards that are running the specified GPL or GPL version.



## Parameters

### **display (optional)**

Display the power consumption and power threshold value for all provisioned frames or for one specific provisioned frame.

This parameter must be specified when the `frm` parameter is specified, to display the power information for one frame.

#### **Range:**

***power***

Display frame power information in the command output.

### **frm (optional)**

Frame ID. Displays information for the specified provisioned frame.

#### **Range:**

***cf00***

Control Frame identifier

***ef00***

Identifier for the first Extension Frame

***ef01***

Identifier for the second Extension Frame

***ef02***

Identifier for the third Extension Frame

***ef03***

Identifier for the fourth Extension Frame

***ef04***

Identifier for the fifth Extension Frame

### **gp1 (optional)**

Generic program load. Displays hardware configuration information for all card locations equipped with cards that are running the specified GPL.

#### **Note:**

This parameter must be specified with the `ver` parameter to display information for a specific version of the GPL.

#### **Range:**

***xyyyyyyy***

1 alphabetic character followed by up to 7 alphanumeric characters. Valid GPLs are:

***atmhc***—Used by E5-ATM-B cards to allow the card to support up to 3 signaling links

***blxp***—Flash GPL containing a tar image with all code required on E5-IPSM, E5-TSM, and E5-SM4G cards

*blmcap*—Flash GPL containing a tar image with all code required on E5-MCAP, E5-E1T1-B, E5-MCPM-B, E5-ATM-B, E5-ENET-B, and E5-SM8G-B cards

*deirhc*— Used by E5-SM8G-B cards to support the S13/S13' EIR feature

*enumhc*— Used by E5-SM8G-B cards to support the ENUM Mobile Number Portability and Tier One Address Resolution application

*erthc*—Used by E5-ENET-B cards when the card acts as an STC card (E5-STC card) for EAGLE 5 Integrated Monitoring Support functions

*glshc*—Used by E5-TSM cards to download gateway screening to LIM and SCCP cards

*hipr2*—Communication software used on the High Speed IMT Packet Router (HIPR2) card

*ipghc*—Used by E5-ENET-B cards to support point-to-multipoint IP connectivity for ANSI and ITU point codes

*iplhc*—Used by E5-ENET-B cards for point-to-point IP connectivity for ANSI and ITU point codes

*ipsg*—Used by E5-ENET-B and SLIC cards to support the combined functionality of IPLIMx M2PA and IPGWx M3UA

*ipsg32*—Used by SLIC cards to support IPSEG application with 64-bit addressing either with GTT functionality or without it.

*ipshc*—Used by E5-IPSM and E5-ENET-B cards to support the IPS application

*mcphc*—Used by E5-MCPM-B cards for the Measurements Platform feature

*oamhc*—Used by E5-MCAP cards for enhanced OAM functions

*sccphc*—Used by E5-SM4G and E5-SM8G-B cards to support EPAP-based features and the LNP ELAP Configuration feature. If no EPAP-based or LNP ELAP Configuration feature is turned on, and an E5-SM4G or E5-SM8G-B card is present, then the GPL processes normal GTT traffic.

*siphc*— Used by E5-SM8G-B Cards to support the SIP application

*slanhc*—Used by E5-ENET-B cards to support the STPLAN application

*ss7hc*—Used by , and E5-E1T1-B cards. Allows the card to support up to 64 (E5-E1T1-B) signaling links for E1 and T1 functions.

**partnum (optional)**

Display the hardware configuration for all card locations that contain a card with the specified Board Part Number.

**Range:**

*zzz-zzzz-zz* or *zzzzzzz*

Specify the Board Part Number in the format *xxx-xxxx-xx*. See the Hardware Baseline in *Release Notes* for a list of Board Part Numbers that are supported for the release.

**shelf (optional)**

Display the hardware configuration information for all card locations in the specified EAGLE shelf.

**Range:**

**1100**

**1200**

**1300**

**2100**

**2200**

**2300**

**3100**

**3200**

**3300**

**4100**

**4200**

**4300**

**5100**

**5200**

**5300**

**6100**

**6200**

**6300**

**type (optional)**

Display the hardware configuration information for all card locations that contain cards of the specified card type.

**Range:**

**dcm**

**dsm**

**e5appb**

**enet**

**enetb**

**ipsm**

**limatm**

**lime1**

**lime1atm**

**limt1**

**mcpm**

**slic**

**stc**

**telco**

***tsm*****ver (optional)**

Display the hardware configuration information for all the card locations that have cards with the specified GPL Type and the specified GPL Version. The version format is *major-minor-fix*.

**Range:**

*major-minor-fix*

*major*—Range 0-255

*minor*—Range 0-255

*fix*—Range 0-255

**Example**

Retrieve the frame power information for all provisioned frames of the STP.

```
rtrv-stp:display=power
```

Retrieve the card level power information for the control frame in the STP.

```
rtrv-stp:display=power:frm=cf00
```

Retrieve the hardware configuration information for the STP control shelf (shelf 1100).

```
rtrv-stp:shelf=1100
```

Retrieve the hardware configuration information for all cards equipped in the STP that have the specified Board Part Number.

```
rtrv-stp:partnum=870-1275-01
```

Retrieve the hardware configuration information for all provisioned E5-TSM cards in the STP.

```
rtrv-stp:type=tsm
```

Retrieve the hardware configuration information for all cards in the STP that are running the IMT communication GPL with GPL version 126-039-043.

```
rtrv-stp:gpl=imt:ver=126-039-043
```

Retrieve the hardware configuration information for all provisioned frames in the STP.

```
rtrv-stp
```

Retrieve the hardware configuration information for all cards in the STP that are running the ATMHC GPL.

```
rtrv-stp:gpl=atmhc
```

Retrieve the hardware configuration information for all provisioned E5-APP-B cards in the STP.

```
rtrv-stp:type=e5appb
```

Retrieve the hardware configuration information for all provisioned Telco Switches in the STP.

```
rtrv-stp:type=telco
```

Retrieve the hardware configuration information for all cards in the STP that are running the SIPHC GPL.

```
rtrv-stp:gpl=siphc
```

Retrieve the hardware configuration information for all cards in the STP that are running the DEIRHC GPL.

```
rtrv-stp:gpl=deirhc
```

## Dependencies

A valid value must be specified for the `display` parameter.

A valid value must be specified for the `frm` parameter.

A valid value must be specified for the `shelf` parameter.

The `partnum` parameter value must contain no more than 12 characters.

A valid value must be specified for the `type` parameter.

The `gpl` parameter value must contain no more than 8 characters.

Valid values must be specified for the `ver` parameter subfields (format *major-minor-fix*).

The `display` parameter must be specified when the `frm` parameter is specified.

The `gpl` parameter must be specified when the `ver` parameter is specified.

Only one optional parameter can be specified in the command, except for the following parameter combinations:

- The `display` parameter must be specified when the `frm` parameter is specified.
- The `gpl` parameter must be specified when the `ver` parameter is specified.

The `frm` parameter value must specify a provisioned frame.

The Assembly Power table must be available.

The value specified for the `gpl` parameter must be supported. See the `gpl` definition for a list of supported GPLs.

## Notes

When the power threshold value has not been provisioned for a provisioned frame, the default frame power threshold value is displayed and prefixed with a plus sign (+).

For an un-provisioned card that is present in the frame, the card power consumption value is displayed prefixed with a plus sign (+).

For the E5-TDM and E5-MDAL cards in the Control Frame, "E5-TDM" and "E5-MDAL" are displayed as the Part Number of the card.

If a MUX card is not present, then "Empty" is displayed.

If the Board Part Number received in the BIP response from a card is not present in the Assembly Power table, then the Part Number for the card is displayed with a prefix of a plus sign (+).

If the Card power value is not present in the BIP data and the Assembly Power table, then the default card power value of *1563 milliamps* is displayed for the card.

If board information is not available from a card,

- *BIP Data inv* is displayed as the Part number for the card.
- The default card power value of 1563 milliamps is displayed for the card.

If a card location is empty (no card is present in that slot),

- *Empty* is displayed as the Part Number for the card
- A card power value of 0 is assumed and displayed.

For Standby E5-MASP cards, “Unavailable” is displayed as the Part Number if the card is absent. In this case, the card power of the Active E5-MASP card is shown for the card power of the standby card.

If a flash or communication GPL is specified with the `rtrv-stp` command, then the GPL output displays the version of the application GPL that is running on the card and not the version of the specified flash or communication GPL.

An unequipped MUX location does not have any type of MUX card in the slot. If a MUX card is present in the slot, then the location is equipped. When a location is unequipped, “EMPTY” is displayed for the slots, and an error message is generated. Locations 1109 and 1110, which support the control shelf, must contain MUX cards before the EAGLE is considered to be fully operational.

This command can be used to display the power consumption of MUX cards within a frame. The power consumption displays 0 for an unequipped MUX location. The Part Number, Revision, and Power Consumption obtained from the BIP data associated with the MUX card are displayed.

Because E5-APP-B cards provisioned using the `ent-card` command (`type=e5appb`) do not connect to the IMT bus and do not have a BIP record, the part number for these cards will be displayed as "870-3096-XX".

### Output

If a flash or communication GPL is specified, then the output displays the GPL version of the application GPL running on the card instead of the GPL version of the specified flash or communication GPL.

The power consumption values that are displayed in the `rtrv-stp:display=power` or the `rtrv-stp:display=power:frm=` commands indicate the maximum calculated power for the frame. The calculation is based on the cards that are populated in the system, and includes a fan tray assembly for every shelf (the system cannot detect the presence or absence of a fan tray, and assumes presence for the calculation). These values are typically much higher than the actual power being drawn; the values cannot be used as a gauge of the actual power consumption of the EAGLE.

Abbreviated output is indicated by 3 vertical dots:

```
.
.
.
```

This example shows the output for a specific shelf containing a HIPR2 card at location 1109:

```
rtrv-stp:shelf=1100
```

```
tekelecstp 12-03-15 11:07:17 EST EAGLE 45.0.0
  Card Part Number Rev Serial Number Type DB APPL GPL
Version
-----
1101 870-1275-01 W 10245689323 DSM 4096M VSCCP
027-010-000
```

```

1102 Empty
1103 870-1788-03 A 10234658345 TSM 128M GLSHC
027-010-000
1104 Empty
1105 870-1339-06 A 10274568974 LIMATM - ATMANSI
027-010-000
1106 Empty
1107 Empty
1108 870-1456-05 A 10204764378 DCM 512M SS7IPGW
027-010-000
1109 870-2872-01 A 10207185554 HIPR2 - HIPR2
129-001-000
1110 MUX BPHMUX
027-345-000
1111 870-1788-05 A 10205734657 MCPM 4096M MCP
027-010-000
1112 Empty
1113 870-2360-01 A 10346357678 GPSM 1024M EOAM
025-340-000
1114 TDM
1115 Unavailable GPSM EOAM
1116 Unavailable
1117 MDAL
1118 Empty
Command Completed.
;

```

This example shows the output for the frame power information for all provisioned frames in the STP:

```
rtrv-stp:display=power
```

```

tekelecstp 07-03-30 11:07:17 EST EAGLE 37.0.0
      Power Threshold      Power Consumption
Frame (Amps) (Watts) (Amps) (Watts)
-----
CF00 45 2160 37.71 1810
EF00 40 1920 33.99 1631
EF01 35 1680 10.00 480
EF04 +30 +1440 14.06 675
Command Completed.
;

```

This example shows the output for the frame and card power information for the control frame in the system. The frame contains HIPR cards at location 1109 and 1110, HMUX card at location 1209, and HIPR2 cards at location 1309 and 1310. MUX location 1210 is unequipped.

```
rtrv-stp:display=power:frm=cf00
```

```

tekelecstp 09-06-30 11:07:17 EST EAGLE 5 41.1.0
      Power Threshold      Power Consumption
Frame (Amps) (Watts) (Amps) (Watts)
-----

```

CF00	45	2160	34.58	1795	
Card	Part Number	Revision	Power Consumption		
----	-----	-----	(MilliAmps)	(Watts)	-----
1101	850-0484-01	E	313		15
1102	870-2372-01	J	521		25
1103	870-1289-04	K	313		15
1104	+ 870-2198-01	M	+ 1563		+ 75
1105	870-1984-05	M	+ 646		+ 31
1106	870-2372-01	J	521		25
1107	870-2061-01	K	542		26
1108	870-2061-01	K	+ 542		+ 26
1109	MUX		313		15
1110	MUX		313		15
1111	870-2061-01	B	542		26
1112	850-0419-03	C	521		25
1113	870-2360-01	B	625		30
1114	TDM		333		16
1115	Unavailable		625		30
1116	Unavailable		333		16
1117	MDAL		333		16
1118	Empty		0		0
1201	870-2061-01	A	542		26
1202	870-2061-01	A	542		26
1203	850-0549-01	A	313		15
1204	+ 870-2198-01	M	1563		75
1205	850-0549-01	A	313		15
1206	+ 870-2198-01	M	1563		75
1207	870-2371-02	E	625		30
1208	870-1293-02	B	521		25
1209	MUX		313		15
1210	Empty		0		0
1211	870-2061-01	D	542		26
1212	850-0549-01	A	313		15
1213	850-0549-01	A	313		15
1214	850-0549-01	A	313		15
1215	870-2061-01	C	542		26
1216	870-1945-03	D	646		31
1217	Empty		0		0
1218	870-2061-01	K	542		26
1301	870-1984-05	M	646		31
1302	850-0549-01	A	313		15
1303	+ 870-2198-01	M	1563		75
1304	870-2371-02	E	625		30
1305	870-2371-02	E	625		30
1306	850-0419-03	C	521		25
1307					
1308	870-2061-01	K	542		26
1309	870-2872-01	A	313		15
1310	870-2872-01	A	313		15
1311	850-0484-01	E	313		15
1312	+ 870-2198-01	M	+ 1563		+ 75
1313	BIP Data inv		+ 1563		+ 75
1314	BIP Data inv		1563		75
1315	Empty		0		0



```

    1316      Empty                0
0
    1317      Empty                0
0
    1318      850-0419-03          C          521
25
      FAN ASSYs Power Consumption          7812
375
      Command Completed.
;

```

This example shows the output for the hardware configuration information for all equipped SM cards that contain the specified Board Part Number:

```

rtrv-stp:partnum=870-2990-01

tekelecstp 13-07-27 14:31:06 EST EAGLE 45.0.0
rtrv-stp:partnum=870-2990-01
Command entered at terminal #18.
;

Command Accepted - Processing
tekelecstp 13-07-27 14:31:06 EST EAGLE 45.0.0
Card Part Number Rev Serial Number Type DB APPL GPL
Version
---- -
-----
    1101 870-2990-01 A 10208087123 DSM 4096M SIPHC
134-070-000
    1105 870-2990-01 B 10209135229 DSM 4096M SCCPHC
134-067-000
      Command Completed
;

```

This example shows the output for the hardware configuration information for all cards of the specified card type:

```

rtrv-stp:type=tsm

tekelecstp 08-10-10 11:07:17 EST EAGLE 40.0.0
Card Part Number Rev Serial Number Type DB APPL GPL
Version
---- -
-----
    1103 870-1788-03 A 10234658345 TSM 128M GLSHC
027-010-000
    1212 870-1788-03 A 10234632455 TSM 128M GLSHC
027-010-000
    2105 TSM GLSHC
    2217 870-2943-03 A 10229185653 TSM 512M GLSHC
030-005-000

```

```
Command Completed.
```

```
;
```

This example shows the output for the hardware configuration information for all cards that are running the specified GPL:

```
rtrv-stp:gpl=ss7ansi
```

```
tekelecstp 07-03-30 11:07:17 EST EAGLE 37.0.0
Card Part Number Rev Serial Number Type DB APPL GPL
Version
-----
1301 870-2671-02 C 10145689323 LIMT1 512M SS7ANSI
126-033-000
1303 870-1873-01 C 10345689323 LIMT1 512M SS7ANSI
126-033-000
Command Completed.
```

```
;
```

This example shows the output for the hardware configuration information for all cards that are running the specified GPL:

```
rtrv-stp:gpl=siphc
```

```
tekelecstp 13-07-27 14:31:06 EST EAGLE 45.0.0
rtrv-stp:gpl=siphc
Command entered at terminal #4.
Card Part Number Rev Serial Number Type DB APPL GPL
Version
-----
1101 870-2990-01 A 10208087123 DSM 4096M SIPHC
134-067-000
Command Completed.
```

```
;
```

This example shows the output for the hardware configuration information for all cards that are running the specified version of the specified GPL:

```
rtrv-stp:gpl=ss7ansi:ver=126-033-000
```

```
tekelecstp 07-03-30 11:07:17 EST EAGLE 37.0.0
Card Part Number Rev Serial Number Type DB APPL GPL
Version
-----
1301 870-2671-02 C 10145689323 LIMT1 512M SS7ANSI
126-033-000
1303 870-1873-01 C 10345689323 LIMT1 512M SS7ANSI
126-033-000
Command Completed.
```

```
;
```

```

rtrv-stp:gpl=siphc:ver=134-067-000

tekelecstp 13-07-27 14:31:06 EST EAGLE 45.0.0
rtrv-stp:gpl=siphc:ver=134-067-000
Command entered at terminal #18.
;

Command Accepted - Processing
tekelecstp 13-07-27 14:31:06 EST EAGLE 45.0.0
Card Part Number Rev Serial Number Type DB APPL GPL
Version
-----
1101 870-2990-01 A 10208087123 DSM 4096M SIPHC
134-067-000
Command Completed.
;

```

This example shows the output for the hardware configuration information for all cards that are running the specified GPL:

```

rtrv-stp:gpl=deirhc

tekelecstp 13-03-20 11:07:17 EST EAGLE 45.1.0

Card Part Number Rev Serial Number Type DB APPL
GPL Version
-----
1101 870-2990-01 A 10302135627 DSM 8192M DEIRHC
134-056-000
1103 870-2990-02 A 10502135627 DSM 8192M DEIRHC
134-056-000
Command Completed.
;

```

This example shows output for the hardware configuration information for all frames of the STP, without specifying any optional parameters in the command. This example includes EPM-B and SLIC cards and shows abbreviated output.

```

rtrv-stp

stpc9070501 16-06-22 15:39:29 EDT EAGLE5 46.4.0
Card Part Number Rev Serial Number Type DB APPL GPL
Version
-----
1101 870-2212-03 E 10207435071 ENET 512M IPSG
009-003-000
1102 870-2212-03 E 10207425102 ENET 512M IPSG
009-003-000
1103 870-2212-03 E 10207425103 ENET 512M IPSG

```

009-003-000							
1104	870-2212-03	E	10207425104	ENET	512M	IPSG	
009-003-000							
1105	870-2212-03	E	10207425107	ENET	512M	IPSG	
009-003-000							
1106	870-2212-03	E	10207425106	ENET	512M	IPSG	
009-003-000							
1107	870-2212-03	E	10207425108	ENET	512M	IPSG	
009-003-000							
1108	870-2212-03	E	10207425109	ENET	512M	IPSG	
009-003-000							
1109	870-2872-01	B	10209135026				HIPR2
009-003-000							
1110	870-2872-01	B	10209125156				HIPR2
009-003-000							
1111	870-2971-01	C	10210245182	ENETB	2048M	IPSG	
009-003-000							
1112	870-2212-03	E	10207425093	ENET	512M	IPSG	
009-003-000							
1113	870-2903-01	C	10208245108	E5MCAP	4096M	OAMHC	
009-003-000							
1114	TDM						
1115	870-2903-01	H	10209287087	E5MCAP	4096M	OAMHC	
009-003-000							
1116	TDM						
1117	MDAL						
1118	Empty						
1201	870-2212-03	F	10208337195	DCM	512M	IPGHC	
009-003-000							
1202	870-2212-03	E	10207425094	DCM	512M	IPGHC	
009-003-000							
1203	870-2212-03	E	10207425060	DCM	512M	IPGHC	
009-003-000							
1204	870-2212-03	E	10207425071	DCM	512M	IPGHC	
009-003-000							
1205	870-2212-03	F	10208337194	DCM	512M	IPGHC	
009-003-000							
1206	870-2212-03	E	10207425070	DCM	512M	IPGHC	
009-003-000							
1207	870-2212-03	E	10207435090	DCM	512M	IPGHC	
009-003-000							
1208	870-2212-03	E	10207425101	DCM	512M	IPGHC	
009-003-000							
1209	MUX						HIPR
009-003-000							
1210	870-2872-01	B	10209135079				HIPR2
009-003-000							
1211	870-2212-03	E	10207295241	ENET	512M	IPSG	
009-003-000							
1212	870-2212-03	E	10207425090	ENET	512M	IPSG	
009-003-000							
1213	870-2212-03	E	10207425025	ENET	512M	IPSG	
009-003-000							
1214	870-2212-03	E	10207435016	ENET	512M	IPSG	
009-003-000							

009-003-000	1215	870-2212-03	E	10207435089	ENET	512M	IPSG
009-003-000	1216	870-2212-03	E	10208047109	ENET	512M	IPSG
009-003-000	1217	870-2212-05	D	10209177197	STC	512M	ERTHC
009-003-000	1218	870-2372-08	D	10206215361	STC	-	EROUTE
009-003-000	1301	870-2212-03	E	10207435020	ENET	512M	IPSG
009-003-000	1302	870-2212-03	E	10207435019	ENET	512M	IPSG
009-003-000	1303	870-2212-02	A	10206135605	ENET	512M	IPSG
009-003-000	1304	870-2212-03	E	10207425105	ENET	512M	IPSG
009-003-000	1305	870-2212-03	E	10207435018	ENET	512M	IPSG
009-003-000	1306	870-2212-03	E	10207435023	ENET	512M	IPSG
009-003-000	1307	870-2212-03	E	10207435024	ENET	512M	IPSG
009-003-000	1308	870-2212-03	E	10207425033	ENET	512M	IPSG
009-003-000	1309	870-2872-01	B	10209125033			HIPR2
009-003-000	1310	870-2872-01	B	10209065053			HIPR2
009-003-000	1311	870-2212-03	E	10207435025	ENET	512M	IPSG
009-003-000	1312	870-2212-05	D	10209517269	ENET	512M	IPSG
009-003-000	1313	870-2212-03	F	10208337191	ENET	512M	IPSG
009-003-000	1314	870-2212-03	E	10207425012	ENET	512M	IPSG
009-003-000	1315	870-2212-02	A	10206125247	ENET	512M	IPSG
009-003-000	1316	870-2212-05	D	10209517134	ENET	512M	IPSG
009-003-000	1317	870-2212-02	E	10206305256	ENET	512M	IPSG
009-003-000	1318	870-2212-05	D	10209327104	ENET	512M	IPSG
134-000-056	2101	870-2990-02	A	10502135627	DSM	8192M	DEIRHC
139-003-000	2102	870-2212-02	A	10206385232	SLIC	8192M	IPSG
	2103	Empty					
	2104	Empty					
	2105	Empty					
	2106	Empty					
	2107	Empty					
	2108	Empty					
	2109	Empty					

```

2110 Empty
2111 Empty
2112 Empty
2113 Empty
2114 Empty
2115 Empty
2116 Empty
2117 Empty
2118 Empty
3101 870-2990-01 A 10208087123 DSM 4096M SIPHC
139-003-000

```

```

.
.
.

```

```

6101 Empty
6102 Empty
6103 Empty
6104 Empty
6105 Empty
6106 Empty
6107 Empty
6108 Empty
6109 Empty
6110 Empty
6111 Empty
6112 Empty
6113 Empty
6114 Empty
6115 Empty
6116 Empty
6117 Empty
6118 Empty

```

Command Completed.

```
;
```

This example shows the output for the hardware configuration information for cards, including an E5-STC card. This example displays abridged output.

```
rtrv-stp
```

```

tekelecstp 12-03-14 13:19:14 GMT EAGLE 45.0.0
Card Part Number Rev Serial Number Type DB APPL GPL
Version
-----
1101 870-1289-04 K 10206035030 TSM 256M GLSHC
128-018-000
1102 Empty
1104 Empty
1105 Empty
1106 Empty
1107 Empty
1108 870-2212-02 A 10206365046 DCM 512M STPLAN

```

```

128-018-000
  1109 MUX                                HIPR
128-016-000
  1110 MUX                                HIPR
128-016-000
  1111 870-2212-02 A 10206275736  STC    512M  EROUTE
028-018-000
  1112 870-2372-08 D 10206125537  STC    -      EROUTE
028-018-000
  1113 870-2360-06 C 10206255064  GPSM   1024M  EOAM
128-018-000
  1114 TDM
  1115 870-2360-06 C 10206255165  GPSM   1024M  EOAM
128-018-000
  1116 TDM
  1117 MDAL
  1118 Empty
  1201 Empty
  1202 Empty
  1203 Empty
  1204 Empty
  1205 Empty
  1206 Empty
  1207 Empty
  1208 Empty                                DCM          STPLAN
  1209 MUX                                HIPR
128-016-000
  1210 MUX                                HIPR
128-016-000
  1211 Empty
  1212 Empty
  1213 Empty
  1214 Empty

```

This example shows the output for the hardware configuration information for E5APPB cards and Telco Switches. This example displays abridged output.

```
rtrv-stp
```

```

tekelecstp 13-09-06 15:43:40 EST 45.0.0
rtrv-stp
Command entered at terminal #4.
Card Part Number Rev Serial Number Type DB APPL GPL
Version
---- -
-----
  1101 870-3096-01                E5APPB - EPAP
255-255-255
  1102 Empty
  1103 Empty
  1104 Empty
  1105 Empty
  1106 Empty
  1107 Empty
  1108 Empty

```

```

1109 Empty BPHMUX 000-000-000
1110 Empty BPHMUX 000-000-000
1111 Empty
1112 Empty
1113 Unavailable GPSM - EOAM 255-255-255
1114 Unavailable
1115 Unavailable GPSM - EOAM 255-255-255
1116 Unavailable
6201 870-2904-01 TELCO - SWITCH 255-255-255
6202 870-2904-01 TELCO - SWITCH 255-255-255

```

Command Completed.

;

This example shows the output when the `rtrv-stp` command is issued with the `partnum` parameter.

```

rtrv-stp:partnum=870-2990-02

tekelecstp 13-03-25 14:31:06 EST EAGLE 45.1.0
  rtrv-stp:partnum=870-2990-02
  Command entered at terminal #18.
;

```

Command Accepted - Processing

tekelecstp 13-03-25 14:31:06 EST EAGLE 45.0.0

```

      Card Part Number Rev Serial Number Type DB APPL GPL
Version
-----
1103 870-2990-02 A 10502135627 DSM 8192M DEIRHC
134-000-056
  Command Completed.

```

This example shows the output when the `rtrv-stp` command is issued with mix of part number formats:

```

rtrv-stp

tekelecstp 16-12-12 05:03:42 MST EAGLE 46.5.0.0.0-70.12.0
  rtrv-stp
  Command entered at terminal #17.
;

```

Command Accepted - Processing

tekelecstp 16-12-12 05:03:42 MST EAGLE 46.5.0.0.0-70.12.0

```

      Card Part Number Rev Serial Number Type DB APPL GPL

```



```

Version
-----
1101 870-2990-01 H 10213365171 DSM 8192M SCCP64
007-012-000
1102
Empty
1103 870-2990-01 HC 10215352166 DSM 8192M SCCP64
007-012-000
1104
Empty
1105 BIP Data inv SLIC 16384M IPSPG64
007-012-000
1106 870-3089-01 A 10211257038 MCPM 4096M MCPHC
007-012-000
1107 870-2990-01 HC 10215352206 DSM 8192M SCCP64
007-012-000
1108
Empty
1109 870-2872-02 F 10214372022 HIPR2
140-011-000
1110 870-2872-02 F 10214372009 HIPR2
140-011-000
1111 870-2877-01 C 10207195432 IPSPM 2048M IPSPHC
007-012-000
1112 7094646 16 10216302182 SLIC 16384M
IPSPG
1113 870-2903-01 N 10210377102 E5MCPAP 4096M OAMHC
140-011-000
1114
TDM
1115 870-2903-01 C 10208245087 E5MCPAP 4096M OAMHC
140-011-000
1116
TDM
1117
E5MDAL
1118 Empty

```

This example shows the output for the hardware configuration information for all cards that are running the specified GPL:

```
rtrv-stp:gpl=ipsg32
```

```

tekelecstp 16-09-01 14:31:06 EST EAGLE 46.5.0.0.0-70.4.0
rtrv-stp:gpl=ipsg32
Command entered at terminal #4.
Card Part Number Rev Serial Number Type DB APPL
GPL Version
-----
1103 720-2990-01 A 10208056582 SLIC 16384M IPSPG
140-012-000

```

```
Command Completed.  
;
```

### Legend

- **Frame**—Frame ID for the control shelf or an extension shelf
- **Power Threshold**—Power threshold (in Amps or Milliamps and Watts) at which an alarm is generated to indicate that power consumption is approaching a maximum allowed level. (See the `ent-frm-pwr` command.)
- **Power Consumption**—Current calculated power consumption (Amps or Milliamps and Watts) of the frame or card
- **Card**—Card Location
- **Part Number**—Board Part Number
- **Rev**—Board Part Number revision
- **Serial Number**—Card serial number
- **Type**—Card type
- **DB**—Daughterboard memory
- **APPL**—Application that has been provisioned on the card
- **GPL Version**—GPL version of the Application GPL being used by the card

### Related Topics

- [chg-frm-pwr](#)
- [dlt-frm-pwr](#)
- [ent-frm-pwr](#)
- [rtrv-frm-pwr](#)

## rtrv-stpopts

Use this command to retrieve the current value of the system's node-level processing option indicators maintained in the system's options table.

### Parameters

This command has no parameters.

### Example

```
rtrv-stpopts
```

### Dependencies

The MAS Configuration table must be available.

The STP Options table must be available.

None

## Notes

The timer output for this command is in milliseconds, even though the timer could have been entered in seconds on the `chg-stpopts` command.

## Output

The following example displays MTP STP options with no affecting features on. Certain features that are shown in other examples control changes and additional options in this option list:

```
rtrv-stpopts
```

```
Command Accepted - Processing
```

```
tekelecstp 18-04-20 13:22:52 EST EAGLE 46.7.0.0-74.5.0
STP OPTIONS
-----
MTPT31CTL                1
MTPLTI                   yes
MTPLTCTDPCQ              3
MTPLTST                  10000
MTPDPCQ                  2000
TFATFRPR                 1000
MTPLPRST                 yes
MTPT10ALT                30000
UIMRD                    no
SLSCNV                    off
CRITALMINH               no
DISPACTALMS              no
NPCFMTI                  14-00-00-00
DEFCC                     none
DEFNDC                    none
DSMAUD                    off
RPTLNPMRSS               yes
RANDSLS                   off
RSTRDEV                   off
SECMTPMATE                off
SECMTPSID                 off
SECMTPSNM                 off
SECSCCPSCMG              off
ANSIGFLEX                 no
ARCHBLDID                 off
MFC                       on
PCT                       off
PCN16FMT                  745
UITHROTTLE                0
GBSUSNMNM                 off
GDPCA                     -----
EPAP240M                  off
EPAPX                     off
VISUALIZATION            off
```

```
;
```

The following example displays all MTP STP options. The following list indicates which options appear in the output when the associated features are on:

 **Note:**

All options will not appear in actual output, because all features that cause these options to appear cannot be on in the system at the same time.

- Cluster Routing and Management Diversity (CRMD) feature—MTPXLQ, MTPXLET, MTPXLOT
- MTP Restart (MTPRS or ITUMTPRS) feature—MTPRSI, MTPRSIT
- 6000, 7000, or 8000 Routesets feature—MTPDPCQ=6000 or 7000 or 8000
- GSM MAP Screening (GSMSCRN) feature—GSMDFLT, GSMDECERR
- GSM Mobile Number Portability (G-Port), IS41 to GSM Migration (IGM), Prepaid SMS Intercept (PPSMS) Ph1, Voice Mail Router (V-Flex), Prepaid IDP Query Relay (IDPR), ANSI-41 Mobile Number Portability (A-Port), or any TIF feature is enabled **OR** INAP Number Portability (INP) or GSM Flexible Numbering (G-Flex) feature is ON—DEFCC, DEFNDC
- ATINP feature is enabled—DEFCC
- EPAP-based features or LNP ELAP Configuration feature—DSMAUD
- GSM Flexible Numbering (G-Flex) feature—ANSIGFLEX
- Network Security (NSE) feature—SECMTPMATE, SECMTPSID, SECMTPSNM, SECSCCPSCMG
- ANSI-ITU-China SCCP Conversion (SCCP Conversion) feature is enabled—CNVCGDA, CNVCGDI, CNVCGDN, CNVCGDN24, GTCNVDFLT
- PC & CIC Translation feature—PCT
- VISUALIZATION—MSG

```
rtrv-stpopts
```

```
rlghncxa03w 11-03-17 16:02:05 EST EAGLE 46.7.0.0-74.5.0
STP OPTIONS
-----
MTPT31CTL          1
MTPLTI             yes
MTPLTCTDPCQ        3
MTPLTST            10000
MTPXLQ              500
MTPXLET            0100
MTPXLOT             90%
MTPDPCQ            8000
TFATFRPR           1000
MTPRSI              yes
MTPRSIT            5000
MTPLPRST           yes
MTPT10ALT          30000
UIMRD               yes
SLSCNV              perl5
```

CRITALMINH	yes
DISPACTALMS	no
NPCFMTI	14-0-0-0
GSMDFLT	PASS
GSMDECERR	PASS
DEFCC	49
DEFNDC	177
DSMAUD	no
RPTLNPMRSS	yes
RANDSLS	all
RSTRDEV	on
SECMPMATE	off
SECMTPSID	off
SECMTPSNM	notify
SECSCCPSCMG	notify
CNVCGDA	yes
CNVCGDI	yes
CNVCGDN	yes
CNVCGDN24	yes
GTCNVDFLT	yes
ANSIGFLEX	yes
HSCLKSRC	RS422
HSCLKLL	LONGHAUL
ARCHBLDID	off
MFC	on
PCT	on
UITHROTTL	0
GDPC	004-004-004
EPAP240M	off
EPAPX	on
VISUALIZATION	msg

;

### Legend

- **MTPT31CTL**—MTP T31 congestion trigger level. The signaling link congestion level at which the system starts the level 3 t31 timer. When the level 3 t31 timer expires, the associated signaling link is removed from service for realignment.
- **MTPLTI**—MTP loop test indicator. Specifies whether the MTP loop detection procedures are enabled or disabled at the system.
- **MTPLTCTDPCQ**—MTP loop test congestion trigger DPC quantity. The number of most frequently occurring DPCs to which the MTP loop test messages are to be sent when the MTP loop test is triggered by congestion.
- **MTPLTST**—MTP loop test supervision timer. The amount of time, in milliseconds, that the MTP loop test detection procedures run when started.
- **MTPXLQ**—MTP x-list quantity. The number of dynamic status exception list (x-list) entries the system maintains.
- **MTPXLET**—MTP x-list expiration time. The maximum amount of time the system maintains an unreferenced dynamic status exception list (x-list) entry.
- **MTPXLOT**—MTP x-list occupancy threshold. The dynamic status exception list (x-list) occupancy threshold at which the system raises a minor alarm. The threshold is expressed as a percentage of space available.

- **MTPDPCQ**—MTP destination point code quantity. The maximum number of DPCs that can be provisioned in the system.
- **TFATFRPR**—TFA/TFR pacing rate. The amount of time, in milliseconds, between partial broadcasts of up to 20 percent increments of the number of TFAs/TCAs or TFRs/TCRs to be broadcast by the STP when an affected destination becomes accessible using its primary route rather than an alternate route. The STP uses this pacing to prevent congestion on the newly-recovered linksets.
- **MTPRSIT**—MTP Restart isolation timer. The minimum duration of node isolation, in milliseconds, before the MTP Restart procedure is deemed necessary.
- **MTPRSI**—MTP Restart indicator. Specifies whether ANSI or ITU MTP Restart procedures are enabled or disabled at the STP.
- **MTPLPRST**—MTP low priority route set test. Specifies whether low priority route set polling is enabled or disabled at the STP.
- **MTPT10ALT**—MTP T10 alternate timer. Specifies the interval at which the STP performs a route set test on low priority routes.
- **SLSCNV**—Per node SLS conversion indicator. Specifies whether SLS conversion is on, off, or performed per linkset (perls).
- **UIMRD**—Unsolicited Information Message (UIM) redirect. Specifies whether specific UIMs are redirected to this output group.
- **CRITALMINH**—Indicates whether the option that allows the inhibiting of critical alarms is enabled (yes) or disabled (no).
- **DISPACTALMS**—Indicates whether to display active or total alarms in the alarm status area of the VT320 screen.
- **NPCFMTI**—Defines how the ITU national point code is entered into the database and how it is displayed in any outputs from the system.
- **GSMDFLT**—Indicates whether the GSM MAP screening default action is set to pass or discard.
- **GSMDECERR**—Indicates whether the GSM MAP screening decode error action is set to pass or discard.
- **DEFCC**—Defines the default country code.
- **DEFNDC**—Defines the default network destination code.
- **DSMAUD**—Indicates whether the DSM audit is running (on) or disabled (off).
- **RANDSLS**—Displays the Random SLS setting.
- **RTPLNPMRSS**—Displays the setting for reporting or suppressing UIM 1049 for LNP MR with missing subsystems.
- **RSTRDEV**—Allow or disable restoration of device states when an `init-sys` command is executed, an OAM role changes, or a card reload occurs.
- **SECMTPMATE**—Indicates Network Security screening for MTP messages received by an STP on a non-C-Link, with an OPC equal to the SID (True, Adjacent, or Capability) point code of its mate.
- **SECMTPSID**—Indicates Network Security screening for MTP messages received at MTP3 containing an OPC equal to its own SID (OPC that is the True, Secondary, or Capability point code entered in the `chg-sid` command) that is not a route-set-congestion-message. The EAGLE should not receive a message with its own OPC

unless the message is a result of a circular route test or is an SLTM when the far end is in loopback. (SLTM messages are not checked).

- **SECMTPSNM**—Indicates Network Security screening for MTP SNM messages. The EAGLE should not receive an MTP network management message unless:
  - The OPC is an adjacent point code. (For all link types, this rule does not apply to UPU, TFC, and RCT messages.)
  - The EAGLE has a route to the OPC of the MTP network management message on the linkset which the message was received.
  - The EAGLE has a route to the destination field in the message (if applicable to the concerned message) on the linkset which the message was received. (For all link types, this rule is not applicable to RST messages.)
- **SECSCCPSCMG**—Indicates Network Security screening for SCCP SCMG messages. This value applies only to SSP and SOR messages. SSA, SST, SOG, SBR, SNR and SRT messages are not affected. The EAGLE should not receive an SCCP network management message unless:
  - The EAGLE has a route to the OPC of the SCMG message on the linkset on which the message was received.
  - The EAGLE has a route to the Affected Point Code (also called the Concerned Point Code in EAGLE) in the message on the linkset on which the message was received.
- **CNVCGDA**—Indicates whether or not to discard the CGPA PC in SCCP messages if the destination network type is ANSI, and the PC or ALIAS PC of the destination network type is not defined.
- **CNVCGDI**—Indicates whether or not to discard the CGPA PC in SCCP messages if the destination network type is ITU-I, and the PC or ALIAS PC of the destination network type is not defined.
- **CNVCGDN**—Indicates whether or not to discard the CGPA PC in SCCP messages if the destination network type is ITU-N, and the PC or ALIAS PC of the destination network type is not defined.
- **CNVCGDN24**—Indicates whether or not to discard the CGPA PC in SCCP messages if the destination network type is 24-bit ITU-N, and the PC or ALIAS PC of the destination network type is not defined.
- **ANSIGFLEX**—Indicates enable or disable of ANSI G-Flex to execute at 1700 TPS per DSM card
- **GTCNVDFLT**—Indicates enable or disable of routing of SCCP messages using system defaults when an appropriate entry is not found in the Default GT Conversion table.
- **HSCLKLL**—High speed master clock line length option (SHORTHAUL, LONGHAUL)
- **HSCLKSRC**—High speed master clock source
- **ARCHBLDID**—Archive build ID
- **MFC**—Indicates that the system is using Message Flow Control (MFC).
- **PCT**—Indicates whether PCT is applied to MSUs
- **GDPC**—MSU duplicated by GWS DUP Stop Action will be routed to the point code configured in GDPC.

- **UITHROTTLE**—Indicates the speed at which output is sent to the terminal. Zero represents the most throttling, or the slowest output. Nine represents the least throttling, or the fastest output.
- **EPAP240M**—Indicates that the E5-SM8G-B card can download the maximum 240M DN/IMSI RTDB data from EPAP.
- **EPAPX**— Indicates that the SLIC cards running 64-bits flash SCCP gpls can download 480M individual DN entries, 600M individual IMSI entries or 600M individual IMEI entries from EPAP.
- **VISUALIZATION**— Indicates that whether system wide visualization feature is disable or specific visualization (UIM/MSG/BOTH) is enable.

### Related Topics

- [chg-stpopts](#)

## rtrv-subnetid

Use this command to retrieve a list of Subnet ID entries from the SUBNETID table, for the ISUP NP with EPAP feature.

### Parameters

#### **subnetnum (optional)**

Subnet Number

#### **Range:**

1 - 5

### Example

```
rtrv-subnetid
rtrv-subnetid:subnetnum=1
```

### Dependencies

The SUBNETID table is corrupt or cannot be found by the system.

The ISUP NP with EPAP feature must be enabled before this command can be entered.

### Notes

None.

### Output

This example shows output when the command is entered with no parameter. Subnet IDs for Subnet number 1 are listed in numerical order, followed by the Subnet IDs for Subnet number 2 in numerical order, etc.

```
rtrv-subnetid

tekelecstp 04-09-21 16:11:21 EST  EAGLE 31.11.0
                               Subnet
ID                               Number
```



```

-----
886932          1
886936          1
886935          2
886938          2
886939          2

Subnetidlen = 6

SUBNETID table is (5 of 50) 3% full

;

```

This example shows output when a Subnet number is specified. Subnet IDs for the specified Subnet number are listed in numerical order. The table capacity line shows the total number of entries in use, not just the number of entries displayed.

```

rtrv-subnetid:subnetnum=2

tekelecstp 04-09-21 16:13:54 EST EAGLE 31.11.0
          Subnet
ID          Number
-----
886935          2
886938          2
886939          2

Subnetidlen = 6

SUBNETID table is (5 of 50) 3% full

;

```

### Related Topics

- [dlt-subnetid](#)
- [ent-subnetid](#)

## rtrv-t1

Use this command to retrieve information for a specified T1 interface or for all T1 interfaces that have been defined by the `ent-t1` command for an E5-E1T1-B card that is used as a T1 or ST-HSL-A card.

### Parameters

#### loc (optional)

The card location as stenciled on the shelf of the system.

**Range:**

1101 - 1108, 1111 - 1112, 1201 - 1208, 1211 - 1218, 1301 - 1308, 1311 - 1318, 2101 - 2108, 2111 - 2118, 2201 - 2208, 2211 - 2218, 2301 - 2308, 2311 - 2318, 3101 - 3108, 3111 - 3118, 3201 - 3208, 3211 - 3218, 3301 - 3308, 3311 - 3318, 4101 - 4108, 4111 - 4118, 4201 - 4208, 4211 - 4218, 4301 - 4308, 4311 - 4318, 5101 - 5108, 5111 - 5118, 5201 - 5208, 5211 - 5218, 5301 - 5308, 5311 - 5318, 6101 - 6108, 6111 - 6118

**Default:**

all T1 card locations are listed

**t1port (optional)**

T1 port number. The value must be a T1 port that has already been configured with a T1 interface on the specified T1 card (`loc` parameter).

**Range:**

1 - 8

**Default:**

If not specified, all T1 ports are listed.

**Example**

```
rtrv-t1
rtrv-t1:loc=1307:t1port=2
rtrv-t1:loc=1311:t1port=1
```

**Dependencies**

The `loc` and `t1port` parameters must be specified together, if any parameters are specified for the command.

The T1 interface of the T1 card specified by the `loc` parameter must already be defined before this command can be entered.

The card specified by the `loc` parameter must be a LIMT1 card type.

The Card (IMT) table must be accessible.

The E1/T1 table must be accessible.

The port specified by the `t1port` parameter on the card specified by the `loc` parameter must be already equipped with a T1 interface.

The following card locations (`loc` parameter) are not valid for this command: 1113 - 1118 and all xy09 and xy10 locations (where x is the frame and y is the shelf).

**Notes**

None.

**Output****Legend**

- **LOC**—T1card location in the shelf
- **T1PORT**—T1 port number on a T1 card

- **ENCODE**—Indicator for use of B8ZS or AMI encoding/decoding
- **FRAMING**—Framing format (SF or ESF)
- **LL**—Line length; T1 cable length in feet between the EAGLE and the connecting node
- **MINSURATE**—Minimum number of signaling units present on a link uniformly distributed. A value appears in this field only when the LINKCLASS field value is UNCHAN.
- **TSx**—Timeslot

#### Related Topics

- [chg-t1](#)
- [dlt-t1](#)
- [ent-t1](#)
- [tst-t1](#)

## rtrv-tatr-msg

Use this command to display the configured Triggerless ANSI TCAP Relay message parameter values.

#### Parameters

##### **msgn (optional)**

Message number. The number of the TATR message.

##### **Range:**

1 - 10

#### Example

```
rtrv-tatr-msg:msgn=1
```

#### Dependencies

The TSTMSG table is corrupt or could not be found.

None.

#### Notes

None.

#### Output

```
rtrv-tatr-msg:msgn=1
```

```
tekelecstp 09-06-26 13:46:01 EST 41.1.0
rtrv-tatr-msg:msgn=1
Command entered at terminal #4.
MSG = 1          ACTIVE = NO
TRIGTYPE = h'25
```

```
CGPA_GT = 2
CGPA_GT_NAI = 4      CGPA = 0123456789abcde

CDPA_GT = 2
CDPA_GT_NAI = 4      CDPA = 0123456789abcde

CGPN_NAI = 1         CGPN = 01234567890abcdef
CDPN_NAI = 1         CDPN = 01234567890abcdef

;
```

### Related Topics

- [chg-tatr-msg](#)
- [tst-msg](#)

## rtrv-tatropts

Use this command to display all of the Triggerless ANSI TCAP Relay options that are configured in the database.

### Parameters

This command has no parameters.

### Example

```
rtrv-tatropts
```

### Dependencies

The EGLEOPTS table is corrupt or cannot be found.

None.

### Notes

None.

### Output

```
rtrv-tatropts
```

```
tekelecstp 09-08-26 15:15:20 EST  EAGLE 41.1.0
```

```
TATR OPTIONS
```

```
-----
CDNPTYPE      = rnspl
CGNPTYPE      = rnspl
CGPACCCK      = nonintl
SPORTTYPE     = none
DFLTRN        = none
```

;

**Related Topics**

- [chg-tatropts](#)

## rtrv-tbl-capacity

Use this command to retrieve table use capacity summary information. For each table listed, the number of table entry elements in use and the total allowed number of table elements is presented, along with a percent (%) full value.

**Parameters**

This command has no parameters.

**Example**

```
rtrv-tbl-capacity
```

**Dependencies**

None

**Notes**

This command can be canceled using the **F9** function key or the `canc-cmd` command. See `canc-cmd` for more information.

XLIST table information is shown only if the CRMD feature is ON.

Secondary Point Code (SPC) table information is shown only if the MPC feature is ON.

If the EGTT feature is ON then table name is GTA instead of GTT.

Additional information for each listed table can be displayed using the commands listed in [Retrieve Commands for Additional Table Information](#).

Though the ASP table entries are now part of the IPAPSOCK table, command entry and output still appear as though they are separate tables. The `rtrv-tbl-capacity` command shows the number of ASPs in the 4000-entry IPAPSOCK table.

**Table 4-55 Retrieve Commands for Additional Table Information**

Command	Table name	Description of table
<code>rept-stat-xlist</code>	XLIST	Destination - Routeset Extension
<code>rtrv-appl-rtkey</code>	IPRTKEY	IP Routing Key
<code>rtrv-as</code>	AS	Application Server
<code>rtrv-assoc</code>	IPAPSOCK	IP Socket/Association
<code>rtrv-dstn</code>	DSTN	Destination Routeset, Exception Routeset
<code>rtrv-gta</code>	GTA	Global Title Address

**Table 4-55 (Cont.) Retrieve Commands for Additional Table Information**

Command	Table name	Description of table
rtrv-gtt	GTT	Global Title Translation
rtrv-ip-host	IP-HOST	IP Host
rtrv-ip-lnk	IP-LNK	Internet Process Link
rtrv-ls	LS	Link Set
rtrv-map	MAP	Mated Application
rtrv-mrn	MRN	Mated Relay Node
rtrv-npp-as	NPP-AS	Numbering Plan Processor
rtrv-npp-srs	NPP-SRS	Numbering Plan Processor
rtrv-scrset	SCRSET	Gateway Screening Screen Set
rtrv-slk	SLK	Signal Link
rtrv-spc	SPC	Secondary Point Code
rtrv-vflx-cd	VFLXCD	V-Flex Call Decision
rtrv-vflx-rn	VFLXRN	V-Flex Routing Number
rtrv-vflx-vmsid	VFLXVID	V-Flex VMSID
rtrv-gttact	GTT-ACT	GTT Action
rtrv-gttaset	GTT-ASET	GTT Action Set
rtrv-gttapath	GTT-PATH	GTT Action Path
rtrv-gtmod	GTMOD	GT Modification

The MRN table capacity value is adjusted to subtract any point code values allocated to support the SCCP-SERV reroute service.

V-Flex Call Decision (VFLXCD), Routing Number (VFLXRN) and VMSID (VFLXVID) table information is shown only if the V-Flex feature is enabled.

### Output

This example shows the output for the minimum table sizes in the system when CRMD, MPC, EGTT and VFLEX features are off:

```
rtrv-tbl-capacity
```

```
tekelecstp 010-03-06 13:57:06 EST EAGLE 42.0.0

DSTN    table is (      8 of    2000)  1% full
LS      table is (      6 of   1024)  1% full
SLK     table is (     12 of   1200)  1% full
IP-LNK  table is (      0 of    512)  0% full
IP-HOST table is (      2 of   2048)  1% full
MAP     table is (      8 of   1024)  1% full
MRN     table is (      0 of   3000)  0% full
SCCPSRV table is (      0 of    384)  0% full
```

```

GTT      table is (      0 of    269999)  0% full
GTT-SET  table is (     21 of     2000)  2% full
SSNSELID table is (      0 of   100000)  0% full
SCRSET   table is (      0 of     255)  0% full
RTEKEY   table is (      0 of     1000)  0% full
APPLSOCK table is (      0 of     4000)  0% full
AS       table is (      0 of     250)  0% full
NPP-AS   table is (      0 of     1024)  0% full
NPP-SRS  table is (      0 of     8192)  0% full
GTMOD    table is (      1 of   100000)  1% full

```

;

This example shows the output for the maximum table sizes in the system. For the DSTN, SLK, GTT, and MAP tables, maximum values depend on the enabled feature quantity value applicable to the table in the system. GTT, MPC, CRMD, VFLEX and FGTTLS features are turned on.

```
rtrv-tbl-capacity
```

```

rlghncxa03w 10-08-17 08:29:15 EST  EAGLE 43.0.0

DSTN      table is (     600 of    10000)  6% full
XLIST     table is (      0 of     500)  0% full
SPC       table is (      0 of      40)  0% full
LS        table is (     512 of    1024)  50% full
SLK       table is (    1501 of    2800)  54% full
IP-LNK    table is (      0 of     512)  0% full
IP-HOST   table is (      0 of    2048)  0% full
MAP       table is (    1500 of   36000)  5% full
MRN       table is (      0 of    3000)  0% full
SCCPSRV   table is (      0 of     384)  0% full
GTA       table is (      0 of   269999)  0% full
GTT-SET   table is (     10 of     2000)  1% full
SSNSELID  table is (      0 of   100000)  0% full
SCRSET    table is (     25 of     255)  10% full
RTEKEY    table is (      0 of     1000)  0% full
APPLSOCK  table is (      0 of     4000)  0% full
AS        table is (      0 of     250)  0% full
VFLXCD    table is (      1 of    4950)  1% full
VFLXRN    table is (      1 of   10000)  1% full
VFLXVID   table is (      1 of     1000)  1% full
NPP-AS    table is (      0 of     1024)  0% full
NPP-SRS   table is (      0 of     8192)  0% full
GTT-ACT   table is (      0 of     2000)  0% full
GTT-ASET  table is (      0 of   20000)  0% full
GTMOD     table is (      1 of   100000)  1% full
GTT-PATH  table is (      3 of    10000)  1% full

```

;

This example shows the output when the MRN table limit is 3000 entries and 12 entries are used for SCCP-SERV reroute:

rtrv-tbl-capacity

```
tklc1090701 10-03-06 13:57:06 EST EAGLE 42.0.0
DSTN      table is (    5940 of    6000) 99% full
XLIST     table is (     0 of     500)  0% full
SPC       table is (     4 of     40) 10% full
LS        table is (   738 of   1024) 72% full
SLK       table is (   360 of   2000) 18% full
IP-LNK    table is (     6 of    512)  1% full
IP-HOST   table is (    58 of   2048)  3% full
MAP       table is (   336 of   1024) 33% full
MRN       table is (   768 of   2988) 26% full
SCCPSRV   table is (    12 of     96) 13% full
GTA       table is ( 269999 of 269999) 100% full
GTT-SET   table is (    10 of   2000)  1% full
SSNSELID  table is (     0 of  10000)  0% full
SCRSET    table is (    40 of    255) 16% full
RTEKEY    table is (     0 of   1000)  0% full
APPLSOCK  table is (     0 of   4000)  0% full
AS        table is (     0 of    250)  0% full
VFLXRN    table is (     1 of  10000)  1% full
VFLXCD    table is (     1 of   4950)  1% full
VFLXVID   table is (     1 of   1000)  1% full
NPP-AS    table is (     6 of   1024)  1% full
NPP-SRS   table is (     0 of   8192)  0% full
GTT-ACT   table is (     0 of   2000)  0% full
GTT-ASET  table is (     0 of  20000)  0% full
GTMOD     table is (     1 of 100000)  1% full
GTT-PATH  table is (     3 of   10000)  1% full
```

;

### Related Topics

- [rept-stat-xlist](#)
- [rtrv-appl-rtkey](#)
- [rtrv-as](#)
- [rtrv-assoc](#)
- [rtrv-dstn](#)
- [rtrv-gta](#)
- [rtrv-gtmod](#)
- [rtrv-gtt](#)
- [rtrv-gttact](#)
- [rtrv-gttapath](#)
- [rtrv-gttaset](#)
- [rtrv-ip-host](#)
- [rtrv-ip-lnk](#)



- [rtrv-ls](#)
- [rtrv-map](#)
- [rtrv-scrset](#)
- [rtrv-slk](#)
- [rtrv-spc](#)
- [rtrv-vflx-cd](#)
- [rtrv-vflx-rn](#)
- [rtrv-vflx-vmsid](#)

## rtrv-th-alm

Use this command to retrieve the alarm thresholds and associated values. For additional information on these values, refer to the *Database Administration Manual - SS7* in your EAGLE documentation set.

### Parameters

This command has no parameters.

### Example

```
rtrv-th-alm
```

### Dependencies

None

### Notes

None

### Output

```
rtrv-th-alm
```

```
tekelecstp 13-03-19 13:14:44 EST EAGLE 45.1.0
Thermal Alarm Level 1:          92%
Thermal Alarm Level 2:          100%
SCCP TPS Threshold:             80%
SCCP Calculation Method:        N
LNP TN DB Alarm Level 1:        80%
LNP TN DB Alarm Level 2:        95%
GTT SCCP Service Alarm Level 1: 10%
GTT SCCP Service Alarm Level 2: 20%
Non-GTT SCCP Service Alarm Level 1: 10%
Non-GTT SCCP Service Alarm Level 2: 20%
SCCP Service Alarm Level 1 Interval: 0
SCCP Service Alarm Level 2 Interval: 0
IMT Bus Combined Utilization Alarm Level 1: 70%
IMT Bus Combined Utilization Alarm Level 2: 80%
IMT Bus Congestion Alarm Level 1: 70%
```

```

IMT Bus Congestion Alarm Level 2:      80%
DEIR Congestion Alarm Level 1:        40%
DEIR Congestion Alarm Level 2:      80%
SFTHROT Threshold:                    80%
RTRV-TH-ALM: MASP A - COMPLTD.
;

```

**Related Topics**

- [chg-th-alm](#)
- [rept-stat-sccp](#)

## rtrv-tifopts

Use this command to retrieve the current values of the TIF option indicators from the TIFOPTS table.

**Parameters**

This command has no parameters.

**Example**

```
rtrv-tifopts
```

**Dependencies**

The EGLEOPTS table is corrupt or cannot be found.

None

**Notes**

The NSADDLDATA and NSPUBLIC options are displayed only when the TIF Number Substitution feature is enabled.

**Output**

```
rtrv-tifopts
```

```

tekelecstp 09-06-10 12:32:21 EST  EAGLE 41.1.0
Command entered at terminal #4.

```

```
TIF OPTIONS
```

```

-----
IAMCGPN      = dn
NPFLAG      = none
RCAUSENP    = 0
RCAUSEPFX   = 0
NPTYPEPLS   = sprn
NPTYPEPLY   = sprn
NPTYPEPCGPN = sprn
SPLITIAM    = none
CONDCGPN    = none
CRPREL      = 31

```

```

RNRQD           = yes
DFLTRN          = none
DLMA            = none
DLMB            = none
DLMC            = none
SNSCGPNDFLT    = none
MATCHSEQ       = dn
SPORTRLS       = all
SPORTRELAY     = gsm
SPFILL         = on
RLCOPC         = off
NSADDLDATA     = yes
NSPUBLIC       = 5

```

```
;
```

### Related Topics

- [chg-tifopts](#)

## rtrv-tps

Use this command to display the total provisioned system TPS for IPSG and E5-ATM-B cards. The total of these four values, and the maximum allowed system TPS value, are also displayed.

### Parameters

This command has no parameters.

### Example

```
rtrv-tps
```

### Dependencies

The Linkset table is corrupt or cannot be found.

The Signaling Link table is corrupt or cannot be found.

None

### Notes

The maximum total provisioned System TPS is based on whether the HIPR2 High Rate Mode feature is turned on. The maximum total provisioned System TPS is 500,000 if the HIPR2 High Rate Mode feature is turned off, 750,000 if the HIPR2 High Rate Mode feature is turned on, and 1,000,000 if both the HIPR2 High Rate Mode and 1M System TPS features are turned on.

### MAX TPS calculations

The provisioned (max) system TPS calculation is calculated by summing the SIGTRAN TPS values (values for the IPSG linksets TPS usage) and the ATM links TPS values. The total provisioned system TPS is calculated by using the following:

- Sum all TPS values for IPSG linksets using the (num\_ipsg\_links \* the value of the maxslktps parameter (see the ent/chg-ls commands)).
- Sum all ATM over T1 links ((ATM ANSI links) \* per ATM ANSI links TPS (1630))
- Sum all ATM over E1 links ((ATM ITU links) \* per ATM ITU links TPS (2038))

### RSVD TPS Calculations

The reserved TPS calculation is calculated by summing the SIGTRAN TPS values (values for the and IPSG linksets TPS usage) and the ATM links TPS values. The total provisioned system TPS is calculated by using the following:

- Sum all TPS values for IPSG linksets using the (num\_ipsg\_links \* the value of the slktps or rsvdslktps parameter (see the ent/chg-ls commands)).
- Sum all ATM over T1 links ((ATM ANSI links) \* per ATM ANSI links TPS (1630))
- Sum all ATM over E1 links ((ATM ITU links) \* per ATM ITU links TPS (2038))

### Output

This example shows the output when the HIPR2 High Rate Mode feature is turned off:

```
rtrv-tps
```

```
rlghncxa03w 10-02-10 16:20:46 EST EAGLE 42.0.0
```

CARD TYPE	NUM CARDS	NUM LINKS	RSVD TPS	MAX TPS
-----	-----	-----	-----	-----
IPGW	9	8	32000	40000
IPSG	100	16	80000	80000
ATM	0	0	0	0

```
Total provisioned System TPS (120000 of 500000) 24%
```

```
Command Completed.
```

```
;
```

This example shows the output when the HIPR2 High Rate Mode feature is turned on:

```
rtrv-tps
```

```
rlghncxa03w 10-02-10 16:20:46 EST EAGLE 42.0.0
```

CARD TYPE	NUM CARDS	NUM LINKS	RSVD TPS	MAX TPS
-----	-----	-----	-----	-----
IPGW	9	8	32000	40000
IPSG	100	16	80000	80000
ATM	0	0	0	0

```
Total provisioned System TPS (120000 of 750000) 16%
```

```
Command Completed.
```

```
;
```

### Related Topics

- [chg-ctrl-feat](#)
- [chg-ls](#)
- [ent-ls](#)
- [rept-stat-iptps](#)
- [rtrv-ctrl-feat](#)
- [rtrv-ls](#)

## rtrv-trbl

Use this command to display detailed information for one or more troubles that are currently logged into the system.

### Parameters

#### **loc (mandatory)**

The address of the card that is running the OAM from which logged trouble reports are to be displayed.

#### **Range:**

*1113, 1115*

#### **mode (optional)**

Display mode

#### **Range:**

**c**

Continuous mode; shows troubles already logged and new troubles as they occur.

**m**

Manual mode; shows troubles on demand only

#### **Default:**

*c*

#### **num (optional)**

Indicates how many troubles to display.

#### **Range:**

*1 - 1023*

#### **Default:**

*99*

### Example

```
rtrv-trbl:loc=1113:num=2
```

## Dependencies

At least one trouble must be in the trouble log, or the command is rejected.

Only one `rtrv-trbl` or `rtrv-obit` command can be in progress at a time.

If the `mode` parameter is specified without the `num` parameter, the entire log is displayed.

The card specified by the `loc` parameter must be 1113 or 1115.

If the `loc` parameter specifies the card that is running the standby OAM, that card must be available.

The `num` parameter must be between 1 - 1023.

## Notes

When a trouble is generated in the system, it is logged into the RAM storage area of the active OAM. Each OAM can store up to 1023 troubles in a queue. If the OAM resets, logged troubles are lost.

## Output

The output from this command should be reviewed with a member of the Customer Care Center. See the "My Oracle Support (MOS)" section in Chapter 1 of this reference guide.

```
rtrv-trbl:loc=1113:num=2
```

```
rlghncxa03w 03-03-07 08:47:43 EST EAGLE 31.3.0  
Card 1113 Module 0000 Mod_loc 0 Class 0000 Severity 0  
Report Date:00-00-00 Time:00:00:00
```

```
rlghncxa03w 03-03-07 08:47:43 EST EAGLE 31.3.0  
Card 1108 Module 8001 Mod_loc 6 Class 100A Severity 1  
Report Date:03-03-04 Time:09:19:59
```

```
;
```

## Related Topics

- [act-alm-trns](#)
- [dact-alm-trns](#)
- [rept-stat-alm](#)
- [rept-stat-clk](#)
- [rept-stat-trbl](#)
- [rls-alm](#)
- [rtrv-obit](#)

## rtrv-trbltx

Use this command to retrieve Alarm and UIM message information including MRN (message reference number), level (for Alarms), Output Group, and text.

The default report displays all Alarms (in numerical order) and then all UIMs.

The optional parameters can be used to:

- Display a range of Alarms or UIMs (ranges spanning both Alarms and UIMs are not supported)
- Search for Alarms, UIMs, or both message types matching a specific Output Group
- Sort all entries by Output Group

### Parameters

#### **enum (optional)**

The ending Message Reference Number (MRN) when specifying a range.

##### **Range:**

*1 - 1999*

*1-999-UAMs*

*1000-1999 -UIMs*

##### **Default:**

If *snum* is specified, the *enum* value defaults to the specified *snum* value.

If *snum* is not specified and *type=all*, *type=uim*, or *type* is not specified, the *enum* value defaults to 1999

If *snum* is not specified and *type=alarm*, the *enum* value defaults to 999.

#### **outgrp (optional)**

The Output Group to sort or filter the Alarm/UIMs on.

##### **Range:**

##### ***appserv***

Application Server

##### ***appss***

Application Subsystem

##### ***card***

Card

##### ***clk***

Clock

##### ***db***

Database

##### ***dbg***

Debug

##### ***gtt***

GTT Maintenance

##### ***gws***

GWS Maintenance

**link**

Link Maintenance

**meas**

Measurements Maintenance

**mon**

Monitoring (Sentinel or IMF) Maintenance

**mps**

MPS Maintenance

**pu**

Program Update

**sa**

System Administration

**seas**

SEAS (Sentinel or IMF)

**slan**

SLAN Maintenance

**sys**

System Maintenance

**traf**

Traffic

**all**

Retrieve information for all Output Groups

**Default:**

No sorting or filtering is done on Output Groups.

**snum (optional)**

A single Message Reference Number (MRN), or the starting MRN when specifying a range.

**Range:**

1 - 1999

1-999 —UAMs

1000-1999—UIMs

**Default:**

All message entries for the specified type are displayed.

For `type=all`, `type=alarm`, or type not specified the `snum` value defaults to 1.For `type=uim`, the `snum` value defaults to 1000.**type (optional)**

The type of trouble text entry to display.

**Range:****all**

Both types are displayed



**alarm**

Only Alarm entries are displayed

**uim**

Only UIM entries are displayed

**Default:**

*all*

**Example**

```
rtrv-trbltx
rtrv-trbltx:type=alarm
rtrv-trbltx:outgrp=sys
rtrv-trbltx:type=alarm:outgrp=all
rtrv-trbltx:snum=1002
```

**Dependencies**

If the `enum` parameter is specified, then the `snum` parameter must be specified.

The value specified for the `enum` parameter must be greater than or equal to the value specified for the `snum` parameter.

The specified `enum` value must be in the same range as the specified `snum` value (1-999 for Alarms and 1000-1999 for UIMs). The range cannot span both types.

The values specified for the `snum` and `enum` parameters must be in the range of the specified `type` (1-999 for Alarms and 1000-1999 for UIMs).

If the `outgrp` parameter is specified, then the `snum` and `enum` parameters cannot be specified.

If the `snum` parameter is specified, the `snum` parameter specified is out of range.

If the `enum` parameter is specified, the `enum` parameter specified is out of range.

**Notes**

This command can be canceled using the **F9** function key or the `canc-cmd` command. See `canc-cmd` for more information.

To display a single Alarm or UIM, enter the Alarm or UIM MRN as the value of the `snum` parameter. Either do not specify the `enum` parameter or specify the `enum` parameter with the same value as the `snum` value.

If an unused MRN is specified as an `snum` parameter value, the header information is displayed without any Output Group header or MRN information.

If an `snum/enum` range is specified, and there are unused MRNs within that range, only the used MRNs are displayed.

**Output**

This example shows the output when the command has no parameters. All entries are not shown; the list is long.

```
rtrv-trbltx
```

```
ncralstp00001 03-07-16 10:15:29 EST EAGLE 31.3.0
```

```
Alarm Report
```

```
MRN LEVEL OUTPUT GROUP TEXT
```

```
-----
          0001 MAJR SYS          Card has reset
          0002 MINR SYS          Card is not running approved GPL
          0003 NONE SYS          Alarm cleared for GPL
          .
          .
          .
          0912 NONE SYS          Dynamic database is now consistent
```

```
UIM Report
```

```
MRN OUTPUT GROUP TEXT
```

```
-----
SCCP          1000          SYS          MTP rcvd UPU - user part is not
          1001          SYS          MTP rcvd Transfer Controlled (TFC)
          1002          SYS          MTP rcvd invalid TFC - status 0
          .
          .
          .
          1999          SYS          Invalid MRN detected
```

```
END OF RTRV-TRBLTX REPORT.
```

```
;
```

This example shows output with `type=alarm`. All entries are not shown.

```
rtrv-trbltx:type=alarm
```

```
ncralstp00001 03-07-16 10:15:29 EST EAGLE 31.3.0
```

```
Alarm Report
```

```
MRN LEVEL OUTPUT GROUP TEXT
```

```
-----
          0001 MAJR SYS          Card has reset
          0002 MINR SYS          Card is not running approved GPL
          0003 NONE SYS          Alarm cleared for GPL
          .
          .
          .
          0912 NONE SYS          Dynamic database is now consistent
```

```
END OF RTRV-TRBLTX REPORT.
```

```
;
```

This example shows the output with `type=uim`. All entries are not shown.



```

consistent
.
.
.
Output Group - LINK
  0155  MINR  LINK          STPLAN connection unavailable
  0156  NONE  LINK          STPLAN connection available
.
  0479  NONE  LINK          Link not Monitored
UIM Report
  MRN              OUTPUT GROUP  TEXT
-----
Output Group - SYS
SCCP  1000          SYS          MTP rcvd UPU - user part is not
      1001          SYS          MTP rcvd Transfer Controlled (TFC)
.
.
.
      1999          SYS          Invalid MRN detected
.
.
.
Output Group - LINK
      13nn          LINK          Example text

END OF RTRV-TRBLTX REPORT.
;

```

This example shows the output for `outgrp=sys`. All entries are not shown.

```
rtrv-trbltx:type=alarm:outgrp=sys
```

```

ncralstp00001 03-07-16 10:15:29 EST EAGLE 31.3.0
Alarm Report
  MRN  LEVEL  OUTPUT GROUP  TEXT

```

```

-----
Output Group - SYS
  0001  MAJR  SYS          Card has reset
  0002  MINR  SYS          Card is not running approved GPL
.
.
.
  0912  NONE  SYS          Dynamic database is now consistent

END OF RTRV-TRBLTX REPORT.
;

```

This example shows the output for Alarm MRN 3:

```
rtrv-trbltx:snum=3

ncralstp00001 03-07-16 10:15:29 EST  EAGLE 31.3.0
Card 1113; SYS REL= 31.3.0; STP CLLI= ncralstp00001; Timezone= EST
Alarm Report
      MRN      LEVEL  OUTPUT GROUP      TEXT
-----
--
          0003   NONE   SYS              Alarm cleared for GPL
END OF RTRV-TRBLTX REPORT.
;
```

This example shows the output for UIM MRN 1002:

```
rtrv-trbltx:snum=1002

ncralstp00001 03-07-16 10:15:29 EST  EAGLE 31.3.0
UIM Report
      MRN      OUTPUT GROUP      TEXT
-----
--
          1002          SYS              MTP rcvd invalid TFC -
status 0
END OF RTRV-TRBLTX REPORT.
;
```

## rtrv-trm

Use this command to show the port configuration for all TDM terminals or a specified terminal. These ports are used to connect modems, printers, and terminals to the system. This command displays the following information: device type, data transmission rate, parity, type of flow control used, number of stop bits, number of data bits, and the type of unsolicited messages to be received.

### Parameters

#### **trm (optional)**

The ID number of the terminal whose characteristics are to be retrieved and displayed.

**Range:**

1 - 40

**Default:**

Display all

**Example**

```
rtrv-trm
```

```
rtrv-trm:trm=17
```

**Dependencies**

The IP User Interface feature must be enabled and turned on, and at least one IPSM card must be equipped, before `telnet` or `emsa1m` type terminals with IDs 17 - 40 can be specified.

The specified terminal must be equipped.

If a value of `telnet`, `seas`, or `emsa1m` was specified for the `type` parameter (see the `chg-trm` command) and a Telnet terminal is specified by the `trm` parameter (IDs 17-40), then an IPSM card must be equipped in the system.

**Notes**

None

**Output**

This example shows the output for 16 terminal ports (no IPSM cards are equipped):

```
rtrv-trm
```

```
rlghncxa03w 10-03-11 16:02:08 EST EAGLE 42.0.0
TRM  TYPE      COMM          FC      TMOUT  MXINV  DURAL
1    VT320      9600-7-E-1 SW    60     5      99:59:59
2    VT320      9600-7-E-1 SW    60     5      INDEF
3    KSR        9600-7-E-1 SW    60     0      00:00:00
4    NONE       9600-7-E-1 SW    60     5      00:30:00
5    NONE       9600-7-E-1 SW    60     5      00:00:30
6    NONE       9600-7-E-1 SW    60     5      00:30:00
7    VT320      9600-7-E-1 SW    60     5      99:59:59
8    VT320      9600-7-E-1 SW    60     5      INDEF
9    VT320      9600-7-E-1 SW    60     0      00:00:00
10   VT320      9600-7-E-1 SW    60     5      00:30:00
11   VT320      9600-7-E-1 NONE  60     5      00:00:30
12   NONE       19200-7-E-1 SW    0      5      INDEF
13   VT320      9600-7-E-1 SW    60     5      99:59:59
14   VT320      9600-7-E-1 SW    60     5      INDEF
15   VT320      9600-7-E-1 SW    60     0      00:00:00
16   VT320      9600-7-E-1 SW    60     5      00:30:00
```

```
TRM  TRAF LINK SA  SYS PU  DB  UIMRD
1    YES YES  YES YES YES YES YES
2    YES YES  YES YES YES YES YES
3    YES YES  YES YES YES YES YES
```

```

4  YES YES YES YES NO YES YES
5  YES YES YES YES YES YES YES
6  NO  YES YES YES YES YES YES
7  NO  YES YES YES YES YES YES
8  YES YES YES YES YES YES YES
9  YES YES YES YES YES YES YES
10 NO  NO  NO  NO  NO  NO  NO
11 NO  NO  NO  NO  NO  NO  NO
12 NO  NO  NO  NO  NO  NO  NO
13 NO  NO  NO  NO  NO  NO  NO
14 NO  NO  NO  NO  NO  NO  NO
15 NO  NO  NO  NO  NO  NO  NO
16 NO  NO  NO  NO  NO  NO  NO

```

```

          APP APP
TRM  SERV SS  CARD CLK DBG GTT GWS MEAS MON MPS SEAS SLAN
1    YES YES YES  YES YES YES YES YES YES YES YES NO  NO
2    YES YES YES  YES YES YES YES YES YES YES YES NO  NO
3    YES YES YES  YES YES YES YES YES YES YES YES NO  NO
4    YES YES YES  YES YES NO  YES YES YES YES NO  NO
5    YES YES YES  YES YES YES YES YES YES YES YES NO  NO
6    YES YES YES  YES YES YES YES YES YES YES YES NO  NO
7    NO  YES YES  YES YES YES YES YES YES YES NO  NO
8    YES YES YES  YES YES YES YES YES YES YES YES YES YES
9    YES YES YES  YES YES YES YES YES YES YES YES YES YES
10   NO  NO  NO  NO  NO  NO  NO  NO  NO  NO  NO  NO  NO
11   NO  NO  NO  NO  NO  NO  NO  NO  NO  NO  NO  NO  NO
12   NO  NO  NO  NO  NO  NO  NO  NO  NO  NO  NO  NO  NO
13   NO  NO  NO  NO  NO  NO  NO  NO  NO  NO  NO  NO  NO
14   NO  NO  NO  NO  NO  NO  NO  NO  NO  NO  NO  NO  NO
15   NO  NO  NO  NO  NO  NO  NO  NO  NO  NO  NO  NO  NO
16   NO  NO  NO  NO  NO  NO  NO  NO  NO  NO  NO  NO  NO

```

;

This example shows the output with the IP User Interface feature enabled and three IPSM cards equipped:

```
rtrv-trm
```

```

rlghncxa03w 09-01-11 16:02:08 EST EAGLE 40.1.0
TRM  TYPE      COMM          FC      TMOUT MXINV DURAL
1    VT320     9600 -7-E-1 SW    0      5      00:01:00
2    VT320     9600 -7-E-1 SW    0      5      00:01:00
3    VT320     9600 -7-E-1 SW    0      5      00:01:00
4    KSR       9600 -7-E-1 SW    0      5      00:01:00
5    NONE      9600 -7-E-1 SW   30     5      00:01:00
6    NONE      9600 -7-E-1 SW   30     5      00:01:00
7    NONE      9600 -7-E-1 SW   30     5      00:01:00
8    NONE      9600 -7-E-1 SW   30     5      00:01:00
9    VT320     9600 -7-E-1 SW    0      5      00:01:00
10   VT320     9600 -7-E-1 SW    0      5      00:01:00
11   VT320     9600 -7-E-1 SW    0      5      00:01:00
12   KSR       9600 -7-E-1 SW    0      5      00:01:00
13   NONE      9600 -7-E-1 SW   30     5      00:01:00

```

14	NONE	9600	-7-E-1 SW	30	5	00:01:00
15	NONE	9600	-7-E-1 SW	30	5	00:01:00
16	NONE	9600	-7-E-1 SW	30	5	00:01:00

TRM	TYPE	LOC	TMOUT	MXINV	DURAL
17	TELNET	1201	60	5	00:30:00
18	TELNET	1201	60	5	00:30:00
19	TELNET	1201	60	5	00:30:00
20	TELNET	1201	60	5	00:30:00
21	TELNET	1201	60	5	00:30:00
22	TELNET	1201	60	5	00:30:00
23	TELNET	1201	60	5	00:30:00
24	TELNET	1201	60	5	00:30:00
25	TELNET	1203	60	5	00:30:00
26	TELNET	1203	60	5	00:30:00
27	TELNET	1203	60	5	00:30:00
28	TELNET	1203	60	5	00:30:00
29	TELNET	1203	60	5	00:30:00
30	TELNET	1203	60	5	00:30:00
31	TELNET	1203	60	5	00:30:00
32	TELNET	1203	60	5	00:30:00
33	TELNET	1208	60	5	00:30:00
34	TELNET	1208	60	5	00:30:00
35	TELNET	1208	60	5	00:30:00
36	TELNET	1208	60	5	00:30:00
37	TELNET	1208	60	5	00:30:00
38	TELNET	1208	60	5	00:30:00
39	TELNET	1208	60	5	00:30:00
40	TELNET	1208	60	5	00:30:00

TRM	LOGINTMR (sec)	LOGOUTTMR (sec)	PNGTIMEINT (msec)	PNGFAILCNT
17	none	none	none	1
18	none	none	none	1
19	none	none	none	1
20	none	none	none	1
21	none	none	none	1
22	none	none	none	1
23	none	none	none	1
24	none	none	none	1
25	none	none	none	1
26	none	none	none	1
27	none	none	none	1
28	none	none	none	1
29	none	none	none	1
30	none	none	none	1
31	none	none	none	1
32	none	none	none	1
33	none	none	none	1
34	none	none	none	1
35	none	none	none	1
36	none	none	none	1
37	none	none	none	1
38	none	none	none	1
39	none	none	none	1



40 none none none 1

TRM	TRAF	LINK	SA	SYS	PU	DB	UIMRD
1	YES	YES	YES	YES	YES	YES	YES
2	YES	YES	YES	YES	YES	YES	YES
3	YES	YES	YES	YES	YES	YES	YES
4	YES	YES	YES	YES	NO	YES	YES
5	YES	YES	YES	YES	YES	YES	YES
6	NO	YES	YES	YES	YES	YES	YES
7	NO	YES	YES	YES	YES	YES	YES
8	YES	YES	YES	YES	YES	YES	YES
9	YES	YES	YES	YES	YES	YES	YES
10	NO	NO	NO	NO	NO	NO	NO
11	NO	NO	NO	NO	NO	NO	NO
12	NO	NO	NO	NO	NO	NO	NO
13	NO	NO	NO	NO	NO	NO	NO
14	NO	NO	NO	NO	NO	NO	NO
15	NO	NO	NO	NO	NO	NO	NO
16	NO	NO	NO	NO	NO	NO	NO
17	NO	NO	NO	NO	NO	NO	NO
18	NO	NO	NO	NO	NO	NO	NO
19	NO	NO	NO	NO	NO	NO	NO
20	NO	NO	NO	NO	NO	NO	NO
21	NO	NO	NO	NO	NO	NO	NO
22	NO	NO	NO	NO	NO	NO	NO
23	NO	NO	NO	NO	NO	NO	NO
24	NO	NO	NO	NO	NO	NO	NO
25	NO	NO	NO	NO	NO	NO	NO
26	NO	NO	NO	NO	NO	NO	NO
27	NO	NO	NO	NO	NO	NO	NO
28	NO	NO	NO	NO	NO	NO	NO
29	NO	NO	NO	NO	NO	NO	NO
30	NO	NO	NO	NO	NO	NO	NO
31	NO	NO	NO	NO	NO	NO	NO
32	NO	NO	NO	NO	NO	NO	NO
33	NO	NO	NO	NO	NO	NO	NO
34	NO	NO	NO	NO	NO	NO	NO
35	NO	NO	NO	NO	NO	NO	NO
36	NO	NO	NO	NO	NO	NO	NO
37	NO	NO	NO	NO	NO	NO	NO
38	NO	NO	NO	NO	NO	NO	NO
39	NO	NO	NO	NO	NO	NO	NO
40	NO	NO	NO	NO	NO	NO	NO

TRM	SERV	SS	CARD	CLK	DBG	GTT	GWS	MEAS	MON	MPS	SEAS	SLAN
1	YES	YES	YES	YES	YES	YES	YES	YES	YES	YES	NO	NO
2	YES	YES	YES	YES	YES	YES	YES	YES	YES	YES	NO	NO
3	YES	YES	YES	YES	YES	YES	YES	YES	YES	YES	NO	NO
4	YES	YES	YES	YES	YES	NO	YES	YES	YES	YES	NO	NO
5	YES	YES	YES	YES	YES	YES	YES	YES	YES	YES	NO	NO
6	YES	YES	YES	YES	YES	YES	YES	YES	YES	YES	NO	NO
7	NO	YES	YES	YES	YES	YES	YES	YES	YES	YES	NO	NO
8	YES	YES	YES	YES	YES	YES	YES	YES	YES	YES	YES	YES
9	YES	YES	YES	YES	YES	YES	YES	YES	YES	YES	YES	YES

```

10 NO NO NO NO NO NO NO NO NO NO NO NO NO
11 NO NO NO NO NO NO NO NO NO NO NO NO NO
12 NO NO NO NO NO NO NO NO NO NO NO NO NO
13 NO NO NO NO NO NO NO NO NO NO NO NO NO
14 NO NO NO NO NO NO NO NO NO NO NO NO NO
15 NO NO NO NO NO NO NO NO NO NO NO NO NO
16 NO NO NO NO NO NO NO NO NO NO NO NO NO
17 NO NO NO NO NO NO NO NO NO NO NO NO NO
18 NO NO NO NO NO NO NO NO NO NO NO NO NO
19 NO NO NO NO NO NO NO NO NO NO NO NO NO
20 NO NO NO NO NO NO NO NO NO NO NO NO NO
21 NO NO NO NO NO NO NO NO NO NO NO NO NO
22 NO NO NO NO NO NO NO NO NO NO NO NO NO
23 NO NO NO NO NO NO NO NO NO NO NO NO NO
24 NO NO NO NO NO NO NO NO NO NO NO NO NO
25 NO NO NO NO NO NO NO NO NO NO NO NO NO
26 NO NO NO NO NO NO NO NO NO NO NO NO NO
27 NO NO NO NO NO NO NO NO NO NO NO NO NO
28 NO NO NO NO NO NO NO NO NO NO NO NO NO
29 NO NO NO NO NO NO NO NO NO NO NO NO NO
30 NO NO NO NO NO NO NO NO NO NO NO NO NO
31 NO NO NO NO NO NO NO NO NO NO NO NO NO
32 NO NO NO NO NO NO NO NO NO NO NO NO NO
33 NO NO NO NO NO NO NO NO NO NO NO NO NO
34 NO NO NO NO NO NO NO NO NO NO NO NO NO
35 NO NO NO NO NO NO NO NO NO NO NO NO NO
36 NO NO NO NO NO NO NO NO NO NO NO NO NO
37 NO NO NO NO NO NO NO NO NO NO NO NO NO
38 NO NO NO NO NO NO NO NO NO NO NO NO NO
39 NO NO NO NO NO NO NO NO NO NO NO NO NO
40 NO NO NO NO NO NO NO NO NO NO NO NO NO

```

;

This example shows the output for Telnet terminal 30:

```
rtrv-trm:trm=30
```

```

rlghncxa03w 08-05-01 16:02:08 EST EAGLE 39.0.0
TRM TYPE LOC TMOUT MXINV DURAL
30 TELNET 1204 60 0 00:00:00

TRM LOGINTMR LOGOUTTMR PNGTIMEINT PNGFAILCNT
(sec) (sec) (msec)
30 none none none 1

TRM TRAF LINK SA SYS PU DB UIMRD
30 YES YES YES YES YES YES YES

APP APP
TRM SERV SS CARD CLK DBG GTT GWS MEAS MON MPS SEAS SLAN
30 YES YES YES YES YES YES YES YES YES YES NO NO

```

;

This example shows the output with the IP User Interface feature enabled, one IPSM card equipped, and the OA&M IP Security Enhancements feature or the parameter SSH in SECUDFLT table is turned off:

```
rtrv-trm
```

```
rlghncxa03w 09-01-11 16:02:08 EST EAGLE 40.1.0
TRM  TYPE      COMM          FC      TMOUT MXINV  DURAL
1    VT320     9600 -7-E-1 SW    0      5     00:01:00
2    VT320     9600 -7-E-1 SW    0      5     00:01:00
3    VT320     9600 -7-E-1 SW    0      5     00:01:00
4    KSR       9600 -7-E-1 SW    0      5     00:01:00
5    NONE      9600 -7-E-1 SW    30     5     00:01:00
6    NONE      9600 -7-E-1 SW    30     5     00:01:00
7    NONE      9600 -7-E-1 SW    30     5     00:01:00
8    NONE      9600 -7-E-1 SW    30     5     00:01:00
9    VT320     9600 -7-E-1 SW    0      5     00:01:00
10   VT320     9600 -7-E-1 SW    0      5     00:01:00
11   VT320     9600 -7-E-1 SW    0      5     00:01:00
12   KSR       9600 -7-E-1 SW    0      5     00:01:00
13   NONE      9600 -7-E-1 SW    30     5     00:01:00
14   NONE      9600 -7-E-1 SW    30     5     00:01:00
15   NONE      9600 -7-E-1 SW    30     5     00:01:00
16   NONE      9600 -7-E-1 SW    30     5     00:01:00

TRM  TYPE      LOC          TMOUT MXINV  DURAL      SECURE
17   TELNET    1201         60    5     00:30:00   no
18   TELNET    1201         60    5     00:30:00   no
19   TELNET    1201         60    5     00:30:00   no
20   TELNET    1201         60    5     00:30:00   no
21   TELNET    1201         60    5     00:30:00   no
22   TELNET    1201         60    5     00:30:00   no
23   TELNET    1201         60    5     00:30:00   no
24   TELNET    1201         60    5     00:30:00   no

TRM  LOGINTMR LOGOUTTMR  PNGTIMEINT  PNGFAILCNT
      (sec)    (sec)      (msec)
17   none     none       none         1
18   none     none       none         1
19   none     none       none         1
20   none     none       none         1
21   none     none       none         1
22   none     none       none         1
23   none     none       none         1
24   none     none       none         1

TRM  TRAF LINK SA  SYS PU  DB  UIMRD
1    YES YES  YES YES YES YES YES
2    YES YES  YES YES YES YES YES
3    YES YES  YES YES YES YES YES
4    YES YES  YES YES NO  YES YES
5    YES YES  YES YES YES YES YES
6    NO  YES  YES YES YES YES YES
7    NO  YES  YES YES YES YES YES
```

```

8   YES  YES  YES YES YES YES YES
9   YES  YES  YES YES YES YES YES
10  NO   NO   NO  NO  NO  NO  NO
11  NO   NO   NO  NO  NO  NO  NO
12  NO   NO   NO  NO  NO  NO  NO
13  NO   NO   NO  NO  NO  NO  NO
14  NO   NO   NO  NO  NO  NO  NO
15  NO   NO   NO  NO  NO  NO  NO
16  NO   NO   NO  NO  NO  NO  NO
17  NO   NO   NO  NO  NO  NO  NO
18  NO   NO   NO  NO  NO  NO  NO
19  NO   NO   NO  NO  NO  NO  NO
20  NO   NO   NO  NO  NO  NO  NO
21  NO   NO   NO  NO  NO  NO  NO
22  NO   NO   NO  NO  NO  NO  NO
23  NO   NO   NO  NO  NO  NO  NO
24  NO   NO   NO  NO  NO  NO  NO

```

```

      APP  APP
TRM  SERV SS  CARD CLK  DBG  GTT  GWS  MEAS  MON  MPS  SEAS  SLAN
1    YES  YES  YES  YES  YES  YES  YES  YES  YES  YES  YES  NO   NO
2    YES  YES  YES  YES  YES  YES  YES  YES  YES  YES  YES  NO   NO
3    YES  YES  YES  YES  YES  YES  YES  YES  YES  YES  YES  NO   NO
4    YES  YES  YES  YES  YES  YES  NO   YES  YES  YES  YES  NO   NO
5    YES  YES  YES  YES  YES  YES  YES  YES  YES  YES  YES  NO   NO
6    YES  YES  YES  YES  YES  YES  YES  YES  YES  YES  YES  NO   NO
7    NO   YES  YES  YES  YES  YES  YES  YES  YES  YES  YES  NO   NO
8    YES  YES  YES  YES  YES  YES  YES  YES  YES  YES  YES  YES  YES
9    YES  YES  YES  YES  YES  YES  YES  YES  YES  YES  YES  YES  YES
10   NO   NO   NO   NO   NO   NO   NO   NO   NO   NO   NO   NO   NO
11   NO   NO   NO   NO   NO   NO   NO   NO   NO   NO   NO   NO   NO
12   NO   NO   NO   NO   NO   NO   NO   NO   NO   NO   NO   NO   NO
13   NO   NO   NO   NO   NO   NO   NO   NO   NO   NO   NO   NO   NO
14   NO   NO   NO   NO   NO   NO   NO   NO   NO   NO   NO   NO   NO
15   NO   NO   NO   NO   NO   NO   NO   NO   NO   NO   NO   NO   NO
16   NO   NO   NO   NO   NO   NO   NO   NO   NO   NO   NO   NO   NO
17   NO   NO   NO   NO   NO   NO   NO   NO   NO   NO   NO   NO   NO
18   NO   NO   NO   NO   NO   NO   NO   NO   NO   NO   NO   NO   NO
19   NO   NO   NO   NO   NO   NO   NO   NO   NO   NO   NO   NO   NO
20   NO   NO   NO   NO   NO   NO   NO   NO   NO   NO   NO   NO   NO
21   NO   NO   NO   NO   NO   NO   NO   NO   NO   NO   NO   NO   NO
22   NO   NO   NO   NO   NO   NO   NO   NO   NO   NO   NO   NO   NO
23   NO   NO   NO   NO   NO   NO   NO   NO   NO   NO   NO   NO   NO
24   NO   NO   NO   NO   NO   NO   NO   NO   NO   NO   NO   NO   NO

```

;

This example shows the output for a SEAS terminal.

```
rtrv-trm:trm=30
```

```

tekelecstp 07-12-16 22:37:01 IST  EAGLE 37.5.0
TRM  TYPE   LOC                TMOUT MXINV DURAL      SECURE
30   SEAS   1102                30    5    00:01:00  no

```

```

TRM TRAF LINK SA SYS PU DB UIMRD
30 NO NO NO NO NO NO NO NO

APP APP
TRM SERV SS CARD CLK DBG GTT GWS MEAS MON MPS SEAS SLAN
30 NO NO NO NO NO NO NO NO NO NO NO YES NO

```

;

This example shows the output with the IP User Interface feature enabled, one IPSM card equipped, and the OA&M IP Security Enhancements feature and the parameter SSH in SECUDFLT table are turned on.

- Terminals 17,18 and 19 are of type TELNET.
- Terminals 20,21 and 22 are of type EMSALM.
- Terminal 23 is of type NONE.
- Terminal 24 is of type SEAS.

The *LOGIN*TMR and *LOGOUT*TMR fields apply to terminals 17 - 19. The *PNG*TIMEINT and *PNG*FAILCNT fields apply to terminals 17 - 22. None of the fields apply to terminals 23 and 24.

rtrv-trm

```

tekelecstp 08-06-16 00:17:30 IST EAGLE 39.0.0
TRM TYPE COMM FC TMOUT MXINV DURAL
1 VT320 9600 -7-E-1 SW 30 5 00:01:00
2 VT320 9600 -7-E-1 SW 30 5 00:01:00
3 VT320 9600 -7-E-1 SW 30 5 00:01:00
4 VT320 9600 -7-E-1 SW 30 5 00:01:00
5 VT320 9600 -7-E-1 SW 30 5 00:01:00
6 VT320 9600 -7-E-1 SW 30 5 00:01:00
7 VT320 9600 -7-E-1 SW 30 5 00:01:00
8 VT320 9600 -7-E-1 SW 30 5 00:01:00
9 VT320 9600 -7-E-1 SW 30 5 00:01:00
10 VT320 9600 -7-E-1 SW 30 5 00:01:00
11 VT320 9600 -7-E-1 SW 30 5 00:01:00
12 VT320 9600 -7-E-1 SW 30 5 00:01:00
13 VT320 9600 -7-E-1 SW 30 5 00:01:00
14 VT320 9600 -7-E-1 SW 30 5 00:01:00
15 VT320 9600 -7-E-1 SW 30 5 00:01:00
16 VT320 9600 -7-E-1 SW 30 5 00:01:00

TRM TYPE LOC TMOUT MXINV DURAL SECURE
17 TELNET 1111 30 5 00:01:00 yes
18 TELNET 1111 30 5 00:01:00 yes
19 TELNET 1111 30 5 00:01:00 yes
20 EMSALM 1111 30 5 00:01:00 yes
21 EMSALM 1111 30 5 00:01:00 yes
22 EMSALM 1111 30 5 00:01:00 yes
23 NONE 1111 30 5 00:01:00 yes
24 SEAS 1111 30 5 00:01:00 yes

```

TRM	LOGINTMR (sec)	LOGOUTTMR (sec)	PNGTIMEINT (msec)	PNGFAILCNT
17	15	15	none	1
18	15	none	none	1
19	15	none	none	1
20	----	----	none	1
21	----	----	none	1
22	----	----	none	1

TRM	TRAF	LINK	SA	SYS	PU	DB	UIMRD
1	YES	YES	YES	YES	YES	YES	YES
2	YES	YES	YES	YES	YES	YES	YES
3	YES	YES	YES	YES	YES	YES	YES
4	YES	YES	YES	YES	YES	YES	YES
5	NO	NO	NO	NO	NO	NO	NO
6	NO	NO	NO	NO	NO	NO	NO
7	NO	NO	NO	NO	NO	NO	NO
8	NO	NO	NO	NO	NO	NO	NO
9	NO	NO	NO	NO	NO	NO	NO
10	NO	NO	NO	NO	NO	NO	NO
11	NO	NO	NO	NO	NO	NO	NO
12	NO	NO	NO	NO	NO	NO	NO
13	NO	NO	NO	NO	NO	NO	NO
14	NO	NO	NO	NO	NO	NO	NO
15	NO	NO	NO	NO	NO	NO	NO
16	NO	NO	NO	NO	NO	NO	NO
17	YES	YES	YES	YES	YES	YES	YES
18	YES	YES	YES	YES	YES	YES	YES
19	YES	YES	YES	YES	YES	YES	YES
20	YES	YES	YES	YES	YES	YES	YES
21	YES	YES	YES	YES	YES	YES	YES
22	YES	YES	YES	YES	YES	YES	YES
23	YES	YES	YES	YES	YES	YES	YES
24	YES	YES	YES	YES	YES	YES	YES

TRM	SERV	APP	APP	SS	CARD	CLK	DBG	GTT	GWS	MEAS	MON	MPS	SEAS	SLAN
1	YES	YES	YES	YES	YES	YES	YES	YES	YES	YES	YES	YES	YES	YES
2	YES	YES	YES	YES	YES	YES	YES	YES	YES	YES	YES	YES	YES	YES
3	YES	YES	YES	YES	YES	YES	YES	YES	YES	YES	YES	YES	YES	YES
4	YES	YES	YES	YES	YES	YES	YES	YES	YES	YES	YES	YES	YES	YES
5	NO	NO	NO	NO	NO	NO	NO	NO	NO	NO	NO	NO	NO	NO
6	NO	NO	NO	NO	NO	NO	NO	NO	NO	NO	NO	NO	NO	NO
7	NO	NO	NO	NO	NO	NO	NO	NO	NO	NO	NO	NO	NO	NO
8	NO	NO	NO	NO	NO	NO	NO	NO	NO	NO	NO	NO	NO	NO
9	NO	NO	NO	NO	NO	NO	NO	NO	NO	NO	NO	NO	NO	NO
10	NO	NO	NO	NO	NO	NO	NO	NO	NO	NO	NO	NO	NO	NO
11	NO	NO	NO	NO	NO	NO	NO	NO	NO	NO	NO	NO	NO	NO
12	NO	NO	NO	NO	NO	NO	NO	NO	NO	NO	NO	NO	NO	NO
13	NO	NO	NO	NO	NO	NO	NO	NO	NO	NO	NO	NO	NO	NO
14	NO	NO	NO	NO	NO	NO	NO	NO	NO	NO	NO	NO	NO	NO
15	NO	NO	NO	NO	NO	NO	NO	NO	NO	NO	NO	NO	NO	NO
16	NO	NO	NO	NO	NO	NO	NO	NO	NO	NO	NO	NO	NO	NO
17	YES	YES	YES	YES	YES	YES	YES	YES	YES	YES	YES	YES	YES	YES
18	YES	YES	YES	YES	YES	YES	YES	YES	YES	YES	YES	YES	YES	YES

```

19  YES  YES  YES  YES  YES  YES  YES  YES  YES  YES  YES  YES  YES
20  YES  YES  YES  YES  YES  YES  YES  YES  YES  YES  YES  YES  YES
21  YES  YES  YES  YES  YES  YES  YES  YES  YES  YES  YES  YES  YES
22  YES  YES  YES  YES  YES  YES  YES  YES  YES  YES  YES  YES  YES
23  YES  YES  YES  YES  YES  YES  YES  YES  YES  YES  YES  YES  YES
24  YES  YES  YES  YES  YES  YES  YES  YES  YES  YES  YES  YES  YES

```

;

This example shows the output for an EMSALM terminal on an IPSM card:

```
rtrv-trm:trm=22
```

```

tekelecstp 08-06-16 01:29:28 EST  EAGLE 39.0.0
TRM  TYPE    LOC                TMOUT MXINV DURAL    SECURE
22   EMSALM  1111                30    5    00:01:00  yes

TRM  PNGTIMEINT PNGFAILCNT
      (msec)
22   none      1

TRM  TRAF LINK SA  SYS PU  DB  UIMRD
22   YES  YES  YES YES YES YES YES YES

      APP  APP
TRM  SERV SS  CARD CLK DBG GTT GWS MEAS MON MPS SEAS SLAN
22   YES  YES YES  YES YES YES YES YES  YES YES YES  YES

```

;

This example shows the output for a NONE terminal on an IPSM card:

```
rtrv-trm:trm=23
```

```

tekelecstp 08-06-16 01:28:03 EST  EAGLE 39.0.0
TRM  TYPE    LOC                TMOUT MXINV DURAL    SECURE
23   NONE     1111                30    5    00:01:00  yes

TRM  TRAF LINK SA  SYS PU  DB  UIMRD
23   YES  YES  YES YES YES YES YES YES

      APP  APP
TRM  SERV SS  CARD CLK DBG GTT GWS MEAS MON MPS SEAS SLAN
23   YES  YES YES  YES YES YES YES YES  YES YES YES  YES

```

;

### Legend

Part one of the report contains these fields:

- **TRM**—TDM terminal port number associated with the output device
- **TYPE**—Type of output device that is connected

- **COMM**—This field consists of four communication attributes in the format *baud-dbts-prty-sb*. The parts are:
  - **BAUD**—Serial port baud rate of the output device
  - **DBTS**—Number of data bits used by the output device
  - **PRTY**—Parity of the output device
  - **SB**—Number of stop bits used in communications with the output device
- **FC**—Type of protocol used between the system and the output devices
- **TMOUT**—Maximum amount of time (in minutes) that a login session can remain idle
- **MXINV**—Login/unlock failure threshold
- **DURAL**—Length of time (in seconds, minutes, and hours) the terminal is disabled after each failed login/unlock attempt in excess of the threshold configured with the `mxinv` parameter
- **SECURE**—Shows whether the OA&M IP Security Enhancements feature and the parameter `SSH` in the `SECUDFLT` table are turned on or off for Telnet terminals

Part two of the report contains these fields:

- **LOGINTMR**—Maximum time for logging on to the telnet terminal after selecting the terminal
- **LOGOUTTMR**—Maximum time the telnet session remains open after the user manually or automatically logs out
- **PNGTIMEINT**—Time period after which IPSM card initiates new ping cycle
- **PNGFAILCNT**—Number of consecutive ping fails waited before dropping the telnet connection

Part three of the `rtrv-trm` report contains these fields:

- **TRM**—TDM terminal associated with the output device
- **TRAF**—Shows whether traffic-related unsolicited messages are received by the output device
- **LINK**—Shows whether link-related unsolicited messages are received by the output device
- **SA**—Shows whether security administration-related unsolicited messages are received by the output device
- **SYS**—Shows whether system maintenance-related unsolicited messages are received by the output device
- **PU**—Shows whether program update-related unsolicited messages are received by the output device
- **DB**—Shows whether database-related unsolicited messages are received by the output device
- **UIMRD**—Shows whether Unsolicited Information Messages (UIMs) specific to the group are received by the output device

Part four of the `rtrv-trm` report contains these fields:

- **APP SERV**—Shows whether Application Server unsolicited messages are received by the output device



- **APP SS**—Shows whether Application Subsystem unsolicited messages are received by the output device
- **CARD**—Shows whether Card unsolicited messages are received by the output device
- **CLK**—Shows whether Clock unsolicited messages are received by the output device
- **DBG**—Shows whether Debug unsolicited messages are received by the output device
- **GTT**—Shows whether GTT unsolicited messages are received by the output device
- **GWS**—Shows whether GWS unsolicited messages are received by the output device
- **MEAS**—Shows whether Measurements Maintenance unsolicited messages are received by the output device
- **MON**—Shows whether Monitor unsolicited messages are received by the output device
- **MPS**—Shows whether MPS unsolicited messages are received by the output device
- **SEAS**—Shows whether SEAS Maintenance unsolicited messages are received by the output device
- **SLAN**—Shows whether STP LAN unsolicited messages are received by the output device

#### Related Topics

- [act-echo](#)
- [canc-echo](#)
- [chg-trm](#)
- [dact-echo](#)
- [inh-trm](#)
- [rept-stat-trm](#)
- [rmv-trm](#)
- [rst-trm](#)

## rtrv-tt

Use this command to show the translation types that are currently defined in the system database for global title translations.

 **Note:**

If the EGTT feature is turned on, then the GTT Selector (`ent/chg/dlt/rtrvgttssel`), GTT Set (`ent/dlt/rtrv-gttset`), and GTA (`ent/chg/dlt/rtrvgta`) commands replace the Translation Type (`ent/dlt/rtrv-tt`) and Global Title Translation (`ent/chg/dlt/rtrv-gtt`) commands. It is not recommended to run `ent/dlt/rtrv-tt & ent/chg/dlt/rtrv-gtt` commands as it may cause the advance GTA fields of GTT entry to be reset to the default values.

**Parameters****alias (optional)**

The alias of the global title translation type

**Range:**

0 - 255

**Default:**

Display all

**ovr1apd (optional)**

Overlapped GTT Selectors.

**Range:**

yes

**Default:**

none

**ttn (optional)**

Translation type name.

**Range:**

ayyyyyyy

1 alphabetic character followed by up to 8 alphanumeric characters

**Default:**

Display all

**type/typeea/typeei/typen/typen24/typeis/typens (optional)**

Translation type. The translation type and network type. This parameter is the decimal representation of the 1-byte field used in SS7.

The `type` and `typeea` parameters specify an ANSI network.

The `typei` parameter specifies an ITU-international network.

The `typen` parameter specifies an ITU-national network.

The `typen24` parameter specifies a 24-bit ITU-national network.

The `typeis` parameter specifies an ITU-international spare network.

The `typens` parameter specifies an ITU-national spare network.

A translation type numeric value may be entered as an ANSI type (`type` or `typeea`) and as an ITU type (`typei/typen/typen24/typeis/typens`). However, they are separate entities.

The point code domain translation types for GTT are handled by the EAGLE protocol processing as ANSI or ITU. ITU applies to ITU-I, ITU-I spare, ITU-N, ITU-N spare, and ITU-N24.

**Range:**

0 - 255

**Default:**

No translation type is specified

**Example**

```
rtrv-tt
rtrv-tt:type=230
rtrv-tt:ttn=lidb
rtrv-tt:type=230:ttn=lidb
rtrv-tt:type=230:ttn=lidb:alias=012
rtrv-tt:typeis=2
rtrv-tt:ovrlapd=yes
```

**Dependencies**

If a translation type is specified, it must already exist in the database for the network type and cannot be an alias.

If both translation type and translation type name are specified, the translation type name must correspond to the specified translation type.

If an alias is specified with a translation type and/or translation type name, the alias must exist in the database for the specified network type, and it cannot be a translation type.

If an alias is specified without a translation type or translation type name, the alias must exist in the database for at least one of the network types. If it exists, the entries and the mapped translation type entries that exist in the database for all network types are displayed.

The value specified for the `alias` parameter must be associated with the value specified for the `type/typea/typei/typen/typen24/typeis/typens` parameter and cannot be the value of an existing translation type.

The value specified for the `type/typea/typei/typen/typen24/typeis/typens` parameter cannot be an alias value.

The value specified for the `ttn` parameter must already exist in the database.

The value specified for the `ttn` parameter must correspond to the value specified for the `alias` parameter.

The GTTSET associated with the translation type specified by the `ttn` parameter must have a set type of `cdgta` (see the `ent-gttset` command).

The `ttn=none` parameter cannot be specified.

The network domain of the translation type specified by the `ttn` parameter cannot be CROSS (see the `ent-gttset` command).

The Overlapped TT must exist with the specified filter criteria.

### Notes

If a translation type, translation type name, or both, are specified, the translation type entry and all aliases mapped to that translation type are displayed.

This command retrieves only selector entries that were provisioned by GTT Selector commands, have a GTI value of 2, and a set type of CdGTA.

If the EGTT feature is turned on, the following occurs for the `rtrv-tt` command:

- For ANSI, if any selector for an entry made by TT commands is deleted using the `dlt-gttset` command, that entry cannot be retrieved.
- For ITU, if the GTT set name of a true selector (GTI=2 or GTI=4) is deleted using the `dlt-gttset` command, then that entry cannot be retrieved.
- If the GTT set name of a true selector is changed using the `chg-gttset` command or if a selector is deleted using the `dlt-gttset` command, none of the selector aliases can be retrieved.
- Any entry where the `selid`, `lsn`, `cgssn`, or `eaglegen` is provisioned for the GTT selector cannot be retrieved.

### Output

```
rtrv-tt
```

```
tekelecstp 10-05-03 09:03:09 EST EAGLE 42.0.0
```

TYPEA	TTN	NDGT
130	lidb	5
180	ansi180	9

ALIAS	TYPEA
1	130
7	130
10	180

TYPEI	TTN	NDGT
105	intlabc	15
119	intl119	18

ALIAS	TYPEI
29	119
33	105

TYPEN	TTN	NDGT
204	natlxyz	8
210	natl210	21

ALIAS	TYPEN
7	204

```
TYPEN24  TTN      NDGT

ALIAS    TYPEN24

TYPEIS   TTN      NDGT
5        -----  6

ALIAS    TYPEIS

TYPENS   TTN      NDGT

ALIAS    TYPENS

;

rtrv-tt:type=130:ttn=LIDB

tekelecstp 03-11-02 09:06:38 EST  EAGLE 30.0.0
TYPEA     TTN      NDGT
130      lidb     5

ALIAS     TYPEA
1         130
7         130

;

rtrv-tt:ttn=intlabc

tekelecstp 03-11-02 09:19:34 EST  EAGLE 30.0.0
TYPEI     TTN      NDGT
105      intlabc  15

ALIAS     TYPEI
33       105

;

rtrv-tt:alias=7

tekelecstp 03-11-02 09:19:34 EST  EAGLE 30.0.0
ALIAS     TYPEA
7         130

ALIAS     TYPEN
7         204

;
```

```
rtrv-tt
```

```
tekelecstp 10-03-10 09:19:34 EST EAGLE 42.0.0
TYPEA      TTN      NDGT

TYPEI      TTN      NDGT

TYPEN      TTN      NDGT

TYPEN24    TTN      NDGT
2          set24n002  6
4          first    6
```

```
;
```

```
rtrv-tt:typens=5
```

```
tekelecstp 10-05-03 16:58:03 EST EAGLE 42.0.0
TYPENS     TTN      NDGT
5          abcde    6

ALIAS      TYPENS
```

```
;
```

This example shows the output for overlapped GTT selectors. If a translation type name is specified by more than one entry, the entries specifying that translation type will be preceded by an asterisk (to indicate overlap).

```
rtrv-tt:ovrlapd=yes
```

```
tekelecstp 10-05-03 17:11:36 EST Eagle 42.0.0
TYPEA      TTN      NDGT

ALIAS      TYPEA

TYPEI      TTN      NDGT
*1         set1     6
*2         set2     6

ALIAS      TYPEI

TYPEN      TTN      NDGT
*3         set1     6
*4         set2     6

ALIAS      TYPEN

TYPEN24    TTN      NDGT
*5         set1     6
*6         set2     6
```

```

    ALIAS    TYPEN24

    TYPEIS   TTN        NDGT

    ALIAS    TYPEIS

    TYPENS   TTN        NDGT

    ALIAS    TYPENS
;

```

### Legend

- **TYPEA/TYPEI/TYPEN/TYPEN24/TYPEIS/TYPENS**—Global title translation type
- **TTN**—Name of the global title translation type
- **NDGT**—Number of digits in the global title translation type
- **ALIAS**—Alias global title translation type

### Related Topics

- [dlt-tt](#)
- [ent-tt](#)

## rtrv-ttmap

Use this command to display a mapped SS7 message translation type (TT) for a given gateway linkset name. This command can be used to display the identification of the type of allowed global title translation in the SS7 message before and after translation type mapping, see which linkset the mapping applies to, and see whether the mapping applies to incoming or outgoing messages.

### Parameters

#### **ett (optional)**

Translation type before mapping. The identification of the type of allowed global title translation in the SS7 message *prior to* translation type mapping. This attribute is the decimal representation of the 1-octet binary field used by the SS7 protocol to identify the translation type.

#### **Range:**

0 - 255

#### **Default:**

Display all types allowed

#### **io (optional)**

Incoming or outgoing. The system uses this parameter to indicate whether the translation type mapping data provisioned for the gateway linkset is for SS7 messages *received* or *sent* on the linkset.

**Range:***i*  
incoming*o*  
outgoing**Default:**

Both incoming and outgoing

**lsn (optional)**

Linkset name

**Range:***ayyyyyyyy*

1 alphabetic character followed by up to 9 alphanumeric characters

**Default:**

Display all

**Example**

```
rtrv-ttmap
rtrv-ttmap:lsn=nc001
rtrv-ttmap:lsn=nc001:io=i:ett=128
rtrv-ttmap:io=i:ett=128
rtrv-ttmap:ett=128
rtrv-ttmap:ett=40
```

**Dependencies**

The linkset must be defined.

The Linkset table must be accessible.

The Translation Type Mapping table must be accessible.

The memory space accounting report (MSAR) is not produced if the *io* or *ett* parameter is specified, because the statistics presented may be misleading.**Notes**

The order of display is by linkset index + I/O + ETT.

**Output**

```
rtrv-ttmap

rlghncxa03w 03-11-22 11:39:44 EST EAGLE 30.0.0
LSN          IO   ETT  MTT
nc001        I    047  032
nc001        I    128  055
nc001        I    238  128
```



```
nc001      I   254  016
nc001      O   016  254
nc001      O   128  238
TTMAP table for nc001 is (6 of 64) 9% full

nc002      I   128  055
nc002      I   238  128
nc002      O   128  238
TTMAP table for nc002 is (3 of 64) 5% full

lsi1       I   001  142
lsi1       O   142  001
TTMAP table for lsi1 is (2 of 64) 3% full

lsi2       I   238  128
TTMAP table for lsi2 is (1 of 64) 2% full

lsi3       I   254  016
TTMAP table for lsi3 is (1 of 64) 2% full

lsn1       O   016  254
lsn1       O   128  238
TTMAP table for lsn1 is (2 of 64) 3% full

lsn2       I   128  055
lsn2       I   238  128
lsn2       O   128  238
TTMAP table for lsn2 is (3 of 64) 5% full
;

rtrv-ttmap:lsn=nc001

rlghncxa03w 03-11-22 12:02:36 EST EAGLE 30.0.0
LSN         IO  ETT  MTT
nc001      I   047  032
nc001      I   128  055
nc001      I   238  128
nc001      I   254  016
nc001      O   016  254
nc001      O   128  238
TTMAP table for nc001 is (6 of 64) 9% full
;

rtrv-ttmap:lsn=nc001:io=i:ett=128

rlghncxa03w 03-11-22 12:04:21 EST EAGLE 30.0.0
LSN         IO  ETT  MTT
nc001      I   128  055
;

```

```
rtrv-ttmap:io=i:ett=128
```

```
rlghncxa03w 03-11-22 12:06:13 EST EAGLE 30.0.0
LSN          IO  ETT  MTT
nc001        I   128  055
nc002        I   128  055
lsn2         I   128  055
```

```
;
```

```
rtrv-ttmap:ett=128
```

```
rlghncxa03w 03-11-22 12:41:21 EST EAGLE 30.0.0
LSN          IO  ETT  MTT
nc001        I   128  055
nc001        O   128  238
nc002        I   128  055
nc002        O   128  238
lsn1         O   128  238
lsn2         I   128  055
lsn2         O   128  238
```

```
;
```

```
rtrv-ttmap:ett=40
```

```
rlghncxa03w 03-11-07 16:12:38 EST EAGLE 30.0.0
LSN          IO  ETT  MTT
No mapped translation types defined for ETT specified.
```

```
;
```

### Legend

- **LSN**—Linkset name
- **IO**—Incoming or outgoing linkset
- **ETT**—Translation type before mapping
- **MTT**—Mapped translation type

### Related Topics

- [chg-ttmap](#)
- [dlt-ttmap](#)
- [ent-ttmap](#)

## rtrv-ttr-msg

Use this command to display the configured Triggerless TCAP Relay message parameter values.

## Parameters

### **msgn (mandatory)**

Message number. This parameter specifies the number of the TTR message.

#### **Range:**

1 - 10

#### **Default:**

The values for all TTR messages are displayed.

## Example

```
rtrv-ttr-msg:msgn=1
```

## Dependencies

The Prepaid IDP Query Relay feature must be enabled before this command is entered.

The TSTMSG table is corrupt or could not be found.

## Output

```
rtrv-ttr-msg:msgn=1
```

```
tekelecstp 08-05-05 17:36:25 EST EAGLE 39.0.0
MSG = 1          TCAP_TYPE = CAP          ACTIVE = YES
SK = 00006b00   BCSM = 02

CGPA_GT = 2
CGPA_GT_NAI = 4      CGPA = 0123456789abcde

CDPA_GT = 2
CDPA_GT_NAI = 8      CDPA = 12457896

CGPN_NAI = 4          CGPN = 01234567890abcdef
CDPN_NAI = 9          CDPN = 8764321

LAC = abcdef
```

```
rtrv-ttr-msg:msgn=2
```

```
tekelecstp 11-10-05 11:43:13 EST EAGLE 44.0.0
MSG = 2          TCAP_TYPE = INAP        ACTIVE = YES
SK = 00006b00   BCSM = 02

CGPA_GT = 2
CGPA_GT_NAI = 4      CGPA = 1234567abcde

CDPA_GT = 2
CDPA_GT_NAI = 4      CDPA = 1234567
```

```

CGPN_NAI = 4          CGPN = none
CDPN_NAI = 4          CDPN = 9876543

LAC = abcdef

```

### Related Topics

- [chg-ttr-msg](#)
- [tst-msg](#)

## rtrv-ttropts

Use this command to display all of the Triggerless TCAP Relay options that are configured in the database.

### Parameters

This command has no parameters.

### Example

```
rtrv-ttropts
```

### Dependencies

The EGLEOPTS table is corrupt or cannot be found.

The Prepaid IDP Query Relay feature must be enabled before this command can be entered.

### Notes

None

### Output

This output example displays the default mapping values for NAI2TON MAP and TON2NAI MAP.

```
rtrv-ttropts
```

```
tekelecstp 11-05-10 15:46:44 EST EAGLE 44.0.0
```

```
Command entered at terminal #4.
```

```
TTR OPTIONS
```

```

-----
CDPN DETAILS          CGPN DETAILS
NPTYPE  rnspl         CGNPTYPE  rnspl
SNAI    incoming     CGSNAI    incoming

CGPACCCK             nonintl
DLMA                 NONE
DLMB                 NONE
DLMC                 NONE
DFLTRN              NONE
SPORTTYPE           none

```

```

SPFILL          off
RNSPFILL       off
CGPNSKRTG      no
DRAFRMT        grn
DRANAI         3
CDNRNRP        connect
CDSRPSP        relay
CDNOENTITYRSP  continue
CDDNNOTFNDRSP  release
CDDRA          rndn
CDDRANAI       natl
CDDRANP        e164
CDRELCAUSE     31
CDCNP          off
CGRNRSP        connect
CGSPRSP        relay
CGNOENTITYRSP  continue
CGDNNOTFNDRSP  release
CGDRA          rndn
CGDRANAI       natl
CGDRANP        e164
CGRELCAUSE     31
CGCNP          off

```

```

NAI2TON MAP
NAI TON  NAI TON  NAI TON  NAI TON  NAI TON  NAI TON  NAI TON  NAI
TON
7  0      0  0    1  0    2  0    3  2    4  1    5  0    6  0
15 0      8  0    9  0   10  0   11  0   12  0   13  0   14  0
23 0     16  0   17  0   18  0   19  0   20  0   21  0   22  0
31 0     24  0   25  0   26  0   27  0   28  0   29  0   30  0
39 0     32  0   33  0   34  0   35  0   36  0   37  0   38  0
47 0     40  0   41  0   42  0   43  0   44  0   45  0   46  0
55 0     48  0   49  0   50  0   51  0   52  0   53  0   54  0
63 0     56  0   57  0   58  0   59  0   60  0   61  0   62  0
71 0     64  0   65  0   66  0   67  0   68  0   69  0   70  0
79 0     72  0   73  0   74  0   75  0   76  0   77  0   78  0
87 0     80  0   81  0   82  0   83  0   84  0   85  0   86  0
95 0     88  0   89  0   90  0   91  0   92  0   93  0   94  0
103 0    96  0   97  0   98  0   99  0  100  0  101  0  102  0
111 0   104  0  105  0  106  0  107  0  108  0  109  0  110  0

```

```

112 0 113 0 114 0 115 0 116 0 117 0 118 0 119 0
120 0 121 0 122 0 123 0 124 0 125 0 126 0 127 0

```

```

TON2NAI MAP
TON NAI
 0 2
 1 4
 2 3
 3 2
 4 2
 5 2
 6 2
 7 2

```

```
;
```

### Related Topics

- [chg-ttropts](#)

## rtrv-uaps

Use this command to retrieve one UA parameter set or all UA parameter sets.

### Parameters

#### set (optional)

The UA parameter set to be displayed.

#### Range:

1 - 10

#### Default:

Display all

### Example

```

rtrv-uaps
rtrv-uaps:set=1

```

### Dependencies

None

### Notes

This command can be canceled using the **F9** function key or the `canc-cmd` command. See `canc-cmd` for more information.

### Output

```
rtrv-uaps:set=1
```

```
eagle2 15-03-15 23:29:52 MST EAGLE5 46.2.0-65.42.0
```

5425.1472 CARD 1102 INFO Prolonged SCTP congestion  
Restart  
assoc

Report Date:15-03-15 Time:23:29:52

SET	TIMER	TVALUE	PARM	PVALUE
10	1	0	1	3
10	2	3000	2	0
10	3	10000	3	0
10	4	5000	4	0
10	5	0	5	0
10	6	0	6	0
10	7	0	7	0
10	8	0	8	0
10	9	0	9	0
10	10	0	10	0

TIMER 2: False IP Connection Congestion Timer, max time an association can be congested before failing due to false congestion. SS7IPGW and IPGWI applications enforce 0-30000(ms). Not supported on IPSP application.

TVALUE : Valid range = 32-bits

TIMER 3: UA HeartBeat Period Timer T(beat), time (ms) between sending of BEAT msgs by NE. IPSP, SS7IPGW and IPGWI applications enforce 100(ms)-60000(ms).

TVALUE : Valid range = 32-bits

TIMER 4: UA HeartBeat Received Timer T(beat ack), timeout period for response BEAT ACK msgs by NE. IPSP, SS7IPGW and IPGWI applications enforce 100(ms)-10000(ms).

TVALUE : Valid range = 32-bits

TIMER 5: Timeout period for SCTP TX buffer full and stuck condition during SCTP congestion enforce 200(ms)-15000(ms). TVALUE : Valid range = 32-bits

PARM 1: ASP SNM options. Each bit is used as an enabled/disabled flag for a particular ASP SNM option. Not supported on IPSP

application.

PVALUE : Valid range = 32-bits

BIT	BIT VALUE
0=Broadcast	0=Disabled, 1=Enabled
1=Response Method	0=Disabled, 1=Enabled
2-5=Reserved	
6=Broadcast Congestion Status Change	0=Disabled, 1=Enabled
7-31=Reserved	

PARM 2: ASP/AS Notification options. Each bit is used as an enabled/disabled flag for a particular ASP/AS Notification option. Not supported on IPSP application.

PVALUE : Valid range = 32-bits

BIT	BIT VALUE
0=ASP Active Notifications	0=Disabled, 1=Enabled

1=ASP Inactive Notifications	0=Disabled, 1=Enabled
2=ASP AS State Query	0=Disabled, 1=Enabled
3-31=Reserved	

PARM 3: UA Serviceability Options. Each bit is used as an enabled/disabled flag for a particular UA Serviceability option. Supported on IPSP, SS7IPGW, and IPGWI applications. UA Graceful Shutdown supported on IPSP for M3UA only.

PVALUE : Valid range = 32-bits

BIT	BIT VALUE
0=UA Heartbeats	0=Disabled, 1=Enabled
1=UA Graceful Shutdown	0=Disabled, 1=Enabled
2-31=Reserved	

PARM 4: SCTP Payload Protocol Indicator byte order option. Bit indicates

PPI value is RCV/TX in Big Endian or Little Endian byte format.

Supported on IPSP-M2PA associations only.

PVALUE : Valid range = 32-bits

BIT	BIT VALUE
0=Payload Protocol Indicator	0=Big Endian, 1=Little Endian
1-31=Reserved	

### Related Topics

- [chg-uaps](#)

## rtrv-uim-acthresh

Use this command to query the UIM number, limit, and interval period parameters that are used to report the thresholding of UIM messages.

### Parameters

#### **uimn (optional)**

The UIM number.

#### **Range:**

1000 - 1999

#### **Default:**

Display all

### Example

Display UIM number 1333 threshold:

```
rtrv-uim-acthresh:uimn=1333
```

Display the threshold for all UIMs that have been set:

```
rtrv-uim-acthresh
```



### Dependencies

A valid value must be specified for the `uimn` parameter.

The value specified for the `uimn` parameter must already exist in the system Trouble Text Table.

### Notes

None

### Output

```
rtrv-uim-acthresh:uimn=1333
```

```
rlghncxa03w 03-11-01 08:50:12 EST EAGLE 31.3.0
UIMN      LIMIT      INTRVL
1333      100         5
The UIM Threshold Table is (1 of 499) 1% full.
```

```
rtrv-uim-acthresh
```

```
rlghncxa03w 03-11-01 08:50:12 EST EAGLE 31.3.0
UIMN      LIMIT      INTRVL
1333      100         5
1444      200         15
1155      50          30
The UIM Threshold Table is (3 of 499) 1% full.
```

### Related Topics

- [dlt-uim-acthresh](#)
- [set-uim-acthresh](#)

## rtrv-user

Use this command to show the information about the user currently logged on to the terminal from which this command was entered.

### Parameters

This command has no parameters.

### Example

```
rtrv-user
```

### Dependencies

The CCCNAMES table must be accessible.

None

## Notes

The password is not shown.

This command shows the command class privileges for the user logged onto the system. No other users are shown.

All users have access to this command.

## Output

This example shows the output when the Command Class Management feature is turned on:

```
rtrv-user

rlghncxca03w 09-01-07 09:50:17 EST EAGLE 40.1.0
user id      age page uout rev link sa  sys pu  db  dbg
manny       36  60   60  NO  YES YES YES YES YES YES YES
           u01 u02 u03 u04 u05 u06 u07 u08 u09 u10 u11 u12 u13 u14 u15 u16
           NO NO NO NO YES YES YES YES YES YES YES YES YES YES YES YES YES
           u17 u18 u19 u20 u21 u22 u23 u24 u25 u26 u27 u28 u29 u30 u31 u32
           YES YES YES YES YES YES YES YES YES YES YES YES NO NO NO NO YES
;
```

This example shows the output when the Command Class Management feature is not turned on:

```
rtrv-user

rlghncxca03w 09-01-07 09:50:17 EST EAGLE 40.1.0
USER ID      LINK SA SYS PU DB DBG
eagle       YES YES YES YES YES YES

USER ID      AGE PAGE UOUT REV
eagle       750 0   0   NO
;
```

## Legend

- **USER ID**—Name of the user
- **AGE**—Current age, in days, of the password associated with this user ID. If the password age is greater than 999 days, then 999 is displayed.
- **PAGE**—Maximum password age established for this user ID. When AGE becomes greater than PAGE, the system forces the user to change the password at the next login. An asterisk (\*) displayed after the value indicates that the system-wide default page parameter value, (see the `chg-secu-dflt` command), is in effect for the user ID.
- **UOUT**—User ID aging interval, in days. If the user ID is not used (that is, no successful login) for longer than this interval, the system does not allow a login. An asterisk (\*)

displayed after the value indicates that the system-wide default `uout` parameter value, (see the `chg-secu-dflt` command), is in effect for the user ID.

- **REV**—Shows whether the user ID is denied login (revoked). YES indicates that the user ID is revoked, NO indicates that the user ID is not revoked.
- **LINK**—Shows whether the user has access to all commands in the Link Maintenance command class
- **SA**—Shows whether the user has access to all commands in the Security Administration command class
- **SYS**—Shows whether the user has access to all commands in the System Maintenance command class
- **PU**—Shows whether the user has access to all commands in the Program Update command class
- **DB**—Shows whether the user has access to all commands in the Database Administration command class
- **DBG**—Shows whether the user has access to all commands in the Debug command class

If the Command Class Management feature is enabled and turned on, the following fields are displayed:

- **U01 - U32**—Default configurable command class names. If user-defined names have been provisioned, they will appear instead of the default names.

#### Related Topics

- [act-user](#)
- [chg-pid](#)
- [chg-user](#)
- [dact-user](#)
- [dlt-user](#)
- [ent-user](#)
- [login](#)
- [logout](#)
- [rept-stat-user](#)
- [rtrv-secu-user](#)

## rtrv-vendid

Use this command to retrieve a list of Vendor ID entries from the VENDID table, for the GSM MAP SRI Redirect to Serving HLR feature.

#### Parameters

##### **num (optional)**

Number of Vendor ID entries to be retrieved.

**Range:**  
1 - 500

**Default:**  
500

**vendnum (optional)**

Vendor Number

**Range:**  
1 - 128

**Example**

```
rtrv-vendid
rtrv-vendid:vendnum=15
rtrv-vendid:num=100
```

**Dependencies**

The VENDID table is corrupt or cannot be found by the system.

The GSM MAP SRI Redirect feature must be enabled before this command can be entered.

**Notes**

None.

**Output**

This example shows output when the command is entered with no parameter. Vendor Types are listed in numerical order. Vendor Numbers for each Vendor Type are listed in numerical order, followed by the Vendor ID for each Vendor Number.

```
rtrv-vendid

tekelecstp 14-09-21 16:11:21 EST  EAGLE 46.1.0
Vendor  Vendor  Vendor
Type    Number  ID
-----
1       1       123123123456789
1       1       1234567890abcde
1       2       112233445566778
1       2       214365870912543
2       3       098765432112345
2       3       098767890143251
15      1       098888869321111
32      32      098888811899721

VENDID table is (8 of 500) 2% full

Vendor ID Length = 15
```

;

This example shows output when a Vendor number is specified. Vendor Type and Vendor IDs for the specified Vendor number are listed in numerical order. The table capacity line shows the total number of entries in use, not just the number of entries displayed.

```
rtrv-vendid:vendnum=32
```

```
tekelecstp 14-05-30 17:41:50 EST EAGLE 46.1.0
Vendor   Vendor   Vendor
Type     Number   ID
-----
32       32       899721

VENDID table is (37 of 500) 7% full
```

```
Vendor ID Length = 6
```

;

This example shows the output when the number of Vendor IDs to be retrieved is specified with the `num` parameter.

```
rtrv-vendid:num=5
```

```
tekelecstp 14-07-14 14:46:47 EST EAGLE 46.1.0
Vendor   Vendor   Vendor
Type     Number   ID
-----
1        1        886932
2        1        816932
2        1        886942
3        1        811932
3        3        886989

VENDID table is (38 of 500) 8% full
```

```
Vendor ID Length = 6
```

;

### Related Topics

- [dlt-vendid](#)
- [ent-vendid](#)

## rtrv-vflx-cd

Use this command to retrieve call decision information.

## Parameters

### cdn (optional)

Call decision name. The name of the call decision entry.

#### Range:

ayyy

1 alphabetic character followed by 3 alphanumeric characters

### vmDIG (optional)

Voice mail number or voice mail prefix digits. The voice mail number or voice mail digits associated with the call decision entry.

#### Range:

1 - 15 digits

Valid digits are 0-9, A-F, a-f

## Example

This command retrieves all entries from the Call Decision table.

```
rtrv-vflx-cd
```

This command retrieves a specific Call Decision entry.

```
rtrv-vflx-cd:cdn=cdn1
```

This command retrieves all call decision entries with a specified voice mail number or voice mail prefix digits.

```
rtrv-vflx-cd:vmDIG=123456789abcd2
```

## Dependencies

The `cdn` and `vmDIG` parameters cannot be specified together in the command.

The value specified for the `cdn` parameter cannot be a reserved word, such as *none*.

The Call Decision table is corrupt or cannot be found by the system.

The value specified for the `cdn` parameter must already exist in the Call Decision table.

The V-Flex feature must be enabled before this command can be entered.

## Notes

This command can be cancelled using the **F9** function key or the `canc-cmd` command.

## Output

```
rtrv-vflx-cd
```

```
tekelecstp 08-05-01 09:36:55 EST EAGLE 39.0.0
```

RDI	DN Status	BCAP	VM Number/Prefix	VMRN Index	CD Name
---	-----	---	-----	-----	-----
DIR	NFND	0	1	9	c100
DIR	NFND	0	12	9	c101
DIR	NFND	0	123	9	c102

```

DIR      NFND      0      1234      9      c103
DIR      FND       0      1          9      c200
DIR      *         1      123       9      c201
DIR      *         2      2345678   9      c203
DIR      *         3      456789a   9      c204
DIR      *         4      56789ab   9      c205
REDIR    *         1      123456789abcdef 9      c202

```

VFLEX Call Decision table is (10 of 4950) 1% full.

;

```
rtrv-vflx-cd:cdn=c100
```

```

tekelecstp 08-05-31 17:04:25 EST EAGLE 39.0.0
RDI      DN Status  BCAP  VM Number/Prefix  VMRN Index  CD Name
---      -
DIR      NFND      0      1          9          c100

```

VFLEX Call Decision table is (7 of 4950) 1% full.

;

This example shows how all Call Decision Table entries whose digits match the starting digits of the specified VMDIG will be displayed.

```
rtrv-vflx-cd:vmdig=123456789abcdef
```

```

tekelecstp 08-05-31 17:05:49 EST EAGLE 39.0.0
RDI      DN Status  BCAP  VM Number/Prefix  VMRN Index  CD Name
---      -
DIR      NFND      0      1          9          c100
DIR      NFND      0      12         9          c101
DIR      NFND      0      123        9          c102
DIR      NFND      0      1234       9          c103
DIR      FND       0      1          9          c200
DIR      *         1      123        9          c201
REDIR    *         1      123456789abcdef 9          c202

```

VFLEX Call Decision table is (7 of 4950) 1% full.

;

### Legend

- **RDI**—Redirection Indicator - whether the call has been redirected or not (0 - Not redirected: VM retrieval or direct dial VM deposit, 1 - Redirected: VM deposit)
- **DN Status**—Status of the DN lookup in the RTDB - found in the RTDB, not found in the RTDB, don't care whether found in the RTDB or not
- **BCAP**—INAP/CAP Bearer Capabilities

- **VM Number/Prefix**—Voice Mail Number or Voice Mail Prefix associated with a Call Decision entry
- **VMRN Index**—Index into the list of Routing Numbers associated with a specific VMSID entry
- **CD Name**—Name of the Call Decision entry

#### Related Topics

- [chg-vflx-cd](#)
- [dlt-vflx-cd](#)
- [ent-vflx-cd](#)

## rtrv-vflx-opts

Use this command to retrieve the data that is used for number conditioning.

#### Parameters

This command has no parameters.

#### Example

This command displays V-Flex Options Table data.

```
rtrv-vflx-opts
```

#### Dependencies

The V-Flex feature must be enabled before this command can be specified.

#### Notes

If no DRANAI value or DRANAIV value has been provisioned, the command output displays the DRANAIV default value of 0.

#### Output

This example shows the output with default V-Flex Options:

```
rtrv-vflx-opts
```

```
tekelecstp 08-05-04 07:53:46 EST EAGLE 39.0.0
```

```
VFLEX OPTIONS
```

```
-----
```

```
DRANPV      = 0  
DRANAIV     = 0  
DRA         = RN  
NEQUERYONLY = OFF  
NETYPE      = VMSID
```

```
;
```

This example shows the output with some V-Flex Options provisioned:



```
rtrv-vflx-opts
```

```
tekelecstp 08-05-04 07:55:30 EST EAGLE 39.0.0
```

```
VFLEX OPTIONS
```

```
-----
DRANP          = E164
DRANAI         = SUB
DRA            = RN
NEQUERYONLY   = ON
NETYPE        = GRN
```

```
;
```

### Legend

- **DRANP**—Numbering plan for the destination routing address
- **DRANAI**—Nature of address indicator for the destination routing address
- **DRA**—Format of the destination routing address
- **NEQUERYONLY**—Network Entity Query Only option
- **NETYPE**—Network Entity Type for the NEQUERYONLY option

### Related Topics

- [chg-vflx-opts](#)

## rtrv-vflx-rn

Use this command to retrieve voice mail routing numbers and routing number names and to view the associated reference count. The V-Flex feature must be enabled before this command can be entered.

### Parameters

#### **refcnt (optional)**

Reference count. This parameter specifies whether to display the reference count.

#### **Range:**

**yes**  
display the reference count

#### **rn (optional)**

Routing number. A voice mail routing number.

#### **Range:**

1-15 digits  
Valid digits are 0-9, A-F, a-f.

#### **rname (optional)**

Routing number name. The name associated with a voice mail routing number.

**Range:**

ayyyyyyy

1 alphabetic character followed by 7 alphanumeric characters.

**Example**

```
rtrv-vflx-rn:rnname=rn01
rtrv-vflx-rn:rn=123456789ABC
rtrv-vflx-rn
rtrv-vflx-rn:rnname=rn01:refcnt=yes
rtrv-vflx-rn:rn=123456789ABC:refcnt=yes
```

**Dependencies**

The V-Flex feature must be enabled before this command can be entered.

The Routing Number table is corrupt or cannot be found by the system.

The value specified for the `rnname` parameter must already exist in the Routing Number table.

The `rn` and `rnname` parameters cannot be specified together in the command.

The value specified for the `rnname` parameter cannot be a reserved word, such as *none*.

The value specified for the `rn` parameter must already exist in the Routing Number table.

**Notes**

This command can be cancelled using the **F9** function key or the `canc-cmd` command. See `canc-cmd` for more information.

**Output**

This command shows the output for a routing number name:

```
rtrv-vflx-rn:rnname=rn01

tekelecstp 08-05-29 15:07:01 EST  EAGLE 39.0.0

RN Name      Routing Number
-----      -
rn01         123456789abcdef

VFLEX Routing Number table is (2 of 10000) 1% full.

;
```

This command shows all of the entries in the Routing Number table:

```
rtrv-vflx-rn

tekelecstp 08-05-29 15:07:01 EST  EAGLE 39.0.0
```

```

RN Name      Routing Number
-----
rn01         123456789abcd01
rn02         123456789abcd02
rn03         123456789abcd03
rn04         123456789abcd04
rn05         123456789abcd05
rn06         123456789abcd06
rn07         123456789abcd07
rn08         123456789abcd08
rn09         123456789abcd09
rn10         123456789abcd0A
rn11         123456789abcd0B
rn12         123456789abcd0C
rn13         123456789abcd0D
rn14         123456789abcd0E
rn15         123456789abcd0F
.           .
.           .
.           .
.           .
rn10000     100000000abcdef

```

VFLEX Routing Number table is (10000 of 10000) 100% full.

;

This command shows the reference count for a specified routing number name:

```
rtrv-vflx-rn:rnname=rn01:refcnt=yes
```

```
tekelecstp 08-05-29 15:07:01 EST EAGLE 39.0.0
```

```

RN Name      Routing Number      Ref Count
-----
rn01         123456789abcdef      2

```

VFLEX Routing Number table is (2 of 10000) 1% full.

;

This command shows the reference count for a specified routing number:

```
rtrv-vflx-rn:rn=123456789ABC:refcnt=yes
```

```
tekelecstp 08-05-29 15:07:01 EST EAGLE 39.0.0
```

```

RN Name      Routing Number      Ref Count
-----
rn02         123456789abc        3

```

```
VFLEX Routing Number table is (2 of 10000) 1% full.
```

```
;
```

### Legend

- **RN Name**—Voice mail routing number name
- **Routing Number**—Voice mail routing number digits
- **Ref Count**—Number of VMSID table entries that refer to an routing number entry

### Related Topics

- [chg-vflx-rn](#)
- [dlt-vflx-rn](#)
- [ent-vflx-rn](#)

## rtrv-vflx-vmsid

Use this command to retrieve information for voice mail server IDs.

### Parameters

#### **id (optional)**

The voice mail server ID.

#### **Range:**

1-15 digits, *dflt*

Valid digits are *0-9, A-F, a-f*.

*dflt* —a default set of routing numbers used when a query is received with an invalid MSISDN or an MSISDN that is not found in the RTDB

#### **rname (optional)**

A routing number name associated with the voice mail server ID.

#### **Range:**

*ayyyyyyy*

1 alphabetic character followed by up to 7 alphanumeric characters.

### Example

```
rtrv-vflx-vmsid
```

```
rtrv-vflx-vmsid:id=123456789012345
```

```
rtrv-vflx-vmsid:rname=rn90
```

### Dependencies

The value specified for the `rname` parameter cannot be a reserved word, such as *none*.

The V-Flex feature must be enabled before this command can be entered.

The value specified for the `rname` parameter must already exist in the Routing Number table.

The value specified for the `id` parameter must already exist in the VMSID table.

The GTT DBMM table is corrupt or cannot be found by the system.

The VMSID table is corrupt or cannot be found by the system.

The `rname` and `id` parameters cannot be specified together in the command.

The Routing Number table is corrupt or cannot be found by the system.

### Notes

This command can be cancelled using the **F9** function key or the `canc-cmd` command. See `canc-cmd` for more information.

### Output

This command shows the output for all the entries from the VMSID table:

```
rtrv-vflx-vmsid
```

```

rlghncxa03w 08-05-07 11:11:28 EST EAGLE 39.0.0
VMS ID          IDX0          IDX1          IDX2          IDX3          IDX4
IDX5
-----
-----
123456789abcdef RN000000 RN000001 RN000002 RN000003 RN000004
RN000005
      IDX6          IDX7          IDX8          IDX9
      -----
      -----
      RN000006 RN000007 RN000008 RN000009

VMS ID          IDX0          IDX1          IDX2          IDX3          IDX4
IDX5
-----
-----
123456789012abc RN000010 RN000011 RN000012 RN000013 RN000014
RN000015
      IDX6          IDX7          IDX8          IDX9
      -----
      -----
      RN000016 RN000017 RN000018 RN000019

VMS ID          IDX0          IDX1          IDX2          IDX3          IDX4
IDX5
-----
-----
a23456789012abc RN000020 RN000021 RN000022 RN000023 RN000024
RN000025
      IDX6          IDX7          IDX8          IDX9
      -----
      -----
      RN000026 RN000027 RN000028 RN000029

VFLEX VMSID table is (3 of 1000) 1% full.
;
```

This command shows the output for an entry with the default voice mail server ID:

```
rtrv-vflx-vmsid:id=dflt
```

```

tekelecstp 08-05-29 15:07:01 EST EAGLE 39.0.0
VMS ID          IDX0          IDX1          IDX2          IDX3          IDX4          IDX5
-----
dflt            RN000040     RN000041     RN000042     RN000043     RN000044
RN000045

          IDX6          IDX7          IDX8          IDX9
          -----
RN000046   RN000047   RN000048   RN000049
VFLEX VMSID table is (3 of 1000) 1% full.
;

```

### Legend

- **VMS ID**—Voice Mail Server ID.
- **IDX0**—Routing Number Name for index 0
- **IDX1**—Routing Number Name for index 1
- **IDX2**—Routing Number Name for index 2
- **IDX3**—Routing Number Name for index 3
- **IDX4**—Routing Number Name for index 4
- **IDX5**—Routing Number Name for index 5
- **IDX6**—Routing Number Name for index 6
- **IDX7**—Routing Number Name for index 7
- **IDX8**—Routing Number Name for index 8
- **IDX9**—Routing Number Name for index 9

### Related Topics

- [chg-vflx-vmsid](#)
- [dlt-vflx-vmsid](#)
- [ent-vflx-vmsid](#)

## rtrv-vlr-prof

Use this command to display entries from the Visitor Location Register (VLR) Profile table.

### Parameters

#### **v1r** (mandatory)

VLR Number: Hexadecimal digit GT Number with variable length (1 to 16).

#### **Range:**

Hexadecimal digit string 1 to 16 digits

**filter (optional)**

Determines the category in which the number falls into.

**Range:**

*whitelist*

*blacklist*

*graylist*

**Default:**

*graylist*

**num (optional)**

Number of entries in the VLR table which user wants to view.

**Range:**

*1-50000*

**vlrtbl (optional)**

Selects either the static or dynamic table the user wants to view.

**Range:**

*static*

*dynamic*

**Default:**

*static*

**Example**

```
rtrv-vlr-prof
rtrv-vlr-prof:num=2
rtrv-vlr-prof:filter=blacklist
rtrv-vlr-prof:vlrtbl=static
```

**Dependencies**

VLR\_PROF table must be accessible.

VLR parameter length must be in the range 1 to 5 digits as per current restriction.

VLR parameter and NUM parameter both cannot be specified together.

**Output**

```
rtrv-vlr-prof

tekelecstp 17-11-23 14:21:51 MST EAGLE 46.5.1.5.0-73.2.0
  rtrv-vlr-prof:num=50000
  Command entered at terminal #17.
;

Command Accepted - Processing
tekelecstp 17-11-23 14:21:51 MST EAGLE 46.5.1.5.0-73.2.0
```

VLRIDX	VLRNb	FILTER	AGEOFLOC	LASTUEACTIVITY	REFCNT
1	1234	whitelist	no	no	1
2	56545	whitelist	no	no	1
3	4234	blacklist	no	no	0
4	9234	whitelist	no	yes	0

VLR-PROF table is (4 of 500) 1% full.

;

rtrv-vlr-prof:num=2

tekelecstp 17-11-23 14:23:35 MST EAGLE 46.5.1.5.0-73.2.0

rtrv-vlr-prof:num=2

Command entered at terminal #17.

;

Command Accepted - Processing

tekelecstp 17-11-23 14:23:35 MST EAGLE 46.5.1.5.0-73.2.0

VLRIDX	VLRNb	FILTER	AGEOFLOC	LASTUEACTIVITY	REFCNT
1	1234	whitelist	no	no	1
2	56545	whitelist	no	no	1

VLR-PROF table is (4 of 500) 1% full.

;

rtrv-vlr-prof:filter=blacklist

tekelecstp 17-11-23 14:23:23 MST EAGLE 46.5.1.5.0-73.2.0

rtrv-vlr-prof:filter=blacklist

Command entered at terminal #17.

;

Command Accepted - Processing

tekelecstp 17-11-23 14:23:23 MST EAGLE 46.5.1.5.0-73.2.0

VLRIDX	VLRNb	FILTER	AGEOFLOC	LASTUEACTIVITY	REFCNT
3	4234	blacklist	no	no	0

VLR-PROF table is (4 of 500) 1% full.

;



```
rtrv-vlr-prof:filter=whitelist:num=1

tekelecstp 17-10-12 18:11:44 EST EAGLE 46.5.1.5.0-73.2.0
  rtrv-vlr-prof:filter=whitelist:num=1
  Command entered at terminal #23.
;

Command Accepted - Processing
  tekelecstp 17-10-12 18:11:44 EST EAGLE 46.5.1.5.0-73.2.0

      VLRIDX  VLRNb          FILTER      AGEOFLOC
LASTUEACTIVITY  REFCNT
      1      17071          whitelist  no
no                                     1

      VLR-PROF table is (2 of 50000) 1% full.

;

Command Executed

rtrv-vlr-prof:vlr=1707

tekelecstp 17-10-12 18:11:00 EST EAGLE 46.5.1.5.0-73.2.0
  rtrv-vlr-prof:vlr=1707
  Command entered at terminal #23.
;

Command Accepted - Processing
  tekelecstp 17-10-12 18:11:00 EST EAGLE 46.5.1.5.0-73.2.0

      VLRIDX  VLRNb          FILTER      AGEOFLOC
LASTUEACTIVITY  REFCNT
      2      1707          whitelist  no
no                                     1

      VLR-PROF table is (2 of 50000) 1% full.

;

Command Executed

rtrv-vlr-prof:vlr=100

Command Accepted - Processing

  tekelecstp 17-11-27 14:43:15 MST EAGLE 46.5.1.5.0-73.2.0
  rtrv-vlr-prof:vlr=100
  Command entered at terminal #2.
;

tekelecstp 17-11-27 14:43:15 MST EAGLE 46.5.1.5.0-73.2.0

      VLRIDX  VLRNb          FILTER      AGEOFLOC
```

```
LASTUEACTIVITY      REFCNT
```

```
No VLR Profiles matching the specified criteria were found.
```

```
VLR-PROF table is (3 of 500) 1% full.
```

```
;
```

```
rtrv-vlr-prof:vlrtbl=static
```

```
tklc1110801 18-09-25 16:25:44 EST EAGLE 46.7.0.0-75.14.0
```

```
rtrv-vlr-prof:vlrtbl=static
```

```
Command entered at terminal #2.
```

```
;
```

```
tklc1110801 18-09-25 16:25:44 EST EAGLE 46.7.0.0-75.14.0
```

VLRIDX	VLRNb	FILTER	AGEOFLOC	IMEIRTRV	REFCNT
1	ab123	whitelist	no	yes	1
2	ab456	whitelist	no	yes	1
3	bb123	whitelist	no	yes	1
4	bb456	whitelist	no	yes	1
5	cd123	whitelist	no	yes	1
6	cd456	whitelist	no	yes	1
7	cc123	whitelist	no	yes	1
8	cc456	whitelist	no	yes	1
9	ab789	whitelist	no	yes	0
10	ab987	whitelist	no	yes	0
11	bb789	whitelist	no	yes	0
12	bb987	whitelist	no	yes	0
13	cd789	whitelist	no	yes	0
14	cd987	whitelist	no	yes	0
15	cc789	whitelist	no	yes	0
16	cc987	whitelist	no	yes	0
17	ff789	whitelist	no	yes	0
18	ee789	whitelist	no	yes	0
19	dd789	whitelist	no	yes	0
20	12345	graylist	yes	yes	1

```
VLR-PROF table is (100 of 50000) 1% full.
```

### Legend

- **VLRIDX** - Index of entry in VLR table.
- **VLRNb** - VLR Number
- **FILTER** - Flag to findout whether the number is whitelisted, blacklisted, or graylisted.
- **GEOFLOC** - Whether age of location is supported or not.
- **LASTUEACTIVITY** - Whether the last use activity is supported or not.
- **REFCNT** - Number of times this entry is referred in VLR\_ROAM table.

### Related Topics

- [chg-vlr-prof](#)

- [dlt-vlr-prof](#)
- [ent-vlr-prof](#)

## rtrv-vlr-roaming

Use this command to display entries from the Visitor Location Register (VLR) Profile table.

### Parameters

#### **oldv1r (optional)**

VLR Number from which mobile subscriber has moved, hexadecimal digit GT number with variable length (1 to 16).

##### **Range:**

Hexadecimal digit string 1 to 16 digits

#### **newv1r (optional)**

VLR Number to which mobile subscriber has moved, hexadecimal digit GT number with variable length (1 to 16).

##### **Range:**

Hexadecimal digit string 1 to 16 digits

#### **num (optional)**

Number of entries in the VLR table which user wants to view.

##### **Range:**

1-50000

#### **vlrtbl (optional)**

Selects either the static or dynamic table the user wants to view.

##### **Range:**

*static*

*dynamic*

##### **Default:**

*static*

### Example

```
rtrv-vlr-roaming
rtrv-vlr-roaming:num=2
rtrv-vlr-roaming: newv1r=12345:oldv1r=56780
rtrv-vlr-roaming:vlrtbl=static
```

### Dependencies

VLR\_ROAM table must be accessible.

Both OLDVLR and NEWVLR must be specified

OLDVLR or NEWVLR parameter must be existing in VLR-PROF table

The entry should be existing in VLR\_ROAM table

OLDVLR and NEWVLR parameter length must be in the range 1 to 5 digits as per current restriction.

### Output

```
rtrv-vlr-roaming
```

```
tekelecstp 17-11-23 17:37:44 MST EAGLE 46.5.1.5.0-73.2.0
rtrv-vlr-roaming
Command entered at terminal #17.
```

```
;
```

```
Command Accepted - Processing
```

```
tekelecstp 17-11-23 17:37:44 MST EAGLE 46.5.1.5.0-73.2.0
```

OLD_VLR	NEW_VLR	TIME
1234	56545	20

```
VLR-ROAMING table is (1 of 1000) 1% full.
```

```
;
```

```
rtrv-vlr-roaming:num=1
```

```
tekelecstp 17-11-23 17:37:44 MST EAGLE 46.5.1.5.0-73.2.0
rtrv-vlr-roaming:num=1
Command entered at terminal #17.
```

```
;
```

```
Command Accepted - Processing
```

```
tekelecstp 17-11-23 17:37:44 MST EAGLE 46.5.1.5.0-73.2.0
```

OLD_VLR	NEW_VLR	TIME
1234	56545	20

```
VLR-ROAMING table is (1 of 1000) 1% full.
```

```
;
```

```
rtrv-vlr-roaming:oldvlr=1234:newvlr=56545
```

```
tekelecstp 17-11-23 17:39:12 MST EAGLE 46.5.1.5.0-73.2.0
rtrv-vlr-roaming:oldvlr=1234:newvlr=56545
Command entered at terminal #17.
```

```
;
```

```
Command Accepted - Processing
```

```
tekelecstp 17-11-23 17:39:12 MST EAGLE 46.5.1.5.0-73.2.0
```

OLD_VLR	NEW_VLR	TIME
1234	56545	20

```
VLR-ROAMING table is (1 of 1000) 1% full.

;

rtrv-vlr-roaming:vlrtbl=static

tklc1110801 18-09-25 16:23:19 EST EAGLE 46.7.0.0-75.14.0
rtrv-vlr-roaming:vlrtbl=static
Command entered at terminal #2.

;

tklc1110801 18-09-25 16:23:19 EST EAGLE 46.7.0.0-75.14.0

OLD_VLR          NEW_VLR          TIME
ab123            35100            240
ab456            35100            240
bb123            35100            240
bb456            35100            240
cd123            35100            240
cd456            35100            240
cc123            35100            240
cc456            35100            240
12345            35100            500
67890            35100            500
54321            35100            500
22222            35100            500
33333            35100            500
44444            35100            500
74444444455     64444444455     1440
77bbf23636      99eea09439       150
77bbf22222      99eea09439       300
77bbf29393      99eea42222       16
77bbf28765      99eea09393       60
88776655        887766554433    120

VLR-ROAMING table is (26 of 1000000) 1% full.
```

### Related Topics

- [chg-vlr-roaming](#)
- [dlt-vlr-roaming](#)
- [ent-vlr-roaming](#)

## set-date

Use this command to set the date in the system.

### Parameters

#### **date (mandatory)**

The system date, to be reflected on all reports and output messages.

**Range:**

000101 - 991231

(in the form *yymmdd*, where *yy*=year, *mm*=month, *dd*=day)**Example**

```
set-date:date = 010307
```

**Dependencies**

The system date day value (the *dd* in the *yymmdd* format) must accurately reflect the number of days in the specified month and year. For example, February never has 30 days. The value *050230* is not valid (February 30, 2005).

None

The system date month value (the *mm* in the *yymmdd* format) must be in the range 01-12.

**Notes**

None

**Output**

```
set-date:date = 010307
```

```
rlghncxa03w 03-11-07 11:11:28 EST EAGLE 31.3.0
```

```
Date set complete.
```

;

**Related Topics**

- [set-time](#)

## set-gtwy-acthresh

Use this command to set or change the level of activity thresholds to be used when reporting gateway screening activity. The STP reports screening activity only if the threshold is set and only if the threshold is reached. The thresholds are set on a linkset basis.

**Parameters****intrvl (mandatory)**

Monitor interval. The examination period, in minutes, during which the gateway screening activity thresholds are to be tested.

**Range:**

5, 10, 15, 20, 30

**System Default:**

0 -Indicates that thresholds are not set

**lsn (mandatory)**

Linkset name

**Range:**

ayyyyyyyyy

1 alphabetic character followed by up to 9 alphanumeric characters

**recv (optional)**

Received message threshold. The threshold for MSUs received on the gateway linkset.

**Range:**

0 - 999999

**Default:**

The current value

**System Default:**

0

**rej (optional)**

Reject threshold. The threshold for MSUs rejected on the gateway linkset because of screening.

**Range:**

0 - 999999

**Default:**

The current value

**System Default:**

0

**Example**

This example shows how to set the linkset WY644368 rejection threshold to 100, with a 15 minute interval.

```
set-gtwy-acthresh:lsn=wy644368:rej=100:intrvl=15
```

This example shows how to set the linkset WY644368 message threshold to 1000 and the rejection threshold to 300, with an interval of 20 minutes.

```
set-gtwy-acthresh:lsn=wy644368:intrv=20:rej=300:recv=1000
```

This example shows how to set the linkset WY644368 so that no activity messages are produced.

```
set-gtwy-acthresh:lsn=wy644368:intrv=5:rej=0:recv=0
```

**Dependencies**

At least one optional parameter must be specified.

The Linkset table must be accessible.

The linkset specified must exist in the gateway linkset entity set of the requesting system.

The Extended Linkset table must be accessible.

The linkset specified must exist in the active database.

A valid value must be specified for the `intrvl` parameter.

### Notes

None

### Output

```
set-gtwy-acthresh:lsn=wy644368:rej=100:intrvl=15
```

```
rlghncxa03w 03-11-18 08:50:12 EST EAGLE 31.3.0
SET-GTWY-TRSHLD: MASP A - COMPLTD
;
```

### Related Topics

- [rtv-gtwy-acthresh](#)

## set-scrrej-prmtrs

Use this command to change the STP values that limit the display of MSUs rejected because of gateway screening notification messages that could become excessive. The new values overwrite the existing values.

### Parameters

#### **intrvl (mandatory)**

Monitor interval. The examination period, in minutes, during which the gateway screening activity thresholds are to be tested.

#### **Range:**

5, 10, 15, 20, 30

#### **System Default:**

5

#### **limit (mandatory)**

Threshold not to be exceeded.

#### **Range:**

0 - 9999

#### **System Default:**

9999

### Example

```
set-scrrej-prmtrs:limit=200:intrvl=10
```

### Dependencies

The Extended STP Options table must be accessible.

A valid value must be specified for the `intrvl` parameter.



**Notes**

None

**Output**

```
set-scrrej-prmtrs:limit=200:intrvl=10

      rlghncxa03w 03-11-18 08:50:12 EST  EAGLE 31.3.0
      SET-SCRREJ-PRMTRS: MASP A - COMPLTD
;

```

**Related Topics**

- [rtrv-gtwy-acthresh](#)
- [rtrv-gtwy-prmtrs](#)
- [set-gtwy-acthresh](#)

## set-time

Use this command to set the system clock. The clock is used to determine when measurements collection takes place as well as several other time-driven events.

**Parameters****time (mandatory)**

The system time that is to be reflected on all reports and output messages.

**Range:**

0000 - 2359

*hhmm* where *hh* = 00-23 (hour) and *mm* =00-59(minute)

**tz (optional)**

The time zone

**Range:**

*est, edt, cst, cdt, mst, mdt, pst, pdt, hst, hdt, ast, adt, gmt, wet, west, utc, bst, cet, cest, met, mest, fwt, fst, eet, eest, sast, msk, msd, ist, idt, cct, awst, awdt, rok, acst, acdt, aest, aedt, nzst, nzdt, akst, akdt, nst, ndt, bra*

The time zones are described in [Table 4-56](#).

**Default:**

Current value

Abbreviation	Time Zone	Abbreviation	Time Zone
est	Eastern Standard Time	edt	Eastern Daylight Time
cst	Central Standard Time	cdt	Central Daylight Time

Abbreviation	Time Zone	Abbreviation	Time Zone
mst	Mountain Standard Time	mdt	Mountain Daylight Time
pst	Pacific Standard Time	pdh	Pacific Daylight Time
hst	Hawaiian Standard Time	hdt	Hawaiian Daylight Time
ast	Atlantic Standard Time	adt	Atlantic Daylight Time
gmt	Greenwich Mean Time	wet	Western European Time
west	Western European Summer Time	utc	Universal Time Coordinated
bst	British Summer Time	cet	Central European Time
cest	Central European Summer Time	met	Middle European Time
mest	Middle European Summer Time	fwt	French Winter Time
fst	French Summer Time	eet	Eastern European Time
eest	Eastern European Summer Time	sast	South African Standard Time
msk	Moscow Time	msd	Moscow Summer Time
ist	India Standard Time	idt	India Daylight Time
cct	China Coast Time	awst	Australian Western Standard Time
awdt	Australian Western Daylight Time	rok	Republic of Korea
acst	Australian Central Standard Time	acdt	Australian Central Daylight Time
aest	Australian Eastern Standard Time	aedt	Australian Eastern Daylight Time
nzst	New Zealand Standard Time	nzdt	New Zealand Daylight Time
akst	Alaska Standard Time	akdt	Alaska Daylight Time

Abbreviation	Time Zone	Abbreviation	Time Zone
nst	Newfoundland Standard Time	ndt	Newfoundland Daylight Time
bra	Brazil Standard Time		

**Example**

```
set-time:time=1432:tz=est
```

**Dependencies**

None

The system time minutes value (the *mm* in the *hhmmss* format) must be in the range 00-59.

**Notes**

None

**Output**

```
set-time:time=1432:tz=est
```

```
rlghncxa03w 02-11-07 14:32:28 EST EAGLE 30.0.0
Time set complete.
```

```
;
```

**Related Topics**

- [set-date](#)

## set-uim-acthresh

Use this command to set or change the level-of-activity threshold for reporting UIM messages. The system suppresses the generation of UIM messages when message generation exceeds the threshold that was defined for the interval period. The values are set within five seconds after the command was entered. Any previous count is cleared and the new or changed threshold and limit is enforced. Refer to the *Database Administration Manual – System Management* for additional information.

**Parameters****intrvl (mandatory)**

The monitor interval in minutes.

**Range:**

5, 10, 15, 20, 25, 30

**Default:**

No change to the current value

**uimn (mandatory)**

The UIM number.

**Range:**

1000 - 1999

**force (optional)**

Required to set the `limit` parameter to 0 for a given interval.

 **Caution:**

Setting the limit to 0 turns off all occurrences of the specified UIM. Use this manner of creating thresholds only if you are certain you have specified the correct UIM.

**Range:**

yes

no

**Default:**

none

**limit (optional)**

The message threshold.

 **Caution:**

Setting the `limit` to 0 turns off all occurrences of the specified UIM. This can be dangerous if the wrong UIM number is specified by mistake. It is highly recommended that thresholds for UIMs are not set in this manner, but the ability is provided for certain extreme cases. The `force` parameter must be specified to specify `limit=0`, and an additional scroll area message is issued.

**Range:**

0 - 9999

**Default:**

No change to the current value

**Example**

This example sets UIM number 1333 threshold to 100 in a 5-minute interval:

```
set-uim-acthresh:uimn=1333:limit=100:intrvl=5
```

This example sets UIM number 1444 threshold to 200 in a 15-minute interval:

```
set-uim-acthresh:uimn=1444:limit=200:intrvl=15
```

**Dependencies**

At least one optional parameter must be specified.

A valid value must be specified for the `uimn` parameter.

A valid value must be specified for the `limit` parameter.

A valid value must be specified for the `intrvl` parameter.

The `force=yes` parameter must be specified before the `limit=0` parameter can be specified for a given interval. Specifying `limit=0` turns off all occurrences of the specified UIM. See the cautions under the `force` and `limit` parameters.

When creating a new UIM threshold, the `limit` and `intrvl` parameters must be specified.

The specified `uimn` parameter value must exist in the system Trouble Text table.

The UIM Threshold table is corrupt or cannot be found by the system.

The system Trouble Text table is corrupt or cannot be found by the system.

## Notes

None

## Output

```
set-uim-acthresh:uimn=1333:limit=100:intrvl=5
```

```
rlghncxa03w 03-11-01 08:50:12 EST EAGLE 31.3.0
SET-UIM-ACTHRESH: MASP A - COMPLTD
;
```

## Related Topics

- [dlt-uim-acthresh](#)
- [rtrv-uim-acthresh](#)

# tst-bip

Use this command to test each byte of the specified board identification PROM (BIP) by reading and writing to the PROM. The test is performed for the main assembly.

## Parameters

### loc (mandatory)

The card location as stenciled on the shelf of the system.

### Range:

1101 - 1108, 1111 - 1112, 1201 - 1208, 1211 - 1218, 1301 - 1308, 1311 - 1318,  
2101 - 2108, 2111 - 2118, 2201 - 2208, 2211 - 2218, 2301 - 2308, 2311 - 2318,  
3101 - 3108, 3111 - 3118, 3201 - 3208, 3211 - 3218, 3301 - 3308, 3311 - 3318,  
4101 - 4108, 4111 - 4118, 4201 - 4208, 4211 - 4218, 4301 - 4308, 4311 - 4318,  
5101 - 5108, 5111 - 5118, 5201 - 5208, 5211 - 5218, 5301 - 5308, 5311 - 5318,  
6101 - 6108, 6111 - 6118, 1109, 1110, 1209, 1210, 1309, 1310, 2109, 2110, 2209,  
2210, 2309, 2310, 3109, 3110, 3209, 3210, 3309, 3310, 4109, 4110, 4209, 4210,  
4309, 4310, 5109, 5110, 5209, 5210, 5309, 5310, 6109, 6110, 1113, 1115

### Example

```
tst-bip:loc=1211
```

### Dependencies

The card location, frame, shelf, or slot must be within the allowed range.

The card location must be valid for the command.

The card specified by the `loc` parameter must be equipped in the database.

The card specified by the `loc` parameter must be in the OOS-MT-DSBLD state prior to BIP testing.

### Notes

The specified card must be inhibited.

This command verifies that the PROM is good by writing and reading to the PROM. The `rtrv-bip` command shows the level of the BIP, as well as the board part number, the revision number, and the serial number. If the `rtrv-bip` command fails, this indicates that communications to the card has failed, and the card should be replaced.

### Output

```
tst-bip:loc=1211
```

```
tekelecstp 10-02-20 17:10:32 CST EAGLE 42.0.0
Test Board Identification PROM Location: 1211 - MBD Packet: 1
-----
BIP Passed
```

```
;
```

### Related Topics

- [chg-bip-fld](#)
- [chg-bip-rec](#)
- [rtrv-bip](#)

## tst-disk

Use this command prior to an upgrade, or as a diagnostic tool, to test the integrity of an EAGLE fixed drive or removable media drive, at the specified location. The test is non-intrusive and non-destructive to the disk. A read-only test is executed for all logical blocks (LBAs) used on the specified target disk and a report identifying any bad or questionable LBAs is output.

### Parameters

#### **loc (mandatory)**

The location of the disk to be tested.

**Range:**

**1114**  
TDM

**1116**  
TDM

**1113**  
Latched USB port

**1115**  
Latched USB port

**disk (optional)**

The disk that is being tested

**Range:**

**remove**  
The removable drive

**fixed**  
The fixed drive

**usb**  
This parameter is to be used by Oracle personnel only.

**partition (optional)**

Portion of disk to be tested. This parameter specifies the individual physical disk partition (1, 2, 3, or 4) or all defined partitions for a given disk size up to a maximum of 4 partitions.

**Range:**

**1, 2, 3, 4** —Tests the specified existing partition on the disk. Only the number or numbers for the partition or partitions that exist on the disk are valid. (For example, if the disk size allows only 2 partitions, `partition=3` and `partition=4` are invalid for that disk.)

**all** —Tests all existing partitions on the fixed disk or removable drive

**Default:**

*all*

**Example**

```
tst-disk:loc=1116
```

**Dependencies**

The card in the specified location (`loc`) must be an E5-TDM or E5-MCAP card.

The disk to be tested must be in service.

If a TDM location is specified, the TDM cannot be reserved (as when a copy-disk command is running).

The target drive must have low level format.

This command can be run simultaneously on both TDMs, if entered from different terminals.

The removable drive can be tested simultaneously with the standby TDM but not with the active TDM.

To test the Removable drive when `loc=1113/1115:disk=remove/usb`, the removable media must be inserted in the corresponding removable drive.

The `partition=3` and `partition=4` values are invalid for a 4GB fixed drive. The only valid value for the 2.3 GB and 4.1 GB removable disks is `partition=1`

An error message will be generated for a disk that has been Formatted (`format-disk` command) but does not yet contain a DOS directory structure (created with the `copy-disk` command) when the `partition=` parameter is specified.

This command cannot be entered when other database commands are running.

If an E5-TDM card is installed, then the `disk=fixed` parameter cannot be specified.

The disk to be tested must be available.

### Notes

A physical fixed disk (TDM) or removable drive is formatted and given a DOS directory structure to define the number of physical partitions that the disk size can accommodate. (The logical partitions that contain database, backup, GPL, and measurements files are placed in these physical partitions, with no correlation between the physical numbers and the logical contents.)

For a fixed TDM disk, the `partition` parameter specifies the individual partition (1, 2, 3, or 4) or all existing partitions to be tested.

- One partition = 2 GB.
- The 4 GB drive contains two 2 GB partitions.
- The 9 GB drive and the 18 GB drive each contain four 2 GB partitions.
- The 9 GB drive contains four 2 GB partitions.
- Any disk space beyond the four 2 GB partitions is unused disk space (and always has been due to EAGLE DISK FAT structure used).

The `partition=all` parameter implies that testing starts with the first partition, then second, and so on, until the last existing disk partition is detected without skipping any non-existing or defined partitions.

[Table 4-57](#) outlines execution time estimates based on disk capacity.

**Table 4-57 Test Disk Execution Times**

Capacity	Nominal Execution Time	Maximum Execution Time for 100% Errors
4.0 GB	40 minutes	27.5 hours
9.0 GB	1 hour 45 minutes	(Not determined)



**Table 4-57 (Cont.) Test Disk Execution Times**

Capacity	Nominal Execution Time	Maximum Execution Time for 100% Errors
18 GB	30 minutes (partition=1) 5 hours (partition=disk) depending on amount of disk tested and EAGLE provisioning/activity	(Not determined)
507 MB	5 minutes	3.4 hours
2.0 GB	20 minutes	13.5 hours
4.0 GB	40 minutes	27.5 hours
Removable Drive	30 seconds	Less than 1 minute

Nominal times for `tst-disk` command execution depend on the capacity of the disk being tested and assume that few or no errors are found. Maximum execution times are based on disk capacity, retry count, and retry delay. Each read error and retry may cause a delay of up to three seconds. If a TDM has 100% error sectors, the MASP will likely reset, terminating the disk test. A termination and reset will not occur, however, when testing the removable media.

Because of the intense, sustained disk activity created when `tst-disk` is executed, concurrently performing other disk-based activities, such as prolonged LNP command entry or database backups, will result in performance degradation up to twice the usual execution time.

Because of the extended processing time required for large disks, a progress message is displayed every five minutes providing the current LBA and the total LBA count for the partition.

Specific errors are reported for the first 10 error occurrences. Thereafter, only the error count is tracked and summary results are reported upon completion.

### Output

```
tst-disk:loc=1116
```

```
rlghncxa03w 03-11-27 11:40:02 EST EAGLE 31.3.0
TST-DISK of all partitions initiated for TDM 1116
```

```
;
```

```
rlghncxa03w 03-11-27 11:40:02 EST EAGLE 31.3.0
TST-DISK: TDM 1116 in progress 868680 of 4124735 LBA read
```

```
;
```

```
rlghncxa03w 03-11-27 11:40:02 EST EAGLE 31.3.0
TST-DISK Error: TDM 1116 LBA range 4124706 - 4124960
Check Condition: DISK_NOT_READY
TST-DISK results for TDM 1116
Total LBAs = 4124735    LBA size = 512
Retries    = 1    Errors    = 1
```

```

Command Completed
;

tst-disk:loc=1116:partition=2

rlghncxa03w 03-11-27 11:40:02 EST EAGLE 31.3.0
TST-DISK on Partition 2 initiated for TDM 1116
;

rlghncxa03w 03-11-27 11:40:02 EST EAGLE 31.3.0
TST-DISK: TDM 1116 in progress 1234567 of 4194304 LBA read
;

rlghncxa03w 03-11-27 11:40:02 EST EAGLE 31.3.0
TST-DISK Error: TDM 1116 LBA range 4194304 - 4194558
(NOTE: w/i 2nd disk partition)
Check Condition: DISK_NOT_READY
TST-DISK results for TDM 1116
Total LBAs = 4194304 LBA size = 512
Retries = 1 Errors = 1
Command Completed
;

```

### Related Topics

- [copy-disk](#)

## tst-dlk

Use this command to test the specified TCP/IP data link. The TCP/IP data link is tested with an ethernet test that is an echo test type called ping.

### Parameters

#### **loc (mandatory)**

The card location as stenciled on the shelf of the system.

#### **Range:**

1101 - 1108, 1111 - 1112, 1201 - 1208, 1211 - 1218, 1301 - 1308, 1311 - 1318, 2101 - 2108, 2111 - 2118, 2201 - 2208, 2211 - 2218, 2301 - 2308, 2311 - 2318, 3101 - 3108, 3111 - 3118, 3201 - 3208, 3211 - 3218, 3301 - 3308, 3311 - 3318, 4101 - 4108, 4111 - 4118, 4201 - 4208, 4211 - 4218, 4301 - 4308, 4311 - 4318, 5101 - 5108, 5111 - 5118, 5201 - 5208, 5211 - 5218, 5301 - 5308, 5311 - 5318, 6101 - 6108, 6111 - 6118

#### **type (mandatory)**

The type of test to run.

#### **Range:**

*ping*

**ipaddr (optional)**

The IP address of the remote host. This is a TCP/IP address expressed in standard dot notation. IP addresses consist of the system's network number and the machine's unique host number. An example IP address is *192.126.100.5*, where *192.126.100* is the network number and *5* is the machine's host number.

**Range:**

*1-223, 0-255*

4 numbers separated by dots

*1-223*-first number

*0-255*-the other 3 numbers

**Default:**

Host IP

**rc (optional)**

The number of times the test is repeated.

**Range:**

*1 - 15*

**Default:**

*1*

**Example**

```
tst-dlk: loc=1206:type=ping
```

**Dependencies**

No other action command can be in progress when this command is entered.

The card location must contain an STPLAN card.

The shelf and card must be equipped.

The specified card must have a TCP/IP data link assigned to it.

If a test repeat count (*rc*) is not entered, the test is not repeated.

If a data link test is in progress, another data link test cannot be started.

The card location, frame, shelf, or slot must be within the allowed range.

A card location that is valid and defined in the database must be specified.

The *ipaddr* parameter must specify a valid IP address.

**Notes**

None

**Output**

```
tst-dlk:loc=1206:type=ping
```

```
rlghncxa03w 03-11-27 17:00:36 EST EAGLE 31.3.0  
Command Accepted: Test Link message is sent.
```

```
rlghncxa03w 03-11-27 17:00:36 EST EAGLE 31.3.0  
Command Completed.
```

```
rlghncxa03w 03-11-27 17:00:36 EST EAGLE 31.3.0  
1310.1132 CARD 1206 INFO STPLAN DLK ping test completed  
TESTS REQUESTED= 1 PASSED COUNT= 1 FAILED COUNT= 0  
AVR RND TRIP= 10 MAX RND TRIP=10 MIN RND TRIP=10  
HOST IPADDR=198.089.040.069
```

;

### Related Topics

- [act-dlk](#)
- [canc-dlk](#)
- [dlt-dlk](#)
- [ent-dlk](#)
- [rept-stat-dlk](#)
- [rtrv-dlk](#)

## tst-e1

Use this command to test E1 ports. The command is rejected if a loopback test is not compatible with the port type. This command can be used with E5-E1T1-B cards.

### Parameters

#### **e1port (mandatory)**

E1 port number. The value must be an E1 port that has already been configured with an E1 interface on the specified card.

#### **Range:**

1 - 8

#### **loc (mandatory)**

Card location. The card location as stenciled on the shelf of the system.

#### **Range:**

1101 - 1108, 1111 - 1112, 1201 - 1208, 1211 - 1218, 1301 - 1308, 1311 - 1318, 2101 - 2108, 2111 - 2118, 2201 - 2208, 2211 - 2218, 2301 - 2308, 2311 - 2318, 3101 - 3108, 3111 - 3118, 3201 - 3208, 3211 - 3218, 3301 - 3308, 3311 - 3318, 4101 - 4108, 4111 - 4118, 4201 - 4208, 4211 - 4218, 4301 - 4308, 4311 - 4318, 5101 - 5108, 5111 - 5118, 5201 - 5208, 5211 - 5218, 5301 - 5308, 5311 - 5318, 6101 - 6108, 6111 - 6118

#### **action (optional)**

Indicator of command action to stop or start a test.

#### **Range:**

*start*

*stop*

**Default:***start***loopback (optional)**

Select loopback test type.

**Range:***line**lxvr*

local transceiver

*payload***Default:***lxvr***Example**

```
tst-e1:elport=1:loc=1203:loopback=lxvr
```

```
tst-e1:elport=1:loc=1203:action=stop
```

**Dependencies**

This command cannot be entered during upgrade.

The value specified for the `loc` parameter must indicate an E5-E1T1-B card with card type LIME1.

The card in the specified card location (`loc` parameter) must be equipped.

The card in the specified card location (`loc` parameter) must be in service.

The specified E1 port (`elport` parameter) on the card (`loc` parameter) must have a defined E1 interface.

All signaling links that provide timeslots serviced by E1 interfaces on the specified card must be deactivated before this command can be entered. None of the signaling links can be running link diagnostic tests (`tst-slk` and `act-cdl`) when this command is entered.

Only one port test can be running on an E1 port (`elport` parameter) at one time.

When the `action=stop` parameter is specified, the `loopback` parameter cannot be specified.

The E1/T1 table must be accessible.

The `action=stop` parameter can be specified only when a port test is running.

**Notes**

Only one port test can be performed at a time on an E1 port. When a port test is in progress on an E1 port, subsequent test requests are rejected.

## Output

```
tst-e1:elport=1:loc=1203:loopback=lxvr

    rlghncxa03w 05-01-07 16:19:08 EST  EAGLE5 33.0.0
    Command Accepted: Test Port message is sent.
;
    rlghncxa03w 05-01-07 16:19:08 EST  EAGLE5 33.0.0
    Command Completed.
;

tst-e1:elport=1:loc=1203:action=stop

    rlghncxa03w 05-01-07 16:19:08 EST  EAGLE5 33.0.0
    Command Accepted: Stop Port test message is sent.
;
    rlghncxa03w 05-01-07 16:19:08 EST  EAGLE5 33.0.0
    Command Completed.
;
```

## Related Topics

- [chg-e1](#)
- [dlt-e1](#)
- [ent-e1](#)
- [rtrv-e1](#)

## tst-imt

Use this command to:

- Perform a Fault Isolation test to determine the location of faults on a failed or abnormal IMT bus. The Alternate Bus must be in the IS-NR state. The Target Bus must be in the OOS-MT-DSBLD state.
- Perform an Extended Bit Error Rate Test (BERT) on all IMT Buses. The Target Bus must be in the IS-NR or IS-ANR state. The Alternate Bus must be in the IS-NR state.
- Cancel an Extended BERT

### Note:

At least one card must be populated in each EAGLE extension shelf provisioned as ent-shlf:type=EXT to allow the command to successfully execute a Fault Isolation Test. See the "Notes" section for this command for more information about executing the command.

 **Note:**

No physical status change can be made to the IMT Bus (e.g., unplugging MUX cards) while an Extended BERT is running.

**Parameters**

**type (mandatory)**

The type of test to perform.

**Range:**

*faulttest*

perform a Fault Isolation test

*extbert*

perform an Extended BERT on all MUX cards on an IMT Bus

**action (optional)**

Indicator of command action to stop or start a test.

Currently, only the cancellation of an Extended BERT is supported by this parameter.

**Range:**

*start*

*stop*

**Default:**

*start*

**bus (optional)**

IMT bus to test.

**Range:**

*a*

*b*

**maxerr (optional)**

The number of errors allowed for the period during which an Extended BERT is being performed.

 **Note:**

This value is the Bit error threshold.

**Range:**

*0 - 1000*

**Default:**

*20*

**time (optional)**

The time, in minutes, for which an Extended BERT runs in order to determine success or failure.

**Range:**

1 - 60

**Example**

```
tst-imt:bus=a:type=faultttest
tst-imt:bus=b:type=extbert:time=50
tst-imt:bus=b:type=extbert:time=50:maxerr=30
tst-imt:bus=a:type=extbert:action=stop
```

**Dependencies**

Valid IMT bus entries are "A" or "B".

A related IMT command cannot be in progress. Only one Fault Isolation Test or Extended BERT can be active at a time.

An Extended BERT cannot be performed if the `init-sys`, `act-upgrade`, `init-flash`, `act-flash`, `init-network`, `flash-card`, or `init-card` (when initializing multiple cards using the `appl` parameter) commands are running.

This command cannot be entered if the alternate bus is other than in-service normal (IS-NR).

The target bus must be in the out of service - maintenance disabled (OOS-MT-DSBLD) state before this command can be entered for a Fault Isolation test.

This command cannot be entered during the IMT statistics collection period following an hourly boundary (IMT performance monitoring).

The target bus must be in the in-service normal (IS-NR) or in-service abnormal (IS-ANR) state before this command can be entered for an Extended BERT.

If the `type=extbert` parameter is specified, then the `time` parameter must be specified.

If the `type=faultttest` parameter is specified, then the `time`, `maxerr`, and `action` parameters cannot be specified.

If the `action=stop` parameter is specified for an extended BERT, then the `time` and `maxerr` parameters cannot be specified.

This command cannot be entered for an Extended BERT, if the target bus contains HMUX or HIPR cards.

The `action=stop` parameter cannot be specified until an Extended BERT acknowledgment from a MUX card is received.

If an Extended BERT is about to complete, then the `action=stop` parameter cannot be specified.

If an Extended BERT is not in progress, then the `action=stop` parameter cannot be specified.



## Notes

### Fault Isolation Test

Probable causes are listed in order of most probable to least probable. The listed components should be replaced in order listed by the output of this command.

Multiple, masking points of failure can occur in the same bus segment. Such faults are reported as a single bus segment fault. Because running this command on a system with no IMT bus faults prints an indication that no faults were found, you can iteratively replace components and run this test until all components in the segment are ruled out.

A detection of an IMT address mismatch indicates a faulty backplane or card.

A detection of an inconsistency with a particular card's IMT card list indicates an error of unknown origin, probably due to one or more lost messages.

When this command completes, either through normal termination of the command or because the command was ended for another reason, you must administratively enable the target bus. If all faults have meanwhile been isolated and corrected, the target bus becomes operational.

When a fault is detected, the possible error sources are listed in order from the most likely to the least likely. This ordering is based on operational experience.

At least one card must be populated in each EAGLE extension shelf provisioned as `ent-shlf:type=EXT` to allow this command to execute successfully. The card does not need to be a provisioned card; the card must be in IS-NR state on both IMT busses before this command is entered. If an empty shelf that is provisioned as `ent-shlf:type = EXT` or an un-provisioned shelf that is IMT enabled does exist, the following text is displayed when this command is entered:

*Notice: IMT Fault test terminated.*

*Non-Standard cabling or IMT Bus-X state change detected.*

### Extended BERT

This command for an Extended BERT allows a BERT to be executed for a longer period of time during installation to verify there are no signal integrity issues. The standard BERT is used as a basic sanity test during bring-up of the ring.

When an Extended BERT is started, the target bus is inhibited. The bus is allowed when the test completes either through normal termination of the command or because the command was ended for another reason.

When the Extended BERT completes, the output is generated as a maintenance report indicating the test passed or failed. An error rate less than or equal to 1 error in 10E12 bits determines whether the test passed.

The `maxerr` parameter allows the Extended BERT to be performed for the longer duration even if the test fails for any of the MUX cards.

An on-going Extended BERT can be cancelled with the `action=stop` parameter.

Hourly report generation is not allowed if the request comes during an Extended BERT. Notification of the hourly boundary is multicast to all IMT processors to age out the least-recent error bucket and advance the current error bucket. The following notice is displayed if the Hourly report is bypassed during Extended BERT:

*Extended BERT: Hourly Report is bypassed*

One of the following notices is displayed if an Extended BERT terminates prematurely:

- *Extended BERT: Test aborted, Loss of Heartbeat*—Failure observed for the Extended BERT Heartbeat communication maintained between the Active OAM and the Control shelf MUX card.
- *Extended BERT: Test aborted, Alternate IMT Bus [A|B] abnormal*—Alternate IMT Bus becomes abnormal.
- *Extended BERT: Test terminated, Command cancelled*—Test is cancelled using `tst-imt` command with `action=stop`.
- *Extended BERT: Error in results retrieval, HIPR2 card(s) failure*—Extended BERT results are not displayed if an error is encountered during results retrieval from HIPR2 card.
- *Extended BERT: Active MASP failed to disconnect on IMT Bus [A|B]*—Active MASP did not disconnect on the IMT Bus undergoing Extended BERT.
- *Extended BERT: Active MASP failed to reconnect on IMT Bus [A|B]*—Active MASP did not reconnect on the IMT Bus undergoing Extended BERT.
- *Extended BERT: ACK for Extended BERT not received from IMT Bus [A|B]*—The acknowledgement for an Extended BERT is not received from MUX card.
- *Extended BERT: Test aborted, Card failure detected at X location*—Failure detected on a card due to both IMT Buses becoming unavailable.

**Output**

This example shows the output when the Connectivity test fails for the Fault Isolation test:

```
tst-imt:bus=a:type=faulttest

rlghncxa03w 09-12-07 12:47:07 EST  EAGLE 42.0.0
IMT Fault Isolation Bus A
Fault Location    Probable Cause  Failure(s)
Bus  1218-1301    HIPR2 1209
                   HIPR2 1309
                   Card 1218
                   Card 1301
                   Cable connecting Shelves 1200 and 1300 on Bus A
                   Backplane 1200
                   Backplane 1300
                                     Connectivity Test Failed
Bus  1304-1305    HIPR2 1309
                   Card 1304
                   Card 1305
                   Backplane 1300
                                     Connectivity Test Failed
;
```

This example shows the output when the Pass-through test fails for the Fault Isolation test:

```
tst-imt:bus=a:type=faultttest
```

```
rlghncxa03w 09-12-07 12:47:07 EST EAGLE 42.0.0
IMT Fault Isolation Bus B
Fault Location    Probable Cause  Failure(s)
Card 1201        Card 1201
                                     Pass-through Test Failed
Card 1301        Card 1301
                                     Pass-through Test Failed
```

```
;
```

This example shows the output when all tests pass for Fault Isolation test:

```
tst-imt:bus=b:type=faultttest
```

```
rlghncxa03w 09-12-07 12:47:07 EST EAGLE 42.0.0
IMT Fault Isolation Bus B
Fault Location    Probable Cause  Failure(s)
No Faults Found
                                     All Tests Passed.
```

```
;
```

This example shows the output when the Extended BERT fails for the HIPR2 cards at locations 1109 and 1309: however, the test continues for 20 minutes because none of the HIPR2 cards exceed the threshold:

```
tst-imt:bus=a:type=extbert:time=20:maxerr=20
```

```
rlghncxa03w 09-12-09 12:47:07 EST EAGLE 42.0.0
Extended Bit Error Rate Test Bus A
MAX ERROR = 20    TIME = 00:20:00    START TIME = 11:10:34
TEST STATUS = FAIL
```

DURATION	CARD	TYPE	SERIAL_NUMBER	BERT_STATUS	BIT_ERROR	ERRORED_SEC
00:20:00	1109	HIPR2	10208345027	FAIL	5	2
00:20:00	1209	HIPR2	10208345047	PASS	2	8
00:20:00	1309	HIPR2	10208345053	FAIL	19	15

```
;
```

This example shows the output when the test passes for all HIPR2 cards but the BERT terminates prematurely because the HIPR2 card at 1109 reaches the error threshold:

```
tst-imt:bus=a:type=extbert:time=20:maxerr=1
```

```
rlghncxa03w 09-12-09 12:47:07 EST EAGLE 42.0.0
Extended Bit Error Rate Test Bus A
```

```

MAX ERROR = 1      TIME = 00:20:00      START TIME = 11:10:34
TEST STATUS = PASS

```

DURATION	CARD	TYPE	SERIAL_NUMBER	BERT_STATUS	BIT_ERROR	ERRORED_SEC
00:10:00	1109	HIPR2	10208345027	PASS	2	1
00:10:01	1209	HIPR2	10208345047	PASS	1	1
00:10:01	1309	HIPR2	10208345053	PASS	0	0

```

;

```

This example shows the output when the BERT passes for all HIPR2 cards:

```
tst-imt:bus=b:type=extbert:time=60:maxerr=30
```

```

rlghncxa03w 09-12-09 12:47:07 EST EAGLE 42.0.0
Extended Bit Error Rate Test Bus B
MAX ERROR = 30      TIME = 01:00:00      START TIME = 12:10:30
TEST STATUS = PASS

```

DURATION	CARD	TYPE	SERIAL_NUMBER	BERT_STATUS	BIT_ERROR	ERRORED_SEC
01:00:00	1110	HIPR2	10208345012	PASS	3	2
01:00:00	1210	HIPR2	10208345031	PASS	2	1
01:00:00	1310	HIPR2	10208345052	PASS	5	3

```

;

```

This example shows the output when the Extended BERT is cancelled for Bus A:

```
tst-imt:bus=a:type=extbert:action=stop
```

```

rlghncxa03w 09-12-09 16:02:05 EST EAGLE5 42.0.0
Extended BERT: Test terminated, Command cancelled
;

```

### Legend

- **MAX ERROR**—Bit error threshold. The number of errors allowed for the specific time period during which the BERT is being performed. If this threshold is exceeded in the specified time period, the Extended BERT is prematurely terminated.
- **TIME**—Specified length of time (*hr:min:sec*) to run the test in order to determine success or failure
- **START TIME**—Time at which the test was started (*hr:min:sec*)
- **TEST STATUS**—PASS if the BERT Status is PASS for all the MUX cards, FAIL otherwise
- **CARD**—MUX Card location that contains the BERT being tested

- **TYPE**—MUX Card type
- **SERIAL\_NUMBER**—Serial number of the main assembly board of the MUX card obtained from board identification PROM (BIP) data
- **BERT\_STATUS**—Extended BERT PASS/FAIL status
- **BIT\_ERROR**—Number of bit errors observed during the test
- **ERRORED\_SEC**—Number of seconds that contained bit errors during the test. Bit errors are sampled once per second; each sample that contains bit errors adds one second to this count.
- **DURATION**—Length of time (*hr:min:sec*) that the test runs for the BERT. For a successful test, the TIME and DURATION should be the same. If a test runs for less than the specified amount of time, the DURATION is less than the TIME.

### Related Topics

- [clr-imt-stats](#)
- [init-imt-gpl](#)
- [rept-imt-lvl1](#)
- [rept-imt-lvl2](#)

## tst-j1

Use this command to test J1 ports. The command is rejected if a loopback test is not compatible with the port type.



### Note:

This command can be entered for E5-E1T1-B cards.

### Parameters

#### loc (mandatory)

The card location as stenciled on the shelf of the system.

#### Range:

1101 - 1108, 1111 - 1112, 1201 - 1208, 1211 - 1218, 1301 - 1308, 1311 - 1318,  
2101 - 2108, 2111 - 2118, 2201 - 2208, 2211 - 2218, 2301 - 2308, 2311 - 2318,  
3101 - 3108, 3111 - 3118, 3201 - 3208, 3211 - 3218, 3301 - 3308, 3311 - 3318,  
4101 - 4108, 4111 - 4118, 4201 - 4208, 4211 - 4218, 4301 - 4308, 4311 - 4318,  
5101 - 5108, 5111 - 5118, 5201 - 5208, 5211 - 5218, 5301 - 5308, 5311 - 5318,  
6101 - 6108, 6111 - 6118

#### Default:

All T1 card locations having J1 interfaces configured are listed.

#### action (optional)

Indicator of command action to stop or start a test.

**Range:***start**stop***Default:***start***loopback (optional)**

Select loopback test type.

**Range:***line**lxvr*

local transceiver

*payload**feline*

far end line

*far end payload*

far end payload

**Default:***line***j1port (optional)**

J1 port number. The value must be a J1 port that has already been configured with a J1 interface on the specified card.

**Range:***1-8***Example**

```
tst-j1:j1port=1:loc=1102:action=stop
```

**Dependencies**

This command cannot be entered during upgrade.

The value specified for the `loc` parameter must indicate an E5-E1T1-B card with card type LIMT1.The card in the location specified by the `loc` parameter must be equipped.The card in the location specified by the `loc` parameter must be in service.The J1 port specified by the `j1port` parameter must have a defined J1 interface.All signaling links that provide timeslots serviced by J1 interfaces on the specified card must be deactivated before this command can be entered. None of the signaling links can be running link diagnostic tests (`tst-slk` and `act-cdl` commands) when this command is entered.Only one port test can be running on the J1 port specified by the `j1port` parameter at one time.

The J1 table must be accessible.

The action=stop parameter can be specified only when a port test is running.

If the action=stop parameter is specified, a value of feline or fepayload must be specified for the loopback parameter.

If the action=stop parameter is specified, and a value of feline or fepayload is specified for the loopback parameter, then there cannot be an active loopback for the T1 span, or the active loopback must be the one specified in the tst-t1:action=stop command.

### Notes

Only one port test can be performed at a time on a J1 port. When a port test is in progress on a J1 port, subsequent test requests are rejected.

If a loopback type of feline or fepayload is specified, then the loopback requests are sent to the far end. No response is given from the far end indicate if the request was acted upon or received. The local card which hosts the J1 span in the EAGLE does not instrument the loopback locally but maintains a knowledge of the far end loopback request. If the local card boots, this knowledge is lost by the card.

To maintain the far end loopback states, if the J1 card with an active feline or fepayload test boots, the card loses any knowledge of the Far End loopback request, but the OAM retains that knowledge. If the OAM boots, the J1 card updates the OAM with its last known loopback state. If both the J1 card and the active OAM card boots while a Far End Loopback is active, then there is no way of determining the J1 state; however, a `tst-j1:action=stop:action=(feline or fepayload)` command can still be sent.

### Output

```
tst-j1:j1port=1:loc=1102:action=stop
```

```
tekelecstp 13-12-19 19:02:51 EST 46.0.0-65.3.0
Command Accepted: Stop Port test message is sent.
;
tekelecstp 13-12-19 19:02:51 EST 46.0.0-65.3.0
Command Completed.
;
```

### Related Topics

- [chg-j1](#)
- [dlt-j1](#)
- [ent-j1](#)
- [rtrv-j1](#)

## tst-msg

Use this command to invoke the Test Tool to test the feature call flow for the specified test message from the TESTMSG table.

The command sends the specified message from the TESTMSG table to an EAGLE feature. The test message that is sent does not create a new raw MSU. The test message is used only to modify the internal data structures of the Feature to study the call flow behavior when a message with the specified parameters is injected into the call path. The test message is never sent out to the network.

### Parameters

#### **feat (mandatory)**

Feature. The Service Feature where the message is processed on the network card.

#### **Range:**

##### ***ttr***

Service Feature for processing Prepaid IDP Query Relay test messages

##### ***tif***

Service Feature for processing ISUP test messages when the provisioned Gateway Screening Stop Action is TIF.

##### ***tif2***

Service Feature for processing ISUP test messages when the provisioned Gateway Screening Stop Action is TIF2.

##### ***tif3***

Service Feature for processing ISUP test messages when the provisioned Gateway Screening Stop Action is TIF3.

##### ***mosmsnpp***

Service Feature for processing MO SMS NPP test messages

##### ***gtt***

Service feature for processing GTT test messages.

##### ***iar***

Service Feature for processing IAR test messages

#### **loc (mandatory)**

Card location. The location of the network card where the message is to be sent.

#### **Range:**

1101 - 1108, 1111 - 1112, 1201 - 1208, 1211 - 1218, 1301 - 1308, 1311 - 1318, 2101 - 2108, 2111 - 2118, 2201 - 2208, 2211 - 2218, 2301 - 2308, 2311 - 2318, 3101 - 3108, 3111 - 3118, 3201 - 3208, 3211 - 3218, 3301 - 3308, 3311 - 3318, 4101 - 4108, 4111 - 4118, 4201 - 4208, 4211 - 4218, 4301 - 4308, 4311 - 4318, 5101 - 5108, 5111 - 5118, 5201 - 5208, 5211 - 5218, 5301 - 5308, 5311 - 5318, 6101 - 6108, 6111 - 6118

#### **msgn (mandatory)**

Message number. The message number of the test message to be sent for feature service processing.

#### **Range:**

1 - 10

#### **prot (mandatory)**

Protocol. The protocol of the test message that is sent to the feature for processing.



**Range:***ttr**isup**is41**gsm**sccp**tatr***mode (optional)**

Output mode. The mode in which output is shown while processing is performed on the specified test message.

**Note:**

The most complete and accurate test results are obtained when `mode=debug` is used.

**Range:***brief*

summary format

*full*

full format

*debug*

debug format

**Default:***brief***Example**

```
tst-msg:loc=1103:prot=is41:feat=mosmsnpp:msgn=1:mode=full
```

```
tst-msg:loc=1103:prot=ttr:feat=ttr:msgn=1:mode=full
```

```
tst-msg:loc=1103:prot=gsm:feat=mosmsnpp:msgn=1:mode=debug
```

```
tst-msg:msgn=1:prot=isup:loc=1215:feat=tif:mode=debug
```

```
tst-msg:loc=1103:prot=sccp:feat=gtt:msgn=1
```

**Dependencies**

The Prepaid IDP Query Relay feature must be enabled before the `feat=ttr` parameter can be specified.

The card in the location that is specified in the `loc` parameter must be equipped in the system.

The value specified for the `loc` parameter must indicate a Service Module card running the VSCCP application.

The card in the location specified in the `loc` parameter must be in the Active state.

The values specified for the `prot` and `feat` parameters must be compatible as shown:

- `feat=ttr — prot=ttr`
- `feat=iar — prot=tatr`
- `feat=tif, tif2, tif3 — prot=isup`
- `feat=mosmsnpp — prot=gsm, is41`
- `feat=gtt — prot=sccp`

If the specified test message is defined with `ACTIVE=YES` (see the `chg-isup-msg` command), then the message is sent to the specified network card for test processing. (Test messages are never sent out to the live network.)

The TSTMSG table is corrupt or cannot be found.

The MO SMS ASD, MO SMS GRN, MO SMS IS41-to-GSM Migration, or MO-based IS1 SMS NP feature must be enabled before the `feat=mosmsnpp` and `prot=is41` parameters can be specified.

The MO SMS ASD, MO SMS GRN, Prepaid SMS Intercept Ph1, MO-based GSM SMS NP, or Portability Check for MO SMS feature must be enabled before the `feat=mosmsnpp` and `prot=gsm` parameters can be specified.

At least one TIF feature must be enabled before a value of `tif`, `tif2`, or `tif3` can be specified for the `feat` parameter.

For an ANSI message, the CDPA GTI must be 2 and the CGPA GTI must be 0 or 2 (see the `chg-sccp-msg` command). For an ITU message, the CDPA GTI must be 2 or 4 and the CGPA GTI must be 0, 2, or 4.

The linkset specified by the `lsn` parameter must already exist.

The network domain of the values specified for the OPC, CGPA PC, CDPA PC and DPC must match.

The IAR Base feature must be enabled before the `feat=iar` parameter can be specified.

## Notes

The `tst-msg` output for `feat=gtt` with `mode=full` and `debug` will be the same.

## Output

When the `mode=full` or `mode=debug` parameter is specified, the `FORMAT` field indicates whether formatting actions are executed. If formatting actions are not executed, then the `OUTG DIGITS` field displays a value of `UNMODIFIED`. If any digit string is blank, then the associated field displays a value of `EMPTY`.

This example shows the output in brief format:

```
tst-msg:feat=ttr:prot=ttr:msgn=1:mode=brief
```

```
tekelecstp 09-08-05 18:20:46 EST EAGLE 41.1.0
tst-msg:feat=ttr:prot=ttr:msgn=1:mode=brief
Command Accepted: Test message is sent.
```

```
;
```

```
TST-MSG-RESULT
```

```
=====
```

```
MSG = 1          TCAP_TYPE = INAP
```

```
SCCP
```

```
CGPA_GT = 2
```

```
CGPA_GT_NAI = 4          CGPA = 9111111111
```

```
CDPA_GT = 2
```

```
CDPA_GT_NAI = 4          CDPA = 9818555001
```

```
TCAP
```

```
SK = 6ba1b1c1          BCSM = 02
```

```
CGPN_NAI = 4          CGPN = 919818000005
```

```
CDPN_NAI = 4          CDPN = 919818000001
```

```
CDPN NPP PROCESSING
```

```
SERVICE NAME = idprcdpn SERVICE STATUS = ON
```

```
INC DIGITS = 919818000001
```

```
NAI = 4 FNAI = intl FDL = 12
```

```
MATCHING RULE
```

```
FNAI = intl FDL = * FPFX = *
```

```
ACTION SET NAME = cdpnintl
```

```
CONDITIONING RESULT
```

```
INC DIGITS = 919818000001
```

```
COND DIGITS = 919818000001
```

```
FORMATING RESULT
```

```
OUTG DIGITS = 00910123459818000001
```

```
OUTG FNAI = intl
```

```
;
```

```
tekelecstp 09-08-05 18:20:46 EST EAGLE 41.1.0
```

```
CGPN NPP PROCESSING
```

```
SERVICE NAME = idprcgn SERVICE STATUS = ON
```

```
INC DIGITS = 919818000005
```

```
NAI = 4 FNAI = intl FDL = 12
```

```
MATCHING RULE
```

```
FNAI = intl FDL = 12 FPFX = *
```

```
ACTION SET NAME = cgpn1
```

```
CONDITIONING RESULT
```

```
INC DIGITS = 919818000005
COND DIGITS = 919818000005

FORMATING RESULT
OUTG DIGITS = 00915432109818000005
OUTG FNAI = intl
;
```

This example shows the output in full format:

```
tst-msg:feat=ttr:prot=ttr:msgsn=1:mode=full
```

```
tekelecstp 09-08-05 18:20:46 EST EAGLE 41.1.0
tst-msg:feat=ttr:prot=ttr:msgsn=1:mode=full
Command Accepted: Test message is sent.
;
```

```
TST-MSG-RESULT
=====

MSG = 1          TCAP_TYPE = INAP

SCCP
CGPA_GT = 2
CGPA_GT_NAI = 4      CGPA = 9111111111
CDPA_GT = 2
CDPA_GT_NAI = 4      CDPA = 9818555001

TCAP
SK = 6ba1b1c1      BCSM = 02
CGPN_NAI = 4        CGPN = 919818000005
CDPN_NAI = 4        CDPN = 919818000001

CDPN NPP PROCESSING

SERVICE NAME = idprcdpn SERVICE STATUS = ON
INC DIGITS = 919818000001
NAI = 4 FNAI = intl FDL = 12

MATCHING RULE
FNAI = intl FDL = * FPFX = *
ACTION SET NAME = cdpnintl

CONDITIONING RESULT
CA1 = cc2          EXECUTED = Y RESULT = PASS
CA2 = ac2          EXECUTED = Y RESULT = PASS
CA3 = snx          EXECUTED = Y RESULT = PASS
INC DIGITS = 919818000001
COND DIGITS = 919818000001

SERVICE APPLICATION
SA1 = ccncchk      EXECUTED = Y FORMAT = Y
SA2 = cdpnpn       EXECUTED = Y FORMAT = Y
SA3 = cgpnpnprqd  EXECUTED = Y FORMAT = Y
```

```

FORMATING RESULT
  FA1 = dlma          EXECUTED = Y RESULT = PASS
  FA2 = cc            EXECUTED = Y RESULT = PASS
  FA3 = rn            EXECUTED = Y RESULT = PASS
  FA4 = ac            EXECUTED = Y RESULT = PASS
  FA5 = sn            EXECUTED = Y RESULT = PASS
  OUTG DIGITS = 00910123459818000001
  OUTG FNAI = intl
;

tekelecstp 09-08-05 18:20:46 EST  EAGLE 41.1.0

CGPN NPP PROCESSING

SERVICE NAME = idprcgpn SERVICE STATUS = ON
  INC DIGITS = 919818000005
  NAI = 4 FNAI = intl FDL = 12

MATCHING RULE
  FNAI = intl FDL = 12 PPFX = *
  ACTION SET NAME = cgpn1

CONDITIONING RESULT
  CA1 = cc2          EXECUTED = Y RESULT = PASS
  CA2 = ac2          EXECUTED = Y RESULT = PASS
  CA3 = sn8          EXECUTED = Y RESULT = PASS
  INC DIGITS = 919818000005
  COND DIGITS = 919818000005

SERVICE APPLICATION
  SA1 = cgpnnp       EXECUTED = Y FORMAT = Y

FORMATING RESULT
  FA1 = dlma          EXECUTED = Y RESULT = PASS
  FA2 = cc            EXECUTED = Y RESULT = PASS
  FA3 = rn            EXECUTED = Y RESULT = PASS
  FA4 = ac            EXECUTED = Y RESULT = PASS
  FA5 = sn            EXECUTED = Y RESULT = PASS
  OUTG DIGITS = 00915432109818000005
  OUTG FNAI = intl
;

```

This example shows the output in debug format for the TTR protocol:

```
tst-msg:feat=ttr:prot=ttr:msgn=1:mode=debug
```

```

tekelecstp 09-08-05 18:20:46 EST  EAGLE 41.1.0
tst-msg:feat=ttr:prot=ttr:msgn=1:mode=debug
Command Accepted: Test message is sent.
;

TST-MSG-RESULT
=====

```

```
MSG = 2          TCAP_TYPE = INAP

SCCP
CGPA_GT = 4
CGPA_GT_NAI = 4      CGPA = 9111111111
CDPA_GT = 4
CDPA_GT_NAI = 4      CDPA = 9818555001

TCAP
SK = 6ba1b1c1      BCSM = 02
CGPN_NAI = 4        CGPN = 919818000005
CDPN_NAI = 4        CDPN = 009090919818000001

CDPN NPP PROCESSING

SERVICE NAME = idprcdpn SERVICE STATUS = ON
INC DIGITS = 009090919818000001
NAI = 4 FNAI = intl FDL = 18

MATCHING RULE
FNAI = intl FDL = 18 PPFX = 00
ACTION SET NAME = cdpn6

CONDITIONING RESULT
CA1 = fpx          EXECUTED = Y RESULT = PASS
CA2 = pfxa4        EXECUTED = Y RESULT = PASS
CA3 = cc2          EXECUTED = Y RESULT = PASS
CA4 = ac2          EXECUTED = Y RESULT = PASS
CA5 = sn8          EXECUTED = Y RESULT = PASS
INC DIGITS = 009090919818000001
COND DIGITS = 919818000001

SERVICE APPLICATION
SA1 = ccncchk      EXECUTED = Y FORMAT = Y
CCNC Check Passed
SA2 = cdpnpnp      EXECUTED = Y FORMAT = Y
RTDB LKPSUCC Entity=1 Cdpn=919818000001
SA3 = lacck        EXECUTED = Y FORMAT = Y
PPFX & PFXA FAs set to None
SA4 = cgpnpnpqd    EXECUTED = Y FORMAT = Y

FORMATING RESULT
FA1 = fpx          EXECUTED = Y RESULT = PASS
FA2 = pfxa         EXECUTED = Y RESULT = PASS
FA3 = dlma         EXECUTED = Y RESULT = PASS
FA4 = cc           EXECUTED = Y RESULT = PASS
FA5 = rn           EXECUTED = Y RESULT = PASS
FA6 = ac           EXECUTED = Y RESULT = PASS
FA7 = sn           EXECUTED = Y RESULT = PASS
OUTG DIGITS = 00910123459818000001
OUTG FNAI = intl
;
```

```
tekelecstp 09-08-05 18:20:46 EST EAGLE 41.1.0
```

```
CGPN NPP PROCESSING

SERVICE NAME = idprcpgn SERVICE STATUS = ON
  INC DIGITS = 919818000005
  NAI = 4 FNAI = intl FDL = 12

MATCHING RULE
  FNAI = intl FDL = 12 PPFX = *
  ACTION SET NAME = cgpn1

CONDITIONING RESULT
  CA1 = cc2          EXECUTED = Y RESULT = PASS
  CA2 = ac2          EXECUTED = Y RESULT = PASS
  CA3 = sn8          EXECUTED = Y RESULT = PASS
  INC DIGITS = 919818000005
  COND DIGITS = 919818000005

SERVICE APPLICATION
  SA1 = cgpnnp      EXECUTED = Y FORMAT = Y
  RTDB LKPSUCC Entity=1 Cgpn=919818000005

FORMATING RESULT
  FA1 = dlma        EXECUTED = Y RESULT = PASS
  FA2 = cc          EXECUTED = Y RESULT = PASS

;
```

This example shows the output in debug format when the ISUP protocol is used:

```
tst-msg:msgn=1:loc=2217:prot=isup:feat=tif3:mode=debug
```

```
tklcl1191001 09-08-08 08:06:03 EST EAGLE5 41.1.0

SERVICE NAME = tif3 SERVICE STATUS = ON
  INC DIGITS = 1970442001
  NAI = 4 FNAI = intl FDL = 10

MATCHING RULE
  FNAI = intl FDL = * PPFX = 1970
  ACTION SET NAME = temp3

CONDITIONING RESULT
  CA1 = cc1          EXECUTED = Y RESULT = PASS
  CA2 = dnx          EXECUTED = Y RESULT = PASS
  INC DIGITS = 1970442001
  COND DIGITS = 1970442001

SERVICE APPLICATION
  SA1 = nprls        EXECUTED = Y FORMAT = Y
  INDIV RLS redir=1 cause=np(0) RN=ffffff SP=dd02001

FORMATING RESULT
  FA1 = rn           EXECUTED = Y RESULT = PASS
  FA2 = cc           EXECUTED = Y RESULT = PASS
```

```
OUTG DIGITS = fffffff1
OUTG FNAI = intl
```

;

This example shows the output in brief format when the MO SMS NPP IS41 protocol is used:

```
tst-msg:feat=mosmsnpp:loc=1101:prot=is41:msgn=1:mode=brief
```

```
tekelecstp 09-08-02 10:46:51 EST EAGLE 41.1.0
tst-msg:feat=mosmsnpp:loc=1101:prot=is41:msgn=1:mode=brief
Command Accepted: Test message is sent.
```

;

```
TST-MSG-RESULT
```

```
=====
```

```
MSG = 1
```

```
CGPA_GT = 4
```

```
CGPA_GT_NAI = 4 CGPA = 0123456789abcde
```

```
CDPA_GT = 4
```

```
CDPA_GT_NAI = 4 CDPA = 0123456789abcde
```

```
CGPN_NAI = 1
```

```
CGPN_NP = 2
```

```
CGPN_ES = 1
```

```
CGPN = 919899999901
```

```
CDPN_NAI = 1
```

```
CDPN_NP = 2
```

```
CDPN_ES = 1
```

```
CDPN = 919918000004
```

```
MOSMSICGPN NPP PROCESSING
```

```
SERVICE NAME = mosmsicgpn SERVICE STATUS = ON
```

```
INC DIGITS = 919899999901
```

```
NAI = 1 FNAI = intl FDL = 12
```

```
MATCHING RULE
```

```
FNAI = intl FDL = * FPFX = *
```

```
ACTION SET NAME = asdgrn1
```

```
CONDITIONING RESULT
```

```
INC DIGITS = 919899999901
```

```
COND DIGITS = 919899999901
```

```
FORMATING RESULT
```

```
OUTG DIGITS = 919899999901
```

```
OUTG FNAI = intl
```

;

```
eagle1 09-08-02 08:45:05 EST EAGLE 41.1.0
```

```
MOSMSICDPN NPP PROCESSING
```

```
SERVICE NAME = mosmsicdpn SERVICE STATUS = ON
```



```
INC DIGITS = 919918000004
NAI = 1 FNAI = intl FDL = 12

MATCHING RULE
FNAI = intl FDL = 12 FPFX = *
ACTION SET NAME = cgpnasd1

CONDITIONING RESULT
INC DIGITS = 919918000004
COND DIGITS = 919918000004

FORMATING RESULT
OUTG DIGITS = 917777444409918000004
OUTG FNAI = intl
;
```

This example shows the output in full format when the MO SMS NPP IS41 protocol is used:

```
tst-msg:feat=mosmsnpp:loc=1101:prot=is41:msgn=1:mode=full
```

```
tekelecstp 09-08-02 10:51:51 EST EAGLE 41.1.0
tst-msg:feat=mosmsnpp:loc=1101:prot=is41:msgn=1:mode=full
Command Accepted: Test message is sent.
;
```

```
TST-MSG-RESULT
=====
MSG = 1

CGPA_GT = 4
CGPA_GT_NAI = 4      CGPA = 0123456789abcde

CDPA_GT = 4
CDPA_GT_NAI = 4      CDPA = 0123456789abcde

CGPN_NAI = 1          CGPN_NP = 2
CGPN_ES = 1           CGPN = 919899999901

CDPN_NAI = 1          CDPN_NP = 2
CDPN_ES = 1           CDPN = 919918000004

MOSMSICGPN NPP PROCESSING

SERVICE NAME = mosmsicgpn SERVICE STATUS = ON
INC DIGITS = 919899999901
NAI = 1 FNAI = intl FDL = 12

MATCHING RULE
FNAI = intl FDL = * FPFX = *
ACTION SET NAME = asdgrn1

CONDITIONING RESULT
CA1 = cc2           EXECUTED = Y RESULT = PASS
```

```
CA2 = dnx          EXECUTED = Y RESULT = PASS
INC DIGITS = 91989999901
COND DIGITS = 91989999901

SERVICE APPLICATION
SA1 = asdlkup     EXECUTED = Y FORMAT IND = N
SA2 = grnlkup     EXECUTED = Y FORMAT IND = N

FORMATING RESULT
FA1 = orig        EXECUTED = Y RESULT = PASS
OUTG DIGITS = 91989999901
OUTG FNAI = intl
;

eagle1 09-08-02 08:45:26 EST  EAGLE 41.1.0

MOSMSICDPN NPP PROCESSING

SERVICE NAME = mosmsicdpn SERVICE STATUS = ON
INC DIGITS = 919918000004
NAI = 1 FNAI = intl FDL = 12

MATCHING RULE
FNAI = intl FDL = 12 PPFX = *
ACTION SET NAME = cgpnasd1

CONDITIONING RESULT
CA1 = cc2         EXECUTED = Y RESULT = PASS
CA2 = dn10        EXECUTED = Y RESULT = PASS
INC DIGITS = 919918000004
COND DIGITS = 919918000004

SERVICE APPLICATION
SA1 = migrate     EXECUTED = Y FORMAT IND = N
SA2 = cdpnp       EXECUTED = Y FORMAT IND = N
SA3 = cgpnasdrqd EXECUTED = Y FORMAT IND = N
SA4 = cgpngrnrqd EXECUTED = Y FORMAT IND = N

FORMATING RESULT
FA1 = cc          EXECUTED = Y RESULT = PASS
FA2 = rn          EXECUTED = Y RESULT = PASS
FA3 = asd         EXECUTED = Y RESULT = PASS
FA4 = grn         EXECUTED = Y RESULT = PASS
FA5 = dn          EXECUTED = Y RESULT = PASS
OUTG DIGITS = 91777444409918000004
OUTG FNAI = intl
;
```

This example shows the output in brief format when the MO SMS NPP GSM protocol is used:

```
tst-msg:feat=mosmsnpp:loc=1101:prot=gsm:msgn=1:mode=brief
```

```
tekelecstp 09-08-03 09:23:01 EST  EAGLE 41.1.0
tst-msg:feat=mosmsnpp:loc=1101:prot=gsm:msgn=1:mode=brief
Command Accepted: Test message is sent.
```

```
;

TST-MSG-RESULT
=====
MSG = 1
CGPA_GT = 4
CGPA_GT_NAI = 4      CGPA = 0123456789abcde

CDPA_GT = 4
CDPA_GT_NAI = 4      CDPA = 123456789

CGPN_NAI = 1
CGPN_NP = 1          CGPN = 919899999901

CDPN_NAI = 1
CDPN_NP = 1          CDPN = 919918000004

MOSMSGCGPN NPP PROCESSING

SERVICE NAME = mosmsgcgpn SERVICE STATUS = ON
  INC DIGITS = 919899999901
  NAI = 1 FNAI = intl FDL = 12

MATCHING RULE
  FNAI = intl FDL = * FPFX = *
  ACTION SET NAME = gcgpn1

CONDITIONING RESULT
  INC DIGITS = 919899999901
  COND DIGITS = 919899999901

FORMATING RESULT
  OUTG DIGITS =
  OUTG FNAI = unkn
;

tekelecstp 09-08-03 09:23:01 EST  EAGLE 41.1.0

MOSMSGCDPN NPP PROCESSING

SERVICE NAME = mosmsgcdpn SERVICE STATUS = ON
  INC DIGITS = 919918000004
  NAI = 1 FNAI = intl FDL = 12

MATCHING RULE
  FNAI = intl FDL = * FPFX = *
  ACTION SET NAME = gcdpn1

CONDITIONING RESULT
  INC DIGITS = 919918000004
  COND DIGITS = 919918000004

FORMATING RESULT
  OUTG DIGITS = 91777744409918000004
  OUTG FNAI = intl
;
```

This example shows the output in full format when the MO SMS NPP GSM protocol is used:

```
tst-msg:feat=mosmsnpp:loc=1101:prot=gsm:msgn=1:mode=full
```

```
tekelecstp 09-08-03 09:50:01 EST EAGLE 41.1.0
tst-msg:feat=mosmsnpp:loc=1101:prot=gsm:msgn=1:mode=full
Command Accepted: Test message is sent.
```

```
;
```

```
TST-MSG-RESULT
=====
MSG = 1
CGPA_GT = 4
CGPA_GT_NAI = 4      CGPA = 0123456789abcde

CDPA_GT = 4
CDPA_GT_NAI = 4      CDPA = 123456789

CGPN_NAI = 1
CGPN_NP = 1          CGPN = 919899999901

CDPN_NAI = 1
CDPN_NP = 1          CDPN = 919918000004

MOSMSGCGPN NPP PROCESSING

SERVICE NAME = mosmsgcgpn SERVICE STATUS = ON
  INC DIGITS = 919899999901
  NAI = 1 FNAI = intl FDL = 12

MATCHING RULE
  FNAI = intl FDL = * FPFX = *
  ACTION SET NAME = gcgpn1

CONDITIONING RESULT
  CA1 = cc2          EXECUTED = Y RESULT = PASS
  CA2 = dnx          EXECUTED = Y RESULT = PASS
  INC DIGITS = 919899999901
  COND DIGITS = 919899999901

SERVICE APPLICATION
  SA1 = fraudchk     EXECUTED = Y FORMAT IND = N
  SA2 = pprelay      EXECUTED = Y FORMAT IND = Y
  SA3 = asdlkup      EXECUTED = Y FORMAT IND = N
  SA4 = grnlkup      EXECUTED = Y FORMAT IND = N

FORMATING RESULT
  OUTG DIGITS =
  OUTG FNAI = unkn
```

```
;
```

```
tekelecstp 09-08-03 09:50:01 EST EAGLE 41.1.0
```

```
MOSMSGCDPN NPP PROCESSING
```

```

SERVICE NAME = mosmsgcdpn SERVICE STATUS = ON
  INC DIGITS = 919918000004
  NAI = 1 FNAI = intl FDL = 12

MATCHING RULE
  FNAI = intl FDL = * FPFX = *
  ACTION SET NAME = gcdpn1

CONDITIONING RESULT
  CA1 = cc2          EXECUTED = Y RESULT = PASS
  CA2 = dnx          EXECUTED = Y RESULT = PASS
  INC DIGITS = 919918000004
  COND DIGITS = 919918000004

SERVICE APPLICATION
  SA1 = pprelay      EXECUTED = Y FORMAT IND = N
  SA2 = cdpnpnp      EXECUTED = Y FORMAT IND = N
  SA3 = cgpnasdrqd   EXECUTED = Y FORMAT IND = N

  SA4 = cgpngrnrqd   EXECUTED = Y FORMAT IND = N
FORMATING RESULT
  FA1 = cc           EXECUTED = Y RESULT = PASS
  FA2 = rn           EXECUTED = Y RESULT = PASS
  FA3 = asd          EXECUTED = Y RESULT = PASS
  FA4 = grn          EXECUTED = Y RESULT = PASS
  FA5 = dn           EXECUTED = Y RESULT = PASS
  OUTG DIGITS = 91777744409918000004
  OUTG FNAI = intl
;

```

This example shows the output in debug format when the MO SMS NPP IS41 protocol is used:

```
tst-msg:feat=mosmsnpp:loc=1101:prot=is41:msgn=1:mode=debug
```

```

tekelecstp 09-08-02 10:46:51 EST EAGLE 41.1.0
tst-msg:feat=mosmsnpp:loc=1101:prot=is41:msgn=1:mode=debug
Command Accepted: Test message is sent.
;
tekelecstp 09-08-02 10:46:51 EST EAGLE 41.1.0
TST-MSG-RESULT
=====
MSG = 1

CGPA_GT = 4
CGPA_GT_NAI = 4   CGPA = 0123456789abcde

CDPA_GT = 4
CDPA_GT_NAI = 4   CDPA = 0123456789abcde

CGPN_NAI = 1      CGPN_NP = 2
CGPN_ES = 1      CGPN = 919899999901

CDPN_NAI = 1      CDPN_NP = 2

```

```
CDPN_ES = 1          CDPN = 919918000004

MOSMSICGPN NPP PROCESSING

SERVICE NAME = mosmsicgpn SERVICE STATUS = ON
  INC DIGITS = 919899999901
  NAI = 1 FNAI = intl FDL = 12

MATCHING RULE
  FNAI = intl FDL = * PPFX = *
  ACTION SET NAME = asdgrn1

CONDITIONING RESULT
  CA1 = cc2          EXECUTED = Y RESULT = PASS
  CA2 = dnx          EXECUTED = Y RESULT = PASS
  INC DIGITS = 919899999901
  COND DIGITS = 919899999901

SERVICE APPLICATION
  SA1 = asdlkup      EXECUTED = Y FORMAT IND = N
  ASDLKUP: ASD Data Copied to NPPSTATE:ASD
  RTDB LKPSUCC DN=919899999901
  PT   =5            ASD   =444
  SP   =NONE         SRFIMSI=NONE
  RN   =3000         SRFIMSI=NONE
  VMSID=NONE         SRFIMSI=NONE
  GRN  =40           SRFIMSI=NONE
  SA2 = grnlkup      EXECUTED = Y FORMAT IND = N
  GRN Data Copied to NPPSTATE:GRN

FORMATING RESULT
  FA1 = orig         EXECUTED = Y RESULT = PASS
  OUTG DIGITS = 919899999901
  OUTG FNAI = intl
```

;

tekelecstp 09-08-02 10:46:51 EST EAGLE 41.1.0

```
MOSMSICDPN NPP PROCESSING

SERVICE NAME = mosmsicdpn SERVICE STATUS = ON
  INC DIGITS = 919918000004
  NAI = 1 FNAI = intl FDL = 12
```

```
MATCHING RULE
  FNAI = intl FDL = 12 PPFX = *
  ACTION SET NAME = cgpnasd1
```

```
CONDITIONING RESULT
  CA1 = cc2          EXECUTED = Y RESULT = PASS
  CA2 = dn10         EXECUTED = Y RESULT = PASS
  INC DIGITS = 919918000004
  COND DIGITS = 919918000004
```

```
SERVICE APPLICATION
```

```

SA1 = migrate      EXECUTED = Y FORMAT IND = N
I2GM:Subscriber is not migrated
RTDB LKPSUCC DN=919918000004
PT   = 255          ASD    =56
SP   =NONE          SRFIMSI=NONE
RN   =7777          SRFIMSI=98989
VMSID=NONE          SRFIMSI=NONE
GRN  =40            SRFIMSI=NONE
SA2 = cdpnpn       EXECUTED = Y FORMAT IND = N
SMS NP:Validation Passed: NPPSTATE:RN=7777.
SA3 = cgpnasdrqd  EXECUTED = Y FORMAT IND = N
CGPNASDRQD:CgPN ASD Data Copied to NPPSTATE:ASD
SA4 = cgpngrnrqd  EXECUTED = Y FORMAT IND = N
CGPNGRNRQD:CgPN GRN Data Copied to NPPSTATE:GRN

```

## FORMATING RESULT

```

FA1 = cc           EXECUTED = Y RESULT = PASS
FA2 = rn           EXECUTED = Y RESULT = PASS
FA3 = asd          EXECUTED = Y RESULT = PASS
FA4 = grn          EXECUTED = Y RESULT = PASS
FA5 = dn           EXECUTED = Y RESULT = PASS
OUTG DIGITS = 917777444409918000004
OUTG FNAI = intl

```

;

This example shows the output in debug format when the MO SMS NPP GSM protocol is used:

```
tst-msg:feat=mosmsnpp:loc=1101:prot=gsm:msgn=1:mode=debug
```

```

tekelecstp 09-08-02 10:46:51 EST  EAGLE 41.1.0
tst-msg:feat=mosmsnpp:loc=1101:prot=gsm:msgn=1:mode=debug
Command Accepted: Test message is sent.

```

;

```
tekelecstp 09-08-02 10:46:51 EST  EAGLE 41.1.0
```

## TST-MSG-RESULT

=====

MSG = 1

CGPA\_GT = 4

CGPA\_GT\_NAI = 4 CGPA = 0123456789abcde

CDPA\_GT = 4

CDPA\_GT\_NAI = 4 CDPA = 123456789

CGPN\_NAI = 1

CGPN\_NP = 1 CGPN = 919899999901

CDPN\_NAI = 1

CDPN\_NP = 1 CDPN = 919918000004

MOSMSGCGPN NPP PROCESSING

SERVICE NAME = mosmsgcgpn SERVICE STATUS = ON

INC DIGITS = 91989999901  
NAI = 1 FNAI = intl FDL = 12

## MATCHING RULE

FNAI = intl FDL = \* FPFX = \*  
ACTION SET NAME = gcgpn1

## CONDITIONING RESULT

CA1 = cc2 EXECUTED = Y RESULT = PASS  
CA2 = dnx EXECUTED = Y RESULT = PASS  
INC DIGITS = 91989999901  
COND DIGITS = 91989999901

## SERVICE APPLICATION

SA1 = fraudchk EXECUTED = Y FORMAT IND = N  
FRAUDCHK:CgPN is not Ported/Migrated  
RTDB LKPSUCC DN=91989999901  
PT =5 ASD =44  
SP =NONE SRFIMSI=NONE  
RN =3000 SRFIMSI=NONE  
VMSID=NONE SRFIMSI=NONE  
GRN =40 SRFIMSI=NONE  
SA2 = pprelay EXECUTED = Y FORMAT IND = Y  
PPRELAY:DN is Prepaid  
SA3 = asdlkup EXECUTED = Y FORMAT IND = N  
ASDLKUP: ASD Data Copied to NPPSTATE:ASD  
SA4 = grnlkup EXECUTED = Y FORMAT IND = N  
GRN Data Copied to NPPSTATE:GRN

## FORMATING RESULT

OUTG DIGITS =  
OUTG FNAI = unkn

;

tekelecstp 09-08-02 10:46:51 EST EAGLE 41.1.0

## MOSMSGCDPN NPP PROCESSING

SERVICE NAME = mosmsgcdpn SERVICE STATUS = ON

INC DIGITS = 919918000004  
NAI = 1 FNAI = intl FDL = 12

## MATCHING RULE

FNAI = intl FDL = \* FPFX = \*  
ACTION SET NAME = gcdpn1

## CONDITIONING RESULT

CA1 = cc2 EXECUTED = Y RESULT = PASS  
CA2 = dnx EXECUTED = Y RESULT = PASS  
INC DIGITS = 919918000004  
COND DIGITS = 919918000004

## SERVICE APPLICATION

SA1 = pprelay EXECUTED = Y FORMAT IND = N  
PPRELAY:CgPN is Prepaid, Do not check CdPN prepaid status



```

SA2 = cdpnp      EXECUTED = Y FORMAT IND = N
SMS NP:Validation Passed: NPPSTATE:RN=7777.
RTDB LKPSUCC DN=919918000004
PT   = 40          ASD   =56
SP   =NONE        SRFIMSI=NONE
RN   =7777        SRFIMSI=98989
VMSID=NONE       SRFIMSI=NONE
GRN  =40          SRFIMSI=NONE
SA3 = cgpnasdrqd EXECUTED = Y FORMAT IND = N
CGPNASDRQD:CgPN ASD Data Copied to NPPSTATE:ASD
SA4 = cgpngrnrqd EXECUTED = Y FORMAT IND = N
CGPNGRNRQD:CgPN GRN Data Copied to NPPSTATE:GRN

```

## FORMATING RESULT

```

FA1 = cc          EXECUTED = Y RESULT = PASS
FA2 = rn          EXECUTED = Y RESULT = PASS
FA3 = asd         EXECUTED = Y RESULT = PASS
FA4 = grn         EXECUTED = Y RESULT = PASS
FA5 = dn          EXECUTED = Y RESULT = PASS
OUTG DIGITS = 91777744409918000004
OUTG FNAI = intl

```

;

This example shows the output in debug mode for TIF Number Substitution:

```
tst-msg:msgn=1:prot=isup:loc=1215:feat=tif:mode=debug
```

```
tifstp 09-08-06 19:54:03 GMT EAGLE 41.1.0
```

```

SERVICE NAME = tif SERVICE STATUS = ON
INC DIGITS = 88123456
NAI = 4 FNAI = intl FDL = 8

```

## MATCHING RULE

```

FNAI = intl FDL = 8 FPFX = 88
ACTION SET NAME = set1

```

## CONDITIONING RESULT

```

CA1 = cc2          EXECUTED = Y RESULT = PASS
CA2 = ac1          EXECUTED = Y RESULT = PASS
CA3 = snx          EXECUTED = Y RESULT = PASS
INC DIGITS = 88123456
COND DIGITS = 88123456

```

## SERVICE APPLICATION

```

SA1 = nscdpn      EXECUTED = Y FORMAT = Y
INDIV CC=91 AC=5 SN=46789
SA2 = nscgpn      EXECUTED = Y FORMAT = Y
INDIV InCat=244 InDN=91123456
OutCat=4 OutDN=741852

```

## FORMATING RESULT

```

FA1 = cc          EXECUTED = Y RESULT = PASS
FA2 = ac          EXECUTED = Y RESULT = PASS

```

```
FA3 = sn          EXECUTED = Y RESULT = PASS
OUTG DIGITS = 91546789
OUTG FNAI = intl
;
```

This example shows the output in debug mode for TIF Number Substitution:

```
tst-msg:msgn=2:prot=isup:loc=1215:feat=tif:mode=debug
```

```
tklcl071001 09-08-05 10:13:22 EDT  EAGLE 41.1.0

SERVICE NAME = tif SERVICE STATUS = ON
  INC DIGITS = 2345678197001
  NAI = 4 FNAI = intl FDL = 20

MATCHING RULE
  FNAI = intl FDL = 20 PPFX = 2345
  ACTION SET NAME = tifasn1

CONDITIONING RESULT
  CA1 = ign3          EXECUTED = Y RESULT = PASS
  CA2 = znx           EXECUTED = Y RESULT = PASS
  INC DIGITS = 2345678197001
  COND DIGITS = 5678197001

SERVICE APPLICATION
  SA1 = nscdpn        EXECUTED = Y FORMAT = Y
  INDIV ZN=8474657346
  SA2 = nscgpn        EXECUTED = Y FORMAT = Y
  INDIV InCat=5      InDN=7463467238
  OutCat=7          OutDN=4736475834

FORMATING RESULT
  OUTG DIGITS = 8474657346
  OUTG FNAI = intl
;
```

This example shows the output in debug mode for TIF Number Substitution when the Formatting Action for the outgoing CgPN is RN ( `tifopts:iamcgpn=rn` ):

```
tst-msg:msgn=3:prot=isup:loc=1103:feat=tif:mode=debug
```

```
tifstp 09-08-06 19:52:42 GMT  EAGLE 41.1.0

SERVICE NAME = tif SERVICE STATUS = ON
  INC DIGITS = 88123456
  NAI = 4 FNAI = intl FDL = 8

MATCHING RULE
  FNAI = intl FDL = 8 PPFX = 88
  ACTION SET NAME = set1
```

```
CONDITIONING RESULT
CA1 = cc2          EXECUTED = Y RESULT = PASS
CA2 = ac1          EXECUTED = Y RESULT = PASS
CA3 = snx          EXECUTED = Y RESULT = PASS
INC DIGITS = 88123456
COND DIGITS = 88123456
```

```
SERVICE APPLICATION
SA1 = nscdpn       EXECUTED = Y FORMAT = Y
INDIV CC=91 AC=5  SN=46789
SA2 = nscgpn       EXECUTED = Y FORMAT = Y
No operation for IAMCGPN=RN
```

```
FORMATING RESULT
FA1 = cc           EXECUTED = Y RESULT = PASS
FA2 = ac           EXECUTED = Y RESULT = PASS
FA3 = sn           EXECUTED = Y RESULT = PASS
OUTG DIGITS = 91546789
OUTG FNAI = intl
```

;

This example shows the output in debug mode for TIF Number Substitution when no CgPN is present in the IAM message:

```
tst-msg:msgn=4:prot=isup:loc=1215:feat=tif:mode=debug
```

```
tifstp 09-08-06 19:50:08 GMT EAGLE 41.1.0
```

```
SERVICE NAME = tif SERVICE STATUS = ON
INC DIGITS = 88123456
NAI = 4 FNAI = intl FDL = 8
```

```
MATCHING RULE
FNAI = intl FDL = 8 FPFX = 88
ACTION SET NAME = set1
```

```
CONDITIONING RESULT
CA1 = cc2          EXECUTED = Y RESULT = PASS
CA2 = ac1          EXECUTED = Y RESULT = PASS
CA3 = snx          EXECUTED = Y RESULT = PASS
INC DIGITS = 88123456
COND DIGITS = 88123456
```

```
SERVICE APPLICATION
SA1 = nscdpn       EXECUTED = Y FORMAT = Y
INDIV CC=91 AC=5  SN=46789
SA2 = nscgpn       EXECUTED = Y FORMAT = Y
no cgpn
```

```
FORMATING RESULT
FA1 = cc           EXECUTED = Y RESULT = PASS
FA2 = ac           EXECUTED = Y RESULT = PASS
FA3 = sn           EXECUTED = Y RESULT = PASS
OUTG DIGITS = 91546789
```

```
        OUTG FNAI = intl  
;
```

This example shows the output in debug mode for TIF Number Substitution when the incoming Calling Party's Category value is the same as the TIFOPTS `nspublic` option value and the TIFOPTS `nsaddldata` option value is yes :

```
tst-msg:msgn=5:prot=isup:loc=1103:feat=tif:mode=debug
```

```
tifstp 09-08-06 20:16:09 GMT  EAGLE 41.1.0
```

```
SERVICE NAME = tif SERVICE STATUS = ON  
  INC DIGITS = 88123456  
  NAI = 4 FNAI = intl FDL = 8
```

```
MATCHING RULE  
  FNAI = intl FDL = 8 FPFX = 88  
  ACTION SET NAME = set1
```

```
CONDITIONING RESULT  
  CA1 = cc2          EXECUTED = Y RESULT = PASS  
  CA2 = ac1          EXECUTED = Y RESULT = PASS  
  CA3 = snx          EXECUTED = Y RESULT = PASS  
  INC DIGITS = 88123456  
  COND DIGITS = 88123456
```

```
SERVICE APPLICATION  
  SA1 = nscdpn       EXECUTED = Y FORMAT = Y  
  INDIV CC=91 AC=5 SN=46789  
  SA2 = nscgpn       EXECUTED = Y FORMAT = Y  
  Incoming CgPN category is NSPublic
```

```
FORMATING RESULT  
  FA1 = cc          EXECUTED = Y RESULT = PASS  
  FA2 = ac          EXECUTED = Y RESULT = PASS  
  FA3 = sn          EXECUTED = Y RESULT = PASS  
  OUTG DIGITS = 91546789  
  OUTG FNAI = intl
```

```
;
```

This example shows the output when the GTT feature is turned on for `mode=full` or `mode=debug`:

```
tst-msg:msgn=1:prot=sccp:feat=gtt:loc=1105:mode=full
```

```
tekelecstp 16-10-04 10:10:38 MST  EAGLE 46.5.0.0.0-70.5.0
```

```
GTT Trace Tool:
```

```
Input:  
EAGLE-Generated? No  
OPCI    = 3-003-2  
LSN     = 1s332
```

DPCI = 1-001-1  
SelId = -----

CDPA: GTI=2  
TT=20  
SSN=6  
PCI=1-001-1  
ADDR=123456

CGPA: GTI=2  
TT=10  
SSN=8  
PCI=3-003-2  
ADDR=121212

GTT Search Results:

Search Hierarchy: FLOBR CDPA CGPA

GTT Set Name Key	Set Type	CgPA/CdPA		FallBack	Found	Matching
		SELID	TestMode			
set1	CDPA GTA	-----	OFF	Dft	Y	123456
set3	CGPA GTA	-----	OFF	Dft	Y	121212

Search Depth = 2  
Loop Detected = No

Translation Results:  
Translation Found: Yes [GTT Set Name = set3]  
DPCI = 2-002-2  
RI = GT  
GTMOD = gt1  
Action Set = set

Actid	Action	DPC	RI	SSN	MAPSET/ MRNSET	ErrCode
UIMREQD						
dup1	DUP	3-003-2	GT	---	-----	----
-						
dup2	DUP	3-003-2	GT	---	-----	----
-						
dup3	DUP	3-003-2	GT	---	-----	----
-						
dup4	DUP	3-003-2	GT	---	-----	----
-						
dup5	DUP	3-003-2	GT	---	-----	----
-						

```
fwd1      FWD      3-003-2      GT   ---  -----  ----  -  
  
Command Complete
```

;

This example shows the output when the GTT feature is turned on for mode=brief:

```
tst-msg:msgn=1:prot=sccp:feat=gtt:loc=1105:mode=brief
```

```
tekelecstp 16-10-04 10:12:33 MST  EAGLE 46.5.0.0.0-70.5.0
```

```
GTT Trace Tool:
```

```
Input:
```

```
EAGLE-Generated? No
```

```
OPCI      = 3-003-2
```

```
LSN       = 1s332
```

```
DPCI      = 1-001-1
```

```
SelId     = -----
```

```
CDPA:  GTI=2
```

```
        TT=20
```

```
        SSN=6
```

```
        PCI=1-001-1
```

```
        ADDR=123456
```

```
CGPA:  GTI=2
```

```
        TT=10
```

```
        SSN=8
```

```
        PCI=3-003-2
```

```
        ADDR=121212
```

```
GTT Search Results:
```

```
Search Hierarchy:  FLOBR CDPA CGPA
```

```
GTT Set Name(s):  set1,set3
```

```
Search Depth = 2
```

```
Loop Detected = No
```

```
Translation Results:
```

```
Translation Found: Yes [GTT Set Name = set3]
```

```
DPCI = 2-002-2
```

```
RI   = GT
```

```
GTMOD = gt1
```

```
Action Set = set
```

```
Actid(s):  dup1,dup2,dup3,dup4,dup5,fwd1
```

```
Command Complete
```

;

This example shows the output with scpval, sftthrot and sflog gttactions.

```
tst-msg:msgn=1:loc=1103:prot=sccp:feat=gtt
```

```
GTT Trace Tool:
```

```
Input:
```

```
EAGLE-Generated? No
OPC      = 004-005-006
LSN      = 1s456
DPC      = 001-001-001
SelId    = -----
```

```
CDPA:   GTI=2
        TT=10
        SSN=6
        PC=010-010-010
        ADDR=1234567890
```

```
CGPA:   GTI=2
        TT=0
        SSN=8
        PC=020-020-020
        ADDR=1234567890
```

```
Family=none
```

```
Family2=notpresent
```

```
Family3=notpresent
```

```
Opcode=0
```

```
Opcode2=notpresent
```

```
Opcode3=notpresent
```

```
Pkgtype=bgn  (0x62)
```

```
Acn= none
```

```
MAP Parameters Present in Test Message:
```

```
-- No Param
```

```
GTT Search Results:
```

```
Search Hierarchy:  FLOBR CDPA
```

```

                                     CgPA/CdPA
GTT Set Name      Set Type  SELID TestMode FallBack Found Matching
Key
set1              OPCODE    ----- OFF    Dft      Y    pkg=bgn
```

```

(0x62)
acn=any
op =0, prio =1024
op2=notpresent,
prio2=notpresent
prio3=notpresent
op3=notpresent,

Search Depth = 1
Loop Detected = No

Translation Results:
Translation Found: Yes [GTT Set Name = set1]
DPC = 004-005-006
RI = GT
GTMOD = -----
Action Set = actset1
GTT user action: Discard MSU

Actid      Action  DPC          RI  SSN  MAPSET/  ErrCode  UIMREQD
          MRNSET
sfthrot1   SFTHROT  ----         ---  ---  -----  ----     -
dup1       DUP      004-005-008  GT   ---  -----  ----     -
sflog1     SFLOG    ----         ---  ---  -----  ----     -
scpvall1   SCPVAL   ----         ---  ---  -----  ----     N
disc1      DISC     ----         ---  ---  -----  ----     N

Command Complete

```

This example shows the output in brief mode for the Info Analyzed Relay Base feature:

```
tst-msg:loc=1101:prot=tatr:feat=iar:msgn=1:mode=brief
```

```

tekelecstp 09-07-24 18:20:46 EST  EAGLE 41.1.0
tst-msg:feat=iar:prot=tatr:msgn=1:mode=brief
Command Accepted: Test message is sent.
;

```

```

TST-MSG-RESULT
=====
IAR Decoding Successfull., (0)
TTR Preprocessing successful.
TTR CgPN Encoded

MSG = 1

SCCP
CGPA_GTI = 2
CGPA_GT_NAI = 4          CGPA = 9194605500

```



```

CDPA_GTI = 2
CDPA_GT_NAI = 3          CDPA = 404009246139988

TCAP
TRIG = 26
CGPN_NAI = 48           CGPN = 9246138610
CDPN_NAI = 48           CDPN = 9246138700

CDPN NPP PROCESSING
SERVICE NAME = iarcdpn SERVICE STATUS = ON
INC DIGITS = 9246138700
NAI = 48 FNAI = intl FDIGLEN = 10

MATCHING RULE
FNAI = intl FDIGLEN = 0 PPFX = *
ACTION SET NAME = DSET1

CONDITIONING RESULT
INC DIGITS = 9246138700
COND DIGITS = 19246138700

FORMATING RESULT
OUTG DIGITS = 198769246138700
OUTG FNAI = intl

CGPN NPP PROCESSING
SERVICE NAME = iarcgpn SERVICE STATUS = ON
INC DIGITS = 9246138610
NAI = 49 FNAI = natl FDIGLEN = 10

MATCHING RULE
FNAI = natl FDIGLEN = 0 PPFX = *
ACTION SET NAME = DSET2

CONDITIONING RESULT
INC DIGITS = 9246138610
COND DIGITS = 19246138610

FORMATING RESULT
OUTG DIGITS = 15555924613861044443333
OUTG FNAI = intl

```

This example shows the output in full mode for the Info Analyzed Relay Base feature:

```
tst-msg:loc=1101:prot=tatr:feat=iar:msgn=1:mode=full
```

```

tekelecstp 09-07-24 18:20:46 EST EAGLE 41.1.0
tst-msg:feat=iar:prot=tatr:msgn=1:mode=full
Command Accepted: Test message is sent.

```

```
;
```

```

TST-MSG-RESULT
=====
IAR Decoding Successfull., (0)

```

```
TTR Preprocessing successful.
TTR CgPN Encoded

MSG = 1

SCCP
CGPA_GTI = 2
CGPA_GT_NAI = 4          CGPA = 9194605500
CDPA_GTI = 2
CDPA_GT_NAI = 3          CDPA = 404009246139988

TCAP
TRIG = 26
CGPN_NAI = 48           CGPN = 9246138610
CDPN_NAI = 48           CDPN = 9246138700

CDPN NPP PROCESSING
SERVICE NAME = iarcdpn SERVICE STATUS = ON
INC DIGITS = 9246138700
NAI = 48 FNAI = intl FDIGLEN = 10

MATCHING RULE
FNAI = intl FDIGLEN = 0 PPFX = *
ACTION SET NAME = DSET1

CONDITIONING RESULT
CA1 = ccdef             EXECUTED = Y RESULT = PASS
CA2 = dnx               EXECUTED = Y RESULT = PASS
INC DIGITS = 9246138700
COND DIGITS = 19246138700

SERVICE APPLICATION
SA1 = cdpnp             EXECUTED = Y FORMAT = Y
SA2 = cgpnasdrqd       EXECUTED = Y FORMAT = Y
SA3 = cgpngrnrqd       EXECUTED = Y FORMAT = Y

FORMATING RESULT
FA1 = cc               EXECUTED = Y RESULT = PASS
FA2 = rn               EXECUTED = Y RESULT = PASS
FA3 = sp               EXECUTED = Y RESULT = PASS
FA4 = srfimsi          EXECUTED = Y RESULT = PASS
FA5 = dn               EXECUTED = Y RESULT = PASS
FA6 = asd              EXECUTED = Y RESULT = PASS
FA7 = grn              EXECUTED = Y RESULT = PASS
OUTG DIGITS = 198769246138700
OUTG FNAI = intl

CGPN NPP PROCESSING
SERVICE NAME = iarcgpn SERVICE STATUS = ON
INC DIGITS = 9246138610
NAI = 49 FNAI = natl FDIGLEN = 10

MATCHING RULE
FNAI = natl FDIGLEN = 0 PPFX = *
```

```
ACTION SET NAME = DSET2

CONDITIONING RESULT
  CA1 = ccdef      EXECUTED = Y RESULT = PASS
  CA2 = dnx        EXECUTED = Y RESULT = PASS
  INC DIGITS = 9246138610
  COND DIGITS = 19246138610

SERVICE APPLICATION
  SA1 = cgpnp      EXECUTED = Y FORMAT = Y
  SA2 = asdlkup    EXECUTED = Y FORMAT = Y
  SA3 = grnlkup    EXECUTED = Y FORMAT = Y

FORMATING RESULT
  FA1 = cc         EXECUTED = Y RESULT = PASS
  FA2 = rn         EXECUTED = Y RESULT = PASS
  FA3 = sp         EXECUTED = Y RESULT = PASS
  FA4 = srfimsi    EXECUTED = Y RESULT = PASS
  FA5 = dn         EXECUTED = Y RESULT = PASS
  FA6 = asd        EXECUTED = Y RESULT = PASS
  FA7 = grn        EXECUTED = Y RESULT = PASS
  OUTG DIGITS = 15555924613861044443333
  OUTG FNAI = intl
```

This example shows the output in debug mode for the Info Analyzed Relay Base feature:

```
tst-msg:loc=1101:prot=tatr:feat=iar:msgn=2:mode=debug
```

```
tekelecstp 09-07-24 18:20:46 EST  EAGLE 41.1.0
tst-msg:feat=iar:prot=tatr:msgn=2:mode=debug
Command Accepted: Test message is sent.
```

```
;
```

```
TST-MSG-RESULT
=====
IAR DEST NUM decode error., (0)
TTR Preprocessing successful.
TTR CgPN Encoded

MSG = 2

SCCP
  CGPA_GTI = 2
  CGPA_GT_NAI = 4      CGPA = 9194605500
  CDPA_GTI = 2
  CDPA_GT_NAI = 3      CDPA = 404009246139988

TCAP
  TRIG = 26
  CGPN_NAI = 48      CGPN = 9876543210
  CDPN_NAI = 49      CDPN = 135792468011223344

CDPN NPP PROCESSING
```

```
SERVICE NAME = iarcdpn SERVICE STATUS = ON
INC DIGITS = 135792468011223344
NAI = 48 FNAI = intl FDIGLEN = 18
```

```
MATCHING RULE
FNAI = intl FDIGLEN = 0 PPFX = *
ACTION SET NAME = DSET1
```

```
CONDITIONING RESULT
CA1 = ccdef EXECUTED = Y RESULT = PASS
CA2 = dnx EXECUTED = Y RESULT = PASS
INC DIGITS = 135792468011223344
COND DIGITS = 1135792468011223344
```

```
SERVICE APPLICATION
SA1 = cdpnp EXECUTED = Y FORMAT = Y
ENTITY = RN - SPORT APPLIED, RESULT = SUCCESS SA2 = cgpnasdrqd
EXECUTED = Y FORMAT = Y
CgPN ASD will be made available during CdpN FAE.
SA3 = cgpngrnrqd EXECUTED = Y FORMAT = Y
CgPN GRN will be made available during CdpN FAE.
```

```
FORMATING RESULT
FA1 = cc EXECUTED = Y RESULT = PASS
FA2 = rn EXECUTED = Y RESULT = PASS
FA3 = sp EXECUTED = Y RESULT = PASS
FA4 = srfimsi EXECUTED = Y RESULT = PASS
FA5 = dn EXECUTED = Y RESULT = PASS
FA6 = asd EXECUTED = Y RESULT = PASS
FA7 = grn EXECUTED = Y RESULT = PASS
OUTG DIGITS = 19876135792468011223344
OUTG FNAI = natl
```

```
CGPN NPP PROCESSING
SERVICE NAME = iarcgpn SERVICE STATUS = ON
INC DIGITS = 9876543210
NAI = 48 FNAI = intl FDIGLEN = 10
```

```
MATCHING RULE
FNAI = intl FDIGLEN = 0 PPFX = *
ACTION SET NAME = DSET2
```

```
CONDITIONING RESULT
CA1 = ccdef EXECUTED = Y RESULT = PASS
CA2 = dnx EXECUTED = Y RESULT = PASS
INC DIGITS = 9876543210
COND DIGITS = 19876543210
```

```
SERVICE APPLICATION
SA1 = cgpnp EXECUTED = Y FORMAT = Y
ENTITY = SP, RESULT = SUCCESS

SA2 = asdlkup EXECUTED = Y FORMAT = Y
ASD lkup done
SA3 = grnlkup EXECUTED = Y FORMAT = Y
```

GRN lkup done

```
FORMATING RESULT
FA1 = cc          EXECUTED = Y RESULT = PASS
FA2 = rn          EXECUTED = Y RESULT = PASS
FA3 = sp          EXECUTED = Y RESULT = PASS
FA4 = srfimsi     EXECUTED = Y RESULT = PASS
FA5 = dn          EXECUTED = Y RESULT = PASS
FA6 = asd         EXECUTED = Y RESULT = PASS
FA7 = grn         EXECUTED = Y RESULT = PASS
OUTG DIGITS = 155555987654321044443333
OUTG FNAI = intl
```

This example shows the output in brief mode with TIF processing that invokes the TIFCGPN service:

```
tst-msg:loc=1105:prot=isup:feat=tif:msgn=8:mode=brief
```

```
tekelecstp 11-02-16 13:54:10 EAGLE EST 44.0.0
SERVICE NAME = tif SERVICE STATUS = ON
INC DIGITS = 5001234567890
NAI = 4 FNAI = intl FDL = 13
```

```
MATCHING RULE
FNAI = intl FDL = 13 FPFX = 500
ACTION SET NAME = as90
INVOKE SERVICE = tificgpn
```

```
CONDITIONING RESULT
INC DIGITS = 5001234567890
COND DIGITS = 5001234567890
```

```
FORMATING RESULT
OUTG DIGITS = 1234567890
OUTG FNAI = intl
```

;

```
tekelecstp 11-02-16 13:54:10 EAGLE EST 44.0.0
SERVICE NAME = tificgpn SERVICE STATUS = ON
INC DIGITS = 5701234567
NAI = 4 FNAI = intl FDL = 10
```

```
MATCHING RULE
FNAI = intl FDL = 10 FPFX = 570
ACTION SET NAME = as130
INVOKE SERVICE = none
```

```
CONDITIONING RESULT
INC DIGITS = 5701234567
COND DIGITS = 5701234567
```

```
FORMATING RESULT
OUTG DIGITS = UNMODIFIED
```

```
        OUTG FNAI = UNMODIFIED
;
tekelecstp 11-02-16 13:54:10 EAGLE EST 44.0.0

TIF SERVICE
    REL will be sent without redirection number
;
```

This example shows the output in Full mode shows TIF processing that invokes the TIFCGPN service:

```
tst-msg:loc=1105:prot=isup:feat=tif:msgn=8:mode=full
```

```
tekelecstp 11-02-16 13:52:44 EAGLE EST 44.0.0

SERVICE NAME = tif SERVICE STATUS = ON
    INC DIGITS = 5001234567890
    NAI = 4 FNAI = intl FDL = 13

MATCHING RULE
    FNAI = intl FDL = 13 PPFX = 500
    ACTION SET NAME = as90
    INVOKE SERVICE = tificgpn

CONDITIONING RESULT
    CA1 = cc3          EXECUTED = Y RESULT = PASS
    CA2 = dnx          EXECUTED = Y RESULT = PASS
    INC DIGITS = 5001234567890
    COND DIGITS = 5001234567890

SERVICE APPLICATION
    SA1 = cdial        EXECUTED = Y FORMAT = Y

FORMATING RESULT
    FA1 = dn           EXECUTED = Y RESULT = PASS
    OUTG DIGITS = 1234567890
    OUTG FNAI = intl
;

tekelecstp 11-02-16 13:52:44 EAGLE EST 44.0.0

SERVICE NAME = tificgpn SERVICE STATUS = ON
    INC DIGITS = 5701234567
    NAI = 4 FNAI = intl FDL = 10

MATCHING RULE
    FNAI = intl FDL = 10 PPFX = 570
    ACTION SET NAME = as130
    INVOKE SERVICE = none

CONDITIONING RESULT
    CA1 = cc3          EXECUTED = Y RESULT = PASS
    CA2 = ac3          EXECUTED = Y RESULT = PASS
    CA3 = snx          EXECUTED = Y RESULT = PASS
```

```
INC DIGITS = 5701234567
COND DIGITS = 5701234567

SERVICE APPLICATION
  SA1 = fpxrls    EXECUTED = Y FORMAT = N

FORMATING RESULT
  OUTG DIGITS = UNMODIFIED
  OUTG FNAI = UNMODIFIED
;
tekelecstp 11-02-16 13:52:44 EAGLE EST 44.0.0

TIF SERVICE
  REL will be sent without redirection number
;
```

This example shows the output in DEBUG mode with TIF processing that invokes the TIFCGPN service:

```
tst-msg:loc=1105:prot=isup:feat=tif:msgn=8:mode=debug
```

```
tekelecstp 11-02-16 13:55:39 EAGLE EST 44.0.0

SERVICE NAME = tif SERVICE STATUS = ON
  INC DIGITS = 5001234567890
  NAI = 4 FNAI = intl FDL = 13

MATCHING RULE
  FNAI = intl FDL = 13 FPFX = 500
  ACTION SET NAME = as90
  INVOKE SERVICE = tificgpn

CONDITIONING RESULT
  CA1 = cc3      EXECUTED = Y RESULT = PASS
  CA2 = dnx      EXECUTED = Y RESULT = PASS
  INC DIGITS = 5001234567890
  COND DIGITS = 5001234567890

SERVICE APPLICATION
  SA1 = cdial    EXECUTED = Y FORMAT = Y
  Set FASKIP to FALSE, previous value was FALSE.

FORMATING RESULT
  FA1 = dn      EXECUTED = Y RESULT = PASS
  OUTG DIGITS = 1234567890
  OUTG FNAI = intl
;
tekelecstp 11-02-16 13:55:39 EAGLE EST 44.0.0

SERVICE NAME = tificgpn SERVICE STATUS = ON
  INC DIGITS = 5701234567
  NAI = 4 FNAI = intl FDL = 10

MATCHING RULE
```

```

FNAI = intl FDL = 10 FPFX = 570
ACTION SET NAME = as130
INVOKE SERVICE = none

CONDITIONING RESULT
CA1 = cc3          EXECUTED = Y RESULT = PASS
CA2 = ac3          EXECUTED = Y RESULT = PASS
CA3 = snx          EXECUTED = Y RESULT = PASS
INC DIGITS = 5701234567
COND DIGITS = 5701234567

SERVICE APPLICATION
SA1 = fpxrls      EXECUTED = Y FORMAT = N
SAVAL1 (ANSI ISUP)=54 SAVAL2 (ITU ISUP)=43
NOT SEARCHED, RLS cause=FPFXRLS(4)

FORMATING RESULT
OUTG DIGITS = UNMODIFIED
OUTG FNAI = UNMODIFIED
;
tekelecstp 11-02-16 13:55:39 EAGLE EST 44.0.0

TIF SERVICE
REL will be sent without redirection number
;

```

This example displays the command output in debug format for the IDPRCDPN2 service when the INPRTG Service Action generates a connect response and the DRA digits are formatted by NPP.

```

tst-msg:feat=ttr:prot=ttr:msgn=1:mode=debug

tekelecstp 12-02-31 18:20:46 EST EAGLE 45.0.0
tst-msg:feat=ttr:prot=ttr:msgn=1:mode=debug
Command Accepted: Test message is sent.
;
TST-MSG-RESULT
=====

MSG = 1          TCAP_TYPE = INAP

SCCP
CGPA_GT = 2
CGPA_GT_NAI = 4      CGPA = 0123456789abcde
CDPA_GT = 2
CDPA_GT_NAI = 4      CDPA = 9912345

TCAP
SK = 00000003      BCSM = 02
CGPN_NAI = 4        CGPN = 81123457
CDPN_NAI = 4        CDPN = 91123457

CDPN NPP PROCESSING

SERVICE NAME = idprcdpn3 SERVICE STATUS = ON

```



INC DIGITS = 91123457  
NAI = 4 FNAI = intl FDL = 8

## MATCHING RULE

FNAI = intl FDL = 8 FPFX = 91  
ACTION SET NAME = cdset5

## CONDITIONING RESULT

CA1 = cc2 EXECUTED = Y RESULT = PASS  
CA2 = dn6 EXECUTED = Y RESULT = PASS  
INC DIGITS = 91123457  
COND DIGITS = 91123457

## SERVICE APPLICATION

SA1 = inprtg EXECUTED = Y FORMAT = N  
INPRTG SA executed from IDPRCDPN3 NPP service  
INDIV Action=INPRTG CONNECT Tokens: RN=a12  
SA2 = cdpnpn EXECUTED = Y FORMAT = N  
CDPNNP SA processing bypassed if INPRTG SA  
generating a response  
SA3 = cgpnsvcrqd EXECUTED = Y FORMAT = N  
SA4 = skgtartg EXECUTED = Y FORMAT = N  
SA5 = grnlkup EXECUTED = Y FORMAT = N  
Entity = 3 GRN = c12  
SA6 = asdlkup EXECUTED = Y FORMAT = N  
ASD = d12

## FORMATING RESULT

OUTG DIGITS = UNMODIFIED  
OUTG FNAI = UNMODIFIED

;

## CGPN NPP PROCESSING

SERVICE NAME = idprcgpn SERVICE STATUS = ON  
INC DIGITS = 81123457  
NAI = 4 FNAI = intl FDL = 8

## MATCHING RULE

FNAI = intl FDL = 8 FPFX = 81  
ACTION SET NAME = cgset2

## CONDITIONING RESULT

CA1 = cc2 EXECUTED = Y RESULT = PASS  
CA2 = ac2 EXECUTED = Y RESULT = PASS  
CA3 = sn4 EXECUTED = Y RESULT = PASS  
INC DIGITS = 81123457  
COND DIGITS = 81123457

## SERVICE APPLICATION

SA1 = inprtg EXECUTED = Y FORMAT = Y  
INPRTG SA execution bypassed for IDPRCGPN NPP service  
since it has already executed in IDPRCDPN3 NPP service  
SA2 = cgpnpn EXECUTED = Y FORMAT = Y  
CGPNNP SA processing bypassed if INPRTG SA

```
generating a response
SA3 = asdlkup      EXECUTED = Y FORMAT = Y
ASD = ddd1
SA4 = grnlkup      EXECUTED = Y FORMAT = Y
Entity = 3 GRN = ccc1

FORMATING RESULT
FA1 = asd          EXECUTED = Y RESULT = PASS
FA2 = grn          EXECUTED = Y RESULT = PASS
OUTG DIGITS = ddd1ccc1
OUTG FNAI = intl
;

INPRTG CONNECT RESPONSE DRA FORMATING RESULT
ACTION SET NAME = cdset5
FA LIST = FARN
FA1 = cc          EXECUTED = Y RESULT = PASS
FA2 = grn         EXECUTED = Y RESULT = PASS
FA3 = rn          EXECUTED = Y RESULT = PASS
FA4 = dn          EXECUTED = Y RESULT = PASS
OUTG DIGITS = 91c12a12123457
;
```

### Related Topics

- [chg-gsm-msg](#)
- [chg-is41-msg](#)
- [chg-isup-msg](#)
- [chg-sccp-msg](#)
- [chg-tatr-msg](#)
- [chg-ttr-msg](#)
- [rtrv-gsm-msg](#)
- [rtrv-is41-msg](#)
- [rtrv-isup-msg](#)
- [rtrv-sccp-msg](#)
- [rtrv-tatr-msg](#)
- [rtrv-ttr-msg](#)

## tst-npp-msg

Use this command to provision and test the NPP provided service, NPPT. The NPP Test Service allows customers to provision NPP Action Sets and Rules associated with the NPPT Service Rule Set. Customers can inject test messages to a provisioned NPPT Service Rule to verify proper digit string processing.

## Parameters

### **digs (mandatory)**

Digits. The incoming digit string for NPP to process.

**Range:**

1 - 32

### **loc (mandatory)**

The Service Module card to which the test message is issued.

**Range:**

1101 - 1108, 1111 - 1112, 1201 - 1208, 1211 - 1218, 1301 - 1308, 1311 - 1318,  
2101 - 2108, 2111 - 2118, 2201 - 2208, 2211 - 2218, 2301 - 2308, 2311 - 2318,  
3101 - 3108, 3111 - 3118, 3201 - 3208, 3211 - 3218, 3301 - 3308, 3311 - 3318,  
4101 - 4108, 4111 - 4118, 4201 - 4208, 4211 - 4218, 4301 - 4308, 4311 - 4318,  
5101 - 5108, 5111 - 5118, 5201 - 5208, 5211 - 5218, 5301 - 5308, 5311 - 5318,  
6101 - 6108, 6111 - 6118

### **nai (mandatory)**

Incoming digit string Nature of Address Indicator (NAI) mapping value.

**Range:**

0 - 255

### **mode (optional)**

The output format.

**Range:**

***brief***

summary format

***full***

full format

***debug***

debug format

**Default:**

*brief*

## Example

```
tst-npp-msg:loc=1101:mode=full:digs=0ab4041234567:nai=3
```

## Dependencies

None.

## Output

When the `mode=full` or `mode=debug` parameter is specified, the `FORMAT` field indicates whether formatting actions are executed. If formatting actions are not executed, then the `OUTG DIGITS` field displays a value of `UNMODIFIED`. If any digit string is blank, then the associated field displays a value of `EMPTY`.

The numbers shown to identify Conditioning Actions, Service Actions, and Formatting Actions are the individual parameter numbers or the position of the value in the parameter list when the command was entered. For example, CA2 identifies either the value for the `ca2` parameter or the second CA value in the `ca` parameter list in the command (such as `ac3` in the `ca=cc2, ac3` parameter).

```
tst-npp-msg:loc=1101:digs=9090920292252645:nai=7:mode=full
```

```
SERVICE NAME = nppt SERVICE STATUS = ON
  INC DIGITS = 9090920292252645
  NAI = 7 FNAI = intl FDL = 16

MATCHING RULE
  FNAI = intl FDL = 16 FPFX = 9090
  ACTION SET NAME = set1

CONDITIONING RESULT
  CA1 = ign4      EXECUTED = Y RESULT = PASS
  CA2 = cc2      EXECUTED = Y RESULT = PASS
  CA3 = dn10     EXECUTED = Y RESULT = PASS
  INC DIGITS = 9090920292252645
  COND DIGITS = 920292252645

SERVICE APPLICATION
  SA1 = rtdbtrn  EXECUTED = Y FORMAT = Y

FORMATING RESULT
  FA1 = cc      EXECUTED = Y RESULT = PASS
  FA2 = rn      EXECUTED = Y RESULT = PASS
  FA3 = dn      EXECUTED = Y RESULT = PASS
  OUTG DIGITS = 92abcd0292252645
  OUTG FNAI = intl
```

```
tst-npp-msg:loc=1101:digs=0609192252645:nai=5:mode=full
```

```
SERVICE NAME = nppt SERVICE STATUS = ON
  INC DIGITS = 0609192252645
  NAI = 5 FNAI = natl FDL = 13

MATCHING RULE
  FNAI = natl FDL = 13 FPFX = 060
  ACTION SET NAME = set2

CONDITIONING RESULT
  CA1 = ccdef    EXECUTED = Y RESULT = PASS
  CA2 = ign3     EXECUTED = Y RESULT = PASS
  CA3 = dn7      EXECUTED = Y RESULT = PASS
  INC DIGITS = 0609192252645
  COND DIGITS = 989192252

SERVICE APPLICATION
  SA1 = rtdbtrnsp EXECUTED = Y FORMAT = Y
```

```

FORMATING RESULT
  FA1 = rn          EXECUTED = Y RESULT = PASS
  FA2 = sp          EXECUTED = Y RESULT = PASS
  FA3 = orig        EXECUTED = Y RESULT = PASS
  OUTG DIGITS = 1bce0609192252645
  OUTG FNAI = natl

```

## tst-slk

Use this command for testing signaling links.

- The loopback parameter on the `tst-slk` command provides the ability to select from among the following loopback tests: local transceiver (`lxvr`), `oam`, `line`, `payload`, and either low-speed signaling links or ATM high-speed signaling links (`sltc`).
- The command is not valid on E5-ENET-B cards with SS7IPGW and IPGWI links.
- For low-speed links, `LXVR` and `SLTC` tests are allowed.
- For E5-ATM-B cards, the `LXVR`, `SLTC`, `PAYLOAD`, `LINE`, and `OAM` tests are allowed.
- For E5-ENET-B cards with IPLHC links, the `SLTC` test is allowed.
- For E5-E1T1-B cards, only the `SLTC` test is allowed.
- For E5-ENET-B or SLIC cards running the IPSP application, the command is only supported for IPSP-M2PA signaling links, and the `SLTC` test is allowed.

See [Summary of Loopback Testing Commands and Functions](#) in Appendix A.

### Parameters

#### **link (mandatory)**

The signaling link on the card specified in the `loc` parameter. The links can be specified in any sequence or pattern.

#### **Synonym:**

*port*

#### **Range:**

*a, b, a1 - a63, b1 - b63*

Not all card types support all link parameter values.

See [Table A-1](#) for valid link parameter range values for each type of card that can have a location specified in the `loc` parameter.

#### **loc (mandatory)**

The card location as stenciled on the shelf of the system.

#### **Range:**

*1101 - 1108, 1111 - 1112, 1201 - 1208, 1211 - 1218, 1301 - 1308, 1311 - 1318,  
2101 - 2108, 2111 - 2118, 2201 - 2208, 2211 - 2218, 2301 - 2308, 2311 - 2318,  
3101 - 3108, 3111 - 3118, 3201 - 3208, 3211 - 3218, 3301 - 3308, 3311 - 3318,  
4101 - 4108, 4111 - 4118, 4201 - 4208, 4211 - 4218, 4301 - 4308, 4311 - 4318,  
5101 - 5108, 5111 - 5118, 5201 - 5208, 5211 - 5218, 5301 - 5308, 5311 - 5318,  
6101 - 6108, 6111 - 6118*

**action (optional)**

Indicator of command action to stop or start a test.

**Range:**

*start*

*stop*

**Default:**

*start*

**force (optional)****Range:**

*yes*

*no*

**Default:**

*no*

**loopback (optional)**

The type of loopback test to run

**Range:*****line***

This test is similar to the payload loopback test, but the data transmitted to the remote system is received by the remote system's ATM driver.

***lxvr***

Loopback at the local transceiver without involving the remote STP. For the ADS0, AINF, AOCU, and AV35 appliques, the MTP-2 protocol stack and ISCC hardware are tested. For AATM applique and DS1 interface, the AATM hardware, ATM level 2 protocol stack, and AAL5CP portion of ATM driver are tested,

***oam***

Messages are passed between local and remote systems to guarantee that the ATMM portion of ATM driver is functioning.

***payload***

This test is similar to the local transceiver loopback test. The wire is also tested because the loopback is at the remote's DS1 interface instead of the local's DS1 interface.

***sltc***

This test can be run on either the low-speed signaling links or the ATM high-speed signaling links. This is the only test that is supported for *m2pa* links on IPLHC cards.

**Default:**

*sltc*

**time (optional)**

The time duration for testing the link.

**Range:**

1 - 240000

hhmmss

hh=hours (00-24)

mm=minutes (00-59)

ss=seconds (00-59)

For example, `time=1` or `time=000001` is one second; `time=240000` is 24 hours; `time=200` or `time=000200` is 2 minutes.

**Default:**

1

**Example**

```
tst-slk:loc=1203:link=a
```

```
tst-slk:loc=1203:link=a:loopback=lxvr
```

```
tst-slk:loc=1205:link=b:time=000200:force=yes:action=start
```

```
tst-slk:loc=1205:link=b:action=stop
```

```
tst-slk:loc=1205:link=b:time=200
```

**Dependencies**

The card in the location indicated by the `loc` parameter must already be equipped.

A card location that is valid and defined in the database must be specified.

- A card location equipped with an E5-APP-B card cannot be specified.
- A card location equipped with a Telco Switch cannot be specified.

If the signaling link is an ATM HSL signaling link, only the `link=a` parameter can be specified.

This command is not supported for cards running the IPGHC application.

The *payload* and *line* values are not valid for the `loopback` parameter when the card is an E1 ATM.

Only the SLTC test can be run on card types LIME1 and LIMT1.

The card must contain the specified signaling link.

The specified signaling link must be provisioned in the database.

The specified signaling link must be an SS7 signaling link.

The signaling link that is used for LFS (Link Fault Sectionalization) testing cannot be active.

A previously entered command for a link test must be accepted before another link test command can be entered.

This command cannot be entered if the LFS test is running on the specified link.

The specified link cannot be in Command Driven Loopback (CDL) when this command is entered. The link must be removed from CDL before this command can be entered for the link. (See the `act/dact-cdl` commands).

The `force=yes` parameter must be specified to start a test when 256 or more tests are already running in the system.

This command cannot be entered if the maximum number of LFS or link tests are already running in the system. At least one active test must complete before the command can be entered again.

Only one link test can be running on a signaling link at one time.

The `action=stop` parameter cannot be specified when there is no active link test running on the specified link.

When the `action=stop` parameter is specified, the `loopback`, `time`, and `force` parameters cannot be specified.

If an IPSPG-M3UA signaling link is used, then this command cannot be entered.

If an IPSPG-M2PA signaling link is used, the `loopback=sltc` parameter must be specified.

The card must be equipped and in service, and must be one of the following cards:

- E5-E1T1-B card running the SS7ANSI or CCS7ITU application
- E5-ATM-B card running the ATMANSI or ATMITU application
- E5-ENET-B card running the IPLHC or IPSPG application
- SLIC card running the IPSPG application

### Notes

The `lxvr` and `sltc` loopback tests can be run on low-speed signaling links. All the loopback tests can be run on the ATM high-speed signaling links.

### Output

If the card is inhibited (not in service), this message appears when a link test is attempted:

```
tst-slk:loc=1203:link=a
```

```
rlghncxa03w 03-11-07 16:19:08 EST EAGLE 31.3.0  
Command Rejected : Card is not in service.
```

```
;
```

```
tst-slk:loc=1205:link=b:time=000200:force=yes:action=start
```

```
tekelecstp 03-11-27 16:15:20 EST EAGLE 31.3.0  
tst-slk:loc=1205:link=b:time=000200:force=yes:action=start  
Command Accepted: Test Link message is sent.
```

```
;
```

```
tekelecstp 03-11-27 16:15:22 EST EAGLE 31.3.0  
Command Completed.
```

```
;
```

```
tekelecstp 03-11-27 16:22:25 EST EAGLE 31.3.0  
LOC = 1205 Link = B LSN = 1s12345678 Start time = 16:22:25
```



```

LOOPBACK = SLTC      TIME = 00:02:00
TEST STATUS = Loopback success
;

tst-slk:loc=1205:link=b:action=stop

tekelecstp 03-11-27 16:15:20 EST  EAGLE 31.3.0
tst-slk:loc=1205:link=b:action=stop
Command Accepted: Stop Test Link message is sent.
;

tekelecstp 03-11-27 16:15:22 EST  EAGLE 31.3.0
Command Completed.
;

tekelecstp 03-11-27 16:22:25 EST  EAGLE 31.3.0
LOC = 1205   = B  LSN = ls12345678  Start time = 16:22:25
LOOPBACK = LXVR      TIME = 00:01:00
TEST STATUS = Loopback cleared
;

tst-slk:loc=1205:link=b:time=200

tekelecstp 03-11-27 16:15:20 EST  EAGLE 31.3.0
tst-slk:loc=1205:link=b:time=200
Command Accepted: Stop Test Link message is sent.
;

tekelecstp 03-11-27 16:15:22 EST  EAGLE 31.3.0
Command Completed.
;

tekelecstp 03-11-27 16:22:25 EST  EAGLE 31.3.0
LOC = 1205  Link = B  LSN = ls12345678  Start time = 16:22:25
LOOPBACK = SLTC      TIME = 00:00:53
TEST STATUS = Loopback failed
;

```

### Legend

- **LOC**—Card location that contains the signaling being tested
- **Link**—Signaling link being tested on the card
- **LSN**—Name of the linkset that contains the link being tested
- **Start time**—Time that the test started
- **LOOPBACK**—Type of loopback test being run
- **TIME**—Length of time that the test ran. This value can exceed the value specified in the `time` parameter if the test requires more than the specified time to complete.

- **TEST STATUS—**
  - If the `action=start` (specified or default) is specified, any of the following *TEST STATUS* values can appear:
    - \* Loopback success
    - \* Loopback failed
    - \* Loopback aborted
    - \* Loopback in-progress
    - \* Loopback prevented
    - \* Loopback invalid
  - If the `action=stop` parameter is specified, any of the following *TEST STATUS* values can appear:
    - \* Loopback cleared
    - \* Loopback could not be cleared

#### Related Topics

- [act-lpo](#)
- [act-slk](#)
- [blk-slk](#)
- [canc-lpo](#)
- [canc-slk](#)
- [dact-slk](#)
- [inh-slk](#)
- [rept-stat-tstslk](#)
- [rtrv-slk](#)
- [ublk-slk](#)
- [unhb-slk](#)

## tst-t1

Use this command to test T1 ports. The command is rejected if a loopback test is not compatible with the port type.



#### Note:

This command can be entered for E5-E1T1-B cards.

#### Parameters

##### **loc (mandatory)**

The card location as stenciled on the shelf of the system.

**Range:**

1101 - 1108, 1111 - 1112, 1201 - 1208, 1211 - 1218, 1301 - 1308, 1311 - 1318,  
2101 - 2108, 2111 - 2118, 2201 - 2208, 2211 - 2218, 2301 - 2308, 2311 - 2318,  
3101 - 3108, 3111 - 3118, 3201 - 3208, 3211 - 3218, 3301 - 3308, 3311 - 3318,  
4101 - 4108, 4111 - 4118, 4201 - 4208, 4211 - 4218, 4301 - 4308, 4311 - 4318,  
5101 - 5108, 5111 - 5118, 5201 - 5208, 5211 - 5218, 5301 - 5308, 5311 - 5318,  
6101 - 6108, 6111 - 6118

**t1port (mandatory)**

T1 port number. The value must be a T1 port that has already been configured with a T1 interface on the specified card.

**Range:**

1 - 8

**action (optional)**

Indicator of command action to stop or start a test.

**Range:**

*start*

*stop*

**Default:**

*start*

**loopback (optional)**

Select loopback test type.

**Range:**

*line*

*lxvr*

local transceiver

*payload*

*feline*

far end line

*fepayload*

far end payload

**Default:**

*lxvr*

**Example**

```
tst-t1:t1port=1:loc=1203:loopback=lxvr
```

```
tst-t1:t1port=1:loc=1203:action=stop
```

**Dependencies**

This command cannot be entered during upgrade.

The value specified for the `loc` parameter must indicate an E5-E1T1-B card with card type LIMT1.

The card in the location specified by the `loc` parameter must be equipped.

The card in the location specified by the `loc` parameter must be in service.

The T1 port specified by the `t1port` parameter must have a defined T1 interface.

All signaling links that provide timeslots serviced by T1 interfaces on the specified card must be deactivated before this command can be entered. None of the signaling links can be running link diagnostic tests (`tst-slk` and `act-cdl` commands) when this command is entered.

Only one port test can be running on the T1 port specified by the `t1port` parameter at one time.

The E1/T1 Port table must be accessible.

The `action=stop` parameter can be specified only when a port test is running.

If the `action=stop` parameter is specified, a value of *feline* or *fepayload* must be specified for the `loopback` parameter.

If the `action=stop` parameter is specified, and a value of *feline* or *fepayload* is specified for the `loopback` parameter, then there cannot be an active loopback for the T1 span, or the active loopback must be the one specified in the `tst-t1:action=stop` command.

## Notes

Only one port test can be performed at a time on a T1 port. When a port test is in progress on a T1 port, subsequent test requests are rejected.

If a loopback type of *feline* or *fepayload* is specified, then the loopback requests are sent to the far end. No response is given from the far end to indicate if the request was acted upon or received. The local card which hosts the T1 span in the EAGLE does not instrument the loopback locally but maintains knowledge of the far end loopback request. If the local card boots, this knowledge is lost by the card.

To maintain the far end loopback states, if the T1 card with an active *feline* or *fepayload* test boots, the card loses any knowledge of the Far End loopback request, but the OAM retains that knowledge. If the OAM boots, the T1 card updates the OAM with its last known loopback state. If both the T1 card and the active OAM card boot while a Far End Loopback is active, then there is no way of determining the T1 state; however, a `tst-t1:action=stop:action=(feline or fepayload)` command can still be sent.

## Output

```
tst-t1:t1port=1:loc=1203:loopback=lxvr

rlghncxa03w 05-01-07 16:19:08 EST  EAGLE5 33.0.0
Command Accepted: Test Port message is sent.
;
rlghncxa03w 05-01-07 16:19:08 EST  EAGLE5 33.0.0
Command Completed.
;
```

```
tst-t1:t1port=1:loc=1203:action=stop

    rlghncxa03w 05-01-07 16:19:08 EST  EAGLE5 33.0.0
    Command Accepted: Stop Port test message is sent.
;
    tekelecstp 03-12-16 14:31:23 EST  EAGLE5 33.0.0
    Command Completed.
;
```

### Related Topics

- [chg-t1](#)
- [dlt-t1](#)
- [ent-t1](#)
- [rtrv-t1](#)

## ublk-slk

Use this command to cancel a local processor outage (LPO) and restore the link to its previous state. Link status signal units (LSSU) with status of processor outage are stopped, and the link begins sending MSUs again. IPSP-M3UA signaling links are allowed to enter service by allowing received AS-ACTIVE messages to be accepted.



### Note:

The blocked status of the signaling link is not preserved across a LIM reboot.

### Parameters

#### link (mandatory)

The signaling link on the card specified in the `loc` parameter. The signaling links can be specified in any sequence or pattern.

#### Synonym:

*port*

#### Range:

*a, b, a1 - a63, b1 - b63*

Not all card types support all link parameter values.

See [Table A-1](#) for valid link parameter range values for each type of card that can have a location specified in the `loc` parameter.

#### loc (mandatory)

The card location as stenciled on the shelf of the system.

#### Range:

*1101 - 1108, 1111 - 1112, 1201 - 1208, 1211 - 1218, 1301 - 1308, 1311 - 1318, 2101 - 2108, 2111 - 2118, 2201 - 2208, 2211 - 2218, 2301 - 2308, 2311 - 2318,*

3101 - 3108, 3111 - 3118, 3201 - 3208, 3211 - 3218, 3301 - 3308, 3311 - 3318, 4101 - 4108, 4111 - 4118, 4201 - 4208, 4211 - 4218, 4301 - 4308, 4311 - 4318, 5101 - 5108, 5111 - 5118, 5201 - 5208, 5211 - 5218, 5301 - 5308, 5311 - 5318, 6101 - 6108, 6111 - 6118

### Example

```
ublk-slk:loc=2311:link=b
```

### Dependencies

A card location that is valid and defined in the database must be specified.

No other action command can be in progress when this command is entered.

The value specified for the `loc` parameter must refer to one of the following cards, and the referenced card must be equipped:

- E5-ATM-B card running the ATMANSI or ATMITU application
- E5-ENET-B card running the IPLHC or IPSG application
- E5-E1T1, or E5-E1T1-B card running the SS7ANSI or CCS7ITU application
- SLIC card running the IPSG application

This command is not valid for E5-ENET-B cards with IPGHC or TCP/IP links.

The card must contain signaling links.

The signaling link must be equipped in the database.

The card in the specified card location cannot be an E5-TDM card, an E5-MDAL card, a MUX card, or the cards running the OAM application.

This command is not valid for links belonging to proxy linksets.

An appropriate value must be specified for the `link` parameter when an ATM card is used:

- *a-a1, b*—E5-ATM-B card running the ATMANSI or ATMITU application

This command is not supported for links associated with J7 APCs.

### Notes

Unblocking a signaling link removes a Level 2 failure resulting from a `blk-slk` of an ATM high-speed signaling link.

The function of this command is the same as the `canc-lpo` command.

*Installation Guide* provides an illustration of card locations.

### Output

```
ublk-slk:loc=2311:link=b
```

```
rlghncxa03w 03-03-07 11:11:28 EST EAGLE 31.3.0  
Local processor outage being cleared.
```

```
;
```

```
ublk-slk:loc=1113:link=a
```

```
rlghncxa03w 03-03-07 11:11:28 EST EAGLE 31.3.0  
Command Rejected : Location is not valid for command.
```

```
;
```

### Related Topics

- [act-lpo](#)
- [blk-slk](#)
- [canc-lpo](#)

## unhb-alm

Use this command to restore the reporting of alarms for the given device.

### Parameters



#### Note:

See [Point Code Formats and Conversion](#) for a detailed description of point code formats, rules for specification, and examples.

### **dev (mandatory)**

Device. The device where the reporting of alarms is to be restored.

#### Range:

##### ***applsock***

IP gateway application socket

##### ***as***

IP gateway application. Application Server

##### ***card***

Cards in the database

##### ***cdt***

Customer defined troubles

##### ***clock***

System clock

##### ***dlk***

IP ports on the VSCCP, EROUTE, SLAN, MCPM, and FC-capable cards

##### ***e1port***

E1 port on E5-E1T1-B cards

**ls**  
Linksets

**lsmconn**  
Communication link between the LSMS and the EMS

**route**  
Route

**slk**  
Signaling links

**t1port**  
T1 port on E5-E1T1-B cards

**trm**  
Terminals

**rtx**  
Exception Route

**enet**  
Ethernet

**tps**  
TPS subsystem

**asname (optional)**

Gateway Application Server name. When used with the `dev=as` parameter, this parameter can be used to uninhibit alarms for the named Application Server.

**Range:**

aaaaaaaaaaaaaaaa

Up to 15 alphanumeric characters; the first character must be a letter

**cic (optional)**

Starting Circuit Identification Code. This parameter is used alone or together with the `ecic` parameter to define the CIC range, which is used as an exception routing criterion for the specified exception route.

**Range:**

0 - 16383

**dpc (optional)**

ANSI destination point code with subfields *network indicator-network cluster-network cluster member (ni-nc-ncm)*. The *prefix* subfield indicates a private point code (*prefix-ni-nc-ncm*).

**Synonym:**

*dpc*

**Range:**

*p-*, 000-255, \*

Specify a valid value for each subfield of the point code, and separate the subfields with a dash (-).

*prefix—p-*



The asterisk value (\*) is not valid for the *ni* subfield.

When `chg-sid:pctype=ansi` is specified, *ni* = 000 is not valid.

When `chg-sid:pctype=ansi` is specified, *nc* = 000 is not valid if *ni* = 001–005.

When `chg-sid:pctype=ansi` is specified, *nc* = 000 is valid if *ni* = 006–255.

The point code 000-000-000 is not a valid point code.

#### **dpc/dpca/dpci/dpcn/dpcn24/dpcn16 (optional)**

Destination point code for inhibiting alarms for routes.

#### **dpci (optional)**

ITU international destination point code with subfields *zone-area-id*. The *prefix* subfield indicates a spare point code, private point code, or private and spare point code (*prefix-zone-area-id*).

##### **Range:**

*s-*, *p-*, *ps-*, 0-255

Specify a valid value for each subfield of the point code, and separate the subfields with a dash (-).

*prefix*—*s-*, *p-*, *ps*

*zone*—0-7

*area*—000-255

*id*—0-7

The point code 0-000-0 is not a valid point code.

#### **dpcn (optional)**

ITU national destination point code in the format of a 5-digit number (*nnnnn*); or 2, 3, or 4 numbers (members) separated by dashes (*m1-m2-m3-m4*) as defined by the `chg-stpopts:npcfmt1` flexible point code option. A group code must be specified when the ITUDUPPC feature is turned on (*nnnnn-gc*, *m1-m2-m3-m4-gc*). The *prefix* subfield indicates a spare point code, private point code, or private and spare point code (*prefix-nnnnn*, *prefix-nnnnn-gc*, *prefix-m1-m2-m3-m4*, *prefix-m1-m2-m3-m4-gc*).

##### **Range:**

*s-*, *p-*, *ps-*, 0-16383, *aa-zz*

Specify a valid value for each subfield of the point code, and separate the subfields with a dash (-).

*prefix*—*s-*, *p-*, *ps*

*nnnnn*—0-16383

*gc*—*aa-zz*

*m1-m2-m3-m4*—0-14 for each member; values must sum to 14

#### **dpcn24 (optional)**

24-bit ITU national destination point code with subfields *main signaling area-sub signaling area-signaling point* (*msa-ssa-sp*). The *prefix* subfield indicates a private point code (*prefix-msa-ssa-sp*).

##### **Range:**

*p-*, 000-255

Specify a valid value for each subfield of the point code, and separate the subfields with a dash (-).

*prefix*—*p*

*msa*—000–255

*ssa*—000–255

*sp*—000–255

**dpcn16 (optional)**

16-bit ITU national point code with subfields *unit number-sub number area-main number area (un-sna-mna)*. The *prefix* subfield indicates a private point code (*prefix-un-sna-mna*).

**Range:**

*p--*, 000---127

Specify a valid value for each subfield of the point code, and separate the subfields with a dash (-).

*prefix---p*

*un---000---127*

*sna---000---15*

*mna---000---31*

**e1port (optional)**

Port ID. The E1 port on the specified E5-E1T1-B card. This parameter is mandatory if the `dev=e1port` parameter is specified.

**Range:**

1 - 8

**ecic (optional)**

Ending Circuit Identification Code. This parameter is used with the `cic` parameter to define the CIC range, which is used as an exception routing criterion for the specified exception route.

**Range:**

0 - 16383

**id (optional)**

Customer Defined Trouble (CDT) ID. Customer Defined Trouble IDs 1 through 4 are generated critical alarms. Because critical alarms cannot be turned off, Customer Defined Trouble IDs 1 through 4 cannot be specified as values for the `id` parameter. This parameter is mandatory if the `dev=cdt` parameter is specified.

**Range:**

5 - 16

**ilsn (optional)**

Incoming Link Set Name. The name of the originating linkset. This value is used as part of the exception routing criteria for the specified exception route.

**Range:**

*aaaaaaaa*

1 alphabetic character followed by up to 9 alphanumeric characters

**link (optional)**

Signaling link on the card specified in the `loc` parameter.

**Synonym:**

*port*

**Range:***a, b, a1 - a31, b1 - b31**a1, a2, b1, b2* — dev=lsmsconn*a, b, a1-a31, b1-b31* — dev=slk for an E5-E1T1-B card*a1, b1* — dev=dlk for an FC-capable card*a, b* — dev=enet for an E5-ENET-B card**loc (optional)**

The card location as stenciled on the shelf of the system.

**Range:***1101 - 1113, 1115, 1201 - 1218, 1301 - 1318, 2101 - 2118, 2201 - 2218, 2301 - 2318, 3101 - 3118, 3201 - 3218, 3301 - 3318, 4101 - 4118, 4201 - 4218, 4301 - 4318, 5101 - 5118, 5201 - 5218, 5301 - 5318, 6101 - 6118***lsn (optional)**

Linkset name. The name of the linkset containing the device where alarm reporting is to be restored.

**Range:***ayyyyyyyyy*

1 alphabetic character followed by up to 9 alphanumeric characters

**opc (optional)**ANSI point code with subfields *network indicator-network cluster-network cluster member (ni-nc-ncm)*. The *prefix* subfield indicates a private point code (*prefix-ni-nc-ncm*).**Synonym:***opca***Range:***000-255*

Specify a valid value for each subfield of the point code, and separate the subfields with a dash (-).

When *chg-sid:pctype=ansi* is specified, *ni = 000* is not valid.When *chg-sid:pctype=ansi* is specified, *nc = 000* is not valid if *ni = 001-005*.When *chg-sid:pctype=ansi* is specified, *nc = 000* is valid if *ni = 006-255*.The point code *000-000-000* is not a valid point code.**opc/opca/opci/opcn/opcn24/opcn16 (optional)**

Origination point code

**opci (optional)**ITU international origination point code with subfields *zone-area-id*. The *prefix* subfield indicates a spare point code, private point code, or private and spare point code (*prefix-zone-area-id*).**Range:***s-, p-, ps-, 0-255*

Specify a valid value for each subfield of the point code, and separate the subfields with a dash (-).

*prefix—s-, p-, ps**zone—0-7*

*area—000-255*

*id—0-7*

The point code *0-000-0* is not a valid point code.

**opc<sub>n</sub>** (optional)

ITU national origination point code in the format of a 5-digit number (*nnnnn*); or 2, 3, or 4 numbers (members) separated by dashes (*m1-m2-m3-m4*) as defined by the `chg-stpopts:npcfmti` flexible point code option. A group code must be specified when the ITUDUPPC feature is turned on (*nnnnn-gc*, *m1-m2-m3-m4-gc*). The *prefix* subfield indicates a spare point code, private point code, or private and spare point code (*prefix-nnnnn*, *prefix-nnnnn-gc*, *prefix-m1-m2-m3-m4*, *prefix-m1-m2-m3-m4-gc*).

**Range:**

*s-*, *p-*, *ps-*, *0-16383*, *aa-zz*

Specify a valid value for each subfield of the point code, and separate the subfields with a dash (-).

*prefix—s-*, *p-*, *ps*

*nnnnn—0-16383*

*gc—aa-zz*

*m1-m2-m3-m4—0-14* for each member; values must sum to 14

**opc<sub>n24</sub>** (optional)

24-bit ITU national destination point code with subfields *main signaling area-sub signaling area-signaling point* (*msa-ssa-sp*). The *prefix* subfield indicates a private point code (*prefix-msa-ssa-sp*).

**Range:**

*p-*, *000-255*

Specify a valid value for each subfield of the point code, and separate the subfields with a dash (-).

*prefix—p*

*msa—000-255*

*ssa—000-255*

*sp—000-255*

**opc<sub>n16</sub>** (optional)

16-bit ITU national point code with subfields *unit number-sub number area-main number area* (*un-sna-mna*). The *prefix* subfield indicates a private point code (*prefix-un-sna-mna*).

**Range:**

*p--*, *000---127*

Specify a valid value for each subfield of the point code, and separate the subfields with a dash (-).

*prefix---p*

*un---000---127*

*sna---000---15*

*mna---000---31*

**si (optional)**

Service Indicator. This parameter is used as the exception routing criterion for the specified exception route.

**Range:**

0 - 15

**sname (optional)**

Gateway application socket. When used with the `dev=applsock` parameter, this parameter can be used to uninhibit alarms for the named IP7 application socket.

**Range:**

aaaaaaaaaaaaaaaa

1 to 15 alphanumeric characters

**t1port (optional)**

Port ID. T1 port on the specified E5-E1T1-B card. This parameter is mandatory if the `dev=t1port` parameter is specified.

**Range:**

1 - 8

**trm (optional)**

Terminal ID. The ID number of the terminal whose alarms are to be uninhibited.

**Range:**

1 - 40

**Default:**

Report displays on the terminal where the command was issued.

**Example**

```
unhb-alm:dev=route:dpc=1-1-1
```

```
unhb-alm:dpc=1-101-1:opc=4-4-4:dev=rtx
```

```
unhb-alm:loc=1102:dev=dlk:port=a1
```

```
unhb-alm:dpcn16=121-10-15:opc16=121-10-15:dev=rtx
```

**Dependencies**

This command is not allowed in the upgrade mode.

No other action command can be in progress when this command is entered.

When the `dev=card` parameter is specified, the `loc` parameter must be specified.

When the `dev=dlk` parameter is specified, the `loc` parameter must be specified.

When the `dev=slk` parameter is specified, the `loc` and `link` parameters must be specified.

When the `dev=e1port` parameter is specified, the `loc` and `e1port` parameters must be specified.

When the `dev=t1port` parameter is specified, the `loc` and `t1port` parameters must be specified.

When the `dev=ls` parameter is specified, the `lsn` parameter must be specified.

When the `dev=trm` parameter is specified, the `trm` parameter must be specified.

When the `dev=cdt` parameter is specified, the `id` parameter must be specified.

When the `dev=lsmsconn` parameter is specified, the `link` parameter must be specified.

When the `dev=route` parameter is specified, a `dpc/dpca/dpci/dpcn/dpcn24/dpcn16` parameter must be specified.

When the `dev=applsock` parameter is specified, the `sname` parameter must be specified.

When the `dev=as` parameter is specified, the `asname` parameter must be specified.

The linkset specified by the `lsn` parameter must be equipped in the database.

If the `dev=slk` or `dev=dlk` parameter is specified, the specified `link` must exist in the database.

The STP Options table must be accessible.

The Device Alarm Inhibit table must be accessible.

The parameters that can be specified with the `dev` parameter vary, depending on the value specified for the `dev` parameter as shown:

- `dev= (any value)`— `dur` or `lvl`
- `dev=asname` — `as`
- `dev=dpc/dpca/dpci/dpcn/dpcn24/dpcn16` — `route`
- `dev=id` — `cdt`
- `dev=loc` — `card`, `dlk`, `elport`, `slk`, `tlport`, `enet`
- `dev=lsn` — `ls`
- `dev=elport` — `elport`
- `dev=link (link=a, b)`— `dlk`, `slk`, `enet`
- `dev=link ( link=a1, b1)`— `dlk` (For FC-capable cards)
- `dev=link ( link=a, b, a1, a2, b1, b2, a3, b3)`— `slk`
- `dev=link (link=a1, a2, b1, b2)`— `lsmsconn`
- `dev=sname` — `applsock`
- `dev=tlport` — `tlport`
- `dev=trm` — `trm`

If the `sname` parameter is specified, the socket name must exist in the IPAPSOCK table.

If a point code parameter is specified, the point code must exist in the Routing table.

The card location that is specified in the `loc` parameter must be equipped.

The specified device type must be supported by the card in the specified card location.

The Origin-Based MTP Routing feature must be turned on before specifying the `dev=rtx` parameter.

The `link` parameter must be valid for the selected device type.

The card specified by the `loc` parameter must have an IPS, MCP, STPLAN, EROUTE, VSCCP, IPSG, IPLIMI, SS7IPGW, or IPGWI application.

The J7 Support feature must be enabled before the `opc16/dpc16` parameters can be specified.

### Notes

In this command, only ITU-international and ITU national point codes support the spare point code subtype prefix (s-) and the private and spare point code subtype prefix (ps-). All of the point code types support the private (internal) point code subtype prefix (p-).

### Output

```
unhb-alm:dev=route:dpc=1-1-1
```

```
rlghncxa03w 03-03-23 13:20:59 EST EAGLE 31.3.0  
Alarms are inhibited.
```

```
rlghncxa03w 03-03-23 13:20:59 EST EAGLE 31.3.0  
Command Completed.
```

```
;
```

```
unhb-alm:dpc=1-101-1:opc=4-4-4:dev=rtx
```

```
stdcfg2b 06-05-27 20:22:02 EST EAGLE 35.0.0  
Alarms are enabled  
Command Completed.
```

```
;
```

### Related Topics

- [inh-alm](#)
- [rept-stat-alm](#)
- [rept-stat-card](#)
- [rept-stat-cdt](#)
- [rept-stat-dlk](#)
- [rept-stat-dstn](#)
- [rept-stat-ls](#)
- [rept-stat-rte](#)
- [rept-stat-rtx](#)
- [rept-stat-seas](#)
- [rept-stat-slk](#)
- [rept-stat-sys](#)

- [rept-stat-trbl](#)
- [rept-stat-trm](#)
- [rtrv-log](#)

## unhb-slk

Use this command to return an inhibited signaling link to service. If the link was aligned when it was inhibited, a changeover occurred. This command causes a changeback on the specified link. MSUs are transmitted on the link after the changeback is issued.



### Note:

The inhibited status of the signaling link is not preserved across a LIM reboot.

### Parameters

#### link (mandatory)

The signaling link on the card specified in the `loc` parameter. The signaling links can be specified in any sequence or pattern.

#### Synonym:

*port*

#### Range:

*a, b, a1 - a63, b1 - b63*

Not all card types support all link parameter values.

See [Table A-1](#) for valid link parameter range values for each type of card that can have a location specified in the `loc` parameter.

#### loc (mandatory)

The card location as stenciled on the shelf of the system.

#### Range:

*1101 - 1108, 1111 - 1112, 1201 - 1208, 1211 - 1218, 1301 - 1308, 1311 - 1318, 2101 - 2108, 2111 - 2118, 2201 - 2208, 2211 - 2218, 2301 - 2308, 2311 - 2318, 3101 - 3108, 3111 - 3118, 3201 - 3208, 3211 - 3218, 3301 - 3308, 3311 - 3318, 4101 - 4108, 4111 - 4118, 4201 - 4208, 4211 - 4218, 4301 - 4308, 4311 - 4318, 5101 - 5108, 5111 - 5118, 5201 - 5208, 5211 - 5218, 5301 - 5308, 5311 - 5318, 6101 - 6108, 6111 - 6118*

### Example

```
unhb-slk:loc=1301:link=a
```

### Dependencies

A card location that is valid and defined in the database must be specified.

No other action command can be in progress when this command is entered.

The value specified for the `loc` parameter must refer to one of the following cards, and the referenced card must be equipped:

- E5-E1T1-B card running the SS7ANSI or CCS7ITU application



- E5-ATM-B card running the ATMANSI or ATMITU application
- E5-ENET-B card running the IPLIMI, or IPSP application
- SLIC card running the IPSP application

The card must contain signaling links.

The signaling link must be equipped in the database.

The inhibit and uninhibit actions are valid for links on E5-ENET-B cards running the IPLIMx application.

The card in the specified card location cannot be an E5-TDM card, an E5-MDAL card, a MUX card, or the cards running the OAM application.

This command is not valid on E5-ENET-B cards with SS7IPGW, IPGWI, or IPSP-M3UA links. IPLIMI links can be uninhibited.

If an IPSP-M3UA signaling link is used, then this command cannot be entered.

An appropriate value must be specified for the `link` parameter when an ATM card is used:

- *a-a1, b*—E5-ATM-B card running the ATMANSI or ATMITU application

This command is not supported for links associated with J7 APCs.

### Notes

The function of this command is the same as the `canc-lpo` command.

*Installation Guide* provides an illustration of card locations.

### Output

```
unhb-slk:loc=1301:link=a
```

```
rlghncxa03w 03-03-23 13:20:59 EST EAGLE 31.3.0
Allow Link message sent to card
;
```

### Related Topics

- [act-slk](#)
- [blk-slk](#)
- [dact-slk](#)
- [dlt-slk](#)
- [ent-slk](#)
- [inh-slk](#)
- [rept-stat-slk](#)
- [rtrv-slk](#)
- [tst-slk](#)
- [ublk-slk](#)

# unlock

Use this command to unlock a previously locked terminal keyboard. Anyone attempting to use the keyboard is prompted to enter the password of the currently logged-in user.

## Parameters

This command has no parameters.

## Example

```
unlock
```

## Dependencies

You must enter the password of the logged in user to unlock the keyboard.

This command is valid only if the keyboard is locked.

The port must not be in an unlock disabled state because of excessive successive unlock failures.

## Notes

None

## Output

```
unlock
```

```
Enter LOGIN password to unlock keyboard :
```

## Related Topics

- [lock](#)

# 5

## Debug Commands

This chapter contains information about debug commands used in troubleshooting and debugging the system. These commands are intended only for [My Oracle Support \(MOS\)](#) personnel and authorized engineering personnel in the operating companies. The use of these commands is restricted to personnel who have access to the command class Debug.

**CAUTION:** These commands are to be used precisely as they are described in this chapter, and only under the direction of Customer Care Center personnel. Any other use of these commands can result in a system failure.

This chapter contains the debug commands in alphabetical order.

### act-gedti

Use this command to activate a GEDTI Hub for Eagle Eyes. The state of the GEDTI Hub is changed from DACT(Deactivated) to ACT(Active).



#### Note:

The GEDTI hub must be Deactivated on the specified card before the command can be executed. If the card boots, then the status of the GEDTI Hub will be reset to DACT.

#### Parameters

##### loc (mandatory)

The card location as stenciled on the shelf of the system.

##### Range:

1101 - 1108, 1111 - 1112, 1201 - 1208, 1211 - 1218, 1301 - 1308, 1311 - 1318, 2101 - 2108, 2111 - 2118, 2201 - 2208, 2211 - 2218, 2301 - 2308, 2311 - 2318, 3101 - 3108, 3111 - 3118, 3201 - 3208, 3211 - 3218, 3301 - 3308, 3311 - 3318, 4101 - 4108, 4111 - 4118, 4201 - 4208, 4211 - 4218, 4301 - 4308, 4311 - 4318, 5101 - 5108, 5111 - 5118, 5201 - 5208, 5211 - 5218, 5301 - 5308, 5311 - 5318, 6101 - 6108, 6111 - 6118

#### Example

```
act-gedti:loc=1102
```

#### Dependencies

The value specified for the `loc` parameter must refer to an equipped card location.

The card at the specified location must be configured as GEDTI Hub.

Activating the state of GEDTI Hub that is already activated has no effect.

The card at the specified location must not be a reserved location.

## Notes

None.

## Output

```
act-gedti:loc=1101
```

```
Command Accepted - Processing
```

```
tekelecstp 11-08-16 18:35:44 MST EAGLE 46.0.0 act-gedti:loc=1101  
Command entered at terminal #1.;
```

```
tekelecstp 11-08-16 18:35:44 MST  
UNKNOWN EAGLE 46.0.0 Activate GEDTI Hub message sent to card.;
```

```
tekelecstp 11-08-16 18:35:44 MST EAGLE 46.0.0  
Command Completed.;
```

## Related Topics

- [chg-gedti-card](#)
- [dact-gedti](#)
- [rept-stat-gedti](#)

# act-ip-lnk

Use this command to activate an IP link and put the link into service. The state of the link is changed from OOS-MT-DSBLD (Out-Of-Service-Maintenance-Disabled) to OOS-MT (Out-Of-Service-Maintenance), IS-ANR (In-Service-Abnormal) or IS-NR (In-Service-Normal).



### Note:

The specified card must be Active before the command can be executed. If the card boots, then the status of the IP link will be reset.

## Parameters

### loc (mandatory)

The card location as stenciled on the shelf of the system.

### Range:

*1101 - 1108, 1111 - 1112, 1201 - 1208, 1211 - 1218, 1301 - 1308, 1311 - 1318,  
2101 - 2108, 2111 - 2118, 2201 - 2208, 2211 - 2218, 2301 - 2308, 2311 - 2318,  
3101 - 3108, 3111 - 3118, 3201 - 3208, 3211 - 3218, 3301 - 3308, 3311 - 3318,  
4101 - 4108, 4111 - 4118, 4201 - 4208, 4211 - 4218, 4301 - 4308, 4311 - 4318,*

5101 - 5108, 5111 - 5118, 5201 - 5208, 5211 - 5218, 5301 - 5308, 5311 - 5318, 6101 - 6108, 6111 - 6118, 1113, 1115

**port (mandatory)**

Ethernet interface Port ID.

**Range:****a**

IP Port A

**b**

IP Port B

**c**

IP Port C

**d**

IP Port D

**fca**

Fast Copy Port A

**fcb**

Fast Copy Port B

**Example**

```
act-ip-lnk:loc=1102:port=a
```

```
act-ip-lnk:loc=1203:port=fca
```

```
act-ip-lnk:loc=1103:port=c
```

```
act-ip-lnk:loc=1202:port=d
```

**Dependencies**

The value specified for the `loc` parameter must refer to one of the following cards, and the referenced card must be equipped:

- E5-ENET-B card running the EROUTE, IPGWx, IPLIMx, IPSG, or STPLAN application
- IPSM card
- E5-SM4G or E5-SM8G-B card running the VSCCP application
- E5-OAM card running the OAMHC application
- E5-MCPM-B
- SLIC card

A valid value must be specified for the `loc` parameter.

The value specified for the `port` parameter must be supported by the card:

- port A - E5-OAM card running OAMHC application, IPSM card, E5-MCPM-B card, E5-ENET-B card running the STPLAN application
- port A, B - E5-ENET-B card running the EROUTE or IPLIMx application, E5-SM4G or E5-SM8G-B card running the VSCCP application

- port A, B, FCA, FCB - E5-ENET-B card running the IPGWx or IPSG application
- port A, B, C and D are valid for SIP/ENUM/DEIR application running on SLIC card.

The card at the specified location must be configured.

The card in the specified location must be Active before this command can be executed.

### Notes

The act-ip-lnk/dact-ip-lnk commands were created as debug means - aids to turn off or disable the IP interface to troubleshoot network problems, specifically to allow the operator to troubleshoot IP network flooding issues that can cause EAGLE cards to boot repeatedly while trying to come up. These commands should NOT be used for general maintenance actions since they have not been rigorously tested and their usage should be limited to situations like described above.

Interface A/D is used for ExAP connectivity and interface B/C is used for the signaling network on the SLIC card running the SIP/ENUM/DEIR application.

### Output

```
act-ip-lnk:loc=1101:port=a
```

```
Command Accepted - Processing
```

```
tekelecstp 11-08-16 19:52:01 MST EAGLE 44.0.0
act-ip-lnk:loc=1101:port=a
Command entered at terminal #1.
;

tekelecstp 11-08-16 19:52:01 MST EAGLE 44.0.0
Activate IP link message sent to card.
;

tekelecstp 11-08-16 19:52:01 MST EAGLE 44.0.0
Command Completed.
;
```

```
act-ip-lnk:loc=1103:port=c
```

```
Command Accepted - Processing
```

```
tekelecstp 16-05-25 03:48:33 MST EAGLE 46.4.0.0.0-69.1.0
act-ip-lnk:loc=1103:port=c
Command entered at terminal #18.
;

tekelecstp 16-05-25 03:48:33 MST EAGLE 46.4.0.0.0-69.1.0
Activate IP link message sent to card.
;

tekelecstp 16-05-25 03:48:33 MST EAGLE 46.4.0.0.0-69.1.0
Command Completed.
;
```

## Related Topics

- [rtrv-ip-lnk](#)

# act-upgrade

Use this command to perform a software upgrade from a source release to the target release on an in-service system.

### ▲ Caution:

It is strongly recommended that this command be used only in conjunction with the system Upgrade Procedure for your target release. The Upgrade Procedure provides step-by-step information on performing an upgrade.

## Parameters

### **action (mandatory)**

The action to be performed for the upgrade process.

### ▲ Caution:

The `converttoam` and `netcomplete` actions should be used only under the direction of My Oracle Support (MOS).

### **Range:**

yyyyyyyyyy

Up to 10 alphabetic characters. Valid actions are:

- *chkrel*—Validates the stored upgrade target release on the physical disk as specified by the `src` parameter.
- *converttoam*—Converts the standby OAM database.
- *convertstp*—Performs all OAM and network conversions necessary for an upgrade. This command transitions through all of the upgrade phases to upgrade completion. If measurement collection is turned on, this command automatically inhibits measurements during the upgrade. Upon completion of the upgrade, this command returns the MASPs to full-function mode with measurement collection turned back on.
- *createsets*—Assigns network cards to upgrade-grouping sets.
- *dbstatus*—Reports the status of all database partitions on the TDM fixed disks and the removable drive(s) (similar to the `rept-stat-db:display=version` command).
- *displaysets*—Reports the upgrade-grouping sets of network cards.
- *getrel*—Retrieves the upgrade target release file from either the EAGLE software release distribution server or the plug-in flash drive. It then expands the data on the inactive partition group of the hard disks.

- *netcomplete*—Indicates upgrade completion and places the system in a fully functional mode.
- *oamcomplete*—Sets the upgrade phase number to 3, and enables the beginning of controlled card loading.
- *refreshsets*—Not yet supported.
- *verifysets*—Verifies that the card set list is consistent with the current EAGLE configuration and displays detailed information on any inconsistencies found.

**force (optional)**

Allows the user to override Card Set List verification and perform upgrade when only minor inconsistencies are present.

**Range:**

yes

Override the Card Set List verification and perform the upgrade.

**release (optional)**

The name of the software release file to be downloaded.

This file contains the upgrade target release on the software release distribution server or plug-in flash drive.

**Range:**

xxxxxxxxxxxxxxxxxxxxxxxxxxxxxxxx

1 alphabetic character followed by up to 29 alphanumeric characters. One or more periods can be used.

**Note:**

The value must be at least 11 characters in length and must contain a hyphen (-). The format of the value must be *xx.xx.xx-yy.yy.yy*, where *xx.xx.xx* is the release number, and *yy.yy.yy* is the engineering build number.

**src (optional)**

The physical disk that contains the upgrade target release.

**Range:*****fixed***

The upgrade target release is on the fixed disk

***usb***

The upgrade target release is on the removable media inserted in the flush-mount USB port

***server***

The upgrade target release is on the remote server

**thres (optional)**

Network Threshold value. The percentage of signaling links that is to remain in service (IS) during the network conversion phase. This enables SCCP thresholding and flashing on non-provisioned cards during the upgrade.



**Range:**

50 - 90

**Default:**

Network cards are updated serially

**Example**

```
act-upgrade:action=convertstp
act-upgrade:action=dbstatus
act-upgrade:action=convertstp:thres=75
act-upgrade:action=getrel:release="46.7.0.0.0-74.2.0.tar.gz":src=usb
act-upgrade:action=chkrel:src=fixed
```

**Dependencies**

The value specified for the `action` parameter must correspond to a specific upgrade phase:

- `action=converttoam`—upgrade phase=0 and 1
- `action=oamcomplete`—upgrade phase=2
- `action=convertnet`—upgrade phase=3
- `action=netcomplete`—upgrade phase=3
- `action=convertstp`—upgrade phase=0-3

The Measurements Collection function must be turned off (`chg-meas:collect=off`) or the Measurements Platform feature must be turned on (`chg-measopts:platformenable=on`) before a value of `converttoam`, `oamcomplete`, or `netcomplete` can be specified for the `action` parameter.

A valid upgrade release must reside on the plug-in flash drive or the inactive partition of the fixed disk.

The standby OAM database must be the source release.

The current OAM database must be the source release.

The database partition must be coherent.

The database partition must be in the correct functional mode.

The `action=convertstp` and `thres` parameters must be specified together in the command.

Upgrade conversion cannot be initiated from a telnet-type terminal (terminal IDs 17-40).

The DCM cards are obsolete for SS7IPGW, IPGWI, IPLIM, and IPLIMI applications.

The `action=getrel` and `release` parameters must be specified together in the command.

An IPSM card must be provisioned and in service before a value of `getrel` or `chkrel` can be specified for the `action` parameter.

The `ent-ftp-serv:app=dist` command must be entered before a value of `getrel` or `chkrel` can be specified for the `action` parameter.

The `act-upgrade:action=convertstp` cannot be issued with any removable media inserted in any of the USB ports.

Invalid hardware configuration alarms are set or an HMUX alarm must be addressed.

All cards that are in the auto-inhibited state must be removed before this command can be entered.

Cards that prevent the IMT buses from being inhibited during the upgrade cannot exist in the system.

The specified source drive must be at the correct database version for the upgrade to proceed.

The plug-in flash drive cannot contain an EAGLE backup image.

If the `src=usb` parameter is selected, then the plug-in flash drive upgrade media must be inserted in the Active OAM's flush-mounted USB port.

The internal RAM disk must be available for the plug-in flash drive's upgrade image to be unpackaged.

The disk that contains the upgrade target release must be in a known upgrade mode.

If the `src=usb` or `src=server` parameter is specified, then the `action=getrel` parameter must be specified. If the `src=fixed` parameter is specified, then the `action=getrel` parameter cannot be specified.

The EAGLE PVN address in the source database cannot be identical to the EAGLE FCNA or FCNB network address in the target database.

The `icdpnunknx` and `icdpnunknX` and the `gcdpnunknx` and `gcdpnunknX` NPP Action Sets cannot co-exist in the source release.

The value specified for the `release` parameter must be at least 11 characters in length and contain a hyphen (-). The format of the value must be `xx.xx.xx-yy.yy.yy`, where `xx.xx.xx` is the release number, and `yy.yy.yy` is the engineering build number.

The card must have sufficient DRAM memory to perform the GTMOD table Health Check.

The AMGTT data in the GTT table cannot exceed the capacity of the GTMOD table (100 K).

Unable to access GTT table from source drive.

The MFC feature must be ON prior to upgrading to release 46.2 or later.

The `action=refreshsets` and `action=verifysets` parameters are not supported.

The `thres` parameter cannot be specified if the threshold type (`threstype`) has been changed to `set`.

When issuing the `act-upgrade` command with the `threstype` assigned to card sets, the list of card sets needs to be created and valid.

When issuing the `act-upgrade` command with the `threstype` assigned to Card Set, the card set list must be consistent with the current EAGLE configuration, unless **force=yes** is allowed and specified. Details of any such inconsistencies and recovery instructions will be reported in a similar manner as `act-upgrade:action=verifysets`.

The `act-upgrade` command cannot be issued when SFAPP(P)->OAM sync is ON.

This command cannot be entered when CAT2 IPSM to OAM syncing is in progress.

### Notes

The `act-upgrade:action=convertstp` command executes all four upgrade phases consecutively.

If the `act-upgrade:action=convertstp` command is entered following a command abort, the upgrade processing determines the last upgrade phase that was successfully completed. The upgrade processing then attempts to restart from that point to successful completion. Re-entering the `act-upgrade:action=convertstp` command following a command abort is the recommended method for recovery.

The TDMS and plug-in flash drives have upgrade phase indicators. The upgrade command expects the disks to be in certain phases before executing a specific action. If the disks are not in the correct phases, an error is generated.

The `act-upgrade:action=dbstatus` command generates output similar to that provided by the `rept-stat-db:display=version` command.

The `thres` parameter is used to:

- Allow multiple cards to be upgraded together, as long as the specified percentage of links remains in service. The value is applied to groups of links based upon the link-supporting group or the entire system. The grouping is set by the `chg-upgrade-config:threstype=` command.
- Enable SCCP thresholding, which allows multiple Service Module cards to be upgraded together. The specified `thres` parameter value is not used to determine the number of Service Module cards to upgrade. The peak SCCP load since the last OAM boot is used to determine the number of cards that must remain in service (at least half of the cards must remain in service).
- Enable the non-provisioned flash function, which flash-downloads any boot-prom type card if the card is in the system but not provisioned.

The `act-upgrade:action=getrel` action defaults to getting the release from the provisioned IPSM card using the provisioned FTP Server. If the `src=usb` parameter is specified, then the release is obtained from the plug-in USB flash drive upgrade media.

### Output

#### Note:

The `act-upgrade:action=convertstp` command performs the OAM conversion and the network conversion. During the conversion, this command broadcasts the current activity in the scroll area. Refer to Appendix B of the EAGLE Release Software Upgrade Procedure for a sample of message output.

The action `dbstatus` reports the current database status.

```
act-upgrade:action=dbstatus
```

```
eaglestp 15-02-13 11:45:51 MST EAGLE5 45.0.1-64.70.35 Upg Phase 0
  DATABASE STATUS: >> OK <<
          TDM 1114 ( STDBY)          TDM 1116 ( ACTV )
          C  LEVEL      TIME LAST BACKUP      C  LEVEL      TIME LAST
BACKUP
-----
          FD BKUP Y      210      -      -      Y      210      -      -
          FD CRNT Y      210      -      -      Y      210      -      -
          MCAP 1113          MCAP 1115
          - -----
          RD BKUP -      -      -      -      -      -      -      -
          USB BKP -      -      -      -      -      -      -      -

          CARD/APPL  LOC  C  T  LEVEL      TIME LAST UPDATE  VERSION
STATUS
-----
          OAM-RMV    1113  -  -  -      -      -      -
          TDM-CRNT   1114  Y  N  210    15-01-16 12:22:02  135-000-000
NORMAL
          TDM-BKUP   1114  Y  -  210    15-01-16 12:22:02  135-000-000
NORMAL
          OAM-RMV    1115  -  -  -      -      -      -
          OAM-USB    1115  -  -  -      -      -      -
          TDM-CRNT   1116  Y  N  210    15-01-16 12:22:02  135-000-000
NORMAL
          TDM-BKUP   1116  Y  -  210    15-01-16 12:22:02  135-000-000
NORMAL

          INACTIVE PARTITION GROUP
          CARD/APPL  LOC  C  T  LEVEL      TIME LAST UPDATE  VERSION
STATUS
-----
          TDM-CRNT   1114  N  -  1      00-00-00 00:00:00  136-000-000
NORMAL
          TDM-BKUP   1114  N  -  1      00-00-00 00:00:00  136-000-000
NORMAL
          TDM-CRNT   1116  Y  -  1      00-00-00 00:00:00  136-000-000
NORMAL
          TDM-BKUP   1116  Y  -  1      00-00-00 00:00:00  136-000-000
NORMAL
;
```

## Related Topics

- [rept-stat-db](#)





**Range:**

1101 - 1112, 1201 - 1218, 1301 - 1318, 2101 - 2118, 2201 - 2218, 2301 - 2318, 3101 - 3118, 3201 - 3218, 3301 - 3318, 4101 - 4118, 4201 - 4218, 4301 - 4318, 5101 - 5118, 5201 - 5218, 5301 - 5318, 6101 - 6118, 6202 - 6212, 6302 - 6312

**init (optional)**

This parameter initializes the contents of a PROM to contain only the record specified in the `data` parameter, if that record is a board identification record.

**Range:****yes**

The contents of the PROM are initialized.

**no**

The contents of the PROM are not initialized.

**Default:**

*no*

**typed (optional)**

Type of board.

**Range:****mbd**

main assembly

**Example**

This example initializes the contents of a main assembly BIP to contain only the record specified in the `data` parameter:

```
chg-bip-rec:loc=1105:data=xxxx:init=yes
```

This example displays the programming of the DCM Ethernet Addresses for Port A (ENT01):

```
chg-bip-rec:loc=1102:data="ENT01,AD00001704000D,cs104"
```

**Dependencies**

The value of the `loc` parameter cannot specify a location for a fixed disk or removable drive.

If the `init=yes` parameter is specified, then the value of the `data` parameter must be a Board IDentification (BID) record.

**Notes**

The card in the specified location must be inhibited.

**Output**

```
chg-bip-rec:loc=1107:data=xxx:init=yes
```

```
tekelecstp 10-04-01 12:05:44 IST EAGLE 42.0.0  
Board ID Prom updated.
```

```
;
```

**Related Topics**

- [chg-bip-fld](#)
- [disp-bip](#)
- [rtrv-bip](#)
- [tst-bip](#)

## chg-ee-card

Use this command to enter/modify Eagle Eyes Network card data in the Eagle Eyes Card (EE CARD) table. The EE CARD entry consists of Card location and Eagle Eyes specific data.

**Parameters****loc (mandatory)**

Eagle Eyes Card location.

**Range:**

1101 - 1108, 1111 - 1112, 1201 - 1208, 1211 - 1218, 1301 - 1308, 1311 - 1318,  
2101 - 2108, 2111 - 2118, 2201 - 2208, 2211 - 2218, 2301 - 2308, 2311 - 2318,  
3101 - 3108, 3111 - 3118, 3201 - 3208, 3211 - 3218, 3301 - 3308, 3311 - 3318,  
4101 - 4108, 4111 - 4118, 4201 - 4208, 4211 - 4218, 4301 - 4308, 4311 - 4318,  
5101 - 5108, 5111 - 5118, 5201 - 5208, 5211 - 5218, 5301 - 5308, 5311 - 5318,  
6101 - 6108, 6111 - 6118

**action (optional)**

Action to be performed on the specified filter ID for the card.

**Range:**

*attach*

*detach*

**Default:**

No change to the current value.

**System Default:**

0

**fltId (optional)**

A comma-separated Eagle Eyes Filter ID list to be associated or disassociated with the card. Up to 8 FLT IDs can be specified in the list.

**Range:**

1-200

**Default:**

No change to the current value.

**System Default:**

0



**kblim (optional)**

Sets the file size limit of the capture file created, in kilobytes.

**Range:**

*1-4000000*

**Default:**

No change to the current value.

**System Default:**

none

**pktlim (optional)**

Sets the limit on the number of Ethernet frames to send.

**Range:**

*1-10000000*

none

**Default:**

No change to the current value.

**System Default:**

none

**seclim (optional)**

Sets the limit on the amount of time to perform the trace, in seconds.

**Range:**

*1-5644800*

none

**Default:**

No change to the current value.

**System Default:**

none

**thr (optional)**

Sets the sending rate of the Eagle Eyes throttle task in IMT packets per second. The packets will not be captured unless this parameter is set to a non-zero value for the particular card.

**Range:**

*1000--10000*

**Default:**

No change to the current value.

**System Default:**

0

**Example**

```
chg-ee-card:loc=1101:fltId=12:action=attach:thr=2000:pktlim=5000
```

```
chg-ee-card:loc=1102:kblim=40000:seclim=3000000
```

```
chg-ee-card:loc=1101:fltId=13:action=detach:pktlim=none
```

### Dependencies

If the `fltId` parameter is specified, then the action parameter must be specified.

The EE CARD table cannot contain more than 256 entries.

The EE CARD table must be accessible.

At least one optional parameter must be specified.

The `fltId` specified should not be already associated with the card.

The value specified for the `fltId` parameter must already exist in the EE FLT table.

Maximum of 16 include filters can be attached to a card.

Maximum of 16 exclude filters can be attached to a card.

The value specified for the `loc` parameter must not be a system reserved location.

The IMT table must be accessible.

The card in the location specified by the `loc` parameter must have Eagle Eyes service capability.

The card `loc` specified to detach a filter must have Eagle Eyes configured.

The card at the specified location must be equipped.

The Filter `appl` and card `appl` should be same.

### Notes

The value specified for the `loc` parameter must refer to a card running one of the following GPLs, and the referenced card must be equipped:

- IPSTG, IPLHC, IPGHC
- ATMHC
- SS7HC
- SIPHC
- DEIRHC

### Output

```
chg-ee-  
card:loc=1101:fltId=12:action=attach:thr=2000:pktlim=5000
```

```
tekelecstp 10-03-08 14:43:31 EST EAGLE 46.0.0
```

```
EE CARD table is (2 of 256) 1% full
```

```
CHG-EE-CARD: MASP A - COMPLTD
```

### Related Topics

- [dact-ee](#)

- [rept-stat-ee](#)
- [rtrv-ee-card](#)

## chg-gedti-card

Use this command to configure GEDTI Hub for Eagle Eyes traffic capture.

### Parameters

#### **loc (mandatory)**

IPSM Card location to be configured as GEDTI Hub.

#### **Range:**

*1101 - 1108, 1111 - 1112, 1201 - 1208, 1211 - 1218, 1301 - 1308, 1311 - 1318, 2101 - 2108, 2111 - 2118, 2201 - 2208, 2211 - 2218, 2301 - 2308, 2311 - 2318, 3101 - 3108, 3111 - 3118, 3201 - 3208, 3211 - 3218, 3301 - 3308, 3311 - 3318, 4101 - 4108, 4111 - 4118, 4201 - 4208, 4211 - 4218, 4301 - 4308, 4311 - 4318, 5101 - 5108, 5111 - 5118, 5201 - 5208, 5211 - 5218, 5301 - 5308, 5311 - 5318, 6101 - 6108, 6111 - 6118*

#### **port (mandatory)**

GEDTI Port to be set.

#### **Range:**

*1025 - 65354*

### Example

```
chg-gedti-card:loc=1211:port=1124
```

### Dependencies

The value specified for the loc parameter must correspond to the location of an IPSM card.

The value specified for the port parameter must not be configured on any other IPSM card.

If the GEDTI Hub is in ACTIVE state then port cannot be changed.

The EE Card table must be accessible.

### Notes

None.

### Output

```
chg-gedti-card:loc=1211:port=1245
```

```
tekelecstp 10-03-08 14:43:31 EST EAGLE 46.0.0  
EE CARD table is (2 of 256) 1% full  
CHG-GEDTI-CARD:MASP A - COMPLTD ;
```

### Related Topics

- [act-gedti](#)
- [dact-gedti](#)

- [rept-stat-gedti](#)

## chg-tbl

Use this command to create, rename, or reset any table on a fixed disk or removable drive.

### **Caution:**

Before entering the `chg-tbl` command, contact My Oracle Support.

### Parameters

#### **action (mandatory)**

The desired action to perform on the table.

#### **Range:**

##### ***create***

Creates a DOS entry in the FAT table and updates the DOS directory table.

##### ***rename***

Changes the name of an existing system table to a new DOS file name (does not update the *dms.cfg* file).

##### ***reset***

Initializes an existing table to the value designated by the `resetchar` parameter.

#### **disk (mandatory)**

Target disk. The disk that contains the file.

#### **Range:**

##### ***remove***

Removable drive

##### ***fixed***

Fixed disk

##### ***usb***

Argument to be used by Oracle personnel only.

#### **ext (optional)**

Extension. The three character DOS filename extension.

#### **Range:**

*azz*

0–3 ASCII characters

#### **filelength (optional)**

The amount of space the file occupies on the disk.

**Range:**  
1 - 32505856

**id (optional)**  
Table identification number.

**Range:**  
0 - 499

**name (optional)**  
Name of the file.

**Range:**  
azzzzzzz  
1–8 ASCII characters

**prtnggrp (optional)**  
Partition group. The disk partition group to be changed.

**Range:**  
*active*  
*inactive*

**Default:**  
*active*

**resetchar (optional)**  
Reset character. The table reset character that is written to every byte of the table.

**Range:**  
0 - 255

### Example

```
chg-  
tbl:action=create:disk=remove:name=test:ext=sys:filelength=150000  
chg-tbl:action=reset:disk=remove:id=0  
chg-tbl:action=rename:disk=remove:id=0:name=dms:ext=old
```

### Dependencies

If the `action=create/rename` parameter is specified, then the `name` parameter must be specified.

If the `action=create` parameter is specified, then the `name`, `ext`, and `filelength` parameters must be specified.

If the file type is a directory, the `filelength` parameter is not required. The directory entry file length is always 1 cluster in length.

The attributes used during file creation are current date and time of the active MASP. Readable/writable files are allocated contiguously from the last free FAT cluster.

If the `action=reset` parameter is specified, then the `id` parameter must be specified.

If the `action=rename` parameter is specified, then the `id`, `name`, and `ext` parameters must be specified.

This command cannot be used to modify the security log.

### Notes

None

### Output

```
chg-  
tbl:action=create:disk=remove:name=test:ext=sys:filelength=1500  
00
```

```
chg-tbl: CREATE OK : filename = test.sys, byte length = 150000  
chg-tbl: command complete  
;
```

```
chg-tbl:action=reset:disk=remove:id=0
```

```
chg-tbl: RESET OK : Table 0, DMS.CFG  
chg-tbl: command complete  
;
```

```
chg-tbl:action=rename:disk=remove:id=0:name=dms:ext=old
```

```
chg-tbl: RENAME OK : Table 0, DMS.CFG to DMS.OLD  
chg-tbl: command complete  
;
```

### Related Topics

- [disp-disk-dir](#)

## chg-upgrade-config

Use this command to configure data used by the upgrade software during an upgrade of an in-service EAGLE from a source release to the target release.

#### Note:

This command stores data that will be used during the software upgrade. The command does not start the software upgrade.

## Parameters

### **addtblcnv (optional)**

This parameter sets the flag of the corresponding entry in the Table Conversion Definition table that forces the table to be converted during a software upgrade.

#### **Caution:**

The `addtblcnv` parameter should be used only under the direction of My Oracle Support (MOS).

#### **Range:**

*0 - 1023*

### **assignset (optional)**

Assigned Set. The card specified by the `loc` parameter is assigned to the upgrade-grouping set specified by this parameter.

#### **Range:**

*0*

removes the card from the set list

*2 - 10*

assigns the card to that particular set list for the group corresponding to the card type

### **deltblcnv (optional)**

This parameter clears the flag of the corresponding entry in the Table Conversion Definition table that forces the table to be converted during a software upgrade.

#### **Caution:**

The `deltblcnv` parameter should be used only under the direction of My Oracle Support (MOS).

#### **Range:**

*0 - 1023*

### **limsets (optional)**

LIM Sets. This parameter sets the number of sets for link cards.

#### **Range:**

*2 - 10*

### **loc (optional)**

Location. The location of a network card to be assigned to a set specified by the `assignset` parameter.

**Range:**

1101 - 1113, 1115, 1201 - 1218, 1301 - 1318, 2101 - 2118, 2201 - 2218, 2301 - 2318, 3101 - 3118, 3201 - 3218, 3301 - 3318, 4101 - 4118, 4201 - 4218, 4301 - 4318, 5101 - 5118, 5201 - 5218, 5301 - 5318, 6101 - 6118

**src (optional)**

Source. The disk that physically contains the upgrade target release.

**Range:*****fixed***

The upgrade target release is on the fixed disk

***remove***

The upgrade target release is on the removable drive

**srvsets (optional)**

Service Sets. This parameter sets the number of sets for service cards.

**Range:**

2 - 10

**threstype (optional)**

Threshold type. The type of thresholding to be used during the upgrade.

**Range:*****set***

Network conversion is based on the defined sets of cards

**Example**

```
chg-upgrade-config:addtblcnv=327
```

```
chg-upgrade-config:delttblcnv=327
```

```
chg-upgrade-config:sak=vbjyapdpbtejb:src=fixed
```

```
chg-upgrade-config:threstype=set:srvsets=2:limsets=4
```

**Dependencies**

The `addtblcnv` and `delttblcnv` parameters cannot be specified together in the command.

One of the optional parameters must be specified in the command.

The `srvsets` and `limsets` parameters cannot be specified unless the `threstype` is being changed to or has been changed to `set`.

The `loc` parameter is required when the `assignset` parameter is specified.

The value specified for the `assignset` parameter cannot be greater than the current value of `srvsets` or `limsets` for the specified card.

The `chg-upgrade-config` command cannot be issued when SFAPP(P)->OAM sync is ON.

This command cannot be entered when CAT2 IPSM to OAM syncing is in progress.



## Output

```
chg-upgrade-config:addtblcnv=327
```

```
rlghncxa03w 07-03-13 08:15:45 EST EAGLE 37.5.0  
Command Completed.  
;
```

## Related Topics

- [act-upgrade](#)
- [rtrv-upgrade-config](#)

# clr-disk-stats

Use this command to clear the disk performance statistics. All associated disk statistics are zeroed.

## Parameters

### loc (mandatory)

Location. The location of the card.

#### Range:

1113, 1115

#### Default:

none

## Example

```
clr-disk-stats:loc=1113
```

## Dependencies

The specified card location must contain a card that is running an OAM (1113 or 1115).

A related command must not be in progress.

## Notes

None

## Output

```
clr-disk-stats:loc=1113
```

```
rlghncxa03w 01-03-01 14:14:05 EST Rel 28.1.0  
Disk performance statistics cleared.  
;
```

**Related Topics**

- [disp-disk-stats](#)

## copy-tbl

Use this command to copy a single table from one source to another. A table can be copied to any verifiable location in the system; however, the source and destination tables must have identical configurations (same number of entries, same entry size, both 1- dimensional and 2-dimensional).

**Note:**

A table cannot be copied onto itself.

**Parameters****dloc (mandatory)**

Destination location. The location of the destination table.

**Range:**

*1101 - 1108, 1111 - 1112, 1201 - 1208, 1211 - 1218, 1301 - 1308, 1311 - 1318, 2101 - 2108, 2111 - 2118, 2201 - 2208, 2211 - 2218, 2301 - 2308, 2311 - 2318, 3101 - 3108, 3111 - 3118, 3201 - 3208, 3211 - 3218, 3301 - 3308, 3311 - 3318, 4101 - 4108, 4111 - 4118, 4201 - 4208, 4211 - 4218, 4301 - 4308, 4311 - 4318, 5101 - 5108, 5111 - 5118, 5201 - 5208, 5211 - 5218, 5301 - 5308, 5311 - 5318, 6101 - 6108, 6111 - 6118*

**1114**

TDM

**1116**

TDM

**1113**

Latched USB port

**1115**

Latched USB port

**sloc (mandatory)**

Source location. The location of the source table.

**Range:**

*1101 - 1108, 1111 - 1112, 1201 - 1208, 1211 - 1218, 1301 - 1308, 1311 - 1318, 2101 - 2108, 2111 - 2118, 2201 - 2208, 2211 - 2218, 2301 - 2308, 2311 - 2318, 3101 - 3108, 3111 - 3118, 3201 - 3208, 3211 - 3218, 3301 - 3308, 3311 - 3318, 4101 - 4108, 4111 - 4118, 4201 - 4208, 4211 - 4218, 4301 - 4308, 4311 - 4318, 5101 - 5108, 5111 - 5118, 5201 - 5208, 5211 - 5218, 5301 - 5308, 5311 - 5318, 6101 - 6108, 6111 - 6118*

**1114**

TDM

**1116**

TDM

**1113**

Latched USB port

**1115**

Latched USB port

**stb1 (mandatory)**

Source table. The identifying number of the source table.

**Range:***0 - 1023***ddrv (optional)**

Destination drive. The identification of the disk to which the table is copied.

**Range:*****fixed***

The fixed disk

***remove***

The removable drive

***usb***

Argument to be used by Oracle personnel only.

**Default:***fixed***dprtngrp (optional)**

Disk partition group. The disk partition group of the destination table.

**Range:*****active******inactive*****Default:***active***dtb1 (optional)**

Destination table. The identifying number of the destination table.

**Range:***0 - 1023***Default:**The `stb1` parameter value

**sdrv (optional)**

Source drive. The identification of the disk from which the table is copied.

**Range:*****fixed***

The fixed disk

***remove***

The removable drive

***usb***

Argument to be used by Oracle personnel only.

**Default:**

*fixed*

**sprtnggrp (optional)**

Source partition group. The disk partition group of the source table.

**Range:*****active******inactive*****Default:**

*active*

**Example**

```
copy-tbl:stbl=25:dtbl=24:sloc=1114:dloc=1116:sdrv=fixed
```

**Dependencies**

Only one table copy command can be executed at a time.

The source and destination tables must exist and be compatible.

This command cannot be used to modify the security log.

The same value cannot be specified for the `sloc` and `dloc` or the `stbl` and `dtbl` parameters.

If a value of *fixed* is specified for the `sdrv` or `ddrv` parameter, then a value of 1114 or 1116 must be specified for the `sloc` or `dloc` parameter.

This command cannot be entered when CAT2 IPSPM to OAM syncing is in progress.

**Notes**

None

**Output**

```
copy-tbl:stbl=25:dtbl=24:sloc=1114:dloc=1116:sdrv=fixed
```

```
rlghncxa03w 01-03-04 16:11:53 EST Rel 28.1.0
```

```
Table copy command complete.  
;
```

## dact-ee

Use this command to deactivate an Eagle Eyes Card and stop capturing traffic on it. The state of the card is changed from ACT (Active) to DACT (Deactivated).



### Note:

If the card boots, then the status of the card would be reset to DACT. This will clear the EE configuration from the card.

### Parameters

#### **loc (mandatory)**

The Eagle Eyes card location as stenciled on the shelf of the system.

#### **Range:**

*1101 - 1108, 1111 - 1112, 1201 - 1208, 1211 - 1218, 1301 - 1308, 1311 - 1318, 2101 - 2108, 2111 - 2118, 2201 - 2208, 2211 - 2218, 2301 - 2308, 2311 - 2318, 3101 - 3108, 3111 - 3118, 3201 - 3208, 3211 - 3218, 3301 - 3308, 3311 - 3318, 4101 - 4108, 4111 - 4118, 4201 - 4208, 4211 - 4218, 4301 - 4308, 4311 - 4318, 5101 - 5108, 5111 - 5118, 5201 - 5208, 5211 - 5218, 5301 - 5308, 5311 - 5318, 6101 - 6108, 6111 - 6118*

### Example

```
dact-ee:loc=1203
```

### Dependencies

The card at the specified location must be equipped.

The card should be configured as an Eagle Eyes card.

### Notes

The value specified for the loc parameter must refer to a card running one of the following GPLs, and the referenced card must be equipped:

- IPSPG, IPLHC, IPGHC
- ATMHC
- SS7HC
- SIPHC
- DEIRHC
- ERTHC

## Output

```
dact-ee:loc=1101
```

```
Command Accepted - Processing
```

```
tekelecstp 11-08-16 18:35:44 MST EAGLE 46.0.0
```

```
dact-ee:loc=1101
```

```
Command entered at terminal #1.
```

```
;
```

```
tekelecstp 11-08-16 18:35:44 MST UNKNOWN EAGLE 46.0.0
```

```
Deactivate EE message sent to card.
```

```
;
```

```
tekelecstp 11-08-16 18:35:44 MST EAGLE 46.0.0
```

```
Command Completed.
```

```
;
```

## Related Topics

- [chg-ee-card](#)
- [rept-stat-ee](#)
- [rtrv-ee-card](#)

# dact-gedti

Use this command to deactivate a GEDTI Hub. The state of the GEDTI Hub is changed from ACT (Active) to DACT (Deactivated).



### Note:

The specified card must be Active before the command can be executed. If the card boots, then the status of the GEDTI Hub will be reset to DACT.

## Parameters

### loc (mandatory)

The card location as stenciled on the shelf of the system.

#### Range:

1101 - 1108, 1111 - 1112, 1201 - 1208, 1211 - 1218, 1301 - 1308, 1311 - 1318,  
2101 - 2108, 2111 - 2118, 2201 - 2208, 2211 - 2218, 2301 - 2308, 2311 - 2318,  
3101 - 3108, 3111 - 3118, 3201 - 3208, 3211 - 3218, 3301 - 3308, 3311 - 3318,  
4101 - 4108, 4111 - 4118, 4201 - 4208, 4211 - 4218, 4301 - 4308, 4311 - 4318,  
5101 - 5108, 5111 - 5118, 5201 - 5208, 5211 - 5218, 5301 - 5308, 5311 - 5318,  
6101 - 6108, 6111 - 6118, 1113, 1115

**Example**

```
dact-gedti:loc=1102
```

**Dependencies**

The value specified for the `loc` parameter must refer to an equipped card location.

A valid value must be specified for the `loc` parameter.

The card at the specified location must be configured as a GEDTI Hub.

Deactivating the state of a GEDTI Hub that is already deactivated has no effect.

**Notes**

None.

**Output**

```
dact-gedti:loc=1101
```

```
Command Accepted - Processing
```

```
tekelecstp 11-08-16 18:35:44 MST EAGLE 46.0.0
```

```
dact-gedti:loc=1101
```

```
Command entered at terminal #1.
```

```
;
```

```
tekelecstp 11-08-16 18:35:44 MST UNKNOWN EAGLE 46.0.0
```

```
Deactivate GEDTI Hub message sent to card.
```

```
;
```

```
tekelecstp 11-08-16 18:35:44 MST EAGLE 46.0.0
```

```
Command Completed.;
```

**Related Topics**

- [act-gedti](#)
- [chg-gedti-card](#)
- [rept-stat-gedti](#)

## dact-ip-lnk

Use this command to deactivate an IP link and put the link out of service. The state of the link is changed from IS-NR (In-Service-Normal), IS-ANR (In-Service-Abnormal), or OOS-MT (Out-Of-Service-Maintenance), to OOS-MT-DSBLD (Out-Of-Service-Maintenance-Disabled).

 **Note:**

The specified card must be Active before the command can be executed. If the card boots, then the status of the IP link will be reset.

**Parameters****loc (mandatory)**

The card location as stenciled on the shelf of the system.

**Range:**

1101 - 1108, 1111 - 1112, 1201 - 1208, 1211 - 1218, 1301 - 1308, 1311 - 1318,  
2101 - 2108, 2111 - 2118, 2201 - 2208, 2211 - 2218, 2301 - 2308, 2311 - 2318,  
3101 - 3108, 3111 - 3118, 3201 - 3208, 3211 - 3218, 3301 - 3308, 3311 - 3318,  
4101 - 4108, 4111 - 4118, 4201 - 4208, 4211 - 4218, 4301 - 4308, 4311 - 4318,  
5101 - 5108, 5111 - 5118, 5201 - 5208, 5211 - 5218, 5301 - 5308, 5311 - 5318,  
6101 - 6108, 6111 - 6118, 1113, 1115

**port (mandatory)**

Ethernet interface Port ID.

**Range:****a**

IP Port A

**b**

IP Port B

**c**

IP Port C

**d**

IP Port D

**fca**

Fast Copy Port A

**fcb**

Fast Copy Port B

**Example**

```
dact-ip-lnk:loc=1102:port=a
dact-ip-lnk:loc=1203:port=fca
dact-ip-lnk:loc=1103:port=c
dact-ip-lnk:loc=1202:port=d
```

**Dependencies**

The value specified for the `loc` parameter must refer to one of the following cards, and the referenced card must be equipped:



- E5-ENET-B card running the EROUTE, IPGWx, IPLIMx, IPSG, or STPLAN application
- IPSM card
- E5-SM4G or E5-SM8G-B card running the VSCCP application
- E5-OAM card running the OAMHC application
- E5-MCPM-B card
- SLIC card

A valid value must be specified for the `loc` parameter.

The value specified for the `port` parameter must be supported by the card:

- port A-E5-OAM card running OAMHC application, IPSM card, E5-MCPM-B card, E5-ENET-B card running the STPLAN application
- port A, B- E5-ENET-B card running the EROUTE or IPLIMx application, E5-SM4G or E5-SM8G-B card running the VSCCP application
- port A, B, FCA, FCB- E5-ENET-B card running the IPGWx or IPSG application
- ports A, B, C and D are valid for DEIR/SIP/ENUM applications running on SLIC card

The card at the specified location must be configured.

The card in the specified location must be Active before this command can be executed.

### Notes

The `act-ip-lnk/dact-ip-lnk` commands were created as debug means - aids to turn off or disable the IP interface to troubleshoot network problems, specifically to allow the operator to troubleshoot IP network flooding issues that can cause EAGLE cards to boot repeatedly while trying to come up. These commands should NOT be used for general maintenance actions since they have not been rigorously tested and their usage should be limited to situations like described above.

Interface A/D is used for ExAP connectivity and interface B/C is used for the signaling network on the SLIC card running DEIR/SIP/ENUM applications.

### Output

```
dact-ip-lnk:loc=1101:port=a
```

```
Command Accepted - Processing
```

```
tekelecstp 11-08-16 18:35:44 MST EAGLE 44.0.0
```

```
dact-ip-lnk:loc=1101:port=a
```

```
Command entered at terminal #1.
```

```
;
```

```
tekelecstp 11-08-16 18:35:44 MST UNKNOWN EAGLE 44.0.0
```

```
Deactivate IP link message sent to card.
```

```
;
```

```
tekelecstp 11-08-16 18:35:44 MST EAGLE 44.0.0
```

```
Command Completed.
```

```
;
```

```
dact-ip-lnk:loc=1103:port=c

Command Accepted - Processing

    tekelecstp 16-05-25 03:51:03 MST    EAGLE 46.4.0.0.0-69.1.0
    dact-ip-lnk:loc=1103:port=c
    Command entered at terminal #18.
;

    tekelecstp 16-05-25 03:51:03 MST    EAGLE 46.4.0.0.0-69.1.0
    Deactivate IP link message sent to card.
;

    tekelecstp 16-05-25 03:51:03 MST    EAGLE 46.4.0.0.0-69.1.0
    Command Completed.
;
```

### Related Topics

- [rtrv-ip-lnk](#)

## dbg-ddb

Use this command to display the checksum, statistics, and wild write audit (WWA) updates of dynamic database (DDB) table entries, audit a specific table, and reset the DDB statistics on the cards.

### Parameters

#### **action (mandatory)**

The action taken by the command.

#### **Range:**

##### **stats**

display dynamic database statistics

##### **aud**

audit a specific table

##### **disp**

display a table entry

##### **wwa**

display any entries updated by WWA task

##### **rststat**

reset following DDB audit statistics:

- Number of DDB updates
- Number of consecutive DDB update in progress
- Maximum DDB updates in 100 msec

- Idle period
- Maximum and minimum idle period

**audtype (optional)**

Audit type. This parameter specifies whether a unicast or multicast audit is performed.

**Range:**

**mc**  
multicast

**uc**  
unicast

**Default:**

*mc*

**dpc (optional)**

The destination point code value. The Route table entry corresponding to the DPC value is displayed.

**Range:**

*p-*, *000-255*, *\**

Specify a valid value for each subfield of the point code, and separate the subfields with a dash (-).

*prefix—p-*

The asterisk value (\*) is not valid for the *ni* subfield.

When *chg-sid:pctype=ansi* is specified, *ni = 000* is not valid.

When *chg-sid:pctype=ansi* is specified, *nc = 000* is not valid if *ni = 001-005*.

When *chg-sid:pctype=ansi* is specified, *nc = 000* is valid if *ni = 006-255*.

The point code *000-000-000* is not a valid point code.

**dpc/dpca/dpci/dpcn/dpcn24/dpcn16 (optional)****dpci (optional)**

ITU international destination point code with subfields *zone-area-id*. The *prefix* subfield indicates a spare point code, private point code, or private and spare point code (*prefix-zone-area-id*).

**Range:**

*s-*, *p-*, *ps-*, *0-255*, *none*

Specify a valid value for each subfield of the point code, and separate the subfields with a dash (-).

*prefix—s-*, *p-*, *ps*

*zone—0-7*

*area—000-255*

*id—0-7*

The point code *0-000-0* is not a valid point code.

Enter *none* to delete the point code.

**dpcn (optional)**

ITU national destination point code in the format of a 5-digit number (*nnnnn*); or 2, 3, or 4 numbers (*members*) separated by dashes (*m1-m2-m3-m4*) as defined by the *chg-stpopts:npcfmti* flexible point code option. A group code must be specified when the ITUDUPPC feature is turned on (*nnnnn-gc*, *m1-m2-m3-m4-gc*). The *prefix* subfield indicates

a spare point code, private point code, or private and spare point code (*prefix-nnnnn*, *prefix-nnnnn-gc*, *prefix-m1-m2-m3-m4*, *prefix-m1-m2-m3-m4-gc*).

**Range:**

*s*-, *p*-, *ps*-, 0-16383, *aa-zz*

Specify a valid value for each subfield of the point code, and separate the subfields with a dash (-).

*prefix*—*s*-, *p*-, *ps*

*nnnnn*—0-16383

*gc*—*aa-zz*

*m1-m2-m3-m4*—0-14 for each member; values must sum to 14

**dpcn24 (optional)**

24-bit ITU national destination point code with subfields *main signaling area-sub signaling area-signaling point* (*msa-ssa-sp*). The *prefix* subfield indicates a private point code (*prefix-msa-ssa-sp*).

**Range:**

*p*-, 000-255

Specify a valid value for each subfield of the point code, and separate the subfields with a dash (-).

*prefix*—*p*

*msa*—000–255

*ssa*—000–255

*sp*—000–255

**Default:**

No change to current value.

**dpcn16 (optional)**

16-bit ITU national point code with subfields *unit number sub number area main number area* (*un-sna-mna*). The *prefix* subfield indicates a private point code (*prefix-un-sna-mna*).

**Range:**

*p*--, 000--127

Specify a valid value for each subfield of the point code, and separate the subfields with a dash (-).

*prefix*--*p*

*un*---000---127

*sna*---000---15

*mna*---000---31

**Default:**

No change to the current value.

**link (optional)**

The entry in the Link table that corresponds to the specified link value.

**Range:**

*a*, *b*, *a1* -*a31*, *b1* - *b31*

**loc (optional)**

The location of the MTP card that is being debugged.

**Range:**

1101 - 1108, 1111 - 1112, 1201 - 1208, 1211 - 1218, 1301 - 1308, 1311 - 1318, 2101 - 2108, 2111 - 2118, 2201 - 2208, 2211 - 2218, 2301 - 2308, 2311 - 2318, 3101 - 3108, 3111 - 3118, 3201 - 3208, 3211 - 3218, 3301 - 3308, 3311 - 3318, 4101 - 4108, 4111 - 4118, 4201 - 4208, 4211 - 4218, 4301 - 4308, 4311 - 4318, 5101 - 5108, 5111 - 5118, 5201 - 5208, 5211 - 5218, 5301 - 5308, 5311 - 5318, 6101 - 6108, 6111 - 6118

**lsn (optional)**

Linkset name. The entry in the Linkset table that corresponds to the specified linkset name.

**Range:**

ayyyyyyy

**rloc (optional)**

Reference card location. This parameter audits the table where the reference card is located.

**Range:**

1101 - 1108, 1111 - 1112, 1201 - 1208, 1211 - 1218, 1301 - 1308, 1311 - 1318, 2101 - 2108, 2111 - 2118, 2201 - 2208, 2211 - 2218, 2301 - 2308, 2311 - 2318, 3101 - 3108, 3111 - 3118, 3201 - 3208, 3211 - 3218, 3301 - 3308, 3311 - 3318, 4101 - 4108, 4111 - 4118, 4201 - 4208, 4211 - 4218, 4301 - 4308, 4311 - 4318, 5101 - 5108, 5111 - 5118, 5201 - 5208, 5211 - 5218, 5301 - 5308, 5311 - 5318, 6101 - 6108, 6111 - 6118

**tbl (optional)**

The table used as the source of the audit data.

**Range:**

*lnk*

Link table

*ls*

Linkset table

*rte*

Route table

**tidx (optional)**

Table index. This parameter displays the corresponding table entry.

**Range:**

0 - 16000

**System Default:**

0

**Example**

This command displays the 126th entry in the Link table.

```
dbg-ddb:loc=1105:tbl=lnk:action=disp:tidx=126
```

This command displays the entry in the Link table corresponding to link=a and

```
rloc=1107.
```

```
dbg-ddb:loc=1105:tbl=lnk:action=disp:rloc=1107:link=a
```

This command audits the Link table in multicast mode.

```
dbg-ddb:loc=1105:tbl=lnk:action=aud:audtype=mc
```

This command audits the Link table in unicast mode.

```
dbg-ddb:loc=1105:tbl=lnk:action=aud:audtype=uc
```

This command audits the Link table at the card location 1105 using the reference card 1107.

```
dbg-ddb:loc=1105:tbl=lnk:action=aud:audtype=uc:rloc=1107
```

This command displays the statistics of a specified card.

```
dbg-ddb:loc=1201:action=stats
```

This command displays the WWA entries on a specified card.

```
dbg-ddb:action=wwa:loc=1201
```

This command resets the statistics of a specified card.

```
dbg-ddb:action=rststat:loc=2100
```

This command resets the statistics of all active MTP cards.

```
dbg-ddb:action=rststat
```

### Dependencies

The `dpc`, `tidx`, `lsn`, and `rloc` parameters cannot be specified together in the command.

The `dpc`, `tidx`, `lsn`, and `link` parameters cannot be specified together in the command.

The `action=disp` and `tbl=rte` parameters must be specified before the `dpc` parameter can be specified.

The `action=disp` and `tbl=ls` parameters must be specified before the `lsn` parameter can be specified.

The `action=disp` and `tbl=lnk` parameters must be specified before the `link` parameter can be specified.

The `action=disp` parameter must be specified before the `tidx` parameter can be specified.

The `action= aud` parameter must be specified before the `audtype` parameter can be specified.

The `action=disp` and `tbl=lnk` parameters or the `action=aud` and `audtype=uc` parameters must be specified before the `rloc` parameter can be specified.

If the `action` parameter has a value of `wwa`, `stats`, or `rststat`, then the `loc` parameter is the only other parameter that can be specified.

If the `action=disp` and `tbl=lnk` parameters are specified, then the `rloc` and `link` parameters must be specified together in the command.

The card location specified by the `loc` or `rloc` parameter must be equipped.

The value specified for the `loc` or `rloc` parameter must indicate an MTP card.

The status of the card at the location specified by the `loc` or `rloc` parameter must be active.

The linkset specified by the `lsn` parameter must already exist in the Linkset table.

The link specified by the `link` parameter must already be equipped.

The value specified for the `dpc` parameter must already exist in the Route table.

The Link table is corrupt or cannot be found.

The value specified for the `dpc` parameter must be a full point code, network point code, or a cluster point code.

Values of 1113 - 1118 cannot be specified for the `loc` or `rloc` parameters.

If the `action` parameter has a value of `disp`, `aud`, `stats`, or `wwa`, then the `loc` parameter must be specified.

If the `action=aud` parameter and the `rloc` parameter are specified, then the `audtype` parameter must be specified.

If the `action` parameter has a value of `disp` or `aud`, then the `tbl` parameter must be specified.

The J7 support feature must be enabled before the `opcn16/dpcn16` parameters can be specified.

### Notes

For a multicast audit, the card that receives the message sends the audit request to all other MTP cards simultaneously. For a unicast audit, the card that receives the message sends the audit request to another MTP card, which sends the request to next MTP card, etc. This process continues until the last MTP card in the system receives the request.

A maximum of the last 10 entries of WWA updates are displayed.

### Output

A maximum of 20 entries with mismatched card values can be displayed as necessary.

If mismatched card entries occur, the `SeqNo` field can be used to correlate the entries between two cards (e.g. `SeqNo: 1` of card 1 can be compared against `SeqNo: 1` of card 2.)

```
dbg-ddb:loc=1104:action=disp:tbl=ls:tidx=1
```

```
tekelecstp 09-10-15 12:37:37 EST EAGLE5 41.1.0
dbg-ddb:loc=1104:action=disp:tbl=ls:tidx=1
Command entered at terminal #4.
;

tekelecstp 09-10-15 12:37:37 EST EAGLE5 41.1.0
User Message sent to location 1104.
;

tekelecstp 09-10-15 12:37:37 EST EAGLE5 41.1.0
[SeqNo: 0] [1104] [Linkset:1] Chksum h'1624 at h'28e84a (138 bytes)
Assign:1 Avail:0 APC: 001-001-002 ITUNVar:0
;
```

```
dbg-ddb:loc=1104:action=disp:tbl=lnk:tidx=1

tekelecstp 09-10-15 12:37:37 GMT EAGLE5 41.1.0
dbg-ddb:loc=1104:action=disp:tbl=lnk:tidx=1
Command entered at terminal #4.
;

tekelecstp 09-10-15 12:37:37 GMT EAGLE5 41.1.0
User Message sent to location 1104.
;

tekelecstp 09-10-15 12:37:37 GMT EAGLE5 41.1.0
[SeqNo: 0] [1104] [Link:x1] Chksum h'da8d at h'2877ce (14 bytes)
PortId:h'1e6 (Card:1104 Link h'0)
Slc:0 Stat:h'2 LsId:h'0 Class:0
Status:Fail
;

dbg-ddb:loc=1104:action=aud:tbl=lnk:audtype=mc

tekelecstp 09-10-15 13:40:38 GMT EAGLE5 41.1.0
dbg-ddb:loc=1104:action=aud:tbl=lnk:audtype=mc
Command entered at terminal #4.
;

tekelecstp 09-10-15 13:40:38 GMT EAGLE5 41.1.0
User Message sent to location 1104.
;

tekelecstp 09-10-15 13:40:38 GMT EAGLE5 41.1.0
[1104] Bcast:Card->Sys (Tbl 0) MTPCards:h'2 Reply:h'2 Mismatch:h'0
;

dbg-ddb:loc=1104:action=aud:tbl=lnk:audtype=uc

tekelecstp 09-10-15 16:37:11 GMT EAGLE5 41.1.0
dbg-ddb:loc=1104:action=aud:tbl=lnk:audtype=uc
Command entered at terminal #4.
;

tekelecstp 09-10-15 16:37:11 GMT EAGLE5 41.1.0
User Message sent to location 1104.
;

tekelecstp 09-10-15 16:37:11 GMT EAGLE5 41.1.0
[1104]Card->System (Tbl:0) Successful System Audit Completed
;
```

This example shows the output when multiple mismatch entries occur between two cards:



```
dbg-ddb:loc=1205:rloc=1207:action=aud:tbl=rte:audtype=uc
```

```
tekelecstp 10-01-28 16:37:11 GMT EAGLE5 42.0.0
dbg-ddb:loc=1205:rloc=1207:action=aud:tbl=rte:audtype=uc
Command entered at terminal #4.
```

```
;
```

```
tekelecstp 10-01-28 16:37:11 GMT EAGLE5 42.0.0
User Message sent to location 1205.
```

```
;
```

```
tekelecstp 10-01-28 16:37:11 GMT EAGLE5 42.0.0
Card[1205]->card[1207] (Tbl:0) TblAuditDone:TotalMisses:h'2
FirstMiss:h'0
```

```
;
```

```
tekelecstp 10-01-28 16:37:11 GMT EAGLE5 42.0.0
[SeqNo: 1] [1205] [Route:h'0] Chksum h'320b at h'8fc3b0 (75 bytes)
PC: 001-001-001 LstRt:0 CmbRt:6 Dyn:h'1 TFC:0
Xlst:0 MOBR:0 NAdj:1 3 3 3 3 3 NmTFR:0 PrevSt:1
```

```
;
```

```
tekelecstp 10-01-28 16:37:11 GMT EAGLE5 42.0.0
[SeqNo: 1] [1205] nway: 0 cost_grp(0-5): c7 c6 c6 c6 c6 c6
rte_used(0-5): c0 36 36 36 36 36
curr_cost_grp: 0 prev_cost_grp 0
SRT:h'88079c (28 bytes) AKT:h'8bb43c (12 bytes)
```

```
;
```

```
tekelecstp 10-01-28 16:37:11 GMT EAGLE5 42.0.0
[SeqNo: 2] [1205] [Route:h'1] Chksum h'c96e at h'8fc3fb (75 bytes)
PC: 001-001-002 LstRt:0 CmbRt:6 Dyn:h'1 TFC:0
Xlst:0 MOBR:0 NAdj:1 3 3 3 3 3 NmTFR:0 PrevSt:1
```

```
;
```

```
tekelecstp 10-01-28 16:37:11 GMT EAGLE5 42.0.0
[SeqNo: 2] [1205] nway: 0 cost_grp(0-5): c7 c6 c6 c6 c6 c6
rte_used(0-5): c0 36 36 36 36 36
curr_cost_grp: 0 prev_cost_grp 0
SRT:h'8807b8 (28 bytes) AKT:h'8bb448 (12 bytes)
```

```
;
```

```
tekelecstp 10-01-28 16:37:11 GMT EAGLE5 42.0.0
[SeqNo: 1] [1207] [Route:h'0] Chksum h'cecc at h'9688ea0 (243 bytes)
PC: 001-001-001 LstRt:0 CmbRt:6 Dyn:h'1 TFC:0
Xlst:0 MOBR:0 NAdj:1 3 3 3 3 3 NmTFR:0 PrevSt:1
```

```
;
```

```
tekelecstp 10-01-28 16:37:11 GMT EAGLE5 42.0.0
[SeqNo: 1] [1207] nway: 0 cost_grp(0-5): c8 c6 c6 c6 c6 c6
rte_used(0-5): c0 46 36 36 36 36
curr_cost_grp: 0 prev_cost_grp 0
SRT:h'95148e0 (28 bytes) AKT:h'9575980 (12 bytes)
```

```
;
```

```

tekelecstp 10-01-28 16:37:11 GMT EAGLE5 42.0.0
[SeqNo: 2] [1207] [Route:h'1] Chksum h'662f at h'9688f93 (243
bytes)
PC: 001-001-002 LstRt:0 CmbRt:6 Dyn:h'1 TFC:0
Xlst:0 MOBR:0 NAdj:1 3 3 3 3 3 NmTFR:0 PrevSt:1
;

tekelecstp 10-01-28 16:37:11 GMT EAGLE5 42.0.0
[SeqNo: 2] [1207] nway: 0 cost_grp(0-5): c8 c6 c6 c6 c6 c6
rte_used(0-5): c0 46 36 36 36 36
curr_cost_grp: 0 prev_cost_grp 0
SRT:h'95148fc (28 bytes) AKT:h'957598c (12 bytes)
;

dbg-ddb:action=wwa:loc=1301

tekelecstp 09-10-12 17:37:11 GMT EAGLE5 41.1.0
dbg-ddb:action=wwa:loc=1301
Command entered at terminal #10.
;

tekelecstp 09-10-12 17:37:11 GMT EAGLE5 41.1.0
User Message sent to location 1301.
;

tekelecstp 09-10-12 17:37:11 GMT EAGLE5 41.1.0
DDB WWA REPORT (LOC = 1301)
      WILD WRITE AUDIT UPDATED (1) ENTRIES:
      TIME STAMP          TABLE      ENTRY_IDX  ORIG CHKSUM
UPD CHKSUM
      1. 09-10-12 17:35:02:586 RTE          0      H'41880000
H'00000000
;

dbg-ddb:action=stats:loc=1201

tekelecstp 09-10-03 17:37:11 GMT EAGLE5 41.1.0
dbg-ddb:action=stats:loc=1201
Command entered at terminal #10.
;

tekelecstp 09-10-03 17:37:11 GMT EAGLE5 41.1.0
User Message sent to location 1201.
;

tekelecstp 09-10-03 17:37:11 GMT EAGLE5 41.1.0
DDB STATISTICS
      LOC                      : 1201
      CARD STATUS              (DDL)      : [CROSSLOADED]
                                   (DDB)      : [INITIALIZED]
      IN UPDATE STATUS        (DDB CHECKSUM) : [FALSE]

```

```

                                (TSRC)                : [IDLE]
SUCCESSION TIMES CARD REPORTED (IN UPDATE) : 0
DDB UPDATES                        : 2000
MAXIMUM UPDATES PER 100ms          : 900
DDB IDLE PERIOD:                    : 03:12:30:20:50
MAXIMUM IDLE PERIOD                : 02:12:30:20:50
MINIMUM IDLE PERIOD                : 01:04:40:10:80
NUMBER OF WWA UPDATED ENTRIES     : 4
;

```

```
dbg-ddb:action=wwa:loc=1201
```

```

tekelecstp 09-10-21 17:37:11 GMT EAGLE5 41.1.0
dbg-ddb:action=wwa:loc=1201
Command entered at terminal #10.
;

tekelecstp 09-10-21 17:37:11 GMT EAGLE5 41.1.0
User Message sent to location 1201.
;

tekelecstp 09-10-21 17:37:11 GMT EAGLE5 41.1.0
DDB WWA REPORT (LOC = 1201)
      WILD WRITE AUDIT UPDATED (NO) ENTRIES:
;

```

### Legend

- **WWA**—Wild Write Audit
- **DDB**—Dynamic Database
- **Time stamp**—Card time stamp when the checksum was detected and updated by wild write audit. The time stamp is in *YY-MM-DD hh:mm:ss:msec* format.
- **TABLE**—Table where the checksum is being performed
- **Entry Idx**—Index of entry that is updated by wild write audit
- **Orig Chksum**—Original Checksum
- **Upd Chksum**—Checksum after update by wild write audit
- **Idle Period**—Time elapsed, in milliseconds, since the last DDB update was received by this card. All idle periods are displayed in *ind:hh:mm:ss:msec* format.
- **Number of WWA Updated Entries**—Number of entries updated by the WWA

### Related Topics

- [rept-stat-ddb](#)

## disp-bip

Use this command to display the Board Identification PROM (BIP) hex and ASCII data for the specified card type and location. The PROM data consists of the board ID, part number, revision, date of manufacture, power, serial number, software match ID, and check sums.

## Parameters

### loc (mandatory)

The card location as stenciled on the shelf of the system.

#### Range:

1101 - 1108, 1111 - 1112, 1113, 1115, 1201 - 1208, 1211 - 1218, 1301 - 1308, 1311 - 1318, 2101 - 2108, 2111 - 2118, 2201 - 2208, 2211 - 2218, 2301 - 2308, 2311 - 2318, 3101 - 3108, 3111 - 3118, 3201 - 3208, 3211 - 3218, 3301 - 3308, 3311 - 3318, 4101 - 4108, 4111 - 4118, 4201 - 4208, 4211 - 4218, 4301 - 4308, 4311 - 4318, 5101 - 5108, 5111 - 5118, 5201 - 5208, 5211 - 5218, 5301 - 5308, 5311 - 5318, 6101 - 6108, 6111 - 6118, 1109, 1110, 1209, 1210, 1309, 1310, 2109, 2110, 2209, 2210, 2309, 2310, 3109, 3110, 3209, 3210, 3309, 3310, 4109, 4110, 4209, 4210, 4309, 4310, 5109, 5110, 5209, 5210, 5309, 5310, 6109, 6110

### type (optional)

The board type to be displayed.

#### Range:

*mbd*

Displays the main assembly.

## Example

This example displays the BIP data for the main assembly of the specified card location.

```
disp-bip:loc=1105
```

## Dependencies

The value of the `loc` parameter cannot specify the location of a fixed disk or removable drive.

## Notes

None.

## Output

This example displays the BIP data for the main assembly:

```
disp-bip:loc=1105
```

```
tekelecstp 10-03-30 20:24:41 IST EAGLE 42.0.0
Board Identification PROM Dump Location: 1105 - MDB Packet: 1
```

```
-----
--
0000 42 49 44 30 31 2c 50 4e 38 37 30 2d 32 32 31 32
BID01,PN870-2212
0010 2d 30 33 2e 45 2c 53 4d 45 47 2e 30 30 31 2c 44
-03.E,SM EG.001,D
0020 53 32 30 30 38 2e 31 34 2e 43 2e 31 30 32 30 38
```

```
S2008.14.C.10208
0030 31 34 37 30 39 39 2c 50 57 36 34 36 2c 43 53 32 147099,PW646,CS2
0040 32 35 00 00 01 26 07 ff 01 00 26 00 80 14 21 ff 25...&....&...!.
0050 ff ff 01 00 00 00 00 00 00 00 00 00 00 00 00 00 00 .....
0060 00 00 00 00 00 00 00 00 00 00 00 00 00 00 00 00 .....
0070 00 00 00 00 00 00 00 00 00 00 00 00 00 00 00 00 .....
```

;

```
tekelecstp 10-03-30 20:24:41 IST EAGLE 42.0.0
Board Identification PROM Dump Location: 1105 - MDB Packet: 2
```

```
-----
0000 ff ff ff ff ff ff ff ff ff ff ff ff ff ff ff .....
0010 ff ff ff ff ff ff ff ff ff ff ff ff ff ff ff .....
0020 ff ff ff ff ff ff ff ff ff ff ff ff ff ff ff .....
0030 ff ff ff ff ff ff ff ff ff ff ff ff ff ff ff .....
0040 ff ff ff ff ff ff ff ff ff ff ff ff ff ff ff .....
0050 ff ff ff ff ff ff ff ff ff ff ff ff ff ff ff .....
0060 ff ff ff ff ff ff ff ff ff ff ff ff ff ff ff .....
0070 ff ff ff ff ff ff ff ff ff ff ff ff ff ff ff .....
```

;

```
tekelecstp 10-03-30 20:24:41 IST EAGLE 42.0.0
Board Identification PROM Dump Location: 1105 - MDB Packet: 3
```

```
-----
0000 ff ff ff ff ff ff ff ff ff ff ff ff ff ff ff .....
0010 ff ff ff ff ff ff ff ff ff ff ff ff ff ff ff .....
0020 ff ff ff ff ff ff ff ff ff ff ff ff ff ff ff .....
0030 ff ff ff ff ff ff ff ff ff ff ff ff ff ff ff .....
0040 ff ff ff ff ff ff ff ff ff ff ff ff ff ff ff .....
0050 ff ff ff ff ff ff ff ff ff ff ff ff ff ff ff .....
0060 ff ff ff ff ff ff ff ff ff ff ff ff ff ff ff .....
0070 ff ff ff ff ff ff ff ff ff ff ff ff ff ff ff .....
```

;

```
tekelecstp 10-03-30 20:24:41 IST EAGLE 42.0.0
Board Identification PROM Dump Location: 1105 - MDB Packet: 4
```

```
-----
0000 ff ff ff ff ff ff ff ff ff ff ff ff ff ff ff .....
0010 ff ff ff ff ff ff ff ff ff ff ff ff ff ff ff .....
0020 ff ff ff ff ff ff ff ff ff ff ff ff ff ff ff .....
0030 ff ff ff ff ff ff ff ff ff ff ff ff ff ff ff .....
0040 ff ff ff ff ff ff ff ff ff ff ff ff ff ff ff .....
0050 ff ff ff ff ff ff ff ff ff ff ff ff ff ff ff .....
0060 ff ff ff ff ff ff ff ff ff ff ff ff ff ff ff .....
0070 ff ff ff ff ff ff ff ff ff ff ff ff ff ff ff .....
```

;

### Related Topics

- [chg-bip-fld](#)
- [chg-bip-rec](#)
- [rtrv-bip](#)
- [tst-bip](#)

## disp-bp

Use this command to display currently active breakpoints in the communication and application processors.

### Parameters

#### **card (optional)**

This parameter specifies the card location, in the form of *GPLID–Subsystem ID*.

#### **Range: GPLID-Subsystem ID**

##### **GPLID**

*atmhc, deirhc, erthc, glshc, hipr2, ipghc, iplhc, ipsg, ipshc, mcphc, oamhc, pktgen, sccphc, siphc, slanhc, ss7hc, utility*

##### **Subsystem ID**

*a, b, act, stb, all*

The *oamhc* GPL can be specified with any of the subsystem IDs. For all other GPLs, only the *all* subsystem ID is valid.

#### **imt (optional)**

The IMT address of the card.

#### **Range:**

*0 - 254*

#### **loc (optional)**

The card location as stenciled on the shelf of the system.

#### **Range:**

*1101 - 1108, 1111 - 1112, 1201 - 1208, 1211 - 1218, 1301 - 1308, 1311 - 1318, 2101 - 2108, 2111 - 2118, 2201 - 2208, 2211 - 2218, 2301 - 2308, 2311 - 2318, 3101 - 3108, 3111 - 3118, 3201 - 3208, 3211 - 3218, 3301 - 3308, 3311 - 3318, 4101 - 4108, 4111 - 4118, 4201 - 4208, 4211 - 4218, 4301 - 4308, 4311 - 4318, 5101 - 5108, 5111 - 5118, 5201 - 5208, 5211 - 5218, 5301 - 5308, 5311 - 5318, 6101 - 6108, 6111 - 6118, 1109, 1110, 1209, 1210, 1309, 1310, 2109, 2110, 2209, 2210, 2309, 2310, 3109, 3110, 3209, 3210, 3309, 3310, 4109, 4110, 4209, 4210, 4309, 4310, 5109, 5110, 5209, 5210, 5309, 5310, 6109, 6110, 1113, 1115*

#### **proc (optional)**

This parameter specifies the processor type.

#### **Range:**

##### ***appl***

Application processor

##### ***com***

Communication processor

#### **Default:**

*appl*

**ueng (optional)**

The microengine number.

This parameter is valid only on IXP-based cards. If this parameter is not specified for IXP-based cards, then the command is assumed to be intended for the ARM processor in the IXP chip.

**Range:**

0 - 5

**Example**

```
disp-bp:loc=1109:ueng=3
```

**Dependencies**

The `loc`, `imt`, or `card` parameter must be specified.

Only one of the `loc`, `imt`, and `card` parameters can be specified in the command.

The `imt` parameter allows this command to be entered for a card that has not been configured in the system.

The `ueng` parameter can be specified only for IXP-based cards.

The `oamhc` GPLID accepts all subsystem values; all other GPLIDs accept only the `all` subsystem value.

The card location specified by the `loc` parameter must be in the database.

Values of 1114, 1116, 1117, and 1118 cannot be specified for the `loc` parameter.

**Notes**

None

**Output**

These examples are for x86-based cards:

```
disp-bp:card=ss7ansi-all
```

```
rlghncxa03w 01-03-22 21:14:58 EST EAGLE5 31.3.0
SDS Installed Breakpoint Report from IMT Address H'00f4
Brkpoint-Addr Memory-Dump-Addr Condition-1 Condition-2 Repeat-Count
-----
H'003a-H'0001 ANY ANY 0
```

```
rlghncxa03w 01-03-22 21:14:58 EST EAGLE5 31.3.0
SDS Installed Breakpoint Report from IMT Address H'000a
BP Address Memory-Dump Address Conditions Rpt Ct Ind
-----
H'0000a974 H'000c030c 1- ANY 3 1
Code Breakpoint 2- ANY
H'0000a975 1- ANY PERM 0
Data Write - WORD 2- ANY
H'0000a976 1- ANY 15 0
Any Access - DWORD 2- ANY
```

```

H'0000a977          1- ANY          PERM  0
  Data Read - BYTE          2- ANY

rlghncxa03w 01-03-22 21:14:58 EST EAGLE5 31.3.0
80386/80486 Debug Registers in Use: DR0 DR2 DR3
;

```

disp-bp:card=vsccp-all:

```

rlghncxa03w 01-03-22 21:14:58 EST EAGLE5 31.3.0
SDS Installed Breakpoint Report from IMT Address H'0005
BP Address Memory-Dump Address          Conditions          Rpt Ct Ind
-----
H'0000a974          1- ANY          1      0
Code Breakpoint          2- ANY
;

```

These examples are for IXP-based cards:

disp-bp:loc=1109

```

tekelecstp 05-01-10 13:58:45 GMT EAGLE5 33.0.0
SDS Installed Breakpoint Report from IMT Address H'00ff

BP Address Memory-Dump Address Conditions          Rep  Ind CPU
-----
H'000401000 R11+H'0000ffff  1- R15 > H'ffffffff  2   0   ARM
Any Access -          2- R0 <= H'0000ffff
Data value: H'00000000 Data Mask: H'ffffffff

```

disp-bp:loc=1109:ueng=3

```

tekelecstp 05-01-10 13:58:45 GMT EAGLE 33.0.0
SDS Installed Breakpoint Report from IMT Address H'00ff

BP Address Memory-Dump Address Conditions          Rep  Ind CPU
-----
H'00235000 H'00020044          1- ANY          PERM 1   UENG
3          CODESW Breakpoint          2- ANY          CTX
2
;

```

### Related Topics

- [dlt-bp](#)
- [ent-bp](#)



## disp-disk-dir

Use this command to display the DOS directory on the specified disk. This command can display the creation date for each file or for selected files and applies to fixed disks and removable drives.

**Note:**

This command can be used to verify that the correct version of a file is on the disk.

**Parameters****file (optional)**

The name of the file to be displayed.

**Range:**

*ZZZZZZZZZZZZ*

1–12 ASCII characters

**Default:**

All files are displayed

**loc (optional)**

The card location in the system.

**Range:**

***1114***

TDM

***1116***

TDM

***1117***

Removable cartridge drive

***1113***

Latched USB port

***1115***

Latched USB port

**prtnggrp (optional)**

Partition group. The disk partition group to be displayed.

**Range:**

***active***

***inactive***

**Default:**

*active*

**src (optional)**

Source. The identification of the disk containing the files to be displayed.

**Range:****fixed**

The fixed disk

**remove**

The removable drive in the latched USB port of the E5-MCAP

**usb**

The plug-in USB flash drive in the flush-mounted USB port of the E5-MCAP

**Default:**

The fixed disk

**Example**

```
disp-disk-dir:loc=1117:file="dms.cfg"
```

```
disp-disk-dir:src=remove:file="fta"
```

```
disp-disk-dir:src=remove:file="*.*"
```

**Dependencies**

Valid filenames must be in the format *filename.extension* with the following requirements:

- File name—1–8 ASCII Characters
- Extension—0–3 ASCII Characters

Wildcards (asterisks) are allowed when the wildcard pattern is enclosed in parentheses.

- \*—Matches all characters in either filename or extension
- ?—Matches one character in either filename or extension
- file="\*.\*"—Matches all files on disk
- file="\*.tbl"—Matches all files on disk with *.tbl* as the extension

The `src` parameter must be specified.

The 1113 and 1115 locations are used by E5-MCAP cards. The 1114 and 1116 locations are used by E5-TDM cards.

A removable drive must be inserted in the slot indicated by the value specified for the `loc` or `src` parameter.

The card specified by the `loc` parameter must be connected to at least one IMT bus.

**Notes**

None

**Output**

```
disp-disk-dir
```

```
lnpstp 01-03-30 15:52:04 EST Rel 28.1.0
DISP-DISK-DIR, Loc=1116, Device = FIXED, Dir = :\  
Filename Ext          Length  Last Modified      Cluster      LBA  
DMS      CFG           16384  00-08-01 18:45        2           573  
:
```

```
File(s) : 175  Bytes : 457956761  
Volume : FIXED DISK  
Bytes free : 73654887  
Disk Size (MB) : 2014
```

```
;
```

```
disp-disk-dir:loc=1117
```

```
lnpstp 01-03-30 15:52:46 EST Rel 28.1.0
```

```
disk-disk-dir:loc=1117:file="dms1024.cfg"
```

```
DISP-DISK-DIR, Loc=1117, Device = REMOVE, Dir = :\  
Filename Ext          Length  Last Modified      Cluster      LBA  
DMS1024  CFG           16384  00-08-01 15:48        2           339  
:
```

```
File(s) : 72  Bytes : 192883124  
Volume : SYSTEM DISK  
Bytes free : 956339788  
Disk Size (MB) : 1096
```

```
;
```

```
disp-disk-dir:file=ttserv.tbl
```

```
lnpstp 01-03-30 15:53:09 EST Rel 28.1.0  
DISP-DISK-DIR, Loc=1116, Device = FIXED, Dir = :\  
Filename Ext          Length  Last Modified      Cluster      LBA  
TTSERV   TBL            8192  00-08-01 18:45       2731       44237
```

```
File(s) : 1  Bytes : 8192  
Volume : FIXED DISK  
Bytes free : 73654887  
Disk Size (MB): 2014
```

```
;
```

```
disp-disk-dir:loc=1116
```

```

eaglestp 10-03-06 15:53:09 EST TTTT PPP EAGLE 42.0.0
DISP-DISK-DIR, Loc=1116, Device = FIXED, Dir = :\
Filename Ext Length Last Modified
Cluster LBA
2 DMS CFG 16384 08-07-97 11:00
OAM ELF 3145728 08-07-97 11:00
4 TOAM ELF 3145728 08-07-97 11:00 388
6749 SS7 ELF 1048576 08-07-97 11:00 772
12893 TSS7 ELF 1048576 08-07-97 11:00 900
14941 CCS7ITU ELF 1048576 08-07-97 11:00 1284
21085
.
.
.
LNP_LRN BKP 3072096 08-07-97 11:00 38963
623949 LNP_MR BKP 1679392 08-07-97 11:00 39339
629965 LNP_NPA BKP 5120096 08-07-97 11:00 39545
633261 LNP_4DIG BKP 128000064 08-07-97 11:00 40171
643277 ACG_MIC BKP 187712 08-07-97 11:00 55797
893293 LNP_CHCK BKP 197378 08-07-97 11:00 55820
893661 LNP_DBMM BKP 801600 08-07-97 11:00 55845
894061 TRBLTX BKP 63980 08-07-97 11:00 55943
895629 MTT BKP 384000 08-07-97 11:00 55951
895757 2201800 REL 2048 08-07-97 11:00 55998
896509

```

```

File(s) : 175 Bytes : 457956761
Volume : FIXED DISK
Bytes free : 73654887
Disk Size (MB) : 507
Largest Free Space : 73654887

```

```
;
```

This example shows the output when an E5-MCAP card is used:

```
disp-disk-dir:loc=1113:src=remove
```

```
e5oam 09-01-20 22:24:12 EST EAGLE 40.1.0
DISP-DISK-DIR Loc=1113 Dev = REMOVE
Filename Ext Length
DMS1024 CFG 32768
TATMANSI ELF 3145728
TATMHC ELF 5242880
TATMITU ELF 3145728
TBLBEPM ELF 3145728
TBLBIOS ELF 3145728
TBLBSMG ELF 3145728
TBLCPLD ELF 3145728
TBLDIAG ELF 3145728
TBLDIAG6 ELF 3145728
...
SMEAS_ST SYS 12228
UIMLOG SYS 11263947
SYSREL SYS 949
MTT BKP 384000
TRBLTX BKP 96000
FEATCTRL BKP 128000
ASSYPWR BKP 8016
TS30100 REL 5120
BLMCAP TAR 13721600
File(s) : 178 Bytes : 437596655 Disk Size (MB) : 1972;
```

## Legend

- **Filename**—Name of the file in the directory
- **Ext**—Extension of the file name (for example, for the file MFC.BIN, MFC is the file name and BIN is the extension of the file name)
- **Length**—Amount of space, in bytes, the file occupies on the disk
- **Last Modified**—Date and time the file was changed
- **Cluster**—A 2-byte, 16-digit binary number that represents the first section of the disk occupied by the file
- **LBA**—Starting logical block address that corresponds to the cluster
- **File(s)**—Number of files on the disk that match the search criteria
- **Bytes**—Amount of space, in bytes, the displayed files occupy on the disk
- **Volume**—11-character name for the disk
- **Bytes free**—Number of bytes that are available on the disk for file storage
- **Disk Size**—Total capacity of the specified disk

## Related Topics

- [act-gpl](#)
- [chg-db](#)
- [chg-gpl](#)

- [copy-gpl](#)
- [copy-meas](#)
- [init-sys](#)
- [rept-stat-db](#)

## disp-disk-stats

Use this command to display the disk performance statistics.

### Note:

The OAMs maintain disk read/writer access times as well as per table and per application statistics on the number of disk accesses and cache accesses. Per application and per table statistics that have zero values are not displayed if an application ID or table ID is not specified; only nonzero statistics are displayed in the default report.

### Parameters

#### **loc (mandatory)**

The card location in the system.

##### **Range:**

*1113, 1115*

#### **applid (optional)**

Application ID. The application IDs used to define tasks.

##### **Range:**

*0 - 255*

##### **Default:**

*all*

#### **tblid (optional)**

Table ID. The table IDs used to define tables.

##### **Range:**

*0 - 1023*

##### **Default:**

*all*

### Example

```
disp-disk-stats:loc=1113:applid=29
```

```
disp-disk-stats:loc=1113:applid=93
```

```
disp-disk-stats:loc=1113
```

**Dependencies**

The specified card location must contain a card that is running an OAM (1113 or 1115).

GPSM-II and E5-MCAP cards cannot co-exist in the system.

**Notes**

None

**Output**

```
disp-disk-stats:loc=1113:applid=29
```

```
rlghncxa03w 01-03-01 14:14:05 EST Rel 28.1.0
```

```
Disk Performance Statistics Report:
```

Appl Id	Cache Read Hits	Disk Read Accesses	Cache Write Hits	Disk Write Accesses
-----	-----	-----	-----	-----
29	113	23	25	40

Command Completed.

```
disp-disk-stats:loc=1113:applid=93
```

```
tekelecstp 01-06-01 14:14:05 EST Rel 28.1.0
```

```
Disk Performance Statistics Report:
```

Appl Id	Cache Read Hits	Disk Read Accesses	Cache Write Hits	Disk Write Accesses
-----	-----	-----	-----	-----
93	0	0	0	0

Command Completed.

```
;
```

```
disp-disk-stat:loc=1113
```

```
rlghncxa03w 01-03-01 14:14:05 EST Rel 28.1.0
```

```
Disk Performance Statistics Report:
```

Appl Id	Cache Read Hits	Disk Read Accesses	Cache Write Hits	Disk Write Accesses
-----	-----	-----	-----	-----
29	113	23	25	40
120	12	223	225	361

Cache Read      Disk Read      Cache Write      Disk Write

Table Id	Hits	Accesses	Hits	Accesses
185	12	223	225	361
201	113	23	25	40
Total Cache Read Hits		Total Disk Reads	Total Cache Write Hits	Total Disk Writes
125		246	250	401
Disk Access Times (microseconds)				
Minimum		Maximum	Average	Access Type
1260		31121	6380	Read
1215		31090	6350	Write

Command Completed.  
;

### Related Topics

- [clr-disk-stats](#)

## disp-mem

Use this command to display memory in communication and application processors. This display is in byte format.

### Parameters

#### addr (optional)

The address in the form of *segment–offset*.

##### Range:

*segment–offset*  
*segment— h'00-h'ffff*  
*offset— h'00-h'ffff*

#### bc (optional)

Byte count. The number of data bytes to display.

##### Range:

1 - 65535

##### Default:

96

#### card (optional)

Card location. The card location in the form of *GPLID–Subsystem ID*.

##### Range:

*GPLID–Subsystem ID*



*GPLID*— *atmhc, deirhc, erthc, glshc, hipr2, ipghc, iplhc, ipsg, ipshc, mcphc, oamhc, pktgen, sccphc, siphc, slanhc, ss7hc, utility*  
*Subsystem ID*— *a, b, act, stb, all*

**dformat (optional)**

The memory dump format.

**Range:**

*byte*

*word*

*dword*

**Default:**

*byte*

**imt (optional)**

The IMT address.

**Range:**

*0 - 254*

**loc (optional)**

The card location as stenciled on the shelf of the system.

**Range:**

*1101 - 1108, 1111 - 1112, 1201 - 1208, 1211 - 1218, 1301 - 1308, 1311 - 1318, 2101 - 2108, 2111 - 2118, 2201 - 2208, 2211 - 2218, 2301 - 2308, 2311 - 2318, 3101 - 3108, 3111 - 3118, 3201 - 3208, 3211 - 3218, 3301 - 3308, 3311 - 3318, 4101 - 4108, 4111 - 4118, 4201 - 4208, 4211 - 4218, 4301 - 4308, 4311 - 4318, 5101 - 5108, 5111 - 5118, 5201 - 5208, 5211 - 5218, 5301 - 5308, 5311 - 5318, 6101 - 6108, 6111 - 6118, 1109, 1110, 1209, 1210, 1309, 1310, 2109, 2110, 2209, 2210, 2309, 2310, 3109, 3110, 3209, 3210, 3309, 3310, 4109, 4110, 4209, 4210, 4309, 4310, 5109, 5110, 5209, 5210, 5309, 5310, 6109, 6110, 1113, 1115*

**paddr (optional)**

The physical offset of the memory address.

**Range:**

*h'00-h'ffffff*

**proc (optional)**

The processor type.

**Range:**

*appl*

Application processor

*com*

Communication processor

**Default:**

*appl*

**Example**

```
disp-mem:loc=1204:paddr=h'103abc:bc=8:dformat=word
disp-mem:loc=1204:paddr=h'103abc:bc=8:dformat=dword
disp-mem:card=ss7ansi-all:addr=h'03a-h'001:bc=8
```

**Dependencies**

The `loc`, `imt`, or `card` parameter must be specified.

Only one of the `loc`, `imt`, and `card` parameters can be specified in the command.

The card location specified by the `loc` parameter must be in the database.

All of the subsystem values can be specified with the `oamhc` GPLID. The other GPLID values can be specified only with the `all` subsystem value.

Card locations 1114, 1116, 1117, and 1118 are not valid for memory commands.

The GPL specified in the `card` parameter must be supported.

The `addr` and `paddr` parameters cannot be specified together in the command.

**Notes**

The `imt` parameter allows this command to be entered for a card that has not been configured in the system.

**Output**

```
disp-mem:loc=1204:paddr=h'103abc:bc=8:dformat=word
```

```

rlghncxa03w 01-03-22 21:13:50 EST Rel 28.1.0
SDS Memory Dump from IMT Address H'000a
Source-Address = H'00103abc      Length = 8 bytes
0000 ffff 00ff 00ff 0000          .....
;

```

```
disp-mem:card=psm-a:addr=h'03a-h'001:bc=8
```

```

rlghncxa03w 01-03-22 21:13:50 EST Rel 28.1.0
SDS Memory Dump from IMT Address H'00f6
Source-Address = H'003a0001     Length = 8 bytes
0000 04 0d 3d 1c 04 0d 3d 1c    ..=...=.
;

```

**Related Topics**

- [set-mem](#)

## disp-trace

Use this command to display trace entries.

### Parameters

#### **traceid (optional)**

Trace ID. The trace entry to be displayed.

#### **Range:**

1 - 10

### Example

```
disp-trace
```

```
disp-trace:traceid=5
```

### Dependencies

A valid value must be specified for the `traceid` parameter.

None

### Output

```
disp-trace
```

```
stdcfg2b 07-10-05 12:55:32 EST EAGLE 37.5.0
Trace Request 1:
CARD=          SS7ANSI      OPC=          001-001-001
TRACE DISPLAY COMPLETE.
;
```

### Related Topics

- [dlt-trace](#)
- [ent-trace](#)

## dlt-bp

Use this command to delete breakpoints in the communication or application processors.

### Parameters

#### **addr (optional)**

The address in the form of *segment–offset*.

#### **Range:**

*segment–offset*

*segment— h'00–h'ffff*

*offset— h'00–h'ffff*

**card (optional)**

The card location in the form of *GPLID–Subsystem ID*.

**Range:**

*GPLID-Subsystem ID*

*GPLID— atmhc, deirhc, erthc, glshc, hipr2, ipghc, iplhc, ipsg, ipshc, mcphc, oamhc, pktgen, sccphc, siphc, slanhc, ss7hc, utility*

*Subsystem ID— a, b, act, stb, all*

The OAMHC GPL can be specified with any of the subsystem IDs. For all other GPLs, only the *all* subsystem ID is valid.

**imt (optional)**

The IMT address of the card.

**Range:**

*0 - 254*

**loc (optional)**

The card location as stenciled on the shelf of the system.

**Range:**

*1101 - 1108, 1111 - 1112, 1201 - 1208, 1211 - 1218, 1301 - 1308, 1311 - 1318, 2101 - 2108, 2111 - 2118, 2201 - 2208, 2211 - 2218, 2301 - 2308, 2311 - 2318, 3101 - 3108, 3111 - 3118, 3201 - 3208, 3211 - 3218, 3301 - 3308, 3311 - 3318, 4101 - 4108, 4111 - 4118, 4201 - 4208, 4211 - 4218, 4301 - 4308, 4311 - 4318, 5101 - 5108, 5111 - 5118, 5201 - 5208, 5211 - 5218, 5301 - 5308, 5311 - 5318, 6101 - 6108, 6111 - 6118, 1109, 1110, 1209, 1210, 1309, 1310, 2109, 2110, 2209, 2210, 2309, 2310, 3109, 3110, 3209, 3210, 3309, 3310, 4109, 4110, 4209, 4210, 4309, 4310, 5109, 5110, 5209, 5210, 5309, 5310, 6109, 6110, 1113, 1115*

**paddr (optional)**

The physical offset of the memory address.

**Range:**

*h'00–h'ffffff*

**proc (optional)**

The processor type.

**Range:**

***appl***

Application processor

***com***

Communication processor

**Default:**

*appl*

**ueng (optional)**

The microengine number.

 **Note:**

This parameter is valid only on IXP-based cards. If this parameter is not specified for IXP-based cards, then the command is assumed to be intended for the ARM processor in the IXP chip.

**Range:**

0 - 5

**Example**

```
dlt-bp:loc=1209:ueng=2
```

```
dlt-bp:card=hipr2-all
```

```
dlt-bp:loc=6312
```

**Dependencies**

The `loc`, `imt`, or `card` parameter must be specified.

Only one of the `loc`, `imt`, and `card` parameters can be specified in the command.

The `ueng` parameter can be specified only for IXP-based cards.

The card location specified by the `loc` parameter must be in the database.

Values of 1114, 1116, 1117, and 1118 cannot be specified for the `loc` parameter.

All of the subsystem values can be specified with the `oamhc` GPLID. The other GPLID values can be specified only with the `all` subsystem value.

The `addr` and `paddr` parameters cannot be specified together in the command.

**Notes**

The `imt` parameter allows this command to be entered for a card that has not been configured in the system.

**Output**

```
dlt-bp:card=oam-all:proc=com
```

```
Command Accepted - Processing
```

```
tekelecstp 97-01-20 19:21:10 EST Rel 37.0.0
```

```
dlt-bp:card=oam-all:proc=com
```

```
Command entered at terminal #1.
```

```
;
```

**Related Topics**

- [disp-bp](#)
- [ent-bp](#)

## dlt-ee-flt

Use this command to delete an Eagle Eyes Filter from the Eagle Eyes Filter (EE FLT) table. The EE FLT entry consists of a Filter ID and Filter specific data. It can be used to delete a filter only when it is not associated with any card.

### Parameters

**fltid (mandatory)**

Eagle Eyes Filter ID.

**Range:**

1-200

### Example

```
dlt-ee-flt:fltid=20
```

### Dependencies

The specified Filter ID must exist in the EE FLT table.

The Eagle Eyes Filter table must be available.

The specified filter should not be associated with any network card.

### Notes

None.

### Output

```
dlt-ee-flt:fltid=3
```

```
tekelecstp 10-03-08 14:43:31 EST EAGLE 46.0.0
EE FLT table is (2 of 200) 1% full
DLT-EE-FLT: MASP A - COMPLTD
;
```

### Related Topics

- [ent-ee-flt](#)
- [rtrv-ee-flt](#)

## dlt-trace

Use this command to delete provisioned MSU tracing criteria from the database.

### Parameters

**traceid (optional)**

Trace ID. Identifier of the trace entry to be deleted.

**Range:**  
1 - 10

### Example

```
dlt-trace:traceid=5
```

```
dlt-trace
```

### Dependencies

Only values between 1 and 10 are valid for the `traceid` parameter.

None

### Output

```
dlt-trace:traceid=1
```

```
stdcfg2b 07-10-05 13:03:29 EST EAGLE 37.5.0  
dlt-trace:traceid=1  
Command entered at terminal #4.
```

```
;
```

### Related Topics

- [disp-trace](#)
- [ent-trace](#)

## ent-bp

Use this command to add breakpoints in communications and application processors in the system.

### Parameters

#### **access (optional)**

The access type, in the form of *access type-format*.

Use the `data` parameter to set the format on IXP-based cards.

#### **Range:**

*access type-format*

*access type*—*r*, *w*, *rw* (read, write, read-write)

*format*—*byte*, *word*, *dword*, *any*

#### **Default:**

For x86-based cards—*rw-byte*

For IXP-based cards—*rw-any*

#### **addr (optional)**

The memory location in the form of *segment-offset*.

**Range:**

*segment-offset*  
*segment—h'00–h'ffff*  
*offset—h'00–h'ffff*

**bc (optional)**

The number of data bytes to display.

For IXP-based cards, *bc* represents the number of bytes of memory. The number of bytes of stack to be displayed is  $255 - bc$ . For example, if *bc*=128, then 128 bytes of memory and 127 bytes of stack are displayed. If *bc*=0, then 0 bytes of memory and 255 bytes of stack are displayed. The exception to this rule is that 1 byte of stack is never displayed.

**Range:**

*0 - 255*

For x86-based cards, the maximum number of bytes is 96.

For IXP-based cards, the maximum number of bytes is 255.

**ca (optional)**

Condition “a” in the form of *register–condition–integer*.

The value *register* is the CPU internal register.

The value *condition* is the comparison condition (equal, not equal, greater than, less than, greater than or equal, less than or equal).

The value *integer* is the value for comparison.

**Range:**

*register-condition-integer*  
*register— sp, bp, ds, ss, es, cs, fl, ax, ah, al, bx, bh, bl, cx, ch, cl, dx, dh, dl, di, si, ip, fs, gs, esi, edi, ebp, esp, eip, efl, eax, ebx, ecx, edx, lr, pc, r1-r15*  
*condition—eq, neq, gt, lt, gte, lte*  
*integer—h'00–h'ffffff*

**card (optional)**

The card location, in the form of *GPLID–Subsystem ID*.

**Range:**

*GPLID-Subsystem ID*  
*GPLID—atmhc, deirhc, erthc, glshc, hipr2, ipghc, iplhc, ipsg, ipshc, mcphc, oamhc, pktgen, sccphc, siphc, slanhc, ss7hc, utility*  
*Subsystem ID— a, b, act, stb, all*

The OAMHC GPL can be specified with any of the subsystem IDs.

For all other GPLs, only the *all* subsystem ID is valid.

**cb (optional)**

Condition b in the form of *register–condition–integer*.

The value *register* is the CPU internal register.

The value *condition* is the comparison condition (equal, not equal, greater than, less than, greater than or equal, less than or equal).

The value *integer* is the value for comparison.

**Range:**

*register-condition-integer*  
*register—sp, bp, ds, ss, es, cs, fl, ax, ah, al, bx, bh, bl, cx, ch, cl, dx, dh, dl, di, si, ip, fs, gs, esi, edi, ebp, esp, eip, efl, eax, ebx, ecx, edx, lr, pc, r0-r15*



*condition*—*eq, neq, gt, lt, gte, lte*  
*integer*—*h'00–h'ffffff*

**ctx (optional)**

The bit-mapped microengine context mask.

**Range:**

*1 - 15*

**da (optional)**

The dump address, in the form of *segment–offset*.

**Range:**

*segment–offset*

*segment*—*h'00–h'fff*

*offset*—*h'00–h'fff*

**data (optional)**

This parameter instructs a data breakpoint to qualify on a match of the data.

 **Note:**

This parameter is valid only on IXP-based cards.

**Range:**

*value–mask*

*value*—*0-0xFFFFFFFF*

*mask*—*0-0xFFFFFFFF*

**Default:**

*0*

**dformat (optional)**

Memory dump format (byte, doubleword, word).

**Range:**

*byte*

*dword*

*word*

**Default:**

*byte*

**dpaddr (optional)**

Memory dump address (physical offset).

**Range:**

*h'00–h'ffffff*

**dr (optional)**

The data register indirect memory dump, in the form *register–register–integer*.

The *register-register* value is the CPU internal register.  
The *integer* value is the offset value.

**Range:**

*register-register-integer*

*register*—*sp, bp, ss, ds, es, cs, fl, ax, ah, al, bx, bh, bl, cx, ch, cl, dx, dh, dl, di, si, ip, fs, gs, esi, edi, ebp, esp, eip, efl, eax, ebx, ecx, edx*

*register*—*sp, bp, ds, ss, es, cs, fl, ax, ah, al, bx, bh, bl, cx, ch, cl, dx, dh, dl, di, si, ip, fs, gs, esi, edi, ebp, esp, eip, efl, eax, ebx, ecx, edx*

*integer*— *h'00–h'ffffff*

**drarm (optional)**

ARM register indirect memory dump.

**Range:**

*ARM register-integer*

arm register- *r0-r15, sp, lr, pc*

mask- *0-65535*

The value *ARM register* is the CPU internal register.

The value *integer* is the offset value.

**Default:**

*0*

**dur (optional)**

Breakpoint duration.

**Range:**

*temp*

*perm*

**Default:**

*temp*

**imt (optional)**

IMT address of the card.

**Range:**

*0 - 254*

**ind (optional)**

Indirection count.

**Range:**

*0 - 3*

**Default:**

*0*

**loc (optional)**

The card location as stenciled on the shelf of the system.

**Range:**

1101 - 1108, 1111 - 1112, 1201 - 1208, 1211 - 1218, 1301 - 1308, 1311 - 1318, 2101 - 2108, 2111 - 2118, 2201 - 2208, 2211 - 2218, 2301 - 2308, 2311 - 2318, 3101 - 3108, 3111 - 3118, 3201 - 3208, 3211 - 3218, 3301 - 3308, 3311 - 3318, 4101 - 4108, 4111 - 4118, 4201 - 4208, 4211 - 4218, 4301 - 4308, 4311 - 4318, 5101 - 5108, 5111 - 5118, 5201 - 5208, 5211 - 5218, 5301 - 5308, 5311 - 5318, 6101 - 6108, 6111 - 6118, 1109, 1110, 1209, 1210, 1309, 1310, 2109, 2110, 2209, 2210, 2309, 2310, 3109, 3110, 3209, 3210, 3309, 3310, 4109, 4110, 4209, 4210, 4309, 4310, 5109, 5110, 5209, 5210, 5309, 5310, 6109, 6110, 1113, 1115

**paddr (optional)**

The physical offset of the memory address.

**Range:**

*h'00-h'ffffff*

**proc (optional)**

Processor type.

**Range:*****appl***

Application processor

***com***

Communication processor

**Default:**

*appl*

**rep (optional)**

Repetitions for this breakpoint.

**Range:**

*0 - 255*

**Default:**

*0*

**type (optional)**

Breakpoint type in the form of processor type-breakpoint type

**Range:**

*processor type-breakpoint type*  
*processor type—p186, p286, p486, arm, ixp*  
*breakpoint type—code, codehw, codesw, data*

**Default:**

For x86-based cards—*p486-code*  
 For IXP-based cards—*arm-codesw*

**ueng (optional)**

Microengine number. This parameter is valid only on IXP-based cards.

 **Note:**

If this parameter is not specified for an IPX-based card, then the command is assumed to be intended for the ARM processor in the IXP chip.

**Range:**  
0 - 5

**Example**

```
ent-bp:loc=1204:paddr=h'27c3c:type=p486-data:access=rw-word
ent-bp:loc=1109:paddr=h'401000:type=arm-codesw:access=rw-
any:ca=r7-eq-0
ent-bp:loc=1209:paddr=h'402000:type=arm-data:access=w-
any:data=h'1111-h'ff
ent-bp:loc=1309:paddr=h'403000:type=ixp-codesw:ueng=2:ctx=1
ent-bp:card=hipr2-all:paddr=h'404000:type=arm-
codehw:drarm=r3-0:bc=64
ent-bp:loc=1113:addr=h'03a-0001
```

**Dependencies**

All of the subsystem values can be specified with the OAMHC GPLID. The other GPLID values can be specified only with the *all* subsystem value.

Values of 1114, 1116, 1117, and 1118 cannot be specified for the `loc` parameter.

The `loc`, `imt`, or `card` parameter must be specified.

Only one of the `loc`, `imt`, and `card` parameters can be specified in the command.

The `dr` parameter and the `da` parameter cannot be specified together in the command.

The `dur=perm` parameter and the `rep` parameter cannot be specified together in the command.

The `dur=perm` parameter cannot be specified when the value of the processor type portion of the `type` parameter is *p186* or *p286*.

When the `da`, `dr`, or `drarm` parameter is specified, the `dpaddr` parameter cannot be specified.

For the `type` parameter (which is in the form of *processor type-breakpoint type*), a breakpoint type of *data* cannot be specified in combination with a processor type of *P186*, *P286*, or *IXP*.

When the `paddr` parameter and the `bc` parameter are specified, either the `dpaddr` or `dr` parameter must be specified in the command.

The `access` parameter can be specified only when the `type` parameter value is *p486-data* or *arm-data*.

The `bc` parameter value cannot be greater than 96 for x86-based cards.

The `ind` parameter value cannot be greater than 3.

The specified card must be in use.

For 80286 processors, registers for 80386 processors cannot be specified.

For 80286 processors, `integer` values for registers and conditions must be less than 65535.

The `ueng` parameter is valid only on IXP-based cards (the value `ixp` is specified for the processor type portion of the `type` parameter).

The `cts` parameter is valid only on IXP-based cards (the value `ixp` is specified for the processor type portion of the `type` parameter).

The `data` parameter is valid only on IXP-based cards.

The `data` parameter is valid only when the value is `data` for the breakpoint type portion of the `type` parameter.

The register values `sp`, `lr`, `pc`, and `r0-r15` for the `ca` or `cb` parameters are valid only on IXP-based (ARM processor) cards.

The `ca` and `cb` parameters cannot be specified when the value `ixp` is specified for the processor type portion of the `type` parameter.

The `drarm` parameter can be specified only on IXP-based cards.

The `drarm` parameter can be specified only when the value `arm` is specified for the processor type portion of the `type` parameter.

The `dr` parameter cannot be specified for IXP-based cards.

The `data` and `codesw` values for the breakpoint type portion of the `type` parameter cannot be specified when the value `ixp` is specified for the processor type portion of the `type` parameter.

The `arm` and `ixp` values for the processor type portion of the `type` parameter are valid only on IXP-based cards.

The value `any` for the format portion of the `access` parameter can be specified only on IXP-based cards. The format value must be set to `any` on IXP-based cards.

When the value `ixp` is specified for the processor type portion of the `type` parameter, the `ueng` and `cts` parameters must be specified.

The `addr` parameter can be specified only when the `proc=com` parameter is specified for DS0 cards with PROM-based COM processors (such as TSMS).

When the `ca`, `cb`, and `dr` parameters are used with 80186 and 80286 processors, the register values `ip`, `fs`, `gs`, `esi`, `edi`, `ebp`, `esp`, `eip`, `efl`, `eax`, `ebx`, `ecx`, and `edx` cannot be specified. These registers can be used only with 80486 processors. The integer values for these parameters when used with 80186 and 80286 processors must be less than `h'ffff` (65535).

The `data` value for the breakpoint type portion of the `type` parameter cannot be specified with the values `p186`, `p286`, and `ixp` for the processor type portion of the `type` parameter.

The `da` parameter cannot be specified for IXP-based cards.

An ARM register value must be specified for an IXP-based card with an ARM processor.

The `addr` or `paddr` parameter must be specified in the command. Both parameters cannot be specified in the command.

### Notes

The `imt` parameter allows this command to be entered for a card that has not been configured in the system.

### Output

```
ent-bp:loc=1113:addr=h'03a-0001
```

```
rlghncxa03w 04-08-22 21:14:41 EST EAGLE 33.0.0  
SDS Response Code 22 from IMT Address H'00f6 - command complete.
```

```
rlghncxa03w 04-08-22 21:14:41 EST EAGLE 33.0.0  
SDS Response from IMT Address H'000a - command complete.
```

```
;
```

```
ent-bp:loc=6205:paddr=h'03a002
```

```
rlghncxa03w 12-05-22 21:14:41 EST EAGLE 45.0.0  
SDS Response Code 22 from IMT Address H'00fd - command complete.
```

```
;
```

### Related Topics

- [disp-bp](#)
- [dlt-bp](#)

## ent-ee-flt

Use this command to enter Eagle Eyes Filter data in the Eagle Eyes Filter (EE FLT) table. The EE FLT entry consists of a Filter ID and Filter specific data. After the FLT ID is provisioned, it can be used in the `dlt-ee-flt` and `chg-ee-card` commands.

### Parameters

#### **type (mandatory)**

Eagle Eyes Filter Type.

#### **Range:**

*inc*

*exl*

#### **app1 (mandatory)**

Card Application Type

**Range:**

*atm*

*ip*

*e1t1*

**ipprot (optional)**

Filter based on IP sub-protocol

**Range:**

*sctp*

*tcp*

*udp*

**ipsrc (optional)**

Filter based on IP source address

**Range:**

*4 numbers separated by dots, with each number in the range of 0-255*

**ipdst (optional)**

Filter based on IP destination address

**Range:**

*4 numbers separated by dots, with each number in the range of 0-255*

**ssport (optional)**

Filter based on SCTP source port

**Range:**

*0-65535*

**sdport (optional)**

Filter based on SCTP destination port.

**Range:**

*0-65535*

**stype (optional)**

Filter based on SCTP chunk type

**Range:**

*abrt*

*data*

*err*

*hbak*

*htbt*

*inak*

*init*

*sack*

**sctppld (optional)**

Filter based on SCTP data payload identifier.

**Range:**

*diam*

*m2pa*

*m3ua*

*sua*

*unspec*

**sctpstr (optional)**

Filter based on SCTP data stream identifier

**Range:**

*0-65535*

**sscopsu (optional)**

Filter based on SSCOP sub-protocol or SU type.

**Range:**

*all*

*ctrl*

*data*

**mtp3si (optional)**

Filter MTP3 user.

**Range:**

*bicc*

*isup*

*sccp*

*snm*

*tup*

**port (optional)**

Filter based on port.

**Range:**

*a-b*

*a1-a31*



*b1-b31*

*all*

**sutype (optional)**

Filter based on SU type.

**Range:**

*allsu*

*lsu*

*msu*

**Example**

```
ent-ee-
flt:appl=ip:type=inc:ipprot=sctp:ssport=2048:stype=data:sctpstr=100
ent-ee-flt:appl=atm:type=exl:port=a:sscopsu=data:mtp3si=sccp
ent-ee-flt:appl=e1t1:type=exl:port=a1:sutype=msu:mtp3si=tup
```

**Dependencies**

If the `appl=ip` then `ipprot`, `ipsrc` or `ipdst` parameters must be specified.

If the `ssport`, `sdport` or `stype` parameters are specified, then the `ipprot=sctp` parameter must be specified.

At least one optional parameter (`ipprot` or `port`) must be specified.

If the `sctpld` parameter is specified, then the `stype=data` and `ipprot=sctp` parameters must be specified.

If the `sctpstr` parameter is specified, then the `stype=data` and `ipprot=sctp` parameters must be specified.

The Eagle Eyes Filter table cannot contain more than 200 entries.

The Eagle Eyes Filter table must be available.

If the `appl=ip` parameter is specified, then the `appl=atm` and `appl=e1t1` parameters must not be specified.

If the `appl=atm` parameter is specified, then the `appl=ip` and `appl=e1t1` parameters must not be specified.

If the `appl=e1t1` parameter is specified, then the `appl=atm` and `appl=ip` parameters must not be specified.

If the `appl=atm` parameter is specified, then the `port` parameter can only be either `a`, `b` or `a1`.

**Notes**

IP7 parameters:

- *ipprot, ipsrc, ipdst, ssport, sdport, style, sctpld, sctpstr*

ATM parameters:

- *sscopsu, mtp3si, port*

E1T1 parameters:

- *sutype, mtp3si, port*

### Output

```
ent-ee-flt:appl=atm:type=inc:port=a:sscopsu=data
```

```
tekelecstp 10-03-08 14:43:31 EST EAGLE 46.0.0
EE FLT table is (1 of 200) 1% full
ENT-EE-FLT: MASP A - COMPLTD
;
```

### Related Topics

- [dlt-ee-flt](#)
- [rtrv-ee-flt](#)

## ent-trace

Use this debug command to trace MSUs sent to Service Module cards or to LIM cards running the SS7ANSI, CCS7ITU, VSCCP, ATMITU, ATMANSI, IPLIMI, SS7IPGW, IPGWI, or IPSP applications.

The EAGLE traps MSUs that meet the provisioned tracing criteria, and the MSU remains in the trapped state for the life span of that MSU. The life span varies depending on the type of MSU. For MTP-Routed or GTT MSUs, the life span lasts until the MSU travels out of the EAGLE or is discarded. For LNP MSUs, the life span lasts until the request is processed. The response is not part of the LNP MSU. Trapping a response requires the provisioning of another MSU trace.

This command uses different parameters depending on the card type sending the MSU as shown:

- Service Module— *error, gt, lrn, tn, ssp/sspa/sspi/sspn/sspn24/sspn16, dn, entityid, imei, and imsi*
- LIM card running ANSI applications— *error, ssp/sspa, opc/opca, dpc/dpca, tlnpisuptype, and gt*
- LIM card running ITU applications— *error, sspi/sspn/sspn24/sspn16, opci/opcn/opcn24/opcn16, dpci/dpcn/dpcn24/dpcn16, and gt*

The *lrn, tn, dn, entityid, imsi, imei, and error* parameters are mutually exclusive.

The following parameters can be used once in a single MSU trace request with ONE of the mutually exclusive parameters specified above: *opc, dpc, ilsn, si, gt, ssp, h0h1, cpc, or cic/ecic*.

The *cic/ecic* parameters can be used only for ISUP traffic. The *ecic* parameter must be specified with the *cic* parameter.

For all cards supported by this command, the *error* parameter can be provisioned as the only optional parameter or in addition to any other optional parameter to trace any

messages that fail verification or processing. If the `error` parameter not specified, the default value is `error=no`.

**▲ Caution:**

If the system configuration approaches the maximum number of provisioned Service Module cards, then entering this command might cause an OAM to reset because of the amount of information that may be returned.

## Parameters

### **card (mandatory)**

The card location in the form of *APPL CLASS-Subsystem ID*.

**Range:**

*APPL CLASS-Subsystem ID*

*APPL CLASS— atmansi, atmitu, ccs7itu, iplimi, ss7ansi, ss7ipgw, ipgwi, ipsg, vsccp*  
*Subsystem ID— all*

### **brief (optional)**

This parameter specifies whether all information is provided for each MSU as it moves through the EAGLE.

**Range:**

*no*

All information, including data sections for the MSU, is displayed.

*yes*

The data sections for the MSU are not displayed.

### **cic (optional)**

The beginning value for a CIC range.

**Range:**

*0 - 16383*

### **cpc (optional)**

ANSI destination point code with subfields *network indicator-network cluster-network cluster member (ni-nc-ncm)*.

**Synonym:**

*cpc*

**Range:**

*000-255*

Specify a valid value for each subfield of the point code, and separate the subfields with a dash (-).

When `chg-sid:pctype=ansi` is specified, *ni = 000* is not valid.

When `chg-sid:pctype=ansi` is specified, *nc = 000* is not valid if *ni = 001–005*.

When `chg-sid:pctype=ansi` is specified, *nc = 000* is valid if *ni = 006–255*.

The point code *000-000-000* is not a valid point code.

**cpci (optional)**

ITU international destination point code with subfields *zone-area-id*. The *prefix* subfield indicates a spare point code (*prefix-zone-area-id*).

**Range:**

0-255

Specify a valid value for each subfield of the point code, and separate the subfields with a dash (-).

*zone*—0-7

*area*—000-255

*id*—0-7

The point code 0-000-0 is not a valid point code.

**cpcn (optional)**

ITU national destination point code in the format of a 5-digit number (*nnnnn*); or 2, 3, or 4 numbers (members) separated by dashes (*m1-m2-m3-m4*) as defined by the `chg-stpopts:npcfmt1` flexible point code option. A group code must be specified when the ITUDUPPC feature is turned on (*nnnnngc*, *m1-m2-m3-m4-gc*). The *prefix* subfield indicates a spare point code (*prefix-nnnnn*, *prefix-nnnngc*, *prefix-m1-m2-m3-m4*, *prefix-m1-m2-m3-m4-gc*).

**Range:**

*s-*, 0-16383, *aa-zz*

Specify a valid value for each subfield of the point code, and separate the subfields with a dash (-).

*prefix*—*s-*

*nnnnn*—0-16383

*gc*—*aa-zz*

*m1-m2-m3-m4*—0-14 for each member; values must sum to 14

**cpcn24 (optional)**

24-bit ITU national destination point code with subfields *main signaling area-sub signaling area-signaling point* (*msa-ssa-sp*).

**Range:**

000-255

Specify a valid value for each subfield of the point code, and separate the subfields with a dash (-).

*msa*—000-255

*ssa*—000-255

*sp*—000-255

**cpcn16 (optional)**

16-bit ITU national point code with subfields *unit number-sub number area-main number area* (*un-sna-mna*).

**Range:**

000---127

Specify a valid value for each subfield of the point code, and separate the subfields with a dash (-).

*un*---000---127

*sna---000---15*

*mna---000---31*

**dn (optional)**

Directory Number. This parameter is used for the ANSI41 AIQ, ATINP, G-Flex, G-Port, INP, PPSMS, or V-Flex features.

The *tn* parameter is used as the directory number for LNP.

**Range:**

5-15 digits

Valid digits are 0-9, a-f, A-F.

**dpc (optional)**

ANSI destination point code with subfields *network indicator-network cluster-network cluster member (ni-nc-ncm)*

**Synonym:**

*dpca*

**Range:**

*000-255*

Specify a valid value for each subfield of the point code, and separate the subfields with a dash (-).

When *chg-sid:pctype=ansi* is specified, *ni = 000* is not valid.

When *chg-sid:pctype=ansi* is specified, *nc = 000* is not valid if *ni = 001-005*.

When *chg-sid:pctype=ansi* is specified, *nc = 000* is valid if *ni = 006-255*.

The point code *000-000-000* is not a valid point code.

**dpci (optional)**

ITU international destination point code with subfields *zone-area-id*. The *prefix* subfield indicates a spare point code (*prefix-zone-area-id*).

**Range:**

*s-, 0-255*

Specify a valid value for each subfield of the point code, and separate the subfields with a dash (-).

*prefix—s*

*zone—0-7*

*area—000-255*

*id—0-7*

The point code *0-000-0* is not a valid point code.

**dpcn (optional)**

ITU national destination point code in the format of a 5-digit number (*nnnnn*); or 2, 3, or 4 numbers (members) separated by dashes (*m1-m2-m3-m4*) as defined by the *chg-stpopts:npcfmti* flexible point code option. A group code must be specified when the ITUDUPPC feature is turned on (*nnnnn-gc*, *m1-m2-m3-m4-gc*). The *prefix* subfield indicates a spare point code (*prefix-nnnnn*, *prefix-nnnnn-gc*, *prefix-m1-m2-m3-m4*, *prefix-m1-m2-m3-m4-gc*).

**Range:**

*s-, 0-16383, aa-zz*

Specify a valid value for each subfield of the point code, and separate the subfields with a dash (-).

*prefix*—*s*-

*nnnnn*—*0-16383*

*gc*—*aa-zz*

*m1-m2-m3-m4*—*0-14* for each member; values must sum to 14

**dpcn24 (optional)**

24-bit ITU national destination point code with subfields *main signaling area-sub signaling area-signaling point* (*msa-ssa-sp*).

**Range:**

*000-255*

Specify a valid value for each subfield of the point code, and separate the subfields with a dash (-).

*msa*—*000-255*

*ssa*—*000-255*

*sp*—*000-255*

**dpcn16 (optional)**

16-bit ITU national point code with subfields *unit number-sub number area-main number area* (*un-sna-mna*).

**Range:**

*000---127*

Specify a valid value for each subfield of the point code, and separate the subfields with a dash (-).

*un---000---127*

*sna---000---15*

*mna---000---31*

**ecic (optional)**

The end value for a CIC range.

**Range:**

*0 - 16383*

**entityid (optional)**

The entity ID.

**Range:**

1-15 digits

Valid digits are *0-9, a-f, A-F*

**error (optional)**

This parameter specifies whether to perform a trace on any message verification error and message processing error

**Range:**

*yes*

**no**

**Default:**

*no*

**gt (optional)**

Global title. The CdPA global title digits.

**Range:**

1-21 digits

Valid digits are *0-9, a-f, A-F*

**h0h1 (optional)**

A combination of values contained in some MSUs. The *h0* value is the code for a message group, and the *h1* value is the code for a message within that group.

**Range:**

*0 - 255*

**ilsn (optional)**

The incoming linkset name.

**Range:**

*ayyyyyyyy*

1 alphabetic character followed by up to 9 alphanumeric characters.

**imei (optional)**

The International Equipment Identifier.

**Range:**

Exactly 14 digits; valid digits are *0-9, a-f, A-F*

**imsi (optional)**

The International Mobile Station Identifier.

**Range:**

5-15 digits

Valid digits are *0-9, a-f, A-F*

**loc (optional)**

The card location of the card as stenciled on the shelf of the system.

**Range:**

*1101 - 1108, 1111 - 1112, 1201 - 1208, 1211 - 1218, 1301 - 1308, 1311 - 1318, 2101 - 2108, 2111 - 2118, 2201 - 2208, 2211 - 2218, 2301 - 2308, 2311 - 2318, 3101 - 3108, 3111 - 3118, 3201 - 3208, 3211 - 3218, 3301 - 3308, 3311 - 3318, 4101 - 4108, 4111 - 4118, 4201 - 4208, 4211 - 4218, 4301 - 4308, 4311 - 4318, 5101 - 5108, 5111 - 5118, 5201 - 5208, 5211 - 5218, 5301 - 5308, 5311 - 5318, 6101 - 6108, 6111 - 6118*

**lrn (optional)**

The local routing number.

**Range:**

Exactly 14 digits: Valid digits are *0-9*.

**mode (optional)**

The type of output displayed.

**Range:****default**

The default value of this parameter.

**detail**

Detailed information is displayed when an MSU matches the request.

**debug**

Complete information is displayed when an MSU matches the request.

**opc (optional)**

ANSI point code with subfields *network indicator-network cluster-network cluster member (ni-nc-ncm)*. The *prefix* subfield indicates a private point code (*prefix-ni-nc-ncm*).

**Synonym:**

*opca*

**Range:**

*000-255*

Specify a valid value for each subfield of the point code, and separate the subfields with a dash (-).

When *chg-sid:pctype=ansi* is specified, *ni = 000* is not valid.

When *chg-sid:pctype=ansi* is specified, *nc = 000* is not valid if *ni = 001-005*.

When *chg-sid:pctype=ansi* is specified, *nc = 000* is valid if *ni = 006-255*.

The point code *000-000-000* is not a valid point code.

**opci (optional)**

ITU international origination point code with subfields *zone-area-id*. The *prefix* subfield indicates a spare point code, private point code, or private and spare point code (*prefix-zone-area-id*).

**Range:**

*s-, p-, ps-, 0-255*

Specify a valid value for each subfield of the point code, and separate the subfields with a dash (-).

*prefix—s-, p-, ps*

*zone—0-7*

*area—000-255*

*id—0-7*

The point code *0-000-0* is not a valid point code.

**opcni (optional)**

ITU national destination point code in the format of a 5-digit number (*nnnnn*); or 2, 3, or 4 numbers (members) separated by dashes (*m1-m2-m3-m4*) as defined by the *chg-stpopts:npcfnti* flexible point code option. A group code must be specified when the ITUDUPPC feature is turned on (*nnnnngc, m1-m2-m3-m4-gc*). The *prefix* subfield indicates a spare point code (*prefix-nnnnn, prefix-nnnnngc, prefix-m1-m2-m3-m4, prefix-m1-m2-m3-m4-gc*).



**Range:***s*-, 0-16383, *aa-zz*

Specify a valid value for each subfield of the point code, and separate the subfields with a dash (-).

*prefix—s-**nnnnn—0-16383**gc—aa-zz**m1-m2-m3-m4—0-14* for each member; values must sum to 14**opc<sub>n</sub>24 (optional)**

24-bit ITU national destination point code with subfields *main signaling area-sub signaling area-signaling point (msa-ssa-sp)*.

**Range:***000-255*

Specify a valid value for each subfield of the point code, and separate the subfields with a dash (-).

*msa—000–255**ssa—000–255**sp—000–255***opc<sub>n</sub>16 (optional)**

16-bit ITU national point code with subfields *unit number-sub number area-main number area (un-sna-mna)*.

**Range:***000---127*

Specify a valid value for each subfield of the point code, and separate the subfields with a dash (-).

*un---000--127**sna--000---15**mna---000--31***rep (optional)**

The number of MSUs to trap.

**Range:***0 - 255***service (optional)**

The service offered by the EAGLE.

**Range:***gflex**gport**inpmr**inpq*

**smsmr**

**mnpsms**

**eir**

**idpr**

**idps**

**tif**

**tif2**

**tif3**

**tobr**

**aiq**

**si (optional)**

Service indicator.

**Range:**

0 - 15

**s1s (optional)**

Signaling link selector.

**Range:**

0 - 255

**ssp (optional)**

ANSI destination point code with subfields *network indicator-network cluster-network cluster member (ni-nc-ncm)*.

**Synonym**

*sspa*

**Range:**

000-255

Specify a valid value for each subfield of the point code, and separate the subfields with a dash (-).

When *chg-sid:pctype=ansi* is specified, *ni = 000* is not valid.

When *chg-sid:pctype=ansi* is specified, *nc = 000* is not valid if *ni = 001–005*.

When *chg-sid:pctype=ansi* is specified, *nc = 000* is valid if *ni = 006–255*.

The point code *000-000-000* is not a valid point code.

**sspi (optional)**

ITU international destination point code with subfields *zone-area-id*. The *prefix* subfield indicates a spare point code (*prefix-zone-area-id*).

**Range:**

*s-*, 0-255

Specify a valid value for each subfield of the point code, and separate the subfields with a dash (-).

*prefix*—s  
*zone*—0-7  
*area*—000-255  
*id*—0-7

The point code 0-000-0 is not a valid point code.

#### **sspn (optional)**

ITU national destination point code in the format of a 5-digit number (*nnnnn*); or 2, 3, or 4 numbers (members) separated by dashes (*m1-m2-m3-m4*) as defined by the `chg-stpopts:npcfmti` flexible point code option. A group code must be specified when the ITUDUPPC feature is turned on (*nnnnngc*, *m1-m2-m3-m4-gc*). The *prefix* subfield indicates a spare point code (*prefix-nnnnn*, *prefix-nnnnngc*, *prefix-m1-m2-m3-m4*, *prefix-m1-m2-m3-m4-gc*).

#### **Range:**

*s*-, 0-16383, *aa-zz*

Specify a valid value for each subfield of the point code, and separate the subfields with a dash (-).

*prefix*—s-  
*nnnnn*—0-16383  
*gc*—aa-zz  
*m1-m2-m3-m4*—0-14 for each member; values must sum to 14

#### **sspn24 (optional)**

24-bit ITU national destination point code with subfields *main signaling area-sub signaling area-signaling point* (*msa-ssa-sp*).

#### **Range:**

000-255

Specify a valid value for each subfield of the point code, and separate the subfields with a dash (-).

*msa*—000-255  
*ssa*—000-255  
*sp*—000-255

#### **sspn16 (optional)**

16-bit ITU national point code with subfields *unit number-sub number area-main number area* (*un-sna-mna*).

#### **Range:**

000---127

Specify a valid value for each subfield of the point code, and the separate the subfields with a dash (-).

*un*---000---127

*sna*---000---15

*mna*---000---31

#### **tlnpisuptype (optional)**

The ISUP message type.

**Range:**  
0 - 255

**tn (optional)**  
The directory number.

**Range:**  
Exactly 10 digits. Valid digits are 0-9

### Example

```
ent-trace:opc=1-1-1:card=SS7ANSI-ALL:rep=2
ent-trace:tlnpisuptype=01:card=SS7ANSI-ALL
ent-trace:dn=12345:card=VSCCP-ALL
ent-trace:imsi=c122d:card=VSCCP-ALL
ent-trace:card=ccs7itu-all:dpc=2-7-5:error=no
ent-trace:card=vscpp-all:error=yes
ent-trace:card=ccs7itu-
all:sspn24=10-11-12:opcn24=10-10-10:dpcn24=10-101-11
ent-trace:imei=123456789101234:card=VSCCP-ALL
ent-trace:entityid=c123:card=VSCCP-ALL
ent-trace:loc=1305:si=5:brief=yes
ent-trace:dn=98912345:loc=1105
ent-trace:card=ccs7itu-
all:sspn16=121-10-12:opcn16=121-10-13:dpcn16=121-10-14
```

### Dependencies

The `card` parameter or the `loc` parameter must be specified.

At least one optional parameter must be specified. The `error` parameter can be specified as the only optional parameter or with any of the other optional parameters in the command.

The `gt`, `entityid`, `dn`, `imei`, and `imsi` parameters cannot have a value of *none*.

A valid value must be specified for the `card` parameter.

The only qualifier allowed for the `card` parameter is *all*.

The `gt`, `entityid`, `dn`, `imei`, `imsi`, `lrn`, and `tn` parameters are invalid for LIM cards running the SS7ANSI, ATMANSI, or SS7IPGW applications.

The `opci/opcn/opcn24/opcn16`, `dpci/dpcn/dpcn24/dpcn16`, and `sspi/sspn/sspn24/sspn16` ITU point code parameters are invalid for LIM cards running the SS7ANSI, ATMANSI, or SS7IPGW applications.

The `gt`, `entityid`, `dn`, `imei`, `imsi`, `lrn`, `tn`, and `tlnpisuptype` parameters are invalid for LIM cards running the ATMITU or IPLIMI applications.

The `opc/opca`, `dpc/dpca`, and `ssp/sspa` ANSI point code parameters are invalid for LIM cards running the IPLIMI application.

The `opc`, `dpc`, and `tlnpisuptype` parameters cannot be specified for Service Module cards.

The G-Flex feature or the Equipment Identity Register feature must be turned on before the `imsi` parameter can be specified.

If the ITUDUPPC feature is turned on, the ITU national point code must be specified as a full point code.

The EIR feature must be turned on before the `imei` parameter can be specified.

The AINPQ, G-Flex, G-Port, IDP Relay, INP, PPSMS, or V-Flex feature must be turned on or the ANSI41 AIQ or ATINP feature must be enabled before the `dn` parameter can be specified.

The G-Flex, G-Port, INP, or V-Flex feature must be turned on or the ATINP, IDP Relay or any TIF feature must be enabled before the `entityid` parameter can be specified.

The `loc` and `card` parameters are mutually exclusive.

Only one of the `lrn`, `tn`, `dn`, `entityid`, `imsi`, `imei`, or `error` parameters can be specified in a single MSU trace request.

A maximum of 10 traces can be entered in the system at a time.

Values 1113 - 1118 cannot be specified for the `loc` parameter.

The J7 Support feature must be enabled before the `ssp16/opcn16/dpcn16` parameters can be specified.

## Output

This example shows the output for an MTP trace:

```
ent-trace:loc=1101:dpc=7-1-0

stdcfg1b 07-08-10 15:51:33 EST  EAGLE 37.5.0
MSU TRACE H'00e1:  Card=1101  RX - Link B0
Trace Condition:
LOC=                1101
DPC=                007-001-000

MSU info:
TOTAL MSU SIZE=    12 Bytes
MSU DATA SIZE =   4 Bytes

      0  1  2  3  4  5  6  7  8  9  0  1  2  3  4  5  6  7  8  9
MTP:  85 00 01 07 01 65 01 16

DATA: 00 00 09 00
TRACE OUTPUT COMPLETE.
;

stdcfg1b 07-08-10 15:51:33 EST  EAGLE 37.5.0
MSU TRACE H'00e1:  Card=1101  Use RTE:  007-001-000:H'0001
Trace Condition:
```

```
LOC=          1101
DPC=          007-001-000
```

```
MSU info:
TOTAL MSU SIZE= 12 Bytes
MSU DATA SIZE = 4 Bytes
```

```
      0 1 2 3 4 5 6 7 8 9 0 1 2 3 4 5 6 7 8 9
MTP: 85 00 01 07 01 65 01 16
```

```
DATA: 00 00 09 00
TRACE OUTPUT COMPLETE.
```

;

```
stdcfg1b 07-08-10 15:51:33 EST EAGLE 37.5.0
MSU TRACE H'00e1: Card=1101 Sending to 1103:B1
Trace Condition:
LOC=          1101
DPC=          007-001-000
```

```
MSU info:
TOTAL MSU SIZE= 12 Bytes
MSU DATA SIZE = 4 Bytes
```

```
      0 1 2 3 4 5 6 7 8 9 0 1 2 3 4 5 6 7 8 9
MTP: 85 00 01 07 01 65 01 0b
```

```
DATA: 00 00 09 00
TRACE OUTPUT COMPLETE.
```

;

```
stdcfg1b 07-08-10 15:51:33 EST EAGLE 37.5.0
MSU TRACE H'00e1: Card=1103 MSU Received from 1101
Trace Condition:
LOC=          1101
DPC=          007-001-000
```

```
MSU info:
TOTAL MSU SIZE= 12 Bytes
MSU DATA SIZE = 4 Bytes
```

```
      0 1 2 3 4 5 6 7 8 9 0 1 2 3 4 5 6 7 8 9
MTP: 85 00 01 07 01 65 01 0b
```

```
DATA: 00 00 09 00
TRACE OUTPUT COMPLETE.
```

;

```
stdcfg1b 07-08-10 15:51:33 EST EAGLE 37.5.0
MSU TRACE H'00e1: Card=1103 MSU sent to L2 - B1
Trace Condition:
LOC=          1101
DPC=          007-001-000
```

```
MSU info:
```

```

TOTAL MSU SIZE= 12 Bytes
MSU DATA SIZE = 4 Bytes

      0 1 2 3 4 5 6 7 8 9 0 1 2 3 4 5 6 7 8 9
MTP:  85 00 01 07 01 65 01 0b

DATA: 00 00 09 00
TRACE OUTPUT COMPLETE.
;

```

This example shows the output for an SCCP trace:

```
ent-trace:loc=1101:gt=9194605500
```

```

stdcfg1b 07-08-10 15:51:33 EST  EAGLE 37.5.0
MSU TRACE H'00e2:  Card=1101  RX - Link B0
Trace Condition:
LOC=          1101
GT=          9194605500

MSU info:
TOTAL MSU SIZE= 90 Bytes
MSU DATA SIZE = 82 Bytes

      0 1 2 3 4 5 6 7 8 9 0 1 2 3 4 5 6 7 8 9
MTP:  83 00 01 01 01 65 01 02

SCCP: 09 80 03 0e 13 0b 8b 8c 28 04 01 0a 19 49 06 55 00 05 c3 0a
      04 05 06

TCAP: 3a e2 38 c7 04 e5 04 61 80 e8 30 e9 2e cf 01 00 d0 02 83 01
      f2 25 aa 0b 84 09 01 00 11 0a 19 49 06 12 19 84 09 02 00 11
      0a 19 39 88 41 63 84 07 07 00 01 03 21 03 00 df 45 01 00
TRACE OUTPUT COMPLETE.
;

```

```

stdcfg1b 07-08-10 15:51:33 EST  EAGLE 37.5.0
MSU TRACE H'00e2:  Card=1101  TVG: Sending to SCCP 1107
Trace Condition:
LOC=          1101
GT=          9194605500

MSU info:
TOTAL MSU SIZE= 90 Bytes
MSU DATA SIZE = 82 Bytes

      0 1 2 3 4 5 6 7 8 9 0 1 2 3 4 5 6 7 8 9
MTP:  83 00 01 01 01 65 01 02

SCCP: 09 80 03 0e 13 0b 8b 8c 28 04 01 0a 19 49 06 55 00 05 c3 0a
      04 05 06

TCAP: 3a e2 38 c7 04 e5 04 61 80 e8 30 e9 2e cf 01 00 d0 02 83 01
      f2 25 aa 0b 84 09 01 00 11 0a 19 49 06 12 19 84 09 02 00 11

```

```
0a 19 39 88 41 63 84 07 07 00 01 03 21 03 00 df 45 01 00
TRACE OUTPUT COMPLETE.
```

;

```
stdcfg1b 07-08-10 15:51:33 EST EAGLE 37.5.0
MSU TRACE H'00e2: Card=1107 MSU Received from 1101
Trace Condition:
LOC=          1101
GT=          9194605500
```

```
MSU info:
TOTAL MSU SIZE= 90 Bytes
MSU DATA SIZE = 82 Bytes
```

```
0 1 2 3 4 5 6 7 8 9 0 1 2 3 4 5 6 7 8 9
MTP: 83 00 01 01 01 65 01 02
```

```
SCCP: 09 80 03 0e 13 0b 8b 8c 28 04 01 0a 19 49 06 55 00 05 c3 0a
04 05 06
```

```
TCAP: 3a e2 38 c7 04 e5 04 61 80 e8 30 e9 2e cf 01 00 d0 02 83 01
f2 25 aa 0b 84 09 01 00 11 0a 19 49 06 12 19 84 09 02 00 11
0a 19 39 88 41 63 84 07 07 00 01 03 21 03 00 df 45 01 00
```

```
TRACE OUTPUT COMPLETE.
```

;

```
stdcfg1b 07-08-10 15:51:33 EST EAGLE 37.5.0
MSU TRACE H'00e2: Card=1107 SCCP: Before SS7 Trans Encod
Trace Condition:
LOC=          1101
GT=          9194605500
```

```
MSU info:
TOTAL MSU SIZE= 97 Bytes
MSU DATA SIZE = 89 Bytes
```

```
0 1 2 3 4 5 6 7 8 9 0 1 2 3 4 5 6 7 8 9
MTP: 83 00 01 01 01 65 01 02
```

```
SCCP: 09 80 03 0e 13 0b 8b 8c 28 04 01 0a 19 49 06 55 00 05 c3 0a
04 05 06
```

```
TCAP: 3a e2 38 c7 04 e5 04 61 80 e8 30 e9 2e cf 01 00 d0 02 83 01
f2 25 aa 0b 84 09 01 00 11 0a 19 49 06 12 19 84 09 02 00 11
0a 19 39 88 41 63 84 07 07 00 01 03 21 03 00 df 45 01 00 02
08 01 65 01 00 04
```

```
TRACE OUTPUT COMPLETE.
```

;

```
stdcfg1b 07-08-10 15:51:33 EST EAGLE 37.5.0
MSU TRACE H'00e2: Card=1107 SCCP: After SS7 Trans Encode
Trace Condition:
LOC=          1101
GT=          9194605500
```



```
MSU info:
TOTAL MSU SIZE= 97 Bytes
MSU DATA SIZE = 89 Bytes

      0 1 2 3 4 5 6 7 8 9 0 1 2 3 4 5 6 7 8 9
MTP:  83 00 01 07 00 01 01 02

SCCP: 09 80 03 0e 13 0b cb 10 00 01 07 0a 19 49 06 55 00 05 c3 0a
      04 05 06

TCAP: 3a e2 38 c7 04 e5 04 61 80 e8 30 e9 2e cf 01 00 d0 02 83 01
      f2 25 aa 0b 84 09 01 00 11 0a 19 49 06 12 19 84 09 02 00 11
      0a 19 39 88 41 63 84 07 07 00 01 03 21 03 00 df 45 01 00 02
      08 01 65 01 00 04
TRACE OUTPUT COMPLETE.
```

;

```
stdcfg1b 07-08-10 15:51:33 EST EAGLE 37.5.0
MSU TRACE H'00e2: Card=1107 Use RTE 007-001-000:H'0009
Trace Condition:
LOC=          1101
GT=           9194605500
```

```
MSU info:
TOTAL MSU SIZE= 97 Bytes
MSU DATA SIZE = 89 Bytes

      0 1 2 3 4 5 6 7 8 9 0 1 2 3 4 5 6 7 8 9
MTP:  83 00 01 07 00 01 01 02

SCCP: 09 80 03 0e 13 0b cb 10 00 01 07 0a 19 49 06 55 00 05 c3 0a
      04 05 06

TCAP: 3a e2 38 c7 04 e5 04 61 80 e8 30 e9 2e cf 01 00 d0 02 83 01
      f2 25 aa 0b 84 09 01 00 11 0a 19 49 06 12 19 84 09 02 00 11
      0a 19 39 88 41 63 84 07 07 00 01 03 21 03 00 df 45 01 00 02
      08 01 65 01 00 04
TRACE OUTPUT COMPLETE.
```

;

```
stdcfg1b 07-08-10 15:51:33 EST EAGLE 37.5.0
MSU TRACE H'00e2: Card=1107 Sending to 1103:B1
Trace Condition:
LOC=          1101
GT=           9194605500
```

```
MSU info:
TOTAL MSU SIZE= 97 Bytes
MSU DATA SIZE = 89 Bytes

      0 1 2 3 4 5 6 7 8 9 0 1 2 3 4 5 6 7 8 9
MTP:  83 00 01 07 00 01 01 01

SCCP: 09 80 03 0e 13 0b cb 10 00 01 07 0a 19 49 06 55 00 05 c3 0a
      04 05 06
```

```
TCAP: 3a e2 38 c7 04 e5 04 61 80 e8 30 e9 2e cf 01 00 d0 02 83 01
      f2 25 aa 0b 84 09 01 00 11 0a 19 49 06 12 19 84 09 02 00 11
      0a 19 39 88 41 63 84 07 07 00 01 03 21 03 00 df 45 01 00 02
      08 01 65 01 00 04
```

TRACE OUTPUT COMPLETE.

;

```
stdcfg1b 07-08-10 15:51:33 EST EAGLE 37.5.0
MSU TRACE H'0000: Card=1103 MSU Received from 1107
Trace Condition:
LOC=          1101
GT=           9194605500
```

```
MSU info:
TOTAL MSU SIZE= 97 Bytes
MSU DATA SIZE = 89 Bytes
```

```
      0 1 2 3 4 5 6 7 8 9 0 1 2 3 4 5 6 7 8 9
MTP: 83 00 01 07 00 01 01 01
```

```
SCCP: 09 80 03 0e 13 0b cb 10 00 01 07 0a 19 49 06 55 00 05 c3 0a
      04 05 06
```

```
TCAP: 3a e2 38 c7 04 e5 04 61 80 e8 30 e9 2e cf 01 00 d0 02 83 01
      f2 25 aa 0b 84 09 01 00 11 0a 19 49 06 12 19 84 09 02 00 11
      0a 19 39 88 41 63 84 07 07 00 01 03 21 03 00 df 45 01 00 02
      08 01 65 01 00 04
```

TRACE OUTPUT COMPLETE.

;

```
stdcfg1b 07-08-10 15:51:33 EST EAGLE 37.5.0
MSU TRACE H'0000: Card=1103 MSU sent to L2 - B1
Trace Condition:
LOC=          1101
GT=           9194605500
```

```
MSU info:
TOTAL MSU SIZE= 90 Bytes
MSU DATA SIZE = 82 Bytes
```

```
      0 1 2 3 4 5 6 7 8 9 0 1 2 3 4 5 6 7 8 9
MTP: 83 00 01 07 00 01 01 01
```

```
SCCP: 09 80 03 0e 13 0b cb 10 00 01 07 0a 19 49 06 55 00 05 c3 0a
      04 05 06
```

```
TCAP: 3a e2 38 c7 04 e5 04 61 80 e8 30 e9 2e cf 01 00 d0 02 83 01
      f2 25 aa 0b 84 09 01 00 11 0a 19 49 06 12 19 84 09 02 00 11
      0a 19 39 88 41 63 84 07 07 00 01 03 21 03 00 df 45 01 00
```

TRACE OUTPUT COMPLETE.

;

This example shows the output for a trace when truncated output is requested. Only the filters that are specified in the command are displayed.

```
ent-  
trace:loc=1305:si=0:hoh1=20:sls=255:cpc=001-002-003:mode=debug:brief  
=yes
```

```
tklcl071501 08-09-22 10:49:00 EST EAGLE5 39.2.0
```

```
;
```

```
tklcl071501 08-09-22 10:49:00 EST EAGLE5 39.2.0
```

```
MSU TRACE H'0081: Card=1305
```

```
Trace ID 1 Condition:
```

```
LOC=          1305  
SI=           0  
H0H1=        20  
SLS=         255  
CPC=         001-002-003  
MODE=        DEBUG
```

```
Info: RX - Link A0
```

```
TRACE OUTPUT COMPLETE.
```

```
;
```

```
tklcl071501 08-09-22 10:49:00 EST EAGLE5 39.2.0
```

```
MSU TRACE H'0081: Card=1305
```

```
Trace ID 1 Condition:
```

```
LOC=          1305  
SI=           0  
H0H1=        20  
SLS=         255  
CPC=         001-002-003  
MODE=        DEBUG
```

```
Info: TIF Stop Action: OK
```

```
TRACE OUTPUT COMPLETE.
```

```
;
```

```
tklcl071501 08-09-22 10:49:00 EST EAGLE5 39.2.0
```

```
MSU TRACE H'0081: Card=1305
```

```
Trace ID 1 Condition:
```

```
LOC=          1305  
SI=           0  
H0H1=        20  
SLS=         255  
CPC=         001-002-003  
MODE=        DEBUG
```

```
Info: TVG: Sending to SCCP 1317
```

```
TRACE OUTPUT COMPLETE.
```

```
;
```

```
tklcl071501 08-09-22 10:49:00 EST EAGLE5 39.2.0
MSU TRACE H'0081: Card=1317
Trace ID 1 Condition:
LOC=          1305
SI=           0
H0H1=        20
SLS=         255
CPC=         001-002-003
MODE=        DEBUG
```

Info: SCCP: MSU RX from 1305

TRACE OUTPUT COMPLETE.

;

```
tklcl071501 08-09-22 10:49:00 EST EAGLE5 39.2.0
MSU TRACE H'0081: Card=1317
Trace ID 1 Condition:
LOC=          1305
SI=           0
H0H1=        20
SLS=         255
CPC=         001-002-003
MODE=        DEBUG
```

Info: TIF Process Msg: Ruleset TIF1

TRACE OUTPUT COMPLETE.

;

```
tklcl071501 08-09-22 10:49:00 EST EAGLE5 39.2.0
MSU TRACE H'0081: Card=1317
Trace ID 1 Condition:
LOC=          1305
SI=           0
H0H1=        20
SLS=         255
CPC=         001-002-003
MODE=        DEBUG
```

Info: TIF: No Error CdPN:111111119703819111100

TRACE OUTPUT COMPLETE.

;

```
tklcl071501 08-09-22 10:49:00 EST EAGLE5 39.2.0
MSU TRACE H'0081: Card=1305
Trace ID 1 Condition:
LOC=          1305
SI=           0
H0H1=        20
SLS=         255
CPC=         001-002-003
MODE=        DEBUG
```

Info: Use RTE (16) DPCa: 023-172-011, OPCa: 013-159-005

```
TRACE OUTPUT COMPLETE.
;

tklc1071501 08-09-22 10:49:00 EST EAGLE5 39.2.0
MSU TRACE H'0081: Card=1305
Trace ID 1 Condition:
LOC=          1305
SI=           0
H0H1=         20
SLS=          255
CPC=          001-002-003
MODE=         DEBUG

Info: Sending to 2311:B3

TRACE OUTPUT COMPLETE.
;

tklc1071501 08-09-22 10:49:00 EST EAGLE5 39.2.0
MSU TRACE H'0081: Card=2311
Trace ID 1 Condition:
LOC=          1305
SI=           0
H0H1=         20
SLS=          255
CPC=          001-002-003
MODE=         DEBUG

Info: MSU Received from 1305

TRACE OUTPUT COMPLETE.
;

tklc1071501 08-09-22 10:49:00 EST EAGLE5 39.2.0
MSU TRACE H'0081: Card=2311
Trace ID 1 Condition:
LOC=          1305
SI=           0
H0H1=         20
SLS=          255
CPC=          001-002-003
MODE=         DEBUG

Info: MSU sent to L2 - B3: DPCa= 023-172-011, OPCa= 013-159-005

TRACE OUTPUT COMPLETE.
;

tklc1071501 08-09-22 10:49:00 EST EAGLE5 39.2.0
MSU TRACE H'0081: Card=2311
Trace ID 1 Condition:
LOC=          1305
SI=           0
H0H1=         20
```

```
SLS=          255
CPC=          001-002-003
MODE=         DEBUG
```

```
Info: Transmitted and ACK'd on B3
```

```
TRACE OUTPUT COMPLETE.
```

```
;
```

**This example shows the output for an MTP trace:**

```
ent-trace:loc=1101:dpcn16=7-1-0
```

```
stdcfg1b 07-08-10 15:51:33 EST  EAGLE 37.5.0
MSU TRACE H'00e1: Card=1101  RX - Link B0
Trace Condition:
LOC=          1101
DPC=          007-001-000
```

```
MSU info:
TOTAL MSU SIZE= 12 Bytes
MSU DATA SIZE = 4 Bytes
```

```
      0 1 2 3 4 5 6 7 8 9 0 1 2 3 4 5 6 7 8 9
MTP:  85 00 01 07 01 65 01 16
```

```
DATA: 00 00 09 00
TRACE OUTPUT COMPLETE.
```

```
;
```

```
stdcfg1b 07-08-10 15:51:33 EST  EAGLE 37.5.0
MSU TRACE H'00e1: Card=1101  Use RTE:  007-001-000:H'0001
Trace Condition:
LOC=          1101
DPC=          007-001-000
```

```
MSU info:
TOTAL MSU SIZE= 12 Bytes
MSU DATA SIZE = 4 Bytes
```

```
      0 1 2 3 4 5 6 7 8 9 0 1 2 3 4 5 6 7 8 9
MTP:  85 00 01 07 01 65 01 16
```

```
DATA: 00 00 09 00
TRACE OUTPUT COMPLETE.
```

```
;
```

```
stdcfg1b 07-08-10 15:51:33 EST  EAGLE 37.5.0
MSU TRACE H'00e1: Card=1101  Sending to 1103:B1
Trace Condition:
LOC=          1101
DPC=          007-001-000
```

```
MSU info:
```

```
TOTAL MSU SIZE= 12 Bytes
MSU DATA SIZE = 4 Bytes

      0 1 2 3 4 5 6 7 8 9 0 1 2 3 4 5 6 7 8 9
MTP: 85 00 01 07 01 65 01 0b

DATA: 00 00 09 00
TRACE OUTPUT COMPLETE.
;

stdcfg1b 07-08-10 15:51:33 EST EAGLE 37.5.0
MSU TRACE H'00e1: Card=1103 MSU Received from 1101
Trace Condition:
LOC=          1101
DPC=          007-001-000

MSU info:
TOTAL MSU SIZE= 12 Bytes
MSU DATA SIZE = 4 Bytes

      0 1 2 3 4 5 6 7 8 9 0 1 2 3 4 5 6 7 8 9
MTP: 85 00 01 07 01 65 01 0b

DATA: 00 00 09 00
TRACE OUTPUT COMPLETE.
;

stdcfg1b 07-08-10 15:51:33 EST EAGLE 37.5.0
MSU TRACE H'00e1: Card=1103 MSU sent to L2 - B1
Trace Condition:
LOC=          1101
DPC=          007-001-000

MSU info:
TOTAL MSU SIZE= 12 Bytes
MSU DATA SIZE = 4 Bytes

      0 1 2 3 4 5 6 7 8 9 0 1 2 3 4 5 6 7 8 9
MTP: 85 00 01 07 01 65 01 0b

DATA: 00 00 09 00
TRACE OUTPUT COMPLETE.
;

stdcfg1b 07-08-10 15:51:33 EST EAGLE 37.5.0
MSU TRACE H'00e2: Card=1101 RX - Link B0
Trace Condition:
LOC=          1101
GT=           9194605500
```

This example shows the output for an SCCP trace:

```
ent-trace:loc=1101:gt=9194605500
```

```
stdcfg1b 07-08-10 15:51:33 EST EAGLE 37.5.0
MSU TRACE H'00e2: Card=1101 RX - Link B0
Trace Condition:
LOC=          1101
GT=           9194605500
```

```
MSU info:
TOTAL MSU SIZE= 90 Bytes
MSU DATA SIZE = 82 Bytes

      0 1 2 3 4 5 6 7 8 9 0 1 2 3 4 5 6 7 8 9
MTP:  83 00 01 01 01 65 01 02

SCCP: 09 80 03 0e 13 0b 8b 8c 28 04 01 0a 19 49 06 55 00 05 c3 0a
      04 05 06

TCAP: 3a e2 38 c7 04 e5 04 61 80 e8 30 e9 2e cf 01 00 d0 02 83 01
      f2 25 aa 0b 84 09 01 00 11 0a 19 49 06 12 19 84 09 02 00 11
      0a 19 39 88 41 63 84 07 07 00 01 03 21 03 00 df 45 01 00
TRACE OUTPUT COMPLETE.
```

;

```
stdcfg1b 07-08-10 15:51:33 EST EAGLE 37.5.0
MSU TRACE H'00e2: Card=1101 TVG: Sending to SCCP 1107
Trace Condition:
LOC=          1101
GT=          9194605500
```

```
MSU info:
TOTAL MSU SIZE= 90 Bytes
MSU DATA SIZE = 82 Bytes

      0 1 2 3 4 5 6 7 8 9 0 1 2 3 4 5 6 7 8 9
MTP:  83 00 01 01 01 65 01 02

SCCP: 09 80 03 0e 13 0b 8b 8c 28 04 01 0a 19 49 06 55 00 05 c3 0a
      04 05 06

TCAP: 3a e2 38 c7 04 e5 04 61 80 e8 30 e9 2e cf 01 00 d0 02 83 01
      f2 25 aa 0b 84 09 01 00 11 0a 19 49 06 12 19 84 09 02 00 11
      0a 19 39 88 41 63 84 07 07 00 01 03 21 03 00 df 45 01 00
TRACE OUTPUT COMPLETE.
```

;

```
stdcfg1b 07-08-10 15:51:33 EST EAGLE 37.5.0
MSU TRACE H'00e2: Card=1107 MSU Received from 1101
Trace Condition:
LOC=          1101
GT=          9194605500
```

```
MSU info:
TOTAL MSU SIZE= 90 Bytes
MSU DATA SIZE = 82 Bytes

      0 1 2 3 4 5 6 7 8 9 0 1 2 3 4 5 6 7 8 9
MTP:  83 00 01 01 01 65 01 02

SCCP: 09 80 03 0e 13 0b 8b 8c 28 04 01 0a 19 49 06 55 00 05 c3 0a
      04 05 06

TCAP: 3a e2 38 c7 04 e5 04 61 80 e8 30 e9 2e cf 01 00 d0 02 83 01
```



```
      f2 25 aa 0b 84 09 01 00 11 0a 19 49 06 12 19 84 09 02 00 11
      0a 19 39 88 41 63 84 07 07 00 01 03 21 03 00 df 45 01 00
TRACE OUTPUT COMPLETE.
```

;

```
stdcfg1b 07-08-10 15:51:33 EST  EAGLE 37.5.0
MSU TRACE H'00e2:  Card=1107  SSCP: Before SS7 Trans Encod
Trace Condition:
LOC=          1101
GT=          9194605500
```

```
MSU info:
TOTAL MSU SIZE=  97 Bytes
MSU DATA SIZE =  89 Bytes
```

```
      0  1  2  3  4  5  6  7  8  9  0  1  2  3  4  5  6  7  8  9
MTP:  83 00 01 01 01 65 01 02
```

```
SCCP: 09 80 03 0e 13 0b 8b 8c 28 04 01 0a 19 49 06 55 00 05 c3 0a
      04 05 06
```

```
TCAP: 3a e2 38 c7 04 e5 04 61 80 e8 30 e9 2e cf 01 00 d0 02 83 01
      f2 25 aa 0b 84 09 01 00 11 0a 19 49 06 12 19 84 09 02 00 11
      0a 19 39 88 41 63 84 07 07 00 01 03 21 03 00 df 45 01 00 02
      08 01 65 01 00 04
```

```
TRACE OUTPUT COMPLETE.
```

;

```
stdcfg1b 07-08-10 15:51:33 EST  EAGLE 37.5.0
MSU TRACE H'00e2:  Card=1107  SSCP: After SS7 Trans Encode
Trace Condition:
LOC=          1101
GT=          9194605500
```

```
MSU info:
TOTAL MSU SIZE=  97 Bytes
MSU DATA SIZE =  89 Bytes
```

```
      0  1  2  3  4  5  6  7  8  9  0  1  2  3  4  5  6  7  8  9
MTP:  83 00 01 07 00 01 01 02
```

```
SCCP: 09 80 03 0e 13 0b cb 10 00 01 07 0a 19 49 06 55 00 05 c3 0a
      04 05 06
```

```
TCAP: 3a e2 38 c7 04 e5 04 61 80 e8 30 e9 2e cf 01 00 d0 02 83 01
      f2 25 aa 0b 84 09 01 00 11 0a 19 49 06 12 19 84 09 02 00 11
      0a 19 39 88 41 63 84 07 07 00 01 03 21 03 00 df 45 01 00 02
      08 01 65 01 00 04
```

```
TRACE OUTPUT COMPLETE.
```

;

```
stdcfg1b 07-08-10 15:51:33 EST  EAGLE 37.5.0
MSU TRACE H'00e2:  Card=1107  Use RTE 007-001-000:H'0009
Trace Condition:
LOC=          1101
```

GT= 9194605500

MSU info:

TOTAL MSU SIZE= 97 Bytes

MSU DATA SIZE = 89 Bytes

0 1 2 3 4 5 6 7 8 9 0 1 2 3 4 5 6 7 8 9  
MTP: 83 00 01 07 00 01 01 02

SCCP: 09 80 03 0e 13 0b cb 10 00 01 07 0a 19 49 06 55 00 05 c3 0a  
04 05 06

TCAP: 3a e2 38 c7 04 e5 04 61 80 e8 30 e9 2e cf 01 00 d0 02 83 01  
f2 25 aa 0b 84 09 01 00 11 0a 19 49 06 12 19 84 09 02 00 11  
0a 19 39 88 41 63 84 07 07 00 01 03 21 03 00 df 45 01 00 02  
08 01 65 01 00 04

TRACE OUTPUT COMPLETE.

;

stdcfg1b 07-08-10 15:51:33 EST EAGLE 37.5.0

MSU TRACE H'00e2: Card=1107 Sending to 1103:B1

Trace Condition:

LOC= 1101

GT= 9194605500

MSU info:

TOTAL MSU SIZE= 97 Bytes

MSU DATA SIZE = 89 Bytes

0 1 2 3 4 5 6 7 8 9 0 1 2 3 4 5 6 7 8 9  
MTP: 83 00 01 07 00 01 01 01

SCCP: 09 80 03 0e 13 0b cb 10 00 01 07 0a 19 49 06 55 00 05 c3 0a  
04 05 06

TCAP: 3a e2 38 c7 04 e5 04 61 80 e8 30 e9 2e cf 01 00 d0 02 83 01  
f2 25 aa 0b 84 09 01 00 11 0a 19 49 06 12 19 84 09 02 00 11  
0a 19 39 88 41 63 84 07 07 00 01 03 21 03 00 df 45 01 00 02  
08 01 65 01 00 04

TRACE OUTPUT COMPLETE.

;

stdcfg1b 07-08-10 15:51:33 EST EAGLE 37.5.0

MSU TRACE H'0000: Card=1103 MSU Received from 1107

Trace Condition:

LOC= 1101

GT= 9194605500

MSU info:

TOTAL MSU SIZE= 97 Bytes

MSU DATA SIZE = 89 Bytes

0 1 2 3 4 5 6 7 8 9 0 1 2 3 4 5 6 7 8 9  
MTP: 83 00 01 07 00 01 01 01

```

SCCP: 09 80 03 0e 13 0b cb 10 00 01 07 0a 19 49 06 55 00 05 c3 0a
      04 05 06

TCAP: 3a e2 38 c7 04 e5 04 61 80 e8 30 e9 2e cf 01 00 d0 02 83 01
      f2 25 aa 0b 84 09 01 00 11 0a 19 49 06 12 19 84 09 02 00 11
      0a 19 39 88 41 63 84 07 07 00 01 03 21 03 00 df 45 01 00 02
      08 01 65 01 00 04
TRACE OUTPUT COMPLETE.
;

stdcfg1b 07-08-10 15:51:33 EST  EAGLE 37.5.0
MSU TRACE H'0000:  Card=1103  MSU sent to L2 - B1
Trace Condition:
LOC=          1101
GT=          9194605500

MSU info:
TOTAL MSU SIZE=  90 Bytes
MSU DATA SIZE =  82 Bytes

      0  1  2  3  4  5  6  7  8  9  0  1  2  3  4  5  6  7  8  9
MTP:  83 00 01 07 00 01 01 01

SCCP: 09 80 03 0e 13 0b cb 10 00 01 07 0a 19 49 06 55 00 05 c3 0a
      04 05 06

TCAP: 3a e2 38 c7 04 e5 04 61 80 e8 30 e9 2e cf 01 00 d0 02 83 01
      f2 25 aa 0b 84 09 01 00 11 0a 19 49 06 12 19 84 09 02 00 11
      0a 19 39 88 41 63 84 07 07 00 01 03 21 03 00 df 45 01 00
TRACE OUTPUT COMPLETE.
;

```

This example shows the output to display the selected highest priority component in a TCAP message:

```
ent-trace:loc=1103:si=3:mode=debug
```

```

tekelecstp 17-03-22 11:30:07 MST  EAGLE 46.5.0.0.0-70.26.0
MSU TRACE H'0021:  Card=1103
Trace ID 1 Condition: (brief=Y, MSU size=145)
LOC=          1103
SI=           3
MODE=         debug

Info: SCCP: service selector not found

MSU info:
TOTAL MSU SIZE=  145 Bytes
MSU DATA SIZE =  140 Bytes

      0  1  2  3  4  5  6  7  8  9  0  1  2  3  4  5  6  7  8  9
MTP:  03 3f 78 0c 0c

```

```
SCCP: 09 80 03 0c 16 09 0b 31 30 0a 0b 22 22 22 01 0a 4b 81 3a f2
      f2 89 67 45 23 01
```

```
TCAP: 71 62 6f 48 01 00 6b 1f 28 1d 06 07 00 11 86 05 01 01 01 a0
      12 60 10 80 01 00 a1 03 06 01 00 be 06 28 04 a0 02 00 00 6c
      49 a1 24 02 01 00 02 01 02 30 1c 04 05 79 58 45 28 93 80 0b
      80 00 00 00 00 00 00 00 00 00 00 04 06 91 22 33 44 55 66 a1
      10 02 01 00 02 01 16 30 08 80 06 91 21 43 65 87 09 a1 0f 02
      01 00 02 01 08 30 07 80 05 89 67 45 23 01
```

TRACE OUTPUT COMPLETE.

;

```
tekelecstp 17-03-22 11:30:07 MST EAGLE 46.5.0.0.0-70.26.0
1660.0309 SYSTEM Node is no longer isolated
```

;

```
tekelecstp 17-03-22 11:30:07 MST EAGLE 46.5.0.0.0-70.26.0
MSU TRACE H'0021: Card=1103
Trace ID 1 Condition: (brief=Y, MSU size=145)
LOC= 1103
SI= 3
MODE= debug
```

Info: TOBR:Msg=Begin Opcode=2,22,8 ACN(hex)= 0

MSU info:

TOTAL MSU SIZE= 145 Bytes

MSU DATA SIZE = 140 Bytes

```
0 1 2 3 4 5 6 7 8 9 0 1 2 3 4 5 6 7 8 9
```

```
MTP: 03 3f 78 0c 0c
```

```
SCCP: 09 80 03 0c 16 09 0b 31 30 0a 0b 22 22 22 01 0a 4b 81 3a f2
      f2 89 67 45 23 01
```

```
TCAP: 71 62 6f 48 01 00 6b 1f 28 1d 06 07 00 11 86 05 01 01 01 a0
      12 60 10 80 01 00 a1 03 06 01 00 be 06 28 04 a0 02 00 00 6c
      49 a1 24 02 01 00 02 01 02 30 1c 04 05 79 58 45 28 93 80 0b
      80 00 00 00 00 00 00 00 00 00 00 04 06 91 22 33 44 55 66 a1
      10 02 01 00 02 01 16 30 08 80 06 91 21 43 65 87 09 a1 0f 02
      01 00 02 01 08 30 07 80 05 89 67 45 23 01
```

TRACE OUTPUT COMPLETE.

;

```
tekelecstp 17-03-22 11:30:08 MST EAGLE 46.5.0.0.0-70.26.0
MSU TRACE H'0021: Card=1103
Trace ID 1 Condition: (brief=Y, MSU size=145)
LOC= 1103
SI= 3
MODE= debug
```

Info: GTT Mode=FD-

FG,GTIi=2/2,TT11/242,SS10/242,NP-/-,NAI-/-,SelID=NONE

MSU info:

```
TOTAL MSU SIZE= 145 Bytes
MSU DATA SIZE = 140 Bytes
```

```
      0  1  2  3  4  5  6  7  8  9  0  1  2  3  4  5  6  7  8  9
MTP:  03 3f 78 0c 0c

SCCP: 09 80 03 0c 16 09 0b 31 30 0a 0b 22 22 22 01 0a 4b 81 3a f2
      f2 89 67 45 23 01

TCAP: 71 62 6f 48 01 00 6b 1f 28 1d 06 07 00 11 86 05 01 01 01 a0
      12 60 10 80 01 00 a1 03 06 01 00 be 06 28 04 a0 02 00 00 6c
      49 a1 24 02 01 00 02 01 02 30 1c 04 05 79 58 45 28 93 80 0b
      80 00 00 00 00 00 00 00 00 00 00 04 06 91 22 33 44 55 66 a1
      10 02 01 00 02 01 16 30 08 80 06 91 21 43 65 87 09 a1 0f 02
      01 00 02 01 08 30 07 80 05 89 67 45 23 01
```

```
TRACE OUTPUT COMPLETE.
```

```
;
```

```
tekelecstp 17-03-22 11:30:08 MST EAGLE 46.5.0.0.0-70.26.0
MSU TRACE H'0021: Card=1103
Trace ID 1 Condition: (brief=Y, MSU size=145)
LOC=          1103
SI=           3
MODE=         debug
```

```
Info: LS:     ls661
```

```
MSU info:
TOTAL MSU SIZE= 145 Bytes
MSU DATA SIZE = 140 Bytes
```

```
      0  1  2  3  4  5  6  7  8  9  0  1  2  3  4  5  6  7  8  9
MTP:  03 3f 78 0c 0c

SCCP: 09 80 03 0c 16 09 0b 31 30 0a 0b 22 22 22 01 0a 4b 81 3a f2
      f2 89 67 45 23 01

TCAP: 71 62 6f 48 01 00 6b 1f 28 1d 06 07 00 11 86 05 01 01 01 a0
      12 60 10 80 01 00 a1 03 06 01 00 be 06 28 04 a0 02 00 00 6c
      49 a1 24 02 01 00 02 01 02 30 1c 04 05 79 58 45 28 93 80 0b
      80 00 00 00 00 00 00 00 00 00 00 04 06 91 22 33 44 55 66 a1
      10 02 01 00 02 01 16 30 08 80 06 91 21 43 65 87 09 a1 0f 02
      01 00 02 01 08 30 07 80 05 89 67 45 23 01
```

```
TRACE OUTPUT COMPLETE.
```

```
;
```

```
tekelecstp 17-03-22 11:30:09 MST EAGLE 46.5.0.0.0-70.26.0
MSU TRACE H'0021: Card=1103
Trace ID 1 Condition: (brief=Y, MSU size=145)
LOC=          1103
SI=           3
MODE=         debug
```

```
Info: dGT=22222210,gGT=9876543210,gPC=7-080-1,  
OPCi=6-006-1,DPCi=7-007-7
```

```
MSU info:
```

```
TOTAL MSU SIZE= 145 Bytes
```

```
MSU DATA SIZE = 140 Bytes
```

```
0 1 2 3 4 5 6 7 8 9 0 1 2 3 4 5 6 7 8 9
```

```
MTP: 03 3f 78 0c 0c
```

```
SCCP: 09 80 03 0c 16 09 0b 31 30 0a 0b 22 22 22 01 0a 4b 81 3a f2  
f2 89 67 45 23 01
```

```
TCAP: 71 62 6f 48 01 00 6b 1f 28 1d 06 07 00 11 86 05 01 01 01 a0  
12 60 10 80 01 00 a1 03 06 01 00 be 06 28 04 a0 02 00 00 6c  
49 a1 24 02 01 00 02 01 02 30 1c 04 05 79 58 45 28 93 80 0b  
80 00 00 00 00 00 00 00 00 00 00 04 06 91 22 33 44 55 66 a1  
10 02 01 00 02 01 16 30 08 80 06 91 21 43 65 87 09 a1 0f 02  
01 00 02 01 08 30 07 80 05 89 67 45 23 01
```

```
TRACE OUTPUT COMPLETE.
```

```
;
```

```
tekelecstp 17-03-22 11:30:10 MST EAGLE 46.5.0.0.0-70.26.0
```

```
MSU TRACE H'0021: Card=1103
```

```
Trace ID 1 Condition: (brief=Y, MSU size=145)
```

```
LOC= 1103
```

```
SI= 3
```

```
MODE= debug
```

```
Info: Opcode 8 from component#3 selected for translation
```

```
MSU info:
```

```
TOTAL MSU SIZE= 145 Bytes
```

```
MSU DATA SIZE = 140 Bytes
```

```
0 1 2 3 4 5 6 7 8 9 0 1 2 3 4 5 6 7 8 9
```

```
MTP: 03 3f 78 0c 0c
```

```
SCCP: 09 80 03 0c 16 09 0b 31 30 0a 0b 22 22 22 01 0a 4b 81 3a f2  
f2 89 67 45 23 01
```

```
TCAP: 71 62 6f 48 01 00 6b 1f 28 1d 06 07 00 11 86 05 01 01 01 a0  
12 60 10 80 01 00 a1 03 06 01 00 be 06 28 04 a0 02 00 00 6c  
49 a1 24 02 01 00 02 01 02 30 1c 04 05 79 58 45 28 93 80 0b  
80 00 00 00 00 00 00 00 00 00 00 04 06 91 22 33 44 55 66 a1  
10 02 01 00 02 01 16 30 08 80 06 91 21 43 65 87 09 a1 0f 02  
01 00 02 01 08 30 07 80 05 89 67 45 23 01
```

```
TRACE OUTPUT COMPLETE.
```

```
;
```

```
tekelecstp 17-03-22 11:30:10 MST EAGLE 46.5.0.0.0-70.26.0
```

```
MSU TRACE H'0021: Card=1103
```

```
Trace ID 1 Condition: (brief=Y, MSU size=145)
```

```
LOC=          1103
SI=           3
MODE=         debug
```

```
Info: Opcode 2 from component#1 selected for translation
```

```
MSU info:
```

```
TOTAL MSU SIZE= 145 Bytes
MSU DATA SIZE = 140 Bytes
```

```
0 1 2 3 4 5 6 7 8 9 0 1 2 3 4 5 6 7 8 9
```

```
MTP: 03 3f 78 0c 0c
```

```
SCCP: 09 80 03 0c 16 09 0b 31 30 0a 0b 22 22 22 01 0a 4b 81 3a f2
      f2 89 67 45 23 01
```

```
TCAP: 71 62 6f 48 01 00 6b 1f 28 1d 06 07 00 11 86 05 01 01 01 a0
      12 60 10 80 01 00 a1 03 06 01 00 be 06 28 04 a0 02 00 00 6c
      49 a1 24 02 01 00 02 01 02 30 1c 04 05 79 58 45 28 93 80 0b
      80 00 00 00 00 00 00 00 00 00 00 04 06 91 22 33 44 55 66 a1
      10 02 01 00 02 01 16 30 08 80 06 91 21 43 65 87 09 a1 0f 02
      01 00 02 01 08 30 07 80 05 89 67 45 23 01
```

```
TRACE OUTPUT COMPLETE.
```

```
;
```

```
tekelecstp 17-03-22 11:30:11 MST EAGLE 46.5.0.0.0-70.26.0
```

```
MSU TRACE H'0021: Card=1103
```

```
Trace ID 1 Condition: (brief=Y, MSU size=145)
```

```
LOC=          1103
SI=           3
MODE=         debug
```

```
Info: SET=FD-cdl-amituopcd-cg1-ZITUOPCD
```

```
MSU info:
```

```
TOTAL MSU SIZE= 145 Bytes
MSU DATA SIZE = 140 Bytes
```

```
0 1 2 3 4 5 6 7 8 9 0 1 2 3 4 5 6 7 8 9
```

```
MTP: 03 3f 78 0c 0c
```

```
SCCP: 09 80 03 0c 16 09 0b 31 30 0a 0b 22 22 22 01 0a 4b 81 3a f2
      f2 89 67 45 23 01
```

```
TCAP: 71 62 6f 48 01 00 6b 1f 28 1d 06 07 00 11 86 05 01 01 01 a0
      12 60 10 80 01 00 a1 03 06 01 00 be 06 28 04 a0 02 00 00 6c
      49 a1 24 02 01 00 02 01 02 30 1c 04 05 79 58 45 28 93 80 0b
      80 00 00 00 00 00 00 00 00 00 00 04 06 91 22 33 44 55 66 a1
      10 02 01 00 02 01 16 30 08 80 06 91 21 43 65 87 09 a1 0f 02
      01 00 02 01 08 30 07 80 05 89 67 45 23 01
```

```
TRACE OUTPUT COMPLETE.
```

```
;
```

```
tekelecstp 17-03-22 11:30:11 MST EAGLE 46.5.0.0.0-70.26.0
MSU TRACE H'0021: Card=1103
Trace ID 1 Condition: (brief=Y, MSU size=145)
LOC=          1103
SI=           3
MODE=         debug
```

```
Info: xlatPCi=6-008-1,SS=0,RI=0,GTMODID=-,CGPACT=DFLT,ACTSN=-
```

```
MSU info:
```

```
TOTAL MSU SIZE= 145 Bytes
```

```
MSU DATA SIZE = 140 Bytes
```

```
0 1 2 3 4 5 6 7 8 9 0 1 2 3 4 5 6 7 8 9
```

```
MTP: 03 3f 78 0c 0c
```

```
SCCP: 09 80 03 0c 16 09 0b 31 30 0a 0b 22 22 22 01 0a 4b 81 3a f2
      f2 89 67 45 23 01
```

```
TCAP: 71 62 6f 48 01 00 6b 1f 28 1d 06 07 00 11 86 05 01 01 01 a0
      12 60 10 80 01 00 a1 03 06 01 00 be 06 28 04 a0 02 00 00 6c
      49 a1 24 02 01 00 02 01 02 30 1c 04 05 79 58 45 28 93 80 0b
      80 00 00 00 00 00 00 00 00 00 00 04 06 91 22 33 44 55 66 a1
      10 02 01 00 02 01 16 30 08 80 06 91 21 43 65 87 09 a1 0f 02
      01 00 02 01 08 30 07 80 05 89 67 45 23 01
```

```
TRACE OUTPUT COMPLETE.
```

```
;
```

```
tekelecstp 17-03-22 11:30:12 MST EAGLE 46.5.0.0.0-70.26.0
MSU TRACE H'0021: Card=1103
Trace ID 1 Condition: (brief=Y, MSU size=145)
LOC=          1103
SI=           3
MODE=         debug
```

```
Info: SCCP - Before Encode :old, GTT perfd
```

```
MSU info:
```

```
TOTAL MSU SIZE= 145 Bytes
```

```
MSU DATA SIZE = 140 Bytes
```

```
0 1 2 3 4 5 6 7 8 9 0 1 2 3 4 5 6 7 8 9
```

```
MTP: 03 3f 78 0c 0c
```

```
SCCP: 09 80 03 0c 16 09 0b 31 30 0a 0b 22 22 22 01 0a 4b 81 3a f2
      f2 89 67 45 23 01
```

```
TCAP: 71 62 6f 48 01 00 6b 1f 28 1d 06 07 00 11 86 05 01 01 01 a0
      12 60 10 80 01 00 a1 03 06 01 00 be 06 28 04 a0 02 00 00 6c
      49 a1 24 02 01 00 02 01 02 30 1c 04 05 79 58 45 28 93 80 0b
      80 00 00 00 00 00 00 00 00 00 00 04 06 91 22 33 44 55 66 a1
      10 02 01 00 02 01 16 30 08 80 06 91 21 43 65 87 09 a1 0f 02
      01 00 02 01 08 30 07 80 05 89 67 45 23 01
```



TRACE OUTPUT COMPLETE.

;

tekelecstp 17-03-22 11:30:12 MST EAGLE 46.5.0.0.0-70.26.0

MSU TRACE H'0021: Card=1103

Trace ID 1 Condition: (brief=Y, MSU size=145)

LOC= 1103

SI= 3

MODE= debug

Info: After Encd:OPCi=7-007-7,DPCi:6-008-1,CgPC=7-080-1

MSU info:

TOTAL MSU SIZE= 145 Bytes

MSU DATA SIZE = 140 Bytes

0 1 2 3 4 5 6 7 8 9 0 1 2 3 4 5 6 7 8 9

MTP: 03 41 f0 0f 0e

SCCP: 09 80 03 0c 16 09 0b 41 30 0a 0b 22 22 22 01 0a 4b 81 3a f2  
f2 89 67 45 23 01

TCAP: 71 62 6f 48 01 00 6b 1f 28 1d 06 07 00 11 86 05 01 01 01 a0  
12 60 10 80 01 00 a1 03 06 01 00 be 06 28 04 a0 02 00 00 6c  
49 a1 24 02 01 00 02 01 02 30 1c 04 05 79 58 45 28 93 80 0b  
80 00 00 00 00 00 00 00 00 00 04 06 91 22 33 44 55 66 a1  
10 02 01 00 02 01 16 30 08 80 06 91 21 43 65 87 09 a1 0f 02  
01 00 02 01 08 30 07 80 05 89 67 45 23 01

TRACE OUTPUT COMPLETE.

;

tekelecstp 17-03-22 11:30:13 MST EAGLE 46.5.0.0.0-70.26.0

MSU TRACE H'0021: Card=1103

Trace ID 1 Condition: (brief=Y, MSU size=145)

LOC= 1103

SI= 3

MODE= debug

Info: route\_message\_hp:DPCi=6-008-1,OPC=7-007-7>route\_msg\_on\_rtidx

MSU info:

TOTAL MSU SIZE= 145 Bytes

MSU DATA SIZE = 140 Bytes

0 1 2 3 4 5 6 7 8 9 0 1 2 3 4 5 6 7 8 9

MTP: 03 41 f0 0f 0e

SCCP: 09 80 03 0c 16 09 0b 41 30 0a 0b 22 22 22 01 0a 4b 81 3a f2  
f2 89 67 45 23 01

TCAP: 71 62 6f 48 01 00 6b 1f 28 1d 06 07 00 11 86 05 01 01 01 a0  
12 60 10 80 01 00 a1 03 06 01 00 be 06 28 04 a0 02 00 00 6c  
49 a1 24 02 01 00 02 01 02 30 1c 04 05 79 58 45 28 93 80 0b

```
80 00 00 00 00 00 00 00 00 00 00 04 06 91 22 33 44 55 66 a1
10 02 01 00 02 01 16 30 08 80 06 91 21 43 65 87 09 a1 0f 02
01 00 02 01 08 30 07 80 05 89 67 45 23 01
```

TRACE OUTPUT COMPLETE.

;

tekelecstp 17-03-22 11:30:13 MST EAGLE 46.5.0.0.0-70.26.0

MSU TRACE H'0021: Card=1103

Trace ID 1 Condition: (brief=Y, MSU size=145)

LOC= 1103

SI= 3

MODE= debug

Info: Use RTE (5) DPCi: 6-008-1, OPCi: 7-007-7

MSU info:

TOTAL MSU SIZE= 145 Bytes

MSU DATA SIZE = 140 Bytes

```
0 1 2 3 4 5 6 7 8 9 0 1 2 3 4 5 6 7 8 9
```

MTP: 03 41 f0 0f 0e

```
SCCP: 09 80 03 0c 16 09 0b 41 30 0a 0b 22 22 22 01 0a 4b 81 3a f2
f2 89 67 45 23 01
```

```
TCAP: 71 62 6f 48 01 00 6b 1f 28 1d 06 07 00 11 86 05 01 01 01 a0
12 60 10 80 01 00 a1 03 06 01 00 be 06 28 04 a0 02 00 00 6c
49 a1 24 02 01 00 02 01 02 30 1c 04 05 79 58 45 28 93 80 0b
80 00 00 00 00 00 00 00 00 00 00 04 06 91 22 33 44 55 66 a1
10 02 01 00 02 01 16 30 08 80 06 91 21 43 65 87 09 a1 0f 02
01 00 02 01 08 30 07 80 05 89 67 45 23 01
```

TRACE OUTPUT COMPLETE.

;

tekelecstp 17-03-22 11:30:14 MST EAGLE 46.5.0.0.0-70.26.0

MSU TRACE H'0021: Card=1103

Trace ID 1 Condition: (brief=Y, MSU size=145)

LOC= 1103

SI= 3

MODE= debug

Info: Rotated SLS = H'0000

MSU info:

TOTAL MSU SIZE= 145 Bytes

MSU DATA SIZE = 140 Bytes

```
0 1 2 3 4 5 6 7 8 9 0 1 2 3 4 5 6 7 8 9
```

MTP: 03 41 f0 0f 0e

```
SCCP: 09 80 03 0c 16 09 0b 41 30 0a 0b 22 22 22 01 0a 4b 81 3a f2
f2 89 67 45 23 01
```

```
TCAP: 71 62 6f 48 01 00 6b 1f 28 1d 06 07 00 11 86 05 01 01 01 a0
      12 60 10 80 01 00 a1 03 06 01 00 be 06 28 04 a0 02 00 00 6c
      49 a1 24 02 01 00 02 01 02 30 1c 04 05 79 58 45 28 93 80 0b
      80 00 00 00 00 00 00 00 00 00 00 04 06 91 22 33 44 55 66 a1
      10 02 01 00 02 01 16 30 08 80 06 91 21 43 65 87 09 a1 0f 02
      01 00 02 01 08 30 07 80 05 89 67 45 23 01
```

TRACE OUTPUT COMPLETE.

;

tekelecstp 17-03-22 11:30:14 MST EAGLE 46.5.0.0.0-70.26.0

MSU TRACE H'0021: Card=1103

Trace ID 1 Condition: (brief=Y, MSU size=145)

LOC= 1103

SI= 3

MODE= debug

Info: Sending to 1102:A1

MSU info:

TOTAL MSU SIZE= 145 Bytes

MSU DATA SIZE = 140 Bytes

```
      0 1 2 3 4 5 6 7 8 9 0 1 2 3 4 5 6 7 8 9
```

MTP: 03 41 f0 0f 0e

```
SCCP: 09 80 03 0c 16 09 0b 41 30 0a 0b 22 22 22 01 0a 4b 81 3a f2
      f2 89 67 45 23 01
```

```
TCAP: 71 62 6f 48 01 00 6b 1f 28 1d 06 07 00 11 86 05 01 01 01 a0
      12 60 10 80 01 00 a1 03 06 01 00 be 06 28 04 a0 02 00 00 6c
      49 a1 24 02 01 00 02 01 02 30 1c 04 05 79 58 45 28 93 80 0b
      80 00 00 00 00 00 00 00 00 00 00 04 06 91 22 33 44 55 66 a1
      10 02 01 00 02 01 16 30 08 80 06 91 21 43 65 87 09 a1 0f 02
      01 00 02 01 08 30 07 80 05 89 67 45 23 01
```

TRACE OUTPUT COMPLETE.

;

tekelecstp 17-03-22 11:30:15 MST EAGLE 46.5.0.0.0-70.26.0

MSU TRACE H'0021: Card=1102

Trace ID 1 Condition: (brief=Y, MSU size=145)

LOC= 1103

SI= 3

MODE= debug

Info: MSU Received from 1103

MSU info:

TOTAL MSU SIZE= 145 Bytes

MSU DATA SIZE = 140 Bytes

```
      0 1 2 3 4 5 6 7 8 9 0 1 2 3 4 5 6 7 8 9
```

MTP: 03 41 f0 0f 0e

```

SCCP: 09 80 03 0c 16 09 0b 41 30 0a 0b 22 22 22 01 0a 4b 81 3a f2
      f2 89 67 45 23 01

```

```

TCAP: 71 62 6f 48 01 00 6b 1f 28 1d 06 07 00 11 86 05 01 01 01 a0
      12 60 10 80 01 00 a1 03 06 01 00 be 06 28 04 a0 02 00 00 6c
      49 a1 24 02 01 00 02 01 02 30 1c 04 05 79 58 45 28 93 80 0b
      80 00 00 00 00 00 00 00 00 00 00 04 06 91 22 33 44 55 66 a1
      10 02 01 00 02 01 16 30 08 80 06 91 21 43 65 87 09 a1 0f 02
      01 00 02 01 08 30 07 80 05 89 67 45 23 01

```

TRACE OUTPUT COMPLETE.

;

```
tekelecstp 17-03-22 11:30:15 MST EAGLE 46.5.0.0.0-70.26.0
```

```
MSU TRACE H'0021: Card=1102
```

```
Trace ID 1 Condition: (brief=Y, MSU size=145)
```

```
LOC=          1103
```

```
SI=           3
```

```
MODE=         debug
```

```
Info: MSU sent to L2: A1: DPCi=6-008-1,OPCi=7-007-7,NI=0
```

MSU info:

```
TOTAL MSU SIZE= 145 Bytes
```

```
MSU DATA SIZE = 140 Bytes
```

```
0 1 2 3 4 5 6 7 8 9 0 1 2 3 4 5 6 7 8 9
```

```
MTP: 03 41 f0 0f 0e
```

```

SCCP: 09 80 03 0c 16 09 0b 41 30 0a 0b 22 22 22 01 0a 4b 81 3a f2
      f2 89 67 45 23 01

```

```

TCAP: 71 62 6f 48 01 00 6b 1f 28 1d 06 07 00 11 86 05 01 01 01 a0
      12 60 10 80 01 00 a1 03 06 01 00 be 06 28 04 a0 02 00 00 6c
      49 a1 24 02 01 00 02 01 02 30 1c 04 05 79 58 45 28 93 80 0b
      80 00 00 00 00 00 00 00 00 00 00 04 06 91 22 33 44 55 66 a1
      10 02 01 00 02 01 16 30 08 80 06 91 21 43 65 87 09 a1 0f 02
      01 00 02 01 08 30 07 80 05 89 67 45 23 01

```

TRACE OUTPUT COMPLETE.

;

**This example shows the output for mode=debug:**

```
ent-trace:loc=1107:si=12:mode=debug
```

```
tekelecstp 17-03-03 10:23:27 EST EAGLE 46.5.0.0.0-70.21.0
```

```
MSU TRACE H'00c1: Card=1107
```

```
Trace ID 1 Condition: (brief=N, MSU size=101)
```

```
LOC=          1107
```

```
SI=           12
```

```
MODE=         debug
```

```
Info: RX:SLK A0,DPCi=1-001-3,APCi=1-001-2,TSPCi=1-001-1,SAPC =
```

```
MSU info:
TOTAL MSU SIZE= 101 Bytes
MSU DATA SIZE = 096 Bytes

      0  1  2  3  4  5  6  7  8  9  0  1  2  3  4  5  6  7  8  9

MTP:  0c 0b 48 02 c2

DATA: 09 08 00 01 6e f9 de 91 b8 81 f6 00 0c 00 00 0e 00 10 00 12
      00 14 00 16 00 18 00 1a 00 1c 00 1e 00 20 00 22 00 24 00 26
      00 28 00 2a 00 2c 00 2e 00 30 00 32 00 34 00 36 00 38 00 3a
      00 3c 00 3e 00 40 00 42 00 44 00 46 00 48 00 4a 00 4c 00 4e
      00 50 00 52 00 54 00 56 00 58 00 5a 00 5c 00 5e

TRACE OUTPUT COMPLETE.
;
tekelecstp 17-03-03 10:23:27 EST  EAGLE 46.5.0.0.0-70.21.0
MSU TRACE H'00c1:  Card=1107
Trace ID 1 Condition: (brief=N, MSU size=101)
LOC=                1107
SI=                 12
MODE=               debug

Info: SS7_HMDC:4thisPC=N,TRUE_PCi=1-001-3 =>sccp=No

MSU info:
TOTAL MSU SIZE= 101 Bytes
MSU DATA SIZE = 096 Bytes

      0  1  2  3  4  5  6  7  8  9  0  1  2  3  4  5  6  7  8  9

MTP:  0c 0b 48 02 c2

DATA: 09 08 00 01 6e f9 de 91 b8 81 f6 00 0c 00 00 0e 00 10 00 12
      00 14 00 16 00 18 00 1a 00 1c 00 1e 00 20 00 22 00 24 00 26
      00 28 00 2a 00 2c 00 2e 00 30 00 32 00 34 00 36 00 38 00 3a
      00 3c 00 3e 00 40 00 42 00 44 00 46 00 48 00 4a 00 4c 00 4e
      00 50 00 52 00 54 00 56 00 58 00 5a 00 5c 00 5e

TRACE OUTPUT COMPLETE.
;
tekelecstp 17-03-03 10:23:27 EST  EAGLE 46.5.0.0.0-70.21.0
MSU TRACE H'00c1:  Card=1107
Trace ID 1 Condition: (brief=N, MSU size=101)
LOC=                1107
SI=                 12
MODE=               debug

Info: HMDC MTP-routes MSU: call route_message_hp

MSU info:
TOTAL MSU SIZE= 101 Bytes
MSU DATA SIZE = 096 Bytes

      0  1  2  3  4  5  6  7  8  9  0  1  2  3  4  5  6  7  8  9
```

```
MTP: 0c 0b 48 02 c2

DATA: 09 08 00 01 6e f9 de 91 b8 81 f6 00 0c 00 00 0e 00 10 00 12
      00 14 00 16 00 18 00 1a 00 1c 00 1e 00 20 00 22 00 24 00 26
      00 28 00 2a 00 2c 00 2e 00 30 00 32 00 34 00 36 00 38 00 3a
      00 3c 00 3e 00 40 00 42 00 44 00 46 00 48 00 4a 00 4c 00 4e
      00 50 00 52 00 54 00 56 00 58 00 5a 00 5c 00 5e
```

TRACE OUTPUT COMPLETE.

;

```
tekelecstp 17-03-03 10:23:28 EST EAGLE 46.5.0.0.0-70.21.0
```

```
MSU TRACE H'00c1: Card=1107
```

```
Trace ID 1 Condition: (brief=N, MSU size=101)
```

```
LOC=          1107
```

```
SI=           12
```

```
MODE=         debug
```

```
Info: route_message_hp:DPCi=1-001-3,OPC=1-001-1>route_msg_on_rtidx
```

MSU info:

```
TOTAL MSU SIZE= 101 Bytes
```

```
MSU DATA SIZE = 096 Bytes
```

```
0 1 2 3 4 5 6 7 8 9 0 1 2 3 4 5 6 7 8 9
```

```
MTP: 0c 0b 48 02 c2
```

```
DATA: 09 08 00 01 6e f9 de 91 b8 81 f6 00 0c 00 00 0e 00 10 00 12
      00 14 00 16 00 18 00 1a 00 1c 00 1e 00 20 00 22 00 24 00 26
      00 28 00 2a 00 2c 00 2e 00 30 00 32 00 34 00 36 00 38 00 3a
      00 3c 00 3e 00 40 00 42 00 44 00 46 00 48 00 4a 00 4c 00 4e
      00 50 00 52 00 54 00 56 00 58 00 5a 00 5c 00 5e
```

TRACE OUTPUT COMPLETE.

;

```
tekelecstp 17-03-03 10:23:28 EST EAGLE 46.5.0.0.0-70.21.0
```

```
MSU TRACE H'00c1: Card=1107
```

```
Trace ID 1 Condition: (brief=N, MSU size=101)
```

```
LOC=          1107
```

```
SI=           12
```

```
MODE=         debug
```

```
Info: Use RTE (5) DPCi: 1-001-3, OPCi: 1-001-1
```

MSU info:

```
TOTAL MSU SIZE= 101 Bytes
```

```
MSU DATA SIZE = 096 Bytes
```

```
0 1 2 3 4 5 6 7 8 9 0 1 2 3 4 5 6 7 8 9
```

```
MTP: 0c 0b 48 02 c2
```

```
DATA: 09 08 00 01 6e f9 de 91 b8 81 f6 00 0c 00 00 0e 00 10 00 12
      00 14 00 16 00 18 00 1a 00 1c 00 1e 00 20 00 22 00 24 00 26
```

```
00 28 00 2a 00 2c 00 2e 00 30 00 32 00 34 00 36 00 38 00 3a
00 3c 00 3e 00 40 00 42 00 44 00 46 00 48 00 4a 00 4c 00 4e
00 50 00 52 00 54 00 56 00 58 00 5a 00 5c 00 5e
```

TRACE OUTPUT COMPLETE.

;

```
tekelecstp 17-03-03 10:23:29 EST EAGLE 46.5.0.0.0-70.21.0
```

```
MSU TRACE H'00c1: Card=1107
```

```
Trace ID 1 Condition: (brief=N, MSU size=101)
```

```
LOC=          1107
```

```
SI=           12
```

```
MODE=         debug
```

```
Info: Rotated SLS = H'000c
```

```
MSU info:
```

```
TOTAL MSU SIZE= 101 Bytes
```

```
MSU DATA SIZE = 096 Bytes
```

```
0 1 2 3 4 5 6 7 8 9 0 1 2 3 4 5 6 7 8 9
```

```
MTP: 0c 0b 48 02 c2
```

```
DATA: 09 08 00 01 6e f9 de 91 b8 81 f6 00 0c 00 00 0e 00 10 00 12
00 14 00 16 00 18 00 1a 00 1c 00 1e 00 20 00 22 00 24 00 26
00 28 00 2a 00 2c 00 2e 00 30 00 32 00 34 00 36 00 38 00 3a
00 3c 00 3e 00 40 00 42 00 44 00 46 00 48 00 4a 00 4c 00 4e
00 50 00 52 00 54 00 56 00 58 00 5a 00 5c 00 5e
```

TRACE OUTPUT COMPLETE.

;

```
tekelecstp 17-03-03 10:23:29 EST EAGLE 46.5.0.0.0-70.21.0
```

```
MSU TRACE H'00c1: Card=1107
```

```
Trace ID 1 Condition: (brief=N, MSU size=101)
```

```
LOC=          1107
```

```
SI=           12
```

```
MODE=         debug
```

```
Info: Sending to 1108:A0
```

```
MSU info:
```

```
TOTAL MSU SIZE= 101 Bytes
```

```
MSU DATA SIZE = 096 Bytes
```

```
0 1 2 3 4 5 6 7 8 9 0 1 2 3 4 5 6 7 8 9
```

```
MTP: 0c 0b 48 02 c2
```

```
DATA: 09 08 00 01 6e f9 de 91 b8 81 f6 00 0c 00 00 0e 00 10 00 12
00 14 00 16 00 18 00 1a 00 1c 00 1e 00 20 00 22 00 24 00 26
00 28 00 2a 00 2c 00 2e 00 30 00 32 00 34 00 36 00 38 00 3a
00 3c 00 3e 00 40 00 42 00 44 00 46 00 48 00 4a 00 4c 00 4e
00 50 00 52 00 54 00 56 00 58 00 5a 00 5c 00 5e
```

TRACE OUTPUT COMPLETE.

```

;
tekelecstp 17-03-03 10:23:29 EST  EAGLE 46.5.0.0.0-70.21.0
MSU TRACE H'00c1:  Card=1108
Trace ID 1 Condition: (brief=N, MSU size=101)
LOC=          1107
SI=           12
MODE=         debug

Info: MSU Received from 1107

MSU info:
TOTAL MSU SIZE= 101 Bytes
MSU DATA SIZE = 096 Bytes

      0  1  2  3  4  5  6  7  8  9  0  1  2  3  4  5  6  7  8  9
MTP:  0c 0b 48 02 c2

DATA: 09 08 00 01 6e f9 de 91 b8 81 f6 00 0c 00 00 0e 00 10 00 12
      00 14 00 16 00 18 00 1a 00 1c 00 1e 00 20 00 22 00 24 00 26
      00 28 00 2a 00 2c 00 2e 00 30 00 32 00 34 00 36 00 38 00 3a
      00 3c 00 3e 00 40 00 42 00 44 00 46 00 48 00 4a 00 4c 00 4e
      00 50 00 52 00 54 00 56 00 58 00 5a 00 5c 00 5e

TRACE OUTPUT COMPLETE.
;

```

This example shows the output for mode=debug and brief=yes:

```
ent-trace:loc=1107:si=12:mode=debug:brief=yes
```

```

tekelecstp 17-03-03 10:23:40 EST  EAGLE 46.5.0.0.0-70.21.0
MSU TRACE H'00c1:  Card=1107
Trace ID 1 Condition: (brief=Y, MSU size=101)
LOC=          1107
SI=           12
MODE=         debug

Info: RX:SLK A0,DPCi=1-001-3,APCi=1-001-2,TSPCi=1-001-1,SAPC =

TRACE OUTPUT COMPLETE.
;
tekelecstp 17-03-03 10:23:40 EST  EAGLE 46.5.0.0.0-70.21.0
MSU TRACE H'00c1:  Card=1107
Trace ID 1 Condition: (brief=Y, MSU size=101)
LOC=          1107
SI=           12
MODE=         debug

Info: SS7_HMDC:4thisPC=N,TRUE_PCi=1-001-3 =>sccp=No

TRACE OUTPUT COMPLETE.
;
tekelecstp 17-03-03 10:23:40 EST  EAGLE 46.5.0.0.0-70.21.0
MSU TRACE H'00c1:  Card=1107

```



```
Trace ID 1 Condition: (brief=Y, MSU size=101)
LOC=          1107
SI=           12
MODE=         debug

Info: HMDc MTP-routes MSU: call route_message_hp

TRACE OUTPUT COMPLETE.
;
tekelecstp 17-03-03 10:23:40 EST  EAGLE 46.5.0.0.0-70.21.0
MSU TRACE H'00c1: Card=1107
Trace ID 1 Condition: (brief=Y, MSU size=101)
LOC=          1107
SI=           12
MODE=         debug

Info: route_message_hp:DPCi=1-001-3,OPC=1-001-1>route_msg_on_rtidx

TRACE OUTPUT COMPLETE.
;
tekelecstp 17-03-03 10:23:41 EST  EAGLE 46.5.0.0.0-70.21.0
MSU TRACE H'00c1: Card=1107
Trace ID 1 Condition: (brief=Y, MSU size=101)
LOC=          1107
SI=           12
MODE=         debug

Info: Use RTE (5) DPCi:  1-001-3, OPCi:  1-001-1

TRACE OUTPUT COMPLETE.
;
tekelecstp 17-03-03 10:23:41 EST  EAGLE 46.5.0.0.0-70.21.0
MSU TRACE H'00c1: Card=1107
Trace ID 1 Condition: (brief=Y, MSU size=101)
LOC=          1107
SI=           12
MODE=         debug

Info: Rotated SLS = H'0000

TRACE OUTPUT COMPLETE.
;
tekelecstp 17-03-03 10:23:41 EST  EAGLE 46.5.0.0.0-70.21.0
MSU TRACE H'00c1: Card=1107
Trace ID 1 Condition: (brief=Y, MSU size=101)
LOC=          1107
SI=           12
MODE=         debug

Info: Sending to 1108:A0

TRACE OUTPUT COMPLETE.
;
tekelecstp 17-03-03 10:23:41 EST  EAGLE 46.5.0.0.0-70.21.0
MSU TRACE H'00c1: Card=1108
```

```
Trace ID 1 Condition: (brief=Y, MSU size=101)
LOC=          1107
SI=           12
MODE=         debug
```

```
Info: MSU Received from 1107
```

```
TRACE OUTPUT COMPLETE.
```

```
;
```

This example shows the output for when the mode is not defined:

```
ent-trace:loc=1107:si=12
```

```
tekelecstp 17-03-03 10:23:49 EST EAGLE 46.5.0.0.0-70.21.0
```

```
MSU TRACE H'00c2: Card=1107
```

```
Trace ID 2 Condition: (brief=N, MSU size=101)
```

```
LOC=          1107
```

```
SI=           12
```

```
Info: RX:SLK A0,DPCi=1-001-3,APCi=1-001-2,TSPCi=1-001-1,SAPC =
```

```
MSU info:
```

```
TOTAL MSU SIZE= 101 Bytes
```

```
MSU DATA SIZE = 096 Bytes
```

```
0 1 2 3 4 5 6 7 8 9 0 1 2 3 4 5 6 7 8 9
```

```
MTP: 0c 0b 48 02 52
```

```
DATA: 09 08 00 01 81 97 2f 93 bd 83 f6 00 05 00 00 0e 00 10 00 12
      00 14 00 16 00 18 00 1a 00 1c 00 1e 00 20 00 22 00 24 00 26
      00 28 00 2a 00 2c 00 2e 00 30 00 32 00 34 00 36 00 38 00 3a
      00 3c 00 3e 00 40 00 42 00 44 00 46 00 48 00 4a 00 4c 00 4e
      00 50 00 52 00 54 00 56 00 58 00 5a 00 5c 00 5e
```

```
TRACE OUTPUT COMPLETE.
```

```
;
```

```
tekelecstp 17-03-03 10:23:49 EST EAGLE 46.5.0.0.0-70.21.0
```

```
MSU TRACE H'00c2: Card=1107
```

```
Trace ID 2 Condition: (brief=N, MSU size=101)
```

```
LOC=          1107
```

```
SI=           12
```

```
Info: SS7_HMDC:4thisPC=N,TRUE_PCi=1-001-3 =>sccp=No
```

```
MSU info:
```

```
TOTAL MSU SIZE= 101 Bytes
```

```
MSU DATA SIZE = 096 Bytes
```

```
0 1 2 3 4 5 6 7 8 9 0 1 2 3 4 5 6 7 8 9
```

```
MTP: 0c 0b 48 02 52
```

```
DATA: 09 08 00 01 81 97 2f 93 bd 83 f6 00 05 00 00 0e 00 10 00 12
```

```
00 14 00 16 00 18 00 1a 00 1c 00 1e 00 20 00 22 00 24 00 26
00 28 00 2a 00 2c 00 2e 00 30 00 32 00 34 00 36 00 38 00 3a
00 3c 00 3e 00 40 00 42 00 44 00 46 00 48 00 4a 00 4c 00 4e
00 50 00 52 00 54 00 56 00 58 00 5a 00 5c 00 5e
```

TRACE OUTPUT COMPLETE.

;

```
tekelecstp 17-03-03 10:23:50 EST EAGLE 46.5.0.0.0-70.21.0
MSU TRACE H'00c2: Card=1107
Trace ID 2 Condition: (brief=N, MSU size=101)
LOC=          1107
SI=           12
```

Info: Use RTE (5) DPCi: 1-001-3, OPCi: 1-001-1

MSU info:

```
TOTAL MSU SIZE= 101 Bytes
MSU DATA SIZE = 096 Bytes
```

```
0 1 2 3 4 5 6 7 8 9 0 1 2 3 4 5 6 7 8 9
```

MTP: 0c 0b 48 02 52

```
DATA: 09 08 00 01 81 97 2f 93 bd 83 f6 00 05 00 00 0e 00 10 00 12
00 14 00 16 00 18 00 1a 00 1c 00 1e 00 20 00 22 00 24 00 26
00 28 00 2a 00 2c 00 2e 00 30 00 32 00 34 00 36 00 38 00 3a
00 3c 00 3e 00 40 00 42 00 44 00 46 00 48 00 4a 00 4c 00 4e
00 50 00 52 00 54 00 56 00 58 00 5a 00 5c 00 5e
```

TRACE OUTPUT COMPLETE.

;

```
tekelecstp 17-03-03 10:23:51 EST EAGLE 46.5.0.0.0-70.21.0
MSU TRACE H'00c2: Card=1107
Trace ID 2 Condition: (brief=N, MSU size=101)
LOC=          1107
SI=           12
```

Info: Sending to 1107:A0

MSU info:

```
TOTAL MSU SIZE= 101 Bytes
MSU DATA SIZE = 096 Bytes
```

```
0 1 2 3 4 5 6 7 8 9 0 1 2 3 4 5 6 7 8 9
```

MTP: 0c 0b 48 02 52

```
DATA: 09 08 00 01 81 97 2f 93 bd 83 f6 00 05 00 00 0e 00 10 00 12
00 14 00 16 00 18 00 1a 00 1c 00 1e 00 20 00 22 00 24 00 26
00 28 00 2a 00 2c 00 2e 00 30 00 32 00 34 00 36 00 38 00 3a
00 3c 00 3e 00 40 00 42 00 44 00 46 00 48 00 4a 00 4c 00 4e
00 50 00 52 00 54 00 56 00 58 00 5a 00 5c 00 5e
```

TRACE OUTPUT COMPLETE.

;

```

tekelecstp 17-03-03 10:23:51 EST  EAGLE 46.5.0.0.0-70.21.0
MSU TRACE H'00c2:  Card=1107
Trace ID 2 Condition: (brief=N, MSU size=101)
LOC=          1107
SI=           12

Info: MSU Received from 1107

MSU info:
TOTAL MSU SIZE=  101 Bytes
MSU DATA SIZE =  096 Bytes

      0  1  2  3  4  5  6  7  8  9  0  1  2  3  4  5  6  7  8  9
MTP:  0c 0b 48 02 52

DATA: 09 08 00 01 81 97 2f 93 bd 83 f6 00 05 00 00 0e 00 10 00 12
      00 14 00 16 00 18 00 1a 00 1c 00 1e 00 20 00 22 00 24 00 26
      00 28 00 2a 00 2c 00 2e 00 30 00 32 00 34 00 36 00 38 00 3a
      00 3c 00 3e 00 40 00 42 00 44 00 46 00 48 00 4a 00 4c 00 4e
      00 50 00 52 00 54 00 56 00 58 00 5a 00 5c 00 5e

TRACE OUTPUT COMPLETE.
;

tekelecstp 17-03-03 10:23:51 EST  EAGLE 46.5.0.0.0-70.21.0
MSU TRACE H'00c2:  Card=1107
Trace ID 2 Condition: (brief=N, MSU size=101)
LOC=          1107
SI=           12

Info: MSU sent to L2: A0: DPCi=1-001-3,OPCi=1-001-1,NI=0

MSU info:
TOTAL MSU SIZE=  101 Bytes
MSU DATA SIZE =  096 Bytes

      0  1  2  3  4  5  6  7  8  9  0  1  2  3  4  5  6  7  8  9
MTP:  0c 0b 48 02 52

DATA: 09 08 00 01 81 97 2f 93 bd 83 f6 00 05 00 00 0e 00 10 00 12
      00 14 00 16 00 18 00 1a 00 1c 00 1e 00 20 00 22 00 24 00 26
      00 28 00 2a 00 2c 00 2e 00 30 00 32 00 34 00 36 00 38 00 3a
      00 3c 00 3e 00 40 00 42 00 44 00 46 00 48 00 4a 00 4c 00 4e
      00 50 00 52 00 54 00 56 00 58 00 5a 00 5c 00 5e

TRACE OUTPUT COMPLETE.
;

```

## rept-stat-ee

Use this command to generate the status report of Eagle Eyes on network cards.

**Parameters****loc (optional)**

Eagle Eyes Card location.

**Range:**

1101 - 1108, 1111 - 1112, 1201 - 1208, 1211 - 1218, 1301 - 1308, 1311 - 1318, 2101 - 2108, 2111 - 2118, 2201 - 2208, 2211 - 2218, 2301 - 2308, 2311 - 2318, 3101 - 3108, 3111 - 3118, 3201 - 3208, 3211 - 3218, 3301 - 3308, 3311 - 3318, 4101 - 4108, 4111 - 4118, 4201 - 4208, 4211 - 4218, 4301 - 4308, 4311 - 4318, 5101 - 5108, 5111 - 5118, 5201 - 5208, 5211 - 5218, 5301 - 5308, 5311 - 5318, 6101 - 6108, 6111 - 6118

**Example**

```
rept-stat-ee
rept-stat-ee:loc=1102
```

**Dependencies**

The card location specified in the 'loc' parameter must be configured to use Eagle Eyes.

The shelf and card must be equipped.

The specified card location must not be a reserved card location.

**Notes**

This command can be canceled using the F9 function key or the `canc-cmd` command. See `canc-cmd` for more information

**Output**

This example generates the Eagle Eyes status report for the specified Network Card.

```
rept-stat-ee:loc=1101
```

```
tekelecstp 10-03-08 14:43:31 EST  EAGLE 46.0.0
LOC          STATE
-----
1101         ACTIVE
```

Command Completed.

This example generates the Eagle Eyes status report for all the EE configured Network Cards.

```
rept-stat-ee
```

```
tekelecstp 10-03-08 14:43:31 EST  EAGLE 46.0.0
LOC          STATE
-----
1101         ACTIVE
```

```
1103          INACTIVE
Command Completed.
```

### Related Topics

- [chg-ee-card](#)
- [dact-ee](#)
- [rtrv-ee-card](#)

## rept-stat-gedti

Use this command to generate a report of the GEDTI Hub's status.

### Parameters

#### **loc (optional)**

GEDTI Hub Card location.

#### **Range:**

*1101 - 1108, 1111 - 1112, 1201 - 1208, 1211 - 1218, 1301 - 1308, 1311 - 1318,  
2101 - 2108, 2111 - 2118, 2201 - 2208, 2211 - 2218, 2301 - 2308, 2311 - 2318,  
3101 - 3108, 3111 - 3118, 3201 - 3208, 3211 - 3218, 3301 - 3308, 3311 - 3318,  
4101 - 4108, 4111 - 4118, 4201 - 4208, 4211 - 4218, 4301 - 4308, 4311 - 4318,  
5101 - 5108, 5111 - 5118, 5201 - 5208, 5211 - 5218, 5301 - 5308, 5311 - 5318,  
6101 - 6108, 6111 - 6118*

### Example

```
rept-stat-gedti
rept-stat-gedti:loc=1111
```

### Dependencies

The value specified for the loc parameter must correspond to the location of an IPSM card which is configured as a GEDTI Hub.

### Notes

This command can be canceled using the F9 function key or the `canc-cmd` command. See `canc-cmd` for more information.

### Output

This example generates the report of all the IPSM cards configured as GEDTI Hubs.

```
rept-stat-gedti
```

```
tekelecstp 08-01-29 10:41:52 EST  EAGLE 46.0.0
```

```
LOC          PORT          STATE
```

-----

```
--
1101      4567      ACTIVE

SID  SOCK FD  APPL CARD  APPL SUBSYS  APPL ID  PC STATE  APPL STATE
-----
0    -1      0          0            0        0         0
1    -1      0          0            0        0         0
2    -1      0          0            0        0         0
3    -1      0          0            0        0         0
4    -1      0          0            0        0         0
5    -1      0          0            0        0         0
6    -1      0          0            0        0         0
7    -1      0          0            0        0         0

LOC      PORT      STATE
-----
1112     4568     INACTIVE

SID  SOCK FD  APPL CARD  APPL SUBSYS  APPL ID  PC STATE  APPL STATE
-----
0    0      0          0            0        0         0

Command Completed.
```

This example generates the report of the specified IPSM card configured as a GEDTI Hub.

```
rept-stat-gedti:loc=1101
```

```
tekelecstp 08-01-29 10:41:54 EST EAGLE 46.0.0
```

```
LOC      PORT      STATE
-----
1101     4567     ACTIVE

SID  SOCK FD  APPL CARD  APPL SUBSYS  APPL ID  PC STATE  APPL STATE
-----
0    -1      0          0            0        0         0
1    -1      0          0            0        0         0
2    -1      0          0            0        0         0
3    -1      0          0            0        0         0
4    -1      0          0            0        0         0
5    -1      0          0            0        0         0
6    -1      0          0            0        0         0
7    -1      0          0            0        0         0

Command Completed.
```

### Related Topics

- [act-gedti](#)
- [chg-gedti-card](#)
- [dact-gedti](#)

## rtrv-ee-card

Use this command to display Eagle Eyes Card Configuration data from the Eagle Eyes Card (EE CARD) table. The EE CARD entry consists of a Card Loc and Eagle Eyes Card specific data.

### Parameters

#### loc (optional)

Eagle Eyes Card location.

#### Range:

1101 - 1108, 1111 - 1112, 1201 - 1208, 1211 - 1218, 1301 - 1308, 1311 - 1318,  
2101 - 2108, 2111 - 2118, 2201 - 2208, 2211 - 2218, 2301 - 2308, 2311 - 2318,  
3101 - 3108, 3111 - 3118, 3201 - 3208, 3211 - 3218, 3301 - 3308, 3311 - 3318,  
4101 - 4108, 4111 - 4118, 4201 - 4208, 4211 - 4218, 4301 - 4308, 4311 - 4318,  
5101 - 5108, 5111 - 5118, 5201 - 5208, 5211 - 5218, 5301 - 5308, 5311 - 5318,  
6101 - 6108, 6111 - 6118

### Example

```
rtrv-ee-card  
rtrv-ee-card:loc=1102
```

### Dependencies

The EE CARD table must be available.

The card location specified in the 'loc' parameter must be configured to use Eagle Eyes.

The Eagle Eyes Filter table must be available.

### Notes

None.

### Output

This example displays the Eagle Eyes parameters for all the EE configured network cards.

```
rtrv-ee-card  
  
tekelecstp 10-03-08 14:43:31 EST EAGLE 46.0.0  
LOC THR SECLIM PKTLIM KBLIM  
-----  
1101 10000 5644800 10000000 4000000  
1201 1000 464400 NONE 2000000  
  
EE CARD table is (2 of 254) 1% full
```



```
RTRV-EE-CARD: MASP A - COMPLTD
;
```

This example displays the Eagle Eyes parameters for the specified EE configured network card.

```
rtrv-ee-card:loc=1201

tekelecstp 10-03-08 14:43:31 EST EAGLE 46.0.0

EE OAM Card Configuration
-----
LOC  THR   SECLIM  PKTLIM  KBLIM  PORT
-----
1201 1000  2000    2000    3000   -

ATM FILTERS
-----
ID  TYPE  PORT  SSCOPSU  MTP3SI
-----
71  INC  a    ctrl    -
13  INC  a    -        -
5   EXC  b    -        -

EE CARD table is (2 of 254) 1% full

RTRV-EE-CARD: MASP A - COMPLTD
;
```

### Legend

- **LOC---** Card location as stenciled on the shelf of the system.
- **THR---** The sending rate of the Eagle Eyes throttle task in IMT packets per second.
- **SECLIM---** The limit on the amount of time to perform the trace, in seconds.
- **PKTLIM---** The limit on the number of Ethernet frames to send.
- **KBLIM---** The file size limit of the capture file created, in kilobytes.
- **PORT---** Port being filtered.
- **ID---** Eagle Eyes Filter ID.
- **TYPE---** Eagle Eyes Filter Type.
- **SSCOPSU---** SSCOP sub-protocol or SU type filter.
- **MTP3SI---** MTP3 user filter.

### Related Topics

- [chg-ee-card](#)
- [dact-ee](#)
- [rept-stat-ee](#)

## rtrv-ee-flt

Use this command to retrieve Eagle Eyes Filter data from the Eagle Eyes Filter (EE FLT) table. The EE-FLT entry consists of a Filter ID and Filter specific data. It can be used to obtain the Filter ID of the filter to be associated to a card using the CHG-EE-CARD command.

### Parameters

**app1 (optional)**

Card Application Type

**Range:**

*ATM*

*IP*

*E1T1*

**fltid (optional)**

Eagle Eyes Filter ID

**Range:**

*1-200*

### Example

```
rtrv-ee-flt:appl=ip
```

```
rtrv-ee-flt:fltid=16
```

### Dependencies

The Eagle Eyes Filter table must be available.

The specified Filter ID must exist in the EE FLT table.

The Filter ID and APPL are mutually exclusive parameters.

### Notes

None.

### Output

This example displays the Filter parameters for the specified Filter ID.

```
rtrv-ee-flt:fltid=85
```

```
tekelecstp 10-03-08 14:43:31 EST  EAGLE 46.0.0
  EE OAM Filter Configuration
  IP FILTERS
```

```
-----
---
  ID  TYPE IP   IP           IP           SCTP  SCTP  SCTP
```

```

SCTP  SCTP
      PROT SRC          DST          SRC  DST  TYPE  DATA
DATA
      ADDR          ADDR          PORT  PORT          PLD  STR
-----
      85  INC sctp  -          -          -  -  data sua  -
      EE Filter table is (83 of 200) 42% full.

;
Command Executed

```

This example displays the Filter parameters for the ATM Application Type.

```
rtrv-ee-flt:appl=atm
```

```

tekelecstp 10-03-08 14:43:31 EST  EAGLE 46.0.0
EE OAM Filter Configuration
ATM FILTERS
-----
ID  TYPE PORT SSCOP SU MTP3SI
-----
5   EXC b   -   -
13  INC a   -   -
67  INC a   -   -
68  INC a1  -   -
71  INC a   ctrl -
77  INC all -   -

      EE Filter table is (83 of 200) 42% full.

;
Command Executed

```

This example displays the Filter parameters for the IP Application Type.

```
rtrv-ee-flt:appl=ip
```

```

tekelecstp 10-03-08 14:43:31 EST  EAGLE 46.0.0
EE OAM Filter Configuration
IP FILTERS
-----
-----
      ID  TYPE IP  IP          IP          SCTP  SCTP  SCTP  SCTP
SCTP
      PROT SRC          DST          SRC  DST  TYPE  DATA
DATA
      ADDR          ADDR          PORT  PORT          PLD  STR
-----
-----
      3   INC tcp  -          -          -  -  -  -

```

```

      8   EXC  -   -           3.3.3.3       -   -   -
-   -
      9   EXC  -   -           5.5.50.5      -   -   -
-   -
     18   INC  sctp 10.248.13.9   -           1234  -   -
-   -
     19   INC  sctp 10.248.13.9   -           -    1234  -
-   -
     32   INC  sctp 10.248.13.9   -           1234  -   data
m2pa -
     34   INC  sctp 111.248.131.119 111.111.111.111 1234  2345  data
m2pa -
     37   EXC  sctp 111.248.131.119 111.111.111.111 1234  2345  data
m2pa -
     38   EXC  sctp 111.248.131.119 111.111.111.111 1234  2345  data
-   -
     46   EXC  sctp 10.248.13.9   -           1234  -   data
m2pa -
     50   EXC  sctp 10.248.13.9   -           1234  -   data
m2pa -
     85   INC  sctp -             -           -    -    data
sua  -

```

EE Filter table is (83 of 200) 42% full.

```

;
Command Executed

```

This example displays the Filter parameters for the E1T1 Application Type.

```
rtrv-ee-flt:appl=elt1
```

```

tekelecstp 10-03-08 14:43:31 EST  EAGLE 46.0.0
EE OAM Filter Configuration
E1T1 FILTERS
-----
ID  TYPE  PORT  SUTYPE  MTP3SI
-----
 6   INC  a21   -       -
 7   INC  a22   -       -
12   INC  a     -       -
69   INC  a31   -       -
70   INC  b31   -       -
72   INC  a     lsu    -
EE Filter table is (83 of 200) 42% full.

```

```

;
Command Executed

```

This example displays the Filter parameters for all the configured Filters.

```

rtrv-ee-flt

tekelecstp 10-03-08 14:43:31 EST EAGLE 46.0.0
EE Filter Configuration
IP Filters
ID TYPE IP IP IP SS SD STYPE SCTP
SCTP
PROT SRC DST PORT PORT PLD STR
ADDR ADDR

-----
-----
1 INC SCTP 10.248.13.10 10.25.80.191 65535 10000 DATA M2PA
65535
47 EXC SCTP 101.248.131.191 102.251.118.111 65432 10245 HTBT - -
ATM Filters
ID TYPE PORT SSCOPUS MTP3SI
-----
100 INC A DATA SCCP
105 EXC B CTRL -
E1T1 Filters
ID TYPE PORT SUTYPE MTP3SI
-----
2 INC A1 MSU SCCP
EE FLT table is (5 of 200) 2% full
;
Command Executed

```

### Related Topics

- [dlt-ee-flt](#)
- [ent-ee-flt](#)

## rtrv-upgrade-config

Use this command to retrieve provisioned data used by the upgrade software during an upgrade of an in-service EAGLE from a source release to the target release.

### Parameters

#### **display (optional)**

Display Indicator. This parameter indicates what type of output is to be displayed.

#### **Range:**

##### ***tblcnv***

Displays a list of DMS tables that will be converted during the next upgrade. These tables are selected for conversion using the `chg-upgrade-config` command.

##### ***prtostat***

This parameter is not implemented at this time.

**all**  
Display all upgrade configuration data.

**Default:**  
*all*

### Example

Display a list of DMS tables that will be converted during the next upgrade.

```
rtrv-upgrade-config:display=tblcnv
```

```
rtrv-upgrade-config
```

### Dependencies

None

### Output

```
rtrv-upgrade-config:display=tblcnv
```

```
rlghncxa03w 07-03-13 08:15:45 EST EAGLE 37.5.0
```

```
The following tables will be converted:
```

```
FEAT_CTRL Table, ID=327
```

```
Command Completed.
```

```
;
```

```
rtrv-upgrade-config
```

```
rlghncxa03w 10-02-13 08:15:45 EST EAGLE 42.0.0
```

```
Software Access Key no longer required for this system
```

```
Configured Upgrade Threshold Type: SET
```

```
Command Completed.
```

```
;
```

### Related Topics

- [act-upgrade](#)
- [chg-upgrade-config](#)

## send-msg

Use this command to manually simulate a system generated message from a user terminal. The parameters (not entered by the user) are defaulted to:

- Origination subsystem = *cam\_active*
- Destination subsystem = *orig application ID=appl\_ID\_ui*
- Violation= *no report*
- Bus = *imt choice*
- Message length = *computed*

**Parameters****da (mandatory)**

The destination application ID.

**Range:**

*0 - 255*

**ds (mandatory)**

The destination subsystem.

**Range:**

*0 - 255*

**f (mandatory)**

The function ID.

**Range:**

*0 - 255*

**loc (mandatory)**

The card location as stenciled on the shelf of the system.

**Range:**

*1101 - 1108, 1111 - 1113, 1115, 1201 - 1208, 1211 - 1218, 1301 - 1308, 1311 - 1318, 2101 - 2108, 2111 - 2118, 2201 - 2208, 2211 - 2218, 2301 - 2308, 2311 - 2318, 3101 - 3108, 3111 - 3118, 3201 - 3208, 3211 - 3218, 3301 - 3308, 3311 - 3318, 4101 - 4108, 4111 - 4118, 4201 - 4208, 4211 - 4218, 4301 - 4308, 4311 - 4318, 5101 - 5108, 5111 - 5118, 5201 - 5208, 5211 - 5218, 5301 - 5308, 5311 - 5318, 6101 - 6108, 6111 - 6118*

**alt (optional)**

This parameter specifies whether to use the alternate bus bit.

**Range:**

*on*

*off*

**Default:**

*on*

**bus (optional)**

The IMT bus.

**Range:**

*a*

*b*

**Default:**

*a*

**d0 (optional)**

The application data.

**Range:**  
*0 - 255*

**d1 (optional)**  
The application data.

**Range:**  
*0 - 255*

**d2 (optional)**  
The application data.

**Range:**  
*0 - 255*

**d3 (optional)**  
The application data.

**Range:**  
*0 - 255*

**d4 (optional)**  
The application data.

**Range:**  
*0 - 255*

**d5 (optional)**  
The application data.

**Range:**  
*0 - 255*

**d6 (optional)**  
The application data.

**Range:**  
*0 - 255*

**d7 (optional)**  
The application data.

**Range:**  
*0 - 255*

**d8 (optional)**  
The application data.

**Range:**  
*0 - 255*

**d9 (optional)**  
The application data.

**Range:**  
*0 - 255*



**len (optional)**

The message length in bytes.

**Range:**

0 - 65535

**Default:**

Calculated

**oa (optional)**

The originating application ID.

**Range:**

0 - 255

**Default:**

2

**os (optional)**

The originating subsystem.

**Range:**

0 - 255

**Default:**

0

**si (optional)**

This parameter allows the service ID field in the violation indicator to be set.

**Range:**

0 - 31

**Default:**

0

**sut (optional)**

The signal unit type.

**Range:**

0 - 9

**Default:**

2

**Example**

```
send-msg:loc=1113:os=2:oa=h'28:ds=2:da=h'28:f=7
```

```
send-msg:loc=1113:ds=2:oa=h'17:da=h'30:f=11
```

```
send-msg:loc=1116:ds=2:oa=h'17::da=h'30:f=12
```

```
send-msg:loc=1101:ds=1:da=65:f=27:d0=78:si=3
```

```
send-msg:loc=6212:ds=2:oa=h'17:da=h'30:f=11
```

```
send-msg:loc=6312:ds=1:da=64:f=171
```

## Dependencies

The value of the `da` parameter must be valid.

The destination location must be equipped to receive messages.

Card locations `xy09` and `xy10` cannot be used with bus `b` and bus `a`, respectively.

The value of the `ds` parameter must be valid.

## Notes

The `bus` and `sut` parameters must be used when sending a message to a MUX card.

If the `bus` parameter is not specified with a MUX card location on imt B (such as `xy10`), the bus `b` value is used instead of the bus `a` value.

## Output

```
send-msg:loc=1113:os=2:oa=h'28:ds=2:da=h'28:f=7
```

```
rlghncxa03w 01-03-13 15:01:02 EST
0061.0019    CARD 1113 PSM    ADMIN    PSM became active
;
```

```
send-msg:loc=1113:ds=2:oa=h'17:da=h'30:f=11
```

```
rlghncxa03w 01-03-13 15:02:34 EST
System Buffer sent has following attributes :
  Msg Length = H'0006
  Dest Card = H'00f4
  Orig Subsys = H'0002          Dest Subsys = H'0002
  Orig Appl ID = H'0017        Dest Appl ID = H'0030
  Func ID = H'000b            Bus/Alt/SUT = H'000b
  Violation Ind = H'0000
User Message sent to location 1113.
;
```

```
send-msg:sut=7:loc=1110:ds=0:da=h'40:f=h'a3:d0=0:bus=b
```

```
tekelecstp 06-01-11 11:39:15 EST  EAGLE 35.1.0
System Buffer sent has following attributes :
Msg Length = H'0010
Dest Card = H'00ff
Orig Subsys = H'0001          Dest Subsys = H'0000
Orig Appl ID = H'0030        Dest Appl ID = H'0040
Func ID = H'00a3            Bus/Ret/Sut = H'0087
Violation Ind = H'0000
User Message sent to location 1110.
;
```

```
send-msg:loc=1101:ds=1:da=65:f=27:d0=78:si=3
```

```
slanmfc 11-03-18 05:12:51 EST EAGLE 44.0.0
System Buffer sent has following attributes :
  Msg Length = H'001c
  Dest Card = H'00f0
  Orig Subsys = H'0001           Dest Subsys = H'0001
  Orig Appl ID = H'0030         Dest Appl ID = H'0041
  Func ID = H'001b             Bus/Ret/Sut = H'0002
  Violation Ind = H'0018
User Message sent to location 1101.
```

```
;
```

```
send-msg:loc=6212:ds=2:oa=h'17:da=h'30:f=11
```

```
tekelecstp 12-05-11 11:39:15 EST EAGLE 45.0.0
System Buffer sent has following attributes :
  Msg Length = H'0006
  Dest Card = H'00f4
  Orig Subsys = H'0002           Dest Subsys = H'0002
  Orig Appl ID = H'0017         Dest Appl ID = H'0030
  Func ID = H'000b             Bus/Alt/SUT = H'000b
  Violation Ind = H'0000
User Message sent to location 6212.
```

```
;
```

## set-mem

Use this command to set values in memory in the communication and application processors. If a card is reloaded, these memory changes are lost.

### Parameters

#### **addr (optional)**

The address, in the form of *segment–offset*.

#### **Range:**

```
segment–offset
segment—h'00–h'fff
offset—h'00–h'fff
```

#### **byte (optional)**

The byte value to write to the specified memory location(s).

#### **Range:**

```
0–h'00–h'ff
```

#### **card (optional)**

The card location, in the form of *GPLID–Subsystem ID*.

**Range:***GPLID—Subsystem ID**GPLID— atmhc, deirhc, erthc, glshc, hipr2, ipghc, iplhc, ipsg, ipshc, mcphc, oamhc, pktgen, sccphc, siphc, slanhc, ss7hc, utility**Subsystem ID— a, b, act, stb, all*

The OAMHC GPL can be specified with any of the subsystem IDs.

For all other GPLs, only the *all* subsystem ID is valid.**dword (optional)**

A double word value to write to the specified memory location(s).

**Range:***0-h'00-h'ffffff***fill (optional)**

The number of times that the value is to be written to successive addresses.

**Range:***0 - 65535***Default:***1***imt (optional)**

The IMT address.

**Range:***0 - 254***loc (optional)**

Location. The card location as stenciled on the shelf of the system.

**Range:***1101 - 1108, 1111 - 1112, 1201 - 1208, 1211 - 1218, 1301 - 1308, 1311 - 1318, 2101 - 2108, 2111 - 2118, 2201 - 2208, 2211 - 2218, 2301 - 2308, 2311 - 2318, 3101 - 3108, 3111 - 3118, 3201 - 3208, 3211 - 3218, 3301 - 3308, 3311 - 3318, 4101 - 4108, 4111 - 4118, 4201 - 4208, 4211 - 4218, 4301 - 4308, 4311 - 4318, 5101 - 5108, 5111 - 5118, 5201 - 5208, 5211 - 5218, 5301 - 5308, 5311 - 5318, 6101 - 6108, 6111 - 6118, 1109, 1110, 1209, 1210, 1309, 1310, 2109, 2110, 2209, 2210, 2309, 2310, 3109, 3110, 3209, 3210, 3309, 3310, 4109, 4110, 4209, 4210, 4309, 4310, 5109, 5110, 5209, 5210, 5309, 5310, 6109, 6110, 1113, 1115***mask (optional)**

The mask that selects the bits that are to be included in the operation (op).

**Range:***0-0xFFFFFFFF***Default:***0xFFFFFFFF***op (optional)**

Operation. The operation performed in order to arrive at the final value in the memory location.

**Range:***replace**and**or**x***Default:***replace***paddr (optional)**

The physical offset of the memory address.

**Range:***h'00–h'ffffff***proc (optional)**

The processor type.

**Range:***appl*

Application processor

*com*

Communication processor

**Default:***appl***word (optional)**

A word value to write to the specified memory location(s).

**Range:***h'00–h'fff***Example**

```
set-mem:loc=1109:paddr=h'201000:byte=0:fill=1024
```

```
set-mem:card=hipr2-all:paddr=h'202000:word=h'2a:op=and:mask=h'fff
```

**Dependencies**

The `loc`, `imt`, or `card` parameter must be specified.

Only one of the `loc`, `imt`, and `card` parameters can be specified in the command.

The `card` location specified by the `loc` parameter must be in the database.

All of the subsystem values can be specified with the OAMHC GPLID. The other GPLID values can be specified only with the *all* subsystem value.

Values of 1114, 1116, 1117, and 1118 cannot be specified for the `loc` parameter.

The `byte`, `word`, or `dword` parameter must be specified.

Only one of the `byte`, `word`, and `dword` parameters can be specified in the command.

The `paddr` parameter cannot be specified for an SS7 LIM card.

Memory Type of FWORD is NOT supported at this time.

The `addr` and `paddr` parameters cannot be specified together in the command.

The value specified for the `fill` parameter cannot exceed 65535.

### Notes

The `imt` parameter allows this command to be entered for a card that has not been configured in the system.

### Output

```
set-mem:loc=6205:paddr=h'0345fe:byte=2
```

```
rlghncxa03w 12-05-22 21:14:03 EST Rel 45.0.0  
SDS Response Code 22 from IMT Address H'00fd - command complete.  
;
```

### Related Topics

- [disp-mem](#)

# 6

## Pass-Through Commands

This chapter introduces the pass-through commands and describes the command conventions. The pass-through commands are listed in alphabetical order.

These commands are intended for use by My Oracle Support (MOS) personnel and authorized engineering personnel in the operating companies. Documentation might not include all options and/or definitions of these commands.

### ▲ Caution:

These commands are to be used precisely as they are described in this chapter, and only under the direction of My Oracle Support (MOS) personnel. Any other use of these commands can result in a system failure.

## Command Conventions

Pass-through commands are passed through the OAM and sent to individual cards for processing.

An example of a pass command is:

```
pass:loc=1201:cmd="connmgr -c"
```

The `cmd` parameter contains the pass-through command (`connmgr -c`) within the double quotes.

Pass-through commands consist of two types of tokens: command name and command options. Tokens are whitespace-delimited and null-terminated. The generalized format of a pass-through command is:

```
command_name option1 option2....option n-1.... option n
```

In the example, the *command\_name* is `connmgr` and the option is `-c`.

Options and option parameters are made up of a specific character string or a variable. The variable is to be replaced with a value selected from a range of values. Option variables and option parameter variables are underlined. For example, the `arp` command option `-d` has the parameter variable IPaddress. Specify the IP address as in the command `arp -d 192.9.200.44`. Do not enter the underlined text; enter a value instead.

Help information for each pass-through command can be obtained by using the option `-h` on any command.

## arp

This command is used to display and modify the internet to ethernet address translation tables used by the address resolution protocol.

## Options

Options and option parameters that are underlined indicate that a value must be specified for that option or parameter. For example, the `arp` command option `-d` has the parameter *IP address*. The IP address must be specified for which an ARP entry will be deleted, as in the command `arp -d 192.9.200.44`. Do not enter the underlined option or parameter; enter a value for the information represented by the underlined option or parameter.

`-a`

This option displays all entries in the ARP table.

`-d IP address`

This option deletes an ARP entry for the specified IP address.

The IP address is a TCP/IP address expressed in standard “dot notation.” IP addresses consist of the system’s network number and the machine’s unique host number. An example IP address is *192.9.200.44*, where *192.9.200* is the network number and *44* is the machine’s host number.

### Range:

4 numbers separated by dots, with each number in the range of 0-255.

`-f`

This option flushes all entries from the ARP table.

`-h`

This option displays help (usage) information for the command.

`-s IP addressMAC address`

This option creates an ARP entry for the specified IP address and ethernet address.

### Range:

4 numbers separated by dots, with each number in the range of 0-255.

The IP address is a TCP/IP address expressed in standard “dot notation.” IP addresses consist of the system’s network number and the machine’s unique host number. For example, *192.9.200.44*, where *192.9.200* is the network number and *44* is the machine’s host number.

### Range:

6 hexadecimal numbers separated by colons; each number in the range 0 - FF. The MAC (media access control) address is an ethernet address with the format *x:x:x:x:x:x*, where *x* is a hexadecimal integer from 0 to FF. For example, *08:00:20:1b:0f:f2*.

## Example

```
arp -a
arp -s 192.9.200.44 08:00:20:1b:0f:f2
arp -d 192.9.200.44
arp -f
```



## Dependencies

Only one of the options can be specified at a time.

The `arp` command with no options displays all of the current ARP cache entries.

## Notes

The `arp` command is executed through the `pass` command.

## Output

```
pass:loc=1105:cmd="arp" or
pass:loc=1105:cmd="arp -h"

Command Accepted - Processing

rlghncxa03w 04-07-27 08:10:00 EST  EAGLE5 31.6.0
pass:loc=1105:cmd="arp"
Command entered at terminal #1.
;

rlghncxa03w 04-07-27 08:10:00 EST  EAGLE5 31.6.0
PASS: Command sent to card
;

rlghncxa03w 04-07-27 08:10:00 EST  EAGLE5 31.6.0

Usage: arp [-a] [-d ipaddr] [-f] [-h] [-s ipaddr enetaddr]

Options:
  -a          Display All entries in ARP table
  -d          Delete specified entry (ipaddr) from ARP table
  -f          Flush all entries from ARP table
  -h          Displays this message
  -s          Set ARP table entry to associate ipaddr with enetaddr
enetaddr    x:x:x:x:x:x
ipaddr      d.d.d.d
;

rlghncxa03w 04-07-27 08:10:01 EST  EAGLE5 31.6.0

ARP command complete
;

pass:loc=1105:cmd="arp -s 192.168.100.234 11:22:33:44:55:66"

Command Accepted - Processing

rlghncxa03w 04-07-27 08:11:08 EST  EAGLE5 31.6.0
pass:loc=1105:cmd="arp -s 192.168.100.234 11:22:33:44:55:66"
Command entered at terminal #1.
;

rlghncxa03w 04-07-27 08:11:08 EST  EAGLE5 31.6.0
```

```

    PASS: Command sent to card
;
    rlghncxa03w 04-07-27 08:11:08 EST  EAGLE5 31.6.0

    ARP: 192.168.100.234 (11:22:33:44:55:66) added
;
    rlghncxa03w 04-07-27 08:11:09 EST  EAGLE5 31.6.0

    ARP command complete
;

```

**Output for 32-bit GPLs:**

```
pass:loc=1105:cmd="arp -a"
```

```
Command Accepted - Processing
```

```

    rlghncxa03w 04-07-27 08:11:18 EST  EAGLE5 31.6.0
    pass:loc=1105:cmd="arp -a"
    Command entered at terminal #1.
;
    rlghncxa03w 04-07-27 08:11:18 EST  EAGLE5 31.6.0
    PASS: Command sent to card
;
    RLGHNCA03WRLGHNCXA03W 04-07-27 08:11:18 EST  EAGLE5 31.6.0

    LINK LEVEL ARP TABLE
    destination      gateway          flags  Refcnt  Use
Interface
-----
--
    192.168.55.250   00:e0:16:9b:0d:86   405    1      0
seeq1
    192.168.100.234 11:22:33:44:55:66   c05    0      0
seeq0
-----
--
;
    rlghncxa03w 04-07-27 08:11:19 EST  EAGLE5 31.6.0
    ARP command complete
;

```

**Output for 64-bit GPLs:**

```
pass:loc=1105:cmd="arp -a"
```

```

tklc9010801 17-06-19 07:29:45 EST  EAGLE 46.5.0.0.0-70.35.0
    pass:loc=1217:cmd="arp -a"
    Command entered at terminal #20.
;

```

```
tklc9010801 17-06-19 07:29:51 EST EAGLE 46.5.0.0.0-70.35.0
PASS: Command sent to card
;
Command Accepted - Processing
tklc9010801 17-06-19 07:29:54 EST EAGLE 46.5.0.0.0-70.35.0

ARP command complete

;
Command Executed
-> arpShow
192.168.120.255 at ff:ff:ff:ff:ff:ff on gei4
192.168.121.3 at 00:00:17:0f:55:45 permanent published on gei5
192.168.120.3 at 00:00:17:0f:55:44 permanent published on gei4
192.168.121.255 at ff:ff:ff:ff:ff:ff on gei5
192.168.121.200 at 00:00:00:00:00:00 on gei5
192.168.121.100 at 00:00:17:0e:a6:9b on gei5
192.168.120.200 at 00:00:00:00:00:00 on gei4
192.168.120.100 at 00:00:17:0e:a6:9c on gei4
value = 0 = 0x0

;

pass:loc=1105:cmd="arp -f"

Command Accepted - Processing

rlghncxa03w 04-07-27 08:11:38 EST EAGLE5 31.6.0
pass:loc=1105:cmd="arp -f"
Command entered at terminal #1.
;
rlghncxa03w 04-07-27 08:11:38 EST EAGLE5 31.6.0
PASS: Command sent to card
;
rlghncxa03w 04-07-27 08:11:38 EST EAGLE5 31.6.0
ARP: ARP table flushed
;
rlghncxa03w 04-07-27 08:11:38 EST EAGLE5 31.6.0

ARP command complete
;

pass:loc=1105:cmd="arp -d 192.111.111.222"

E3780 Cmd Rej: Syntax Error Found

rlghncxa03w 04-07-27 08:26:37 EST EAGLE5 31.6.0
pass:loc=1105:cmd="arp -d 192.111.111.222"
Command entered at terminal #1.
;
rlghncxa03w 04-07-27 08:26:37 EST EAGLE5 31.6.0
```

```

    PASS: Command sent to card
;
rlghncxa03w 04-07-27 08:26:37 EST  EAGLE5 31.6.0
ARP: entry not deleted
;
rlghncxa03w 04-07-27 08:26:37 EST  EAGLE5 31.6.0

ARP command complete

```

## aslog

This command is used to display the state changes for a specified Application Server (AS).

### Options

Options and option parameters that are underlined indicate that a value must be specified for that option or parameter. For example, the `aslog` command has the parameter `asname`. The Application Server name must be specified for which the log will be displayed, as in the command `aslog as1`. Do not enter the underlined option or parameter; enter a value for the information represented by the underlined option or parameter.

#### `asname`

This option specifies the Association Server name for the display.

#### `-h`

This option displays help (usage) information for the command.

### Example

```
aslog as1
```

### Dependencies

None

### Notes

None

### Output

```
pass:loc=1105:cmd="aslog as1"
```

```
Command Accepted - Processing
```

```

    rlghncxa03w 00-01-27 08:10:00 EST  EAGLE5 31.6.0
    pass:loc=1105:cmd="aslog as1"
    Command entered at terminal #3.
;
rlghncxa03w 00-01-27 08:10:00 EST  EAGLE5 31.6.0
PASS: Command sent to card
;
rlghncxa03w 00-01-27 08:10:00 EST  EAGLE5 31.6.0

```

```

ASLOG command in progress
;
rlghncxa03w 00-01-27 08:10:00 EST  EAGLE5 31.6.0

ASLOG: AS history log

ASLOG: AS state history log

Date          Time          AS Event
-----
65-05-31  22:27:29.075  Transition to AS-Down
65-05-31  22:27:29.080  Transition to AS-Active Override
65-05-31  22:38:24.050  Transition to AS-Active Override

ASLOG command complete
;

```

## assocrtt

This command is used to display the SCTP round trip times for a specified association. Minimum, maximum, and average times are kept for each open association. The Retransmission Mode (RFC or LIN) and the configured Minimum and Maximum Retransmission Timeout limits are also displayed.

### Options

Options and option parameters that are underlined indicate that a value must be specified for that option or parameter. For example, the `assocrtt` command has the parameter `aname`. The association name must be specified for which the information will be displayed, as in the command `assocrtt c7000`. Do not enter the underlined option or parameter; enter a value for the information represented by the underlined option or parameter.

#### `aname`

This option specifies the association name for the display.

#### `-r`

This option resets all statistics for the specified association name.

### Example

```

assocrtt c7000
assocrtt c7000 -r

```

### Dependencies

None

### Notes

This command does not indicate whether or not the socket is congested.

### Output

```

pass:loc=1105:cmd="assocrtt" 0R

```

```
pass:loc=1105:cmd="assocrtt -h"
```

```
Command entered at terminal #1.
;
rlghncxa03w 00-01-27 08:10:00 EST EAGLE5 31.6.0
PASS: Command sent to card
;
rlghncxa03w 00-01-27 08:10:00 EST EAGLE5 31.6.0

Usage: ASOCR TT sockname [-r] [-h]
Options:
    -r          Resets rtt data for specified association
    -h          Displays this message
;
rlghncxa03w 00-01-27 08:10:00 EST EAGLE5 31.6.0
ASSocrtt command complete
;
```

```
pass:loc=1105:cmd="assocrtt c7000"
```

```
Command Accepted - Processing
rlghncxa03w 00-01-27 08:10:00 EST EAGLE5 31.6.0
pass:loc=1105:cmd="assocrtt c7000"
Command entered at terminal #1.
;
rlghncxa03w 00-01-27 08:10:00 EST EAGLE5 31.6.0
PASS: Command sent to card
;
rlghncxa03w 00-01-27 08:10:00 EST EAGLE5 31.6.0
ASSOCR TT: Association round trip time report (in milliseconds)

Retransmission Configuration
Retransmission Mode          : LIN
Minimum RTO      : 120
Maximum RTO      : 800

Traffic Round-Trip Times

Minimum round-trip time      : 5
Maximum round-trip time      : 120
Weighted Average round-trip time : 10
Last recorded round-trip time : 10
;
Measured Congested Traffic Round-Trip Times

Minimum round-trip time      : 0
Maximum round-trip time      : 0
Weighted Average round-trip time : 0
Last recorded round-trip time : 0
;
rlghncxa03w 00-01-27 08:10:01 EST EAGLE5 31.6.0
```

```
ASSOCRtt command complete
;

pass:loc=1105:cmd="assocrtt c7000 -r"

Command entered at terminal #1.
;
rlghncxa03w 00-01-27 08:10:01 EST  EAGLE5 31.6.0
PASS: Command sent to card
;
rlghncxa03w 00-01-27 08:10:01 EST  EAGLE5 31.6.0

ASSocrtt: Association round-trip time report (in milliseconds)

Retransmission Configuration
Retransmission Mode           : RFC
Minimum RTO      : 120
Maximum RTO      : 800

Traffic Round-Trip Times

Minimum round-trip time       : 5
Maximum round-trip time       : 120
Weighted Average round-trip time : 10
Last recorded round-trip time  : 10

Measured Congested Traffic Round-Trip Times

Minimum round-trip time       : 0
Maximum round-trip time       : 0
Weighted Average round-trip time : 0
Last recorded round-trip time  : 0
;
rlghncxa03w 00-01-27 08:10:01 EST  EAGLE5 31.6.0
ASSocrtt command complete
;
```

## connmgr

This command is used to generate reports about the status of the connection manager.

### Options

-d

This option displays a connection manager data summary. For IPSPG cards, this report contains summary information and does not contain information for individual signaling links.

-h

This option displays help (usage) information for the command.

-i

This option displays SCTP instance and association data.

-l  
This option displays the connection manager event log.

-n  
This option displays the SCTP notification log.

-r  
This option resets the connection manager event log.

### Example

```
connmgr -r
connmgr -c
connmgr -s
```

### Dependencies

Only one of the options can be specified at a time.

If no options are specified, usage information is displayed.

### Notes

The `connmgr` command is executed through the `pass` command.

### Output

```
pass:loc=1107:cmd="connmgr" or
pass:loc=1304:cmd="connmgr -h"
```

```
Command Accepted - Processing
```

```

    rlghncxa03w 08-01-21 15:29:46 EST  EAGLE5 38.0.0
    pass:loc=1304:cmd="connmgr -h"
    Command entered at terminal #1.
;
    rlghncxa03w 08-01-21 15:29:46 EST  EAGLE5 38.0.0
    PASS: Command sent to card
;
    rlghncxa03w 04-07-02 15:29:46 EST  EAGLE5 31.6.0
    Usage: CONNMGR [-d] [-h] [-i] [-l] [-n] [-r]
    Options:
        -d  Display connection manager data summary
        -h  Displays this message
        -i  Displays instance data
        -l  Display the connection manager event log
        -n  Display the SCTP notification log
        -r  Reset the connection manager event log
;

```

```
pass:loc=1107:cmd="connmgr -d"
```

The Connection Manager Data Summary displays all provisioned signaling link ports.



In this example, signaling link port (slk) B is valid only for IPLIMx cards:

```
Command Accepted - Processing

    rlghncxa03w 04-07-02 15:37:12 EST  EAGLE5 31.6.0
    pass:loc=1107:cmd="connmgr -d"
    Command entered at terminal #1.
;
    rlghncxa03w 04-07-02 15:37:12 EST  EAGLE5 31.6.0
    PASS: Command sent to card
;
    rlghncxa03w 04-07-02 15:37:12 EST  EAGLE5 31.6.0
    CONNMGR: command being processed
;
    rlghncxa03w 04-07-02 15:37:12 EST  EAGLE5 31.6.0
    CONNMGR: Connection Manager Data Summary
    slk  link state  srv  cli  opn sock  inst  opn assoc
    ---  -
    A   active      1   0      1   0      0
    B   active      0   0      0   1      1

    CONNMGR command complete
;
```

In this example, a summary data report is requested for an IPSG card:

```
pass:loc=1304:cmd="connmgr -d"

Command Accepted - Processing

    eagle10110 08-01-15 16:09:24 EST  EAGLE 38.0.0
    pass:loc=1304:cmd="connmgr -d"
    Command entered at terminal #3.
;

    eagle10110 08-01-15 16:09:24 EST  EAGLE 38.0.0
    PASS: Command sent to card
;

    eagle10110 08-01-15 16:09:24 EST  EAGLE 38.0.0
    CONNMGR: Connection Manager Data Summary

    num_instances:                1
    num_assocs:                    1
    num_established_assocs:        0
    num_cli_assocs:                0
    num_established_cli_assocs:    0
    num_assocs_with_tx_data:       0
    num_full_assocs:              0
    num_assoc_with_rcv_data:       0
    num_times_tx_q_full:          0
    num_assoc_down_notif:         0
    num_assoc_aborted_notif:      0
    num_assoc_restart_notif:      0
```

```
num_intf_up_notif:          0
num_intf_down_notif:        0
num_hb_resp_notif:         0
num_dg_fail_notif:         0
num_rd_errors:              0
num_wt_errors:              0
num_wt_shutdown:           0
num_wt_empty:               0
```

CONNMGR: command complete

;

eagle10110 08-01-15 16:09:24 EST EAGLE 38.0.0

;

pass:loc=1301:cmd="connmgr -i"

Command Accepted - Processing

```
eagle10213 04-07-22 08:49:37 GMT EAGLE5 31.6.0
pass:loc=1301:cmd="connmgr -i"
Command entered at terminal #4.
```

;

```
eagle10213 04-07-22 08:49:37 GMT EAGLE5 31.6.0
PASS: Command sent to card
```

;

eagle10213 04-07-22 08:49:37 GMT EAGLE5 31.6.0

CONNMGR command being processed

;

```
eagle10213 04-07-22 08:49:37 GMT EAGLE5 31.6.0
CONNMGR: Connection Manager Instance Data
inst id  lport  cfg  est  tot grntd  tot rfsd
-----  -
021B7880  1301    2    2           0           0
```

CONNMGR command complete

;

pass:loc=1107:cmd="connmgr -l"

Command Accepted - Processing

```
rlghncxa03w 04-07-02 15:35:28 EST EAGLE5 31.6.0
pass:loc=1107:cmd="connmgr -l"
Command entered at terminal #1.
```

```

;
rlghncxa03w 04-07-02 15:35:28 EST EAGLE5 31.6.0
PASS: Command sent to card
;
rlghncxa03w 04-07-02 15:35:28 EST EAGLE5 31.6.0
CONNMGR: command being processed
;
rlghncxa03w 04-07-02 15:35:28 EST EAGLE5 31.6.0
CONNMGR: Connection Manager Event Log
04-07-03 13:17:40.730 conn-rcvd 5005 from 192.168.100.174:5005
04-07-03 13:17:40.735 conn-rfsd lnk-not-actv 5005 192.168.100.174
04-07-03 13:17:40.850 conn-rcvd 5006 from 192.168.100.174:5006
04-07-03 13:17:40.855 conn-rfsd lnk-not-actv 5006 192.168.100.174
04-07-03 13:17:40.910 conn-rcvd 5002 from 192.168.100.174:5002
04-07-03 13:17:40.915 conn-rfsd lnk-not-actv 5002 192.168.100.174
04-07-03 13:17:40.950 conn-rcvd 5004 from 192.168.100.174:5004
04-07-03 13:17:40.955 conn-rfsd lnk-not-actv 5004 192.168.100.174

CONNMGR command complete
;

pass:loc=1103:cmd="connmgr -l"

```

Command Accepted - Processing

```

rlghncxa03w 04-07-02 15:35:28 EST EAGLE5 31.6.0
pass:loc=1103:cmd="connmgr -l"
Command entered at terminal #4.
;
rlghncxa03w 04-07-02 15:35:28 EST EAGLE5 31.6.0
PASS: Command sent to card
;
rlghncxa03w 04-07-02 15:35:28 EST EAGLE5 31.6.0
CONNMGR: command being processed
;
rlghncxa03w 04-07-02 15:35:28 EST EAGLE5 31.6.0
CONNMGR: Connection Manager Event Log
00-01-13 13:17:40.170 sock-add ipl1103
00-01-13 13:17:40.885 lnk-act Port A
00-01-13 13:17:40.080 conn-made ipl1101

CONNMGR command complete
;

```

This example shows output when a remote host mismatch occurs:

```

pass:loc=1107:cmd="connmgr -l"

Command Accepted - Processing

eagle10110 09-05-15 16:09:24 EST EAGLE 41.0.0
pass:loc=1304:cmd="connmgr -l"
Command entered at terminal #3.

```

```

;

eagle10110 09-05-15 16:09:24 EST EAGLE 41.0.0
PASS: Command sent to card
;

eagle10110 09-05-15 16:09:24 EST EAGLE 41.0.0
CONNMGR: Connection Manager Event Log

07-05-03 13:17:40.730 conn-rcvd 5005 from 192.168.100.174:5005
07-05-03 13:17:40.735 conn-rfsd lnk-not-actv 5005
192.168.100.174
07-05-03 13:17:40.950 conn-rcvd 5004 from 192.168.100.174:5004
07-05-03 13:17:40.955 conn-rfsd host-unreslvd 5004
192.168.100.174
07-05-03 13:17:40.960 conn-rcvd 5003 from 192.168.100.174:5003
07-05-03 13:17:40.965 conn-rfsd host-mismatch 5003
192.168.100.174

CONNMGR: command complete

```

#### Event descriptions for `connmgr -l`

- `Ink-act`-The signaling link (slk) was activated.
- `Ink-deact`-The signaling link (SLK) was deactivated.
- `adptr-clc`-An association was closed.
- `admin-open`-An association was opened via admin and available for connection.
- `admin-clc`-An association was closed via admin and not available for connection.
- `conn-rcvd`-A connection request has been received from a client.
- `conn-rfsd`-Connection request was refused by the server.
- `conn-grnt`-Connection was granted by the server.
- `conn-fail`-Connection request made by the client has failed.
- `conn-made`-A connection has been made between the client and server.
- `pause-rcv`-A connection received a pause event.
- `resume-rcv`-A connection received a resume event.
- `conn-cnsgsd`-An association has become congested.
- `conn-uncng`-An association is no longer congested.
- `host-unreslvd`-A remote host is unresolved.
- `undef-evnt`-An undefined event has come in.

#### Event reasons for `connmgr -l`

- `Ink-not-actv`-The SLK (signaling link) is not active.
- `no-sock-avail`-No association is available.
- `unknown-sock`-Unknown association.
- `addr-in-use`-Address is in use.

- net-unreach-The network is unreachable.
- net-reset-Network dropped connection on reset.
- sw-abort-Software caused connection abort.
- conn-reset-The connection was reset by the peer.
- no-buffers-No buffer space available.
- is-connected-Association is already connected.
- not-connected-Association not connected.
- shutdown-Can't send after association shutdown.
- too-many-refs-Too many references : can't splice.
- timed-out-Connection timed out.
- refused-connection refused.
- net-down-The network is down.
- txt-busy-Text file is busy.
- loop-Too many levels of symbolic links.
- host-unreachb-Host unreachable.
- not-blk-Block device required.
- host-down-Host is down.
- host-unreslvd-Host is unresolved.
- host-mismatch-Remote Host validation rule fails.
- undef-reason-Undefined reason.

```
pass:loc=1301:cmd="connmgr -n"
```

```
Command Accepted - Processing
```

```

eagle10213 04-07-22 08:50:04 GMT EAGLE5 31.6.0
pass:loc=1301:cmd="connmgr -n"
Command entered at terminal #4.
;

eagle10213 04-07-22 08:50:04 GMT EAGLE5 31.6.0
PASS: Command sent to card
;

eagle10213 04-07-22 08:50:04 GMT EAGLE5 31.6.0

CONNMGR command being processed

;

eagle10213 04-07-22 08:50:04 GMT EAGLE5 31.6.0
CONNMGR: Connection Manager SCTP Notification Log
04-07-21 18:06:34.860 assoc-up   ipl1301a from 192.168.110.17:1301
04-07-21 18:06:49.620 assoc-up   ipl1301b from 192.168.110.18:1303
04-07-21 18:07:54.185 assoc-down ipl1301b from 192.168.110.18:1303
```

```

04-07-21 18:09:21.990 assoc-up   ip11301b from 192.168.110.18:1303

CONNMGR command complete
;

```

Notification descriptions for `connmgr -n`

- `init-recvd`-An INIT chunk was received to start an association.
- `assoc-up`-An association is up.
- `assoc-down`-An association is taken out of service.
- `intf-down`-Interface on an association is down and out of consideration for selection.
- `intf-up`-Interface on an association is up and now back in consideration for selection.
- `dg-fail`-The given datagram can not be delivered to the peer.
- `sdata-err`-A datagram was sent on a non-open stream.
- `assoc-abrt`-An association has been taken down ungracefully.
- `peer-strm`-Peer opened stream notification.
- `strm-ok`-Notification that the stream opened ok.
- `assoc-rst`-A Notification was received that an association was restarted.
- `hb-resp`-A response to a heartbeat request.
- `data-msg`-A DATA message has arrived. An SCTP packet includes user data encapsulated within SCTP DATA chunks.
- `host-mismatch`-Remote Host validation rule fails.
- `host-unreslvd`-Host is unresolved.
- `rem-unreslvd`-Remote host is unresolved.
- `invalid`-Invalid/Unknown event.

```
pass:loc=1107:cmd="connmgr -r"
```

Command Accepted - Processing

```

rlghncxa03w 04-07-02 15:36:18 EST  EAGLE5 31.6.0
pass:loc=1107:cmd="connmgr -r"
Command entered at terminal #1.
;
rlghncxa03w 04-07-02 15:36:18 EST  EAGLE5 31.6.0
PASS: Command sent to card
;
rlghncxa03w 04-07-02 15:36:18 EST  EAGLE5 31.6.0
CONNMGR: command being processed
;
rlghncxa03w 04-07-02 15:36:18 EST  EAGLE5 31.6.0
CONNMGR command complete
;

```

```
pass:loc=1107:cmd="connmgr -s"
```

```
Command Accepted - Processing
```

```
rlghncxa03w 04-07-02 15:39:54 EST EAGLE5 31.6.0  
pass:loc=1107:cmd="connmgr -s"  
Command entered at terminal #1.
```

```
;
```

```
rlghncxa03w 04-07-02 15:39:54 EST EAGLE5 31.6.0  
PASS: Command sent to card
```

```
;
```

```
rlghncxa03w 04-07-02 15:40:02 EST EAGLE5 31.6.0  
CONNMGR: command being processed
```

```
;
```

```
rlghncxa03w 04-07-02 15:40:03 EST EAGLE5 31.6.0  
CONNMGR: Connection Manager Server Data  
task_id server state lport cfg opn cn_grntd cn_rfsd  
-----  
0114FEE8 listening 5001 1 1 2 546  
0114ED40 listening 5002 1 1 2 434  
0114DB98 listening 5003 1 1 2 539  
0114C9F0 listening 5004 1 1 2 542  
0114B848 listening 5005 1 1 2 539  
0114A6A0 listening 5006 1 1 2 549  
011494F8 listening 5007 1 0 0 548  
01148350 listening 5008 1 1 2 560  
011471A8 listening 5009 1 1 2 523  
01146000 listening 5010 1 1 2 532  
01144E58 listening 5011 1 1 2 534  
01143CB0 listening 5012 1 1 2 481  
01142B08 listening 5013 1 1 2 474  
01141960 listening 5014 1 1 2 521  
011407B8 listening 5015 1 0 2 515  
0113F610 listening 5016 5 0 14 2741  
0113E468 listening 5017 5 0 11 2723
```

```
CONNMGR command complete
```

```
;
```

```
pass:loc=1103:cmd="connmgr -s"
```

```
Command Accepted - Processing
```

```
rlghncxa03w 04-07-02 15:39:54 EST EAGLE5 31.6.0  
pass:loc=1103:cmd="connmgr -s"  
Command entered at terminal #4.
```

```
;
```

```
rlghncxa03w 04-07-02 15:39:54 EST EAGLE5 31.6.0  
PASS: Command sent to card
```

```
;
```

```
rlghncxa03w 04-07-02 15:40:02 EST EAGLE5 31.6.0  
CONNMGR: command being processed
```

```

;
rlghncxa03w 04-07-02 15:40:03 EST  EAGLE5 31.6.0
CONNMGR: Connection Manager Server Data
task_id  server state slk lport cfg opn cn_grntd cn_rfsd
-----
CONNMGR command complete
;

```

## ftptest

Use this command to send a test file to a configured FTP server that is used for the Measurements Platform feature

### Options

Options and option parameters that are underlined indicate that a value must be specified for that option or parameter. For example, the `ftptest` command option `-a` has the parameter `appl`. The FTP registered application to be tested can be specified, as in the command `ftptest -a meas`. Do not enter the underlined option or parameter; enter a value for the information represented by the underlined option or parameter.

`-h`

This option provides help information for the command.

`-a appl`

This option specifies the FTP registered application to be tested.

### Range:

***meas***

The Measurements Platform application

### Example

```

ftptest
ftptest -h

ftptest -a meas

```

### Dependencies

None

### Notes

The `ftptest` command is executed through the `pass` command.

The specified card location must have an IP port configured to an FTP server using the `ent-ftp-serv` command, and the card must have its IP port configured using the `chg-ip-lnk` command.

### Output

```

pass:loc=1105:cmd="ftptest-h"
or

```



```
pass:loc=1105:cmd="ftptest"

Command Accepted - Processing

    rlghncxa03w 04-07-29 11:31:09 EST  EAGLE5 31.6.0
    pass:loc=1215:cmd="ftptest -h"
    Command entered at terminal #3.
;

    rlghncxa03w 04-07-29 11:31:09 EST  EAGLE5 31.6.0
    PASS: Command sent to card
;

    rlghncxa03w 04-07-29 11:31:09 EST  EAGLE5 31.6.0

Usage: ftptest -a appl [-h]

Options:
    -a appl  FTP client application name
    -h      Displays this message
;

    rlghncxa03w 04-07-29 11:31:09 EST  EAGLE5 31.6.0

FTPTEST: Command Complete
;

pass:loc=1105:cmd="ftptest -a meas"

    PASS: Command sent to card
;

    rlghncxa03w 04-07-29 11:31:09 EST  EAGLE5 31.6.0

FTPTEST: Command In Progress
;

    rlghncxa03w 04-07-29 11:31:09 EST  EAGLE5 31.6.0
    FTP Interface Test
    Test Results: PASS
    Server IP:    10.25.61.71
    FTP Error:    0
    File Error:   0
    Segment:     190004a2
    Diag Msg:
    FTPTEST: Command Complete
;
```

This example shows the output if the wrong password is specified in the `ent-ftp-serv` command for the application specified in the `ftpptest` command:

```
pass:loc=1215:cmd="ftpptest -a meas"

rlghncxa03w 04-07-29 11:31:09 EST  EAGLE5 31.6.0
PASS: Command sent to card
;

rlghncxa03w 04-07-29 11:31:09 EST  EAGLE5 31.6.0

FTPTEST: Command In Progress

;

rlghncxa03w 04-07-29 11:31:09 EST  EAGLE5 31.6.0
FTP Interface Test
  Test Results: FAIL
  Server IP:    0.0.0.0
  FTP Error:   530
  Segment:     190004dd
  Diag Msg:    Server Connection Error

FTPTEST: Command Complete

;
```

## linkinfo

This command is used to display the state of a signaling link and to retrieve/clear a specified event log for a signaling link. The signaling link is any valid signaling link provisioned for the card. For IPLIMx cards, the *a:a7 - b:b7* signaling links are supported. For IPSP ENET cards, the *a:a15 - b:b15* signaling links are supported. For IPSP SLIC cards, the *a:a63 - b:b63* signaling links are supported.

For E5-E1T1-B cards, the *a:a31 - b:b31* signaling links are supported. For E5-ATM-B cards, the *a, a1, b* links are supported. E5-E1T1-B and E5-ATM-B cards only support the `-c` option, the output will display the buffer information and congestion levels information.

### Options

Options and option parameters that are underlined indicate that a value must be specified for that option or parameter. For example, the `linkinfo` command option `-i` has the parameter *event*. The event to be included in the report can be specified, as in the command `linkinfo a -a -i m2pa`. Do not enter the underlined option or parameter; enter a value for the information represented by the underlined option or parameter.

**Note:**

For E5-E1T1-B and E5-ATM-B cards, `-c` and `-h` are the only valid options.

`-h`

This option provides help information for the command.

`port`

This option specifies the signaling link port.

**Range:**

*a, A1: A63-B, B1:B63*

`-a`

This option displays the adapter layer interface (ALI) log for the specified signaling link. For M3UA associations the `link -a` option is used to display the UA event log. This command logs information on an association basis. The **link** parameter is used to obtain this report on IPSPG instead of the association name. This information is currently provided by the `ualog` command on IPGWx cards.

`-c`

This option displays congestion tuning parameters for M3UA and M2PA links. The report is enhanced to include card level congestion thresholds and the high-water mark for IPSPG cards.

This option also displays congestion levels for E5-E1T1-B and E5-ATM-B cards.

`-i event`

This option includes (does not filter) a link event in the log. For IPSPG cards, this option may be used to include or exclude events for the `ali` and `link` logs. Valid events for the ALI event log are *ua* and *service*.

**Range:**

*ali, all, data, l2l3, l3l2, m2pa, state, ua, service*  
*all*-include all events

`-m`

This option displays acknowledgment times on an M2PA connection (minimum, maximum, weighted average, last recorded). For IPSPG cards, this measurement is supported for only IPSPG-M2PA links.

`-r`

This option resets (clears) the event log for the specified signaling link. This option is valid only with the `-a` option or `-l` option.

`-s`

This option displays the state information for the specified signaling link. For the IPSPG cards, this option is enhanced to display M3UA signaling link status.

`-v`

This option displays the link event filter configuration.

`-x event`

This option excludes (filters) a link event in the log. For IPSPG cards, this option may be used to include or exclude events for the `ali` and `link` logs. Valid events for the ALI event log are *ua* and *service*.

**Range:**

*ali, all, data, l2l3, l3l2, m2pa, state, ua, service*  
*all-exclude all events*

**Example**

Provide help information for the command.

```
pass:loc=1301:cmd="linkinfo -h"
```

Set the filter to include ua events in the ua log report.

```
pass:loc=1304:cmd="linkinfo a -i ua"
```

Set the filter to include service events in the ua log report.

```
pass:loc=1304:cmd="linkinfo a -i service"
```

Display the ua log report for signaling link a.

```
pass:loc=1304:cmd="linkinfo a -a"
```

Display the ALI event log for signaling link a1.

```
pass:loc=1301:cmd="linkinfo a1 -a"
```

Reset/clear the link event log for signaling link a1.

```
pass:loc=1301:cmd="linkinfo a1 -l -r"
```

Clear the ua log report for signaling link a.

```
pass:loc=1304:cmd="linkinfo a -a -r"
```

Display the state information for signaling link a1.

```
pass:loc=1301:cmd="linkinfo a1 -s"
```

Display acknowledgement times for an M2PA connection on signaling link b1.

```
pass:loc=3315:cmd="linkinfo b1 -m"
```

Display congestion tuning information for an IPSPG-M3UA signaling link and Display congestion levels and buffer information for signaling links on E5-E1T1-B and E5-ATM-B cards.

```
pass:loc=1301:cmd="linkinfo a -c "
```

**Dependencies**

None

**Notes**

None

**Output**

This example shows the output for the help command on IPSPG cards:

```
pass:loc=1301:cmd="linkinfo" or
```

```
pass:loc=1301:cmd="linkinfo -h"
```

```
tekelecstp 16-05-25 12:38:16 EST EAGLE5 46.4.0.0.0-69.3.1
```

```
PASS: Command sent to card
```

```
;
```

```
tekelecstp 16-05-25 12:38:16 EST EAGLE5 46.4.0.0-69.3.1
```

```
Usage: LINKINFO port [-a [-r]] [-h] [-l [-r]]
      [-m [-r]] [-s] [-v] [-x event]
```

## Options:

```
link      Signaling link port: a, b, a1, b1,.....a63, b63
-a        Display the ALI event log for a signaling link
-c        Display Congestion Tuning Information for a signaling link
-h        Displays this message
-i event  Include (do not filter) a link event type in the log
-l        Displays the event log for a signaling link
-m        Display Link Measurements
-r        Resets the specified event log for a signaling link
-s        Displays the state information for a signaling link
-v        View the link event filter configuration
-x event  Exclude (filter) a link event type from the log
```

```
Valid 'event' for link event log is ali, all, data, 1213, 1312, m2pa,
state
```

```
;
```

```
rlghncxa03w 04-07-29 11:31:09 EST EAGLE5 31.6.0
```

```
LINKINFO command complete
```

```
;
```

This example shows the output for the help command on E5-E1T1-B and E5-ATM-B cards:

```
pass:loc=1101:cmd="linkinfo" or
```

```
pass:loc=1101:cmd="linkinfo -h"
```

```
tekelecstp 02-01-25 05:31:18 MST 46.0.0-65.11.0
```

```
PASS: Command sent to card
```

```
;
```

```
Command Accepted - Processing
```

```
tekelecstp 02-01-25 05:31:19 MST 46.0.0-65.11.0
```

```
LINKINFO: command complete
```

```
;
```

```
Command Executed
```

```
tekelecstp 02-01-25 05:31:18 MST 46.0.0-65.11.0
```

```
Usage: LINKINFO link [-c ]
```

## Options:

```
link      Signaling link: a, b, a1..a31, b1..b31
-c        Display Congestion Tuning Information,RTB,TB and L3-L2
buffer counts for a signaling link
```

```
;
```

This example resets/clears the link event log for signaling link A1:

```
pass:loc=1301:cmd="linkinfo a1 -l -r"

    rlghncxa03w 04-07-29 11:31:09 EST  EAGLE5 31.6.0
    PASS: Command sent to card
;

    rlghncxa03w 04-07-29 11:31:09 EST  EAGLE5 31.6.0

    LINKINFO command being processed

;

    rlghncxa03w 04-07-29 11:31:09 EST  EAGLE5 31.6.0
    LINKINFO command complete

;
```

This example shows acknowledgment times for an IPLIMx M2PA connection on signaling link B1:

```
pass:loc=1301:cmd="linkinfo b1 -m"

    rlghncxa03w 04-07-29 11:31:09 EST  EAGLE5 31.6.0
    PASS: Command sent to card
;

    rlghncxa03w 04-07-29 11:31:09 EST  EAGLE5 31.6.0

    LINKINFO: Command In Progress

;

    rlghncxa03w 04-07-29 11:31:09 EST  EAGLE5 31.6.0
    IPLIMx M2PA Measurements Information for Port B1

    Measured M2PA Traffic Acknowledgement Times

        Minimum acknowledge time      : 14
        Maximum acknowledge time      : 35
        Weighted Average acknowledge time: 17
        Last recorded acknowledge time : 20

    end of report

;

    rlghncxa03w 04-07-29 11:31:09 EST  EAGLE5 31.6.0

;
```

This example shows state information for signaling link A1:

```
pass:loc=1301:cmd="linkinfo a1 -s"

rlghncxa03w 03-07-29 11:31:09 EST  EAGLE5 30.0.0
PASS: Command sent to card
;

rlghncxa03w 03-07-29 11:31:09 EST  EAGLE5 30.0.0

LINKINFO command being processed
;

rlghncxa03w 03-07-29 11:31:09 EST  EAGLE5 30.0.0
SLK      LINKINFO STATE
1301,A1  OOS      CONNECTING

end of report
;

rlghncxa03w 03-07-29 11:31:09 EST  EAGLE5 30.0.0
LINKINFO command complete
;
```

### Output for IPSG Card

This example shows the signaling link event log for an IPSG-M3UA link:

```
pass:loc=1304:cmd="linkinfo a -1"

Command Accepted - Processing

eagle10110 08-01-16 16:52:59 EST  EAGLE 38.0.0
pass:loc=1304:cmd="linkinfo a -1"
Command entered at terminal #3.
;

eagle10110 08-01-16 16:52:59 EST  EAGLE 38.0.0
PASS: Command sent to card
;

eagle10110 08-01-16 16:52:59 EST  EAGLE 38.0.0

IP7 Layer 2 Link Events for Link A

08-01-16 15:03:37.080 LINK_STATE_INHIBITED
08-01-16 15:05:23.510 L3_L2_EMERGENCY_Cease
08-01-16 15:05:23.510 L3_L2_START
08-01-16 15:05:23.510 LINK_STATE_NOT_ALIGNED
08-01-16 15:53:02.660 ASP_UP
08-01-16 15:53:02.660 LINK_STATE_ALIGNED_READY
08-01-16 16:19:45.755 ASP_ACTIVE
08-01-16 16:19:45.755 LINK_STATE_INS
08-01-16 16:19:45.755 L2_L3_IN_SERVICE
08-01-16 16:19:45.780 L3_L2_LINKSET_ALLOWED
```

end of report

;

This example shows the signaling link event for an IPSP-M2PA link:

```
pass:loc=1314:cmd="linkinfo b2 -1"
```

```
eagle10110 08-01-16 16:46:05 EST EAGLE 38.0.0
```

```
IP7 Layer 2 Link Events for Link B2
```

```
08-01-16 16:45:26.050 L3_L2_START
08-01-16 16:45:26.050 L2_L3_OUT_OF_SERVICE
08-01-16 16:45:26.060 RETRIEVAL_COMPLETE
08-01-16 16:45:26.860 L3_L2_EMERGENCY
08-01-16 16:45:26.860 L3_L2_START
08-01-16 16:45:26.860 L2_L3_OUT_OF_SERVICE
08-01-16 16:45:26.870 RETRIEVAL_COMPLETE
08-01-16 16:45:27.215 IP_CONN_OPENED
08-01-16 16:45:27.215 LINK_STATE_CONNECTING
08-01-16 16:45:27.215 IP_CONN_ALLOWED
08-01-16 16:45:27.225 IP_CONN_CONNECTED
08-01-16 16:45:27.225 M2PA_LSO_TRANSMITTED
08-01-16 16:45:27.225 LINK_STATE_CONNECTED
08-01-16 16:45:27.230 M2PA_LSO_RECEIVED
08-01-16 16:45:27.670 L3_L2_EMERGENCY
08-01-16 16:45:27.670 L3_L2_START
08-01-16 16:45:27.670 M2PA_LSA_TRANSMITTED
08-01-16 16:45:27.670 LINK_STATE_NOT_ALIGNED
08-01-16 16:45:27.680 M2PA_LSA_RECEIVED
08-01-16 16:45:27.680 M2PA_LSPE_TRANSMITTED
08-01-16 16:45:27.680 LINK_STATE_ALIGNED
08-01-16 16:45:27.685 M2PA_LSPE_RECEIVED
08-01-16 16:45:27.685 LINK_STATE_PROVING
08-01-16 16:45:27.890 M2PA_T16_EXPIRED
08-01-16 16:45:28.085 M2PA_T16_EXPIRED
08-01-16 16:45:28.185 M2PA_T4_EXPIRED
08-01-16 16:45:28.185 M2PA_LSR_TRANSMITTED
08-01-16 16:45:28.185 LINK_STATE_ALIGNED_READY
08-01-16 16:45:28.195 M2PA_LSR_RECEIVED
08-01-16 16:45:28.195 L2_L3_IN_SERVICE
08-01-16 16:45:28.195 M2PA_LSR_TRANSMITTED
08-01-16 16:45:28.195 LINK_STATE_INS
08-01-16 16:45:28.200 M2PA_LSR_RECEIVED
```

end of report

;

```
eagle10110 08-01-16 16:46:05 EST EAGLE 38.0.0
```



```
LINKINFO: Command Complete
```

```
;
```

This example shows sets the filter to include UA events in the UA log report for signaling link A:

```
pass:loc=1304:cmd="linkinfo a -i ua"
```

```
rlghncxa03w 08-01-29 11:31:09 EST EAGLE 38.0.0
```

```
Link event type (ua) is logged for link A
```

```
end of report
```

```
;
```

This example sets the filter to include service events in the UA log report for signaling link A:

```
pass:loc=1304:cmd="linkinfo a -i service"
```

```
rlghncxa03w 08-01-29 11:31:09 EST EAGLE 38.0.0
```

```
Link event type (service) is logged for link A
```

```
end of report
```

```
;
```

This example shows the UA log report for signaling link A:

```
pass:loc=1304:cmd="linkinfo a -a"
```

```
rlghncxa03w 08-01-29 11:31:09 EST EAGLE 38.0.0
```

```
Adapter Layer Events for Link A
```

```
UALOG: UA event history log
        UA Version: 01
        ASP ID: undefined
        User Adapter Implemented: M3UA RFC
        Current settings: -i service ua
```

Date	Time	Event
08-01-16	15:51:45.890	IP Conn Established
08-01-16	15:51:45.890	Transition to SERVER_DOWN (RC=0000000004)
08-01-16	15:53:02.660	ASPUP PDU Received (ASP ID=undefined)
08-01-16	15:53:02.660	Transition to SERVER_INACTIVE (RC=0000000004)
08-01-16	15:53:02.660	ASP to SLK Up
08-01-16	15:53:02.660	Link Activated
08-01-16	15:53:02.660	ASPUPACK PDU Transmitted

```

08-01-16 15:53:02.660 AS INACTIVE NTFY PDU Transmitted
(RC=0000000004)
08-01-16 16:19:45.755 ASPACTIVE PDU Received (RC=none)
08-01-16 16:19:45.755 ASPACTIVEACK PDU Transmitted
(RC=0000000004)
08-01-16 16:19:45.755 Transition to SERVER_ACTIVE LOADSHARE
(RC=0000000004)
08-01-16 16:19:45.755 ASP to SLK Active
08-01-16 16:19:45.780 AS Active
08-01-16 16:19:45.780 AS ACTIVE NTFY PDU Transmitted
(RC=0000000004)

```

end of report

;

This example clears the UA log report for signaling link A:

```
pass:loc=1304:cmd="linkinfo a -a -r"
```

```
rlghncxa03w 08-01-29 11:31:09 EST EAGLE 38.0.0
```

```
LINKINFO: Command Complete
```

;

This example shows link measurement information for an IPSG-M2PA signaling link:

```
pass:loc=1301:cmd="linkinfo b2 -m "
```

```
rlghncxa03w 08-01-29 11:31:09 EST EAGLE5 38.0.0
```

```
M2PA Measurements Information for Link B2
```

```
Measured M2PA Traffic Acknowledgement Times
```

```

Minimum acknowledge time      : 16
Maximum acknowledge time      : 44
Weighted Average acknowledge time: 16
Last recorded acknowledge time : 16

```

end of report

;

This example shows state information for an IPSG-M3UA signaling link:

```
pass:loc=1301:cmd="linkinfo a -s "
```

```
rlghncxa03w 08-01-29 11:31:09 EST EAGLE 38.0.0
```

```
IP7 Layer 2 Link State Information for Link A
```

```
LINK_STATE_ALIGNED          ASP_STATE_SERVER_DOWN
```

```
end of report
```

```
;
```

This example shows state information for an IPSP-M2PA signaling link:

```
pass:loc=1314:cmd="linkinfo b2 -s"
```

```
rlghncxa03w 08-01-29 11:31:09 EST  EAGLE 38.0.0
```

```
IP7 Layer 2 Link State Information for Link B2
```

```
LINK_STATE_INS              IP_CONN_STATE_ESTABLISHED
```

```
end of report
```

```
;
```

This example shows congestion tuning information for an IPSP-M3UA signaling link:

```
pass:loc=1301:cmd="linkinfo a -c "
```

```
rlghncxa03w 08-01-29 11:31:09 EST  EAGLE 38.0.0
```

```
Congestion Tuning Information for Link A
```

```
High-Water Mark             : 0
```

```
High-Water Mark Date & Time : 00-00-00 00:00:00.000
```

```
HMCG SLK Congestion Threshold Values
```

```
Danger of Congestion Onset : 240
Abatement Level-1          : 241
Onset Level-1               : 480
Abatement Level-2          : 481
Discard Level-1             : 600
Onset Level-2               : 605
Abatement Level-3          : 606
Discard Level-2             : 720
Onset Level-3               : 725
Discard Level-3             : 840
Maximum Buffers for L2     : 960
```

```
HMCG Card-Level Congestion Threshold Values
```

```
Danger of Congestion Onset : 2500
```

```
Abatement Level-1      : 2501
Onset Level-1          : 5000
Abatement Level-2      : 5001
Discard Level-1        : 7601
Onset Level-2          : 6251
Abatement Level-3      : 6252
Discard Level-2        : 7601
Onset Level-3          : 7501
Discard Level-3        : 7601
Maximum Buffers for L2 : 10000
High Water Mark        : 0
```

end of report

;

```
rlghncxa03w 08-01-29 11:31:09 EST EAGLE 38.0.0
```

```
LINKINFO: Command Complete
```

;

This example shows congestion tuning information for an IPSPG-M2PA signaling link:

```
pass:loc=1301:cmd="linkinfo b2 -c "
```

```
rlghncxa03w 08-01-29 11:31:09 EST EAGLE 38.0.0
Congestion Tuning Information for Link B2
```

```
RETX Queue Depth threshold : 240
```

```
High-Water Mark            : 0
```

```
High-Water Mark Date & Time : 00-00-00 00:00:00.000
```

```
HMCG SLK Congestion Threshold Values
```

```
Danger of Congestion Onset : 120
Abatement Level-1          : 121
Onset Level-1              : 240
Abatement Level-2          : 241
Discard Level-1            : 300
Onset Level-2              : 305
Abatement Level-3          : 306
Discard Level-2            : 360
Onset Level-3              : 365
Discard Level-3            : 420
Maximum Buffers for L2     : 480
```

```
HMCG Card-Level Congestion Threshold Values
```

```
Danger of Congestion Onset : 2500
Abatement Level-1          : 2501
Onset Level-1              : 5000
Abatement Level-2          : 5001
Discard Level-1            : 7601
Onset Level-2              : 6251
Abatement Level-3          : 6252
Discard Level-2            : 7601
Onset Level-3              : 7501
Discard Level-3            : 7601
Maximum Buffers for L2     : 10000
High Water Mark            : 2
```

```
end of report
```

```
;
```

```
rlghncxa03w 08-01-29 11:31:09 EST EAGLE 38.0.0
```

```
LINKINFO: Command Complete
```

```
;
```

This example shows congestion levels for signaling links on E5-E1T1-B and E5-ATM-B cards:  
**For SS7HC:**

```
Command Executed
```

```
tekelecstp 02-01-24 00:38:06 MST 46.0.0-65.11.0
```

```
Congestion Tuning Information for Link A
```

```
HMCG SLK Congestion Threshold Values
```

```
Danger of Congestion Onset : 59
Abatement Level-1          : 60
Onset Level-1              : 80
Discard Level-1            : 99
Abatement Level-2          : 81
Onset Level-2              : 101
Discard Level-2            : 109
Abatement Level-3          : 102
Onset Level-3              : 111
Discard Level-3            : 120
Maximum Buffers for L2     : 130
```

```
TB count                   : 0
```

```
RTB count                   : 0
```

```
L3 L2 MSU count            : 0
```

```
;
```

```
tekelecstp 02-01-24 00:38:06 MST 46.0.0-65.11.0
```

```
LINKINFO: Command Complete
```

**For ATMHC:**

```

Command Executed
tekelecstp 02-01-24 00:36:45 MST 46.0.0-65.11.0
Congestion Tuning Information for Link A
HMCG SLK Congestion Threshold Values
  Danger of Congestion Onset : 885
  Abatement Level-1         : 900
  Onset Level-1             : 1200
  Discard Level-1          : 1800
  Abatement Level-2        : 1215
  Onset Level-2            : 1515
  Discard Level-2          : 1800
  Abatement Level-3        : 1530
  Onset Level-3            : 1665
  Discard Level-3          : 1800
  Maximum Buffers for L2   : 1950

TB count                    : 0

RTB count                   : 10

L3 L2 MSU count            : 0
;
tekelecstp 02-01-24 00:36:45 MST 46.0.0-65.11.0
LINKINFO: Command Complete

```

This example shows state information when graceful shutdown has occurred:

```
pass:loc=1305:cmd="linkinfo -a a"
```

```

rlghncxa03w 09-04-29 11:31:09 EST EAGLE 41.0.0

Adapter Layer Events for Link A

UALOG: UA event history log
       UA Version: 01
       ASP ID: undefined
       User Adapter Implemented: M3UA RFC
       Current settings: -i ua
                       -x service

Date      Time          Event
-----
08-10-08 09:29:15.705  Management IP Conn Close
08-10-08 09:29:15.705  Transition to SERVER_SHUTDOWN
                       (RC=0000000002)
08-10-08 09:29:15.705  ASP to SLK Down
08-10-08 09:29:15.705  Link Not Aligned
08-10-08 09:29:15.705  UA Graceful Shutdown
08-10-08 09:29:15.710  UA Shutdown Complete
08-10-08 09:29:15.710  Transition to IDLE
                       (RC=0000000002)

```

end of report

## msucount

This command is used to report the count of SS7 MSUs and bytes that pass through links, routing keys, and IP connections. These counts can be reported and reset at the same time to get accurate counts for longer periods of time. In addition to MSUs transmitted and received, the command also reports statistics on packets related to MTP Primitives and on discarded transmit and receive data.

### Options

Options and option parameters that are underlined indicate that a value must be specified for that option or parameter. For example, the `msucount` command option `-l` has the parameter port. The link for which counts will be displayed can be specified, as in the command `msucount -l a1`. Do not enter the underlined option or parameter; enter a value for the information represented by the underlined option or parameter.

`-a`

This option is used to display IP connection statistics for a specific association. When `-a aname` is specified on the same line as `-k rtkey`, the output is assumed to be routing key output. When `-a aname` is specified on the command line without `-k rtkey`, association statistics output is generated.

For IPSPG cards, this option is enhanced to include receive and transmit counts for M3UA SSNMs (DAUD messages and M3UA SSNM PDUs) and replicated M3UA PDUs.

`-b`

This option is used to display signaling link bytes statistics. The signaling link bytes report displays data for measurements on a per-signaling-link basis for both the transmit and receive directions. The report can display link statistics for a specified signaling link number. If a link is not specified, the report displays link statistics for signaling link A for IPGWx cards and for all equipped signaling links for IPLIMx and IPSPG cards. If a signaling link is valid for the card and application type, but is unequipped, then the report displays all zeros.

`-h`

This option is used to provide help information for the command.

`-f`

This option is used to display a full report (IPGWx application only).

`-k rtkey`

This option is used to specify the routing key for which the counts will be displayed. The routing key is specified as a single parameter with up to five colon-separated fields. The subsystem is not specified when SI is not equal to 3.

This option is not supported for the IPSPG cards.

The `-p` modifier can be specified to identify the point code type of the routing key that follows the `-k` option in the command.

The `-p` modifier is not supported for IPLIMx and IPSPG cards.

The rtkey variable is optional when used with `-t default`, and mandatory for all other cases.

The following formats are valid for the routing key that follows the `-k` option in the command:

- n-c-m:s:n-For DPC, SI, SSN type routing keys. The network, cluster and member (*n-c-m*) are in the range 0-255. The service indicator (*s*) is 3 or *sccp*. The subsystem (*n*) is in the range 0-255.
- n-c-m:s-For DPC, SI, type routing keys. The network, cluster and member (*n-c-m*) are in the range 0-255. The service indicator (*s*) is in the range 0-2, 4, or 6-15. There is no subsystem. As a default, counts for all routing keys within the option combination are displayed.
- n-c-m:s:no-co-mo:cs:ce-For DPC, SI, CIC type routing keys. The DPC network, cluster and member (*n-c-m*) are in the range 0-255. The service indicator (*s*) is 5 or *isup*. There is no subsystem. The OPC network, cluster and member (*no-co-mo*) are in the range 0-255. The starting circuit identification code (*cs*) and ending circuit identification code (*ce*) are in the range 0 to 16363.

-l

For IPSPG cards, this option displays the link report for all equipped signaling links on the card.

-l link

This option is used to display counts for links. The link report optionally allows display of link statistics for a specified port.

The link report contains data, per link, for MSUs (tx/rcv), MSU bytes (tx/rcv), MGMT msgs (tx/rcv), and discarded data (tx/rcv).

For the IPSPG card, the M2PA link report is the same as the IPLIMx M2PA report. The M3UA link report contains an additional detail line for non-discard pegs for SS7 SNM and Replicated M3UA PDU counts.

**Range:**

*a, b, a1, b1, a2, b2, a3, b3a:a63-b:b63*

If a port is not specified, `msucount` displays link statistics for port *a* for IPGWx links, and port *a* and port *b* for IPLIMx links.

The `msucount` link statistics report contains all zeros for a port that is valid for the card and application type but is unequipped.

The range *a:a15-b:b15* is valid for IPSPG ENET cards.

The range *a:a63-b:b63* is valid for IPSPG ENET cards.

-l

link -f

This option displays the full link report. For IPSPG-M2PA links, this option displays the same report as the `-l <link>` option. For IPSPG-M3UA links the report includes the data from the `-l <link>` report and includes an additional detail line displaying tx/rcv discards counts and discard data.

-p point code type

This option modifier can be specified along with the `-k` option to identify the point code type (ANSI, ITU international, ITU-national, 24-bit ITU national, 16-bit ITU national, ITU international spare, and ITU national spare) in the routing key that follows the `-k` option in the command.

**Range:**

*ansi, itui, itun, itun24, itun16, ituis, ituns*

-r



This option is used with other options to reset counts at the same time of reporting them.

`-t keytype`

This option is used to display the routing key type (IPGWx only).

`-x`

The routing context is an index that uniquely defines a routing key associated with an SUA or M3UA AS. For the IPGS card, the option displays a link report for all signaling links on the card that are members of the linkset that contains the specified routing context value (equivalent to the **msucount -l** report. The `-x` option is used as an alternative to the `-k` option to identify the routing key by specifying its routing context in the command line.



#### Note:

The `-x rc` option can only be used to specify routing keys containing M3UA/SUA associations.

### Example

Link counts only. Displays brief count for signaling link a for IPGWx. Displays counts for all equipped signaling links for IPLIMx.

```
msucount -l
```

Link counts only, for signaling link port a1.

```
msucount -l a1
```

Full/detail report for signaling link a for IPGWx.

```
msucount -l -f
```

Counts for the specified association only.

```
msucount -a association name
```

Counts for first matching routing key

```
msucount -k 10-10-10:3:16
```

Counts for the routing key report using the routing context.

```
msucount -x 5
```

Counts for first matching routing key and an associated association.

```
msucount -a association name -k rtkey
```

Counts for the default routing key

```
msucount -k -t default
```

Counts for a matching partial routing key.

```
msucount -k 3-3-3 -t partial
```

Counts for counts for link only. Displays brief report for signaling link a for IPGWx. Displays counts for all equipped signaling links for IPLIMx.

```
msucount
```

Resets the signaling link count measurements.

```
msucount -r
```

Brief version of help text.

```
msucount -h
```

Full version of help text.

```
msucount -h full
```

Counts for link and first matching routing key

```
msucount -b
```

Byte report for signaling link A for IPGWx cards. Byte report for all equipped signaling links for IPLIMx cards.

```
msucount -b -link
```

Byte report for specified signaling link.

```
msucount -l -k 10-10-10:3:16
```

Use with other parameters to display and reset counts. Valid with the above combinations.

```
msucount -l -r
```

```
msucount -r
```

```
msucount -x 5 -r
```

Examples showing the correct syntax to specify partial or default keys, or to specify a key by routing context:

```
pass:loc=1105:cmd="msucount -k 5-5-1:5:6-6-6 -t partial
```

```
pass:loc=1105:cmd="msucount -k 5-5-1:5 -t partial"
```

```
pass:loc=1105:cmd="msucount -p ITUI -t partial -k 1-235-1"
```

```
pass:loc=1105:cmd="msucount -p ITUN -t partial -k 2351"
```

```
pass:loc=1105:cmd="msucount -p ITUN -t partial -k 2351-gr
```

```
pass:loc=1105:cmd="msucount -t partial -k :2 "
```

```
pass:loc=1105:cmd="msucount -k -t default"
```

```
pass:loc=1105:cmd="msucount -p ITUN24 -t partial -k 10-235-1"
```

```
pass:loc=1105:cmd="msucount -p ITUN24 -t partial -k 10-235-1"
```

```
pass:loc=1105:cmd="msucount -p ITUN16 -t partial -k 1-2-1"
```

Examples of other valid routing key inputs:

```
pass:loc=1105:cmd="msucount -r -k 5-5-6:5:5-5-7:1:1000"
```

```
pass:loc=1105:cmd="msucount -r -p ITUI -k 5-5-6:4:5-5-7:1:1000"
```

```
pass:loc=1105:cmd="msucount -k 5-5-1:3:5 -a assoc1"
```

```
pass:loc=1105:cmd="msucount -r -p ITUN24 -k
15-105-16:5:15-105-17:1:1000"
```

### Dependencies

At least one option must be specified.

### Notes

The `msucount` command is executed through the `pass` command.

Combinations of the `-l`, `-a`, `-k`, `-t`, `-x` and `-b` options provide count information based on the entered combination.

If no parameters are specified, then the `-l` brief report is output.

Multiple reports are not supported with the IP Signaling Serviceability feature.

For the SS7IPGW and IPGWI GPLs, 4 types of reports can be generated: the link report, the routing key report, the IP connection statistics report, and the signaling link bytes report. For the IPLIMI card, the routing key report is not supported.

The 4 reports are:

1. The link report (`-l` option) contains statistics per link about MSUs (transmit/receive), MSU bytes (transmit/receive), MGMT messages (transmit/receive), and discarded data (transmit/receive).
2. The routing key report (`-k` option) contains statistics for a specific routing key about MSUs (transmit), MSU bytes (transmit), and discards on the transmit path for the routing key.

A list of one or more IP connections associated with the routing key, with the MSU and MSU bytes counts for each connection, is also displayed. If `-a aaname` is in the same input command with `-k rtkey`, only the connection association data for the specified connection is displayed. If `-a aaname` is not specified with `-k rtkey`, all connection associations are listed. If `-x rc` is specified, only the connection association data for the specified routing context is displayed.

The `-p` (point code type) modifier option can be used with the `-k` option to specify the point code type of the routing key that follows the `-k` option in the command.

For the `-k` options, the routing key must be an exact match of a routing key that exists in the static Routing Key table.

3. The IP connection statistic report (`-a aaname` option) contains statistics for a specified IP connection about MSUs (transmit/receive), MSU bytes (transmit/receive), and discarded data (transmit/receive).

When the `-a aaname` option is specified in the command with the `-k` option, the output type is assumed to be routing key output.

When the `-a aaname` option is specified in the command without the `-k` option, association statistics output is generated.

4. The signaling link bytes report (`-b` option) provides the following information for both IPGWx and IPLIMx cards: bytes/sec for the last second, average MSU size during the last second, and maximum one-second average MSU size since card load time or reset. For the IPLIMx cards, the report also provides the following information: sum of bytes/sec for the last second for all signaling link, average MSU size for last second for all signaling links, maximum average MSU size since load time or reset for all signaling links, and maximum MSU size since load time or reset for all signaling links.

The link report, routing key report, and IP connection statistics report (IPGWx only) can display individual transmit MSUs that were discarded at layer 2. The first 32 bytes of the MSU transmit data that is discarded is stored beginning at the SIO bytes. If the MSU is not 32 bytes long, the remaining bytes are set to 0.

The signaling link bytes report optionally allows display of link statistics for a specified signaling link number. If a link is not specified for the bytes report, the `msucount` command displays link statistics for signaling link A for IPGWx cards and for all equipped signaling links for IPLIMx cards.

The signaling link bytes report contains all zeros for a signaling link that is valid for the card and application type but that is unequipped.

The link and IP connection statistics reports can display individual receive packets that were discarded at layer 2. If the storage space is larger than the service data, the extra bytes are set to 0.

The reset option (`-r`) resets the specified measurements. This option can be added to any command.

## Output

In these examples, the hexadecimal output for discarded *transmit* data represents data stored beginning at the SIO bytes through the first 32 bytes of the MSU. If the MSU was less than 32 bytes, the remaining bytes are represented by zeros.

Stored *receive* data takes the following format:

- Bytes 13-x = Service data. If the storage space is greater than the size of the service data, the remaining bytes are zeroed.

## Output Specific to SS7IPGW and IPGWI

Either brief or full help reports can be displayed. A full help report is generated by adding the `full` (`-f`) option to the command line.

This example shows a brief help report:

```
pass:loc=1105:cmd="msucount -h"

tekelecstp 10-09-10 11:50:34 EST  EAGLE 43.0.0

Usage: msucount [ [-l [link]] | [-b [link]] ] |
               [ [-a aname] ] |
               [ [-x rc] | [-k [rtkey] [-p pctype] [-t keytype]] ]
               [-f] [-r] [-h [full]]

Options: -l  display signaling link report
         -b  display signaling link bytes report
         -a  display association report
         -x  routing key report using routing context
         -k  routing key report using MTP3 parameters
            rtkey :: ([dpc][:si][:opc | :ssn][:cics][:cice])
         -p  pctype :: (ANSI, ITUI, ITUN, ITUN24, ITUN16, ITUIS,
ITUNS)
         -t  routing key type
            keytype :: (<full>, partial, default)
         -f  display full report
         -r  resets the specified counts
         -h  display command help (brief or full)

tekelecstp 10-09-10 11:50:34 EST  EAGLE 43.0.0
MSUCOUNT command complete

;
```

This example shows a full help report:

```
pass:loc=1105:cmd="msucount -h full"
```

```
tekelecstp 10-09-10 11:50:34 EST EAGLE 43.0.0
```

```
Usage: msucount [ [-l [link]] | [-b [link]] ] |
               [ [-a aname] ] |
               [ [-x rc] | [-k [rtkey] [-p pctype] [-t keytype]] ]
               [-f] [-r] [-h [full]]
```

```
Options: -l display signaling link report
         -b display signaling link bytes report
         -a display association report
         -x routing key report using routing context
         -k routing key report using MTP3 parameters
           rtkey :: ([dpc][:si][:opc | :ssn][:cics][:cice])
         -p pctype :: (ANSI, ITUI, ITUN, ITUN24, ITUN16, ITUIS, ITUNS)
         -t routing key type
           keytype :: (<full>, partial, default)
         -f display full report
         -r resets the specified counts
         -h display command help (brief or full)
```

-k option details:

Use the -p option along with -k to specify the SS7 network domain and point code format for the network. The SS7IPGW default pctype is ANSI. The IPGWI default pctype is ITUI.

Network	PC Format	Notes
ANSI	N-C-M	
ITUN	N	Non-Spare ITU National, no group code
ITUN	N-GC	Non-Spare ITU National with group code
ITUI	Z-A-I	Non-Spare ITU International
ITUN24	N-C-M	Non-Spare ITU National, 24-bits
ITUN16	U-S-M	Non-Spare ITU National, 16-bits
ITUNS	N	Spare ITU National, no group code
ITUNS	N-GC	Spare ITU National with group code
ITUIS	Z-A-I	Spare ITU International

Use the -t option along with -k to specify certain MTP3 and user part MSU fields as wildcards for the routing key.

SS7 Traffic Partition	RTKEY Parameter	Example
Any User Part to DPC 1-1-1	-k 1-1-1	-t partial
SCCP to DPC 1-1-1	-k 1-1-1:3	-t partial
ISUP to DPC 1-1-1	-k 1-1-1:5	-t partial
TUP to DPC 1-1-1	-k 1-1-1:4	-t partial
QBICC to DPC 1-1-1	-k 1-1-1:13	-t partial
SI [0-2,6-12,14,15] to DPC 1-1-1	-k 1-1-1:SI	
SCCP SSN 5 to DPC 1-1-1	-k 1-1-1:3:5	
ISUP to DPC 1-1-1 from OPC 2-2-2	-k 1-1-1:5:2-2-2	-t partial
TUP to DPC 1-1-1 from OPC 2-2-2	-k 1-1-1:4:2-2-2	-t partial

```

QBICC to DPC 1-1-1 from OPC 2-2-2 -k 1-1-1:13:2-2-2 -t partial
ISUP CIC 1 to 1-1-1 from 2-2-2 -k 1-1-1:5:2-2-2:1
TUP CIC 1 to 1-1-1 from 2-2-2 -k 1-1-1:4:2-2-2:1
QBICC CIC 1 to 1-1-1 from 2-2-2 -k 1-1-1:13:2-2-2:1
ISUP CIC 0-5 to 1-1-1 from 2-2-2 -k 1-1-1:5:2-2-2:0:5
TUP CIC 0-5 to 1-1-1 from 2-2-2 -k 1-1-1:4:2-2-2:0:5
QBICC CIC 0-5 to 1-1-1 from 2-2-2 -k 1-1-1:13:2-2-2:0:5
Default Routing Key -k -t
default

tekelecstp 10-09-10 11:50:34 EST EAGLE 43.0.0
MSUCOUNT command complete

```

A brief version for the link measurement report can be specified for IPGWx. If no parameters are specified for a link measurements report, then a brief report is displayed. The brief report does not display the transmit/receive discard counts.

This example shows a brief link measurements report:

```

pass:loc=1305:cmd="msucount"
or
pass:loc=1305:cmd="msucount -l"

tekelecstp 10-08-17 11:50:34 EST EAGLE 42.0.0

MSUCOUNT: MSU Count Report

-----
Link Measurements (Link A)
-----

Transmit Counts                                Receive Counts
-----
rate  msus          bytes          rate  msus          bytes
-----
2000  4294967295  4294967295  2000  4294967295  4294967295

MTP Primitive (MTPP) counts                    Reroute Counts
-----
sent pdus   rcvd pdus   dscrd pdus   sent msus   rcvd msus
-----
4294967295  4294967295  4294967295  4294967295  4294967295

MSUCOUNT: command complete
;

```

This example shows a full link measurements report:

```

pass:loc=1305:cmd="msucount -f"
or

```

```
pass:loc=1305:cmd="msucount -l -f"
```

```
tekelecstp 10-08-17 11:50:34 EST EAGLE 42.0.0
```

```
MSUCOUNT: MSU Count Report
```

```
-----  
Link Measurements (Link A)  
-----
```

```
Transmit Counts
```

```
-----  
rate  msus      bytes  
-----  
2000  4294967295  4294967295
```

```
Receive Counts
```

```
-----  
rate  msus      bytes  
-----  
2000  4294967295  4294967295
```

```
MTP Primitive (MTPP) Counts
```

```
-----  
sent pdus  rcvd pdus  dscrd pdus  
-----  
4294967295 4294967295 4294967295
```

```
Reroute Counts
```

```
-----  
sent msus  rcvd msus  
-----  
4294967295 4294967295
```

```
Transmit Discard Counts
```

```
-----  
reason                                     count  
-----  
no ss7 rtbl entry                        4294967295  
no ss7 rtkey                             4294967295  
no conn avail to pc                      4294967295  
no conn avail to rtkey                   4294967295  
congested connection                     4294967295  
sccp msg type                            4294967295  
sccp class                               4294967295  
circular rte                             4294967295  
normalization error                      4294967295  
invalid traffic type                     4294967295  
M3UA conversion error                    4294967295  
SUA conversion error                     4294967295  
AS-Pending overflow                      4294967295  
AS timer Tr expiry                       4294967295  
reroute failure                          4294967295  
unexpected for APC                       4294967295  
lrg MSU not supported                    4294967295
```

```
Receive Discard Counts
```

```
-----  
reason                                     count  
-----  
link state                               4294967295  
sccp msg type                            4294967295  
sccp class                               4294967295  
sccp called party                        4294967295  
sccp calling party                       4294967295  
isup sio                                 4294967295  
normalization error                      4294967295  
error in XSRV packet                     4294967295  
M3UA PDU error                           4294967295  
SUA PDU error                             4294967295  
invalid rcontext                          4294967295  
management blocking                      4294967295  
lrg MSU not supported                    4294967295
```

```
Stored Transmit Discard Data
```

```
-----  
83 01 05 05 0a 01 03 bf 09 80 03 08 0d 05 c3 07  
01 05 05 05 c3 07 0a 01 03 08 e2 06 c7 04 13 10
```

```

Stored Receive Discard Data
-----
53 41 53 49 73 63 63 70 1a 00 09 01 03 08 0d 05
c3 05 0a 01 03 05 c3 05 01 05 05 08 e2 06 c7 04

MSUCOUNT: command complete
;

```

This example shows an output report when all counts are zero:

```

pass:loc=1305:cmd="msucount -f"
or
pass:loc=1305:cmd="msucount -l -f"

```

```

MSUCOUNT: MSU Count Report
-----
Link Measurements (Link A)
-----

Transmit Counts                                Receive Counts
-----
rate  msus      bytes          rate  msus      bytes
-----
00000 00000      00000          00000 00000      00000

MTP Primitive (MTPP) Counts                    Reroute Counts
-----
sent pdu  rcvd pdu  dscrd pdu  sent msus  rcvd msus
-----
00000      00000      00000          00000      00000

Transmit Discard Counts                        Receive Discard Counts
-----
reason          count          reason
count
-----
no transmit discard counts                    no receive discard counts

Stored Transmit Discard Data
-----
no stored transmit discard data

Stored Receive Discard Data
-----
no stored receive discard data

```



```
MSUCOUNT: command complete
```

### Routing Key Report Output Examples

The routing key report contains data about MSUs (tx), MSU bytes (tx), and discards on the transmit path for the routing key. A list of one or more connections associated with the routing key, with the MSU and MSU bytes counts for each connection, is also presented. If `-a aname` is in the same input command with `-k rtkey`, only the connection association data for the specified connection is displayed. If `-a aname` is not specified with `-k rtkey`, all connection associations are listed. If `-x rc` is specified, only the connection association data for the specified routing context is displayed.



#### Note:

For IPGWx, `-k rtkey` is optional when used with `-t default`, and mandatory for all other cases.

The report output itself does not display the routing key that was entered, other than an exact copy of the command line being generated as part of the output.

Partial routing keys (where some fields in the MSU are ignored with respect to finding a routing key to use for the MSU) and default keys can be specified in the command. The output does not change for these key types; the only difference is the routing key syntax (`-p`) that must be processed as part of identifying the partial and default keys. (See the Example section of this command description for syntax examples).

This example shows a routing key report for an ANSI routing key that specifies the Routing Key table:

```
pass:loc=1105:cmd="msucount -k 5-5-1:3: -t partial"
```

```
tekelecstp 10-09-10 11:50:34 EST EAGLE 43.0.0
```

```
MSUCOUNT: MSU Count Report
```

```
-----  
Routing Key Measurements for Static Routing Key  
-----
```

```
Transmit Counts
```

```
-----  
tx bytes                4294967295  
tx msus                 4294967295
```

```
Transmit Discard Counts
```

```
-----  
sccp msg type          4294967295  
sccp class             4294967295  
normalization error    4294967295  
invalid traffic type   4294967295
```

```
Associated IP Connection      tx bytes      tx msus
```

```

-----
c7000                                4294967295
4294967295
c7050                                4294967295
4294967295
c7052                                4294967295
4294967295
c7054                                4294967295
4294967295

```

Stored Transmit Discard Data

```

-----
83 01 05 05 0a 01 03 94 09 01 03 08 0d 05 c3 05
01 05 05 05 c3 05 0a 01 03 08 e2 06 c7 04 28 10

```

MSUCOUNT: command complete

;

This example shows an ITU-I routing key report (only 1 specific association is displayed):

```
pass:loc=1105:cmd="msucount -p ITUI -k 5-5-1:3:5 -a c7000"
```

```
tekelecstp 10-09-10 11:50:34 EST EAGLE 43.0.0
```

MSUCOUNT: MSU Count Report

-----  
Routing Key Measurements for Static Routing Key  
-----

Transmit Counts

```

-----
tx bytes:                            4294967295
tx msus:                              4294967295

```

Transmit Discard Counts

```

-----
sccp msg type                        4294967295
sccp class                           4294967295
normalization error                  4294967295
invalid traffic type                 4294967295

```

```

Associated IP Connection              tx bytes      tx msus
-----
c7000                                4294967295
4294967295

```

Stored Transmit Discard Data

```

-----
83 01 05 05 0a 01 03 94 09 01 03 08 0d 05 c3 05
01 05 05 05 c3 05 0a 01 03 08 e2 06 c7 04 28 10

```

```
MSUCOUNT: command complete
;
```

This example shows a routing key report when the routing context =5 (because a table is not specified, the key is searched for in the Static table):

```
pass:loc=1105:cmd="msucount -x 5"
```

```
tekelecstp 10-09-10 11:50:34 EST EAGLE 43.0.0
```

```
MSUCOUNT: MSU Count Report
```

```
-----
Routing Key Measurements for Static Routing Key
-----
```

```
Transmit Counts
```

```
-----
```

```
tx bytes          4294967295
tx msus           4294967295
```

```
Transmit Discard Counts
```

```
-----
```

```
sccp msg type    4294967295
sccp class       4294967295
normalization error 4294967295
invalid traffic type 4294967295
```

Associated IP Connection	tx bytes	tx msus
-----	-----	-----
c7000	4294967295	4294967295
c7050	4294967295	4294967295
c7052	4294967295	4294967295
c7054	4294967295	4294967295

```
Stored Transmit Discard Data
```

```
-----
```

```
83 01 05 05 0a 01 03 94 09 01 03 08 0d 05 c3 05
01 05 05 05 c3 05 0a 01 03 08 e2 06 c7 04 28 10
```

```
MSUCOUNT: command complete
```

### IP Connection Report

This example shows an IP Connection report for an association:

```
pass:loc=1105:cmd="msucount -a c7050"
```

```
tekelecstp 10-09-10 11:50:34 EST EAGLE 43.0.0
```

```
MSUCOUNT: MSU Count Report
```

```
-----
IP Connection Measurements
```

```

-----
Receive Counts                                Transmit Counts
-----
msus          bytes                            msus          bytes
-----
4294967295    4294967295                                4294967295    4294967295

Receive Discard Counts                        Transmit Discard
Counts
-----
reason          count                            reason
count
-----
link state      4294967295    sccp msg type
4294967295
sccp msg type  4294967295    sccp class
4294967295
sccp class     4294967295    normalization error
4294967295
sccp called party 4294967295    invalid traffic type
4294967295
sccp calling party 4294967295    M3UA conversion error
4294967295
isup sio       4294967295    SUA conversion error
4294967295
normalization error 4294967295    management blocking
4294967295
error in XSRV packet 4294967295    transmit queue full
4294967295
M3UA PDU error  4294967295
SUA PDU error   4294967295
invalid rcontext 4294967295

Stored Transmit Discard Data
-----
no stored transmit discard data

Stored Receive Discard Data
-----
53 41 53 49 69 73 6f 74 11 00 87 0a 01 03 01 05
05 00 01 02 03 04 05 06 07 08 09 00 00 00 00 00

MSUCOUNT: command complete

```

;

The transmit queue full reason under Transmit Discard Counts section of this report refers to the count of the messages which are discarded due to connection manager transmit queue full. This count is incremented only for M3UA messages which are discardable.

## Signaling Link Bytes Report

This example shows a signaling link bytes report for an IPGWx card:

```
pass:loc=1305:cmd=msucount -b"
or
```

```
pass:loc=1305:cmd=msucount -b a
```

```
MSUCOUNT: MSU Count Report
```

```
-----
Link Byte Measurements (Link A)
-----
```

SLK Transmit counts				SLK Receive counts			
bytes/ sec	avg msu	max avg msu	max msu	bytes/ sec	avg msu	max avg msu	max msu
444400	2020	2020	2020	444400	2020	2020	2020

```
MSUCOUNT: command complete
```

## Output Specific to IPLIMI

### Note:

The routing key report is not supported for IPLIMx applications. The -k, -t, -p, -x options are not supported because the IPLIMx card does not use routing keys.

### Note:

The IPLIMx reports include all equipped signaling links instead of just ports A and B. These reports include the transmit/receive counts alongside each other for the link case.

This example shows help for using the command:

```
pass:loc=1103:cmd="msucount -h" or
pass:loc=1103:cmd="msucount"
```

```
tekelecstp 10-09-10 11:50:34 EST EAGLE 43.0.0
```

```
Usage: msucount [ [-l [link]] | [-b [link]] ] |
               [ [-a aname] ]
               [-r] [-h]
```

```
Options: -l display signaling link report
         -b display signaling link bytes report
```

```

-a display association report
-r resets the specified counts
-h display command help

tekelecstp 10-09-10 11:50:34 EST EAGLE 43.0.0
MSUCOUNT command complete

;
```

This example shows a link report for an IPLIMx card with 2 M2PA links.

The report does not contain MTPP or RGRP MGMT statistics, because those capabilities are not supported on the IPLIMx applications. The report also does not contain tx/rcv discard data, because there are no discards performed at layer 2 of the IPLIMx applications. The IPLIMx card can also contain 2 links per card; the output contains link data for each link.

```
pass:loc=1301:cmd="msucount"
or
```

```
pass:loc=1301:cmd="msucount -l"
```

```
MSUCOUNT: Command In Progress
```

```

;
MSUCOUNT: MSU Count Report
```

SLK Transmit counts				SLK Receive counts		
slk	rate	msus	bytes	rate	msus	bytes
A	2000	4294967295	4294967295	2000	4294967295	4294967295
B	2000	4294967295	4294967295	2000	4294967295	4294967295
A1	2000	4294967295	4294967295	2000	4294967295	4294967295
B1	2000	4294967295	4294967295	2000	4294967295	4294967295
A2	0000	0000000000	0000000000	0000	0000000000	0000000000

```
MSUCOUNT: command complete
```

This example shows signaling link A1 on an IPLIMx card:

```
pass:loc=1103:cmd="msucount -l a1"
```

```
MSUCOUNT: MSU Count Report
```

SLK Transmit counts				SLK Receive counts		
slk	rate	msus	bytes	rate	msus	bytes
A1	2000	4294967295	4294967295	2000	4294967295	4294967295

```

;
MSUCOUNT: command complete
```

This example shows an IP connection statistics report. The IPLIMx IP connection report does not contain `tx/rcv` discard data, because there are no discards performed at layer 2 of the IPLIMx applications.

```
pass:loc=1105:cmd="msucount -a c7050"
```

```
tekelecstp 10-09-10 11:50:34 EST EAGLE 43.0.0
```

```
MSUCOUNT: MSU Count Report
```

```
-----  
IP Connection Measurements  
-----
```

Transmit Counts		Receive Counts	
msus	bytes	msus	bytes
4294967295	4294967295	4294967295	4294967295

```
MSUCOUNT: command complete
```

```
;
```

### Signaling Link Bytes Report

This example shows a signaling link bytes report for an IPLIMx card:

```
pass:loc=1303:cmd="msucount -b"
```

```
MSUCOUNT: SLK Bytes Report
```

SLK Transmit					SLK Receive				
slk	bytes/sec	avg msu	avg msu	max msu	slk	bytes/sec	avg msu	avg msu	max msu
A	35000	140	273	273	A	35000	140	273	273
B	35000	140	273	273	B	35000	140	273	273
A1	35000	140	578	578	A1	35000	140	578	578
B1	35000	140	273	273	B1	35000	140	273	273
A2	35000	140	140	140	A2	35000	140	140	140
B2	35000	140	169	169	B2	35000	140	169	169
A3	35000	2048	2048	2048	A3	35000	2048	2048	2048
B3	35000	140	166	166	B3	35000	140	166	166
-----					-----				
	280000	140	2048	2048		280000	140	2048	2048

```
MSUCOUNT: command complete
```

This example shows a signaling link bytes report for a specified link on an IPLIMx card:

```
pass:loc=1303:cmd="msucount -b a"
```

```
MSUCOUNT: SLK Bytes Report
```

SLK Transmit					SLK Receive				
slk	bytes/sec	avg msu	avg msu	max msu	slk	bytes/sec	avg msu	avg msu	max msu
A	35000	140	273	273	A	35000	140	273	

```
MSUCOUNT: command complete
```

### Enhanced Reset Option

The reset option resets the specified measurements without displaying `msucount` output. The default is to reset the link measurements report.

This example shows resetting link measurements:

```
pass:loc=1305:cmd="msucount -l -r"
```

or

```
pass:loc=1305:cmd="msucount -r"
```

```
eagle10212 06-06-01 08:50:47 EST EAGLE 35.0.0
```

```
MSUCOUNT: MSU Count Report
```

```
Link measurements have been reset.
```

```
MSUCOUNT: command complete
```

This example shows resetting Routing Key measurements:

```
pass:loc=1305:cmd="msucount -x -5 -r"
```

```
eagle10212 06-01-05 08:50:47 EST EAGLE 35.0.0
```

```
MSUCOUNT: MSU Count Report
```

```
Routing Key measurements have been reset.
```

```
MSUCOUNT: command complete
```

### Output specific to IP SG Cards

The option to display a full help report is not supported for IP SG cards.

```
pass:loc=1304:cmd="msucount -h"
```

```
rlghncxa03w 08-01-29 11:31:09 EST EAGLE 38.0.0
```



```
Usage: msucount [ [-l [link]] | [-b [link]] | [-l link -f] ] |
               [ [-a aname] ]
               [ [-x rc] ]
               [-r] [-h]
```

```
Options: -l display signaling link report
         -b display signaling link bytes report
         -a display association report
         -x display routing context report
         -f display full report
         -r resets the specified counts
         -h display command help
```

;

```
rlghncxa03w 08-01-29 11:31:09 EST EAGLE 38.0.0
```

```
MSUCOUNT: command complete
```

For link reports on IPSPG signaling links, if a specific link is not requested, then counts for all equipped signaling links on the card are displayed. The report includes counts for up to 32 links per card. The `-l <link>` report adds counts for *Replicated M3UA PDU sent*, *Replicated M3UA PDU rcvd*, and *SS7 SNM Counts sent* for M3UA links.

This example shows a brief measurements report:

```
pass:loc=1303:cmd="msucount -l"
```

```
tekelecstp 16-05-25 12:38:16 EST EAGLE5 46.4.0.0.0-69.3.1
```

```
pass:loc=1303:cmd="msucount -l"
```

```
MSUCOUNT: MSU Count Report
```

SLK Transmit counts				SLK Receive counts		
slk	rate	msus	bytes	rate	msus	bytes
A	0	3	72	0	0	0
B	0	62	1916	0	62	1916
A41	0	2	48	0	0	0
A2	0	1	24	0	0	0
A3	0	0	0	0	0	0
A54	0	0	0	0	0	0
-----				-----		
	0	68	2060	0	62	1916
-----				-----		

```
MSUCOUNT: command complete
```

This example shows a measurement report for an IPSPG-M3UA signaling link:

```
pass:loc=1303:cmd="msucount -l a"
```

```
rlghncxa03w 08-01-29 11:31:09 EST EAGLE 38.0.0
MSUCOUNT: MSU Count Report
```

SLK Transmit counts				SLK Receive counts		
slk	rate	msus	bytes	rate	msus	bytes
A	0	3	72	0	0	0

Replicated M3UA PDU counts		SS7 SNM counts
sent	rcvd	sent
0	0	3

This example shows a measurement report for an IPSP-M2PA signaling link:

```
pass:loc=1303:cmd="msucount -l b"
```

```
rlghncxa03w 08-01-29 11:31:09 EST EAGLE 38.0.0
MSUCOUNT: MSU Count Report
```

SLK Transmit counts				SLK Receive counts		
slk	rate	msus	bytes	rate	msus	bytes
B	0	62	1916	0	62	1916

```
MSUCOUNT: command complete
```

The `msucount -l <link> -f` report displays the same information as the brief report (`msucount -l <link>`) for IPSP-M2PA links. For IPSP-M3UA links, the `msucount -l <link> -f` report displays both the information from the brief report and the *discarded tx due to M3UA Conversion Error*, *discarded rcv due to M3UA PDU Error*, *discarded rcv due to Management Blocking*, and *discarded rcv due to Lrg BICC not supported* discard counts.

This example shows a full report for an IPSP-M3UA signaling link when discard counts are not received:

```
pass:loc=1303:cmd=msucount -l a -f
```

```
rlghncxa03w 08-01-29 11:31:09 EST EAGLE 38.0.0
MSUCOUNT: MSU Count Report
```

SLK Transmit counts				SLK Receive counts		
slk	rate	msus	bytes	rate	msus	bytes

```
A      0      3      72      0      0      0
```

```
Replicated M3UA PDU counts
```

```
-----
```

```
sent      rcvd
```

```
-----
```

```
0          0
```

```
SS7 SNM counts
```

```
-----
```

```
sent
```

```
-----
```

```
3
```

```
Transmit Discard Counts
```

```
-----
```

```
reason          count
```

```
-----
```

```
M3UA conversion error 2
```

```
Receive Discard Counts
```

```
-----
```

```
reason          count
```

```
-----
```

```
no receive discard counts
```

```
Stored Transmit Discard Data
```

```
-----
```

```
b0 04 04 04 00 d4 01 1b 61 00 00 bb a9 02 00 00
00 00 00 00 00 00 00 00 00 00 00 00 00 00 00
```

```
b0 04 04 04 00 d4 01 16 61 00 00 27 b8 02 00 00
00 00 00 00 00 00 00 00 00 00 00 00 00 00 00
```

```
Stored Receive Discard Data
```

```
-----
```

```
no stored receive discard data
```

```
MSUCOUNT: command complete
```

This example shows a full report for an IPSP-M3UA signaling link when discard counts are received:

```
pass:loc=1304:cmd="msucount -l a -f"
```

```
Command Accepted - Processing
```

```
rlghncxa03w 10-03-09 11:31:09 EST EAGLE 42.0.0
```

```
MSUCOUNT: MSU Count Report
```

```
SLK Transmit counts
```

```
-----
```

```
slk rate  msus      bytes
```

```
-----
```

```
A      0      58      3380
```

```
SLK Receive counts
```

```
-----
```

```
rate  msus      bytes
```

```
-----
```

```
0      5      292
```

```

Replicated M3UA PDU counts          SS7 SNM counts
-----
sent          rcvd                  sent
-----
1             1                     13

Transmit Discard Counts             Receive Discard Counts
-----
reason          count                reason          count
-----
M3UA conversion error 3             M3UA PDU Error      1
management blocking 1              management blocking 1
lrg MSU not supported 1            lrg MSU not supported 1

Stored Transmit Discard Data
-----
b0 04 04 04 00 6e 01 18 51 01 00 0f 49 02 00 00
00 00 00 00 00 00 00 00 00 00 00 00 00 00 00

80 04 04 04 00 d2 01 00 23 05 05 05 02 1f 61 02
00 00 00 00 00 00 00 00 00 00 00 00 00 00 00

80 04 04 04 00 d2 01 00 13 20 19 02 00 00 00 00
00 00 00 00 00 00 00 00 00 00 00 00 00 00 00

Stored Receive Discard Data
-----
01 00 04 01 00 00 00 18 00 0b 00 08 02 00 00 00
00 06 00 08 00 00 00 04 00 00 00 00 00 00 00

01 00 01 01 00 00 00 3c 00 06 00 08 00 00 00 04
02 10 00 2b 00 04 04 04 00 05 05 05 0d 02 00 96

01 00 00 10 00 00 00 1c 00 0c 00 08 00 00 00 06
00 07 00 0c 01 00 02 02 00 00 00 18 00 00 00 00

MSUCOUNT: command complete
;

```

This example shows a link report for an IPSPG-M2PA signaling link:

```
pass:loc=1303:cmd="msucount -l b"
```

```
rlghncxa03w 08-01-29 11:31:09 EST EAGLE 38.0.0
MSUCOUNT: MSU Count Report
```

SLK Transmit counts

SLK Receive counts

```

-----
slk  rate  msus      bytes      rate  msus      bytes
---  -
B    0     62       1916       0     62       1916
-----

```

MSUCOUNT: command complete

This example shows a full link report for an IPSPG-M3UA link where discard counts are not received:

```
pass:loc=1303:cmd=msucount -l a -f
```

```
rlghncxa03w 08-01-29 11:31:09 EST EAGLE 38.0.0
MSUCOUNT: MSU Count Report
```

```

SLK Transmit counts
-----
slk  rate  msus      bytes
---  -
A    0     3         72

SLK Receive counts
-----
rate  msus      bytes
----  -
0     0         0
-----

```

```

Replicated M3UA PDU counts
-----
sent      rcvd
-----
0         0

SS7 SNM counts
-----
sent
-----
3
-----

```

```

Transmit Discard Counts
-----
reason          count
-----
M3UA conversion error 2

Receive Discard Counts
-----
reason          count
-----
no receive discard counts
-----

```

```

Stored Transmit Discard Data
-----
b0 04 04 04 00 d4 01 1b 61 00 00 bb a9 02 00 00
00 00 00 00 00 00 00 00 00 00 00 00 00 00 00

b0 04 04 04 00 d4 01 16 61 00 00 27 b8 02 00 00
00 00 00 00 00 00 00 00 00 00 00 00 00 00 00
-----

```

```

Stored Receive Discard Data
-----
no stored receive discard data
-----

```

MSUCOUNT: command complete

This example shows a full link report that contains discard counts for an IPSP-M3UA link:

```
pass:loc=1304:cmd="msucount -l a -f"
```

Command Accepted - Processing

rlghncxa03w 10-03-09 11:31:09 EST EAGLE 42.0.0

MSUCOUNT: MSU Count Report

SLK Transmit counts				SLK Receive counts		
slk	rate	msus	bytes	rate	msus	bytes
A	0	58	3380	0	5	292

Replicated M3UA PDU counts

sent	rcvd
1	1

SS7 SNM counts

sent
13

Transmit Discard Counts

reason	count
M3UA conversion error	3

Receive Discard Counts

reason	count
M3UA PDU Error	1
management blocking	1
lrg MSU not supported	1

Stored Transmit Discard Data

```

b0 04 04 04 00 6e 01 18 51 01 00 0f 49 02 00 00
00 00 00 00 00 00 00 00 00 00 00 00 00 00 00

80 04 04 04 00 d2 01 00 23 05 05 05 02 1f 61 02
00 00 00 00 00 00 00 00 00 00 00 00 00 00 00

80 04 04 04 00 d2 01 00 13 20 19 02 00 00 00 00
00 00 00 00 00 00 00 00 00 00 00 00 00 00 00

```

```

Stored Receive Discard Data
-----
01 00 04 01 00 00 00 18 00 0b 00 08 02 00 00 00
00 06 00 08 00 00 00 04 00 00 00 00 00 00 00 00

01 00 01 01 00 00 00 3c 00 06 00 08 00 00 00 04
02 10 00 2b 00 04 04 04 00 05 05 05 0d 02 00 96

01 00 00 10 00 00 00 1c 00 0c 00 08 00 00 00 06
00 07 00 0c 01 00 02 02 00 00 00 18 00 00 00 00

MSUCOUNT: command complete

```

;

### Signaling Link Bytes Report

The IPSP signaling link bytes report is the same as the IPLIMx link bytes report.

This example shows a signaling link bytes report for an IPSP card:

```
pass:loc=1303:cmd="msucount -b"
```

```

rlghncxa03w 08-01-29 11:31:09 EST EAGLE 38.0.0
MSUCOUNT: MSU Count Report

```

SLK Transmit counts					SLK Receive counts			
slk	bytes/ sec	avg msu	max avg msu	max msu	bytes/ sec	avg msu	max avg msu	max msu
A	0	0	24	24	0	0	0	0
B	62	31	31	31	62	31	31	31
A1	0	0	24	24	0	0	0	0
A2	0	0	24	24	0	0	0	0
A3	0	0	0	0	0	0	0	0
A4	0	0	0	0	0	0	0	0
-----					-----			
	62	31	31	31	62	31	31	31
-----					-----			

This example shows the B link report:

```
pass:loc=1305:cmd="msucount -b a"
```

```

rlghncxa03w 08-01-29 11:31:09 EST EAGLE 38.0.0
MSUCOUNT: MSU Count Report

```

SLK Transmit counts					SLK Receive counts			
slk	bytes/ sec	avg msu	max avg msu	max msu	bytes/ sec	avg msu	max avg msu	max msu

```

-----
-----
A      0      0      24      24      0      0
0      0
-----
-----
0      0      0      24      24      0      0
-----
-----

```

MSUCOUNT: MSU Count Report

### Routing Context Report

The `msucount -x <routing context>` report for an IPSPG card displays the equivalent of the `msucount -l` report for all signaling links on the card that are members of the linkset containing the specified routing context.

This example shows a routing context report:

```
pass:loc=1303:cmd="msucount -x 74565"
```

```
rlghncxa03w 08-01-29 11:31:09 EST EAGLE 38.0.0
MSUCOUNT: MSU Count Report
```

```
-----
Routing Context Measurements
-----
```

SLK Transmit counts				SLK Receive counts		
slk	rate	msus	bytes	rate	msus	bytes
A	0	3	72	0	0	0
	0	3	72	0	0	0

MSUCOUNT: command complete

;

### IP Connection Report

The IP connection statistic report for an IPSPG card contains data regarding MSUs (tx/rcv), MSU bytes (tx/rcv), and discarded data (tx/rcv) for a specific socket or an association. The `-a <aname>` report for M3UA links adds the *Replicated M3UA PDU*



sent, Replicated M3UA PDU rcvd, SS7 SNM sent, Discarded rcv due to SS7 SNM not supported, and Discarded rcv due to no SS7 SNM capacity.

The existing *Discarded rcv due to M3UA PDU error* and *Invalid rcontext counts* are also supported.

This example shows an aname report:

```
pass:loc=1303:cmd="msucount -a a1303a"
```

```
rlghncxa03w 08-01-29 11:31:09 EST EAGLE 38.0.0
```

```
MSUCOUNT: MSU Count Report
```

```
-----  
IP Association Measurements  
-----
```

Transmit PDUs		Receive PDUs	
pdus	bytes	pdus	bytes
3	72	0	0

```
SS7 SNM counts  
-----  
sent      rcvd  
-----  
0         0
```

```
Receive Discard Counts  
-----  
reason          count  
-----  
M3UA PDU error      3
```

```
Stored Receive Discard Data  
-----  
01 00 00 00 00 00 00 1c 00 0c 00 08 00 00 00 06  
00 07 00 0c 01 00 02 02 00 00 00 18 00 00 00 00  
  
01 00 00 00 00 00 00 1c 00 0c 00 08 00 00 00 06  
00 07 00 0c 01 00 02 02 00 00 00 18 00 00 00 00  
  
01 00 00 00 00 00 00 1c 00 0c 00 08 00 00 00 06  
00 07 00 0c 01 00 02 02 00 00 00 18 00 00 00 00
```

```

MSUCOUNT: command complete
;

pass:loc=1304:cmd="msucount -a a1304m3ua1"

Command Accepted - Processing

rlghncxa03w 08-01-29 11:31:09 EST EAGLE 38.0.0

MSUCOUNT: MSU Count Report

-----
IP Association Measurements
-----

Transmit PDUs                                Receive PDUs
-----
pdu      bytes                                pdu      bytes
-----
58        3380                                5         292

SS7 SNM counts
-----
sent      rcvd
-----
8         7

Receive Discard Counts
-----
reason          count
-----
SS7 SNM not supported  1
SS7 SNM no capacity    1
M3UA PDU error        13
invalid rcontext      5

Stored Receive Discard Data
-----
01 00 01 01 00 00 00 3c 00 06 00 08 00 00 00 01
02 10 00 2b 00 04 04 04 00 05 05 05 05 00 00 9a

01 00 03 01 00 00 00 08 00 00 00 00 00 00 00 00
00 00 00 00 00 00 00 00 00 00 00 00 00 00 00 00

01 00 01 01 00 00 00 3c 00 06 00 08 00 00 00 04
02 10 00 2b 00 04 04 04 00 05 05 05 85 02 00 9a

01 00 01 01 00 00 00 3c 00 06 00 08 00 00 00 04
02 10 00 2b 00 04 04 04 00 05 05 05 85 02 00 9a

```

```
01 00 04 01 00 00 00 18 00 0b 00 08 02 00 00 00
00 06 00 08 00 00 00 04 00 00 00 00 00 00 00 00
```

```
01 00 01 01 00 00 00 3c 00 06 00 08 00 00 00 04
02 10 00 2b 00 04 04 04 00 05 05 05 85 02 00 9a
```

```
01 00 01 01 00 00 00 3c 00 06 00 08 00 00 00 04
02 10 00 2b 00 04 04 04 00 05 05 05 85 02 00 9a
```

```
01 00 01 01 00 00 0a fc 00 06 00 08 00 00 00 0a
02 10 0a eb 00 04 32 01 00 04 32 01 0d 02 00 99
```

```
01 00 01 01 00 00 00 08 00 00 00 00 00 00 00 00
00 00 00 00 00 00 00 00 00 00 00 00 00 00 00 00
```

```
01 00 07 01 00 00 00 70 00 06 00 08 00 00 00 02
01 15 00 08 00 00 00 80 01 02 00 18 00 02 00 03
```

```
MSUCOUNT: command complete
```

```
;
```

### Output Specific to High-Speed Link (HSL) cards (SS7HC and ATMHC - non-IP7 GPLs)

#### Note:

The `-a`, `-x`, `-k`, `-p`, and `-t` options are not supported for HSL cards.

#### Note:

The option to display a full help report is not supported for HSL cards.

```
pass:loc=1103:cmd="msucount -h"
```

```
tekelecstp 10-01-19 11:50:34 EST EAGLE 41.1.0
```

```
Usage: msucount  [[-l [link]] | [-f]]|
                 [-r] [-h]]
```

```
Options:  -l display signaling link report
          -f display full report
          -r resets the specified counts
          -h display command help
          -l link r resets the counts for specified link
```

```
tekelecstp 10-01-19 11:50:34 EST EAGLE 41.1.0
MSUCOUNT command complete
```

### Link Reports

The link report contains the statistics of the equipped links (TDM/ATM) on the SS7HC/ATMHC cards collected on a per link basis.

An SS7HC/ATMHC generic link report is reported if the MSUCOUNT command is entered without any parameters. The output contains data regarding MSU bytes (tx/rcv), %bandwidth used (tx/rcv), MSUs (tx/rcv) collected during the last full second per link. Total MSU counts (tx/rcv) per link since the card load time or the last reset are also displayed.

```
pass:loc=1301:cmd="msucount"
```

```
tekelecstp 10-01-19 11:50:34 EST EAGLE 41.1.0
MSUCOUNT: Command In Progress
```

```
;
MSUCOUNT: MSU Count Report
```

SLK	Last Transmit Counts/Total MSUs				Last Receive Counts/			
Total MSUs								
---	-----							
-----								
slk	bytes	%bw	msus	total msus	bytes	%bw	msus	total msus
total msus								
---	-----	-----	-----	-----	-----	-----	-----	-----
-----								
A	51200	20%	700	1234567890	26700	10%	400	1234567890
B	256000	100%	5000	1234567890	256000	100%	5000	1234567890
---	-----	-----	-----	-----	-----	-----	-----	-----
-----								
TOTAL	307200		5700	2469135780	282700		5400	2469135780

```
tekelecstp 10-01-19 11:50:34 EST EAGLE 41.1.0
MSUCOUNT: command complete
```

```
;
```

The full link report includes the generic information, the maximum amount seen for each MSU, and the percent bandwidth tracked for the full one second period since the card load time or the last reset.

```
pass:loc=1301:comd="msucount -f"
```

```
tekelecstp 10-01-19 11:50:34 EST EAGLE 41.1.0
MSUCOUNT: Command In Progress
```

```
;
```

MSUCOUNT: MSU Count Report

SLK	Last Second/MAX Transmit Counts					Last Second/MAX Receive Counts				
---	-----					-----				
slk	bytes	%bw	%max	msus	mmax	bytes	%bw	%max	msus	
mmax	---	-----	-----	-----	-----	-----	-----	-----	-----	
A	51200	20%	40%	700	1385	26700	10%	20%	400	
730										
B	256000	100%	100%	5000	5000	256000	100%	100%	5000	
5000	---	-----	-----	-----	-----	-----	-----	-----	-----	
TOTAL	307200			5700		282700			5400	

tekelecstp 10-01-19 11:50:34 EST EAGLE 41.1.0  
MSUCOUNT: command complete

;

If the `-l slk` option is specified, then the statistics for the specified link is shown (if the link is equipped).

On cards running SS7HC GPL, in addition to the information shown in the Generic and Full reports, data is collected for the error counts (MSUs and SUs) and retransmits pegged during the last full second. Averages for the MSUs, percent bandwidth, bytes transmitted and received for the last rolling sampling period, and the maximum of these averages since the card was loaded or the data was reset is also displayed.

pass:loc=1301:cmd="msucount -l a"

tekelecstp 10-01-19 11:50:34 EST EAGLE 41.1.0  
MSUCOUNT: Command In Progress

;

MSUCOUNT: MSU Count Report

	Last	Avg	Avg Max	Max	Total
	-----	-----	-----	-----	-----
TX Bandwidth:	98%	61%	80%	98%	
RX Bandwidth:	98%	61%	80%	98%	
Bytes TXed:	7840	4900	6370	7840	1248056004
Bytes RXed:	7840	4900	6370	7840	1024579036
MSUs TXed:	160	100	130	160	45937854
MSUs RXed:	160	100	130	160	41495837
Errored SUs:	1			10	103
Errored MSUs:	4			4	21
Retransmits:	10			23	353
Forced PCR:	20			50	189

```
tekelecstp 10-01-19 11:50:34 EST EAGLE 41.1.0
MSUCOUNT: command complete
```

```
;
```

On cards running ATMHC GPL, the `-l_slk` option, in addition to the information shown in the Generic and Full reports, data is collected for the different types of error counts during the last full second. Averages for the MSUs, percent bandwidth used, bytes transmitted and received for the last rolling sampling period and the maximum of these averages since the card was loaded or the data was reset is displayed. The total number of MSUs and bytes and errors since the card was loaded or the data was reset is also displayed.

```
pass:loc=1301:cmd="msucount -l a"
```

```
tekelecstp 10-01-19 11:50:34 EST EAGLE 41.1.0
MSUCOUNT: Command In Progress
```

```
;
```

```
MSUCOUNT: MSU Count Report
```

	Last	Avg	Avg Max	Max	Total
	-----	-----	-----	-----	
-----					
TX Bandwidth:	98%	61%	80%	98%	
RX Bandwidth:	98%	61%	80%	98%	
Bytes TXed:	7840	4900	6370	7840	
1248056004					
Bytes RXed:	7840	4900	6370	7840	
1024579036					
MSUs TXed:	160	100	130	160	
45937854					
MSUs RXed:	160	100	130	160	
41495837					
Errored SUs:	1				
10 103					
Errored MSUs:	4				
4 21					
Retransmits:	10				
23 353					
Forced PCR:	20				
50 189					

```
tekelecstp 10-01-19 11:50:34 EST EAGLE 41.1.0
MSUCOUNT: command complete
```

```
;
```

## msuroute

This command is used to provide a list of all routing keys currently configured on an SS7IPGW/IPGWI card that could be used to route a particular MSU. With 3 types of routing keys (fully specified, partial and default) the complexity associated with figuring out how a particular MSU would be routed at any point in time is not trivial. This command provides output to help determine how MSUs will be routed based on current conditions.

### Options

Options and option parameters that are underlined indicate that a value must be specified for that option or parameter. For example, the `msuroute` command option `-k` has the parameter `rtkey`. The full routing key must be specified for the MSU for which the summary will be displayed, as in the command `msuroute -k 5-5-5:5:6-6-6:1100`. Do not enter the underlined option or parameter; enter a value for the information represented by the underlined option or parameter.

`-h`

This option is used to provide help information for the command.

`-k rtkey`

This option is mandatory in the command to specify the full routing key for the MSU for which the summary will be displayed. The routing key is specified as a single parameter with up to five colon-separated fields. The subsystem is not specified when SI is not equal to 3.

The `-p point code type` modifier is used to identify the format of the routing key that follows the `-k` option in the command.

The following are valid formats for the routing key that follows the `-k` option in the command:

- `n-c-m:s:n`—For DPC, SI, SSN type routing keys. The network, cluster and member (`n-c-m`) are in the range 0-255. The service indicator (`s`) is 3 or *sccp*. The subsystem (`n`) is in the range 0-255.
- `n-c-m:s`—For DPC, SI, type routing keys. The network, cluster and member (`n-c-m`) are in the range 0-255. The service indicator (`s`) is in the range 0-2, 4, or 6-15. There is no subsystem.
- `n-c-m:s:no-co-mo:cs:ce`—For DPC, SI, CIC type routing keys. The DPC network, cluster and member (`n-c-m`) are in the range 0-255. The service indicator (`s`) is 5 or *isup*. There is no subsystem. The OPC network, cluster and member (`no-co-mo`) are in the range 0-255. The starting circuit identification code (`cs`) and ending circuit identification code (`ce`) are in the range 0 to 16363.

`-p point code type`

This option modifier is used to identify the point code type (ANSI, ITU international, ITU national, 24-bit ITU national, 16-bit ITU national, ITU international spare, ITU national spare) in the routing key that follows the `-k` option in the command.

#### Range:

*ansi, itui, itun, itun24, itun16, ituis, ituns*

#### Default:

*ansi*

`-x routing context`

This option modifier is used to display the routing key report using routing context.

### Example

```
msuroute -h
msuroute -p ansi -k 5-5-5:5:6-6-6:1100

msuroute -p ansi -k 5-5-5:5:6-6-6:1100:1100

msuroute -k 5-5-5:5:6-6-6:1100

msuroute -k 5-5-5:5:6-6-6:1100:1100

msuroute -p ansi -k 5-5-5:8

msuroute -p itun -k 345:5:678:100:200

msuroute -p itun -k 345-gr:5:678-gr:100:200

msuroute -p itun24 -k 10-200-10:5:10-200-1:1:100

msuroute -p itun16 -k 1-2-1:5:1-2-1:1:100
```

### Dependencies

The `-k` option must be specified in the command, and must specify a full routing key.

This command is not supported for IPLIM/IPLIMI cards.

### Notes

The `msuroute` command is executed through the pass command.

The `-ppoint_code_type` modifier option can be used with the `-k` option to specify the format of the routing key that follows the `-k` option in the command.

### Output

The output for each `msuroute` command consists of a list of all of the routing keys that exist on the IPGWx card that could be used to route the MSU. The list of routing keys is presented in the hierarchical search order in which the keys would be used. The list of routing keys indicates keys that have IP connections available for traffic, and indicates which routing key would currently be used to route the MSU (marked with \*\*\*).

For the routing key that is selected to route the MSU, the list of IP connections associated with the key is also displayed.

#### Note:

Most of the following output examples show command entries for ANSI MSUs. Because, other than echoing the input command back to the screen, there is nothing in the output that contains specific fields from any configured keys. The output would not be different if the user entered ITUI MSUs instead of ANSI MSUs.

Either brief or full help reports can be displayed. A full help report is generated by adding the `-h full` option to the command line.



This example shows a brief help report:

```
pass:loc=1105:cmd="msuroute -h"
```

```
Command Accepted - Processing
```

```
Usage: msuroute [ [-x rc] | [-k [rtkey] [-p pctype] ] ]
        [-h [full]]
```

```
Options: -x routing key report using routing context
        -k routing key report using MTP3 parameters
           rtkey :: ([dpc][:si][:opc | :ssn][:cics][:cice])
        -p pctype :: (ANSI, ITUI, ITUN, ITUN24, ITUN16, ITUIS, ITUNS)
        -h display command help (brief or full)
```

```
;
```

This example shows a full help report:

```
pass:loc=1305:cmd="msuroute -h full"
```

```
0          1          2          3          4          5          6          7
1234567890123456789012345678901234567890123456789012345678901234567
8
```

```
Usage: msuroute [ [-x rc] | [-k [rtkey] [-p pctype] ] ]
        [-h [full]]
```

```
Options: -x routing key report using routing context
        -k routing key report using MTP3 parameters
           rtkey :: dpc:si:opc:cics:cice | dpc:si:ssn | dpc:si
        -p pctype :: (ANSI, ITUI, ITUN, ITUN24, ITUN16, ITUIS, ITUNS)
        -h display command help (brief or full)
```

-k option details:

Use the -p option along with -k to specify the SS7 network domain and point code format for the network. The SS7IPGW default pctype is ANSI. The IPGWI default pctype is ITUI.

Network	PC Format	Notes
ANSI	N-C-M	
ITUN	N	Non-Spare ITU National, no group code
ITUN	N-GC	Non-Spare ITU National with group code
ITUI	Z-A-I	Non-Spare ITU International
ITUN24	N-C-M	Non-Spare ITU National, 24-bits
ITUN16	U-S-M	Non-Spare ITU National, 16-bits
ITUNS	N	Spare ITU National, no group code
ITUNS	N-GC	Spare ITU National with group code
ITUIS	Z-A-I	Spare ITU International

SS7 Traffic Partition

RTKEY Parameter Example

```

      SSCP SSN 5 to DPC 1-1-1          -k 1-1-1:3:5
      ISUP CIC 1 to 1-1-1 from 2-2-2   -k 1-1-1:5:2-2-2:1
      TUP CIC 1 to 1-1-1 from 2-2-2   -k 1-1-1:4:2-2-2:1
      QBICC CIC 1 to 1-1-1 from 2-2-2 -k 1-1-1:13:2-2-2:1
      ISUP CIC 0-5 to 1-1-1 from 2-2-2 -k 1-1-1:5:2-2-2:0:5
      TUP CIC 0-5 to 1-1-1 from 2-2-2 -k 1-1-1:4:2-2-2:0:5
      QBICC CIC 0-5 to 1-1-1 from 2-2-2 -k 1-1-1:13:2-2-2:0:5
;
eagle10212 06-06-01 12:56:46 EST  EAGLE 35.0.0
MSURROUTE command complete

```

This example shows output for an ANSI CIC-based MSU, showing at least 1 routing key of every key type in the search hierarchy configured on the 1105 card. Only key types that are configured on the card will be listed in the display.

```
pass:loc=1105:cmd="msuroute -p ANSI -k 5-5-5:5:6-6-6:1100"
```

Command Accepted - Processing

```

      rlghncxa03w 06-06-01 11:31:09 EST  EAGLE5 35.0.0
      pass:loc=1105:cmd="msuroute -x ANSI -k 5-5-5:5:6-6-6:1100"
      Command entered at terminal #1.
;

      rlghncxa03w 06-06-01 11:31:09 EST  EAGLE5 35.0.0
      PASS: Command sent to card
;

      rlghncxa03w 06-06-01 11:31:09 EST  EAGLE5 35.0.0
      MSURROUTE command in progress
;

      rlghncxa03w 04-04-29 11:31:09 EST  EAGLE5 31.6.0

TABLE   KEYTYPE                               #ConnCfgd  #ConnAvail  RTKEY
USED
DYN     FULL                                  1           0           no
DYN     PARTIAL: IGNORE-CIC                  2           0           no
DYN     PARTIAL: IGNORE-CIC+OPC             1           0           no
DYN     PARTIAL: DPC-SI ONLY                 3           3           yes
DYN     PARTIAL: DPC ONLY                    2           2           no
DYN     PARTIAL: SI ONLY                     4           0           no
DYN     DEFAULT                              4           4           no
STATIC  FULL                                  12          4           no
STATIC  PARTIAL: IGNORE-CIC                  3           0           no
STATIC  PARTIAL: IGNORE-CIC+OPC             2           0           no
STATIC  PARTIAL: DPC-SI ONLY                 3           2           no
STATIC  PARTIAL: DPC ONLY                    2           2           no
STATIC  PARTIAL: SI ONLY                     1           0           no
STATIC  DEFAULT                              2           0           no

IP Connections Associated with the RTKEY USED
Name                                     Avail?

```

```
Vox1          yes
Mgc2          yes
Mgc24        yes
```

```
MSURROUTE command complete
```

```
;
```

This example shows output for an ANSI SCCP MSU. Several key types in the search hierarchy are not configured on the 1105 card, and therefore are not part of the output (for example, static full key or static partial SI only). Only key types that are configured on the card will be listed in the display.

```
pass:loc=1105:cmd="msuroute -p ANSI -k 5-5-5:3:34"
```

```
Command Accepted - Processing
```

```
rlghncxa03w 06-06-01 11:31:09 EST EAGLE5 35.0.0
pass:loc=1105:cmd="msuroute -p ANSI -k 5-5-5:3:34"
Command entered at terminal #1.
```

```
;
```

```
rlghncxa03w 06-06-01 11:31:09 EST EAGLE5 35.0.0
PASS: Command sent to card
```

```
;
```

```
rlghncxa03w 06-06-01 11:31:09 EST EAGLE5 35.0.0
MSURROUTE command in progress
```

```
;
```

```
rlghncxa03w 06-06-01 11:31:09 EST EAGLE5 35.0.0
TABLE  KEYTYPE                #ConnCfgd  #ConnAvail  RTKEY USED
DYN     PARTIAL: DPC-SI ONLY    3           2            yes
DYN     PARTIAL: DPC ONLY      2           2            no
DYN     DEFAULT                 4           4            no
STATIC  PARTIAL: DPC-SI ONLY    3           2            no
STATIC  PARTIAL: DPC ONLY      2           2            no
STATIC  DEFAULT                 2           0            no
```

```
IP Connections Associated with the RTKEY USED
```

```
Name                Avail?
Scpsandiego         no
scpdenver           yes
scpkansascity       yes
```

```
MSURROUTE command complete
```

```
;
```

This example shows output for an ANSI MSU with SI=8:

```
pass:loc=1105:cmd="msuroute -p ANSI -k 5-5-5:8"
```

```
Command Accepted - Processing
```

```

rlghncxa03w 06-06-01 11:31:09 EST  EAGLE5 35.0.0
pass:loc=1105:cmd="msuroute -p ANSI -k 5-5-5:8"
Command entered at terminal #1.
;

rlghncxa03w 06-06-01 11:31:09 EST  EAGLE5 35.0.0
PASS: Command sent to card
;

rlghncxa03w 06-06-01 11:31:09 EST  EAGLE5 35.0.0
MSUROUTE command in progress
;

rlghncxa03w 06-06-01 11:31:09 EST  EAGLE5 35.0.0

TABLE      KEYTYPE                #ConnCfgd  #ConnAvail  RTKEY
USED
DYN        FULL                    7           0            no
DYN        PARTIAL: DPC ONLY        2           2            yes
DYN        PARTIAL: SI ONLY        2           0            no
DYN        DEFAULT                 4           4            no
STATIC     FULL                    11          0            no
STATIC     PARTIAL: DPC ONLY        2           2            no
STATIC     PARTIAL: SI ONLY        1           0            no
STATIC     DEFAULT                 2           0            no

IP Connections Associated with the RTKEY USED
Name                    Avail?
SI8sock1                yes
SI8sock2                yes

MSUROUTE command complete
;

```

These examples show output for an ITUN and an ITUN24 MSU with SI=5. The output format is the same for all four commands.

The ITUDUPPC feature is OFF (default):

```
pass:loc=1105:cmd="msuroute -p itun -k 345:5:678:100:200"
```

The ITUDUPPC feature is ON (the 2-letter group code must be specified with the DPC and OPC)

```
pass:loc=1105:cmd="msuroute -p itun -k 345-gr:5:678-gr:100:200"
```

An ITUN24 MSU with SI=5:

```
pass:loc=1105:cmd="msuroute -p itun24 -k
10-200-10:5:10-200-1:1:100"
```

An ITU-I Spare MSU with SI=5:

```
msuroute -p ituis -k 3-11-1:5:4-11-1:5:5
```

Command Accepted - Processing

```

rlghncxa03w 06-06-01 11:31:09 EST  EAGLE5 35.0.0
pass:loc=1105:cmd="msuroute -p ITUN -k 345:678:100:200"
Command entered at terminal #1.
;

rlghncxa03w 06-06-01 11:31:09 EST  EAGLE5 35.0.0
PASS: Command sent to card
;

rlghncxa03w 06-06-01 11:31:09 EST  EAGLE5 35.0.0
MSUROUTE command in progress
;

rlghncxa03w 06-06-01 11:31:09 EST  EAGLE5 35.0.0
TABLE  KEYTYPE                #ConnCfgd  #ConnAvail  RTKEY USED
DYN    FULL                    1          0           no
DYN    PARTIAL: IGNORE CIC     2          0           no
DYN    PARTIAL: IGNORE CIC+OPC 1          0           no
DYN    PARTIAL: DPC-SI ONLY    3          3           yes
DYN    PARTIAL: DPC ONLY       2          2           no
DYN    PARTIAL: SI ONLY        4          0           no
DYN    DEFAULT                 4          4           no
STATIC FULL                    12         4           no
STATIC PARTIAL: IGNORE-CIC     3          0           no
STATIC PARTIAL: IGNORE-CIC+OPC 2          0           no
STATIC PARTIAL: DPC-SI ONLY    3          2           no
STATIC PARTIAL: DPC ONLY       2          2           no
STATIC PARTIAL: SI ONLY        1          0           no
STATIC DEFAULT                 2          0           no

IP Connections Associated with the RTKEY USED
Name                               Avail?
Vox1                               yes
Mgc2                               yes
Mgc24                              yes

MSUROUTE command complete
;

```

## msutrace

This command provides filter and trace capability for MSUs passing through the IP7 GPLs. This command provides a view of MSU data as it exists in the PSTN network and its corresponding format as it exists in the IP network.

### Options

Options and option parameters that are underlined indicate that a value must be specified for that option or parameter. For example, the `msutrace` command option `-a` has the parameter action. The action that the command is to take can be specified, as in the command `msutrace -a acttrace`. Do not enter the underlined option or parameter; enter a value for the information represented by the underlined option or parameter.

`-a action`

Action option.

**Range:**

***acttrace***

Activate (turn on) MSU tracing

***clrtrace***

Clear all data from trace buffers

***dacttrace***

Deactivate (turn off) MSU tracing

***chgfilter***

Change filter used to indicate which MSUs are placed in the trace buffers

-g get\_option

Get option.

**Range:**

***config***

Displays the current command settings: trace ON/OFF status, filter settings, and trace buffers used/available

***trace***

Displays contents of trace buffers containing captured MSU data

-h help

This option displays help information about the command.

**Range:**

*full*

If *full* is specified, the detailed version of the help information is displayed.

If *full* is not specified (just -h), the simple version of the help information is displayed.

-m mode

This option specifies which MSUs are captured.

**Range:**

***normerr***

trace only MSUs with normalization errors

***all***

trace all MSUs regardless of MSU contents

-p point\_code\_type

This option specifies which type of point code is contained in the filter key, when the key contains a DPC or OPC.

**Range:**

*ansi, itui, itun, itun24, itun16, ituis, ituns*

**Default:**

*ansi*

-k filter\_key

The `-k`, `-c`, and `-p` options are used to specify the filter key used to determine which MSUs will have data placed in the trace buffers.

**Range:**

`-k filter key [-p] [-c pcType]`

The syntax for the filter key portion of the `-k filter key` option is specified as a single string parameter with up to five colon-separated fields. The filter key can contain one or more of the following fields:

- *n-c-m*—ANSI DPC in the format *network-cluster-member*
- *no-co-mo*—ANSI OPC in the format *network-cluster-member*
- *z-a-i*—ITU-I DPC in the format *zone-area-id*
- *zo-ao-io*—ITU-I OPC in the format *zone-area-id*
- *un-sna-mna---*16-bit ITU-N DPC in the format *unit number-sub number area-main number area*
- *msa-ssa-sp*—24-bit ITU-N DPC in the format *main signaling area-sub signaling area-signaling point*
- *nnnnn*—ITU-N DPC
- *nnnnn-gc*—ITU-N DPC with Group Code when the Duplicate Point Code feature is ON
- *no*—ITU-N OPC
- *no-gc*—ITU-N OPC with Group Code when the Duplicate Point Code feature is ON
- *s*—SI (Service Indicator)
- *cs*—CIC Start value (start of the CIC range)
- *ce*—CIC End value (end of the CIC range)
- *n*—SSN (Subsystem Number)

These examples show valid formats:

- *n-c-m:s:n*—For DPC, SI, SSN type routing keys. The network, cluster and member (*n-c-m*) are in the range 0-255. The service indicator (*s*) is 3 or *sccp*. The subsystem (*n*) is in the range 0-255.
- *n-c-m:s*—For DPC, SI type routing keys. The network, cluster and member (*n-c-m*) are in the range 0-255. The service indicator (*s*) is in the range 0-2, 4, or 6-15. There is no subsystem number. As a default, counts for all routing keys within the option combination are displayed.
- *n-c-m:s:no-co-mo:cs:ce*—For DPC, SI, CIC type routing keys. The DPC network, cluster and member (*n-c-m*) are in the range 0-255. The service indicator (*s*) is 5 or *isup*. There is no subsystem. The OPC network, cluster and member (*no-co-mo*) are in the range 0-255. The starting circuit identification code (*cs*) and ending circuit identification code (*ce*) are in the range 0 - 16363.
- *z-a-i*—For DPCN and DPCI routing keys, the zone, area and ID (*z-a-i*) are in the range of 000-007 (zone and ID) and 000-255 (area).
- *msa-ssa-sp*—For 24-bit DPCN routing keys, the main signaling area, sub signaling area and signaling point (*msa-ssa-sp*) are in the range of 000-255.
- *un-sna-mna---*—For 16-bit DPCN routing keys, the unit number, sub number area and main number area (*un-sna-mna*) are in the range of 0-127, 0-15, 0-31 respectively.

-t

This option specifies the routing key type (IPGWx only).

-x rc

This option generates a routing key report using routing context.

### Example

```
pass:loc=1105:cmd="msutrace -h"
pass:loc=1105:cmd="msutrace -h full"

pass:loc=1105:cmd="msutrace -g config"
pass:loc=1315:cmd="msutrace -g trace"
pass:loc=1105:cmd="msutrace -a clrtrace"
pass:loc=1105:cmd="msutrace -a acttrace"

pass:loc=1105:cmd="msutrace -a chgfilter -p ansi -k
3-3-3:5:4-4-4:10:1000"

pass:loc=1105:cmd="msutrace -a chgfilter -p itui -t partial -k
1-3-3:5:2-4-4"

pass:loc=1105:cmd="msutrace -a chgfilter -p itun -t partial -k
1536:5"

pass:loc=1105:cmd="msutrace -a chgfilter -m normerr"
pass:loc=1105:cmd="msutrace -a chgfilter -m all"

pass:loc=1105:cmd="msutrace -a chgfilter -p ansi -k
1-1-1:5:2-2-2:10:1000"
```

### Dependencies

If no options are specified, the simple version of the help information is displayed.

The point code type defaults to ANSI when the `-p` option is not specified.

The `-p` option is allowed only on key types that contain a DPC or OPC.

### Notes

The `msutrace` command is executed through the `pass` command.

The `mustrace` command captures the data portion of the PSTN packet, starting at the SIO bytes.

The `msutrace` command captures the entire M3UA or SUA packet. This includes the M3UA or SUA header and additional data stored inside system buffer chain elements. The `msutrace` command currently does not support the trace and capture of M3UA / SUA SSNM (Class 2) messages.

The `msutrace` command captures data in trace buffers. If the set of trace buffers becomes full with captured MSU data after MSU tracing is activated, no more data capturing will take place. The `-aclrtrace` option must be specified to reset (clear) the content of the trace buffers. After the trace buffers are empty again, `msutrace` will restart capturing qualified MSUs.



If MSU tracing is activated with the `-a acttrace` option before a properly formatted filter key is entered, the `msutrace` command will not capture any data due to lack of a proper filter. When the `-a chgfilter` option is specified to enter a properly formatted filter, the `msutrace` command will start capturing qualified MSUs.

## Output

### Note:

The `msutrace pass` command exists on the IPLIMI cards as a debug-only pass command. All command syntax and output are identical to the `SS7IPGW` and `IPGWI` commands described in this section.

Both brief and full versions of IPGW reports can be requested. A full report is requested by including the `-f` in the command line.

This example shows a brief help report:

```
pass:loc=1305:cmd="msutrace -h"
```

```
Usage: msutrace [-a action_cmd] [-g get_cmd]
           [ [-x rc] | [-k [rtkey] [-p pctype] [-t keytype]] ]
           [-m mode] [-h [full]]

Options:
  -a  action_cmd: an Action Command
  -g  get_cmd: a Get Command
  -x  routing key report using routing context
  -k  routing key report using MTP3 parameters
      rtkey :: ([dpc][:si][:opc | :ssn][:cics][:cice])
  -p  pctype :: (ANSI, ITUI, ITUN, ITUN24, ITUN16, ITUIS, ITUNS)
      routing key type
  -t  routing key type
      keytype :: (<full>, partial, default)
  -m  mode: mode for qualifying MSUs captured=[normerr | all]
  -h  displays this message (brief or full)

get_cmd:      [config | trace]
  config      config
  trace       trace

action_cmd:   [acttrace | chgfilter | clrtrace | dacttrace]
  acttrace    acttrace
  chgfilter   chgfilter [<fltrkey>] | [-m mode] (at least 1 required)
              (valid fltrkey should be present either before
              specifying mode or in the same command)
  clrtrace    clrtrace
  dacttrace   dacttrace

<fltrkey>:   [ [-x rc] | [-k [rtkey] [-p pctype] [-t keytype]] ]
              (see 'msutrace -h full' for complete description)
```

```
MSUTRACE command complete
```

```
;
```

This example shows a full help report:

```
pass:loc=1305:cmd="msutrace -h full"
```

```
Usage: msutrace [-a action_cmd] [-g get_cmd]
           [ [-x rc] | [-k [rtkey] [-p pctype] [-t keytype]] ]
           [-m mode] [-h [full]]

Options:
  -a  action_cmd: an Action Command
  -g  get_cmd: a Get Command
  -x  routing key report using routing context
  -k  routing key report using MTP3 parameters
      rtkey :: ([dpc][:si][:opc | :ssn][:cics][:cice])
  -p  pctype :: (ANSI, ITUI, ITUN, ITUN24, ITUN16, ITUIS,
ITUNS)
  -t  routing key type
      keytype :: (<full>, partial, default)
  -m  mode: mode for qualifying MSUs captured = [normerr | all]
  -h  displays this message (brief or full)

get_cmd:      [config | trace]
  config      Display the current MSUTRACE settings:
               trace On/Off status, filter settings, and
               trace buffers used/available.
               ex: msutrace -g config
  trace       Display content of trace buffers containing
captured      MSU data
               ex: msutrace -g trace

action_cmd:   [acttrace | chgfilter | clrtrace | dacttrace ]
  acttrace    Activate (turn-on) MSU-tracing.
               ex: msutrace -a acttrace
  chgfilter   chgfilter [<fltrkey>] | [-m mode] (at least 1
required)
               (valid fltrkey should be present either
before
               specifying mode or in the same command)
               Change filter used to qualify which MSUs are
placed in
               trace buffers:
               Flow of command should be
               Either entering filter key before specifying mode :
               ex: To trace MSUs based on MSU content:
                   msutrace -a chgfilter <fltrkey>
               ex: To only trace MSUs with Normalization errors:
                   msutrace -a chgfilter -m normerr
               ex: To trace all MSUs regardless of error
conditions:
               msutrace -a chgfilter -m all
               Or entering filter key along with mode:
               ex: To trace MSUs based on MSU content
                   with Normalization errors:
```

```

msutrace -a chgfilter <fltrkey> -m normerr
ex: To trace MSUs based on MSU content
    regardless of error conditions:
msutrace -a chgfilter <fltrkey> -m all

```

```

clrtrace    Clear all data from trace buffers.
ex: msutrace -a clrtrace

```

```

dacttrace   Deactivate (turn-off) MSU-tracing.
ex: msutrace -a dacttrace

```

-k option details:

Use the -p option along with -k to specify the SS7 network domain and point code format for the network. The SS7IPGW default pctype is ANSI. The IPGWI and IPLIMI default pctype is ITUI.

For IPSG both ANSI and ITU network point code formats are eligible for trace when the default filter or an SI only filter is specified. The IPSG default pctype is ANSI when the filter contains OPC or DPC and the -p option is not specified.

Network	PC Format	Notes
ANSI	N-C-M	
ITUN	N	Non-Spare ITU National, no group code
ITUN	N-GC	Non-Spare ITU National with group code
ITUI	Z-A-I	Non-Spare ITU International
ITUN24	N-C-M	Non-Spare ITU National, 24-bits
ITUN16	U-S-M	Non-Spare ITU National, 16-bits
ITUNS	N	Spare ITU National, no group code
ITUNS	N-GC	Spare ITU National with group code
ITUIS	Z-A-I	Spare ITU International

Use the -t option along with -k to specify certain MTP3 and user part MSU fields as wildcards for the routing key or LS.

SS7 Traffic Partition	RTKEY/MTP3	Parameter	Example
Any User Part to DPC 1-1-1	-k 1-1-1	-t partial	
SCCP to DPC 1-1-1	-k 1-1-1:3	-t partial	
ISUP to DPC 1-1-1	-k 1-1-1:5	-t partial	
TUP to DPC 1-1-1	-k 1-1-1:4	-t partial	
QBICC to DPC 1-1-1	-k 1-1-1:13	-t partial	
SI [0-2,6-12,14,15] to DPC 1-1-1	-k 1-1-1:SI		
SCCP SSN 5 to DPC 1-1-1	-k 1-1-1:3:5		
ISUP to DPC 1-1-1 from OPC 2-2-2	-k 1-1-1:5:2-2-2	-t partial	
TUP to DPC 1-1-1 from OPC 2-2-2	-k 1-1-1:4:2-2-2	-t partial	
QBICC to DPC 1-1-1 from OPC 2-2-2	-k 1-1-1:13:2-2-2	-t partial	
ISUP CIC 1 to 1-1-1 from 2-2-2	-k 1-1-1:5:2-2-2:1		
TUP CIC 1 to 1-1-1 from 2-2-2	-k 1-1-1:4:2-2-2:1		
QBICC CIC 1 to 1-1-1 from 2-2-2	-k 1-1-1:13:2-2-2:1		
ISUP CIC 0-5 to 1-1-1 from 2-2-2	-k 1-1-1:5:2-2-2:0:5		
TUP CIC 0-5 to 1-1-1 from 2-2-2	-k 1-1-1:4:2-2-2:0:5		

```

        QBICC CIC 0-5 to 1-1-1 from 2-2-2 -k 1-1-1:13:2-2-2:0:5
        Default Routing Key                -k                    -t
default
        Any User Part to DPC=LS APC        -x LS RCONTEXT        (IPSG
Only)

;

tekelecstp 10-03-06 19:41:33 EST  EAGLE5 42.0.9

MSUTRACE command complete

;

```

This example shows the current settings of the `msutrace` command options: trace ON/OFF status, filter settings, and trace buffers that are used and available:

```
pass:loc=1105:cmd="msutrace -g config"
```

```

Command Accepted - Processing
  eagle20003 99-11-27 10:16:57 EST  EAGLE5 31.6.0
  pass:loc=1105:cmd="msutrace -g config"
  Command entered at terminal #1.
;
  eagle20003 99-11-27 10:16:57 EST  EAGLE5 31.6.0
  PASS: Command sent to card
;
  eagle20003 99-11-27 10:16:57 EST  EAGLE5 31.6.0
  MSUTRACE command in progress
;
  eagle20003 99-11-27 10:16:57 EST  EAGLE5 31.6.0
  MSUTRACE configurations

Trace = On

Trace buffers: 2 of 3 contain captured MSU data

MSUTRACE: filter settings
DPCA      SI SSN OPCA      CICS      CICE      MODE
055-055-055 13 *** 016-006-006 1234567890 1234567890 normerr
;
  eagle20003 99-11-27 10:16:57 EST  EAGLE5 31.6.0
  MSUTRACE command complete
;

```

This example shows the current settings of the `msutrace` command options: trace ON/OFF status, filter settings, and trace buffers that are used and available, when the filter key specifies an ITU-I spare point code:

```

pass:loc=1105:cmd="msutrace -g config"

Command Accepted - Processing
  eagle20003 05-01-27 10:16:03 EST  EAGLE5 31.12.0
  pass:loc=1105:cmd="msutrace -g config"
  Command entered at terminal #1.
;
  eagle20003 05-01-27 10:16:03 EST  EAGLE5 31.12.0
  PASS: Command sent to card
;
  eagle20003 05-01-27 10:16:03 EST  EAGLE5 31.12.0
  MSUTRACE command in progress
;
  eagle20003 05-01-27 10:16:03 EST  EAGLE5 31.12.0
  MSUTRACE configurations

Trace = On

Trace buffers: 3 of 3 USED

MSUTRACE: filter settings
  DPCI      SI SSN      OPCI      CICS      CICE      MODE
s-2-011-1   2   ***      ****      ****      ****      all
;
  eagle20003 05-01-27 10:16:03 EST  EAGLE5 31.12.0
  MSUTRACE command complete
;

```

This example shows the current settings of the `msutrace` command when an IPSP card is used:

```

pass:loc=1304:cmd="msutrace -g config"

  rlgncxa03w 08-01-29 11:31:09 EST  EAGLE 38.0.0

MSUTRACE: Configurations

MSU Tracing is off

Trace buffers: 0 of 3 USED

MSUTRACE: filter settings

  DPCA      SI SSN      OPCA      CICS      CICE      MODE
004-004-004 **   ***   ****      ****      ****      all
;

```

This example shows a trace with a DPC-only filter key specified via the `-x` `<rcontext>option:`.

```

pass:loc=1304:cmd="msutrace -a acttrace"

    rlgncxa03w 08-01-29 11:31:09 EST  EAGLE 38.0.0

    MSUTRACE command complete
;

```

This example shows the captured trace buffer for an IPSG card:

```

pass:loc=1304:cmd="msutrace -g trace"

    rlgncxa03w 08-01-29 11:31:09 EST  EAGLE 38.0.0

    -----
    BUFFER: 0
    -----
    Filter used:

        DPCA          SI SSN      OPCA          CICS          CICE          MODE
        004-004-004  ** ***  ****          ****          ****          all

    Timestamp: 08-01-21 16:06:17.420
    Direction: Tx
    Error Code: 0

    PSTN DATA
    -----
    85 04 04 04 05 05 05 00 00 00 00 6e 01 00 f9
e3      .....n....
    33 c7 00 00 1d 00 00 00 00 10 00 12 00 14 00 16
3.....
    00 18 00 1a 00 1c 00 1e 00          .....

    IP DATA
    -----
    01 00 01 01 00 00 00 44 00 06 00 08 00 00 00
04      .....D.....
    02 10 00 31 00 05 05 05 00 04 04 04 05 02 00
00      ...1.....
    00 00 00 6e 01 00 f9 e3 33 c7 00 00 1d 00 00
00      ...n....3.....
    00 10 00 12 00 14 00 16 00 18 00 1a 00 1c 00
1e      .....
    00 00 00 00          ....

    MSUTRACE command complete
;

```

This example retrieves contents of the trace buffers. The example contains 1 stored trace buffer for a transmitted M3UA PDU.

```

pass:loc=1303:cmd="msutrace -g trace"

Command Accepted - Processing
  eagle10202 01-01-19 10:20:56 GMT  EAGLE5 31.6.0
  pass:loc=1303:cmd="msutrace -g trace"
  Command entered at terminal #4.
;

  eagle10202 01-01-19 10:20:56 GMT  EAGLE5 31.6.0
  PASS: Command sent to card
;

  eagle10202 01-01-19 10:20:56 GMT  EAGLE5 31.6.0

MSUTRACE command in progress
;

  eagle10202 01-01-19 10:20:56 GMT  EAGLE5 31.6.0

-----
BUFFER:  0
-----
Filter used:

DPCA      SI SSN OPCA      CICS      CICE      MODE
001-001-001 5  *** 001-001-002 0          100      all

Timestamp: 02-06-07 08:40:29.435
Direction: Tx
Error Code: 0

PSTN DATA
-----
85 01 01 01 02 01 01 b2 00 00 01 00 00 00 03 .....
05 00 02 80 80 0d 00 00 21 43 65 87 09 21 43 65 .....!Ce..!Ce
87 09 01 .....

IP DATA
-----
01 00 01 01 00 00 00 3c 02 00 00 08 00 00 00 01 .....<.....
02 10 00 2b 00 01 01 02 00 01 01 01 05 02 00 b2 ...+.....
00 00 01 00 00 00 00 03 05 00 02 80 80 0d 00 00 .....
21 43 65 87 09 21 43 65 87 09 01 00 !Ce..!Ce....

MSUTRACE command complete
;

```

This example retrieves contents of the trace buffers with ITU-I spare point codes. The example contains 3 stored trace buffers.

```
pass:loc=1317:cmd="msutrace -g trace"
```

```
Command Accepted - Processing
```

```
eagle20003 05-01-27 10:16:03 EST EAGLE5 31.12.0
```

```
pass:loc=1317:cmd="msutrace -g trace"
```

```
Command entered at terminal #4.
```

```
;
```

```
eagle20003 05-01-27 10:16:03 EST EAGLE5 31.12.0
```

```
PASS: Command sent to card
```

```
;
```

```
eagle20003 05-01-27 10:16:03 EST EAGLE5 31.12.0
```

```
MSUTRACE command in progress
```

```
;
```

```
eagle20003 05-01-27 10:16:03 EST EAGLE5 31.12.0
```

```
-----  
BUFFER: 0  
-----
```

```
Filter used:
```

DPCI	SI	SSN	OPCI	CICS	CICE	MODE
s-2-011-1	2	***	****	****	****	all

```
Timestamp: 05-01-26 10:33:14.330
```

```
Direction: Tx
```

```
Error Code: 0
```

```
PSTN DATA
```

```
-----  
02 59 50 16 a2 80 03 83 ce 46 0a 00 00 00 .YP.....F....
```

```
IP DATA
```

```
-----  
54 41 4c 49 6d 74 70 33 0e 00 02 59 50 16 a2 80
```

```
TALImtp3...YP...
```

```
03 83 ce 46 0a 00 00 00 ...F....
```

```
-----  
BUFFER: 1  
-----
```

```
Filter used:
```

DPCI	SI	SSN	OPCI	CICS	CICE	MODE
s-2-011-1	2	***	****	****	****	all

```
Timestamp: 05-01-26 10:33:14.335
```

```
Direction: Tx
```

```
Error Code: 0
```



```

PSTN DATA
-----
02 59 50 16 a2 80 84 04 c8 46 0a 00 00 00      .YP.....F....

IP DATA
-----
54 41 4c 49 6d 74 70 33 0e 00 02 59 50 16 a2 80  TALImtp3...YP...
84 04 c8 46 0a 00 00 00                          ...F.....

-----
BUFFER: 2
-----
Filter used:

      DPCI      SI SSN      OPCI      CICS      CICE      MODE
s-2-011-1      2 ***      ****      ****      ****      all

Timestamp: 05-01-26 10:33:14.340
Direction: Tx
Error Code: 0

PSTN DATA
-----
02 59 50 16 f2 80 01 81 c1 46 0f 00 00 00      .YP.....F....

IP DATA
-----
54 41 4c 49 6d 74 70 33 0e 00 02 59 50 16 f2 80  TALImtp3...YP...
01 81 c1 46 0f 00 00 00                          ...F.....

MSUTRACE command complete

```

;

This example clears the contents of the trace buffers:

```
pass:loc=1105:cmd="msutrace -a clrtrace"
```

Command Accepted - Processing

```

eagle20003 99-11-27 10:16:57 EST EAGLE5 31.6.0
pass:loc=1105:cmd="msutrace -a clrtrace"
Command entered at terminal #1.
;
eagle20003 99-11-27 10:16:57 EST EAGLE5 31.6.0
PASS: Command sent to card
;
eagle20003 99-11-27 10:16:57 EST EAGLE5 31.6.0
MSUTRACE command in progress
;
eagle20003 99-11-27 10:16:57 EST EAGLE5 31.6.0

```

```

    MSUTRACE command completed
;

```

This example activates MSU tracing:

```
pass:loc=1105:cmd="msutrace -a acttrace"
```

Command Accepted - Processing

```

    eagle20003 99-11-27 10:16:57 EST  EAGLE5 31.6.0
    pass:loc=1105:cmd="msutrace -a acttrace"
    Command entered at terminal #1.
;
    eagle20003 99-11-27 10:16:57 EST  EAGLE5 31.6.0
    PASS: Command sent to card
;
    eagle20003 99-11-27 10:16:57 EST  EAGLE5 31.6.0
    MSUTRACE command in progress
;
    eagle20003 99-11-27 10:16:57 EST  EAGLE5 31.6.0
    MSUTRACE command completed
;

```

This example deactivates MSU tracing:

```
pass:loc=1105:cmd="msutrace -a dacttrace"
```

Command Accepted - Processing

```

    eagle20003 99-11-27 10:16:57 EST  EAGLE5 31.6.0
    pass:loc=1105:cmd="msutrace -a dacttrace"
    Command entered at terminal #1.
;
    eagle20003 99-11-27 10:16:57 EST  EAGLE5 31.6.0
    PASS: Command sent to card
;
    eagle20003 99-11-27 10:16:57 EST  EAGLE5 31.6.0
    MSUTRACE command in progress
;
    4.0.0
    eagle20003 99-11-27 10:16:57 EST  EAGLE5 31.6.0
    MSUTRACE command completed
;

```

### Examples for Entering a Filter Key

The output shown at the end of these command examples is the same for each example, except for the echo of the entered command.

Command with the `-a chgfilter` option to insert a fully specified ANSI PC CIC filter key.

This filter key qualifies for capture MSUs with the following properties:

- DPC = 3-3-3 (ANSI)

- SI = 5
- OPC = 4-4-4 (ANSI)
- CIC = [10..1000]

```
pass:loc=1105:cmd="msutrace -a chgfilter -p ansi -k  
3-3-3:5:4-4-4:10:1000"
```

Command with the `-a chgfilter` option to insert a fully specified ANSI SCCP filter.

This filter key qualifies for capture MSUs with the following properties:

- DPC = 3-3-3 (ANSI)
- SI = 3
- SSN = 230

```
pass:loc=1105:cmd="msutrace -a chgfilter -k 3-3-3:3:230"
```

Command with the `-a chgfilter` option to insert a fully specified ANSI DPC SI filter key.

This filter key qualifies for capture MSUs with the following properties:

- DPC = 3-3-3 (ANSI)
- SI = 6

```
pass:loc=1105:cmd="msutrace -a chgfilter -k 3-3-3:6"
```

Command with the `-a chgfilter` option to insert a fully specified ITUN24 PC CIC filter key.

This filter key qualifies for capture MSUs with the following properties:

- DPC = 13-103-3 (ITUN24)
- SI = 5
- OPC = 14-104-4 (ITUN24)
- CIC = [10..1000]

```
pass:loc=1105:cmd="msutrace -a chgfilter -p itun24 -k  
13-103-3:5:14-104-4:10:1000"
```

Command with the `-a chgfilter` option to insert a partial ITUI DPC SI OPC filter key.

This filter key qualifies for capture MSUs with the following properties:

- DPC = 1-3-3 (ITUI)
- SI = 5
- OPC = 2-4-4 (ITUI)

```
pass:loc=1105:cmd="msutrace -a chgfilter -p itui -k 1-3-3:5:2-4-4"
```

Command with the `-a chgfilter` option to insert a partial DPC SI ITUN PC filter key, with the Duplicate Point Code feature turned off:

This filter key qualifies for capture MSUs with the following properties:

- DPC = 1536 (ITUN)
- SI = 5

```
pass:loc=1105:cmd="msutrace -a chgfilter -p itun -k 1536:5"
```

Command with the `-a chgfilter` option to insert a partial DPC SI ITUN PC filter key, with the Duplicate Point Code feature turned on:

This filter key qualifies for capture MSUs with the following properties:

- DPC = 1536-bb (ITUN)
- SI = 5

```
pass:loc=1105:cmd="msutrace -a chgfilter -p itun -k 1536-bb:5"
Command with the -a chgfilter option to insert a partial ANSI DPC filter key.
```

This filter key qualifies for capture MSUs with the following properties:

- DPC = 3-3-3 (ANSI)

```
pass:loc=1105:cmd="msutrace -a chgfilter -k 3-3-3"
Command with the -a chgfilter option to insert a partial SI filter key. Because no DPC
or OPC field is specified, point code type does not have to be indicated.
```

This filter key qualifies for capture MSUs with the following properties:

- SI = 5

This filter key qualifies for capture MSUs with the following properties:

- DPC = 13-113-3 (ITUN24)

```
pass:loc=1105:cmd="msutrace -a chgfilter -p itun24 -k 13-113-3"
```

Command Accepted - Processing

```

eagle20003 06-06-01 10:16:57 EST EAGLE5 35.0.0
pass:loc=1105:cmd="msutrace -a chgfilter -p ansi -k
3-3-3:5:4-4-4:10:1000"
Command entered at terminal #1.
;
eagle20003 99-11-27 10:16:57 EST EAGLE5 31.6.0
PASS: Command sent to card
;
eagle20003 99-11-27 10:16:57 EST EAGLE5 31.6.0
MSUTRACE command in progress
;
eagle20003 99-11-27 10:16:57 EST EAGLE5 31.6.0
MSUTRACE command completed
;
```

These commands include the -m *mode* option to change the trace capture mode.

Mode to have a 'capture-on-normalization error' property such that only MSUs with normalization processing errors are traced:

```
pass:loc=1105:cmd="msutrace -a chgfilter -m normerr"
```

Set a default filter key and the filter's mode at the same time:

```
pass:loc=1105:cmd="msutrace -a chgfilter -k -t default -m all"
```

Command Accepted - Processing

```

eagle20003 99-11-27 10:16:57 EST EAGLE5 31.6.0
pass:loc=1105:cmd="msutrace -a chgfilter -k -t default -m all"
Command entered at terminal #1.
;
```

```

eagle20003 99-11-27 10:16:57 EST  EAGLE5 31.6.0
PASS: Command sent to card
;
eagle20003 99-11-27 10:16:57 EST  EAGLE5 31.6.0
MSUTRACE command in progress
;
eagle20003 99-11-27 10:16:57 EST  EAGLE5 31.6.0
MSUTRACE command completed
;

```

These commands insert a partial DPC-SI filter key with ITU-I spare point code and show the `msutracegetfilter` command output with the filter key after the `chgfilter` command is processed to completion.

This filter key will qualify MSUs with at least the following properties:

- DPCI = (ITU-I Spare) 2-11-1
- SI=5

```
pass:loc=1317:cmd="msutrace -a chgfilter -p ituis -k 2-11-1:5"
```

Command Accepted - Processing

```

eagle20003 06-06-01 10:16:03 EST  EAGLE5 35.5.0
pass:loc=1317:cmd="msutrace -a chgfilter -p ituis -k 2-11-1:5"
Command entered at terminal #1.
;
eagle20003 06-06-01 10:16:03 EST  EAGLE5 35.5.0
PASS: Command sent to card
;
eagle20003 06-06-01 10:16:03 EST  EAGLE5 35.5.0
MSUTRACE command in progress
;
eagle20003 06-06-01 10:16:03 EST  EAGLE5 35.5.0
MSUTRACE command completed
;

```

```
pass:loc=1317:cmd="msutrace -g config"
```

Command Accepted - Processing

```

eagle20003 05-01-27 10:16:03 EST  EAGLE5 31.12.0
pass:loc=1317:cmd="msutrace -g config"
;
eagle20003 05-01-27 10:16:03 EST  EAGLE5 31.12.0
PASS: Command sent to card
;
eagle20003 05-01-27 10:16:03 EST  EAGLE5 31.12.0
MSUTRACE command in progress
;
eagle20003 05-01-27 10:16:03 EST  EAGLE5 31.12.0
MSUTRACE configurations

```

```

Trace = On

Trace buffers: 3 of 3 USED

MSUTRACE: filter settings
   DPCI      SI SSN   OPCI      CICS      CICE      MODE
s-2-011-1    5   ***    ****      ****      ****      all
;
eagle20003 05-01-27 10:16:03 EST  EAGLE5 31.12.0
MSUTRACE command complete
;

```

These commands insert a full DPC-SI-OPC filter key with an ITU-N spare point code when the Duplicate Point Code feature is on, and show the `msutracegetfilter` command output with the filter key after the `chgfilter` command is processed to completion.

This filter key will qualify MSUs with at least the following properties:

- DPC = (ITU-N Spare) 6234-aa
- SI=5
- OPC=(ITU-N Spare) 6233-aa
- CICS=1
- CICE=200

```
pass:loc=1315:cmd="msutrace -a chgfilter -p ITUNS -k 6234-aa:5:6233-aa:1:200"
```

Command Accepted - Processing

```

eagle20003 06-06-01 10:16:03 EST  EAGLE5 35.0.0
pass:loc=1315:cmd="msutrace -a chgfilter -p ITUNS -k
6234-aa:5:6233-aa:1:200"
Command entered at terminal #1.
;
eagle20003 06-06-01 10:16:03 EST  EAGLE5 35.0.0
PASS: Command sent to card
;
eagle20003 06-06-01 10:16:03 EST  EAGLE5 35.0.0
MSUTRACE command in progress
;
eagle20003 06-06-01 10:16:03 EST  EAGLE5 35.0.0
MSUTRACE command completed
;

```

```
pass:loc=1317:cmd="msutrace -g config"
```

Command Accepted - Processing

```

eagle20003 05-01-27 10:16:03 EST  EAGLE5 31.12.0
pass:loc=1317:cmd="msutrace -g config"
Command entered at terminal #1.
;
eagle20003 05-01-27 10:16:03 EST  EAGLE5 31.12.0
PASS: Command sent to card
;
eagle20003 05-01-27 10:16:03 EST  EAGLE5 31.12.0
MSUTRACE command in progress
;
eagle20003 05-01-27 10:16:03 EST  EAGLE5 31.12.0
MSUTRACE configurations

Trace = On

Trace buffers: 0 of 3 USED

MSUTRACE: filter settings
      DPCN      SI SSN      OPCI      CICS      CICE      MODE
s-6234-aa      5   ***      s-6233-aa      ****      ****      all
;
eagle20003 05-01-27 10:16:03 EST  EAGLE5 31.12.0
MSUTRACE command complete
;

```

## netstat

This command is used to display network statistics from the TCP/IP stack. This command allows troubleshooting of network interface and routing configuration problems within the private EPAP-Service Module IP network.

### Options

Options and option parameters that are underlined indicate that a value must be specified for that option or parameter. For example, the `netstat` command option `-m` has the parameter buffer pool. The pool for which information will be displayed can be specified, as in the command `netstat -m sys`. Do not enter the underlined option or parameter; enter a value for the information represented by the underlined option or parameter.

`-a`

This option displays socket information for all protocols.

`-d`

This option displays driver measurement data.

The `-m` modifier displays multicast information. The `-p` modifier displays PHY registers. The `-z` modifier clears driver measurements. The `-h` modifier displays history measurements for the past 24 hours or the measurements collected a user defined hour ago. The `-f` modifier displays driver measurement data in full format (for GPLs that are loaded on E5-based cards only).

The `-m`, `-p`, and `-h` modifiers are not supported for GPLs that are loaded on E5-based cards.

`-e`

This option displays DPL driver measurement data. This option is supported only for GPLs that are loaded on E5-based cards.

-f, -h

These options provide help information for the command.

-i

This option displays interface information for all interfaces.

-m buffer\_pool

This option displays buffer pool information for the specified pool.

**Range:**

***data***

SENS protocol stack data buffer pool

***sys***

system buffer pool

***dd***

Ethernet device driver buffer pool

**Default:**

All three buffer pools are displayed.

-p protocol

This option displays information for the specified protocol.

**Rnage:**

***tcp***

transmission control protocol

***udp***

user datagram protocol

***ip***

internet protocol

***icmp***

internet control message protocol

***sctp***

stream control transmission protocol

**Default:**

None

-r

This option displays the Route table.

**Example**

```
pass:cmd="netstat -i":loc=1105
```

```
pass:cmd="netstat -a":loc=1111
```

```
pass:cmd="netstat -p tcp":loc=1111
```

```
pass:cmd="netstat -m data":loc=1105
```

```
pass:cmd="netstat -r":loc=1105
```



```
pass:cmd="netstat -e":loc=1111
pass:cmd="netstat -d 0 -f":loc=1111
```

### Dependencies

Only one of the options can be specified at a time.

### Notes

The `netstat` command is executed through the `pass` command.

The options `{-m,-p,-h}` are not supported for GPLs that are loaded on E5-based cards.

### Output for GPLs that are NOT loaded on E5-based cards

```
pass:loc=1107:cmd="netstat"
or
pass:loc=1107:cmd="netstat -h"

      Command Accepted - Processing

tekelecstp 08-02-02 12:16:34 EST  EAGLE 38.0.0
PASS: Command sent to card

Usage: netstat [-a] [-h] [-m data|sys|dd] [-p icmp|igmp|ip|sctp|tcp|udp]
           [-i] [-r] [-d 0|1] [-m] [-p] [-z] [-h 1..24]]

Options:
  -a      display socket information for all protocols
  -h      Displays this message
  -m      display buffer pool information for 1 of the system pools
  -p      display socket information for 1 of the protocols
  -i      display interface information for all interfaces
  -r      display the route table information
  -d      display driver measurement data

;
tekelecstp 08-02-02 12:16:34 EST  EAGLE 38.0.0

NETSTAT command complete

;

pass:loc=1105:cmd="netstat -a"

      Command Accepted - Processing

tekelecstp 08-02-07 07:59:12 EST  EAGLE 38.0.0
PASS: Command sent to card

;

tekelecstp 08-02-07 07:59:12 EST  EAGLE 38.0.0

Active Internet connections (including servers)
```

```

                                Local Address
PCB      Proto Recv-Q Send-Q Foreign Address (state)
-----
11df510  TCP      0      0      0.0.0.0.111 LISTEN
                                0.0.0.0.0
11df384  UDP      0      0      0.0.0.0.1008
                                0.0.0.0.0
11df48c  UDP      0      0      0.0.0.0.111
                                0.0.0.0.0
;

tekelecstp 08-02-07 07:59:12 EST EAGLE 38.0.0

NETSTAT command complete

```

The interfaces listed in the `netstat -i` output correspond to the card's ports as follows:

- `seeq 0` = IP interface A
- `seeq 1` = IP interface B
- `DPLend` = pseudo-IP interface used only by network cards for STC-style Integrated Monitoring
- `LO` = local loopback interface

```

pass:loc=1105:cmd="netstat -i"

tekelecstp 11-01-07 07:59:20 EST EAGLE 43.0.0
pass: loc=1105: cmd="netstat -i"
Command entered at terminal #1.
;

tekelecstp 11-01-07 07:59:20 EST EAGLE 43.0.0
PASS: Command sent to card
;

tekelecstp 11-01-07 07:59:20 EST EAGLE 43.0.0
DPLend (unit number 0):
  Flags: (0x63) UP BROADCAST ARP RUNNING 10MB HDX DIX
  Type: ETHERNET_CSMACD
  Internet address: 172.20.48.25
  Broadcast address: 172.20.51.255
  Netmask 0xffff0000 Subnetmask 0xfffffc00
  Ethernet address is 00:00:00:00:00:00
  Metric is 0
  Maximum Transfer Unit size is 485
  1 packets received; 1 packets sent
  0 multicast packets received
  0 multicast packets sent
  0 input errors; 0 output errors
  0 collisions; 0 dropped
seeq (unit number 1):
  Flags: (0x63) UP BROADCAST ARP RUNNING 10MB HDX DIX
  Type: ETHERNET_CSMACD
  Internet address: 192.168.55.112

```

```
Broadcast address: 192.168.55.255
Netmask 0xffffffff Subnetmask 0xffffffff
Ethernet address is 00:00:17:04:00:62
Metric is 0
Maximum Transfer Unit size is 1500
28 packets received; 16 packets sent
13 multicast packets received
0 multicast packets sent
0 input errors; 0 output errors
0 collisions; 0 dropped
lo (unit number 0):
Flags: (0x8069) UP LOOPBACK MULTICAST ARP RUNNING 10MB HDX DIX
Type: SOFTWARE_LOOPBACK
Internet address: 127.0.0.1
Netmask 0xff000000 Subnetmask 0xff000000
Metric is 0
Maximum Transfer Unit size is 32768
6 packets received; 6 packets sent
0 multicast packets received
0 multicast packets sent
0 input errors; 0 output errors
0 collisions; 0 dropped
seeq (unit number 0):
Flags: (0x63) UP BROADCAST ARP RUNNING 10MB HDX DIX
Type: ETHERNET_CSMACD
Internet address: 192.168.100.112
Broadcast address: 192.168.100.255
Netmask 0xffffffff Subnetmask 0xffffffff
Ethernet address is 00:00:17:04:00:61
Metric is 0
Maximum Transfer Unit size is 1500
5 packets received; 1 packets sent
5 multicast packets received
0 multicast packets sent
0 input errors; 0 output errors
0 collisions; 0 dropped

;

tekelecstp 11-01-07 07:59:20 EST EAGLE 43.0.0

NETSTAT command complete

pass:loc=1105:cmd="netstat -m data"

Command Accepted - Processing

tekelecstp 08-02-07 07:59:56 EST EAGLE 38.0.0
PASS: Command sent to card

;

eagle20004 08-02-07 07:59:56 EST EAGLE 38.0.0
type          number
-----
-----
```

```
FREE      :    9553
DATA      :         0
HEADER    :         0
SOCKET    :         0
PCB       :         0
RTABLE    :         0
HTABLE    :         0
ATABLE    :         0
SONAME    :         0
ZOMBIE    :         0
SOOPTS    :         0
FTABLE    :         0
RIGHTS    :         0
IFADDR    :         0
CONTROL   :         0
OOBDATA   :         0
IPMOPTS   :         0
IPMADDR   :         0
IFMADDR   :         0
MRTABLE   :         0
TOTAL     :    9553
number of mbufs: 9553
number of times failed to find space: 0
number of times waited for space: 0
number of times drained protocols for space: 0
-----
CLUSTER POOL TABLE
-----
size      clusters  free      usage
-----
64        1000        1000      41
128       1250        1250      848
256       1250        1250      0
512       200         200       0
1024      100         100       0
2048      20          20        0
-----

;

tekelecstp 08-02-07 07:59:56 EST  EAGLE 38.0.0

NETSTAT command complete

pass:loc=1105:cmd="netstat -m sys"

Command Accepted - Processing

tekelecstp 08-02-07 08:00:14 EST  EAGLE 38.0.0
PASS: Command sent to card

;

eagle20004 08-02-07 08:00:14 EST  EAGLE 38.0.0
type      number
```

```
-----
FREE      :    3069
DATA      :         0
HEADER    :         0
SOCKET    :         3
PCB       :         4
RTABLE    :        17
HTABLE    :         0
ATABLE    :         0
SONAME    :         0
ZOMBIE    :         0
SOOPTS    :         0
FTABLE    :         0
RIGHTS    :         0
IFADDR    :         6
CONTROL   :         0
OOBDATA   :         0
IPMOPTS   :         0
IPMADDR   :         1
IFMADDR   :         0
MRTABLE   :         0
TOTAL     :    3100
number of mbufs: 3100
number of times failed to find space: 0
number of times waited for space: 0
number of times drained protocols for space: 0
-----
CLUSTER POOL TABLE
-----
size      clusters  free      usage
-----
64        650        640       12
128       200        188       33
256       500        494        6
512       200        197       24
-----
;

tekelecstp 08-02-07 08:00:14 EST  EAGLE 38.0.0

NETSTAT command complete

pass:loc=1105:cmd="netstat -m dd"

Command Accepted - Processing

tekelecstp 08-02-07 08:00:24 EST  EAGLE 38.0.0
PASS: Command sent to card
;

tekelecstp 08-02-07 08:00:24 EST  EAGLE 38.0.0

END-0 Buffer Pool
-----
```

```
CLUSTER POOL TABLE
-----
size      clusters  free      usage
-----
1528      80         77        10
-----

END-1 Buffer Pool
-----
CLUSTER POOL TABLE
-----
size      clusters  free      usage
-----
1528      80         72        58
-----

;

tekelecstp 08-02-07 08:00:24 EST  EAGLE 38.0.0

NETSTAT command complete

pass:loc=1105:cmd="netstat -p icmp"

Command Accepted - Processing

;

tekelecstp 08-02-07 08:00:29 EST  EAGLE 38.0.0
0966.1083   SYSTEM      INFO      REPT COND: system alive
          Report Date:08-02-27  Time:08:00:29

;

tekelecstp 08-02-27 08:00:29 EST  EAGLE 38.0.0
PASS: Command sent to card

;

tekelecstp 08-02-27 08:00:29 EST  EAGLE 38.0.0
ICMP:
  1 call to icmp_error
  0 error not generated because old message was icmp
Output histogram:
  destination unreachable: 1
  0 message with bad code fields
  0 message < minimum length
  0 bad checksum
  0 message with bad length
Input histogram:
  echo reply: 6
  destination unreachable: 1
  0 message response generated

;

tekelecstp 08-02-07 08:00:29 EST  EAGLE 38.0.0
```

```
NETSTAT command complete
```

```
pass:loc=1105:cmd="netstat -p ip"
```

```
Command Accepted - Processing
```

```
tekelecstp 08-02-07 08:00:44 EST EAGLE 38.0.0  
PASS: Command sent to card
```

```
;
```

```
tekelecstp 08-02-07 08:00:44 EST EAGLE 38.0.0  
IP:
```

```
    48 total  
    0 badsum  
    0 tooshort  
    0 toosmall  
    0 badhlen  
    0 badlen  
    0 infragments  
    0 fragdropped  
    0 fragtimeout  
    0 forward  
   14 cantforward  
    0 redirectsent  
    1 unknownprotocol  
    0 nobuffers  
    0 reassembled  
    0 outfragments  
    0 noroute
```

```
;
```

```
tekelecstp 08-02-07 08:00:44 EST EAGLE 38.0.0
```

```
NETSTAT command complete
```

```
pass:loc=1105:cmd="netstat -p tcp"
```

```
Command Accepted - Processing
```

```
tekelecstp 08-02-07 08:00:54 EST EAGLE 38.0.0  
PASS: Command sent to card
```

```
;
```

```
tekelecstp 08-02-07 08:00:54 EST EAGLE 38.0.0  
TCP:
```

```
    0 packet sent  
      0 data packet (0 byte)  
      0 data packet (0 byte) retransmitted  
      0 ack-only packet (0 delayed)  
      0 URG only packet  
      0 window probe packet  
      0 window update packet
```

```

        0 control packet
0 packet received
    0 ack (for 0 byte)
    0 duplicate ack
    0 ack for unsent data
    0 packet (0 byte) received in-sequence
    0 completely duplicate packet (0 byte)
    0 packet with some dup. data (0 byte duped)
    0 out-of-order packet (0 byte)
    0 packet (0 byte) of data after window
    0 window probe
    0 window update packet
    0 packet received after close
    0 discarded for bad checksum
    0 discarded for bad header offset field
    0 discarded because packet too short
0 connection request
0 connection accept
0 connection established (including accepts)
0 connection closed (including 0 drop)
0 embryonic connection dropped
0 segment updated rtt (of 0 attempt)
0 retransmit timeout
    0 connection dropped by rexmit timeout
0 persist timeout
0 keepalive timeout
    0 keepalive probe sent
    0 connection dropped by keepalive
0 pcb cache lookup failed

;

tekelecstp 08-01-07 08:00:54 EST  EAGLE 38.0.0

NETSTAT command complete

pass:loc=1305:cmd="netstat -p sctp"

Command Accepted - Processing

tekelecstp 08-01-25 11:20:41 EST  EAGLE 38.0.0
PASS: Command sent to card

;

tekelecstp 08-01-25 11:20:41 EST  EAGLE 38.0.0
ip packets sent..... 1474882
  ip packets sent with data chunk..... 306354
  control chunks (excluding retransmissions)..... 1172759
  ordered data chunks (excluding retransmissions).. 1534350
  unordered data chunks (excluding retransmissions) 0
  user messages fragmented due to MTU..... 0
  retransmit data chunks sent..... 4
  sacks sent..... 496302
  send failed..... 0

```



```
ip packets received..... 1816035
  ip packets received with data chunk..... 989957
  control chunks (excluding duplicates)..... 833141
  ordered data chunks (excluding duplicates)..... 989968
  unordered data chunks (excluding duplicates)..... 0
  user messages reassembled..... 0
  data chunks read..... 988601
  duplicate tsns received..... 0
  sacks received..... 153763
  gap ack blocks received..... 0
  out of the blue..... 4
  with invalid checksum..... 0
connections established..... 2954
  by upper layer..... 0
  by remote endpoint..... 2958
connections terminated..... 4
  ungracefully..... 2952
  gracefully..... 0
associations dropped due to retransmits..... 0
consecutive retransmit timeouts..... 4
retransmit timer count..... 6
fast retransmit count..... 0
heartbeat requests received..... 330275
heartbeat acks received..... 340239
heartbeat requests sent..... 340258
associations supported..... 50
milliseconds cookie life at 4-way start-up handshake. 5000
retransmission attempts allowed at start-up phase.... 8
```

;

```
tekelecstp 08-01-25 11:20:41 EST EAGLE 38.0.0
```

```
NETSTAT command complete
```

```
pass:loc=1105:cmd="netstat -p udp"
```

```
Command Accepted - Processing
```

```
tekelecstp 08-02-10 08:01:05 EST EAGLE 38.0.0
```

```
PASS: Command sent to card
```

;

```
tekelecstp 08-02-10 08:01:05 EST EAGLE 38.0.0
```

```
UDP:
```

```
 42 total packets
 29 input packets
 13 output packets
  0 incomplete header
  0 bad data length field
  0 bad checksum
 16 broadcasts received with no ports
  0 full socket
 13 pcb cache lookups failed
```

```
1 pcb hash lookup failed

;

tekelecstp 08-02-10 08:01:05 EST EAGLE 38.0.0

NETSTAT command complete

pass:loc=1105:cmd="netstat -r"

Command Accepted - Processing

tekelecstp 08-02-07 08:01:14 EST EAGLE 38.0.0
PASS: Command sent to card

;

tekelecstp 08-02-07 08:01:14 EST EAGLE 38.0.0

ROUTE NET TABLE
destination      gateway          flags  Refcnt  Use
Interface
-----
-----
0.0.0.0          192.168.55.250  3      0       14
seeq1
192.168.55.0    192.168.55.112  101    0       0
seeq1
192.168.100.0   192.168.100.112 101    0       0
seeq0
-----
-----

ROUTE HOST TABLE
destination      gateway          flags  Refcnt  Use
Interface
-----
-----
127.0.0.1       127.0.0.1       5      1       6
lo0
-----
-----

;

tekelecstp 08-02-07 08:01:14 EST EAGLE 38.0.0

NETSTAT command complete
```

```
pass:loc=1107:cmd="netstat -d 0"
```

```
Command Accepted - Processing
```

```
tekelecstp 08-01-30 09:49:57 EST EAGLE 38.0.0
6734.1083 SYSTEM INFO REPT COND: system alive
Report Date:08-01-30 Time:09:49:57
```

```
;
```

```
tekelecstp 08-01-30 09:49:57 EST EAGLE 38.0.0
PASS: Command sent to card
```

```
;
```

```
tekelecstp 08-01-30 09:49:57 EST EAGLE 38.0.0
Report Time = 05-11-30 09:50:01.435
Card Load Time = 05-11-29 16:46:49.775
Last Reset Time = 05-11-29 16:46:49.775
```

```
overflow = 0 excess coll. = 0 align. error = 0
crc = 0 underflow = 0 rx collision = 0
dribble = 0 late coll. = 0 very long = 0
short fr = 0 coll. = 0 exc defer = 0
oversize = 0 cs error = 0 rxerror = 132
rxabort = 0 tx bytes = 60 rx broadcast = 104853
read err = 0 tx frames = 1 tx broadcast = 1
rx bytes = 6385476 tx multicast = 0
rx frames = 104856
bit bucket = 0
term count = 0
runts = 0
```

```
;
```

```
pass:loc=1107:cmd="netstat -d 0 -m"
```

```
Command Accepted - Processing
```

```
tekelecstp 08-02-02 10:34:59 EST EAGLE 38.0.0
6734.1083 SYSTEM INFO REPT COND: system alive
Report Date:08-02-02 Time:10:34:59
```

```
;
```

```
tekelecstp 08-02-02 10:34:59 EST EAGLE 38.0.0
PASS: Command sent to card
```

```
;
```

```
tekelecstp 08-02-02 10:34:59 EST EAGLE 38.0.0
```

```
Report Time = 05-12-02 10:35:01.755
Card Load Time = 05-11-30 16:14:26.590
Last Reset Time = 05-11-30 16:14:26.590
```

```
IP Multicast Reference Table
```

```
Bit 0 1 2 3 4 5 6 7
```

```
Byte-0 0 0 0 0 0 0 0 0
Byte-1 0 0 0 0 0 0 0 0
Byte-2 0 0 0 0 0 0 0 0
Byte-3 0 0 0 0 0 0 0 0
Byte-4 0 0 0 0 0 0 0 0
Byte-5 0 0 0 0 0 0 0 0
Byte-6 0 0 0 0 0 0 1 0
Byte-7 0 0 0 0 0 0 0 0
```

## Multicast MAC Address List

MAC Addr	Ref-Cnt	Byte	Bit
01:00:5e:00:00:01	01	6	6

## Hardware Multicast Filter Register (unit=0)

```
00 00 00 00 00 00 40 00
```

;

```
tekelecstp 08-02-02 10:34:59 EST EAGLE 38.0.0
```

```
NETSTAT command complete
```

;

```
pass:loc=1107:cmd="netstat -d 1 -m"
```

```
Command Accepted - Processing
```

```
tekelecstp 08-01-30 09:51:07 EST EAGLE 38.0.0
```

```
PASS: Command sent to card
```

;

```
tekelecstp 08-01-30 09:51:07 EST EAGLE 38.0.0
```

```
Report Time = 05-11-30 09:51:07.745
```

```
Card Load Time = 05-11-29 16:46:49.775
```

```
Last Reset Time = 05-11-30 09:50:43.510
```

```
Multicast is NOT enabled for unit=1
```

;

```
tekelecstp 08-01-30 09:51:07 EST EAGLE 38.0.0
```

```
NETSTAT command complete
```

;

```
pass:loc=1107:cmd="netstat -d 0 -p"
```

```
Command Accepted - Processing
```

```
tekelecstp 08-01-30 09:50:55 EST EAGLE 38.0.0
```

```
PASS: Command sent to card
```

;

```
tekelecstp 08-01-30 09:50:55 EST EAGLE 38.0.0

Register          Value
-----
Control           = 0x2100
Status            = 0x7809
PHY ID #1         = 0x0016
PHY ID #2         = 0xf831
AN Adv.           = 0x01e1
AN REC            = 0x0000
Config #1         = 0x0022
Config #2         = 0xff00
Status Output     = 0x02c0
Mask              = 0xffff

;

tekelecstp 08-01-30 09:50:55 EST EAGLE 38.0.0

NETSTAT command complete

;

pass:loc=1107:cmd="netstat -d 0 -z"

Command Accepted - Processing

tekelecstp 08-01-30 09:50:43 EST EAGLE 38.0.0
PASS: Command sent to card

;

tekelecstp 08-01-30 09:50:43 EST EAGLE 38.0.0
Report Time       = 05-11-30 09:50:43.510
Card Load Time   = 05-11-29 16:46:49.775
Last Reset Time  = 05-11-30 09:50:43.510

overflow = 0          excess coll. = 0          align. error = 0
crc = 0              underflow = 0          rx collision = 0
dribble = 0          late coll. = 0        very long = 0
short fr = 0         coll. = 0             exc defer = 0
oversize = 0         cs error = 0          rxerror = 0
rxabort = 0          tx bytes = 0          rx broadcast = 0
read err = 0         tx frames = 0         tx broadcast = 0
rx bytes = 0
rx frames = 0
bit bucket = 0
term count = 0
runts = 0
tx multicast = 0

Driver measurements for unit=0 cleared

;

tekelecstp 08-01-30 09:50:43 EST EAGLE 38.0.0
```

```
NETSTAT command complete

;

pass:loc=1107:cmd="netstat -d 0 -h"

Command Accepted - Processing

tekelecstp 08-01-30 09:50:12 EST EAGLE 38.0.0
PASS: Command sent to card

;

tekelecstp 08-01-30 09:50:12 EST EAGLE 38.0.0
Report Time      = 05-11-30 09:50:12.500
Card Load Time   = 05-11-29 16:46:49.775
Last Reset Time  = 05-11-29 16:46:49.775

Hours Ago      Tx Frames    Tx Errors    Rx Frames    Rx Errors
1              0            0            6298         0
2              0            0            6295         0
3              0            0            6295         0
4              0            0            6295         0
5              0            0            6295         0
6              0            0            6295         0
7              0            0            6296         0
8              0            0            6296         0
9              0            0            6294         0
10             0            0            6294         0
11             0            0            6295         0
12             0            0            6296         0
13             0            0            6294         0
14             0            0            6295         0
15             0            0            6294         0
16             0            0            5248         0
17             1            0            4852         0
18             --            --            --            --
19             --            --            --            --
20             --            --            --            --
21             --            --            --            --
22             --            --            --            --
23             --            --            --            --
24             --            --            --            --

;

tekelecstp 08-01-30 09:50:12 EST EAGLE 38.0.0

NETSTAT command complete

;
```

```
pass:loc=1107:cmd="netstat -d 0 -h 18"

Command Accepted - Processing

tekelecstp 08-01-30 10:20:57 EST EAGLE 38.0.0
PASS: Command sent to card
;

tekelecstp 08-01-30 10:20:57 EST EAGLE 38.0.0

Report Time      = 05-11-30 10:20:57.735
Card Load Time   = 05-11-29 16:46:49.775
Last Reset Time  = 05-11-30 09:51:22.480

NETSTAT: Invalid hour number, cannot display 18 hour(s) ago.
Stats have only been saved for 17 hour(s).
;

tekelecstp 08-01-30 10:20:57 EST EAGLE 38.0.0

NETSTAT command complete
;

pass:loc=1107:cmd="netstat -d 0 -h 15"

Command Accepted - Processing
;

tekelecstp 08-01-30 09:50:24 EST EAGLE 38.0.0
PASS: Command sent to card
;

tekelecstp 08-01-30 09:50:24 EST EAGLE 38.0.0

Report Time      = 05-11-30 09:50:24.080
Card Load Time   = 05-11-29 16:46:49.775
Last Reset Time  = 05-11-29 16:46:49.775

overflow = 0          excess coll. = 0          align. error = 0
crc = 0              underflow = 0            rx collision = 0
dribble = 0          late coll. = 0          very long = 0
short fr = 0         coll. = 0               exc defer = 0
oversize = 0         cs error = 0            rxerror = 0
rxabort = 0          tx bytes = 0            rx broadcast = 6296
read err = 0         tx frames = 0           tx broadcast = 0
rx bytes = 383160
rx frames = 6294
bit bucket = 0
term count = 0
runts = 0
;

```

```
tekelecstp 08-01-30 09:50:24 EST EAGLE 38.0.0
```

```
NETSTAT command complete
```

```
;
```

### Output for GPLs on E5-based Cards

```
pass:cmd="netstat":loc=1111
```

```
Or
```

```
pass:cmd="netstat -h":loc=1111
```

```
Command Accepted - Processing
```

```
tekelecstp 08-01-19 04:43:47 EST EAGLE 38.0.0
```

```
PASS: Command sent to card
```

```
;
```

```
tekelecstp 08-01-19 04:43:47 EST EAGLE 38.0.0
```

```
Usage: netstat [-a] [-e] [-h] [-m data|sys|dd] [-p icmp|igmp|ip|
sctp|tcp|udp]
```

```
[-i] [-r] [-d 0|1] [-m] [-p] [-z] [-h 1..24] [-f]]
```

```
Options:
```

```
-a      display socket information for all protocols
-e      display DPL driver measurement data
-d      display Ethernet driver measurement data
-h      display this message
-m      display buffer pool information for 1 of the system
```

```
pools
```

```
-p      display socket information for 1 of the protocols
-i      display interface information for all interfaces
-r      display the route table information
```

```
;
```

```
tekelecstp 08-01-19 04:43:47 IST EAGLE 38.0.0
```

```
NETSTAT command complete
```

```
;
```

```
pass:cmd="netstat -a":loc=1111
```

```
Command Accepted - Processing
```

```
tekelecstp 08-06-21 16:26:30 IST EAGLE5 39.0.0
```

```
pass:cmd="netstat -a":loc=1105
```

```
Command entered at terminal #3.
```

```
;
```

```
tekelecstp 08-06-21 16:26:30 IST EAGLE5 39.0.0
```

```
PASS: Command sent to card
```



```
;

tekelecstp 08-06-21 16:26:30 IST EAGLE5 39.0.0
SDS Shell Output

-> tklc_inetstatShow
PCB      Proto Recv-Q   Send-Q   Local Address   Foreign Address (state)
-----  -
2354720  TCP      0         0   0.0.0.0.23     0.0.0.0.0       LISTEN
232cd60  UDP    16921935   0   0.0.0.0.161   0.0.0.0.0
232cc20  UDP      0         0   127.0.0.1.1026 127.0.0.1.17185
232cae0  UDP    16921930   0   0.0.0.0.17185 0.0.0.0.0
232c9a0  UDP    16921922   0   0.0.0.0.68    0.0.0.0.0
232c5e0  UDP    16921912   0   127.0.0.1.1024 0.0.0.0.0
232c220  UDP      0         0   127.0.0.1.1025 127.0.0.1.1024

value = 1 = 0x1

;

tekelecstp 08-06-21 16:26:30 IST EAGLE5 39.0.0

;

tekelecstp 08-06-21 16:26:30 IST EAGLE5 39.0.0

NETSTAT command complete

;

pass:cmd="netstat -e":loc=1111

Command Accepted - Processing

tekelecstp 08-01-19 04:45:51 EST EAGLE 38.0.0
PASS: Command sent to card

;

tekelecstp 08-01-19 04:45:51 EST EAGLE 38.0.0

Dual Port Link Statistics
In Ucast Octets = 0           In Ucast Pkts = 0
Out Ucast Octet = 0          Out Ucast Pkts = 0
Out Bcast Octets = 0         Out Bcast Pkts = 0
Out Ucast Octets Err = 0     Out Ucast Pkts Err = 0
Out Bcast Octet Err = 0     Out Bcast Pkts Err = 0
Invaled copy lenth = 0      IP Frame too big = 0
```

```

No Mbufs Avail = 0
TVG Func Err = 0
Inbound too big = 0

No System bufs Avail = 0
System buf Err = 0

;

tekelecstp 08-01-19 04:45:51 EST EAGLE 38.0.0

NETSTAT command complete

;

```

Output for the `netstat -i` command varies based on the card type. The GEI interfaces are the ports that carry signaling and monitoring traffic external to the EAGLE. The number of these ports varies with the IP connection. Information for all 4 GEI interfaces is displayed on only FC Capable cards as shown below.

The interfaces listed in the `netstat -i` output correspond to a card's ports as follows:

- For Signaling GPLs (IPSG, IPLIMx, IPGWx):
- `gei 2` = IP signaling interface A
- `gei 0` = IP signaling interface B
- `gei 3` = Fast Copy interface A
- `gei 1` = Fast Copy interface B
- `DPLend` = pseudo-IP interface used only by network cards for STC-style Integrated Monitoring
- `LO` = local loopback interface

For SCCPx GPLs:

- `gei 0` = IP interface A
- `gei 1` = IP interface B
- `DPLend` = pseudo-IP interface used only by network cards for STC-style Integrated Monitoring
- `LO` = local loopback interface
- `BOND` = interface formed by bonding the two IP interfaces

```

pass:cmd="netstat -i":loc=1111

e1030703 09-12-13 19:15:31 EST EAGLE 42.0.0
pass:loc=1111:cmd="netstat -i"
Command entered at terminal #17.

;

e1030703 09-12-13 19:15:31 EST EAGLE 42.0.0
PASS: Command sent to card

;
Command Accepted - Processing
e1030703 09-12-13 19:15:38 EST EAGLE 42.0.0

NETSTAT command complete

```

```
;
Command Executed
e1030703 09-12-13 19:15:31 EST EAGLE 42.0.0
SDS Shell Output

-> tklc_ifShow
lo (unit number 0):
  Flags: (0x48049) UP LOOPBACK MULTICAST TRAILERS ARP RUNNING INET_UP
  Type: SOFTWARE_LOOPBACK
  inet: 127.0.0.1
  Netmask 0xff000000 Subnetmask 0xff000000
  Metric is 0
  Maximum Transfer Unit size is 1536
  0 packets received; 1 packets sent
  0 multicast packets received
  0 multicast packets sent
  0 input errors; 0 output errors
  0 collisions; 0 dropped
  0 output queue drops
DPLend (unit number 0):
  Flags: (0x60043) UP BROADCAST ARP RUNNING INET_UP
  Type: ETHERNET_CSMACD
  inet: 172.20.48.249
  Broadcast address: 172.20.51.255
  Netmask 0xffff0000 Subnetmask 0xfffffc00
  Ethernet address is 00:00:00:00:00:f9
  Metric is 0
  Maximum Transfer Unit size is 485
  84 octets received
  56 octets sent
  2 unicast packets received
  2 unicast packets sent
  0 non-unicast packets received
  0 non-unicast packets sent
  0 incoming packets discarded
  0 outgoing packets discarded
  0 incoming errors
  0 outgoing errors
  0 unknown protos
  0 collisions; 0 dropped
  0 output queue drops
gei (unit number 2):
  Flags: (0x70043) UP BROADCAST ARP RUNNING INET_UP
  PHY Flags: (0x12212) AUTONEG 100MB FDX DIX
  Type: ETHERNET_CSMACD
  inet: 192.168.54.117
  Broadcast address: 192.168.54.255
  Netmask 0xffffffff00 Subnetmask 0xffffffff00
  Ethernet address is 00:00:17:0d:46:bc
  Metric is 0
  Maximum Transfer Unit size is 1500
  320 octets received
  128 octets sent
  0 unicast packets received
```

```
0 unicast packets sent
0 multicast packets received
0 multicast packets sent
5 broadcast packets received
2 broadcast packets sent
0 incoming packets discarded
0 outgoing packets discarded
0 incoming errors
0 outgoing errors
0 unknown protos
0 collisions; 0 dropped
0 output queue drops
gei (unit number 0):
Flags: (0x30002) DOWN BROADCAST ARP
PHY Flags: (0x2221) AUTONEG DIX
Type: ETHERNET_CSMACD
inet: 192.168.51.42
Broadcast address: 192.168.51.255
Netmask 0xffffffff Subnetmask 0xffffffff00
Ethernet address is 00:00:17:0d:48:64
Metric is 0
Maximum Transfer Unit size is 1500
0 octets received
64 octets sent
0 unicast packets received
0 unicast packets sent
0 multicast packets received
0 multicast packets sent
0 broadcast packets received
1 broadcast packets sent
0 incoming packets discarded
0 outgoing packets discarded
0 incoming errors
0 outgoing errors
0 unknown protos
0 collisions; 0 dropped
0 output queue drops
gei (unit number 3):
Flags: (0x78042) DOWN BROADCAST MULTICAST ARP RUNNING INET_UP
PHY Flags: (0x2224) AUTONEG DIX
Type: ETHERNET_CSMACD
inet: 172.21.48.249
Broadcast address: 172.21.49.255
Netmask 0xffff0000 Subnetmask 0xfffffe00
Ethernet address is 00:00:17:0d:46:bd
Metric is 0
Maximum Transfer Unit size is 2000
0 octets received
0 octets sent
0 unicast packets received
0 unicast packets sent
0 multicast packets received
0 multicast packets sent
0 broadcast packets received
0 broadcast packets sent
```

```

0 incoming packets discarded
0 outgoing packets discarded
0 incoming errors
0 outgoing errors
0 unknown protos
0 collisions; 0 dropped
0 output queue drops
gei (unit number 1):
Flags: (0x78042) DOWN BROADCAST MULTICAST ARP RUNNING INET_UP
PHY Flags: (0x2221) AUTONEG DIX
Type: ETHERNET_CSMACD
inet: 172.22.48.249
Broadcast address: 172.22.49.255
Netmask 0xffff0000 Subnetmask 0xfffffe00
Ethernet address is 00:00:17:0d:48:65
Metric is 0
Maximum Transfer Unit size is 2000
0 octets received
0 octets sent
0 unicast packets received
0 unicast packets sent
0 multicast packets received
0 multicast packets sent
0 broadcast packets received
0 broadcast packets sent
0 incoming packets discarded
0 outgoing packets discarded
0 incoming errors
0 outgoing errors
0 unknown protos
0 collisions; 0 dropped
0 output queue drops
value = 26 = 0x1a
;
e1030703 09-10-13 19:15:38 EST EAGLE 42.0.0
;
e1030703 09-10-13 19:15:38 EST EAGLE 42.0.0
NETSTAT command complete
;

```

This example displays BOND and GEI interfaces. Bond interfaces are supported by only E5-SM4G and E5-SM8G-B cards.

```

pass:cmd="netstat -i":loc=1111

e1030703 09-12-13 19:15:31 EST EAGLE 42.0.0
pass:loc=1111:cmd="netstat -i"
Command entered at terminal #17.
;

e1030703 09-12-13 19:15:31 EST EAGLE 42.0.0

```

```
PASS: Command sent to card
;
Command Accepted - Processing
e1030703 09-12-13 19:15:38 EST EAGLE 42.0.0

NETSTAT command complete

;
Command Executed
e1030703 09-12-13 19:15:31 EST EAGLE 42.0.0
SDS Shell Output

-> tklc_ifShow
lo (unit number 0):
  Flags: (0x48049) UP LOOPBACK MULTICAST TRAILERS ARP RUNNING
INET_UP
  Type: SOFTWARE_LOOPBACK
  inet: 127.0.0.1
  Netmask 0xff000000 Subnetmask 0xff000000
  Metric is 0
  Maximum Transfer Unit size is 1536
  0 packets received; 1 packets sent
  0 multicast packets received
  0 multicast packets sent
  0 input errors; 0 output errors
  0 collisions; 0 dropped
  0 output queue drops
DPLend (unit number 0):
  Flags: (0x20043) UP BROADCAST ARP RUNNING
  Type: ETHERNET_CSMACD
  Ethernet address is 00:00:00:00:00:00
  Metric is 0
  Maximum Transfer Unit size is 485
  0 octets received
  0 octets sent
  0 unicast packets received
  0 unicast packets sent
  0 non-unicast packets received
  0 non-unicast packets sent
  0 incoming packets discarded
  0 outgoing packets discarded
  0 incoming errors
  0 outgoing errors
  0 unknown protos
  0 collisions; 0 dropped
  0 output queue drops
gei (unit number 0):
  Flags: (0x78042) DOWN BROADCAST MULTICAST ARP RUNNING INET_UP
  PHY Flags (0x2022) 100MB HDX DIX
  Type: ETHERNET_CSMACD
  inet: 192.168.122.4
  Broadcast address: 192.168.122.255
  Netmask 0xffffffff00 Subnetmask 0xffffffff00
  Ethernet address is 00:00:17:0d:0f:3a
  Metric is 0
```

```
Maximum Transfer Unit size is 1500
0 octets received
0 octets sent
0 unicast packets received
0 unicast packets sent
0 multicast packets received
0 multicast packets sent
0 broadcast packets received
0 broadcast packets sent
0 incoming packets discarded
0 outgoing packets discarded
0 incoming errors
0 outgoing errors
0 unknown protos
0 collisions; 0 dropped
0 output queue drops
gei (unit number 1):
Flags: (0x78042) DOWN BROADCAST MULTICAST ARP RUNNING INET_UP
PHY Flags (0x2021) 10MB HDX DIX
Type: ETHERNET_CSMACD
inet: 192.168.121.4
Broadcast address: 192.168.121.255
Netmask 0xffffffff Subnetmask 0xffffffff
Ethernet address is 00:00:17:0d:0f:3b
Metric is 0
Maximum Transfer Unit size is 1500
0 octets received
0 octets sent
0 unicast packets received
0 unicast packets sent
0 multicast packets received
0 multicast packets sent
0 broadcast packets received
0 broadcast packets sent
0 incoming packets discarded
0 outgoing packets discarded
0 incoming errors
0 outgoing errors
0 unknown protos
0 collisions; 0 dropped
0 output queue drops
Bond (unit number 0):
Flags: (0x60043) UP BROADCAST ARP RUNNING INET_UP
Type: ETHERNET_CSMACD
inet: 192.168.123.4
Broadcast address: 192.168.123.255
Netmask 0xffffffff Subnetmask 0xffffffff
Ethernet address is 00:00:00:00:00:00
Metric is 0
Maximum Transfer Unit size is 485
0 octets received
0 octets sent
0 unicast packets received
0 unicast packets sent
0 non-unicast packets received
```

```
0 non-unicast packets sent
0 incoming packets discarded
0 outgoing packets discarded
0 incoming errors
0 outgoing errors
0 unknown protos
0 collisions; 0 dropped
0 output queue drops
value = 26 = 0x1a

;

e1030703 09-12-13 19:15:38 EST  EAGLE 42.0.0
;

e1030703 09-12-13 19:15:38 EST  EAGLE 42.0.0

NETSTAT command complete

;

pass:cmd="netstat -m data":loc=1111

Command Accepted - Processing

tekelecstp 08-01-19 04:46:24 EST  EAGLE5 38.0.0
PASS: Command sent to card

;

tekelecstp 08-01-19 04:46:24 EST  EAGLE5 38.0.0
SDS Shell Output
-> netStackDataPoolShow
type          number
-----
FREE          :    37587
DATA          :      23
HEADER       :      22
SOCKET        :       0
PCB           :       0
RTABLE        :       0
HTABLE        :       0
ATABLE        :       0
SONAME        :       0
ZOMBIE        :       0
SOOPTS        :       0
FTABLE        :       0
RIGHTS        :       0
IFADDR        :       0
CONTROL       :       0
OOBDATA       :       0
IPMOPTS       :       0
IPMADDR       :       0
IFMADDR       :       0
MRTABLE       :       0
```



```

TAG      :      0
TOTAL    :    37632
number of mbufs: 37632
number of times failed to find space: 0
number of times waited for space: 0
number of times drained protocols for space: 0

```

---

CLUSTER POOL TABLE

size	clusters	free	usage	minsize	maxsize	avgsz
64	6336	6336	33	4	56	13
128	6336	6313	712952418	128	128	1
256	6336	6336	0	0	0	0
512	10240	10218	712654339	293	293	3
1024	1024	1024	0	0	0	0
2048	1024	1024	0	0	0	0

---

```
value = 80 = 0x50 = 'P'
```

```
;
```

```
tekelecstp 08-01-19 04:46:24 EST EAGLE5 38.0.0
```

```
NETSTAT command complete
```

```
;
```

```
pass:cmd="netstat -m sys":loc=1111
```

```
Command Accepted - Processing
```

```
tekelecstp 08-01-19 04:46:44 EST EAGLE 38.0.0
```

```
PASS: Command sent to card
```

```
;
```

```
tekelecstp 08-01-19 04:46:44 EST EAGLE 38.0.0
```

```
SDS Shell Output
```

```
-> netStackSysPoolShow
```

```
type          number
```

```

-----
FREE      :    3696
DATA      :         4
HEADER    :         0
SOCKET    :         0
PCB       :         0
RTABLE    :         0
HTABLE    :         0
ATABLE    :         0
SONAME    :         0
ZOMBIE    :         0

```

```

SOOPTS : 0
FTABLE : 0
RIGHTS : 0
IFADDR : 0
CONTROL : 0
OOBDATA : 0
IPMOPTS : 0
IPMADDR : 0
IFMADDR : 0
MRTABLE : 0
TAG : 0
TOTAL : 3700
number of mbufs: 3700
number of times failed to find space: 0
number of times waited for space: 0
number of times drained protocols for space: 0

```

---

CLUSTER POOL TABLE

---

size	clusters	free	usage	minsize	maxsize	avgsize
20	500	477	28	8	20	16
44	500	495	5	24	32	35
96	500	487	13	48	96	65
172	500	490	10	116	160	150
292	500	487	1059	176	256	0
664	500	486	1064	384	592	1
1144	100	95	5	1144	1144	228

---

```

-----
value = 80 = 0x50 = 'P'
;

tekelecstp 08-01-19 04:46:47 EST EAGLE 38.0.0

NETSTAT command complete

;

pass:cmd="netstat -m dd":loc=1111

Command Accepted - Processing

tekelecstp 08-01-19 04:47:03 EST EAGLE 38.0.0
PASS: Command sent to card

;

tekelecstp 08-01-19 04:47:03 EST EAGLE 38.0.0
END-0 Buffer Pool

```

```
-----
CLUSTER POOL TABLE
-----
size clusters  free      usage
-----
1536 800      480      0
-----

END-1 Buffer Pool
-----
CLUSTER POOL TABLE
-----
size clusters  free      usage
-----
1536 800      640      0
-----

;

tekelecstp 08-01-19 04:47:05 EST  EAGLE 38.0.0

NETSTAT command complete

;

pass:cmd="netstat -p icmp":loc=1111

Command Accepted - Processing

tekelecstp 08-01-19 04:47:13 EST  EAGLE 38.0.0
PASS: Command sent to card

;

tekelecstp 08-01-19 04:47:13 EST  EAGLE 38.0.0
SDS Shell Output

-> icmpstatShow
ICMP:
  0 call to icmp_error
  0 error not generated because old message was icmp
Output histogram:
  echo: 1042
  0 message with bad code fields
  0 message < minimum length
  0 bad checksum
  0 message with bad length
Input histogram:
  echo reply: 1042
  0 message response generated
value = 30 = 0x1e

;

tekelecstp 08-01-19 04:47:13 EST  EAGLE 38.0.0
```

```
NETSTAT command complete

;

pass:cmd="netstat -p igmp":loc=1111

Command Accepted - Processing

tekelecstp 08-01-19 04:47:31 EST EAGLE 38.0.0
PASS: Command sent to card

;

tekelecstp 08-01-19 04:47:31 EST EAGLE 38.0.0
SDS Shell Output

-> igmpstatShow
IGMP:
    0 invalid queries received
    0 invalid reports received
    0 bad checksums received
    0 reports for local groups received
    0 membership queries received
    0 membership reports received
    0 short packets received
    0 total messages received
    0 membership reports sent
value = 27 = 0x1b

;

tekelecstp 08-01-19 04:47:31 EST EAGLE 38.0.0

NETSTAT command complete

;

pass:cmd="netstat -p ip":loc=1111

Command Accepted - Processing

tekelecstp 08-01-19 04:47:50 EST EAGLE 38.0.0
PASS: Command sent to card

;

tekelecstp 08-01-19 04:47:50 EST EAGLE 38.0.0
SDS Shell Output

-> ipstatShow
      total 392695394
      badsum      0
      tooshort    0
      toosmall    0
      badhlen     0
```

```
        badlen          0
    infragments        0
    fragdropped        0
    fragtimeout        0
        forward        0
    fastforward        0
    cantforward        0
    redirectsent       0
    unknownprotocol    0
        delivered      392695394
        localout       712875071
    nobuffers          0
    reassembled        0
    fragmented         0
    outfragments       0
    cantfrag           0
    badoptions         0
        noroute        0
        badvers        0
        rawout         0
        toolong        0
    notmember          0
        nogif          0
        badaddr        0
```

```
value = 1 = 0x1
```

```
;
```

```
tekelecstp 08-01-19 04:47:50 EST EAGLE 38.0.0
```

```
NETSTAT command complete
```

```
;
```

```
pass:cmd="netstat -p tcp":loc=1111
```

```
Command Accepted - Processing
```

```
tekelecstp 08-01-19 04:48:10 EST EAGLE 38.0.0
```

```
PASS: Command sent to card
```

```
;
```

```
tekelecstp 08-01-19 04:48:10 EST EAGLE 38.0.0
```

```
SDS Shell Output
```

```
-> tcpstatShow
```

```
TCP:
```

```
712802525 packets sent
    712802521 data packets (-1599247397 bytes)
    0 data packet (0 byte) retransmitted
    2 ack-only packets (0 delayed)
    0 URG only packet
    0 window probe packet
```

```

        0 window update packet
        3 control packets
392101363 packets received
        392101363 acks (for -1599247397 bytes)
        0 duplicate ack
        0 ack for unsent data
        0 packet (0 byte) received in-sequence
        0 completely duplicate packet (0 byte)
        0 packet with some dup. data (0 byte duped)
        0 out-of-order packet (0 byte)
        0 packet (0 byte) of data after window
        0 window probe
        0 window update packet
        0 packet received after close
        0 discarded for bad checksum
        0 discarded for bad header offset field
        0 discarded because packet too short
    3 connection requests
    0 connection accept
    1 connection established (including accepts)
    2 connections closed (including 0 drop)
    0 embryonic connection dropped
    392101363 segments updated rtt (of 44575243 attempts)
    1 retransmit timeout
        0 connection dropped by rexmit timeout
    0 persist timeout
    7 keepalive timeouts
        0 keepalive probe sent
        0 connection dropped by keepalive
    0 pcb cache lookup failed
value = 27 = 0x1b
;

tekelecstp 08-01-19 04:48:10 EST  EAGLE 38.0.0

NETSTAT command complete

;

pass:cmd="netstat -p sctp":loc=1106

Command Accepted - Processing

tekelecstp 08-01-24 05:41:04 EST  EAGLE 38.0.0
PASS: Command sent to card

;

tekelecstp 08-01-24 05:41:04 EST  EAGLE 38.0.0
ip packets sent..... 214
    ip packets sent with data chunk..... 8
    control chunks (excluding retransmissions)..... 211
    ordered data chunks (excluding retransmissions).. 8
    unordered data chunks (excluding retransmissions) 0
    user messages fragmented due to MTU..... 0

```

```
retransmit data chunks sent..... 0
sacks sent..... 9
send failed..... 0
ip packets received..... 215
  ip packets received with data chunk..... 8
  control chunks (excluding duplicates)..... 211
  ordered data chunks (excluding duplicates)..... 8
  unordered data chunks (excluding duplicates)..... 0
  user messages reassembled..... 0
  data chunks read..... 8
  duplicate tsns received..... 0
  sacks received..... 9
  gap ack blocks received..... 0
  out of the blue..... 0
  with invalid checksum..... 0
connections established..... 1
  by upper layer..... 0
  by remote endpoint..... 1
connections terminated..... 0
  ungracefully..... 0
  gracefully..... 0
associations dropped due to retransmits..... 0
consecutive retransmit timeouts..... 0
retransmit timer count..... 0
fast retransmit count..... 0
heartbeat requests received..... 99
heartbeat acks received..... 99
heartbeat requests sent..... 99
associations supported..... 16
milliseconds cookie life at 4-way start-up handshake. 5000
retransmission attempts allowed at start-up phase.... 10

;

tekelecstp 08-01-24 05:41:04 EST EAGLE 38.0.0

NETSTAT command complete

;

pass:cmd="netstat -p udp":loc=1111

Command Accepted - Processing

tekelecstp 08-01-19 04:48:40 EST EAGLE 38.0.0
PASS: Command sent to card

;

tekelecstp 08-01-19 04:48:40 EST EAGLE 38.0.0
SDS Shell Output

-> udpstatShow
UDP:
    714029 total packets
```

```
        612012 input packets
        102017 output packets
        0 incomplete header
        0 bad data length field
        0 bad checksum
        510042 broadcasts received with no ports
        0 full socket
        0 pcb cache lookup failed
        0 pcb hash lookup failed
value = 26 = 0x1a
;

tekelecstp 08-01-19 04:48:40 EST  EAGLE 38.0.0

NETSTAT command complete
;

pass:cmd="netstat -r":loc=1112

Command Accepted - Processing

tekelecstp 08-02-19 05:58:13 EST  EAGLE 38.0.0
PASS: Command sent to card
;

tekelecstp 08-02-19 05:58:13 EST  EAGLE 38.0.0
SDS Shell Output

-> tklc_routeShow

ROUTE NET TABLE
destination      gateway          flags  Refcnt  Use
Interface
-----
-
    172.20.48.0    172.20.48.250   33554689  0      0
DPLend0
    192.168.55.0  192.168.55.252  33554689  2      0
gei2
-----
-

ROUTE HOST TABLE
destination      gateway          flags  Refcnt  Use
Interface
-----
-
    127.0.0.1     127.0.0.1       35651589  3      15
lo0
```



```
192.168.99.100 192.168.55.211 33554439 0 0 gei2
-----
value = 0 = 0x0

;

tekelecstp 08-02-19 05:58:13 EST EAGLE 38.0.0

NETSTAT command

pass:cmd="netstat -d 0":loc=1111

Command Accepted - Processing

tekelecstp 08-01-19 04:49:16 EST EAGLE 38.0.0
PASS: Command sent to card

;

tekelecstp 08-01-19 04:49:16 EST EAGLE 38.0.0

Report Time      = 00-00-00 00:00:59.001
Card Load Time   = 00-00-00 00:00:09.905
Last Reset Time  = 00-00-00 00:00:09.905

crc err = 0          align err = 0          symbol err = 0
rx err = 0          missed pkt = 0        sequence err = 0
cr ex er = 0       rx len err = 0       rx no buf = 0
rx total = 243721  rx undersz = 0       rx frag = 0
good pkt rx= 243721 rx bcast = 11652     rx mcast = 0
rx oversz = 0       rx jabber = 0        collision = 0
tx total = 381079  late coln = 0        tx underun = 0
good pkt tx= 381079 tx bcast = 0          tx mcast = 0
defer count = 0          tx no crs = 0
good octets rx = 16988038 total octets rx = 16988038
good octets tx = 137538057 total octets tx = 137538057

;

tekelecstp 08-01-19 04:49:16 EST EAGLE 38.0.0

NETSTAT command complete

;

pass:cmd="netstat -d 0 -z":loc=1111

tekelecstp 08-01-19 04:50:07 EST EAGLE 38.0.0
PASS: Command sent to card

;

tekelecstp 08-01-19 04:50:07 EST EAGLE 38.0.0

Driver measurements for unit 0 cleared

;
```

```
tekelecstp 08-01-19 04:50:07 EST EAGLE 38.0.0

NETSTAT command complete

;

pass:cmd="netstat -d 0 -f":loc=1111

Command Accepted - Processing

tekelecstp 08-01-19 04:50:22 EST EAGLE 38.0.0
PASS: Command sent to card

;

tekelecstp 08-01-19 04:50:22 EST EAGLE 38.0.0

Report Time          = 00-00-00 00:01:01.335
Card Load Time       = 00-00-00 00:00:09.905
Last Reset Time      = 00-00-00 00:00:46.665

crc err = 0          align err = 0          symbol err = 0
rx err = 0          missed pkt = 0        sequence err = 0
cr ex er = 0       rx len err = 0       rx no buf = 0
rx total = 13562    rx undersz = 0       rx frag = 0
good pkt rx= 13562  rx bcast = 149       rx mcast = 0
rx oversz = 0       rx jabber = 0        collision = 0
tx total = 22019    late coln = 0        tx underun = 0
good pkt tx= 22019  tx bcast = 0         tx mcast = 0
single col = 0      excess coln = 0      multi colsn = 0
pkt rx 64 = 179     pkt rx 127 = 13383   pkt rx 255 = 0
pkt rx 511 = 0      pkt rx 1023 = 0      pkt rx 1522 = 0
pkt tx 64 = 30      pkt tx 127 = 0       pkt tx 255 = 0
pkt tx 511 = 21989  pkt tx 1023 = 0      pkt tx 1522 = 0
tcp cxt tx = 0      rx FIFO head = 0x00000caf rx FIFO tail =
0x00000caf
rx FIFO pc = 0      rx FIFO hs = 0x00000caf rx FIFO ts =
0x00000caf
tcp tx fc = 0      tx FIFO head = 0x00001f30 tx FIFO tail =
0x00001f30
tx FIFO pc = 0      tx FIFO hs = 0x00001f30 tx FIFO ts =
0x00001f30
XON rcv = 0        XON xmit = 0         XOFF rcv = 0
XOFF tx = 0        unsupport FC = 0
defer count = 0    tx no crs = 0
good octets rx = 948266 total octets rx = 948266
good octets tx = 7983927 total octets tx = 7983927

;

tekelecstp 08-01-19 04:50:22 EST EAGLE 38.0.0
5463.1083 SYSTEM INFO REPT COND: system alive
Report Date:02-01-19 Time:04:50:24
```

```
;
tekelecstp 08-01-19 04:50:22 EST EAGLE 38.0.0
NETSTAT command complete
;
```

## nslookup

This command returns the IP address for a given hostname, or returns a hostname for a given IP address.

### Options

Options and option parameters that are underlined indicate that a value must be specified for that option or parameter. For example, the `nslookup` command has the option destination. An IP address or hostname can be specified for the destination, as in the commands `nslookup 192.168.100.3` and `nslookup dcm1107a`. Do not enter the underlined option or parameter; enter a value for the information represented by the underlined option or parameter.

#### destination

The destination can be either an IP address or hostname.

#### IP address

The IP address is a TCP/IP address expressed in standard “dot notation.” IP addresses consist of the system’s network number and the machine’s unique host number. An example IP address is `192.9.200.44`, where `192.9.200` is the network number and `44` is the machine’s host number.

#### **Range:**

4 numbers separated by dots, with each number in the range of 0-255.

#### hostname

Hostname. The logical name assigned to the device with the IP address indicated.

#### **Range:**

`a-z, A-Z, 0-9, -, .`

(any string of characters beginning with a letter and comprising up to 60 characters in length)

#### `-h`

This option provides help information for the command.

### Example

```
nslookup 192.9.200.44
```

```
nslookup nc.tekelec.com
```

```
nslookup 2005:1a3c:2a3e:12ef:9064:8b6c:567a:78fd
```

### Dependencies

The actual `nslookup` text string must be followed by a destination (either a hostname or IP address).

Whether a host is found depends on the configuration of the host table and domain name servers.

### Notes

The `nslookup` command is executed through the `pass` command.

### Output

```
pass:loc=1105:cmd="nslookup"
or
pass:loc=1105:cmd="nslookup -h"

Command Accepted - Processing
  rlghncxa03w 04-07-27 08:43:21 EST  EAGLE5 31.6.0
  pass:loc=1105:cmd="nslookup"
  Command entered at terminal #1.
;
  rlghncxa03w 04-07-27 08:43:21 EST  EAGLE5 31.6.0
  PASS: Command sent to card
;
  rlghncxa03w 04-07-27 08:43:21 EST  EAGLE5 31.6.0

Usage: nslookup [hostname|ipaddr]

Options:
  hostname  String name
  ipaddr    d.d.d.d
;
  rlghncxa03w 04-07-27 08:43:22 EST  EAGLE5 31.6.0
  NSLOOKUP command complete

pass:loc=1105:cmd="nslookup dcm1107a"

Command Accepted - Processing
  rlghncxa03w 04-07-27 08:43:46 EST  EAGLE5 31.6.0
  pass:loc=1105:cmd="nslookup dcm1107a"
  Command entered at terminal #1.
;
  rlghncxa03w 04-07-27 08:43:46 EST  EAGLE5 31.6.0
  PASS: Command sent to card
;
  rlghncxa03w 04-07-27 08:43:46 EST  EAGLE5 31.6.0

NSLOOKUP command in progress
;
  rlghncxa03w 04-07-27 08:43:46 EST  EAGLE5 31.6.0

Configured Domain Name Data
```

```

DNSA = 192.168.100.3
DNSB = 0.0.0.0
Domain Name = nc.tekelec.com
Search Order = LOCAL First

Resolving host name - dcm1107a

Host Table entry
    dcm1107a - 192.168.100.113
DNS Server - No entry exists

Currently using Host Table entry

NSLOOKUP command complete
;

pass:loc=1105:cmd="nslookup 198.89.40.60"

Command Accepted - Processing

    rlghncxa03w 04-07-27 13:21:49 EST EAGLE5 31.6.0
pass: loc=1105: cmd="nslookup 198.89.40.60"
Command entered at terminal #1.
;

    rlghncxa03w 04-07-27 13:21:49 EST EAGLE5 31.6.0
PASS: Command sent to card
;

    rlghncxa03w 04-07-27 13:21:49 EST EAGLE5 31.6.0

NSLOOKUP command in progress

;

    rlghncxa03w 04-07-27 13:21:49 EST EAGLE5 31.6.0

Configured Domain Name Data

DNSA = 198.89.40.60
DNSB = 0.0.0.0
Domain Name = nc.tekelec.com
Search Order = LOCAL First

Resolving IP address - 198.89.40.60

Host Table - No entry exists
DNS Server
    tekral.nc.tekelec.com - 198.89.40.60

Currently using DNS Server entry
```

NSLOOKUP command complete

## pct

This command is used to maintain per-translation statistics and to test Point Code and CIC Translation (PCT) functionality. The command can use Stats mode to reset or display per-translation statistics or Test mode to test PCT behavior.

### Options

Options and option parameters that are underlined indicate that a value must be specified for that option or parameter. Do not enter the underlined option or parameter; enter a value for the information represented by the underlined option or parameter.

-h

This option is used to provide help information for the command.

The following options are common to both Stats mode and Test mode:

-p pctype

Point Code Type. This option applies to all point codes in the option list.

#### Range:

*ansi, itui, itun*

#### Default

*ansi*

The following options apply to only Stats mode:

-a realpc

Real Point Code

-c cicr

CIC range. This option can be specified only if SI is 4, 5, or 13.

#### Range:

The option can be in one of these forms:

- wildcard(\*)
- *ecics-ecice:rcics-rcice*, e.g., *5-10:15-20*
- *ecics:rcics* (e.g., *5:6*, which is equivalent to *5-5:6-6*)

-e epc

Emulated Point Code

-f fpc

Filter Point Code. This option can be a wildcard (\*).

-l

List the stats for the selected rules. The -e or -a option must be supplied. Both of these options can be specified.

-r

Resets the stats for selected rules. If no other options are specified, then this option resets stats on all rules. If other options are specified, then the `-e` or `-a` option must be specified.

`-s si`

**Range:**

0, 3, 4, 5, 13, or wildcard (\*)

`-u ssn`

Subsystem Number. The `si=3` option must be specified before this option can be specified. This option can be a wildcard (\*)

The following options apply only to Test mode.

`-c cic`

CIC in simulated MSU. If a value of 4, 5, or 13 is specified for the `si` option, then the `-c` must be specified.

`-d dpc`

Destination Point Code in simulated MSU.

`-o opc`

Originating Point Code in simulated MSU.

`-s si`

SI in simulated MSU.

`-u ssn`

Subsystem number in CgPA and CdPA in simulated MSU. The `si=3` option must be specified before the `-u` option can be specified. If the `-u` is not specified, and the `si=3` is specified, then the route on SSN is off.

```
pass:loc=1201:cmd="pct -h"
```

```
pass:loc=1201:cmd="pct -m stats -r -e 4-3-1"
```

```
pass:loc=1201:cmd="pct -m test -d 4-3-1 -o 7-2-30 -s 3 -u 26"
```

## Dependencies

None

## Notes

None

## Output

This example shows a help report:

```
pass:loc=1201:cmd="pct -h"
```

```
Command Accepted - Processing
```

```
Usage:
```

```
pct -m stats [-l | -r] [-p pctype] [-e epc] [-f fpc] [-a realpc] [-s  
si] [-u ssn] [-c cicr]
```

```
pct -m test [-p pctype] -d dpc -o opc -s si [-c cic] [-u ssn]
```

```
pct -h
```

```
Modes:
```

```

stats - reset or display per-rule stats
test  - test PCT behavior for a message with the specified field
values
Common Options:
-p    pctype is ANSI, ITUI, or ITUN
stats Mode Options:
-r    reset the stats for selected rules
      with no other options, resets stats on all rules
      if other options present, -e or -a must be supplied
-l    list the stats for selected rules (default)
      the -e or -a option must be supplied
      both -e and -a may be supplied
-e    emulated point code
-a    real point code
-c    cicr is in these forms:
      * (see Note 1)
      ecics-ecice:rcics-rcice, e.g., 5-10:15-20
      ecics:rcics, e.g., 5:6 which is equiv to 5-5:6-6
      allowed only if SI is 4, 5, or 13
-f    filter pc; may be * (see Note 1)
-s    si; can be 0, 3, 4, 5, 13, or * (see Note 1)
-u    ssn; may be * (see Note 1)
      allowed only if SI is 3
test Mode Options:
-d    DPC in simulated MSU
-o    OPC in simulated MSU
-s    SI in simulated MSU
-u    SSN in CgPA and CdPA in simulated MSU;
      if absent and si is 3, indicates that route on SSN is off;
      allowed only if SI is 3
-c    CIC in simulated MSU;
      required if SI is 4, 5, or 13
Notes:
1. an explicit * will match only with rule containing a
wildcard; to match
      on wildcard or a specific value, do not specify the
associated option

```

### Stats Mode

With the `-l` option, all matching translations are displayed along with the following three statistics for each translation:

- DPCLKP – Number of successful translations of the DPC and/or CIC of a message (the number of successful DPC lookups).
- OPCLKP – Number of successful translations of the OPC and/or CIC of a message (the number of successful OPC lookups).
- MSUDISC – Number of messages discarded after successfully translating the DPC of a message from an emulated point code to a real point code, but where the real point code is unreachable.

The IDX (index) column is the unique row number of the entry in the PCT table. The index for a particular translation is the same across all cards.

The output for a single translation consists of two or three lines.



For translations with an SI of 4, 5, or 13, the CIC range field is displayed only for translations with a specific value for the CIC range.

This example lists all translations with an EPC of 4-3-1 (ANSI):

```
pass:loc=1201:cmd="pct -m stats -l -e 4-3-1"
```

Command Accepted - Processing

idx	epc	rpc	fpc	si	ssn
6	004-003-001	007-003-001	007-002-030	3	24
	dpclkp: 0	opclkp: 0	msudisc: 0		
7	004-003-001	007-003-002	007-002-030	3	26
	dpclkp: 0	opclkp: 0	msudisc: 0		
8	004-003-001	007-003-006	007-002-030	5	---
	ecic: 100-105	rcic: 200-205			
	dpclkp: 0	opclkp: 0	msudisc: 0		
9	004-003-001	007-003-011	007-002-*	3	24
	dpclkp: 0	opclkp: 0	msudisc: 0		
10	004-003-001	007-003-016	007-**-*	3	24
	dpclkp: 0	opclkp: 0	msudisc: 0		
11	004-003-001	007-003-021	007-002-030	3	*
	dpclkp: 0	opclkp: 0	msudisc: 0		
12	004-003-001	007-003-026	007-002-030	5	---
	dpclkp: 0	opclkp: 0	msudisc: 0		
13	004-003-001	007-003-031	007-002-*	3	*
	dpclkp: 0	opclkp: 0	msudisc: 0		
14	004-003-001	007-003-036	007-003-*	3	*
	dpclkp: 0	opclkp: 0	msudisc: 0		
15	004-003-001	007-003-041	007-**-*	3	*
	dpclkp: 0	opclkp: 0	msudisc: 0		
16	004-003-001	007-003-046	008-**-*	3	*
	dpclkp: 0	opclkp: 0	msudisc: 0		
17	004-003-001	007-003-051	007-002-029	*	---
	dpclkp: 0	opclkp: 0	msudisc: 0		
18	004-003-001	007-003-056	007-002-030	*	---
	dpclkp: 0	opclkp: 0	msudisc: 0		
19	004-003-001	007-003-061	007-002-*	*	---
	dpclkp: 0	opclkp: 0	msudisc: 0		
20	004-003-001	007-003-066	007-**-*	*	---
	dpclkp: 0	opclkp: 0	msudisc: 0		
21	004-003-001	007-003-071	-----	3	24
	dpclkp: 0	opclkp: 0	msudisc: 0		
22	004-003-001	007-003-076	-----	5	---
	ecic: 100-105	rcic: 200-205			
	dpclkp: 0	opclkp: 0	msudisc: 0		
23	004-003-001	007-003-081	-----	3	*
	dpclkp: 0	opclkp: 0	msudisc: 0		
24	004-003-001	007-003-086	-----	5	---
	dpclkp: 0	opclkp: 0	msudisc: 0		
25	004-003-001	007-003-091	-----	*	---
	dpclkp: 0	opclkp: 0	msudisc: 0		

This example resets counters for all translations with an EPC of 4-3-1 (ANSI):

```
pass:loc=1201:cmd="pct -m stats -r -e 4-3-1"
```

```
Command Accepted - Processing
```

```
Stats reset on 20 rules
```

### Test Mode

Test mode allows determination of whether an incoming message with the specified field values would result in a match on an entry in the PCT table. Output includes the content of the message, as specified on the command line, the lookup result, and the matching entry if a match exists.

This example shows a match on the DPC lookup:

```
pass:loc=1201:cmd="pct -m test -d 4-3-1 -o 7-2-30 -s 3 -u 26"
```

```
Command Accepted - Processing
```

```
Point Code and CIC Translation Lookup Test
```

```
MSU content:
```

```
OPC: 007-002-030
```

```
DPC: 004-003-001
```

```
SI: 3
```

```
SSN: 26
```

```
Lookup result:
```

```
Match on DPC was found
```

```
Matching entry:
```

idx	epc	rpc	fpc	si	ssn
7	004-003-001	007-003-002	007-002-030	3	26

This example shows a match on the OPC lookup:

```
pass:loc=1201:cmd="pct -m test -d 7-2-30 -o 7-3-2 -s 3 -u 26"
```

```
Command Accepted - Processing
```

```
Point Code and CIC Translation Lookup Test
```

```
MSU content:
```

```
OPC: 007-003-002
```

```
DPC: 007-002-030
```

```
SI: 3
```

```
SSN: 26
```

```
Lookup result:
```

```
Match on OPC was found
```

```
Matching entry:
```

idx	epc	rpc	fpc	si	ssn
7	004-003-001	007-003-002	007-002-030	3	26

This example shows a match on a DPC lookup where the matching translation has a wildcard Filter PC and a wildcard SI:

```
pass:loc=1201:cmd="pct -m test -d 4-3-1 -o 9-9-9 -s 4 -c 106"
```

```
Command Accepted - Processing
```

```
Point Code and CIC Translation Lookup Test
MSU content:
  OPC:    009-009-009
  DPC:    004-003-001
  SI:           4
  CIC:           106
Lookup result:
  Match on DPC was found
Matching entry:
idx      epc          rpc          fpc si ssn
25      004-003-001    007-003-091 ----- * ---
```

## ping

This command is used to test for the presence of hosts on the network. This command is invoked with a destination (either a hostname or IP address).

### Options

Options and option parameters that are underlined indicate that a value must be specified for that option or parameter. For example, the `ping` command has the option destination. An IP address or hostname can be specified for the destination, as in the commands `ping 192.9.200.44` and `ping nc.tekelec.com`. Do not enter the underlined option or parameter; enter a value for the information represented by the underlined option or parameter.

#### destination

The destination can be either an IP address or hostname.

##### **IP address**

The IP address is a TCP/IP address expressed in standard "dot notation." IP addresses consist of the system's network number and the machine's unique host number. An example IP address is `192.9.200.44`, where `192.9.200` is the network number and `44` is the machine's host number.

##### **Range:**

4 numbers separated by dots, with each number in the range of 0-255.

##### **hostname**

Hostname. The logical name assigned to the device with the IP address indicated.

##### **Range:**

any string of characters beginning with a letter and comprising (a..z, A..Z, 0..9, '-', or '.') up to 120 characters in length.

##### **-i**

The number of ping requests to send.

**Range:**

1 - 5

**Default:**

3

**-n**

The size of message to use in test.

**Range:**

12 - 2048

**Default:**

64

**-h**

This option provides help information for the command.

**-f**

This option sets the DF (Don't Fragment) bit in the IP header of ICMP packet.

**Example**

```
ping 192.9.200.44
ping nc.tekelec.com

ping 192.9.200.44 -i 5 -n 2048

ping 10.254.111.21 -f -n 1480
```

**Dependencies**

The actual `ping` text string must be followed by a destination (either a hostname or IP address) prior to the options.

**Notes**

The `ping` command is executed through the `pass` command.

**Output**

```
pass:loc=1105:cmd="ping" or
pass:loc=1105:cmd="ping -h"
```

```
Command Accepted - Processing
```

```
    rlghncxa03w 04-07-27 08:29:35 EST  EAGLE5 31.6.0
    pass:loc=1105:cmd="ping"
    Command entered at terminal #1.
;
    rlghncxa03w 04-07-27 08:29:35 EST  EAGLE5 31.6.0
    PASS: Command sent to card
;
    rlghncxa03w 04-07-27 08:29:35 EST  EAGLE5 31.6.0

Usage: ping <hostname | ipaddr> [-h] [-i size] [-n count]
Options:
```

```
-f          Sets the DF (Don't Fragment) bit in IP header of ICMP
packet.
-h          Displays this message
-i count    Number of pings to send. Range=1..5. Default=3.
-n size     Sets size of ICMP echo packet. Range=12..2048. Default=64.
hostname    Name of machine to ping
ipaddr      IP Address of machine to ping (d.d.d.d)
;
rlghncxa03w 04-07-27 08:29:36 EST  EAGLE5 31.6.0

PING command complete
;
```

```
pass:loc=1105:cmd="ping tekral"
```

```
Command Accepted - Processing
```

```
rlghncxa03w 04-07-27 08:30:16 EST  EAGLE5 31.6.0
pass:loc=1105:cmd="ping tekral"
Command entered at terminal #1.
;
rlghncxa03w 04-07-27 08:30:16 EST  EAGLE5 31.6.0
PASS: Command sent to card
;
rlghncxa03w 04-07-27 08:30:16 EST  EAGLE5 31.6.0
PING command in progress
;
rlghncxa03w 04-07-27 08:30:18 EST  EAGLE5 31.6.0
PING tekral (192.168.100.3): 56 data bytes
64 bytes from tekral.nc.tekelec.com (192.168.100.3):icmp_seq=0.time=5. ms
64 bytes from tekral.nc.tekelec.com (192.168.100.3):icmp_seq=1.time=0. ms
64 bytes from tekral.nc.tekelec.com (192.168.100.3):icmp_seq=2.time=0. ms
----tekral PING Statistics----
3 packets transmitted, 3 packets received, 0% packet loss
round-trip (ms)  min/avg/max = 0/1/5

PING command complete
;

pass:loc=1105:cmd="ping 192.168.100.3"
```

```
Command Accepted - Processing
```

```
rlghncxa03w 04-07-27 08:30:44 EST  EAGLE5 31.6.0
pass:loc=1105:cmd="ping 192.168.100.3"
Command entered at terminal #1.
;
rlghncxa03w 04-07-27 08:30:44 EST  EAGLE5 31.6.0
PASS: Command sent to card
;
rlghncxa03w 04-07-27 08:30:44 EST  EAGLE5 31.6.0
PING command in progress
```

```
;
rlghncxa03w 04-07-27 08:30:46 EST EAGLE5 31.6.0
PING 192.168.100.3: 56 data bytes
64 bytes from tekral.nc.tekelec.com
(192.168.100.3):icmp_seq=0.time=5. ms
64 bytes from tekral.nc.tekelec.com
(192.168.100.3):icmp_seq=1.time=0. ms
64 bytes from tekral.nc.tekelec.com
(192.168.100.3):icmp_seq=2.time=0. ms
----192.168.100.3 PING Statistics----
3 packets transmitted, 3 packets received, 0% packet loss
round-trip (ms) min/avg/max = 0/1/5

PING command complete
;

pass:loc=1105:cmd="ping tekral -i 2"

Command Accepted - Processing

rlghncxa03w 04-07-27 08:31:46 EST EAGLE5 31.6.0
pass:loc=1105:cmd="ping tekral -i 2"
Command entered at terminal #1.
;
rlghncxa03w 04-07-27 08:31:46 EST EAGLE5 31.6.0
PASS: Command sent to card
;
rlghncxa03w 04-07-27 08:31:46 EST EAGLE5 31.6.0

PING command in progress
;
rlghncxa03w 04-07-27 08:31:47 EST EAGLE5 31.6.0
PING tekral (192.168.100.3): 56 data bytes
64 bytes from
tekral.nc.tekelec.com(192.168.100.3):icmp_seq=0.time=10. ms
64 bytes from
tekral.nc.tekelec.com(192.168.100.3):icmp_seq=1.time=0. ms
----tekral PING Statistics----
2 packets transmitted, 2 packets received, 0% packet loss
round-trip (ms) min/avg/max = 0/5/10

PING command complete
;

pass:loc=1105:cmd="ping tekral -i 2 -n 200"

rlghncxa03w 04-07-27 08:32:09 EST EAGLE5 31.6.0
pass:loc=1105:cmd="ping tekral -i 2 -n 200"
Command entered at terminal #1.
;
rlghncxa03w 04-07-27 08:32:09 EST EAGLE5 31.6.0

PING command in progress
```

```

;
rlghncxa03w 04-07-27 08:32:10 EST EAGLE5 31.6.0
PING tekral (192.168.100.3): 192 data bytes
200 bytes from tekral.nc.tekelec.com(192.168.100.3):icmp_seq=0.time=5. ms
200 bytes from tekral.nc.tekelec.com(192.168.100.3):icmp_seq=1.time=0. ms
----tekral PING Statistics----
2 packets transmitted, 2 packets received, 0% packet loss
round-trip (ms)  min/avg/max = 0/2/5

PING command complete
;

```

**Note:**

In this example, the response shows eight bytes less than the entry (192 as opposed to 200) because the ping command may use eight bytes automatically.

```
pass:loc=1308:cmd="ping 10.254.111.21 -f -n 1480"
```

```
Command Accepted - Processing
```

```
eagle10212 12-06-19 10:07:42 EST EAGLE5 44.0.0-64.33.0
pass:loc=1380:cmd="ping 10.254.111.21 -f - n 1480"
Command entered at terminal #5.
```

```
eagle10212 12-06-19 10:07:42 EST EAGLE5 44.0.0-64.33.0
```

```
PING command in progress
```

```
;
```

```
eagle10212 12-06-16 10:07:42 EST EAGLE5 44.0.0-64.33.0
PING 10.254.111.21: 1472 data bytes
DF bit set. Fragmentation Needed
PING: no answer from 10.254.111.21
PING command complete
```

```
;
```

```
pass:loc=1308:cmd="ping 10.254.111.21 -f -n 1380"
```

```
Command Accepted -Processing
```

```
eagle10212 12-06-19 10:06:58 EST EAGLE5 44.0.0-64.33.0
pass:loc=1308:cmd="ping 10.254.111.21 -f -n 1380"
Command entered at terminal #5.
```

```
eagle10212 12-06-19 10:06:58 EST EAGLE5 44.0.0-64.33.0
```

```
PING command in progress
```

```
;
```

```
eagle10212 12-06-19 10:06:58 EST EAGLE5 44.0.0-64.33.0
```

```

;
 eagle10212 12-06-19 10:07:00 EST EAGLE5 44.0.0-64.33.0
 PING 10.254.111.21: 1372 data bytes
 1380 bytes from e1021301.1308a (10.254.111.21): icmp_seq=0.
time=329319. ms
 1380 bytes from e1021301.1308a (10.254.111.21): icmp_seq=1.
time=330319. ms
 1380 bytes from e1021301.1308a (10.254.111.21): icmp_seq=2.
time=331319. ms
----10.254.111.21 PING Statistics----
 3 packets transmitted, 3 packets received, 0% packet loss
 round-trip (ms)  min/avg/max = 329319/330319/331319

 PING command complete

;

```

## sctp

This command is used to provide a view of SCTP instance and association information.

### Options

`-a aname`

This option is used to retrieve the measurements and information for a specific association.

`-l`

This option is used to display logging details for associations. The logging details are independent of the association state (close or open).

`-p <port>`

This option is used to retrieve the measurements for a specified SCTP port.

`-r`

This option is used to reset specified measurements. The associated report is not displayed.

`-h`

This option is used to display help information for the command. Either brief or full help reports can be generated.

`-m`

This option is used to display SCTP incoming/outgoing (IO) header audit reports for common and dedicated IO header pools. The IO header is a transmission sequence number (TSN) control block used in processing SCTP chunks. The report shows total, currently available, and minimum IO header counts for the IO header pool shared by all associations (common pool) and the IO header pool for each association (dedicated pool).

### Example

```

pass:cmd="sctp -a aname":loc=1307
pass:cmd="sctp -l":loc=1307

```



```

pass:cmd="sctp -l aname":loc=1307
pass:cmd="sctp -p port":loc=1307
pass:cmd="sctp -r -a aname":loc=1307
pass:cmd="sctp -r -l aname":loc=1307
pass:cmd="sctp -m"
pass:cmd="sctp"

```

### Dependencies

The `-r` option can be specified in the same command as the `-a`, `-p`, or `-l` option. Otherwise, only one option can be specified at a time.

### Notes

None

### Output

Either brief or full help reports can be displayed. A full help report is generated by adding the `-h full` option to the command line.

This example shows a brief help report:

```
pass:loc=1305:cmd="sctp -h"
```

```
Usage: [ [[[-a aname] | [-p port] | [-l [aname]]] [-r [-s]]] | [-m] | [-h [full]] ]
```

#### Options:

(no parameters)	display list of SCTP ports
-a aname	display association report
-p port	display SCTP port report
-r	reset specified SCTP measurements
-m	display IO header usage report
-l aname	display association event log
-l	display all event logs
-r -l	reset all SCTP event logs
-r -s	reset all SCTP measurements and pegs
-h	displays command help (brief or full)

```
;
```

```
rlghncxa03w 08-02-01 08:32:09 EST EAGLE5 38.0.0
```

```
SCTP command complete
```

```
;
```

This example shows a full help report:

```
pass:loc=1307:cmd="sctp -h full"
```

```
Usage: sctp [[[-a aname] | [-p port] | [-l [aname]]] [-r [-s]] | [-m] | [-h [full]]]
```

Options:

(no parameters)	display list of SCTP ports
-a aname	display association report
-p port	display SCTP port report
-r	reset specified SCTP measurements
-m	display IO header usage report
-l aname	display association event log
-l	display all event logs
-r -l	reset all SCTP event logs
-r -s	reset all SCTP measurements and pegs
-h	displays command help (brief or full)

no parameters option

Summary list of all SCTP instances. To list all the SCTP ports issue the following command:

```
sctp
```

-a aname option details

Retrieves detailed information and measurements for a specific association. For example the following SCTP command will get

the

measurements and detailed information for the association with association name = assoc1.

```
sctp -a assoc1
```

In remote address field of output configured RHOST or ARHOST or both IP

address will be displayed based on the presence in association remote network

array

-p port option details

Retrieves detailed information for a specified SCTP port. For example the following SCTP command will get the detailed information for the SCTP port with a local port of 200.

```
sctp -p 200
```

In remote address field of output configured RHOST or ARHOST or both IP

address will be displayed based on the presence in association remote network

array

-r option details

Resets specified SCTP Measurements. See examples below.

Resets measurements for specified association:

```
sctp -r -a assoc
```

Resets measurements for all associations on port 2000:

```
sctp -r -p 2000
```

Resets measurements and event logs for all ports/associations:

```
sctp -r
```

Resets event logs for specified association:

```

sctp -r -l assoc
Resets event logs for all associations:
sctp -r -l
Resets measurements for all associations:
sctp -r -s

```

-m

This option displays SCTP IO header audit report for common and dedicated IO header pools. The report shows total, currently available and minimum (low water mark) IO header counts for common and each association's dedicated pool. IO header is a TSN control block used in processing SCTP chunks. Common pool is IO header pool shared by all associations. Dedicated pool is a per-association IO header pool.

```
sctp -m;
```

-l option details

This option displays logging details for associations. The logging details are independent of the association state (close or open). See examples below:

The following SCTP command will get the logging details for all associations on the specified card.

```
sctp -l
```

The following SCTP command will get the logging details for the association with association name = assoc1.

```
sctp -l assoc1
```

```

;
rlghncxa03w 08-02-01 08:32:09 EST  EAGLE5 38.0.0

SCTP command complete

;

```

This example shows a summary list of all SCTP ports. All SCTP ports and number of associations associated with each port is displayed.

```
pass:loc=1307:cmd="sctp"
```

```

rlghncxa03w 08-02-01 08:32:09 EST  EAGLE5 38.0.0
Local   Local IP      Num of
Port    Address        Assoc
7001    192.168.110.35    1
2222    192.168.110.12 3
        192.168.112.12

;

rlghncxa03w 08-02-01 08:32:09 EST  EAGLE5 38.0.0

SCTP command complete

;

```

This example shows specific SCTP association information and measurements:

```
pass:loc=1307:cmd="sctp -a assoc1"
```

```
e1090203 10-11-01 12:52:56 EST EAGLE 43.0.0
Aname      Local          Local Remote      Remote
          Address      Port  Address      Port
assoc1     192.168.110.12 2222  192.168.112.4 5555
          192.168.112.12          192.168.110.2
```

```
Configuration                               State
Retransmission Mode = LIN                   State = OPEN
Min. Retransmission Timeout = 10000         ULP association id = 18
Max. Retransmission Timeout = 800000       Number of nets = 2
Max. Number of Retries = 10                 Inbound Streams = 1
Min. Congestion Window = 3000               Outbound Streams = 2
Inbound Streams = 2
Outbound Streams = 2
Checksum Algorithm = crc32c
Send/Rcv Buffer Size = 204800
```

#### Nets Data

```
IP Address 192.168.112.4      State Reachable
Port       5555                      Primary YES
MTU        1500                      cwnd  16384
ssthresh   16384                    RTO   120
IP Address 192.168.112.5      State Reachable
Port       5555                      Primary NO
MTU        1500                      cwnd  16384
ssthresh   16384                    RTO   120
IP Address 192.168.110.2     State Reachable
Port       5555                      Primary NO
MTU        1500                      cwnd  16384
ssthresh   16384                    RTO   120
```

```
Last Net Sent To = 192.168.112.4
Last Net Rcvd From = 192.168.112.4
Over All Error Count = 0
Peers Rwnd = 13880
My Rwnd = 16384
Max Window = 16384
Initial Seq Number = 24130
Next Sending Seq Number = 124686
Last Acked Seq Number = 124669
Maximum Outbound Char Count = 16384
Current Outbound Char Count = 2112
Number Unsent Char Count = 0
Outbound Data Chunk Count = 16
Number Unsent = 0
Number To Retransmit = 0

ip datagrams rcvd = 155402
ip datagrams with data chunks rcvd = 120844
```

```

        data chunks rcvd = 367908
        data chunks read = 367900
        dup tsns rcvd = 8
        sacks rcvd = 38734
        gap ack blocks rcvd = 3
        heartbeat requests rcvd = 135
        heartbeat acks rcvd = 52
        heartbeat requests sent = 52
        ip datagrams sent = 129254
    ip datagrams with data chunks sent = 73084
        data chunks sent = 396330
    retransmit data chunks sent = 135
        sacks sent = 64872
        send failed = 0
    retransmit timer count = 0
    consecutive retransmit timeouts = 0
    RTO between RMIN and RMAX inclusive = 6
    RTT greater than RMAX = 0
    fast retransmit count = 135
    recv timer count = 0
    heartbeat timer count = 244
    none left tosend = 0
    none left rwnd gate = 5
    none left cwnd gate = 8
    UNKNOWN = 0
;

e1090203 10-11-01 12:52:56 EST EAGLE 43.0.0

SCTP command complete
;

```

#### Field Descriptions for `sctp -a` Output

- Local Address-IP Address of the near end. The address that the local SCTP endpoint should bind.
- Local Port-SCTP port number, if ULP wants it to be specified.
- Remote Address-IP Address of the far end/destination. Destination address for transporting DATA.
- Remote Port-Port number of the destination.

Configuration:[Following rows are SCTP configured values]

- Retransmission Mode-Configured retransmission mode. Values are "LIN" or "RFC".
- Min. Retransmission Timeout-Minimum Retransmission Timeout value configured.
- Max. Number of Retries-Configured maximum number of retries.
- Min. Congestion Window-Minimum and initial congestion window.
- Inbound Streams-The maximum number of inbound streams this association allows the peer end to create. The value can not be 0.

- Outbound Streams-The maximum number of outbound streams this association allows the peer end to create. The value can not be 0.

State: [Following rows are association state values]

- State-State of the association.
- ULP association id-Upper Layer Protocol association id.
- Number of nets-Number of networks.
- Inbound Streams-Number of Inbound streams the far end can support.  
Min(requested,offered)
- Outbound Streams-Number of Outbound streams the far end can support.  
Min(requested,offered)
- Checksum Algorithm-32 bit checksum field that is included in the SCTP common header. The CRC32c checksum should be set by the sender of each SCTP packet to provide additional protection against data corruption in the network.
- Send/Rcv Buffer Size-The maximum size of data to be transmitted/received in bytes.
- Nets Data-All of the available remote IP addresses and if they are reachable or not.
- Last Net Sent To-IP address of the last network sent on.
- Last Net Rcvd From-IP address of the last network received on.
- Over All Error Count-Total error count on the association.
- Peers Rwnd-The peers receive window.
- My Rwnd-My receive window.
- Max Window-Maximum receive window (the peers receive window is set to this value until it is learned).
- Initial Seq Number-Initial sequence number started at.
- Next Sending Seq Number-Next Sending sequence number.
- Last Acked Seq Number-Highest consecutive TSN that has been Acked.
- Maximum Outbound Char Count-Maximum outbound byte count (high water mark).
- Current Outbound Char Count-Current outbound byte count.
- Number Unsent Char Count-Number of unsent bytes.
- Outbound Data Chunk Count-Number of data chunks that were sent.
- ip datagrams rcvd-Number of IP packets received.
- ip datagrams with data chunks rcvd-Number of IP packets containing SCTP data chunks received.
- data chunks rcvd-Number of SCTP data chunks received.
- data chunks read-Number of SCTP data chunks read.
- dup tsns rcvd-Number of duplicate data chunks received.
- sacks rcvd-Number of selective acknowledgements received.

- gap ack blocks rcvd-Indicates the number of GAP Ack Blocks included in a SACK. This value informs the peer endpoint of gaps in the received sequences of DATA chunks as represented by their TSNs.
- heartbeat requests rcvd-Number of heartbeat requests received.
- heartbeat acks rcvd-Number of heartbeat acknowledges received.
- heartbeat requests sent-Number of heartbeat requests sent.
- ip datagrams sent-Number of IP packets transmitted.
- ip datagrams with data chunks sent-Number of IP packets containing SCTP data transmitted.
- data chunks sent-Number of data chunks sent.
- retransmit data chunks sent-Number of retransmitted data chunks for this association.
- sacks sent-Number of selective acknowledgements sent.
- send failed-Number of selective acknowledgements failed.
- retransmit timer count-Reports the retransmit timer count. Number of times the transmit timer has expired.
- consecutive retransmit timeouts-Count of the number of times consecutive timeouts occurred.
- RTO between RMIN and RMAX inclusive-If the calculated RTO is between the configured RMIN value and the RMAX value inclusively, then increment this peg count. This peg serves as an indication that the RMIN value may be configured incorrectly and will possibly cause frequent retransmits to occur due to RTO fluctuations.
- RTT greater than RMAX-If the calculated RTT is above the configured RMAX value, then increment this peg count. This peg serves as an indication that the RMAX value is configured incorrectly and will possibly cause frequent retransmits to occur due to RTO fluctuations.
- fast retransmit count-Number of retransmits due to fast retransmit.
- rcv timer count-Number of times the receive timer has expired.
- heartbeat timer count-Number of times the heartbeat timer has expired.
- none left tosend-Number of times a transmit is attempted and there is no data chunks to send.
- none left rwnd gate-Number of times a transmit is denied due to no receive window space at peer.
- none left cwnd gate-Number of times a transmit is denied due to exceeding the local congestion window.
- UNKNOWN-Number of retransmit Datagrams for this assoc for error monitoring.

This example shows SCTP port measurements:

```
pass:loc=1307:cmd="sctp -p 2222"
```

```
rlghncxa03w 09-05-01 08:32:09 EST EAGLE5 41.0.0
Local   Local IP      Num of
Port    Address       Assoc
2222    192.168.110.12 3
        192.168.112.12
```

Assoc ID	Local IP Address	Local Port	Remote Address	Remote Port
1	192.168.110.12	2222	192.168.112.4	5555
	192.168.112.12		192.168.110.2	
2	192.168.110.12	2222	192.168.112.4	5555
	192.168.112.12		192.168.110.3	
3	192.168.110.12	2222	192.168.112.4	7777
	192.168.112.12		192.168.110.4	

```

no.of inqueued msgs = 0
      max mtu = 1500
      max init times = 8
max size reassembly = 1048576
default rwnd value = 16384
pre-open streams = 1
ip datagram counter = 2781

```

Timer Values:	seconds	milliseconds
INIT	1	0
RCV	0	200
SEND	1	0
SHUTDOWN	0	300
HEARTBEAT	0	500
PMTU	600	0

;

```
rlghncxa03w 09-05-01 08:32:09 EST EAGLE5 41.0.0
```

```
SCTP command complete
```

;

This example shows all event logs for an association:

```
pass:loc=1307:cmd="sctp -l assoc1"
```

```
rlghncxa03w 08-02-01 08:32:09 EST EAGLE 38.0.0
```

```

SCTP Event Log
Time          Event          Reason
Ripaddr      Rport
-----
-----
01:19:04.165 SACK send fail   None
192.168.63.235 10001
01:19:04.175 Ck echo ack snd fail None
192.168.63.235 10001
01:19:04.180 Assoc UP           Unknown
192.168.63.235 10001
01:19:04.180 Assoc Down        Shutdown Rcv
192.168.63.235 10001
01:19:04.180 Shutdown ack send  None
192.168.63.235 10001
01:19:06.425 INIT Rcv          None

```



```

192.168.63.142 10002
  01:19:06.425 Datagram Ignored      No Assoc Found      192.168.63.142
10002
  01:19:16.500 INIT tmr expr          None                 192.168.63.235
10001
  01:19:16.500 SACK send fail         None                 192.168.63.235
10001
  01:19:17.500 INIT tmr expr          None                 192.168.63.235
10001
  01:19:17.500 SACK send fail         None                 192.168.63.235
10001

SCTP: command complete
;

rlghncxa03w 08-02-01 08:32:09 EST  EAGLE 38.0.0

SCTP command complete
;

```

This example shows event logs for all associations on a given card location:

```
pass:loc=1307:cmd="sctp -l"
```

```

rlghncxa03w 08-02-01 08:32:09 EST  EAGLE 38.0.0

SCTP Event Log
Time          Event                      Reason              Ripaddr
Rport
-----
  01:19:04.165 SACK send fail            None                 192.168.63.235
10001
  01:19:04.175 Ck echo ack snd fail None                 192.168.63.235
10001
  01:19:04.180 Assoc UP              Unknown              192.168.63.235
10001
  01:19:04.180 Assoc Down            Shutdown Rcv        192.168.63.235
10001
  01:19:04.180 Shutdown ack send       None                 192.168.63.235
10001
  01:19:06.425 INIT Rcv              None                 192.168.63.142
10002
  01:19:06.425 Datagram Ignored      No Assoc Found      192.168.63.142
10002
  01:19:16.500 INIT tmr expr          None                 192.168.63.235
10001
  01:19:16.500 SACK send fail         None                 192.168.63.235
10001
  01:19:17.500 INIT tmr expr          None                 192.168.63.235
10001
  01:19:17.500 SACK send fail         None                 192.168.63.235
10001

```

```
SCTP: command complete
```

```
;
```

#### Event descriptions for the `sctp -l` command

- Shutdwn ACK tmr exp-No shutdown complete was received in response to the shutdown acknowledgement within the timer's limits.
- PathMTU tmr expr-Indicates the PathMTU daemon timer has expired. At the expiration of this timer, path MTU for each path of each association that is not at the default of 1500 bytes is marked for retesting by raising that path's MTU. The MTU will be adjusted accordingly when the next frame that exceeds the updated MTU occurs, thereby allowing the path MTU to reflect dynamic network conditions.
- INIT tmr expr-If the T1-initialized timer expires, the endpoint must retransmit INIT and restart the T1-init timer without changing state.
- RECV tmr expr-If the receive timer expires, then a stand alone SACK is sent to the peer and this timer is moved back to idle.
- Send tmr expr-This retransmission timer will expire when outstanding data sent to an address has not been acknowledged.
- Shutdwn tmr expr-No shutdown acknowledgement was received in response to the transmitted shutdown within the timer's limits.
- HB tmr expr-No heartbeat acknowledgement was received in response to the transmitted heartbeat within the timer's limits.
- Cookie tmr expr-No cookie acknowledgement was received in response to the transmitted cookie echo within the timer's limits.
- New Cookie tmr expr-When this occurs, time to schedule another timer for the cookie change.
- Tx CHK tmr expr-Transmit check timer expired.
- Unknwn tmr expr-An unknown timer expired.
- INIT Rcv-An INIT was received for an association.
- Datagram Ignored-When an unrecognized chunk time is encountered.
- Assoc Down-An association is taken out of service.
- INTF Down-Interface on an association is down and out of consideration for selection.
- INTF Up-Interface on an association is up and now back in consideration for selection.
- Datagram Send Fail-IP Packet failed to send.
- Ignore Cookie-Happens when the cookie is not received first.
- Ignore INIT-If the INIT message is not received first, is not the only chunk, is received with a non-zero Verification tag, if the T bit value is 1 or if mandatory parameters are missing then the INIT message is discarded/ignored.
- Ignore INIT ACK-If the INIT ACK is not first, not the only chunk or too small (missing mandatory parameters), then the INIT ACK chunk is ignored.
- Ignore Shutdwn ACK-The SHUTDOWN Complete MUST be the only chunk, otherwise the packet is ignored.

- Ignore HB ACK-The received HB acknowledgement was ignored due to asymmetric routing (HBA not received on the same interface the original HB was transmitted on).
- Op Error Rcv-Occurs when the peer notifies that we are using an invalid stream or we received a Stale cookie.
- Assoc UP-Association up notification was generated for the upper layer.
- Assoc Restart-Association restart notification was generated for the upper layer.
- Shutdn ack send fail-Attempt to transmit a shutdown acknowledgement chunk failed.
- Shutdown ack send-A shutdown acknowledgement chunk was transmitted to the far end.
- Cookie ack send fail-An attempt to send a Cookie ACK to a specified address failed.
- Cookie ack send-A Cookie ACK was sent to a specified address.
- Stale Cookie send fail-Attempt to send a stale cookie error to the far end failed.
- Stale Cookie send-A stale cookie error was sent to the far end.
- HB req send fail-Attempt to send a HB to the far end failed.
- HB resp send fail-Attempt to send a HB acknowledgement to the far end failed.
- Shutdown send fail-The Shutdown chunk sent to a specified association failed.
- Shutdown send-A Shutdown chunk was sent to a specified association.
- Abort send fail-The Abort chunk sent to a specified association failed.
- Abort send-An Abort chunk was sent to a specified association.
- Abt W cause snd fail-The Abort chunk sent with the Cause parameter to a specified association failed.
- Abort wth cause send-An Abort chunk was sent to a specified association with the Cause parameter.
- SACK send fail-Attempt to send a SACK to the far end failed.
- Initiate send fail-An INIT chunk is used to initiate a SCTP association between two endpoints. This event occurs when an INIT send has failed.
- Initiate send-An INIT chunk is used to initiate a SCTP association between two endpoints. This event occurs when an INIT was successfully sent.
- OprErr send-An endpoint sends this chunk to its peer endpoint to notify it of certain error conditions. It contains one or more error causes. This event occurs when the OPPErr was successfully sent.
- OprErr send Fail-This event occurs when the OPPErr send failed.
- Init ack send fail-This event occurs when an INIT ACK send has failed.
- Init ack sent-This event occurs when an INIT ACK was successfully sent.
- Ck echo ack snd fail-An attempt to send a Cookie-Echo has failed.
- Cookie echo ack send-A cookie echo was sent to the far end in response to an accepted init-ack.
- Chunks send fail-This event occurs when a chunk that was sent has failed.
- Chunks send-This event occurs when a chunk has been successfully sent.
- Cookie send fail-Attempt to transmit a cookie to the far end during the four-way handshake failed.

- Init ack rcv-Init acknowledgement chunk was received.
- Shutdown ack rcv-Shutdown ack chunk was received.
- Shutdown ack sent-Shutdown ack chunk was transmitted to the far end in response to a received shutdown chunk.
- Abort sent-An Abort message was sent to ungracefully shutdown an association.
- Shutdn complete sent-Shutdown complete chunk was transmitted to the far end.

This example clears the logged events for an association:

```
pass:loc=1307:cmd="sctp -r -l assoc1"

    Command Accepted - Processing

    rlghncxa03w 08-02-01 08:32:09 EST  EAGLE 38.0.0

    All event logs for specified association have been reset.

;

    rlghncxa03w 08-02-01 08:32:09 EST  EAGLE 38.0.0

    SCTP command complete

;
```

This example resets association measurements:

```
pass:loc=1307:cmd="sctp -r -a assoc1"

    rlghncxa03w 08-02-01 08:32:09 EST  EAGLE5 38.0.0
    PASS: Command sent to card

    Association measurements have been reset.

    SCTP command complete
```

This example resets port measurements:

```
pass:loc=1307:cmd="sctp -r -p 4001"

    rlghncxa03w 08-02-01 08:32:09 EST  EAGLE5 38.0.0
    PASS: Command sent to card

    Port measurements have been reset.

    SCTP command complete
```

This example resets all measurements and event logs:

```
pass:loc=1307:cmd="sctp -r"

rlghncxa03w 08-02-01 08:32:09 EST  EAGLE5 38.0.0
PASS: Command sent to card

All measurements and logs have been reset.

SCTP command complete
```

This example resets measurements for all ports/associations:

```
pass:loc=1307:cmd="sctp -r -s"

Command Accepted - Processing

rlghncxa03w 08-02-01 08:32:09 EST  EAGLE5 38.0.0

All measurements have been reset.

;

rlghncxa03w 08-02-01 08:32:09 EST  EAGLE5 38.0.0

SCTP command complete

;
```

This example shows an IO header audit report:

```
sctp -m

rlghncxa03w 08-02-01 08:32:09 EST  EAGLE5 38.0.0

IO Headers in Common Pool (Total/CurrentFree/Min):
20494/20494/20494

Inst ID   Sock Idx   Assoc ID   IO Headers(Total/CurrentFree/Min)
2         0         1         400/400/398

;
```

## sockrft

This command is used to report and reset the round-trip time statistics for application sockets. Minimum, maximum, and average times are kept for each open socket. The Retransmission Mode (BSD, FIXED, or MOD) and the Fixed Round Trip Time are also displayed.

## Options

Options and option parameters that are underlined indicate that a value must be specified for that option or parameter. For example, the `sockrtt` command has the option socket\_name. The socket name must be specified for which statistics will be displayed, as in the command `sockrtt socyellow`. Do not enter the underlined option or parameter; enter a value for the information represented by the underlined option or parameter.

socket\_name

This option is **mandatory** and specifies the socket name for which statistics are to be displayed.

### Range:

up to 15 alphanumeric characters.

`-r`

This option resets all statistics for the given socket name.

`-h`

This option provides help information for the command.

## Example

```
sockrtt
sockrtt -h

sockrtt socyellow
sockrtt socyellow -r
```

## Dependencies

None

## Notes

The `sockrtt` command is executed through the `pass` command.

## Output

```
pass:loc=1105:cmd="sockrtt" OR
pass:loc=1105:cmd="sockrtt -h"
```

```
Command Accepted - Processing
```

```

    rlghncxa03w 04-07-27 08:32:34 EST  EAGLE5 31.6.0
    PASS: Command sent to card
;
    rlghncxa03w 04-07-27 08:32:34 EST  EAGLE5 31.6.0
    Usage: SOCKRTT socketname [-r] [-h]
    Options:
        -r          Resets rtt data for specified socket
        -h          Displays this message
;
    rlghncxa03w 04-07-27 08:32:34 EST  EAGLE5 31.6.0
```

```
SOCKRTT command complete
;

pass:loc=1105:cmd="sockrtt c7000"

Command Accepted - Processing

rlghncxa03w 04-07-27 08:32:34 EST EAGLE5 31.6.0
PASS: Command sent to card
;

rlghncxa03w 04-07-27 08:32:34 EST EAGLE5 31.6.0

SOCKRTT: Socket round-trip time report (in milliseconds)
Configured Traffic Round-Trip Time
    Retransmission Mode          : FIXED
    Fixed Round Trip Time        : 250

Measured Normal Traffic Round-Trip Times

    Minimum round-trip time      : 5
    Maximum round-trip time      : 195
    Weighted Average round-trip time : 10
    Last recorded round-trip time : 10

Measured Congested Traffic Round-Trip Times

    Minimum round-trip time      : 0
    Maximum round-trip time      : 0
    Weighted Average round-trip time : 0
    Last recorded round-trip time : 0
;

rlghncxa03w 04-07-27 08:32:34 EST EAGLE5 31.6.0
SOCKRTT command complete
;

pass:loc=1105:cmd="sockrtt c7000 -r"

Command Accepted - Processing

rlghncxa03w 04-07-27 08:32:34 EST EAGLE5 31.6.0
pass:loc=1105:cmd="sockrtt c7000 -r"
Command entered at terminal #1.
;

rlghncxa03w 04-07-27 08:32:34 EST EAGLE5 31.6.0
PASS: Command sent to card
;

rlghncxa03w 04-07-27 08:32:34 EST EAGLE5 31.6.0

SOCKRTT: Socket round-trip time report (in milliseconds)
Configured Traffic Round-Trip Time
```

```

Retransmission Mode           : FIXED
Fixed Round Trip Time         : 250

Measured Normal Traffic Round-Trip Times
Minimum round-trip time       : 0
Maximum round-trip time       : 0
Weighted Average round-trip time : 0
Last recorded round-trip time : 0

Measured Congested Traffic Round-Trip Times
Minimum round-trip time       : 0
Maximum round-trip time       : 0
Weighted Average round-trip time : 0
Last recorded round-trip time : 0
;
rlghncxa03w 04-07-27 08:32:34 EST EAGLE5 31.6.0
SOCKRRTT command complete
;

```

## soipdata

This command is used to display the SOIP operational data captured for the last 24 hours.

### Options

Options and option parameters that are underlined indicate that a value must be specified for that option or parameter.

-f

This option displays full operational data (all counts).

-s

This option displays the number of errors received with error type Bad Source.

-d

This option displays the number of of errors received with error type Bad Destination.

-v

This option displays the number of errors received with error type Bad Version.

-g

This option displays the number of Good Day messages received.

-e

This option displays the number of error messages sent (Sum of Bad Version, Bad Source and Bad Destination).

-u

This option displays the number of UPL messages received.

-t

This option displays the number of UPL messages transmitted.

-r

This option resets the specified error count.



-h  
This option displays help for the command.

### Example

```
soipdata -h
soipdata -f

soipdata -r

soipdata -u
```

### Dependencies

None

### Notes

None

### Output

```
pass:loc=1305:cmd= "soipdata -h"
```

```
Usage: soipdata [[-f ] | [[-s] [-d] [-v] [-g] [-e] [-u] [-t] [-r] [-h]]
```

```
Options:
-f  Display Full Operational data (all the counts)
-s  Display number of SR-5129 Messages received with Bad Source
-d  Display number of SR-5129 Messages received with Bad Destination
-v  Display number of SR-5129 Messages received with Bad Version
-g  Display number of Good Day Messages Received.
-e  Display number of error messages sent (Sum of BadVersion, BadSource
and BadDestination)
-u  Display number of Number of UPL messages received
-t  Display number of Number of UPL messages transmitted.
-r  Reset the Specified Error Count
-h  display command help
```

```
pass:loc=1305:cmd=" soipdata -f"
```

```
SOIPDATA: SR-5129 Operational Data Report
```

```
Operational Data
```

---

```
-
  reason
count
-----
-----
  Message Recived with Bad Source                1
```

```

Message Received with Bad Destination      2
Message Received with Bad Version          0
Number of Goodday Messages Received      1
Number of Error Messages Sent             10
Number of UPL Messages Received          12000
Number of UPL Messages Sent              19000

```

```
pass:loc=1105:cmd=pass:loc=1305:cmd="soipdata -r"
```

```
SOIPDATA : All SOIP Operational data has been reset
```

```
pass:loc=1305:cmd="soipdata -r -u"
```

```
SOIPDATA: Number of UPL Messages Received has been reset.
```

```
pass:loc=1305:cmd="soipdata -u"
```

```
SOIP Operational Data
```

```

-----
reason
count
-----
-----
Number of UPL Messages Received      0

```

## soiplog

This command is used to display the logs for the SR-5129 messages for a particular SEAS terminal.

### Options

Options and option parameters that are underlined indicate that a value must be specified for that option or parameter.

-l

This option enables and disables logging.

-d

This option displays live message logs

-n X

This option displays the last X number of messages.

-h  
This option displays the help for this command.

### Example

```
soiplog -h
soiplog -l enable":loc=XXXX
```

### Dependencies

None

### Notes

With two active connections to the CCS MR, logging must be enabled on each IPSM card that has an active SEAS terminal in order to properly log all SR-5129 communication data.

Assuming a message size of 500 bytes, each IPSM card can log approximately 2000 messages.

If an attempt is made to enable logging on a terminal when logging is already enabled on a different terminal, then the following warning message appears in the previously enabled terminal.

**"Warning: SOIP Logging Enabled from Terminal: <New logging enabled terminal>"**

If an attempt is made to disable logging on a terminal when logging is already enabled on a different terminal, then the following warning message appears in the previously enabled terminal

**"Warning: SOIP Logging disabled from Terminal: <New logging enabled terminal>"**

If an attempt is made to turn on logging on a terminal when it is already enabled on a different terminal, then the following warning message appears in the previously enabled terminal.

**"Warning: SOIPLLOG Started on Terminal: <New logging enabled terminal>"**

### Output

```
pass:loc=1305:cmd= "soiplog -h"
```

```
Usage: SOIPLLOG [[-l option] |
                [-d] [-n] [-h]]

Options:
  -l <enable/disable>   Enable/Disable the logs
  -d                    Display live message logs
  -n <num>              Display last <num> number of messages.
Range=1..2000
  -h                    Display Command Help
```

To Enable Real time logging and display, the following commands must be entered one after the other:

```
pass:cmd="soiplog -l enable":loc=XXXX
pass:cmd="soiplog -d":loc=XXXX
```

To enable logging and to display the last N number of logged messages, the following commands must be entered one after the other:

```
pass:cmd="soiplog -l enable":loc=XXXX
pass:cmd="soiplog -n N":loc=XXXX
```

```
[mm/dd/yy:hour:min:sec ] Message Received.

      0353 SR5129 Rcvd 064 bytes, trm=17
      7E 7E 7E 7E 00 00 00 38      02 01 01 02 01 50 04 0A      *~~~~
8      P *
      41 42 43 44 45 46 47 48      49 50 04 0B 53 45 41 53
*ABCDEFGH IJ SEAS*
      4E 4A 43 43 53 4D 31 04      11 50 49 53 43 4E 4A 53      *NJCCSM1
PISCNJS*
      4E 44 38 31 58 49 46 30      31 41 02 01 00 02 01 01
*ND81XIF01A      *
```

```
[mm/dd/yy:hour:min:sec ] Message Received.

      0354 SR5129 Rcvd 133 bytes, trm=17
      7E 7E 7E 7E 00 00 00 7D      02 01 01 02 01 50 04 0A
*~~~~ }      P *
      41 42 43 44 45 46 47 48      49 50 04 0B 53 45 41 53
*ABCDEFGH IJ SEAS*
      4E 4A 43 43 53 4D 31 04      11 50 49 53 43 4E 4A 53      *NJCCSM1
PISCNJS*
      4E 44 38 31 58 49 46 30      31 41 02 01 00 02 01 13
*ND81XIF01A      *
      04 43 03 41 41 42 44 45      46 47 48 49 50 51 53 45      *
ABCDEFGHIJKSE *
      41 53 4E 4A 43 43 53 4D      31 00 56 52 46 00 2A 56      *ASNJCCSM1
VFY *V*
      46 59 2D 47 54 54 3A 3A      30 31 30 2C 2A 2A 2D 2A      *FY-
GTT::010,      **-*
      2A 2D 2A 2A 2C 2A 2A 3A      31 32 33 34 35 36 3A 35      **-
**, **:123456:5      *
      30 2C 56 52
46
*0, VRF      *
```

## traceroute

This command is used to determine the path taken by a UDP message to a specified remote host. The command can be invoked with either a hostname or IP address.

### Options

Options and option parameters that are underlined indicate that a value must be specified for that option or parameter. For example, the `traceroute` command has the option destination. The IP address can be specified for the remote host to which the UDP message is sent, as in the command `traceroute 208.55.20.177`.

Do not enter the underlined option or parameter; enter a value for the information represented by the underlined option or parameter.

IP address

The IP address is a TCP/IP address expressed in standard “dot notation.” IP addresses consist of the system’s network number and the machine’s unique host number. An example IP address is *192.9.200.44*, where *192.9.200* is the network number and *44* is the machine’s host number.

**Range:**

4 numbers separated by dots, with each number in the range of 0-255.

hostname

Hostname. The logical name assigned to the device with the IP address indicated.

**Range:**

String of characters, beginning with a letter, up to 120 characters in length. Valid characters are *a-z*, *A-Z*, *0-9*, - (hyphen), . (period)

-h

This option provides help information for the command.

-m maximum hops

This option specifies the maximum number of hops before the trace is terminated.

**Range:**

1-30

**Default:**

10

-n

This option specifies that only the IP Address of each host will be displayed (not the hostname).

-p port

This option provides the user port number.

**Range:**

1-65535

**Default:**

33434

**Example**

```
traceroute
```

```
traceroute www.remotedest.com
```

```
traceroute www.remotedest.com -m 20
```

```
traceroute www.remotedest.com -m 20 -n
```

```
traceroute 208.55.20.177
```

```
traceroute 208.55.20.177 -m 20 -p 40000
```

## Dependencies

If a Domain Name is specified, the Domain Name must exist in the IP Host table or the Domain Name Server A or B must be provisioned.

## Notes

The `traceroute` command is executed through the `pass` command.

## Output

This example shows the help information for the command:

```
pass:loc=1103:cmd="traceroute" or
pass:loc=1103:cmd="traceroute -h"

    Command entered at terminal #1.
;

    rlghncxa03w 04-07-27 08:32:34 EST  EAGLE5 31.6.0
    PASS: Command sent to card
;

    rlghncxa03w 04-07-27 08:32:34 EST  EAGLE5 31.6.0

Usage: traceroute <hostname | ipaddr> [-h] [-m maxhops] [-n] [-p
port]
Options:
    -h          Displays this message
    -m maxhops  Maximum number of hops to destination.  Range=1..30.
Default= 10.
    -n names    Inhibits the display of intermediate host names
    -p port     Port number. Range=1..65535. Default=33434.
hostname      Name of machine to trace
ipaddr
Errors:
    *          Timeout
    !N         Unreachable Network
    !H         Unreachable Host
    !?nn      Unknown Failure (nn = ICMP Code)
;

    rlghncxa03w 04-07-27 08:32:34 EST  EAGLE5 31.6.0

TRACEROUTE command complete
```

This example shows output for a request to host *www.remotedest.com*. A maximum of 20 hops has been specified. Three packets are sent to each hop, with the time for each sample displayed. Intermediate host names are also displayed.

```
pass:loc=1103:cmd="traceroute www.remotedest.com -m 20"
```

```
    Command entered at terminal #1.
;
```

```

rlghncxa03w 04-07-27 08:32:34 EST EAGLE5 31.6.0
PASS: Command sent to card
;

rlghncxa03w 04-07-27 08:32:34 EST EAGLE5 31.6.0
TRACEROUTE command in progress
;

rlghncxa03w 04-07-27 08:32:34 EST EAGLE5 31.6.0
;

rlghncxa03w 04-07-27 08:32:34 EST EAGLE5 31.6.0
Traceroute to www.remotedest.com (208.55.20.177),
  20 hops max, 100 byte packets
  1   5ms   5ms   5ms 216-187-242-57.ded.btitelecom.net
(216.187.242.57)
  2  25ms  25ms  85ms 216-187-251-74.ded.btitelecom.net
(216.187.251.74)
  3  25ms  25ms  25ms bti-rdu-cl-rtr.btitelecom.net (208.216.228.254)
  4  30ms  25ms  25ms Serial4-1-0.GW2.RDU1.ALTER.NET (157.130.34.93)
  5  35ms  35ms  40ms 178.ATM2-0.XR1.DCA1.ALTER.NET (146.188.162.50)
  6  40ms  40ms  35ms 195.at-2-0-0.XR1.DCA6.ALTER.NET (152.63.33.22)
  7  40ms  40ms  40ms 0.so-1-3-0.XL1.DCA6.ALTER.NET (152.63.35.114)
  8  40ms  40ms  40ms POS6-0.BR3.DCA6.ALTER.NET (152.63.38.117)
  9  40ms  40ms  40ms a3-0.uunet.mclnva02.us.bb.verio.net
(204.255.169.90)
 10  75ms  75ms  75ms p16-0-0-0.r00.atlnga03.us.bb.verio.net
(129.250.2.49)
 11  95ms  95ms  95ms p4-0-2-0.r01.bcrtf101.us.bb.verio.net
(129.250.4.54)
 12  95ms  95ms  95ms ge-1-1.r01.border.boca.verio.net (129.250.28.52)
 13  95ms  95ms  95ms ge-8-1.r01.edge.boca.verio.net (208.55.254.9)
 14  95ms  95ms  95ms www.remotedest.com (208.55.20.177)

TRACEROUTE command complete
;

```

This example shows a request to host *www.remotedest.com*. No maximum number of hops has been specified. Intermediate host names are displayed. The display terminates after 10 hops.

```
pass:loc=1103:cmd="traceroute www.remotedest.com"
```

```

Command entered at terminal #1.
;

rlghncxa03w 04-07-27 08:32:34 EST EAGLE5 31.6.0
PASS: Command sent to card
;

rlghncxa03w 04-07-27 08:32:34 EST EAGLE5 31.6.0

TRACEROUTE command in progress

```

```

;

rlghncxa03w 04-07-27 08:32:34 EST EAGLE5 31.6.0
;

rlghncxa03w 04-07-27 08:32:34 EST EAGLE5 31.6.0
Traceroute to www.remotedest.com (208.55.20.177),
  10 hops max, 100 byte packets
  1    5ms    5ms    5ms 216-187-242-57.ded.btitelecom.net
(216.187.242.57)
  2   25ms   25ms   25ms 216-187-251-74.ded.btitelecom.net
(216.187.251.74)
  3   25ms   25ms   25ms bti-rdu-c1-rtr.btitelecom.net
(208.216.228.254)
  4   25ms   25ms   25ms 157.130.34.93 (157.130.34.93)
  5   35ms   40ms   40ms 178.ATM2-0.XR1.DCA1.ALTER.NET
(146.188.162.50)
  6   40ms   35ms   45ms 195.at-2-0-0.XR1.DCA6.ALTER.NET
(152.63.33.22)
  7   45ms   40ms   40ms 0.so-1-3-0.XL1.DCA6.ALTER.NET
(152.63.35.114)
  8   40ms   35ms   35ms POS6-0.BR3.DCA6.ALTER.NET (152.63.38.117)
  9   40ms   40ms   40ms a3-0.uunet.mclnva02.us.bb.verio.net
(204.255.169.90)
 10   75ms   75ms   80ms p16-0-0-0.r00.atlnga03.us.bb.verio.net
(129.250.2.49)

Maximum number of hops reached

TRACEROUTE command complete
;

```

This example shows a request to host IP address `208.55.20.177`. No maximum number of hops has been specified. Intermediate host names are displayed. The display terminates after 10 hops.

```
pass:loc=1103:cmd="traceroute 208.55.20.177"
```

```

Command entered at terminal #1.
;

rlghncxa03w 04-07-27 08:32:34 EST EAGLE5 31.6.0
PASS: Command sent to card
;

rlghncxa03w 04-07-27 08:32:34 EST EAGLE5 31.6.0

TRACEROUTE command in progress
;

rlghncxa03w 04-07-27 08:32:34 EST EAGLE5 31.6.0
Traceroute to www.remotedest.com (208.55.20.177),

```



```

                10 hops max, 100 byte packets
  1    5ms    5ms    5ms 216-187-242-57.ded.btitelecom.net
(216.187.242.57)
  2   55ms   260ms  300ms 216-187-251-74.ded.btitelecom.net
(216.187.251.74)
  3   25ms   25ms   25ms bti-rdu-c1-rtr.btitelecom.net (208.216.228.254)
  4   25ms   25ms   25ms Serial4-1-0.GW2.RDU1.ALTER.NET (157.130.34.93)
  5   40ms   35ms   35ms 178.ATM2-0.XR1.DCA1.ALTER.NET (146.188.162.50)
  6   40ms   35ms   40ms 195.at-2-0-0.XR1.DCA6.ALTER.NET (152.63.33.22)
  7   35ms   40ms   40ms 0.so-1-3-0.XL1.DCA6.ALTER.NET (152.63.35.114)
  8   40ms   35ms   40ms POS6-0.BR3.DCA6.ALTER.NET (152.63.38.117)
  9   40ms   40ms   40ms a3-0.uunet.mclnva02.us.bb.verio.net
(204.255.169.90)
 10   75ms   75ms   75ms p16-0-0-0.r00.atlnga03.us.bb.verio.net
(129.250.2.49)
Maximum number of hops reached

TRACEROUTE command complete
;

```

This example shows a request to host IP address 208.55.20.177. A maximum of 20 hops has been specified. Intermediate host names are displayed.

```
pass:loc=1103:cmd="traceroute 208.55.20.177 -m 20"
```

```

Command entered at terminal #1.
;

rlghncxa03w 04-07-27 08:32:34 EST  EAGLE5 31.6.0
PASS: Command sent to card
;

rlghncxa03w 04-07-27 08:32:34 EST  EAGLE5 31.6.0

TRACEROUTE command in progress
;

rlghncxa03w 04-07-27 08:32:34 EST  EAGLE5 31.6.0
;

rlghncxa03w 05-07-27 08:32:34 EST  EAGLE5 31.6.0
Traceroute to www.remotedest.com (208.55.20.177),
                20 hops max, 100 byte packets
  1    5ms    5ms    5ms 216-187-242-57.ded.btitelecom.net
(216.187.242.57)
  2   25ms   25ms   25ms 216-187-251-74.ded.btitelecom.net
(216.187.251.74)
  3   25ms   25ms   25ms bti-rdu-c1-rtr.btitelecom.net (208.216.228.254)
  4   25ms   25ms   25ms Serial4-1-0.GW2.RDU1.ALTER.NET (157.130.34.93)
  5   35ms   35ms   35ms 178.ATM2-0.XR1.DCA1.ALTER.NET (146.188.162.50)
  6   35ms   40ms   35ms 195.at-2-0-0.XR1.DCA6.ALTER.NET (152.63.33.22)
  7   35ms   35ms   35ms 0.so-1-3-0.XL1.DCA6.ALTER.NET (152.63.35.114)
  8   40ms   35ms   35ms POS6-0.BR3.DCA6.ALTER.NET (152.63.38.117)

```

```

    9   40ms   40ms   40ms a3-0.uunet.mclnva02.us.bb.verio.net
(204.255.169.90)
    10  75ms   75ms   75ms
p16-0-0-0.r00.atlga03.us.bb.verio.net (129.250.2.49)
    11  95ms   95ms   95ms p4-0-2-0.r01.bcrtf101.us.bb.verio.net
(129.250.4.54)
    12  95ms   95ms   95ms ge-1-1.r01.border.boca.verio.net
(129.250.28.52)
    13  95ms   95ms   95ms ge-8-1.r01.edge.boca.verio.net
(208.55.254.9)
    14  95ms   95ms   95ms www.remotedest.com (208.55.20.177)

TRACEROUTE command complete
;

```

This example shows a request to host IP address *208.55.20.177*. A maximum of 20 hops has been specified. Intermediate host names are not displayed because the `-n` option is specified.

```
pass:loc=1103:cmd="traceroute 208.55.20.177 -m 20 -n"
```

```

Command entered at terminal #1.
;
  rlghncxa03w 04-07-27 08:32:34 EST  EAGLE5 31.6.0
PASS: Command sent to card
;

  rlghncxa03w 04-07-27 08:32:34 EST  EAGLE5 31.6.0

TRACEROUTE command in progress
;

  rlghncxa03w 04-07-27 08:32:34 EST  EAGLE5 31.6.0

;

  rlghncxa03w 04-07-27 08:32:34 EST  EAGLE5 31.6.0
Traceroute to www.remotedest.com (208.55.20.177),
  20 hops max, 100 byte packets
  1    5ms    5ms    5ms 216.187.242.57
  2   25ms   25ms   25ms 216.187.251.74
  3   25ms   25ms   25ms 208.216.228.254
  4   30ms   30ms   30ms 157.130.34.93
  5   35ms   40ms   40ms 146.188.162.50
  6   40ms   40ms   40ms 152.63.33.22
  7   40ms   45ms   40ms 152.63.35.114
  8   40ms   40ms   35ms 152.63.38.117
  9   40ms   40ms   40ms 204.255.169.90
 10   75ms   75ms   75ms 129.250.2.49
 11   95ms   95ms   95ms 129.250.4.54
 12   95ms   95ms   95ms 129.250.28.52
 13   95ms   95ms   95ms 208.55.254.9
 14  110ms  100ms   95ms 208.55.20.177

```

```

    TRACEROUTE command complete
;

```

This example shows a request to host IP address *www.remotedest.com*. A maximum of 20 hops has been specified. Intermediate host names are not displayed because the `-n` option is specified.

```
pass:loc=1103:cmd="traceroute www.remotedest.com -m 20 -n"
```

```

    Command entered at terminal #1.
;
    rlghncxa03w 04-07-27 08:32:34 EST  EAGLE5 31.6.0
    PASS: Command sent to card
;

    rlghncxa03w 04-07-27 08:32:34 EST  EAGLE5 31.6.0

    TRACEROUTE command in progress
;

    rlghncxa03w 04-07-27 08:32:34 EST  EAGLE5 31.6.0
;

    rlghncxa03w 05-07-27 08:32:34 EST  EAGLE5 31.6.0
    Traceroute to www.remotedest.com (208.55.20.177),
        20 hops max, 100 byte packets
  1    5ms    5ms    5ms 216.187.242.57
  2   25ms   25ms   25ms 216.187.251.74
  3   25ms   25ms   25ms 208.216.228.254
  4   30ms   30ms   30ms 157.130.34.93
  5   35ms   40ms   40ms 146.188.162.50
  6   40ms   40ms   40ms 152.63.33.22
  7   40ms   45ms   40ms 152.63.35.114
  8   40ms   40ms   35ms 152.63.38.117
  9   40ms   40ms   40ms 204.255.169.90
 10   75ms   75ms   75ms 129.250.2.49
 11   95ms   95ms   95ms 129.250.4.54
 12   95ms   95ms   95ms 129.250.28.52
 13   95ms   95ms   95ms 208.55.254.9
 14  110ms  100ms   95ms 208.55.20.177

    TRACEROUTE command complete
;

```

This example shows a request to host IP address *208.55.20.177*. A maximum of 20 hops has been specified. Intermediate host names are displayed. Application Port 40000 is used.

```
pass:loc=1103:cmd="traceroute 208.55.20.177 -m 20 -p 40000"
```

```

    Command entered at terminal #1.
;

```

```

rlghncxa03w 04-07-27 08:32:34 EST EAGLE5 31.6.0
PASS: Command sent to card
;

rlghncxa03w 04-07-27 08:32:34 EST EAGLE5 31.6.0

TRACEROUTE command in progress
;

rlghncxa03w 04-07-27 08:32:34 EST EAGLE5 31.6.0
;

rlghncxa03w 04-07-27 08:32:34 EST EAGLE5 31.6.0
Traceroute to www.remotedest.com (208.55.20.177),
  20 hops max, 100 byte packets
  1   5ms   5ms   5ms 216-187-242-57.ded.btitelecom.net
(216.187.242.57)
  2  25ms  25ms  25ms 216-187-251-74.ded.btitelecom.net
(216.187.251.74)
  3  25ms  25ms  25ms 208.216.228.254 (208.216.228.254)
  4  25ms  25ms  25ms 157.130.34.93 (157.130.34.93)
  5  35ms  40ms  40ms 178.ATM2-0.XR1.DCA1.ALTER.NET
(146.188.162.50)
  6  45ms  35ms  40ms 195.at-2-0-0.XR1.DCA6.ALTER.NET
(152.63.33.22)
  7  35ms  40ms  40ms 0.so-1-3-0.XL1.DCA6.ALTER.NET
(152.63.35.114)
  8  40ms  35ms  40ms POS6-0.BR3.DCA6.ALTER.NET (152.63.38.117)
  9  40ms  40ms  40ms a3-0.uunet.mclnva02.us.bb.verio.net
(204.255.169.90)
 10 75ms  75ms  75ms
p16-0-0-0.r00.atlna03.us.bb.verio.net (129.250.2.49)
 11 95ms  95ms  95ms p4-0-2-0.r01.bcrtf101.us.bb.verio.net
(129.250.4.54)
 12 95ms  95ms  95ms ge-1-1.r01.border.boca.verio.net
(129.250.28.52)
 13 95ms  95ms  95ms ge-8-1.r01.edge.boca.verio.net
(208.55.254.9)
 14 95ms  95ms  95ms www.remotedest.com (208.55.20.177)

TRACEROUTE command complete
;

This example shows a request to host IP address 204.202.136.31. A maximum of 20
hops has been specified. Intermediate host names are displayed. Several timeouts
occur. An ICMP error is received (in this case, an unknown response with an ICMP
code = 13), and the command is terminated immediately.

pass:loc=1103:cmd="traceroute 204.202.136.31 -m 20"

Command entered at terminal #1.
;

rlghncxa03w 04-07-27 08:32:34 EST EAGLE5 31.6.0

```

```

PASS: Command sent to card
;

rlghncxa03w 04-07-27 08:32:34 EST EAGLE5 31.6.0
TRACEROUTE command in progress
;

rlghncxa03w 04-07-27 08:32:34 EST EAGLE5 31.6.0
;

rlghncxa03w 04-07-27 08:32:34 EST EAGLE 31.6.0
Traceroute to 204.202.136.31 (204.202.136.31),
  20 hops max, 100 byte packets
 1   5ms   5ms   5ms 216-187-242-57.ded.btitelecom.net
(216.187.242.57)
 2  25ms  25ms  25ms 216-187-251-74.ded.btitelecom.net
(216.187.251.74)
 3  25ms  25ms  25ms bti-rdu-c1-rtr.btitelecom.net (208.216.228.254)
 4  25ms  25ms  25ms Serial4-1-0.GW2.RDU1.ALTER.NET (157.130.34.93)
 5  35ms  40ms  35ms 178.ATM2-0.XR1.DCA1.ALTER.NET (146.188.162.50)
 6  40ms  35ms  35ms 195.at-1-0-0.TR1.DCA6.ALTER.NET (152.63.33.206)
 7 110ms 115ms 115ms 121.at-1-1-0.TR1.SEA1.ALTER.NET (146.188.140.74)
 8 110ms 115ms 115ms 299.ATM7-0.XR1.SEA1.ALTER.NET (146.188.200.109)
 9 115ms 115ms 115ms 195.ATM5-0.GW5.SEA1.ALTER.NET (146.188.201.57)
10 110ms 110ms 110ms waltdisney1-OC12-
gw.customer.alter.net(157.130.182.30)
11 110ms 115ms 110ms 204.202.138.71 (204.202.138.71)
12 *      *      *      Request timed out
13  !?13      Unreachable

TRACEROUTE command complete
;

```

## ualog

Use this command to report on the user adapter (UA) state machine history for a specified association name. State machine history is kept in a circular buffer in memory. The `-i` and `-x` options are used to include or exclude groups of events from the state machine history.

### Options

Options and option parameters that are underlined indicate that a value must be specified for that option or parameter. For example, the `ualog` command has the parameter aname. The association name must be specified for which the user adapter log will be displayed, as in the command `ualog s7000`. Do not enter the underlined option or parameter; enter a value for the information represented by the underlined option or parameter.

aname

This option specifies the association name for the display.

`-h`

This option displays help (usage) information for the command.

`-i event_group`

This option includes groups of events in the state machine history.

**Range:**

**service**

**ua**

-xevent\_group

This option excludes groups of events from the state machine history.

**Range:**

**service**

**ua**

**Example**

```
pass:loc=1105:cmd="ualog s7000"
```

**Dependencies**

None

**Notes**

None

**Output**

```
pass:loc=1105:cmd="ualog s7000"
```

```

rlghncxa03w 05-07-27 08:10:00 EST  EAGLE5 34.0.0
PASS: Command sent to card
;
rlghncxa03w 05-07-27 08:10:00 EST  EAGLE5 34.0.0
UALOG command in progress
;
rlghncxa03w 05-07-27 08:10:00 EST  EAGLE5 34.0.0

```

```

UALOG: User Adapter state history log
      UA Version: 01
      ASP ID:0x00000002
      User Adapter Implemented: M3UA RFC
      Current settings: -i service ua

```

Date	Time	ASP Event
05-07-27	17:17:46.940	Management Socket Open
05-07-27	17:17:46.940	Transition to Connecting
05-07-27	17:17:47.500	Socket Allowed for Traffic
05-07-27	17:17:49.375	Socket Connection Established
05-07-27	17:17:49.375	Transition to ASP-DOWN
05-07-27	17:17:49.390	ASPUP PDU Received (ASP ID = 0x00000002)
05-07-27	17:17:49.390	ASPUPACK PDU Transmitted
05-07-27	17:17:49.390	Transition to ASP-INACTIVE LOADSHARE

```
(RC=none)
05-07-27 17:17:49.390 AS INACTIVE NTFY PDU Transmitted (RC=none)
05-07-27 17:17:49.405 ASPACTIVE PDU Received (RC=none)
05-07-27 17:17:49.405 ASPACTIVEACK PDU Transmitted (RC=none)
05-07-27 17:17:49.405 Transition to ASP-ACTIVE LOADSHARE (RC=none)
05-07-27 17:17:49.405 AS ACTIVE NTFY PDU Transmitted (RC=none)
05-07-27 17:17:50.405 ASP INACT NTFY PDU Transmitted (ASP ID =
0x00000005)
05-07-27 17:17:50.405 ASP ACT NTFY PDU Transmitted (ASP ID =
0x00000005)
05-07-27 17:17:52.730 ASP FAILURE NFY PDU Transmitted (ASP ID =
0x00000003)
```

UALOG command complete

;

```
pass:loc=1105:cmd="ualog s7000"
```

Command Accepted - Processing

```
rlghncxa03w 05-07-27 08:10:00 EST EAGLE5 34.0.0
pass:loc=1105:cmd="ualog s7000"
```

;

```
rlghncxa03w 05-07-27 08:10:00 EST EAGLE5 34.0.0
PASS: Command sent to card
```

;

```
rlghncxa03w 05-07-27 08:10:00 EST EAGLE5 34.0.0
UALOG command in progress
```

;

```
rlghncxa03w 05-07-27 08:10:00 EST EAGLE5 34.0.0
```

UALOG: User Adapter state history log

UA Version: 01

ASP ID: 0x00000007

User Adapter Implemented: SUA RFC

Current settings: -i service ua

Date	Time	Event
05-07-27	19:45:33.265	CLDT PDU Transmitted(RC=000000001)
05-07-27	19:48:07.490	ASPINACTIVE PDU Received(RC=none)
05-07-27	19:48:07.490	ASPINACTIVEACK PDU Transmitted(RC=000000002)
05-07-27	19:48:07.490	Transition to ASP-INACTIVE LOADSHARE(RC=000000002)
05-07-27	19:48:07.490	AS PENDING NTFY PDU Transmitted(RC=000000002)
05-07-27	19:48:07.500	AS INACTIVE NTFY PDU Transmitted(RC=000000002)
05-07-27	19:48:19.730	ASPACTIVE PDU Received(RC=000000001)
05-07-27	19:48:19.730	ASPACTIVEACK PDU Transmitted(RC=000000001)
05-07-27	19:48:19.730	Transition to ASP-ACTIVE LOADSHARE(RC=000000001)
05-07-27	19:48:19.730	AS ACTIVE NTFY PDU Transmitted(RC=000000001)

```

    UALOG: command complete
;

```

When a M3UA or SUA PDU is received that contains one or more errors, a response error message is transmitted containing an error code. Error codes are recorded to and displayed in the UALOG only when the UA peer-to-peer message logging option is enabled (*-i ua*), as shown.

```
pass:loc=1315:cmd="ualog assoc1315a1"
```

```

Command Accepted - Processing
  rlghncxa03w 05-07-27 08:10:00 EST  EAGLE5 34.0.0
  pass:loc=1315:cmd="ualog assoc1315a1"
  Command entered at terminal #3.
;

```

```

  rlghncxa03w 05-07-27 08:10:00 EST  EAGLE5 34.0.0
  PASS: Command sent to card
;

```

```
rlghncxa03w 05-07-27 08:10:00 EST  EAGLE5 34.0.0
```

```
UALOG command in progress
;

```

```
rlghncxa03w 05-07-27 08:10:00 EST  EAGLE5 34.0.0
```

```

UALOG: User Adapter state history log
  UA Version: 01
  ASP ID:undefined
  User Adapter Implemented: M3UA RFC
  Current settings: -i service ua

```

Date	Time	Socket Event
05-07-27	17:17:46.940	Management Socket Open
05-07-27	17:17:46.940	Transition to Connecting
05-07-27	17:17:49.375	Socket Connection Established
05-07-27	17:17:49.375	Transition to ASP-DOWN
05-07-27	17:17:49.390	ASPUP PDU Received (ASP ID = undefined)
05-07-27	17:17:49.390	ASPUPACK PDU Transmitted
05-07-27	17:17:49.390	Transition to ASP-INACTIVE LOADSHARE
05-07-27	17:17:49.390	AS INACTIVE NTFY PDU Transmitted
05-07-27	17:17:49.405	ASPACTIVE PDU Received
05-07-27	17:17:49.405	ASPACTIVEACK PDU Transmitted
05-07-27	17:17:49.405	Transition to ASP-ACTIVE LOADSHARE
05-07-27	17:17:49.405	AS ACTIVE NTFY PDU Transmitted
05-07-27	17:17:49.450	DAUD PDU Received
05-07-27	17:17:49.480	ERR PDU Transmitted (0x00000015)

```
UALOG command complete
;

```



## Error Codes

 **Note:**

Error codes 0x02, 0x08, 0x1a, 0x1b, 0x1c, 0x10, 0x17, and 0x18 are not used in M3UA

Error codes that can appear in the error messages:

- **0x01**—Invalid Version  
A message was received with an invalid or unsupported version. The error message contains the supported version in the Common Header.
- **0x03**—Unsupported Message Class  
A message was received with an unexpected or unsupported Message Class.
- **0x04**—Unsupported Message Type  
A message was received with an unexpected or unsupported Message Type.
- **0x05**—Unsupported Traffic Handling Mode  
This error is sent by a Signaling Gateway Process (SGP) if an Application Server Process (ASP) sends an ASP Active message with an unsupported Traffic Mode Type or a Traffic Mode Type that is inconsistent with the currently configured mode for the Application Server (AS).
- **0x06**—Unexpected Message  
This error message can be sent if a defined and recognized message is received that is not expected in the current state. In some cases the ASP might silently discard the message and not send an error message. Silent discard is used by an ASP if it received a DATA message from a signaling point while the ASP is in the ASP-INACTIVE state. If the unexpected message contains Routing Context, the Routing Context can be included in the error message.
- **0x07**—Protocol Error  
This error message is sent for any protocol anomaly, such as reception of a parameter that is syntactically correct but unexpected in the current situation.
- **0x09**—Invalid Stream Identifier  
A message is received on an unexpected SCTP stream (for example, a Management message was received on a stream other than 0).
- **0x0d**—Refused - Management Blocking  
An ASP Up or ASP Active message is received and the request is refused for management reasons (such as management lockout). If this error is in response to an ASP Active message, the Routing Context in the ASP Active message can be included in the error message.
- **0x0e**—ASP Identifier Required  
This error message is sent by an SGP in response to an ASP Up message that does not contain an ASP Identifier parameter when the SGP requires one. The ASP should resend the ASP Up message with an ASP Identifier.
- **0x0f**—Invalid ASP Identifier  
This error message is sent by an SGP in response to an ASP Up message with an invalid (for example, non-unique) ASP Identifier.
- **0x11**—Invalid Parameter Value

A message is received with an invalid parameter value (for example, a DUPU message was received with a Mask value other than 0).

- **0x12**—Parameter Field Error  
A message is received with a parameter that has a wrong length field.
- **0x13**—Unexpected Parameter  
A message contains an invalid parameter.
- **0x14**—Destination Status Unknown  
This error message can be sent if a DAUD is received at a Signaling Gateway (SG) asking for the availability/congestion status of a destination, and the SG does not provide the status (as in the case when the sender is not authorized to know the status). For this error, each invalid or unauthorized Point Code is included along with the Network Appearance and/or Routing Context associated with the Point Code.
- **0x15**—Invalid Network Appearance  
This error message is sent by an SGP if an ASP sends a message with an invalid (unconfigured) Network Appearance value. For this error, the invalid (unconfigured) Network Appearance is included in the Network Appearance parameter.
- **0x16**—Missing Parameter  
A message is received, and a mandatory parameter is not included in the message.
- **0x19**—Invalid Routing Context  
A message is received from a peer with an invalid (unconfigured) Routing Context value. The invalid Routing Context is included in the error message.
- **0x1a**—No Configured AS for ASP  
A message is received from a peer without a Routing Context parameter, and it is not known by configuration data which Application Servers are referenced.

# A

## Reference Information

This Appendix contains information that is used by multiple commands.

### Summary of Range Values for :link Parameter

[Table A-1](#) lists the valid *link* parameter range values for signaling links assigned to each type of card for which a location can be specified in the command's `loc` parameter. The commands that use these values refer to this table in their *link* parameter description.



#### Note:

The *port* parameter is a synonym for the *link* parameter in signaling link definitions for EAGLE commands. The *port* parameter will be removed in a future EAGLE release.

**Table A-1 Summary of Ranges for *link* Parameter**

Card	Link	Supported Application
E5-E1T1-B	A-A31, B-B31	SS7ANSI or CCS7ITU application.
E5-E1T1-B for SE-HSL	A, B	SS7ANSI or CCS7ITU application. The card can support a maximum of 2 SE-HSL links.
E5-E1T1-B for ST-HSL-A	A, B	SS7ANSI application. The card can support a maximum of 2 ST-HSL-A links.
E5-ATM-B	A, A1, B	ATMANSI or ATMITU application. The card can support up to 3 signaling links.
E5-ENET/E5-ENET-B	A-A7, B-B7	IPLIMI application with sockets, M2PA/SCTP associations, or M3UA/SCTP associations.
E5-ENET/E5-ENET-B SLIC	A-A15, B-B15 A-A63, B-B63	IPSG application. IPSG application, SLIC card running IPSG application can support up to 128 links.

## Valid CIC Ranges for SI and MSU Types in Routing Key Static Entries

Table A-2 lists the valid CIC ranges for use with SI and MSU types in Routing Key table static entries.

**Table A-2 Valid CIC Ranges for SI and MSU Types**

SI	MSU for ANSI DPC	MSU for ITU DPC	Comments
4 (TUP)	N/A	CIC is 12 bits. Range is 0-4095.	The TUP protocol is used only in ITU networks.
5 (ISUP)	CIC is 14 bits. Range is 0-16383.	CIC is 12 bits. Range is 0-4095.	
13 (QBICC)	CIC is 32 bits. Range is 0-4294967295.		

## DRANAIV/DRANAI Mapping

Table A-5 shows the mapping between the *drainaiv* and *dranai* parameters.

**Table A-3 DRANAIV/DRANAI Mapping**

DRANAIV	DRANAI	Description
1	sub	Subscriber Number
2	unknown	Unknown
3	natl	National significant number
4	intl	International number
5	ntwk	Network

## DRANPV/DRANP Mapping

Table A-6 shows the mapping between the *dranpv* and *dranp* parameters.

**Table A-4 DRANPV/DRANP Mapping**

DRANPV	DRANP	Description
1	E164	ISDN/telephony numbering plan
3	X121	Data numbering plan
4	F69	Telex Numbering Plan

## NAIV/NAI Mapping

Table 58: NAIV/NAI Mapping shows the mapping between the *naiv* and the *nai* parameters.

**Table A-5 NAIV/NAI Mapping**

NAIV	NAI	Description
0	–	Unknown
1	Sub	Subscriber Number
2	Rsvd	Reserved for national use
3	Natl	National significant number
4	Intl	International number
5–127	–	Spare

## NPV/NP Mapping

Table A-8 shows the mapping between the *npv* and the *np* parameters.

**Table A-6 NPV/NP Mapping**

NPV	NP	Description
0	–	Unknown
1	E164	ISDN/telephony numbering plan
2	Generic	Generic numbering plan
3	X121	Data numbering plan
4	F69	Telex numbering plan
5	E210	Maritime mobile numbering plan
6	E212	Land mobile numbering plan
7	E214	ISDN/mobile numbering plan
8	Private	Private network or network-specific numbering plan
9-15	-	Spare

## Cards that use the ent-card Command

Table 60 contains information about cards that use the `ent-card` command for provisioning.

**Table A-7 Valid Card Applications and Types**

Card Name (as shown on card label)	Part Number	Card Type (:type)	Application Type (:appl)	Maximum Cards in the Database
E5-APP-B	870-3096-01	e5appb	epap elap	2 2

**Table A-7 (Cont.) Valid Card Applications and Types**

Card Name (as shown on card label)	Part Number	Card Type (:type)	Application Type (:appl)	Maximum Cards in the Database
E5-APP-B	870-3096-02	e5appb	lsms nas imf	2 1 255
E5-ATM-B	870-2972-01 (R)	limatm lime1atm	atmansi atmitu	180 if only one link is provisioned per card. A maximum of 180 links for either application can exist in the system.
E5-E1T1-B††	870-2970-01	lime1 limt1	ss7ansi ccs7itu	250 for each application
E5-ENET-B	870-2971-01 (R)	dcm enet enetb ipsm stc	ss7ipgw ipgwi iplimi stplan eroute ips ipsg	125 for IPGWx 125 for IPLIMx 100 for ipsg 32 for stplan 32 for eroute
E5-MCPM-B*	870-3089-01 (R)	mcpm	mcp	250
E5-SM4G***	870-2860-01 (R) 870-2860-02 (R)	dsm	vsccp	18 for use with ELAP 32 for use with EPAP
E5-SM8G-B***	870-2990-01 (R)	dsm	vsccp	18 for use with ELAP 32 for use with EPAP
E5-SM8G-B***	870-2990-01 (R)	dsm	siphc deirhc enumhc	16 of the E5- SM8G-B cards connected to ELAP or EPAP for siphc and deirhc 16 of the E5- SM8G-B cards connected to EPAP for enumhc
E5-TSM SLIC	870-2943-03 (R)	tsm slic	gls ipsg siphc deirhc enumhc vsccp sfapp	8 40 for use as GTT on IPSTG 75 for use as GTT- disabled IPSTG 40 for use as Service Module cards

**Table A-7 (Cont.) Valid Card Applications and Types**

Card Name (as shown on card label)	Part Number	Card Type (:type)	Application Type (:appl)	Maximum Cards in the Database
TELCO	870-2904-01	telco	switch	136

\* Though the system allows 250 MCPM cards, practical usage is 2.

\*\*\* If any MPS-based features are running in the system, up to 25 Service Modules are allowed in the system. If only GTT is running, up to 32 Service Modules can be used in the system with the 50,000 GTT feature.

† † For the E1 or T1 interface, either SS7 application (SS7ANSI or CCS7ITU) can be assigned to these cards. For more information on the E1 or T1 interface go to Appendix A "E1 Interface" or Appendix B "T1 Interface" in the *Database Administration - SS7 User's Guide*.

Part numbers followed by (R) are ROHS numbers. These numbers are equivalent to the non-ROHS numbers that they are paired with.

\*\*\*Connectivity to a TekServer 3 (T1200) with EPAP 13.0 or higher or connectivity to an E5-APP-B card with EPAP 15.0 or higher is required for more than 25 Service Module cards.

## Summary of Loopback Testing Commands and Functions

[Table A-8](#) and [Figure A-1](#) summarize the loopback testing commands and functions in the system.

The `tst-slk` command provides several methods for testing signaling links. The `loopback` parameter provides the ability to select *lxvr* (local transceiver), *oam*, *line*, *payload*, and *sltc* loopback tests. The command will be rejected if a loopback test is not compatible with the link type.

- For low-speed links, the *lxvr* and *sltc* tests are allowed.
- For high-speed links (ATM, E5-ATM-B), the *lxvr*, *oam*, *line*, *payload*, and *sltc* tests are allowed.
- For SS7IPGW and IPGWI DCMs, the `tst-slk` command is not supported.
- For LIME1 or LIMT1 cards, or for the E5-ENET-B cards running the IPSP application, only the `loopback=sltc` test is allowed.
- The E5-E1T1-B cards can function as either an E1 MIM card or a T1 MIM card, depending on how the card is provisioned. The `loopback=sltc` test is allowed.

The `act-lbp` command activates test on one or more loopback points for testing data signaling link elements in one CCS7 transmission path. The maximum number of loopback points is 32.

For a single loopback point test, the parameters can be entered on the command line. If the parameters are not entered at the command line, the LFS database is used. For multiple loopback point tests, the LFS database must be used.

The `ent-lbp` command is used to create the loopback points in the LFS database. The LBPs may be entered in any order.

See the command descriptions in this manual for details on entering parameters and using the commands.

**Table A-8 Loopback Testing Commands and Functions**

Command/Function	Card Supported	Testing limits
<p><i>act/dact-cdl NETWORK payload low-level loopback test.</i></p> <p>Link State-Down</p> <p>Equipment tested-All links on the T1 port</p> <p>Purpose-tests connectivity between 2 nodes at the T1 level with some isolation for the LIU and/or framer</p> <p>Description-Tests near-end card for line, lxr, and network payload loopback and far-end card for line and payload loopback.</p> <p>Typical use-Tests connectivity</p>	<ul style="list-style-type: none"> <li>E5-E1T1-B</li> <li>E5-ATM-B</li> </ul>	1024 concurrent tests per system
<p><i>ent-lbp OAM Database for Multiple LFS points per LFS tests</i></p> <p>No impact on link behavior other than allowing multiple points</p>	<ul style="list-style-type: none"> <li>E5-E1T1-B (T1 mode) (channelized)</li> </ul>	32 points per card no limit on # of cards
<p><i>act/dact-lbp EAGLE initiated Level 1 DS0 LFS tests</i></p> <p>Link State-Down</p> <p>Equipment tested-Level 1 element(s) in a signaling path</p> <p>Purpose-Test the error rates of a signaling path</p> <p>Description-Sends loopback code to establish loopback, then performs BERT test for a specified period of timed</p> <p>Typical use-Validates signaling path has acceptable error rate</p>	<ul style="list-style-type: none"> <li>E5-E1T1-B (T1 mode) (channelized)</li> </ul>	1024 concurrent tests per system



**Table A-8 (Cont.) Loopback Testing Commands and Functions**

Command/Function	Card Supported	Testing limits
<p><b>Remote Loopback FAR END initiated DS0 LFS Test</b> Link State-Up or down Equipment tested-Near end hardware up to level 2 and far end hardware level 1 interface Purpose-Auto-Loopback a BERT test to the far end Description-When receiving a loopback code, deactivate the link and go into loopback Typical use-Remotely tests the far end with standard DS0 BERT tests</p>	<ul style="list-style-type: none"> <li>• E5-E1T1-B (channelized)</li> </ul>	no limit on # of cards
<p><code>tst-slk</code> <b>SLTC EAGLE initiated Level 3 SS7 SLT</b> Link State-Up Equipment tested-Near and far end up to Level 3 Purpose-Test the entire path to the far end at Level 3 Description-Sends an SLTM out and expects an SLTA back Typical use-Validates connectivity of a signaling path</p>	<ul style="list-style-type: none"> <li>• E5-E1T1-B</li> <li>• IPGW</li> <li>• E5-ATM-B</li> </ul>	1024 concurrent link tests per system
<p><code>tst-slk</code> <b>OAM EAGLE initiated Level 1 ATM test</b> Link State-Down Equipment tested-Near and far end level 1 software and hardware including all hardware on the cards Purpose-Test the entire near and far end level 1 hardware by exchanging ATM cells Description-Sends OAM cells out to far end for 60 seconds if no errors, or 2 minutes if errors are received Typical use-Verifies ATM cells can be exchanged between 2 signaling points</p>	<ul style="list-style-type: none"> <li>• E5-ATM-B</li> </ul>	1024 concurrent link tests per system

**Table A-8 (Cont.) Loopback Testing Commands and Functions**

Command/Function	Card Supported	Testing limits
<p><code>tst-slk</code> LINE <i>EAGLE</i>  <i>initiated Level 1-2 ATM test</i>                      Link State-Down                      Equipment tested-Near end hardware up to level 2 and far end hardware level 1 interface                      Purpose-Hardware continuity check between near and far end                      Description-The following steps occur:</p> <ol style="list-style-type: none"> <li>1. Device under test (DUT) sends T1 Payload bit-oriented code (BOC) to remote device</li> <li>2. Remote device receives BOC and programs hardware</li> <li>3. DUT attempts level 2 alignment</li> <li>4. If link aligns (level 2), test passes, else test fails</li> <li>5. DUT sends BOC to remote device to remove loopback</li> <li>6. Remote device receives BOC and re-programs hardware</li> </ol>	<ul style="list-style-type: none"> <li>• E5-ATM-B (T1 mode)</li> </ul>	1024 concurrent link tests per system

 **N**  
**o**  
**t**  
**e**  
**:**  
If  
t  
h  
e  
D  
U  
T  
b  
o  
o

Table A-8 (Cont.) Loopback Testing Commands and Functions

Command/Function	Card Supported	Testing limits
tsinthemiddles of sequence, activate the order - activate the link, and		

**Table A-8 (Cont.) Loopback Testing Commands and Functions**

Command/Function	Card Supported	Testing limits
t h e r e m o t e d e v i c e r e t u r n s t o t h e o r i g i n a l p r o g r a m m i n g . 		

Typical use-Checks continuity from the near end level 2 hardware to the level 1 interface at the far end for a link in line timing

**Table A-8 (Cont.) Loopback Testing Commands and Functions**

Command/Function	Card Supported	Testing limits
<p><code>tst-slk PAYLOAD EAGLE</code>  <i>initiated Level 1-2 ATM test</i></p> <p>Link State-Down</p> <p>Equipment tested-Near end hardware up to level 2 and far end hardware level 1 interface</p> <p>Purpose-Hardware continuity check between near and far end</p> <p>Description-The following steps occur:</p> <ol style="list-style-type: none"> <li>1. Device under test (DUT) sends T1 Payload bit oriented code (BOC) to remote device</li> <li>2. Remote device receives BOC and programs hardware</li> <li>3. DUT attempts level 2 alignment</li> <li>4. If link aligns (level 2), test passes, else test fails</li> <li>5. DUT sends BOC to remote device to remove loopback</li> <li>6. Remote device receives BOC and re-programs hardware</li> </ol>	<ul style="list-style-type: none"> <li>• E5-ATM-B (T1 mode)</li> </ul>	<p>1024 concurrent link tests per system</p>

 **N**  
**o**  
**t**  
**e**  
**:**  
If  
t  
h  
e  
D  
U  
T  
b  
o  
o

Table A-8 (Cont.) Loopback Testing Commands and Functions

Command/Function	Card Supported	Testing limits
tsinthemiddles of sequence, activate the order - activate the link, and		

**Table A-8 (Cont.) Loopback Testing Commands and Functions**

Command/Function	Card Supported	Testing limits
t h e r e m o t e d e v i c e r e t u r n s t o t h e o r i g i n a l p r o g r a m m i n g . 		

Typical use-Checks continuity from the near end level 2 hardware to the level 1 interface at the far end for a link in master timing

**Table A-8 (Cont.) Loopback Testing Commands and Functions**

Command/Function	Card Supported	Testing limits
<p><code>tst-slk</code> LXVR (DS1 loop)  <i>EAGLE initiated Level 1</i>  <i>Internal card loopback</i></p> <p>Link State-Down            Equipment tested-Local card            Purpose-Test the near end card only            Description-Test the near end card up through level 2.            Typical use-Validates the card on the Eagle as good</p>	<ul style="list-style-type: none"> <li>E5-E1T1-B</li> <li>E5-ATM-B</li> </ul>	1024 concurrent link tests per system
<p><code>tst-e1</code> LINE, LXVR (DS1 loop), PAYLOAD <i>EAGLE Initiated E1 Port test</i></p> <p>Link State-Down            Equipment tested-All links on the E1 port            Purpose-Tests connectivity between 2 nodes at the E1 level with some isolation for the LIU and/or framer            Description-Tests near-end card for line, lxvr, and payload loopback            Typical use-Tests connectivity</p>	<ul style="list-style-type: none"> <li>E5-E1T1-B</li> </ul>	1024 concurrent tests per system
<p><code>tst-t1</code> LINE, LXVR (DS1 loop), PAYLOAD, FELINE, FEPAYLOAD <i>EAGLE initiated T1 port test</i></p> <p>Link State-Down            Equipment tested-All links on the T1 port            Purpose-Tests connectivity between 2 nodes at the T1 level with some isolation for the LIU and/or framer            Description-Tests near-end card for line, lxvr, and payload loopback and far end card for line and payload loopback            Typical use-Tests connectivity</p>	<ul style="list-style-type: none"> <li>E5-E1T1-B (T1 mode)</li> </ul>	1024 concurrent tests per system



**Figure A-1 ATM Loopback Tests**

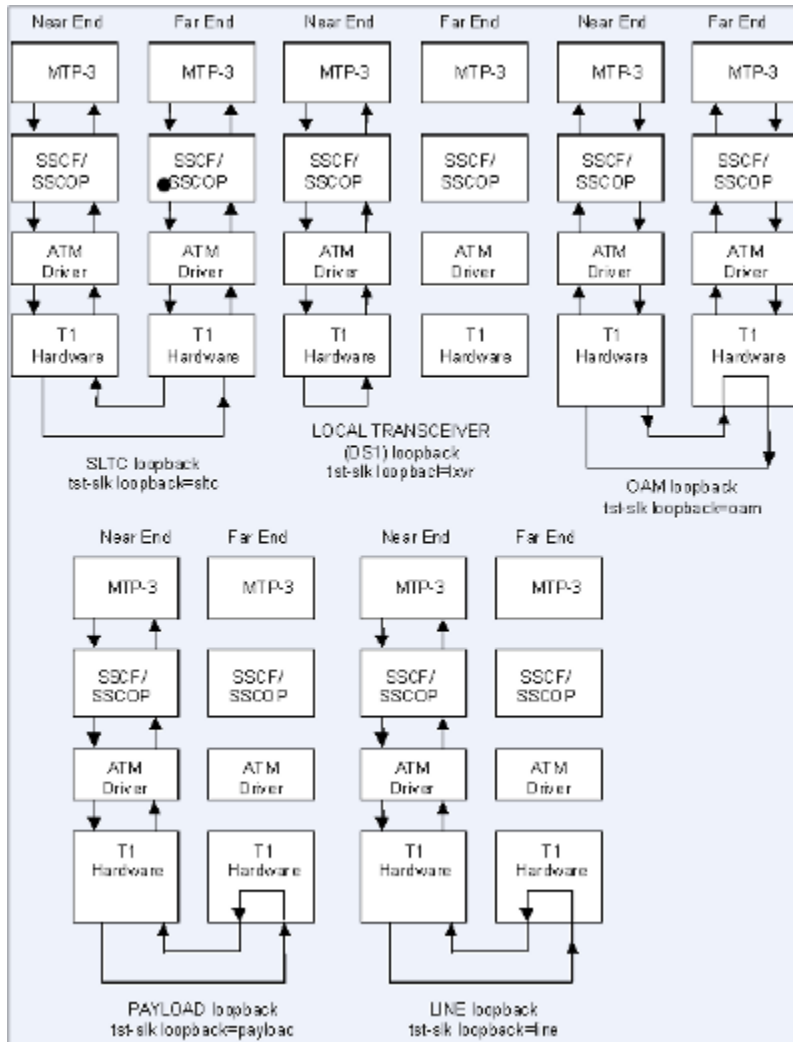

## Commands Listed by Class

### Basic Commands

- [act-echo](#)
- [act-user](#)
- [canc-echo](#)
- [canc-echo](#)
- [canc-user](#)
- [chg-pid](#)
- [dact-user](#)
- [dlt-sccp-serv](#)

- lock
- login
- logout
- rept-stat-user
- rtrv-cmd
- rtrv-cmdclass
- rtrv-sccp-serv
- rtrv-user
- unlock

## Database Administration Commands

- act-ftp-trns
- act-lbp
- chg-acg-mic
- chg-acg-noc
- chg-ainpopts
- chg-aiqopts
- chg-appl-rtkey
- chg-as
- chg-assoc
- chg-atinpopts
- chg-atm-lps
- chg-card
- chg-clkopts
- chg-csl
- chg-ctrl-feat
- chg-dstn
- chg-e1
- chg-feat
- chg-frm-pwr
- chg-ftp-serv
- chg-gsm-msg
- chg-gsmmap-scrn
- chg-gsmopts
- chg-gsms-opcode
- chg-gsmsmsopts
- chg-gta

- chg-gtcnv
- chg-gtmod
- chg-gtt
- chg-gttact
- chg-gttapath
- chg-gttaset
- chg-gttset
- chg-gttset
- chg-gtw-stp
- chg-gws-actset
- chg-gws-redirect
- chg-inpopts
- chg-ip-card
- chg-ip-conn
- chg-ip-lnk
- chg-is41-msg
- chg-is41opts
- chg-is41smsopts
- chg-isup-msg
- chg-l2t
- chg-l3t
- chg-lbp
- chg-lnp-serv
- chg-lnpopts
- chg-loopset
- chg-ls
- chg-lsopts
- chg-m2pa-tset
- chg-map
- chg-mrn
- chg-netopts
- chg-npp-as
- chg-npp-serv
- chg-npp-srs
- chg-ppsopts
- chg-prefix
- chg-rte

- chg-rtx
- chg-sccp-msg
- chg-sccp-serv
- chg-sccpopts
- chg-scr-aftpc
- chg-scr-blkdpc
- chg-scr-blkopc
- chg-scr-cdpa
- chg-scr-cgpa
- chg-scr-destfld
- chg-scr-dpc
- chg-scr-isup
- chg-scr-opc
- chg-scr-sio
- chg-scr-tt
- chg-scrset
- chg-sg-opts
- chg-shlf
- chg-sid
- chg-sip-npp
- chg-sipopts
- chg-slt
- chg-snmp-host
- chg-snmppopts
- chg-srvsel
- chg-ss-appl
- chg-ss7opts
- chg-stpopts
- chg-t1
- chg-tatr-msg
- chg-tatropts
- chg-th-alm
- chg-tifopts
- chg-trm
- chg-ttmap
- chg-ttr-msg
- chg-ttropts

- chg-uaps
- chg-vflx-cd
- chg-vflx-opts
- chg-vflx-rn
- chg-vflx-vmsid
- chk-unref-ent
- dlt-acg-mic
- dlt-acg-noc
- dlt-appl-rtkey
- dlt-as
- dlt-assoc
- dlt-card
- dlt-csl
- dlt-cspc
- dlt-dlk
- dlt-dstn
- dlt-e1
- dlt-frm-pwr
- dlt-ftp-serv
- dlt-gserv-data
- dlt-gsmmap-scrn
- dlt-gsms-opcode
- dlt-gsmssn-scrn
- dlt-gta
- dlt-gtcnv
- dlt-gtmod
- dlt-gtt
- dlt-gttact
- dlt-gttapath
- dlt-gttaset
- dlt-gttset
- dlt-gttset
- dlt-gws-redirect
- dlt-home-smsc
- dlt-homern
- dlt-ip-conn
- dlt-ip-host

- dlt-ip-node
- dlt-ip-rte
- dlt-lbp
- dlt-lnp-serv
- dlt-loopset
- dlt-ls
- dlt-map
- dlt-mrn
- dlt-na
- dlt-npp-as
- dlt-npp-srs
- dlt-pct
- dlt-prefix
- dlt-rmt-appl
- dlt-rte
- dlt-rtx
- dlt-scr-aftpc
- dlt-scr-blkdpc
- dlt-scr-blkopc
- dlt-scr-cdpa
- dlt-scr-cgpa
- dlt-scr-destfld
- dlt-scr-dpc
- dlt-scr-isup
- dlt-scr-opc
- dlt-scr-sio
- dlt-scr-tt
- dlt-scrset
- dlt-shlf
- dlt-sip-npp
- dlt-slk
- dlt-snmp-host
- dlt-spc
- dlt-srvsel
- dlt-ss-appl
- dlt-subnetid
- dlt-t1

- dlt-tt
- dlt-ttmap
- dlt-uim-acthresh
- dlt-vendid
- dlt-vflx-cd
- dlt-vflx-rn
- dlt-vflx-vmsid
- enable-ctrl-feat
- ent-acg-mic
- ent-acg-noc
- ent-appl-rtkey
- ent-as
- ent-assoc
- ent-card
- ent-csl
- ent-cspc
- ent-dlk
- ent-dstn
- ent-e1
- ent-frm-pwr
- ent-ftp-serv
- ent-gserv-data
- ent-gsmmap-scrn
- ent-gsms-opcode
- ent-gsmssn-scrn
- ent-gta
- ent-gtcnv
- ent-gtmod
- ent-gtt
- ent-gttact
- ent-gttapath
- ent-gttaset
- ent-gttset
- ent-gttset
- ent-gws-redirect
- ent-home-smsc
- ent-homern

- ent-ip-conn
- ent-ip-host
- ent-ip-node
- ent-ip-rte
- ent-lbp
- ent-lnp-serv
- ent-loopset
- ent-ls
- ent-map
- ent-mrn
- ent-na
- ent-npp-as
- ent-npp-srs
- ent-pct
- ent-rmt-appl
- ent-rte
- ent-rtx
- ent-scr-aftpc
- ent-scr-blkdpc
- ent-scr-blkopc
- ent-scr-cdpa
- ent-scr-cgpa
- ent-scr-destfld
- ent-scr-dpc
- ent-scr-isup
- ent-scr-opc
- ent-scr-sio
- ent-scr-tt
- ent-scrset
- ent-serial-num
- ent-shlf
- ent-sid
- ent-sip-npp
- ent-slk
- ent-snmp-host
- ent-spc
- ent-srvsel



- ent-ss-appl
- ent-subnetid
- ent-t1
- ent-scr-tt
- ent-ttmap
- ent-vendid
- ent-vflx-cd
- ent-vflx-rn
- ent-vflx-vmsid
- rept-stat-db
- rtrv-acg-mic
- rtrv-acg-noc
- rtrv-ainpopts
- rtrv-aiqopts
- rtrv-appl-rtkey
- rtrv-as
- rtrv-assoc
- rtrv-atinpopts
- rtrv-atm-lps
- rtrv-atm-prm
- rtrv-card
- rtrv-clkopts
- rtrv-csl
- rtrv-cspc
- rtrv-ctrl-feat
- rtrv-data-rtdb
- rtrv-dlk
- rtrv-dstn
- rtrv-e1
- rtrv-feat
- rtrv-frm-pwr
- rtrv-ftp-serv
- rtrv-gserv-data
- rtrv-gsm-msg
- rtrv-gsmmap-scrn
- rtrv-gsmopts
- rtrv-gsms-opcode

- rtrv-gsmsmsopts
- rtrv-gsmssn-scrn
- rtrv-gta
- rtrv-gtcnv
- rtrv-gtmod
- rtrv-gtt
- rtrv-gttact
- rtrv-gttapath
- rtrv-gttaset
- rtrv-gttset
- rtrv-gttset
- rtrv-gtw-stp
- rtrv-gtwy-acthresh
- rtrv-gtwy-prmtrs
- rtrv-gws-actset
- rtrv-gws-redirect
- rtrv-home-smsc
- rtrv-homern
- rtrv-inpopts
- rtrv-ip-card
- rtrv-ip-conn
- rtrv-ip-host
- rtrv-ip-lnk
- rtrv-ip-node
- rtrv-ip-rte
- rtrv-is41-msg
- rtrv-is41opts
- rtrv-is41smsopts
- rtrv-isup-msg
- rtrv-l2t
- rtrv-l3t
- rtrv-lbp
- rtrv-lnp-serv
- rtrv-lnpopts
- rtrv-loopset
- rtrv-ls
- rtrv-m2pa-tset

- rtrv-map
- rtrv-mrn
- rtrv-na
- rtrv-netopts
- rtrv-npp-as
- rtrv-npp-serv
- rtrv-npp-srs
- rtrv-pct
- rtrv-ppsopts
- rtrv-prefix
- rtrv-rmt-appl
- rtrv-rte
- rtrv-rtx
- rtrv-sccp-msg
- rtrv-sccpopts
- rtrv-scr-aftp
- rtrv-scr-blkdpc
- rtrv-scr-blkopc
- rtrv-scr-cdpa
- rtrv-scr-cgpa
- rtrv-scr-destfld
- rtrv-scr-dpc
- rtrv-scr-isup
- rtrv-scr-opc
- rtrv-scr-sio
- rtrv-scr-tt
- rtrv-scrset
- rtrv-seas-config
- rtrv-serial-num
- rtrv-sg-opts
- rtrv-shlf
- rtrv-sip-npp
- rtrv-sipopts
- rtrv-slk
- rtrv-slt
- rtrv-snmp-host
- rtrv-snmptests

- rtrv-spc
- rtrv-srvsel
- rtrv-ss7opts
- rtrv-ss-appl
- rtrv-stp
- rtrv-stpopts
- rtrv-subnetid
- rtrv-t1
- rtrv-tatr-msg
- rtrv-tatropts
- rtrv-tbl-capacity
- rtrv-th-alm
- rtrv-tifopts
- rtrv-tps
- rtrv-trbltx
- rtrv-trm
- rtrv-tt
- rtrv-ttmap
- rtrv-ttr-msg
- rtrv-ttropts
- rtrv-uaps
- rtrv-uim-acthresh
- rtrv-vendid
- rtrv-vflx-cd
- rtrv-vflx-opts
- rtrv-vflx-rn
- rtrv-vflx-vmsid
- set-gtwy-acthresh
- set-scrrej-prmtrs
- set-uim-acthresh
- tst-msg
- tst-npp-msg

## System Maintenance Commands

- act-alm-trns
- act-file-trns
- act-flash

- alw-card
- alw-imt
- alw-map-ss
- alw-trm
- aud-data
- canc-alm-trns
- chg-db
- chg-seas-config
- clr-imt-stats
- conn-imt
- copy-disk
- copy-ext-stats
- copy-fta
- copy-gpl
- copy-meas
- dact-alm-trns
- dact-rstst
- disc-imt
- disp-fta-dir
- dlt-fta
- flash-card
- format-disk
- inh-alm
- inh-card
- inh-imt
- inh-map-ss
- inh-trm
- init-card
- init-ext-stats
- init-flash
- init-imt-gpl
- init-mux
- init-network
- init-sys
- pass
- rept-imt-info
- rept-imt-lvl1

- rept-imt-lvl2
- rept-stat-alm
- rept-stat-aplsock
- rept-stat-as
- rept-stat-assoc
- rept-stat-card
- rept-stat-cdt
- rept-stat-clk
- rept-stat-cluster
- rept-stat-ddb
- rept-stat-dlk
- rept-stat-dstn
- rept-stat-e1
- rept-stat-enet
- rept-stat-imt
- rept-stat-ipconn
- rept-stat-iptps
- rept-stat-lnp
- rept-stat-ls
- rept-stat-meas
- rept-stat-mfc
- rept-stat-mon
- rept-stat-mps
- rept-stat-mux
- rept-stat-rtd
- rept-stat-rte
- rept-stat-rtkey
- rept-stat-rtx
- rept-stat-sccp
- rept-stat-seas
- rept-stat-sip
- rept-stat-slan
- rept-stat-slk
- rept-stat-sys
- rept-stat-t1
- rept-stat-trbl
- rept-stat-trm

- rept-stat-xlist
- rls-alm
- rmv-card
- rmv-imt
- rmv-trm
- #unique\_728
- rst-dstn
- rst-imt
- rst-trm
- rtrv-bip
- rtrv-log
- rtrv-obit
- rtrv-trbl
- tst-bip
- tst-disk
- tst-e1
- tst-imt
- tst-t1
- unhb-alm

## Link Maintenance Commands

- act-cdl
- act-dlk
- act-lpo
- act-slk
- alw-slk
- blk-slk
- canc-dlk
- cancel-lpo
- cancel-slk
- chg-meas
- chg-measopts
- chg-mtc-measopts
- dact-cdl
- dact-lbp
- dact-slk
- inh-slk

- rept-ftp-meas
- rept-meas
- rept-stat-cdl
- rept-stat-lfs
- rept-stat-tstslk
- rtrv-meas-sched
- rtrv-measopts
- rtrv-mtc-measopts
- tst-dlk
- tst-slk
- ublk-slk
- unhb-slk

## Program Update Commands

- act-gpl
- chg-gpl
- rept-stat-gpl
- rtrv-gpl

## Security Administration Commands

- canc-cmd
- chg-attr-seculog
- chg-cmd
- chg-cmdclass
- chg-eisopts
- chg-secu-dflt
- chg-secu-trm
- chg-user
- copy-seculog
- dlt-user
- ent-user
- rept-stat-seculog
- rtrv-attr-seculog
- rtrv-eisopts
- rtrv-secu-dflt
- rtrv-secu-trm
- rtrv-secu-user



- rtrv-seculog
- rtrv-sid
- set-date
- set-time

## Debug Commands

- act-ip-lnk
- act-upgrade
- chg-bip-fld
- chg-bip-rec
- chg-tbl
- chg-upgrade-config
- clr-disk-stats
- copy-tbl
- dact-ip-lnk
- dbg-ddb
- disp-bip
- disp-bp
- disp-disk-dir
- disp-disk-stats
- disp-mem
- disp-trace
- dlt-bp
- dlt-trace
- ent-bp
- ent-trace
- rtrv-upgrade-config
- send-msg
- set-mem

## Pass-Through Commands

- arp
- aslog
- assocrtt
- connmgr
- ftptest
- linkinfo

- msucount
- msuroute
- msutrace
- netstat
- nslookup
- pct
- ping
- sctp
- sockrtt
- soipdata
- soiplog
- traceroute
- ualog

## Possible Values for PST/SST/AST

This section lists the possible values for the primary state (PST), secondary state (SST), and associated state (AST) shown in the output of the Report Status (rept-stat-) commands.

### PST

Primary state possible values are the following:

**IS-ANR**

(IN SERVICE - ABNORMAL) The entity is in service but only able to perform a limited subset of its normal service functions.

**IS-NR**

(IN SERVICE - NORMAL) The entity is in service and handling all its normal service functions.

**OOS-MA**

(OUT OF SERVICE - MEMORY ADMINISTRATION) The entity is out of service because it has not been equipped.

**OOS-MT**

(OUT OF SERVICE - MAINTENANCE) The entity is out of service and is not available to perform its normal service function. The maintenance system is actively working to restore the entity to service.

**OOS-MT-DSBLD**

(OUT OF SERVICE - MAINTENANCE - DISABLED) The entity is out of service and the maintenance system is preventing the entity from performing its normal service function.

## SST

Secondary state possible values are the following:

**Active**

(ACTIVE) The entity is currently in use and is handling its normal service function as the primary service provider. (MASTER) The entity is currently in a master state in relation to its redundant unit.

**Allowed**

(ALLOWED) The entity is handling its normal service function.

**Avail**

(AVAILABLE) Entity service is available to another entity.

**Blocked**

(BLOCKED) The entity has been manually prohibited from handling traffic.

**Busy**

(BUSY) The entity is handling the maximum traffic capacity and has no spare capacity for new service requests.

**Conn**

(CONNECT) The card's entity status is in connected state.

**DDL Hunt**

(DDL HUNTING) The entity is currently in a state where the DDL is hunting for crossload info.

**DDL Inhib**

(DDL INHIBITED) The entity is currently in a state where the DDL is inhibited from crossload.

**DDL NoXld**

(DDL Unable to XLOAD) The entity is currently in a state where the DDL is unable to crossload.

**DDLunstab**

(DDL UNSTABLE) The entity is currently in DDL unstable state.

**Disc**

(Disconnect) The card's entity status is in disconnected state.

**Fault**

(FAULT) The entity has failed.

**Idle**

(IDLE) The entity is in use and has spare capacity for service.

**Inhibited**

(INHIBITED) The entity has been manually prevented from performing its normal service function.

**Isolated**

(ISOLATED) The entity cannot be detected through software or hardware.

**LPBK**

(LOOPBACK) The entity is currently in the Loopback state.

**Manual**

(MANUAL) The entity has manually been removed from service and is not carrying any traffic.

**MEA**

(Maintenance Equipment Administration) The entity has been auto-inhibited and has been restricted from functioning because it has not met the minimum hardware requirements for the current configuration.

**MPS Unavl**

(MPS unavailable). MPS is required, but unavailable for the entity.

**Ovflw-1**

(OVERFLOW) One entity cannot provide service to another entity due to service denial.

**Prohibit**

(PROHIBITED) The entity is not handling traffic because of a failure in the network.

**Proh-Blk**

(PROHIBITED and BLOCKED) The entity has been prohibited and blocked from handling traffic.

**Restart**

(RESTART) The entity is in MTP Restart.

**Restrict**

(RESTRICTED) Normal operation for the entity is restricted. The normal capacity or configuration is not being used because of a failure in the network. The normal capacity, functionality or configuration of an entity may be restricted during loading or syncing of data. This can occur when the Measurements Platform has not yet been enabled.

**Standby**

(STANDBY) The entity is currently in use and is handling its normal service function as an alternate service provider if the primary service provider failed. (SLAVE) The entity is currently in a slave state in relation to its redundant unit.

**Test**

(TEST) The entity is currently in a test state.

**Unavail**

(UNAVAILABLE) Entity service is unavailable to another entity.

**Ueq**

(UNEQUIPPED) The entity is not equipped.

**Unblocked**

(UNBLOCKED) The entity is handling its normal service function.

## AST

Associated state possible values are the following:

----

(BLANK) The field may be left blank.

**ACCESS**

(ACCESSIBLE) Traffic is being carried between the local entity and an adjacent, or remote, service provider. A full connection has been completed.

**ALMINH**

(ALARM INH) The alarms on the entity are inhibited.

**BRDG MSTR**

(MASTER) The E1/T1 channel bridge is in Master mode.

**BRDG SLAVE**

(SLAVE) The E1/T1 channel bridge is in Slave mode when the adjacent odd-numbered channel bridge is provisioned in Master mode.

**CDL**

(COMMAND DRIVEN LOOPBACK) The entity is in command driven loopback state.

**DB DIFF**

(DATABASE DIFFERENT) The entity has a database difference.

**ENET FLT**

(ETHERNET FAULT) An Ethernet fault exists.

**EXT BERT**

(EXTENDED BERT TEST) The entity is undergoing Extended BERT.

**FE LINE**

(FAR END LINE LOOPBACK) The entity is in far end line loopback.

**FE PAYLD**

(FAR END PAYLOAD LOOPBACK) The entity is in far end payload loopback.

**FLT CHK**

(FAULT ISOLATION TEST) The entity is undergoing a fault isolation test.

**INACCESS**

(INACCESSIBLE) Traffic is not being carried from the local entity to another service provider. A breakdown in a complete circuit has been detected.

**LFS**

(LINK FAULT SECTIONALIZATION) The entity is in Link Fault State.

**LINE**

(LINE LOOPBACK) The entity is in line loopback state.

**LOCAL**

(LOCAL) The entity has become locally isolated.

**LXVR**

(LXVR LOOPBACK) The entity is in local transceiver loopback state.

**M BIP ERR**

(MOTHERBOARD IDENTITY PROM) The entity has a motherboard prom error.

**NOT BRDGD**

(NOT BRIDGED) The E1/T1 port channel is not bridged.

**OAM F5 FM**

(OAM LOOPBACK) The entity is in OAM initiated loopback state.

**PAYLOAD**

(PAYLOAD LOOPBACK) The entity is in payload loopback state.

**SLTM**

(SPECIAL MAINTENANCE TEST MESSAGES) The entity is in SLTM testing state.

## Point Code Formats and Conversion

Many of the commands used for database configuration use point codes. This section describes the point code formats that the system supports. If you need additional information or procedural information, refer to the *Database Administration Manual - SS7*.

The system supports four different point code formats:

- ANSI point codes
- ITU International point codes
- ITU National point codes
- ITU National 24-bit point codes

Each format is described in further detail in the following sections.

### ANSI Point Codes

ANSI point codes are made up of three groups of digits called the network indicator (*ni*), network cluster (*nc*), and network cluster member (*ncm*). The values for ANSI point codes depend on the value of the `pctype` parameter of the `chg-sid` command, either *ansi* or *other*.

If the `pctype=ansi` command is entered, the range of values for an ANSI point code is as follows:

- *ni-001-255*
- *nc-001-255* (if *ni* = 001-005)
- *-000-255, \** (if *ni* = 006-255)
- *ncm-000-255*

The following rules apply to provisioning ANSI point codes if the `pctype=ansi` parameter is specified:

- An *ni* value of 0 is not allowed (e.g., `dpc=0-1-1` and `dpc=0-0-0` are not valid point codes).
- If the *ni* value is 1, 2, 3, 4, or 5, then the *nc* value cannot be 0 (e.g., `dpc=5-0-1` is rejected).
- If the *ni* value is 1, 2, 3, 4, or 5, then network routing point codes are not allowed (e.g., `dpc=4-*-*` is rejected).

If the `pctype=other` parameter is specified, the ANSI point codes do not meet ANSI standards. The range of values for these ANSI point codes is as follows:

- `ni-000-255`
- `nc-000-255, *`
- `ncm -000-255, *`

The following rules apply to provisioning ANSI point code if the `pctype=other` parameter is specified:

- An `ni` value of 0 is allowed, however `dpc=0-0-0` is rejected (e.g., `dpc=0-1-1` is accepted).
- The `nc` value can be 0 for all values of `ni` (e.g., `dpc=5-0-1` is accepted).
- Network routing point codes are allowed for all values of `ni` (e.g., `dpc=4-*-*` is accepted).

An ANSI point code containing all zeros (0-0-0) is not a valid point code and cannot be entered into the database.

ANSI point codes support the Private (Internal) Point Code subtype prefix (p-). The prefix can be specified before the point code subfield values to indicate a Private Point Code (i.e p-5-0-1). See [Spare and Private Point Code Subtype Prefixes](#).



#### Note:

Point codes specified by many commands, including those for site identification, routing keys, and LNP, are required to be full point codes. The asterisk values are not valid in the commands that specify these point codes. The command Dependencies sections identify the point codes that must be full point codes in the commands.

A range of values for a subfield is specified by separating the values that define the range by two ampersands (&&); for example, `ni=025&&100` specifies all network indicators for ANSI point codes from 25 - 100.

The asterisk (\*) point code value indicates a single cluster address for a cluster point code (e.g., 20-2-\*) or a network routing destination (20-\*-\*). If \* is used for the `nc` subfield, then \* must be also be used for the `ncm` subfield.

A double asterisk (\*\*) and a triple asterisk (\*\*\*) can also be used for the `nc` and `ncm` subfields of the ANSI point code, but only for the `rtrv-dstn`, `rept-stat-dstn`, `rtrv-rte`, and `rept-stat-rte` commands. If \*, \*\*, or \*\*\* is used for the `nc` subfield, then \*, \*\*, or \*\*\* must be used for the `ncm` field

For examples of all of these point code values, see the `rtrv-dstn` command output.

## ITU International Point Codes

The ITU international point codes are made up of three groups of digits called *zone*, *area*, and *id*. The range of varnames for ITU International point codes are:

- `zone-0-7`
- `area-000-255`
- `id-0-7`

An ITU international point code containing all zeros (0-000-0) is not a valid point code and cannot be entered into the database.

ITU international point codes support the Spare Point Code subtype prefix (s-). The prefix can be specified before the point code subfield varnames to indicate a Spare Point Code (s-5-222-1, for example). See [Spare and Private Point Code Subtype Prefixes](#).

## ITU National Point Codes

The ITU national point code is a 14-bit integer. The point codes can be a single number up to five digits, or two, three, or four numbers (members) separated by dashes.

If the ITU National Duplicate Point Code (ITUDUPPC) feature is on, ITU national point codes can have group codes assigned to them. The point code is a 1- to 5-digit number. The group code is a two-character field ranging from aa to zz that is entered as the last subfield of the point code and is separated by a dash from the rest of the point code. An example is 12345-az.

If the flexible point codes option is enabled (see the `chg-stpopts` command, `:npcfmt` parameter), an ITU national point code format consists of 2, 3, or 4 numbers separated by dashes (formatted as *m1-m2-m3-m4*). When the ITUDUPPC feature is also on, the format is *m1-m2-m3-m4-gc* with a group code. If one of the *m1*, *m2*, *m3*, *m4* members is set to zero bits, no value is entered for that position in the point code. For example, if the `npcfmt` parameter value is set to 3-8-3-0, valid point codes would be 1-100-1-aa with a group code, or 7-255-7 with no group code. See the tables in the `chg-stpopts` command description for valid member values and additional examples.

The following ranges of values are valid:

- *nnnnn016383*
- *nnnnn-gc0-16363*; group code is aa-zz (the ITUDUPPC feature must be on)
- *m1-m2-m3-m4* Each member represents the number of bits allowed in the corresponding position for a flexible ITU national point code. The range of each member is from 0 - 14. Each member must be specified; the member value of 0 indicates that the position is not specified in the flexible point code. The sum of the member values must equal 14.
- *m1-m2-m3-m4-gc* Each member represents the number of bits allowed in the corresponding position for a flexible ITU national point code. The range of each member is from 0 to 14. Each member must be specified; the member value of 0 indicates that the position is not specified in the flexible point code. The sum of the member values must equal 14. Group code is aa-zz (the ITUDUPPC feature must be on).

An asterisk value (\*) is allowed only for the `rtrv-dstn` and `rtrv-rte` commands to retrieve ITU-N DPCs if the ITUDUPPC feature is on (for point codes with group codes). The node and group code cannot both be \*. For example, `dpcn=12345-*` and `dpcn=*aa` are allowed, but `dpcn=**` is not allowed.

If flexible point codes are also used, all valid *m1*, *m2*, *m3*, and *m4* must all be either a number or an \*. For example, 1-100-1-aa and \*-\*-aa are allowed, but 1-\*-\*-aa is not allowed.



ITU national point codes support the Spare Point Code subtype prefix (s-). The prefix can be specified before the point code subfield values to indicate a Spare Point Code (s-12345 or s-1-3-5-5-gc, for example). See [Spare and Private Point Code Subtype Prefixes](#).

## Converting ITU National Point Code Formats

Gateway screening only allows ITU national point codes to be provisioned in the database by the enter, delete, or change gateway screening commands, and displayed by the gateway screening retrieve commands as a single number. If a format other than a single number (14-0-0-0) for the ITU national point code has been defined by the `npcfnti` parameter of the `chg-stpopts` command, the ITU national point code must be converted into a single number so that it can be used by gateway screening.

For example, the format of the ITU national point code is 4-4-4-2 and you would like to add point code 7-7-7-1 into the allowed OPC screen. The point code 7-7-7-1 would have to be converted to a single number so that the point code can be added to the allowed OPC screen. To determine what multiple-part ITU national point code is represented by the single number ITU national point code in the gateway screening table, the single number point code must be converted to a multiple-part point code.

To convert a single number ITU national point code to a multiple-part point code, go to [Converting Single Number ITU National Point Codes](#).

To convert a multiple-part ITU national point code to a single number point code, go to [Converting Multiple-Part ITU National Point Codes](#).

For a definition of the different formats that can be used for ITU national point codes, see [ITU National Point Codes](#).

When the ITU national point codes are converted from single numbers to multiple-part point codes, the resulting value of the multiple-part point code depends on the point code format specified by the `npcfnti` parameter of the `chg-stpopts` command. When converting the single number point code 14781 to the point code format 3-8-3-0, the resulting point code value is 7-55-5. If point code 14781 is converted to the point code format 4-4-4-2, the resulting point code value is 14-6-15-1.

## Converting Single Number ITU National Point Codes

To make this conversion, you will need to know the format of the ITU national point code. This can be verified in the `NPCFMTI` field of the `rtrv-stpopts` command output. For this example, the ITU national point codes 14781 and 695 are converted to point codes using the 3-8-3-0 format.

Convert a single number ITU national point code to a multiple-part ITU national point code as follows.

### Converting a Single Number ITU national point code to a multiple-part ITU national point code

1. Convert the point code to a binary number. This can be done with most scientific calculators.

The number **14781** converts to the binary number 11100110111101.

The number **695** converts to the binary number 1010110111.

 **Note:**

Make sure the binary number contains 14 digits. If it does not, add leading zeros to the binary number to bring the total number of digits in the number to 14.

In this example, the binary equivalent for the decimal number 695 (1010110111) contains 10 digits; four zeros must be added to the beginning of the binary number. The resulting binary number is now 00001010110111.

2. Divide the binary number into the number of parts required by the format of the ITU national point code. For this example, the format is 3-8-3-0. Because the last part of the point code format is 0, the point code format contains only three parts. Divide the point code into three parts, the first part of the point code contains the first three digits of the 14-digit binary number, the second part of the point code contains the next eight digits of the 14-digit binary number, and the third part of the point code contains the last three digits of the 14-digit binary number.

For this example, the binary numbers would be divided like this:

11100110111101 = 111 00110111 101

00001010110111 = 000 01010110 111

3. Convert each part of the point code into a decimal number using the same scientific calculator used in step 1 and separate each part of the point code with dashes. The results are as follows.

111 00110111 101 = **7-55-5**

000 01010110 111 = **0-86-7**

## Converting Multiple-Part ITU National Point Codes

To make this conversion, you will need to know the format of the ITU national point code. This can be verified in the `npcfmt_i` field of the `rtrv-stpopts` command output. For this example, the ITU national point codes 7-55-5 and 0-86-7, using the 3-8-3-0 point code format, are converted into a single number.

Convert multiple-part ITU national point codes to a single number as follows.

### Converting Multiple-Part ITU National Point Codes to a Single Number

## Converting Multiple-Part ITU National Point Codes to a Single Number

1. Convert each part of the point code into a binary number using a scientific calculator. The results are as follows.

**7-55-5** = 111 00110111 101

**0-86-7** = 000 01010110 111

2. Combine each part of the point code into a single binary number as follows.

111 00110111 101 = 11100110111101

000 01010110 111 = 00001010110111

 **Note:**

If the binary number has any zeros at the beginning of the number, remove these zeros as they are not necessary.

In this example, the binary equivalent for the point code **0-86-7** (00001010110111) contains four zeros at the beginning of the binary number. When the leading zeros are removed from the binary number, the resulting binary number is now 1010110111.

3. Convert the binary number to a decimal number using the same scientific calculator used in step 1.

The binary number 11100110111101 converts to the decimal number 14781.

The binary number 1010110111 converts to the decimal number 695.

## 24-bit ITU-National Point Codes

The 24-bit ITU national point codes are made up of three groups of digits called *main signaling area*, *sub signaling area*, and *signaling point*. The valid values for 24-bit ITU national point codes are:

- *main signaling area-000-255*
- *sub signaling area-000-255*
- *signaling point-000-255*

24-bit ITU national point codes support the Private (Internal) Point Code subtype prefix (p-). The prefix can be specified before the point code field values to indicate a Private Point Code (p-2055-222-2011, for example). See [Spare and Private Point Code Subtype Prefixes](#).

## Spare and Private Point Code Subtype Prefixes

The Spare Point Code Support feature and the Internal Point Code Support feature provide optional point code subtype prefixes. The Spare Point Code feature must be enabled before a point code subtype prefix can be specified for a point code.

 **Note:**

The SEAS interface does not support point code subtype prefixes.

The values *p-*, *s-*, and *ps-* are valid point code subtype prefixes. The dash- separates the point code subtype prefix from the remainder of the point code. The prefixes are displayed in lower case. The syntax for the remainder of the point code remains the same.

The Spare Point Code prefix (*s-*) applies only to ITU-I and ITU-N point code domains (ITU-N24 point codes do not support the Spare Point Code prefix), to allow the EAGLE to fully support ITU National and International Spare Point Codes. [Table A-9](#) lists the commands that support the Spare Point Code subtype prefix.

The Private (Internal) Point Code prefix (*p-*) applies to all point code domain types (including ITU-N24 point codes), to allow messages destined to the End Office Node to be routed from the inbound LIM to the outbound IPGWx. [Table A-10](#) lists the commands that support the Private Point Code subtype prefix.

The subtype prefix *ps-* can be specified when the point code parameter supports both the spare and private point code prefixes.

**Table A-9 Commands that support the Spare Point Code Prefix**

Command	Description	Applicable Point Code Parameters
alm	Alarm	<i>dpci</i> and <i>dpcn</i>
appl-rtkey	Application Route Key	<i>dpci</i> and <i>dpcn</i> ; <i>opci</i> and <i>opcn</i>
cspc	Concerned Signaling Point Code	<i>pci</i> and <i>pcn</i>
dstn	Destination	<i>spci</i> and <i>spcn</i> ; <i>dpci</i> and <i>dpcn</i> ; and Alias combinations.
ent-trace	Enter Trace	<i>dpci</i> and <i>dpcn</i> ; <i>opci</i> and <i>opcn</i>
gsmmap-scrn	GSM MAP Screening	<i>npci</i> and <i>npcn</i>
gsmopts	GSM Options	<i>ppsmspci1</i> , <i>ppsmspci2</i> , <i>ppsmspcn1</i> , <i>ppsmspcn2</i>
gsms-opcode	GSM Short Message Services OP-Code	<i>pci</i> and <i>pcn</i>
gtt/gta	Global Title Translation/Global Title Address	<i>pci</i> and <i>pcn</i>
ls	Linkset	<i>apci</i> and <i>apcn</i>
map	Mated Application	<i>pci</i> and <i>pcn</i> ; <i>mpci</i> and <i>mpcn</i>
mrn	Mated Relay Node	<i>pci</i> and <i>pcn</i> ; <i>pci1</i> and <i>pcn1</i> ; <i>pci2</i> and <i>pcn2</i> ; <i>pci3</i> and <i>pcn3</i> ; <i>pci4</i> and <i>pcn4</i>
na	Network Appearance	<i>type=ituis</i> , <i>type=ituns</i>
pass	Pass Commands	Syntax for routing keys
rmt-appl	Remote Application	<i>ipci</i> and <i>ipcn</i>
rte	Route	<i>dpci</i> and <i>dpcn</i>
scr-aftpc	Gateway Screening Allowed Affected Point Code	<i>pcst</i> and <i>pctype</i>
scr-blkdpc	Gateway Screening Blocked Destination Point Code	<i>pcst</i> and <i>pctype</i>
scr-blkopc	Gateway Screening Blocked Origination Point Code	<i>pcst</i> and <i>pctype</i>
scr-cdpa	Gateway Screening Called Party (CDPA PC Destination) Point Code	<i>pcst</i> and <i>pctype</i>
scr-cgpa	Gateway Screening Calling Party (Origination) Point Code	<i>pcst</i> and <i>pctype</i>
scr-destfld	Gateway Screening Affected Destination (Concerned) Point Code	<i>pcst</i> and <i>pctype</i>
scr-dpc	Gateway Screening Destination Point Code	<i>pcst</i> and <i>pctype</i>
scr-opc	Gateway Screening Origination Point Code	<i>pcst</i> and <i>pctype</i>

**Table A-9 (Cont.) Commands that support the Spare Point Code Prefix**

Command	Description	Applicable Point Code Parameters
sid	Site ID	True <i>pci</i> and <i>pcn</i> ; <i>cpci</i> and <i>cpcn</i> ; <i>ncpci</i> and <i>ncpcn</i> .
spc	Secondary Point Code	<i>spci</i> and <i>spcn</i>

**Table A-10 Commands that support the Private Point Code Prefix**

Command	Description	Applicable Point Code Parameters
dstn	Destination	<i>spci</i> and <i>spcn</i> ; <i>dpc</i> , <i>dpca</i> , <i>dpci</i> , and <i>dpcn</i> Does not apply to Aliases
ls	Linkset	If <i>ipgwpc=yes</i> , <i>apc</i> , <i>apcn</i> , <i>apci</i> , and <i>apcn</i>
gtt/gta	Global Title Translation	<i>pc</i> , <i>pca</i> , <i>pci</i> , and <i>pcn</i>
inh/unhb-alm	Destination alarm inhibit	<i>dpc</i> , <i>dpca</i> , <i>dpci</i> , and <i>dpcn</i>
rept-stat-cluster	Report Cluster Status	<i>dpc</i> and <i>dpca</i>
rept-stat-dstn	Report Destination Status	<i>dpc</i> , <i>dpca</i> , <i>dpci</i> , and <i>dpcn</i>
rmt-appl	Remote Application	<i>ipc</i> , <i>ipca</i> , <i>ipci</i> , and <i>ipcn</i>
rst-dstn	Restore Destination	<i>dpc</i> and <i>dpca</i>
rte	Route	<i>dpc</i> , <i>dpca</i> , <i>dpci</i> , and <i>dpcn</i>

# B

## Acronyms and Abbreviations

### Acronyms and Abbreviations

**A-Port**

ANSI-41 Mobile Number Portability

**AINPQ**

ANSI-41 INP Query

**AAL**

ATM Adaptation Layer

**AAL5**

ATM Adaptation Layer 5

**AAL5CP**

ATM Adaptation Layer 5 Common Port

**AATM**

ATM Applique

**ACG**

Automatic Call Gapping

**ADJ DPC**

Adjacent Destination Point Code

**AI**

Address Indicator

**AIN**

Advanced Intelligent Network

**AINF**

Application Interface Applique

**ANSI**

American National Standards Institute

**AP**

Application Processor

**APC**

Adjacent Point Code

**ARP**

Address Resolution Protocol

**AS**

Application Server; a logical entity serving a specific Routing Key

**ASP**

Application Server Process

**ATI**

Any Time Interrogation

**ATM**

Asynchronous Transfer Mode

**ATMANSI**

The application software for the ATM (high-speed) SS7 signaling links

**ATM HSL**

Asynchronous Transfer Mode High Speed Link

**ATMM**

ATM Layer Management

**AVL**

Availability Measurements report

**AVLD**

Daily Availability measurements report

**AVLDTH**

Day-to-Hour Availability measurements report

**BCSM**

Basic Call State Model

**BIP**

Board Identification PROM

**BITS**

Building Integrated Timing System

**BLM**

Bulk Load Module

**BSD**

Berkeley Software Distribution

**BSN**

Backward Sequence Number

**CAS**

Channel Associated Signaling

**CCM**

Command Class Management

**CCS**

Common Channel Signaling

**CCS7**  
Common Channel Signaling System #7

**CCS7ITU**  
The application software for the ITU SS7 signaling links

**CDPA**  
Called Party Address

**CDPN**  
Called Party Number

**CGPA**  
Calling Party Address

**CF**  
Control Frame

**CIC**  
Circuit Identification Code

**CLLI**  
Common Language Location Identifier

**CLU**  
Network Cluster

**CM**  
Cluster Management

**CNCF**  
Calling Name Conversion Facility

**CP**  
Communication Processor

**CPU**  
Central Processing Unit

**CRC**  
Cyclic Redundancy Check

**CRMD**  
Cluster Routing and Management Diversity

**CRP**  
Circular Route Prevention

**CSL**  
Common Screening List

**CSPC**  
Concerned Signaling Point Code Group

**CSU**  
Channel Service Unit



**DB**

Database

**DCM**

Database Communications Module

**DIP**

Dual In-Line Package

**DIX**

Digital/Intel/Xerox de facto standard for Ethernet Media Access Control Type

**DN**

Dialed or Directory Number

**DPC**

Destination Point Code

**DRAM**

Dynamic Random Access Memory

**DSM**

Database Services Module

**DSU**

Data Service Unit

**DTA**

Database Transport Access

**E5IS**

EAGLE 5 Integrated Monitoring Support

**EBDA**

Enhanced Bulk Download and Audit

**EDR**

Efficient Data Representation

**EF**

Extension Frame

**EGTT**

Enhanced Global Title Translation

**EIA**

Electronic Industries Association

**EIR**

Equipment Identity Register

**ELAP**

EAGLE LNP Application Processor

**EMP**

EAGLE Monitoring Protocol

**EMSALM**  
Element Management System Alarm Monitor

**ENET**  
Ethernet

**EOAM**  
Enhanced Operations, Administration, and Maintenance

**EOAP**  
Enhanced OSS Application Process

**EPAP**  
EAGLE Provisioning Application Processor

**EPM**  
Embedded Processor Module

**EPROM**  
Erasable PROM

**ESP**  
Extended Services Platform

**FAK**  
Feature Access Key

**FAP**  
Fuse and Alarm Panel

**FAS**  
Frame Alignment Signal

**FISU**  
Fill In Signal Unit

**FPBA**  
Frame Power Budget Alarm

**FPCR**  
Full Point Code Routing

**FPT**  
Frame Power Threshold

**FSN**  
Forward Sequence Number

**FTA**  
File Transfer Area

**FTP**  
File Transfer Protocol

**FTRA**  
FTP-based Table Retrieve Application

<b>GDB</b>	GSM Real-Time Database
<b>G-Flex</b>	GSM Flexible Numbering
<b>G-Port</b>	GSM Mobile Number Portability
<b>GLS</b>	Generic Loading Service
<b>GMSC</b>	Gateway MSC
<b>GPL</b>	Generic Program Load
<b>GPSM</b>	General Purpose Service Module
<b>GSL</b>	Generic Software Load
<b>GSM</b>	Global System for Mobile Communications
<b>GTA</b>	Global Title Address
<b>GTI</b>	Global Title Indicator
<b>GTT</b>	Global Title Translation
<b>GTWY</b>	Gateway Administration measurements report
<b>GWS</b>	Gateway Screening
<b>GWSA</b>	Gateway Screening Application
<b>GWSM</b>	Gateway Screening Messages
<b>HDB3</b>	High Density Bipolar 3 encoding
<b>HIPR</b>	High Speed IMT Packet Router
<b>HLR</b>	Home Location Register

**HOMERN**  
Home Network Routing Number Prefix

**HMUX**  
High-Speed Multiplexer

**HRN**  
Home Routing Number

**HSL**  
High-Speed Links

**IAM**  
Initial Address Message

**IC**  
Integrated Circuit

**ICMP**  
Internet Control Message Protocol

**ID**  
Identity

**IDP**  
Initial Detection Point

**IEC**  
International Escape Code

**IETF**  
Internet Engineering Task Force

**IGM**  
IS41 GSM Migration

**IGTTLS**  
Intermediate Global Title Translation Load Sharing

**IL**  
Incremental loading

**ILA**  
Integrated LIM Applique

**IMEI**  
International Mobile Equipment Identifier

**IMF**  
Integrated Message Feeder

**IMSI**  
International Mobile Station Identifier

**IMT**  
Inter-processor Message Transport

**IN**  
Intelligent Network

**INAP**  
Intelligent Network Application Part

**INET**  
Internet

**INH**  
Inhibit

**INP**  
INAP-based Number Portability

**INSL**  
In-Network Subscriber List

**IP**  
Internet Protocol

**IPGWI**  
An ITU version of SS7IPGW

**IPGWx**  
Point to multi-point IP Transport GPL, referring to SS7IPGW (ANSI) and IPGWI (ITU)

**IPLIMI**  
The application software used by the DCM card for TCP/IP point-to-point connectivity for ITU point codes.

**IPLIMx**  
Point to point IP Transport GPL, referring to IPLIMI (ITU)

**IPMX**  
IMT Power and Multiplexer

**IPS**  
Internet Protocol Services

**IS-41**  
Interim Standard 41, same as and interchangeable with ANSI-41

**IS-ANR**  
In Service - Abnormal

**ISDN**  
Integrated Services Digital Network

**IS-NR**  
In Service - Normal

**ISUP**  
ISDN User Part

**ITU**  
International Telecommunications Union

**ITUDUPPC**  
ITU National Duplicate Point Code

**JIP**  
Jurisdiction Indicator Parameter

**LAN**  
Local Area Network

**LB**  
Load Balancing

**LBP**  
Loop Back Point

**LC**  
Logical channel

**LED**  
Light Emitting Diode

**LFS**  
Link Fault Sectionalization

**LNP**  
Local Number Portability

**LNPMR**  
LNP Message Relay

**LNPQS**  
LNP Query Service

**LNP SMS**  
LNP Short Message Service

**LPE**  
Logical Processing Element

**LPO**  
Link Processor Outage

**LRN**  
Location Routing Number

**LS**  
Link Set

**LSA**  
Link Status Alignment

**LSB**  
Least Significant Bit (bit 1)

**LSL**  
Low-Speed Link

<b>LSMS</b>	Local Service Management System
<b>LSN</b>	Link Set Name
<b>LSO</b>	Link Status out of Service
<b>LSPE</b>	Link Status Proving Emergency
<b>LSPN</b>	Link Status Proving Normal
<b>LSR</b>	Link Status Ready
<b>LSSU</b>	Link Status Signal Unit
<b>M2PA</b>	SS7 MTP2-User Peer-to-Peer Adaptation Layer
<b>M3UA</b>	SS7 MTP3-User Adaptation Layer
<b>MAAL</b>	Management ATM Adaptation Layer
<b>MAP</b>	Mobile Application Part
<b>MAPSCRN</b>	GSM MAP Screening measurements report
<b>MCAP</b>	MAS Communication Application Processor Card
<b>MCC</b>	Mobile Country Code
<b>MCM</b>	Maintenance Communication Module
<b>MCP</b>	Measurement Collection Processor
<b>MCPM</b>	Measurement Collection and Polling Module
<b>MDAL</b>	Maintenance Disk and Alarm (card)
<b>MDN</b>	Mobile Dialed Number

**MGT**

Mobile Global Title

**MGTT**

Modified Global Title Translation

**MF**

Miscellaneous Frame

**MFC**

Message Flow Control

**MIM**

Multi-Channel Interface Module

**MIN**

Mobile Identification Number

**MLPRST**

MTP Low Priority Route Set

**MNP**

Mobile Number Portability

**MNP SMS**

Portability Check for Mobile Originated SMS

**MNP-SRF**

Signaling Relay Function for support of Mobile Number Portability

**MOBR**

Origin-based MTP Routing feature

**MPC**

Multiple Point Code feature

**MPL**

Multi-port LIM

**MPS**

Multi-Purpose Server

**MR**

Message Relay

**MRN**

Mated Relay Node

**MRN**

Message Reference Number

**MS**

Mobile Station

**MSB**

Most Significant Bit



**MSC**

Mobile Switching Center

**MSAR**

Memory space accounting reporting

**MSISDN**

Mobile Station ISDN Number or Mobile Switching ISDN Number

**MSRN**

Mobile Station Roaming Number

**MSU**

Message Signal Unit

**MTCD**

Maintenance Daily measurements report

**MTCDTH**

Maintenance Day-to-Hour measurements report

**MTCH**

Maintenance Hourly (marginal) measurements report

**MTCS**

Maintenance Status (link/link set) measurements report

**MTP**

Message Transfer Part

**MTP2**

Message Transfer Part, Level 2

**NAI**

Nature of Address Indicator

**NCAI**

Nested Cluster Allowed Indicator

**NCR**

Nested Cluster Routing

**NEC**

National Escape Code

**NFAS**

Non-Frame Alignment Signal

**NI**

Network Indicator

**NIC**

Network Information Center

**NID**

Network Identification

<b>NM</b>	Network Management
<b>NP</b>	Number Plan
<b>NPA</b>	Numbering Plan Area
<b>NPAC</b>	Number Portability Administration Center
<b>NPANXX</b>	Numbering Plan Area and Exchange
<b>NRT</b>	Network Routing
<b>NSAP</b>	Network Service Access Point
<b>NSE</b>	Network Security Enhancement
<b>NSFI</b>	Next Screening Function Indicator
<b>NSP</b>	Network Services Part
<b>NSPC</b>	New Secondary Point Code
<b>OAM</b>	Operations, Administration, and Maintenance
<b>OAP</b>	Operation System Support Application Processor
<b>OAMP</b>	Operations, Administration and Maintenance Part
<b>OBSR</b>	Origin-based SCCP Routing feature
<b>OCU</b>	Office Channel Unit
<b>OOS-MA</b>	Out of Service - Memory Administration
<b>OOS-MT</b>	Out of Service - Maintenance
<b>OOS-MT-DSBLD</b>	Out of Service - Maintenance Disabled

**OPC**  
Origination Point Code

**OPCODE**  
Operation Code

**OPNAME**  
Operation Name

**OSI**  
Open Systems Interconnection

**OSS**  
Operations Systems Support

**PC**  
Point Code

**PCR**  
Preventive Cyclic Retransmission

**PCS**  
Personal Communications Service (North American GSM)

**PDBA**  
Provisioning Database Application

**PDBI**  
Provisioning Database Interface

**PDN**  
Packet Data Network

**PDS**  
Persistent Device States

**PLNP**  
PCS 1900 LNP

**PLNPQS**  
LNPQS support provided for PLNP

**PPSMS**  
Prepaid Short Message Service Intercept

**PROM**  
Programmable Read-Only Memory

**PSEL**  
Presentation Selector

**PST**  
Primary State for Maintenance

**PSTN**  
Public Switched Telephone Network

<b>PVC</b>	Permanent Virtual Circuit
<b>PVN</b>	Private Virtual Network
<b>Q3</b>	Q.3 Protocol
<b>RAM</b>	Random Access Memory
<b>RBASE</b>	Record Base measurements report
<b>RC</b>	Relative Cost
<b>RI</b>	Routing Indicator
<b>RFC</b>	Request for Comments
<b>RMC</b>	Remote Maintenance Center
<b>RMTP</b>	Reliable Multicast Transport Protocol
<b>RN</b>	Routing Number
<b>RTDB</b>	DSM Real-time database
<b>RTT</b>	Round Trip Time
<b>SAAL</b>	Signaling ATM Adaptation Layer
<b>SAPC</b>	Secondary Adjacent Point Code
<b>SCCP</b>	Signaling Connection Control Part
<b>SCM</b>	System Configuration Manager
<b>SCMG</b>	SCCP Management
<b>SCP</b>	Service Control Point

**SCRSET**

Screen Set

**SCSI**

Small Computer System Interface

**SCTP**

Stream Control Transmission Protocol

**SE-HSL**

Synchronous E1 High Speed Link

**SEAS**

Signaling Engineering and Administration System

**SFAPP**

Stateful Applications

**SIB**

Status Indication "Busy"

**SIE**

Status Indication "Emergency" Alignment

**SIN**

Status Indication "Normal Alignment"

**SIO**

Service Information Octet

**SIO**

Status Indication "Out of Alignment"

**SIOS**

Status Indication "Out of Service"

**SK**

Service Key

**SKTS**

Service Key/TeleService List

**SLIC**

Service and Link Interface Card

**SLK**

Signaling Link

**SLS**

Signaling Link Selection

**SLSCI**

Signaling Link Conversion Indicator

**SLTA**

Signaling Link Test Acknowledgement

<b>SLTM</b>	Signaling Link Test Message
<b>SMS</b>	Short Message Service
<b>SMSC</b>	Short Message Service Center
<b>SMSMR</b>	Prepaid Short Message Service
<b>SNAI</b>	Service Nature of Address Indicator
<b>SNM</b>	Signaling Network Management
<b>SNR</b>	Subsystem Normal Routing
<b>SOR</b>	Support for Optimal Routing
<b>SORP</b>	Socket Option Registration Primitive
<b>SPC</b>	Secondary Point Code Signaling Point Code
<b>SRF</b>	Signaling Relay Function
<b>SRI</b>	Send Routing Information
<b>SRVSEL</b>	Service Selector
<b>SS7</b>	Signaling System #7
<b>SS7ANSI</b>	The application software for the ANSI SS7 signaling links
<b>SSA</b>	Subsystem Allowed (An SCCP management message)
<b>SSEL</b>	Session Selector
<b>SSN</b>	SS7 Subsystem Number
<b>SSP</b>	Service Switching Point

**SSU**

Status Signal Unit

**ST**

Stop Digit—BCD value 15 (0xF)—used to indicate the end of dialing in some applications

**STC**

Signaling Transport Card

**STP**

Signal Transfer Point

**STP LAN**

The application software for the STP LAN feature

**SUA**

SS7 SCCP-User Adaptation Layer

**SVC**

Switched Virtual Circuit

**TALI**

Transport Adapter Layer Interface (RFC 3094)

**TCP**

Transmission Control Protocol

**TCAP**

Transaction Capabilities Application Part

**TDM**

Terminal Disk Module

**TFA**

Transfer Allowed

**TFC**

Transfer Congested (traffic)

**TFP**

Transfer Prohibited

**TFR**

Transfer Restricted

**TLNP**

Triggerless LNP

**TOS**

Type of Service

**TPS**

Transactions Per Second

**TRA**

Traffic Restarting Allowed

**TRBL**

Trouble

**TRW**

Traffic Restarting Waiting

**TSC**

Time Slot Counter Synchronization

**TSM**

Translation Services Module

**TT**

Translation Type

**TUP**

Telephone User Part

**TV**

Ticket Voucher

**UA**

IETF User Adaptation Layers

**UAM**

Unsolicited Alarm Message

**UART**

Universal Asynchronous Receiver - Transmit

**UDP**

User Datagram Protocol

**UDTS**

Unit Data Transfer Service

**UI**

User Interface

**UID**

User ID

**UIM**

Unsolicited Informational Message

**UPD**

Update

**VGTT**

Variable Length GTT

**VLR**

Visitor Location Register

**VMSC**

Voice Mail Service Center Visited Mobile Switching Center



**VSCCP**

VxWorks Signaling Connection Control Part

**WNP**

Wireless Number Portability

**WNPQS**

Wireless Number Portability Query Service

**X.25 DE**

X.25 Destination Entity

**XGTT**

Expanded GTT (GTT Table Expansion)

**XMAP**

Expanded MAP Table