

Oracle® Application Server ProcessConnect

User's Guide

10g (9.0.4)

Part No. B12121-01

September 2003

Oracle Application Server ProcessConnect User's Guide, 10g (9.0.4)

Part No. B12121-01

Copyright © 2003 Oracle Corporation. All rights reserved.

Primary Author: Mark Kennedy

Contributing Author: Deanna Bradshaw

Contributors: Oracle Application Server ProcessConnect development, product management, and quality assurance teams

The Programs (which include both the software and documentation) contain proprietary information of Oracle Corporation; they are provided under a license agreement containing restrictions on use and disclosure and are also protected by copyright, patent and other intellectual and industrial property laws. Reverse engineering, disassembly or decompilation of the Programs, except to the extent required to obtain interoperability with other independently created software or as specified by law, is prohibited.

The information contained in this document is subject to change without notice. If you find any problems in the documentation, please report them to us in writing. Oracle Corporation does not warrant that this document is error-free. Except as may be expressly permitted in your license agreement for these Programs, no part of these Programs may be reproduced or transmitted in any form or by any means, electronic or mechanical, for any purpose, without the express written permission of Oracle Corporation.

If the Programs are delivered to the U.S. Government or anyone licensing or using the programs on behalf of the U.S. Government, the following notice is applicable:

Restricted Rights Notice Programs delivered subject to the DOD FAR Supplement are "commercial computer software" and use, duplication, and disclosure of the Programs, including documentation, shall be subject to the licensing restrictions set forth in the applicable Oracle license agreement. Otherwise, Programs delivered subject to the Federal Acquisition Regulations are "restricted computer software" and use, duplication, and disclosure of the Programs shall be subject to the restrictions in FAR 52.227-19, Commercial Computer Software - Restricted Rights (June, 1987). Oracle Corporation, 500 Oracle Parkway, Redwood City, CA 94065.

The Programs are not intended for use in any nuclear, aviation, mass transit, medical, or other inherently dangerous applications. It shall be the licensee's responsibility to take all appropriate fail-safe, backup, redundancy, and other measures to ensure the safe use of such applications if the Programs are used for such purposes, and Oracle Corporation disclaims liability for any damages caused by such use of the Programs.

Oracle is a registered trademark, and Oracle Store, Oracle9i, SQL*Plus, and PL/SQL are trademarks or registered trademarks of Oracle Corporation. Other names may be trademarks of their respective owners.

Contents

Send Us Your Comments	li
Preface.....	liii
Audience	liv
Organization	liv
Related Documentation	lviii
Conventions.....	lviii
Documentation Accessibility	lxii

Volume 1

Part I Oracle Application Server ProcessConnect Introduction and Concepts

1 A Road Map to Using this Guide

A Road Map to Using this Guide	1-2
Chapters For All Users to Read.....	1-4
Chapters For Modelers to Read.....	1-6
Chapters for Connection Managers to Read.....	1-6
Chapters for Event Managers to Read.....	1-7
Chapters for Business Process Managers to Read	1-8
Chapters For Administrators to Read	1-9
Chapters for Business Administrators to Read.....	1-9

Chapters for Systems Administrators to Read	1-10
Chapters For Analysts to Read	1-10
Additional Chapters	1-10
Chapter Summary	1-11

2 Introduction to Oracle Application Server ProcessConnect

What Are E-business and Integration?	2-2
E-business and Integration Importance.....	2-4
What Are the Challenges of Integration?.....	2-5
How Does Oracle Application Server ProcessConnect Answer Integration Challenges? ...	2-6
Integration Challenges and Oracle Application Server ProcessConnect Solutions:	
Examples	2-9
Challenge of Integrations Within an Enterprise: Example.....	2-9
Solution for Integrations Within an Enterprise: Oracle Application Server ProcessConnect.....	2-12
Challenge of Integrations Between Enterprises: Example.....	2-14
Solution for Integrations Between Enterprises: Oracle Application Server ProcessConnect.....	2-16
Chapter Summary	2-17

3 Oracle Application Server ProcessConnect Concepts

Oracle Application Server ProcessConnect Users	3-2
Integration Design Concepts	3-4
Concept: Integrated View of Data.....	3-4
Concept: Correlation	3-5
Concept: Data Flows and Control Flows.....	3-5
Concept: Translation	3-5
Concept: Transformation.....	3-6
Concept: Validation	3-6
Concept: Adapters	3-6
Concept: Agreements	3-7
Concept: Auditing and Business Process Activity Intelligence	3-7
Oracle Application Server ProcessConnect Support for Integration Design Concepts.....	3-8
Support for an Integrated View of Data.....	3-8
Support for Correlation with Native Event Correlation and Native Roles.....	3-9

Support for Data Flow and Control Flow	3-10
Support for Translation	3-10
Support for Transformation.....	3-11
Support for Validation with Native Event Validation.....	3-11
Support for Adapters	3-11
Support for Agreements	3-12
Support for Business Intelligence.....	3-12
Oracle Application Server ProcessConnect Concepts in Detail	3-13
Modeling Metadata and Profile Data Overview	3-13
Modeling Metadata Design	3-15
Native-Level Concepts.....	3-15
Event Types and Event Instances.....	3-16
Wire Messages and Oracle Records.....	3-17
Adapter Interactions	3-19
Native Events.....	3-20
Native Event Validation.....	3-22
Native Datatypes	3-23
Native Roles	3-23
Native Event Correlation	3-26
Event Maps.....	3-26
Internal Processing Elements for Native, Application, and Business Levels	3-27
Role Ports.....	3-28
Steps	3-28
Step Ports.....	3-29
Data Flow.....	3-29
Control Flow	3-29
Application-Level Concepts.....	3-30
Application Events and Translation.....	3-30
Application Datatypes.....	3-32
Application Roles	3-33
Translation Binding Role.....	3-34
Acknowledgment Consumption and Generation	3-35
Business-Level Concepts	3-37
Business Events.....	3-37
Business Datatypes.....	3-38
Transformation	3-39

Business Roles	3-40
Transformation Binding Role	3-41
Business Process	3-44
Event Addressing with the SetParty Step	3-47
Runtime Instance Behavior	3-48
Event Instances	3-49
Role Instances.....	3-49
Step Instances.....	3-50
Coordinations.....	3-50
Profile Data Design	3-51
Applications and Adapters	3-51
Technology Adapters.....	3-51
Application Adapters.....	3-53
B2B Protocol Adapters.....	3-55
Trading Partners	3-56
Agreements.....	3-57
Trading Partner Agreements	3-57
Application Agreements.....	3-58
Create and Deploy a Configuration	3-58
Manage the Modeling Metadata and Profile Data Lifecycle	3-59
Lifecycle States for an Agreement	3-60
Modeling Metadata Lifecycle States	3-60
Profile Data Lifecycle States	3-62
Deployment Lifecycle States	3-64
Integration Management	3-65
Integration Reports.....	3-66
Chapter Summary	3-66

4 Oracle Application Server ProcessConnect Architecture

Oracle Application Server ProcessConnect Architecture Overview.....	4-2
Designing the Integration: Overview	4-5
Storing the Integration in the Design-Time Repository: Overview	4-5
Deploying the Integration to the Runtime Repository: Overview	4-6
Storing the Integration in the Runtime Repository: Overview	4-7

Executing Runtime System Components: Overview	4-8
Executing the Adapter Framework: Overview	4-9
Managing the Integration: Overview	4-10
Oracle Enterprise Manager System Administration	4-11
Oracle Application Server ProcessConnect User Interface Tool Administration	4-12
Create Integration Reports: Overview	4-12
Chapter Summary	4-13

Part II Introduction to the User Interface Tool

5 Getting Started with the User Interface Tool

Accessing the Oracle Application Server ProcessConnect User Interface Tool	5-2
Oracle Application Server ProcessConnect User Interface Tool Page Layouts	5-4
Main List Pages	5-5
Details Pages	5-8
Business Process and Role Diagrams	5-10
Transformation Map Details Page	5-11
Creating Incomplete Modeling Metadata and Profile Data	5-12
Creating, Adding, Deleting, and Removing Data	5-13
Modeling Metadata and Profile Data Naming Conventions	5-13
Using the Browser Back and Forward Buttons	5-13
Searching for Data on the Main List Page.....	5-14
Exporting Profile Data to an XML File	5-15
Viewing the State of Modeling Metadata and Profile Data on the Details Page.....	5-17
Draft State for Modeling Metadata and Profile Data.....	5-18
Validated State for Modeling Metadata and Profile Data	5-19
Pending Approval State for Profile Data	5-20
Update the Approver.....	5-22
Delete the Approver.....	5-22
Approval State for Profile Data.....	5-22
Deployed State for Modeling Metadata and Profile Data	5-23
Modeling Tab Overview	5-24
Business Processes List Page.....	5-26
Business Process Tasks	5-26

Roles List Page	5-28
Role Tasks	5-28
Event Types List Page	5-30
Event Type Tasks.....	5-30
Datatypes List Page	5-31
Datatype Tasks.....	5-31
Transformations List Page.....	5-33
Transformation Tasks	5-33
Interactions List Page	5-34
Interaction Tasks.....	5-34
Condition Expressions List Page	5-35
Condition Expression Tasks.....	5-35
Profiles Tab Overview.....	5-36
Host List Page.....	5-38
Host Tasks	5-38
Trading Partners List Page	5-40
Trading Partner Tasks.....	5-40
Applications List Page	5-41
Applications Tasks	5-41
Agreements List Page.....	5-42
Agreement Tasks	5-43
Deployment Tab Overview	5-44
Deployment Tasks.....	5-44
Reports Tab Overview.....	5-45
Administration Tab Overview.....	5-46
Configuration List Page	5-47
Configuration Tasks	5-48
Management List Page.....	5-48
Management Tasks.....	5-48
Chapter Summary	5-49

6 Methodologies for Using Oracle Application Server ProcessConnect

Methodologies for Using Oracle Application Server ProcessConnect	6-2
Adapter-Centric Methodology	6-3
What is an Adapter-Centric Methodology?.....	6-3

When Do I Want to Use an Adapter-Centric Methodology?	6-4
Adapter-Centric Methodology Steps	6-5
Create Applications and Add Adapters	6-5
Create Native and Application Events and Select Translators	6-6
Create Roles, Transformation Maps, a Business Event, and a Business Process	6-6
Create Business Event Datatypes	6-7
Create Business Event Body Element	6-7
Create Transformation Rules	6-8
Update the SetParty Step in the Business Process	6-8
Create Agreements	6-9
Create and Deploy a Configuration	6-10
Business Process-Centric Methodology	6-11
What is a Business Process-Centric Methodology?	6-11
When Do I Want to Use Business Process-Centric Methodology?	6-11
Business Process-Centric Methodology Creation Procedures	6-12
Chapter Summary	6-13

7 Tutorial of an Integration within an Enterprise

Tutorial Overview	7-2
Example Scenario	7-2
Human Resources Application Details	7-2
Global Newspaper Application Details	7-2
Human Resources Person Application Details	7-3
Overview of Phases	7-3
Phase A	7-3
Phase B1 through B4	7-4
Preparations before Starting	7-5
Methods to Designing the Tutorial	7-6
Phase A: Creating and Deploying the Initial Configuration	7-6
Task 1: Creating Application Details	7-7
Creating the Human Resources Application	7-7
Adding an Adapter to the Human Resources Application	7-8
Creating the Delivery Channel for the Human Resources Application Adapter	7-8

Validating the Human Resources Application	7-9
Sending the Application for Approval.....	7-9
Approving the Application.....	7-10
Creating the Global Newspaper Application.....	7-10
Adding an Adapter to the Global Newspaper Application.....	7-11
Creating the Delivery Channel for the Global Newspaper Application Adapter	7-11
Validating the Global Newspaper Application	7-12
Sending the Application for Approval.....	7-12
Approving the Application.....	7-12
Task 2: Creating the Modeling Metadata	7-13
Creating the Inbound Interaction for the Human Resources Application Adapter..	7-14
Creating the Native Event, Translation, and Application Event for the Human Resources Application.....	7-15
Creating an Event Map for the HR New Ad Native Event.....	7-18
Creating the Outbound Interaction for the Global Newspaper Application Adapter	7-19
Creating the Native Event, Translation, and Application Event for the Global Newspaper Application.....	7-20
Creating an Event Map for the Global NP Ad Native Event.....	7-22
Creating the Modeling Metadata with the Modeling Wizards	7-23
Creating the Business Event Datatypes.....	7-28
Creating the Business Event Body Element.....	7-29
Creating the Rules for the Inbound Event Transformation Map	7-32
Creating the Rules for the Outbound Event Transformation Map	7-34
Selecting the Destination Party in the SetParty Step	7-35
Task 3: Creating the Agreements	7-36
Creating the Human Resources Application Agreement.....	7-36
Adding the Delivery Channel for the Human Resources Application Adapter.....	7-37
Adding the Human Resources Application Native Role to the Agreement.....	7-37
Validating the Human Resources Application Agreement.....	7-38
Sending the Agreement for Approval.....	7-38
Creating the Global Newspaper Application Agreement.....	7-39
Adding the Delivery Channel for the Global Newspaper Application Adapter.....	7-39
Adding the Global Newspaper Application Native Role to the Agreement.....	7-40
Validating the Global Newspaper Application Agreement.....	7-40

Sending the Agreement for Approval.....	7-40
Task 4: Creating and Deploying a Configuration.....	7-41
Task 5: Testing the Results	7-42
Task 6: Troubleshooting Any Errors with Log Files and Reports.....	7-43
Creating Reports.....	7-44
Checking the Log Files.....	7-45
More Troubleshooting Tips	7-45
Phase B1: Manually Design Some Modeling Metadata in an Integration	7-47
Task 1: Creating the Business Event Types and Body Elements.....	7-48
Importing the Business Event Datatypes from an XSD File	7-48
Creating the Ad Confirmation Business Event	7-48
Creating a Body Element for the Ad Confirmation Business Event.....	7-49
Importing the Business Event Datatypes from an XSD File	7-49
Creating the Business Event Ad Problem.....	7-49
Creating a Body Element for the Ad Problem Business Event.....	7-49
Task 2: Creating a Conditional Step.....	7-50
Creating a Condition Expression	7-50
Creating the Condition Step Using the Condition Expression.....	7-51
Task 3: Creating a Transformation Step to Notify Human Resources	7-52
Creating an Event Transformation Map	7-52
Copying the Ad_ID Integer	7-53
Copying the Problem_Details String.....	7-53
Creating a Transformation Step Using the Transformation Map	7-53
Task 4: Creating an Or Step.....	7-54
Task 5: Creating a Role Port and Data Flow to Deliver the Ad Problem Event to Human Resources.....	7-55
Task 6: Creating a Split Step	7-56
Task 7: Creating a Role Port and Data Flow to Splitting the Ad Confirmation Event.....	7-56
Task 8: Removing Unnecessary Control Flow (Optional)	7-57
Phase B2: Using the Add Event Flow Wizard.....	7-58
Task 1: Creating a Native Event for an Existing Interaction.....	7-58
Task 2: Creating an Event Map for the Global NP Confirmation Native Event	7-59
Task 3: Creating an Event Correlation.....	7-60
Task 4: Adding an Event Flow to a Spoke with the Add Event Flow Wizard	7-61
Task 5: Creating Transformation Statements	7-62

Copying the Ad_ID Integer.....	7-62
Copying the Confirmed String.....	7-63
Copying the Problem_Details String.....	7-63
Phase B3: Using the Add Spoke Wizard.....	7-64
Task 1: Creating a Native Event, Translation, and Application Event.....	7-64
Creating an Event Map for the HR Problem Native Event.....	7-65
Task 2: Adding a Spoke.....	7-66
Task 3: Creating Transformation Statements.....	7-66
Copying the Ad_ID Integer.....	7-67
Setting a Default for the Action String.....	7-67
Copying the Problem_Description String.....	7-67
Setting the Party to HR Person in an Event Header Rule.....	7-68
Phase B4: Creating the HR Person Application and Agreement.....	7-68
Task 1: Creating a Third Application.....	7-69
Creating the Application.....	7-69
Adding an Adapter Type.....	7-69
Creating a Delivery Channel.....	7-69
Validating the Application.....	7-70
Sending the Application for Approval.....	7-70
Approving the Application.....	7-70
Task 2: Creating a Third Application Agreement.....	7-71
Creating the Application Agreement.....	7-71
Adding the Delivery Channel.....	7-71
Adding the Native Role.....	7-71
Validating the Application Agreement.....	7-72
Sending the Agreement for Approval.....	7-72
Approving the Agreement.....	7-72
Task 3: Creating and Deploying a New Configuration.....	7-72
Task 4: Testing the Results.....	7-72
Manually Creating the Business Datatypes.....	7-73
Task 1: Creating the AdType Complex Datatype and its Datatype Members.....	7-73
Creating the Complex Datatype Members of AdType.....	7-74
Task 2: Creating the Ad_Request Complex Datatype.....	7-75
Creating the Complex Datatype Members of Ad_Request.....	7-75
Updating the Interaction, Native Event, and Application Event.....	7-77

Task 1: Deleting a Spoke.....	7-78
Task 2: Deleting a Transformation Map.....	7-79
Task 3: Deleting a Native Event	7-79
Task 4: Creating a Native Event	7-79
Task 5: Creating a Spoke.....	7-80
Task 6: Creating Event Transformation Map Statements.....	7-81
Task 7: Updating the Agreement to Use a New Native Role.....	7-81
.xsd and .xml Files Used in This Tutorial.....	7-82
HR_Ad.xsd File	7-82
Global_Newspaper_Ad.xsd File	7-83
Ad_CommonView.xsd File	7-84
Global_NP_AdConfirmation.xsd File	7-84
HR_AdProblem.xsd File.....	7-85
HR_Ad.xml File	7-86
Global_NP_AdConfirmation.xml File.....	7-86
Chapter Summary.....	7-86

Part III Modeler Management Tasks

8 Oracle Application Server ProcessConnect Technology Adapters

Layout of Adapter Details in this Chapter.....	8-2
Adapter-Related Tasks in User Interface Tool	8-4
Create a Delivery Channel	8-4
Add an Interaction.....	8-5
Create and View the Native and Application Events and Body Elements.....	8-6
View the Interaction	8-9
Native Formats and Value Types	8-11
Advanced Queuing Adapter.....	8-11
Benefits of Using the Advanced Queuing Adapter.....	8-12
Reliable, Scalable Asynchronous Communication.....	8-12
Application Location Transparency	8-12
Support for both XML and Non-XML Message Payloads	8-12
Security	8-13
Advanced Queuing Adapter Supported Versions	8-13
Advanced Queuing Adapter Application Delivery Channel Description.....	8-13

Advanced Queuing Adapter Exchange Protocols.....	8-14
Advanced Queuing Adapter Design-Time Tasks.....	8-15
Advanced Queuing Adapter Interaction and Record Naming Restrictions.....	8-17
Advanced Queuing Adapter Errors.....	8-18
Native Event Validation Failure.....	8-18
Advanced Queuing Adapter Validation Prerequisites.....	8-18
Advanced Queuing Adapter Additional Setup Tasks.....	8-19
Queue Runtime State.....	8-19
Queue Privileges.....	8-19
Advanced Queuing Adapter Application Integration and Runtime Behavior.....	8-20
Advanced Queuing Adapter Limitations.....	8-21
Advanced Queuing Adapter Diagnostics and Troubleshooting.....	8-21
Common Problems and Errors in the Log File and Their Solutions.....	8-22
Advanced Queuing Adapter Use Case.....	8-27
Delivery Channel Questions.....	8-27
Interaction Questions.....	8-28
E-Mail Adapter.....	8-30
Benefits of Using the E-Mail Adapter.....	8-30
E-Mail Adapter Supported Versions.....	8-31
E-Mail Adapter Application Delivery Channel Description.....	8-31
E-Mail Adapter Exchange Protocols.....	8-32
E-Mail Adapter Design-Time Tasks.....	8-32
E-Mail Adapter Outbound Interaction and Record Element Naming Conventions.....	8-32
E-Mail Adapter Inbound Interaction and Record Element Naming Conventions....	8-34
E-Mail Adapter Interaction and Record Naming Restrictions.....	8-35
E-Mail Adapter Errors.....	8-35
E-Mail Adapter Validation Prerequisites.....	8-35
E-Mail Adapter Additional Setup Tasks.....	8-36
E-Mail Adapter Application Integration and Runtime Behavior.....	8-36
E-Mail Adapter Limitations.....	8-36
E-Mail Adapter Diagnostics and Troubleshooting.....	8-37
E-Mail Adapter Use Case.....	8-37
File/FTP Adapter.....	8-38
Benefits of Using the File/FTP Adapter.....	8-38
File/FTP Adapter Application Delivery Channel Description.....	8-39

File/FTP Adapter Exchange Protocols	8-39
File Adapter Exchange Protocols - Inbound and Outbound Directions	8-40
FTP Adapter Exchange Protocols - Inbound and Outbound Directions.....	8-40
File/FTP Adapter Design-Time Tasks.....	8-41
File/FTP Adapter Interaction and Record Naming Restrictions.....	8-41
File/FTP Adapter Errors.....	8-41
File/FTP Adapter Validation Prerequisites	8-42
File/FTP Adapter Additional Setup Tasks	8-42
File/FTP Adapter Application Integration and Runtime Behavior	8-42
File/FTP Adapter Limitations	8-42
File/FTP Adapter Diagnostics and Troubleshooting.....	8-43
File/FTP Adapter Use Case	8-43
HTTP Adapter.....	8-44
Benefits of Using the HTTP Adapter	8-44
HTTP Adapter Supported Versions.....	8-45
HTTP Adapter Application Delivery Channel Description	8-46
HTTP Adapter Exchange Protocols	8-46
HTTP Adapter Design-Time Tasks.....	8-46
HTTP Adapter Inbound Interaction and Record Element Naming Conventions	8-47
HTTP Adapter Outbound Interaction and Record Element Naming Conventions ..	8-47
HTTP Adapter Interaction and Record Naming Restrictions.....	8-49
HTTP Adapter Errors.....	8-49
HTTP Adapter Validation Prerequisites	8-49
HTTP Adapter Additional Setup Tasks	8-50
HTTP Adapter Post-Installation Tasks.....	8-50
HTTP Adapter Testing.....	8-52
HTTP Adapter Application Integration and Runtime Behavior	8-52
HTTP Adapter Limitations.....	8-54
HTTP Adapter Diagnostics and Troubleshooting.....	8-54
HTTP Adapter Use Case.....	8-55
Delivery Channel Questions.....	8-55
Interaction Questions - Inbound and Outbound Directions.....	8-56
JMS Adapter.....	8-58
Benefits of Using the JMS Adapter.....	8-58
JMS Adapter Supported Versions.....	8-59

JMS Adapter Application Delivery Channel Description	8-59
JMS Adapter Exchange Protocols.....	8-59
JMS Adapter Exchange Protocols - Inbound Direction	8-60
JMS Adapter Exchange Protocols - Outbound Direction	8-60
JMS Adapter Design-Time Tasks	8-61
JMS Adapter Interaction and Record Naming Restrictions	8-63
JMS Adapter Errors	8-64
JMS Adapter Validation Prerequisites.....	8-64
JMS Adapter Additional Setup Tasks.....	8-65
Instructions for Oracle JMS	8-66
Instructions for MQSeries JMS	8-68
JMS Adapter Application Integration and Runtime Behavior.....	8-69
JMS Adapter Limitations.....	8-70
JMS Adapter Diagnostics and Troubleshooting.....	8-70
JMS Adapter Use Case	8-71
Delivery Channel Questions	8-71
Interaction Questions - Inbound and Outbound Directions	8-72
Oracle Database Adapter	8-75
Benefits of Using the Oracle Database Adapter	8-75
Oracle Database Adapter Supported Versions.....	8-75
Oracle Database Adapter Application Delivery Channel Description.....	8-76
Oracle Database Adapter Exchange Protocols	8-76
Oracle Database Adapter Exchange Protocols - Inbound Direction.....	8-76
Oracle Database Adapter Exchange Protocols - Outbound Direction.....	8-77
Oracle Database Adapter Design-Time Tasks	8-78
Adapter Exchange Protocol User Interface Naming Conventions.....	8-79
Oracle Database Adapter Interaction and Record Naming Restrictions.....	8-81
Oracle Database Adapter Errors.....	8-82
Oracle Database Adapter Validation Prerequisites	8-82
Oracle Database Adapter Additional Setup Tasks	8-83
Oracle Database Adapter Application Integration and Runtime Behavior	8-84
Oracle Database Adapter Features and Limitations.....	8-85
Adapter Exchange Protocols.....	8-85
Oracle Database Adapter Restrictions.....	8-87
Oracle Database Adapter Diagnostics and Troubleshooting.....	8-87

Oracle Database Adapter Use Case	8-88
Web Service Adapter	8-92
Benefits of Using the Web Service Adapter	8-92
Web Service Adapter Supported Versions	8-93
Web Service Adapter Application Delivery Channel Description.....	8-93
Web Service Adapter Exchange Protocols.....	8-93
Interaction Name Example	8-94
Web Service Adapter Design-Time Tasks.....	8-95
Web Service Adapter Interaction and Record Naming Restrictions.....	8-97
Web Service Adapter Errors	8-97
WSDL Definition Processing Errors:	8-97
Execution Errors:	8-97
Web Service Adapter Validation Prerequisites.....	8-98
Web Service Adapter Additional Setup Tasks.....	8-98
Web Service Adapter Limitations	8-98
Web Service Adapter Diagnostics and Troubleshooting.....	8-99
Web Service Adapter Use Case	8-100
Delivery Channel Questions.....	8-101
Interaction Questions.....	8-102
Chapter Summary	8-103

9 Creating Metadata with the Modeling Wizards

Modeling Wizards Concepts Overview	9-2
Single Spoke	9-2
Multiple Spokes with a Business Process	9-3
Event Flow in a Spoke.....	9-5
Modeling Wizards Overview	9-6
Create End-To-End Basic Integration Wizard.....	9-6
Add End-To-End Basic Event Flow Wizard.....	9-8
Create Spoke Wizard.....	9-10
Add Event Flow Wizard.....	9-12
Features Common to All Wizards.....	9-12
Diagrams.....	9-13
Disabling a Native Event.....	9-18
Modeling Metadata Name Creation.....	9-18

Interactions	9-18
Prerequisites to Using the Modeling Wizards	9-19
Starting the Modeling Wizards	9-19
Starting From the Modeling Tab	9-20
Starting From the Business Processes Tab or Roles Tab	9-20
Starting From the Event Flow Diagram	9-20
Starting From the Integration Diagram	9-20
Creating Two Spokes.....	9-21
Adding Event Flow to Two Spokes	9-22
Creating a Single Spoke	9-23
Adding Event Flow to a Single Spoke	9-26
Reviewing Modeling Metadata Before Creation.....	9-28
Reviewing Modeling Metadata After Creation	9-32
Tasks to Perform after Modeling Metadata Creation	9-37
Create Event Body Elements for Business Events	9-37
Access the Business Event from the Event Flow Diagram	9-37
Access the Business Event from the Main Menu	9-37
Define Transformation Rules for Event Transformation Maps	9-38
Access the Event Transformation Map from the Event Flow Diagram.....	9-38
Access the Event Transformation Map from the Main Menu.....	9-38
Create Additional Steps, Ports, Data Flows, and Control Flows.....	9-38
Update the Target Party of the SetParty Step	9-39
Access the SetParty Step from the Event Flow Diagram	9-39
Access the SetParty Step from the Main Menu	9-39
Deleting a Spoke	9-40
Common Modeling Wizard Errors	9-41
Using the Wrong Wizard.....	9-41
Specifying a Previously-Used Role	9-41
Chapter Summary	9-42

10 Managing Datatypes

Oracle Application Server ProcessConnect Datatype Support Overview.....	10-2
Core Datatypes.....	10-2
Datatype Classifications.....	10-2
Native Datatypes	10-3

Application Datatypes.....	10-3
Business Datatypes.....	10-3
Datatype Namespaces.....	10-5
Examples of Datatype Formats in Oracle Application Server ProcessConnect.....	10-5
Wire Message Native Datatype Format in XSD File	10-5
Native and Application Datatype Formats.....	10-7
Business Datatype Creation Methods.....	10-9
Business Datatype Format.....	10-10
Viewing Core Datatypes.....	10-11
Managing Business Datatypes	10-13
Managing Complex Datatypes.....	10-15
Scalar Member	10-15
Compound Member.....	10-15
Wildcard Member	10-16
Accessing Complex Datatype Management Tasks	10-18
Creating a Complex Datatype	10-19
Deleting a Complex Datatype	10-20
Updating a Complex Datatype.....	10-21
Viewing a Complex Datatype.....	10-22
Managing Complex Datatype Members	10-24
Accessing Complex Datatype Member Management Tasks	10-25
Creating a Complex Datatype Member	10-26
Deleting a Complex Datatype Member	10-30
Updating a Complex Datatype Member.....	10-31
Viewing a Complex Datatype Member.....	10-32
Managing Scalar Datatypes	10-36
Accessing Scalar Datatype Management Tasks	10-40
Creating a Scalar Datatype.....	10-41
Deleting a Scalar Datatype.....	10-42
Updating a Scalar Datatype	10-43
Viewing a Scalar Datatype	10-43
Creating a Scalar Datatype Facet	10-45
Deleting a Scalar Datatype Facet.....	10-47
Updating a Scalar Datatype Facet.....	10-47
Viewing a Scalar Datatype Facet.....	10-48

Creating a Valid Value for the Scalar Datatype Enumeration or Pattern Facet	10-49
Deleting a Valid Value for the Scalar Datatype Enumeration or Pattern Facet	10-49
Updating a Valid Value for the Scalar Datatype Enumeration or Pattern Facet	10-50
Importing XSD Datatypes	10-51
Managing Application Datatypes.....	10-55
Viewing Native Datatypes	10-58
Managing Datatype Namespaces	10-59
Accessing Datatype Namespace Management Tasks	10-61
Creating a Datatype Namespace	10-63
Deleting a Datatype Namespace	10-63
Updating a Datatype Namespace	10-63
Viewing a Datatype Namespace	10-64
Common User Errors	10-65
Chapter Summary	10-66

11 Managing Adapter Interactions and Event Types

Adapter Interaction and Event Type Management Tasks Overview	11-2
Managing Adapter Interactions	11-4
Accessing Adapter Interaction Management Tasks	11-6
Adding an Adapter Interaction	11-7
Adding an Advanced Queuing Adapter Interaction	11-11
Adding an E-Mail Adapter Interaction	11-13
Adding a File/FTP Adapter Interaction	11-14
Adding an HTTP Adapter Interaction	11-16
Adding a JMS (Java Message Service) Adapter Interaction	11-18
Adding an Oracle Database Adapter Interaction	11-20
Adding a Web Service Adapter Interaction.....	11-23
Review the Adapter Interaction Details	11-25
Creating Native and Application Event Types and Body Elements.....	11-27
Review the Create Native Event Type Details	11-32
Deleting an Adapter Interaction.....	11-35
Viewing an Adapter Interaction.....	11-36
Managing Native Event Types	11-37
Accessing Native Event Type Management Tasks	11-39
Creating a Native Event Type.....	11-40

Deleting a Native Event Type.....	11-42
Viewing a Native Event Type.....	11-42
Viewing a Record Type Element.....	11-43
Viewing an Event Body Element.....	11-44
Adding Native Event Body Element Validation.....	11-45
Managing Native Event Correlations	11-47
Accessing Native Event Correlation Management Tasks.....	11-49
Creating a Native Event Correlation	11-50
Deleting a Native Event Correlation.....	11-52
Updating a Native Event Correlation.....	11-52
Viewing a Native Event Correlation.....	11-53
Managing Event Maps	11-54
Accessing Event Map Management Tasks.....	11-56
Creating an Event Map	11-57
Deleting an Event Map	11-58
Updating an Event Map	11-59
Viewing an Event Map	11-59
Viewing Application Event Types	11-60
Managing Business Event Types	11-63
Accessing Business Event Type Management Tasks	11-65
Creating a Business Event Type	11-66
Deleting a Business Event Type	11-67
Updating a Business Event Type	11-67
Viewing a Business Event Type	11-68
Creating an Event Body Element	11-69
Deleting an Event Body Element	11-70
Updating an Event Body Element.....	11-70
Viewing an Event Body Element.....	11-71
Common User Errors	11-72
Chapter Summary	11-72

Volume 2

12 Managing Business Processes and Roles

Business Process and Role Management Tasks Overview	12-2
---	------

Business Process and Role Management Tasks Graphical View	12-6
Business Process and Role Creation Methods	12-10
Viewing the Metadata Modeling Diagrams	12-11
Accessing the Metadata Modeling Diagrams.....	12-12
Accessing the Diagrams from the Business Processes or Roles Pages	12-12
Accessing the Diagrams from the Business Process Details : <i>Name</i> and <i>Role Name</i> Pages.....	12-13
Accessing the Diagrams from the Data Port Details : <i>Name</i> Page (For Role Ports) .	12-13
Accessing the Diagrams from the Data Flow Group Details : <i>Name</i> Page	12-13
Accessing the Diagrams from the Step Details : <i>Name</i> Page	12-14
Accessing the Diagrams from the Data Port Details : <i>Name</i> Page (For Step Ports) .	12-14
Accessing Diagram Details	12-14
Viewing an Integration Diagram.....	12-15
Viewing an Event Flow Diagram	12-18
Viewing a Process Diagram	12-23
Viewing a Step Binding Diagram.....	12-28
Managing Business Processes	12-33
Accessing Business Process Management Tasks.....	12-36
Creating a Business Process	12-36
Deleting a Business Process.....	12-37
Updating a Business Process.....	12-37
Viewing a Business Process.....	12-38
Managing Role Types.....	12-40
Native Role	12-41
Translation Binding Role	12-41
Application Role	12-42
Transformation Binding Role.....	12-42
Business Role	12-42
Accessing Role Management Tasks	12-44
Creating a Role.....	12-44
Deleting a Role	12-45
Updating a Role	12-46
Viewing a Role	12-46
Managing Role Ports	12-48
Accessing Role Port Management Tasks.....	12-51

Creating a Role Port	12-52
Deleting a Role Port.....	12-54
Updating a Role Port.....	12-54
Viewing a Role Port.....	12-55
Creating a Data Flow Between a Role Port and a Step Port.....	12-56
Deleting a Data Flow Between a Role Port and a Step Port	12-57
Managing Role Data Flow	12-58
Accessing Role Data Flow Management Tasks.....	12-60
Creating a Role Data Flow Group.....	12-62
Deleting a Role Data Flow.....	12-67
Updating a Role Data Flow	12-67
Viewing the Other Role Connected to the Role Data Flow	12-68
Viewing a Role Data Flow.....	12-69
Managing Steps.....	12-70
Types of Steps	12-71
Start Step.....	12-72
End Step.....	12-72
Pass-through Step.....	12-72
Transformation Step	12-73
Translation Step	12-74
Condition Step	12-75
SetParty Step	12-76
Consume Step	12-76
Split Step	12-77
Or Step	12-78
And Step	12-78
Accessing Step Management Tasks.....	12-79
Creating a Step.....	12-81
Deleting a Step	12-85
Updating a Step	12-85
Viewing a Step	12-86
Managing Step Ports	12-87
Accessing Step Port Management Tasks.....	12-89
Creating a Step Port.....	12-91
Deleting a Step Port.....	12-93

Updating a Step Port	12-93
Viewing a Step Port	12-94
Managing Step Data Flow	12-95
Accessing Step Data Flow Management Tasks	12-97
Creating a Step Data Flow	12-98
Deleting a Step Data Flow	12-100
Viewing the Target Port of a Step Data Flow	12-100
Managing Step Control Flow	12-102
Accessing Step Control Flow Management Tasks	12-104
Creating a Step Control Flow	12-105
Deleting a Step Control Flow	12-107
Updating a Step Control Flow	12-107
Managing Condition Expressions in Steps	12-108
Accessing Condition Expression Management Tasks	12-110
Creating a Condition Expression	12-111
Deleting a Condition Expression	12-112
Updating a Condition Expression	12-112
Viewing a Condition Expression	12-113
Creating a Condition Parameter	12-114
Deleting a Condition Parameter	12-115
Updating a Condition Parameter	12-115
Building a Condition Expression	12-116
Viewing a Condition Parameter	12-119
Designing Roles to Ensure Proper Validation	12-121
Loops	12-121
Invalid Or Steps	12-123
Invalid And Steps	12-124
Invalid Merging of Data Flows from Step Ports to Role Port	12-124
Invalid Merging of Data Flows Between Role Ports	12-130
Current Modeling Restrictions	12-131
Role Runtime Behavior	12-133
Coordination	12-133
Error Handling	12-135
Common User Errors	12-135
Chapter Summary	12-135

13 Managing Transformations

Transformation Overview	13-2
Transformation Maps Overview	13-3
Event Type Transformation Maps	13-3
Datatype Transformation Maps	13-4
Managing Event Type Transformation Maps	13-5
Accessing Event Type Transformation Map Management Tasks	13-8
Creating an Event Type Transformation Map	13-9
Deleting an Event Type Transformation Map	13-13
Updating an Event Type Transformation Map	13-13
Viewing an Event Type Transformation Map	13-14
Creating Additional Sources or Targets	13-17
Deleting Sources and Targets	13-18
Updating Sources and Targets	13-19
Viewing an Event Type Transformation Map Parameter	13-20
Managing Datatype Transformation Maps	13-21
Accessing Datatype Transformation Map Management Tasks	13-23
Creating a Datatype Transformation Map	13-24
Deleting a Datatype Transformation Map	13-24
Updating a Datatype Transformation Map	13-25
Viewing a Datatype Transformation Map	13-25
Transformation Statements Overview	13-27
Managing Transformation Statements	13-29
Transformation Rules	13-30
Accessing Transformation Rule Management Tasks	13-31
Creating a Transformation Rule	13-32
Mapping a Single Source and a Single Target	13-33
Mapping Multiple Sources and Targets	13-35
Explicitly Mapping Sources and Targets	13-37
Deleting a Transformation Rule	13-40
Updating a Transformation Rule	13-41
Transformation Rules Case Study: Basic Transformations Using Rules	13-41
Extending the First Transformation (HR Ad to Common View)	13-41
Extending the Second Transformation (Common View to Global NP Ad)	13-43
Transformation Conditions	13-45

Accessing Transformation Condition Management Tasks.....	13-45
Creating an IF Condition	13-46
Creating an Initial IF Condition	13-47
Inserting an AND Condition	13-49
Creating an ELSE Statement	13-52
Associating a Statement with an IF Condition or ELSE Condition.....	13-52
Removing a Statement from an IF Condition or ELSE Condition.....	13-54
Deleting an IF or ELSE Condition	13-54
Updating an IF Condition	13-54
Transformation Condition Case Study: Converting Importance to Featured/Ordinary Ad.....	13-55
Creating an IF-ELSE Condition	13-55
Associating Statements with IF-ELSE Blocks	13-56
Transformation Iterators.....	13-58
Accessing Iterator Management Tasks	13-58
Creating an Iterator	13-59
Deleting an Iterator.....	13-61
Updating an Iterator.....	13-61
Iterator Case Study: Transforming Ad Request with an Unbounded Number of Ads .	13-62
Creating an Iterator for the Inbound Direction.....	13-62
Creating an Iterator for the Outbound Direction.....	13-66
Transformation Map Variables.....	13-70
Accessing Map Variable Management Tasks	13-70
Creating a Map Variable	13-71
Using a Map Variable in a Rule	13-73
Deleting a Map Variable	13-73
Updating a Map Variable	13-74
Map Variable Case Study: Using Map Variables to Create a Formatted Name.....	13-74
Event Header Rules	13-77
Accessing Event Header Rule Management Tasks.....	13-77
Creating an Event Header Rule	13-78
Deleting an Event Header Rule	13-81
Updating an Event Header Rule	13-81
Event Header Rules Case Study: Sending to the Correct Target Newspaper	13-82
Domain Value Maps.....	13-83

Domain Value Maps Overview	13-83
Managing Domain Value Maps	13-85
Accessing Domain Value Map Management Tasks	13-86
Creating a Domain Value Map	13-87
Deleting a Domain Value Map	13-88
Updating a Domain Value Map	13-88
Viewing a Domain Value Map	13-89
Managing Domain Columns and Parties	13-90
Accessing Domain Column and Party Management Tasks	13-91
Creating a Domain Column	13-92
Deleting a Domain Column	13-94
Updating a Domain Column	13-94
Viewing a Domain Column	13-95
Adding a Domain Party	13-95
Removing a Domain Party	13-97
Managing Domain Value Map Columns and Rows	13-97
Accessing Domain Value Map Column and Row Management Tasks	13-100
Adding a Domain Value Map Column	13-101
Removing a Domain Value Map Column	13-101
Creating a Domain Value Map Row	13-102
Deleting a Domain Value Map Row	13-103
Updating a Domain Value Map Row	13-103
Domain Value Map Rules	13-104
Accessing Domain Value Map Rule Management Tasks	13-105
Creating a Domain Value Map Rule	13-106
Deleting a Domain Value Map Rule	13-109
Updating a Domain Value Map Rule	13-109
Domain Value Map Case Study: Changing Ad Vocabulary	13-110
Creating Domain Columns	13-110
Creating a Domain Value Map	13-111
Creating an Incoming Domain Value Map Rule	13-112
Creating an Outgoing Domain Value Map Rule	13-114
Common User Errors	13-115
Chapter Summary	13-115

14 Advanced Transformations Design

Implicit Conversion Support	14-2
Example 1: Implicit Conversion for Source and Target Parameters	14-3
Mapping Logic	14-4
Example 2: Implicit Conversion of Source and Target Parameters in the Same Datatype Transformation Map	14-4
Mapping Logic	14-6
Invalid Case	14-6
Invalid Mapping Logic	14-6
Valid Mapping Logic	14-7
Common User Errors in Transformation Design	14-9
Not Checking for the Existence of an Optional Datatype Member.....	14-9
Example.....	14-9
Incorrect Design.....	14-9
Correct Design	14-10
Not Checking for the Existence of a Datatype Member of the Model Group Choice	14-10
Example.....	14-10
Incorrect Design.....	14-10
Correct Design	14-11
Mapping Logic	14-11
Not Defining an Iterator to Access a Datatype Member with Multiple Occurrences	14-12
Example.....	14-12
Incorrect Design.....	14-12
Correct Design	14-12
Not Creating a Submap to Populate a Multiple Occurrence Target Member	14-12
Example.....	14-13
Incorrect Design.....	14-14
Correct Design	14-15
Incrementally Populating a Complex Datatype Using Submaps.....	14-15
Example.....	14-16
Incorrect Design.....	14-16
Correct Design	14-17
Not Populating Mandatory Target Members.....	14-17
Example.....	14-17
Incorrect Design.....	14-17

Correct Design	14-17
Transformation Design Limitations	14-18
Only Global Map Variables are Supported	14-18
Example	14-18
Workaround	14-19
Transformation Statements Cannot be Moved in the User Interface Tool	14-19
Example	14-19
Workaround	14-20
No Overwrite Ability for Target Members	14-20
Example	14-20
Workaround	14-21
NOT Operator is Unsupported	14-21
Description	14-21
Example	14-21
Workaround	14-21
Transformation Iterator Design	14-23
Multiple Occurrence Target Members from Multiple Occurrence Source Members.....	14-23
Target Member of Scalar Datatype	14-24
Target Member of Complex Datatype.....	14-24
Different Target Members Mapped from the Same Source Member	14-26
Nested Multiple Occurrence Members in the Target Datatype	14-28
Single Occurrence Target Members from Multiple Occurrence Source Members	14-30
Data-Based Condition.....	14-30
Position-Based Condition.....	14-32
User Discretion - Direct Mapping without an Iteration	14-34
Cumulative Computation	14-35
Structure Flattening Iterations (Nested Iterators).....	14-36
Nesting Design	14-40
Iteration within a Condition	14-40
Example	14-40
Mapping Logic.....	14-41
Condition within a Condition.....	14-42
Example	14-42
Mapping Logic.....	14-43
Transformation Map Variable Design	14-44

Reuse (Preservation of State).....	14-44
Example.....	14-44
Mapping Logic.....	14-45
Event Header Rule Design	14-46
Retrieving Contact/Identifier Information after Getting the Party	14-46
Domain Value Map Design	14-47
Multiple Party to Single Domain Relationship	14-47
Miscellaneous Designs	14-48
Constructs with Anonymous Members	14-48
Constructs with Anonymous Members Example.....	14-48
Mapping Logic	14-48
Choice	14-49
Referring to the Entire Map Parameter	14-50
Example.....	14-50
Mapping Logic.....	14-50
Multiple Datatype Members with the Same Name	14-50
Multiple Members with the Same Name Example.....	14-50
Mapping Logic.....	14-51
Chapter Summary	14-52

Part IV Administrator Management Tasks

15 Managing Applications and Application Agreements

Application and Application Agreement Overview	15-2
Managing Applications	15-4
Accessing Application Management Tasks	15-5
Creating an Application.....	15-5
Deleting an Application.....	15-6
Updating an Application.....	15-6
Viewing an Application.....	15-7
Managing Adapters and Delivery Channels	15-9
Accessing Adapter and Delivery Channel Management Tasks	15-10
Adding an Adapter to an Application.....	15-12
Removing an Adapter from an Application.....	15-13
Viewing an Adapter	15-13

Creating an Application Delivery Channel	15-14
Creating an Advanced Queuing Adapter Delivery Channel	15-16
Creating an E-Mail adapter Delivery Channel	15-17
Creating a File/FTP Adapter Delivery Channel.....	15-18
Creating an HTTP Adapter Delivery Channel.....	15-20
Creating a JMS Adapter Delivery Channel	15-22
Creating an Oracle Database Delivery Channel	15-24
Creating a Web Service Delivery Channel	15-25
Deleting an Application Delivery Channel	15-26
Updating an Application Delivery Channel.....	15-26
Viewing an Application Delivery Channel.....	15-27
Managing Application Agreements	15-29
Accessing Application Agreement Management Tasks	15-31
Creating an Application Agreement.....	15-32
Deleting an Application Agreement.....	15-33
Updating an Application Agreement	15-34
Viewing an Application Agreement.....	15-34
Viewing an Application Agreement Participant	15-36
Adding an Application Delivery Channel to an Application Agreement	15-37
Removing an Application Delivery Channel from an Application Agreement	15-38
Updating an Application Delivery Channel in an Application Agreement.....	15-38
Viewing an Application Delivery Channel in an Application Agreement.....	15-39
Managing Native Roles in Application Agreements	15-41
Accessing Application Agreement Native Role Management Tasks	15-42
Adding an Application Agreement Native Role	15-43
Removing an Application Agreement Native Role.....	15-43
Managing Application and Agreement Validation and Approval	15-44
Common User Errors	15-45
Chapter Summary	15-45

16 Creating and Deploying a Configuration

Configuration Overview	16-2
What is a Configuration?.....	16-2
Configuration Creation Overview	16-2
Creating a Configuration	16-3

Successful Configuration Creation and Validation	16-6
Unsuccessful Configuration Creation and Validation	16-7
Deploying a Configuration	16-9
Configuration Deployment Overview	16-9
Deploying a Validated Configuration	16-10
Discarding a Configuration	16-12
Exporting a Configuration	16-12
Common User Errors	16-13
Chapter Summary	16-13

17 Administering Integrations with the User Interface Tool

Administering Oracle Application Server ProcessConnect with the User Interface Tools	17-2
Administering Adapters	17-5
Accessing Adapter Administration Tasks	17-8
Adding an Adapter	17-9
Deleting an Adapter	17-10
Viewing an Adapter	17-10
Viewing an Adapter Provider	17-11
Creating an Adapter Error Message Code	17-11
Managing the Adapter Framework Instance	17-13
Updating an Adapter Framework Instance	17-14
Viewing an Adapter Framework Instance	17-15
Administering Native Formats	17-16
Accessing Native Format Administration Tasks	17-19
Creating a Native Format	17-20
Viewing a Native Format	17-21
Adding an Adapter Exchange Protocol to a Native Format	17-22
Removing an Adapter Exchange Protocol from a Native Format	17-23
Adding a Translator to a Native Format	17-24
Removing a Translator from a Native Format	17-24
Creating Validation for a Native Format	17-25
Deleting Validation from a Native Format	17-26
Updating Validation of a Native Format	17-26
Viewing Validation of a Native Format	17-27
Viewing a Translator of a Native Format	17-27

Administering Translators	17-29
Accessing Translator Administration Tasks.....	17-30
Creating a Translator	17-31
Deleting a Translator.....	17-33
Viewing a Translator.....	17-33
Adding a Native Format to a Translator.....	17-34
Removing a Native Format from a Translator	17-34
Administering Application Types.....	17-35
Accessing Application Type Administration Tasks	17-36
Creating an Application Type	17-37
Viewing an Application Type.....	17-37
Viewing Business Protocols.....	17-38
Viewing Collaborations.....	17-40
Administering Contact Types.....	17-42
Accessing Contact Type Administration Tasks	17-43
Creating a Contact Type	17-44
Updating a Contact Type	17-45
Viewing a Contact Type	17-45
Viewing Digital Envelopes.....	17-47
Viewing Digital Signatures	17-48
Administering Trading Partner Identification Types.....	17-49
Accessing Trading Partner Identification Type Administration Tasks	17-50
Creating a Trading Partner Identification Type.....	17-51
Viewing a Trading Partner Identification Type.....	17-52
Exporting and Importing Integrations.....	17-53
Exporting an Integration	17-56
Importing an Integration.....	17-56
Chapter Summary.....	17-57

18 System Management with Oracle Enterprise Manager

Oracle Enterprise Manager Monitoring and Administration Overview	18-2
Oracle Application Server ProcessConnect Management Concepts and Components...	18-3
Oracle Application Server Metadata Repository.....	18-3
Oracle Application Server ProcessConnect Instance	18-4
Integration Manager	18-4

Adapter Framework.....	18-4
OC4J Instance for Oracle Application Server ProcessConnect.....	18-4
Oracle Enterprise Manager Application Server Control Tasks.....	18-4
Managing and Monitoring a Middle-Tier Instance from Oracle Enterprise	
Manager Application Server Control.....	18-5
Oracle Application Server ProcessConnect Monitoring and Administration Tasks.....	18-8
Oracle Application Server ProcessConnect Log Files.....	18-10
Oracle Application Server ProcessConnect Middle-Tier Instance Configuration Parameters	18-11
Oracle Application Server ProcessConnect Middle-Tier Instance Performance.....	18-13
Oracle Process Management Notification Management.....	18-14
Oracle Application Server ProcessConnect Port Management.....	18-14
Oracle Application Server and Enterprise Relationship Management.....	18-16
Starting and Stopping Oracle Application Server ProcessConnect Components with OPMN	18-17
Additional Oracle Application Server and Oracle Application Server ProcessConnect Management Tasks	18-18
Changing Port Numbers.....	18-19
Port Changing Error Message.....	18-19
Modifying Ports	18-20
Chapter Summary	18-22

19 Performance Tuning

Performance Factors in Oracle Application Server ProcessConnect.....	19-2
Components of an Oracle Application Server ProcessConnect Instance	19-2
Diagnosing Performance Issues in Oracle Application Server ProcessConnect.....	19-3
Adapter Framework Performance.....	19-4
Tuning the Adapter Framework.....	19-6
Increasing JVM Memory for the Adapter Framework	19-7
Increasing the Outbound Processor Threads	19-8
Tuning Technology Adapters.....	19-8
Advanced Queuing Adapter.....	19-8
Oracle Database Adapter.....	19-9
File/FTP Adapter.....	19-9
Integration Manager Performance.....	19-10

Using Enterprise Manager to Configure the Number of Threads	19-10
Using Enterprise Manager to View Transformation and Translation Performance	19-11
Tuning the Integration Manager	19-12
Increasing JVM Memory for the Integration Manager	19-13
Increasing the Binding Role Threads.....	19-14
Setting the Appropriate BI Reporting Level.....	19-14
Design Tool Performance	19-15
Increasing JVM Memory for the OC4J Instance	19-15
Metadata Repository Tuning	19-16
Memory Configuration.....	19-16
I/O Contention	19-17
Undo and Temporary Tablespaces.....	19-17

20 Oracle Application Server ProcessConnect Security

About Oracle Application Server ProcessConnect Security	20-2
Classes of Users and Their Privileges.....	20-2
Resources Protected	20-3
Authorization and Access Enforcement.....	20-4
Use of Oracle Application Server Security Services	20-4
Use of Oracle Identity Management Infrastructure	20-4
Security for Oracle Application Server ProcessConnect Extensibility	20-4
Configuring Oracle Application Server Security Framework for Oracle Application Server ProcessConnect	20-5
Oracle Application Server ProcessConnect Security Framework Configuration Issues ..	20-5
Identity Management Configuration Issues Specific to Oracle Application Server ProcessConnect	20-5
Configuring Oracle Application Server ProcessConnect Security	20-6
Oracle Application Server ProcessConnect Installation	20-6
Oracle Application Server ProcessConnect Security Configuration.....	20-7
Application Delivery Channels.....	20-7
Digital Envelopes	20-8
Digital Signatures for Host and Remote Trading Partners	20-9
Secure HTTP and Client Authentication	20-10
Encrypted Wallet Passwords for Host Trading Partners	20-12
Host Trading Partner Password Encryption in High Availability Environments.....	20-13

Configuration Issues and Options to Use for Oracle Application Server Security Framework.....	20-14
Chapter Summary	20-14

21 Oracle Application Server ProcessConnect Error Handling

Domain and System Error Handling	21-2
Administrator Types	21-2
System Administrator	21-2
Business Administrator	21-2
Types of Errors	21-3
Error Handling with Step Return Code Ports	21-4
Creating a Step Return Code Port.....	21-7
Additional Domain Error Modeling Examples.....	21-8
Implications of Role Instances and Event Instances Being in an Error State	21-10
Where Do I Find Runtime Error Details?	21-13
Typical Adapter Framework and Integration Manager Errors	21-15
Alert E-Mail Message Format	21-17
Creating an Alert E-Mail Message Native Format.....	21-19
Chapter Summary	21-20

22 Oracle Application Server ProcessConnect Troubleshooting

Runtime Troubleshooting Methods	22-2
Log Files	22-2
Business Intelligence Logging Levels	22-3
Reports	22-4
Performing Runtime Troubleshooting	22-5
Creating an Error Status Report	22-5
Creating a Coordination Status Report	22-6
Creating an Event Status Report	22-7
Using the IP.tip_rtlog table.....	22-8
Troubleshooting Use Case.....	22-8
Design-Time Troubleshooting of Modeling Metadata Dependencies	22-9
Modeling Metadata Dependency Graphical View	22-10
Application Event Dependency Example	22-11
Modeling Metadata Dependency Cases.....	22-12

Native Event Type.....	22-13
Common Modeling Metadata Dependency Error Examples.....	22-14
Additional Troubleshooting Documentation.....	22-17
Troubleshooting Details in the User Guide.....	22-17
Troubleshooting Details in the Application Adapter Guides.....	22-19
Chapter Summary.....	22-19

Part V Analyst Management Tasks

23 Creating Reports

Reports Overview.....	23-2
Configuration Support in Reports.....	23-3
Values Available when the Default Configuration is Selected.....	23-3
Values Available when Unspecified is Selected.....	23-4
Values Available when a Different Configuration is Selected.....	23-4
Process Monitoring Reports.....	23-5
Activity Monitoring.....	23-6
Process Optimization.....	23-6
Creating Process Monitoring Reports.....	23-7
Event Status Report.....	23-8
Specify Event Status Report Parameters.....	23-9
Specify Advanced Event Status Report Parameters.....	23-11
Specify Event Contents.....	23-12
Coordination Status Report.....	23-13
Specify Coordination Status Report Parameters.....	23-14
Specify Advanced Coordination Status Report Parameters.....	23-15
Error Status Report.....	23-17
Specify Error Status Report Parameters.....	23-18
Specify Advanced Error Status Report Parameters.....	23-19
Specify Event Contents.....	23-20
Collaboration Status Report.....	23-21
Specify Report Parameters.....	23-21
Business Message Status Report.....	23-22
Specify Report Parameters.....	23-22
Creating Activity Monitoring Reports.....	23-23

Specify Activity Monitoring Report Parameters.....	23-24
Specify Advanced Activity Monitoring Report Parameters	23-25
Specify Event Contents	23-26
Creating Process Optimization Reports	23-28
Specify Process Optimization Report Parameters	23-29
Specify the First Port	23-29
Specify a Second Port.....	23-30
Specifying the Layout of Your Report	23-30
Reviewing Your Selections Before Creation.....	23-31
Reviewing Your Output.....	23-31
Reviewing Business Message and Collaboration Status Report Output.....	23-31
Reviewing the Report Output for All Others	23-31
Report Creation Examples.....	23-32
Monitoring iProcurement Process Status.....	23-32
Monitoring Coordination Details.....	23-36
Monitoring Current Errors in an Integration.....	23-38
Monitoring the Total and Average Amount of Desktop Personal Computers for this Month	23-39
Monitoring Business Process Efficiency.....	23-44
Common User Errors	23-50
Chapter Summary	23-50

Part VI RosettaNet Solutions

24 RosettaNet B2B Protocol Standard

What is a B2B Protocol Standard?.....	24-2
What Is RosettaNet?	24-3
RosettaNet Implementation Framework.....	24-4
RNIF Version 1.1.....	24-4
RNIF Version 2.0.....	24-5
Partner Interface Processes.....	24-6
What Is a Partner Interface Process?.....	24-6
PIP Components	24-7
PIP Classifications	24-8
PIP Message Flow Example	24-9

RosettaNet Dictionaries	24-10
RosettaNet Validation.....	24-11
Oracle Application Server ProcessConnect Support for RosettaNet.....	24-12
Oracle Application Server ProcessConnect Support for the RosettaNet Implementation Framework	24-12
RNIF Version 1.1.....	24-13
RNIF Version 2.0.....	24-13
Oracle Application Server ProcessConnect Support for Partner Interface Processes	24-14
Oracle Application Server ProcessConnect Support for RosettaNet Dictionaries.....	24-15
Oracle Application Server ProcessConnect Support for RosettaNet Validation	24-15
What Is a Trading Partner Agreement?.....	24-16
What Are Trading Partners?	24-18
Party ID	24-18
Delivery Channel.....	24-18
What Are Collaborations?	24-19
Business Transaction.....	24-19
Business Collaboration	24-20
Roles	24-20
Business Actions.....	24-20
Oracle Application Server ProcessConnect Support for Trading Partner Agreements	24-21
Oracle Application Server ProcessConnect Support for Trading Partners.....	24-21
Party ID	24-21
Delivery Channel.....	24-22
Oracle Application Server ProcessConnect Support for Collaborations.....	24-23
Business Transaction.....	24-23
Business Collaboration	24-24
Roles	24-24
Business Actions.....	24-24
RosettaNet and Oracle Application Server ProcessConnect Terminology Differences ...	24-25
Chapter Summary	24-25

Volume 3

25 Managing Host and Remote Trading Partner Capabilities

Host and Remote Trading Partner Management Tasks Overview	25-2
---	------

Defining Host and Remote Trading Partner Capabilities.....	25-3
Managing Trading Partner Identifications	25-4
Accessing Trading Partner Identification Management Tasks	25-7
Updating the Trading Partner Name and Description	25-8
Creating Trading Partner Identification.....	25-8
Deleting Trading Partner Identification.....	25-9
Updating Trading Partner Identification	25-10
Viewing Trading Partner Identification	25-10
Managing Organizations.....	25-11
Managing Persons	25-13
Accessing Person Management Tasks.....	25-15
Creating a Person	25-16
Deleting a Person.....	25-18
Updating a Person.....	25-18
Viewing a Person and Updating the Password	25-18
Creating Person Contact Details.....	25-20
Deleting Person Contact Details.....	25-21
Updating Person Contact Details.....	25-21
Viewing Person Contact Details.....	25-22
Adding a User Role to a Host Trading Partner Person.....	25-23
Removing a User Role from a Host Trading Partner Person.....	25-24
Viewing User Role and Use Case Group Details	25-24
Managing Organization Contact Details.....	25-26
Accessing Organization Contact Management Tasks.....	25-27
Creating Organization Contact Details	25-28
Deleting Organization Contact Details	25-28
Updating Organization Contact Details.....	25-29
Viewing Organization Contact Details.....	25-29
Managing Cooperations	25-30
Managing Supported Actors.....	25-31
Accessing Supported Actor Management Tasks	25-32
Creating a Supported Actor	25-34
Deleting a Supported Actor	25-35
Updating a Supported Actor	25-35
Viewing a Supported Actor for a Host Trading Partner	25-36

Viewing a Supported Actor for a Remote Trading Partner	25-38
Updating Validation Rules States for a Host Trading Partner	25-40
Updating Validation Rules States for a Remote Trading Partner	25-40
Managing Business Protocols	25-42
Accessing Business Protocol Management Tasks.....	25-43
Adding a Business Protocol	25-45
Removing a Business Protocol	25-45
Viewing a Document Protocol.....	25-45
Viewing an Exchange Protocol.....	25-46
Viewing a Business Protocol.....	25-48
Viewing a Process Protocol.....	25-49
Managing Delivery and Security	25-50
Managing Remote Trading Partner Certificates	25-51
Accessing Remote Trading Partner Certificate Management Tasks.....	25-52
Creating a Remote Trading Partner Certificate	25-53
Deleting a Remote Trading Partner Certificate.....	25-54
Updating a Remote Trading Partner Certificate.....	25-54
Viewing a Remote Trading Partner Certificate.....	25-55
Managing Transports.....	25-56
Accessing Transport Management Tasks	25-57
Creating a Transport	25-59
Deleting a Transport	25-60
Updating a Transport	25-60
Viewing a Transport	25-60
Deleting a Transport Endpoint.....	25-61
Updating a Transport Endpoint.....	25-61
Viewing a Transport Endpoint.....	25-62
Managing Document Exchanges.....	25-63
Accessing Document Exchange Management Tasks	25-66
Creating a Document Exchange.....	25-67
Deleting a Document Exchange	25-69
Updating a Document Exchange	25-69
Viewing a Document Exchange	25-70
Updating Exchange Protocol Override Elements.....	25-71
Updating Exchange Protocol Parameters	25-71

Managing Delivery Channels	25-73
Accessing Delivery Channel Management Tasks.....	25-74
Creating a Delivery Channel.....	25-75
Deleting a Delivery Channel.....	25-77
Updating a Delivery Channel.....	25-78
Viewing a Delivery Channel.....	25-78
Managing Endpoints	25-79
Managing Endpoints.....	25-80
Accessing Endpoint Management Tasks	25-81
Creating an Endpoint.....	25-82
Deleting an Endpoint	25-82
Updating an Endpoint	25-83
Viewing an Endpoint	25-83
Managing Protocol Endpoints	25-84
Accessing Protocol Endpoint Management Tasks.....	25-85
Creating a Protocol Endpoint	25-86
Deleting a Protocol Endpoint.....	25-88
Updating a Protocol Endpoint.....	25-88
Viewing a Protocol Endpoint.....	25-89
Managing the Host Trading Partner Wallet Password.....	25-90
Creating a Host Trading Partner Wallet Password	25-91
Updating a Host Trading Partner Wallet Password.....	25-92
Managing Host and Remote Trading Partner Profile Data Validation and Approval	25-93
Chapter Summary	25-94

26 Managing Trading Partners and Trading Partners Agreements

Trading Partner Agreement Overview.....	26-2
Trading Partner Agreement	26-3
Application Agreement	26-5
Managing Remote Trading Partners	26-6
Accessing Remote Trading Partner Management Tasks	26-8
Creating a Remote Trading Partner	26-9
Deleting a Remote Trading Partner	26-10
Updating a Remote Trading Partner	26-10
Viewing a Remote Trading Partner	26-10

Creating Remote Trading Partner Identification	26-12
Managing Trading Partner Agreements	26-14
Accessing Trading Partner Agreement Management Tasks	26-15
Creating a Trading Partner Agreement.....	26-15
Deleting a Trading Partner Agreement.....	26-16
Updating a Trading Partner Agreement	26-17
Viewing a Trading Partner Agreement.....	26-17
Managing Trading Partner Agreement Participants	26-20
Accessing Trading Partner Agreement Participant Management Tasks	26-22
Adding Trading Partner Agreement Participants	26-23
Removing a Trading Partner Agreement Participant	26-25
Updating a Trading Partner Agreement Participant.....	26-25
Viewing a Trading Partner Agreement Participant	26-26
Adding a Delivery Channel to a Trading Partner Agreement Participant	26-26
Removing a Delivery Channel from a Trading Partner Agreement Participant	26-27
Updating a Delivery Channel of a Trading Partner Agreement Participant.....	26-28
Viewing a Delivery Channel of a Trading Partner Agreement Participant	26-28
Managing Native Roles in Trading Partner Agreements	26-30
Accessing Trading Partner Agreement Native Role Management Tasks	26-31
Adding a Trading Partner Agreement Native Role	26-32
Removing a Trading Partner Agreement Native Role.....	26-33
Managing Trading Partner and Agreement Validation and Approval	26-33
Common User Errors	26-34
Chapter Summary	26-35

Part VII Reference

A Native Formats and Translators

Native Format and Translation Overview	A-2
Native Event Type and Native Event Body Element Creation.....	A-2
Datatype Creation.....	A-3
XSD	A-3
Ignored XSD Tags and Attributes	A-4
Unsupported Tags	A-6
all with minOccurs="0"	A-6

anyAttribute	A-8
choice or sequence with minOccurs="0", maxOccurs Greater than 1 Except If parent is choice or sequence, or Both.....	A-8
complexContent or complexType with mixed="true"	A-10
list.....	A-13
union.....	A-13
restriction (simpleContent) if the base attribute refers to a simpleType or if it has a locally defined base simpleType	A-13
restriction (simpleContent) that restricts any facets of its base complexType	A-15
Reference to an Empty Group.....	A-17
Unsupported Structure	A-18
Workaround	A-19
Invalid XSDs	A-19
Nondeterministic choice Block	A-20
Nondeterministic sequence Block.....	A-21
Deterministic XSD Constructs with lookahead.....	A-26
Attributes with Unsupported Values	A-29
Unsupported XML Instance Constructs.....	A-30
xsi:type	A-30
xsi:nil	A-30
Naming Restrictions.....	A-31
simpleType and complexType	A-31
element, attribute, group, and attributeGroup	A-31
XSD Support Unavailable through Oracle Application Server ProcessConnect User Interface Tool.....	A-34
Derived Datatypes.....	A-34
Datatypes	A-35
Datatype Members	A-35
Data Definition Description Language	A-37
About D3L.....	A-37
What Is D3L?	A-37
When Is D3L Used?.....	A-37
Wire Message Format and D3L File Example	A-38
Wire Message Contents Description in a D3L File	A-39
D3L File Structure	A-40

D3L File Structure Example	A-40
Supported D3L Datatypes	A-43
Signed and Unsigned Integers	A-43
Floating Point Numbers	A-46
Strings and Dates.....	A-47
Structures.....	A-56
Sequences and Arrays.....	A-57
Data Padding Usage.....	A-63
Comma-Separated Values File Parsing with D3L	A-64
CSVs Assigned to Named Fields	A-65
All CSVs Are Read into an Array	A-66
Delimiter Encoding Styles.....	A-66
Oracle Application Server ProcessConnect Enhancements to D3L	A-67
New D3L Document Type	A-68
Import Function.....	A-70
Field Separators	A-71
Field Terminators	A-71
Delimited Array Cardinality	A-72
Field Optionality.....	A-73
Escape Character and Sequences	A-75
Variables in D3L	A-76
Assignment Blocks	A-78
Strict vs. Lenient (Relaxed) Translation Modes	A-80
Type Aliasing.....	A-81
Conditional Parsing (One Token Look Ahead)	A-82
Validation - D3L Valid Values.....	A-84
Character Set Encoding	A-85
Importing D3L Datatypes	A-85
Additional D3L Sample Files and DTD.....	A-90
Additional D3L Sample Files.....	A-91
D3L DTDs.....	A-96
Token Substituted Text	A-124
Definition File.....	A-124
Subject Body of a Definition File	A-126
Message Body of a Definition File.....	A-126

Token Substituted Text in a Definition File	A-127
Token Substituted Text Datatypes and Event Body Elements.....	A-128
Inbound E-Mail Responses to an Alert E-Mail.....	A-129
Appendix Summary	A-130

B Transformation Rules

Transformation Rules.....	B-2
add:first=decimal,second=decimal->result=decimal	B-2
add:first=float,second=float->result=float	B-2
add:first=integer,second=integer->result= integer.....	B-3
concat:firstString=string,secondString=string->resultString=string	B-3
copy:from=binary->to=binary	B-4
copy:from=boolean->to=boolean	B-4
copy:from=character->to=character	B-5
copy:from=dateTime->to=dateTime.....	B-5
copy:from=decimal->to=decimal	B-5
copy:from=double->to=double	B-6
copy:from=float->to=float	B-6
copy:from=integer->to=integer	B-6
copy:from=string->to=string	B-7
copy:from=xmlOpaque->to=xmlOpaque	B-7
decimalToInteger:source=decimal->result=integer	B-8
divide:first=decimal,second=decimal->result=decimal	B-8
divide:first=float,second=float->result=float	B-8
divide:first=integer,second=integer->result=integer	B-9
doubleToDecimal:source=double->result=decimal	B-9
doubleToFloat:source=double->result=float	B-10
doubleToInteger:source=double->result=integer.....	B-10
endsWith:sourceString=string,sourceSuffix=string->resultFoundSuffix=boolean	B-10
endsWith:sourceString=string,sourceSuffix=string,sourceBeginOffset=integer-> resultFoundSuffix=boolean.....	B-11
floatToInteger:source=float->result=integer	B-12
format:date=dateTime,formatPattern=string->resultString=string.....	B-12
Date and Time Patterns	B-12
Parameters	B-15

format:value=decimal,formatPattern=string->resultString=string	B-15
Patterns	B-16
Special Pattern Characters	B-17
Scientific Notation	B-18
Rounding	B-19
Parameters	B-19
format:value=double,formatPattern=string->resultString=string	B-20
format:value=float,formatPattern=string->resultString=string	B-20
format:value=integer,formatPattern=integer->resultString=string	B-21
generateGUIDString:->GUIDString=string	B-21
getPartyContactInformation:partyName=string,contactInfoType=string->contactInfo=string	B-22
getPartyIdentification:partyName=string,partyIdentificationType=string->partyIdentification=string	B-22
getSystemDate:->systemDate=datetime	B-23
getTradingPartnerNameFromIdentifier:identifierNumber=string,identifierType=string->tradingPartnerName=string	B-23
indexOfString:sourceString=string,searchString=string,beginOffset=integer->resultIndex=integer	B-24
indexOfString:sourceString=string,searchString=string->resultIndex=integer	B-24
lastIndexOfString:sourceString=string,searchString=string->resultIndex=integer	B-25
lastIndexOfString:sourceString=string,searchString=string,beginOffset=integer->resultIndex=integer	B-25
leftTrim:sourceString=string->resultString=string	B-26
lowerCase:sourceString=string->resultString=string	B-26
multiply:first=decimal,second=decimal->result=decimal	B-27
multiply:first=float,second=float->result=float	B-27
multiply:first=integer,second=integer->result=integer	B-28
rightTrim:sourceString=string->resultString=string	B-28
startsWith:sourceString=string,sourcePrefix=string->resultFoundPrefix boolean	B-29
startsWith:sourceString=string,sourcePrefix=string,sourceBeginOffset=integer->resultFoundPrefix boolean	B-29
stringCompareTo:sourceString=string,sourceCompareTo=string->resultEquals=integer	B-30
stringCompareToIgnoreCase:sourceString=string,sourceCompareTo=string->	

resultEquals=integer	B-31
stringLength:sourceString=string->resultLength=integer	B-32
stringToBoolean:source=string->result=boolean.....	B-32
stringToCharacter:source=string->result=character	B-32
stringToDateTime:source=string->result=dateTime.....	B-33
stringToDateTime:source=string,pattern=string->result=dateTime	B-33
stringToDecimal:source=string->result=decimal	B-34
stringToDouble:source=string->result=double	B-34
stringToFloat:source=string->result=float.....	B-34
stringToInteger:sourcesting=string->resultinteger=integer	B-35
substring:sourceString=string,beginIndex=integer,endIndex=integer->resultString=string	B-35
substring:sourceString=string,beginIndex=integer->resultString=string	B-36
substringAfter:sourceString=string,delimiter=string->resultString=string.....	B-36
substringBefore:sourceString=string,delimiter=string->resultString=string.....	B-37
subtract:first=decimal,second=decimal->result=decimal	B-37
subtract:first=float,second=float->result=float.....	B-38
subtract:first=integer,second=integer->result=integer	B-38
trim:sourceString=string->resultString=string	B-39
upperCase:sourceString=string->resultString=string.....	B-39
Event Header Rules	B-40
setToParty	B-40
setFromParty	B-40
getToParty.....	B-41
getFromParty.....	B-41
Domain Value Map Rules	B-41
lookupPartyDomainWithDefaultValue	B-42
lookupPartyDomain	B-42
lookupBusinessViewDomainWithDefaultValue	B-43
lookupBusinessViewDomain.....	B-44
Appendix Summary	B-44

C Error Codes

AIP-10000 to AIP-10438 Runtime Error Codes	C-2
AIP-11000 to AIP-11999 Repository Error Codes.....	C-13

AIP-12000 to AIP 12600 Adapter Error Codes.....	C-20
AIP-13000 to AIP-16014 Business Logic Layer Error Codes.....	C-27
AIP-14000 to AIP-14018 Transformation Error Codes.....	C-42
AIP-14100 to AIP-14114 Translation Error Codes.....	C-45
AIP-14115 to AIP-14119 XSD Translation Error Codes	C-46
AIP-14321 to AIP-14325 Event Validation Error Codes.....	C-47
AIP-14401 to AIP-14406 Correlation Error Codes	C-48
AIP-14451 to AIP-14455 Domain Value Map Error Codes	C-48
AIP-16020 to AIP-17997 Metadata Validation Rules Error Codes.....	C-49
AIP-18000 to AIP-18999 Deployment Error Codes	C-94
AIP-19000 to AIP-19999 UI Modeling Error Codes.....	C-96
AIP-50000 to AIP-51999 Transport Error Codes.....	C-100
AIP-51801 to AIP-51928 RosettaNet Validation Error Codes.....	C-119

D Jacada Integrator Adapter for Legacy Systems

Jacada Integrator as a JCA Resource Adapter	D-2
Mapping Application Screens Using MapMaker	D-2
Trails and Trail Recording.....	D-3
Screens and Screen Mapping.....	D-3
Data Field Mapping	D-4
Definition of Methods.....	D-4
Definition of Services	D-6
Jacada Integrator and Java Connector Architecture	D-6
Service Provider Interface	D-7
Common Client Interface	D-7
More Information About Jacada Integrator.....	D-8

Glossary

Index

Send Us Your Comments

Oracle Application Server ProcessConnect User's Guide, 10g (9.0.4)

Part No. B12121-01

Oracle Corporation welcomes your comments and suggestions on the quality and usefulness of this document. Your input is an important part of the information used for revision.

- Did you find any errors?
- Is the information clearly presented?
- Do you need more information? If so, where?
- Are the examples correct? Do you need more examples?
- What features did you like most?

If you find any errors or have any other suggestions for improvement, please indicate the document title and part number, and the chapter, section, and page number (if available). You can send comments to us in the following ways:

- Electronic mail: appserverdocs_us@oracle.com
- FAX: (650) 506-7407 Attn: Oracle Application Server Documentation Manager
- Postal service:
Oracle Corporation
Oracle Application Server ProcessConnect Documentation Manager
500 Oracle Parkway, Mailstop 1op6
Redwood Shores, CA 94065
USA

If you would like a reply, please give your name, address, telephone number, and (optionally) electronic mail address.

If you have problems with the software, please contact your local Oracle Support Services.

Preface

This guide is the primary source of introduction, installation, configuration, and usage information for Oracle Application Server ProcessConnect.

This preface contains these topics:

- [Audience](#)
- [Organization](#)
- [Related Documentation](#)
- [Conventions](#)
- [Documentation Accessibility](#)

Audience

Oracle Application Server ProcessConnect User's Guide is intended for customers who want to design, deploy, monitor, and manage integrations within an enterprise and integrations between enterprises.

Organization

This document contains:

Part I, "Oracle Application Server ProcessConnect Introduction and Concepts"

Chapter 1, "A Road Map to Using this Guide"

This chapter provides a road map to using this guide for each type of Oracle Application Server ProcessConnect user.

Chapter 2, "Introduction to Oracle Application Server ProcessConnect"

This chapter defines e-business and integration challenges, and describes how Oracle Application Server ProcessConnect answers integration challenges.

Chapter 3, "Oracle Application Server ProcessConnect Concepts"

This chapter provides a conceptual overview of Oracle Application Server ProcessConnect.

Chapter 4, "Oracle Application Server ProcessConnect Architecture"

This chapter provides a high-level overview of the capabilities provided by the Oracle Application Server ProcessConnect architecture.

Part II, "Introduction to the User Interface Tool"

Chapter 5, "Getting Started with the User Interface Tool"

This chapter describes how to get started with the Oracle Application Server ProcessConnect user interface tool. This chapter also briefly describes the tasks you can perform and the features available from each user interface tool tab.

Chapter 6, "Methodologies for Using Oracle Application Server ProcessConnect"

This chapter describes several methodologies for using the Oracle Application Server ProcessConnect user interface tool to design and deploy integrations.

Chapter 7, "Tutorial of an Integration within an Enterprise"

This chapter provides a simple tutorial on how to use the Oracle Application Server ProcessConnect user interface tool to design and deploy an integration within an enterprise.

Part III, "Modeler Management Tasks"

Chapter 8, "Oracle Application Server ProcessConnect Technology Adapters"

This chapter provides details about the technology adapters included with Oracle Application Server ProcessConnect.

Chapter 9, "Creating Metadata with the Modeling Wizards"

This chapter describes how to create integration modeling metadata with the assistance of the Oracle Application Server ProcessConnect modeling wizards.

Chapter 10, "Managing Datatypes"

This chapter describes the datatype management tasks required to design an integration.

Chapter 11, "Managing Adapter Interactions and Event Types"

This chapter describes the adapter interaction and event type management tasks required to design an integration.

Chapter 12, "Managing Business Processes and Roles"

This chapter describes the business process and role management tasks required to design an integration.

Chapter 13, "Managing Transformations"

This chapter describes transformation concepts and management tasks for designing an integration.

Chapter 14, "Advanced Transformations Design"

This chapter describes how to design advanced transformations. Common transformation errors and transformation limitations are also described.

Part IV, "Administrator Management Tasks"

Chapter 15, "Managing Applications and Application Agreements"

This chapter describes the application and application agreement tasks required to design an integration within an enterprise.

Chapter 16, "Creating and Deploying a Configuration"

This chapter describes how to create and deploy a configuration of an end-to-end integration that consists of the modeling metadata and profile data you created.

Chapter 17, "Administering Integrations with the User Interface Tool"

This chapter describes how to administer Oracle Application Server ProcessConnect with the Oracle Application Server ProcessConnect user interface tool.

Chapter 18, "System Management with Oracle Enterprise Manager"

This chapter provides an overview of Oracle Application Server ProcessConnect monitoring and administration tasks that you can perform from Oracle Enterprise Manager.

Chapter 19, "Performance Tuning"

This chapter describes how you can manage the performance of components of the Oracle Application Server ProcessConnect runtime engine.

Chapter 20, "Oracle Application Server ProcessConnect Security"

This chapter describes the architecture and configuration of security for Oracle Application Server ProcessConnect.

Chapter 21, "Oracle Application Server ProcessConnect Error Handling"

This chapter describes how to detect and handle system and domain errors in Oracle Application Server ProcessConnect runtime components.

Chapter 22, "Oracle Application Server ProcessConnect Troubleshooting"

This chapter describes Oracle Application Server ProcessConnect troubleshooting methodologies.

Part V, "Analyst Management Tasks"

Chapter 23, "Creating Reports"

This chapter describes how to create Oracle Application Server ProcessConnect reports.

Part VI, "RosettaNet Solutions"

Chapter 24, "RosettaNet B2B Protocol Standard"

This chapter describes the RosettaNet business-to-business (B2B) protocol standard and its implementation of trading partner agreements, and how Oracle Application Server ProcessConnect provides support for both.

Chapter 25, "Managing Host and Remote Trading Partner Capabilities"

This chapter describes the host and remote trading partner identification, organization, cooperation, delivery, security, and endpoint capability tasks required to design an integration between enterprises. The host trading partner uses the Oracle Application Server ProcessConnect user interface tool to define the capabilities for all trading partners (both host and remote). The host trading partner consults with the remote trading partner to obtain the necessary details.

Chapter 26, "Managing Trading Partners and Trading Partners Agreements"

This chapter describes the trading partner and trading partner agreement tasks required to design an integration between enterprises.

Part VII, "Reference"

Appendix A, "Native Formats and Translators"

This appendix describes the native formats and translators supported with Oracle Application Server ProcessConnect.

Appendix B, "Transformation Rules"

This appendix describes the datatype transformation map rules, event header rules, and domain value map rules included with Oracle Application Server ProcessConnect.

Appendix C, "Error Codes"

This appendix describes Oracle Application Server ProcessConnect error messages.

Appendix D, "Jacada Integrator Adapter for Legacy Systems"

With Jacada Integrator®, Oracle Application Server ProcessConnect customers can integrate legacy applications when prebuilt APIs or legacy application source code is not available.

Glossary

Related Documentation

For more information, see these Oracle resources:

In North America, printed documentation is available for sale in the Oracle Store at

<http://oraclestore.oracle.com/>

Customers in Europe, the Middle East, and Africa (EMEA) can purchase documentation from

<http://www.oraclebookshop.com/>

Other customers can contact their Oracle representative to purchase printed documentation.

To download free release notes, installation documentation, white papers, or other collateral, please visit the Oracle Technology Network (OTN). You must register online before using OTN; registration is free and can be done at

<http://otn.oracle.com/admin/account/membership.html>

If you already have a username and password for OTN, then you can go directly to the documentation section of the OTN Web site at

<http://otn.oracle.com/docs/index.htm>

To access the database documentation search engine directly, please visit

<http://tahiti.oracle.com>

Conventions

This section describes the conventions used in the text and code examples of this documentation set. It describes:

- [Conventions in Text](#)

- [Conventions in Code Examples](#)
- [Conventions for Microsoft Windows Operating Systems](#)

Conventions in Text

We use various conventions in text to help you more quickly identify special terms. The following table describes those conventions and provides examples of their use.

Convention	Meaning	Example
Bold	Bold typeface indicates terms that are defined in the text or terms that appear in a glossary, or both.	When you specify this clause, you create an index-organized table .
<i>Italics</i>	Italic typeface indicates book titles or emphasis.	<i>Oracle9i Database Concepts</i> Ensure that the recovery catalog and target database do <i>not</i> reside on the same disk.
UPPERCASE monospace (fixed-width) font	Uppercase monospace typeface indicates elements supplied by the system. Such elements include parameters, privileges, datatypes, RMAN keywords, SQL keywords, SQL*Plus or utility commands, packages and methods, as well as system-supplied column names, database objects and structures, usernames, and roles.	You can specify this clause only for a NUMBER column. You can back up the database by using the BACKUP command. Query the TABLE_NAME column in the USER_TABLES data dictionary view. Use the DBMS_STATS.GENERATE_STATS procedure.
lowercase monospace (fixed-width) font	Lowercase monospace typeface indicates executables, filenames, directory names, and sample user-supplied elements. Such elements include computer and database names, net service names, and connect identifiers, as well as user-supplied database objects and structures, column names, packages and classes, usernames and roles, program units, and parameter values. Note: Some programmatic elements use a mixture of UPPERCASE and lowercase. Enter these elements as shown.	Enter sqlplus to open SQL*Plus. The password is specified in the orapwd file. Back up the datafiles and control files in the /disk1/oracle/dbs directory. The department_id, department_name, and location_id columns are in the hr.departments table. Set the QUERY_REWRITE_ENABLED initialization parameter to true. Connect as oe user. The JReplUtil class implements these methods.

Convention	Meaning	Example
<i>lowercase italic monospace (fixed-width) font</i>	Lowercase italic monospace font represents placeholders or variables.	You can specify the <i>parallel_clause</i> . Run <code>Uold_release.SQL</code> where <i>old_release</i> refers to the release you installed before upgrading.

Conventions in Code Examples

Code examples illustrate SQL, PL/SQL, SQL*Plus, or other command-line statements. They are displayed in a monospace (fixed-width) font and separated from normal text as shown in this example:

```
SELECT username FROM dba_users WHERE username = 'MIGRATE';
```

The following table describes typographic conventions used in code examples and provides examples of their use.

Convention	Meaning	Example
[]	Brackets enclose one or more optional items. Do not enter the brackets.	DECIMAL (<i>digits</i> [, <i>precision</i>])
{ }	Braces enclose two or more items, one of which is required. Do not enter the braces.	{ENABLE DISABLE}
	A vertical bar represents a choice of two or more options within brackets or braces. Enter one of the options. Do not enter the vertical bar.	{ENABLE DISABLE} [COMPRESS NOCOMPRESS]
...	Horizontal ellipsis points indicate either: <ul style="list-style-type: none"> That we have omitted parts of the code that are not directly related to the example That you can repeat a portion of the code 	CREATE TABLE ... AS <i>subquery</i> ; SELECT <i>col1</i> , <i>col2</i> , ... , <i>coln</i> FROM employees;
.	Vertical ellipsis points indicate that we have omitted several lines of code not directly related to the example.	
Other notation	You must enter symbols other than brackets, braces, vertical bars, and ellipsis points as shown.	acctbal NUMBER(11,2); acct CONSTANT NUMBER(4) := 3;

Convention	Meaning	Example
<i>Italics</i>	Italicized text indicates placeholders or variables for which you must supply particular values.	CONNECT SYSTEM/ <i>system_password</i> DB_NAME = <i>database_name</i>
UPPERCASE	Uppercase typeface indicates elements supplied by the system. We show these terms in uppercase to distinguish them from terms you define. Unless terms appear in brackets, enter them in the order and with the spelling shown. However, because these terms are not case sensitive, you can enter them in lowercase.	SELECT last_name, employee_id FROM employees; SELECT * FROM USER_TABLES; DROP TABLE hr.employees;
lowercase	Lowercase typeface indicates programmatic elements that you supply. For example, lowercase indicates names of tables, columns, or files. Note: Some programmatic elements use a mixture of UPPERCASE and lowercase. Enter these elements as shown.	SELECT last_name, employee_id FROM employees; sqlplus hr/hr CREATE USER mjones IDENTIFIED BY ty3MU9;

Conventions for Microsoft Windows Operating Systems

The following table describes conventions for Microsoft Windows operating systems and provides examples of their use.

Convention	Meaning	Example
Choose Start >	How to start a program.	To start the Database Configuration Assistant, choose Start > Programs > Oracle - <i>HOME_NAME</i> > Configuration and Migration Tools > Database Configuration Assistant.
File and directory names	File and directory names are not case sensitive. The following special characters are not allowed: left angle bracket (<), right angle bracket (>), colon (:), double quotation marks ("), slash (/), pipe (), and dash (-). The special character backslash (\) is treated as an element separator, even when it appears in quotes. If the file name begins with \\, then Windows assumes it uses the Universal Naming Convention.	c:\winnt\"system32 is the same as C:\WINNT\SYSTEM32

Convention	Meaning	Example
C:\>	<p>Represents the Windows command prompt of the current hard disk drive. The escape character in a command prompt is the caret (^). Your prompt reflects the subdirectory in which you are working. Referred to as the <i>command prompt</i> in this manual.</p> <p>The backslash (\) special character is sometimes required as an escape character for the double quotation mark (") special character at the Windows command prompt. Parentheses and the single quotation mark (') do not require an escape character. Refer to your Windows operating system documentation for more information on escape and special characters.</p>	<p>C:\oracle\oradata></p> <p>C:\>exp scott/tiger TABLES=emp QUERY=\"WHERE job='SALESMAN' and sal<1600\"</p> <p>C:\>imp SYSTEM/password FROMUSER=scott TABLES=(emp, dept)</p>
HOME_NAME	<p>Represents the Oracle home name. The home name can be up to 16 alphanumeric characters. The only special character allowed in the home name is the underscore.</p>	<p>C:\> net start OracleHOME_ NAMETNSListener</p>

Documentation Accessibility

Our goal is to make Oracle products, services, and supporting documentation accessible, with good usability, to the disabled community. To that end, our documentation includes features that make information available to users of assistive technology. This documentation is available in HTML format, and contains markup to facilitate access by the disabled community. Standards will continue to evolve over time, and Oracle Corporation is actively engaged with other market-leading technology vendors to address technical obstacles so that our documentation can be accessible to all of our customers. For additional information, visit the Oracle Accessibility Program Web site at

<http://www.oracle.com/accessibility/>

Accessibility of Code Examples in Documentation JAWS, a Windows screen reader, may not always correctly read the code examples in this document. The conventions for writing code require that closing braces should appear on an otherwise empty line; however, JAWS may not always read a line of text that consists solely of a bracket or brace.

Part I

Oracle Application Server ProcessConnect Introduction and Concepts

This section provides Oracle Application Server ProcessConnect introduction, conceptual, and architecture details.

This part contains the following chapters:

- [Chapter 1, "A Road Map to Using this Guide"](#)
- [Chapter 2, "Introduction to Oracle Application Server ProcessConnect"](#)
- [Chapter 3, "Oracle Application Server ProcessConnect Concepts"](#)
- [Chapter 4, "Oracle Application Server ProcessConnect Architecture"](#)

A Road Map to Using this Guide

This chapter provides a road map to using this guide for each type of Oracle Application Server ProcessConnect user.

This chapter contains these topics:

- [A Road Map to Using this Guide](#)
- [Chapters For All Users to Read](#)
- [Chapters For Modelers to Read](#)
- [Chapters For Administrators to Read](#)
- [Chapters For Analysts to Read](#)
- [Additional Chapters](#)
- [Chapter Summary](#)

See Also: The Oracle Application Server 10g Documentation Library for the Oracle Application Server ProcessConnect application adapter documentation (if you are interested in learning about those capabilities)

A Road Map to Using this Guide

Several types of users can use the Oracle Application Server ProcessConnect features described in this User Guide. This chapter provides a road map to using the information described in this User Guide. Some information is applicable to all users, while other information is applicable to the responsibilities of a specific user. Oracle recommends that each user review the road map described in this chapter before getting started.

[Table 1-1](#) identifies the users, provides a brief description of their responsibilities, and provides references on where to begin.

Table 1-1 Oracle Application Server ProcessConnect User Types

User	Responsibility	First See Section...	Then See Section...
Modeler (three types):		"Chapters For All Users to Read" on page 1-4	
<ul style="list-style-type: none"> ■ Connection manager 	Designs the interactions part of the modeling metadata in an integration		"Chapters for Connection Managers to Read" on page 1-6
<ul style="list-style-type: none"> ■ Event manager 	Designs the datatype, event type, translation, and transformation parts of the modeling metadata in an integration		"Chapters for Event Managers to Read" on page 1-7
<ul style="list-style-type: none"> ■ Business process manager 	Designs the business process and role parts of the modeling metadata in an integration		"Chapters for Business Process Managers to Read" on page 1-8

Table 1–1 (Cont.) Oracle Application Server ProcessConnect User Types

User	Responsibility	First See Section...	Then See Section...
Administrator (two types): <ul style="list-style-type: none"> ▪ Business ▪ Systems 	Designs the profile data portion of an integration, including: <ul style="list-style-type: none"> ▪ The applications, adapters, delivery channel, and agreements for integrations within an enterprise ▪ The trading partner and agreements for integrations between enterprises, including security, delivery channel, and endpoint data Monitors and administers an integration of modeling metadata and profile data, including: <ul style="list-style-type: none"> ▪ Deploying an integration (known as a configuration) ▪ Performing system administration of deployed configurations from Oracle Enterprise Manager and the Oracle Application Server ProcessConnect user interface tool 	"Chapters For All Users to Read" on page 1-4	"Chapters for Business Administrators to Read" on page 1-9
Analyst	Creates and analyzes integration reports		"Chapters For Analysts to Read" on page 1-10

See Also: [Chapter 3, "Oracle Application Server ProcessConnect Concepts"](#) for descriptions of terms used in this chapter

Chapters For All Users to Read

Table 1–2 lists chapters applicable to all Oracle Application Server ProcessConnect users. Oracle recommends that all users begin their introduction to Oracle Application Server ProcessConnect by reading these chapters in this order.

Table 1–2 *Chapters for All Users to Read*

Chapter	Description
Chapter 2, "Introduction to Oracle Application Server ProcessConnect"	Defines e-business and integration, describes integration challenges, and provides a high-level description of how Oracle Application Server ProcessConnect answers integration challenges
Chapter 3, "Oracle Application Server ProcessConnect Concepts"	<p>Provides a detailed description of Oracle Application Server ProcessConnect concepts that all users are strongly recommended to read entirely, but specific users are recommended to pay particular attention to the following sections:</p> <ul style="list-style-type: none">■ Modelers (all types) "Modeling Metadata Design" on page 3-15 and "Manage the Modeling Metadata and Profile Data Lifecycle" on page 3-59■ Administrators:<ul style="list-style-type: none">Business "Profile Data Design" on page 3-51 and "Manage the Modeling Metadata and Profile Data Lifecycle" on page 3-59Systems "Create and Deploy a Configuration" on page 3-58, "Manage the Modeling Metadata and Profile Data Lifecycle" on page 3-59, and "Integration Management" on page 3-65■ Analysts "Integration Reports" on page 3-66
Chapter 4, "Oracle Application Server ProcessConnect Architecture"	Provides a high-level overview of Oracle Application Server ProcessConnect architecture

Table 1–2 (Cont.) Chapters for All Users to Read

Chapter	Description
Chapter 5, "Getting Started with the User Interface Tool"	<p>Provides an overview on how to navigate and use the Oracle Application Server ProcessConnect user interface tool. All users must read this chapter entirely, but specific users are recommended to pay particular attention to the following sections:</p> <ul style="list-style-type: none"> ■ Modelers (all types) "Modeling Tab Overview" on page 5-24 ■ Administrators: <ul style="list-style-type: none"> Business "Profiles Tab Overview" on page 5-36 Systems "Deployment Tab Overview" on page 5-44 and "Administration Tab Overview" on page 5-46 ■ Analysts "Reports Tab Overview" on page 5-45
Chapter 6, "Methodologies for Using Oracle Application Server ProcessConnect"	<p>Describes two methodologies for using the Oracle Application Server ProcessConnect user interface tool, including providing an overview of tasks to perform. This chapter is particularly important to modelers and administrators, as they must perform specific portions of these tasks.</p>
Chapter 7, "Tutorial of an Integration within an Enterprise"	<p>Provides a step-by-step tutorial for using the Oracle Application Server ProcessConnect user interface tool. This chapter is particularly important to modelers and administrators, as they must perform specific portions of these tasks.</p>
Chapter 15, "Managing Applications and Application Agreements"	<p>Describes the application, adapter, delivery channel, and agreement tasks required to design an integration within an enterprise (known as application-to-application (A2A) or enterprise application integration (EAI))</p>
Chapter 21, "Oracle Application Server ProcessConnect Error Handling"	<p>Describes how to design error handling methods into integrations and how to detect and handle system and domain errors in Oracle Application Server ProcessConnect runtime components</p>
Chapter 22, "Oracle Application Server ProcessConnect Troubleshooting"	<p>Describes the Oracle Application Server ProcessConnect troubleshooting methodology, describes dependencies to understand before deleting modeling metadata, and provides references to troubleshooting details described throughout this User Guide and the Application Adapter Guides.</p>

Chapters For Modelers to Read

The following sections describe the recommended chapters for the three modeler user types to read.

- [Chapters for Connection Managers to Read](#)
- [Chapters for Event Managers to Read](#)
- [Chapters for Business Process Managers to Read](#)

Chapters for Connection Managers to Read

After reading the chapters described in [Table 1-2](#) on page 1-4, it is recommended that connection managers read the chapters described in [Table 1-3](#).

Table 1-3 *Chapters for Connection Managers to Read*

Chapter	Description
Chapter 8, "Oracle Application Server ProcessConnect Technology Adapters"	Provides an overview of the Oracle Application Server ProcessConnect technology adapters, including capabilities, naming conventions, restrictions, and troubleshooting details. Adapter user cases are also provided.
Chapter 11, "Managing Adapter Interactions and Event Types"	Describes the adapter interaction, translation, and event type management tasks required to design all integrations
Appendix A, "Native Formats and Translators"	Describes the native formats and translators supported by Oracle Application Server ProcessConnect. This appendix is a supplement to Chapter 11, "Managing Adapter Interactions and Event Types" .

Chapters for Event Managers to Read

After reading the chapters described in [Table 1-2](#) on page 1-4, it is recommended that event managers read the chapters described in [Table 1-4](#).

Table 1-4 *Chapters for Event Managers to Read*

Chapter	Description
Chapter 10, "Managing Datatypes"	Describes the datatype management tasks required to design all integrations.
Chapter 11, "Managing Adapter Interactions and Event Types"	Describes the adapter interaction, translation, and event type management tasks required to design all integrations
Chapter 13, "Managing Transformations"	Describes the transformation management tasks required to design all integrations. Transformation use cases are also provided.
Chapter 14, "Advanced Transformations Design"	Describes how to design advanced transformations
Appendix A, "Native Formats and Translators"	Describes the native formats and translators supported by Oracle Application Server ProcessConnect. This appendix is a supplement to Chapter 11, "Managing Adapter Interactions and Event Types" .
Appendix B, "Transformation Rules"	Describes the datatype transformation map rules, event header rules, and domain value map rules included with Oracle Application Server ProcessConnect. This appendix is a supplement to Chapter 13, "Managing Transformations" .

Chapters for Business Process Managers to Read

After reading the chapters described in [Table 1-2](#) on page 1-4, it is recommended that business process managers read the chapters described in [Table 1-5](#).

Table 1-5 *Chapters for Business Process Managers to Read*

Chapter	Description
Chapter 9, "Creating Metadata with the Modeling Wizards"	Describes how to create integration modeling metadata with the assistance of the Oracle Application Server ProcessConnect modeling wizards. These wizards offer an alternative to manually performing many of the tasks described in Chapter 12, "Managing Business Processes and Roles" . See "Business Process and Role Creation Methods" on page 12-10 for a comparison of both methods.
Chapter 12, "Managing Business Processes and Roles"	Describes the role and business process management tasks required to design all integrations

Chapters For Administrators to Read

The following sections describe the recommended chapters for the two administrator user types to read.

- [Chapters for Business Administrators to Read](#)
- [Chapters for Systems Administrators to Read](#)

Chapters for Business Administrators to Read

After reading the chapters described in [Table 1–2](#) on page 1-4, it is recommended that business administrators read the chapters described in [Table 1–6](#).

Table 1–6 *Chapters for Business Administrators to Read*

Chapter	Description
Chapter 8, "Oracle Application Server ProcessConnect Technology Adapters"	Provides an overview of the Oracle Application Server ProcessConnect technology adapters, including capabilities, naming conventions, restrictions, and troubleshooting details.
Chapter 16, "Creating and Deploying a Configuration"	Describes how to create and deploy a configuration of modeling metadata and profile data.
Chapter 20, "Oracle Application Server ProcessConnect Security"	Provides an overview of architecture and configuration of Oracle Application Server ProcessConnect security.
Chapter 24, "RosettaNet B2B Protocol Standard"	Describes the RosettaNet business-to-business (B2B) protocol standard and trading partner agreements, and how Oracle Application Server ProcessConnect provides support for both.
Chapter 25, "Managing Host and Remote Trading Partner Capabilities"	Describes the host and remote trading partner identification, organization, cooperations (collaborations), delivery, security, and endpoint tasks required to design an integration between enterprises (also known as B2B integrations).
Chapter 26, "Managing Trading Partners and Trading Partners Agreements"	Describes the trading partner and trading partner agreement tasks required to design an integration between enterprises.

Chapters for Systems Administrators to Read

After reading the chapters described in [Table 1-2](#) on page 1-4, it is recommended that systems administrators read the chapters described in [Table 1-7](#).

Table 1-7 *Chapters for Systems Administrators to Read*

Chapter	Description
Chapter 17, "Administering Integrations with the User Interface Tool"	Describes how to perform administration tasks from the Oracle Application Server ProcessConnect user interface tool.
Chapter 18, "System Management with Oracle Enterprise Manager"	Provides an overview of Oracle Application Server ProcessConnect monitoring and administration tasks that you can perform from Oracle Enterprise Manager.
Chapter 19, "Performance Tuning"	Describes how to manage the performance of Oracle Application Server ProcessConnect components.

Chapters For Analysts to Read

After reading the chapters described in [Table 1-2](#) on page 1-4, it is recommended that systems administrators read the chapter described in [Table 1-8](#).

Table 1-8 *Chapter for Analysts to Read*

Chapter	Description
Chapter 23, "Creating Reports"	Describes how to generate different types of reports that provide details on deployed configurations. Use case examples are also provided.

Additional Chapters

[Table 1-9](#) lists additional chapters available to interested users.

Table 1-9 *Chapters for All Users to Read*

Chapter	Description
Appendix C, "Error Codes"	Lists Oracle Application Server ProcessConnect error messages.
Appendix D, "Jacada Integrator Adapter for Legacy Systems"	Describes the Jacada Integrator, which enables Oracle Application Server ProcessConnect customers to integrate legacy applications when prebuilt APIs or legacy application source code is not available.

Chapter Summary

This chapter is a road map describing which chapters of this User Guide to read, depending on your user role in the integration process. Chapters aimed at modelers (connection managers, event managers, and business process managers), administrators (business administrators and systems administrators), and analysts are identified, as well as those chapters relevant to all users.

Introduction to Oracle Application Server ProcessConnect

This chapter defines e-business and integration challenges, and describes how Oracle Application Server ProcessConnect answers integration challenges.

This chapter contains these topics:

- [What Are E-business and Integration?](#)
- [What Are the Challenges of Integration?](#)
- [How Does Oracle Application Server ProcessConnect Answer Integration Challenges?](#)
- [Integration Challenges and Oracle Application Server ProcessConnect Solutions: Examples](#)
- [Chapter Summary](#)

What Are E-business and Integration?

E-business is a method for improving your existing business processes by using Internet technologies within an enterprise and between enterprises. A key requirement for successfully automating e-business activities is integration technology. Integration technology enables:

- Applications to communicate with other applications that differ in architecture and technology
- Trading partners to communicate with other trading partners

Successful implementation of integration technology enables:

- Applications such as SAP, Siebel, J.D. Edwards, and PeopleSoft and legacy applications to communicate with one another
- Applications using technologies such as HTTP, FTP, SMTP, and Web services to communicate with one another
- Trading partners to communicate with other trading partners through business-to-business (B2B) protocols. A B2B protocol standard, such as RosettaNet, provides guidelines for trading partners to follow when conducting business across company boundaries.

Two types of integration technologies are described throughout this User Guide:

- Application-to-application (A2A) integration (also known as enterprise application integration [EAI])

A2A integration enables companies to integrate applications within the same company boundaries (known as an enterprise). The phrase *integrations within an enterprise* is used throughout this User Guide to describe this type of integration. Integration is managed by a business process. A business process spans all participants in an integration to coordinate sending and receiving data between applications. This management ensures that the correct applications send and receive data.

Figure 2-1 shows A2A integration.

Figure 2-1 A2A Integration Type

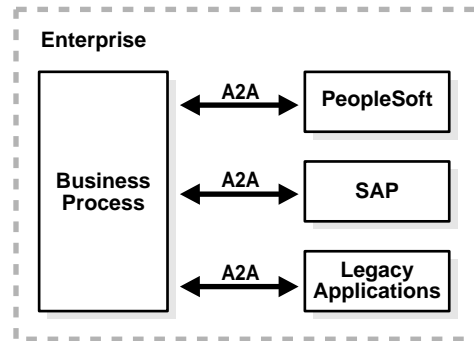

- B2B integration

B2B integration enables companies to extend A2A integration between enterprises to integrate trading partners with other trading partners. The phrase *integrations between enterprises* is used throughout this User Guide to describe this type of integration.

As with A2A, B2B integration is also managed by a business process that extends between enterprises to coordinate the data sent and received between trading partners. B2B integration uses a B2B protocol such as RosettaNet that provides guidelines for conducting business between enterprises. [Figure 2-2](#) shows B2B integration.

Figure 2-2 B2B Integration Type

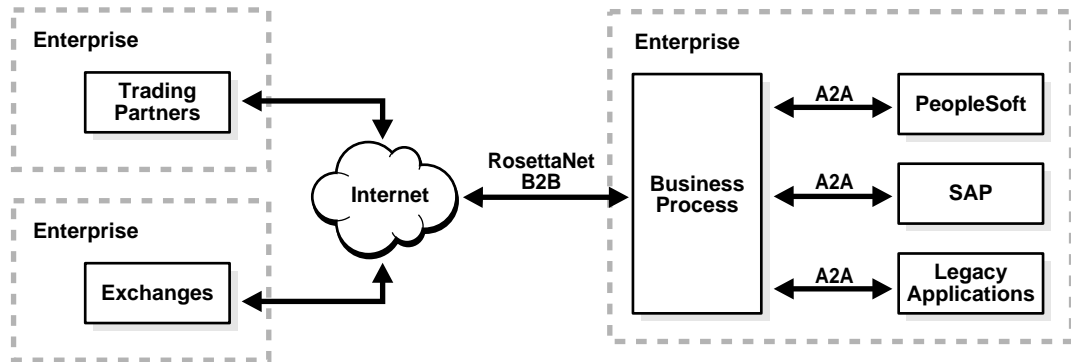

E-business and Integration Importance

The growth in the importance of e-business and integration technologies is based on business objectives such as the following:

- Business process streamlining

Companies want to streamline online business systems to deliver products and services to customers. Automating business processes reduces costs and improves efficiencies. Integration automates processes and reduces the reliance on human interaction with phones, fax machines, and manual data updates to multiple applications.

- Quick access to data for competitive advantages

Companies want quick access to the latest data from many information systems to better serve their customers and compete more efficiently. Better data is derived both by integration of many different systems to share data in a real-time manner and by having facilities to monitor and analyze business processes in real time.

What Are the Challenges of Integration?

Successfully enabling integrations within an enterprise and between enterprises presents major challenges. Integration challenges include the following:

- Different applications use different technologies and architectures that were never designed for integration with one another.
- Integrations often focus on building separate, customized, point-to-point integrations lacking an overall architectural view on how to create large-scale integrations.
- Each application has unique terminology for defining and displaying data. This means that no common language exists for the data moving between participating applications.
- New versions of integrated applications are regularly released, thus complicating integration implementation and maintenance.
- Integrations have not been designed to enable the parties to evolve while allowing the integration infrastructure to evolve with them.
- Business processes that manage data sent and received between applications or between trading partners can require coordination across multiple systems.
- Managing complexity is difficult and expensive, since integrations are often highly customized.
- Costs and schedules are difficult to predict, as customized integrations use many separate components with different software licenses and maintenance contracts. Expensive consultants are often required to maintain these integrations.
- Conducting business between enterprises creates a new set of integration concerns with trading partners, such as:
 - How do you securely send data?
 - How do you coordinate the exchange of data?
 - How do you transport data?
- Integrations can involve complicated coordinations with multiple trading partners, including buyers, sellers, retailers, manufacturers, and raw material distributors

How Does Oracle Application Server ProcessConnect Answer Integration Challenges?

Oracle Application Server ProcessConnect provides the following features for designing, deploying, monitoring, and maintaining integrations:

- A complete, integrated product

Oracle Application Server ProcessConnect provides a single product for designing, deploying, monitoring, and managing integrations within enterprises and between enterprises. Oracle Application Server ProcessConnect provides an overall architecture for integrating applications and integrating trading partners. The Oracle Application Server ProcessConnect user interface tool enables you to:

- Design integrations within an enterprise and integrations between enterprises that use B2B protocols, such as RosettaNet
- Create business processes that coordinate sending and receiving data and implement the business logic of an integration
- Validate integrations before deployment to ensure that the data is correct and complete
- Deploy integrations from a design environment to a production environment
- Monitor and administer online business activities of the entire integration
- Analyze the integration history and audit trail

Figure 2–3 provides a high-level overview of Oracle Application Server ProcessConnect.

Figure 2–3 Oracle Application Server ProcessConnect High-Level Overview

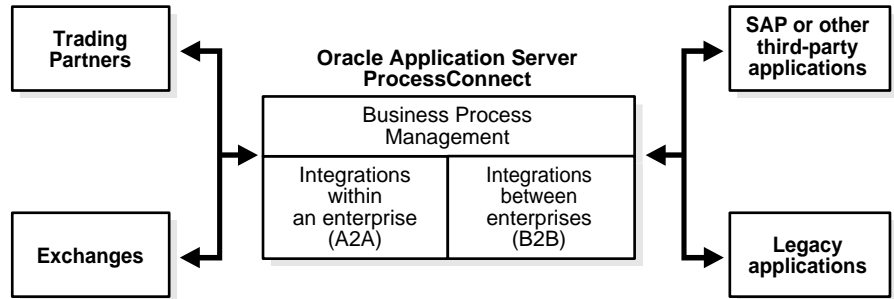

- Ease of integration for different systems and applications

Oracle Application Server ProcessConnect enables you to integrate applications, legacy systems, and business partners that each use differing technologies and architectures. This includes applications such as SAP, PeopleSoft, J.D. Edwards, and Siebel; B2B protocols such as RosettaNet; and legacy mainframe applications.

- Business view of data

Oracle Application Server ProcessConnect takes the differing terminologies and message structures of participating applications or B2B protocols and creates a business view of the data. This view, known as a business event, enables you to view and monitor the data sent and received between different systems in a common vocabulary. By defining a standardized business event, Oracle Application Server ProcessConnect also makes it easy to connect multiple applications together without needing to design point-to-point integrations between applications.

- Management of data through business processes

Oracle Application Server ProcessConnect enables you to create business processes that coordinate sending and receiving data. This management ensures that the correct parties send and receive data. Business processes also hide the unique characteristics of each party in an integration. Data is sent and received in the form of events. You can specify the business process to manage a specific event (for example, the arrival of a purchase order). You can also design the

business processes separately, and associate them with the specific data to send and receive at a later time.

- **No code writing required**

No code needs to be written to design an integration. The Oracle Application Server ProcessConnect user interface tool provides a modeling approach to creating integrations, which provides all the functionality required for designing, deploying, monitoring, and administering an integration. This enables you to fully concentrate on solving your business needs.

- **Deployment and Administration**

You create, validate, and deploy a configuration of an integration from a design to a production environment. You can monitor the status of a configuration through Oracle Enterprise Manager and create business reports that describe the configuration status

- **Reuse of components**

You can reuse components in additional integrations to reduce the duplication of effort required to create additional ones and the amount of retesting required

- **Integration with Oracle E-Business Suite**

Oracle Application Server ProcessConnect addresses RosettaNet requirements by integrating with the Oracle E-Business Suite Supply Chain Trading Connector for RosettaNet module.

See Also:

- [Chapter 3, "Oracle Application Server ProcessConnect Concepts"](#) for a detailed description of Oracle Application Server ProcessConnect concepts
- [Chapter 4, "Oracle Application Server ProcessConnect Architecture"](#) for a detailed description of Oracle Application Server ProcessConnect architecture
- Oracle Technology Network for details about Oracle Application Server ProcessConnect integration with Oracle E-Business Suite:

<http://otn.oracle.com/>

Integration Challenges and Oracle Application Server ProcessConnect Solutions: Examples

This section provides high-level examples of integration challenges and how Oracle Application Server ProcessConnect answers these challenges.

This section contains these topics:

- [Challenge of Integrations Within an Enterprise: Example](#)
- [Solution for Integrations Within an Enterprise: Oracle Application Server ProcessConnect](#)
- [Challenge of Integrations Between Enterprises: Example](#)
- [Solution for Integrations Between Enterprises: Oracle Application Server ProcessConnect](#)

Challenge of Integrations Within an Enterprise: Example

When companies consolidate through mergers and acquisitions, they must integrate their information systems to synchronize and share data between their billing systems and applications.

For example, a telecommunications company named Company A merges with a former competitor, Company B. Both companies become two separate organizations within a new company called Company A+B. Salespeople want to find information about the consolidated customer base for their regions. Both organizations use different applications for maintaining data about customers:

- Organization A uses an SAP ERP application for maintaining customer data.
- Organization B uses an Oracle ERP application for maintaining customer data.

Figure 2-4 shows this environment.

Figure 2-4 *Integrations Within an Enterprise*

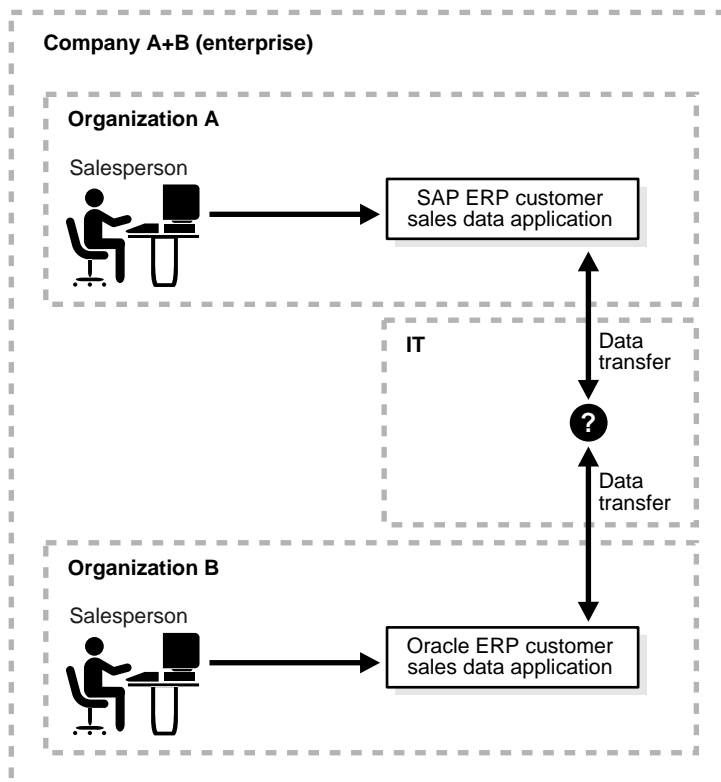

Company A+B wants to integrate the systems of both organizations to enable them to communicate and share data. For example, if Organization B's salesperson adds customer data through their application, this data must be automatically published to Organization A. Currently, the only method for updating both is for Organization B's salesperson to send an e-mail to Organization A's salesperson requesting them to make manual updates through their application.

Company A+B faces many integration challenges, several of which are shown in [Table 2-1](#).

Table 2-1 Challenges of Integrations Within an Enterprise

Challenge	Description of Challenge
Different terminologies and message formats of both ERP applications	The applications of both organizations have their own terminologies for defining data and formats for displaying that data. This means that no common, viewable language exists of the data moving between participating applications. How do you successfully integrate these two organizations?
Separate updates to both applications	Both ERP applications are updated independently of each other by the different sales teams of the two merged companies.
Business analysis at the enterprise level	Business intelligence analysis is difficult and incomplete because both systems are separate.
Inhouse code writing required	The consolidated company is unsure how much inhouse code writing is required, if any. The consolidated company does not have the budget or expertise to create their own integration solution.
Multiple tools required for multiple tasks	Since there are many aspects to an integration (creating a common view of data, automatically updating both, and so on), the consolidated company is unsure how many separate tools are required for an integration.
Future integration requirements	The company must design integrations in such a way as to make future integration enhancements easy.

Solution for Integrations Within an Enterprise: Oracle Application Server ProcessConnect

Company A+B uses Oracle Application Server ProcessConnect to design and deploy an integration that operates between the two different systems. [Figure 2-5](#) shows this integration.

Figure 2-5 Oracle Application Server ProcessConnect Solution for Integrations Within an Enterprise

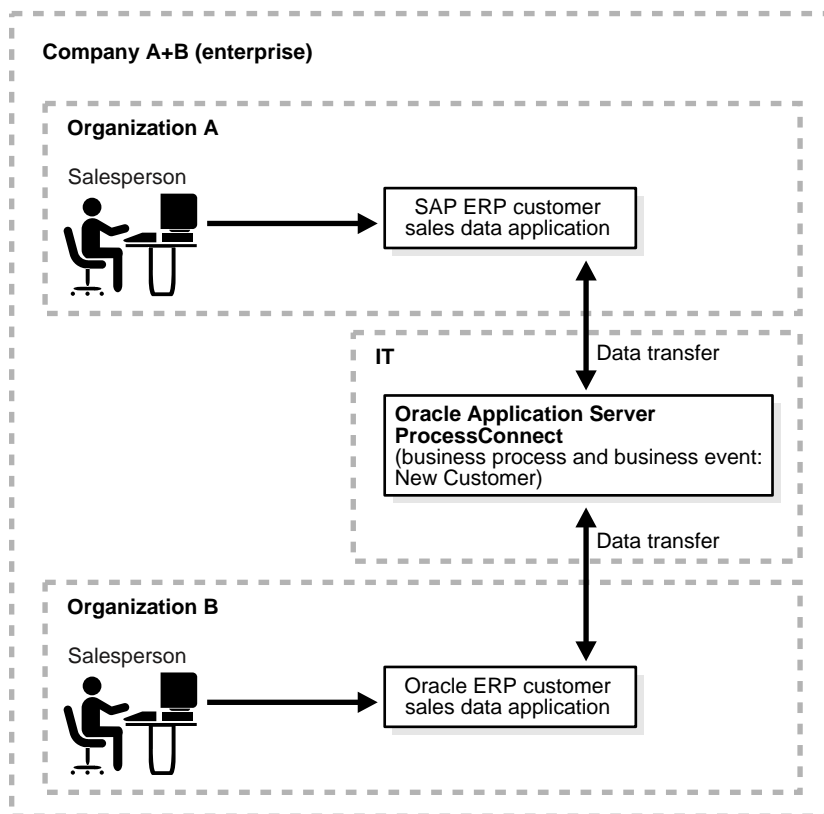

[Table 2–2](#) describes how Oracle Application Server ProcessConnect provides a solution to the integration challenges described in [Table 2–1](#) on page 2-11.

Table 2–2 Oracle Application Server ProcessConnect Solution for Integrations Within an Enterprise

Challenge	Description of Oracle Application Server ProcessConnect Solution
Different terminologies and message formats of both ERP applications	<p>Oracle Application Server ProcessConnect enables you to define a common view of the customer and sales data independent of the two applications. This view, known as a business event, enables you to view the data sent and received between both systems in a common language. Both applications participate in the integration by binding to business events.</p> <p>You also create a business process that coordinates the movement of this data between the two ERP applications.</p>
Separate updates to both applications	<p>Oracle Application Server ProcessConnect enables a single individual to update data through the Oracle ERP application and have the data automatically published. Independent updates by separate salespersons are no longer required.</p>
Business analysis at the enterprise level	<p>One salesperson can perform business intelligence analysis and receive a single, consolidated report that reflects the data in both systems.</p>
Inhouse code writing required	<p>No inhouse code writing is required. The Oracle Application Server ProcessConnect user interface tool enables you to design an integration without writing any code.</p>
Multiple tools required for multiple tasks	<p>Oracle Application Server ProcessConnect provides a single user interface tool for designing, deploying, monitoring, and administering all aspects of an integration; no additional integration tools are required.</p>
Future integration requirements	<p>Oracle Application Server ProcessConnect provides methods for integrating additional applications with an existing integration. One method is through the use of modeling wizards that enable you to add an additional spoke to an integration using the same business process and business event.</p>

Challenge of Integrations Between Enterprises: Example

After designing and deploying the integration described in "[Solution for Integrations Within an Enterprise: Oracle Application Server ProcessConnect](#)" on page 2-12, Company A+B starts subcontracting telecommunication projects in San Jose, California to Company C, a local, smaller company. Company C uses a PeopleSoft ERP application for customer data. [Figure 2-6](#) shows this environment.

Figure 2-6 Integrations Between Enterprises

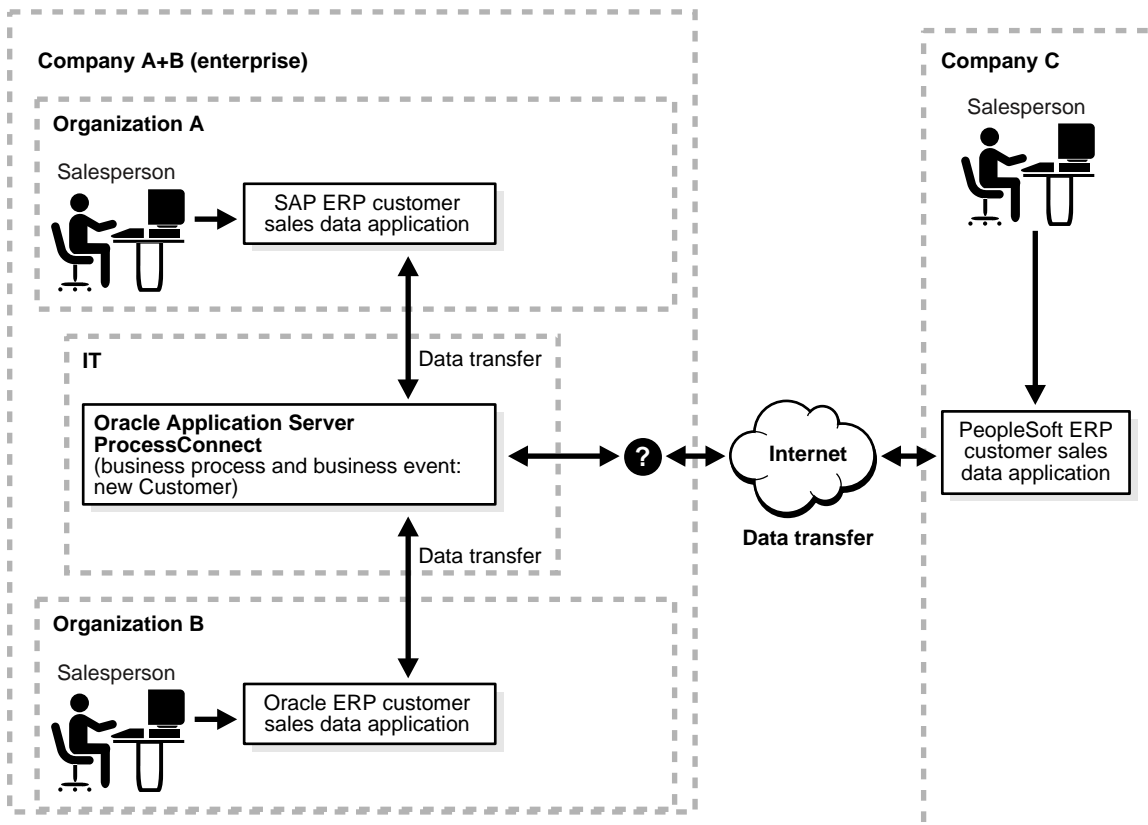

If Company A+B initiates a business transaction with a subcontractor in San Jose, Company C requires receipt of a purchase order request from the subcontractor.

Company A+B now faces new challenges in integrating their billing systems and applications with those of Company C, which is located outside their enterprise.

Table 2–3 describes several of the integration challenges.

Table 2–3 Challenges of Integrations Between Enterprises

Challenge	Description of Challenge
Additional integration points	Company A+B must add a new integration point to their environment. This integration point presents new challenges, as it is outside their enterprise.
Security and transport for businesses between enterprises	Conducting business between enterprises creates a new set of integration concerns that have not been previously addressed, such as: <ul style="list-style-type: none"> ■ How do you ensure security? ■ How do you transport data? ■ What protocol do you use? ■ How do you coordinate the exchange of data?
B2B protocol	Company A+B must implement a B2B protocol (such as RosettaNet) to conduct business between enterprises, but they lack the technical experience.

Solution for Integrations Between Enterprises: Oracle Application Server ProcessConnect

Company A+B uses Oracle Application Server ProcessConnect to design and deploy an integration between their company applications and the trading partner, Company C. Figure 2-7 shows this integration.

Figure 2-7 Oracle Application Server ProcessConnect Solution for Integrations Between Enterprises

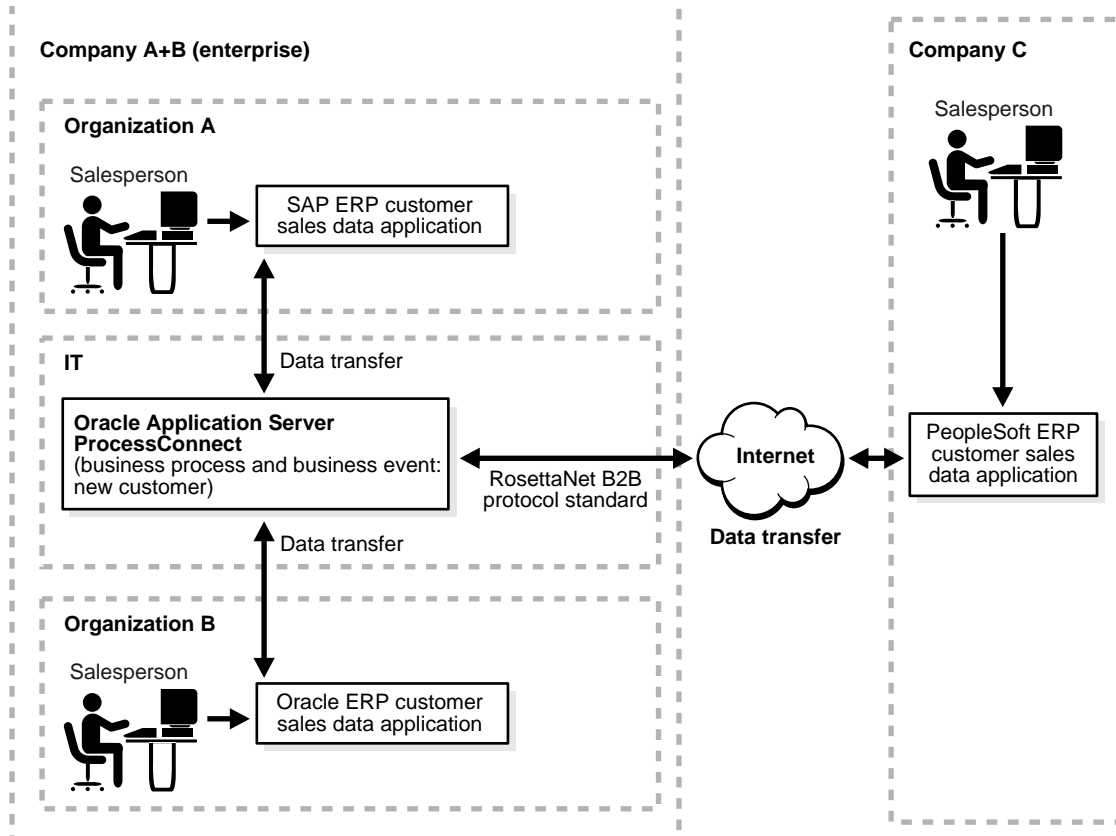

[Table 2-4](#) describes how Oracle Application Server ProcessConnect provides a solution to the integration challenges described in [Table 2-3](#) on page 2-15.

Table 2-4 Oracle Application Server ProcessConnect Solution for Integrations Between Enterprises

Challenge	Description of Solution
Additional integration points	Oracle Application Server ProcessConnect enables Company A+B to add the additional, external integration point that resides outside an enterprise. This enables the trading partner, Company C, to communicate and share data with Company A+B's internal systems.
Security and transport for businesses between enterprises	Oracle Application Server ProcessConnect's support for B2B protocols, such as RosettaNet, enables Company A+B to design a B2B integration that provides for the secure exchange of business data across the Internet with Company C.
B2B protocol	Company A+B implements Oracle Application Server ProcessConnect's support for the RosettaNet B2B protocol to conduct business across the Internet. The RosettaNet B2B protocol enforces business guidelines between Company A+B's applications and the trading partner, Company C.

See Also: [Chapter 3, "Oracle Application Server ProcessConnect Concepts"](#) for a detailed description of how Oracle Application Server ProcessConnect supports integrations within an enterprise and between enterprises

Chapter Summary

This chapter defines A2A and B2B integrations. The challenges of integrations are identified, and how Oracle Application Server ProcessConnect addresses these challenges. A2A and B2B examples (using RosettaNet) are provided of how Oracle Application Server ProcessConnect integrates parties by defining a common view of the data.

Oracle Application Server ProcessConnect Concepts

This chapter provides a conceptual overview of Oracle Application Server ProcessConnect.

This chapter contains these topics:

- [Oracle Application Server ProcessConnect Users](#)
- [Integration Design Concepts](#)
- [Oracle Application Server ProcessConnect Support for Integration Design Concepts](#)
- [Oracle Application Server ProcessConnect Concepts in Detail](#)
- [Modeling Metadata and Profile Data Overview](#)
- [Modeling Metadata Design](#)
- [Profile Data Design](#)
- [Create and Deploy a Configuration](#)
- [Manage the Modeling Metadata and Profile Data Lifecycle](#)
- [Integration Management](#)
- [Integration Reports](#)
- [Chapter Summary](#)

Oracle Application Server ProcessConnect Users

Different users interact with Oracle Application Server ProcessConnect depending on the state of an integration. [Table 3–1](#) describes these users and their responsibilities. The terms used in [Table 3–1](#) are described in detail in this chapter. Oracle recommends that each user read this chapter before using Oracle Application Server ProcessConnect.

Table 3–1 Oracle Application Server ProcessConnect Users

User	Integration Stage	Responsibility
Systems integration consultant	Pre-design stage	Evaluates if Oracle Application Server ProcessConnect meets the integration requirements
Integration architect	Design stage before using the user interface tool	Plans the design of an integration before the Oracle Application Server ProcessConnect user interface tool is used
Modeler: <ul style="list-style-type: none"> ▪ Connection manager ▪ Event manager ▪ Business process manager 	Design stage with user interface tool	<p>Uses the Oracle Application Server ProcessConnect user interface tool to design the interactions part of the modeling metadata in an integration</p> <p>Uses the Oracle Application Server ProcessConnect user interface tool to design the datatype, event type, translation, and transformation parts of the modeling metadata in an integration</p> <p>Uses the Oracle Application Server ProcessConnect user interface tool to design the business process and roles parts of the modeling metadata in an integration</p>

Integration Design Concepts

Before describing Oracle Application Server ProcessConnect features, it is important to identify several key integration design concepts. Successful integrations are characterized by adherence to these design concepts. By adhering to the design concepts, you can successfully design and maintain an integration, and easily add additional integration parties (known as trading partners or applications). This section briefly describes the following design concepts:

- [Concept: Integrated View of Data](#)
- [Concept: Correlation](#)
- [Concept: Data Flows and Control Flows](#)
- [Concept: Translation](#)
- [Concept: Transformation](#)
- [Concept: Validation](#)
- [Concept: Adapters](#)
- [Concept: Agreements](#)
- [Concept: Auditing and Business Process Activity Intelligence](#)

See Also:

- ["Oracle Application Server ProcessConnect Support for Integration Design Concepts"](#) on page 3-8 for an overview of Oracle Application Server ProcessConnect support for these design concepts
- ["Oracle Application Server ProcessConnect Concepts in Detail"](#) on page 3-13 for a detailed description of Oracle Application Server ProcessConnect support for these design concepts

Concept: Integrated View of Data

Ensure that you design an integration that provides for a single, integrated view of data from different parties that reside within the same enterprise or between enterprises.

Achieving a single, integrated view of data can be challenging. For example, you may need to integrate an SAP application with an Oracle customer resource management (CRM) application. Each application uses its own application interface and data format. The challenge here is to integrate the data from these two different

applications into a single view of data. Later on, you may also need to add an additional application with its own unique application interface and data format to this existing integration. The challenge here is to add a new application or trading partner into this existing integration without significantly impacting the data of the current integration of the existing application or trading partner.

Concept: Correlation

Ensure that you design an integration that ensures that parties send and receive messages in the correct sequence. For example, a buying party that sends an airline ticket purchase order request expects to receive an airline ticket purchase order acknowledgment, and not a personal computer purchase order acknowledgment. The mechanism that ensures that the correct messages are sent and received is called correlation. A second example is where a purchase order is sent to a business partner that then sends the originator an acknowledgment. The acknowledgment must update the originator's receivables system. In this case, the acknowledgment from the business partner must be correlated to the originating business process.

Concept: Data Flows and Control Flows

Ensure that you design an integration ensuring that data flowing through the integration is correct and in the proper sequence.

Data flows enable data to move through an integration, such as a purchase order request sent from one party to another. Control flows enable you to define the logic for moving data through the system. For example, you can define which data goes first, and in which sequential order, instead of sending all data in parallel.

Concept: Translation

Ensure that you design an integration that successfully translates the various datatypes in the messages of all parties into a format recognized by your integration software.

Different parties use different syntax to represent data in their messages. This means that the syntax of one party is almost certainly unrecognizable to another party. Translation enables you to convert the syntax of all parties into a syntax recognized by your integration software (for example, conversion of delimited text to XML, or conversion of nontagged syntax to delimited text, and vice versa). When messages are sent out, the message syntax is translated to the original native format of each party.

Concept: Transformation

Ensure that you design an integration that successfully transforms the vocabularies of all parties into a common vocabulary of the integration.

Different parties in an integration use different vocabularies in their business messages. For example, one party may use the term *item* in its purchase order, while another party may use the term *component* in its purchase order. This creates a vocabulary mismatch between the two parties.

Transformation enables you to standardize on the terminology used by all parties in an integration and establish a common structure and vocabulary across all parties. Whenever data is sent between these parties, the term *item* must be replaced by *component*, and vice versa. Structural changes are also handled (such as an address being presented in a single string for one party, as opposed to being part of a structure for another party).

Concept: Validation

Ensure that you design an integration that ensures that incoming data is validated for correctness and is valid at all points during integration.

All parties participating in an integration are concerned with the consistency of data being sent or received. A method must exist to ensure the validity of data. Validation ensures that data in an integration is correct.

Concept: Adapters

Ensure that you provide adapters that enable a variety of parties (applications and trading partners) to easily communicate with your integration software.

The interfaces of all parties in an integration can vary greatly. Parties can expose many different interfaces, such as synchronous APIs, asynchronous APIs, databases, screen scraping, Java2 Environment Enterprise Edition (J2EE) connector architecture (JCA), Web services, and so on.

Adapters provide the connectivity that enables parties and their different interfaces to be included in an integration. Adapter types can include the following:

- Application adapters that enable applications such as SAP or Siebel to connect and exchange messages
- Technology adapters that connect to a specific technology, such as FTP, HTTP, or SMTP
- Business-to-business (B2B) protocol adapters that connect to a trading partner using B2B protocols such as RosettaNet

Concept: Agreements

Ensure that you design an integration in which parties electronically agree to and sign off on integrations before deployment in a production environment.

Agreements capture the necessary modeling metadata that governs the communication between partners. Such information can include the communication protocol to use, the security facilities to use, the formats in which data is exchanged, and even the appropriate acknowledgments that are to be sent and received.

To participate in an integration, an electronic agreement between all parties (applications or trading partners) must be created. Before an agreement can be included in an integration, all parties must review the contents and approve the agreement.

Concept: Auditing and Business Process Activity Intelligence

Ensure that you design an integration for which you can create business intelligence reports that enable you to analyze integrations.

Oracle Application Server ProcessConnect Support for Integration Design Concepts

Oracle Application Server ProcessConnect provides capabilities that adhere to the concepts described in "[Integration Design Concepts](#)" on page 3-4. This section briefly describes how Oracle Application Server ProcessConnect supports these guidelines.

This section contains these topics:

- [Support for an Integrated View of Data](#)
- [Support for Correlation with Native Event Correlation and Native Roles](#)
- [Support for Data Flow and Control Flow](#)
- [Support for Translation](#)
- [Support for Transformation](#)
- [Support for Validation with Native Event Validation](#)
- [Support for Adapters](#)
- [Support for Agreements](#)
- [Support for Business Intelligence](#)

See Also: "[Oracle Application Server ProcessConnect Concepts in Detail](#)" on page 3-13 for a detailed description of Oracle Application Server ProcessConnect support for these design concepts

Support for an Integrated View of Data

To support the creation of a single, integrated view of data, Oracle Application Server ProcessConnect uses event-driven business process integration. An event-driven business process integrates business processes based on the data (format and semantics) associated with the business process.

Events are caused or received by parties, and are indications of state changes within parties that require a reaction from other parties. For example, an event to create a purchase order expresses a specific intent, namely to purchase a product. Oracle Application Server ProcessConnect supports the use of three types of events: native, application, and business. Each event type captures the format of event data at a particular moment as it moves through Oracle Application Server ProcessConnect.

Roles and business processes define how events are executed; for example, sending an event requiring user approval from one party to another party. Oracle Application Server ProcessConnect supports the use of five types of roles for managing the various types of events moving through Oracle Application Server ProcessConnect: native, translation binding, application, transformation binding, and business.

Business processes operate at the center of an integration to implement business logic and manage the movement of business events.

By enabling the user to define business processes and business events between parties, the integration becomes independent of the particular end-point semantics in terms of both data and process. This provides organizations with the ability to integrate existing applications and trading partners while providing the flexibility to extend the same in the future as more applications, trading partners, and B2B protocols become available for integration.

See Also: The following sections for specific details on event types, role types, and business process support:

- ["Native Events"](#) on page 3-20
- ["Native Roles"](#) on page 3-23
- ["Application Events and Translation"](#) on page 3-30
- ["Application Roles"](#) on page 3-33
- ["Business Events"](#) on page 3-37
- ["Transformation"](#) on page 3-39
- ["Business Roles"](#) on page 3-40
- ["Business Process"](#) on page 3-44

Support for Correlation with Native Event Correlation and Native Roles

Oracle Application Server ProcessConnect supports the concept of native event correlation to ensure that native events correctly match and parties send and receive messages in the correct sequence. The mechanism that ensures that the correct messages are sent and received is called native roles.

See Also: ["Native Event Correlation"](#) on page 3-26 for a detailed description of how correlation ensures that native events match correctly

Support for Data Flow and Control Flow

Oracle Application Server ProcessConnect supports the following features:

- Data flows to connect processes, roles, and steps to move event data through Oracle Application Server ProcessConnect
- Control flows to define the logic for ordering the execution of steps. For example, you can define which event data goes first, and in which sequential order, instead of sending all data in parallel.

By separating data flow and control flow, Oracle Application Server ProcessConnect enables you to combine a single data flow with multiple control flows, and vice versa. For example, you may want to process purchase orders through a business process before they are updated in a general ledger system. However, you may want to process purchase orders that are greater than a certain amount differently from smaller purchase orders. Separation of data flow and control flow within Oracle Application Server ProcessConnect allows for the flexibility to keep a consistent data flow while providing for different control flows.

See Also: The following sections for specific details on data flow and control flow support:

- ["Data Flow"](#) on page 3-29
- ["Control Flow"](#) on page 3-29

Support for Translation

Oracle Application Server ProcessConnect supports the feature of translation to convert the datatype syntax of all integration parties to a syntax recognized by Oracle Application Server ProcessConnect. A specific role, the translation binding role, is provided for performing this task.

See Also: The following sections for specific details on translation support:

- ["Application Events and Translation"](#) on page 3-30
- ["Translation Binding Role"](#) on page 3-34

Support for Transformation

Oracle Application Server ProcessConnect supports the concept of transformation for standardizing on the vocabulary used by all parties in an integration. A specific role, the transformation binding role, is provided for performing this task.

See Also:

- ["Transformation"](#) on page 3-39 for a detailed description of transformation support
- ["Transformation Binding Role"](#) on page 3-41

Support for Validation with Native Event Validation

Oracle Application Server ProcessConnect supports the feature of native event validation to ensure that before a native event is created, it is validated to prevent the processing of invalid native events. This process occurs before translation of native events in the translation binding role. When an inbound native event has been fully translated to an application event, it is considered fully valid because of the prior native event validation. Before a native event is delivered to an adapter, it is also validated to ensure that invalid data is not sent out.

Further, since Oracle Application Server ProcessConnect captures the data and events in its native format, it is possible to audit or determine which events are not valid and why.

See Also: ["Native Event Validation"](#) on page 3-22

Support for Adapters

Oracle Application Server ProcessConnect provides adapters that enable applications and their different interfaces to be included in an integration. These adapters enable you to include application, technology, and B2B protocol adapters in an integration. Oracle Application Server ProcessConnect enables the integration of these adapters through a J2EE Connector Architecture (JCA) standard. JCA is a Java standard for building adapters to provide a standard way to access parties through Java. The application interface for all parties must comply to JCA.

See Also: ["Applications and Adapters"](#) on page 3-51 for a detailed description of adapter support

Support for Agreements

Oracle Application Server ProcessConnect supports the creation of an electronic agreement between parties participating in an integration. Parties must approve and sign off on an agreement to participate in an integration. After this agreement is approved, Oracle Application Server ProcessConnect uses the information when the integration is deployed to process events appropriately. Two types of agreements are supported:

- Application agreements for application integrations within an enterprise
- Trading partner agreements for trading partner integrations between enterprises

See Also: ["Agreements"](#) on page 3-57 for a detailed description of agreements support

Support for Business Intelligence

Oracle Application Server ProcessConnect provides support for creating business intelligence reports about integrations. Oracle Application Server ProcessConnect captures information or state associated with business processes and integrations in a runtime repository. It also provides a number of reporting facilities that provide you with the ability to analyze this information both at an individual level (for example, what happened to a specific purchase order) and at an aggregate level (for example, how many purchase orders have been placed in SAP in the past five days).

Such reports can provide intelligence on a specific event (or business activity), on a specific business process for business process intelligence, or on groups of events, processes, agreements, and errors.

See Also: ["Integration Reports"](#) on page 3-66

Oracle Application Server ProcessConnect Concepts in Detail

This section describes the key Oracle Application Server ProcessConnect concepts from start to finish, beginning with the arrival of a message from a party (either an application or trading partner) and proceeding onto the deployment and administration of an actively running integration. The following concepts enable you to define integrations within enterprises and integrations between enterprises.

- [Modeling Metadata and Profile Data Overview](#)
- [Modeling Metadata Design](#)
- [Profile Data Design](#)
- [Create and Deploy a Configuration](#)
- [Manage the Modeling Metadata and Profile Data Lifecycle](#)
- [Integration Management](#)
- [Integration Reports](#)

References are provided to sections that describe how to use the Oracle Application Server ProcessConnect user interface tool to implement these concepts.

Modeling Metadata and Profile Data Overview

Integrations consist of the following elements:

- Modeling metadata, which includes interactions, business processes, datatypes, event types, translations, transformations, role types, and condition expressions. Modeling metadata is defined by a modeler, of which there are several user types: connection manager, event manager, and business process manager).
- Profile data, which includes host and remote trading partner identification, organization, cooperation (collaboration), security, delivery, and endpoint data; trading partners; applications; and agreements between parties (between trading partners and between applications). Profile data is defined by a business administrator.

The modeler and business administrator use the Oracle Application Server ProcessConnect user interface tool to create and store modeling metadata and profile data in the design-time repository. After the modeling metadata and profile data become part of a deployed integration (known as a configuration), they are stored in the runtime repository.

Modelers and business administrators require the correct set of privileges to perform their specific design tasks in an integration. Oracle Application Server ProcessConnect provides these privileges through use cases. Use cases are the privileges that you assign to a user of the Oracle Application Server ProcessConnect user interface tool.

See Also:

- ["Storing the Integration in the Design-Time Repository: Overview"](#) on page 4-5 for additional details on the design-time repository
- ["Storing the Integration in the Runtime Repository: Overview"](#) on page 4-7 for additional details on the runtime repository
- ["Creating a Person"](#) on page 25-16 for instructions on creating a person
- ["Adding a User Role to a Host Trading Partner Person"](#) on page 25-23 for instructions on assigning use case privileges to a modeler or business administrator

Modeling Metadata Design

Modeling metadata concepts are divided into the native, application, and business levels.

This section contains these topics:

- [Native-Level Concepts](#)
- [Internal Processing Elements for Native, Application, and Business Levels](#)
- [Application-Level Concepts](#)
- [Business-Level Concepts](#)
- [Runtime Instance Behavior](#)
- [Coordinations](#)

Native-Level Concepts

This section describes the Oracle Application Server ProcessConnect native-level features. These features are designed to enable you to process events and data in the form in which the external party (either the originating or receiving party) manages the information (for instance, to validate information received from the party to ensure that it is valid).

- [Event Types and Event Instances](#)
- [Wire Messages and Oracle Records](#)
- [Adapter Interactions](#)
- [Native Events](#)
- [Native Event Validation](#)
- [Native Datatypes](#)
- [Native Roles](#)
- [Native Event Correlation](#)
- [Event Maps](#)

Event Types and Event Instances

An event type is an internal definition of business-relevant data that either arrived from a party or is to be sent to a party. An event instance is an actual occurrence of an event type and contains real business data. For example, a specific purchase order for an airplane or a car is represented as a purchase order event instance. Events represent intentions. For example, sending an event to create a purchase order expresses the intent of buying a product. A party reacts to that intention by expressing either to fulfill or not fulfill the purchase order event. Accepting an event establishes an obligation for proper execution.

Oracle Application Server ProcessConnect provides the following types of events, each of which represents a different stage and format of business-relevant data moving through Oracle Application Server ProcessConnect:

- Native
- Application
- Business

Each event has the same structure:

- An event header stores the modeling metadata necessary to manage event instances at runtime. An event header identifies the following:
 - The party from which the event instance is coming
 - The party to which to send the event instance
 - The event instance creation time
 - The event instance lifecycle state
 - A reference to its event type definition
 - Other relevant data necessary for processing the event
- An event can have any number of body elements. A body element contains a complete set of business data. For example, a purchase order, such as the order of an airplane, is represented as a body element. A design drawing accompanying the purchase order is placed in another body element. This enables any inbound set of data to be represented appropriately in a structured form, and makes it accessible later for content processing.

See Also: The following sections for descriptions and benefits of the three event types:

- "Native Events" on page 3-20
- "Application Events and Translation" on page 3-30
- "Business Events" on page 3-37
- Chapter 11, "Managing Adapter Interactions and Event Types" for instructions on managing events
- "Runtime Instance Behavior" on page 3-48

Wire Messages and Oracle Records

Oracle Application Server ProcessConnect does not understand the format of data from parties outside its component boundaries. This unrecognizable data format is known as a wire message. Inbound wire messages are received from parties. Outbound wire messages are sent to parties.

Wire messages can be e-mail or queue messages, or synchronous invocations such as a remote procedure call to an SAP system. Wire messages generally follow a message layout defined in message packaging protocols such as multipurpose internet mail extensions (MIME) or marshaling rules in the case of remote procedure calls of programming languages. Other wire messages can follow a particular encoding, be encrypted, and signed, or any combination of these.

Figure 3–1 shows an example of a wire message in SAP IDoc format outside the Oracle Application Server ProcessConnect boundary.

Figure 3–1 Wire Message

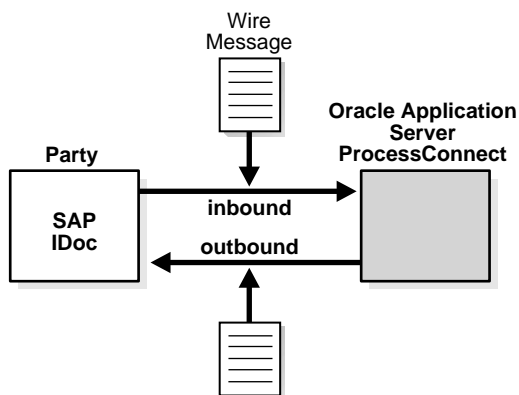

The Oracle Application Server ProcessConnect boundary is established with an Oracle record. Data in the form of wire messages received from a party is represented as an Oracle record on the Oracle Application Server ProcessConnect boundary. An Oracle record to be sent to a party is represented as a wire message.

The Oracle record definition is based on the J2EE Connector Architecture (JCA) 1.0 specification. Data received from a party is represented in an Oracle record instance. An Oracle record instance represents the occurrence of data received from or to be sent to a party. Oracle Application Server ProcessConnect provides a series of adapters that enable communication between parties with their different interfaces and Oracle Application Server ProcessConnect. An adapter creates the Oracle record instance for inbound communication and unpacks the Oracle record for outbound communication.

Figure 3–2 shows the Oracle record on the Oracle Application Server ProcessConnect boundary.

Figure 3–2 Oracle Record

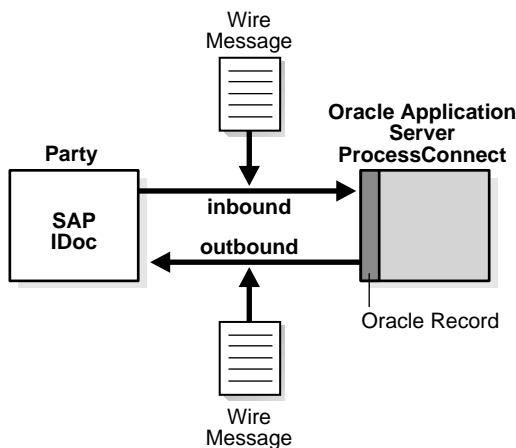

Oracle Application Server ProcessConnect only processes wire messages represented as an Oracle record.

See Also:

- <http://java.sun.com/j2ee/connector> for additional details about JCA standards
- ["Applications and Adapters"](#) on page 3-51 for additional details about JCA-supported adapters
- ["Executing the Adapter Framework: Overview"](#) on page 4-9 for details on Oracle's implementation of JCA standards

Adapter Interactions

As described in ["Wire Messages and Oracle Records"](#) on page 3-17, Oracle Application Server ProcessConnect provides a series of adapters that enable parties (and their different interfaces) to be included in an integration. The type of adapter to use and the specific actions you want this adapter to perform are based on the adapter interactions that you add with the Oracle Application Server ProcessConnect user interface tool. Interactions define the communication between the Oracle Application Server ProcessConnect runtime system and various adapters to send and receive data.

Interactions consist of two parts:

- An adapter exchange protocol, which represents the unique actions that can be performed with a specific adapter (such as requesting a purchase order, confirming a purchase order, sending a text file to an external HTTP server, and so on)
- Files that define these actions (such as an XSD definition file that defines the specific details of how a party requests a purchase order to buy computer equipment)

Figure 3–3 provides an example of adapter interactions. An inbound adapter interaction is added that reads an expense report from a file (`expense001.xml`). An outbound interaction is added that writes an outbound expense report notification to a file (`notification001.xml`) for a notification application.

Figure 3–3 Adapter Interactions

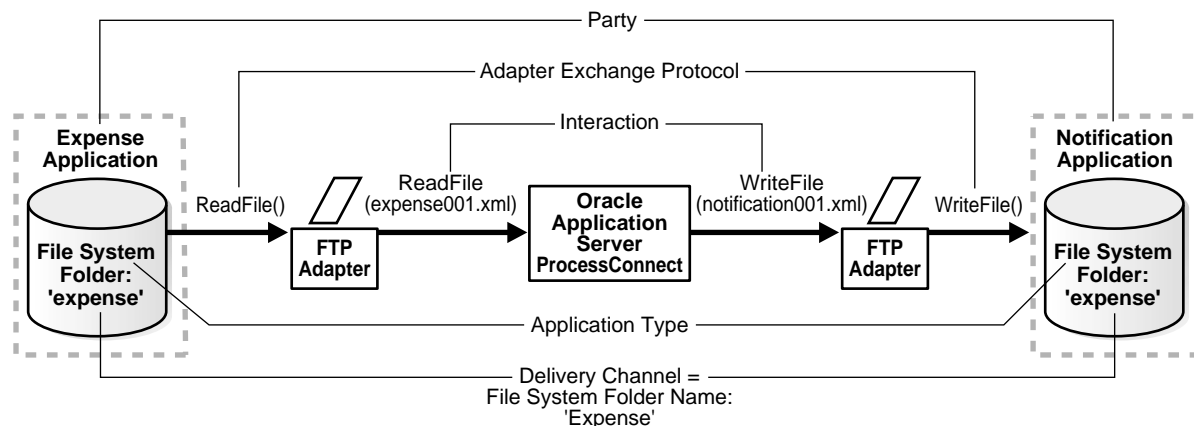

See Also: ["Managing Adapter Interactions"](#) on page 11-4 for instructions on adding adapter interactions

Native Events

A native event is the Oracle Application Server ProcessConnect internal implementation of the business data contained in an Oracle record. Wire messages can contain a number of sections, such as headers, payloads, and attachments. After the wire message is represented as an Oracle record instance, the event message structure is used. The structure consists of one header plus any number of body elements of datatypes. The different sections are placed into the different body elements of a native event instance, as shown in [Figure 3–4](#). The representation of the contents does not change. For example, a binary data structure sent by a party is still a binary data structure in the body element of a native event instance.

Figure 3–4 Body Elements of Native Events

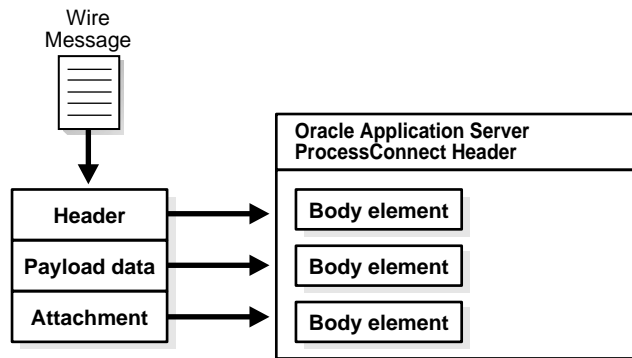

After an Oracle record instance is represented as a native event instance, an important first event abstraction (removal of a native feature of a party's wire message) is achieved. The native event instance's body elements contain the data as sent in the wire message. However, the particular wire message transmission structure is removed (such as encoding, packaging, signing, or encryption). The native data sent by the party is all that remains in the body elements of the native event instance. For this reason, the event classification is native.

In the outbound direction, native event instances must contain the native format for the target party so that the appropriate Oracle record can be created and sent out as a wire message.

Figure 3-5 shows the native event and each of its body elements.

Figure 3-5 Native Events

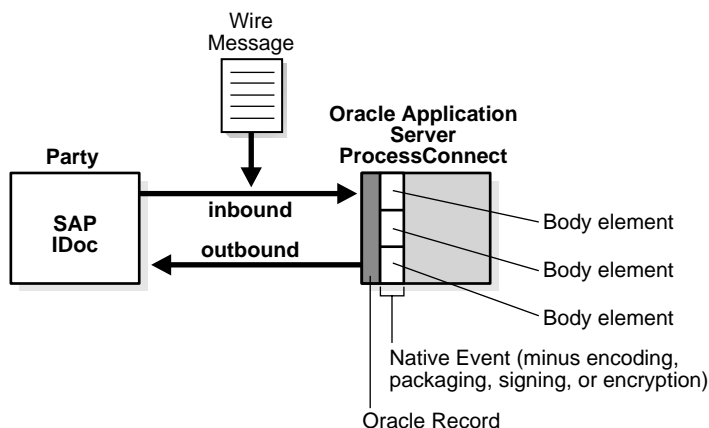

See Also: ["Managing Native Event Types"](#) on page 11-37 for instructions on managing native event types

Native Event Validation

Every party is concerned with the data consistency of wire messages being sent or received. Validation rules are defined that must be enforced to guarantee data consistency. The concept of native event validation is provided for this purpose. Each native event can be supplemented with native event validation rules that you invoke. If the validation rules are satisfied, the native event instance is considered consistent and made available for further processing. If at least one validation rule fails, the native event instance is considered inconsistent. In the outbound case, the native event instance is put into the error state. After it is in an error state, specific error handling is modeled for handling the error situation. In the inbound case, the native event instance is not created and the error is returned to the adapter framework that tries to create the native event instance. The adapter framework is responsible for communicating between the Oracle Application Server ProcessConnect runtime system and various adapters to send and receive data in the form of native events. In the case of a failed native event validation (inbound), the adapter framework always returns an error to the initiating adapter (sending party), which can inform the application about the problem (such as, returning an HTTP error code to the application in the case of the HTTP adapter).

Native event validation rules can access every body element in the native event and can be of arbitrary complexity. This includes checking for the existence of elements, specific values, cross-element checks, enumeration checks, and so on. The native event validation rules enable Oracle Application Server ProcessConnect to guarantee event instance consistency.

Native event validation is not explicitly modeled as steps since the native event validation rules are applied when the native event instance is created. If the native event instance is inconsistent, the native event instance is never placed into ports.

See Also: ["Steps"](#) on page 3-28

Native Datatypes

A wire message contains datatypes in their own native format. For example, a payload data section in a purchase order uses datatypes for the quantity ordered, the total cost, the product being ordered, and so on). Oracle Application Server ProcessConnect creates native datatypes for the body elements of a wire message when an adapter interaction is added. However, Oracle Application Server ProcessConnect does not understand these native datatype formats (for example, whether they are scalar or complex types, whether they are string or integer datatypes, and so on). For Oracle Application Server ProcessConnect to understand datatypes, they must be translated into application datatypes.

See Also:

- ["Application Events and Translation"](#) on page 3-30
- ["Viewing Native Datatypes"](#) on page 10-58 for instructions on viewing details about native datatypes

Native Roles

Wire messages exchanged with parties are generally not one-way wire messages sent in isolation. Wire messages typically follow a message transmission exchange pattern in which a sequence of messages are sent and received between parties.

A native event that is received typically causes another native event to be sent. Or, a native event that is sent causes a response to be received. The initial native event that starts a message exchange is called an initiating native event instance. Other native events are communicated based on this initiating native event. Any number of native events are possible.

For example, an exchange between a credit approval request (CAR) and credit approval acknowledgment (CAA) is described throughout this section. A selling party sends out an initiating CAR native event to check the credit record of a buying party and later receives an inbound CAA native event. Since the wire transmission exchange can be unreliable, additional acknowledgment (ACK) wire messages are exchanged to indicate the receipt of other, previously-sent wire messages. For example, the CAR wire message and the CAA wire message are each acknowledged with ACK wire messages. This results in four wire message exchanges: the CAR, the CAA, and two ACK messages, which results in three Oracle Application Server ProcessConnect native events:

- CAR
- CAA
- ACK

The native roles feature expresses this dependency between native events. The term role is used since the parties exchanging native events (through wire messages) exhibit a specific behavior (role), such as buyer or seller.

The native role defines the exchange behavior of native events between two parties from the viewpoint of one party. Native roles support the modeling of native event exchange behavior. A native role contains a set of internal processing steps that define the processing of native event instances. [Figure 3-6](#) shows a native role for these native events. [Table 3-2](#) describes these events.

Native roles implement native event exchange behavior because they control the specific native event instance to process and the order in which to process them.

The native role implements the buyer behavior. The native CAR is sent out as an initiating event (the first event). At runtime, a native role instance is created for each wire transmission exchange.

By convention, the left side of the native role in [Figure 3-6](#) is the outbound direction to a party. The right side of the native role in [Figure 3-6](#) is the inbound direction to further model elements (introduced later on).

The native role in the end sequences the events to perform the credit approval. Since native events correspond to wire messages, the native role governs their execution sequence.

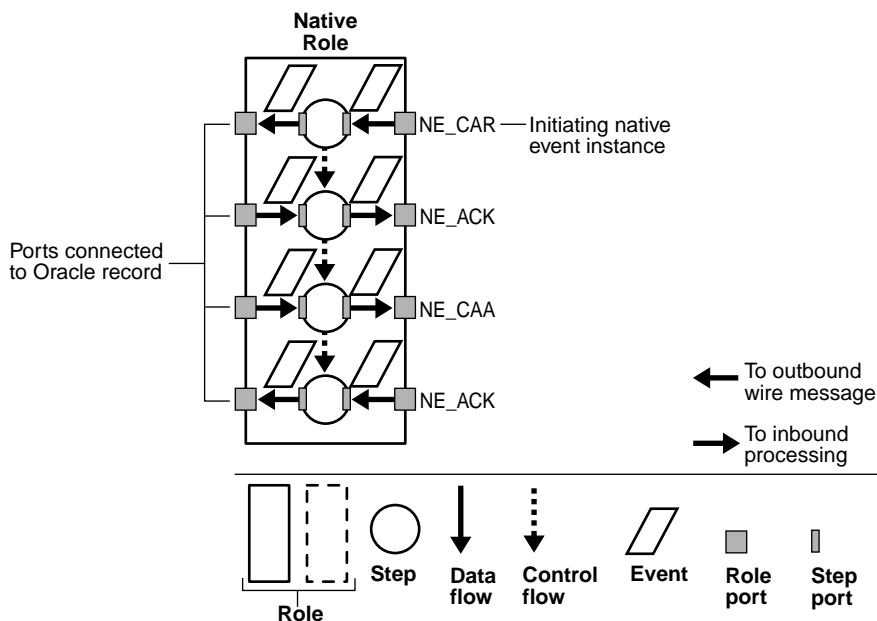
Figure 3–6 Native Events and Native Role**Table 3–2 Native Events**

Event	Description
NE_CAR	The credit approval request event (initiating)
NE_ACK	Acknowledgment of credit approval request event
NE_CAA	Credit approval request acknowledgment event
NE_ACK	Acknowledgment of credit approval request acknowledgment event

For these events to respond to one another, a series of key internal processing elements must also be defined. The bottom of [Figure 3–6](#) identifies these elements that enable events to move to and from all roles in Oracle Application Server ProcessConnect.

See Also: "[Internal Processing Elements for Native, Application, and Business Levels](#)" on page 3-27 for a description of the internal processing elements shown at the bottom of [Figure 3–6](#)

Native Event Correlation

A selling party that sends out several CARs expects to receive the same number of CAAs (in the normal nonerror case) in return. Each CAR-CAA pair (with the necessary ACK events) is executed by its separate native role instance. After a CAR is sent out, the native role instance waits to receive the CAA. Several native role instances can wait to receive their CAAs. After a CAA is received, Oracle Application Server ProcessConnect determines to which of the waiting native role instances it belongs. If the inbound CAA can be related with its corresponding CAR, the waiting native role instance can be determined, since the native role instance that earlier sent out the CAR is known.

This relationship is called native event correlation. Native event correlation ensures that the right native event instances are matched and provided to the corresponding native role instances. Native event correlation is an expression that defines when two native event instances are related. For example, consider the following expression:

```
CAR.request_id = CAA.request_id
```

This expression declares that a CAR and a CAA are correlated if they contain identical credit request identifiers. After a CAA is received, the expression finds the correlated CAR. After this CAR is identified, the waiting native role instance that sent the CAR is identified. The CAA must be given to that native role instance to have the same native role instance process the corresponding CAA for the CAR.

See Also: ["Managing Native Event Correlations"](#) on page 11-47 for instructions on managing native event correlation

Event Maps

Some parties represent different business-relevant events within the same message structure. Therefore, the same type of wire message can contain different types of business data. For example, instead of having three different types of payloads for creating, updating, and deleting a CAR, only one type is defined. That type contains a field (sometimes called an action field) that indicates if the contents are a create, update, or delete type.

At runtime, it is also necessary to identify which type is meant, based on the Oracle record. For example, if a purchase order payload is received through a wire message, the Oracle record contains the content. The action field indicates if the purchase order payload is a create, update, or delete type. Based on this type, a native event instance is created that represents either a create CAR, update CAR, or delete CAR.

The concept that makes this distinction is called an event map. An event map consists of an expression for each type of Oracle record that determines the native event type for a given instance of the Oracle record. After the Oracle record is available, the event map applies the expression to it. The expression results in one native event type. After this is determined, an instance of this native event type is created and populated. If an Oracle record maps only to one native event type, the event map is simple. The expression becomes true and the map has only one entry.

See Also: ["Managing Event Maps"](#) on page 11-54 for instructions on managing event maps

Internal Processing Elements for Native, Application, and Business Levels

For the native levels, and application and business levels described in subsequent sections, to respond to one another, a series of key internal processing elements must also be defined. The bottom of [Figure 3-7](#) identifies these elements that enable the events to move to and from all roles. While [Figure 3-7](#) shows a native role, these internal processing elements are also used in application and business roles.

Figure 3-7 *Internal Processing Elements*

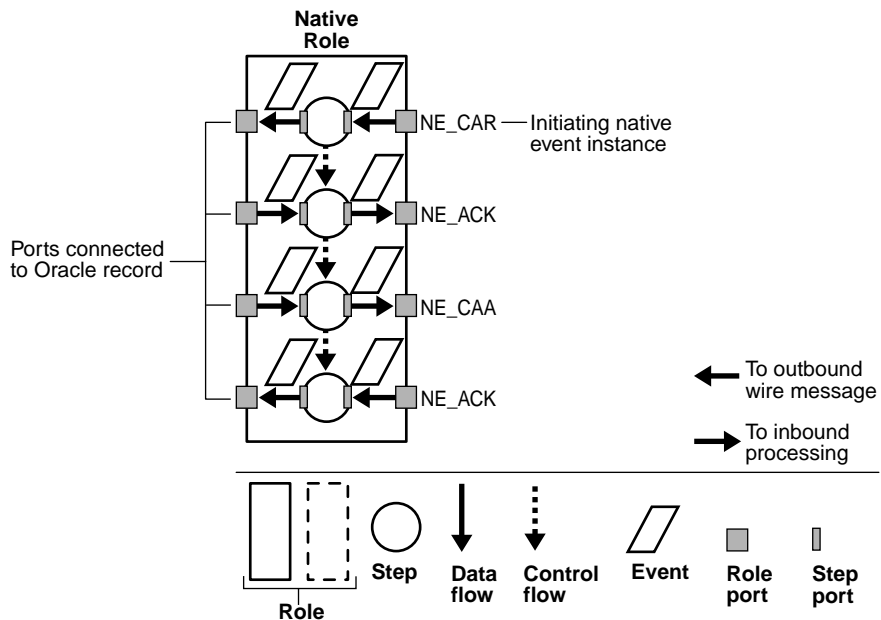

These sections describe the following internal processing elements available at the native, application, and business levels:

- [Role Ports](#)
- [Steps](#)
- [Step Ports](#)
- [Data Flow](#)
- [Control Flow](#)

Role Ports

A role port represents an input or output parameter of a native, application, and business role containing event instances at runtime. [Figure 3-7](#) provides an example of role ports in a native role. You connect the ports on the left side of the native role to Oracle records (that is, the boundary of Oracle Application Server ProcessConnect) using the Oracle Application Server ProcessConnect user interface tool. The native role ports on the right side are connected to other ports for further processing. The native role shown in [Figure 3-7](#) has four input and four output parameters. Ports are identified by events. The name of each event is shown next to the ports. At runtime, only event instances of this type are permitted in the ports.

Ports are distinguished as follows:

- Inbound ports are those that receive an event instance from outside the role.
- Outbound ports are those that receive event instances from within a role. The same convention also applies to step ports.

See Also: ["Managing Role Ports"](#) on page 12-48

Steps

A step defines execution logic in a native, application, and business role that is applied to one or more events. The steps in the native role example in [Figure 3-7](#) do not apply any execution logic. Instead, they send the native event instance without any processing. Steps of this type are called pass-through steps. These steps are useful when no processing other than sending events is required. Other steps perform more detailed processing, such as transformation or conditional branching. With conditional branching, for example, you can specify that a specific condition be performed if the amount field of a purchase order is over a specific number, such as notifying a second approver. A step waits for all control flows and all data flows to arrive before executing its logic. The only exception to this is the Or Step, which executes its logic as soon as the first control flow arrives.

See Also:

- ["Managing Steps"](#) on page 12-70
- ["Types of Steps"](#) on page 12-71

Step Ports

Step ports are the input parameter and the output parameter of steps in native, application, and business roles. The first step has one input parameter and one output parameter, both of event type NE_CAR in the example shown in [Figure 3-7](#) (NE standing for native event).

See Also: ["Managing Step Ports"](#) on page 12-87

Data Flow

Data flows connect step ports and role ports of native, application, and business roles. For example, the inbound port of native event type NE_CAR in [Figure 3-7](#) on page 3-27 is connected to the inbound step port of the first step. At runtime, the native event instance placed on the inbound role port is made available to the inbound step port. This behavior is analogous to binding actual and formal parameters in method invocations of a programming language.

Data flows from one role to another are grouped together. The set of data flows between a given pair of roles is called a data flow group. A data flow group aids in specifying the role to choose when there are potentially multiple roles to which an event instance can be passed (that is, when there are multiple data flow groups between a given pair of roles).

See Also:

- ["Managing Role Data Flow"](#) on page 12-58
- ["Managing Step Data Flow"](#) on page 12-95

Control Flow

Control flows between steps indicate their execution order. As shown in [Figure 3-7](#) on page 3-27, the control flow relationship and the data flow relationship does not necessarily relate the same pairs of steps. [Figure 3-7](#) contains only sequential relationships that enforce the sequential execution of the steps. More complex control flow relationships such as conditional branching or parallelism are also available.

Control flows also use a guard value to specify the next step to execute based on the outcome of a condition expression evaluation or the outcome of a given step. In the case of condition expressions, the outcome could be true or false. In the case of step execution, the outcome could be success or failure.

See Also: ["Managing Step Control Flow"](#) on page 12-102

Application-Level Concepts

This section describes the following Oracle Application Server ProcessConnect application-level features that are designed to enable you to add additional event processing facilities or rules to the event in the semantics of the party, even though the syntax has been converted into the format used by Oracle Application Server ProcessConnect.

- [Application Events and Translation](#)
- [Application Datatypes](#)
- [Application Roles](#)
- [Translation Binding Role](#)
- [Acknowledgment Consumption and Generation](#)

Application Events and Translation

For Oracle Application Server ProcessConnect to process the datatype contents of inbound native event body elements, the contents must be re-represented in an interpretable syntactic format. This interpretable format is called the application format. Oracle Application Server ProcessConnect represents the following in application format:

- The event instance structure in relational form
- The body elements of event instances in an Oracle Application Server ProcessConnect-specific XML format

For example, if a CAR is received that is represented as a comma-delimited native format, then Oracle Application Server ProcessConnect cannot extract values from it. However, this is necessary when, based on specific values, control flow decisions must be made later in the business process, or if it must be transformed. After the native event is represented as the corresponding application event, Oracle Application Server ProcessConnect can extract values from it and make decisions based on it, or transform it.

The explicit native format re-representing in application format is called translation. For a given pair of corresponding native event and application event types, there is a translation that re-represents the contents of the inbound native event in the native format as an inbound application event in the application format. For outbound events, this re-representation occurs in the opposite direction (outbound application event in the application format to outbound native event in the native format).

Translation only rewrites the syntax, not the particular datatype values. For example, if the native format contains an address consisting of one long string, the application event contains the same long string content. However, if the native event's address is in binary representation, then the address is in application format in the application event.

Translation is performed by a translator that you select with the Oracle Application Server ProcessConnect user interface tool. Oracle Application Server ProcessConnect provides three types of translators for translating native events to application events, and vice versa. [Table 3-3](#) describes these translators.

Table 3-3 Translators

Translator	Description
The XML Schema Definition (XSD)	Translates native messages that use XML
Data definition description language (D3L)	Translates native messages that use a format of structured records of bytes, characters, or both
Token substituted text	Translates the subject and body of alert e-mail messages that use the E-Mail adapter

See Also:

- ["Managing Adapter Interactions"](#) on page 11-4 for instructions on selecting a translator when adding a new adapter interaction
- ["Managing Native Event Types"](#) on page 11-37 for instructions on selecting a translator when adding a native event to an existing interaction
- ["Viewing Application Event Types"](#) on page 11-60 for instructions on viewing application event types
- ["Translation Step"](#) on page 12-74 for conceptual details
- [Appendix A, "Native Formats and Translators"](#) for specific details about XSD, D3L, and token substituted text

Application Datatypes

The internal structure of application event body elements is defined through application datatypes. Application datatypes represent an interpretable syntactic format understood by Oracle Application Server ProcessConnect. Application datatypes are a structured type system with primitive types such as string or integer and complex type constructors. Translation translates from the native format into the application format defined by the application datatypes. These application datatypes enable Oracle Application Server ProcessConnect to access the contents for further processing.

At this point in the event processing, a second important event abstraction is achieved. The particular native format is removed. By viewing the contents of application event body elements, the particular native format cannot be identified. Any specific syntactic property of a party is removed. For example, any business data originally in binary form in the wire message is removed. Instead, the business content is now represented in the application format, (that is, the Oracle Application Server ProcessConnect-specific XML format). The only specific property that remains is the particular vocabulary a party uses (for example, a product is referred to as *car* instead of a *vehicle* in a purchase order).

See Also:

- ["Business Process"](#) on page 3-44
- ["Managing Application Datatypes"](#) on page 10-55

Application Roles

As with native events, the corresponding application events are sent back and forth between parties in a particular sequence. This sequence is defined in Oracle Application Server ProcessConnect. The same internal processing elements as described in "Internal Processing Elements for Native, Application, and Business Levels" on page 3-27 (steps, ports, and so on) are also available with application roles. Figure 3-8 shows the application role. The same symbols are used for roles and events. However, roles that process native events are known as native roles and roles that process application events are known as application roles. Application event names are prefixed with AE in Figure 3-8. In Figure 3-8, the event movement is initiated from within Oracle Application Server ProcessConnect.

See Also: "Managing Role Types" on page 12-40 for instructions on managing application roles

Figure 3-8 Native Role and Application Role

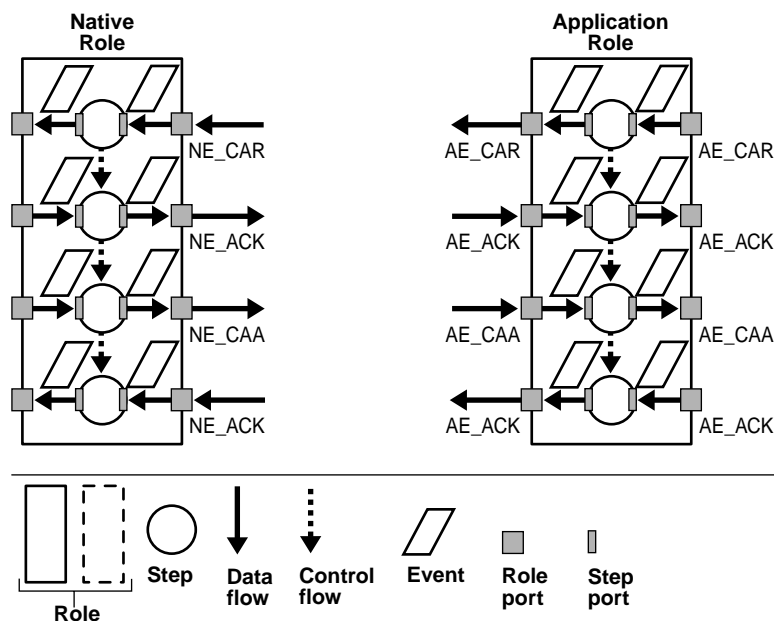

In [Figure 3-8](#), the native role and the application role are not yet connected. Furthermore, the translation steps that translate native events to application events and vice versa are not yet modeled. To model these steps, a translation binding role is required.

Translation Binding Role

The translation binding role connects the native role ports to the application role ports with a data flow. Through this connection, native events are translated into application events, and vice versa. The translation binding role only exists in conjunction with its related native role and application role. The translation binding role is represented as a dashed box in [Figure 3-9](#).

Translation using an XSD, D3L, or token substituted text translator is executed within translation steps in the translation binding role. These steps are prefixed with TL in [Figure 3-9](#).

Figure 3-9 Translation Binding Role

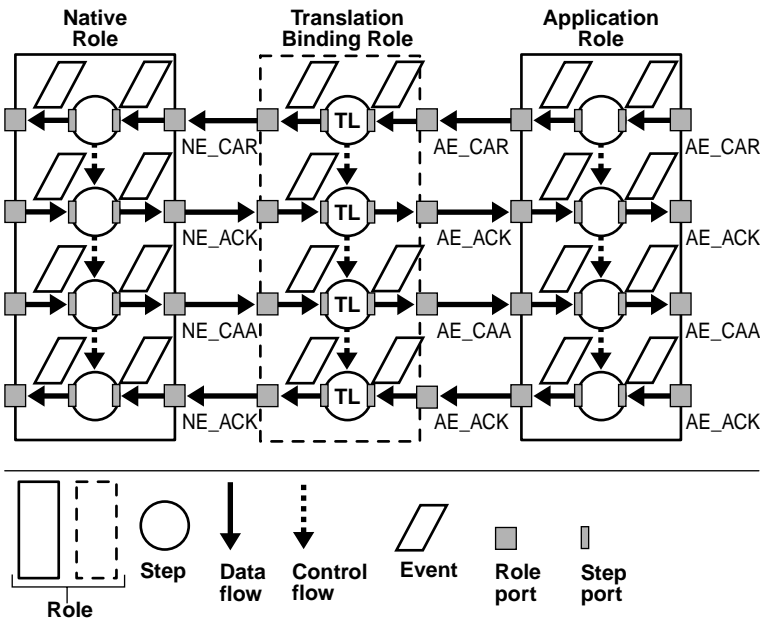

See Also:

- ["Acknowledgment Consumption and Generation"](#) on page 3-35 for details on disabling inbound ACKs
- [Chapter 11, "Managing Adapter Interactions and Event Types"](#) for instructions on selecting a translator
- ["Managing Role Types"](#) on page 12-40 for instructions on managing translation binding roles
- [Appendix A, "Native Formats and Translators"](#) for details about the XSD, D3L, and token substituted text translators

Acknowledgment Consumption and Generation

If the ACKs are only needed in the exchange between a trading partner but not within the enterprise, is there a way to disable inbound ACKs as early as possible and produce outbound ACKs as late as possible to reduce the amount of processing?

The earliest place to disable an inbound ACK is the native role. The ACK must be received from the sending party. Therefore, a role step must be inside the native role that processes the ACK. However, instead of sending it to the translation binding role, it can be disabled within the native role. If this approach is followed, the native role does not pass the native ACK event to the translation binding role.

While this is the most efficient approach, it does not work if the native role is reused for another case where the ACK is needed. Therefore, if reuse is necessary, disable the ACK in the translation binding role. In this approach, the native role preserves its original behavior and the translation binding role in another scenario can again, if necessary, disable the ACK.

Generating an ACK requires access to the events that generated the ACK. The only place currently where event content is interpretable by Oracle Application Server ProcessConnect is the application role (application events) or the translation binding role (the application events in it). Again, a design decision must be made on where to perform the ACK generation. In this example, generation is performed in the translation binding role. [Figure 3–10](#) shows this situation.

Figure 3–10 ACK Consumption and Generation

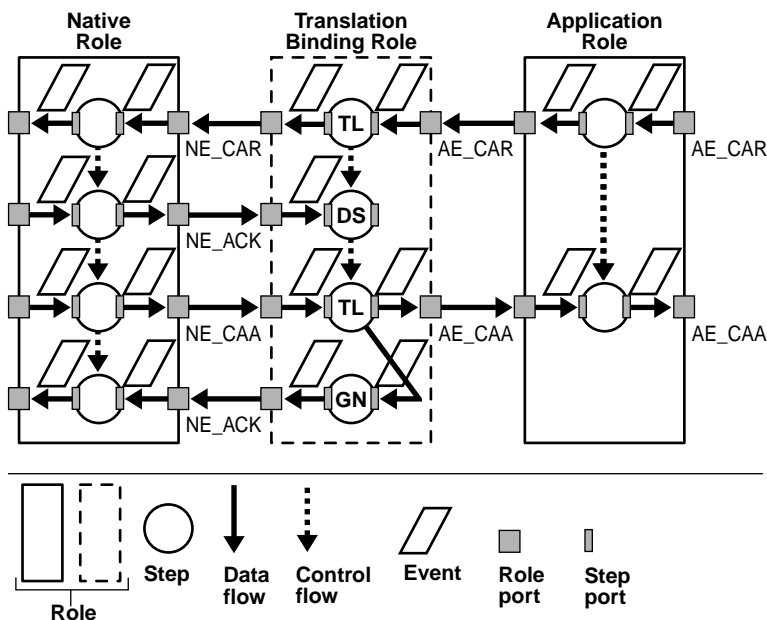

The disabling step is known as a consume step and is called DS (for disabling an event and preventing further processing from occurring) in Figure 3–10. The generating step is called GN. To generate the ACK, the generation step needs the original AE_CAA event. Therefore, an additional data flow is added to an input port of the generation step.

Figure 3–10 also shows that the native role remained unchanged (the initial design goal). Also, the application role does not require interaction with ACKs. ACK disabling is confined to the translation binding role.

This example shows the ability to achieve a very important goal: behavior abstraction. The translation binding role abstracted from the ACK handling that was imposed by the particular party that required ACKs. However, the ACKs may not be relevant on the business level (only on the protocol level). This means that with translation binding roles, the transport-related handling of ACKs can be abstracted. As a result, the application role becomes much simpler with fewer modeling constructs.

Behavior abstractions are different from event abstractions. However, both are achieved concurrently by way in which the spoke is modeled with the corresponding event classes.

See Also: ["Consume Step"](#) on page 12-76

Business-Level Concepts

This section describes the following Oracle Application Server ProcessConnect business-level features:

- [Business Events](#)
- [Business Datatypes](#)
- [Transformation](#)
- [Business Roles](#)
- [Transformation Binding Role](#)
- [Business Process](#)
- [Event Addressing with the SetParty Step](#)

Business Events

A third and final event class is called the business event. A business event is required to establish a common event structure and event vocabulary across all parties. For example, if one party uses *car* and another party uses *vehicle* in a purchase order to refer to the same product, then a vocabulary mismatch exists between the two parties. Whenever an event is sent between these parties, *car* must be replaced by *vehicle*, and vice versa. Transformation corrects this vocabulary mismatch.

Why is a business event required? Why is the transformation not done directly between application events since the application event content is interpretable by Oracle Application Server ProcessConnect? The answers lie in the scalability problem that arises with four or more parties. If four parties exchange events, then two transformations must be defined between each pair of parties. This means 12 transformations in total if direct transformations take place. However, if each of the four parties transforms only to and from a common business event, then only eight transformations are necessary, two for each party. This significantly reduces the number of required transformations. If transformations for 10 parties must be defined, then only 20 transformations are necessary, instead of 90 transformations.

The break-even point is with three parties, in which six transformations are necessary.

See Also:

- ["Transformation"](#) on page 3-39 for details on defining transformations
- ["Managing Business Event Types"](#) on page 11-63 for instructions on managing business events
- [Chapter 13, "Managing Transformations"](#) for instructions on creating transformations to establish a common vocabulary across all parties

Business Datatypes

The different datatypes of parties (applications and trading partners) must all be represented as a single, common set of business datatypes to communicate with Oracle Application Server ProcessConnect and participate in integrations. You can import or create datatypes as business datatypes in Oracle Application Server ProcessConnect. You assign these business datatypes to an event body element of a business event. Business datatypes are the datatypes to which application datatypes are transformed for inbound events. Likewise, business datatypes are transformed into application datatypes for outbound events.

See Also:

- ["Managing Business Datatypes"](#) on page 10-13
- ["Importing XSD Datatypes"](#) on page 10-51
- ["Creating an Event Body Element"](#) on page 11-69

Transformation

A business event must be defined that represents all corresponding application events from all the involved parties. This means that a common structure must be found between the application events. For example, assume the following:

- The application event type of one party contains one long string containing the credit amount to be authorized, the name of the company whose credit must be checked, and the name of the company requesting the check.
- The application event type of a second party requires the credit amount in one element and the two companies in one long string datatype.
- The application event type of a third party requires each data item in a different string datatype.

In what format does the business event appear? The business event has each datatype item in a separate string. Transforming from the application events to the business event for an inbound message means to split the strings into their individual parts where necessary. Transforming from the business event to the application events for an outbound message means to compose strings where necessary.

In addition, a vocabulary must be defined into which all application events are transformed. For each data item, it must be defined if its value can be preserved in the business event or if a vocabulary conversion must take place (such as from *car* to *vehicle*). Maps that relate values such as *car* to *vehicle* are called domain value maps. A lookup takes place for conversions. For example, given *car*, the corresponding value *vehicle* is looked up.

A transformation rule describes how to transform one data item from an application event to a business event, and vice versa. An example of a transformation rule is as follows:

```
copy(from=HR New Ad-IN/Ad/Ad_ID --->to=Global NP Ad-OUT/PAYLOAD/Ad_ID )
```

In this example, the transformation rule copies the value from a data item named *Ad_ID* in a source application event parameter named *HR New Ad-IN* to a data item named *Ad_ID* in a target business event parameter named *Global NP Ad-OUT*. More complex transformation rules such as conditionals, domain value map lookup, and iteration are available.

A transformation map is the set of all transformation rules necessary to transform a business event from an application event, or vice versa. Transformation maps have any number of sources and targets. Sources and targets can be application events, business events, or datatypes.

Transformation maps are separated into event transformation maps and datatype transformation maps. This enables you to reuse the same datatype in multiple event transformation maps.

At this stage, a third important event abstraction is achieved. Business events completely abstract from any party specific properties, including data structure and vocabulary. All related events from all parties follow the same structure and the same vocabulary once they are translated and transformed into business events. [Figure 3-11](#) shows the abstraction levels that lead to an Oracle Application Server ProcessConnect format.

Figure 3-11 Event Abstractions

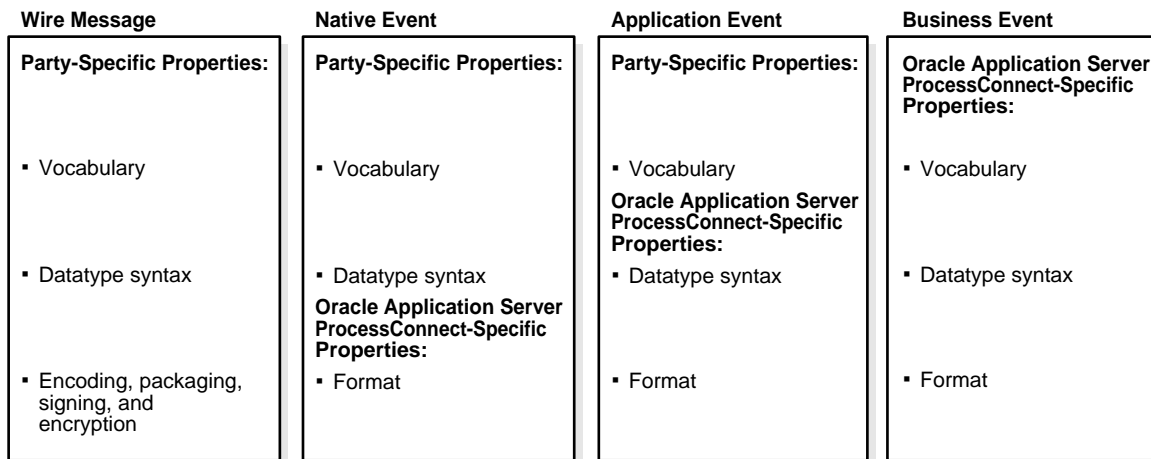

See Also:

- ["Transformation Step"](#) on page 12-73
- [Chapter 13, "Managing Transformations"](#) for instructions on managing transformations

Business Roles

Business events, as with application and native events, are processed in a specific order. The business role defines the execution order, independent of the application roles bound to it. [Figure 3-12](#) shows the business role. In this example, the business event names are prefixed with BE.

Figure 3–12 Business Role

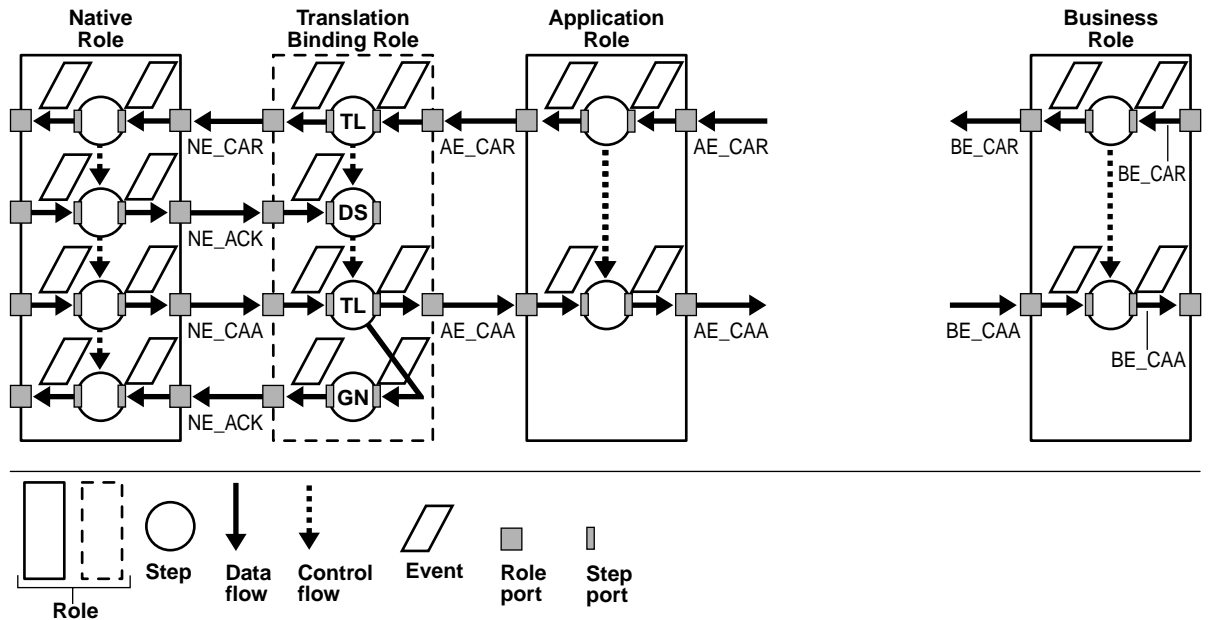

See Also:

- ["Transformation Binding Role"](#) on page 3-41, which connects the application and business roles
- ["Managing Role Types"](#) on page 12-40 for instructions on managing business roles

Transformation Binding Role

Transformation binding roles connect application role ports to business role ports. Transformation steps are located inside transformation binding roles. The transformation step names are prefixed with TF in [Figure 3–13](#).

Figure 3–13 Transformation Binding Role

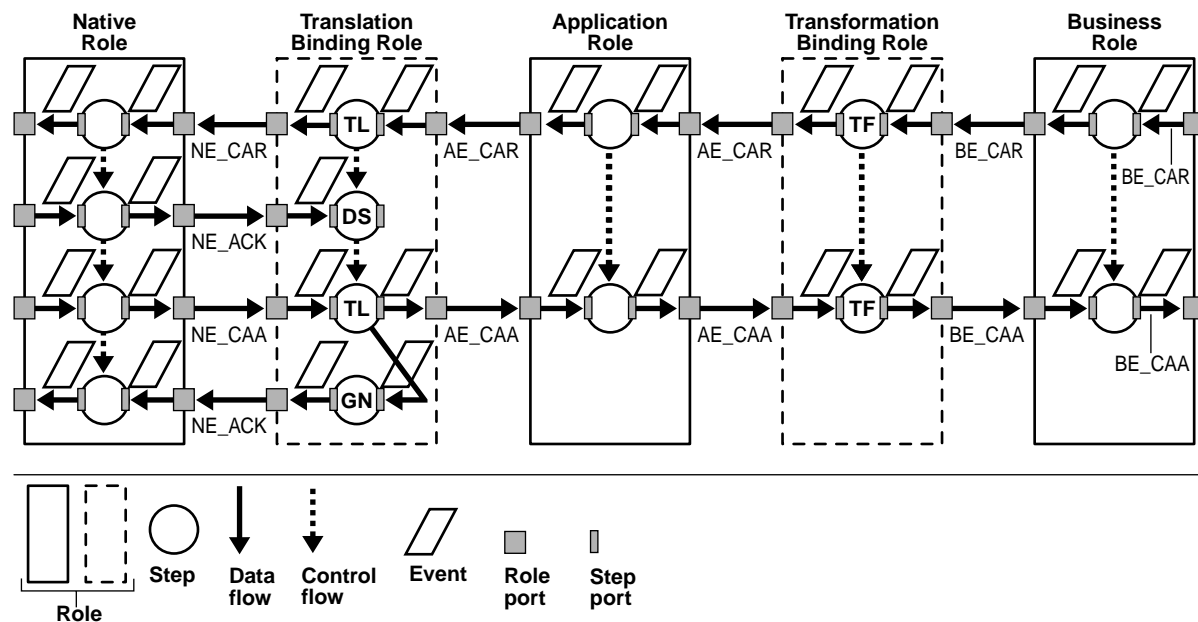

The roles in [Figure 3–13](#) comprise a portion of a spoke. A spoke consists of a role set extending from the native role to the business process (not shown in [Figure 3–13](#)). All roles and event classes up to the business role achieve the three levels of abstraction. The business role is completely removed from any party-specific properties. This includes event characteristics as well as behavior characteristics.

Part of a second spoke is introduced in [Figure 3–14](#) that results in the same abstraction. This can be the case if another party has a different protocol and different types of wire messages dealing with CAR and CAA. To keep it simple, this additional party does not require ACK events, but has a different representation of CAR and CAA. This representation requires its own set of transformations. This is denoted by CAR' and CAA' (note the apostrophes). By adding another spoke, the already-existing spoke remains unchanged. This is important in a business environment where adding and removing parties occurs frequently.

For the additional spoke, the same business events and the same business event sequence are available after the transformation binding role. This enables the business role to be reused, as shown in [Figure 3-14](#). Reuse enables you to avoid having to manually design this role a second time. When designing a business process, this is an important situation because the business processes do not distinguish between party-specific behavior.

See Also:

- ["Business Process"](#) on page 3-44
- ["Managing Role Types"](#) on page 12-40 for instructions on managing roles

Business Process

The business process is at the center of any integration and implements the business logic and manages the movement of business events. The business process also hides the unique characteristics of each party in an integration. For example, if the amount of the credit approval request exceeds a certain limit, specific steps are taken. For example, the approval of two senior supervisors may be required. This business logic is completely independent of where the request is sent and the particular behavior of a wire message for a given party.

Since business roles ensure homogeneous behavior, structure, and content of business events, the business process is used in a homogeneous environment. [Figure 3-15](#) shows the business process. The business process must later be connected to business roles.

Figure 3–15 Business Process

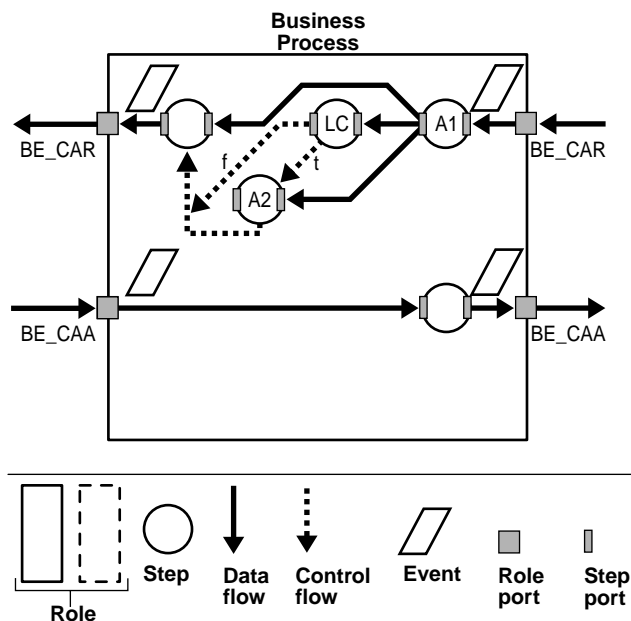

Table 3–4 describes the identifiers in Figure 3–15.

Table 3–4 Identifiers

Identifier	Description
A1	Denotes the mandatory approval step that takes place for every outbound BE_CAR
LC	Denotes the limit check step that tests if the approval amount exceeds a certain limit
A2	If the approval amount exceeds a certain limit, this second approval step takes place.
t	Denotes the true branch. If the approval amount exceeds the limit, the second approval step identified by A2 takes place.
f	Denotes the false branch. If the approval amount does not exceed the limit, the this second approval step is not required.

Figure 3-16 links the business process with the business role in Figure 3-14 on page 3-43 that implements the behavior for trading partners. Only the business role is displayed, not the entire spoke.

Figure 3-16 Business Process and one Business Role

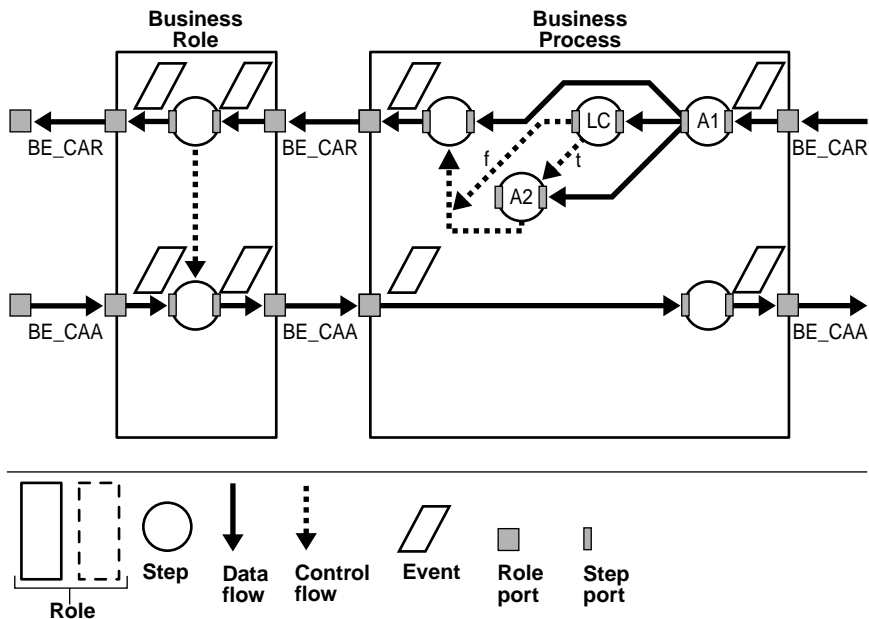

The business process is now connected with the spoke shown in Figure 3-14 for the parties. According to Figure 3-14, two different B2B protocols and their corresponding translations and transformations are available.

An application is the source of the CARs and the target for the CAAs. To connect to the application, another spoke must be modeled in the outbound direction that implements the transformation and translation required for it as well as the wire exchange behavior. This spoke looks similar to the one without the acknowledgments, since the connection to the application is transactional and does not require any transport-level acknowledgments.

See Also: "Managing Business Processes" on page 12-33 for instructions on managing business processes

Event Addressing with the SetParty Step

Events originate from parties and are sent to parties. At some point in event processing, event addressing must be performed. Event addressing enables you to select the target party with whom to integrate in the SetParty step of the business process. There are two methods for performing event addressing:

- The sending party does not include a final destination in the form of a party, but names the hosted trading partner as the address. In this case, the modeler must overwrite the address to send the event to the final party (for example, an application or a trading partner).
- The target party can be set using the setParty step or as part of the event transformation by using the setToParty event header rule.

Figure 3-17 shows an example where a party is set through the SetParty step in a business role. The step SP indicates that a party is set.

Figure 3-17 Example of a SetParty Step (SP)

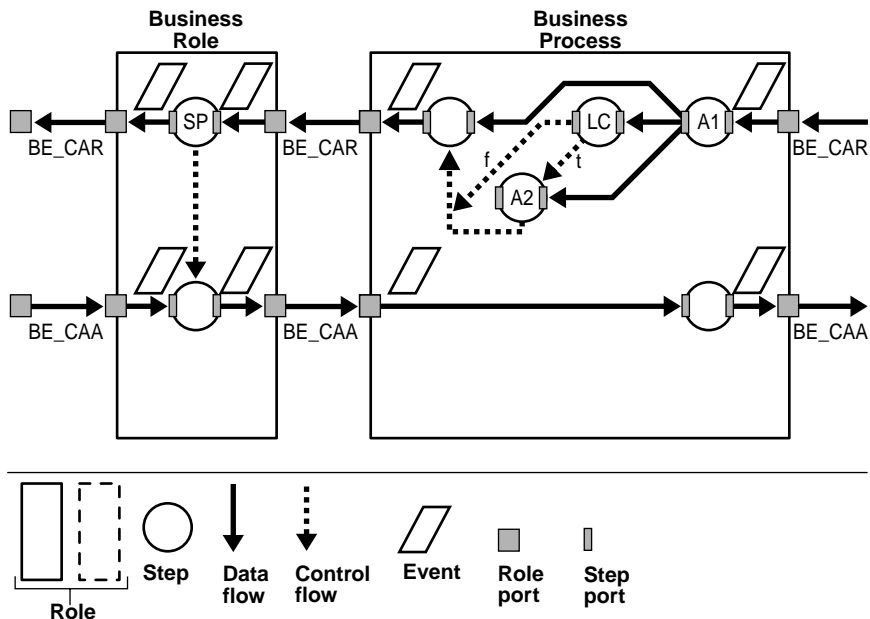

As [Figure 3-17](#) shows, an outbound BE_CAR can take two paths since there are two spokes. Which path is taken? Since each path implements a different wire message exchange sequence, the choice must be correct for the target party (in this example, the target trading partner). The party agreement defines which event can be sent to a party using which particular spoke. This agreement is used by Oracle Application Server ProcessConnect to determine which spoke is taken after the business role in an outbound direction.

See Also:

- ["Managing Steps"](#) on page 12-70 to manage event addressing with the SetParty step
- ["SetParty Step"](#) on page 12-76 for conceptual details
- ["Managing Applications"](#) on page 15-4 to create an application that is selectable from the SetParty step list
- ["Managing Remote Trading Partners"](#) on page 26-6 to create a trading partner that is selectable from the SetParty step list

Runtime Instance Behavior

During runtime, instances of events, roles, and steps are created. These instances go through various states based on their current location in an integration. This section describes these various instance states.

This section contains these topics.

- [Event Instances](#)
- [Role Instances](#)
- [Step Instances](#)

See Also:

- [Chapter 21, "Oracle Application Server ProcessConnect Error Handling"](#) for details about event and role instance error handling
- [Chapter 23, "Creating Reports"](#) for instructions on creating runtime instance reports

Event Instances

Oracle Application Server ProcessConnect persists data being processed. The data that is persisted as events flow through the system are called event instances. Event instances also follow the same classification as event definitions (that is, a native event instance is created when Oracle Application Server ProcessConnect receives an event, an application event instance is created after a native event is translated to Oracle Application Server ProcessConnect's internal format, and a business event instance is created after the application event instance has been transformed to the common (business) view definition).

Each event instance has an event processing state associated with it. As soon as Oracle Application Server ProcessConnect receives an event, it is captured in the design-time repository. Until the event instance is picked up by the integration manager for processing, it is in a `wait` state. Most often the event instance is processed by the integration manager almost immediately. During processing of the event by the integration manager, the event state is set to `active`. When processing is complete, the state is set to either `consumed` or `error`. If processing is successful, then the state is set to `consumed`. If there was an error during processing, the state is set to `error`.

See Also:

- ["Executing Runtime System Components: Overview"](#) on page 4-8 for conceptual details about the integration manager
- [Chapter 23, "Creating Reports"](#)

Role Instances

Oracle Application Server ProcessConnect persists data on the processing of events in a business process. At design time, business process behavior is captured as roles. At runtime, Oracle Application Server ProcessConnect creates role instances when processing for a given role is instantiated. Each role instance has state associated with it. When a role instance is created, its state is set to `created`. The state is set to `running` when the role instance has events being processed. If the role has completed successfully, then its state is set to `completed`. If an error is encountered during processing, then the state of the role instance is set to `error`. If you manually stop a coordination, which aborts all role instances for that coordination, the state is set to `aborted`. Role instance state is set to `WorkflowComplete` when all the steps are complete, but the events have not been delivered to the adapter framework or the next role. The state of a role instance is set to `AFComplete` when all events have been delivered to the adapter framework, but the End step has not

executed yet. Role instance is in this state for a very short period of time, since the End step is executed immediately and the state is changed to `Completed`.

See Also:

- ["Executing the Adapter Framework: Overview"](#) on page 4-9
- ["Role Runtime Behavior"](#) on page 12-133
- [Chapter 23, "Creating Reports"](#)

Step Instances

Oracle Application Server ProcessConnect creates instances of steps as they are executed. Step instances also have states associated with them. Step instance states are the same as those for role instances, as mentioned in ["Role Instances"](#) on page 3-49.

Coordinations

A coordination captures the semantics of a business transaction at runtime. When an event is received from an application or a trading partner, Oracle Application Server ProcessConnect determines if the event instantiates a business transaction (that is, if it instantiates a business process with all its role processing).

If this is the case, then it creates a coordination. A coordination has states associated with it. When a coordination is created, its state is set to `open`.

The coordination state is changed to `closed` when all processing has been completed successfully. The state of a coordination is set to `aborted` if the coordination did not complete successfully. This can happen if an error is encountered in any roles. You can also choose to stop a coordination during deployment; this action updates the state to `aborted`.

See Also:

- ["Coordination"](#) on page 12-133
- ["Implications of Role Instances and Event Instances Being in an Error State"](#) on page 21-10
- ["Coordination Status Report"](#) on page 23-13

Profile Data Design

Profile data consists of the following elements:

- [Applications and Adapters](#)
- [Trading Partners](#)
- [Agreements](#)

Applications and Adapters

The various applications that are parties in an integration have their own data formats and interfaces. A method must exist for enabling these different applications to communicate with Oracle Application Server ProcessConnect. Adapters provide the method of communication. Oracle Application Server ProcessConnect supports the following types of adapters:

- [Technology Adapters](#)
- [Application Adapters](#)
- [B2B Protocol Adapters](#)

See Also:

- ["Executing the Adapter Framework: Overview"](#) on page 4-9 for details on the adapter framework
- ["Adapter Interactions"](#) on page 3-19

Technology Adapters

Oracle Application Server ProcessConnect supports the following technology adapters:

- [Advanced Queuing Adapter](#)
- [E-Mail Adapter](#)
- [File/FTP Adapter](#)
- [HTTP Adapter](#)
- [JMS Adapter](#)
- [Oracle Database Adapter](#)
- [Web Service Adapter](#)

See Also: The following sections for instructions on performing these adapter tasks:

- ["Managing Adapter Interactions"](#) on page 11-4 to add adapter interactions and assign a translator to translate native events to application events
- ["Managing Adapters and Delivery Channels"](#) on page 15-9 to add adapters to applications and delivery channels to adapters
- ["Managing Applications"](#) on page 15-4 to manage applications

Advanced Queuing Adapter The Oracle Advanced Queuing adapter enables applications to communicate asynchronously with Oracle Application Server ProcessConnect over a reliable, scalable, and secure communication channel. Oracle Advanced Queuing provides an extremely flexible mechanism for bidirectional, asynchronous communication between participating applications.

See Also: ["Advanced Queuing Adapter"](#) on page 8-11

E-Mail Adapter The E-Mail adapter enables you to integrate an Oracle e-mail application with other applications using Oracle Application Server ProcessConnect. This adapter is useful in environments where e-mail uses the Internet Message Access Protocol 4 (IMAP4) and SMTP transport protocols.

See Also: ["E-Mail Adapter"](#) on page 8-30

File/FTP Adapter The File/FTP adapter enables you to integrate an Oracle FTP application with other applications using Oracle Application Server ProcessConnect. This adapter is useful in all environments involving the FTP transport protocol or local file system. The File/FTP adapter can monitor inbound messages in the form of FTP files placed on a remote FTP server or on local file systems. The File/FTP adapter also sends messages to remote FTP servers.

See Also: ["File/FTP Adapter"](#) on page 8-38

HTTP Adapter The HTTP adapter enables you to integrate an HTTP application with other applications using Oracle Application Server ProcessConnect. This adapter is useful in all environments that use the HTTP transport protocol. The HTTP adapter performs the following tasks:

- Monitors inbound messages received in the form of HTTP requests to the HTTP adapter servlet
- Sends messages to remote Web servers through a proxy host

See Also: ["HTTP Adapter"](#) on page 8-44

JMS Adapter The Java Message Service (JMS) adapter enables Oracle Application Server ProcessConnect to send and receive messages to and from the queues and topics administered by any JMS provider; the Oracle JMS (OJMS) and MQSeries JMS (IBM) providers are certified with Oracle Application Server ProcessConnect.

See Also: ["JMS Adapter"](#) on page 8-58

Oracle Database Adapter The Oracle Database adapter enables you to integrate an Oracle application, typically PL/SQL-based, with other applications using Oracle Application Server ProcessConnect. This adapter is useful in all environments involving Oracle database applications.

See Also: ["Oracle Database Adapter"](#) on page 8-75

Web Service Adapter The Web Service adapter enables you to interact with a Web service operation selected from a Web Service Description Language (WSDL) document.

See Also: ["Web Service Adapter"](#) on page 8-92

Application Adapters

Oracle Application Server ProcessConnect supports the following application adapters:

- PeopleSoft 8 adapter
- SAP R/3 adapter
- Siebel 2000 adapter
- J.D. Edwards OneWorld XE adapter

- Virtual Storage Access Method (VSAM) adapter
- Customer Information Control System (CICS) adapter
- Information Management System - Transaction Management (IMS/TM) adapter
- Information Management System - Database (IMS/DB) adapter
- Tuxedo adapter
- Oracle 10.7 and 11i

Note: These application adapters are only compatible with Oracle Application Server ProcessConnect, and cannot be used with Oracle Application Server InterConnect. Likewise, the application adapters provided with Oracle Application Server InterConnect cannot be used with Oracle Application Server ProcessConnect.

See Also:

- *Oracle Application Server Integration Adapter for CICS Installation and User's Guide*
- *Oracle Application Server Integration Adapter for IMS/DB Installation and User's Guide*
- *Oracle Application Server Integration Adapter for IMS/TM Installation and User's Guide*
- *Oracle Application Server Integration Adapter for J.D. Edwards OneWorld XE User's Guide*
- *Oracle Application Server Integration Adapter for PeopleSoft 8 User's Guide*
- *Oracle Application Server Integration Adapter for SAP R/3 User's Guide*
- *Oracle Application Server Integration Adapter for Siebel 2000 User's Guide*
- *Oracle Application Server Integration Adapter for Tuxedo Installation and User's Guide*
- *Oracle Application Server Integration Adapter for VSAM Installation and User's Guide*

Oracle e-Business Suite and 10.7 and 11i Oracle Application Server ProcessConnect supports a variety of different ways to interface with Oracle's suite of business applications for 10.7 and 11i. These different alternatives include:

- **Oracle Applications Interface Tables**

Interface tables are Oracle database tables provided through which external systems can interface with many of the modules in Oracle applications. Oracle Application Server ProcessConnect enables systems to Oracle Applications Interface Tables through the Oracle Database adapter.
- **Oracle Applications Business Event System (BES)**

Oracle Applications BES provides a set of asynchronous messaging interfaces through which systems can raise or receive events from some of the modules in Oracle Applications. Oracle Applications BES events are essentially messages that are placed on Oracle's advanced queuing facility. Oracle Application Server ProcessConnect can both raise and receive events from Oracle Applications BES through its Advanced Queuing adapter.
- **Oracle Applications Business Components for Java and J2EE Interfaces**

Oracle Applications modules that are developed in Java and J2EE either as servlets or using Business Components for Java can be interfaced using Web services. Oracle Application Server provides a standard set of tools to publish J2EE Applications as Web services. Oracle Application Server ProcessConnect can integrate these modules through its Web Service adapter.

B2B Protocol Adapters

Oracle Application Server ProcessConnect supports business protocol adapters that enable trading partners to use the RosettaNet business protocol. RosettaNet is a group of leading technology companies that have created and implemented a common set of nonproprietary, XML-based, e-business standards. These standards define how trading partners conduct business through the exchange of business documents over the Internet.

See Also:

- [Chapter 24, "RosettaNet B2B Protocol Standard"](#)
- [Chapter 25, "Managing Host and Remote Trading Partner Capabilities"](#)
- [Chapter 26, "Managing Trading Partners and Trading Partners Agreements"](#)

Trading Partners

You can define a trading partner to be a party in an integration. A trading partner is an entity that engages in business transactions with another trading partner in an integration between enterprises. There are two types of trading partners:

- The host trading partner is the organization (or enterprise) in which Oracle Application Server ProcessConnect is installed. The host trading partner owns all the integration definitions and connects to its trading partners or applications using Oracle Application Server ProcessConnect.
- The remote trading partner is the organization outside the host's enterprise with whom to conduct business.

The host trading partner defines all details with the Oracle Application Server ProcessConnect user interface tool for all trading partners, including:

- Cooperations (collaborations), including:
 - The trading partner's role (known as the actor) in a business collaboration (for example, Buyer - 3A4 -2.0, for RosettaNet PIP3A4)
 - The business protocol to use (such as RosettaNet version 2.0)
- Delivery and security data, including:
 - A delivery channel consisting of:
 - One document exchange that defines the exchange mechanism using the exchange protocol, such as RosettaNet 2.0. You can choose to add additional security, including encryption credentials (such as a certificate) and digital signatures
 - One transport that defines endpoints and associated security, such as secure socket layer (SSL) over HTTP
 - You can also define certificates and endpoints used by the document exchange and transport.
- Endpoints data, including the trading partner endpoint addresses (such as a Web site) and the transport protocols (such as HTTP or secure HTTP)

See Also: [Chapter 25, "Managing Host and Remote Trading Partner Capabilities"](#)

Agreements

Oracle Application Server ProcessConnect provides two types of agreements:

- [Trading Partner Agreements](#)
- [Application Agreements](#)

Trading Partner Agreements

For the hosted trading partner to send or receive wire messages, an agreement must be defined. An agreement defines the specific types of native events sent or received from a particular party using the specific types of native roles. You assign a trading partner to an agreement for integrations between enterprises. This single definition of an agreement makes no distinction between the type of party you assign; to the agreement, it is just a party.

A trading partner agreement defines which native events are received from a trading partner and which ones are sent to a trading partner from the viewpoint of the hosted trading partner. A trading partner agreement is established between two trading partners to define their rules of engagement. Only those native events on which both trading partners agree are exchanged through wire messages. If a trading partner sends a wire message that does not result in an agreed-on native event, it is rejected. If the hosted trading partner tries to send a native event to a trading partner and the native event is not defined in a trading partner agreement, the send action fails. This is because Oracle Application Server ProcessConnect enforces party agreements.

See Also: The following sections for instructions on performing the following tasks:

- [Chapter 26, "Managing Trading Partners and Trading Partners Agreements"](#) to manage trading partners and trading partner agreements
- [Chapter 24, "RosettaNet B2B Protocol Standard"](#) for additional details about RosettaNet and trading partners agreements

Application Agreements

An application agreement defines which native events are sent to or received from an application. Oracle Application Server ProcessConnect enforces application agreements and ensures that only the agreed-on events are sent out or received.

See Also: [Chapter 15, "Managing Applications and Application Agreements"](#) for instructions on managing applications and application agreements

Create and Deploy a Configuration

After designing the modeling metadata and profile data of an integration, you create and include it in a configuration. For this release, there can be only one active, deployed configuration at any point in time. All business processes in the design-time repository are included in the configuration.

Deployment is a two-step process:

1. Intent to deploy: Create and validate a configuration of an integration consisting of the following:
 - Modeling metadata consisting of interactions, all business processes, datatypes, event types, translations, transformations, role types, and condition expressions
 - Profile data consisting of agreements (trading partner or application), adapters, parties (trading partners or applications), and, for integrations between enterprises, host and remote trading partner identification, organization, cooperation (collaboration), security, delivery, and endpoint data

When you create a configuration, the integrity of the modeling metadata and profile data is validated to ensure that it is correct and complete. If validation is successful, the configuration is created.

You can deploy the configuration immediately after validation or at a later time. For this release, options are also available for discarding (deleting) the configuration or exporting the configuration to an XML file.

2. Deploy the configuration: Deploying a configuration enables the integration to send and receive messages.

See Also: [Chapter 16, "Creating and Deploying a Configuration"](#) for instructions on creating and deploying a configuration

Manage the Modeling Metadata and Profile Data Lifecycle

A business relationship must go through several preliminary states before parties can conduct business. For example:

- Each party must define its individual criteria for conducting business.
- Each party must identify a prospective integration party.
- Each party must learn about the other integration party to determine whether or not it wants to conduct business.
- Each party must define the details of data exchange and semantics showing how they want to conduct business. This is referred to as the agreement.
- The agreement is exchanged between each party for their review. A party is contacted by the business administrator to review the agreement and either approve or disapprove with recommended changes. The approver must contact the business administrator with their decision.
- The agreement must be formally signed off by each party once they are satisfied (a process that can take several iterations).
- The parties can then deploy the agreement and begin conducting business.

Lifecycle management enables you to manage these various states.

This section contains these topics:

- [Lifecycle States for an Agreement](#)
- [Modeling Metadata Lifecycle States](#)
- [Profile Data Lifecycle States](#)
- [Deployment Lifecycle States](#)

See Also:

- ["Viewing the State of Modeling Metadata and Profile Data on the Details Page"](#) on page 5-17, which displays on details pages
- [Chapter 16, "Creating and Deploying a Configuration"](#)

Lifecycle States for an Agreement

The modeling metadata and profile data goes through several lifecycle states before business can be conducted. The lifecycle state is the state that modeling metadata or profile data is in at a given point in time. Lifecycle management enables you to manage these states. For example, an agreement (which is defined as profile data) goes through the states shown in [Table 3-5](#):

Table 3-5 Lifecycle States for an Agreement

Description	State
An agreement is defined.	Draft
A defined agreement is subjected to validation to ensure that the data is complete.	Validated
A validated agreement is sent to integration parties for approval.	Pending Approval
An approved agreement is ready for deployment in a configuration.	Approved
An agreement is deployed in a configuration.	Deployed

Modeling Metadata Lifecycle States

Modeling metadata is typically defined by only the host trading partner. Therefore, there is no need for an approval.

Figure 3-18 shows the lifecycle states of modeling metadata.

Figure 3-18 Lifecycle States of Modeling Metadata

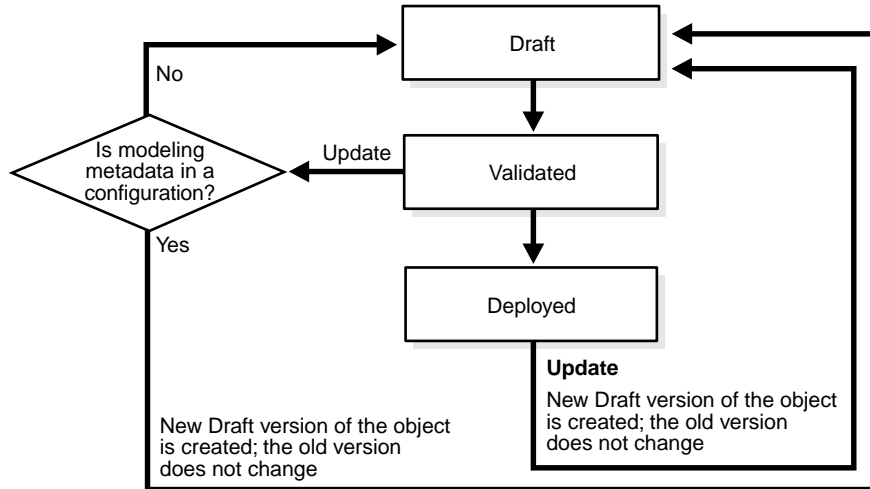

Table 3-6 describes the lifecycle states of modeling metadata in detail.

Table 3-6 Lifecycle States of Modeling Metadata

State	Description
Draft	The modeling metadata state when it is first created.
Validated	The modeling metadata has been validated. The metadata is correct, and ready to be included in a configuration where it undergoes additional validation for end-to-end completeness.
Deployed	The validated configuration (with its modeling metadata) is deployed in a configuration.

See Also:

- [Chapter 16, "Creating and Deploying a Configuration"](#)
- ["Viewing the State of Modeling Metadata and Profile Data on the Details Page"](#) on page 5-17 for details on how these states display on the details pages of modeling metadata

Profile Data Lifecycle States

The profile data states vary slightly from modeling metadata states. [Figure 3-19](#) shows the lifecycle states of profile data.

Figure 3-19 *Lifecycle States of Profile Data*

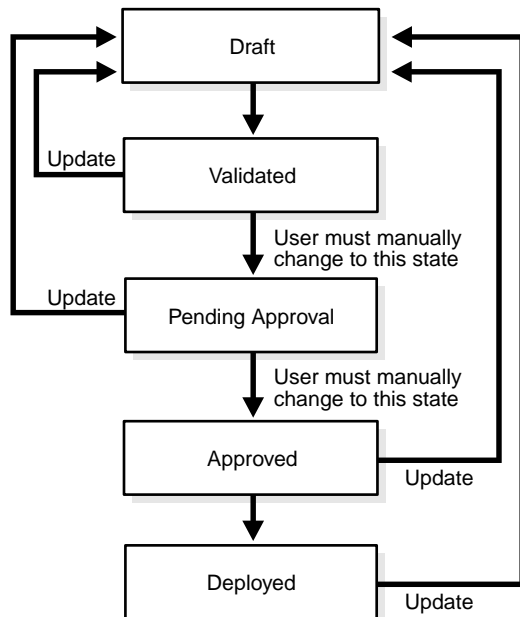

[Table 3-7](#) describes the profile data lifecycle states in detail.

Table 3-7 Lifecycle States of Profile Data

State	Description
Draft	The profile data state when it is first created.
Validated	The profile data has been created and validated for completeness. At this point, the profile data can be: <ul style="list-style-type: none"> ▪ Exported to a file and sent for approval by all parties; the state is changed to Pending Approval ▪ Returned to the Draft state for additional changes
Pending Approval	This state indicates that relevant profile data has been sent to a party for approval.
Approved	The profile data is in this state when all parties have approved it. After the profile data is verified by all agreement parties and formally signed off, the state is changed to Approved. The profile data is ready to be included in a configuration where it undergoes validation for end-to-end completeness. If the profile data must be changed, it is returned to the Draft state.
Deployed	The profile data is in a deployed configuration.

See Also: ["Viewing the State of Modeling Metadata and Profile Data on the Details Page"](#) on page 5-17 for details on how these states display on the details pages of profile data

Deployment Lifecycle States

Deployment lifecycle states indicate the states a configuration goes through during deployment.

[Table 3–8](#) describes the deployment states in detail. The configuration state displays in the **State** column of the **Configurations** section on the Configuration page of the Oracle Application Server ProcessConnect user interface tool.

Table 3–8 Configuration States

Configuration State	Description
Validated	The modeling metadata and profile data of an integration have been successfully validated to ensure that it is correct and complete and a configuration has been created. The configuration is ready for deployment. Only valid configurations can exist; invalid configurations cannot be created.
Active	The business processes included in the configuration are available for execution of business in the Oracle Application Server ProcessConnect runtime repository. Incoming messages are accepted based on your design in each of the business processes, and processed accordingly.
Discarded	A configuration has been discarded. This occurred when you selected the Discard button on the Configuration page.
Retired	A configuration has been quiesced and retired. This occurs when you deploy another configuration. This action causes any currently-running configurations to be quiesced and retired.

See Also: ["Creating a Configuration"](#) on page 16-3 for instructions on creating and deploying a configuration

Integration Management

After an integration is deployed in a configuration, it can be managed from the Oracle Enterprise Manager Application Server Control.

You can perform the following tasks:

- Start and stop the Oracle Application Server ProcessConnect integration manager, adapter framework, and OC4J subcomponents running in each Oracle Application Server middle tier instance.
- View the current running status (started or stopped) and memory and CPU usage for Oracle Application Server ProcessConnect integration manager, adapter framework, and OC4J subcomponents.
- View and edit the Oracle Application Server ProcessConnect configuration parameters.
- View integration manager and adapter framework log files.
- Access the Oracle Application Server ProcessConnect user interface tool for designing and deploying integrations.

See Also: [Chapter 18, "System Management with Oracle Enterprise Manager"](#)

Integration Reports

You can use the Oracle Application Server ProcessConnect user interface tool to create reports that provide the following details about an integration:

- **Process Monitoring Reports**
Process monitoring reports monitor the current state of an integration object (for example, an event instance).
- **Activity Monitoring Reports**
Activity monitoring reports analyze specific business activities across integration objects (for example, the total number of event instances sent by a specific party during this quarter).
- **Process Optimization Reports**
Process optimization reports monitor business process efficiency (for example, the response time for orders placed by a specific party during the last month).

See Also: [Chapter 23, "Creating Reports"](#)

Chapter Summary

This chapter describes how various users (systems integration consultants, systems architects, connection managers, event managers, business process managers, business administrators, systems administrators, and analysts) use Oracle Application Server ProcessConnect. Integration concepts are explained, leading to a detailed discussion of Oracle Application Server ProcessConnect concepts in the following areas:

- Modeling metadata (including business processes, events, roles, datatypes, interactions, translations, and transformations)
- Profile data (including agreements, applications, adapters, and trading partners)
- Deployment of a configuration of validated modeling metadata and profile data
- Lifecycle management of modeling metadata, profile data, and configurations
- Monitoring and administration of configurations
- Reporting of configuration status

Oracle Application Server ProcessConnect Architecture

This chapter provides a high-level overview of the capabilities provided by the Oracle Application Server ProcessConnect architecture.

This chapter contains these topics:

- [Oracle Application Server ProcessConnect Architecture Overview](#)
- [Designing the Integration: Overview](#)
- [Storing the Integration in the Design-Time Repository: Overview](#)
- [Deploying the Integration to the Runtime Repository: Overview](#)
- [Storing the Integration in the Runtime Repository: Overview](#)
- [Executing Runtime System Components: Overview](#)
- [Executing the Adapter Framework: Overview](#)
- [Managing the Integration: Overview](#)
- [Create Integration Reports: Overview](#)
- [Chapter Summary](#)

See Also: [Chapter 3, "Oracle Application Server ProcessConnect Concepts"](#) for details on the terms used in this chapter

Oracle Application Server ProcessConnect Architecture Overview

Figure 4-1 provides an overview of the key Oracle Application Server ProcessConnect components that enable an integration. A key Oracle Application Server ProcessConnect architecture feature is that it separates design time modeling metadata from runtime modeling metadata and instance data. This separation enables you to work on modifications to integrations while the previous definitions are part of a deployed configuration. A separate runtime repository also allows for administration and optimization of runtime schema based on your business needs. (for example, the volume of data, business activity monitoring, and so on).

The components in Figure 4-1 are sequentially numbered to indicate the order in which they are typically used, starting with the design of an integration between parties and continuing through to the administration of a deployed, actively running integration.

Figure 4-1 Key Oracle Application Server ProcessConnect Components

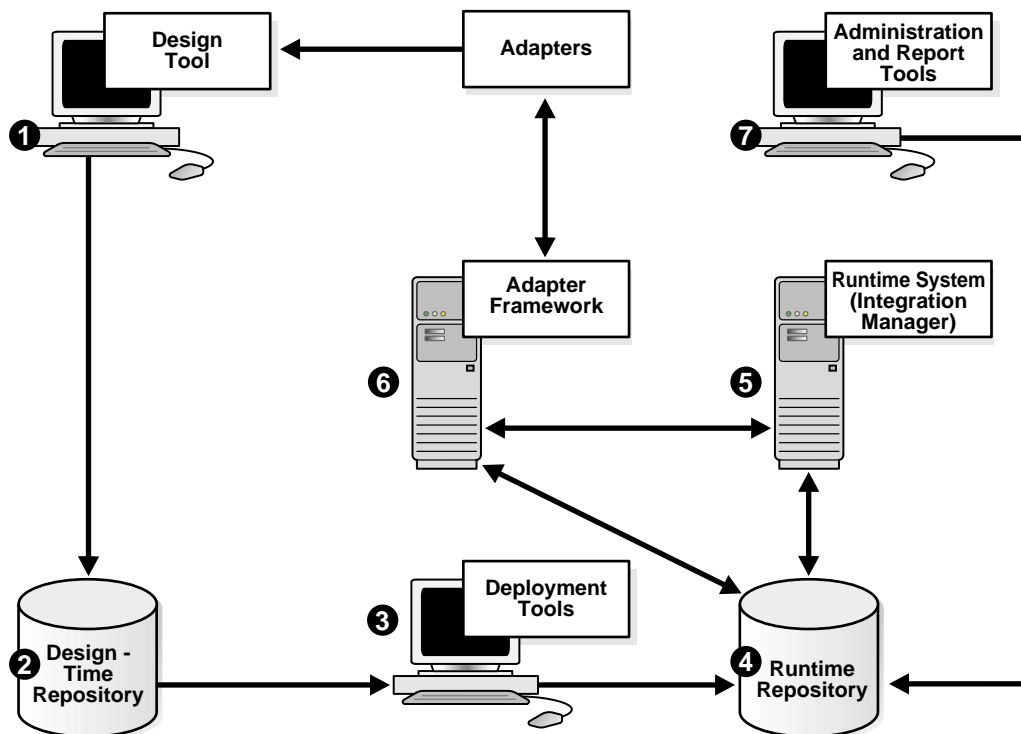

[Table 4-1](#) describes the high-level functions of each component shown in [Figure 4-1](#) on page 4-2 and provides references for more details.

Table 4-1 Oracle Application Server ProcessConnect Component Overview

Key	Component	Function	See Also...
1	Design tool	<p>Use the Oracle Application Server ProcessConnect user interface tool to design modeling metadata and profile data without writing a single line of code:</p> <ul style="list-style-type: none"> ■ Modeling metadata <ul style="list-style-type: none"> Create the interactions, business process, datatypes, event types, transformations, role types, and condition expressions ■ Profile data <ul style="list-style-type: none"> Create applications, add application adapters and delivery channels, and create application agreements between applications Create host and remote trading partner identification, organization, cooperation (collaboration), security, delivery, and endpoint data Create remote trading partners and trading partner agreements between the host (the organization in which Oracle Application Server ProcessConnect is installed) and remote trading partners 	"Designing the Integration: Overview" on page 4-5
2	Design-time repository	Stores the integration created at design time.	"Storing the Integration in the Design-Time Repository: Overview" on page 4-5
3	Deployment tool	<p>Use the Oracle Application Server ProcessConnect user interface tool to perform the following tasks:</p> <ul style="list-style-type: none"> ■ Create a configuration for the integration. During creation, all modeling metadata and profile data of the integration are validated end-to-end a final time to ensure that only a complete and consistent integration is deployed to the runtime repository. ■ Deploy the validated configuration from the design-time repository to the runtime repository 	"Deploying the Integration to the Runtime Repository: Overview" on page 4-6

Table 4–1 (Cont.) Oracle Application Server ProcessConnect Component Overview

Key	Component	Function	See Also...
4	Runtime repository	<ul style="list-style-type: none"> ▪ Stores the validated configuration required to execute an integration, as well as the event instances, role instances, business process instance, and all other data created at runtime. ▪ Enables you to administer and optimize an integration separate from design time. 	"Storing the Integration in the Runtime Repository: Overview" on page 4-7
5	Runtime system	Retrieves the configuration from the runtime repository that is required to execute the integration and creates instance data that can later be used for business activity monitoring.	"Executing Runtime System Components: Overview" on page 4-8
6	Adapter framework (and adapters)	Provides a uniform interface for a variety of application adapters to exchange events with applications and trading partners integrated with Oracle Application Server ProcessConnect. This enables many types of applications with their own data formats and interfaces to communicate with Oracle Application Server ProcessConnect.	Executing the Adapter Framework: Overview on page 4-9
7	Administration and report tool	Enables you to monitor and administer an integration, and generate integration reports with the Oracle Application Server ProcessConnect user interface tool.	"Managing the Integration: Overview" on page 4-10 "Create Integration Reports: Overview" on page 4-12

See Also:

- [Chapter 3, "Oracle Application Server ProcessConnect Concepts"](#)
- ["Managing and Monitoring a Middle-Tier Instance from Oracle Enterprise Manager Application Server Control"](#) on page 18-5 for instructions on managing the adapter framework
- ["Managing the Adapter Framework Instance"](#) on page 17-13

Designing the Integration: Overview

The Oracle Application Server ProcessConnect user interface tool provides a flexibility that does not require you to complete all modeling metadata and profile data tasks at the same time or in a completely sequential order. For example, you can complete all modeling metadata tasks and store the metadata for later use. Or, you can complete a portion of your modeling metadata tasks and complete the remaining tasks later. The same approach can be used when performing profile data tasks. Design tasks consist of two types:

- Modeling metadata design tasks
- Profile data design tasks

See Also:

- ["Modeling Metadata Design"](#) on page 3-15 for details on modeling metadata concepts
- ["Profile Data Design"](#) on page 3-51 for details on profile data concepts
- ["Modeling Tab Overview"](#) on page 5-24 for a list of modeling tasks
- ["Profiles Tab Overview"](#) on page 5-36 for a list of profile tasks

Storing the Integration in the Design-Time Repository: Overview

As you design an integration, the modeling metadata and profile data are stored in the design-time repository. In addition, modeling metadata and profile data that is only partially designed is also stored in the repository. You can later complete the design when you know all the required data.

This modeling metadata and profile data describes the behavior of the integration and the steps that must be sequenced to execute a business process. This modeling metadata and profile data is a design of a specific integration before deployment and execution.

Integration modeling metadata and profile data stored in the design-time repository can also be reused in multiple integrations, thus eliminating duplication of effort in designing an integration.

Deploying the Integration to the Runtime Repository: Overview

You can use the Oracle Application Server ProcessConnect user interface tool to deploy an integration. Deployment is a two-step process:

- Create a configuration of the integration. During configuration creation, all integration modeling metadata and profile data is validated end-to-end to ensure that only correct and complete modeling metadata and profile data appears in the runtime repository. For example, if you have designed all modeling metadata and profile data except for the transformation binding role, you are notified that this portion of the design is missing. If validation of a configuration fails, configuration creation is terminated.
- Deploy the configuration from the design-time repository to the runtime repository. This results in the creation of the necessary metadata in the runtime repository for the runtime system to execute the integration.

See Also:

- ["Create and Deploy a Configuration"](#) on page 3-58 for concepts
- ["Deployment Tab Overview"](#) on page 5-44 for a list of deployment tasks
- [Chapter 16, "Creating and Deploying a Configuration"](#) for instructions on creating and deploying a configuration

Storing the Integration in the Runtime Repository: Overview

After a configuration is deployed, the runtime repository stores the configuration of modeling metadata and profile data required to execute an integration, as well as the event instances, role instances, business process instance, and all other data created at runtime. This includes:

- Trading partner profiles, parties, and agreements
- A comprehensive view of the business process status, providing a single point where the Oracle Application Server ProcessConnect user interface tool can find modeling metadata and profile data
- Event type instances, role type instances, a business process instance, and all other data created at runtime

Components that use the runtime repository include:

- The runtime system (through use of the integration manager) to execute the integration metadata
- The adapter framework for data transfers between parties
- The B2B adapter to customize the RosettaNet B2B protocol standard
- Status tools for monitoring performance
- Administration tools to change values in the runtime configuration, such as parameters settings for logging levels, security, number of role threads, trading partner properties, and so on
- Report tools for gathering business intelligence data created by the runtime repository

The runtime repository provides the following additional features:

- Performance optimization capabilities
For example, if you use a single pass-through step in each role running from the native role to the business role, you can use a single role thread instead of five role threads for processing.
- Persistent state management
Runtime data is persistent and transactionally stored
- History
Logging, auditing, and tracking history for runtime operations

See Also:

- ["Executing the Adapter Framework: Overview"](#) on page 4-9
- ["Managing the Integration: Overview"](#) on page 4-10
- ["Create Integration Reports: Overview"](#) on page 4-12

Executing Runtime System Components: Overview

The runtime system retrieves the configuration with its modeling metadata and profile data from the runtime repository and accesses and stores runtime instance data within it. The runtime system includes two major subcomponents:

- An integration manager

Coordinates the various integration processes and invokes a set of services in the execution of an integration. This enables tasks essential to a deployed configuration to be performed, such as enabling events to be created, role instances to be initiated, translations to be performed, and transformations to be performed.

- An adapter framework

Communicates between the runtime system and various adapters of parties to send and receive data in the form of native events. The adapter framework picks up outbound native events processed by the runtime system and delivers them to appropriate adapters. In addition, the adapter framework raises inbound native events initiated by adapters.

The runtime system executes the following integration processes and components:

- Business process of the integration
- Application adapters to transfer data between applications
- The B2B adapter, if the integration is using the RosettaNet B2B protocol standard

See Also:

- ["Executing the Adapter Framework: Overview"](#) on page 4-9 for a detailed description of the adapter framework
- [Chapter 18, "System Management with Oracle Enterprise Manager"](#) for integration manager and adapter framework management tasks

Executing the Adapter Framework: Overview

Oracle Application Server ProcessConnect provides a series of adapters that enable technology and third party applications with their own data formats and interfaces to communicate and take part in integrations. The adapter framework communicates between the runtime system and various adapters to perform the following tasks:

- Pick up outbound native events processed by the Oracle Application Server ProcessConnect runtime system and deliver them to appropriate adapters built in accordance with the J2EE Connector Architecture (JCA) 1.0 specification.
- Raise inbound native events initiated by applications participating in the integration and still in native format. Inbound events pass through adapters that deliver to the adapter framework the details required to identify and raise appropriate native events.

You can also specify that all or a specific group of applications use an adapter framework instance. This is useful for load balancing. For example, single integration manager and adapter framework instances can communicate with multiple Oracle Database adapters. Each adapter also communicates with a specific database. By separating the adapter framework from the integration manager and the adapters, Oracle Application Server ProcessConnect enables you to load balance requests across different adapter instances and integration manager instances for scalability.

Figure 4–2 provides a high-level overview of the adapter framework communicating between the runtime system and the B2B adapter in an integration between enterprises.

Figure 4–2 Oracle Application Server ProcessConnect Technology Adapter Overview

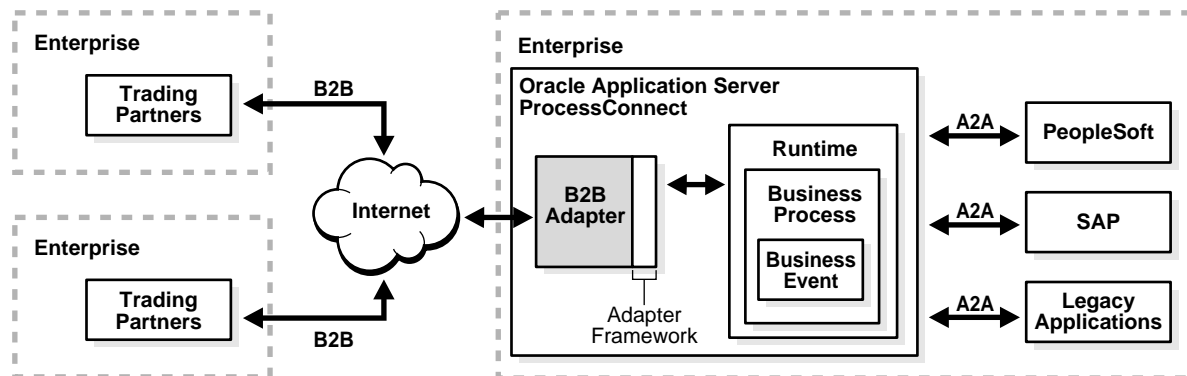

See Also: <http://java.sun.com/j2ee/connector> for additional details on JCA standards

Managing the Integration: Overview

Oracle Application Server ProcessConnect enables you to manage, improve performance, and troubleshoot various aspects of your integrations with two different tools:

- [Oracle Enterprise Manager System Administration](#)

These are administration tasks that are systemwide such as configuring an integration manager or adapter framework instance, starting up or shutting down the integration manager, or setting configuration parameters. These tasks are performed from within Oracle Enterprise Manager.

- [Oracle Application Server ProcessConnect User Interface Tool Administration](#)

These are administration tasks associated with specific integrations, such as adding adapters, updating the adapter framework to work with only specific applications to improve performance, exporting and importing the contents of the design time repository, and other details specific to a particular integration.

Oracle Enterprise Manager System Administration

You can monitor and administer integrations from the Oracle Enterprise Manager Application Server Control. The Oracle Enterprise Manager Application Server Control enables you to perform the following local monitoring and administration tasks:

- Start and stop the integration manager, adapter framework, and Oracle Application Server Containers for J2EE (OC4J) components as required for maintenance
- View the current running status (started or stopped) and memory and CPU consumption for the integration manager, adapter framework, and OC4J
- View and edit the Oracle Application Server ProcessConnect configuration parameters to improve and troubleshoot performance
- View graphics describing integration manager and adapter framework performance
- View integration manager and adapter framework log files to identify problem areas
- Access the Oracle Application Server ProcessConnect user interface tool for designing and deploying integrations

See Also:

- [Chapter 18, "System Management with Oracle Enterprise Manager"](#)
- [Chapter 19, "Performance Tuning"](#)
- Oracle Application Server ProcessConnect online Help included in Oracle Enterprise Manager for configuration parameter settings

Oracle Application Server ProcessConnect User Interface Tool Administration

The Oracle Application Server ProcessConnect user interface tool enables you to perform various administration tasks. For example, you can:

- Export and import an integration to and from another Oracle Application Server ProcessConnect design repository
- View installed adapters, supported business protocols, collaborations, digital envelopes, and digital signatures
- Administer application types, contact types, native formats, translators, and trading partner identification types

See Also:

- ["Administration Tab Overview"](#) on page 5-46 for a list of administration tasks
- [Chapter 17, "Administering Integrations with the User Interface Tool"](#) for additional details and descriptions of the features you can administer

Create Integration Reports: Overview

You can use the Oracle Application Server ProcessConnect user interface tool for complete business activity monitoring of an integration. This enables you to create the following types of reports:

- **Process Monitoring Reports**
Process monitoring reports monitor the current state of an integration object (for example, an event instance).
- **Activity Monitoring Reports**
Activity monitoring reports analyze specific business activities across integration objects (for example, the total number of event instances sent by a specific party during this quarter).
- **Process Optimization Reports**
Process optimization reports monitor business process efficiency (for example, the response time for orders placed by a specific party during the last month).

See Also:

- ["Reports Tab Overview"](#) on page 5-45 for a list of report tasks
- [Chapter 23, "Creating Reports"](#)

Chapter Summary

This chapter provides an overview of the Oracle Application Server ProcessConnect architecture through the following integration cycle:

- Design and storage of modeling metadata and profile data in the design-time repository
- Creation and deployment of a configuration of validated modeling metadata and profile data
- Storage of the deployed configuration in the runtime repository
- Execution of the deployed configuration in the runtime system
- Administration and monitoring of the deployed configuration

Part II

Introduction to the User Interface Tool

This part introduces the Oracle Application Server ProcessConnect user interface tool.

This part contains the following chapters:

- [Chapter 5, "Getting Started with the User Interface Tool"](#)
- [Chapter 6, "Methodologies for Using Oracle Application Server ProcessConnect"](#)
- [Chapter 7, "Tutorial of an Integration within an Enterprise"](#)

Getting Started with the User Interface Tool

This chapter describes how to get started with the Oracle Application Server ProcessConnect user interface tool. This chapter also briefly describes the tasks you can perform and the features available from each user interface tool tab.

This chapter contains these topics:

- [Accessing the Oracle Application Server ProcessConnect User Interface Tool](#)
- [Oracle Application Server ProcessConnect User Interface Tool Page Layouts](#)
- [Modeling Tab Overview](#)
- [Profiles Tab Overview](#)
- [Deployment Tab Overview](#)
- [Reports Tab Overview](#)
- [Administration Tab Overview](#)
- [Chapter Summary](#)

See Also:

- [Chapter 3, "Oracle Application Server ProcessConnect Concepts"](#)
- [Chapter 6, "Methodologies for Using Oracle Application Server ProcessConnect"](#)
- [Chapter 7, "Tutorial of an Integration within an Enterprise"](#)

Accessing the Oracle Application Server ProcessConnect User Interface Tool

Follow these instructions to access the Oracle Application Server ProcessConnect user interface tool.

To access the Oracle Application Server ProcessConnect user interface tool:

1. Open a Web browser.
2. Go to the following URL:

`http://hostname:port/integration`

where:

- *hostname* is the name of the host on which Oracle Application Server ProcessConnect is installed
- *port* is the port number that the Oracle HTTP Server uses (7777 or 4443 can be used). Oracle Application Server ProcessConnect also uses one of these ports. See the *Oracle Application Server 10g Installation Guide* for more information. The `SSOport` parameter in the `ias.properties` file also identifies the port number used.

A page for logging in to the Oracle Application Server ProcessConnect user interface tool appears.

3. Enter the following information:

For This Field...	Enter This...
Username	<code>admin</code>
Password	<p><code>ias_admin_password</code></p> <p>where <code>ias_admin_password</code> is the Oracle Application Server administrator password you entered during J2EE and Web Cache installation. You also entered this password when prompted during Oracle Application Server ProcessConnect installation.</p> <p>See Also: "Updating a Person" on page 25-18 for instructions on changing the password</p>

For This Field...	Enter This...
Organization	<p>organization</p> <p>organization is the host trading partner default value created during Oracle Application Server ProcessConnect installation. This name displays in the title on pages under the Host tab.</p> <p>See Also: "Updating the Trading Partner Name and Description" on page 25-8 to update the host trading partner name to one that uniquely reflects your organization</p>

This username enables you to create, update, and delete modeling metadata and profile data with the Oracle Application Server ProcessConnect user interface tool.

4. Click Login.

The Oracle Application Server ProcessConnect home page appears with the five main tabs: **Modeling, Profiles, Deployment, Reports, and Administration.**

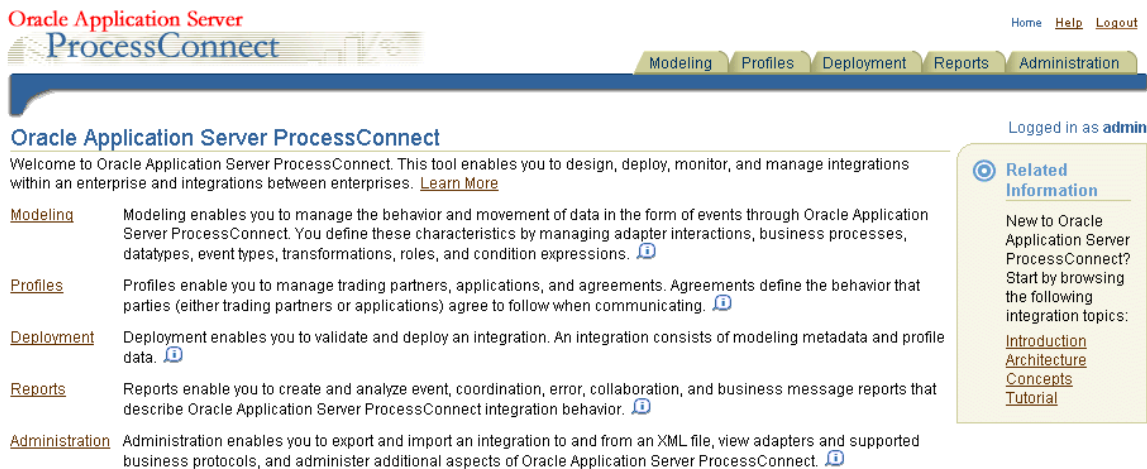

5. See "Oracle Application Server ProcessConnect User Interface Tool Page Layouts" on page 5-4 for a description of the general layout of Oracle Application Server ProcessConnect user interface tool pages.

Oracle Application Server ProcessConnect User Interface Tool Page Layouts

The Oracle Application Server ProcessConnect user interface tool is divided into a series of tabs that enable you to create modeling metadata (under the **Modeling** tab) and profile data (under the **Profiles** tab) and include it in a deployed configuration (under the **Deployment** tab) that you monitor by creating reports that describe various aspects of an integration (under the **Reports** tab). You can also administer various portions of the deployed configuration from the **Administration** tab and from Oracle Enterprise Manager.

The Oracle Application Server ProcessConnect user interface tool presents modeling metadata and profile data tasks in a series of HTML pages. These pages follow a standard layout. This section describes the general layout of pages in the Oracle Application Server ProcessConnect user interface tool. This section contains these topics:

- [Main List Pages](#)
- [Details Pages](#)
- [Business Process and Role Diagrams](#)
- [Transformation Map Details Page](#)
- [Creating Incomplete Modeling Metadata and Profile Data](#)
- [Creating, Adding, Deleting, and Removing Data](#)
- [Modeling Metadata and Profile Data Naming Conventions](#)
- [Using the Browser Back and Forward Buttons](#)
- [Searching for Data on the Main List Page](#)
- [Exporting Profile Data to an XML File](#)
- [Viewing the State of Modeling Metadata and Profile Data on the Details Page](#)

Main List Pages

When you click a subtab of a main tab (for example, the subtab **Applications** of main tab **Profiles**), a main list page displays information such as that shown in [Figure 5-1](#). Main list pages have general names such as Application Agreements, and are not named after specific modeling metadata or profile data that you create. These main list pages enable you to perform a series of tasks.

Figure 5-1 Main List Page Layout

Oracle Application Server
ProcessConnect

Home Help Logout

Modeling Profiles Deployment Reports Administration

Host Trading Partners Applications Agreements

Application Agreements Trading Partner Agreements

Application Agreements

Logged in as **admin**

Search All Go

Create

Shortcut
Create Application

Name	State	Update	Delete
AppAgreement1	Draft		
AppAgreement2	Draft		
AppAgreement3	Draft		
AppAgreement4	Draft		
AppAgreement5	Draft		
AppAgreement6	Draft		
AppAgreement7	Draft		
AppAgreement8	Draft		
Global NP Agreement	Approved		
HR Agreement	Approved		

Previous 1-10 of 11 Next 1

Previous 1-10 of 11 Next 1

Modeling | Profiles | Deployment | Reports | Administration | Home | Help | Logout

Table 5-1 describes the contents of the page shown in Figure 5-1.

Table 5-1 Main List Page Contents

Page Element	Description
Search section	Enables you to search for a specific element by selecting a criteria from the Search list. This list only displays if the quantity for this element exceeds ten. (for example, more than ten applications). See Also: "Searching for Data on the Main List Page" on page 5-14 for details about the search facility
Subtab section (Application Agreements)	Identifies the section of the subtab in which you are located (in this example, the Application Agreements section of the Agreements subtab of the Profiles main tab). Not all subtabs have this additional level.
Subtab (Agreements)	Identifies the subtab of the main tab in which you are located (in this example, the Agreements subtab of the Profiles main tab). The subtabs that appear are based on the main tab you selected.
Main tab (Profiles)	Identifies the main tab in which you are located. (in this example, the Profiles tab) There are five main tabs (Modeling, Profiles, Deployment, Reports, and Administration).
Home link	Returns you to the Oracle Application Server ProcessConnect user interface tool home page. (See Step 4 on page 5-3.)
Help link	Enables you to access online help for the page.
Logout link	Logs you out of the Oracle Application Server ProcessConnect user interface tool and returns you to the login page.
Logged in as admin message	Displays the user currently logged into the Oracle Application Server ProcessConnect user interface tool (in this example, the default username admin).
Shortcut section	Provides shortcuts for performing related tasks specific to this modeling metadata or profile data (in this example, a shortcut for creating an application is provided, since an application must be assigned to an application agreement).
Create button	Enables you to create modeling metadata or profile data (for this example, application profile data).
Delete column	Enables you to delete the selected modeling metadata or profile data (for this example, an application agreement).
Update column	Enables you to update the selected modeling metadata or profile data (for this example, an application agreement).
Previous and Next pages	Enables you to access additional pages of modeling metadata or profile data. This list displays only if the quantity for this element exceeds ten. (for example, more than ten application agreements).

Table 5–1 (Cont.) Main List Page Contents

Page Element	Description
Links at bottom of page	Enables you to: <ul style="list-style-type: none">■ Access the five main tabs (Modeling, Profiles, Deployment, Reports, and Administration)■ Return to the Oracle Application Server ProcessConnect user interface tool home page (Home)■ Access online help for the page (Help)■ Log out of the Oracle Application Server ProcessConnect user interface tool (Logout)
Name column	Enables you to access specific details about the selected modeling metadata or profile data (known as the details page). For example, if you select an application agreement, you can see which application participants are assigned to it. Some main list pages also display a Details column with a Details icon when modeling metadata or profile data cannot be uniquely identified by values in a single column.

Details Pages

Modeling metadata and profile data that you create have their own details pages typically accessed through the **Name** column shown in [Figure 5-1](#) on page 5-5. Details pages are named after specific elements. For example, [Figure 5-2](#) shows the details page for an agreement named **AppAgreement1**:

Figure 5-2 Details Page

The screenshot displays the Oracle Application Server ProcessConnect user interface. At the top, there is a navigation bar with the Oracle Application Server logo and the text 'ProcessConnect'. The main navigation menu includes 'Modeling', 'Profiles', 'Deployment', 'Reports', and 'Administration'. Below this, a breadcrumb trail shows 'Host' > 'Trading Partners' > 'Applications' > 'Agreements'. The current page is titled 'Agreement Details: AppAgreement1'. On the right side, there are buttons for 'Validate', 'Export', 'Delete', and 'Update'. The page is divided into several sections: 'Details', 'Delivery Channels Used', 'Native Roles', and 'Approvers'. Each section contains a table with data and action buttons. The 'Approvers' section shows a table with columns for 'Person', 'Send For Approval Date', 'Approval Date', 'Update', and 'Delete', and a note that no approvers were found.

Oracle Application Server ProcessConnect Home Help Logout

Modeling Profiles Deployment Reports Administration

Host Trading Partners Applications **Agreements**

Application Agreements Trading Partner Agreements Logged in as admin

Delivery Channels Used Native Roles Approvers

Agreement Details: AppAgreement1 Validate Export Delete Update

Details

Agreement Id
Description
Effective From Date
Effective To Date
Application Participant [Global Newspaper](#)
State **Draft**

Delivery Channels Used Return to Top Add

Name	Update	Remove
Global NP DC		

Native Roles Return to Top Add

Name	Remove
HR Placing New Ad-NR	

Approvers Return to Top Add

Person	Send For Approval Date	Approval Date	Update	Delete
(No approvers found.)				

[Return To List](#) Validate Export Delete Update

[Modeling](#) | [Profiles](#) | [Deployment](#) | [Reports](#) | [Administration](#) | [Home](#) | [Help](#) | [Logout](#)

Table 5-2 describes the contents of the page shown in Figure 5-2.

Table 5-2 Details Page Contents

Page Elements	Description
Details section	Enables you to view specific details, including the current state of modeling metadata or profile data. See Also: " Viewing the State of Modeling Metadata and Profile Data on the Details Page " on page 5-17
Subtab section (Application Agreements)	Identifies the section of the subtab in which you are located (in this example, the Application Agreements section of the Agreements subtab of the Profiles main tab). Not all subtabs have this additional level.
Subtab (Agreements)	Identifies the subtab of the main tab in which you are located (in this example, the Agreements subtab of the Profiles main tab). The subtabs that appear are based on the main tab you selected.
Main tab (Profiles)	Identifies the main tab in which you are located. (in this example, the Profiles tab) There are five main tabs (Modeling, Profiles, Deployment, Reports, and Administration).
Home link	Returns you to the Oracle Application Server ProcessConnect user interface tool home page.
Help link	Enables you to access online help for the page.
Logout link	Logs you out of the Oracle Application Server ProcessConnect user interface tool and returns you to the login page.
Logged in as admin message	Displays the user currently logged into the Oracle Application Server ProcessConnect user interface tool (in this example, the default username admin).
Update button	Enables you to update the selected modeling metadata or profile data (for this example, the AppAgreement1 agreement).
Delete button	Enables you to delete the selected modeling metadata or profile data (for this example, the AppAgreement1 agreement).
Export button	Enables you to export the contents of this profile data to an XML file. See Also: " Exporting Profile Data to an XML File " on page 5-15 for details about export
Validate button	Enables you to validate this profile data. See Also: " Viewing the State of Modeling Metadata and Profile Data on the Details Page " on page 5-17 for details about validation
Add button, Remove column, Update column, Delete column	Enables you to manage (add, update, remove, or delete) subelements associated with the main modeling metadata or profile data (for this example, you can manage application participants, delivery channels, native roles, and approvers from this main Agreement Details page. Some details pages contain these subelements.

Table 5–2 (Cont.) Details Page Contents

Page Elements	Description
Links at bottom of page	<p>Enables you to:</p> <ul style="list-style-type: none"> ▪ Access the five main tabs (Modeling, Profiles, Deployments, Reports, and Administration) ▪ Return to the Oracle Application Server ProcessConnect user interface tool home page (Home) ▪ Access online help for the page (Help) ▪ Log out of the Oracle Application Server ProcessConnect user interface tool (Logout)
Return To List link	Enables you to return to the main list page. For example, clicking Return To List on this page returns you to the Application Agreements page shown in Figure 5–1 on page 5-5.

Business Process and Role Diagrams

The Oracle Application Server ProcessConnect user interface tool includes several modeling metadata diagrams that provide a graphical view of your integration. As you create or change modeling metadata, these diagrams are updated to reflect your changes.

[Table 5–3](#) briefly describes these diagrams and provides references for additional details.

Table 5–3 Business Process and Role Diagrams

Diagram	Description	See...
Integration	Displays the roles and business process in an integration	"Viewing an Integration Diagram" on page 12-15
Event Flow	Displays events moving through the selected business process or role	"Viewing an Event Flow Diagram" on page 12-18
Process	Displays events, steps, ports, data flows, and control flows for the selected business process or role	"Viewing a Process Diagram" on page 12-23
Step Binding	Displays the current state of a step, including its step ports, role ports, and data flows.	"Viewing a Step Binding Diagram" on page 12-28

Transformation Map Details Page

The Transformation Map Details page shown in [Figure 5-3](#) differs slightly in layout from most details pages. This page enables you to create transformation rules that typically map source application event datatypes to target business event datatypes, and vice versa. You perform this task by expanding the tree in both the **Sources** and **Targets** sections to display the datatypes. You then map datatypes in each column and create transformation map statements from these mappings, as shown in [Figure 5-4](#).

Figure 5-3 Transformation Map Details Page

Transformation Map Details: Transform exp

Delete Update Modify Sources and Targets

Use the section below to create transformation statements. To create a statement select the statement type, the datatype transformation map type, the datatype transformation map and the sources and targets and choose Append or Insert. Append creates a statement at the end of the statement list. If the selected statement is part of a block (if, else if, iterator), append creates a statement at the end of the selected block. Insert creates a statement before the selected statement.

Sources and Targets

Expand All | Collapse All

Statements		Type	Update	Delete
<input type="checkbox"/>	▼ Statements			
<input type="radio"/>	copyInteger(from=exp-IN/PAYLOAD-IN/employee/id --->to=exp-OUT/Payload/id)	Rule		

Statement Type

Datatype Transformation Map Type

Necessary for rule statements only

Datatype Transformation Map

Necessary for rule statements only

TIP Append creates a statement at the end of the statement list. If the selected statement is part of a block (if, else if, iterator), append creates a statement at the end of the selected block. Insert creates a statement before the selected statement.

Append Insert

Select All | Select None | Expand All | Collapse All

Sources		Type	Mapped
<input type="checkbox"/>	▼ Sources		

Select All | Select None | Expand All | Collapse All

Targets		Type	Mapped
<input type="checkbox"/>	▼ Targets		

Figure 5–4 Expanded Sources and Targets

Sources					Targets				
Select	Focus	Source Items	Type	Mapped	Select	Focus	Target Items	Type	Map
<input type="checkbox"/>		▼ Sources			<input type="checkbox"/>		▼ Targets		
<input type="checkbox"/>	<input type="checkbox"/>	▼ Event Type Parameters			<input type="checkbox"/>	<input type="checkbox"/>	▼ Event Type Parameters		
<input type="checkbox"/>	<input type="checkbox"/>	▼ exp-IN	exp		<input type="checkbox"/>	<input type="checkbox"/>	▼ exp-OUT	exp	
<input type="checkbox"/>	<input type="checkbox"/>	▼ PAYLOAD-IN	expense_type		<input type="checkbox"/>	<input type="checkbox"/>	▼ Payload	notification_type	
<input type="checkbox"/>	<input type="checkbox"/>	▼ employee	employee_type		<input type="checkbox"/>		from	string	
<input type="checkbox"/>		name	string		<input type="checkbox"/>		to	string	
<input type="checkbox"/>	<input type="checkbox"/>	▼ manager	manager_type		<input type="checkbox"/>		subject	string	
<input type="checkbox"/>		name	string		<input type="checkbox"/>		arrival_date	date	
<input type="checkbox"/>		id	integer		<input type="checkbox"/>	<input type="checkbox"/>	▼ status	status_type	
<input type="checkbox"/>		id	integer	<input checked="" type="checkbox"/>	<input type="checkbox"/>		message	string	
<input type="checkbox"/>		costcenter	string		<input type="checkbox"/>		code	string	
<input type="checkbox"/>		purpose	string		<input type="checkbox"/>		modified_date	date	
<input type="checkbox"/>	<input type="checkbox"/>	▼ lineitem	lineitem_type		<input type="checkbox"/>				

See Also: ["Managing Transformation Statements"](#) on page 13-29 for instructions on creating transformation map statements

Creating Incomplete Modeling Metadata and Profile Data

The Oracle Application Server ProcessConnect user interface tool provides a flexibility that does not require you to complete all modeling metadata and profile data tasks at the same time or in a completely sequential order.

For example, you can complete all modeling metadata tasks and store the metadata for later use. Or, you can complete a portion of your modeling metadata tasks and complete the remaining tasks later. The same approach can be used when performing profile data tasks.

When you initially creating a specific element, only fields clearly marked with an asterisk must be completed. You can ignore other fields or select the **Unspecified** option from lists that are not mandatory. You can modify these details at a later time when the correct details are known.

The approach to follow depends on what is best for your integration environment.

Creating, Adding, Deleting, and Removing Data

The Oracle Application Server ProcessConnect user interface tool provides **Create**, **Add**, **Delete**, and **Remove** buttons. The **Add** and **Remove** buttons enable you to add or remove an association between elements. For example, when you remove a native role or a delivery channel from an agreement, the native role and delivery channel are still available in Oracle Application Server ProcessConnect for reuse at a later time.

The **Create** and **Delete** buttons enable you to create and delete modeling metadata or profile data. For example, if you delete a native role, it is deleted from Oracle Application Server ProcessConnect and must be re-created if you want to use it again.

Modeling Metadata and Profile Data Naming Conventions

You are frequently prompted to provide names when creating modeling metadata and profile data. Oracle recommends that you provide modeling metadata and profile data with unique and meaningful names to make it easy to identify their content.

For example, if you are creating an application agreement using the PeopleSoft adapter, use that name in the agreement (for example, PeopleSoft_agreement). Or, if you are creating an event transformation map between an outbound purchase order business event and an outbound purchase order application event, name it PurchaseOrder_BEtoAE.

Using the Browser Back and Forward Buttons

Do not use the **Back** or **Forward** buttons of your Web browser when creating modeling metadata or profile data. For example, if you are creating modeling metadata with the modeling wizards, creating reports, creating transformations maps, or creating native and application events, use the **Back** and **Next** buttons specifically provided by the Oracle Application Server ProcessConnect user interface tool.

Searching for Data on the Main List Page

The Oracle Application Server ProcessConnect user interface tool includes a search feature available from all main list pages. [Figure 5-5](#) provides an example of the search feature that appears on the Business Datatypes page that you access by clicking **Modeling** > **Datatypes**.

Figure 5-5 Search Feature

The screenshot shows the Oracle Application Server ProcessConnect user interface. The top navigation bar includes "Home", "Help", and "Logout". Below this is a blue navigation bar with tabs for "Modeling", "Profiles", "Deployment", "Reports", and "Administration". Under "Modeling", there are sub-tabs for "Business Processes", "Roles", "Event Types", "Datatypes", "Transformations", "Interactions", and "Condition Expressions". The "Datatypes" sub-tab is active, showing a breadcrumb trail: "Business Datatypes" > "Application Datatypes" > "Native Datatypes" > "Core Datatypes" > "Datatype Namespaces".

The main content area is titled "Business Datatypes" and shows a search bar with "All" selected and a "Go" button. To the right of the search bar are "Import" and "Create" buttons. Below the search bar is a table with the following columns: Name, Type, Base Datatype, Namespace, Update, and Delete. The table contains 10 rows of datatypes. To the right of the table is a "Shortcuts" box with links to "Create Business Event Type", "Business Event Types", "Create Datatype Transformation Map", and "Datatype Transformation Maps".

At the bottom of the table, there are navigation controls: "Previous", "1-10 of 46", and "Next 10".

Name	Type	Base Datatype	Namespace	Update	Delete
anyURI	Scalar	string			
QName	Scalar	string			
NOTATION	Scalar	QName			
binaryString	Scalar	string			
base64BinaryString	Scalar	binaryString			
hexBinaryString	Scalar	binaryString			
normalizedString	Scalar	string			
token	Scalar	normalizedString			
language	Scalar	token			
NMTOKEN	Scalar	token			

The search feature is available only if the number of items on a page exceeds ten. For example, the number of datatypes available in [Figure 5-5](#) is 46. Instead of browsing from page to page, select a specific search criteria in the **Search** list to find the appropriate datatype.

The **Search** list contains attributes of the element. For example, if a Boolean attribute is chosen, a true and false list appears to the right of the **Search** list. If a domain value attribute is chosen, a list of domain values appears. If a text attribute is selected (such as **name**), the text field enables you to enter a specific name for which to search.

Exporting Profile Data to an XML File

Some high-level profile data elements include an **Export** button on their details pages. This button enables you to export your profile data to an XML file. You can then submit this file for approval to applicable parties. [Figure 5-6](#) shows the location of the **Export** button in the upper-right section of the details page of an application named **Application1**.

Figure 5-6 Profile Data Export

[Agreement Details: Application1](#)

[Validate](#)
[Export](#)
[Delete](#)
[Update](#)

Details

Agreement Id **1**
 Description
 Effective From Date **6/18/03**
 Effective To Date **6/26/03**
 Application Participant [ExpenseApp Queue](#)
 State **Draft**

Delivery Channels Used [Return to Top](#) [Add](#)

Name	Update	Remove
ExpenseApp Queue DC		
ExpenseApp Queue DC		
ApprovalApp Queue DC		

Native Roles [Return to Top](#) [Add](#)

Name	Remove
aq_approvalApp_Notifying-NR	

Approvers [Return to Top](#) [Add](#)

Person	Send For Approval Date	Approval Date	Update	Delete
ip	6/18/03			
Person1	6/18/03			

You cannot export modeling metadata to an XML file.

Only the details pages of certain high-level profile data elements include the export feature. High-level profile data elements include low-level profile data elements on their details pages that must also be defined.

For example, the Agreement Details page in [Figure 5-6](#) enables you to add such low-level profile data elements as delivery channels, native roles, and approvers. When you click **Export** on the Agreement Details page, the profile data that you defined for the agreement (see the **Details** section in [Figure 5-6](#)), delivery channel, native role, and approver is all included in the XML file.

[Table 5-4](#) identifies the high-level profile data elements that have an **Export** button, and the profile data that is included in the XML file when you click each **Export** button. References are provided for more specific details.

Table 5-4 Profile Data Export

Profile Data Details Pages with an Export Button	Profile Data Exported to an XML File From this Details Page	See...
Agreement Details page (for both trading partners or applications)	The details of the agreement, plus this low-level profile data: <ul style="list-style-type: none"> ▪ Application participants ▪ Native roles ▪ Approvers ▪ Delivery channels 	" Managing Application Agreements " on page 15-29 " Managing Trading Partner Agreements " on page 26-14
Application Details page	The details of the application, plus this low-level profile data: <ul style="list-style-type: none"> ▪ Adapter types ▪ Approvers ▪ Associated agreements 	" Managing Applications " on page 15-4

Table 5–4 (Cont.) Profile Data Export

Profile Data Details Pages with an Export Button	Profile Data Exported to an XML File From this Details Page	See...
<ul style="list-style-type: none"> ▪ Host - <i>name</i> page (for the host trading partner) ▪ Trading Partner Details page (for remote trading partners) 	<p>The identification details of the trading partner, plus this low-level profile data:</p> <ul style="list-style-type: none"> ▪ Organization ▪ Cooperations ▪ Delivery and security ▪ Endpoints 	<ul style="list-style-type: none"> ▪ "Managing Trading Partner Identifications" on page 25-4 (for the host trading partner) ▪ "Managing Remote Trading Partners" on page 26-6 (for remote trading partners) <p>The following sections for all trading partners:</p> <ul style="list-style-type: none"> ▪ "Managing Organizations" on page 25-11 ▪ "Managing Cooperations" on page 25-30 ▪ "Managing Delivery and Security" on page 25-50 ▪ "Managing Endpoints" on page 25-79

Viewing the State of Modeling Metadata and Profile Data on the Details Page

Modeling metadata or profile data goes through several lifecycle states from the time of creation through its role in a deployed configuration. The current state of higher-level profile data and modeling metadata (such as trading partners, agreements, applications, and the Host page) always displays in the **Details** section on its details page. The lifecycle states available for modeling metadata and profile data items vary slightly. [Table 5–5](#) shows the states available with each element.

Table 5–5 Modeling Metadata and Profile Data Item States

Lifecycle State	Description	Available For Modeling Metadata?	Available For Profile Data?
Draft	The state when modeling metadata or profile data is created	Yes	Yes
Validated	The state when modeling metadata or profile data is determined to be valid	Yes	Yes
Pending Approval	The state when the profile data is exported to an XML file and submitted to parties for approval	No	Yes

Table 5–5 (Cont.) Modeling Metadata and Profile Data Item States

Lifecycle State	Description	Available For Modeling Metadata?	Available For Profile Data?
Approved	The state when all parties approve the profile data	No	Yes
Deployed	The state when the modeling metadata or profile data is deployed in a validated configuration	Yes	Yes

The following sections describe the support for these lifecycle states provided by the Oracle Application Server ProcessConnect user interface tool:

- [Draft State for Modeling Metadata and Profile Data](#)
- [Validated State for Modeling Metadata and Profile Data](#)
- [Pending Approval State for Profile Data](#)
- [Update the Approver](#)
- [Delete the Approver](#)
- [Approval State for Profile Data](#)
- [Deployed State for Modeling Metadata and Profile Data](#)

See Also: ["Manage the Modeling Metadata and Profile Data Lifecycle"](#) on page 3-59 for lifecycle state concepts

Draft State for Modeling Metadata and Profile Data

When you create modeling metadata or profile data, its initial state is **Draft**, which is displayed in the **Details** section of the details page. [Figure 5–7](#) shows the **Draft** state.

Figure 5–7 Draft State

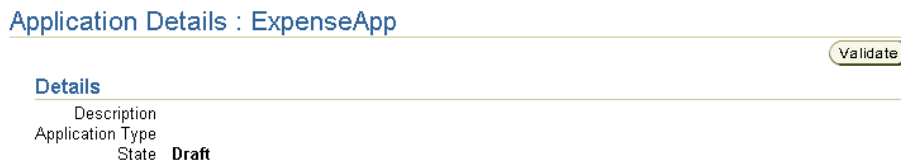

Validated State for Modeling Metadata and Profile Data

You can validate your profile data after creation by clicking the **Validate** button. If no validation errors occur, the details page refreshes and the state changes from **Draft** to **Validated**. For profile data, the **Validate** button is replaced with a **Send For Approval** button, as shown in [Figure 5-8](#).

Figure 5-8 Validated State for Profile Data

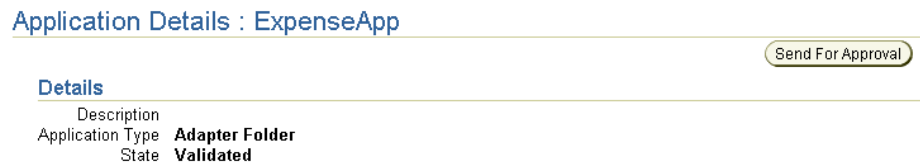

For modeling metadata, there is no **Validate** button, as shown with the business event **BEvent1** in [Figure 5-9](#). The state of modeling metadata displays as **Validated** on a details page when it is included in a validated configuration.

Figure 5-9 Validated State for Modeling Metadata

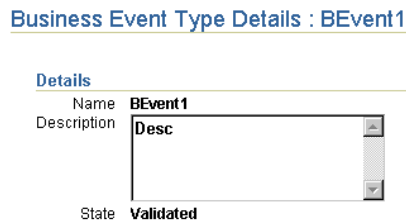

If validation errors occur, they appear on the screen. For example, the **ExpenseApp** application in [Figure 5-7](#) fails validation because the **Application Type** field in the **Details** section is empty. In [Figure 5-8](#), this field is filled in, and the **State** field displays as **Validated**.

Pending Approval State for Profile Data

When the state of profile data is **Validated**, the **Send for Approval** button appears, as shown in [Figure 5-8](#).

1. Click the **Send for Approval** button to change the state from **Validated** to **Pending Approval**.

The following page appears, and enables you to select approvers for the profile data that you export to an XML file. The approvers that appear are individuals that agreed to be approvers and were added in "[Creating a Person](#)" on page 25-16.

Add Approver(s)

Select the persons to approve Application ExpenseApp and choose Apply.

Approvers

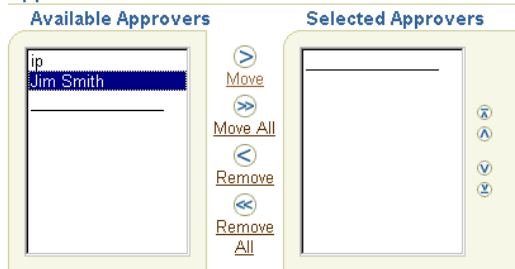

Note: This page is also accessible from the **Approvers** section of the details pages listed in [Table 5-4](#) on page 5-16. [Figure 5-6](#) on page 5-15 shows this section.

2. Select from the list of available approvers in the **Available Approvers** list.
3. Use the > arrow to add the approvers to the **Selected Approvers** list. You are not required to add approvers. Additionally, approvers can be added later from the details pages in [Table 5-4](#) on page 5-16.

4. Click **Send for Approval**.

The Application Details page for ExpenseApp now displays the selected approvers in the **Approvers** section. The **Send For Approval Date** column displays the date when the approvers were added.

Application Details : ExpenseApp

Export Delete Update

Details

Description
 Application Type **Adapter Folder**
 State **Approved**

Adapter Types [Return to Top](#)

Name	Adapter Provider	Remove
(No adapter types found.)		

[Return to Top](#) Add

Approvers [Return to Top](#)

Person	Send For Approval Date	Approval Date	Update	Delete
Jim Smith	3/16/03			

The **Approval Date** column of the **Approvers** section is empty. You update the **Approval Date** column when all approvers approve the profile data.

The State changes from **Validated** to **Pending Approval**, and the **Send For Approval** button is replaced with the **Approve** button:

Application Details : ExpenseApp

Approve

Details

Description
 Application Type **Adapter Folder**
 State **Pending Approval**

5. Follow the instructions in "[Exporting Profile Data to an XML File](#)" on page 5-15 to export the profile data requiring approval to XML files.
6. Submit the XML files to the selected approvers for their approval.

Inform each approver as to when you need a decision. The approval process can take several iterations. When all approvers agree to and sign off on the profile data (for example, through notification by an e-mail), you can update the status with the Oracle Application Server ProcessConnect user interface tool. The approvers have no access to this tool.

Note: The procedure to submit an XML file to an approver is optional. If you do not want to submit an XML file for approval, skip ["Update the Approver"](#) and go to section ["Approval State for Profile Data"](#).

Update the Approver

1. Click the name in the **Update** column of the **Approvers** section when the approver approves the profile data.
2. Use the calendar icon to set the approval date in the **Approval Date** field.
3. Click **Apply**.
4. Repeat Steps 1 through 3 for additional approvers.

Delete the Approver

You can also delete persons assigned as approvers.

1. Click the name in the **Delete** column of the **Approvers** section.
2. Click **Yes** when prompted to delete the approver.

Approval State for Profile Data

1. Click the **Approve** button to change the state from **Pending Approval** to **Approved**.
2. Click **Yes** when prompted to confirm your decision. If you did not select any approvers in Step 3 of ["Pending Approval State for Profile Data"](#) on page 5-20, you are reminded of your decision.

The State changes from **Pending Approval** to **Approved**, and the **Approve** button disappears.

Application Details : ExpenseApp

Details

Description	
Application Type	Adapter Folder
State	Approved

Deployed State for Modeling Metadata and Profile Data

After you create, validate, and deploy a configuration, the **State** field changes to **Deployed** on the details pages of all modeling metadata and profile data included in the configuration.

See Also: "[Creating a Configuration](#)" on page 16-3 for instructions on creating, validating, and deploying a configuration

Modeling Tab Overview

When you select the **Modeling** tab to manage modeling metadata, the page shown in [Figure 5–10](#) appears:

Figure 5–10 Modeling Tab

Oracle Application Server
ProcessConnect

Home Help Logout

Modeling Profiles Deployment Reports Administration

Business Processes Roles Event Types Datatypes Transformations Interactions Condition Expressions

Modeling

Logged in as admin

Modeling tasks define the metadata that describes how data moves through Oracle Application Server ProcessConnect.

Business Processes Business processes span all parties in an integration to implement business logic and manage the movement of business events. ⓘ

Roles Roles define how events are executed and implement the behavior of parties and the entire integration. Five types of roles are supported: native roles, translation binding roles, application roles, transformation binding roles, and business roles. ⓘ

Event Types Event types represent internal definitions of business-relevant data that either arrived from a party or is to be sent to a party. Event types appear in three different formats as they move through Oracle Application Server ProcessConnect: native events, application events, and business events. ⓘ

Datatypes Datatypes appear in several formats in Oracle Application Server ProcessConnect: native, application, and business. ⓘ

Transformations Transformations establish a common event structure and event vocabulary across all parties. ⓘ

Interactions Interactions define the communication between Oracle Application Server ProcessConnect and the runtime system and various adapters to send and receive data. ⓘ

Condition Expressions Condition expressions define how to perform a specific action in a condition step based on the result of an expression. ⓘ

Shortcuts

[Add Interaction](#)

[Create End-To-End Basic Integration](#)

[Add End-To-End Basic Event Flow](#)

[Create Spoke](#)

[Add Event Flow](#)

Related Information

[Using The Modeling Wizards](#)

This page enables you to perform the following modeling metadata tasks:

- View definitions of modeling design features that you access from this page
- Click an icon at the end of each modeling design definition to access additional documentation
- Access the list pages of the following **Modeling** subtabs for performing management tasks:
 - [Business Processes List Page](#)
 - [Roles List Page](#)
 - [Event Types List Page](#)
 - [Datatypes List Page](#)

- [Transformations List Page](#)
- [Interactions List Page](#)
- [Condition Expressions List Page](#)
- Access several modeling wizards listed under the **Shortcuts** section that enable you to create modeling metadata
- Access documentation about the modeling wizards under the **Related Information** section

The **Modeling** tab contains several subtabs and additional subsections that enable you to manage modeling metadata. [Figure 5–11](#) shows the subtabs that are accessible from the **Modeling** tab. The tasks available with each subtab are briefly described in this chapter. References are provided to the chapters that provide detailed instructions for performing these tasks.

Figure 5–11 Modeling Tabs and Subtabs

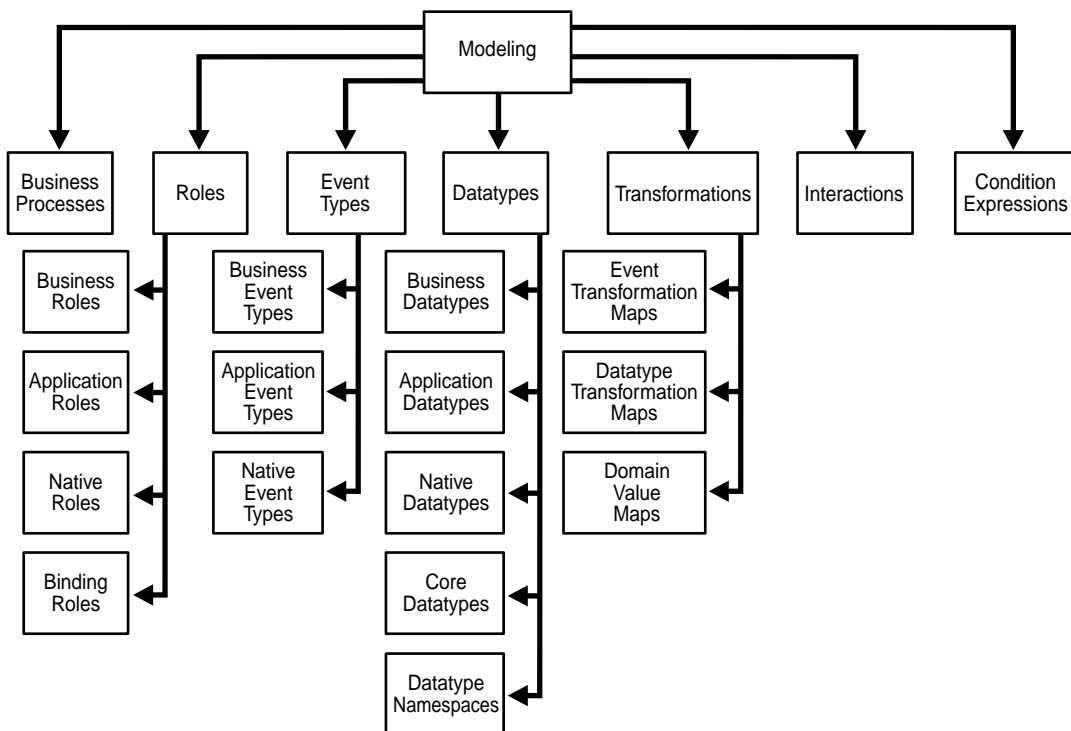

See Also: [Chapter 9, "Creating Metadata with the Modeling Wizards"](#) through [Chapter 14, "Advanced Transformations Design"](#) for instructions on managing modeling metadata

Business Processes List Page

When you select the **Business Processes** tab, the list page shown in [Figure 5–12](#) appears:

Figure 5–12 Business Processes Tab

Oracle Application Server
ProcessConnect

Home Help Logout

Modeling Profiles Deployment Reports Administration

Business Processes Roles Event Types Datatypes Transformations Interactions Condition Expressions

Business Processes

Logged in as admin

Name	Integration Diagram	Event Flow Diagram	Process Diagram	Update	Delete
Placing Ad					

Create

Shortcuts

- [Create End-To-End Basic Integration](#)
- [Add End-To-End Basic Event Flow](#)
- [Create Spoke](#)
- [Add Event Flow](#)
- [Import Datatype Business Datatypes](#)
- [Create Business Event Type](#)
- [Business Event Types](#)

Business Process Tasks

This page enables you to perform the following tasks to manage a business process:

- Manage (create, view, update, and delete) business processes
- View diagrams (integration, event flow, and process) that visually describe the state of the business process in an integration
- Access wizards listed in the **Shortcuts** section to create various parts of modeling metadata (for example, Create End-to-End Basic Integration)
- Access shortcuts listed in the **Shortcuts** section for performing business process-related tasks (for example, Import Datatype)
- Access the details page of a business process listed in the **Name** column. From this page, you can manage (create, view, update, and delete) data ports,

dataflow groups, and steps for the selected business process. After creating a step, you can manage (create, view, update, and delete) dataflow, control flow, and step ports from the details page of the selected step. This enables you to define the logic inside the business process and connect the business process to the business role.

See Also: The following sections for instructions on managing the elements of a business process:

- [Chapter 9, "Creating Metadata with the Modeling Wizards"](#)
- ["Managing Business Processes"](#) on page 12-33
- ["Managing Role Ports"](#) on page 12-48
- ["Managing Role Data Flow"](#) on page 12-58
- ["Managing Steps"](#) on page 12-70
- ["Managing Step Ports"](#) on page 12-87
- ["Managing Step Data Flow"](#) on page 12-95
- ["Managing Step Control Flow"](#) on page 12-102

Roles List Page

When you select the **Roles** tab, the default Business Roles list page shown in [Figure 5–13](#) appears:

Figure 5–13 Roles Tab

Oracle Application Server
ProcessConnect

Home Help Logout

Modeling Profiles Deployment Reports Administration

Business Processes Roles Event Types Datatypes Transformations Interactions Condition Expressions

Business Roles Application Roles Native Roles Binding Roles

Business Roles

Logged in as admin

Name	Integration Diagram	Event Flow Diagram	Process Diagram	Update	Delete
Delivering E-Mail-BR					
HR Placing New Ad-BR					
Placing Ad at Global NP-BR					

Create

Shortcuts

- [Create Business Event Type](#)
- [Business Event Types](#)
- [Add End-To-End Basic Event Flow](#)
- [Create Spoke](#)
- [Add Event Flow](#)

Role Tasks

This page enables you to perform the following role tasks that manage the movement of event types through Oracle Application Server ProcessConnect:

- Manage (create, view, update, and delete) business roles
- View diagrams (integration, event flow, and process) that show various parts of the business role
- Click the appropriate role subtab to access a page to manage (create, view, update, and delete) the following role types:
 - Application roles
 - Native roles
 - Binding roles (transformation or translation)
- Access shortcuts listed in the **Shortcuts** section for performing role-related tasks (for example, Create Business Event Type)
- Access wizards listed in the **Shortcuts** section to create various parts of modeling metadata (for example, Add End-to-End Basic Event Flow)

- Access the details page of a role type listed in the **Name** column. From this page, you can create data ports, dataflow groups, and steps for the selected role. After creating a step, you can manage (create, view, update, and delete) dataflow, control flow, and step ports from the details page of the selected step. This enables you to define the logic inside each role and connect each role together.

See Also: The following sections for instructions on managing the elements of role types:

- [Chapter 9, "Creating Metadata with the Modeling Wizards"](#)
- ["Managing Role Types" on page 12-40](#)
- ["Managing Role Ports" on page 12-48](#)
- ["Managing Role Data Flow" on page 12-58](#)
- ["Managing Steps" on page 12-70](#)
- ["Managing Step Ports" on page 12-87](#)
- ["Managing Step Data Flow" on page 12-95](#)
- ["Managing Step Control Flow" on page 12-102](#)

Event Types List Page

When you select the **Event Types** tab, the default Business Event Types list page shown in [Figure 5–14](#) appears:

Figure 5–14 *Event Types Tab*

Oracle Application Server
ProcessConnect

Home Help Logout

Modeling Profiles Deployment Reports Administration

Business Processes Roles **Event Types** Datatypes Transformations Interactions Condition Expressions

Business Event Types Application Event Types Native Event Types

Business Event Types

Logged in as admin

Name	Update	Delete
Ad Confirmation		
Ad Problem		
Ad Request		
Confirm		

Create

Shortcuts

- [Add Interaction](#)
- [Import Datatype](#)
- [Create Event Transformation Map](#)
- [Event Transformation Maps](#)

Event Type Tasks

This page enables you to perform the following tasks that define the formats in which data moving through Oracle Application Server ProcessConnect appears:

- Manage (create, view, update, and delete) business event types
- Click the appropriate event subtab to access a page to manage (create, view, update, and delete) the following event types:
 - Native event types
 - Application event types
- Access shortcuts in the **Shortcuts** section for performing event-related tasks (for example, Add Interaction)
- Access the details page of an event type listed in the **Name** column. From this page, you can manage (create, view, update, and delete) event body elements of the selected event type.

See Also: [Chapter 11, "Managing Adapter Interactions and Event Types"](#) for instructions on adding adapter interactions and managing native event types, application event types, and business event types

Datatypes List Page

When you select the **Datatypes** tab, the default Business Datatypes list page shown in [Figure 5–15](#) appears:

Figure 5–15 Datatypes Tab

Oracle Application Server
ProcessConnect

Home Help Logout

Modeling Profiles Deployment Reports Administration

Business Processes Roles Event Types **Datatypes** Transformations Interactions Condition Expressions

Business Datatypes Application Datatypes Native Datatypes Core Datatypes Datatype Namespaces

Logged in as admin

Search All Go

Import Create

Previous 1-10 of 46 Next 10

Name	Type	Base Datatype	Namespace	Update	Delete
anyURI	Scalar	string			
QName	Scalar	string			
NOTATION	Scalar	QName			
binaryString	Scalar	string			
base64BinaryString	Scalar	binaryString			
hexBinaryString	Scalar	binaryString			
normalizedString	Scalar	string			
token	Scalar	normalizedString			
language	Scalar	token			
NMTOKEN	Scalar	token			

Previous 1-10 of 46 Next 10

Shortcuts

- [Create Business Event Type](#)
- [Business Event Types](#)
- [Create Datatype Transformation Map](#)
- [Datatype Transformation Maps](#)

Datatype Tasks

This page enables you to perform the following tasks that define the datatypes to use to communicate with Oracle Application Server ProcessConnect:

- Manage (create, import, view, update, delete, and assign namespaces to) complex or scalar business datatypes
- Click the appropriate datatype subtab to access a page to view the following datatypes.
 - Native datatypes
 - Application datatypes

- Core datatypes
- Access shortcuts in the **Shortcuts** section for performing datatype-related tasks (for example, Create Business Event Type)
- Access the details page of a scalar or complex datatype listed in the **Name** column. From this page, you can manage (create, view, update, and delete) the following:
 - Scalar datatypes and any facets that define the constraints (or limitations) of datatypes
 - Complex datatypes and their associated datatype members (compound, scalar, and wildcard)
- Click the **Datatype Namespaces** subtab to access a page to manage (create, view, update, and delete) namespaces to which you assign a datatype.

See Also: [Chapter 11, "Managing Adapter Interactions and Event Types"](#) for instructions on managing business datatypes, application datatypes, native datatypes, core datatypes, and datatype namespaces

Transformations List Page

When you select the **Transformations** tab, the default Event Transformation Maps list page shown in [Figure 5–16](#) appears:

Figure 5–16 Transformations Tab

Oracle Application Server
ProcessConnect

Home Help Logout

Modeling Profiles Deployment Reports Administration

Business Processes Roles Event Types Datatypes **Transformations** Interactions Condition Expressions

Event Transformation Maps Datatype Transformation Maps Domain Value Maps

Event Transformation Maps

Logged in as admin

Name	Source Parameter Types	Target Parameter Types	Update	Delete
HR Ad to Common View	HR New Ad(Application Event Type)	Ad Request(Business Event Type)		
Common View to Global NP Ad	Ad Request(Business Event Type)	Global NP Ad(Application Event Type)		
Ad Confirmation to Ad Problem	Ad Confirmation(Business Event Type)	Ad Problem(Business Event Type)		
Global NP Confirmation to CV	Global NP Confirmation(Application Event Type)	Ad Confirmation(Business Event Type)		
CV to HR Ad Problem	Ad Problem(Business Event Type)	HR Problem(Application Event Type)		

Create

Shortcuts

- [Application Event Types](#)
- [Create Business Event Type](#)
- [Business Event Types](#)

Transformation Tasks

This page enables you to perform the following tasks to manage the transformation of application event datatypes to business event datatypes, and vice versa:

- Manage (create, view, update, and delete) event transformation maps
- Click the appropriate transformation subtab to access a page to manage (create, view, update, and delete) the following:
 - Datatype transformation maps
 - Domain value maps
- Access shortcuts in the **Shortcuts** section for performing transformation-related tasks (for example, Create Business Event Type)

See Also: The following sections for instructions on managing event transformation maps, datatype transformation maps, and domain value maps:

- "[Datatype Transformation Maps](#)" on page 13-4
- "[Domain Value Maps](#)" on page 13-83

Interactions List Page

When you select the **Interactions** tab, the list page shown in [Figure 5–17](#) appears:

Figure 5–17 Interactions Tab

Oracle Application Server
ProcessConnect

Home Help Logout

Modeling Profiles Deployment Reports Administration

Business Processes Roles Event Types Datatypes Transformations **Interactions** Condition Expressions

Logged in as **admin**

Interactions

This shows the interactions defined in the system. Please choose Add to add an interaction.

Expand All | Collapse All

⊕ Adapter Providers

Focus Item	Delete
▼ Adapter Providers	
⊕ ▶ Oracle	
⊕ ▶ Oracle IP Development team	

Shortcuts

[Native Event Types](#)

[Application Event Types](#)

Add

Interaction Tasks

This page enables you to perform the following tasks that define the communication between the Oracle Application Server ProcessConnect runtime system and various adapters to send and receive data in the form of native events:

- Add interactions
- View currently-defined interactions
- Delete currently-defined interactions
- Access shortcuts in the **Shortcuts** section for performing interaction-related tasks (for example, Create Native Event Type)

See Also: ["Managing Adapter Interactions"](#) on page 11-4 for instructions on managing interactions

Condition Expressions List Page

When you select the **Condition Expressions** tab, the list page shown in [Figure 5–18](#) appears:

Figure 5–18 Condition Expressions Tab

Oracle Application Server
ProcessConnect

Home Help Logout

Modeling Profiles Deployment Reports Administration

Business Processes Roles Event Types Datatypes Transformations Interactions **Condition Expressions**

Logged in as admin

Condition Expressions

Search

Previous 1-10 of 23 Next 10

Name	Expression	Update	Delete
IsReturnCodeSuccess	RETURN_CODE/returnCode = 0		
ConditionExpression for Correlation	ConditionParameter for ConditionExpression/Header/inReplyTo/MessageID = ConditionParameter for ConditionExpression/Header/MessageID		
ConditionExpression for Correlation	ConditionParameter for ConditionExpression/Header/inReplyTo/MessageID = ConditionParameter for ConditionExpression/Header/MessageID		
ConditionExpression for Correlation	ConditionParameter for ConditionExpression/Header/inReplyTo/MessageID = ConditionParameter for ConditionExpression/Header/MessageID		
ConditionExpression for Correlation	ConditionParameter for ConditionExpression/Header/inReplyTo/MessageID = ConditionParameter for ConditionExpression/Header/MessageID		
ConditionExpression for Correlation	ConditionParameter for ConditionExpression/Header/inReplyTo/MessageID = ConditionParameter for ConditionExpression/Header/MessageID		
ConditionExpression for Correlation	ConditionParameter for ConditionExpression/Header/inReplyTo/MessageID = ConditionParameter for ConditionExpression/Header/MessageID		
ConditionExpression for Correlation	ConditionParameter for ConditionExpression/Header/inReplyTo/MessageID = ConditionParameter for ConditionExpression/Header/MessageID		
ConditionExpression for Correlation	ConditionParameter for ConditionExpression/Header/inReplyTo/MessageID = ConditionParameter for ConditionExpression/Header/MessageID		
ConditionExpression for Correlation	ConditionParameter for ConditionExpression/Header/inReplyTo/MessageID = ConditionParameter for ConditionExpression/Header/MessageID		

Previous 1-10 of 23 Next 10

Condition Expression Tasks

This page enables you to manage (create, view, update, and delete) condition expressions in condition steps.

See Also: ["Managing Condition Expressions in Steps"](#) on page 12-108 for instructions on managing condition expressions

Profiles Tab Overview

When you select the **Profiles** tab to manage profile data, the page shown in [Figure 5–19](#) appears:

Figure 5–19 Profiles Tab

The screenshot shows the Oracle Application Server ProcessConnect interface. At the top, there is a navigation bar with tabs for Modeling, Profiles, Deployment, Reports, and Administration. Below this is a sub-navigation bar with tabs for Host, Trading Partners, Applications, and Agreements. The Profiles tab is selected. The main content area is titled "Profiles" and contains a definition of profile tasks. Below this are four sections: Host, Trading Partners, Applications, and Agreements, each with a brief description and a link icon. On the right side, there is a "Shortcuts" section with four links: Create Application, Create Trading Partner, Create Application Agreement, and Create Trading Partner Agreement. The user is logged in as admin.

This page enables you to perform the following tasks:

- View definitions of key profile concepts
- Access the following **Profiles** subtabs for performing management tasks:
 - [Host List Page](#)
 - [Trading Partners List Page](#)
 - [Applications List Page](#)
 - [Agreements List Page](#)
- Access shortcuts in the **Shortcuts** section for performing profile-related tasks (for example, Create Application)

The **Profiles** tab contains several subtabs and additional subsections that enable you to manage profile data. [Figure 5–20](#) shows the subtabs that are accessible from the **Profiles** tab. The tasks available with each subtab are briefly described in this chapter. References are provided to the chapters that provide detailed instructions for performing these tasks.

Figure 5–20 Profiles Tabs and Subtabs

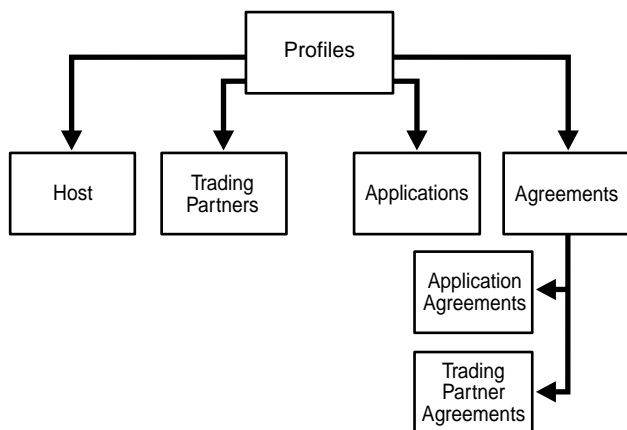

See Also: ["Exporting Profile Data to an XML File"](#) on page 5-15 for instructions on exporting profile data to a file for submittal to an approver for approval

Host List Page

When you select the **Host** tab, the list page shown in [Figure 5–21](#) appears:

Figure 5–21 Host Tab

Oracle Application Server
ProcessConnect

Home Help Logout

Modeling Profiles Deployment Reports Administration

Host Trading Partners Applications Agreements

Organization Cooperations Delivery and Security Endpoints

Logged in as admin

Trading Partner Identifications Approvers Associated Agreements

Host - ipdev

Validate Export Update

Details

Description sfd

Wallet Password Update

State **Draft**

Trading Partner Identifications [Return to Top](#) Create

Trading Partner Identification Type	Value	Details	Update	Delete
(No trading partner identifications found for the specific trading partner.)				

Approvers [Return to Top](#) Add

Person	Send For Approval Date	Approval Date	Update	Delete
ip	8/15/03			

Associated Agreements [Return to Top](#)

Name	State	Update	Delete
(No agreements found.)			

Host Tasks

The host trading partner is the organization in which Oracle Application Server ProcessConnect is installed. The remote trading partner is the organization outside your enterprise with whom to conduct business. The host trading partner uses the Oracle Application Server ProcessConnect user interface tool to define the capabilities for all trading partners (both host and remote). The host trading partner consults with the remote trading partner to obtain the necessary details.

This page enables you to perform the following host trading partner tasks to manage integrations between enterprises:

- Manage (create, view, update, export, and delete) trading partner identification
- Click the appropriate section beneath the **Host** subtab to access a page to manage (create, view, update, and delete) the following:
 - **Organization** section, for managing host trading partner persons and organization contact details
 - **Cooperations** (collaborations) section, for managing supported actors and business protocols
 - **Delivery and Security** section, for managing certificates, transports, document exchanges, and delivery channels
 - **Endpoints** section, for managing trading partner endpoints

See Also: The following sections for instructions on managing trading partner capabilities:

- ["Managing Trading Partner Identifications"](#) on page 25-4
- ["Managing Organizations"](#) on page 25-11
- ["Managing Cooperations"](#) on page 25-30
- ["Managing Delivery and Security"](#) on page 25-50
- ["Managing Endpoints"](#) on page 25-79

Trading Partners List Page

When you select the **Trading Partners** tab, the list page shown in [Figure 5–22](#) appears:

Figure 5–22 *Trading Partners Tab*

The screenshot shows the Oracle Application Server ProcessConnect interface. The top navigation bar includes 'Home', 'Help', and 'Logout'. Below the navigation bar, there are tabs for 'Modeling', 'Profiles', 'Deployment', 'Reports', and 'Administration'. The 'Trading Partners' tab is selected. The main content area displays a table of trading partners and a 'Shortcut' section.

Name	Update	Delete
ApprovalTP		

Buttons: [Create](#), [Shortcut](#)

Logged in as **admin**

Shortcut: [Create Trading Partner Agreement](#)

Trading Partner Tasks

This page enables you to perform the following tasks to manage remote trading partners participating in an integration:

- Manage (create, view, update, export, and delete) remote trading partners
- Click a specific trading partner in the **Name** column to access a page with links for managing (create, view, update, and delete) the following:
 - Organization section, for managing remote trading partner persons and organization contact details
 - Cooperations (collaborations) section, for managing supported actors and business protocols
 - Delivery and Security section, for managing certificates, transports, document exchanges, and delivery channels
 - Endpoints section, for managing trading partner endpoints
- Access shortcuts listed in the **Shortcut** section for performing trading partner-related tasks (for example, Create Trading Partner Agreement)

See Also:

- "Managing Remote Trading Partners" on page 26-6
- "Managing Organizations" on page 25-11
- "Managing Cooperations" on page 25-30
- "Managing Delivery and Security" on page 25-50
- "Managing Endpoints" on page 25-79

Applications List Page

When you select the **Applications** tab, the list page shown in [Figure 5–23](#) appears:

Figure 5–23 Applications Tab

The screenshot displays the Oracle Application Server ProcessConnect interface. The top navigation bar includes 'Home', 'Help', and 'Logout'. Below the navigation bar, the 'Applications' tab is selected. The main content area shows a table of applications with columns for 'Name', 'Update', and 'Delete'. A 'Create' button is visible next to the table. To the right, a 'Shortcuts' section contains a link for 'Create Application Agreement'. The user is logged in as 'admin'.

Name	Update	Delete
ExpenseApp		
Global Newspaper		
HR Person		
Human Resources		
Notification		

Applications Tasks

This page enables you to perform the following tasks to manage applications participating in an integration:

- Manage (create, view, update, and delete) applications, the adapter type associated with an application, and the delivery channel associated with an adapter type of an application
- Access shortcuts listed in the **Shortcuts** section for performing application-related tasks (for example, Create Application Agreement)

See Also: The following sections for instructions on managing applications and adapters:

- ["Managing Applications"](#) on page 15-4 to manage applications
- ["Managing Adapters and Delivery Channels"](#) on page 15-9 to manage adapters and delivery channels

Agreements List Page

When you select the **Agreements** tab, the default Application Agreements list page shown in [Figure 5-24](#) appears:

Figure 5-24 Agreements Tab

Oracle Application Server
ProcessConnect

Home Help Logout

Modeling Profiles Deployment Reports Administration

Host Trading Partners Applications **Agreements**

Application Agreements Trading Partner Agreements

Application Agreements

Logged in as **admin**

Search

Previous 1-10 of 11 Next 1

Name	State	Update	Delete
AppAgreement1	Draft		
AppAgreement2	Draft		
AppAgreement3	Draft		
AppAgreement4	Draft		
AppAgreement5	Draft		
AppAgreement6	Draft		
AppAgreement7	Draft		
AppAgreement8	Draft		
Global NP Agreement	Approved		
HR Agreement	Approved		

Previous 1-10 of 11 Next 1

Modeling | Profiles | Deployment | Reports | Administration | Home | Help | Logout

Agreement Tasks

This page enables you to perform the following tasks to manage agreements between parties (applications or trading partners):

- Manage (create, view, update, export, and delete) application agreements and the party (application or trading partner) and native role associated with an application agreement
- Click the **Trading Partner Agreements** section to access a page to manage (create, view, update, and delete) trading partner agreements and the party and native role associated with an agreement
- Access shortcuts listed in the **Shortcut** section for performing agreement-related tasks (for example, Create Application)

See Also: The following sections for instructions on managing agreements:

- ["Managing Application Agreements"](#) on page 15-29
- ["Managing Native Roles in Application Agreements"](#) on page 15-41
- ["Managing Trading Partner Agreements"](#) on page 26-14
- ["Managing Trading Partner Agreement Participants"](#) on page 26-20
- ["Managing Native Roles in Trading Partner Agreements"](#) on page 26-30

Deployment Tab Overview

When you select the **Deployment** tab with no deployed configurations, the list page shown in [Figure 5–25](#) appears:

Figure 5–25 *Deployment Tab*

[Configuration](#) Create

Last Deployment:

To create a configuration for all business processes choose Create.

Configurations

Configuration	State	Created
(No configurations found.)		

Business Processes

Business Process	State
Placing Ad	Draft

Deployment Tasks

This page enables you to perform the following tasks to deploy integrations:

- Create a configuration that consists of the following:
 - Modeling metadata consisting of the business process, roles, transformations, event types, datatypes, and interactions created under the **Modeling** tab
 - Profile data consisting of trading partner capabilities, parties (trading partners or applications), and agreements between parties created under the **Profiles** tab
- Deploy, discard, or export the configuration

See Also: ["Creating a Configuration"](#) on page 16-3 for instructions on creating, validating, and deploying a configuration

Reports Tab Overview

When you select the **Reports** tab, the Reports list page shown in [Figure 5–26](#) appears:

Figure 5–26 Reports Tab

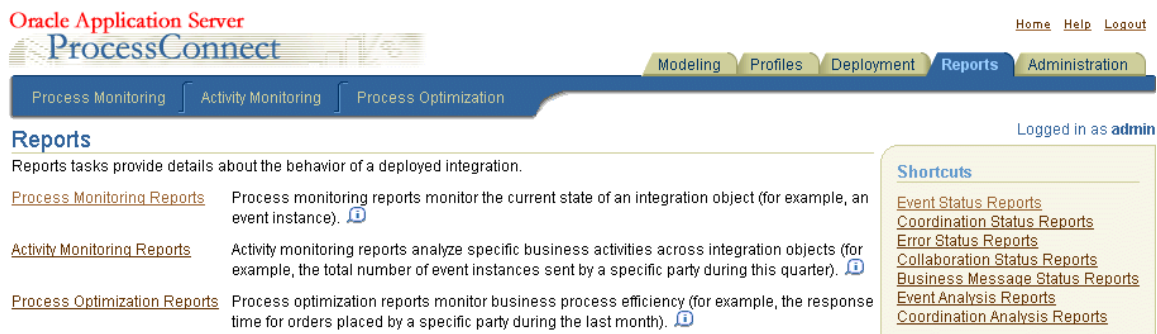

This page enables you to perform the following tasks:

- View definitions of the types of reports available for creation
- Access the following **Reports** subtabs for creating reports:
 - Process monitoring reports
 - Provide details about the current state of an element, such as an event instance
 - Activity monitoring reports
 - Provide specific details about business activity, such as the total number of event instances sent by a specific party during the past week
 - Process optimization reports
 - Provide details about business process efficiency, such as the response time for orders placed by a specific party during the past week
- Access shortcuts listed in the **Shortcuts** section for creating reports

See Also: [Chapter 23, "Creating Reports"](#)

Administration Tab Overview

When you select the **Administration** tab, the list page shown in [Figure 5–27](#) appears:

Figure 5–27 Administration Tab

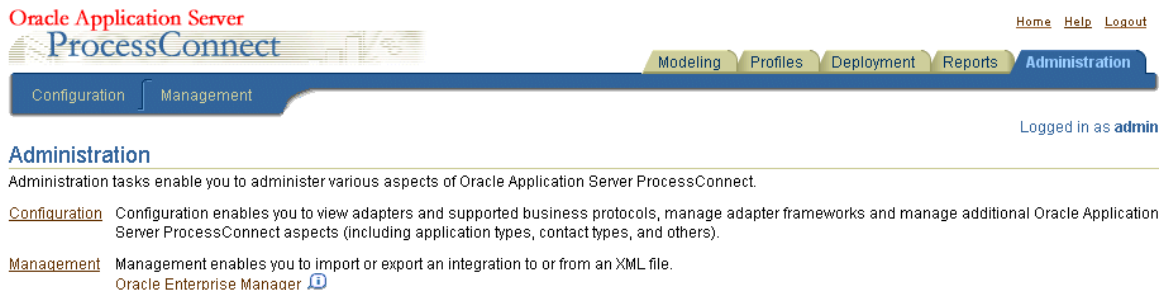

This page enables you to perform the following administration tasks:

- View definitions of administration features that you access from this page
- Access the following **Administration** subtabs for performing management tasks:
 - [Configuration List Page](#)
 - [Management List Page](#)
- Access the Oracle Enterprise Manager Application Server Control from which you can monitor and administer Oracle Application Server ProcessConnect (such as starting and stopping processes, editing configuration parameters, and viewing log files)

Configuration List Page

When you select the **Configuration** tab, the list page shown in [Figure 5–28](#) appears:

Figure 5–28 Configuration Tab

Oracle Application Server
ProcessConnect

Home Help Logout

Modeling Profiles Deployment Reports Administration

Configuration Management

Modeling Profiles

Adapter Framework Instances Native Formats Translators

Logged in as admin

Modeling Configuration

Adapters Add

Adapter Provider	Adapter Type	Delete
Oracle	AQ Adapter	
Oracle	E-Mail Adapter	
Oracle IP Development team	File Adapter	
Oracle	File/FTP Adapter	
Oracle	HTTP Adapter	
Oracle	JMS Adapter	
Oracle	Oracle DB Adapter	
Oracle	Web Service Adapter	

Adapter Framework Instances Return to Top

Name	Update
ip.lmurphy-sun.us.oracle.com	

Native Formats Return to Top

Create

Name
XSD
Token Substituted Text
D3L

Translators Return to Top

Create

Name	Delete
D3L	
Token Substituted Text	

Shortcuts

- [Add Interaction](#)
- [Interactions](#)
- [Native Event Types](#)
- [Application Event Types](#)

Configuration Tasks

This page enables you to perform the following configuration tasks:

- Manage modeling configurations, including adding adapters, updating the adapter framework instance, and managing native formats and translators
- Click the **Profiles** section to manage application types, contact types, and trading partner identification types and view available business protocols, collaborations, digital envelopes, and digital signatures

See Also: [Chapter 17, "Administering Integrations with the User Interface Tool"](#) for instructions on administering parts of Oracle Application Server ProcessConnect

Management List Page

When you select the **Management** tab, the list page shown in [Figure 5–29](#) appears:

Figure 5–29 Management Tab

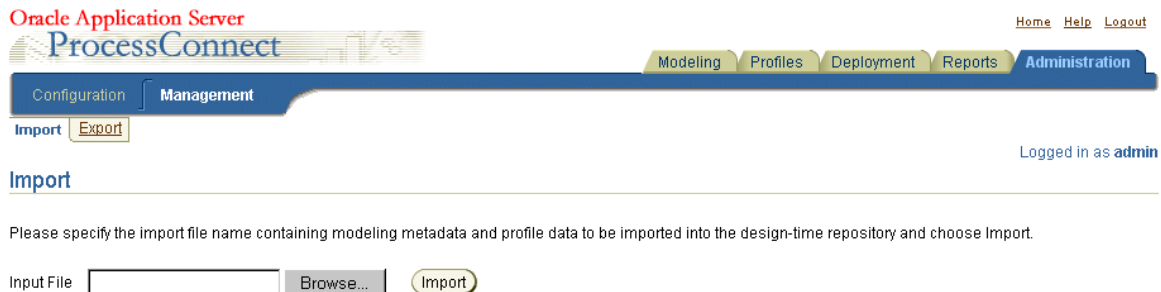

Management Tasks

This page enables you to export and import modeling metadata and profile data to and from a file.

See Also: ["Exporting and Importing Integrations"](#) on page 17-53 for instructions on exporting and importing modeling metadata and profile data

Chapter Summary

This chapter shows the higher-level Web pages of the Oracle Application Server ProcessConnect user interface tool that you use, starting with the Oracle Application Server ProcessConnect home page. This chapter describes in detail the layout, links, and tabs on Main List pages and Details pages. The main tabs (**Modeling, Profiles, Deployment, Reports, and Administration**) are described so that you understand the tasks you can perform on each page. Subtab pages are also described, including **Business Processes, Roles, Event Types, Datatypes, Transformations, Interactions, Condition Expressions, Host, Trading Partners, Applications, and Agreements**.

Methodologies for Using Oracle Application Server ProcessConnect

This chapter describes several methodologies for using the Oracle Application Server ProcessConnect user interface tool to design and deploy integrations.

This chapter contains these topics:

- [Methodologies for Using Oracle Application Server ProcessConnect](#)
- [Adapter-Centric Methodology](#)
- [Business Process-Centric Methodology](#)
- [Chapter Summary](#)

See Also: [Chapter 3, "Oracle Application Server ProcessConnect Concepts"](#) for details on concepts mentioned in this chapter

Methodologies for Using Oracle Application Server ProcessConnect

Oracle Application Server ProcessConnect provides two different methodologies (sets of rules) for using the user interface tool to design an integration:

- [Adapter-Centric Methodology](#)
- [Business Process-Centric Methodology](#)

These two different methodologies enable you to design the two most common types of integration scenarios in a systematic way. However, the number of different types of integration scenarios in which Oracle Application Server ProcessConnect can be used is highly diverse. For this reason, Oracle Application Server ProcessConnect does not impose a specific methodology on you. Therefore, you can use these methodologies or you can use your own methodology.

The Oracle Application Server ProcessConnect user interface tool provides a flexibility that does not require you to complete all modeling metadata and profile data tasks at the same time or even in a particular sequential order. For example, you can complete all modeling metadata tasks and store the metadata for later use. Or, you can complete a portion of your modeling metadata tasks and complete the remaining tasks later. You can also complete your profile data design tasks ahead of your modeling metadata design tasks. This enables you to design in parallel by dividing up tasks with someone working on profile data tasks such as creating delivery channels, while another is working on modeling metadata tasks such as creating event transformation maps. The approach to follow depends on what is best for your integration environment.

However, if you are designing an integration scenario for the first time or if you are uncertain of exactly how to proceed, Oracle strongly recommends that you follow one of the two approaches described in greater detail in this chapter.

Adapter-Centric Methodology

This section describes an adapter-centric methodology for using the Oracle Application Server ProcessConnect user interface tool to create an integration.

This section contains these topics:

- [What is an Adapter-Centric Methodology?](#)
- [When Do I Want to Use an Adapter-Centric Methodology?](#)
- [Create Applications and Add Adapters](#)
- [Create Native and Application Events and Select Translators](#)
- [Create Roles, Transformation Maps, a Business Event, and a Business Process](#)
- [Create Business Event Datatypes](#)
- [Create Business Event Body Element](#)
- [Create Transformation Rules](#)
- [Update the SetParty Step in the Business Process](#)
- [Create Agreements](#)
- [Create and Deploy a Configuration](#)

See Also: [Chapter 7, "Tutorial of an Integration within an Enterprise"](#) for a tutorial that uses the adapter-centric methodology to create a simple integration between two applications within an enterprise

What is an Adapter-Centric Methodology?

An adapter-centric methodology approach is designed to enable you to define and model the capabilities of your parties (applications or trading partners), adapters, and delivery channels before creating roles, business processes, and other modeling metadata.

When Do I Want to Use an Adapter-Centric Methodology?

This methodology is useful for environments where:

- You have a small number of parties (applications or trading partners).
- The business process itself is not complex.
- Your endpoint details are clearly known. For example, you know the following:
 - The parties to participate in an integration (applications or trading partners)
 - The adapters that enable these parties (applications or trading partners) with their unique data formats and interfaces to communicate with Oracle Application Server ProcessConnect
 - The actions that you want these adapters to provide. For example, an expense application must submit an expense report to an approval application for approval. The approval application must be able to submit an approval or a disapproval of the expense report to the expense application. With Oracle Application Server ProcessConnect, these actions that you define for your adapters to perform are known as adapter interactions.
 - The delivery channels that describe the communication capabilities (such as message exchange and security details) to use with trading partner or application adapters

This methodology is called adapter-centric because the behavior of the integration is driven more by the endpoints and less by the business process. Therefore, by first designing the endpoints, the rest of the integration can be defined more quickly and efficiently.

An example of a scenario in which an adapter-centric methodology is the preferred option is when connecting Oracle CRM applications to SAP applications. For instance, taking an order entered in an order entry module of an Oracle CRM application into an SAP financials application using largely pass-through steps between these endpoints. In this case, it is easiest to define the Oracle CRM endpoint through the Oracle Database adapter by way of the Oracle 11*i* Interface Tables. Then, define the SAP Interfaces by accessing the appropriate BAPIs. Only then do you design the business process.

Adapter-Centric Methodology Steps

Before describing the specific steps to follow in an adapter-centric methodology, an overview of the steps is described in [Table 6-1](#):

Table 6-1 Adapter-Centric Methodology Steps

Step	Description
1	Create applications and add adapter details for each party.
2	Create native and application events and select appropriate translators for each party.
3	Create the roles, transformation maps, business events, and a business process for each party.
4	Create application (or trading partner) agreements associated with each party. An integration that includes all modeling metadata and profile data (before creating a configuration) is now complete.
5	Create, validate, and deploy the configuration.

Create Applications and Add Adapters

You first create your application and add adapter details for each party. [Table 6-2](#) provides references to procedures for performing these tasks:

Table 6-2 Application and Adapter Tasks

Task	See Section...
Create an application	"Creating an Application" on page 15-5
Add an adapter to the application	"Adding an Adapter to an Application" on page 15-12
Add a delivery channel to the adapter	"Creating an Application Delivery Channel" on page 15-14
Add an adapter interaction	"Adding an Adapter Interaction" on page 11-7 Note: When you add a new interaction, you have the option of also creating a native event and application event and specifying a translator. You can create this modeling metadata for this new interaction at this time or specify it for an existing interaction at a later time when you can provide all the required details.

Create Native and Application Events and Select Translators

You then create your native and application events and select translators for each party. Two methods are provided. [Table 6-3](#) provides references to procedures for performing tasks with either method:

Table 6-3 *Native Event, Translator, and Application Event Tasks*

Task	See Section...
Native and application event creation and translator selection method:	
<ul style="list-style-type: none"> ■ During interaction creation: 	"Adding an Adapter Interaction" on page 11-7
<ul style="list-style-type: none"> ■ Defining and adding to an existing interaction at a later time: 	"Creating a Native Event Type" on page 11-40

Create Roles, Transformation Maps, a Business Event, and a Business Process

You then create your roles, transformation maps, business event, and business process for each party. Two methods are provided. [Table 6-4](#) provides references to procedures for performing tasks with either method.

Table 6-4 *Role, Transformation Map, Business Event, and Business Process Tasks*

Task	See Section...
Role, transformation map, business event, and business process creation method:	
<ul style="list-style-type: none"> ■ Automatic creation with the modeling wizards 	Chapter 9, "Creating Metadata with the Modeling Wizards"
<ul style="list-style-type: none"> ■ Manual creation 	Chapter 12, "Managing Business Processes and Roles" for creating roles and business processes "Creating an Event Type Transformation Map" on page 13-9 for creating transformation maps "Creating a Business Event Type" on page 11-66 for creating business events

Note: The modeling wizards also automatically create the role and business process steps, step ports, step data flows, role ports, role data flows, and control flows. If you do not use the modeling wizards, you must manually create this modeling metadata.

Create Business Event Datatypes

You then create the business event datatypes once. These are the common datatypes. Two methods are provided. [Table 6-5](#) provides references to procedures for performing tasks with either method:

Table 6-5 Business Event Datatype Tasks

Task	See Section...
Business event datatype creation method:	
<ul style="list-style-type: none"> ■ Manual creation of new business event datatypes 	"Managing Complex Datatypes" on page 10-15 "Managing Complex Datatype Members" on page 10-24 "Managing Scalar Datatypes" on page 10-36
<ul style="list-style-type: none"> ■ Creation through import of business event datatypes 	"Importing XSD Datatypes" on page 10-51

Create Business Event Body Element

You now create the business event body element to contain the business event datatypes. You previously created the business event without a body element in ["Create Roles, Transformation Maps, a Business Event, and a Business Process"](#) on page 6-6. [Table 6-6](#) provides a reference to procedures for performing this task:

Table 6-6 Business Event Body Element Tasks

Task	See Section...
Create business event body elements	"Creating an Event Body Element" on page 11-69

Create Transformation Rules

You now create the transformation rules for each spoke. You previously created the transformation maps without defined rules in "[Create Roles, Transformation Maps, a Business Event, and a Business Process](#)" on page 6-6. [Table 6-7](#) provides a reference to procedures for performing this task:

Table 6-7 Transformation Rule Tasks

Task	See Section...
Create transformation rules	" Creating a Transformation Rule " on page 13-32

Update the SetParty Step in the Business Process

You now update the SetParty step in the business process to specify the destination (outbound) party in this integration. [Table 6-8](#) provides a reference to procedures for performing this task:

Table 6-8 SetParty Step Tasks

Task	See Section...
Update the SetParty step	" Updating a Step " on page 12-85

See Also: "[Creating an Event Header Rule](#)" on page 13-78 for instructions on setting the destination (outbound) party in an event header transformation rule (an alternative to using the SetParty step)

Create Agreements

There are two types of agreements: application agreements for integrations within an enterprise or trading partner agreements for integrations between enterprises. Each application (created in ["Create Applications and Add Adapters"](#) on page 6-5) or trading partner must be assigned to an agreement. The agreement type to use is based on the type of integration you are performing. [Table 6-9](#) provides references to procedures for performing these tasks:

Table 6-9 Agreement Tasks

Task	See Section...
Application agreement tasks:	
<ul style="list-style-type: none"> ■ Create an agreement 	"Creating an Application Agreement" on page 15-32
<ul style="list-style-type: none"> ■ Add an application to the agreement 	"Creating an Application Agreement" on page 15-32
<ul style="list-style-type: none"> ■ Add a delivery channel to the agreement 	"Creating an Application Delivery Channel" on page 15-14
<ul style="list-style-type: none"> ■ Add a native role to the agreement 	"Adding an Application Agreement Native Role" on page 15-43
<ul style="list-style-type: none"> ■ Validate and add approvers to the agreement 	"Managing Application and Agreement Validation and Approval" on page 15-44

Table 6–9 (Cont.) Agreement Tasks

Task	See Section...
Trading partner agreement tasks:	
<ul style="list-style-type: none"> ■ Create host and remote trading partner identification, organization, cooperation (collaborations), delivery, security, and endpoint capabilities 	Chapter 25, "Managing Host and Remote Trading Partner Capabilities"
<ul style="list-style-type: none"> ■ Create an agreement 	"Creating a Trading Partner Agreement" on page 26-15
<ul style="list-style-type: none"> ■ Add a trading partner to the agreement 	"Adding Trading Partner Agreement Participants" on page 26-23
<ul style="list-style-type: none"> ■ Add a delivery channel to the agreement 	"Adding a Delivery Channel to a Trading Partner Agreement Participant" on page 26-26
<ul style="list-style-type: none"> ■ Add a native role to the agreement 	"Adding a Trading Partner Agreement Native Role" on page 26-32
<ul style="list-style-type: none"> ■ Validate and add approvers to the agreement 	"Managing Trading Partner and Agreement Validation and Approval" on page 26-33

Create and Deploy a Configuration

You now create and deploy a configuration that includes all the modeling metadata and profile data you created in previous sections. [Table 6–10](#) provides references to procedures for performing these tasks:

Table 6–10 Deployment Tasks

Task	See Section...
Create and validate a configuration	"Creating a Configuration" on page 16-3
Deploy a configuration	"Deploying a Configuration" on page 16-9

Business Process-Centric Methodology

This section describes how to use the Oracle Application Server ProcessConnect user interface tool to create a business process-centric methodology.

What is a Business Process-Centric Methodology?

A business process-centric methodology approach enables you to manually create and customize the capabilities of your business process and business event before defining other modeling metadata and profile data. For example, you may already know your modeling metadata such as transformation details, but do not yet know the parties with which to integrate. You follow this approach instead of automatically creating these components with the modeling wizards. When you later use the modeling wizards, you select the manually-created business process and business event. Details such as the business event body elements and business datatypes to create and the adapters and delivery channels to add can be defined later.

When Do I Want to Use Business Process-Centric Methodology?

This methodology is useful for environments where:

- A complex business process that spans many parties to coordinate the sending and receiving of events. This is called a business process-centric methodology because the behavior of the integration is driven more by the business process and less by the specific endpoints being integrated with each other.
- You have multiple applications or trading partners participating in an integration. An example of a scenario in which a business process-centric is particularly useful is the case in which you are processing purchase orders from many trading partners and entering them into the financial ledger of the company. In this case, it is easiest to first model the business process and then model the agreements for each trading partner.

Another scenario in which to use a business process-centric methodology is in the case in which multiple parties are participating in different integrations. However, in each integration, the business process is largely the same except for a few additional steps. For instance, in the purchase order example, each trading partner has some specific approval processes (captured in conditional steps) that must be added to the base process purchase order business process definition.

Business Process-Centric Methodology Creation Procedures

A business process-centric methodology approach is similar to an adapter-centric methodology approach. This section describes only the differences.

- Manually create a business process

You first create a business process manually instead of using the modeling wizards by following the procedures in "[Creating a Business Process](#)" on page 12-36.

- Manually create a business event

You first create a business event manually instead of using the modeling wizards by following the procedures in "[Creating a Business Event Type](#)" on page 11-66. You do not need to create an event body element or business event datatypes for the business event. You can perform those tasks later.

- Use the Create Spoke wizard to create a spoke

You run the Create Spoke wizard by following the procedures in "[Create Spoke Wizard](#)" on page 9-10. When running the wizard, do not specify to create a new business process and new business event. Instead, specify the manually-created business process and business event. Ensure that you have added your adapter interactions and created your application events and business events before running the Create Spoke wizard.

- Create parties (applications or trading partners)

You create your integration parties so they can be used to model the business process (in particular, the SetParty steps). You do not need to add adapters or delivery channels. You can perform those tasks later.

Chapter Summary

This chapter describes the adapter-centric methodology and the business process-centric methodology. In the adapter-centric methodology, you define and model the capabilities of your parties (applications or trading partners), adapters, and delivery channels before creating roles, business processes, or other modeling metadata. This is useful when you have a small number of parties. In the business process-centric methodology, you manually create and customize the capabilities of your business process and business event before defining other modeling metadata and profile data. This is useful when a complex business process spans many parties.

Tutorial of an Integration within an Enterprise

This chapter provides a simple tutorial on how to use the Oracle Application Server ProcessConnect user interface tool to design and deploy an integration within an enterprise.

This chapter contains these topics:

- [Tutorial Overview](#)
- [Preparations before Starting](#)
- [Phase A: Creating and Deploying the Initial Configuration](#)
- [Phase B1: Manually Design Some Modeling Metadata in an Integration](#)
- [Phase B2: Using the Add Event Flow Wizard](#)
- [Phase B3: Using the Add Spoke Wizard](#)
- [Phase B4: Creating the HR Person Application and Agreement](#)
- [Manually Creating the Business Datatypes](#)
- [Updating the Interaction, Native Event, and Application Event](#)
- [.xsd and .xml Files Used in This Tutorial](#)
- [Chapter Summary](#)

See Also: [Chapter 3, "Oracle Application Server ProcessConnect Concepts"](#) for details on terms used in this chapter

Tutorial Overview

This section provides an overview of this tutorial.

Example Scenario

The tutorial describes the initial phase of a hiring process. Human resources must find candidates for a new position that is available within the company. The initial phase of this tutorial describes placing an ad in a newspaper. If there is a problem with placing an ad in the newspaper, a human resources person must be notified. Otherwise, human resources assumes the ad is successfully placed.

The scenario uses the following applications:

- A Human Resources application sends the ad placement request to a Global Newspaper application over a file system.
- The Global Newspaper application receives the request and places a confirmation on the file system.
- If there is a problem with the ad placement request, the Global Newspaper application notifies a Human Resources Person application.

Human Resources Application Details

The Human Resources application places a file on the file system containing one or more ads. The file contains additional information indicating whether this is a new ad or a change request for an existing ad. In the case of multiple ads, all ads must be placed in the same newspaper.

Global Newspaper Application Details

The Global Newspaper application expects the Human Resources application to place an ad as a file on the file system. The newspaper always places a confirmation file back on the file system. The confirmation indicates whether the placement was successful or if there was a problem. Although this tutorial uses the file system, an alternative method can be used, such as using Web services or secure HTTP with a custom XML file.

Human Resources Person Application Details

If a problem occurs, human resources expects the problem to be placed as a file on the file system. Although this tutorial uses the file system, other methods can be used, such as using SMTP and sending an e-mail.

Overview of Phases

This tutorial is divided into two phases:

- [Phase A](#)
- [Phase B1 through B4](#)

Phase A

You perform the following tasks in this phase:

- Create the Human Resources and Global Newspaper applications, add an adapter to each application, and create delivery channels for the adapter of each application
- Validate and approve the applications
- Design the `HR_Ad.xsd` file to be delivered to the global newspaper. In this task, you create one interaction to read the ad placement request from the human resources file system and a second interaction to write the file to the global newspaper file system.
- Create the native and application events and specify a translator for each application.
- Use the Create End-to-End Basic Integration wizard to create a pass-through process between the two interactions.
- Import the business (common view) datatypes for the business event.
- Create the business event body element and include the imported business datatypes.
- Design the inbound and outbound transformations between the application events and the business event.
- Update the SetParty step in the business process to include the Global Newspaper application as the destination party in this integration.
- Create the application agreements for both applications, and add a delivery channel and native role to each agreement.

- Validate and approve the agreements.
- Deploy and test the integration.

Phase B1 through B4

You perform the following tasks in this phase:

- Enhance the business process to notify a Human Resources Person application in case of problems by manually performing some business process modeling.
- Create two new native events: one for the problem notification message to the Human Resources Person application and one for the confirmation message from the Global Newspaper application.
- Use the Add Event wizard to integrate the new native event from the global newspaper with the business event.
- Use the Add Spoke wizard to integrate the native event from the human resources person with the business process.
- Create the Human Resources Person application.
- Validate and approve the application.
- Create the human resources person application agreement, and add a delivery channel and native role.
- Validate and approve the agreement.
- Deploy and test the integration.

See Also: [Chapter 13, "Managing Transformations"](#) to model additional transformations that use the same example files as this tutorial

Preparations before Starting

The following `.xsd` files are provided in the `$ORACLE_HOME/ip/import` directory for the different applications used in this tutorial:

- `HR_Ad.xsd`
- `HR_AdProblem.xsd`
- `Global_Newspaper_Ad.xsd`
- `Global_NP_AdConfirmation.xsd`
- `Ad_CommonView.xsd`

The following `.xml` files are also provided in the `$ORACLE_HOME/ip/demo/tutorial` directory:

- `HR_Ad.xml`
- `Global_NPConfirmation.xml`

Perform the following tasks:

1. Ensure that the XML Schema definition `.xsd` files are in the `import` directory before starting this tutorial. The `import` directory is configured as a server property and can be modified through Oracle Enterprise Manager. The directory setting defaults to `$ORACLE_HOME/ip/import` (where `$ORACLE_HOME` is the middle-tier Oracle Application Server instance).

These files are also located at the back of this chapter.

2. Create a directory named `tutorial` anywhere you want (for example, `$ORACLE_HOME/ip/tutorial`)
3. Create the following subdirectories under `tutorial`.
 - `human_resources/inbound`
 - `global_newspaper/inbound`
 - `global_newspaper/outbound`
 - `hr_person/outbound`
4. Place these two `.xml` instance files in the `tutorial` directory:
 - `HR_Ad.xml`
 - `Global_NP_AdConfirmation.xml`

See Also: ["Oracle Application Server ProcessConnect Middle-Tier Instance Configuration Parameters"](#) on page 18-11 for instructions on modifying server properties with Oracle Enterprise Manager

Methods to Designing the Tutorial

There are several methods for designing the tutorial:

- You can start designing the business process completely or partly and integrate the events with the parties.
- You can start designing some of the interactions with the parties and work toward the business process.
- You can start designing datatypes and work toward the process modeling.
- You can start designing the end-to-end process and then design the data details.

This tutorial does not follow one single method; it is a mix that provides many examples used by the different methods.

Phase A: Creating and Deploying the Initial Configuration

This phase of the tutorial describes how to design and deploy an integration (known as a configuration) between the Human Resources and Global Newspaper applications.

This section contains these topics:

- [Task 1: Creating Application Details](#)
- [Task 2: Creating the Modeling Metadata](#)
- [Task 3: Creating the Agreements](#)
- [Task 4: Creating and Deploying a Configuration](#)
- [Task 5: Testing the Results](#)
- [Task 6: Troubleshooting Any Errors with Log Files and Reports](#)

Task 1: Creating Application Details

This section contains the following tasks:

- [Creating the Human Resources Application](#)
- [Adding an Adapter to the Human Resources Application](#)
- [Creating the Delivery Channel for the Human Resources Application Adapter](#)
- [Validating the Human Resources Application](#)
- [Sending the Application for Approval](#)
- [Approving the Application](#)
- [Creating the Global Newspaper Application](#)
- [Adding an Adapter to the Global Newspaper Application](#)
- [Creating the Delivery Channel for the Global Newspaper Application Adapter](#)
- [Validating the Global Newspaper Application](#)
- [Sending the Application for Approval](#)
- [Approving the Application](#)

See Also: The following sections for additional details about tasks covered in this section:

- ["Creating an Application"](#) on page 15-5
- ["Adding an Adapter to an Application"](#) on page 15-12
- ["Creating an Application Delivery Channel"](#) on page 15-14
- ["Managing Application and Agreement Validation and Approval"](#) on page 15-44

Creating the Human Resources Application

Create an application named Human Resources to send the inbound ad.

1. Select the **Profiles** tab.
2. Select the **Applications** tab.
3. Click **Create**.
4. Enter **Human Resources** in the **Name** field.

5. Select the **Generic** application type from the **Application Type** list. The application type enables you to group applications of a similar type together.
6. Click **Apply**.

The Human Resources application is created and the Application Details : Human Resources page appears.

Adding an Adapter to the Human Resources Application

Add an adapter to the Human Resources application by selecting from a list of previously-configured adapters provided by Oracle Application Server ProcessConnect. This adapter provides the connectivity that enables the Human Resources application with its unique data formats and interface to communicate with Oracle Application Server ProcessConnect.

1. Click **Add** in the **Adapter Types** section of the Application Details : Human Resources page.
2. Select **File/FTP Adapter** from the **Type** list.
3. Click **Apply**.

The Adapter Type Details page of the adapter appears.

Creating the Delivery Channel for the Human Resources Application Adapter

Create a delivery channel for the adapter to use. The delivery channel describes the communication capabilities (such as message exchange and security details) of the specific adapter of the Human Resources application. Each adapter has its own unique delivery channel questions.

1. Click **Create** in the **Delivery Channels** section of the Adapter Type Details page of the adapter.
2. Enter the following details:

Field	Enter/Select
Name	HR DC
File or FTP mode	File
Polling interval in milliseconds (inbound)	10000

Field	Enter/Select
Base directory	<p><i>start_at_root</i>/ip/tutorial/human_resources</p> <p>where <i>start_at_root</i> must be the absolute path (for example, /private/Oracle).</p> <p>Note: Do not use the \$ORACLE_HOME variable when specifying a base directory. This is the directory from which the inbound ad is read and is the directory path you created in Step 2 on page 7-5.</p>

Note: Do not enter information in any other fields; the other fields on this page only apply when using FTP mode with the File/FTP adapter.

3. Click **Apply**.

Validating the Human Resources Application

Validate the application to ensure the correctness of the profile data you entered.

1. Click **Return to List**.
2. Click **Return to List**.
3. Click **Validate** on the Application Details : Human Resources page.

If validation is successful, the **Validate** button name changes to **Send for Approval**. If validation is unsuccessful, error messages appear. Make corrections based on the error messages.

Sending the Application for Approval

You can select an approver to approve the profile data of your application (for example, to ensure that the delivery channel details you specified are correct).

1. Click **Send for Approval**.
2. Select approvers (for example, the user **admin**) from the **Available Approvers** list.
3. Click **Move** to move the approver(s) to the **Selected Approvers** list.
4. Click **Send for Approval**.

Your selection appears in the **Approvers** section of the Application Details: Human Resources page. The **Send For Approval** button is replaced with an **Approve** button and the **Validated** status that displays in the **State** field of the **Details** section is replaced with **Pending Approval**.

At this point, you can export the application details to an XML file for submittal to a person for approval. For this tutorial, this task is not performed. Instead, the profile data in this application is assumed to be approved by all persons.

Approving the Application

You must approve the application.

1. Click **Approve**.
2. Click **Approve** again when prompted to confirm.

Creating the Global Newspaper Application

Create a second application named Global Newspaper to receive the ad request and place a confirmation file back on the file system.

1. Select the **Profiles** tab.
2. Select the **Applications** tab.
3. Click **Create**.
4. Enter `Global Newspaper` in the **Name** field.
5. Select the **Generic** application type from the **Application Type** list.
6. Click **Apply**.

The Global Newspaper application is created and the Application Details: Global Newspaper page appears.

Adding an Adapter to the Global Newspaper Application

Add an adapter to the Global Newspaper application by selecting from a list of previously-configured adapters provided by Oracle Application Server ProcessConnect. This adapter provides the connectivity that enables the Global Newspaper application with its unique data formats and interface to communicate with Oracle Application Server ProcessConnect.

1. Click **Add** in the **Adapter Types** section of the Application Details: Global Newspaper page.
2. Select **File/FTP Adapter** from the **Type** list.
3. Click **Apply**.

The Adapter Type Details page for the adapter appears.

Creating the Delivery Channel for the Global Newspaper Application Adapter

Create a delivery channel for the adapter to use. The delivery channel describes the communication capabilities (such as message exchange and security details) of the specific adapter of the Global Newspaper application. Each adapter has its own unique delivery channel questions.

1. Click **Create** in the **Delivery Channels** section of the Adapter Type Details page of the adapter.
2. Enter the following details:

Field	Enter/Select
Name	Global NP DC
File or FTP mode	File
Polling interval in milliseconds (inbound)	10000
Base directory	<p><i>start_at_root</i>/ip/tutorial/global_newspaper</p> <p>where <i>start_at_root</i> must be the absolute path (for example, /private/Oracle).</p> <p>Note: Do not use the \$ORACLE_HOME variable when specifying a base directory. This is the directory in which to receive the ad request and is the directory path you created in Step 2 on page 7-5.</p>

3. Click **Apply**.

Validating the Global Newspaper Application

Validate the application to ensure the correctness of the profile data you entered.

1. Click **Return to List**.
2. Click **Return to List**.
3. Click **Validate** on the Application Details : Global Newspaper page.

If validation is successful, the **Validate** button name changes to **Send for Approval**. If validation is unsuccessful, error messages appear. Make corrections based on the error messages.

Sending the Application for Approval

You can select an approver to approve the profile data of your application (for example, to ensure that the delivery channel details you specified are correct).

1. Click **Send for Approval**.
2. Select approvers (for example, the user **admin**) from the **Available Approvers** list.
3. Click **Move** to move the approver(s) to the **Selected Approvers** list.
4. Click **Send for Approval**.

Your selection appears in the **Approvers** section of the Application Details: Global Newspaper page. The **Send For Approval** button is replaced with an **Approve** button and the **Validated** status that displays in the **State** field of the **Details** section is replaced with **Pending Approval**.

At this point, you can export the application profile data to a file for submittal to a person for approval. For this tutorial, this task is not performed. Instead, the profile data in this application is assumed to be approved by all persons.

Approving the Application

You must approve the application.

1. Click **Approve**.
2. Click **Approve** again when prompted to confirm.
3. Click the **Applications** tab to see the newly created Human Resources and Global Newspaper applications displayed in the **Name** column of the Applications page. Click these applications to see the details about the adapters and delivery channels that you associated with these applications.

Task 2: Creating the Modeling Metadata

This section contains the following tasks:

- [Creating the Inbound Interaction for the Human Resources Application Adapter](#)
- [Creating the Native Event, Translation, and Application Event for the Human Resources Application](#)
- [Creating an Event Map for the HR New Ad Native Event](#)
- [Creating the Outbound Interaction for the Global Newspaper Application Adapter](#)
- [Creating the Native Event, Translation, and Application Event for the Global Newspaper Application](#)
- [Creating an Event Map for the Global NP Ad Native Event](#)
- [Creating the Modeling Metadata with the Modeling Wizards](#)
- [Creating the Business Event Datatypes](#)
- [Creating the Business Event Body Element](#)
- [Creating the Rules for the Inbound Event Transformation Map](#)
- [Creating the Rules for the Outbound Event Transformation Map](#)
- [Selecting the Destination Party in the SetParty Step](#)

See Also: The following sections for additional details about tasks covered in this section:

- ["Managing Adapter Interactions"](#) on page 11-4
- ["Creating Native and Application Event Types and Body Elements"](#) on page 11-27
- ["Creating Two Spokes"](#) on page 9-21 with the Create End-To-End Basic Integration wizard
- ["Importing XSD Datatypes"](#) on page 10-51
- ["Managing Business Event Types"](#) on page 11-63
- ["Transformation Statements Overview"](#) on page 13-27
- ["Managing Steps"](#) on page 12-70

Creating the Inbound Interaction for the Human Resources Application Adapter

For the File/FTP adapter you added in ["Adding an Adapter to the Human Resources Application"](#) on page 7-8 to read the file from an inbound directory, an inbound interaction must be defined. An interaction provides the adapter with the details to deliver and retrieve events to and from Oracle Application Server ProcessConnect. Interactions represent unique actions that can be performed with a specific adapter.

This task creates the interaction to read files with the extension `xml` from the `human_resources` directory (the subdirectory of `tutorial` that you specified in the delivery channel questions at Step 2 on page 7-8). The questions that display onscreen are unique to the File/FTP adapter. The native format must be provided to describe the contents of the body element of the native event (that is, what comes in as an Oracle record from the adapter). Based on the native format, a number of extractors (and later also translators) are available. The extractor is used for event map and correlation.

1. Select the **Modeling** tab.
2. Select the **Interactions** tab.
3. Click **Add**.
4. Expand **Adapter Providers > Oracle**.
5. Select the **File/FTP Adapter**.
6. Expand **Adapter Exchange Protocols > Inbound > File**.
7. Select **Read File(FileRecord)**.
8. Enter the following details:

Field	Enter/Select
Directory (relative path) for incoming files	inbound Note: You created this directory in Step 3 of "Preparations before Starting" on page 7-5. Note also the relationship to the delivery channel directory you created in Step 2 on page 7-8; inbound is a subdirectory of <code>human_resources</code> .
Maximum number of files to read for each poll	1
File extension for the incoming files - for example, txt *	xml

Note: Recheck your answers in Step 8 to ensure their correctness. Updating an interaction at a later time is difficult.

9. Click **Apply**.
10. Ensure that the **Create Native Event Type** box is selected.
11. Click **Apply** on the Add Interaction : Review page.
12. Ensure that **XSD** is selected in both the **Native Format** list and the **Extractor** list.
13. Click **Apply**.

See Also: ["Updating the Interaction, Native Event, and Application Event"](#) on page 7-77 to update an interaction used with a business process

Creating the Native Event, Translation, and Application Event for the Human Resources Application

The inbound ad request of the Human Resources application initially appears in its own unique native format that Oracle Application Server ProcessConnect cannot interpret. This native format can consist of several different parts, including headers, attachments, and payloads. The payload can identify details such as the person submitting the ad request, their phone number, the date, and so on.

The native format received by Oracle Application Server ProcessConnect is represented as an Oracle record on the Oracle Application Server ProcessConnect boundary. A native event is created from the Oracle record. A native event is the Oracle Application Server ProcessConnect internal implementation of the business data contained in an Oracle record. The different parts of the native format (such as the payload) are placed into different parts called body elements in a native event. In addition, the transmission structure of the native format is removed (such as encoding, packaging, signing, or encryption).

When you create a native event, you also specify a translator to translate the contents of the inbound native event into an inbound application event, which represents an interpretable syntactic format understood by Oracle Application Server ProcessConnect.

1. Enter `HR New Ad` in the **Name** field of the Create Native Event Type page.
2. Click **Next**.

3. Select **XSD** from the **Translator** list.
4. Enter **HR Ad** in the **Name** field of the **Native Datatype** section.
5. Click **Browse** next to the **Content** field.
6. Select **HR_Ad.xsd**.
Your selection appears in the **Content** field.
7. Click **Next**.
8. Select **XSD** from the **Translator** list. The translators available for selection are limited to those that can handle the native format you selected in Step 12 on page 7-15.
9. Select **Yes** from the **Preserve Namespaces for Native Instances** list.
10. Select **None** from the **Doctype for Native Instances** list. The page refreshes.
11. Click **Next**.
12. Review your selections and click **Finish** on the Review page.
The native event and application event are created.
13. Click **HR New Ad** in the **Name** column of the Native Event Types page.

The steps you performed in this section took the inbound ad request in its native format, created a native event named **HR New Ad**, and placed the payload part of the native format into a native event body element (named **PAYLOAD**):

Native Event Type Details : HR New Ad

Details

Name	HR New Ad
Application Event	HR New Ad
Record Type	xmlRecord
Description	<div style="border: 1px solid black; height: 40px; width: 100%;"></div>

Event Map

Condition **PAYLOAD/Action = HR New Ad Request** Update Delete

Event Body Elements

Name	Record Type Element
PAYLOAD	PAYLOAD

14. Click **Event Types > Application Event Types** to review the newly created application event.
15. Select **HR New Ad** in the **Name** column. (Note that the application event has the same name as the native event.)
16. Click **Expand All** in the **Event Body Elements** section.

The steps you performed in this section translated the inbound native event into an inbound application event named **HR New Ad** and created an event body element (named **PAYLOAD**) for the payload part that includes the following application event datatypes. Application events contain no native formats. The particular native format of the Human Resources application cannot be identified, and any specific syntactic properties have been removed.

Event Body Elements [Return to Top](#)

[Create](#)

Expand All | Collapse All

Event Body Elements

Focus	Name	Type	Datatype	Cardinality	Update	Delete
	Event Body Elements					
+	PAYLOAD		Ad Request			
	Action	Scalar	string			
	Function Type	Scalar	string			
	Date	Scalar	dateTime			
	HR Contact FirstName	Scalar	string			
	HR Contact LastName	Scalar	string			
	Content Type	Scalar	string			
	Importance	Scalar	integer			
+	(Anonymous)	Compound	(Anonymous)	[1, 1]		
	HR Contact Phone	Scalar	string			
	HR Contact Email	Scalar	string			
	description	Scalar	string			
+	Ad	Compound	AdType	[1,]		
	Title	Scalar	string			
	Text	Scalar	string			
	Ad ID	Scalar	integer			

Remember these datatypes. Later in this tutorial in "[Creating the Rules for the Inbound Event Transformation Map](#)" on page 7-32, you create a transformation rule to transform this source inbound application event and its application datatypes to a target inbound business event and its business datatypes.

Creating an Event Map for the HR New Ad Native Event

Event maps determine the native event type for a specific record type from an interaction. In this tutorial, the File/FTP adapter reads any file with an `.xml` extension.

1. Select the **Modeling** tab.
2. Select the **Event Types** tab.
3. Select **Native Event Types**.
4. Select **HR New Ad** in the **Name** column.
5. Click **Create** in the **Event Map** section.
6. Select **Condition expression not specified**.
7. Click **Update** to create a new event map.
8. Click **Expand All** on the Create Condition Expression page.
9. Select **Action**.
10. Select `=` from the **Operator** list.
11. Enter `HR New Ad Request` in the **Constant Value** field.
12. Click **Apply**.
13. Click **Apply** on the Create Event Map page. The event map condition displays in the **Event Map** section.

Event Map

Condition `PAYLOAD/Action = HR New Ad Request`

Event Body Elements

Name	Record Type Element
<code>PAYLOAD</code>	<code>PAYLOAD</code>

Creating the Outbound Interaction for the Global Newspaper Application Adapter

For the File/FTP adapter you added in ["Adding an Adapter to the Global Newspaper Application"](#) on page 7-11 to write the file to an outbound directory, an outbound interaction must also be defined.

This task creates the outbound interaction to write an `ad_%.xml` file to the outbound directory.

1. Select the **Modeling** tab.
2. Select the **Interactions** tab.
3. Click **Add**.
4. Expand **Adapter Providers > Oracle**.
5. Select the **File/FTP Adapter**.
6. Expand **Adapter Exchange Protocols > Outbound > File**.
7. Select **Write File(FileRecord)**.
8. Enter the following details:

Field	Enter/Select
Directory (relative path) for incoming files	outbound Note: You created this directory in Step 3 of "Preparations before Starting" on page 7-5. Note also the relationship to the delivery channel directory you created in Step 2 on page 7-11; <code>outbound</code> is a subdirectory of <code>global_newspaper</code> .
Staging directory (relative path) for outgoing files	Leave this field blank.
File naming convention for outgoing files (without extension) - for example, po_%.xml	%.xml
File extension for the incoming files - for example, txt *	xml

Note: Recheck your answers in Step 8 to ensure their correctness. Updating an interaction at a later time is difficult.

9. Click **Apply**.
10. Ensure that the **Create Native Event Type** box is selected.
11. Click **Apply**.
12. Ensure that **XSD** is selected in both the **Native Format** list and the **Extractor** list.
13. Click **Apply**.

Creating the Native Event, Translation, and Application Event for the Global Newspaper Application

You must also create a native event and specify a translator to translate the outbound application event to an outbound native event. This is similar to what you did for the Human Resources application in "[Creating the Native Event, Translation, and Application Event for the Human Resources Application](#)" on page 7-15. The only difference is that it operates in the outbound direction.

1. Enter `Global NP Ad` in the **Name** field of the Create Native Event Type page.
2. Click **Next**.
3. Select **XSD** from the **Translator** list.
4. Select **Create New** in the **Native Datatype** section.
5. Enter `Global NP Ad` in the **Name** field.
6. Click **Browse** next to the **Content** field.
7. Select `Global_Newspaper_Ad.xsd` and click **Select**.
Your selection appears in the **Content** field.
8. Click **Next**.
9. Select **XSD** from the **Translator** list. The translators available for selection are limited to those that can handle the native format you selected in Step 12 on page 7-20.
10. Select **Yes** from the **Preserve Namespaces for Native Instances** list.
11. Select **None** from the **Doctype for Native Instances** list. The page refreshes.
12. Click **Next**.
13. Review your selection and Click **Finish** on the Review page.
The native and application events are created.

14. Click **Global NP Ad** in the **Name** column of the Native Event Types page.
The Native Event Type Details page appears:

Native Event Type Details : Global NP Ad

Details

Name	Global NP Ad
Application Event	Global NP Ad
Record Type	xmlRecord
Description	<div style="border: 1px solid gray; height: 40px; width: 100%;"></div>

Event Map

Condition **PAYLOAD/Action = Global NP Ad**

Event Body Elements

Name	Record Type Element
PAYLOAD	PAYLOAD

15. Click **Event Types > Application Event Types** to review the newly created application event.
16. Select **Global NP Ad** in the **Name** column.
17. Click **Expand All** in the **Event Body Elements** section.

The steps you performed in this section translated the outbound application event and its event body element of application event datatypes into an outbound native event with an event body element for the payload (named **PAYLOAD**).

Application Event Type Details : Global NP Ad

Delete Update

Details

Name **Global NP Ad**

Description

State **Deployed**

Event Body Elements

[Return to Top](#)

Create

[Expand All](#) | [Collapse All](#)

Focus Name	Type	Datatype	Cardinality	Update	Delete
Event Body Elements					
▼ PAYLOAD		Ad_Request			
Action	Scalar	string			
Date	Scalar	string			
HR_Contact_Name	Scalar	string			
Content_Type	Scalar	string			
Featured	Scalar	boolean			
▼ (Anonymous)	Compound	(Anonymous)	[1, 1]		
HR_Contact_Phone	Scalar	string			
HR_Contact_Email	Scalar	string			
description	Scalar	string			
▼ Ad	Compound	AdType	[1, 1]		
Title	Scalar	string			
Text	Scalar	string			
Ad_ID	Scalar	integer			

Remember these datatypes. Later in this tutorial in "[Creating the Rules for the Outbound Event Transformation Map](#)" on page 7-34, you create a transformation rule to transform the outbound business event and its business datatypes to an outbound application event and its application datatypes.

At this point the Human Resources application includes its own inbound native event, translator, application event, and event body elements of datatypes. The Global Newspaper application includes its own outbound native event, translator, application event, and event body elements of datatypes.

Creating an Event Map for the Global NP Ad Native Event

Event maps determine the native event type for a specific record type from an interaction.

1. Select the **Modeling** tab.
2. Select **Event Types**.

3. Select **Native Event Types**.
4. Select **Global NP Ad** in the **Name** column.
5. Click **Create** in the **Event Map** section.
6. Select **Condition expression not specified**.
7. Click **Update** to create a new event map.
8. Click **Expand All** in the Create Condition Expression page.
9. Select **Action**.
10. Select = from the **Operator** list.
11. Enter Global NP Ad in the **Constant Value** field.
12. Click **Apply**.
13. Click **Apply** on the Create Event Map page.

The event map condition displays in the **Event Map** section.

Event Map

Condition **PAYLOAD/Action = Global NP Ad**

Event Body Elements

Name	Record Type Element
PAYLOAD	PAYLOAD

Creating the Modeling Metadata with the Modeling Wizards

For the events you have created to move through and be executed by Oracle Application Server ProcessConnect, you must create roles, a business process, and other modeling metadata. Roles define how events are executed and implement the behavior of the Human Resources and Global Newspaper applications (known as the parties), and the entire integration. The business process spans both applications to coordinate the sending and receiving of events. This management ensures that the Human Resources and Global Newspaper applications send and receive the correct data. Business processes also hide the unique characteristics of the Human Resources and Global Newspaper applications from the integration.

Use the modeling wizard to create the modeling metadata, including the following:

- The Human Resources application native role, translation binding role, application role, transformation binding role, and business role
- The Global Newspaper application native role, translation binding role, application role, transformation binding role, and business roles
- The business process that operates in the middle of these roles
- The event transformation maps for both applications with no defined rules (you define these rules later in this tutorial)
- The third and final event, known as the business event. At this point, you have already created the native and application events. This business event includes no event body element (you create that element later in this tutorial).

Follow these procedures to create this modeling metadata:

1. Select the **Modeling** tab.
2. Select the **Business Processes** tab.
3. Click **Create End-To-End Basic Integration** in the **Shortcuts** section.
4. Enter `Placing Ad` in the **Business Process** field.
5. Select **Read File - inbound (xmlRecord) - Inbound** from the **Inbound Interaction** list (for the inbound ad request sent by the Human Resources application). This interaction is available for selection because you:
 - Added **Read File(FileRecord)** as the inbound interaction in Step 7 of ["Creating the Inbound Interaction for the Human Resources Application Adapter"](#) on page 7-14.
 - Entered **xml** as the file extension for the incoming file in Step 8 on page 7-14.
6. Select **HR New Ad** from the **Native Event** list. This is the native event you created in Step 1 of ["Creating the Native Event, Translation, and Application Event for the Human Resources Application"](#) on page 7-15.
7. Enter `HR Placing New Ad` in the **Role Naming Convention** field as the naming convention to use for inbound roles.

8. Select **Write File - %TIME%(xmlRecord) - Outbound** from the **Outbound Interaction** list (for the outbound ad request received by the Global Newspaper application). This interaction is available for selection because you:
 - Added **Write File(FileRecord)** as the outbound interaction in Step 7 of ["Creating the Outbound Interaction for the Global Newspaper Application Adapter"](#) on page 7-19.
 - Entered **%TIME%** as the file naming convention for the outgoing file in Step 8 on page 7-19.
9. Select **Global NP Ad** from the **Native Event** list. This is the native event you created in Step 1 of ["Creating the Native Event, Translation, and Application Event for the Global Newspaper Application"](#) on page 7-20.
10. Enter `Placing Ad at Global NP` in the **Role Naming Convention** field as the naming convention to use for outbound roles.
11. Click **Next**.
12. Review your selections on the Review page. This page displays two tables:
 - The upper table, called the **Initiating Spoke**, shows the roles and events from the **Read File - inbound (xmlRecord) - Inbound** interaction up through the business process. This is the modeling metadata to be created for the inbound ad request and enables the ad request to be read from the inbound directory of the Human Resources application.
 - The lower table, called the **Invoked Spoke**, shows the roles and events from the **Write File - %TIME%(xmlRecord) - Outbound** interaction up through the business process. This is the modeling metadata that enables the ad request to be written to the outbound directory.

The following messages appear to remind you of tasks to perform after running the modeling wizards.

- Beneath both transformation steps:
`You will need to populate the rules for this transformation map.`
- Beneath both SetParty steps:
`You will need to select a party for this SetParty step.`
- Beneath both business events:
`You will need to define the elements for this business event.`

Initiating Spoke

↓ Event Flow - Native Role To Business Process			
	Role	Event	Step
Interaction		Read File - inbound(xmlRecord) - Inbound	
Native	HR Placing New Ad-NR	HR New Ad	Passthrough HR New Ad
Translation	HR Placing New Ad-TL		Translate HR New Ad
Application	HR Placing New Ad-AR	HR New Ad	Passthrough HR New Ad
Transformation	HR Placing New Ad-TX		Transform HR New Ad <small>You will need to populate the rules for this transformation map.</small>
Business	HR Placing New Ad-BR	HR New Ad <small>You will need to define the elements for this business event.</small>	Passthrough HR New Ad
Business Process	Placing Ad		SetParty for HR New Ad <small>You will need to select a party for this SetParty step.</small>

All necessary ports, data flows, and control flows will also be created for the event flow.

Invoked Spoke

↑ Event Flow - Business Process To Native Role			
	Role	Event	Step
Interaction		Write File - %TIME%(xmlRecord) - Outbound	
Native	Placing Ad at Global NP-NR	Global NP Ad	Passthrough Global NP Ad
Translation	Placing Ad at Global NP-TL		Translate Global NP Ad
Application	Placing Ad at Global NP-AR	Global NP Ad	Passthrough Global NP Ad
Transformation	Placing Ad at Global NP-TX		Transform HR New Ad <small>You will need to populate the rules for this transformation map.</small>
Business	Placing Ad at Global NP-BR	HR New Ad <small>You will need to define the elements for this business event.</small>	Passthrough HR New Ad
Business Process	Placing Ad		SetParty for HR New Ad <small>You will need to select a party for this SetParty step.</small>

13. Click **Finish**.

The Event Flow Diagram displays after the modeling wizard has completed. This diagram shows the events moving through the various roles of your integration. (See the following portion of the event flow diagram.) The Event Flow Diagram displays after the modeling wizard has completed. This diagram shows the events moving through the various roles of your integration.

Event Flow Diagram For Native Role : HR Placing New Ad-NR

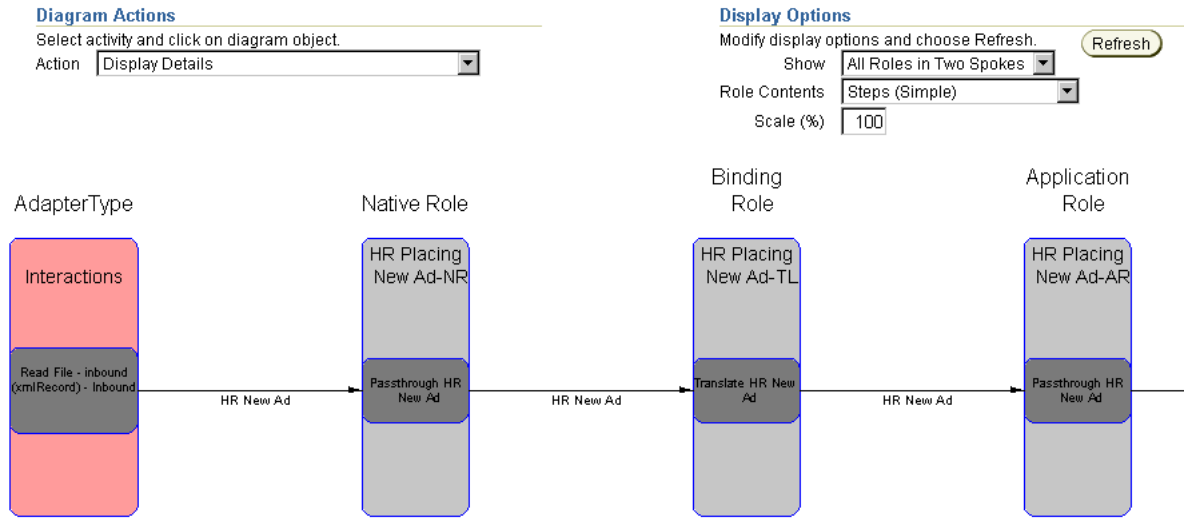

14. Click **Integration Diagram** at the bottom of the Event Flow Diagram to see all the newly created roles and the business process for which you provided names.

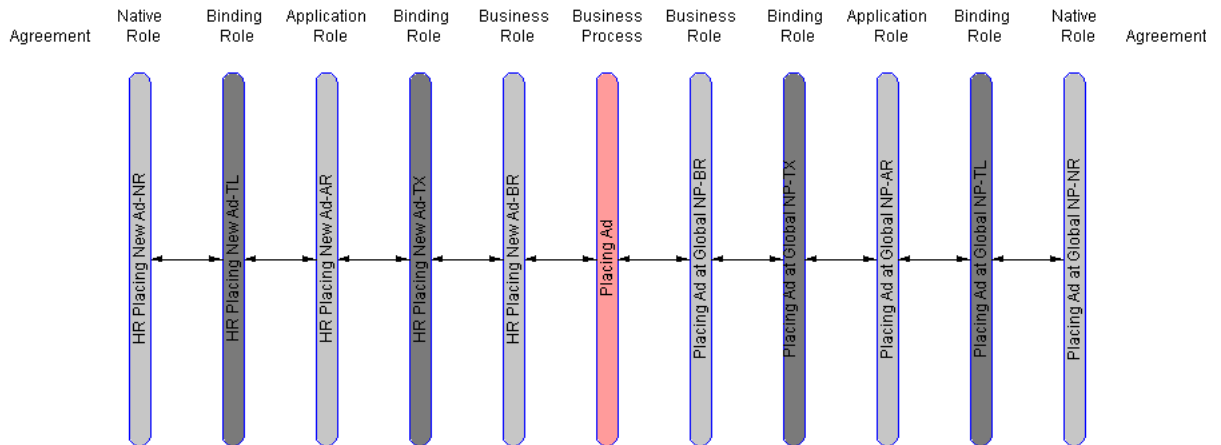

Note that the word **Agreement** displays in two places. The one on the left is for the Human Resources application and the one on the right is for the Global Newspaper application. After you create agreements for both the Human Resources and Global Newspaper applications (described later in this tutorial), an icon appears beneath each. When you click one of these icons, the details page appears for that application agreement.

Creating the Business Event Datatypes

The different datatypes of the Human Resources and Global Newspaper applications that you created earlier must be represented as a single, common set of business datatypes to communicate with Oracle Application Server ProcessConnect and participate in integrations. You can manually create business datatypes or import XSD native formats of datatypes into Oracle Application Server ProcessConnect. In this section of the tutorial, you import these datatypes. As an alternative, you can also manually create datatypes by following the instructions in "[Manually Creating the Business Datatypes](#)" on page 7-73.

You later add these datatypes to the event body element that you create in "[Creating the Business Event Body Element](#)" on page 7-29.

1. Select the **Modeling** tab.
2. Select **Datatypes**.
3. Click **Import** in the Business Datatypes page.
4. Select **Ad_CommonView.xsd** on the Select XSD File page.
5. Review details about the **XSD** when prompted on the Translator Properties page.
6. Select **None** from the **Namespace for Business Datatypes to be Created** list.
7. Click **Apply**.

The Business Datatypes page appears.

8. Select **name** from the **Search** list.
9. Enter `Ad_Request` in the field to the right.
10. Click **Go**.

The **Ad_Request** business datatype appears in the **Name** column.

11. Click **Ad_Request**.

12. Click **Expand All** in the **Datatype Members** section to view the business datatypes.

Datatype Members

[Return to Top](#)[Create](#)[Expand All](#) | [Collapse All](#)

Datatype Members

Focus Name	Type	Datatype	Cardinality	Update	Delete
▼ Datatype Members					
Date	Scalar	string			
HR Contact FirstName	Scalar	string			
HR Contact LastName	Scalar	string			
⊕ ▼ (Anonymous)	Compound	(Anonymous)	[1, 1]		
HR Contact Phone	Scalar	string			
HR Contact Email	Scalar	string			
Content Type	Scalar	string			
Featured	Scalar	string			
description	Scalar	string			
⊕ ▼ Ad	Compound	AdType	[1,]		
Title	Scalar	string			
Text	Scalar	string			
Ad ID	Scalar	integer			

Creating the Business Event Body Element

The modeling wizard you ran in "[Creating the Modeling Metadata with the Modeling Wizards](#)" on page 7-23 created a business event with no event body element. The business event establishes a common event structure and event vocabulary across the Human Resources and Global Newspaper applications. Business events are completely removed from any Human Resources or Global Newspaper application-specific properties, including data structure and vocabulary. All related events from both applications follow the same structure and the same vocabulary once they are translated and transformed into business events.

The event body element of the business event must contain a complete set of business data (for this tutorial, the business event datatypes created in "[Creating the Business Event Datatypes](#)" on page 7-28). You must create an event body element inside this business event that contains the business event datatypes created in "[Creating the Business Event Datatypes](#)" on page 7-28.

1. Select the **Modeling** tab.
2. Select **Event Types**.
3. Select **HR_New_Ad** from the **Name** column of the Business Event Types page. This is the business event automatically created with the modeling wizard in "[Creating the Modeling Metadata with the Modeling Wizards](#)" on page 7-23.
4. Click **Update**.
5. Rename the event type to **Ad Request**. This gives the event type a more meaningful name.
6. Click **Apply**.
7. Click **Create** in the **Event Body Elements** section.
8. Enter **Ad** in the **Name** field.
9. Select **Business Datatype** from the **Classification** list.
10. Select **Unspecified** from the **Namespace** list.
11. Click the flashlight next to the **Name** field.

Note: To quickly search a long list of datatypes, enter **Ad%** in the **Search** field and click **Go**.

12. Select **Ad Request** and click **Select**. These are the business datatypes you imported in "[Creating the Business Event Datatypes](#)" on page 7-28.
Your selection appears in the **Name** field.
13. Click **Apply**.
The Ad event body element is created and the datatypes imported in "[Creating the Business Event Datatypes](#)" on page 7-28 are added to this Ad event body element.
14. Click **Return to Event Type Details** page.
15. Click **Expand All** in the **Event Body Elements** section to view the event body element and its datatypes.

Business Event Type Details : Ad Request

[Delete](#) [Update](#)

Details

Name **Ad Request**

Description

State **Deployed**

Event Body Elements

[Return to Top](#)[Create](#)[Expand All](#) | [Collapse All](#)

⊕ Event Body Elements

Focus Name	Type	Datatype	Cardinality	Update	Delete
▼ Event Body Elements					
⊕ ▼ Ad		Ad Request			
Date	Scalar	string			
HR_Contact_FirstName	Scalar	string			
HR_Contact_LastName	Scalar	string			
⊕ ▼ (Anonymous)	Compound	(Anonymous)	[1, 1]		
HR_Contact_Phone	Scalar	string			
HR_Contact_Email	Scalar	string			
Content_Type	Scalar	string			
Featured	Scalar	string			
description	Scalar	string			
⊕ ▼ Ad	Compound	AdType	[1,]		
Title	Scalar	string			
Text	Scalar	string			
Ad_ID	Scalar	integer			

Both the incoming business role and outgoing business role contain this single, common business event and event body element of business datatypes. You use these business datatypes later in this tutorial to create the following transformation rules:

- Transform an inbound application event into an inbound business event in "[Creating the Rules for the Inbound Event Transformation Map](#)" on page 7-32.
- Transform an outbound business event into an outbound application event in "[Creating the Rules for the Outbound Event Transformation Map](#)" on page 7-34.

At this point, the Human Resources and Global Newspaper applications include their own native events, translators, application events, business events, and event body elements of datatypes.

Creating the Rules for the Inbound Event Transformation Map

The Human Resources and Global Newspaper applications use different vocabulary in their messages. This creates a vocabulary mismatch. Transformation enables you to standardize on the vocabulary used by both applications in an integration and establish a common structure and vocabulary. To establish this common vocabulary, you must create transformation rules. Transformation rules describe how to transform one data item to another (in this section, from the Human Resources application's inbound source application event and its application datatypes to an inbound target business event and its business datatypes).

When you ran the modeling wizard in "[Creating the Modeling Metadata with the Modeling Wizards](#)" on page 7-23, an inbound event transformation map was created with no defined rules. In this section, you define the transformation rules so that a common vocabulary can be established. First, you rename the event transformation map to a more meaningful name.

1. Select the **Modeling** tab.
2. Select **Transformations**.
3. Click **Update** for the first **Transform HR New Ad** in the **Name** column. This is the map with an application event type in the **Source Parameter Types** column and a business event type in the **Target Parameter Types** column.
4. Rename the map to **HR Ad to Common View**.
5. Click **Apply**.
6. Go to the **Sources and Targets** section.
7. Click **Expand All** for both the **Sources** table and the **Targets** table. The mapping you perform in this section is very simple and intended for testing purposes.
8. Select the **Ad_ID** integer in the **Sources** table. The application datatypes that appear in the **Sources** table are the same datatypes you created in "[Creating the Native Event, Translation, and Application Event for the Human Resources Application](#)" on page 7-15. (View these application datatypes under Step 16 on page 7-17.)
9. Select the **Ad_ID** integer in the **Targets** table. The business datatypes in the **Targets** table are the same datatypes you imported in Step 3 of "[Creating the Business Event Datatypes](#)" on page 7-28 and included in the business event body element in Step 12 of "[Creating the Business Event Body Element](#)" on page 7-30. (View these business datatypes under Step 15 on page 7-30.)



10. Select `copy:from=integer->to=integer` from the **Datatype Transformation Map** list.

The Transformation Map Details page appears as follows with the selections you made in Steps 8 through 9.

Select All Select None Expand All Collapse All				Select All Select None Expand All Collapse All					
Sources				Targets					
Select	Focus	Source Items	Type	Mapped	Select	Focus	Target Items	Type	Mapped
<input type="checkbox"/>		▼ Sources			<input type="checkbox"/>		▼ Targets		
<input type="checkbox"/>	<input type="checkbox"/>	▼ Event Type Parameters			<input type="checkbox"/>	<input type="checkbox"/>	▼ Event Type Parameters		
<input type="checkbox"/>	<input type="checkbox"/>	▼ HR New Ad-IN	HR New Ad		<input type="checkbox"/>	<input type="checkbox"/>	▼ HR New Ad-OUT	Ad Request	
<input type="checkbox"/>	<input type="checkbox"/>	▼ PAYLOAD	Ad Request		<input type="checkbox"/>	<input type="checkbox"/>	▼ Ad	Ad Request	
<input type="checkbox"/>		Action	string		<input type="checkbox"/>		Date	string	
<input type="checkbox"/>		Function_Type	string		<input type="checkbox"/>		HR_Contact_FirstName	string	
<input type="checkbox"/>		Date	dateTime		<input type="checkbox"/>		HR_Contact_LastName	string	
<input type="checkbox"/>		HR_Contact_FirstName	string		<input type="checkbox"/>	<input type="checkbox"/>	▼ (Anonymous)	(Anonymous)	
<input type="checkbox"/>		HR_Contact_LastName	string		<input type="checkbox"/>		HR_Contact_Phone	string	
<input type="checkbox"/>		Content_Type	string		<input type="checkbox"/>		HR_Contact_Email	string	
<input type="checkbox"/>		Importance	integer		<input type="checkbox"/>		Content_Type	string	
<input type="checkbox"/>	<input type="checkbox"/>	▼ (Anonymous)	(Anonymous)		<input type="checkbox"/>		Featured	string	
<input type="checkbox"/>		HR_Contact_Phone	string		<input type="checkbox"/>		description	string	
<input type="checkbox"/>		HR_Contact_Email	string		<input type="checkbox"/>	<input type="checkbox"/>	▼ Ad	AdType	
<input type="checkbox"/>	<input type="checkbox"/>	▼ Ad	AdType		<input type="checkbox"/>		Title	string	
<input type="checkbox"/>		Title	string		<input type="checkbox"/>		Text	string	
<input type="checkbox"/>		Text	string		<input checked="" type="checkbox"/>		Ad_ID	integer	<input checked="" type="checkbox"/>
<input checked="" type="checkbox"/>		Ad_ID	integer	<input checked="" type="checkbox"/>	<input type="checkbox"/>	<input type="checkbox"/>	▼ Datatype Parameters		
<input type="checkbox"/>	<input type="checkbox"/>	▼ Datatype Parameters			<input type="checkbox"/>	<input type="checkbox"/>	▼ Map Variables		
<input type="checkbox"/>	<input type="checkbox"/>	▼ Map Variables							
<input type="checkbox"/>	<input type="checkbox"/>	▼ Iterators							

11. Click **Append**.

This maps the vocabulary of the source inbound application event to the vocabulary of the target inbound business event. The rule you created displays in the **Statements** section of this page.

Expand All Collapse All					
Statements					
Select	Focus	Statements	Type	Update	Delete
<input type="radio"/>		▼ Statements			
<input type="radio"/>		copy(from=HR New Ad-IN/PAYLOAD/Ad_ID ---->to=HR New Ad-OUT/Ad/Ad_ID)	Rule		

See Also: ["Transformation Statements Overview"](#) on page 13-27 for additional examples of event transformation mapping

Creating the Rules for the Outbound Event Transformation Map

When you ran the modeling wizard in ["Creating the Modeling Metadata with the Modeling Wizards"](#) on page 7-23, an outbound event transformation map was also created with no defined rules. In this section, you create transformation rules for the Global Newspaper application's outbound source business event and its business datatypes to the outbound target application event and its application datatypes.

1. Select the **Modeling** tab.
2. Select the **Transformations** tab.
3. Click **Update** for the remaining map named **Transform HR Ad** in the **Name** column. This is the map with a business event type in the **Source Parameter Types** column and an application event type in the **Target Parameter Types** column.
4. Rename the map to **Common View to Global NP Ad**.
5. Click **Apply**.
6. Click **Expand All** for both the **Sources** table and the **Targets** table.
7. Select the **Ad_ID** integer in the **Sources** table. The business datatypes in the **Sources** table are the same datatypes you imported in Step 3 of ["Creating the Business Event Datatypes"](#) on page 7-28 and included in the business event body element in Step 12 of ["Creating the Business Event Body Element"](#) on page 7-30. (View these business datatypes under Step 15 on page 7-30.)
8. Select the **Ad_ID** integer in the **Targets** table. The application datatypes in the **Targets** table are the same datatypes you created in ["Creating the Native Event, Translation, and Application Event for the Global Newspaper Application"](#) on page 7-20. (View these application datatypes at Step 17 on page 7-22.)
9. Select **copy:from=integer->to=integer** from the **Datatype Transformation Map** list.
10. Click **Append**.

This maps the vocabulary of the outbound source business event to the vocabulary of the outbound target application event. The rule you created displays in the **Statements** section of this page.

Expand All | Collapse All

Statements		Type	Update	Delete
<input type="radio"/>	Statements			
<input type="radio"/>	copy(from=HR New Ad-IN/Ad/Ad_ID --->to=Global NP Ad-OUT/PAYLOAD/Ad_ID)	Rule		

11. Click **Append**. This takes you to the Advanced Transformation Rules page.
12. Click **Expand All** for the **Targets** table.
13. Select **copy:from=string->to=string** from the **Datatype Transformation Map** list.
14. Select the **Action** string in the **Targets** table.
15. Click **Bind Target**.
16. Enter `Global NP Ad` in the **Constant Value** field.
17. Click **Bind Source**.
18. Click **Apply**.

Selecting the Destination Party in the SetParty Step

Events are sent to and from the Human Resources and Global Newspaper applications. To ensure that events are sent through the correct roles and arrive at the correct party address, you must update the destination party (in this tutorial, the Global Newspaper application) inside the SetParty step. The modeling wizard automatically created a SetParty step in the business process in "[Creating the Modeling Metadata with the Modeling Wizards](#)" on page 7-23.

1. Select the **Modeling** tab.
2. Select the **Business Processes** tab.
3. Select the process diagram in the **Process Diagram** column for the **Placing Ad** business process.
4. Select **Update (Step or Port)** from the **Action** list.
5. Select **SetParty for HR New Ad** in the Process Diagram.
6. Rename to **Deliver Ad to Global NP**.
7. Select **Global Newspaper** from the **Party** list.
8. Click **Apply**.

Task 3: Creating the Agreements

This section contains the following tasks:

- [Creating the Human Resources Application Agreement](#)
- [Adding the Delivery Channel for the Human Resources Application Adapter](#)
- [Adding the Human Resources Application Native Role to the Agreement](#)
- [Validating the Human Resources Application Agreement](#)
- [Sending the Agreement for Approval](#)
- [Creating the Global Newspaper Application Agreement](#)
- [Adding the Delivery Channel for the Global Newspaper Application Adapter](#)
- [Adding the Global Newspaper Application Native Role to the Agreement](#)
- [Validating the Global Newspaper Application Agreement](#)
- [Sending the Agreement for Approval](#)

See Also: [Chapter 15, "Managing Applications and Application Agreements"](#) for additional details about creating application agreements, adding delivery channels and native roles to application agreements, validating application agreements, and sending agreements for approval

Creating the Human Resources Application Agreement

To participate in an integration, electronic agreements for the Human Resource and Global Newspaper applications must be created. Create one agreement for each application. You also select a native role and delivery channel to use in each agreement. Approvers representing both the Human Resources and Global Newspaper applications must review the contents of these agreements and approve them before they can be deployed in an integration.

Create the application agreement for the Human Resources application.

1. Select the **Profiles** tab.
2. Select the **Agreements** tab.
3. Click **Create** in the Application Agreements page.

- Enter the following information:

In this Field...	Enter/Select
Name	HR Agreement
Agreement Id	1
Effective From Date	Leave this field blank
Effective To Date	Leave this field blank
Application Participant	Human Resources

- Click **Apply**.

Adding the Delivery Channel for the Human Resources Application Adapter

Add the delivery channel that describes the communication capabilities (such as message exchange and security details) of the adapter for the Human Resources application. You created this delivery channel in "[Creating the Delivery Channel for the Human Resources Application Adapter](#)" on page 7-8.

- Click **Add** in the **Delivery Channels Used** section of the Application Participant Details: Human Resources Agreement page
- Select **HR DC** from the **Delivery Channel** list.
- Click **Apply**.

Adding the Human Resources Application Native Role to the Agreement

Add the native role of the Human Resources application to the agreement. The native role implements the behavior of the Human Resources application agreement. You created this native role with the modeling wizard in Step 7 of "[Creating the Modeling Metadata with the Modeling Wizards](#)" on page 7-24.

- Click **Add** in the **Native Roles** section of the Agreement Details: Human Resources Agreement page.
- Select **HR Placing New Ad-NR** from the **Native Role** list.
- Click **Apply**.

Validating the Human Resources Application Agreement

1. Click **Validate** on the Agreement Details: Human Resources Agreement page.

If validation is successful, the **Validate** button is replaced with a **Send For Approval** button and the **Draft** status that displays in the **State** field of the **Details** section is replaced with **Validated**.

Sending the Agreement for Approval

The agreement can be approved by specific persons before it can be deployed in an integration. Approval typically involves assigning these persons as approvers in the Oracle Application Server ProcessConnect user interface tool and exporting the contents of the agreement to an XML file for submittal to these approvers for review. For this tutorial, you do not perform Steps 5 and 6 in this section, during which the XML file is submitted for approval.

1. Click **Send for Approval**.
2. Select approvers (for example, the user **admin**) from the **Available Approvers** list.
3. Click **Move** to move the approver(s) to the **Selected Approvers** list.
4. Click **Send for Approval**.

Your selection appears in the **Approvers** section of the Application Details: Human Resources page. The **Send For Approval** button is replaced with an **Approve** button and the **Validated** status that displays in the **State** field of the **Details** section is replaced with **Pending Approval**.

5. Click **Export** to export the agreement to an XML file for submittal to a person for approval.
6. Submit the file to the approvers(s) you selected in Step 5 for approval.
7. Click **Approve**. Typically, you perform this task after your approvers notify you that they are satisfied with the agreement. For this tutorial, you do not wait for an approver.
8. Click **Approve** again when prompted to confirm.

Creating the Global Newspaper Application Agreement

Create the application agreement for the Global Newspaper application.

1. Select the **Profiles** tab.
2. Select the **Agreements** tab.
3. Click **Create**.
4. Enter the following information:

In this Field...	Enter...
Name	Global NP Agreement
Agreement Id	2
Effective From Date	Leave this field blank
Effective To Date	Leave this field blank
Application Participant	Global Newspaper

5. Click **Apply**.

Adding the Delivery Channel for the Global Newspaper Application Adapter

Add the delivery channel that describes the communication capabilities (such as message exchange and security details) of the adapter for the Global Newspaper application. You created this delivery channel in "[Creating the Delivery Channel for the Global Newspaper Application Adapter](#)" on page 7-11.

1. Click **Add** in the **Delivery Channels Used** section of the Application Participant Details: Global Newspaper Agreement page
2. Select **Global NP DC** from the **Delivery Channel** list.
3. Click **Apply**.

Adding the Global Newspaper Application Native Role to the Agreement

Add the native role of the Global Newspaper application to the agreement. You created this native role with the modeling wizard in Step 10 of "[Creating the Modeling Metadata with the Modeling Wizards](#)" on page 7-25.

1. Click **Add** in the **Native Roles** section of the Agreement Details: Global Newspaper Agreement page.
2. Select **Placing Ad at Global NP-NR** from the **Native Role** list.
3. Click **Apply**.

Validating the Global Newspaper Application Agreement

1. Click **Validate** on the Agreement Details: Global Newspaper Agreement page.

If validation is successful, the **Validate** button is replaced with a **Send For Approval** button and the **Draft** status that displays in the **State** field of the **Details** section is replaced with **Validated**.

Sending the Agreement for Approval

You can select an approver to approve the profile data of your agreement. For this tutorial, you do not perform Steps 5 and 6 in this section, during which the XML file is submitted for approval.

1. Click **Send for Approval**.
2. Select approvers (for example, the user **admin**) from the **Available Approvers** list.
3. Click **Move** to move the approver(s) to the **Selected Approvers** list.
4. Click **Send for Approval**.

Your selection appears in the **Approvers** section of the Application Details: Global Newspaper page. The **Send For Approval** button is replaced with an **Approve** button and the **Validated** status that displays in the **State** field of the **Details** section is replaced with **Pending Approval**.

5. Click **Export** to export the agreement to an XML file for submittal to a person for approval.
6. Submit the file to the approvers(s) you selected in Step 5 for approval.

7. Click **Approve**. Typically, you perform this task after your approvers notify you that they are satisfied with the agreement. For this tutorial, you do not wait for an approver.
8. Click **Approve** again when prompted to confirm.
9. Click the **Modeling** tab.
10. Click the **Business Processes** tab.
11. Click the **Integration Diagram** for the **Placing Ad** business process.

Note that both agreements now display as icons in the Integration Diagram. You can click either agreement to display the agreement details page for that application.

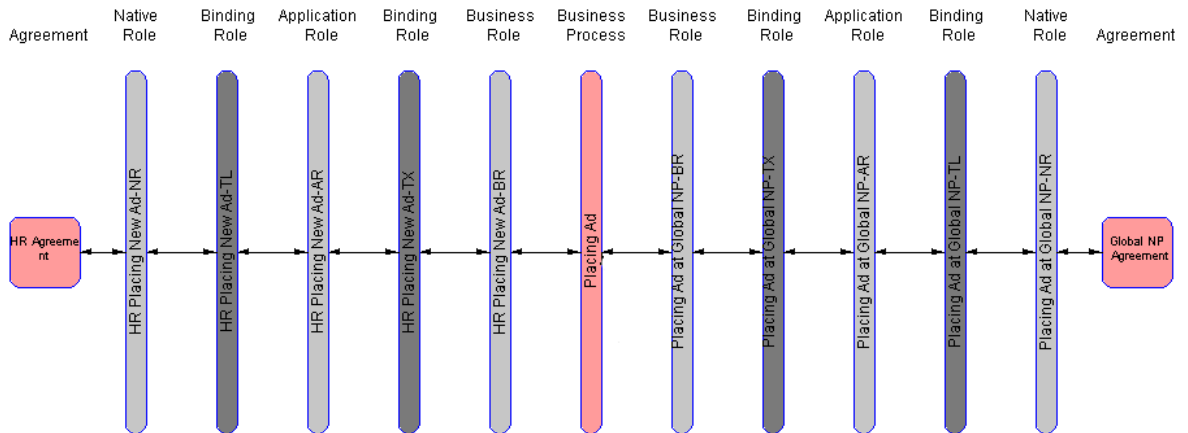

Task 4: Creating and Deploying a Configuration

You are now ready to deploy your integration between the Human Resources and Global Newspaper applications. Deployment first involves creating a feature known as a configuration that includes the integration you designed in this tutorial. This configuration is then validated to ensure that your integration is correct and consistent. If validation is successful, the configuration is created. You can then deploy the configuration from the design-time repository to the runtime repository. If validation is unsuccessful, error messages appear that describe what must be corrected.

1. Select the **Deployment** tab.
2. Click **Create**.
3. Enter `Placing Ad Phase A` as the configuration name.
4. Click **Apply**. If validation is successful, the configuration is created and the following message appears:

```
Creation and validation of configuration Placing Ad successful
```

The **Deploy** button is now enabled.

If validation is not successful, correct the errors and click **Return To Deployment** to retry configuration creation.

5. Click **Deploy**.
6. Select **High** from the **BI Reporting Level** list.

The business intelligence (BI) level indicates how much the deployment tries to optimize the runtime configuration for performance. Low BI provides the fastest possible performance, but does not log complete information during runtime. This impacts the reports you can later create. High BI provides the most details for reports and troubleshooting.

7. Click **Apply**.

If deployment is successful, the configuration is deployed from the design-time repository to the runtime repository and the following message appears:

```
Deployment finished successfully for configuration Placing Ad Phase A
```

See Also: The following sections for additional details about tasks covered in this section:

- ["Creating a Configuration"](#) on page 16-3
- ["Deploying a Configuration"](#) on page 16-9

Task 5: Testing the Results

It is now time to test the results of the integration.

1. Ensure that the integration manager and adapter framework components are running. Both are automatically started after installation. If you are unsure, see [Chapter 18, "System Management with Oracle Enterprise Manager"](#) for instructions on viewing component status and, if necessary, starting these components from Oracle Enterprise Manager.

2. Copy the `HR_Ad.xml` file to the `/start_at_root/ip/tutorial/human_resources/inbound` directory. Note that this directory is a combination of the answers you provided to the Human Resources application delivery channel and interaction questions earlier in this tutorial.

This directory is polled by the File/FTP adapter every 10 seconds, as you specified in Step 2 on page 7-8. The file is read and deleted from the directory, but only when the native event instance is successfully created. The result file `%TIME%.xml` is found in the `/start_at_root/ip/tutorial/global_newspaper/outbound` directory. Note that this directory is a combination of the answers you provided to the Global Newspaper application delivery channel and interaction questions earlier in this tutorial.

Task 6: Troubleshooting Any Errors with Log Files and Reports

If the `HR_Ad.xml` file is not deleted, perform the following troubleshooting tasks:

- Stop and restart the adapter framework.
- Check that the directory in the delivery channel for the Human Resources application in combination with the directory for the Read File - inbound(xmlRecord) interaction matches with the directory in which you placed the `HR_Ad.xml` file. In this tutorial, the directories are as follows:

For the...	The Directory Is...
Delivery channel	<code>/private/Oracle/ip/tutorial/human_resources</code>
Interaction	<code>inbound</code>
Location in which to place the <code>.xml</code> file	<code>/private/Oracle/ip/tutorial/human_resources/inbound/</code>

- Check the adapter framework log file and search for AIP (the prefix for error message codes).

If the file is deleted, but no results file appears:

- Wait several seconds and verify that no file can be found in the expected directory.
- Check that the directory in the delivery channel for the Global Newspaper application in combination with the directory for the Write File -

`%TIME%(xmlRecord)` interaction matches with the directory in which you expect the `%TIME%.xml` file. In this tutorial, the directories are as follows:

For the...	The Directory Is...
Delivery channel	<code>/private/Oracle/ip/tutorial/global_newspaper</code>
Interaction	<code>outbound</code>
Location in which the <code>.xml</code> file is written	<code>/private/Oracle/ip/tutorial/global_newspaper/outbound/</code>

- Create reports

See Also:

- ["Oracle Application Server ProcessConnect Monitoring and Administration Tasks"](#) on page 18-8
- ["Creating Reports"](#) on page 7-44

Creating Reports

Create a report to determine if the event is stuck in the integration manager or the adapter framework:

1. Select the **Reports** tab.
2. Select the **Process Monitoring** tab.
3. Click **Finish**.
 - If the adapter framework created the native event successfully, there is at least one event. Click the **Details** button.
 - If the event was processed successfully by the integration manager, then there are five events in this list: two native events, two application events, and one business event.
 - By clicking on the event, you can follow how the event proceeded through the integration manager. If you went from native event to application event to business event to another application and native event, then all translations and transformations processed successfully.
 - You can expand the status of the roles to verify that all the roles and steps have the status `completed` (you must do this for each event type). The future plan is for coordination reports to show this end-to-end.

See Also: The following sections for additional details about tasks covered in this section:

- ["Creating Process Monitoring Reports"](#) on page 23-7
- ["Report Creation Examples"](#) on page 23-32

Checking the Log Files

After installation, the adapter framework and integration manager are automatically started with default logging. To view errors in, for example, translation or transformation, the logging must be set to `debug`. This can be done in Oracle Enterprise Manager as follows:

1. Select the Oracle Application Server ProcessConnect middle-tier instance.
2. Select the **Server Properties** link.
3. Change the settings of parameters with `oracle.tip.DiagnosticLevel` in their name from `error` to `debug`. You typically do not need to restart the adapter framework and integration manager (but do it anyhow).
4. Check the integration manager log file and search for `AIP`.
5. Check the adapter framework log file and search for `AIP`.

See Also: ["Managing and Monitoring a Middle-Tier Instance from Oracle Enterprise Manager Application Server Control"](#) on page 18-5

More Troubleshooting Tips

Verify that all agreements and applications are approved. You do this by looking at the details of each application and agreement and verifying that none of the following buttons are present:

- Validate
- Send for Approval
- Approve

If any of these buttons are present, click it and follow the steps in ["Task 3: Creating the Agreements"](#) on page 7-36 to approve the application or agreement.

Verify that all agreements have a native role defined. Do this by looking at the details of each agreement and verifying that the correct native role is listed for that particular agreement.

If you created the business datatypes by hand, verify that you did not use the space (" ") character. To view the business datatypes of your configuration, select each business event and click **Expand All** in the **Event Body Elements** section.

Verify that data flow groups are created only between roles that can have data flows between them. For example, a translation binding role can only have data flows to either native roles or application roles. Verify this by clicking the integration diagram for each modeled business process.

See Also: ["Updating the Interaction, Native Event, and Application Event"](#) on page 7-77 if you must update an application event with a different XSD

Phase B1: Manually Design Some Modeling Metadata in an Integration

You can also manually model portions of an integration. Up to this point, the tutorial has only used the wizard to generate the metadata for data flow and control flow. Data flows connect step ports and role ports of native, application, and business roles. Control flows between steps indicate the execution order of steps. Control flows connect directly to steps and do not use step ports.

The Create End-to-End Basic Integration wizard generated all the roles, the business process, the ports, the data flows, the control flows, the event types (without the body elements), and the transformation maps (without the rules). In this task, you enhance the existing business process by adding a conditional step and a transformation step. The scenario is as follows: a confirmation comes back from a newspaper. If the confirmation is positive, the business process can finish. If there is an error, human resources must be notified. The transformation step is chosen here simply to show that transformations can also be used in the business process and not only in transformation binding roles. All of the following phases must be completed before a new configuration can be created, deployed, and tested.

This section contains these topics:

- [Task 1: Creating the Business Event Types and Body Elements](#)
- [Task 2: Creating a Conditional Step](#)
- [Task 3: Creating a Transformation Step to Notify Human Resources](#)
- [Task 4: Creating an Or Step](#)
- [Task 5: Creating a Role Port and Data Flow to Deliver the Ad Problem Event to Human Resources](#)
- [Task 6: Creating a Split Step](#)
- [Task 7: Creating a Role Port and Data Flow to Splitting the Ad Confirmation Event](#)
- [Task 8: Removing Unnecessary Control Flow \(Optional\)](#)

See Also: The following sections for additional details about tasks covered in this section:

- ["Managing Business Event Types"](#) on page 11-63
- ["Managing Steps"](#) on page 12-70
- ["Managing Role Ports"](#) on page 12-48
- ["Managing Role Data Flow"](#) on page 12-58

Task 1: Creating the Business Event Types and Body Elements

Before beginning, it is helpful to create the business event(s) you want to model in the business process. It is possible to model the data flows in the business process without the business events, but it becomes harder to read because no event names can be displayed. The business event(s) can be created without any body element and thus without importing or creating any datatypes at this time.

Importing the Business Event Datatypes from an XSD File

You use the same XSD file in this example to define the business datatypes for the business event body element as you use to define the application datatypes.

1. Select the **Modeling** tab.
2. Select **Datatypes**.
3. Click **Import** on the Business Datatypes page.
4. Select **Global_NP_AdConfirmation.xsd** on the Select XSD File page.
5. Click **Apply**.

Creating the Ad Confirmation Business Event

1. Select the **Modeling** tab.
2. Select **Event Types**.
3. Click **Create** on the Business Events page.
4. Enter `Ad Confirmation` in the **Name** field.
5. Click **Apply**.

Creating a Body Element for the Ad Confirmation Business Event

1. Click **Create** in the **Event Body Elements** section.
2. Enter `Confirmation` in the **Name** field.
3. Select **Business Datatypes** from the **Classification** list.
4. Select `http://www.oracle.com/global_newspaper` from the **Namespace** list.
5. Click the flashlight next to the **Name** field.
6. Select **Confirmation** and click **Select**.
7. Click **Apply**.

This creates the body element and its datatypes for the **Ad Confirmation** business event. This business event is sent if the ad request placement is successful.

Importing the Business Event Datatypes from an XSD File

1. Select the **Modeling** tab.
2. Select **Datatypes**.
3. Click **Import** on the Business Datatypes page.
4. Select `HR_AdProblem.xsd`.
5. Click **Apply**.

Creating the Business Event Ad Problem

1. Select the **Modeling** tab.
2. Select **Event Types**.
3. Click **Create** on the Business Event Types page.
4. Enter `Ad Problem` in the **Name** field.
5. Click **Apply**.

Creating a Body Element for the Ad Problem Business Event

1. Click **Create** in the **Event Body Elements** section.
2. Enter `Problem` in the **Name** field.
3. Select **Business Datatype** from the **Classification** list.

4. Select **http://www.oracle.com/human_resources** from the **Namespace** list.
5. Click the flashlight next to the **Name** field.
6. Select **Problem** and click **Select**.
7. Click **Apply**.

This creates the body element and its datatypes for the **Ad Problem** business event. This business event is sent if there is a problem with the ad request placement.

Task 2: Creating a Conditional Step

In this tutorial, you notify human resources only if there is a problem with the ad placement. If there is no problem, human resources assumes that everything is well. To satisfy these two conditions, you must insert a condition step. A condition step evaluates a specific condition on an event type or datatype. This step is associated with a condition expression. After the condition expression is evaluated, one of the outgoing control flows (either true or false) is executed. In this tutorial, the condition step checks the confirmation event from the newspaper and either ends the process (if placement is successful) or notifies human resources (if a problem occurs).

Creating a Condition Expression

Condition expressions enable you to define that a specific action be performed in a condition step based on the result of an expression. The conditional expression can either be created after the step is modeled or before as preparation for later use. In this tutorial, you create the expression now so that it is available for selection when you create the conditional step.

1. Select the **Modeling** tab.
2. Select **Conditional Expressions**.
3. Click **Create**.
4. Enter `Ad Placement Confirmed?` in the **Name** field.
5. Click **Apply**.
6. Click **Create** in the **Condition Parameters** section.
7. Enter `Ad Confirmation` in the **Name** field.
8. Select **Event Type** from the **Type** list. The page refreshes.

9. Select **Business Event Type** from the **Classification** list.
10. Click the flashlight next to the **Name** field.
11. Select **Ad Confirmation** and click **Select**.
12. Click **Apply**.
13. Click **Return to List**.
14. Click **Create** to the right of **Expression** in the **Details** section.
15. Click **Update** for **Condition expression not specified**.
16. Click **Expand All** for the **Left Operand** field.
17. Select **Confirmed**.
18. Select = from the **Operator** list. The page refreshes.
19. Enter `yes` in the **Constant** field.
20. Click **Apply**.
21. Click **Apply** on the Create Condition page.

Creating the Condition Step Using the Condition Expression

1. Select the **Modeling** tab.
2. Select **Business Processes**.
3. Click **Process Diagram** for the **Placing Ad** business process.
4. Select **Create Step** from the **Action** list.
5. Click the **Deliver Ad to Global NP** step.
6. Enter `Ad Placement Confirmed?` in the **Name** field.
7. Select **Condition Step** from the **Type** field. The page refreshes.
8. Select **Ad Placement Confirmed?** from the **Condition Expression** list.
9. Select **Deliver Ad to Global NP** from the **Step** list of the **Sequence after** section. This places the **Ad Placement Confirmed?** step after the **Deliver Ad to Global NP** step.
10. Select **End** from the **Step** list of the first **Sequence before** section. This places the **Ad Placement Confirmed?** step before the **End** step.

11. Select **False** from the **Guard Value** list of the first **Sequence before** section. A guard value specifies the next step to execute based on the outcome of the condition expression (either true or false) in the condition step.
12. Select **End** from the **Step** list of the second **Sequence before** section.
13. Select **True** from the **Guard Value** list of the second **Sequence before** section.
14. Click **Apply**.
15. View the process diagram by clicking **Modeling > Business Processes > Process Diagram** (for the **Placing Ad** business process). After the condition expression is evaluated, one of the outgoing control flows (either true or false) you specified is executed.

Task 3: Creating a Transformation Step to Notify Human Resources

This task creates the notification event for human resources in case there is a problem. Again, the transformation step is used mainly to demonstrate that transformation steps can be used in the business process to generate new event types (that is, not only in the transformation binding roles). As an alternative, you can also use a pass-through step and perform the transformation in one of the transformation steps in the roles.

Creating an Event Transformation Map

As with the conditional step, the event transformation map can either be created before creating the step in the business process or at a later time. In this tutorial, you create the map first, because you must define it in the step.

1. Select the **Modeling** tab.
2. Select **Transformations**.
3. Click **Create** in the Event Transformation Maps page.
4. Enter `Ad Confirmation to Ad Problem` in the **Name** field.
5. Click **Specify Source and Target**. The page refreshes.
6. Enter `Ad Confirmation` in the **Name** field of the **Source** section.
7. Select **Event Type** from the **Type** list of the **Source** section. The page refreshes.
8. Select **Business Event Type** from the **Classification** list of the **Source** section.
9. Click the flashlight next to the **Name** field of the **Source** section.

10. Select **Ad Confirmation** and click **Select**.
11. Enter `Ad Problem` in the **Name** field of the **Target** section.
12. Select **Event Type** from the **Type** list of the **Target** section. The page refreshes.
13. Select **Business Event Type** from the **Classification** list of the **Target** section.
14. Click the flashlight next to the **Name** field.
15. Select **Ad Problem** and click **Select**.
16. Click **Apply**.
17. Click **Expand All** for both the **Sources** table and the **Targets** table.

Copying the Ad_ID Integer

1. Select **Ad_ID** in the **Sources** table.
2. Select **Ad_ID** in the **Targets** table.
3. Select **copy:from=integer->to=integer** from the **Datatype Transformation Map** list.
4. Click **Append**.
The rule is added to the **Statements** section.

Copying the Problem_Details String

1. Select **Problem_Details** in the **Sources** table.
2. Select **Problem_Description** in the **Targets** table.
3. Select **copy:from=string->to=string** from the **Datatype Transformation Map** list.
4. Click **Append**.
The rule is added to the **Statements** section.

Creating a Transformation Step Using the Transformation Map

1. Select the **Modeling** tab.
2. Select **Business Processes**.
3. Click the **Process Diagram** for the **Placing Ad** business process.

4. Select **Create Step** from the **Action** list.
5. Click the **Ad Placement Confirmed?** step.
6. Enter `Notify HR Person` in the **Name** field.
7. Select **Transformation Step** from the **Type** field. The page refreshes.
8. Select **Ad Confirmation to Ad Problem(Ad Confirmation->Ad Problem)** from the **Transformation Map** list. This is the transformation map to associate with this transformation step.
9. Select **Ad Placement Confirmed?** from the **Step** list of the **Sequence after** section. This places the **Notify HR Person** step after the **Ad Placement Confirmed?** step.
10. Select **End** from the **Step** list of the **Sequence before** section. This places the **Notify HR Person** step before the **End** step.
11. Click **Apply**.
12. View the process diagram by clicking **Modeling > Business Processes > Process Diagram** (for the **Placing Ad** business process).

Task 4: Creating an Or Step

Each step is executed when all control flows and data flows reach it. In this example, the End step is only executed when both control flows reach it. Since this is not the behavior you want, you must create an Or step. An Or step waits for at least one incoming control flow. The step is executed as soon as one of the incoming control flows is executed.

1. Select **Create Step** from the **Action** list.
2. Click the **Notify HR Person** step.
3. Enter `OR` in the **Name** field.
4. Select **Or Step** from the **Type** field. The page refreshes.
5. Select **Notify HR Person** from the **Step** list of the first **Sequence after** section. This places the **OR** step after the **Notify HR Person** step.
6. Select **Ad Placement Confirmed?** from the **Step** list of the second **Sequence after** section. This places the **OR** step after the **Ad Placement Confirmed?** step.
7. Select **End** from the **Step** list of the first **Sequence before** section. This places the **OR** step before the **End** step.

8. Click **Apply**.
9. View the process diagram for the **Placing Ad** business process to see your changes.

The Or step waits for at least one incoming control flow. The step is executed as soon as one of the incoming control flows is executed.

Task 5: Creating a Role Port and Data Flow to Deliver the Ad Problem Event to Human Resources

The **Ad Problem** business event must be delivered from the **Notify HR Person** transformation step out of the business process. To do this, a role port must be created. Role ports define the interfaces for a business process (or role), allowing for re-use.

1. Select **Create Role Port** from the **Action** list.
2. Click anywhere on the diagram.
3. Enter `Ad Problem Out` in the **Name** field.
4. Select **Output** from the **Direction** list.
5. Select **Business Event Type** from the **Classification** list.
6. Click the flashlight next to the **Name** field.
7. Select **Ad Problem** and click **Select**.
8. Click **Apply**.
9. Select **Create Data Flow** from the **Action** list.
10. Select the role port (this is the single red dot on the boundary of the business process).
11. Click **Apply**. There is only one available data port already preselected in the list: the output port on the **Notify HR Person** transformation step.
12. View the process diagram for the **Placing Ad** business process to see your changes.

Task 6: Creating a Split Step

Two of the steps you created require the same business event. The **Ad Placement Confirmed?** conditional step and the **Notify HR Person** transformation step each require the **Ad Confirmation** business event. The way to model both steps that require the same event type is to use a split step. A split step makes multiple copies of the same event type and passes them to each step with which it is linked.

1. Select **Create Step** from the **Action** list.
2. Click the **Deliver Ad to Global NP** step.
3. Enter `SPLIT` in the **Name** field.
4. Select **Split Step** from the **Type** list. The page refreshes.
5. Select **Deliver Ad to Global NP** from the **Step** list of the **Sequence after** section. This places the **SPLIT** step after the **Deliver Ad to Global NP** step.
6. Select **Ad Placement Confirmed?** from the **Step** list of the **Sequence before** section. This places the **SPLIT** step before the **Ad Placement Confirmed?** step.
7. Click **Apply**.
8. View the process diagram for the **Placing Ad** business process to see your changes.

Task 7: Creating a Role Port and Data Flow to Splitting the Ad Confirmation Event

1. Select **Create Role Port** from the **Action** list.
2. Click anywhere on the diagram.
3. Enter `Ad Confirmation In` in the **Name** field.
4. Select **Input** from the **Direction** list.
5. Select **Business Event Type** from the **Classification** list.
6. Click the flashlight next to the **Name** field.
7. Select **Ad Confirmation** and click **Select**.
8. Click **Apply**.
9. Select **Create Data Flow** from the **Action** list.
10. Select the role port (this is the single role port on the edge of the role).

11. Click **Apply**. There is only one available data port already preselected in the list: the output port on the **Notify HR Person** transformation step.
12. Select **Input1**.
13. Click **Apply**.
14. Select **Create Data Flow** from the **Action** list.
15. Click one of the two step ports without data flow on the **SPLIT** step.
16. Select **Ad Confirmation-In** (the **Port Owner** is **Ad Placement Confirmed?**).
17. Click **Apply**.
18. Select **Create Data Flow** from the **Action** list.
19. Click the step port without data flow on the **SPLIT** step.
20. Select **Ad Confirmation-In** (the **Port Owner** is **Notify HR Person**).
21. Click **Apply**.
22. View the process diagram for the **Placing Ad** business process to see your changes.

Task 8: Removing Unnecessary Control Flow (Optional)

When there is a data flow between two steps, the control flow is implicit. This makes the control flow between the **SPLIT** step and the **Ad Placement Confirmed?** step redundant.

1. Click the **SPLIT** step.
2. Delete the **Ad Placement Confirmed?** control flow.
3. Click **Yes**.
4. View the process diagram for the **Placing Ad** business process to see your final changes.

Phase B2: Using the Add Event Flow Wizard

This section describes how to use the Add Event Flow wizard to add an additional event flow to one of the existing spokes you initially created with the End-to-End Basic Integration wizard in "[Task 2: Creating the Modeling Metadata](#)" on page 7-13. An event flow is the complete path a single event takes through a spoke. A spoke consists of a role set extending from the native role to the business process. Role ports and data flow connect the role set together.

This section contains these topics:

- [Task 1: Creating a Native Event for an Existing Interaction](#)
- [Task 2: Creating an Event Map for the Global NP Confirmation Native Event](#)
- [Task 3: Creating an Event Correlation](#)
- [Task 4: Adding an Event Flow to a Spoke with the Add Event Flow Wizard](#)
- [Task 5: Creating Transformation Statements](#)

See Also: The following sections for additional details about tasks covered in this section:

- ["Adding Event Flow to a Single Spoke"](#) on page 9-26
- ["Managing Native Event Types"](#) on page 11-37
- ["Managing Event Maps"](#) on page 11-54
- ["Managing Native Event Correlations"](#) on page 11-47
- ["Transformation Statements Overview"](#) on page 13-27

Task 1: Creating a Native Event for an Existing Interaction

This task creates the third native event for the integration scenario. The global newspaper delivers a confirmation to Oracle Application Server ProcessConnect. The confirmation tells whether or not the ad is placed.

1. Select the **Modeling** tab.
2. Select **Event Types**.
3. Select **Native Event Types**.
4. Click **Create**.
5. Enter `Global NP Confirmation` in the **Name** field.

6. Select **Read File - inbound(xmlRecord - Inbound)** from the **Interaction** list.
7. Select **xmlRecord** from the **Record Type** list.
8. Click **Next**.
9. Select **XSD** from the **Translator** list.
10. Select **Create New**.
11. Enter `Global NP Confirmation` in the **Name** field.
12. Click **Browse** next to the **Content** field.
13. Select **Global_NP_AdConfirmation.xsd**.
14. Click **Next**.
15. Select **XSD** from the **Translator** list.
16. Select **Yes** from the **Preserve Namespaces for Native** instances list.
17. Select **None** from the **Doctype for Native Instances** list.
18. Click **Next**.
19. Click **Finish**.

Task 2: Creating an Event Map for the Global NP Confirmation Native Event

The native event you created is the second one to use the Read File - inbound(xmlRecord - Inbound) interaction (**HR New Ad** was the first one). Therefore, you must specify a condition expression to determine which native event to create for the different records passed.

1. Select the **Modeling** tab.
2. Select **Event Types**.
3. Select **Native Event Types**.
4. Select **Global NP Confirmation** from the **Name** column.
5. Click **Create** in the **Event Map** section.
6. Click **Update** for **Condition expression not specified**.
7. Click **Expand All** for the **Left Operand** field.
8. Select **Action**.

9. Select = from the **Operator** list.
10. Enter `Global NP Ad Confirmation` in the **Constant Value** field.
11. Click **Apply**.
12. Click **Apply** on the Create Event Map page.

Task 3: Creating an Event Correlation

When the global newspaper confirmations are received back from the newspaper, each one must be correlated to the correct ad placement request for which it is a confirmation. Events are correlated either on the presence of a certain datatype or on the content of a datatype. In this case, you correlate the confirmation to the ad based on the `Ad_ID` datatype.

1. Select the **Modeling** tab.
2. Select **Event Types**.
3. Select **Native Event Types**.
4. Click **Create** in the **Correlations** section.
5. Use the flashlight to select **Global NP Confirmation** from the **Correlating Native Event Type** list.
6. Click **Select**.
7. Use the flashlight to select **Global NP Ad** from the **Correlated Native Event Type** list.
8. Click **Select**.
9. Select **True** from the **Directional** list.
10. Click **Next**.
11. Click **Update** for **Condition expression not specified**.
12. Click **Expand All** in the **Correlating Native Event Type** and **Correlated Native Event Type** sections.
13. Select `Ad_ID` in both sections.
14. Select = from the **Operator** list.
15. Click **Apply**.
16. Click **Apply**.

Task 4: Adding an Event Flow to a Spoke with the Add Event Flow Wizard

The Add Event Flow wizard adds an additional event flow to a single, existing spoke. In this case, you add the event flow to the spoke extending from the **Placing Ad at Global NP-NR** native role to the **Placing Ad** business process. This is one of the two spokes you initially created with the End-to-End Basic Integration wizard in "[Creating the Modeling Metadata with the Modeling Wizards](#)" on page 7-23.

1. Select the **Modeling** tab.
2. Select **Business Processes**.
3. Click **Add Event Flow** in the **Shortcuts** section.
4. Select **Placing Ad** from the **Business Process** list.
5. Select **Placing Ad at Global NP-NR** from the **Native Role** list.
6. Select **Read File inbound(xmlRecord) - Inbound** from the **Interaction** list.
7. Click **Next**.
8. Select **Global NP Confirmation** from the **Native Event** list.
9. Click **Use Existing** in the **Business Event** section.
10. Select **Ad Confirmation**.
11. Click **Next**.
12. Click **Create New** in the **Transformation** section.
13. Enter `Global NP Confirmation to CV`.
14. Click **Next**.
15. Click **Finish**.

The Event Flow Diagram appears with the second event flow added to the existing spoke. The following portion of this diagram is shown.

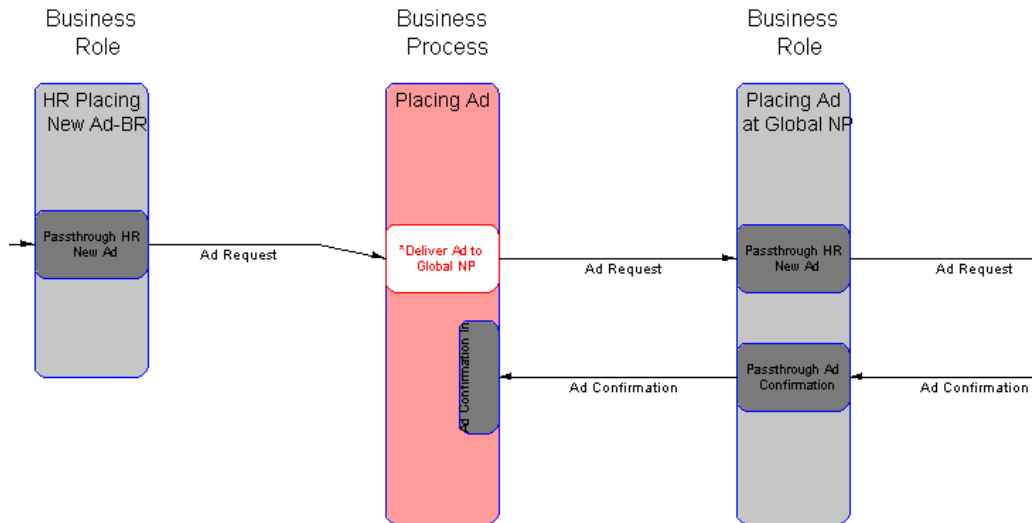

Task 5: Creating Transformation Statements

1. Select the **Modeling** tab.
2. Select **Transformations**.
3. Select **Global NP Confirmation to CV** from the **Name** column.
4. Click **Expand All** for both the **Sources** table and the **Targets** table.

Copying the Ad_ID Integer

1. Select **Ad_ID** in the **Sources** table.
2. Select **Ad_ID** in the **Targets** table.
3. Select **copy:from=integer->to=integer** from the **Datatype Transformation Map** list.
4. Click **Append**.

The statement appears in the **Statements** section.

Copying the Confirmed String

1. Select **Confirmed** in the **Sources** table.
2. Select **Confirmed** in the **Targets** table.
3. Select **copy:from=string->to=string** from the **Datatype Transformation Map** list.
4. Click **Append**.

The statement appears in the **Statements** section.

Copying the Problem_Details String

1. Select **Problem_Details** in the **Sources** table.
2. Select **Problem_Details** in the **Targets** table.
3. Select **copy:from=string->to=string** from the **Datatype Transformation Map** list.
4. Click **Append**.

The statement appears in the **Statements** section.

Phase B3: Using the Add Spoke Wizard

In this phase, you deliver the **Ad Problem** business event to human resources. You can use the same spoke to model the problem event back to the human resources system. In this tutorial, however, you create a separate spoke (just imagine that you received the request for an ad placement from a human resources application, but want to send the confirmation using e-mail). The spokes are different, because the human resources application behaves differently from the e-mail system. Again, just imagine, because in this tutorial you only use the File/FTP adapter.

- [Task 1: Creating a Native Event, Translation, and Application Event](#)
- [Task 2: Adding a Spoke](#)
- [Task 3: Creating Transformation Statements](#)

See Also: The following sections for additional details about tasks covered in this section:

- ["Creating a Single Spoke"](#) on page 9-23
- ["Managing Native Event Types"](#) on page 11-37
- ["Transformation Statements Overview"](#) on page 13-27

Task 1: Creating a Native Event, Translation, and Application Event

You must also create a native event and specify a translator to translate the outbound application event to an outbound native event.

1. Select the **Modeling** tab.
2. Select **Event Types**.
3. Select **Native Event Types**.
4. Click **Create**.
5. Enter `HR Problem` in the **Name** field.
6. Select **Write File %TIME%(xmlRecord) - Outbound** from the **Interaction** list.
7. Select **xmlRecord** from the **Record Type** list.
8. Click **Next**.
9. Select **XSD** from the **Translator** list.
10. Select **Create New**.

11. Enter `HR Problem` in the **Name** field.
12. Click **Browse** next to the **Content** field.
13. Select **HR_AdProblem.xsd**.
14. Click **Next**.
15. Select **XSD** from the **Translator** list.
16. Select **Yes** from the **Preserve Namespaces for Native** instances list.
17. Select **None** from the **Doctype for Native Instances** list.
18. Click **Next**.
19. Click **Finish**.

Creating an Event Map for the HR Problem Native Event

Because this is the second native event to use the Write File %TIME%(xmlRecord) - Outbound interaction, you must create an event map.

1. Select the **Modeling** tab.
2. Select **Event Types**.
3. Select **Native Event Types**.
4. Select **HR Problem**.
5. Click **Create** in the **Event Map** section.
6. Click **Update** for **Condition expression not specified**.
7. Click **Expand All** for the **Left Operand** field.
8. Select **Action**.
9. Select **=** from the **Operator** list.
10. Enter `HR Problem` in the **Constant Value** field.
11. Click **Apply**.
12. Click **Apply**.

Task 2: Adding a Spoke

In this section, you use the Create Spoke wizard to add a spoke to the existing set of roles, business process, transformation maps, and business event you initially created with the End-to-End Basic Integration wizard in "[Creating the Modeling Metadata with the Modeling Wizards](#)" on page 7-23.

1. Select the **Modeling** tab.
2. Select **Business Processes**.
3. Click **Create Spoke** in the **Shortcuts** section.
4. Click **Use Existing**.
5. Select **Placing Ad** in the **Business Process** section.
6. Click **Next**.
7. Select **Write File - %TIME%(xmlRecord) - Outbound** from the **Interaction** list.
8. Click **Next**.
9. Enter `Delivering E-Mail` in the **Role Naming Convention** field.
10. Click **Next**.
11. Select **HR Problem** from the **Native Event** list.
12. Select **Use Existing** in the **Business Event** section.
13. Select **Ad Problem**.
14. Click **Next**.
15. Select **Create New** in the **Transformation** section.
16. Enter `CV to HR Ad Problem`.
17. Click **Next**.
18. Click **Finish**.

Task 3: Creating Transformation Statements

1. Select the **Modeling** tab.
2. Select **Transformations**.
3. Select **CV to HR Ad Problem** from the **Name** column.
4. Click **Expand All** for both the **Sources** table and the **Targets** table.

Copying the Ad_ID Integer

1. Select **Ad_ID** in the **Sources** table.
2. Select **Ad_ID** in the **Targets** table.
3. Select **copy:from=integer->to=integer** from the **Datatype Transformation Map** list.
4. Click **Append**.

The statement appears in the **Statements** section.

Setting a Default for the Action String

1. Select **Rule** from the **Statement Type** list.
2. Click **Append**.
3. Click **Expand All** for both the **Sources** table and the **Targets** table.
4. Select **copy:from=string->to=string**.
5. Select **System Defined** from the **Datatype Transformation Map Type** list.
6. Select **Action** in the **Targets** table.
7. Click **Bind** in the **target** section.
8. Enter **HR Problem** in the **Constant Value** field.
9. Click **Bind** in the **source** section.
10. Click **Apply**.

The statement appears in the **Statements** section.

Copying the Problem_Description String

1. Select **Problem_Description** in the **Sources** table.
2. Select **Problem_Description** in the **Targets** table.
3. Select **copy:from=string->to=string** from the **Datatype Transformation Map** list.
4. Click **Append**.

The statement appears in the **Statements** section.

Setting the Party to HR Person in an Event Header Rule

In "[Selecting the Destination Party in the SetParty Step](#)" on page 7-35, you selected the destination party with whom to integrate in the SetParty step of the business process. In this task, you specify the destination party through an alternative method. You set the destination party as part of the event transformation map by using the setToParty event header rule.

1. Select **Event Header Rule** from the **Statement Type** list.
2. Click **Append**.
3. Select **setToParty** from the **Event Header Rule** list. The page refreshes.
4. Click **Expand All** for both the **Sources** table and the **Targets** table.
5. Select **HR Ad Problem-OUT** in the **Target Event** section.
6. Enter `HR Person` in the **Constant Value** field.
7. Click **Apply**.

Phase B4: Creating the HR Person Application and Agreement

This section describes how to create the **HR Person** application and agreement.

This section contains these topics:

- [Task 1: Creating a Third Application](#)
- [Task 2: Creating a Third Application Agreement](#)
- [Task 3: Creating and Deploying a New Configuration](#)
- [Task 4: Testing the Results](#)

See Also: The following sections for additional details about tasks covered in this section:

- ["Creating an Application"](#) on page 15-5
- ["Adding an Adapter to an Application"](#) on page 15-12
- ["Creating an Application Delivery Channel"](#) on page 15-14
- ["Managing Application and Agreement Validation and Approval"](#) on page 15-44
- ["Creating a Configuration"](#) on page 16-3
- ["Deploying a Configuration"](#) on page 16-9

Task 1: Creating a Third Application

This task creates a third application, also using the File/FTP adapter and using a directory called `hr_person`.

Creating the Application

1. Select the **Profiles** tab.
2. Select the **Applications** tab.
3. Click **Create**.
4. Enter `HR Person` in the **Name** field.
5. Select the **Generic** application type from the **Application Type** list. The application type enables you to group applications of a similar type together.
6. Click **Apply**.

Adding an Adapter Type

1. Click **Add** in the **Adapter Types** section of the Application Details : HR Person page.
2. Select **File/FTP Adapter** from the **Type** list.
3. Click **Apply**.

Creating a Delivery Channel

Create a delivery channel for the adapter to use.

1. Click **Create** in the **Delivery Channels** section of the Adapter Type Details page of the adapter.
2. Enter the following details:

Field	Enter/Select
Name	HR Person DC
File or FTP mode	File
Polling interval in milliseconds (inbound)	10000

Field	Enter/Select
Base directory	<i>start_at_root</i> /ip/tutorial/hr_person where <i>start_at_root</i> must be the absolute path (for example, /private/Oracle). Note: Do not use the \$ORACLE_HOME variable when specifying a base directory.

3. Click **Apply**.

Validating the Application

1. Click the **Profiles** tab.
2. Select **Applications**.
3. Select **HR Person** in the **Name** column.
4. Click **Validate**.

Sending the Application for Approval

1. Click **Send for Approval**.
2. Select approvers (for example, the user **admin**) from the **Available Approvers** list.
3. Click **Move** to move the approver(s) to the **Selected Approvers** list.
4. Click **Send for Approval**.

Approving the Application

1. Click **Approve**.
2. Click **Approve** again when prompted to confirm.

Task 2: Creating a Third Application Agreement

In this task, you create an application agreement that enables the Human Resource Person application to participate in an integration.

Creating the Application Agreement

1. Select the **Profiles** tab.
2. Select the **Agreements** tab.
3. Click **Create** in the Application Agreements page.
4. Enter the following information:

In this Field...	Enter...
Name	HR Person Agreement
Agreement Id	3
Effective From Date	Leave this field blank
Effective To Date	Leave this field blank
Application Participant	HR Person

5. Click **Apply**.

Adding the Delivery Channel

1. Click **Add** in the **Delivery Channels Used** section.
2. Select **HR Person DC** from the **Delivery Channel** list.
3. Click **Apply**.

Adding the Native Role

1. Click **Add** in the **Native Roles** section.
2. Select **Delivering E-Mail-NR** from the **Native Role** list.
3. Click **Apply**.

Validating the Application Agreement

1. Click **Validate**.

Sending the Agreement for Approval

1. Click **Send for Approval**.
2. Select approvers (for example, the user **admin**) from the **Available Approvers** list.
3. Click **Move** to move the approver(s) to the **Selected Approvers** list.
4. Click **Send for Approval**.

Approving the Agreement

1. Click **Approve**.
2. Click **Approve** again when prompted to confirm.

Task 3: Creating and Deploying a New Configuration

1. Select the **Deployment** tab.
2. Click **Create**.
3. Enter `Placing Ad Phase B` as the configuration name.
4. Click **Apply** to create a configuration.
5. Click **Deploy** to deploy the configuration. (This button is only enabled if Step 4 was successful.)
6. Select **High** from the **BI Reporting Level** list.
7. Click **Apply**.

Task 4: Testing the Results

Perform the following steps:

1. Place the `HR_Ad.xml` file in the `/start_at_root/ip/tutorial/human_resources/inbound` directory.
2. Verify that the file is read by the adapter and deleted.

3. Confirm the first part of this tutorial is still working by checking that the file `ad_%TIME%.xml` is in the `/start_at_root/ip/tutorial/global_newspaper/outbound` directory.
4. Place the file `Global_NP_AdConfirmation.xml` in the `/start_at_root/ip/tutorial/global_newspaper/inbound` directory. This directory is polled by the File/FTP adapter every 10 seconds. The file is read and deleted from the directory, but only when the native event is successfully created.

The `ad%TIME%.xml` results file is found in the `/start_at_root/ip/tutorial/hr_person/outbound` directory.

Manually Creating the Business Datatypes

This section demonstrates how business datatypes can be manually created instead of through import of an XSD file.

This section contains these topics:

- [Task 1: Creating the AdType Complex Datatype and its Datatype Members](#)
- [Task 2: Creating the Ad_Request Complex Datatype](#)

See Also: ["Managing Business Datatypes"](#) on page 10-13

Task 1: Creating the AdType Complex Datatype and its Datatype Members

1. Select the **Modeling** tab.
2. Select **Datatypes**.
3. Click **Create** on the Business Datatypes page.
4. Select **Complex** from the **Type** list.
5. Enter `AdType` in the **Name** field.
6. Select **Unspecified** from the **Namespace** list.
7. Select **Sequence Group** from the **Model Group** list.
8. Click **Apply**.

Creating the Complex Datatype Members of AdType

1. Click **Create** in the **Datatype Members** section.
2. Select **Scalar** from the **Type** list.
3. Enter `Title` in the **Name** field.
4. Select **No** from the **Mandatory** list.
5. Select **Core Datatype** from the **Classification** list.
6. Select **Unspecified** from the **Namespace** list.
7. Use the flashlight to select **string** for the **Name** field.
8. Click **Apply**.
9. Click **Return to Datatype Details**.
10. Click **Create** in the **Datatype Members** section.
11. Select **Scalar** from the **Type** list.
12. Enter `Text` in the **Name** field.
13. Select **No** from the **Mandatory** list.
14. Select **Core Datatype** from the **Classification** list.
15. Select **Unspecified** from the **Namespace** list.
16. Use the flashlight to select **string** for the **Name** field.
17. Click **Apply**.
18. Click **Return to Datatype Details**.

The new datatype members for the **AdType** complex datatype appear.

Datatype Members [Return to Top](#)

[Create](#)

[Expand All](#) | [Collapse All](#)

⊕ Datatype Members

Focus Name	Type	Datatype	Cardinality	Update	Delete
▼ Datatype Members					
Title	Scalar	string			
Text	Scalar	string			

Task 2: Creating the Ad_Request Complex Datatype

1. Select the **Modeling** tab.
2. Select **Datatypes**.
3. Click **Create** on the Business Datatypes page.
4. Select **Complex** from the **Type** list.
5. Enter `Ad_Request` in the **Name** field.
6. Select **Unspecified** from the **Namespace** list.
7. Select **Sequence Group** from the **Model Group** list.
8. Click **Apply**.

Creating the Complex Datatype Members of Ad_Request

1. Click **Create** in the **Datatype Members** section.
2. Select **Scalar** from the **Type** list.
3. Enter `Ad_ID` in the **Name** field.
4. Select **No** from the **Mandatory** list.
5. Select **Core Datatype** from the **Classification** list.
6. Select **Unspecified** from the **Namespace** list.
7. Use the flashlight to select **integer** for the **Name** field.
8. Click **Apply**.
9. Click **Return to datatype details**.
10. Click **Create** in the **Datatype Members** section.
11. Select **Scalar** from the **Type** list.
12. Enter `Date` in the **Name** field.
13. Select **No** from the **Mandatory** list.
14. Select **Core Datatype** from the **Classification** list.
15. Select **Unspecified** from the **Namespace** list.
16. Use the flashlight to select **string** for the **Name** field.
17. Click **Apply**.









18. Click **Return to Datatype Details**.
19. Click **Create** in the **Datatype Members** section.
20. Select **Scalar** from the **Type** list.
21. Enter `HR_Contact_Name` in the **Name** field.
22. Select **No** from the **Mandatory** list.
23. Select **Core Datatype** from the **Classification** list.
24. Select **Unspecified** from the **Namespace** list.
25. Use the flashlight to select **string** for the **Name** field.
26. Click **Apply**.
27. Click **Return to Datatype Details**.
28. Click **Create** in the **Datatype Members** section.
29. Select **Compound** from the **Type** list.
30. Enter `Ad` in the **Name** field.
31. Select **No** from the **Mandatory** list.
32. Select **Business Datatype** from the **Classification** list.
33. Select **Unspecified** from the **Namespace** list.
34. Use the flashlight to select **AdType** for the **Name** field.
35. Enter `1` in the **Minimum** field of the **Cardinality** section.
36. Do not enter a value in the **Maximum** field of the **Cardinality** section.
37. Click **Apply**.
38. Click **Return to Datatype Details**.

The new datatype members for the **Ad_Request** complex datatype appear.

Datatype Members

[Return to Top](#)[Create](#)[Expand All](#) | [Collapse All](#)

⊕ Datatype Members

Focus Name	Type	Datatype	Cardinality	Update	Delete
▼ Datatype Members					
Ad ID	Scalar	integer			
Date	Scalar	string			
HR Contact Name	Scalar	string			
⊕ ▼ Ad	Compound	AdType	[1..]		
Title	Scalar	string			
Text	Scalar	string			

You can then include these datatypes in a body element of a business event and in event transformation map statements.

Updating the Interaction, Native Event, and Application Event

To update an application event (and its corresponding native event), it must first be deleted and then created again. The translator creates the application event based on the record type of a native event. If you use the XSD translator, the application event datatypes are created based on the XSD file provided during the creation of the native event. Before an application event can be deleted, all integration metadata referring to it must no longer do so. For example, when the application event is used in an application role port, the role port must be updated to no longer use that application event. Another example is the transformation. When the application event is used in an event transformation map as a source or target, it must be removed first. The easiest method is to delete the complete spoke before deleting the application event. This works best if the spoke only has a few pass-through steps for handling event flows.

This task demonstrates how to update the **HR New Ad** application event and delete the **HR Placing New Ad** spoke after completing phase A of the tutorial (that is, the **HR Problem** event is not yet modeled).

- [Task 1: Deleting a Spoke](#)
- [Task 2: Deleting a Transformation Map](#)
- [Task 3: Deleting a Native Event](#)
- [Task 5: Creating a Spoke](#)
- [Task 6: Creating Event Transformation Map Statements](#)
- [Task 7: Updating the Agreement to Use a New Native Role](#)

See Also: The following sections for additional details about tasks covered in this section:

- ["Creating a Single Spoke"](#) on page 9-23
- ["Deleting a Spoke"](#) on page 9-40
- ["Managing Event Maps"](#) on page 11-54
- ["Transformation Maps Overview"](#) on page 13-3
- ["Transformation Statements Overview"](#) on page 13-27
- ["Managing Native Roles in Application Agreements"](#) on page 15-41

Task 1: Deleting a Spoke

1. Select the **Modeling** tab.
2. Select **Business Processes**.
3. Click the **Integration Diagram** for the **Placing Ad** business process.
4. Select **Delete Spoke** from the **Action** list.
5. Click **HR Placing New Ad-NR**.
6. Click **Yes** when prompted to confirm your selection.

Task 2: Deleting a Transformation Map

1. Select the **Modeling** tab.
2. Select **Transformations**.
3. Select **HR Ad to Common View** in the **Delete** column.
4. Click **Yes** when prompted to confirm your selection.

Task 3: Deleting a Native Event

1. Select the **Modeling** tab.
2. Select **Event Types**.
3. Select **Native Event Types**.
4. Select **HR New Ad** in the **Delete** column.
5. Click **Yes** when prompted to confirm your selection.

Task 4: Creating a Native Event

1. Select the **Modeling** tab.
2. Select **Event Types**.
3. Select **Native Event Types**.
4. Click **Create**.
5. Enter **HR New Ad** in the **Name** field.
6. Select **Read File -inbound(xmlRecord) - Inbound** from the **Interaction** list.
7. Select **xmlRecord** from the **Record Type** list.
8. Click **Next**.
9. Select **XSD** from the **Translator** list.
10. Select **Create New**.
11. Enter **HR Ad** in the **Name** field.
12. Click **Browse** next to the **Content** field.
13. Select **HR_Ad.xsd**.
14. Click **Next**.

15. Select **XSD** from the **Translator** list.
16. Select **Yes** from the **Preserve Namespaces for Native** instances list.
17. Select **None** from the **Doctype for Native Instances** list.
18. Click **Next**.
19. Click **Finish**.

Task 5: Creating a Spoke

1. Select the **Modeling** tab.
2. Select **Business Processes**.
3. Click **Create Spoke** in the **Shortcuts** section.
4. Click **Use Existing**.
5. Select **Placing Ad** from the **Business Process** list.
6. Click **Next**.
7. Select **Read File -inbound(xmlRecord) - Inbound** from the **Interaction** list.
8. Click **Next**.
9. Enter `HR Placing New Ad` in the **Role Naming Convention** field.
10. Click **Next**.
11. Select **HR New Ad** from the **Native Event** list.
12. Select **Use Existing** in the **Business Event** section.
13. Select **Ad Request**.
14. Click **Next**.
15. Select **Create New** in the **Transformation** section.
16. Enter `HR Ad to Common View`.
17. Click **Next**.
18. Click **Finish**.

Task 6: Creating Event Transformation Map Statements

1. Select the **Modeling** tab.
2. Select **Transformations**.
3. Select **HR Ad to Common View** from the **Name** column.
4. Click **Expand All** for both the **Sources** table and the **Targets** table.
5. Select **Ad_ID** in the **Sources** table.
6. Select **Ad_ID** in the **Targets** table.
7. Select **copy:from=integer->to=integer** from the **Datatype Transformation Map** list.
8. Click **Append**.

Task 7: Updating the Agreement to Use a New Native Role

1. Click the **Modeling** tab.
2. Select **Profiles**.
3. Select **Agreements**.
4. Select **HR Agreement** in the **Name** column.
5. Click **Add** in the **Native Roles** section.
6. Select **HR Placing New Ad-NR** from the **Native Role** list.
7. Click **Apply**.

.xsd and .xml Files Used in This Tutorial

This tutorial uses the following files:

- [HR_Ad.xsd File](#)
- [Global_Newspaper_Ad.xsd File](#)
- [Ad_CommonView.xsd File](#)
- [Global_NP_AdConfirmation.xsd File](#)
- [HR_AdProblem.xsd File](#)
- [HR_Ad.xml File](#)
- [Global_NP_AdConfirmation.xml File](#)

HR_Ad.xsd File

This is the file you selected in Step 6 of "Creating the Native Event, Translation, and Application Event for the Human Resources Application" on page 7-16 and in Step 13 of "Task 4: Creating a Native Event" on page 7-79.

```
<?xml version="1.0"?>
<xs:schema targetNamespace="http://www.oracle.com/human_resources"
xmlns:xs="http://www.w3.org/2001/XMLSchema" xmlns="http://www.oracle.com/human_
resources" elementFormDefault="unqualified" attributeFormDefault="unqualified">
  <xs:element name="Ad_Request">
    <xs:annotation>
      <xs:documentation>Comment describing your root element</xs:documentation>
    </xs:annotation>
    <xs:complexType>
      <xs:sequence>
        <xs:element name="Action" type="xs:string"/>
        <xs:element name="Function_Type" type="xs:string"/>
        <xs:element name="Date" type="xs:dateTime"/>
        <xs:element name="HR_Contact_FirstName" type="xs:string"/>
        <xs:element name="HR_Contact_LastName" type="xs:string"/>
        <xs:choice>
          <xs:element name="phone" type="xs:string"/>
          <xs:element name="email" type="xs:string"/>
        </xs:choice>
        <xs:element name="description" type="xs:string" minOccurs="0"/>
        <xs:element name="Ad" type="AdType" maxOccurs="unbounded"/>
      </xs:sequence>
      <xs:attribute name="Ad_ID" type="xs:integer"/>
    </xs:complexType>
  </xs:element>
</xs:schema>
```

```

        </xs:complexType>
    </xs:element>
    <xs:complexType name="AdType">
        <xs:sequence>
            <xs:element name="Title" type="xs:string"/>
            <xs:element name="Text" type="xs:string"/>
        </xs:sequence>
    </xs:complexType>
</xs:schema>

```

Global_Newspaper_Ad.xsd File

This is the file you selected in Step 7 of "[Creating the Native Event, Translation, and Application Event for the Global Newspaper Application](#)" on page 7-20.

```

<?xml version="1.0"?>
<xs:schema targetNamespace="http://www.oracle.com/global_newspaper"
xmlns:xs="http://www.w3.org/2001/XMLSchema" xmlns="http://www.oracle.com/global_
newspaper" elementFormDefault="unqualified" attributeFormDefault="unqualified">
    <xs:element name="Ad_Request">
        <xs:annotation>
            <xs:documentation>Ad placement request definition required by global
newspaper</xs:documentation>
        </xs:annotation>
        <xs:complexType>
            <xs:sequence>
                <xs:element name="Action" type="xs:string"/>
                <xs:element name="Date" type="xs:string"/>
                <xs:element name="HR_Contact_Name" type="xs:string"/>
                <xs:element name="Content_Type" type="xs:string"/>
                <xs:element name="Featured" type="xs:boolean"/>
                <xs:choice>
                    <xs:element name=" HR_Contact_Phone" type="xs:string"/>
                    <xs:element name=" HR_Contact_Email" type="xs:string"/>
                </xs:choice>
                <xs:element name="description" type="xs:string" minOccurs="0"/>
                <xs:element name="Ad" type="AdType" maxOccurs="unbounded"/>
            </xs:sequence>
            <xs:attribute name="Ad_ID" type="xs:integer"/>
        </xs:complexType>
    </xs:element>
    <xs:complexType name="AdType">
        <xs:sequence>
            <xs:element name="Title" type="xs:string"/>
            <xs:element name="Text" type="xs:string"/>

```

```
        </xs:sequence>
    </xs:complexType>
</xs:schema>
```

Ad_CommonView.xsd File

This is the file you selected in Step 4 of ["Creating the Business Event Datatypes"](#) on page 7-28.

```
<?xml version="1.0"?>
<xs:schema xmlns:xs="http://www.w3.org/2001/XMLSchema"
  elementFormDefault="unqualified" attributeFormDefault="unqualified">
  <xs:element name="Ad_Request">
    <xs:annotation>
      <xs:documentation>Comment describing your root element</xs:documentation>
    </xs:annotation>
    <xs:complexType>
      <xs:sequence>
        <xs:element name="Ad_ID" type="xs:integer"/>
        <xs:element name="Date" type="xs:string"/>
        <xs:element name="HR_Contact_Name" type="xs:string"/>
        <xs:element name="Ad" type="AdType" maxOccurs="unbounded"/>
      </xs:sequence>
    </xs:complexType>
  </xs:element>
  <xs:complexType name="AdType">
    <xs:sequence>
      <xs:element name="Title" type="xs:string"/>
      <xs:element name="Text" type="xs:string"/>
    </xs:sequence>
  </xs:complexType>
</xs:schema>
```

Global_NP_AdConfirmation.xsd File

This is the file you selected in Step 4 of ["Importing the Business Event Datatypes from an XSD File"](#) on page 7-48 and in Step 13 of ["Task 1: Creating a Native Event for an Existing Interaction"](#) on page 7-59.

```
<?xml version="1.0"?>
<xs:schema targetNamespace="http://www.oracle.com/global_newspaper"
  xmlns:xs="http://www.w3.org/2001/XMLSchema" xmlns="http://www.oracle.com/global_
  newspaper" elementFormDefault="unqualified" attributeFormDefault="unqualified">
  <xs:element name="Confirmation">
```

```

<xs:annotation>
  <xs:documentation>Comment describing your root element</xs:documentation>
</xs:annotation>
<xs:complexType>
  <xs:sequence>
    <xs:element name="Ad_ID" type="xs:integer"/>
    <xs:element name="Action" type="xs:string"/>
    <xs:element name="Confirmed" type="xs:string"/>
    <xs:element name="Problem_Details" type="xs:string"/>
  </xs:sequence>
</xs:complexType>
</xs:element>
</xs:schema>

```

HR_AdProblem.xsd File

This is the file you selected in Step 4 of ["Importing the Business Event Datatypes from an XSD File"](#) on page 7-49.

```

<?xml version="1.0"?>
<xs:schema targetNamespace="http://www.oracle.com/human_resources"
  xmlns:xs="http://www.w3.org/2001/XMLSchema"
  xmlns:hr="http://www.oracle.com/human_resources"
  elementFormDefault="unqualified" attributeFormDefault="unqualified">
  <xs:element name="Problem">
    <xs:annotation>
      <xs:documentation>Comment describing your root element</xs:documentation>
    </xs:annotation>
    <xs:complexType>
      <xs:sequence>
        <xs:element name="Ad_ID" type="xs:integer"/>
        <xs:element name="Action" type="xs:string"/>
        <xs:element name="Problem_Description" type="xs:string"/>
      </xs:sequence>
    </xs:complexType>
  </xs:element>
  <xs:complexType name="AdType">
    <xs:sequence>
      <xs:element name="Title" type="xs:string"/>
      <xs:element name="Text" type="xs:string"/>
    </xs:sequence>
  </xs:complexType>
</xs:schema>

```

HR_Ad.xml File

This is the file you specified in Step 2 of "[Task 5: Testing the Results](#)" on page 7-42 and in Step 1 of "[Task 4: Testing the Results](#)" on page 7-72.

```
<?xml version="1.0" encoding="UTF-8"?>
<n:Ad_Request xmlns:n="http://www.oracle.com/human_resources"
xmlns:xsi="http://www.w3.org/2001/XMLSchema-instance" Ad_ID="12345">
  <Action>HR New Ad Request</Action>
  <Function_Type>Executive</Function_Type>
  <Date>1999-05-31T13:20:00-05:00</Date>
  <HR_Contact_FirstName>John</HR_Contact_FirstName>
  <HR_Contact_LastName>Do</HR_Contact_LastName>
  <Content_Type>Ad</Content_Type>
  <Importance>6</Importance>
  <HR_Contact_Email>john.do@oracle.com</HR_Contact_Email>
  <Ad>
    <Title>Sales</Title>
    <Text>Position available, please write us.</Text>
  </Ad>
</n:Ad_Request>
```

Global_NP_AdConfirmation.xml File

This is the file you specified in Step 4 of "[Task 4: Testing the Results](#)" on page 7-72.

```
<?xml version="1.0"?>
<n:Confirmation xmlns:n="http://www.oracle.com/global_newspaper"
xmlns:xsi="http://www.w3.org/2001/XMLSchema-instance">
  <Ad_ID>12345</Ad_ID>
  <Action>Global NP Ad Confirmation</Action>
  <Confirmed>no</Confirmed>
  <Problem_Details>Credit check not ok</Problem_Details>
</n:Confirmation>
```

Chapter Summary

This chapter provides a tutorial that takes you through the tasks of designing and deploying an integration. The tasks for Phase A include creating application details, creating modeling metadata, creating agreements, creating and deploying the configuration, and testing the results. Phase B covers more advanced topics, such as creating and integrating an additional application, manually creating business datatypes, and updating the interaction, native event, and application event.

Part III

Modeler Management Tasks

This part describes management tasks that a modeler of integrations performs with the Oracle Application Server ProcessConnect user interface tool.

This part contains the following chapters:

- [Chapter 8, "Oracle Application Server ProcessConnect Technology Adapters"](#)
- [Chapter 9, "Creating Metadata with the Modeling Wizards"](#)
- [Chapter 10, "Managing Datatypes"](#)
- [Chapter 11, "Managing Adapter Interactions and Event Types"](#)
- [Chapter 12, "Managing Business Processes and Roles"](#)
- [Chapter 13, "Managing Transformations"](#)
- [Chapter 14, "Advanced Transformations Design"](#)

Oracle Application Server ProcessConnect Technology Adapters

This chapter provides details about the technology adapters included with Oracle Application Server ProcessConnect.

This chapter contains these topics:

- [Layout of Adapter Details in this Chapter](#)
- [Adapter-Related Tasks in User Interface Tool](#)
- [Native Formats and Value Types](#)
- [Advanced Queuing Adapter](#)
- [E-Mail Adapter](#)
- [File/FTP Adapter](#)
- [HTTP Adapter](#)
- [JMS Adapter](#)
- [Oracle Database Adapter](#)
- [Web Service Adapter](#)
- [Chapter Summary](#)

See Also:

- ["Wire Messages and Oracle Records"](#) on page 3-17 for conceptual details
- ["Technology Adapters"](#) on page 3-51 for conceptual details
- The Oracle Application Server 10g Documentation Library for documentation about additional application adapters that are not described in this chapter, but can be used with Oracle Application Server ProcessConnect

Layout of Adapter Details in this Chapter

The details provided for each technology adapter in this chapter are divided into the sections shown in [Table 8-1](#). Brief descriptions of the details covered in each section are also provided.

Table 8-1 *Adapter Details Overview*

Section	Description
Benefits of using the adapter	This section describes the benefits of using an adapter.
Supported versions	This section describes the supported versions of components that interact with an adapter (such as an Oracle database or Java Messaging Service providers).
Application delivery channel description	<p>An application is a party that you assign to an agreement. This enables the party to participate in an integration with another party. Each application uses an adapter that enables communication between parties (with their different interfaces) and Oracle Application Server ProcessConnect.</p> <p>You also create an application delivery channel for an adapter. Delivery channels describe delivery, security, and endpoint details for messages delivered between parties.</p> <p>This section briefly describes delivery channel parameters and provides references to the delivery channel parameters you must define for an adapter.</p> <p>See Also: "Creating an Application Delivery Channel" on page 15-14</p>

Table 8–1 (Cont.) Adapter Details Overview

Section	Description
Adapter exchange protocols	<p>Interactions define the communication between the Oracle Application Server ProcessConnect runtime system and various adapters to send and receive data. When you add an interaction, you must typically provide responses to a series of questions. The questions that display are based on the type of adapter exchange protocol you select. Adapter exchange protocols are an adapter's logical grouping of interactions and represent the unique actions that can be performed with a specific adapter.</p> <p>This section describes the adapter exchange protocols supported by an adapter and provides references to the interaction questions you must answer for an adapter.</p> <p>See Also: "Adding an Adapter Interaction" on page 11-7</p>
Design-time tasks	This section provides an overview of design-time tasks and Oracle record element conventions for an adapter. The Oracle record represents the input or output to an adapter interaction.
Interaction and record naming restrictions	This section describes interaction and record naming restrictions for an adapter.
Errors	This section describes adapter errors.
Validation prerequisites	This section describes any adapter requirements to satisfy before an adapter can be included in a successfully validated and deployed configuration.
Additional setup tasks	This section describes adapter setup tasks to perform in addition to the delivery channel parameter and interaction question tasks that you perform with the Oracle Application Server ProcessConnect user interface tool.
Application integration and runtime behavior	This section describes additional application integration tasks for most adapters, such as any schema objects you must create to use an adapter.
Limitations	This section describes any adapter limitations.
Diagnostics and troubleshooting	This section describes logging diagnostics and procedures for troubleshooting adapter problems.
Use case	This section provides an example of using an adapter.

See Also: The Interaction and Record Naming Restrictions sections in this chapter for details about any event map requirements for your adapter

Adapter-Related Tasks in User Interface Tool

This chapter references adapter-related tasks that you perform with the Oracle Application Server ProcessConnect user interface tool. These tasks are described in other sections of this User Guide. This section provides a graphical, high-level overview of these tasks using the File/FTP adapter as an example. Similar tasks must be performed to use other technology adapters with Oracle Application Server ProcessConnect.

Create a Delivery Channel

A delivery channel describes the communication capabilities (such as message exchange and security details) of a specific adapter. Each adapter has its own unique delivery channel parameters that you must define. [Figure 8-1](#) shows the parameters to define for the File/FTP adapter.

Figure 8-1 Create a Delivery Channel

Create Delivery Channel

Application **ExpenseApp**

Please enter the delivery channel parameter(s) and choose Apply.

* Indicates required field

* Name	<input type="text"/>
File or FTP mode	File <input type="button" value="v"/> <small>(Default Value = File)</small>
FTP server hostname (FTP mode only)	<input type="text"/>
FTP server port (FTP Mode only)	21 <small>(Default Value = 21)</small>
Polling interval in milliseconds (inbound)	60000 <small>(Default Value = 60000)</small>
FTP server username (FTP mode only)	<input type="text"/>
FTP server password (FTP mode only)	<input type="text"/>
Base directory	<input type="text"/>

See Also: ["Creating an Application Delivery Channel"](#) on page 15-14 for instructions on adding delivery channels for all adapters

Add an Interaction

You select an adapter exchange protocol for which to add an interaction on the Add Interaction: Select Interaction page, as shown in [Figure 8-2](#). For this example, the ReadFile(FileRecord) adapter exchange protocol of the File/FTP adapter is selected.

Figure 8-2 Add an Interaction

Add Interaction: Select Interaction

Please select the interaction to add.

[Expand All](#) | [Collapse All](#)

⊕ Adapter Exchange Protocols	
Focus Item	
▼	Adapter Exchange Protocols
⊕	▼ Inbound
⊕	▼ File
	Read File(FileRecord)
⊕	▼ Outbound
⊕	▼ File
	Write File(FileRecord)

Note: The File portion of the (FileRecord) adapter exchange protocol name in [Figure 8-2](#) is replaced with a content type you select when adding an interaction. For example, if you specify xml as the content type, the interaction name includes (xmlRecord) as part of the interaction name (as shown in [Figure 8-7](#) on page 8-9). This convention is followed by several technology adapters.

You then provide answers to adapter interaction questions when prompted, as shown in [Figure 8-3](#).

Figure 8-3 Add Interaction Questions

Add Interaction: Questions - Read File

Please answer each interaction question. Supply information about incoming files

Directory (relative path) for incoming files

Maximum number of files to read for each poll

* File extension for the incoming files - for example, .txt

More than one page of questions can appear depending on the adapter exchange protocol selected.

See Also: "Adding an Adapter Interaction" on page 11-7 for instructions on adding adapter interactions for each adapter

Create and View the Native and Application Events and Body Elements

After you create your adapter interaction (and its Oracle records), you create a native event and its body elements, select a translator, and create an application event and its body elements through a wizard-based tool. You can perform these tasks during the same session in which you add your adapter interaction or during a separate session. After completing these tasks, you can view the results from the details pages of the native event type. The **Event Body Elements** section enables you to view the Oracle records created from your application's wire message contents, as shown in [Figure 8-4](#).

Figure 8-4 Native Event Details

Native Event Type Details : expense Delete

Details

Name **expense**
 Application Event [expense](#)
 Record Type [xmlRecord](#)
 Description

Event Map

Condition **Unspecified** Create

Event Body Elements

Name	Record Type Element
PAYLOAD	PAYLOAD

The details page of a record element type is available from the **Record Type Element** column, as shown in [Figure 8-5](#).

Figure 8-5 Record Element Type Details

Record Type Element Details: PAYLOAD

Details	
Name	PAYLOAD
Value Type	blob
Native Format	XSD
Extractor	XSD
Description	<div style="border: 1px solid black; height: 40px; width: 100%;"></div>

You can view the following details from this page:

- A record type element has a particular native format (either XSD, data definition description language (D3L), or token substituted text). In this example, the native format is XSD.
- A record element has a value type (either XML, CLOB, or BLOB) with the following restrictions:
 - D3L is only used for value type BLOB.
 - The value type XML is only used with the XSD native format.
 In this example, the value type is **BLOB**.

You can also view the application event details, including the application datatypes created from your application’s wire message contents, as shown in [Figure 8-6](#).

Figure 8-6 Application Event Details

Application Event Type Details : expense Delete Update

Details

Name **expense**

Description

State **Draft**

Event Body Elements Return to Top Create

Expand All | Collapse All

⊕ Event Body Elements

Focus	Name	Type	Datatype	Cardinality	Update	Delete
▼	Event Body Elements					
⊕	▼ PAYLOAD		expense_type			
⊕	▶ employee	Compound	employee_type	[1, 1]		
	costcenter	Scalar	string			
	purpose	Scalar	string			
⊕	▶ lineitem	Compound	lineitem_type	[1, 1]		
	status	Scalar	string			
	id	Scalar	integer			

See Also:

- ["Viewing a Native Event Type"](#) on page 11-42
- ["Viewing a Record Type Element"](#) on page 11-43
- ["Viewing Application Event Types"](#) on page 11-60

View the Interaction

The interaction you added in "[Add an Interaction](#)" on page 8-5 can be viewed from the Interaction page. As part of the interaction name, any IN (inbound) and OUT (outbound) records associated with the interaction appear. In [Figure 8-7](#), the File/FTP adapter has a single IN record in the inbound direction (**xmlRecord**).

Figure 8-7 Interaction Results

Interactions

This shows the interactions defined in the system. Please choose Add to add an interaction.

[Add](#)

[Expand All](#) | [Collapse All](#)

⊕ Adapter Providers

Focus Item	Delete
▼ Adapter Providers	
⊕ ▼ Oracle	
⊕ ▶ B2B Adapter	
⊕ ▼ AQ Adapter	
⊕ ▼ Oracle DB Adapter	
⊕ ▼ JMS Adapter	
⊕ ▼ File/FTP Adapter	
⊕ ▼ File	
Read File - inbound(xmlRecord)	
⊕ ▼ HTTP Adapter	
⊕ ▼ E-Mail Adapter	
⊕ ▼ Web Service Adapter	
⊕ ▶ Oracle IP Development team	

Clicking this interaction displays the details page shown in [Figure 8-8](#). Any IN and OUT records of the interaction appear (for this example, IN record **xmlRecord**).

Figure 8-8 Interaction Details

Interaction Details : Read File - inbound

Details

Name	Read File - inbound
Adapter Exchange Protocol	File
Group Name	
Is Inbound	True
In Record Type	<u>xmlRecord</u>

Interaction Parameters

Parameter	Value
MaxMessages	1
DirectorySuffix	inbound
FileExtension	xml

Clicking the **xmlRecord** IN record type of the interaction displays the details page, as shown in [Figure 8–9](#). The native datatypes and native event type of this record appear.

Figure 8–9 IN Record Details

Record Type Details : xmlRecord

Details

Name	xmlRecord
Revision	
Description	<div style="border: 1px solid gray; height: 40px; width: 100%;"></div>

Record Type Elements

Name	Datatype
PAYLOAD	

Native Event Types

Name	Delete
expense	

The record type element in [Figure 8–9](#) can display its native datatypes in the **Datatype** section. Some adapters, such as the Oracle Database, Advanced Queuing, and Web Service adapters, automatically detect the native datatypes when an interaction is added. This means that when you are creating a native event that uses this interaction, you are not prompted to specify a native datatype format file. Other adapters, such as the File/FTP adapter, do not detect the native datatypes. Instead, you are prompted to specify a native datatype format file during native event creation.

The page provides a definition of the native datatypes, including the file name.

After completing these tasks, you have defined the delivery channel and adapter interaction parameters to include in your integration.

See Also:

- ["Creating Native and Application Event Types and Body Elements"](#) on page 11-27
- ["Viewing an Adapter Interaction"](#) on page 11-36
- ["Viewing a Record Type Element"](#) on page 11-43

Native Formats and Value Types

Oracle Application Server ProcessConnect provides support for the native formats shown in [Table 8–2](#). The value types supported by each native format are also listed. The native formats and content types supported by each adapter are described throughout this chapter.

Table 8–2 Native Formats and Supported Value Types

Native Format	XML Value Type	CLOB Value Type	BLOB Value Type
XSD	Yes	Yes	Yes
Token substituted text	No	Yes	Yes
D3L	No	No	Yes

Advanced Queuing Adapter

This section provides details about using the Advanced Queuing adapter. This section contains these topics:

- [Benefits of Using the Advanced Queuing Adapter](#)
- [Advanced Queuing Adapter Supported Versions](#)
- [Advanced Queuing Adapter Application Delivery Channel Description](#)
- [Advanced Queuing Adapter Exchange Protocols](#)
- [Advanced Queuing Adapter Design-Time Tasks](#)
- [Advanced Queuing Adapter Interaction and Record Naming Restrictions](#)
- [Advanced Queuing Adapter Errors](#)
- [Advanced Queuing Adapter Validation Prerequisites](#)
- [Advanced Queuing Adapter Additional Setup Tasks](#)
- [Advanced Queuing Adapter Application Integration and Runtime Behavior](#)
- [Advanced Queuing Adapter Limitations](#)
- [Advanced Queuing Adapter Diagnostics and Troubleshooting](#)
- [Advanced Queuing Adapter Use Case](#)

See Also: ["Layout of Adapter Details in this Chapter"](#) on page 8-2 for an overview of topics covered for each adapter in this chapter

Benefits of Using the Advanced Queuing Adapter

The Advanced Queuing adapter enables applications to communicate asynchronously with Oracle Application Server ProcessConnect over a reliable, scalable, and secure communication channel. Oracle advanced queuing provides an extremely flexible mechanism for bidirectional, asynchronous communication between participating applications. Application location is transparent, using any number of Oracle's connectivity options, including OCI, JDBC, or PL/SQL. Both XML and non-XML message payloads are supported.

Reliable, Scalable Asynchronous Communication

Since advanced queues are an Oracle database feature, they are extremely scalable and reliable. Backup and recovery (including any-point-in-time recovery), logging, transactional services, and system management are all inherent features of the database and, therefore, advanced queues. Multiple queues can also service a single application, partitioning messages in a variety of ways and providing another level of scalability through load balancing.

Application Location Transparency

Application integration is possible, regardless of the application location. Since advanced queuing is a database feature, the services (API) are accessible through many languages and platforms, including Oracle Call Interface (OCI), JMS through JDBC, and PL/SQL. Complete bidirectional messaging propagation is supported.

Support for both XML and Non-XML Message Payloads

Oracle advanced queues and the Advanced Queuing adapter support both XML and non-XML payload types. Message payloads can be defined in XML and a set of XML utilities and services are now available as features of the database. Non-XML payloads can be defined using Oracle Abstract Data Types (ADTs), or as SQL data structures. In all cases, the payload definitions can be defined, stored, and accessed in the Oracle Catalog and shared across the enterprise.

Note: This description does not suggest that the Advanced Queuing adapter supports the XMLType queue payload type; only that the supported RAW or Object (ADT) type queues can contain either XML or non-XML payloads due to the inherent support for these different formats in the Oracle Application Server ProcessConnect translator layer.

Security

Oracle provides an array of security models and options for authentication, authorization, and encryption. Since Advanced Queues are part of the database, the security model is sharable across the enterprise with different applications and user groups. The Advanced Queuing adapter fully supports all these security options.

Advanced Queuing Adapter Supported Versions

The Advanced Queuing adapter supports Oracle database server versions 8.1.7, 9.0.1.4, and 9.2 as the application (spoke) database. The application database is (but does not need to be) a separate database from the Oracle Application Server Metadata Repository. This repository contains the Oracle Application Server ProcessConnect schema and modeling metadata and profile data that you create with the Oracle Application Server ProcessConnect user interface tool.

Advanced Queuing Adapter Application Delivery Channel Description

You must create a delivery channel to interact with the application database server by specifying a series of parameters that describe Advanced Queuing adapter connection information, including database server hostname and JDBC driver details, a connection username and password, the time between connection retries, and a schema name for the queues being accessed in the database server. These parameter details comprise the delivery channel.

See Also: ["Creating an Advanced Queuing Adapter Delivery Channel"](#) on page 15-16 for the list of parameters you specify to create a delivery channel

Advanced Queuing Adapter Exchange Protocols

[Table 8-3](#) identifies and describes when to use the Advanced Queuing adapter exchange protocols. Each adapter exchange protocol operates in the inbound and outbound directions.

Table 8-3 *Advanced Queuing Adapter Exchange Protocols - Inbound and Outbound Directions*

Inbound and Outbound Direction	Description
RAW Queue	This protocol interacts with RAW advanced queuing queues.
Oracle Object Queue	This protocol interacts with Oracle object queues, where the Oracle object type, also known as an ADT, is the payload.
Oracle Object Queue with payload fields	This protocol interacts with object queues, where one or more large object (LOB)-type fields of the ADT carry a payload.

See Also:

- ["Adapter Interactions"](#) on page 3-19 for conceptual details about interactions and adapter exchange protocols
- ["Adding an Advanced Queuing Adapter Interaction"](#) on page 11-11 for instructions on selecting an adapter exchange protocol during an interaction and for the list of interaction questions to which to respond

Advanced Queuing Adapter Design-Time Tasks

[Table 8–4](#) provides examples of the naming conventions for Advanced Queuing adapter exchange protocols in the Oracle Application Server ProcessConnect user interface tool. The information appearing under the User Interface Naming Convention column is the interaction groups and interaction descriptions (names).

Table 8–4 Advanced Queuing Adapter Naming Conventions

Adapter Exchange Protocol	User Interface Naming Convention
Inbound	Queue names adhere to the following convention when displaying in the user interface tool:
<ul style="list-style-type: none"> ■ RAW Queue 	Queues that begin with R. R Dequeue from RAW_QUEUE(Message)
<ul style="list-style-type: none"> ■ Oracle Object Queue 	Queues that begin with E. E Dequeue to EXPENSE_QUEUE(Message)
<ul style="list-style-type: none"> ■ Oracle Object Queue with Payload Fields 	Queues that begin with N. N Dequeue from NOTIFICATION_QUEUE(Message)
<ul style="list-style-type: none"> ■ RAW Queue 	Queues that begin with R. R Enqueue to RAW_QUEUE(Message)
<ul style="list-style-type: none"> ■ Oracle Object Queue 	Queues that begin with E. E Enqueue to EXPENSE_QUEUE(Message)
<ul style="list-style-type: none"> ■ Oracle Object Queue with payload fields 	Queues that begin with N. N Enqueue to NOTIFICATION_QUEUE(Message)

[Table 8–5](#) describes RAW Queue record element naming conventions.

Table 8–5 RAW Queue Record Element Naming Conventions

Record Element Name	Description	Value Type	Definition Provided By User or Adapter	Native Datatype Name for Adapter-Provided Definition	Native Format Restrictions
AQ-Headers	Includes the advanced queuing headers	XML	Adapter	AQ-Headers	XSD only
Payload	The advanced queuing payload to enqueue or dequeue	BLOB	User	None	None

[Table 8–6](#) describes Oracle Object Queue record element naming conventions.

Table 8–6 Oracle Object Queue Record Element Naming Conventions

Record Element Name	Description	Value Type	Definition Provided By User or Adapter	Native Datatype Name for Adapter-Provided Definition	Native Format Restrictions
AQ-Headers	Includes the advanced queuing headers	XML	Adapter	AQ-Headers	XSD only
<i>Object_Type_Name_</i> Payload	The advanced queuing payload to enqueue or dequeue	XML	Adapter	<i>Object_Type_Name_</i> Payload	XSD only

Table 8-7 describes Oracle Object Queue with Payload Fields record element naming conventions.

Table 8-7 Oracle Object Queue with Payload Fields Record Element Naming Conventions

Record Element Name	Description	Value Type	Definition Provided By User or Adapter	Native Datatype Name for Adapter-Provided Definition	Native Format Restrictions
AQ-Headers	Includes the advanced queuing headers	XML	Adapter	AQ-Headers	XSD only
<i>Object_Type_Name_Headers</i>	Includes the nonpayload fields of the object type	XML	Adapter	<i>Object_Type_Name_Headers</i>	XSD only
<i>Payload_Field_Name</i>	For each payload field of the object type, there is a record element	BLOB if the payload field has a binary datatype CLOB if the payload field has a string datatype	User	None	If the value type is CLOB, then D3L cannot be used.
...					¹

¹ There can be one to *n* record elements, where *n* is any number.

See Also: ["Wire Messages and Oracle Records"](#) on page 3-17 for conceptual details about Oracle records.

Advanced Queuing Adapter Interaction and Record Naming Restrictions

You cannot have two queues with the same name in different schemas if the queues have different structures. This causes the record names to be the same.

See Also: ["Advanced Queuing Adapter Design-Time Tasks"](#) on page 8-15 for additional details on record naming

Advanced Queuing Adapter Errors

[Table 8–8](#) lists when Advanced Queuing adapter errors occur and how they are handled by the adapter.

Table 8–8 Advanced Queuing Adapter Errors

An Error Occurs While...	Adapter Error Handling Behavior
Establishing a connection	<p>Displays the following error: <code>CouldNotConnect</code></p> <p>At design time, it displays the error immediately without any retrying.</p> <p>At runtime, for the outbound case, the error appears in the log file. The Advanced Queuing adapter does not try to re-establish the connection; the adapter framework performs this task. For the inbound case, the adapter attempts to reconnect as often as you specified for connection retries when you created the delivery channel.</p> <p>See Also: "Creating an Advanced Queuing Adapter Delivery Channel" on page 15-16</p>
Enqueuing	Logs an error code initiated by JAQ or JDBC

Native Event Validation Failure

If native event validation fails for an inbound event, the Advanced Queuing adapter discards the message, since this kind of validation error is unrecoverable. However, the Oracle Application Server ProcessConnect runtime has already made a copy of the message available in memory for subsequent diagnostic analysis.

Advanced Queuing Adapter Validation Prerequisites

You can test the validity of the Advanced Queuing adapter delivery channel parameters against a running database by establishing a SQL*Plus connection. Enter the follow command from the command line prompt:

```
sqlplus "username/password@(DESCRIPTION=(ADDRESS=(PROTOCOL=tcp) \
(HOST=hostname)(PORT=port)))(CONNECT_DATA=(SERVICE_NAME=SID))"
```

Advanced Queuing Adapter Additional Setup Tasks

This section describes setup tasks to perform in addition to the delivery channel parameter and interaction question tasks that you perform with the Oracle Application Server ProcessConnect user interface tool.

This section contains the following sections:

- [Queue Runtime State](#)
- [Queue Privileges](#)

Queue Runtime State

The Advanced Queuing adapter only enables you to configure queues that it can find in the database at design time. At runtime, the queues must be in the `STARTED` state.

Queue Privileges

Ensure that you can access the queues. The `admin` user automatically created during Oracle Application Server ProcessConnect installation can access the queues owned by another user.

For example, assume user `Username` accesses a queue named `QueueName` owned by user `Schema`. `QueueName` is an Oracle object type queue, and its underlying queue table is `QueueTableName`. The Oracle object type is `QueueADT`, and it is owned by `ADT_owner`. (`QueueName` and `QueueTableName` must exist in the same schema.)

For this example, the minimum set of database privileges and grants assigned to or issued from the mentioned database users are as follows:

Oracle Object Type Owner (`ADT_owner`)

The following grants are necessary if the queue is an Oracle object type queue, and `Schema` and `ADT_owner` are different. The roles and privileges must be assigned to user `ADT_owner`, while the grants are executed as user `ADT_owner`.

- **Role:** `CONNECT`
- **Privilege:** `CREATE TYPE`
- **Grant:** `GRANT EXECUTE ON QueueADT TO Schema`
- **Grant:** `GRANT EXECUTE ON QueueADT TO Username` (Must be performed by `Schema` if this user owns the ADT.)

Queue Owner (assuming it's owned by Schema, not Username)

- Role: CONNECT
- Role: RESOURCE
- Role: AQ_ADMINISTRATOR_ROLE
- Grant: GRANT SELECT ON QueueTableName TO Username
- Grant: GRANT UPDATE ON QueueTableName TO Username
- Grant: DBMS_AQADM.GRANT_QUEUE_PRIVILEGE (privilege => 'DEQUEUE', queue_name => ' QueueName', grantee => ' Username' , grant_option => FALSE);
- Grant: DBMS_AQADM.GRANT_QUEUE_PRIVILEGE (privilege => 'ENQUEUE', queue_name => ' QueueName', grantee => ' Username', grant_option => FALSE);

Queue Owner (if queue owned by Username; that is, Username = Schema)

- Role: CONNECT
- Grant (from SYS): GRANT EXECUTE ON SYS.DBMS_AQIN TO Username (Must be performed by Schema if this user owns the ADT.)

Advanced Queuing Adapter Application Integration and Runtime Behavior

When Oracle Application Server ProcessConnect invokes an outbound interaction, messages are enqueued to an Oracle advanced queue for all adapter exchange protocols.

For inbound interactions, the Oracle Advanced Queuing adapter creates a configurable number of threads for each queue and dequeues (blocking) from each queue. Whenever a message is dequeued, the Oracle Advanced Queuing adapter creates an inbound record whose name is based on the naming convention shown in [Table 8-9](#):

Table 8-9 *Advanced Queuing Adapter Naming Conventions*

Adapter Exchange Protocol	Oracle Record Name
RAW Queue	RAW_Record
Oracle Object Queue	<i>object_type_name_Record</i>
Oracle Object Queue with payload fields	<i>object_type_name_Record</i>

Advanced Queuing Adapter Limitations

As described in "[Advanced Queuing Adapter Additional Setup Tasks](#)" on page 8-19, the advanced queuing queue and the associated queue table must reside in the same schema.

For the two Oracle object type-based adapter exchange protocols, the following field (column) types are not supported:

- PLSQL_INDEX_TABLE
- JAVA_OBJECT
- JAVA_STRUCT
- BFILE
- REF
- OPAQUE
- XMLTYPE

The following advanced queuing-specific features are not supported:

- Nonpersistent queues
- Rules
- Advanced queuing global queues/topics

See Also: "[Advanced Queuing Adapter Interaction and Record Naming Restrictions](#)" on page 8-17 for details about queue naming restrictions

Advanced Queuing Adapter Diagnostics and Troubleshooting

The Advanced Queuing adapter logs diagnostic messages to the Oracle Application Server ProcessConnect log files in the following situations:

- When a connection is established
- After a message is enqueued
- When an error occurs while enqueueing
- When an error occurs while dequeueing
- When an XML message cannot be parsed or does not match an Oracle object

The Advanced Queuing adapter does not log diagnostic messages outside of Oracle Application Server ProcessConnect.

The configuration parameter logging level must be set to `error` (the default setting) for these errors to appear in the log files.

See Also: ["Oracle Application Server ProcessConnect Middle-Tier Instance Configuration Parameters"](#) on page 18-11 for instructions on accessing the configuration parameters through Oracle Enterprise Manager

Common Problems and Errors in the Log File and Their Solutions

The following Problem-Solution pairs make references to database users `Username` and `Schema` (defined in ["Queue Privileges"](#) on page 8-19) and to the delivery channel database connection properties for the hostname, TNS listener port number, and instance name of the application (spoke) database.

Problem:

```
MessageWriter_enqueue: Could not enqueue message due to database error
java.sql.SQLException: ORA-01031: insufficient privileges ORA-06512: at
"SYS.DBMS_LOB", line 708 ORA-06512: at line 1
```

Solution:

The database user `Username` does not have `UPDATE` permissions on the queue table.

Problem:

```
Adapter does not support the interaction description: Enqueue to
<chosen-queue>(Message)
Adapter does not support the interaction description: Dequeue to
<chosen-queue>(Message)
```

Solution:

There are two potential explanations. The database user `Username` is either lacking `SELECT` permissions on the queue table or `EXECUTE` permissions on the queue ADT (if it is an Oracle Object type queue).

Problem:

Adapter does not support the interaction description: Dequeue to <chosen-queue>(Message)

Solution:

Verify that user Username has been granted DEQUEUE permissions on the queue by user Schema.

Problem:

Adapter does not support the interaction description: Enqueue to <chosen-queue>(Message)

Solution:

Verify that user Username has been granted ENQUEUE permissions on the queue by user Schema.

Problem:

```
oracle.AQ.AQOracleSQLException: ORA-01031: insufficient privileges ORA-06512: at
"SYS.DBMS_AQIN", line 267 ORA-06512: at line 1 at
oracle.AQ.AQOracleQueue.enqueue(AQOracleQueue.java:1236)
```

Solution:

Verify that user Username has been granted ENQUEUE permissions on the queue by user Schema.

Problem:

```
oracle.AQ.AQOracleSQLException: ORA-06550: line 1, column 7: PLS-00201:
identifier 'DBMS_AQIN' must be declared
ORA-06550: line 1, column 7: PL/SQL: Statement ignored at
oracle.AQ.AQOracleQueue.enqueue(AQOracleQueue.java:1236)
```

Solution:

Username must be granted EXECUTE on PL/SQL package SYS.DBMS_AQIN by the SYS user.

Problem:

```
DBConnection_connect: database error while try to connect to
jdbc:oracle:thin:@(description=(address=(host=bstern-sun)(protocol=tcp)
(port=1522))(connect_data=(sid=iasdb))) java.sql.SQLException: Io exception: The
Network Adapter could not establish the connection at
oracle.jdbc.dbaccess.DBError.throwSQLException(DBError.java:185)
```

or

```
java.sql.SQLException: ORA-12545: Connect failed because target host or object
does not exist at
oracle.jdbc.dbaccess.DBError.throwSQLException(DBError.java:185)
```

or

```
java.sql.SQLException: ORA-12541: TNS:no listener at
oracle.jdbc.dbaccess.DBError.throwSQLException(DBError.java:185)
```

Solution:

One or both of the database connection parameters for the spoke database hostname or spoke database TNS listener port number are incorrect.

Problem:

```
DBConnection_connect: database error while try to connect to
jdbc:oracle:thin:@(description=(address=(host=bstern-sun)(protocol=tcp)
(port=1521))(connect_data=(sid=iasdbb)))
java.sql.SQLException: Io exception: Connection
refused(DESCRIPTION=(TMP=)(VSNNUM=150999808)(ERR=12505)(ERROR_
STACK=(ERROR=(CODE=12505)(EMFI=4)))) at
oracle.jdbc.dbaccess.DBError.throwSQLException(DBError.java:185)
```

or

```
DBConnection_connect: database error while try to connect to
jdbc:oracle:oci:@(description=(address=(host=bstern-sun)(protocol=tcp)
(port=1521))(connect_data=(sid=iasdbb)))
java.sql.SQLException: ORA-12505: TNS:listener could not resolve SID given in
connect descriptor at
oracle.jdbc.dbaccess.DBError.throwSQLException(DBError.java:185)
```

Solution:

The database connection property instance is incorrect.

Problem:

```
java.sql.SQLException: ORA-01045: user AQAPP2 lacks CREATE SESSION privilege;  
logon denied at oracle.jdbc.dbaccess.DBError.throwSQLException(DBError.java:185)
```

Solution:

The database user Username has not been granted the CONNECT role.

Problem:

```
java.sql.SQLException: ORA-01017: invalid username/password; logon denied at  
oracle.jdbc.dbaccess.DBError.throwSQLException(DBError.java:185)
```

Solution:

Username, Password, or both are incorrect.

Problem:

```
oracle.AQ.AQOracleSQLException: ORA-25207: enqueue failed, queue AQAPP.ECX_  
OUTQUEUE2 is disabled from enqueueing  
ORA-06512: at "SYS.DBMS_AQIN", line 267  
ORA-06512: at line 1  
at oracle.AQ.AQOracleQueue.enqueue(AQOracleQueue.java:1236)
```

Solution:

The Advanced Queuing queue has not been started.

Problem:

```
oracle.AQ.AQException: JMS-190: Queue AQAPP.ECX_OUTQUEUE3 not found at  
oracle.AQ.AQUtil.throwAQEx(AQUtil.java:196) at  
oracle.AQ.AQOracleSession.getQueue(AQOracleSession.java:629)
```

Solution:

The Advanced Queuing queue no longer exists.

Problem:

```
MessageWriter_getEnqueueObjectFromXML: Parse exception while building enqueue
object: Element 'PAYLOAD' not expected. MessageWriter_enqueue: Could not enqueue
message as it cannot be XML parsed according to it's definition
oracle.xml.parser.v2.XMLParseException: Element 'PAYLOAD' not expected.
```

Solution:

The name of the actual payload column of the queue ADT in the database does not match the Oracle Application Server ProcessConnect metadata ('PAYLOAD' in the example).

Problem:

```
AQDequeueerAdtLOB_raiseInboundInteraction: Exception while raising inbound AdtLOB
interaction javax.resource.ResourceException: Received native event PROCESS_PO_
007 but no inbound metadata has been defined for it. at
oracle.tip.adapter.aq.inbound.AQDequeueer.lookupInteraction
MetaData(AQDequeueer.java:288)
```

Solution:

The root element of message payload (in the PAYLOAD column) does not match any of the registered inbound interactions with the adapter. Ensure that there is a seeded inbound interaction for the native event (PROCESS_PO_007 in the example).

See Also: ["Oracle Application Server ProcessConnect Middle-Tier Instance Configuration Parameters"](#) on page 18-11 for instructions on accessing the configuration parameters through Oracle Enterprise Manager

Advanced Queuing Adapter Use Case

This section provides a brief example of the types of delivery channel and interaction details you must specify to use an Advanced Queuing adapter. For this example, the details are specified for an application named InventoryApp.

Delivery Channel Questions

[Figure 8–10](#) shows the delivery channel details specified for the Advanced Queuing adapter of the InventoryApp application.

Figure 8–10 *Creating an Advanced Queuing Adapter Delivery Channel*

* Name	<input type="text" value="InventoryAppDC"/>
JDBC driver to use to connect to Database (Thin/Oci)	<input type="text" value="Thin"/> <small>(Default Value = Thin)</small>
Database SID (if Thin) or TNS alias (if Oci)	<input type="text" value="or9202"/> <small>(Default Value = ORCL)</small>
Database host name (if Thin)	<input type="text" value="incq234a.idc.oracle.com"/>
Database TNS listener port (if Thin)	<input type="text" value="1521"/>
Number of milliseconds between connection retries	<input type="text" value="15000"/> <small>(Default Value = 15000)</small>
Username for connecting to the spoke Database	<input type="text" value="webstore123"/>
Password for connecting to the spoke Database	<input type="password" value="*****"/>
Name of Database schema where queues are located	<input type="text" value="webstore123"/>

See Also: ["Creating an Advanced Queuing Adapter Delivery Channel"](#) on page 15-16 for specific details about creating an Advanced Queuing adapter delivery channel

Interaction Questions

The Advanced Queuing adapter requires that you initially log in to the application (spoke) database with the credentials specified in the delivery channel created in [Figure 8–10](#) on page 8-27. Click InventoryAppDC to access the database, as shown in [Figure 8–11](#). If successful, inbound and outbound adapter exchange protocols display for selection, as shown in [Figure 8–12](#). If not, an error message appears and the delivery channel parameters shown in [Figure 8–10](#) appear on-screen, enabling you to take corrective actions.

Figure 8–11 Advanced Queuing Adapter Delivery Channel Selection

Add Interaction: Select Delivery Channel

Please select the delivery channel for the adapter type selected. This delivery channel will be used to browse the application's interactions.

[Expand All](#) | [Collapse All](#)

⊕ Applications	
Focus Item	
▼ Applications	
⊕ ▼ InventoryApp	
	InventoryAppDC

[Figure 8–12](#) shows the Enqueue to INVENTORYRECEIVERQ(Message) adapter exchange protocol to add for outbound interactions with the Advanced Queuing adapter:

Figure 8–12 Advanced Queuing Adapter Exchange Protocols

Add Interaction: Select Interaction

Please select the interaction to add.

[Expand All](#) | [Collapse All](#)

⊕ Adapter Exchange Protocols	
Focus Item	
▼ Adapter Exchange Protocols	
⊕ ▶ Inbound	
⊕ ▼ Outbound	
⊕ ▼ RAW Queue	
⊕ ▼ Queues that begin with I	
	Enqueue to INVENTORYRECEIVERQ(Message)
⊕ ▼ Oracle Object Queue	
⊕ ▼ Oracle Object Queue with payload fields	

Figure 8–13 shows the interaction details to specify for the **INVENTORYRECEIVERQ(Message)** adapter exchange protocol of the HTTP adapter in the outbound direction.

Figure 8–13 *Creating an Advanced Queuing Adapter Outbound Interaction*

Add Interaction: Questions - Questions for RAW Queue

Please answer each interaction question. Please provide the following information.

Queue "INVENTORYRECEIVERQ" is a multi consumer queue. Please specify recipients as a comma separated list

Figure 8–14 shows the **INVENTORYRECEIVERQ(RAW_Record)** outbound direction adapter exchange protocol after creation. Click this adapter exchange protocol for additional details. Note the original name of **Message** shown in Figure 8–12 on page 8-28 has been replaced with **RAW_Record**. This is because you selected a RAW Queue adapter exchange protocol in Figure 8–12.

Figure 8–14 *Advanced Queuing Adapter Outbound Adapter Exchange Protocol*

Interactions

This shows the interactions defined in the system. Please choose Add to add an interaction.

Add

Expand All | Collapse All

⊕ Adapter Providers

Focus Item	Delete
▼ Adapter Providers	
⊕ ▼ Oracle	
⊕ ▶ B2B Adapter	
⊕ ▼ AQ Adapter	
⊕ ▼ RAW Queue	
⊕ ▼ Queues that begin with I	
Enqueue to INVENTORYRECEIVERQ(RAW_Record)	🗑
⊕ ▶ Oracle DB Adapter	
⊕ ▶ JMS Adapter	
⊕ ▼ File/FTP Adapter	
⊕ ▶ HTTP Adapter	
⊕ ▼ E-Mail Adapter	
⊕ ▼ Web Service Adapter	

See Also: ["Adding an Advanced Queuing Adapter Interaction"](#) on page 11-11 for specific details about creating inbound and outbound Advanced Queuing adapter interactions

E-Mail Adapter

This section provides details about using the E-Mail adapter. This section contains these topics:

- [Benefits of Using the E-Mail Adapter](#)
- [E-Mail Adapter Supported Versions](#)
- [E-Mail Adapter Application Delivery Channel Description](#)
- [E-Mail Adapter Exchange Protocols](#)
- [E-Mail Adapter Design-Time Tasks](#)
- [E-Mail Adapter Interaction and Record Naming Restrictions](#)
- [E-Mail Adapter Errors](#)
- [E-Mail Adapter Validation Prerequisites](#)
- [E-Mail Adapter Additional Setup Tasks](#)
- [E-Mail Adapter Application Integration and Runtime Behavior](#)
- [E-Mail Adapter Limitations](#)
- [E-Mail Adapter Diagnostics and Troubleshooting](#)
- [E-Mail Adapter Use Case](#)

See Also: ["Layout of Adapter Details in this Chapter"](#) on page 8-2 for an overview of topics covered for each adapter in this chapter

Benefits of Using the E-Mail Adapter

The E-Mail adapter enables you to integrate an Oracle E-Mail application with other applications using Oracle Application Server ProcessConnect. This adapter is useful in environments where e-mail uses the Internet Message Access Protocol 4 (IMAP4) and SMTP transport protocols.

The E-Mail adapter can monitor inbound messages in the form of e-mail placed on an IMAP server. The E-Mail adapter is also capable of sending messages to SMTP servers.

Figure 8–15 shows how the E-Mail adapter sends and receives messages.

Figure 8–15 E-Mail Adapter

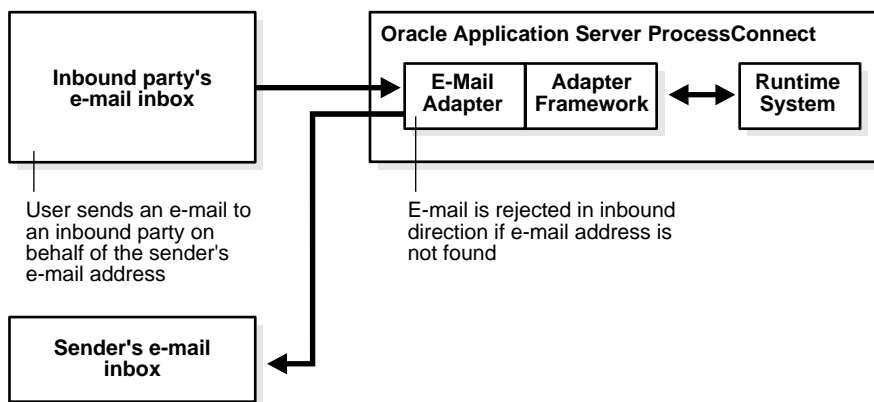

E-Mail Adapter Supported Versions

The E-Mail adapter has been tested with dkimap, an open source IMAP server. Other JavaMail-compliant IMAP4 servers can work with the E-Mail adapter.

E-Mail Adapter Application Delivery Channel Description

You must create a delivery channel to interact with the IMAP server (for inbound interactions) and SMTP server (for outbound interactions) by specifying a series of parameters that describe E-Mail adapter connection information, including SMTP and IMAP server hostnames, IMAP server username and password, SMTP server e-mail addresses, and a polling interval time. These parameter details comprise the delivery channel.

See Also: ["Creating an E-Mail adapter Delivery Channel"](#) on page 15-17 for the list of parameters you specify to create a delivery channel

E-Mail Adapter Exchange Protocols

This section identifies and describes when to use the E-Mail adapter exchange protocols. The E-Mail adapter includes the following outbound (to an SMTP server) and inbound (from an IMAP server) adapter exchange protocols shown in [Table 8-10](#):

Table 8-10 *E-Mail Adapter Exchange Protocols - Inbound Direction*

Direction	Adapter Interaction	Description
Inbound	Receive E-Mail(E-MailRecord)	Reads an inbound e-mail message from an IMAP server.
Outbound	Send E-Mail(E-MailRecord)	Sends an outbound e-mail message to an SMTP server

See Also:

- ["Adapter Interactions"](#) on page 3-19 for conceptual details about interactions and adapter exchange protocols
- ["Adding an E-Mail Adapter Interaction"](#) on page 11-13 for instructions on selecting an adapter exchange protocol during an interaction and for the list of interaction questions to which to respond, including selecting a content type

E-Mail Adapter Design-Time Tasks

This section describes the IN record element and OUT record element naming conventions for each adapter exchange protocol:

- [E-Mail Adapter Outbound Interaction and Record Element Naming Conventions](#)
- [E-Mail Adapter Inbound Interaction and Record Element Naming Conventions](#)

E-Mail Adapter Outbound Interaction and Record Element Naming Conventions

For all outbound interactions with an SMTP server, the interaction name is Send E-Mail. The record name is *content_typeRecord*.

There is no OUT record.

[Table 8-11](#) describes Send E-Mail record element naming conventions for the E-Mail adapter.

Table 8-11 Send E-Mail Outbound Record Element Naming Conventions

Record Element Name	Description	Value Type	Definition Provided By User or Adapter	Native Datatype Name for Adapter-Provided Definition	Native Format Restrictions
Headers	The e-mail header properties for dynamic setting	XML	Adapter	Headers	XSD only
Subject	The e-mail subject text	CLOB	User	None	Cannot be D3L; you typically use token substituted text.
Payload	The body of the e-mail message	Based on answer to Content Type interaction question: <ul style="list-style-type: none"> ▪ regular = CLOB ▪ text attachment = CLOB ▪ binary attachment = BLOB ▪ xml attachment = XML 	User	None	If the value type is CLOB, then D3L cannot be used. If the value type is XML, then only XSD can be used.

See Also: ["E-Mail Adapter Interaction and Record Naming Restrictions"](#) on page 8-35 for details about the content type

E-Mail Adapter Inbound Interaction and Record Element Naming Conventions

For all inbound interactions to an IMAP server, the interaction name is Receive E-Mail. The record name is *content_typeRecord*. There is no OUT record.

[Table 8–12](#) describes Receive E-Mail record element naming conventions for the E-Mail adapter.

Table 8–12 Receive E-Mail Inbound Record Element Naming Conventions

Record Element Name	Description	Value Type	Definition Provided By User or Adapter	Native Datatype Name for Adapter-Provided Definition	Native Format Restrictions
Headers	The header properties from the inbound e-mail	XML	Adapter	Headers	XSD only
Subject	The e-mail subject text	CLOB	User	None	XML or token substituted text
Payload	The body of the e-mail message	Based on answer to Content Type interaction question: <ul style="list-style-type: none"> ▪ regular = CLOB ▪ text attachment = CLOB ▪ binary attachment = BLOB ▪ xml attachment = XML 	User	None	If the value type is CLOB, then D3L cannot be used. D3L can only be used with BLOB. If the value type is XML, then only XSD can be used.

See Also:

- ["E-Mail Adapter Interaction and Record Naming Restrictions"](#) on page 8-35 for details about the content type
- ["Wire Messages and Oracle Records"](#) on page 3-17 for conceptual details about Oracle records

E-Mail Adapter Interaction and Record Naming Restrictions

The record name is created based on the content type you select when adding an interaction. [Table 8-13](#) lists the available content types and their corresponding record names.

Table 8-13 *E-Mail Adapter Interaction and Record Naming Restrictions*

Content Type	Record Name
Regular, text attachment	TextRecord
XML attachment	XMLRecord
Binary attachment	BinaryRecord

If the same record name is used in the inbound and outbound directions due to the same content type being used for both directions, you must define an event map.

See Also: ["Managing Event Maps"](#) on page 11-54

E-Mail Adapter Errors

[Table 8-14](#) lists when E-Mail adapter errors occur and how they are handled by the adapter.

Table 8-14 *E-Mail Adapter Errors*

An Error Occurs While...	Adapter Error Handling Behavior
Establishing an IMAP connection	Displays the following error: <code>CouldNotConnectIMAP</code>
Retrieving mail	Aborts and retries to retrieve e-mail every 30 seconds
Sending mail	Logs an error code from the mail API

E-Mail Adapter Validation Prerequisites

The SMTP server and IMAP server must have valid hostnames.

The e-mail address must use the following form:

`username@domain`

E-Mail Adapter Additional Setup Tasks

Perform the following tasks for E-Mail adapter testing:

1. Ensure that you have an IMAP server username and password account.
2. Ensure that you have an e-mail account to send outbound messages.
3. Oracle recommends that you use a dedicated IMAP account for each e-mail application.

E-Mail Adapter Application Integration and Runtime Behavior

When Oracle Application Server ProcessConnect invokes an outbound interaction for each adapter exchange protocol, a message is sent to the SMTP server.

For inbound interactions, the E-Mail adapter creates a thread monitoring an Inbox you specified during delivery channel creation.

The adapter listens to Inboxes. Whenever a message is received, the adapter creates a record whose name is based on the endpoint information.

E-Mail Adapter Limitations

The E-Mail adapter has the following limitations:

- IMAP with secure socket layer (SSL) is not supported.
- Only IMAP4 is supported. POP3 is not supported.
- If you use multiple adapter framework instances at runtime, ensure that only one adapter framework instance is hosting a given party for receiving e-mail (that is, do not allow more than one adapter framework instance to read from a given IMAP account).

E-Mail Adapter Diagnostics and Troubleshooting

The E-Mail adapter logs diagnostic messages to the Oracle Application Server ProcessConnect log files in the following situations:

- When an IMAP connection is established
- After an e-mail is sent
- When an error occurs while sending an e-mail
- When the IMAP servers being listened to are listed at startup
- When an error occurs while retrieving an e-mail

The E-Mail adapter does not log diagnostic messages outside of Oracle Application Server ProcessConnect.

See Also: ["Managing and Monitoring a Middle-Tier Instance from Oracle Enterprise Manager Application Server Control"](#) on page 18-5 for instructions on setting adapter logging levels with Oracle Enterprise Manager

E-Mail Adapter Use Case

An example of sending an alert e-mail with the E-Mail adapter is provided in "[Alert E-Mail Message Format](#)" on page 21-17.

File/FTP Adapter

This section provides details about using the File/FTP adapter. This section contains these topics:

- [Benefits of Using the File/FTP Adapter](#)
- [File/FTP Adapter Application Delivery Channel Description](#)
- [File/FTP Adapter Exchange Protocols](#)
- [File/FTP Adapter Design-Time Tasks](#)
- [File/FTP Adapter Interaction and Record Naming Restrictions](#)
- [File/FTP Adapter Errors](#)
- [File/FTP Adapter Validation Prerequisites](#)
- [File/FTP Adapter Additional Setup Tasks](#)
- [File/FTP Adapter Application Integration and Runtime Behavior](#)
- [File/FTP Adapter Limitations](#)
- [File/FTP Adapter Diagnostics and Troubleshooting](#)
- [File/FTP Adapter Use Case](#)

See Also: ["Layout of Adapter Details in this Chapter"](#) on page 8-2 for an overview of topics covered for each adapter in this chapter

Benefits of Using the File/FTP Adapter

The FTP adapter enables you to integrate an Oracle FTP application with other applications using Oracle Application Server ProcessConnect. This adapter is useful in all environments involving the FTP transport protocol or local file system. The FTP adapter can monitor inbound messages in the form of FTP files placed on a remote FTP server or on local file systems. The FTP adapter also sends files to remote FTP servers.

Figure 8–16 shows how the File/FTP adapter sends and receives files.

Figure 8–16 File/FTP Adapter

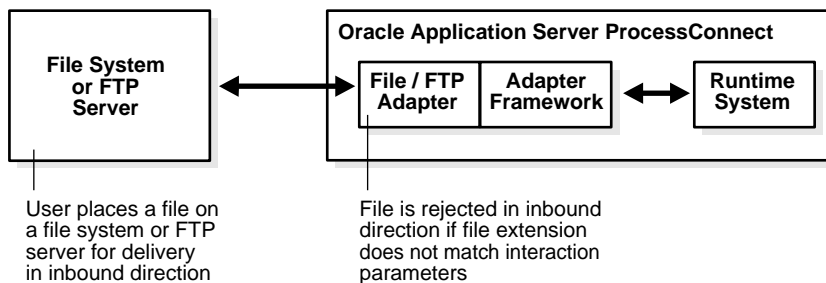

File/FTP Adapter Application Delivery Channel Description

You must create a delivery channel to interact with the FTP server or file system by specifying a series of parameters that describe the FTP server hostname, port, username, and password details for FTP mode and the polling interval time and directory location where files are sent or received for both FTP and File modes. These parameter details comprise the delivery channel.

See Also: ["Creating a File/FTP Adapter Delivery Channel"](#) on page 15-18 for the list of parameters you specify to create a delivery channel

File/FTP Adapter Exchange Protocols

This section identifies and describes when to use the File/FTP adapter exchange protocols. The File/FTP adapter includes the following inbound and outbound adapter exchange protocols for both the File and FTP modes of the File/FTP adapter:

- [File Adapter Exchange Protocols - Inbound and Outbound Directions](#)
- [FTP Adapter Exchange Protocols - Inbound and Outbound Directions](#)

See Also:

- ["Adapter Interactions"](#) on page 3-19 for conceptual details about interactions and adapter exchange protocols
- ["Adding a File/FTP Adapter Interaction"](#) on page 11-14 for instructions on selecting an adapter exchange protocol during an interaction and for the list of interaction questions to which to respond

File Adapter Exchange Protocols - Inbound and Outbound Directions

[Table 8–15](#) describes the inbound and outbound adapter exchange protocols.

Table 8–15 *File Adapter Exchange Protocols - Inbound and Outbound Directions*

Direction	Adapter Exchange Protocol	Description
Inbound	Read File(FileRecord)	Retrieves a file from a directory
Outbound	Write File(FileRecord)	Places a file into a directory

FTP Adapter Exchange Protocols - Inbound and Outbound Directions

[Table 8–16](#) describes the inbound and outbound adapter exchange protocols.

Table 8–16 *FTP Adapter Exchange Protocols - Inbound and Outbound Directions*

Direction	Adapter Exchange Protocol	Description
Inbound	Read File(FileRecord)	Retrieves a file from an FTP server
Outbound	Write File(FileRecord)	Places a file onto an FTP server

File/FTP Adapter Design-Time Tasks

For all inbound and outbound interactions, the IN record name is *file_extensionRecord*. There are no OUT records.

[Table 8-17](#) describes File/FTP adapter record element naming conventions for Read File (inbound) and Write File (outbound).

Table 8-17 Read File and Write File Record Element Naming Conventions

Record Element Name	Description	Value Type	Definition Provided By User or Adapter	Native Datatype Name for Adapter-Provided Definition	Native Format Restrictions
Payload	The file contents	BLOB	User	None	None

See Also: ["Wire Messages and Oracle Records"](#) on page 3-17 for conceptual details about Oracle records.

File/FTP Adapter Interaction and Record Naming Restrictions

The record name is formed based on the file extension you choose when adding an interaction. Therefore, there is one record name for each extension. You can use event maps to handle different types of native messages that use the same file extension. If the same record name is used in the inbound and outbound directions due to the same file extension being chosen for inbound and outbound, you must define an event map.

File/FTP Adapter Errors

[Table 8-18](#) lists when File/FTP adapter errors occur and how they are handled by the adapter.

Table 8-18 File/FTP Adapter Errors

An Error Occurs While...	Adapter Error Handling Behavior
Establishing an FTP connection	Displays the following error: <code>CouldNotConnectFTP</code>
Retrieving a file	Aborts and retries every 30 seconds
Sending a file	Logs an error code based on the appropriate file system or FTP error code

File/FTP Adapter Validation Prerequisites

Follow these conventions when naming FTP file names:

- Do not include special characters (for example, ^, &, and *) in the file name. Use a conventional alphanumeric combination to name files.
- File names must be less than 30 characters in length.

File/FTP Adapter Additional Setup Tasks

Ensure that you have satisfied the following requirements for File/FTP adapter testing:

1. If using the File/FTP adapter in FTP mode, ensure that you have an FTP server username and password account.
2. If you use the staging directory in FTP mode, ensure that it exists.

File/FTP Adapter Application Integration and Runtime Behavior

When Oracle Application Server ProcessConnect invokes an outbound interaction, messages are sent as a file to a file system or an FTP server for each adapter exchange protocol.

For inbound interactions, the File/FTP adapter creates one thread for each file or FTP receiving endpoint. After Oracle Application Server ProcessConnect has retrieved and successfully processed a file, the file is deleted

File/FTP Adapter Limitations

- Secure FTP and FTP/S (FTP over SSL) are not supported.
- If you use multiple adapter framework instances at runtime, ensure that only one adapter framework instance is hosting a given party for reading files; that is, do not allow more than one adapter framework instance to read from a given directory.

File/FTP Adapter Diagnostics and Troubleshooting

The File/FTP adapter logs diagnostic messages to the Oracle Application Server ProcessConnect log files in the following situations:

- When an FTP connection is established
- After a message is sent as a file
- When an error occurs while sending a file
- When the file or FTP directories being listened to are listed at startup
- When an error occurs while retrieving a file

The File/FTP adapter does not log diagnostic messages outside of Oracle Application Server ProcessConnect.

See Also: ["Managing and Monitoring a Middle-Tier Instance from Oracle Enterprise Manager Application Server Control"](#) on page 18-5 for instructions on setting adapter logging levels with Oracle Enterprise Manager

File/FTP Adapter Use Case

An example of using the File/FTP adapter is provided in [Chapter 7, "Tutorial of an Integration within an Enterprise"](#).

HTTP Adapter

This section provides details about using the HTTP adapter. This section contains these topics:

- [Benefits of Using the HTTP Adapter](#)
- [HTTP Adapter Supported Versions](#)
- [HTTP Adapter Application Delivery Channel Description](#)
- [HTTP Adapter Exchange Protocols](#)
- [HTTP Adapter Design-Time Tasks](#)
- [HTTP Adapter Interaction and Record Naming Restrictions](#)
- [HTTP Adapter Errors](#)
- [HTTP Adapter Validation Prerequisites](#)
- [HTTP Adapter Additional Setup Tasks](#)
- [HTTP Adapter Application Integration and Runtime Behavior](#)
- [HTTP Adapter Limitations](#)
- [HTTP Adapter Diagnostics and Troubleshooting](#)
- [HTTP Adapter Use Case](#)

See Also: ["Layout of Adapter Details in this Chapter"](#) on page 8-2 for an overview of topics covered for each adapter in this chapter

Benefits of Using the HTTP Adapter

Use the HTTP adapter to integrate an HTTP or secure HTTP application with other applications using Oracle Application Server ProcessConnect. This adapter is useful in all environments that use the HTTP transport protocol. The HTTP adapter performs the following tasks:

- Monitors inbound messages received in the form of HTTP requests to the HTTP adapter servlet
- Sends messages to remote Web servers, optionally through a proxy host

HTTP Adapter Supported Versions

The HTTP adapter supports HTTP versions 1.0 and 1.1.

For SSL, the HTTP client layer is based on the Oracle JavaSSL implementation, which may need an Oracle Wallet file if certificate-based client authentication is required. You must provide a wallet that contains the certificate of the certificate authority (CA) that signed the certificate of the server to which you are trying to connect.

The HTTP adapter works and is deployed automatically with the Oracle Application Server Containers for J2EE (OC4J) servlet container in Oracle Application Server. In a non-Oracle environment for the inbound direction, the HTTP adapter servlet can be deployed manually by the user in a J2EE-compliant environment.

The HTTP adapter servlet code does not make use of OC4J-specific features.

For the outbound direction, the HTTP adapter is compatible with all HTTP protocol-compliant HTTP servers.

Figure 8-17 shows how the HTTP adapter sends and receives messages.

Figure 8-17 HTTP Adapter

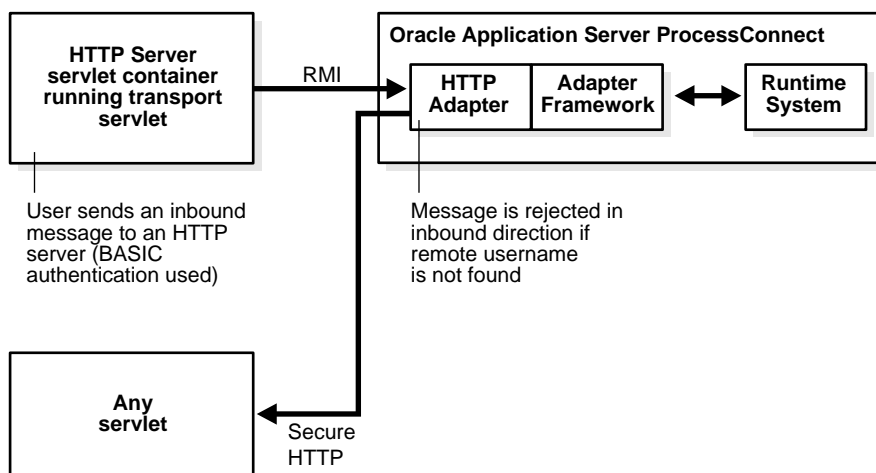

HTTP Adapter Application Delivery Channel Description

You must create a delivery channel by specifying a series of parameters that describe the URL for outgoing messages; the proxy server hostname, port, username, and password; RMI instance name and port; and user authentication details. These parameter details comprise the delivery channel.

See Also: ["Creating an HTTP Adapter Delivery Channel"](#) on page 15-17 for the list of parameters you specify to create a delivery channel

HTTP Adapter Exchange Protocols

This section identifies and describes when to use the HTTP adapter exchange protocols. The HTTP adapter includes the inbound and outbound adapter exchange protocols shown in [Table 8-19](#):

Table 8-19 *HTTP Adapter Exchange Protocols - Inbound and Outbound Direction*

Direction	Interactions	Description
Inbound	Receive Payload(PayloadRecord)	Receives a file from an HTTP server
Outbound	Send Payload(PayloadRecord, PayloadRecord)	Sends a file to an HTTP server

See Also:

- ["Adapter Interactions"](#) on page 3-19 for conceptual details about interactions and adapter exchange protocols
- ["Adding an HTTP Adapter Interaction"](#) on page 11-16 for instructions on selecting an adapter exchange protocol during an interaction and for the list of interaction questions to which to respond

HTTP Adapter Design-Time Tasks

This section describes the IN record element and OUT record element naming conventions for each adapter exchange protocol:

- [HTTP Adapter Inbound Interaction and Record Element Naming Conventions](#)
- [HTTP Adapter Outbound Interaction and Record Element Naming Conventions](#)

HTTP Adapter Inbound Interaction and Record Element Naming Conventions

For inbound interactions, the IN record name is `HTTPReadrecord_type`. The `record_type` is `XMLRecord`, `TextRecord`, or `BinRecord`.

There is no OUT record.

[Table 8–20](#) describes the Receive Payload record element naming conventions.

Table 8–20 Receive Payload Inbound Record Element Naming Conventions

Record Element Name	Description	Value Type	Definition Provided By User or Adapter	Native Datatype Name for Adapter-Provided Definition	Native Format Restrictions
Payload	Payload to be received over HTTP	Based on answer to Content Type interaction question: <ul style="list-style-type: none"> ▪ text = CLOB ▪ binary = BLOB ▪ xml = XML 	User	None	<p>If the value type is CLOB, D3L cannot be used.</p> <p>If the value type is XML, only XSD can be used.</p>

HTTP Adapter Outbound Interaction and Record Element Naming Conventions

For all outbound interactions, the IN record name is the `content_typeRecord`.

You can have an OUT record if you choose the content type for the response content type parameter. If a content type is chosen for the response, the OUT record name is based on `response_content_typeRecord`. The `record_type` is `XMLRecord`, `TextRecord`, or `BinRecord`.

[Table 8–21](#) describes HTTP adapter record element naming conventions for the Send Payload IN Record outbound interaction.

Table 8–21 Send Payload IN Record Outbound Record Element Naming Conventions

Record Element Name	Description	Value Type	Definition Provided By User or Adapter	Native Datatype Name for Adapter-Provided Definition	Native Format Restrictions
Payload	Payload to be sent over HTTP	Based on answer to Content Type interaction question: <ul style="list-style-type: none"> ▪ text = CLOB ▪ binary = BLOB ▪ xml = XML 	User	None	If the value type is CLOB, D3L cannot be used. If the value type is XML, only XSD can be used.

[Table 8–22](#) describes HTTP adapter record element naming conventions for the Send Payload OUT Record outbound interaction.

Table 8–22 Send Payload OUT Record Outbound Record Element Naming Conventions

Record Element Name	Description	Value Type	Definition Provided By User or Adapter	Native Datatype Name for Adapter-Provided Definition	Native Format Restrictions
Response	The response to be received as a result of sending the payload	Based on answer to Content Type interaction question: <ul style="list-style-type: none"> ▪ text = CLOB ▪ binary = BLOB ▪ xml = XML 	User	None	If the value type is CLOB, D3L cannot be used. If the value type is XML, only XSD can be used.

See Also: ["Wire Messages and Oracle Records"](#) on page 3-17 for conceptual details about Oracle records.

HTTP Adapter Interaction and Record Naming Restrictions

There is one record name for each content type. You can use an event map to handle different types of native events that use the same content type.

HTTP Adapter Errors

[Table 8–23](#) lists when HTTP adapter errors occur and how they are handled by the adapter.

Table 8–23 *HTTP Adapter Errors*

An Error Occurs While...	Adapter Error Handling Behavior
Establishing an HTTP connection	Logs the following error: [IPT_HttpSendConnectionRefused] HTTP connection is refused
Sending a message	Logs an error based on the appropriate HTTP status code

HTTP Adapter Validation Prerequisites

You must define an event map if the same content type is used in the inbound and outbound directions.

Ensure that the following delivery channel details that you specify are valid:

- The root URL for outbound messages is a valid HTTP URL.
- The proxy server hostname for outbound messages is valid.
- The proxy server port number is a valid port number greater than zero.
- The proxy server username and password are valid.
- The RMI port matches with the setting in the `web.xml` file.
- The remote username for filtering incoming messages is valid.
- The Oracle Wallet location and password are valid (if secure HTTP is used).
- The authentication username, password, and security realm for outbound messages are valid.

HTTP Adapter Additional Setup Tasks

This section describes the following setup tasks:

- [HTTP Adapter Post-Installation Tasks](#)
- [HTTP Adapter Testing](#)

HTTP Adapter Post-Installation Tasks

Steps 1 through Step 3 describe how to add a user for basic authentication. Steps 5 and 7 describe how to enable secure socket layer (SSL).

1. Open the `jazn-data.xml` file in the `$ORACLE_HOME/j2ee/OC4J_ProcessConnect/application-deployments/integration` directory.
2. Add the following contents after the "principals" tag.

```
<principals path="principals.xml" />
<security-role-mapping name="sr_manager">
  <group name="managers"/>
</security-role-mapping>
```

3. Open the `orion-application.xml` file in the `$ORACLE_HOME/j2ee/OC4J_ProcessConnect/application-deployments/integration` directory.

4. Add the `<users>` and `<roles>` elements and change `<credential>` to the appropriate password.

```
<realm>
  <name>ip</name>
  <users>
    <user>
      <name>manager</name>
      <display-name>manager</display-name>
      <credentials>!welcome</credentials>
    </user>
  </users>
  <roles>
    <role>
      <name>managers</name>
      <display-name>Manager Role</display-name>
      <members>
        <member>
          <type>user</type>
          <name>manager</name>
        </member>
      </members>
    </role>
  </roles>
</realm>
```

5. Ensure that the correct server certificate is in the `$ORACLE_HOME/Apache/Apache/conf/ssl.wlt/default` directory.
6. Place the `ewallet.p12` file in this directory.
7. Ensure the following entries in the `httpd.conf` are correct (you have to add them if they are not there):

```
SSLWallet file:<path-to-wallet-directory>
SSLWalletPassword <wallet password>
```

8. Restart the Oracle HTTP server:

```
%%ORACLE_HOME/opmn/bin/opmnctl stopall
%%ORACLE_HOME/opmn/bin/opmnctl startall
```

9. Test the configuration by invoking the following URL:

```
https://hostname:4443/integration/transportServlet
```

A diagnostic page appears.

HTTP Adapter Testing

Perform the following tasks for HTTP adapter testing:

1. Ensure the transport servlet is running in OC4J.
2. Ensure the transport servlet is working and basic authentication is enabled.
3. Ensure that the adapter framework is running. If it is not, you receive an error saying that the RMI server is not running.
4. Send a message to the HTTP server from the command prompt:

```
java oracle.tip.adapter.test.AdapterTest httpout1.properties
```

HTTP Adapter Application Integration and Runtime Behavior

When Oracle Application Server ProcessConnect invokes an outbound interaction for each adapter exchange protocol, a message is sent to an HTTP listener.

For inbound interactions, the HTTP adapter creates one thread to monitor messages sent by the transport servlet. Depending on the delivery channel details (remote username used as a party identifier), the message is routed to the appropriate interaction. If the message's party is not found, the message is rejected.

When a post is made to the HTTP adapter (through the transport servlet) during an inbound interaction, the transport servlet returns a message based on whether the message is processed successfully or not.

If a message is unsuccessfully processed, you see the following HTTP response:

```
TransportServlet  
RMI Server cannot be contacted!
```

If a message is processed successfully, the following message is received:

```
TransportServlet  
Request has been processed successfully!
```

If the adapter framework is not started and the servlet is running, you receive the following status 503 error:

```
TransportServlet  
RMI Server cannot be contacted!
```

To see if the transport servlet is deployed correctly, attempt to access the following URL through a browser:

`http://hostname:port/integration/servlet/transportServlet`

where *port* can be determined from viewing the `$ORACLE_HOME/install/portlist.ini` file.

A window appears prompting you for the username and password for the OC4J environment. After you enter the correct username and password, the following diagnostic page appears:

Please use HTTP POST to send request.

ACCEPT	image/gif, image/x-xbitmap, image/jpeg, image/pjpeg, image/png, */*
ACCEPT-CHARSET	iso-8859-1,*,utf-8
ACCEPT-ENCODING	gzip
ACCEPT-LANGUAGE	en
AUTHORIZATION	Basic bWFuYWdlcjp3ZWxjb211
CONNECTION	keep-alive
HOST	cchung-sun.7777
USER-AGENT	Mozilla/4.79 [en] (X11; U; SunOS 5.6 sun4u)
VIA	1.0 inet-nc01 (NetCache NetApp/5.3.1R3)
X-FORWARDED-FOR	138.2.140.247

rmiHost	asgsun-dev4
rmiPort	9901
rmiHostList	null
rmiPortList	null
instanceName	IP
logging	on
log level	debug
log file	./ts_IP_1056409768739.log

certs =

HTTP Adapter Limitations

The HTTP adapter has the following limitations:

- The transport servlet must be used as the inbound servlet.
- For the outbound direction, if the get method is used, the attribute name used is message, and the maximum message size allowed is 8k.
- For the outbound direction, if the POST method is used, the message is sent as is; there is no multipurpose internet mail extensions (MIME) packaging support.
- Cookies are not supported.
- Get is not supported in the inbound direction.
- For secure HTTP, only the Oracle Wallet export file is supported.
- Only the POST method is supported in the transport servlet.
- Only the POST method is supported in the inbound direction.
- If you use multiple adapter framework instances at runtime, ensure that only one adapter framework instance is hosting a given party for receiving HTTP requests; that is, do not allow more than one adapter framework instance to read from a given HTTP server.

HTTP Adapter Diagnostics and Troubleshooting

The HTTP adapter logs diagnostic messages to the Oracle Application Server ProcessConnect log files in the following situations:

- After a message is sent
- When an error occurs while sending a message
- At startup

The HTTP adapter does not log diagnostic messages outside of Oracle Application Server ProcessConnect.

See Also: ["Managing and Monitoring a Middle-Tier Instance from Oracle Enterprise Manager Application Server Control"](#) on page 18-5 for instructions on setting adapter logging levels with Oracle Enterprise Manager

HTTP Adapter Use Case

This section provides a brief example of the types of delivery channel and interaction details you must specify to use an HTTP adapter. For this example, the details are specified for an application named SupplierApp.

Delivery Channel Questions

Figure 8–18 shows the delivery channel details specified for the HTTP adapter of the SupplierApp application.

Figure 8–18 *Creating an HTTP Adapter Delivery Channel*

+ Name	SupplierAppDC
RMI instance name (inbound)	iphttp <small>(Default Value = iphttp)</small>
RMI port (inbound)	1111 <small>(Default Value = 1110)</small>
Root URL (outbound) - for example, http://www.oracle.com	http://incq221b.idc.oracle.com:88
Proxy server hostname (outbound)	
Proxy server port (outbound)	80 <small>(Default Value = 80)</small>
Proxy server username (outbound)	
Proxy server password (outbound)	
Remote user name for filtering (inbound)	manager
Authentication type (outbound)	BASIC ▾
Authentication username (outbound)	manager
Authentication password (outbound)	*****
Authentication security realm (outbound)	ip
Oracle Wallet location (outbound)	
Oracle Wallet password (outbound)	
SSL handshake cipher suite (outbound)	

See Also: ["Creating an HTTP Adapter Delivery Channel"](#) on page 15-20 for specific details about creating an HTTP adapter delivery channel

Interaction Questions - Inbound and Outbound Directions

Figure 8–19 shows the two adapter exchange protocols to add for inbound and outbound interactions with the HTTP adapter:

- Receive Payload(PayloadRecord) is the adapter exchange protocol to add for inbound interactions.
- Send Payload(PayloadRecord, PayloadRecord) is the adapter exchange protocol to add for outbound interactions.

You add one interaction at a time.

Figure 8–19 HTTP Adapter Exchange Protocols

Add Interaction: Select Interaction

Please select the interaction to add.

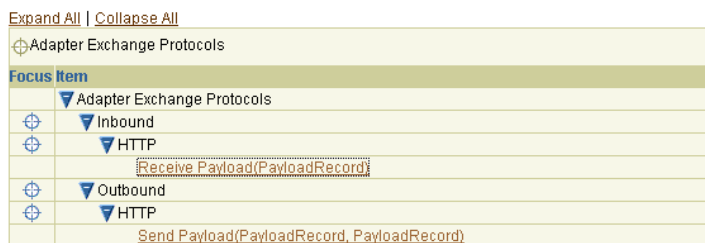

Figure 8–20 shows the interaction details specified for the Receive Payload(PayloadRecord) adapter exchange protocol of the HTTP adapter in the inbound direction.

Figure 8–20 Creating an HTTP Adapter Inbound Interaction

Add Interaction: Questions - Receive Payload

Please answer each interaction question. Supply information about incoming messages

* Content type

Figure 8–21 shows the interaction details specified for the Send Payload(PayloadRecord, PayloadRecord) adapter exchange protocol of the HTTP adapter in the outbound direction.

Figure 8–21 Creating an HTTP Adapter Outbound Interaction

Add Interaction: Questions - Send Payload

Please answer each interaction question. Supply information about outgoing messages

* Content type
 Response content type
 URL suffix (relative to root URL)
 HTTP connection timeout in milliseconds
 Method
 Additional HTTP headers (separated by @@)

Figure 8–22 shows the **Receive Payload(XmlRecord)** inbound and **Send Payload(XmlRecord)** outbound adapter exchange protocols after creation. Click an adapter exchange protocol for details. The original names of **PayloadRecord** shown in Figure 8–19 on page 8-56 have been replaced with **XMLRecord**. This is because you selected **xml** as the content type for each interaction.

Figure 8–22 HTTP Adapter Inbound and Outbound Adapter Exchange Protocols

Interactions

This shows the interactions defined in the system. Please choose Add to add an interaction.

[Add](#)

[Expand All](#) | [Collapse All](#)

⊕ Adapter Providers

Focus Item	Delete
▼ Adapter Providers	
⊕ ▼ Oracle	
⊕ ▶ B2B Adapter	
⊕ ▶ AQ Adapter	
⊕ ▶ Oracle DB Adapter	
⊕ ▶ JMS Adapter	
⊕ ▶ File/FTP Adapter	
⊕ ▼ HTTP Adapter	
⊕ ▼ HTTP	
Send Payload(XMLRecord)	
Receive Payload(XMLRecord)	

See Also: ["Adding an HTTP Adapter Interaction"](#) on page 11-16 for specific details about creating HTTP adapter interactions

JMS Adapter

This section provides details about using the Java Message Service (JMS) adapter. This section contains these topics:

- [Benefits of Using the JMS Adapter](#)
- [JMS Adapter Supported Versions](#)
- [JMS Adapter Application Delivery Channel Description](#)
- [JMS Adapter Exchange Protocols](#)
- [JMS Adapter Design-Time Tasks](#)
- [JMS Adapter Interaction and Record Naming Restrictions](#)
- [JMS Adapter Errors](#)
- [JMS Adapter Validation Prerequisites](#)
- [JMS Adapter Additional Setup Tasks](#)
- [JMS Adapter Application Integration and Runtime Behavior](#)
- [JMS Adapter Limitations](#)
- [JMS Adapter Diagnostics and Troubleshooting](#)
- [JMS Adapter Use Case](#)

See Also: ["Layout of Adapter Details in this Chapter"](#) on page 8-2 for an overview of topics covered for each adapter in this chapter

Benefits of Using the JMS Adapter

The JMS adapter enables Oracle Application Server ProcessConnect to send and receive messages to and from the queues and topics administered by any JMS provider; the Oracle JMS (OJMS) and MQSeries JMS (IBM) providers are certified with Oracle Application Server ProcessConnect.

The JMS adapter provides benefits over using Advanced Queuing or the MQSeries:

- Standards-based
- No lock in
- One adapter supports multiple vendor implementations
- Multiple naming schemes are supported for connection factories, queues, and topics (JNDI, LDAP, and vendor-specific class and user-supplied class names)

JMS Adapter Supported Versions

The JMS adapter supports the following components:

- JMS providers OJMS 8.1.7, 9.0.1.4, 9.2, and IBM MQSeries JMS 5.2 and 5.3

Note: When using OJMS with Oracle Database 8.1.7, the bodiless `javax.jms.Message` type is not supported (adapter exchange protocol Message Payload).

- JMS protocol 1.0.1 (inbound and outbound directions)

Other JMS providers may work, but have not been tested and certified, and are not supported.

JMS Adapter Application Delivery Channel Description

You must create a delivery channel to interact with the JMS service by specifying a series of parameters that describe the JMS connection and JNDI location details. These parameter details comprise the delivery channel.

See Also: ["Creating a JMS Adapter Delivery Channel"](#) on page 15-22 for the list of parameters you specify to create a delivery channel

JMS Adapter Exchange Protocols

This section identifies and describes when to use the JMS adapter exchange protocols. The JMS adapter supports the following inbound and outbound adapter exchange protocols.

- [JMS Adapter Exchange Protocols - Inbound Direction](#)
- [JMS Adapter Exchange Protocols - Outbound Direction](#)

See Also:

- ["Adapter Interactions"](#) on page 3-19 for conceptual details about interactions and adapter exchange protocols
- ["Adding a JMS \(Java Message Service\) Adapter Interaction"](#) on page 11-18 for instructions on selecting an adapter exchange protocol during an interaction and for the list of interaction questions to which to respond

JMS Adapter Exchange Protocols - Inbound Direction

[Table 8–24](#) describes the inbound adapter exchange protocols.

Table 8–24 JMS Adapter Exchange Protocols - Inbound Direction

Inbound Direction	Description
TextMessage Payload	Interaction description for receiving JMS text messages
StreamMessage Payload	Interaction description for receiving JMS stream messages
BytesMessage Payload	Interaction description for receiving JMS bytes messages
Message Payload	Interaction description for receiving JMS messages (headers and properties only)
MapMessage Payload	Interaction description for receiving JMS map messages

JMS Adapter Exchange Protocols - Outbound Direction

[Table 8–25](#) describes the outbound adapter exchange protocols.

Table 8–25 JMS Adapter Exchange Protocols - Outbound Direction

Outbound Direction	Description
TextMessage Payload	Interaction description for sending JMS text messages
StreamMessage Payload	Interaction description for sending JMS stream messages
BytesMessage Payload	Interaction description for sending JMS bytes messages
Message Payload	Interaction description for sending JMS messages (headers and properties only)
MapMessage Payload	Interaction description for sending JMS map messages

JMS Adapter Design-Time Tasks

This section describes the adapter exchange protocol and IN and OUT record element conventions:

[Table 8–26](#) describes the `JmsHeaders` record element naming conventions for each adapter exchange protocol.

Table 8–26 *JmsHeaders Record Element Naming Conventions*

Record Element Name	Description	Value Type	Definition Provided By User or Adapter	Native Datatype Name for Adapter-Provided Definition	Native Format Restrictions
<code>JmsHeaders</code>	Includes the JMS headers	XML	Adapter	<code>JmsHeaders</code>	XSD only

[Table 8–27](#) describes the `JmsProperties` record element naming conventions for each adapter exchange protocol.

Table 8–27 *JmsProperties Record Element Naming Conventions*

Record Element Name	Description	Value Type	Definition Provided By User or Adapter	Native Datatype Name for Adapter-Provided Definition	Native Format Restrictions
<code>JmsProperties</code>	Includes the JMS properties	XML	Adapter	<code>JmsProperties</code>	XSD only

[Table 8–28](#) describes the `Payload` record element naming conventions for each adapter exchange protocol.

Table 8–28 Payload Record Element Naming Conventions

Record Element Name	Description	Value Type	Definition Provided By User or Adapter	Native Datatype Name for Adapter-Provided Definition	Native Format Restrictions
Payload	The payload to be sent. This is not present for the <code>MessagePayload</code> adapter exchange protocol and message	CLOB if the adapter exchange protocol is <code>TextMessage</code> or <code>MapMessage</code> BLOB if the adapter exchange protocol is <code>StreamMessage</code> or <code>BytesMessage</code>	User	None	If the value type is CLOB, then D3L cannot be used. D3L can only be used with BLOB.

For the `MapMessage` Payload adapter exchange protocol, you define the Payload record element through an XSD that must match the contents of the `MapMessage` (property names) and the XML document format into which the JMS adapter converts the `MapMessage`. For example:

```
<?xml version="1.0" encoding="US-ASCII"?>
<Destination-name>
<name-of-map-entry-1 type="String">
  string-value-of-map-entry-1
</name-of-map-entry-1>
...
<name-of-map-entry-n type="Integer">
string-value-of-map-entry-n
</name-of-map-entry-n>
</Destination-name>
```

The value of the type attribute can be Boolean, byte, short, integer, long, float, double, string, and `ByteArray`.

The example structure defined in the preceding code matches the following JMS Map message:

```
MapMessage msg = new MapMessage();
msg.setString("name-of-map-entry-1", "string-value-of-map-entry-1");
...
msg.setInt("name-of-map-entry-n", "string-value-of-map-entry-n");
```

The name of the root element is the same as the destination name parameter entered when adding a JMS adapter interaction.

If the map message entry name is Payload, the MapMessage Payload adapter exchange protocol offers a special case. In this case, the value of the Payload entry is viewed as the entire payload, while the other map message entries are ignored.

See Also:

- ["Wire Messages and Oracle Records"](#) on page 3-17 for conceptual details about Oracle records
- ["Adding a JMS \(Java Message Service\) Adapter Interaction"](#) on page 11-18 for instructions on selecting a JMS adapter exchange protocol during an interaction and for the list of interaction questions to which to respond

JMS Adapter Interaction and Record Naming Restrictions

It is always the case that you must create event maps if more than one event uses the same record type.

Since the destination name is part of the JMS record names, once a certain record definition is assigned, the record name becomes tied to that definition. Therefore, queues (or topics) with the same name, but which externally can be distinguished by additional characteristics (like schema location) besides the name, must use the same record definition if they both are being used by the JMS adapter.

For example, for Oracle JMS, the queue name PROCESS_QUEUE (text type) can exist both in database schemas ORDER and INVENTORY. However, since the record name for this queue is PROCESS_QUEUE_Text_Record, the same record definition is used for both queues.

JMS Adapter Errors

[Table 8–29](#) lists when JMS adapter errors occur and how they are handled by the adapter.

Table 8–29 JMS Adapter Errors

An Error Occurs While...	Adapter Error Handling Behavior
Locating a JMS-administered object (for example, factories and destinations)	Logs the following error: <code>JNDI exception</code>
Establishing a connection	Logs the following error: <code>CouldNotConnect</code>
Enqueuing	JMS provider library initiates an error message
Dequeuing	Retries every 30 seconds

JMS Adapter Validation Prerequisites

In this release of Oracle Application Server ProcessConnect, there are no automated or user interface-based means for verifying and validating the correctness of the delivery channel configuration, except when starting the JMS adapter in runtime.

Typical values for the JNDI locations for an OJMS-based setup are as follows:

- For the JMS Connection Factory:

```
java:comp/resource/Ojms/QueueConnectionFactories/qcf
```

- Vendor properties:

blank

where *blank* indicates to leave the field blank.

- For the JMS Destination:

```
java:comp/resource/Ojms/Queues/${DestinationName}
```

- Vendor properties:

blank

where the `Ojms` substring must match the resource provider instance name (See ["Instructions for Oracle JMS"](#) on page 8-66.) and *blank* indicates to leave the field blank.

For an MQSeries JMS-based setup, the same two settings are as follows:

- **JMS Connection Factory:**

```
com.ibm.mq.jms.MQQueueConnectionFactory
```

- **Vendor properties:**

```
QueueManager=my.queue.manager;TransportType=1;Host=...
```

- **JMS Destination:**

```
queue:///${DestinationName}
```

- **Vendor properties:**

```
?targetClient=1
```

JMS Adapter Additional Setup Tasks

This section describes setup tasks to perform in addition to the delivery channel parameter and interaction question tasks that you perform with the Oracle Application Server ProcessConnect user interface tool.

Depending on the method used for locating JMS administrative objects (connection factories and destinations), the following tasks must be performed:

- Vendor- and user-specific JAR files must be appended to the adapter class path.
- Objects must be bound in a JNDI namespace through pertinent deployment descriptors.

Queues, topics, or both must also be created and enabled in the third-party queuing system. Pertinent third-party listeners, channels, daemons, and so on must also be started.

Instructions for Oracle JMS

Add an OJMS resource provider instance through Oracle Enterprise Manager.

Note: Do not add an OJMS resource provider instance by editing the `application.xml` file. Use Oracle Enterprise Manager to add a provider.

1. Log in to the Oracle Enterprise Manager Application Server Control.
2. Select the Oracle Application Server ProcessConnect middle tier instance in which to add the JMS resource provider.
3. Click **OC4J_ProcessConnect** in the **System Components** section of the Application Server : *middle_tier_instance* page.
4. Click **Administration**.

The OC4J: OC4J_ProcessConnect page appears.

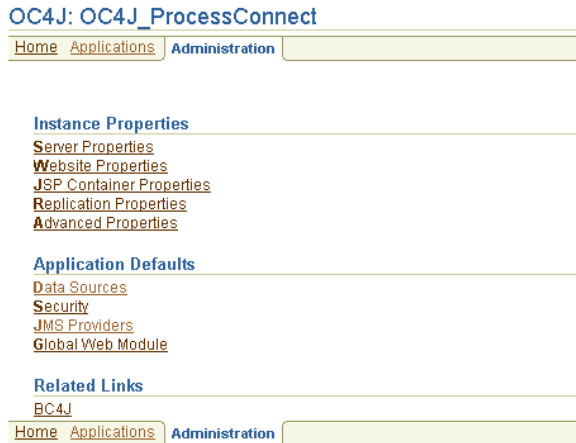

The Data Sources page appears.

5. Click **Data Sources**. You must create a data source before you can add a JMS provider.

The Create Data Source page appears.

6. Select a data source and click **Create**.

7. Follow the on-screen instructions to add connectivity details (username, password, and URL) and a JNDI location.
8. Click **Create** when done.
9. Return to the OC4J: OC4J_ProcessConnect page shown in Step 4.
10. Click **JMS Providers**.
11. Click **Add new JMS Provider**.
12. Follow the on-screen instructions to add the JMS provider and JNDI location. The JNDI location you enter here is the same one as specified in Step 7 on page 8-67.
13. Exit Oracle Enterprise Manager.
14. Ensure the following files are available in the CLASSPATH of the JMS adapter (that is, the adapter framework instance):

```
jndi.properties  
META-INF/application-client.xml
```

The middle-tier directory `$ORACLE_HOME/ip/config` is typically part of the adapter framework CLASSPATH after installing the product, so these files are preinstalled in this directory. You can customize the `jndi.properties` file to point to any given OC4J instance, where the OJMS resource provider instance in "[Instructions for Oracle JMS](#)" on page 8-66 was installed. Upon installation, it points by default to the Oracle Application Server ProcessConnect OC4J instance, which runs the design time Oracle Application Server ProcessConnect user interface tool.

15. If you want to customize `jndi.properties` to point to another OC4J instance, you must modify the second line:

```
java.naming.provider.url=  
opmn:ormi://myhost:6101:OC4J_ProcessConnect
```

In addition, the third and fourth lines (`principal/credentials`) must be assigned values that match either values in `principals.xml` or `jazn-data.xml` on the OC4J server configuration (`$J2EEHOME/config`), for example:

principals.xml:

```
<principals>
...
  <users>
    <user username="admin" password="abc123">
      <group-membership group="administrators" />
    </user>
  ...
</principals>
```

jndi.properties:

```
...
java.naming.security.principal=admin
java.naming.security.credentials=abc123
```

Instructions for MQSeries JMS

Perform the following steps to enable the JMS adapter to communicate with the IBM MQSeries JMS Service:

1. Install an MQSeries client (or server) on the host where the JMS adapter runs. See the IBM MQSeries documentation for instructions on installing the MQSeries client (or server) software.
2. Add the MQSeries JMS jar files to the adapter framework CLASSPATH:
 - a. Add the following jar files to the middle-tier `$ORACLE_HOME/opmn/conf/opmn.xml` file:

```
/opt/mqm/java/lib/jms.jar
/opt/mqm/java/lib/connector.jar
/opt/mqm/java/lib/com.ibm.mqjms.jar
/opt/mqm/java/lib/com.ibm.mq.jar
```

Note: The exact location of these IBM jar files may vary depending on the MQSeries version and the installation choices.

Perform this task by modifying the Oracle Process Management and Notification (OPMN) configuration in Oracle Enterprise Manager or by directly modifying the following section in the `opmn.xml` file:

```
<ias-component id="ProcessConnect" status="enabled">
<environment>
...
<variable id="CLASSPATH" value="$ORACLE_HOME/ip/lib/ip.jar" append="true"/>
<variable id="CLASSPATH" value="/opt/mqm/java/lib/jms.jar" append="true"/>
...
```

3. Add any additional jar files in a similar fashion.
4. Restart the adapter framework instance for the modified `CLASSPATH` to take effect.

JMS Adapter Application Integration and Runtime Behavior

When Oracle Application Server ProcessConnect invokes an outbound interaction, a JMS message is enqueued to a queue or published to a topic for each adapter exchange protocol.

For inbound interactions, the JMS adapter creates a pool of threads for each queue and topic and consumes (blocks) from each inbound destination for each adapter exchange protocol. If the JMS service provider supports JMS message listener's (like OJMS), then the inbound threads are suspended until a message is ready for consumption, at which point the JMS provider notifies the inbound thread (controlled by the inbound direction interaction parameter **Use JMS message listener?** set in Step 1 of "[Inbound Direction](#)" on page 11-19).

When the JMS Adapter has received an inbound message, the JMS adapter creates a record whose name is defined in "[JMS Adapter Design-Time Tasks](#)" on page 8-61.

JMS Adapter Limitations

The JMS adapter does not support the JMS `ObjectMessage` message type:

(`javax.jms.ObjectMessage`)

For the OJMS provider, the `ADTMessage` message type is not specifically supported. The underlying physical advanced queuing queue must be an Object type queue based on one of these (OJMS-specific) ADTs for the OJMS provider:

- `SYS.AQ$_JMS_TEXT_MESSAGE`
- `SYS.AQ$_JMS_BYTES_MESSAGE`
- `SYS.AQ$_JMS_MAP_MESSAGE`
- `SYS.AQ$_JMS_STREAM_MESSAGE`
- `SYS.AQ$_JMS_MESSAGE` (not supported with Oracle 8.1.7)

JMS Adapter Diagnostics and Troubleshooting

The JMS adapter logs diagnostic messages to the Oracle Application Server ProcessConnect log files in the following situations:

- When an administered JMS object is located or instantiated
- When a JMS connection is established
- When a JMS session is created
- After a message is enqueued or dequeued
- When an error occurs while enqueueing a message
- When the queues being listened to are listed at startup
- When an error occurs while dequeuing

The JMS adapter does not log diagnostic messages outside of Oracle Application Server ProcessConnect.

See Also: ["Managing and Monitoring a Middle-Tier Instance from Oracle Enterprise Manager Application Server Control"](#) on page 18-5 for instructions on setting adapter logging levels with Oracle Enterprise Manager

JMS Adapter Use Case

This section provides a brief example of the types of delivery channel and interaction details you must specify to use a JMS adapter. For this example, the details are specified for an application named OrderProcurementApp.

Delivery Channel Questions

Figure 8–23 shows the delivery channel details specified for the JMS adapter of the OrderProcurementApp application.

Figure 8–23 *Creating a JMS Adapter Delivery Channel*

* Name	OrderProcurementAppDC
JNDI location or Java class name for JMS connection factory	java:comp/resource/JMS_e2e/Qu
JMS vendor specific properties to pass to connection factory	
Default username for creating JMS connections	
Default password for creating JMS connections	
Is this a JMS topic connection factory	No <input type="button" value="v"/> <small>(Default Value = No)</small>
JNDI location of or Java class name for the JMS destination	java:comp/resource/JMS_e2e/Qu <small>(Default Value = .#{DestinationName})</small>
JMS vendor specific properties used to instantiate the JMS destination	
JMS Username	op
JMS Password	**
JMS Acknowledge Mode	AUTO_ACKNOWLEDGE <input type="button" value="v"/> <small>(Default Value = AUTO_ACKNOWLEDGE)</small>

See Also: ["Creating a JMS Adapter Delivery Channel"](#) on page 15-22 for specific details about creating a JMS adapter delivery channel

Interaction Questions - Inbound and Outbound Directions

Figure 8–24 shows the two adapter exchange protocols to add for inbound and outbound interactions with the JMS adapter:

- **Consume a message(JMS Text Message)** is the adapter exchange protocol to add for inbound interactions.
- **Produce a message(JMS Text Message)** is the adapter exchange protocol to add for outbound interactions.

You add one interaction at a time.

Figure 8–24 JMS Adapter Exchange Protocols

Add Interaction: Select Interaction

Please select the interaction to add.

[Expand All](#) | [Collapse All](#)

⊕ Adapter Exchange Protocols

Focus Item

⊖	Adapter Exchange Protocols
⊖	Inbound
▶	StreamMessage Payload
▶	Message Payload
▶	MapMessage Payload
▶	BytesMessage Payload
⊖	TextMessage Payload
⊖	Consume
	Consume a message(JMS Text Message)
⊖	Outbound
▶	StreamMessage Payload
▶	Message Payload
▶	MapMessage Payload
▶	BytesMessage Payload
⊖	TextMessage Payload
⊖	Produce
	Produce a message(JMS Text Message)

Figure 8–25 shows the interaction details specified for the **Consume a message(JMS Text Message)** adapter exchange protocol of the JMS adapter in the inbound direction.

Figure 8–25 Creating a JMS Adapter Inbound Interaction

Add Interaction: Questions - JMS Interaction questions

Please answer each interaction question. JMS Interaction questions about message consumer options.

* Name of the JMS queue or topic (value of \${DestinationName})

Optional JMS message selector expression

Optional durable subscriber name

Use JMS message listener? No

Figure 8–26 shows the interaction details specified for the **Produce a message(JMS Text Message)** adapter exchange protocol of the JMS adapter in the outbound direction.

Figure 8–26 Creating a JMS Adapter Outbound Interaction

Add Interaction: Questions - JMS Interaction questions

Please answer each interaction question. JMS Interaction questions about message producer options.

* Name of the JMS queue or topic (value of \${DestinationName})

Message delivery mode

Message priority (0-9)

Time-To-Live (milliseconds; 0 = no limit)

Figure 8–27 shows the **Consume a message(SupplierPOQueue_Text_Record)** inbound direction and **Produce a message(ReqReceiverQueue_Text_Record)** outbound direction adapter exchange protocols after creation. Click a specific adapter exchange protocol for additional details. A third adapter exchange protocol (**Produce a message(SupplierResQ_Text_Record)**) that is not described in this use case has also been created. Note the original names of JMS Text Message shown in Figure 8–24 on page 8-72 have been replaced with the JMS queue or topic names you specified for each interaction.

Figure 8–27 JMS Adapter Inbound and Outbound Adapter Exchange Protocols



Interactions

This shows the interactions defined in the system. Please choose Add to add an interaction.

Add

Expand All | Collapse All

⊕ Adapter Providers

Focus Item	Delete
▼ Adapter Providers	
⊕ ▼ Oracle	
⊕ ▶ B2B Adapter	
⊕ ▶ AQ Adapter	
⊕ ▶ Oracle DB Adapter	
⊕ ▼ JMS Adapter	
⊕ ▼ TextMessage Payload	
⊕ ▼ Produce	
Produce a message(ReqReceiverQueue_Text_Record)	
Produce a message(SupplierResQ_Text_Record)	
⊕ ▼ Consume	
Consume a message(SupplierPOQueue_Text_Record)	

See Also: "Adding a JMS (Java Message Service) Adapter Interaction" on page 11-18 for specific details about creating inbound and outbound JMS adapter interactions

Oracle Database Adapter

This section provides details about using the Oracle Database adapter. This section contains these topics:

- [Benefits of Using the Oracle Database Adapter](#)
- [Oracle Database Adapter Supported Versions](#)
- [Oracle Database Adapter Application Delivery Channel Description](#)
- [Oracle Database Adapter Exchange Protocols](#)
- [Oracle Database Adapter Design-Time Tasks](#)
- [Oracle Database Adapter Interaction and Record Naming Restrictions](#)
- [Oracle Database Adapter Errors](#)
- [Oracle Database Adapter Validation Prerequisites](#)
- [Oracle Database Adapter Additional Setup Tasks](#)
- [Oracle Database Adapter Application Integration and Runtime Behavior](#)
- [Oracle Database Adapter Features and Limitations](#)
- [Oracle Database Adapter Diagnostics and Troubleshooting](#)
- [Oracle Database Adapter Use Case](#)

See Also: ["Layout of Adapter Details in this Chapter"](#) on page 8-2 for an overview of topics covered for each adapter in this chapter

Benefits of Using the Oracle Database Adapter

The Oracle Database adapter enables you to integrate an Oracle application, typically PL/SQL-based, with other applications using Oracle Application Server ProcessConnect. This adapter is useful in all environments involving Oracle database applications.

Oracle Database Adapter Supported Versions

The Oracle Database adapter supports Oracle database server versions 8.1.7, 9.0.1, and 9.2.0 as the application (spoke) database. The application database is a separate database from the Oracle Application Server Metadata Repository. This repository contains the Oracle Application Server ProcessConnect schema and modeling

metadata and profile data that you create with the Oracle Application Server ProcessConnect user interface tool.

Oracle Database Adapter Application Delivery Channel Description

An application represents a database user within a particular database server. To interact with the database server, you must specify delivery channel parameters, including database server hostname and JDBC driver details, a connection username and password, and a username for the objects being selected in the database server. These parameter details comprise the delivery channel.

See Also: ["Creating an Oracle Database Delivery Channel"](#) on page 15-24 for the list of parameters you specify to create a delivery channel

Oracle Database Adapter Exchange Protocols

This section identifies and describes when to use the Oracle Database adapter exchange protocols. The Oracle Database adapter includes the following inbound and outbound adapter exchange protocols:

- [Oracle Database Adapter Exchange Protocols - Inbound Direction](#)
- [Oracle Database Adapter Exchange Protocols - Outbound Direction](#)

See Also:

- ["Adapter Interactions"](#) on page 3-19 for conceptual details about interactions and adapter exchange protocols
- ["Adding an Oracle Database Adapter Interaction"](#) on page 11-20 for instructions on selecting an adapter exchange protocol during an interaction and for the list of interaction questions to which to respond

Oracle Database Adapter Exchange Protocols - Inbound Direction

- Read Record from Interface Table

This adapter exchange protocol supports reading records by specifying a SQL query against an interface table. An interface table is typically defined separately from the database application schema and populated using some mechanism, such as a trigger, from the application schema. However, the protocol can be used directly against an application schema table.

The Oracle Database adapter periodically issues a user-defined query statement for the table and converts each row returned to a record to be created as a native event. If the native event is created successfully, then the Oracle Database adapter issues an `UPDATE` or `DELETE` statement for the row to mark it as processed; this prevents it from being processed again.

Use this adapter exchange protocol in the following situations:

- A record is to be read from a table or view row.
- The record is defined by the columns belonging to the interface table, or a subset of those columns. Joins to other tables are not supported in the query. However, this task is achieved by defining a view and using the view as the interface table.
- The row values remain relatively constant. For example, if a row is inserted into the table and the row is subsequently updated, the Oracle Database adapter can process the record at any time. This means that the row can be processed as it was inserted or updated depending on when the Oracle Database adapter issues the query.
- The connection specified by the delivery channel has `SELECT` and `UPDATE` or `DELETE` privileges on the table or view.

Oracle Database Adapter Exchange Protocols - Outbound Direction

- Write Record to Table

This adapter exchange protocol supports inserting or updating a table row with record values. The record is defined by the table columns.

Use this adapter exchange protocol in the following situations:

- A record is to be written to a table or view. If a view is selected, and the view is not key-updatable, then define instead of triggers against the view to perform the table updates.
 - The connection specified by the delivery channel has `INSERT`, `UPDATE`, and `SELECT` privileges on the table.
 - Stored Procedure Invocation
- This adapter exchange protocol supports the invocation of a stored procedure. The set of `IN` parameters for the procedure forms the `IN` record. If the procedure has `OUT` parameters, these form the `OUT` record for the interaction.

Use this adapter exchange protocol in the following situations:

- A record is to be written using a PL/SQL procedure. This adapter exchange protocol can be preferable to the Write Record to Table adapter exchange protocol in cases where the application of the database server requires multiple inserts, updates, or deletes to process the record.
- The integration requires invocation of business logic to determine a result or decision based on input parameters.
- The connection specified by the delivery channel has `EXECUTE` privileges on the procedure.

See Also:

- ["Adding an Oracle Database Adapter Interaction"](#) on page 11-20 for instructions on selecting an adapter exchange protocol during an interaction and for the list of interaction questions to which to respond
- *Application Developer's Guide - Fundamentals* for details about instead of triggers, which is available on the Oracle Technology Network:

<http://otn.oracle.com>

Oracle Database Adapter Design-Time Tasks

This section describes the adapter exchange protocol and IN and OUT record element conventions.

Adapter Exchange Protocol User Interface Naming Conventions

[Table 8–30](#) provides examples of the naming conventions available for selection for adapter exchange protocols in the Oracle Application Server ProcessConnect user interface tool.

Table 8–30 Adapter Exchange Protocol Naming Conventions

Adapter Exchange Protocol	User Interface Naming Convention
Inbound	
<ul style="list-style-type: none"> Read Record from Interface Table 	<p>Grouped by the first letter of the table name. For example:</p> <p>E</p> <p>Read record from interface table EMP(EMPRecord)</p>
Outbound	
<ul style="list-style-type: none"> Write Record to Table 	<p>Grouped by the first letter of the table name. For example:</p> <p>E</p> <p>Write record to table EMP(EMPRecord)</p>
<ul style="list-style-type: none"> Stored Procedure Invocation 	<p>Grouped by package name with unpackaged procedures in a group named No Package Name. For example:</p> <p>HR_LOGIC</p> <p>Invoke stored procedure GIVE_RAISE(GIVE_RAISERecord)</p>

[Table 8–31](#) describes Read Record from Interface Table and Write Record to Table record element naming conventions.

Table 8–31 Read Record from Interface Table and Write Record to Table Record Element Naming Conventions

Record Element Name	Description	Value Type	Definition Provided By User or Adapter	Native Datatype Name for Adapter-Provided Definition	Native Format Restrictions
Payload	Represents the columns retrieved from a query for the Read Record from Interface Table. For the Write Record to Table, this represents all columns in the table.	XML	Adapter	<i>Schema_</i> <i>Name.Table_Name</i>	XSD only

[Table 8–32](#) describes the Stored Procedure Invocation IN record element naming conventions.

Table 8–32 Stored Procedure Invocation IN Record Element Naming Conventions

Record Element Name	Description	Value Type	Definition Provided By User or Adapter	Native Datatype Name for Adapter-Provided Definition	Native Format Restrictions
Payload	Represents all IN and IN OUT arguments of the stored procedure	XML	Adapter	<i>Schema_</i> <i>Name.Package_</i> <i>Name.In</i>	XSD only

[Table 8–33](#) describes the Stored Procedure Invocation OUT record element naming conventions.

Table 8–33 Stored Procedure Invocation OUT Record Element Naming Conventions

Record Element Name	Description	Value Type	Definition Provided By User or Adapter	Native Datatype Name for Adapter-Provided Definition	Native Format Restrictions
Payload	Represents all OUT and OUT IN arguments in the stored procedure	XML	Adapter	<i>Schema_</i> <i>Name.Package_</i> <i>Name.Out</i>	XSD only

See Also:

- ["Adding an Oracle Database Adapter Interaction"](#) on page 11-20 for the interaction questions to which to respond
- ["Wire Messages and Oracle Records"](#) on page 3-17 for conceptual details about Oracle records

Oracle Database Adapter Interaction and Record Naming Restrictions

The interaction record is named for the schema object being accessed. This means that you cannot create two interactions for the same schema and table name in two different databases where the table structure differs.

See Also: ["Oracle Database Adapter Design-Time Tasks"](#) on page 8-78 for details on record naming for the individual adapter exchange protocols

Oracle Database Adapter Errors

[Table 8–34](#) lists when Oracle Database adapter errors occur and how they are handled by the adapter.

Table 8–34 Oracle Database Adapter Errors

An Error Occurs While...	Adapter Error Handling Behavior
Establishing a connection	Retries the connection after the retry interval duration.
Reading from Table	Logs the database error.
Writing to Table	Logs the database error and raises a system exception.
Invocation of Stored Procedure	Logs the database error and raises a system exception.

Oracle Database Adapter Validation Prerequisites

Adapter exchange protocols typically have requirements that you must satisfy before they can be included and successfully validated in a deployed configuration.

[Table 8–35](#) describes the Oracle Database adapter exchange protocol requirements.

Table 8–35 Oracle Database Adapter Validation Prerequisites

Adapter Exchange Protocol	Description
Read Record from Interface Table	<p>If the table does not have a primary key, ensure that the unique columns selected are truly unique. The unique columns are used to update or delete the row after processing. If the columns are not unique, multiple rows can be updated or deleted. This means that rows not yet processed are ignored. Also, ensure that the update column is not a unique column.</p> <p>If the table has a primary key, the update column must not be one of the primary key columns.</p> <p>The unique columns must be selected as part of the query.</p> <p>If the update option is selected for marking a row as processed, the query must exclude processed rows. For example, consider if the following answers were provided for the Update Column Options interaction question set:</p> <ul style="list-style-type: none"> ■ Select a column for update - STATUS ■ Enter a value for success - Processed ■ Enter a value for failure - Failed <p>A suitable query is as follows (assuming the status column is initially null):</p> <pre>SELECT * FROM emp WHERE status is null</pre> <p>No constraints must be violated as a result of the update or delete action to mark a processed row.</p>

Table 8–35 (Cont.) Oracle Database Adapter Validation Prerequisites

Adapter Exchange Protocol	Description
Write Record to Table	<p>If the table does not have a primary key and the update option is used, the user must ensure that the unique columns selected are truly unique. If the columns are not unique, multiple rows can be updated, which may not be desirable.</p> <p>If the table has any foreign key constraints, the foreign key column values in the record instance must refer to a row in the referenced table. Otherwise, the constraint is violated.</p> <p>Similarly, the record instance values must not violate other constraints defined against the table.</p>
Stored Procedure Invocation	There are no additional requirements.

Oracle Database Adapter Additional Setup Tasks

The Oracle Database adapter requires no additional setup tasks to function. However, integrating the Oracle Database adapter with existing applications may require the creation of additional schema objects, as described in [Table 8–36](#) of "[Oracle Database Adapter Application Integration and Runtime Behavior](#)" on page 8-84.

Oracle Database Adapter Application Integration and Runtime Behavior

[Table 8–36](#) describes the additional schema objects to create when integrating the Oracle Database adapter with existing applications.

Table 8–36 Oracle Database Adapter Setup Tasks

Adapter Exchange Protocol	Description
Read Record from Interface Table	<p>Identify or define the interface table to use. You can use a table from the database application schema. In this case, the connection must support the following:</p> <ul style="list-style-type: none"> ▪ Either an UPDATE or DELETE action on the table ▪ The database application must support an UPDATE or DELETE action <p>For example, it may be invalid to delete a purchase order. A true interface table is typically defined separately for the following reasons:</p> <ul style="list-style-type: none"> ▪ To separate the integration behavior ▪ For security reasons
Write Record to Table	<p>As with the Read Record from Interface Table adapter exchange protocol, identify or define the table. If a table from the database application schema is used, the connection must support the INSERT or UPDATE action and the database application must support either new rows being written or existing ones being updated. The SELECT privilege is also required. In the case of update, all columns are updated with values from the record instance. You can also define a separate interface table and define triggers against the interface table to populate the database application schema.</p>
Stored Procedure Invocation	<p>An existing database application stored procedure can perform application-specific behavior. Alternatively, a new stored procedure can be defined that performs a complex update to the application schema.</p>

Oracle Database Adapter Features and Limitations

This section describes the following Oracle Database adapter features and limitations:

- [Adapter Exchange Protocols](#)
- [Oracle Database Adapter Restrictions](#)

Adapter Exchange Protocols

[Table 8–37](#) describes the features and restrictions of each Oracle Database adapter exchange protocol.

Table 8–37 Adapter Exchange Protocol Features and Restrictions

Adapter Exchange Protocol	Features	Restrictions
Read Record from Interface Table	Reads from relational or object tables and views	<ul style="list-style-type: none"> ■ Date columns become string elements with the date format <code>MM/dd/yyyy HH:mm:ss</code>. ■ The connection must have <code>SELECT</code> and <code>UPDATE</code> or <code>DELETE</code> privileges on the interface table. ■ The native event type is defined by the Oracle Database adapter, and is not user-specified. If a column contains a string column, for example, then this cannot be treated as a payload field having its own definition that you provide. ■ An interaction cannot be created based on a synonym. ■ <code>XMLType</code>, <code>interval</code>, <code>timezone</code>, <code>bfile</code>, and <code>nclob</code> columns are not supported. ■ If you use multiple adapter framework instances at runtime, ensure that only one adapter framework instance is hosting a given party for reading table data; that is, do not allow more than one adapter framework instance to read from the same table.

Table 8–37 (Cont.) Adapter Exchange Protocol Features and Restrictions

Adapter Exchange Protocol	Features	Restrictions
Write Record to Table	Writes to relational or object tables and views	<ul style="list-style-type: none"> ■ Date columns are string elements with the date format MM/dd/yyyy HH:mm:ss. ■ The connection must have SELECT, INSERT, and UPDATE privileges on the table. ■ The native event type is defined by the Oracle Database adapter, and is not user-specified. If a column contains a string column, for example, then this cannot be treated as a payload field having its own definition that you provide. ■ The record must be populated such that constraints are not violated when inserting or updating into the table (for example, ensure that foreign key values exist in the referenced table). ■ An interaction cannot be created based on a synonym. ■ XMLType, interval, timezone, bfile, and nclob columns are not supported. ■ If the table belongs to a different schema than the connection user, a synonym must be created with the same name in the connection user schema.
Stored Procedure Invocation	Invocations of PL/SQL and PL/SQL wrapped Java procedures	<ul style="list-style-type: none"> ■ If an invocation of a function is required, define a procedure that invokes the function and returns the function result as an OUT argument. ■ Overloaded procedures cannot be selected for interactions. ■ The native event type is defined by the Oracle Database adapter, and is not user-specified. If a stored procedure has a string parameter, for example, then this cannot be treated as a payload field having its own definition provided by the user. ■ The connection must have EXECUTE privileges on the procedure. ■ An interaction cannot be created based on a synonym. ■ XMLType, PL/SQL Boolean, record, and table types are not supported as parameters types.

Oracle Database Adapter Restrictions

The Oracle Database adapter currently only works with the Oracle database.

Oracle Database Adapter Diagnostics and Troubleshooting

This section describes common problems and describes solutions to these problems.

Problem

The following error appears when adding a Read Record from Interface Table interaction:

```
An error occurred when adding the Interaction Read record from interface table  
EMP(EMPRecord). oracle.tip.adapter.api.exception.DomainResourceException : Error  
creating metadata for the DB adapter ORA-00942: table or view does not exist
```

Solution

Satisfy the following requirements:

- The query specified for the interaction must query against the table selected for the interaction.
- The query must not include joins to other tables.
- If the database username and schema name differ in the delivery channel, then either qualify the table name with the schema name in the `SELECT` query or create a synonym for the table for the database user.

Problem

Table rows are being raised multiple times for the Read Record from Interface Table interaction at runtime.

Solution

Satisfy the following requirements:

- Ensure that the `DELETE` or `UPDATE` operation against the table succeeds; that is, it is not prevented due to privilege issues or constraint failures.
- If the `UPDATE` option is being used, ensure that the query excludes processed rows.

Problem

Repeated failure of the Write Record to Table interaction or Stored Procedure Invocation interaction at runtime.

Solution

The Oracle Database adapter treats all database-related errors as system exceptions, causing the operation to be retried. Examine the database error given in the log file and fix the issue. Common causes and corrective actions are as follows:

- If the database is down, restart the database and listener.
- If there are a lack of system or object privileges, grant the required privileges to the user.
- If the database is out of tablespace, add more tablespace.
- If there are constraint failures, modify or disable the constraints.

See Also: ["Managing and Monitoring a Middle-Tier Instance from Oracle Enterprise Manager Application Server Control"](#) on page 18-5 for instructions on setting adapter logging levels with Oracle Enterprise Manager

Oracle Database Adapter Use Case

This section describes how to create an object relational view to resolve a complex relational model.

Consider the following relational schema:

```
create table contact (  
    id number(10) not null  
    , name varchar2(50) not null  
    , address varchar2(100) not null  
    , city varchar2(50) not null  
    , state varchar(2) not null  
    , zip varchar2(5) not null  
    , phone varchar2(10)  
    , constraint contact_pk primary key(id)  
)  
/
```

```
create table purchaseorder (  
    id number(10) not null  
    , request_date date
```



```

        , ship_date date
        , ship_to number(10) not null
        , bill_to number(10) not null
        , constraint purchaseorder_pk primary key(id)
        , constraint purchaseorder_shipto_fk foreign key (ship_to) references
contact(id)
        , constraint purchaseorder_billto_fk foreign key (bill_to) references
contact(id)
    )
/

create table lineitem (
    po_id number(10) not null
    , line number(10) not null
    , item varchar2(500) not null
    , quantity number(10) not null
    , price number(10,2) not null
    , shipto number(10)
    , constraint lineitem_pk primary key(po_id, line)
    , constraint lineitem_poid_fk foreign key (po_id) references
purchaseorder(id) on delete cascade
)
/

```

The schema does not permit querying or updating a purchase order including the line items and contact information. This is because joins are not supported. This task can be achieved by defining an object relational view and using the object support that the Oracle database server provides. This permits defining simple and collection object types as a column. This enables the whole purchase order to be selected as a single row from the view.

The following types corresponding to the table structure are created:

```

create type contact_type as object (
    name varchar2(50)
    , address varchar2(100)
    , city varchar2(50)
    , state varchar(2)
    , zip varchar2(5)
    , phone varchar2(10)
);
/

create type lineitem_type as object (
    line number(10)

```

```
, item varchar2(500)
, quantity number(10)
, price number(10,2)
, shipto contact_type
);
/

create type lineitem_list as table of lineitem_type
/

create type purchaseorder_type as object (
    id number(10)
, request_date date
, ship_date date
, ship_to contact_type
, bill_to contact_type
, lineitems lineitem_list
);
/
```

contact_type and lineitem_type do not include the id and po_id columns, respectively. This is because the relationship to the purchase order is implicit in the row selected from the view. The object view is then defined using the following types:

```
create or replace view purchaseorder_objview of purchaseorder_type
with object identifier (id) as
select
po.id
, po.request_date
, po.ship_date
, contact_type(st.name, st.address, st.city, st.state, st.zip, st.phone) ship_to
, contact_type(bt.name, bt.address, bt.city, bt.state, bt.zip, bt.phone) bill_to
, cast(multiset(
        select li.line, li.item, li.quantity, li.price
        , contact_type(lc.name, lc.address, lc.city, lc.state, lc.zip,
        lc.phone) ship_to
        from lineitem li, contact lc
        where li.po_id = po.id) as lineitem_list) lineitems
from purchaseorder po, contact st, contact bt
where po.ship_to = st.id
and po.bill_to = bt.id
```

Select this view for the Read Record from Interface Table adapter exchange protocol with a query such as `SELECT * FROM purchaseorder_objview`. In this case, the

view supports write through of a delete action to the base purchaseorder table. If the view is not key-updatable, triggers must be defined.

You can also use the view for the Write Record to Table adapter exchange protocol. If you use the view, you must create instead of triggers on the view to perform the appropriate inserts and updates to the base tables.

An alternative approach is to define an object table that can be written to directly by the adapter. Triggers on this table can maintain the inserts and updates with the relational application schema.

```
CREATE TABLE purchaseorder_obj OF purchaseorder_type
NESTED TABLE lineitems STORE AS lineitems_obj
```

The application datatypes created from the XML Schema for the view (similar for the object table) are as follows:

```
USER.PURCHASEORDER_OBJVIEW

    ID long
    REQUEST_DATE string
    SHIP_DATE string
    SHIP_TO CONTACT_TYPE
    BILL_TO CONTACT_TYPE
    LINEITEMS LINEITEM_LIST

CONTACT_TYPE

    NAME string
    ADDRESS string
    CITY string
    STATE string
    ZIP string
    PHONE string

LINEITEM_LIST

    LINEITEMS_ITEM LINEITEM_TYPE [0, N]

LINEITEM_TYPE

    LINE long
    ITEM string
    QUANTITY long
    PRICE double
    SHIPTO CONTACT_TYPE
```

Web Service Adapter

This section provides details about using the Web Service adapter. This section contains these topics:

- [Benefits of Using the Web Service Adapter](#)
- [Web Service Adapter Supported Versions](#)
- [Web Service Adapter Application Delivery Channel Description](#)
- [Web Service Adapter Exchange Protocols](#)
- [Web Service Adapter Design-Time Tasks](#)
- [Web Service Adapter Interaction and Record Naming Restrictions](#)
- [Web Service Adapter Errors](#)
- [Web Service Adapter Validation Prerequisites](#)
- [Web Service Adapter Additional Setup Tasks](#)
- [Web Service Adapter Limitations](#)
- [Web Service Adapter Diagnostics and Troubleshooting](#)
- [Web Service Adapter Use Case](#)

See Also: ["Layout of Adapter Details in this Chapter"](#) on page 8-2 for an overview of topics covered for each adapter in this chapter

Benefits of Using the Web Service Adapter

The Web Service adapter enables you to interact with a Web service operation selected from a Web Service Description Language (WSDL) document.

Web Service Adapter Supported Versions

The Web Service adapter provides support for the components shown in [Table 8–38](#).

Table 8–38 Supported Web Service Adapter Components

Component	Support Provided
WSDL	Web service using WSDL 1.1 with Simple Object Access Protocol (SOAP) bindings
Protocols	SOAP used over the HTTP and secure HTTP protocols. The Web Service adapter functions only as a client, and not as a server (that is, only the outbound direction is supported).
Applications	Any application wrapped in a Web Service that provides WSDL and SOAP/HTTP bindings

Web Service Adapter Application Delivery Channel Description

When creating a delivery channel, you must specify a Web Service port name or URL. The other delivery channel parameters that you specify, such as a proxy server hostname, port, username, and password, and user authentication details, may or may not be required.

See Also: ["Creating a Web Service Delivery Channel"](#) on page 15-25 for the list of parameters you specify to create a delivery channel

Web Service Adapter Exchange Protocols

The Web Service adapter includes the Web Service Operation outbound adapter exchange protocol. This adapter exchange protocol supports the selection of a WSDL definition and a specific Web Service operation from that definition. The interaction description is as follows:

Invoke Web Service Operation(RequestRecord,ResponseRecord)

where RequestRecord is the actual request message name and ResponseRecord is the actual response message name.

Interaction Name Example

This example uses a unique interaction name based on concatenation of the following elements:

- `targetNamespace` of the WSDL definition containing the operation
- The # character
- Operation name

After you have added this interaction, the name displays in the Oracle Application Server ProcessConnect user interface tool in the **Details** section of the native event type details page and on the Interaction page (See [Figure 8-31](#) on page 8-103).

Schemas describing native datatypes are generated automatically by the Web Service adapter and can be viewed by browsing the native datatype repository and by examining the `ui.log` file (if the adapter logging level is set to `information` or higher).

Note: If the WSDL definition is included in a file instead of a URL, place the file in the `$ORACLE_HOME/ip/import` directory. This makes the file available for selection when you add a Web Service adapter interaction.

See Also:

- ["Managing and Monitoring a Middle-Tier Instance from Oracle Enterprise Manager Application Server Control"](#) on page 18-5 for instructions on setting adapter logging levels with Oracle Enterprise Manager
- ["Adapter Interactions"](#) on page 3-19 for conceptual details about interactions and adapter exchange protocols
- ["Adding a Web Service Adapter Interaction"](#) on page 11-23 for instructions on selecting an adapter exchange protocol during an interaction and for the list of interaction questions to which to respond

Web Service Adapter Design-Time Tasks

Records are named according to their associated interaction. This is because they contain operation-specific metadata in their annotations and this is the convention with SOAP. The IN record name is the same as the interaction name.

The OUT record name is the concatenation of the following elements:

- The IN record name
- The string Response

[Table 8–39](#) describes Web Service adapter IN record element naming conventions.

Table 8–39 Web Service Operation IN Record Element Naming Conventions

Record Element Name	Description	Value Type	Definition Provided By User or Adapter	Native Datatype Name for Adapter-Provided Definition	Native Format Restrictions
<i>Message_ Part_Name</i>	Input message part to Web Service	XML	Adapter	<i>NS#WSDL_ Message_Part_Name</i>	XSD only
...					¹

¹ There can be one to *n* record elements, where *n* is any number.

[Table 8–40](#) describes Web Service adapter OUT record element naming conventions.

Table 8–40 Web Service Operation OUT Record Element Naming Conventions

Record Element Name	Description	Value Type	Definition Provided By User or Adapter	Native Datatype Name for Adapter-Provided Definition	Native Format Restrictions
<i>Message_ Part_Name</i>	Output message part to Web Service	XML	Adapter	<i>NS#WSDL_ Message_Part_ NameResponse</i>	XSD only
...					¹

¹ There can be one to *n* record elements, where *n* is any number.

The value *NS* in [Table 8–39](#) and [Table 8–40](#) reflects a namespace value that depends on the type of the message part:

- If the message part has an `xsd` primitive type (for example, `xsd:int` or `xsd:string`), the namespace used is the WSDL target namespace.
- If the message part has a type that is described by a schema within the WSDL, the namespace used is the schema target namespace.

For example, an interaction generated from the following WSDL fragment:

```
<definitions
  name="oracle.tip.adapter.ws.test.HotelImpl"
  targetNamespace="http://oracle/tip/adapter/ws/test/HotelImpl.wsdl"
  xmlns="http://schemas.xmlsoap.org/wsdl/"
...
<operation name="getDetails">
  <input name="getDetailsRequest" message="tns:getDetailsRequest"/>
  <output name="getDetailsResponse" message="tns:getDetailsResponse"/>
</operation>
...
</definitions>
```

is named:

```
http://oracle/tip/adapter/ws/test/HotelImpl.wsdl#getDetails
```

with an IN record named:

```
http://oracle/tip/adapter/ws/test/HotelImpl.wsdl#getDetails
```

and an OUT record named:

```
http://oracle/tip/adapter/ws/test/HotelImpl.wsdl#getDetailsResponse
```

The interaction name appears in the Interactions page of the Oracle Application Server ProcessConnect user interface tool as follows:

```
Web Service Adapter
```

```
  Web Service
```

```
    http://oracle/tip/adapter/ws/test/HotelImpl.wsdl#getDetails(http://oracle/tip/adapter/ws/test/HotelImpl.wsdl#getDetails,http://oracle/tip/adapter/ws/test/HotelImpl.wsdl#getDetailsResponse)
```

XML is the native format of all Web Service IN and OUT record elements. XML is the only native format that you can select.

See Also: ["Wire Messages and Oracle Records"](#) on page 3-17 for conceptual details about Oracle records.

Web Service Adapter Interaction and Record Naming Restrictions

Two different Web services implemented by different providers with the same namespace and operation, but with different inputs and outputs, cannot be used together.

Web Service Adapter Errors

This section describes Web Service adapter errors that can occur.

WSDL Definition Processing Errors:

Two types of errors can occur during WSDL definition processing:

- Domain errors
 - All definitions are removed during WSDL processing
 - Too many rounds of questions (ten or more) to choose a unique operation
- System errors
 - Fetching a WSDL (or its imports) using a URL

Execution Errors:

Two types of errors can occur during execution:

- Domain errors can occur in the following cases:
 - If the SOAP request message cannot be constructed from the input Oracle record based on the information specified during interaction questioning (for example, the number of record elements does not equal the number of message parts)
 - If the connection details cannot be used to obtain an HTTP connection (that is, the name or URL of the Web Service port string does not start with `http:` or `https:`, and is not listed in `PortInfo`). Failures to actually connect are reported as system errors.
 - If the output Oracle record cannot be constructed from the SOAP response message (for example, the response contained a SOAP FAULT that was not declared in the WSDL)

- System errors can occur in the following cases:
 - Errors that occur from the time that a connection is requested, until the last response byte is read from the wire message. Some of these errors are likely transient. Use caution when issuing a retry (for example, limit the number and frequency of retries, and be aware that the remote Web service can possibly be invoked more than once.

Web Service Adapter Validation Prerequisites

Ensure that the **Web Service port name or URL** delivery channel parameter setting that you specify matches with that listed in the WSDL file.

Web Service Adapter Additional Setup Tasks

This section describes setup tasks to perform in addition to the delivery channel parameter and interaction question tasks that you perform with the Oracle Application Server ProcessConnect user interface tool.

A Web Service interaction (accessed through a native role) cannot be used until the following tasks have been performed:

- A port (represented by an application party and associated delivery channel) is configured
- That port is configured with the native role by an application agreement

If the port present in the WSDL definition defines the interaction, the name or URL of the port delivery channel parameter must be set to the port name. If the port was not present in the WSDL file, but you obtained a WSDL definition for a port that references the interaction operation through the same binding, you can provide the new party's URL (found in the `<soap:address>` element) as the value of the name or URL of the Web Service port parameter when configuring the new application party. You can then use existing interactions by defining an agreement between the new party and existing native roles that use the existing interactions.

Web Service Adapter Limitations

The Web Service adapter includes the following restrictions:

- The schema for each message part, and therefore for each Oracle record element, must not reference elements or types from any namespace other than its own `targetNamespace` and the XML Schema (`xsd`) namespace. For

example, operations that use SOAP Section 5 array encoding to transmit parameters or results are not supported.

- Overloaded operations (operations with the same name, but different parameter types) are not supported.
- Inbound communication is not supported.
- The underlying SOAP stack is Apache SOAP. A Web service that does not interoperate with Apache SOAP cannot interoperate with the Web Service adapter.
- The schema for each message part, and therefore for each Oracle record element, must not reference the XML Schema (`xsd`) `any` or `anyType` elements, or any unsupported schema constructs.

See Also: ["XSD"](#) on page A-3 for a list of unsupported schema constructs

Web Service Adapter Diagnostics and Troubleshooting

The Web Service adapter provides the following logging capabilities.

The following logging occurs during processing of a WSDL definition (modeling):

- A `WARNING` entry for each WSDL element that is removed from further consideration:
 - A schema import, element, or type definition is removed if it references a namespace other than its own target namespace or the `xsd` and `xsi` namespaces. This means that SOAP-encoded arrays are not supported because those definitions are in a different namespace.
 - A message is removed if part of it refers to an unknown type. Known types are the `xsd:primitive` types and nonremoved global types and elements defined in schemas.
 - A binding operation is removed if it refers to an unknown (removed) message.
 - A binding is removed if it is not a supported SOAP/HTTP binding, or if all of its operations have been removed.
 - A port is removed if it refers to an unknown binding.
 - A service is removed if all its ports are removed.

- INFORMATION entries for each WSDL document processed, showing nonremoved elements
- EXCEPTION entries for errors occurring during processing of the current WSDL document. WSDL text showing all elements (removed or not) is logged.

The following logging occurs during execution (in the adapter framework):

- INFORMATION entries for the SOAP envelope (request and response)
- EXCEPTION entries for `OperationInfo`, `PortInfo`, and SOAP envelope (request and response)

See Also: ["Managing and Monitoring a Middle-Tier Instance from Oracle Enterprise Manager Application Server Control"](#) on page 18-5 for instructions on setting adapter logging levels with Oracle Enterprise Manager

Web Service Adapter Use Case

This section provides a brief example of the types of delivery channel and interaction details you must specify to use a Web Service adapter.

Delivery Channel Questions

Figure 8-28 shows the delivery channel details to specify for the Web Service adapter.

Figure 8-28 Create a Web Service Delivery Channel

Create Delivery Channel

Application **A app**

Please enter the delivery channel parameter(s) and choose Apply.

* Indicates required field

* Name	<input type="text"/>
Proxy server hostname	<input type="text"/>
Proxy server port	<input type="text" value="80"/>
	<small>(Default Value = 80)</small>
Proxy server username	<input type="text"/>
Proxy server password	<input type="password"/>
Web Service port name or URL	<input type="text"/>
Authentication username	<input type="text"/>
Authentication password	<input type="password"/>
Authentication security realm	<input type="text"/>
Oracle Wallet location	<input type="text"/>
Oracle Wallet password	<input type="password"/>

See Also: "Creating a Web Service Delivery Channel" on page 15-25 for specific details about creating a Web Service adapter delivery channel

Interaction Questions

Figure 8–29 shows the **Invoke Web Service Operation(RequestRecord, ResponseRecord)** adapter exchange protocol to add for outbound interactions with the Web Service adapter:

Figure 8–29 Web Service Adapter Exchange Protocol

Add Interaction: Select Interaction

Please select the interaction to add.

[Expand All](#) | [Collapse All](#)

Adapter Exchange Protocols	
Focus Item	
	▼ Adapter Exchange Protocols
⊕	▼ Inbound
⊕	▼ Outbound
⊕	▼ Web Service
	Invoke Web Service Operation(RequestRecord, ResponseRecord)

Figure 8–30 shows the interaction details to specify for the **Invoke Web Service Operation(RequestRecord, ResponseRecord)** adapter exchange protocol of the Web Service adapter in the outbound direction. More than one page of questions can appear.

Figure 8–30 Creating a Web Service Adapter Outbound Interaction

Add Interaction: Questions - WSDL Definition

Please answer each interaction question. Supply a local or remote WSDL definition of the Web Service to invoke.

WSDL definition file name

or, WSDL definition URL

Proxy server hostname (if specifying WSDL definition URL)

Proxy server port (if specifying WSDL definition URL)

Figure 8–31 shows a portion of the outbound direction adapter exchange protocol after creation. Click this adapter exchange protocol for additional details. Note the original name of **RequestRecord** shown in Figure 8–29 on page 8-102 has been replaced with the URL to the WSDL file specified in Figure 8–30. The name of **ResponseRecord** shown in Figure 8–29 has also been replaced with this URL to the specified WSDL file. In addition, however, the word **Response** is appended to the end.

Figure 8–31 Web Service Adapter Outbound Adapter Exchange Protocol

See Also: ["Adding a Web Service Adapter Interaction"](#) on page 11-23 for specific details about creating an outbound Web Service adapter interaction

Chapter Summary

This chapter describes the following details about the Advanced Queuing, E-Mail, File/FTP, HTTP, JMS, Oracle Database, and Web Service technology adapters:

- Benefits of using the adapter
- Supported versions
- Application delivery channel descriptions
- Adapter exchange protocols
- Design-time tasks
- Interaction and record naming restrictions
- Errors
- Validation prerequisites
- Additional setup tasks
- Application integration and runtime behavior
- Limitations
- Diagnostics and troubleshooting
- Use cases

Creating Metadata with the Modeling Wizards

This chapter describes how to create integration modeling metadata with the assistance of the Oracle Application Server ProcessConnect modeling wizards.

This chapter contains these topics:

- [Modeling Wizards Concepts Overview](#)
- [Modeling Wizards Overview](#)
- [Prerequisites to Using the Modeling Wizards](#)
- [Starting the Modeling Wizards](#)
- [Creating Two Spokes](#)
- [Adding Event Flow to Two Spokes](#)
- [Creating a Single Spoke](#)
- [Adding Event Flow to a Single Spoke](#)
- [Reviewing Modeling Metadata Before Creation](#)
- [Reviewing Modeling Metadata After Creation](#)
- [Tasks to Perform after Modeling Metadata Creation](#)
- [Deleting a Spoke](#)
- [Common Modeling Wizard Errors](#)
- [Chapter Summary](#)

See Also: ["Business Process and Role Creation Methods"](#) on page 12-10 for recommendations on when to create modeling metadata automatically with the wizards or manually

Modeling Wizards Concepts Overview

The Oracle Application Server ProcessConnect user interface tool provides several modeling wizards that enable you to create modeling metadata. Before using these wizards, it is important to understand several key modeling wizard concepts:

- [Single Spoke](#)
- [Multiple Spokes with a Business Process](#)
- [Event Flow in a Spoke](#)

See Also: [Chapter 3, "Oracle Application Server ProcessConnect Concepts"](#) for additional details about modeling metadata

Single Spoke

A single spoke consists of a role set extending from the native role to the business process. Role ports and data flow connect the role set together. A native role can belong to only a single spoke. This means that a spoke is uniquely identified by its native role. [Figure 9-1](#) shows an Integration Diagram of a single spoke with the expense-NR native role.

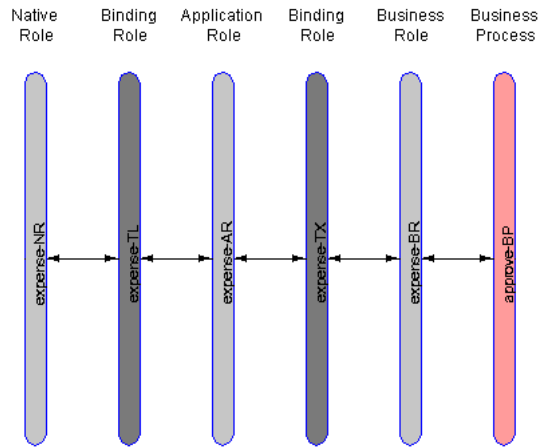
Figure 9–1 Integration Diagram of a Single Spoke

See Also: ["Viewing an Integration Diagram"](#) on page 12-15 for instructions on viewing an Integration Diagram

Multiple Spokes with a Business Process

Multiple spokes connected by a single business process comprise an integration. A business process uniquely identifies an integration. The business process resides in the middle to connect all spokes in an integration. [Figure 9–2](#) shows a single business process (Placing Ad) connecting two spokes. Each spoke has its own native role (HR Placing Ad-NR and Global NP Placing Ad-NR).

Figure 9–2 Integration Diagram of Multiple Spokes with a Business Process

Integration Diagram For Business Process : Placing Ad

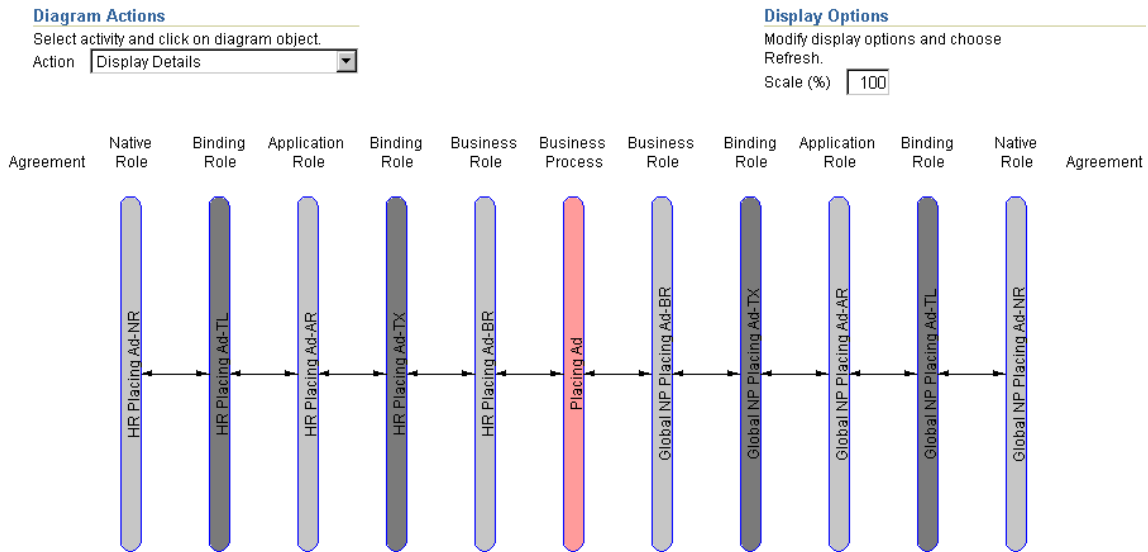

Spokes consist of two types:

- An initiating spoke that contains the first inbound event and the native role bound to the first inbound interaction (for example, native role HR Placing Ad-NR at the far left of [Figure 9–2](#))
- An invoked spoke that contains the first outbound event and the native role bound to the first outbound interaction (for example, native role Global NP Placing Ad-NR at the far right of [Figure 9–2](#))

See Also:

- [Figure 9–3](#) on page 9-5 for an Event Flow Diagram that shows the location of an interaction (far left)
- "[Viewing an Integration Diagram](#)" on page 12-15 for instructions on viewing an Integration Diagram

Event Flow in a Spoke

An event flow is the complete path a single event takes through a spoke. An inbound event flow begins with an inbound interaction that produces an inbound native event. As the event flows from the native role to the business process, the native event is translated to an application event and the application event is transformed to a business event. An outbound event flow takes an event in the opposite direction, going from a business event in a business process to an outbound interaction bound to the native role.

Figure 9-3 shows a portion of the event flow in a spoke. The Event Flow Diagram shows the events and the role steps that process and pass the events (HR Ad in this example) through a spoke.

Figure 9-3 Event Flow Diagram of a Portion of a Spoke

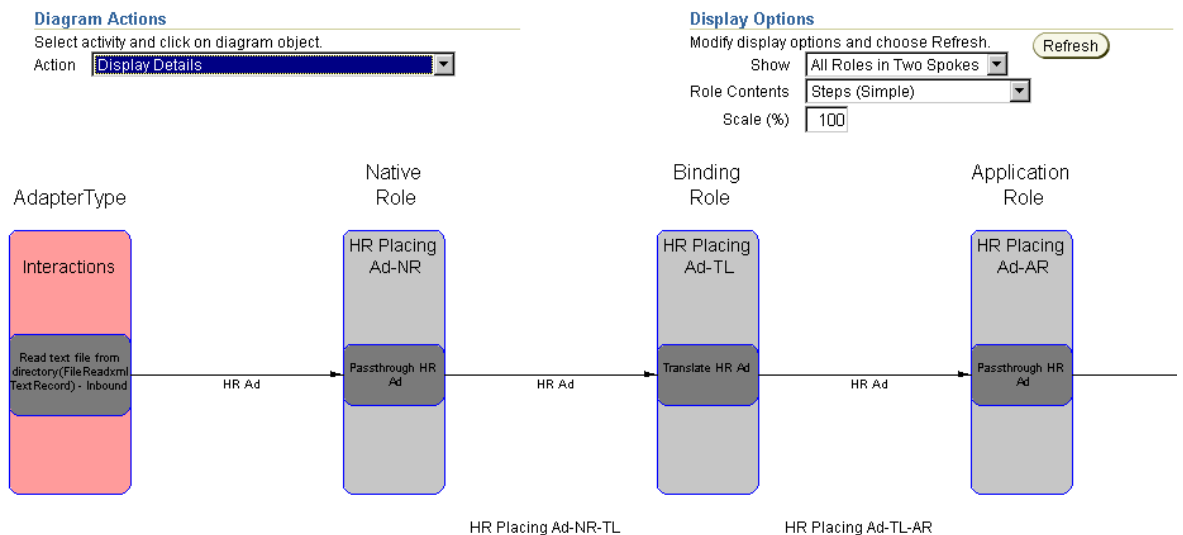

See Also: "[Viewing an Event Flow Diagram](#)" on page 12-18 for instructions on viewing an Event Flow Diagram

Modeling Wizards Overview

This section describes the four modeling wizards that enable you to create modeling metadata.

These modeling wizards provide different types of functionality:

- The Create End-to-End Basic Integration and Add End-to-End Basic Event Flow wizards create or update two spokes, respectively with a minimum of user input. Default values are provided for the names of business events and the transformation map to use. If these business events or transformation maps already exist, they are automatically used.
- The Create Spoke and Add Event Flow wizards only create or update a single spoke at a time, but provide you with more options. Both these wizards enable you to either select existing business events and transformation maps or specify the names of new ones to create.

This section contains these topics:

- [Create End-To-End Basic Integration Wizard](#)
- [Add End-To-End Basic Event Flow Wizard](#)
- [Create Spoke Wizard](#)
- [Add Event Flow Wizard](#)
- [Features Common to All Wizards](#)

Create End-To-End Basic Integration Wizard

The Create End-to-End Basic Integration wizard creates two spokes (with a new business process in the middle) and a single event flow that extends from the initiating spoke's native role to the invoked spoke's native role. Additional (end-to-end) event flows can be added with the Add End-to-End Basic Event Flow wizard. There are no options for selecting existing business events or transformation maps. All metadata is newly created.

The business event names generated are the same as the application event that is associated with the inbound interaction and native event selected. If this name matches an existing business event, the existing business event is used. The Create End-to-End Basic Integration wizard also uses an existing transformation map if there is a map that uses the same application event and business event as source and target parameters.

Figure 9-4 shows all the roles in an integration between two spokes.

Figure 9-4 Integration Diagram of Two Spokes

Integration Diagram For Business Process : Placing Ad

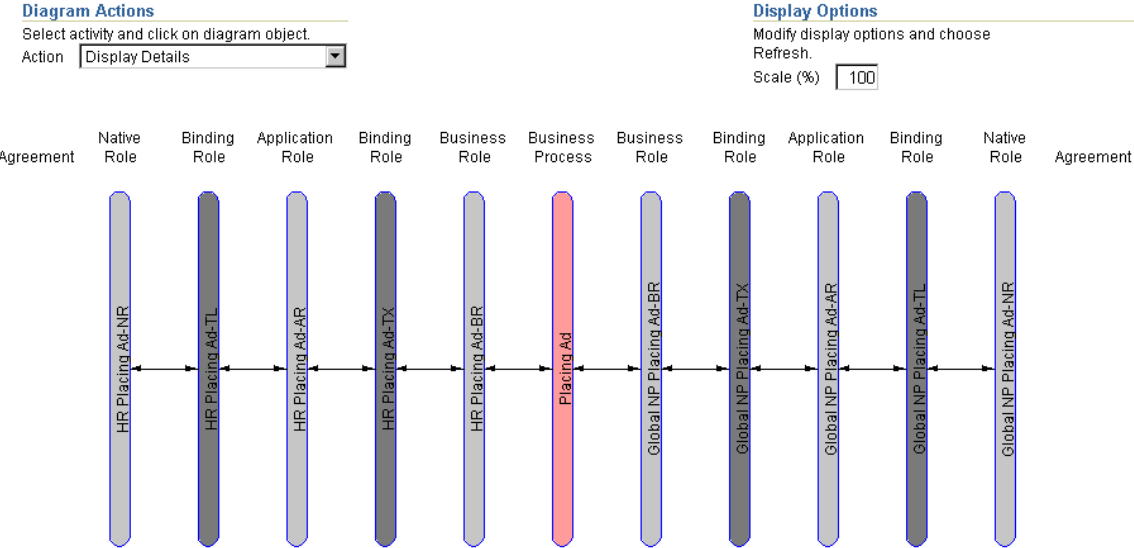

See Also: "Creating Two Spokes" on page 9-21 to use the Create End-to-End Basic Integration wizard

Add End-To-End Basic Event Flow Wizard

The Add End-to-End Basic Event Flow wizard adds an additional event flow to two spokes extending from the native role in the initiating spoke to the native role in the invoked spoke. These two spokes and initial event flow are typically created with the Create End-to-End Basic Integration wizard. There are no options for selecting existing business events or transformation maps. In this case, all metadata is newly created.

You can also use the Add End-To-End Basic Event Flow wizard to add an event flow to two spokes that were created manually without the Create End-to-End Basic Integration wizard. In this case, ensure that both spokes are completely created before you use the Add End-to-End Basic Event Flow wizard. (that is, all roles and data flow groups connecting them are completely created). Otherwise, errors occur when you attempt to add event flow with the Add End-To-End Basic Event Flow wizard.

All generated pass-through, transformation, translation, and SetParty steps appear at the bottom of each role's Process Diagram with a control flow from the previous last step and another control flow to the end step.

The business event names generated are the same as the application event that is associated with the inbound interaction and native event selected. If this name matches an existing business event, the existing business event is used. The Add End-to-End Basic Event Flow wizard also uses an existing transformation map if there is a map that uses the same application event and business event as source and target parameters.

[Figure 9–5](#) shows three roles in an event flow before running the Add End-To-End Basic Event Flow wizard.

Figure 9-5 Event Flow Diagram with One Event Flow

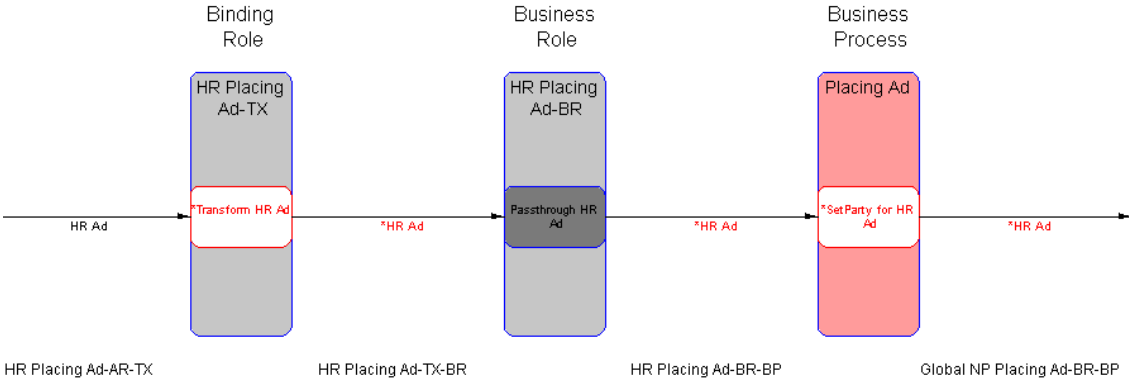
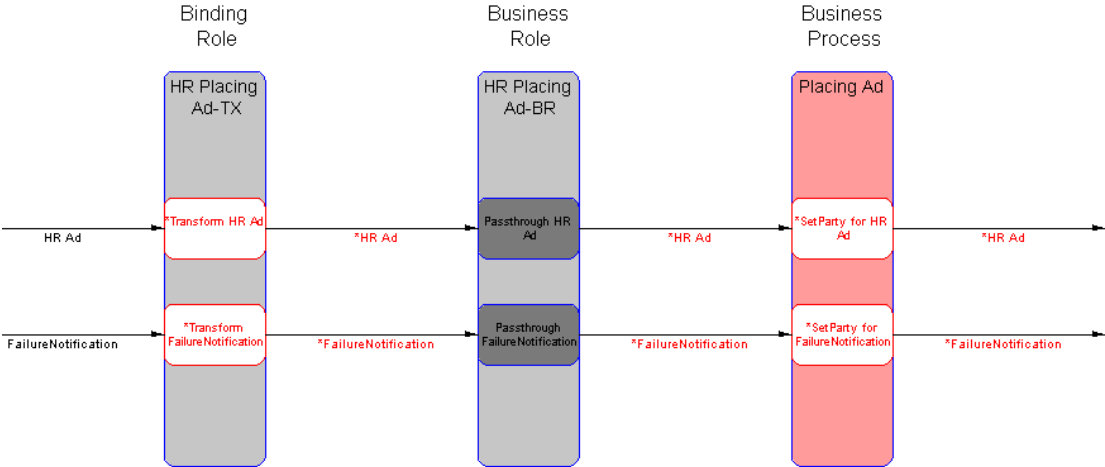

Figure 9-6 shows the same roles in the event flow after running the wizard. A second event flow is added.

Figure 9-6 Event Flow Diagram with Two Event Flows



See Also: "Adding Event Flow to Two Spokes" on page 9-22 to use the Add End-to-End Basic Event Flow wizard

Create Spoke Wizard

The Create Spoke wizard creates a single spoke (extending from the native role to the business process) and a single event flow. This single spoke can be created for use in several places, including the following:

- As an additional spoke added to an end-to-end integration created with the Create End-to-End Basic Integration wizard
- As an initial or additional spoke added to an existing business process created manually without a wizard

Additional event flows can be added to this single spoke with the Add Event Flow wizard. This wizard performs the following tasks based on input you provide:

- Binds the spoke to an existing business process or creates a new business process
- Uses an existing business event or creates a new business event
- Uses an existing transformation map or creates a new map

When the business role ports are data flow-bound to ports on an existing business process, all unbound business process ports are searched for a correct match in event type and direction. If one exists, it is used. If one does not exist, a new business process port is created (and also a pass-through step and port with the opposite flow). If multiple ports match, the first matching unbound port is used. [Figure 9-7](#) shows the third spoke that is added to an end-to-end basic integration.

Figure 9-7 Integration Diagram with Third Spoke

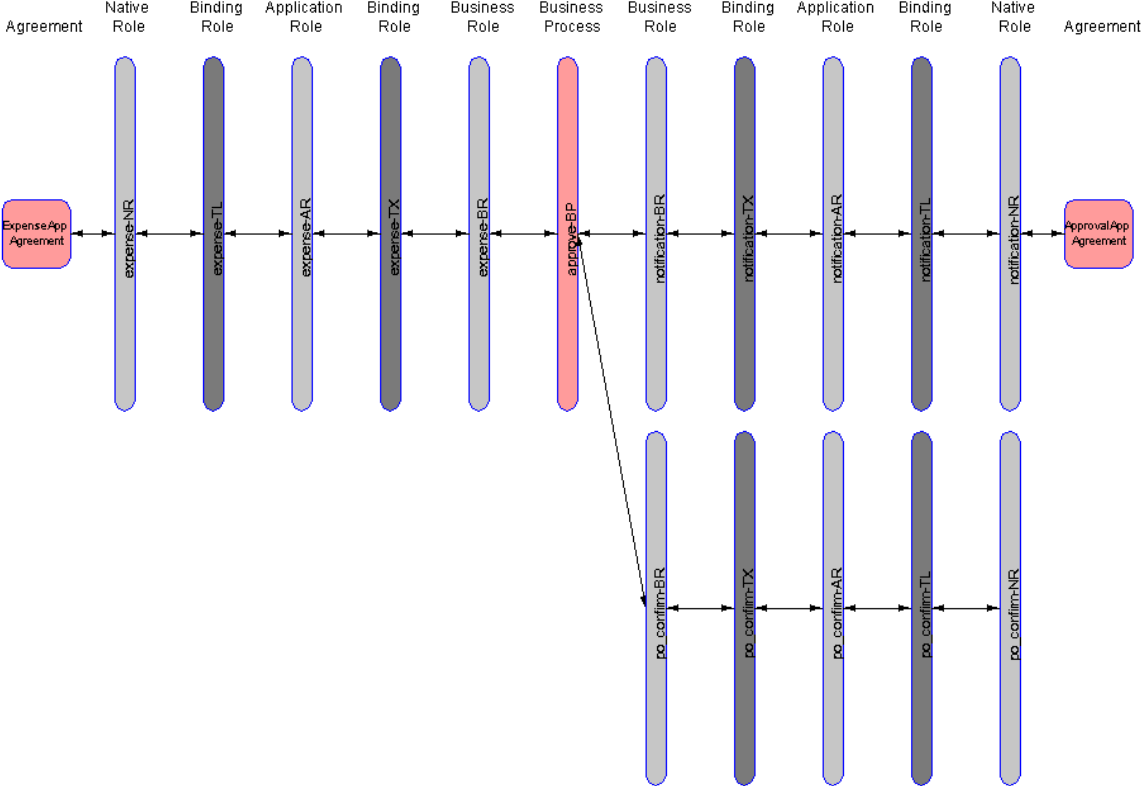

See Also: "Creating a Single Spoke" on page 9-23 to use the Create Spoke wizard

Add Event Flow Wizard

The Add Event Flow wizard adds an additional event flow to a single spoke extending from the native role to the business process. This wizard performs the following tasks based on input you provide:

- Uses an existing business event or creates a new business event
- Uses an existing transformation map or creates a new map
- All generated pass-through, transformation, and translation steps appear at the end of each role's Process Diagram with a control flow from the previous last step and another control flow to the end step.

The event flow is added to the single spoke shown in the lower portion of [Figure 9-7](#) on page 9-11.

When the business role ports are data flow-bound to ports on an existing business process, all unbound business process ports are searched for a correct match in event type and direction. If one exists, it is used. If one does not exist, a new business process port is created (and also a pass-through step and port with the opposite flow). If multiple ports match, the first matching unbound port is used.

See Also: ["Adding Event Flow to a Single Spoke"](#) on page 9-26 to use the Add Event Flow wizard

Features Common to All Wizards

This section describes several features common to all wizards:

- [Diagrams](#)
- [Disabling a Native Event](#)
- [Modeling Metadata Name Creation](#)
- [Interactions](#)

Diagrams

You can view diagrams that show various stages of modeling wizards design. Modeling metadata that is incomplete and requires you to perform additional steps outside the modeling wizards is highlighted in red in all diagrams.

- [Integration Diagram](#)
- [Event Flow Diagram](#)
- [Process Diagram](#)
- [Step Binding Diagram](#)

See Also: ["Viewing the Metadata Modeling Diagrams"](#) on page 12-11 for a detailed description of the tasks you can perform with the modeling metadata diagrams

Integration Diagram [Figure 9-8](#) shows an Integration Diagram, which identifies each role in the end-to-end integration. Click a specific role to view its steps in an Event Flow Diagram.

Figure 9–8 Integration Diagram of End-To-End Basic Integration

Integration Diagram For Business Process : Placing Ad

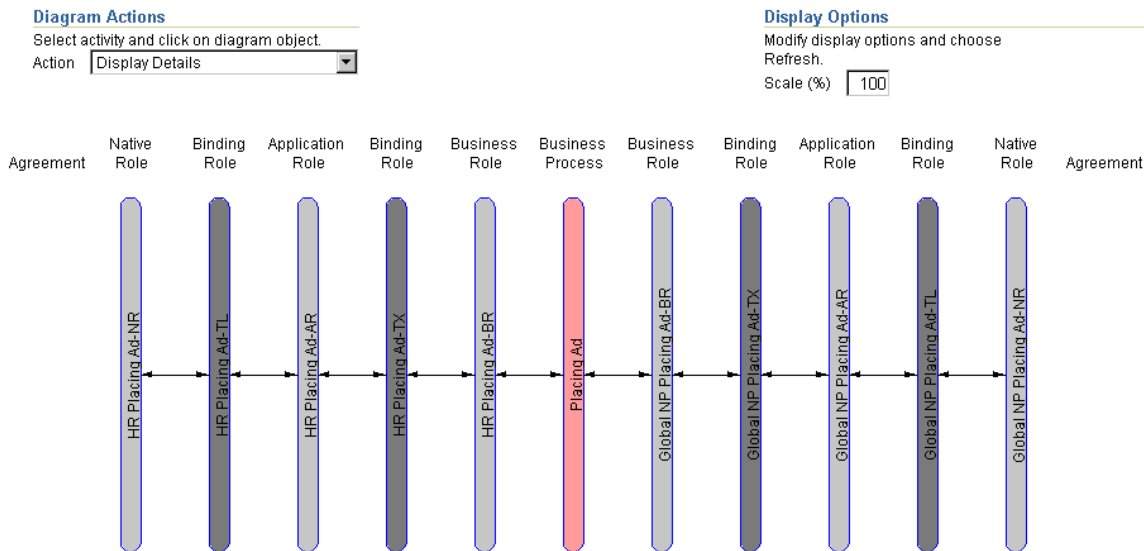

See Also: ["Viewing an Integration Diagram"](#) on page 12-15 for instructions on viewing an Integration Diagram

Event Flow Diagram [Figure 9–9](#) shows a portion of the Event Flow Diagram, which identifies the events and role steps that process and pass the events through the two spokes of the end-to-end basic integration.

Figure 9–9 Event Flow Diagram of a Portion of an End-to-End Basic Integration

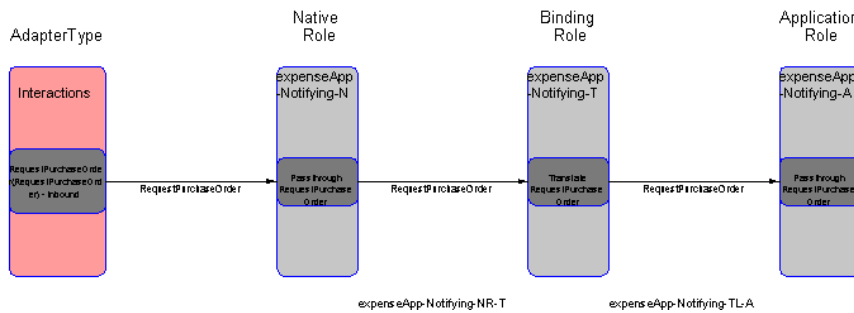

See Also: ["Viewing an Event Flow Diagram"](#) on page 12-18 for instructions on viewing an Event Flow Diagram

The Event Flow Diagram includes three selections available from the **Role Contents** list under the **Display Options** section. (See [Figure 9–13](#) on page 9-32.)

- The **Ports** option displays the ports of a role or business process.
- The **Steps (Simple)** option displays the steps of each role or business process that have a single input and single output data flow (what the wizards create).
- The **Complete Process Diagram** option provides a comprehensive view of modeling metadata, including all steps, data flows, control flows, and ports.

Process Diagram Each business process or role has a Process Diagram. [Figure 9–10](#) shows a Process Diagram for a specific role or business process of the end-to-end basic integration. The Process Diagram identifies the events, steps, control flows, and data flows.

Figure 9–10 *Process Diagram of a Role or Business Process*

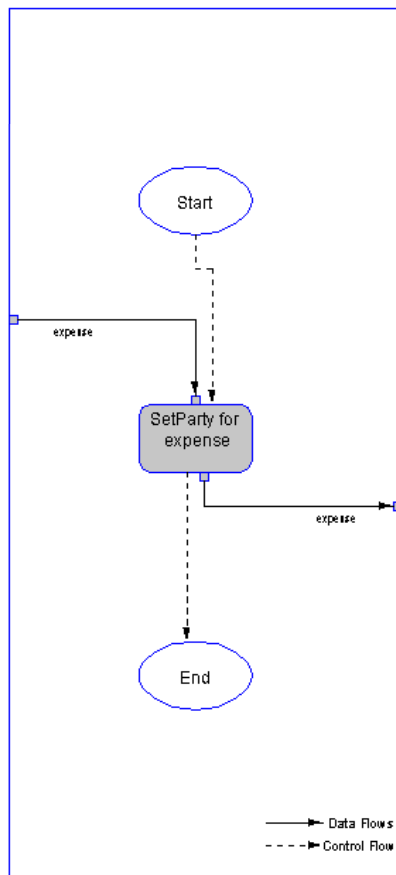

See Also: ["Viewing a Process Diagram"](#) on page 12-23 for instructions on viewing a Process Diagram

Step Binding Diagram [Figure 9-11](#) shows a Step Binding Diagram.

Figure 9-11 *Step Binding Diagram*

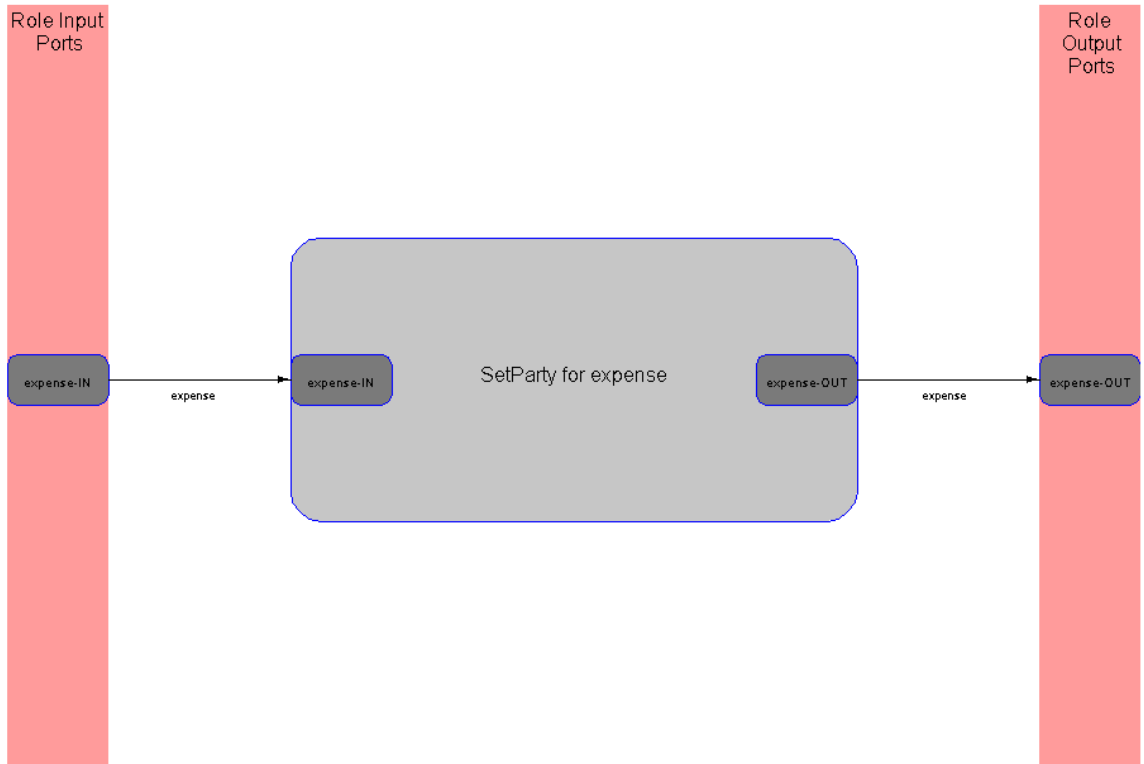

See Also: ["Viewing a Step Binding Diagram"](#) on page 12-28 for instructions on viewing a Step Binding Diagram

Disabling a Native Event

If you select an outbound interaction that includes both an inbound request and an outbound response, you are prompted for additional information for handling the response. For the two End-To-End wizards, when one spoke has a response, you are prompted to select another interaction to handle the response at the other spoke. For the Create Spoke and Add Event Flow wizards, if there is a response, then you are prompted to create (or select existing) business events and transformation maps for both the request and the response event flows. Optionally, you can click the **ignore** box to specify that the response native event must be consumed in the inbound native role (preventing further processing from occurring). In this case, there is no event flow for the response.

Modeling Metadata Name Creation

Names are created that are not always unique. In some cases, you receive an error. For example, if a generated role name already exists, you must enter a different name in the **Role Naming Convention** field. In other cases, the name is made unique by appending a sequence number to the end. For example, if an event named ack flows multiple times in the same spoke, there are multiple role ports with the generated name of ack-OUT. The wizards make the port names unique by appending a sequence number, such as ack-OUT1 or ack-OUT2.

Interactions

The modeling wizards only list interactions for selection that are defined as complete. Incomplete interactions do not have a record type or have a record type that is not associated with a native event type or a native event that is not associated with an application event. The modeling wizards do not list these interactions.

Prerequisites to Using the Modeling Wizards

Ensure that you add the adapter interactions you want to use before using these wizards. The interactions are then selectable in the wizard pages. Interactions represent unique actions that can be performed with a specific adapter (such as requesting a purchase order, confirming a purchase order, and so on).

Ensure that you also create a native event for the interaction and specify a translator. You can perform this task either during or after you add an adapter interaction.

See Also:

- ["Adding an Adapter Interaction"](#) on page 11-7 to add adapter interactions
- ["Managing Native Event Types"](#) on page 11-37 to create native events and select translators

Starting the Modeling Wizards

[Table 9-1](#) describes the locations from which the modeling wizards can be started.

Table 9-1 *Starting the Modeling Wizards*

Wizard	Start From Modeling Tab?	Start From Business Process Tab?	Start From Roles Tab?	Start From Event Flow Diagram?	Start From Integration Diagram?
Create End-To-End Basic Integration	Yes	Yes	No	No	No
Add End-To-End Basic Event Flow	Yes	Yes	Yes	Yes	No
Create Spoke	Yes	Yes	Yes	Yes	Yes
Add Event Flow	Yes	Yes	Yes	Yes	No

Starting From the Modeling Tab

1. Click the **Modeling** tab.
2. Click the appropriate modeling wizard listed under the **Shortcuts** section.

Starting From the Business Processes Tab or Roles Tab

1. Click the **Modeling** tab.
2. Click the **Business Processes** tab or **Roles** tab.
3. Click the appropriate modeling wizard under the **Shortcuts** section.

Starting From the Event Flow Diagram

1. Click the **Modeling** tab.
2. Click the **Business Processes** or **Roles** tab.
3. Select an event flow diagram from the **Event Flow Diagram** column.
4. Select the appropriate modeling wizard in the **Action** list.
5. Click inside the role in the Event Flow Diagram.

Note: When you start a modeling wizard from the Event Flow Diagram, the current business process appears as the default selection in the wizard pages. Similar defaults exist for native roles. For the Add Event Flow Wizard, the native role defaults to the one selected in the Event Flow Diagram. For the Add End-to-End Basic Event Flow wizard, the two native roles default to the two that are displayed in the Event Flow Diagram.

Starting From the Integration Diagram

1. Click the **Modeling** tab.
2. Click the **Business Processes** or **Roles** tab.
3. Select an integration diagram from the **Integration Diagram** column.
4. Select **Create Spoke** in the **Action** list.
5. Click inside a role or business process in the Integration Diagram.

Creating Two Spokes

Use the Create End-To-End Basic Integration wizard to create two spokes.

1. Start the Create End-To-End Basic Integration wizard by following the instructions in ["Starting the Modeling Wizards"](#) on page 9-19.

The Create End-To-End Basic Integration page appears.

2. Enter a business process to create in the **Business Process** field.
3. Go to the **Initiating Spoke** section to initiate a request.
4. Select an inbound interaction from the **Inbound Interaction** list.

The page refreshes to display the native event associated with this interaction.

Note: If the inbound and outbound interactions you select on this page have a record associated with multiple native events, the page is refreshed to include a list from which to choose the appropriate native event.

5. Enter a role naming convention to use as the prefix for all initiating roles in the **Role Naming Convention** field.
6. Go to the **Invoked Spoke** section to initiate a response.
7. Select an outbound interaction from the **Outbound Interaction** list.

The page refreshes to display the native event associated with this interaction.

If you select an outbound interaction that includes both an outbound request and an inbound response, the page refreshes and prompts you to enter an additional interaction.

8. Enter a role naming convention to use as the prefix for all invoked roles in the **Role Naming Convention** field.
9. Click **Next**.
10. Go to ["Reviewing Modeling Metadata Before Creation"](#) on page 9-28 to review an example of the final page of a wizard.

Adding Event Flow to Two Spokes

Use the Add End-To-End Basic Event Flow wizard to add additional event flow to two spokes.

1. Start the Add End-To-End Basic Event Flow wizard by following the instructions in ["Starting the Modeling Wizards"](#) on page 9-19.

The Add End-To-End Basic Event Flow page appears.

2. Select the business process that is used with the two spokes from the **Business Process** list.
3. Go to the **Initiating Spoke** section.
4. Select the native role of the initiating spoke from the **Native Role** list.

Note: Only native roles that have the selected business process appear in the list.

5. Select an interaction from the **Interaction** list for the event flow of the initiating spoke.

The page refreshes to display the native event associated with this interaction.

Note: If the selected interaction has a record associated with multiple native events, the page is refreshed to include a list from which to choose the appropriate native event.

Note: If you selected an outbound interaction that included both an outbound request and an inbound response, the page refreshes and prompts you to enter an additional interaction.

6. Go to the **Invoked Spoke** section.
7. Select the native role of the invoked spoke from the **Native Role** list.
8. Select an interaction from the **Interaction** list for the event flow of the invoked spoke.

The page refreshes to display the native event associated with this interaction.

If you select an outbound interaction that included both an outbound request and an inbound response, the page refreshes and prompts you to enter an additional interaction.

9. Click **Next**.

If the business event and transformation map names to be used exist, they are included in the spoke.

10. Go to "[Reviewing Modeling Metadata Before Creation](#)" on page 9-28 to review an example of the final page of a wizard.

Creating a Single Spoke

Use the Create Spoke wizard to create a single spoke. This single spoke can be created for use in several places, including the following:

- As an additional spoke added to an end-to-end integration created with the Create End-to-End Basic Integration wizard
 - As an initial or additional spoke added to an existing business process created manually without a wizard
1. Start the Create Spoke wizard by following the instructions in "[Starting the Modeling Wizards](#)" on page 9-19.

The Create Spoke: Business Process page appears.

2. Specify the business process to use for the event flow.

To...	Then...
Create a new business process	<ol style="list-style-type: none"> 1. Select Create New. 2. Enter a business process name.
Use an existing business process	<ol style="list-style-type: none"> 1. Select Use Existing. 2. Select a business process name from the list.

3. Click **Next**.

The Create Spoke: Interactions page appears.

4. Select an interaction from the **Interaction** list from which to create the first event flow in the spoke. The direction of the selected interaction (inbound or outbound) determines the direction of the first event flow.

5. Click **Next**.

The Create Spoke: Roles page appears.

6. Enter the role naming convention to use as the prefix for all role names in the spoke in the **Role Naming Convention** field.

7. Click **Next**.

The Create Spoke: Events page appears.

8. Specify the business event to use for the event flow. The interaction that displays (either inbound or outbound) is based on the interaction you selected in Step 4 on page 9-23.

To...	Then...
Create a new business event	<ol style="list-style-type: none"> 1. Select Create New. 2. Enter a business event name. This creates a business event with no event body element.
Use an existing business event	<ol style="list-style-type: none"> 1. Select Use Existing. 2. Select a business event name from the list.

Note: If the selected interaction has a record associated with multiple native events, a list of these native events from which to select is displayed.

If you selected an outbound interaction in Step 4 on page 9-23 that included both an outbound request and an inbound response, you are prompted to create business events for both.

9. Click **Next**.

The Create Spoke: Transformations page appears.

10. Specify the transformation maps to use for the event flow.

To...	Then...
Create a new transformation map	<ol style="list-style-type: none"> 1. Select Create New. 2. Enter a transformation map name. This creates a transformation map with no rules defined.
Use an existing transformation map	<ol style="list-style-type: none"> 1. Select Use Existing. 2. Select a transformation map name from the list.

For an inbound event flow, the list of existing transformation maps includes only maps that have the application event as the source parameter and the business event as the target parameter. For an outbound event flow, the list of existing transformation maps includes only maps that have the business event as the source parameter and the application event as the target parameter.

If you selected an outbound interaction in Step 4 on page 9-23 that included both an outbound request and an inbound response, you are prompted to create transformation maps for both.

11. Click **Next**.

12. Go to "[Reviewing Modeling Metadata Before Creation](#)" on page 9-28 to review an example of the final page of a wizard.

Adding Event Flow to a Single Spoke

You can create additional event flows for an existing single spoke.

1. Start the Add Event Flow wizard by following the instructions in "[Starting the Modeling Wizards](#)" on page 9-19.

The Add Event Flow: Interaction page appears.

2. Select the business process of the spoke from the **Business Process** list.
3. Select the native role of the spoke from the **Native Role** list.

Note: Only native roles that use the selected business process appear in the list.

4. Select an interaction from the **Interaction** list for creating the event flow. The direction of the selected interaction (inbound or outbound) determines the direction of the first event flow.
5. Click **Next**.

The Add Event Flow: Events page appears.

6. Specify the business event to use for the event flow. The interaction that displays (either inbound or outbound) is based on the direction you selected in Step 4 on page 9-26.

To...	Then...
Create a new business event	<ol style="list-style-type: none"> 1. Select Create New. 2. Enter a business event name. This creates a business event with no event body element.
Use an existing business event	<ol style="list-style-type: none"> 1. Select Use Existing. 2. Select a business event name from the list.

If you selected an outbound interaction in Step 4 on page 9-26 that included both an outbound request and an inbound response, you are prompted to create business events for both.

7. Click **Next**.

The Add Event Flow: Transformations page appears.

8. Specify the transformation map to use for the event flow. The interaction that displays (either inbound or outbound) is based on the direction you selected in Step 4 on page 9-26.

To...	Then...
Create a new transformation map	<ol style="list-style-type: none"> 1. Select Create New. 2. Enter a transformation map name. This creates a transformation map name with no rules defined.
Use an existing transformation map	<ol style="list-style-type: none"> 1. Select Use Existing. 2. Select a transformation map name from the list.

For an inbound event flow, the list of existing transformation maps includes only maps that have the application event as the source parameter and the business event as the target parameter. The application event is associated with the native event. The native event is associated with the record type that is associated with the chosen interaction.

For an outbound event flow, the list of existing transformation maps includes only maps that have the business event as the source parameter and the application event as the target parameter.

If you selected an outbound interaction in Step 4 on page 9-26 that included both an outbound request and an inbound response, you are prompted to create transformation maps for both.

9. Click **Next**.
10. Go to "[Reviewing Modeling Metadata Before Creation](#)" on page 9-28 to review an example of the final page of a wizard.

Reviewing Modeling Metadata Before Creation

The review page displays details about the type of modeling metadata for the wizard to create. [Figure 9–12](#) provides an example of the type of information that displays for the review page of the Create End-To-End Basic Integration wizard.

Figure 9–12 Wizard Review Page

Create End-To-End Basic Integration: Review

Cancel Back Step 2 of 2

Choosing Finish will begin a task that may require a long time to process. After choosing Finish please do not use the browser's Stop button or otherwise interrupt the task until the processing has completed.

Please review the end-to-end basic integration details and choose Finish. Additional event flows can be created from the resulting diagram.

Indicates new item(s)

Initiating Spoke

↓ Event Flow - Native Role To Business Process			
	Role	Event	Step
Interaction		Read text file from directory(FileReadxmlTextRecord) - Inbound	
Native	HR Placing Ad-NR	HR Ad	Passthrough HR Ad
Translation	HR Placing Ad-TL		Translate HR Ad
Application	HR Placing Ad-AR	HR Ad	Passthrough HR Ad
Transformation	HR Placing Ad-TX		Transform HR Ad You will need to populate the rules for this transformation map.
Business	HR Placing Ad-BR	HR Ad You will need to define the elements for this business event.	Passthrough HR Ad
Business Process	Placing Ad		SetParty for HR Ad You will need to select a party for this SetParty step.

Invoked Spoke

[Return to Top](#)

↑ Event Flow - Business Process To Native Role			
	Role	Event	Step
Interaction		Write text file to directory(FileWriteglobal_newspaper_ad.xmlTextRecord) - Outbound	
Native	Global NP Placing Ad-NR	Global Newspaper Ad	Passthrough Global Newspaper Ad
Translation	Global NP Placing Ad-TL		Translate Global Newspaper Ad
Application	Global NP Placing Ad-AR	Global Newspaper Ad	Passthrough Global Newspaper Ad
Transformation	Global NP Placing Ad-TX		Transform HR Ad You will need to populate the rules for this transformation map.
Business	Global NP Placing Ad-BR	HR Ad You will need to define the elements for this business event.	Passthrough HR Ad
Business Process	Placing Ad		SetParty for HR Ad You will need to select a party for this SetParty step.

Table 9–2 describes the review page sections shown in Figure 9–12.

Table 9–2 Wizard Review Page

Page Element	Description
Role columns of the Initiating Spoke and Invoked Spoke sections	Identifies the roles involved in the event flow. The Create Spoke and Create End-to-End Basic Integration wizards create new roles, as indicated by the star symbol after the role name. The business process can be created new or an existing one can be selected. The Add Event Flow and the Add End-To-End Event Flow wizards always use existing roles.
Event columns of the Initiating Spoke and Invoked Spoke sections	Identifies the events and their directional flow through the roles. The native role to business process direction is inbound. A down arrow identifies the event flow direction as inbound. The business process to native role direction is outbound. An up arrow identifies the event flow direction as outbound. A business event may be created new (without an event body element) as indicated by a star symbol or an existing business event can be used. You must create the event body element separately.
Step columns of the Initiating Spoke and Invoked Spoke sections	Identifies the steps to be created in each role. Event transformation maps are created in transformation steps with no defined rules. You must define the rules separately. A SetParty step is also created in the business process. You must update the target party of the SetParty step separately.
New metadata (Identified by a sun icon)	Identifies modeling metadata to be newly created by the wizard.
Incomplete metadata (Identified by an exclamation point icon within a triangle)	Identifies incomplete modeling metadata that must be manually created outside of the wizard for your integration to be valid. Examples include the following: <ul style="list-style-type: none"> ■ Event transformation maps with no defined rules, which display this message: You will need to populate the rules for this transformation map. ■ Business events with no event body elements, which display this message: You will need to define the elements for this business event. ■ SetParty steps that must be updated with the correct target party, which display this message: You will need to select a party for this SetParty step.
Business Process for both the Initiating Spoke and Invoked Spoke sections	Identifies the business process. When you create two spokes with the Create End-to-End Basic Integration wizard, the same business process is used for both spokes.

Table 9-3 through Table 9-5 provide additional details about the naming conventions for the modeling metadata to create.

Roles names are appended with the suffixes shown in Table 9-3. These details also display in the review page shown in Figure 9-12 on page 9-28.

Table 9-3 Role Naming Conventions

For Role...	Suffix Is...	For Role...	Suffix Is...
Native role	-NR	Transformation binding role	-TX
Translation binding role	-TL	Business role	-BR
Application role	-AR		

Data flow groups are appended with the suffixes shown in Table 9-4.

Table 9-4 Data Flow Group Naming Conventions

Data Flow Group Between...	Suffix Is...	Data Flow Group Between...	Suffix Is...
Native role and translation binding role	-NR-TL	Transformation binding role and business role	-TX-BR
Translation binding role and application role	-TL-AR	Business role and business process	-BR-BP
Application role and transformation binding role	-AR-TX		

Port, step, and events follow the naming conventions shown in Table 9-5.

Table 9-5 Port, Step, and Event Naming Conventions

Metadata	Naming Convention	Example
Ports	Uses the event name appended with -IN or -OUT depending on whether it is an inbound or outbound port	HR Ad-IN where HR Ad is the inbound business event name
Pass-through steps	Uses the name Passthrough appended with the input event name	Passthrough HR Ad where HR Ad is the input event name
Translation steps	Named Translate and appended with the input event name	Translate HR Ad where HR Ad is the input event name

Table 9–5 (Cont.) Port, Step, and Event Naming Conventions

Metadata	Naming Convention	Example
Transformation steps	Named Transform and appended with the input event name	Transform HR Ad where HR Ad is the input event name
Transformation maps	Named with the input event name	Transform HR Ad where Transform HR Ad is the input event name
Business events	Named the same as the inbound application event name. For an end-to-end wizard where there is both an inbound and outbound application event, the name of the application event in the initiating role is used.	HR Ad where HR Ad is the application event name
SetParty step	Named SetParty and appended with the inbound event name	SetParty for HR Ad where HR Ad is the inbound event name

1. Review the modeling metadata shown in [Figure 9–12](#).
 - a. To modify this modeling metadata, click the **Back** button of the modeling wizard to return to the previous pages. When you complete modifications, click **Next** until you access the review page; then click **Finish**.
 - b. If you are satisfied with this modeling metadata, click **Finish**.
2. If modeling metadata creation is successful, the Event Flow Diagram appears. Go to "[Reviewing Modeling Metadata After Creation](#)" on page 9-32.
3. If modeling metadata creation is unsuccessful, the wizard either returns you to the page requiring modifications or displays errors on the review page. Make appropriate modifications to the modeling metadata.

Note: Do not use the **Back** or **Forward** buttons of your Web browser. Instead, use the **Back** and **Next** buttons specifically provided by the modeling wizards.

Reviewing Modeling Metadata After Creation

If event flow creation is successful, the Event Flow Diagram appears (in this example, the Event Flow Diagram that shows modeling metadata created by the Create End-to-End Basic Integration wizard). The Event Flow Diagram is very large. For this reason, it is broken down into four diagrams, as show in [Figure 9-13](#) through [Figure 9-16](#).

Figure 9-13 Event Flow Diagram: First Part

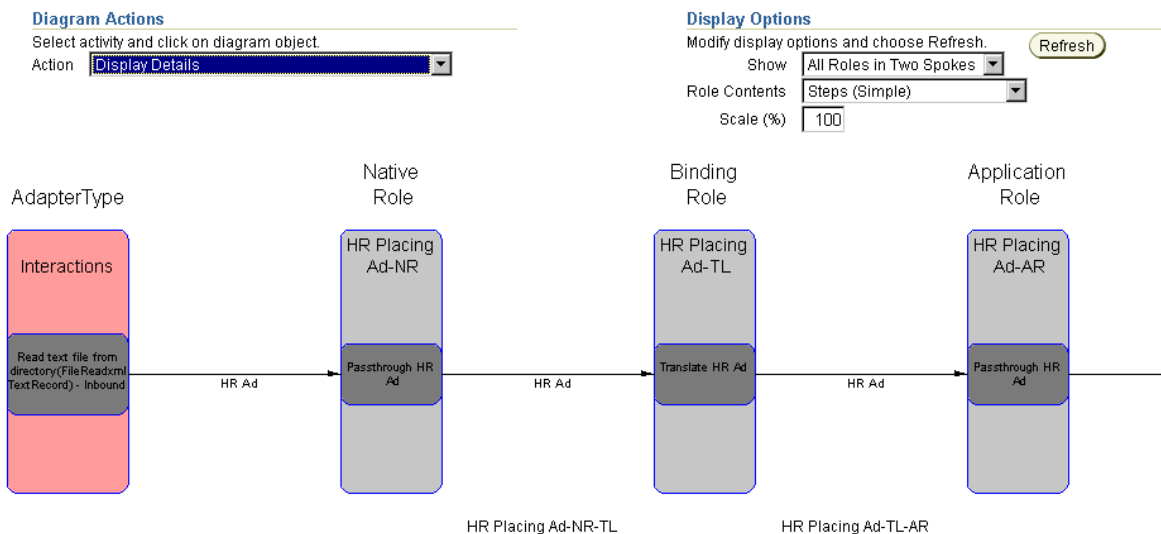

Note: The Event Flow Diagram identifies in red the business events that have no event body elements, transformation maps that have no defined rules, and the business process SetParty step that must be updated. You must separately complete these tasks to make your modeling metadata valid.

Figure 9–14 Event Flow Diagram: Second Part

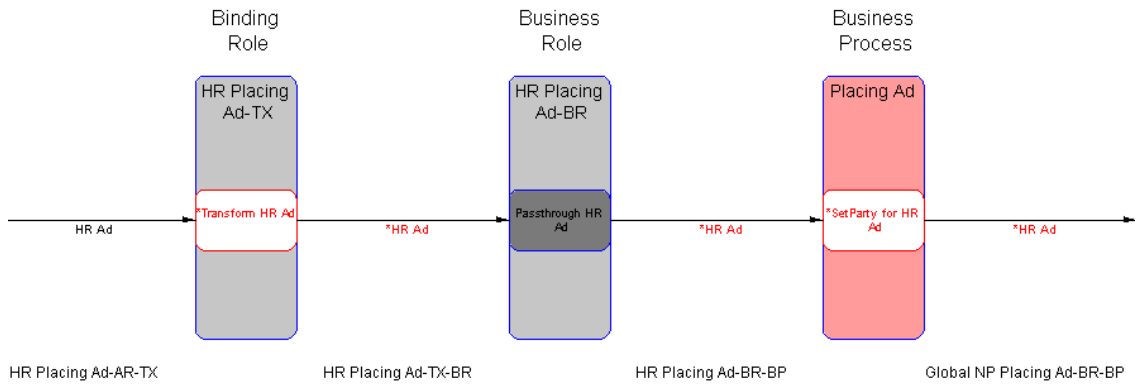

Figure 9–15 Event Flow Diagram: Third Part

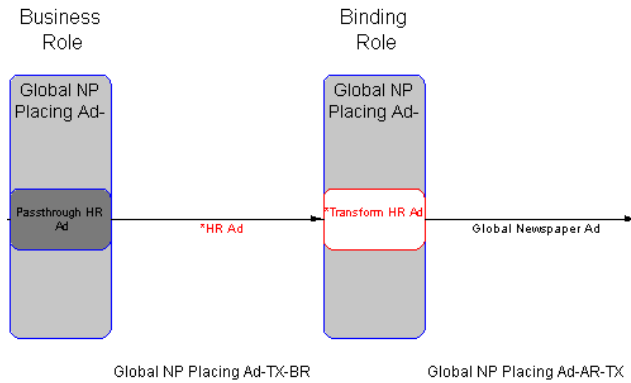

Figure 9–16 Event Flow Diagram: Fourth Part

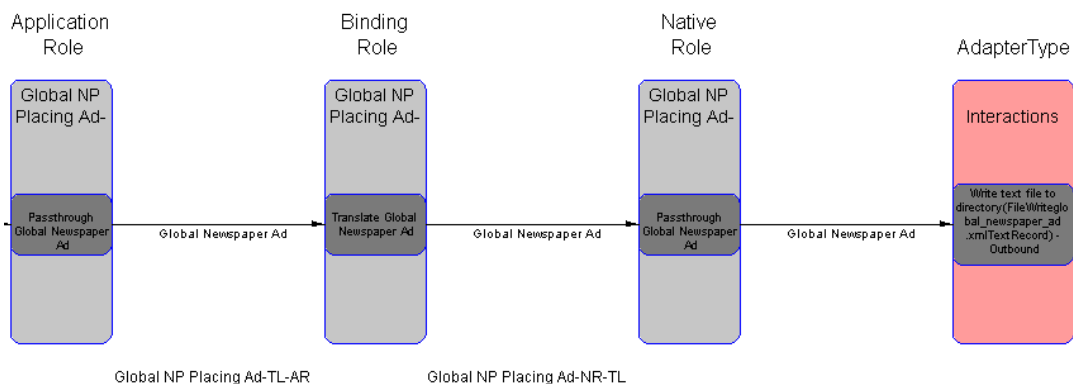
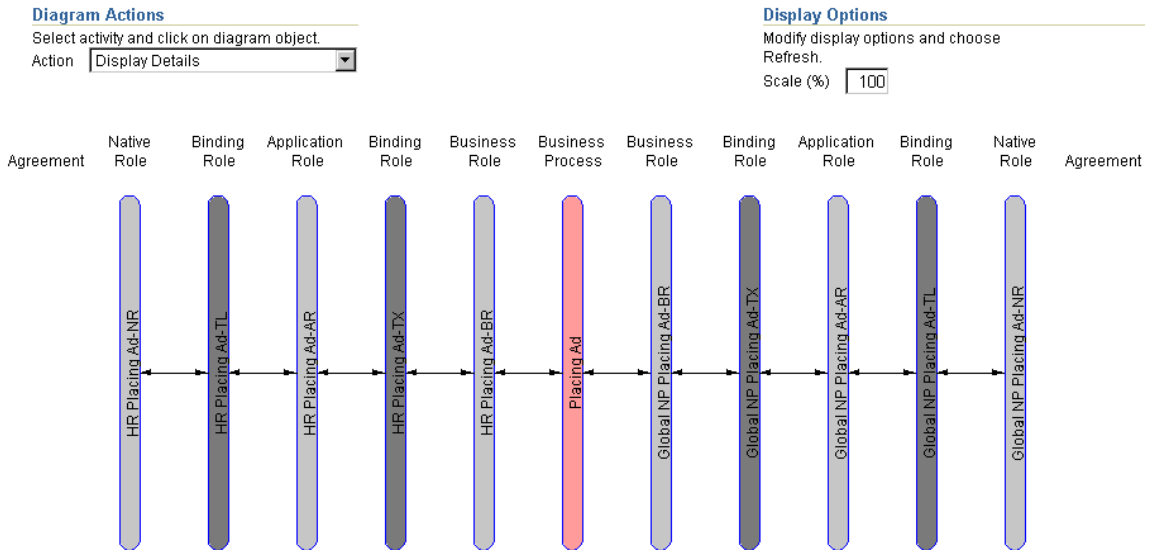

Figure 9–17 shows the Integration Diagram of the two spokes created by the Create End-to-End Basic Integration wizard. The **Agreement** header displays for both native roles. When you add the native role of a spoke to an agreement, an **Agreement** icon displays beneath the **Agreement** header. You can click this icon to display the details page for the agreement.

Figure 9–17 Integration Diagram

Integration Diagram For Business Process : Placing Ad



See Also: ["Viewing an Integration Diagram"](#) on page 12-15 for details about the **Agreement** icon that displays beneath the **Agreement** header

Figure 9–18 shows the Process Diagram of a role created by the Create End-to-End Basic Integration wizard. For this example, one of the transformation binding roles and its transformation step are shown.

Figure 9–18 Process Diagram

Process Diagram For Binding Role : Global NP Placing Ad-TX

Diagram Actions

Select Action and Click on Diagram Object:

Action

Display Options

Modify display options and choose Refresh.

Show Event and Datatype Names

Scale (%)

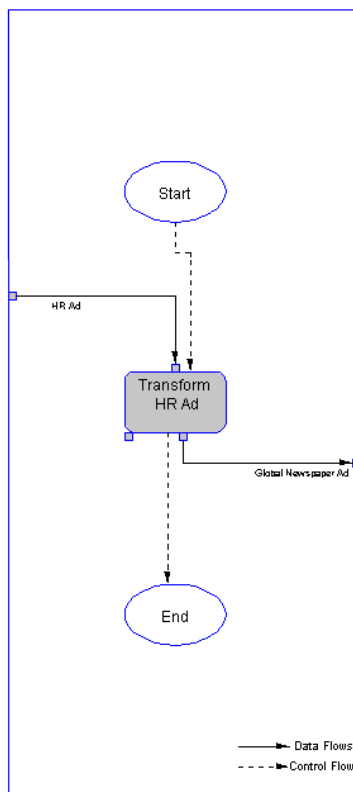

Tasks to Perform after Modeling Metadata Creation

After wizard creation, you must complete several additional steps to make your modeling metadata valid. You can also customize your modeling metadata by creating additional steps, ports, data flows, and control flows.

This section contains these topics:

- [Create Event Body Elements for Business Events](#)
- [Define Transformation Rules for Event Transformation Maps](#)
- [Create Additional Steps, Ports, Data Flows, and Control Flows](#)
- [Update the Target Party of the SetParty Step](#)

Create Event Body Elements for Business Events

Create event body elements for business events created by the wizards. You can access the page for creating event body elements in either of two ways:

- [Access the Business Event from the Event Flow Diagram](#)
- [Access the Business Event from the Main Menu](#)

Access the Business Event from the Event Flow Diagram

1. Click the business event name in red in the Event Flow Diagram. The business event name displays in red between each role from the inbound transformation binding role to the outbound transformation binding role.
2. Follow the instructions in "[Managing Business Event Types](#)" on page 11-63 to create event body elements.

Access the Business Event from the Main Menu

1. Click **Modeling > Event Types**.
2. Select the business event created by the wizard in the **Name** column.
3. Follow the instructions in "[Managing Business Event Types](#)" on page 11-63 to create event body elements.

Define Transformation Rules for Event Transformation Maps

Define transformation rules for event transformation maps created by the wizards. You can access the page for creating event transformation maps in either of two ways:

- [Access the Event Transformation Map from the Event Flow Diagram](#)
- [Access the Event Transformation Map from the Main Menu](#)

Access the Event Transformation Map from the Event Flow Diagram

1. Select **Display Details** from the **Action** list of the Event Flow Diagram.
2. Click the **Transform *input_event_name*** step in red in the Transformation Binding Role of the Event Flow Diagram.
3. Click the **Transformation Map** link in the **Details** section of the Step Transform *input_event_name* page.
4. Follow the instructions in "[Managing Transformation Statements](#)" on page 13-29 to define transformation rules for event transformation maps.

Access the Event Transformation Map from the Main Menu

1. Click **Modeling > Transformations**.
2. Select the event transformation map created by the wizard in the **Name** column.
3. Follow the instructions in "[Managing Transformation Statements](#)" on page 13-29 to define transformation rules for event transformation maps.

Create Additional Steps, Ports, Data Flows, and Control Flows

You can customize your modeling metadata by manually creating additional steps, ports, data flows, and control flows.

1. Go to [Chapter 12, "Managing Business Processes and Roles"](#) for instructions on manually creating additional steps, ports, data flows, and control flows.

Update the Target Party of the SetParty Step

Events originate from parties and are sent to parties. At some point in event processing, event addressing must be performed. Event addressing enables you to update the SetParty step with the target party with which to integrate. You can access the page for updating the target party in the SetParty step in either of two ways:

- [Access the SetParty Step from the Event Flow Diagram](#)
- [Access the SetParty Step from the Main Menu](#)

Access the SetParty Step from the Event Flow Diagram

1. Select **Display Details** from the **Action** list of the Event Flow Diagram.
2. Click the **SetParty for *input_event_name*** step that displays in red in the business process of the Event Flow Diagram.
3. Click **Update** at the top of the Step SetParty for *input_event_name* page to select the target party.
4. Select the correct target party from the **Party** list.
5. Click **Apply**.

Access the SetParty Step from the Main Menu

1. Click **Modeling > Business Processes**.
2. Select the business process in the **Name** column for which to update the SetParty step.
3. Go to the **Steps** section and select **SetParty for *input_event_name***.
4. Click **Update**.
5. Select the correct target party from the **Party** list.
6. Click **Apply**.

Deleting a Spoke

Follow these instructions to delete a spoke.

Notes:

- When you delete a spoke, the business process is not deleted. You must separately delete the business process after deleting the spoke.
 - If you delete a spoke that includes roles shared by another spoke (that is, there is data flow group branching), the shared roles are not deleted. The data flows to the shared roles are deleted (reducing the reuse count). When the last spoke that shares a role is deleted, the role is deleted.
-
-

1. Click the **Modeling** tab.
2. Click the **Business Processes** or **Roles** tab.
3. Select the Event Flow Diagram from the **Event Flow Diagram** column for the spoke that you want to delete.
4. Select **Delete Spoke** in the **Action** list.
5. Click inside the role in the Event Flow Diagram.

Note: Select a role to delete other than the business process. This is because the business process does not uniquely define a spoke. (It is in the middle of several spokes.)

6. Click **Yes** when prompted to delete the spoke.

Common Modeling Wizard Errors

This section describes common modeling wizard user errors.

- [Using the Wrong Wizard](#)
- [Specifying a Previously-Used Role](#)

Using the Wrong Wizard

The most common user error is using the wrong wizard. Specifically, you attempt to use the Create End-To-End Basic Integration wizard when you really want to add a spoke or an event flow to an existing business process.

The Create End-To-End Basic Integration wizard always creates a new integration, including a new business process. If you attempt to specify an existing business process, the Create End-To-End Basic Integration wizard tries to create a new business process with the same name and you get a `UNIQUE CONSTRAINT VIOLATION` error.

```
Error : There was an error creating the business process.
```

```
Error -: AIP-16012: Parameter: owning Composite Step is unique for object
Composite Step OwningCompositeStep.CompositeStep -
```

```
Error -: AIP-11052: Writing following objects: Composite Step failed due to
following constraint violation: COMPOSITESTEP_UK. UNIQUE CONSTRAINT VIOLATION
Name -
```

```
Error -: AIP-11052: Writing following objects: Composite Step
failed due to following constraint violation: COMPOSITESTEP_UK. UNIQUE
CONSTRAINT VIOLATION
```

The first error line is from the wizard, which identifies what it was doing at the time of the error. The two errors following that one are what the repository reports.

Specifying a Previously-Used Role

A similar problem occurs when you specify a role naming convention that was already used in another integration. This results in the wizard creating duplicate role names. You see the following error:

```
Error : There was an error creating native role bplin-NR .
```

```
Error -: AIP-16012: Parameter: owning Composite Step is unique for object
Composite Step
OwningCompositeStep.CompositeStep -
```

```
Error -: AIP-11052: Writing following objects: Composite Step failed due to
following constraint violation: COMPOSITESTEP_UK. UNIQUE CONSTRAINT VIOLATION
Name -
Error -: AIP-11052: Writing following objects: Composite Step failed due to
following constraint violation: COMPOSITESTEP_UK. UNIQUE CONSTRAINT VIOLATION
```

Chapter Summary

This chapter describes how to use the modeling wizards. With the modeling wizards, you can perform the following tasks:

- Create an end-to-end basic integration with the Create End-To-End Basic Integration wizard (that is, create two spokes with a new business process in the middle and a single event flow that extends from the native role of the initiating spoke to the native role of the invoked spoke).
- Add an additional event flow to two spokes with the Add End-To-End Basic Event Flow wizard (extending from the native role in the initiating spoke to the native role in the invoked spoke).
- Create a single spoke and event flow with the Create Spoke wizard (extending from the native role to the business process).
- Add an additional event flow to a single spoke with the Add Event Flow wizard (extending from the native role to the business process).

Managing Datatypes

This chapter describes the datatype management tasks required to design an integration.

This chapter contains these topics:

- [Oracle Application Server ProcessConnect Datatype Support Overview](#)
- [Examples of Datatype Formats in Oracle Application Server ProcessConnect](#)
- [Viewing Core Datatypes](#)
- [Managing Business Datatypes](#)
- [Importing XSD Datatypes](#)
- [Managing Application Datatypes](#)
- [Viewing Native Datatypes](#)
- [Managing Datatype Namespaces](#)
- [Chapter Summary](#)

See Also:

- [Chapter 3, "Oracle Application Server ProcessConnect Concepts"](#) for additional details about datatype concepts
- ["Managing Business Event Types"](#) on page 11-63 for details about defining the business event to include the datatypes you create or import
- [Appendix A, "Native Formats and Translators"](#) for details about XSD, data definition description language (D3L), and token substituted text datatype support and limitations with Oracle Application Server ProcessConnect

Oracle Application Server ProcessConnect Datatype Support Overview

This section provides a high-level overview of Oracle Application Server ProcessConnect support for datatypes. References are provided to sections that describe additional conceptual details and datatype management tasks.

Oracle Application Server ProcessConnect provides support for the wire messages of parties (applications and trading partners) that use the following native formats:

- XSD
For native formats using XML
- Token Substituted Text
For specifying the subject and body of alert e-mail messages
- D3L
For native formats not in XML, but instead in a format of structured records of bytes, characters, or both

See Also: [Appendix A, "Native Formats and Translators"](#)

Core Datatypes

Oracle Application Server ProcessConnect provides datatype support with a set of prepackaged, primitive datatypes (such as string, binary, and integer) with which to become familiar before creating event transformation map rules. All datatypes in Oracle Application Server ProcessConnect are based on these core datatypes.

See Also:

- ["Viewing Core Datatypes"](#) on page 10-11
- [Chapter 13, "Managing Transformations"](#)
- [Appendix B, "Transformation Rules"](#)

Datatype Classifications

Oracle Application Server ProcessConnect provides three classifications of datatype support:

- [Native Datatypes](#)
- [Application Datatypes](#)
- [Business Datatypes](#)

Native Datatypes

Native datatypes are in the native formats of applications or trading partners. These formats are not understood by Oracle Application Server ProcessConnect. You cannot view native datatypes, but you can view details about native formats such as the translator and native event validator to be used.

See Also:

- ["Native Datatypes"](#) on page 3-23 for concepts
- ["Viewing Native Datatypes"](#) on page 10-58 for management tasks

Application Datatypes

When you add an adapter interaction, you also specify a translator (XML, D3L, or token substituted text). When you then create the native event for this interaction, the native event datatypes are automatically translated into application event datatypes. The translator creates the application datatypes based on the native datatype format file that you provided when prompted during native event creation. Translation is the only method by which to create application datatypes. Application datatypes cannot be created manually. An application datatype's syntax is in an interpretable syntactic format understood by Oracle Application Server ProcessConnect. You can view application datatypes and their definitions.

See Also:

- ["Application Datatypes"](#) on page 3-32 for concepts
- ["Managing Application Datatypes"](#) on page 10-55 for management tasks

Business Datatypes

Oracle Application Server ProcessConnect provides support for business datatypes. The different datatypes of parties must all be represented as a single, common set of business datatypes to communicate with Oracle Application Server ProcessConnect and participate in integrations.

Business datatypes can by best practice be a superset of application datatypes. Only business datatypes can be manually created or imported as an XSD file into Oracle Application Server ProcessConnect.

If you already have an XSD file that represents most of the required business datatypes, import the file. Afterwards, you can edit the business datatypes to reflect a superset of the application datatypes that you want represented.

If I know exactly what you want and do not have an available XSD file with which to start, create the business datatype completely manually.

Oracle Application Server ProcessConnect provides support for the following datatypes:

- **Complex datatypes and complex datatype member**

Complex datatypes include other datatypes known as complex datatype members, such as scalar, compound, and wildcard members. An example of complex datatype support is an address, which includes scalar members that define specific address details, such as city, address, and zip code.

- **Scalar datatypes**

Scalar datatypes hold a single item of data. Scalar datatypes can refer to many different datatypes, including integers, floats, strings, objects, and binary types. You can also define facets in scalar datatypes that define the constraints (or limitations) of datatypes.

You can import business datatypes in XSD format into Oracle Application Server ProcessConnect as business datatypes. You cannot import D3L or token substituted text formats.

When you create event transformation maps, you create statements that transform inbound application datatypes into inbound business datatypes, and vice versa in the outbound direction.

See Also:

- ["Business Datatypes"](#) on page 3-38 for concepts
- ["Managing Business Datatypes"](#) on page 10-13
- ["Managing Complex Datatypes"](#) on page 10-15
- ["Managing Complex Datatype Members"](#) on page 10-24
- ["Managing Scalar Datatypes"](#) on page 10-36
- ["Importing XSD Datatypes"](#) on page 10-51
- ["Datatypes"](#) on page A-35 for details about datatype attributes that can only be updated in the XSD file, and not in the Oracle Application Server ProcessConnect user interface tool

Datatype Namespaces

Namespaces provide a way of grouping datatypes. This enables you to organize datatypes more efficiently and easily find a datatype when you need it later. You can create namespaces for storing the datatypes that you create or import.

See Also: ["Managing Datatype Namespaces"](#) on page 10-59

Examples of Datatype Formats in Oracle Application Server ProcessConnect

Before describing datatype and namespace management tasks to perform with the Oracle Application Server ProcessConnect user interface tool, a brief example is provided of how the datatypes in an expense application are changed from their unique native format into a format understood by Oracle Application Server ProcessConnect. This enables the expense application to participate in an integration.

This section contains these topics:

- [Wire Message Native Datatype Format in XSD File](#)
- [Native and Application Datatype Formats](#)
- [Business Datatype Creation Methods](#)
- [Business Datatype Format](#)

Procedures for creating these different datatype formats in Oracle Application Server ProcessConnect are provided in subsequent sections of this chapter.

Wire Message Native Datatype Format in XSD File

The expense application in this example submits an expense report in an extensible markup language (XML) file. This XML file follows the guidelines for presenting data that are defined in an XML Schema definition (XSD) file. XSD is a native format supported by Oracle Application Server ProcessConnect. [Example 10-1](#) shows an example of the XSD file used by the expense report. The XSD file specifies guidelines for defining the employee, their manager, and specific details about the expense incurred, such as the date, cost, amount, and justification.

Example 10–1 XSD File for Expense Report

```
<?xml version="1.0"?>
<xsd:schema targetNamespace="http://www.oracle.com/ipdemo"
  xmlns:xsd="http://www.w3.org/2001/XMLSchema"
  xmlns="http://www.oracle.com/ipdemo"
  elementFormDefault="qualified"
  attributeFormDefault="qualified">

  <!-- manager type definition -->
  <xsd:complexType name="manager_type">
    <xsd:sequence>
      <xsd:element name="name" type="xsd:string" />
    </xsd:sequence>
    <xsd:attribute name="id" type="xsd:integer" />
  </xsd:complexType>

  <!-- employee type definition -->
  <xsd:complexType name="employee_type">
    <xsd:sequence>
      <xsd:element name="name" type="xsd:string" />
      <xsd:element name="manager" type="manager_type" />
    </xsd:sequence>
    <xsd:attribute name="id" type="xsd:integer" />
  </xsd:complexType>

  <!-- line item type definition -->
  <xsd:complexType name="lineitem_type">
    <xsd:sequence>
      <xsd:element name="date" type="xsd:date" />
      <xsd:element name="amount" type="xsd:double" />
      <xsd:element name="currency" type="xsd:string" />
      <xsd:element name="type" type="xsd:string" />
      <xsd:element name="justification" type="xsd:string" />
      <xsd:element name="expensegroup" type="xsd:string" />
      <xsd:element name="receiptmissing" type="xsd:boolean" />
    </xsd:sequence>
  </xsd:complexType>

  <!-- expense type definition -->
  <xsd:complexType name="expense_type">
    <xsd:sequence>
      <xsd:element name="employee" type="employee_type" />
      <xsd:element name="costcenter" type="xsd:string" />
      <xsd:element name="purpose" type="xsd:string" />
    </xsd:sequence>
  </xsd:complexType>
</xsd:schema>
```



```

        <xsd:element name="lineitem" type="lineitem_type" />
        <xsd:element name="status" type="xsd:string" />
    </xsd:sequence>
    <xsd:attribute name="id" type="xsd:integer" />
</xsd:complexType>

<!-- root definition -->
<xsd:element name="expense" type="expense_type" />

</xsd:schema>

```

Native and Application Datatype Formats

The datatypes in the expense application's inbound expense report initially appear in their own unique native format that Oracle Application Server ProcessConnect cannot interpret. When you create an adapter interaction for this inbound expense report, you specify an XSD translator. During this session, you can also automatically create the native event and its event body element, and the application event and its event body element of application datatypes. [Figure 10-1](#) shows the event body element for the native event. An event body element is created and named PAYLOAD by the adapter. PAYLOAD represents the payload (data contents of a native format message) portion of the native event. However, no specific details about the datatypes of the expense report (such as whether they are scalar or complex types, or whether they are string or integer datatypes) are known.

Figure 10-1 Native Datatypes

Native Event Type Details : expense

Details

Name	expense
Application Event	expense
Record Type	btRecord
Description	<div style="border: 1px solid #ccc; height: 40px; width: 100%;"></div>

Event Map

Condition: **Unspecified** Create

Event Body Elements

Name	Record Type Element
PAYLOAD	PAYLOAD

The XSD translator you specify automatically translates the contents of the inbound expense report into an application event and event body element. Application datatypes enable Oracle Application Server ProcessConnect to access the contents for further processing. Application datatypes are a structured type system with primitive types such as string or integer and complex type constructors such as records.

Figure 10-2 shows the event body element and its application datatypes. Note that the details defined in the XSD file shown in "Wire Message Native Datatype Format in XSD File" on page 10-5 (for example, date, amount, currency, type, and justification), appear as application datatypes with recognized types (for example, scalar) and datatypes (for example, string and Boolean).

Figure 10-2 Application Datatypes

Application Event Type Details : expense Delete

Details

Name **expense**

Description

State **Draft**

Event Body Elements

Expand All | Collapse All

⊕ Event Body Elements

Focus Name	Type	Datatype	Cardinality	Update	Delete
⊖ Event Body Elements					
⊕ ⊖ PAYLOAD		expense_type			
⊕ ⊖ employee	Compound	employee_type	[1, 1]		
⊕ name	Scalar	string			
⊕ ▶ manager	Compound	manager_type	[1, 1]		
id	Scalar	integer			
costcenter	Scalar	string			
purpose	Scalar	string			
⊕ ⊖ lineitem	Compound	lineitem_type	[1, 1]		
date	Scalar	date			
amount	Scalar	double			
currency	Scalar	string			
type	Scalar	string			
justification	Scalar	string			
expensegroup	Scalar	string			
recieptmissing	Scalar	boolean			
status	Scalar	string			
id	Scalar	integer			

See Also:

- ["Viewing Native Datatypes"](#) on page 10-58
- ["Managing Application Datatypes"](#) on page 10-55

Business Datatype Creation Methods

The different datatypes of the expense report must be represented as a single, common set of business datatypes to communicate with Oracle Application Server ProcessConnect and participate in integrations. You create business datatypes from the Business Datatypes page by either:

- Clicking the **Create** button to create new datatypes
- Clicking the **Import** button to import datatypes defined in XSD format

[Figure 10-3](#) shows the Business Datatypes page from which you can perform either of these tasks.

Figure 10-3 Business Datatype Creation Methods

Business Datatypes

Search Results : ref Type Only = 'Unspecified'

Search

Previous 10 | 91-100 of 139 | Next 10

Name	Type	Base Datatype	Namespace	Update	Delete
date	Scalar		http://www.oracle.com/ip		
integer	Scalar		http://www.oracle.com/ip		
float	Scalar		http://www.oracle.com/ip		
boolean	Scalar		http://www.oracle.com/ip		
xmlOpaque	Scalar		http://www.oracle.com/ip		
errorLevel	Scalar	string	http://www.oracle.com/ip		
component	Scalar	string	http://www.oracle.com/ip		
returnCode	Complex		http://www.oracle.com/ip		
anyType	Complex		http://www.w3.org/2000/10/XMLSchema		
anyType	Complex		http://www.w3.org/2001/XMLSchema		

Previous 10 | 91-100 of 139 | Next 10

Shortcuts

- [Create Business Event Type](#)
- [Business Event Types](#)
- [Create Datatype Transformation Map](#)
- [Datatype Transformation Maps](#)

See Also: ["Managing Business Datatypes"](#) on page 10-13

Business Datatype Format

After you create business datatypes from the Business Datatypes page by either creating new datatypes or importing datatypes defined in XSD format, you create an event body element in a business event and specify these business datatypes.

Figure 10-4 shows an event body element (for this example, named Payload) that includes the business datatypes you either created or imported.

Figure 10-4 Business Datatypes in an Event Body Element

[Business Event Type Details : expense](#) Delete Update

Details

Name **expense**

Description

State **Draft**

Event Body Elements Return to Top Create

[Expand All](#) | [Collapse All](#)

⊕ Event Body Elements

Focus Name	Type	Datatype	Cardinality	Update	Delete
⊖ Event Body Elements					
⊕ ⊖ Payload		expense_type			
⊕ ⊖ employee	Compound	employee_type	[1, 1]		
name	Scalar	string			
⊕ ⊖ manager	Compound	manager_type	[1, 1]		
name	Scalar	string			
id	Scalar	integer			
id	Scalar	integer			
costcenter	Scalar	string			
purpose	Scalar	string			
⊕ ⊖ lineitem	Compound	lineitem_type	[1, 1]		
date	Scalar	date			
amount	Scalar	double			
currency	Scalar	string			
type	Scalar	string			
justification	Scalar	string			
expensegroup	Scalar	string			
receiptmissing	Scalar	boolean			
status	Scalar	string			
id	Scalar	integer			

You can now define transformation rules that transform the inbound application datatypes of the expense report shown in [Figure 10-2](#) on page 10-8 into the inbound business event datatypes shown in [Figure 10-4](#).

See Also:

- ["Creating an Event Body Element"](#) on page 11-69
- ["Managing Transformation Statements"](#) on page 13-29

Viewing Core Datatypes

Oracle Application Server ProcessConnect provides datatype support with a series of prepackaged primitive datatypes. These datatypes are known as core datatypes. All datatypes in Oracle Application Server ProcessConnect are based on these core datatypes. Oracle recommends that you become familiar with these datatypes before creating event transformation map rules:

Follow these instructions to view details about the core datatypes:

To view core datatypes:

1. Select the **Modeling** tab.
2. Select the **Datatypes** tab.
3. Select **Core Datatypes**.

The Core Datatypes page displays the available scalar and complex core datatypes.

Core Datatypes

Search

◀ Previous 1-10 of 15 Next 5 ▶

Name	Type	Base Datatype	Update	Delete
anySimpleType	Scalar			
string	Scalar	anySimpleType		
binary	Scalar	anySimpleType		
dateTime	Scalar	anySimpleType		
decimal	Scalar	anySimpleType		
double	Scalar	anySimpleType		
integer	Scalar	anySimpleType		
float	Scalar	anySimpleType		
boolean	Scalar	anySimpleType		
character	Scalar	anySimpleType		

◀ Previous 1-10 of 15 Next 5 ▶

Shortcuts

[Create Business Event Type](#)
[Business Event Types](#)
[Create Datatype Transformation Map](#)
[Datatype Transformation Maps](#)

- Click a specific core datatype in the **Name** column.
The details page for the selected core datatype appears.
- View specific details, including description and content of the datatype.

See Also: The following sections for tasks accessible from the **Shortcuts** section of the Core Datatypes page:

- ["Managing Business Event Types"](#) on page 11-63
- [Chapter 13, "Managing Transformations"](#)
- [Appendix B, "Transformation Rules"](#)

Managing Business Datatypes

The Oracle Application Server ProcessConnect user interface tool enables you to perform the business datatype management tasks shown in [Figure 10-5](#). These tasks are described in detail in this section. The different datatypes of parties (applications and trading partners) must all be represented as a single, common set of business datatypes to communicate with Oracle Application Server ProcessConnect and participate in integrations. You assign business datatypes to an event body element of a business event. Business datatypes are the datatypes to which inbound application datatypes are transformed. Likewise, outbound business datatypes are transformed into outbound application datatypes. You can create business datatypes or import datatypes defined in XSD format into Oracle Application Server ProcessConnect as business datatypes.

Figure 10-5 Business Datatype Management Tasks

Business Datatypes
 Search Results : ref Type = 'Unspecified'

Search

Previous 10 Next 10

Name	Type	Base Datatype	Namespace	Update	Delete
date	Scalar		http://www.oracle.com/ip		
integer	Scalar		http://www.oracle.com/ip		
float	Scalar		http://www.oracle.com/ip		
boolean	Scalar		http://www.oracle.com/ip		
xmlOpaque	Scalar		http://www.oracle.com/ip		
errorLevel	Scalar	string	http://www.oracle.com/ip		
component	Scalar	string	http://www.oracle.com/ip		
returnCode	Complex		http://www.oracle.com/ip		
anyType	Complex		http://www.w3.org/2000/10/XMLSchema		
anyType	Complex		http://www.w3.org/2001/XMLSchema		

Previous 10 Next 10

Shortcuts

- [Create Business Event Type](#)
- [Business Event Types](#)
- [Create Datatype Transformation Map](#)
- [Datatype Transformation Maps](#)

Business datatypes consist of complex and scalar datatypes. This section describes the following business datatype management tasks:

- [Managing Complex Datatypes](#)
- [Managing Complex Datatype Members](#)
- [Managing Scalar Datatypes](#)

Note: Oracle Application Server ProcessConnect datatypes also include several preset datatype attributes that are automatically included from the original XSD file. You cannot update these attributes through the Oracle Application Server ProcessConnect user interface tool. To update these attributes, you must modify the XSD file. These attributes appear on the details pages of complex datatypes, complex members, and scalar datatypes throughout this chapter. Each attributed is identified and a section is referenced for details on updating these attributes.

See Also:

- ["Business Datatypes"](#) on page 3-38
- ["Business Datatype Format"](#) on page 10-10
- ["Importing XSD Datatypes"](#) on page 10-51
- ["Datatypes"](#) on page A-35 to update specific datatype attributes in the XSD file

The following sections for tasks accessible from the **Shortcuts** section of the Business Datatypes page:

- ["Managing Datatype Transformation Maps"](#) on page 13-21
- ["Managing Business Event Types"](#) on page 11-63

Managing Complex Datatypes

The Oracle Application Server ProcessConnect user interface tool enables you to perform the complex datatype management tasks shown in [Figure 10-6](#) on page 10-16 and [Figure 10-7](#) on page 10-17. These tasks are described in detail in this section.

A complex datatype is a datatype that includes other types of datatypes known as complex datatype members. Complex datatypes support the following complex datatype members:

- [Scalar Member](#)
- [Compound Member](#)
- [Wildcard Member](#)

Scalar Member

A scalar member can refer to many types, including an integer, a float, a string, an object, and a binary type. An address in a message is an example of a complex datatype (named `Address` in the following example) that includes scalar members (`Name`, `Street_Number`, `City`, `State`, and `Zip_Code`) that define address details:

```
Name:          Joe Smith
Street_Number: 100 1st Street
City:          Redwood Shores
State:         California
Zip_Code:      94065
```

You cannot assign cardinality to a scalar member. You can also only assign scalar datatypes to scalar members.

Compound Member

Compound members are very flexible. You can assign complex and scalar datatypes to a compound member. You can assign cardinality to a compound member. For example, you can have a compound section in an expense report called `line_item`. Within this compound section, you can define specific details about the expense report with scalar types specifying the date, the amount, the currency used, and the justification for the expenses incurred.

Wildcard Member

Wildcard members provide for generic functionality. You can use wildcard members during the development phase as "placeholder" datatypes when you are unsure of the exact datatypes you want to use. Wildcard datatypes can then be replaced at a later time. You can also assign cardinality to a wildcard member. Oracle Application Server ProcessConnect uses XMLOpaque as a datatype of wildcard members.

Figure 10–6 Complex Datatype Management Tasks (Part 1 of 2)

Business Datatypes

Search

⏪ Previous 10 Next 10 ⏩

Name	Type	Base Datatype	Namespace	Update	Delete
nonPositiveInteger	Scalar	integer			
negativeInteger	Scalar	nonPositiveInteger			
nonNegativeInteger	Scalar	integer			
positiveInteger	Scalar	nonNegativeInteger			
unsignedLong	Scalar	nonNegativeInteger			
unsignedInt	Scalar	unsignedLong			
unsignedShort	Scalar	unsignedInt			
unsignedByte	Scalar	unsignedShort			
notification_type	Complex		http://www.oracle.com/ftpdemo		
status_type	Complex		http://www.oracle.com/ftpdemo		

⏪ Previous 10 Next 10 ⏩

Shortcuts

- [Create Business Event Type](#)
- [Business Event Types](#)
- [Create Datatype Transformation Map](#)
- [Datatype Transformation Maps](#)

Selecting a complex datatype in the **Name** column causes a details page such as that shown in [Figure 10-7](#) to appear.

Figure 10-7 Complex Datatype Management Tasks (Part 2 of 2)

Complex Datatype Details : notification_type

[Delete](#) [Update](#)

Details

General

Name **notification_type**
 Namespace <http://www.oracle.com/ipldemo>
 Description
 Definition
 Anonymous **False**
 Abstract **False**
 Reference Only **False**
 Member Group Type **False**
 Model Group **Sequence Group**
 State **Deployed**

Base Datatype

Name
 Namespace
 Inheritance Type

Datatype Members

[Return to Top](#)

[Create](#)

[Expand All](#) | [Collapse All](#)

[Datatype Members](#)

Focus Name	Type	Datatype	Cardinality	Update	Delete
▼ Datatype Members					
from	Scalar	string			
to	Scalar	string			
subject	Scalar	string			
arrival_date	Scalar	date			
status	Compound	status_type	[1, 1]		
modified_date	Scalar	date			

Table 10-1 identifies the complex datatype management tasks shown in Figure 10-6 on page 10-16 and Figure 10-7 on page 10-17 and provides references to procedures for performing these tasks.

Table 10-1 Complex Datatype Management Tasks

Business Datatypes Page Elements	Management Task	First See Section...	Then See Section...
Create button in Figure 10-6	Create a complex datatype	"Accessing Complex Datatype Management Tasks" on page 10-18	"Creating a Complex Datatype" on page 10-19
Delete column in Figure 10-6	Delete a complex datatype		"Deleting a Complex Datatype" on page 10-20
Update column in Figure 10-6	Update a complex datatype		"Updating a Complex Datatype" on page 10-21
Name column in Figure 10-6 (To access the details page of Figure 10-7)	View a complex datatype		"Viewing a Complex Datatype" on page 10-22

See Also: The following sections for tasks accessible from the **Shortcuts** section of the Business Datatypes page:

- [Chapter 13, "Managing Transformations"](#)
- ["Managing Business Event Types"](#) on page 11-63

Accessing Complex Datatype Management Tasks

Follow these instructions to access the complex datatype management tasks shown in [Figure 10-6](#) on page 10-16 and [Figure 10-7](#) on page 10-17:

To access complex datatype management tasks:

1. Select the **Modeling** tab.
2. Select the **Datatypes** tab.

The Business Datatypes page appears. (See [Figure 10-6](#) on page 10-16.)

3. Select a task to perform and see the referenced section for instructions:

To...	Then...	See Section...
Create a complex datatype	Click Create .	"Creating a Complex Datatype" on page 10-19
Delete a complex datatype	Select a specific complex datatype in the Delete column.	"Deleting a Complex Datatype" on page 10-20
Update a complex datatype	Select a specific complex datatype in the Update column.	"Updating a Complex Datatype" on page 10-21
View details about a complex datatype	Select a specific complex datatype in the Name column.	"Viewing a Complex Datatype" on page 10-22

Creating a Complex Datatype

Follow these instructions to create a complex datatype:

To create a complex datatype:

1. Ensure that you followed the instructions in ["Accessing Complex Datatype Management Tasks"](#) on page 10-18 to access the page for creating a complex datatype.

The Create Datatype page appears.

2. Enter the following details to create a complex datatype. An asterisk (*) indicates a required field.

Field	Description
Type	Select Complex .
Name *	Enter a unique and recognizable name for the complex datatype.
Namespace	Select a namespace.
Description	Enter a description for the complex datatype.

Field	Description
Model Group	<p>Select one of the following groups to define the behavior of member datatypes in a runtime instance:</p> <ul style="list-style-type: none"> ▪ All Group Requires that all complex datatype members appear zero or one times, in any order. ▪ Choice Group Allows only one complex datatype members to appear. ▪ Sequence Group Requires that complex datatype members be used in the order in which they are specified. For this release, the order in which they are created is the order in which they are used. <p>See Also: "Managing Complex Datatype Members" on page 10-24</p>

3. Click **Apply.**

The complex datatype is created and the Complex Datatype Details page for the new complex datatype appears.

Deleting a Complex Datatype

Follow these instructions to delete a complex datatype:

Notes:

- All datatype members of the selected complex datatype are also deleted.
 - Deleting a business datatype such as a complex datatype can cause an error to occur if they are used by other modeling metadata such as transformation rules. The transformation rules must be deleted before deleting the datatype.
-
-

To delete a complex datatype:

1. Ensure that you followed the instructions in "[Accessing Complex Datatype Management Tasks](#)" on page 10-18 to access the page for deleting a complex datatype.
2. Click **Yes** when prompted to delete a complex datatype.
The complex datatype is deleted and the Business Datatypes page appears.

Updating a Complex Datatype

Follow these instructions to update a complex datatype:

To update a complex datatype:

1. Ensure that you followed the instructions in "[Accessing Complex Datatype Management Tasks](#)" on page 10-18 to access the page for updating a complex datatype.
The Update Complex Datatype page appears.
2. Make appropriate changes. (See Step 2 on page 10-19 of "[Creating a Complex Datatype](#)" for a list of fields you can update.)
3. Click **Apply**.
The complex datatype is updated and the Complex Datatype Details page for the updated complex datatype appears.

Viewing a Complex Datatype

Follow these instructions to view details about a specific complex datatype:

To view a complex datatype:

1. Ensure that you followed the instructions in "[Accessing Complex Datatype Management Tasks](#)" on page 10-18 to access the page for viewing a complex datatype.

The Complex Datatype Details page for the selected complex datatype appears.

Complex Datatype Details : notification_type

[Delete](#) [Update](#)

Details

General

Name	notification_type
Namespace	http://www.oracle.com/ipldemo
Description	<div style="border: 1px solid black; height: 40px;"></div>
Definition	<div style="border: 1px solid black; height: 40px;"></div>
Anonymous	False
Abstract	False
Reference Only	False
Member Group Type	False
Model Group	Sequence Group
State	Deployed

Base Datatype

Name	
Namespace	
Inheritance Type	

Datatype Members

[Return to Top](#)

[Create](#)

[Expand All](#) | [Collapse All](#)

⊕ Datatype Members

Focus Name	Type	Datatype	Cardinality	Update	Delete
▼ Datatype Members					
from	Scalar	string			
to	Scalar	string			
subject	Scalar	string			
arrival_date	Scalar	date			
⊕ ▶ status	Compound	status_type	[1, 1]		
modified_date	Scalar	date			

2. View specific details, including the complex datatype members. There are also preset attributes (**Anonymous**, **Abstract**, **Reference Only**, and **Member Group Type**) displaying in the **General** section that were automatically included from the original XSD file. You cannot update these attributes through the Oracle Application Server ProcessConnect user interface tool. To update these attributes, you must modify the XSD file..

This page, as with the Business Datatypes page shown in [Figure 10-6](#) on page 10-16, enables you to delete or update the selected complex datatype.

You assign business datatypes such as complex datatypes to an event body element of a business event.

3. Click **Return to List** to return to the Business Datatypes page.

See Also:

- ["Managing Complex Datatype Members"](#) on page 10-24
- ["Creating an Event Body Element"](#) on page 11-69
- ["Datatypes"](#) on page A-35 to update specific datatype attributes in the XSD file

Managing Complex Datatype Members

The Oracle Application Server ProcessConnect user interface tool enables you to perform the complex datatype member management tasks shown in [Figure 10-8](#). These tasks are described in detail in this section.

Figure 10-8 Complex Datatype Member Management Tasks

Complex Datatype Details : notification_type Delete Update

Details

General

Name **notification_type**
 Namespace <http://www.oracle.com/ipdemo>
 Description
 Definition
 Anonymous **False**
 Abstract **False**
 Reference Only **False**
 Member Group Type **False**
 Model Group **Sequence Group**
 State **Deployed**

Base Datatype

Name
 Namespace
 Inheritance Type

Datatype Members Return to Top

Create

Expand All | Collapse All

Datatype Members

Focus Name	Type	Datatype	Cardinality	Update	Delete
▼ Datatype Members					
from	Scalar	string			
to	Scalar	string			
subject	Scalar	string			
arrival_date	Scalar	date			
⊕ ▶ status	Compound	status_type	[1, 1]		
modified_date	Scalar	date			

Table 10-2 identifies the complex datatype management tasks shown in Figure 10-8 and provides references to procedures for performing these tasks.

Table 10-2 Complex Datatype Member Management Tasks

Page Elements	Management Task	First See Section...	Then See Section...
Create button	Create a complex datatype member	"Accessing Complex Datatype Member Management Tasks" on page 10-25	"Creating a Complex Datatype Member" on page 10-26
Delete column	Delete a complex datatype member		"Deleting a Complex Datatype Member" on page 10-30
Update column	Update a complex datatype member		"Updating a Complex Datatype Member" on page 10-31
Datatype Members column	View a complex datatype member		"Viewing a Complex Datatype Member" on page 10-32

Accessing Complex Datatype Member Management Tasks

Follow these instructions to access the complex datatype member management tasks shown in Figure 10-8 on page 10-24:

To access complex datatype member management tasks:

1. Select the **Modeling** tab.
2. Select the **Datatypes** tab.
The Business Datatypes page appears. (See Figure 10-6 on page 10-16.)
3. Select a specific complex datatype in the **Name** column.
The Complex Datatype Details page for the selected complex datatype appears. (See Figure 10-8 on page 10-24.)
4. Go to the **Datatype Members** section.

- Select a task to perform and see the referenced section for instructions:

To...	Then...	See Section...
Create a complex datatype member	Click Create .	"Creating a Complex Datatype Member" on page 10-26
Delete a complex datatype member	Select a specific complex datatype member in the Delete column.	"Deleting a Complex Datatype Member" on page 10-30
Update a complex datatype member	Select a specific complex datatype member in the Update column.	"Updating a Complex Datatype Member" on page 10-31
View details about a complex datatype member	Click Expand All and select a specific complex datatype member in the Name column.	"Viewing a Complex Datatype Member" on page 10-32

Creating a Complex Datatype Member

Follow these instructions to create a complex datatype member:

To create a complex datatype member:

- Ensure that you followed the instructions in ["Accessing Complex Datatype Member Management Tasks"](#) on page 10-25 to access the page for creating a complex datatype member.

The Create Datatype Member page appears.

- See the following section based on the type of complex datatype member you want to create:

If You Select...	See Section...
Compound	"Creating a Compound Member" on page 10-27
Scalar	"Creating a Scalar Member" on page 10-28
Wildcard	"Creating a Wildcard Member" on page 10-29

Creating a Compound Member Follow these instructions to create a compound member:

To create a compound member:

1. Enter the following details to create a compound member. An asterisk (*) indicates a required field.

Field	Description
General	
▪ Type	Select Compound .
▪ Name	Enter a unique and recognizable name.
▪ Mandatory	Select Unspecified, No, or Yes .
Datatype	
▪ Classification *	Select Business Datatype or Core Datatype .
▪ Namespace	Select a namespace.
▪ Name *	Select a datatype from the namespace by clicking the flashlight next to the Name field.
Cardinality	
▪ Minimum	Enter a value for the minimum number of possible occurrences in a runtime instance.
▪ Maximum	Enter a value for the maximum number of possible occurrences in a runtime instance.

2. Click **Apply**.

The compound member is created and the Compound Member Details page for the created compound member appears.

See Also: "[Managing Complex Datatypes](#)" on page 10-15 for a description of compound datatypes

Creating a Scalar Member Follow these instructions to create a scalar member:

To create a scalar member:

1. Enter the following details to create a scalar member. An asterisk (*) indicates a required field.

Field	Description
General	
▪ Type	Select Scalar .
▪ Name	Enter a unique and recognizable name.
▪ Mandatory	Select Unspecified, No, or Yes .
▪ Default Value	Enter a value.
▪ Fixed Value	Enter a value. This setting overrides all other settings.
Datatype	
▪ Classification *	Select Business Datatype or Core Datatype .
▪ Namespace	Select a namespace.
▪ Name *	Select a datatype from the namespace by clicking the flashlight next to the Name field.

Note: You can only assign scalar datatypes to a scalar member.

See Also: ["Managing Complex Datatypes"](#) on page 10-15 for a description of scalar datatypes

2. Click **Apply**.

The scalar member is created and the Scalar Member Details page for the created scalar member appears.

Creating a Wildcard Member Follow these instructions to create a wildcard member:

To create a wildcard member:

1. Enter the following details to create a wildcard member. An asterisk (*) indicates a required field.

Field	Description
General	
▪ Type	Select Wildcard .
▪ Name	Enter a unique and recognizable name.
▪ Mandatory	Select Unspecified, No, or Yes .
Datatype	
▪ Classification *	Select Business Datatype or Core Datatype .
▪ Namespace	Select a namespace.
▪ Name *	Select a datatype from the namespace by clicking the flashlight next to the Name field.
Cardinality	
▪ Minimum	Enter a value for the minimum number of possible occurrences in a runtime instance.
▪ Maximum	Enter a value for the maximum number of possible occurrences in a runtime instance.

2. Click **Apply**.

The wildcard member is created and the Wildcard Member Details page for the new wildcard datatype appears.

See Also: "[Managing Complex Datatypes](#)" on page 10-15 for a description of wildcard datatypes

Deleting a Complex Datatype Member

Follow these instructions to delete a complex datatype member:

To delete a complex datatype member:

1. Ensure that you followed the instructions in "[Accessing Complex Datatype Member Management Tasks](#)" on page 10-25 to access the page for deleting a complex datatype member.
2. Make a selection and see the referenced section for instructions:

If You Selected...	See Section...
Compound	"Deleting a Compound Member" on page 10-30
Scalar	"Deleting a Scalar Member" on page 10-30
Wildcard	"Deleting a Wildcard Member" on page 10-31

Deleting a Compound Member Follow these instructions to delete a compound member:

To delete a compound member:

The Delete Compound Member page for the selected compound member appears.

1. Click **Yes** when prompted to delete a compound member.

The compound member is deleted and the Complex Datatype Details page appears.

Deleting a Scalar Member Follow these instructions to delete a scalar member:

To delete a scalar member:

The Delete Scalar Member page for the selected scalar member appears.

1. Click **Yes** when prompted to delete a scalar member.

The scalar member is deleted and the Complex Datatype Details page appears.

Deleting a Wildcard Member Follow these instructions to delete a wildcard member:

To delete a wildcard member:

The Delete Wildcard Member page for the selected wildcard member appears.

1. Click **Yes** when prompted to delete a wildcard member.

The wildcard member is deleted and the Complex Datatype Details page appears.

Updating a Complex Datatype Member

Follow these instructions to update a complex datatype member:

To update a complex datatype member:

1. Ensure that you followed the instructions in "[Accessing Complex Datatype Member Management Tasks](#)" on page 10-25 to access the page for updating a complex datatype member.
2. Make a selection and see the referenced section for instructions:

If You Selected a...	See Section...
Compound member	"Updating a Compound Member" on page 10-31
Scalar member	"Updating a Scalar Member" on page 10-32
Wildcard member	"Updating a Wildcard Member" on page 10-32

Updating a Compound Member Follow these instructions to update a compound member:

To update a compound member:

The Update Compound Member page appears.

1. Make appropriate changes. (See Step 1 on page 10-27 of "[Creating a Compound Member](#)" for a list of fields you can update.)
2. Click **Apply**.

The compound member is updated and the Complex Datatype Details page appears.

Updating a Scalar Member Follow these instructions to update a scalar member:

To update a scalar member:

The Update Scalar Member page appears.

1. Make appropriate changes. (See Step 1 on page 10-28 of "[Creating a Scalar Member](#)" for a list of fields you can update.)
2. Click **Apply**.

The scalar member is updated and the Complex Datatype Details page appears.

Updating a Wildcard Member Follow these instructions to update a wildcard member:

To update a wildcard member:

The Update Wildcard Member page appears.

1. Make appropriate changes. (See Step 1 on page 10-29 of "[Creating a Wildcard Member](#)" for a list of fields you can update.)
2. Click **Apply**.

The wildcard member is updated and the Complex Datatype Details page appears.

Viewing a Complex Datatype Member

Follow these instructions to view details about a specific complex datatype member:

To view a complex datatype member:

1. Ensure that you followed the instructions in "[Accessing Complex Datatype Member Management Tasks](#)" on page 10-25 to access the page for viewing a complex datatype member.
2. Make a selection and see the referenced section for instructions:

If You Selected a...	See Section...
Compound member	"Viewing a Compound Member" on page 10-33
Scalar member	"Viewing a Scalar Member" on page 10-34
Wildcard member	"Viewing a Wildcard Member" on page 10-34

These pages, as with the Complex Datatype Details page shown in [Figure 10–8](#) on page 10-24, also enable you to delete or update the selected complex datatype member. There are also preset attributes (**Anonymous**, **Element/Attribute**, **Qualified**, and **Member Group Head**) displaying in the **General** section that were automatically included from the original XSD file. You cannot update these attributes through the Oracle Application Server ProcessConnect user interface tool. To update these attributes, you must modify the XSD file.

See Also: ["Datatypes"](#) on page A-35 to update specific datatype attributes in the XSD file

Viewing a Compound Member Follow these instructions to view details about a specific compound member:

To view a compound member:

The Compound Member Details page for the selected compound member appears.

Compound Member Details : status

Delete

Details

General

Name	status
Mandatory	True
Element/Attribute	Element
Anonymous	False
Qualified	False
Member Group Head	False

Datatype

Name	status_type
Namespace	http://www.oracle.com/ipdemo

Cardinality

Minimum	1
Maximum	1

1. View specific details.
2. Click **Return to List** to return to the Complex Datatype Details page.

Viewing a Scalar Member Follow these instructions to view details about a specific scalar member:

To view a scalar member:

The Scalar Member Details page for the selected scalar datatype appears.

[Scalar Member Details : modified_date](#)

Delete

Details

General

Name	modified_date
Mandatory	True
Element/Attribute	Element
Anonymous	False
Qualified	False
Member Group Head	False
Default Value	
Fixed Value	

Scalar Datatype

Name [date](#)
Namespace

1. View specific details.
2. Click **Return to List** to return to the Complex Datatype Details page.

Viewing a Wildcard Member Follow these instructions to view details about a specific wildcard member:

To view a wildcard member:

The Wildcard Member Details page for the selected wildcard datatype appears.

Wildcard Member Details : WC1

[Delete](#) [Update](#)

Details

General

Name **WC1**
 Mandatory
 Replacement Namespace
 Process Contents
 Element/Attribute **Element**
 Anonymous **False**
 Qualified **False**
 Member Group Head

Datatype

Name [xmlOpaque](#)
 Namespace

Cardinality

Minimum
 Maximum

Wildcard Member Namespaces

[Return to Top](#)

Name	Delete
(No wildcard member namespaces found.)	

1. View specific details.
2. Click **Return to List** to return to the Complex Datatype Details page.

Managing Scalar Datatypes

The Oracle Application Server ProcessConnect user interface tool enables you to perform the scalar datatype management tasks shown in [Figure 10-9](#) through [Figure 10-11](#). These tasks are described in detail in this section. A scalar datatype can refer to many types, including an integer, a float, a string, an object, and a binary type. You can also define facets in scalar datatypes. Facets enable you to define the constraints (or limitations) of scalar datatypes. Oracle Application Server ProcessConnect automatically supports some facets. You can also add or override facet values automatically set by Oracle Application Server ProcessConnect.

Figure 10-9 *Scalar Datatype Management Tasks (Part 1 of 3)*

Business Datatypes

Search

Previous 10 Next

Name	Type	Base Datatype	Namespace	Update	Delete
monetaryRange	Complex		http://www.oracle.com/uccnet		
envelope	Complex		http://www.oracle.com/uccnet		
textDescription	Complex		http://www.oracle.com/uccnet		
testit	Complex		http://www.oracle.com/ipdemo		
anySimpleType	Scalar	anyURI	http://www.w3.org/2001/XMLSchema		
hotel_detail_request	Complex				
expense_type	Complex		http://www.oracle.com/ipdemo		
employee_type	Complex		http://www.oracle.com/ipdemo		
manager_type	Complex		http://www.oracle.com/ipdemo		
lineitem_type	Complex		http://www.oracle.com/ipdemo		

Previous 10 Next

Shortcuts

- [Create Business Event Type](#)
- [Business Event Types](#)
- [Create Datatype Transformation Map](#)
- [Datatype Transformation Maps](#)

Selecting a scalar datatype in the **Name** column causes a details page such as that shown in [Figure 10–10](#) to appear.

Figure 10–10 Scalar Datatype Management Tasks (Part 2 of 3)

Scalar Datatype Details : anySimpleType

[Delete](#) [Update](#)

Details

General

Name **anySimpleType**
 Namespace <http://www.w3.org/2001/XMLSchema>
 Description
 Anonymous **False**
 Abstract
 Reference Only
 Member Group Type
 Primitive Datatype
 State **Draft**

Base Datatype

Name [anyURI](#)
 Namespace
 Inheritance Type **Restriction**

Facets

[Return to Top](#)

[Create](#)

Type	Value(s)	Update	Delete
Enumeration	(No valid values found.)		
Pattern	(No valid values found.)		
White Space			

Selecting a facet in the **Type** column causes details pages such as those shown in [Figure 10-11](#) to appear.

Figure 10-11 Scalar Datatype Management Tasks (Part 3 of 3)

Facet Details : Enumeration

Delete Update

Details

Type **Enumeration**
Fixed

Valid Values

Create

Value	Update	Delete
23		

Facet Details : Pattern

Delete Update

Details

Type **Pattern**
Fixed **No**

Valid Values

Create

Value	Update	Delete
4		

Table 10-3 identifies the scalar datatype management tasks shown in Figure 10-9 on page 10-36 through Figure 10-11 on page 10-38 and provides references to procedures for performing these tasks.

Table 10-3 Scalar Datatype Management Tasks

Page Elements	Management Task	First See Section...	Then See Section...
Create button of Business Datatypes page in Figure 10-9	Create a scalar datatype	"Accessing Scalar Datatype Management Tasks" on page 10-40	"Creating a Scalar Datatype" on page 10-41
Delete column of Business Datatypes page in Figure 10-9	Delete a scalar datatype		"Deleting a Scalar Datatype" on page 10-42
Update column of Business Datatypes page in Figure 10-9	Update a scalar datatype		"Updating a Scalar Datatype" on page 10-43
Name column of Business Datatypes page in Figure 10-9	View a scalar datatype		"Viewing a Scalar Datatype" on page 10-43
Create button of Scalar Datatype Details page in Figure 10-10	Create a scalar datatype facet		"Creating a Scalar Datatype Facet" on page 10-45
Delete column of Scalar Datatype Details page in Figure 10-10	Delete a scalar datatype facet		"Deleting a Scalar Datatype Facet" on page 10-47
Update column of Scalar Datatype Details page in Figure 10-10	Update a scalar datatype facet		"Updating a Scalar Datatype Facet" on page 10-47
Type column of Scalar Datatype Details page in Figure 10-10	View a scalar datatype facet	"Viewing a Scalar Datatype Facet" on page 10-48	

Table 10–3 (Cont.) Scalar Datatype Management Tasks

Page Elements	Management Task	First See Section...	Then See Section...
Create button of Facet Details page in Figure 10-11	Create a valid value for a scalar datatype enumeration or pattern facet	"Accessing Scalar Datatype Management Tasks" on page 10-40	"Creating a Valid Value for the Scalar Datatype Enumeration or Pattern Facet" on page 10-49
Delete column of Facet Details page in Figure 10-11	Delete a valid value for a scalar datatype enumeration or pattern facet		"Deleting a Valid Value for the Scalar Datatype Enumeration or Pattern Facet" on page 10-49
Update column of Facet Details page in Figure 10-11	Update a valid value for a scalar datatype enumeration or pattern facet		"Updating a Valid Value for the Scalar Datatype Enumeration or Pattern Facet" on page 10-50

See Also: The following sections for tasks accessible from the **Shortcuts** section of the Business Datatypes page:

- ["Managing Datatype Transformation Maps"](#) on page 13-21
- ["Managing Business Event Types"](#) on page 11-63

Accessing Scalar Datatype Management Tasks

Follow these instructions to access the scalar datatype management tasks shown in [Figure 10-9](#) on page 10-36 through [Figure 10-11](#) on page 10-38:

To access scalar datatype management tasks:

1. Select the **Modeling** tab.
2. Select the **Datatypes** tab.

The Business Datatypes page appears. (See [Figure 10-9](#) on page 10-36.)

3. Select a task to perform and see the referenced section for instructions:

To...	Then...	See Section...
Create a scalar datatype	Click Create .	"Creating a Scalar Datatype" on page 10-41
Delete a scalar datatype	Select a specific scalar datatype in the Delete column.	"Deleting a Scalar Datatype" on page 10-42

To...	Then...	See Section...
Update a scalar datatype	Select a specific scalar datatype in the Update column.	"Updating a Scalar Datatype" on page 10-43
View details about a scalar datatype	Select a specific scalar datatype in the Name column.	"Viewing a Scalar Datatype" on page 10-43
Create a scalar datatype facet	Select a specific scalar datatype in the Name column for which to create a facet.	"Creating a Scalar Datatype Facet" on page 10-45
Delete a scalar datatype facet	Select a specific scalar datatype in the Name column for which to delete a facet.	"Deleting a Scalar Datatype Facet" on page 10-47
Update a scalar datatype facet	Select a specific scalar datatype in the Name column for which to update a facet.	"Updating a Scalar Datatype Facet" on page 10-47
View a scalar datatype facet	Select a specific scalar datatype in the Name column for which to view a facet.	"Viewing a Scalar Datatype Facet" on page 10-48
Create a valid value for a scalar datatype enumeration or pattern facet	Select a specific scalar datatype in the Name column for which to create a valid value for an enumeration or pattern facet.	"Creating a Valid Value for the Scalar Datatype Enumeration or Pattern Facet" on page 10-49
Delete a valid value for a scalar datatype enumeration or pattern facet	Select a specific scalar datatype in the Name column for which to delete a valid value for an enumeration or pattern facet.	"Deleting a Valid Value for the Scalar Datatype Enumeration or Pattern Facet" on page 10-49
Update a valid value for a scalar datatype enumeration or pattern facet	Select a specific scalar datatype in the Name column for which to update a valid value for an enumeration or pattern facet.	"Updating a Valid Value for the Scalar Datatype Enumeration or Pattern Facet" on page 10-50

Creating a Scalar Datatype

Follow these instructions to create a scalar datatype:

To create a scalar datatype:

1. Ensure that you followed the instructions in ["Accessing Scalar Datatype Management Tasks"](#) on page 10-40 to access the page for creating a scalar datatype.

The Create Datatype page appears.

- Enter the following details to create a scalar datatype. An asterisk (*) indicates a required field.

Scalar Datatypes	Description
General	
<ul style="list-style-type: none"> ■ Type 	Select Scalar .
<ul style="list-style-type: none"> ■ Name * 	Enter a unique and recognizable name for the scalar datatype.
<ul style="list-style-type: none"> ■ Namespace 	Select a namespace.
<ul style="list-style-type: none"> ■ Description 	Enter a description for the scalar datatype.
Base Datatype	
<ul style="list-style-type: none"> ■ Classification * 	Select Business Datatype or Core Datatype .
<ul style="list-style-type: none"> ■ Namespace 	Select a namespace.
<ul style="list-style-type: none"> ■ Name * 	Select a datatype as the base datatype.

- Click **Apply**.

The scalar datatype is created and the Scalar Datatype Details page for the new scalar datatype appears.

Deleting a Scalar Datatype

Follow these instructions to delete a scalar datatype:

Note: Deleting a business datatype such as a scalar datatype can cause an error to occur if they are used by other modeling metadata such as transformation rules. The transformation rules must be deleted before deleting the datatype.

To delete a scalar datatype:

- Ensure that you followed the instructions in "[Accessing Scalar Datatype Management Tasks](#)" on page 10-40 to access the page for deleting a scalar datatype.
- Click **Yes** when prompted to delete a scalar datatype.

The scalar datatype is deleted and the Business Datatypes page appears.

Updating a Scalar Datatype

Follow these instructions to update the scalar datatype:

To update a scalar datatype:

1. Ensure that you followed the instructions in "[Accessing Scalar Datatype Management Tasks](#)" on page 10-40 to access the page for updating a scalar datatype.

The Update Scalar Datatype page appears.

2. Make appropriate changes. (See Step 2 on page 10-42 of "[Creating a Scalar Datatype](#)" for a list of fields you can update.)
3. Click **Apply**.

The scalar datatype is updated and the Scalar Datatypes Details page for the updated scalar datatype appears.

Viewing a Scalar Datatype

Follow these instructions to view details about a specific scalar datatype:

To view a scalar datatype:

1. Ensure that you followed the instructions in "[Accessing Scalar Datatype Management Tasks](#)" on page 10-40 to access the page for viewing a scalar datatype.

The Scalar Datatype Details page for the selected scalar datatype appears.

Scalar Datatype Details : anySimpleType

[Delete](#) [Update](#)

Details

General

Name **anySimpleType**
 Namespace <http://www.w3.org/2001/XMLSchema>
 Description
 Anonymous **False**
 Abstract
 Reference Only
 Member Group Type
 Primitive Datatype
 State **Draft**

Base Datatype

Name [anyURI](#)
 Namespace
 Inheritance Type **Restriction**

Facets

[Return to Top](#)

Type	Value(s)	Update	Delete
Enumeration	(No valid values found.)		
Pattern	(No valid values found.)		
White Space			

- View specific details, including the facets assigned to this scalar datatype. There are also preset attributes (**Anonymous**, **Abstract**, **Reference Only**, and **Member Group Type**) displaying in the **General** section that were automatically included from the original XSD file. You cannot update these attributes through the Oracle Application Server ProcessConnect user interface tool. To update these attributes, you must use the XSD file. The Oracle Application Server ProcessConnect user interface tool, however, does enable you to create a base datatype for the scalar datatype.

This page, as with the Business Datatypes page shown in [Figure 10-9](#) on page 10-36, enables you to delete or update the selected scalar datatype.

You assign business datatypes such as scalar datatypes to an event body element of a business event.

- Click **Return to List** to return to the Business Datatypes page.

See Also: ["Datatypes"](#) on page A-35 to update specific datatype attributes in the XSD file

Creating a Scalar Datatype Facet

Facets enable you to define the constraints (or limitations) of datatypes. Follow these instructions to a scalar datatype facet:

To create a scalar datatype facet:

1. Ensure that you followed the instructions in "[Accessing Scalar Datatype Management Tasks](#)" on page 10-40 to access the page for creating a scalar datatype facet.
2. The Scalar Datatype Details page for the selected scalar datatype appears. (See [Figure 10-10](#) on page 10-37.)
3. Go to the **Facets** section.
4. Click **Create**.

The Create Facet page appears.

5. Select a facet type from the **Type** list.

Type	Description
Datatype Length	Datatype length is the number of units of length, where units of length varies depending on the type from which it is being derived. The value of length must be a nonnegative integer. For string and datatypes derived from a string, length is measured in units of characters as defined in XML 1.0 (Second Edition). For any URI, length is measured in units of characters (as for string). For <code>hexBinary</code> and <code>base64Binary</code> and datatypes derived from them, length is measured in octets (eight bits) of binary data. For datatypes derived by list (that is, array datatypes), length is measured in the number of list items.
Encoding	Indicates the encoding type of a binary string. This is used in Oracle Application Server ProcessConnect core datatypes to differentiate between the binary types <code>hexBinary</code> and <code>base64Binary</code> .
Enumeration	Sets constraints on the value space to a specified set of values.
Fraction Digits	The maximum number of digits in the fractional part of values of datatypes derived from a decimal. The value must be a nonnegative integer.
Max Exclusive	The exclusive upper bound of the value space for a datatype with the ordered property. The value must be in the value space of the base type.

Type	Description
Max Inclusive	The inclusive upper bound of the value space for a datatype with the ordered property. The value must be in the value space of the base type.
Max Length	The maximum number of units of length, where units of length varies depending on the type from which it is being derived. The value must be a nonnegative integer.
Min Exclusive	The exclusive lower bound of the value space for a datatype with the ordered property. The value must be in the value space of the base type.
Min Inclusive	The inclusive lower bound of the value space for a datatype with the ordered property. The value must be in the value space of the base type.
Min Length	The minimum number of units of length, where units of length varies depending on the type from which it is being derived. The value must be a nonnegative integer.
Pattern	A constraint on the value space of a datatype that is achieved by constraining the lexical space to literals that match a specific pattern. The value of pattern must be a regular expression. For example, a value for pattern facet can be <code>'[0-9]{5}(-[0-9]{4})?'</code> .
Total Digits	The total number of digits for a numeric datatype. This is the maximum number of digits in values of datatypes derived from a decimal. The value must be a positive integer.
White Space	<p>Sets constraints on the value space of types derived from a string such that the various behaviors specified in Attribute Value Normalization in XML 1.0 (Second Edition) are realized. The value must be one of the following:</p> <ul style="list-style-type: none"> <li data-bbox="635 1154 1275 1275"> <p>■ Collapse</p> <p>After the processing implied by replace, contiguous sequences of <code>#x20</code>s are collapsed to a single <code>#x20</code>, and leading and trailing <code>#x20</code>s are removed.</p> <li data-bbox="635 1288 1275 1409"> <p>■ Preserve</p> <p>No normalization is done, and the value is not changed. This is the behavior required by XML 1.0 (Second Edition) for element content.</p> <li data-bbox="635 1421 1275 1513"> <p>■ Replace</p> <p>All occurrences of <code>#x9</code> (tab), <code>#xA</code> (line feed), and <code>#xD</code> (carriage return) are replaced with <code>#x20</code> (space)</p>

The page refreshes to display an additional **Value** field for facet types that allow only a single value (as opposed to a range of values). All facet types with the exception of enumeration and pattern allow only a single value.

6. Specify a value in the **Value** field.
7. Select **Unspecified**, **Yes**, or **No** from the **Fixed** list. Selecting **Yes** causes this value to override all other values.
8. Click **Apply**.

The scalar datatype facet is created and the Facet Details page for the new scalar datatype facet appears.

See Also: ["XSD"](#) on page A-3 for additional details about facet support and limitations

Deleting a Scalar Datatype Facet

Follow these instructions to delete a scalar datatype facet:

To delete a scalar datatype facet:

1. Ensure that you followed the instructions in ["Accessing Scalar Datatype Management Tasks"](#) on page 10-40 to access the page for deleting a scalar datatype facet.
2. The Scalar Datatype Details page for the selected scalar datatype appears. (See [Figure 10-10](#) on page 10-37.)
3. Go to the **Facets** section.
4. Select the facet to delete in the **Delete** column.
5. Click **Yes** when prompted to delete the scalar datatype facet.

The scalar datatype facet is deleted and the Scalar Datatype Details page appears.

Updating a Scalar Datatype Facet

Follow these instructions to update a scalar datatype facet:

To update a scalar datatype facet:

1. Ensure that you followed the instructions in ["Accessing Scalar Datatype Management Tasks"](#) on page 10-40 to access the page for updating a scalar datatype facet.

2. The Scalar Datatype Details page for the selected scalar datatype appears. (See [Figure 10-10](#) on page 10-37.)
3. Go to the **Facets** section.
4. Select the facet to update in the **Update** column.
The Update Facet page appears.
5. Make appropriate changes. (See Step 5 on page 10-45 through Step 7 on page 10-47 of "[Creating a Scalar Datatype Facet](#)" for a list of fields you can update.)
6. Click **Apply**.
The scalar datatype facet is updated and the Scalar Datatypes Details page for the updated scalar datatype appears.

Viewing a Scalar Datatype Facet

Follow these instructions to view a scalar datatype facet:

To view a scalar datatype facet:

1. Ensure that you followed the instructions in "[Accessing Scalar Datatype Management Tasks](#)" on page 10-40 to access the page for viewing a scalar datatype facet.
2. The Scalar Datatype Details page for the selected scalar datatype appears. (See [Figure 10-10](#) on page 10-37.)
3. Go to the **Facets** section.
4. Select the facet to view in the **Type** column.
5. The Details page for the selected scalar datatype facet appears (for example, for Min Exclusive).

Facet Details : Min Exclusive

Details

Type **Min Exclusive**
Value
Fixed **No**

[Return To Datatype Details](#)

Delete Update

Delete Update

6. View specific details.

This page, as with the Scalar Datatype Details page shown in [Figure 10-10](#) on page 10-37, enables you to delete or update the selected scalar datatype facet.

7. Click **Return to Datatype Details** to return to the Scalar Datatype Details page.

Creating a Valid Value for the Scalar Datatype Enumeration or Pattern Facet

Follow these instructions to create a valid value for a scalar datatype enumeration or pattern facet:

To create a valid value for a scalar datatype enumeration or pattern facet:

1. Ensure that you followed the instructions in "[Accessing Scalar Datatype Management Tasks](#)" on page 10-40 to access the page for creating a valid value for a scalar datatype enumeration or pattern facet.
2. The Scalar Datatype Details page for the selected scalar datatype appears. (See [Figure 10-10](#) on page 10-37.)
3. Go to the **Facets** section.
4. Select **Enumeration** or **Pattern** from the **Type** column.
The Facet Details page appears. (See either page of [Figure 10-11](#) on page 10-38.)
5. Click **Create**.
The Create Valid Value page appears.
6. Enter a value in the **Value** field.
7. Click **Apply**.
The Valid Value Details page for the new valid value appears.

Deleting a Valid Value for the Scalar Datatype Enumeration or Pattern Facet

Follow these instructions to delete a valid value for a scalar datatype enumeration or pattern facet:

To delete a valid value for a scalar datatype enumeration or pattern facet:

1. Ensure that you followed the instructions in "[Accessing Scalar Datatype Management Tasks](#)" on page 10-40 to access the page for deleting the valid value of a scalar datatype enumeration or pattern facet.

2. The Scalar Datatype Details page for the selected scalar datatype appears. (See [Figure 10-10](#) on page 10-37.)
3. Go to the **Facets** section.
4. Select **Enumeration** or **Pattern** from the **Type** column.
The Facet Details page appears. (See either page of [Figure 10-11](#) on page 10-38.)
5. Go to the **Valid Values** section.
6. Select a specific valid value to delete in the **Delete** column.
7. Click **Yes** when prompted to delete the valid value.
The valid value is deleted and the Facet Details page appears.

Updating a Valid Value for the Scalar Datatype Enumeration or Pattern Facet

Follow these instructions to update a valid value for a scalar datatype enumeration or pattern facet:

To update a valid value for a scalar datatype enumeration or pattern facet:

1. Ensure that you followed the instructions in "[Accessing Scalar Datatype Management Tasks](#)" on page 10-40 to access the page for updating a valid value for a scalar datatype enumeration or pattern facet.
2. The Scalar Datatype Details page for the selected scalar datatype appears. (See [Figure 10-10](#) on page 10-37.)
3. Go to the **Facets** section.
4. Select **Enumeration** or **Pattern** from the **Type** column.
The Facet Details page appears. (See either page of [Figure 10-11](#) on page 10-38.)
5. Go to the **Valid Values** section.
6. Select a specific valid value to update in the **Update** column.
The Update Valid Value page appears.
7. Make appropriate changes. (See Step 6 on page 10-49 of "[Creating a Valid Value for the Scalar Datatype Enumeration or Pattern Facet](#)" for a list of fields you can update.)
8. Click **Apply**.
The valid value is updated and the Valid Value Details page for the updated valid value appears.

Importing XSD Datatypes

The Oracle Application Server ProcessConnect user interface tool enables you to import datatypes defined in XSD format into Oracle Application Server ProcessConnect as business datatypes. Click the **Import** button shown at the top of [Figure 10–12](#). This task is described in detail in this section.

Figure 10–12 XSD Datatype Import Management Task

Business Datatypes

Search

Previous 1-10 of 138 Next 10

Name	Type	Base Datatype	Namespace	Update	Delete
anySimpleType	Scalar		http://www.w3.org/2000/10/XMLSchema		
string	Scalar	anySimpleType	http://www.w3.org/2000/10/XMLSchema		
normalizedString	Scalar	string	http://www.w3.org/2000/10/XMLSchema		
token	Scalar	normalizedString	http://www.w3.org/2000/10/XMLSchema		
language	Scalar	token	http://www.w3.org/2000/10/XMLSchema		
Name	Scalar	token	http://www.w3.org/2000/10/XMLSchema		
NCName	Scalar	Name	http://www.w3.org/2000/10/XMLSchema		
NOTATION	Scalar	anySimpleType	http://www.w3.org/2000/10/XMLSchema		
ID	Scalar	NCName	http://www.w3.org/2000/10/XMLSchema		
NMTOKEN	Scalar	token	http://www.w3.org/2000/10/XMLSchema		

Previous 1-10 of 138 Next 10

Shortcuts

- [Create Business Event Type](#)
- [Business Event Types](#)
- [Create Datatype Transformation Map](#)
- [Datatype Transformation Maps](#)

Follow these instructions to import XSD datatypes:

Note: If you import an XSD file that includes datatypes that already exist in the Oracle Application Server ProcessConnect design-time repository, those datatypes are not modified. Only datatypes that do not exist in the design-time repository are created.

To import XSD datatypes:

1. Ensure that you followed the guidelines in "XSD" on page A-3 to create an XSD file that uses the XSD and XML Schema tags that Oracle Application Server ProcessConnect supports.
2. Select the **Modeling** tab.
3. Select the **Datatypes** tab.

The Business Datatypes page appears.

4. Click **Import**.

The Select XSD File page appears and displays the files you placed in the \$ORACLE_HOME/ip/import directory or its subdirectories.

5. Expand individual directories in the list to view all available files. You cannot specify more than one directory for the import of XSD files. However, you can have multiple subdirectories in a single directory that you can browse

Select XSD File

Please select an XSD file to import. This file will be used to import business datatypes. Note that only XSD files can be imported.

[Expand All](#) | [Collapse All](#)

⊕ Home Directory	
Focus Directories/Files	
	▼ Home Directory
⊕	▶ .ade_path
	002_confirm_bod_004.xsd
	003_process_po_007.xsd
	004_acknowledge_po_008.xsd
	adapterhdr.xsd
	adapterinput.xsd
	oagis_fields.xsd
	oagis_segments.xsd
	po.xsd
	sample.xsd
	expense.xsd
	notification.xsd
	testfile
⊕	▶ V3proto_xsd

6. Click the datatype file to import in the **Directories/Files** column.

The Translator Properties page displays the directory path to the XSD file to import.

7. Review details about the XSD file to import. You can also be prompted to enter additional details on this page.
8. Click **Apply**.
The Business Datatypes page appears. The imported file now displays in the **Name** column.
9. Click the imported business datatype name in the **Name** column.
10. Click **Expand All** in the **Datatype Members** section to view the imported business datatypes.

Complex Datatype Details : notification_type

[Delete](#) [Update](#)

Details

General

Name **notification_type**
 Namespace <http://www.oracle.com/jipdemo>
 Description
 Definition
 Anonymous **False**
 Abstract **False**
 Reference Only **False**
 Member Group Type **False**
 Model Group **Sequence Group**
 State **Deployed**

Base Datatype

Name
 Namespace
 Inheritance Type

Datatype Members

[Return to Top](#)

[Create](#)

[Expand All](#) | [Collapse All](#)

⊕ Datatype Members

Focus Name	Type	Datatype	Cardinality	Update	Delete
▼ Datatype Members					
from	Scalar	string			
to	Scalar	string			
subject	Scalar	string			
arrival_date	Scalar	date			
⊕ ▶ status	Compound	status_type	[1, 1]		
modified_date	Scalar	date			

The business datatypes appear (for this example, as part of a complex datatype named **notification_type**).

Note: Only XSD files can be imported, you cannot import D3L or token substituted text files. D3L and token substituted text support is only provided for translation, and not business datatype importing.

See Also: ["XSD"](#) on page A-3 for details about Oracle Application Server ProcessConnect support for XSD and XML Schema tags

Managing Application Datatypes

The Oracle Application Server ProcessConnect user interface tool enables you to view application datatypes. Application datatypes represent an interpretable syntactic format understood by Oracle Application Server ProcessConnect. Application datatypes are created by a translator you select during native and application event type creation. Native and application event type creation occurs:

- When you add a new adapter interaction in "[Adding an Adapter Interaction](#)" on page 11-7
- When you add a native event to an existing adapter interaction in "[Creating a Native Event Type](#)" on page 11-40

Three types of translators are supported: XML, D3L, and token substituted text. With one exception described under Step 10 on page 10-56, you cannot use the Oracle Application Server ProcessConnect user interface tool to create or delete application datatypes, but you can view them.

You cannot update application datatypes after they are created. You must delete and recreate the datatypes if they must be modified. When you delete a native event, the native datatypes and the associated application datatypes are also deleted. If the same application datatypes are used in other native datatypes, they are not deleted. Deleting an application datatype can cause an error to occur if they are used by other modeling metadata such as transformation rules. The transformation rules must be deleted before deleting the datatype.

Follow these instructions to view application datatypes:

To view application datatypes:

1. Select the **Modeling** tab.
2. Select the **Datatypes** tab.
3. Select **Application Datatypes**.

The Application Datatypes page displays the available application datatypes.

Application Datatypes

Search

⊖ Previous 1-10 of 362 Next 10 ⊕

Name	Type	Base Datatype	Namespace	Update	Delete
anyURI	Scalar	string	http://www.w3.org/2001/XMLSchema		
QName	Scalar	string	http://www.w3.org/2001/XMLSchema		
NOTATION	Scalar	QName	http://www.w3.org/2001/XMLSchema		
binaryString	Scalar	string	http://www.w3.org/2001/XMLSchema		
base64BinaryString	Scalar	binaryString	http://www.w3.org/2001/XMLSchema		
hexBinaryString	Scalar	binaryString	http://www.w3.org/2001/XMLSchema		
normalizedString	Scalar	string	http://www.w3.org/2001/XMLSchema		
token	Scalar	normalizedString	http://www.w3.org/2001/XMLSchema		
language	Scalar	token	http://www.w3.org/2001/XMLSchema		
NMTOKEN	Scalar	token	http://www.w3.org/2001/XMLSchema		

⊖ Previous 1-10 of 362 Next 10 ⊕

Shortcuts

- [Application Event Types](#)
- [Create Datatype Transformation Map](#)
- [Datatype Transformation Maps](#)

4. Click a specific application datatype in the **Name** column.
The details page for the selected application datatype appears.
5. View specific details.
6. Click the **Event Types** tab to view the application event body element of which the application datatypes are a part.
7. Click **Application Event Types**.
8. Click the specific application event type name in the **Name** column (for this example, the application event named **notification**).
9. Click **Expand All** in the **Event Body Elements** section.
10. View specific details, including the type and datatype.

Application Event Type Details : Global NP Ad

[Delete](#) [Update](#)

Details

Name **Global NP Ad**

Description

State **Deployed**

Event Body Elements

[Return to Top](#)

[Create](#)

[Expand All](#) | [Collapse All](#)

Event Body Elements

Focus Name	Type	Datatype	Cardinality	Update	Delete
Event Body Elements					
<ul style="list-style-type: none"> PAYLOAD <ul style="list-style-type: none"> Action: Scalar, string Date: Scalar, string HR Contact Name: Scalar, string Content Type: Scalar, string Featured: Scalar, boolean (Anonymous) <ul style="list-style-type: none"> HR Contact Phone: Scalar, string HR Contact Email: Scalar, string description: Scalar, string Ad <ul style="list-style-type: none"> Title: Scalar, string Text: Scalar, string Ad ID: Scalar, integer 		Ad_Request			
	Compound	(Anonymous)	[1, 1]		
	Compound	AdType	[1,]		

Note: Only the datatype of a wildcard member in a complex datatype can be updated. No other application datatypes can be created, updated, or deleted.

See Also:

- ["Application Datatypes"](#) on page 3-32

The following sections for tasks accessible from the **Shortcuts** section of the Application Datatypes page:

- ["Viewing Application Event Types"](#) on page 11-60
- ["Managing Datatype Transformation Maps"](#) on page 13-21

Viewing Native Datatypes

The Oracle Application Server ProcessConnect user interface tool does not understand the format of native datatypes. Native datatypes are created by Oracle Application Server ProcessConnect after adding an adapter interaction. You cannot use the Oracle Application Server ProcessConnect user interface tool to view native datatype details such as structure and semantics. However, you can view details such as the translator and native event validation metadata to be used. Follow these instructions to view native datatype details:

To view native datatypes:

1. Select the **Modeling** tab.
2. Select the **Datatypes** tab.
3. Select **Native Datatypes**.

The Native Datatypes page displays the available native datatypes.

Native Datatypes

Name
AQ-Headers
AQ_ECXMSG_Headers
Acknowledgement - RNIF 1.1
Acknowledgement - RNIF 2.0
Attachment-Native
Correlation
Delivery Header - RNIF 2.0
Exception
Exception RNIF 2.0
FailureNotification

4. Click a specific native datatype in the **Name** column.

The Native Datatype Details page for the selected native datatype appears.

5. View specific details, including a description, content details about the native datatype such as the file required by translation and native event validation, and the full definition to the native format file.

See Also:

- ["Wire Messages and Oracle Records"](#) on page 3-17
- ["Native Datatypes"](#) on page 3-23

Managing Datatype Namespaces

The Oracle Application Server ProcessConnect user interface tool enables you to perform the datatype namespace management tasks shown in [Figure 10–13](#) and [Figure 10–14](#). These tasks are described in detail in this section. A namespace is a method for grouping datatypes. When you create a datatype, you can assign it to a namespace. This enables you to organize datatypes more efficiently and easily find that datatype later. For example, when you create an event body element in a business event, you first select a namespace for the business datatype. When you then select the business datatype to include in the event body element, only the datatypes in the selected namespace appear. If you do not group a datatype in a namespace, you must browse all datatypes in Oracle Application Server ProcessConnect.

For example, you may have a human resources application that uses XSD as its native datatype format. Your Oracle Application Server ProcessConnect design-time repository may include many additional applications and datatypes. If you do not specify a namespace, finding these datatypes can be difficult. However, if you create a namespace named `human_resources` and assign the datatypes of the human resources application to it, you can easily find these datatypes when needed.

Figure 10–13 Datatype Namespace Management Tasks (Part 1 of 2)

Datatype Namespaces

Search

1-10 of 13

Name	Update	Delete
Oracle xmlns		
dtd://www.m.org/B2BAttachment		
dtd://www.m.org/Exception		
dtd://www.m.org/IpCorrelationHeader		
dtd://www.m.org/Pip0A1FailureNotification		
dtd://www.m.org/Pip3A4PurchaseOrderConfirmation		
dtd://www.m.org/Pip3A4PurchaseOrderRequest		
dtd://www.m.org/Pip3A6PurchaseOrderStatusNotification		
dtd://www.m.org/ReceiptAcknowledgment		
http://www.oracle.com/tp		

1-10 of 13

Selecting a datatype namespace in the **Name** column causes a details page such as that shown in [Figure 10-14](#) to appear.

Figure 10-14 Datatype Namespace Management Tasks (Part 2 of 2)

Datatype Namespace Details : [dtd://www.rn.org/Pip3A6PurchaseOrderStatusNotification](#) Delete Update

Details

Name **dtd://www.rn.org/Pip3A6PurchaseOrderStatusNotification**
 State **Draft**

Datatypes Return to Top Create

Previous 1-10 of 105 Next 10

Name	Type	Base Datatype	Classification	Update	Delete
requestedShipFrom	Complex		Application Event		
PhysicalAddress	Complex		Application Event		
addressLine1	Complex		Application Event		
FreeFormText	Complex		Application Event		
addressLine2	Complex		Application Event		
addressLine3	Complex		Application Event		

[Table 10-4](#) identifies the datatype namespace management tasks shown in [Figure 10-13](#) on page 10-59 and [Figure 10-14](#) on page 10-60 and provides references to procedures for performing these tasks.

Table 10-4 Datatype Namespace Management Tasks

Page Elements	Management Task	First See Section...	Then See Section...
Create button of Datatype Namespaces page in Figure 10-13	Create a datatype namespace	"Accessing Datatype Namespace Management Tasks" on page 10-61	"Creating a Datatype Namespace" on page 10-63
Delete column of Datatype Namespaces page in Figure 10-13	Delete a datatype namespace		"Deleting a Datatype Namespace" on page 10-63
Update column of Datatype Namespaces page in Figure 10-13	Update a datatype namespace		"Updating a Datatype Namespace" on page 10-63

Table 10–4 (Cont.) Datatype Namespace Management Tasks

Page Elements	Management Task	First See Section...	Then See Section...
Name column of Datatype Namespaces page in Figure 10–13 (To access the details page of Figure 10–14)	View a datatype namespace	"Accessing Datatype Namespace Management Tasks" on page 10-61	"Viewing a Datatype Namespace" on page 10-64
Create button of Datatype Namespace Details page in Figure 10–14	Create a datatype in a selected namespace		"Creating a Complex Datatype" on page 10-19 "Creating a Scalar Datatype" on page 10-41
Delete column of Datatype Namespace Details page in Figure 10–14	Delete a datatype in a selected namespace		"Deleting a Complex Datatype" on page 10-20 "Deleting a Scalar Datatype" on page 10-42
Update column of Datatype Namespace Details page in Figure 10–14	Update a datatype in a selected namespace		"Updating a Complex Datatype" on page 10-21 "Updating a Scalar Datatype" on page 10-43
Name column of Datatype Namespace Details page in Figure 10–14	View a datatype in a selected namespace		"Viewing a Complex Datatype" on page 10-22 "Viewing a Scalar Datatype" on page 10-43

Accessing Datatype Namespace Management Tasks

Follow these instructions to access the datatype namespace management tasks shown in [Figure 10–13](#) on page 10-59 and [Figure 10–14](#) on page 10-60:

To access datatype namespace management tasks:

1. Select the **Modeling** tab.
2. Select the **Datatypes** tab.
3. Select **Datatype Namespaces**.

The Datatype Namespaces page appears. (See [Figure 10–13](#) on page 10-59.)

4. Select a task to perform and see the referenced section for instructions:

To...	Then...	See Section...
Create a datatype namespace	Click Create .	"Creating a Datatype Namespace" on page 10-63
Delete a datatype namespace	Select a specific datatype namespace in the Delete column.	"Deleting a Datatype Namespace" on page 10-63
Update a datatype namespace	Select a specific datatype namespace in the Update column.	"Updating a Datatype Namespace" on page 10-63
View a datatype namespace	Select a specific datatype namespace in the Name column.	"Viewing a Datatype Namespace" on page 10-64
Create a datatype in a selected namespace	Select a specific datatype namespace in the Name column in which to create a datatype	"Creating a Complex Datatype" on page 10-19 "Creating a Scalar Datatype" on page 10-41
Delete a datatype in a selected namespace	Select a specific datatype namespace in the Name column in which to delete a datatype	"Deleting a Complex Datatype" on page 10-20 "Deleting a Scalar Datatype" on page 10-42
Update a datatype in a selected namespace	Select a specific datatype namespace in the Name column in which to update a datatype	"Updating a Complex Datatype" on page 10-21 "Updating a Scalar Datatype" on page 10-43
View a datatype in a selected namespace	Select a specific datatype namespace in the Name column in which to view a datatype	"Viewing a Complex Datatype" on page 10-22 "Viewing a Scalar Datatype" on page 10-43

Note: If you select to create a datatype in a specific namespace, that namespace automatically displays in the **Namespace** field of the Create Datatype page described in ["Creating a Complex Datatype"](#) on page 10-19 and ["Creating a Scalar Datatype"](#) on page 10-41.

Creating a Datatype Namespace

Follow these instructions to create a datatype namespace:

To create a datatype namespace:

1. Ensure that you followed the instructions in "[Accessing Datatype Namespace Management Tasks](#)" on page 10-61 to access the page for creating a datatype namespace.

The Create Datatype Namespace page appears.

2. Enter a name for the datatype namespace in the **Name** field.
3. Click **Apply**.

The datatype namespace is created and the Datatype Namespace Details page for the new datatype namespace appears.

Deleting a Datatype Namespace

Follow these instructions to delete a datatype namespace:

To delete a datatype namespace:

1. Ensure that you followed the instructions in "[Accessing Datatype Namespace Management Tasks](#)" on page 10-61 to access the page for deleting a datatype namespace.
2. Click **Yes** when prompted to delete a datatype namespace.

The datatype namespace is deleted and the Datatype Namespaces page appears.

Updating a Datatype Namespace

Follow these instructions to update a datatype namespace:

To update a datatype namespace:

1. Ensure that you followed the instructions in "[Accessing Datatype Namespace Management Tasks](#)" on page 10-61 to access the page for updating a datatype namespace.

The Update Datatype Namespace page appears.

2. Make appropriate changes. (See Step 2 on page 10-63 of "[Creating a Datatype Namespace](#)" for a list of fields you can update.)

3. Click **Apply**.

The datatype namespace is updated and the Datatype Namespace Details page for the updated datatype namespace appears.

Viewing a Datatype Namespace

Follow these instructions to view details about a specific datatype namespace and all of the datatypes within the namespace:

To view a datatype namespace:

1. Ensure that you followed the instructions in "[Accessing Datatype Namespace Management Tasks](#)" on page 10-61 to access the page for viewing a datatype namespace.

The Datatype Namespace Details page for the selected datatype namespace appears (for this example, Pip3A6PurchaseOrderStatusNotification).

[Datatype Namespace Details : dtd://www.m.org/Pip3A6PurchaseOrderStatusNotification](#)

[Delete](#) [Update](#)

Details

Name **dtd://www.m.org/Pip3A6PurchaseOrderStatusNotification**
 State **Draft**

Datatypes

[Return to Top](#)

[Create](#)

Previous 1-10 of 105 Next 10

Name	Type	Base Datatype	Classification	Update	Delete
requestedShipFrom	Complex		Application Event		
PhysicalAddress	Complex		Application Event		
addressLine1	Complex		Application Event		
FreeFormText	Complex		Application Event		
addressLine2	Complex		Application Event		
addressLine3	Complex		Application Event		
cityName	Complex		Application Event		
postOfficeBoxIdentifier	Complex		Application Event		
regionName	Complex		Application Event		
expediteReferenceIdentifier	Complex		Application Event		

Previous 1-10 of 105 Next 10

2. View specific details, including the datatypes assigned to this datatype namespace.

This page, as with the Datatype Namespaces page shown in [Figure 10-13](#) on page 10-59, enables you to delete or update the selected datatype namespace.

3. Click **Return to List** to return to the Datatype Namespaces page.

See Also: The following section for instructions on creating and assigning datatypes to a namespace:

- ["Creating a Complex Datatype"](#) on page 10-19
- ["Creating a Complex Datatype Member"](#) on page 10-26
- ["Creating a Scalar Datatype"](#) on page 10-41

Common User Errors

The following are common datatype user errors.

- If you created the business datatypes by hand, verify that you did not use the space (" ") character. To view the business datatypes of your configuration, select each business event and click **Expand All** in the **Event Body Elements** section.
- If you are importing your datatypes through an XSD file, ensure that you review ["XSD"](#) on page A-3 before designing datatypes. This section describes Oracle Application Server ProcessConnect support for XSD, including unsupported features, limitations, and workarounds.
- When importing business datatypes into Oracle Application Server ProcessConnect, you can only import XSD datatypes. D3L and token substituted text files cannot be imported as business datatypes.
- Deleting scalar or complex datatypes used by other modeling metadata such as transformation rules causes errors. You must first delete the transformation rules. See ["Design-Time Troubleshooting of Modeling Metadata Dependencies"](#) on page 22-9 for details about how to delete modeling metadata.

Chapter Summary

This chapter describes the datatypes available to you. The datatype classifications are native, application, and business. Native datatypes are in the native formats of your applications or trading partners. Application datatypes represent an interpretable syntactic format understood by Oracle Application Server ProcessConnect. Application datatypes are created when you create a native event for an adapter interaction and select a translator (XSD, D3L, or token substituted text). Business datatypes are used for representing the different datatypes of parties as a single, common set. Managing datatype namespaces (a method for grouping datatypes) is also discussed.

Managing Adapter Interactions and Event Types

This chapter describes the adapter interaction and event type management tasks required to design an integration.

This chapter contains these topics:

- [Adapter Interaction and Event Type Management Tasks Overview](#)
- [Managing Adapter Interactions](#)
- [Managing Native Event Types](#)
- [Managing Native Event Correlations](#)
- [Managing Event Maps](#)
- [Viewing Application Event Types](#)
- [Managing Business Event Types](#)
- [Common User Errors](#)
- [Chapter Summary](#)

Adapter Interaction and Event Type Management Tasks Overview

Table 11–1 describes Oracle Application Server ProcessConnect adapter interactions and event types and provides references to tasks for defining the adapter interaction and event type portions of an integration.

Table 11–1 Adapter Interaction and Event Type Management Tasks

Component	Description	See Section...
Adapter interactions	<p>Adapter interactions define the communication between the Oracle Application Server ProcessConnect runtime system and various adapters to send and receive data.</p> <p>Adapter interactions consist of two parts:</p> <ul style="list-style-type: none"> ■ An adapter interaction, which represents the unique actions that can be performed with a specific adapter (such as send a message, receive an e-mail, read a file, and so on). ■ Files that define these actions (such as an XSD definition file that specifies details on how a party requests a purchase order to buy computer equipment). Files using token substituted text and data definition description language (D3L) formats can also be used. 	"Managing Adapter Interactions" on page 11-4
Native events	A native event is the Oracle Application Server ProcessConnect internal implementation of the business data. The body elements of the native event contain the various sections of the wire message from a party, such as payloads or attachments.	"Managing Native Event Types" on page 11-37
Native event correlations	Native event correlation is an expression that defines when two native event instances (the requesting native event and the reply native event) are related. Native event correlation ensures that the correct request native event instance and reply native event instance are correlated and provided to the corresponding native role instances.	"Managing Native Event Correlations" on page 11-47

Table 11–1 (Cont.) Adapter Interaction and Event Type Management Tasks

Component	Description	See Section...
Event maps	An event map defines an expression for each Oracle record and determines the specific native event type to use with a given record instance. The event map is defined on a single event body element level.	"Managing Event Maps" on page 11-54
Application events	An application event represents the datatypes in an interpretable syntactic format. To create this format, a translator converts the wire message to an XML-based message and native event validation occurs. After the native event is represented as the corresponding application event, Oracle Application Server ProcessConnect can extract values from it and can make decisions based on it, or transform it.	"Viewing Application Event Types" on page 11-60
Business events	A business event establishes a common event structure and vocabulary across all parties. Business events are completely removed from any party-specific properties, including data structure and vocabulary. All related events from all parties follow the same structure and the same vocabulary once they are translated and transformed into business events. The event body element of the business event contains a complete set of business data. You create an event body element inside a business event that contains the business event datatypes used by all parties in an integration. The business event is essentially a superset of all the corresponding party-specific application events.	"Managing Business Event Types" on page 11-63

Managing Adapter Interactions

The user interface tool enables you to perform the adapter interaction management tasks shown in [Figure 11-1](#). These tasks are described in detail in this section.

Figure 11-1 Adapter Interaction Management Tasks

Interactions

This shows the interactions defined in the system. Please choose Add to add an interaction.

Add

Expand All | Collapse All

Adapter Providers

Focus Item	Delete
▼ Adapter Providers	
▼ Oracle	
▶ B2B Adapter	
▶ AQ Adapter	
▶ Oracle DB Adapter	
▶ JMS Adapter	
▼ File/FTP Adapter	
▼ File	
Read text file from directory(FileReadxmlTextRecord)	
Write text file to directory(FileWritead %TIME%.xmlTextRecord)	
▶ HTTP Adapter	
▶ Email Adapter	
▶ Webservice Adapter	

Shortcuts

- [Create Native Event Type](#)
- [Native Event Types](#)
- [Application Event Types](#)

Adapter interactions define the communication between the Oracle Application Server ProcessConnect runtime system and various adapters to send and receive data.

Adapter interactions consist of two parts:

- An adapter interaction, which represents the unique actions that can be performed with a specific adapter (such as requesting a purchase order, confirming a purchase order, sending a text file to an external HTTP server, and so on)
- Files that define these actions (such as an XSD definition file that defines the specific details of how a party requests a purchase order to buy computer equipment)

Figure 11-2 provides an example of an adapter interaction.

Figure 11-2 Adapter Interactions

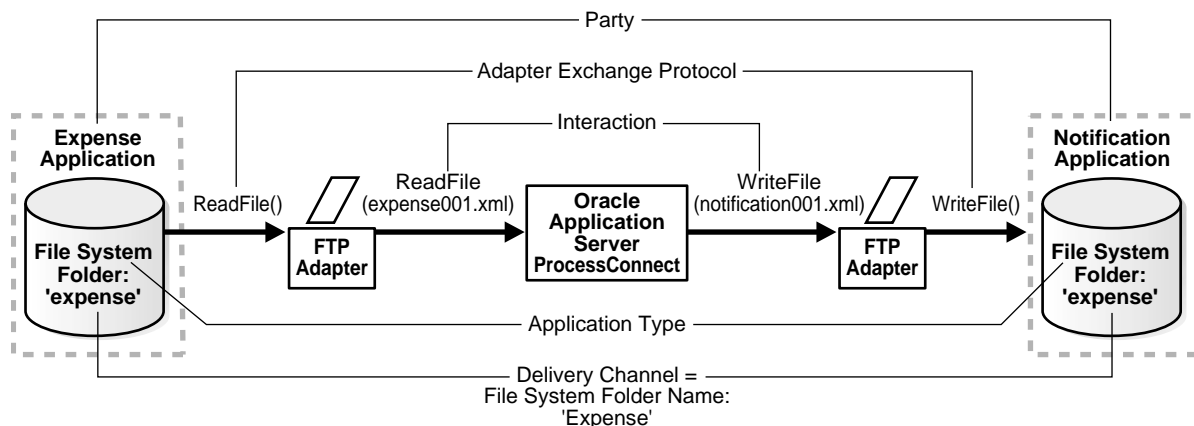

You create two adapter interactions (inbound and outbound) in this example. During the first session, you specify:

- An adapter interaction named `ReadFile()` to submit an inbound expense report for approval to the `expense` directory of a notification application
- A native format XSD file that defines the specific details of the inbound expense report.

During the second session, you specify:

- An adapter interaction named `WriteFile()` to write an outbound expense report notification to the `expense` directory of the notification application.
- An XSD file that defines the specific details of the expense report notification.

Both the inbound and outbound adapter interaction create the Oracle record, which establishes the conceptual boundary between Oracle Application Server ProcessConnect and a party. Immediately after creation of an inbound and outbound adapter interaction, you can use this interaction to create a native event, specify a translator, create an application event, and create application event body elements for the various sections of the wire message, such as header details, attachments, and payload data. The native event body elements are created by the adapter.

Table 11-2 identifies the adapter interaction management tasks shown in Figure 11-1 and provides references to procedures for performing these tasks.

Table 11-2 Adapter Interaction Management Tasks

Interactions Page Elements	Management Task	First See Section...	Then See Section...
Shortcuts section	Take shortcuts to manage native and application event types	N/A	<ul style="list-style-type: none"> ▪ "Managing Native Event Types" on page 11-37 ▪ "Viewing Application Event Types" on page 11-60
Add button	Add an adapter interaction	"Accessing Adapter Interaction Management Tasks" on page 11-6	"Adding an Adapter Interaction" on page 11-7
Delete column	Delete an adapter interaction		"Deleting an Adapter Interaction" on page 11-35
Adapter Providers column	View an adapter interaction		"Viewing an Adapter Interaction" on page 11-36

See Also:

- "Adapter Interactions" on page 3-19 for additional conceptual details
- Chapter 8, "Oracle Application Server ProcessConnect Technology Adapters"

Accessing Adapter Interaction Management Tasks

Follow these instructions to access the adapter interaction management tasks shown in Figure 11-1 on page 11-4.

To access adapter interaction management tasks:

1. Select the **Modeling** tab.
2. Select the **Interactions** tab.

The Interactions page appears.

3. Click **Expand All**.

The list expands to display the available adapter types. (See [Figure 11-1](#) on page 11-4.)

4. Select a task to perform and see the referenced section for instructions:

To...	Then...	See Section...
Add an adapter interaction	Click Add .	"Adding an Adapter Interaction" on page 11-7
Delete an adapter interaction	Select a specific adapter interaction in the Delete column.	"Deleting an Adapter Interaction" on page 11-35
View an adapter interaction	Select a specific adapter interaction from the expanded list.	"Viewing an Adapter Interaction" on page 11-36

See Also: ["Creating a Native Event Type"](#) on page 11-40 if you want to create a native event type to assign to an existing adapter interaction

Adding an Adapter Interaction

This section describes how to perform the following tasks:

- Select an adapter.
- Select an adapter exchange protocol for inbound or outbound communication.
- Provide answers to questions that display based on the selected adapter exchange protocol.
- Select a translator (XSD, token substituted text, or D3L) to use for translating your native format datatypes into application datatypes.

You can also optionally start a wizard during this session to create a native event, an application event, and event body elements for the various sections of the native format (wire) message, such as header details, attachments, and payload data.

To add an adapter interaction:

1. Ensure that you followed the instructions in "[Accessing Adapter Interaction Management Tasks](#)" on page 11-6 to access the page for adding an adapter interaction.

The Add Interaction : Select Adapter Type page appears.

2. Click **Expand All**.

Available adapters appear, including the technology adapters described in this chapter and any application adapters that you have installed.

3. Select the adapter to use from the expanded list.
4. If you are adding an adapter interaction for the Oracle Database adapter or Advanced Queuing adapter, you must already have created a delivery channel by following the instructions in "[Creating an Application Delivery Channel](#)" on page 15-14. You are prompted at this step to select this delivery channel from a list of delivery channels. If successful, the Add Interaction : Select Interaction page appears. If the delivery channel you select cannot log you into the application spoke database, an error displays and you are prompted to correct the credentials.

The Add Interaction: Select Interaction page appears and displays in the **Inbound** direction (for adapter interactions to use for messages being sent to Oracle Application Server ProcessConnect) and the **Outbound** direction (for adapter interactions to use for messages being sent from Oracle Application Server ProcessConnect).

5. Select a specific direction (**Inbound** and **Outbound**) or click **Expand All** to view all inbound and outbound adapter interactions.

Note: Clicking **Expand All** can take time if there are a lot of adapter interactions. This can potentially be the case for the Oracle Database adapter and Advanced Queuing adapter.

In this example, a specific adapter interaction for the JMS adapter is selected:

Add Interaction: Select Interaction

Please select the interaction to add.

[Expand All](#) | [Collapse All](#)

⊕	Adapter Exchange Protocols
Focus Item	
	▼ Adapter Exchange Protocols
⊕	▼ Inbound
⊕	▶ StreamMessage Payload
⊕	▶ Message Payload
⊕	▶ MapMessage Payload
⊕	▶ BytesMessage Payload
⊕	▼ TextMessage Payload
⊕	▼ Consume
⊕	▶ <u>Consume a message(JMS Text Message)</u>
⊕	▶ Outbound

- See the following sections or guides for descriptions of adapter interactions available with each adapter and for procedures on adding an adapter interaction:

Adapter	See Section/Guide...
Advanced Queuing (AQ) adapter	"Adding an Advanced Queuing Adapter Interaction" on page 11-11
E-Mail adapter	"Adding an E-Mail Adapter Interaction" on page 11-13
File/FTP adapter	"Adding a File/FTP Adapter Interaction" on page 11-14
HTTP adapter	"Adding an HTTP Adapter Interaction" on page 11-16
JMS (Java Message Service) adapter	"Adding a JMS (Java Message Service) Adapter Interaction" on page 11-18
Oracle Database adapter	"Adding an Oracle Database Adapter Interaction" on page 11-20
Web Service adapter	"Adding a Web Service Adapter Interaction" on page 11-23
PeopleSoft 8 adapter	<i>Oracle Application Server Integration Adapter for PeopleSoft 8 User's Guide</i>
SAP R/3 adapter	<i>Oracle Application Server Integration Adapter for SAP R/3 User's Guide</i>

Adapter	See Section/Guide...
Siebel 2000 adapter	<i>Oracle Application Server Integration Adapter for Siebel 2000 User's Guide</i>
J.D. Edwards OneWorld XE adapter	<i>Oracle Application Server Integration Adapter for J.D. Edwards OneWorld XE User's Guide</i>
VSAM adapter	<i>Oracle Application Server Integration Adapter for VSAM Installation and User's Guide</i>
CICS adapter	<i>Oracle Application Server Integration Adapter for CICS Installation and User's Guide</i>
IMS/TM adapter	<i>Oracle Application Server Integration Adapter for IMS/TM Installation and User's Guide</i>
IMS/DB adapter	<i>Oracle Application Server Integration Adapter for IMS/DB Installation and User's Guide</i>
Tuxedo adapter	<i>Oracle Application Server Integration Adapter for Tuxedo Installation and User's Guide</i>

Note: If an interaction has already been added, you cannot add it a second time. Attempting to do so causes an error message to appear. You must first delete the existing interaction. Expand the Interactions page shown in [Figure 11-1](#) on page 11-4 to display a list of currently-defined adapter interactions.

Note: More than one page of interaction questions can appear.

Adding an Advanced Queuing Adapter Interaction

1. Select the inbound or outbound adapter interaction to add and see the referenced section for instructions. Only queues supported by the application (spoke) database appear. The questions that appear are based on the adapter exchange protocol you select.

Adapter Exchange Protocol	See Section...
Inbound	"Inbound Direction" on page 11-11
<ul style="list-style-type: none"> ▪ RAW Queue ▪ Oracle Object Queue ▪ Oracle Object Queue with payload fields 	
Outbound	"Outbound Direction" on page 11-12
<ul style="list-style-type: none"> ▪ RAW Queue ▪ Oracle Object Queue ▪ Oracle Object Queue with payload fields 	

See Also: ["Advanced Queuing Adapter"](#) on page 8-11 for additional Advanced Queuing adapter details

Inbound Direction Follow the procedures in this section. An asterisk (*) indicates a required field.

1. Provide responses to the following questions. The questions can vary based on whether a multiconsumer or single consumer queue is detected.

Question	Description
<ul style="list-style-type: none"> ▪ For a multiconsumer queue: Queue <i>queue_name</i> is a multiconsumer queue. Please specify a consumer name. * 	Enter a name from 1 to 30 characters in length. There is no default value.
<ul style="list-style-type: none"> ▪ For a single consumer queue: Specify optional dequeue correlation ID. 	Enter an ID from 1 to 30 characters in length. There is no default value.

Question	Description
<p>Select the object fields in queue <i>queue_name</i> that will contain message payloads. *</p> <p>Note: Only for adapter interactions of the static protocol Oracle Object Queue with payloads.</p>	<p>Select fields from the list. All Oracle object type fields in the queue <i>queue_name</i> that can carry an XML document appear. There is no default value.</p>

2. Click **Apply**.
3. Go to "[Review the Adapter Interaction Details](#)" on page 11-25 to review details about your selection.

Outbound Direction Follow the procedures in this section. An asterisk (*) indicates a required field.

1. Provide responses to the following questions.

Question	Description
<ul style="list-style-type: none"> ▪ For a multiconsumer queue: Queue <i>queue_name</i> is a multiconsumer queue. Please specify the recipients as a comma-separated list. * ▪ For a single consumer queue: Specify an optional enqueue correlation ID. 	<p>Enter recipients from 1 to 500 characters in length. There is no default value.</p> <p>Enter an ID from 1 to 30 characters in length. There is no default value.</p>
<p>Select the object fields in queue <i>queue_name</i> that contain message payloads.</p> <p>Note: Only for adapter interactions of the static protocol Oracle Object Queue with payloads.</p>	<p>Select fields from the list. All Oracle object type fields in the queue <i>queue_name</i> that can carry an XML document appear. There is no default value.</p>

2. Click **Apply**.
3. Go to "[Review the Adapter Interaction Details](#)" on page 11-25 to review details about your selection.

See Also: *Application Developer's Guide - Advanced Queuing* available on the Oracle Technology Network:

<http://otn.oracle.com>

Adding an E-Mail Adapter Interaction

1. Select the inbound or outbound adapter interaction to add and see the referenced section for instructions. The questions that appear are based on the adapter exchanger protocol you select.

Direction	See Section...
Inbound	"Inbound Direction" on page 11-13
<ul style="list-style-type: none"> ▪ Read E-mail(E-MailRecord) 	
Outbound	"Outbound Direction" on page 11-14
<ul style="list-style-type: none"> ▪ Send E-mail(E-MailRecord) 	

See Also: ["E-Mail Adapter"](#) on page 8-30 for additional E-Mail adapter details

Inbound Direction Follow the procedures in this section. An asterisk (*) indicates a required field.

1. Provide responses to the following questions:

Question	Description
Content type	Select either regular (default value), XML attachment , Binary attachment , or Text attachment .
Maximum number of e-mails to read for each poll	Enter the maximum number of messages to retrieve in each polling session (default value is 30). You must enter a value greater than 0.
Folder name for unsuccessfully processed e-mails	Enter the folder name in which to place files that have not been processed successfully. Ensure that the folder name is valid and exists on the IMAP server.

2. Click **Apply**.
3. Go to ["Review the Adapter Interaction Details"](#) on page 11-25 to review details about your selection.

Outbound Direction Follow the procedures in this section. An asterisk (*) indicates a required field.

1. Select **regular** (default value), **xml attachment**, **binary attachment**, or **text attachment** as the content of the file from the **Content type** list.
2. Click **Apply**.
3. Go to "[Review the Adapter Interaction Details](#)" on page 11-25 to review details about your selection.

Adding a File/FTP Adapter Interaction

1. Select the inbound or outbound adapter interaction to add and see the referenced section for instructions. The questions that appear are based on the adapter exchange protocol you select.

Direction	See Section...
Inbound	"Inbound Direction" on page 11-15
<ul style="list-style-type: none"> ▪ Read File(FileRecord) 	
Outbound	"Outbound Direction" on page 11-15
<ul style="list-style-type: none"> ▪ Write File(FileRecord) 	

See Also: ["File/FTP Adapter"](#) on page 8-38 for additional File/FTP adapter details

Inbound Direction Follow the procedures in this section. An asterisk (*) indicates a required field.

1. Provide responses to the following questions.

Field	Description
Directory (relative path) for incoming files	Enter the directory in which incoming files are located. This relative path must be a directory path that begins under \$ORACLE_HOME/ip. This path is relative to the base directory delivery channel property you define in "Creating a File/FTP Adapter Delivery Channel" on page 15-18. For example, if the base directory delivery channel you defined is /Oracle/Ora_904/ip/human_resources, and directory inbound is under human_resources, enter inbound in this field.
Maximum number of files to read for each poll	Enter the maximum number of messages to process during polling (default value is 30).
File extension for the incoming files - for example, txt *	Enter the file extension.

2. Click **Apply**.
3. Go to ["Review the Adapter Interaction Details"](#) on page 11-25 to review details about your selection.

Outbound Direction Follow the procedures in this section. An asterisk (*) indicates a required field.

1. Provide responses to the following questions.

Question	Description
Directory (relative path) for outgoing files	Enter the directory in which outgoing files are located.
Staging directory (relative path) for outgoing files?	Enter the directory to use. This directory is important for when you have large files. This is to prevent an application from picking up a file before it completes being written into a directory.

Question	Description
File naming convention for outgoing files (without extension) - for example, po_%TIME% *	Enter the naming convention for outgoing files. Only %TIME% is allowed for variables in file names.
File extension for the outgoing files - for example, txt *	Enter the file extension.

2. Click **Apply**.
3. Go to "[Review the Adapter Interaction Details](#)" on page 11-25 to review details about your selection.

Adding an HTTP Adapter Interaction

1. Select the inbound or outbound adapter interaction to add and see the referenced section for instructions. The questions that appear are based on the adapter exchange protocol you select.

Adapter Exchange Protocol	See Section...
Inbound	"Inbound Direction" on page 11-16
<ul style="list-style-type: none"> ▪ Receive Payload(PayloadRecord) 	
Outbound	"Outbound Direction" on page 11-17
<ul style="list-style-type: none"> ▪ Send Payload(PayloadRecord, PayloadRecord) 	

See Also: ["HTTP Adapter"](#) on page 8-44 for additional HTTP adapter details

Inbound Direction Follow the procedures in this section. An asterisk (*) indicates a required field.

1. Select **application/xml** (default value), **application/octet**, or **text/plain** as the content of the file from the **Content type** list.
2. Click **Apply**.
3. Go to "[Review the Adapter Interaction Details](#)" on page 11-25 to review details about your selection.

Outbound Direction Follow the procedures in this section. An asterisk (*) indicates a required field.

1. Provide responses to the following questions:

Field	Description
Content type *	Select either application/xml (default value), application/octet , or text/plain as the content of the file.
Response Content Type	Select either application/xml (default value), application/octet , or text/plain as the content of the responding file.
URL suffix (relative to root URL)	Enter the URL servlet suffix to append to the base URL. For example, if the base URL is <code>http://foo:1888/integration</code> and the servlet suffix is <code>transportServlet</code> , the URL for sending messages is as follows: <code>http://foo:1888/integration/transportServlet</code> If a servlet suffix is not provided, only the base URL is used for sending messages.
HTTP connection timeout in milliseconds	Enter the timeout interval in milliseconds for HTTP connections (default value is 60000).
Method	Select either POST (default value) or GET .
Additional HTTP headers (separated by "@@")	Enter additional HTTP headers. For example: <code>Content-Type:application/xml @@</code> <code>Content-Language: mi, en</code>

2. Click **Apply**.
3. Go to ["Review the Adapter Interaction Details"](#) on page 11-25 to review details about your selection.

Adding a JMS (Java Message Service) Adapter Interaction

1. Select the inbound or outbound adapter interaction to add and see the referenced section for instructions. The questions that appear are based on the adapter exchange protocol you select. The adapter exchange protocols display as follows:

Adapter Exchange Protocol	See Section
Inbound <ul style="list-style-type: none"> ▪ StreamMessage Payload ▪ Message Payload ▪ MapMessage Payload ▪ BytesMessage Payload ▪ TextMessage Payload 	"Inbound Direction" on page 11-19
Outbound <ul style="list-style-type: none"> ▪ StreamMessage Payload ▪ Message Payload ▪ MapMessage Payload ▪ BytesMessage Payload ▪ TextMessage Payload 	"Outbound Direction" on page 11-19

See Also:

- ["JMS Adapter"](#) on page 8-58 for additional JMS adapter details
- The following Web location for additional details about JMS:
<http://java.sun.com/products/jms/>

Inbound Direction Follow the procedures in this section. An asterisk (*) indicates a required field.

1. Provide responses to the following questions.

Field	Description
Name of the JMS queue or topic (value of \${DestinationName}) *	Enter a value. The value of this field is most often the actual name of the underlying queue (or topic). Specifically, it simply replaces the <code>\${DestinationName}</code> placeholder used in the JMS delivery channel definition specified in the delivery channel parameters in "Creating a JMS Adapter Delivery Channel" on page 15-22.
Optional JMS message selector expression	Enter a value between 1 and 255 characters in length. The message selector expression applies when receiving messages.
Optional durable subscriber name	Enter a value between 1 and 255 characters in length.
Use JMS message listener?	Select Yes or No (the default) to specify if the JMS consumer is to use a JMS message listener for receiving messages.

2. Click **Apply**.
3. Go to ["Review the Adapter Interaction Details"](#) on page 11-25 to review details about your selection.

Outbound Direction Follow the procedures in this section. An asterisk (*) indicates a required field.

1. Provide responses to the following questions.

Question	Description
Name of the JMS queue or logic (value of \${DestinationName}) *	Enter a value (for example, <code>SEND.QUEUE</code>).
Message delivery mode	Select either NON_PERSISTENT or PERSISTENT .
Message priority (0-9)	Select a value between 0 and 9 (the default is 4).
Time-To-Live (milliseconds; 0 = no limit)	Enter a value in milliseconds. There is no limit.

2. Click **Apply**.
3. Go to ["Review the Adapter Interaction Details"](#) on page 11-25 to review details about your selection.

Adding an Oracle Database Adapter Interaction

1. Select the inbound or outbound adapter interaction to add and see the referenced section for instructions. The questions that appear are based on the adapter exchange protocol you select.

Adapter Exchange Protocol	See Section...
Inbound	
<ul style="list-style-type: none"> ▪ Read Record from Interface Table 	"Read Record from Interface Table" on page 11-21
Outbound	
<ul style="list-style-type: none"> ▪ Stored Procedure Invocation 	"Review the Adapter Interaction Details" on page 11-25. You are not prompted to answer any questions.
<ul style="list-style-type: none"> ▪ Write Record to Table 	"Write Record to Table" on page 11-22

See Also: ["Oracle Database Adapter Exchange Protocols"](#) on page 8-76 for additional details about these adapter exchange protocols

Read Record from Interface Table Follow the procedures in this section. An asterisk (*) indicates a required field.

1. Provide a response to the following question:

Field	Description
Enter a SQL statement for retrieving rows from the interface table - for example, select * from emp	Enter a query by following these rules.

The query must follow these rules:

- You first write and test the query using a separate query tool such as SQL*Plus.
- Only include columns from this table; joins to other tables are not permitted.
- If the table is defined in a separate schema from the connection, then the schema must be qualified in the query.
- Do not end with a punctuation character such as a semicolon (which may be required by query tools such as SQL*Plus).
- If the interface table uses the update option to record that a row has been processed, the query must include a WHERE clause excluding processed rows, for example:

```
SELECT name, salary FROM emp WHERE status <> 'Processed'
```

- If the order of processing the record instances is important, then the query must include an order by clause to enforce the order:

```
SELECT name, salary FROM emp ORDER BY name
```

2. Click **Apply**.

Any additional questions that appear are based on the SQL statement you entered in Step 1 on page 11-21.

3. If the table does not have a primary key or the table is a view (detected by the adapter after the SQL SELECT statement is entered for the first question), perform Steps 3a through 3b. Otherwise, go to Step 5.

- a. Provide responses to the following questions:

Field	Description
Select the columns from the interface table that uniquely identify a row	Select one or more columns from a table to define a unique key. All columns for the table appear.
Specify a method for marking the row as having been read	Select whether to update or delete the row. If update is selected, the query specified in Step 1 must exclude processed rows.

- b. Click **Apply**.

4. If you selected to update a row in Step 3a, perform Steps 4a through 4b. Otherwise, go to Step 5.

- a. Provide responses to the following questions:

Field	Description
Select a column for update	Select a table column to update. Your selection is updated at runtime.
Enter a value for success	Select the value with which to update the column if the record is successfully created as a native event.
Enter a value for failure	Select the value with which to update the column if the record is not created as a native event.

- b. Click **Apply**.

5. Go to "[Review the Adapter Interaction Details](#)" on page 11-25 to review details about your selection.

Write Record to Table Follow the procedures in this section. An asterisk (*) indicates a required field.

1. Provide a response to the following question:

Field	Description
Select an action	This action (either Insert or Update) writes the record to the table. The record can be inserted as a new row or an existing row can be updated.

- If you selected to update a record in Step 1, select one or more columns from the table that uniquely identify a row. All columns for the table appear.

Field	Description
Select the columns from the table that uniquely identify a row	Select one or more columns that define a unique key. All table columns appear for selection.

- Click **Apply**.
- Go to "[Review the Adapter Interaction Details](#)" on page 11-25 to review details about your selection.

Adding a Web Service Adapter Interaction

One outbound adapter interaction is supported. Inbound adapter interactions are not supported.

- Select the **Invoke Web Service Operation(RequestRecord, ResponseRecord)** outbound adapter interaction.

The Add Interaction : Questions page appears and prompts you to answer specific questions about selecting a Web Services Description Language (WSDL) file that describes the web service.

- Provide responses to the following questions for this adapter interaction. An asterisk (*) indicates a required field.

Question	Description
WSDL definition file name or WSDL definition URL	Specify a WSDL definition in either of the following ways: <ul style="list-style-type: none"> Click Browse to access a local XML file with a WSDL definition of the Web service to invoke. Enter a Web location (beginning with <code>http://</code> or <code>https://</code>) in the next field. <p>Note: If you enter a WSDL URL or a WSDL file that contains imported WSDL URLs, the following two questions may be required.</p>
Proxy server hostname (if specifying WSDL definition URL)	Enter the name of the proxy server host.

Question	Description
Proxy server port (if specifying WSDL definition URL)	Enter the proxy server port number.

3. Click **Apply**.

A second Add Interaction : Questions page appears and prompts you to select exactly one Web service operation from the many possible operations contained in the WSDL file. This page allows filtering on many attributes, such as operation name, message name, referenced URIs, and so on. Each question provides a list with many selections. Answer only enough questions to identify the operation. If the header in each list is **Unspecified** (the default), the behavior is as if all the remaining items are selected. You typically select the desired operation and treat the other filter values as additional information (for example, note which ports provide the desired operation, or which XML Schema datatypes are required). However, a Web service can sometimes provide the same operation with a choice of bindings (for example, RPC versus document style). You may also want to first eliminate undesired ports (corresponding to undesired parties) or undesired message part datatypes.

Question	Description
Port Type	Select a port type for this interaction.
Operation	Select the operation to perform.
Binding	Select the binding.
Service	Select the service.
Port	Select the port.
Message	Select a message.
Message part	Select a message part.
URI	Select a URI.

4. Select attributes that identify or filter down to a unique Web service operation and binding.
5. Click **Apply**.
6. Go to "[Review the Adapter Interaction Details](#)" on page 11-25 to review details about your selection.

See Also:

- ["Web Service Adapter"](#) on page 8-92 for additional Web Service adapter details
- The following URL for details about WSDL files:

<http://www.w3.org/TR/wsdl.html>

Review the Adapter Interaction Details

The Add Interaction : Review page displays details on your responses. The following example is the review page for a JMS adapter interaction.

Add Interaction: Review

Please verify the interaction you are about to add. Choose Apply to add the interaction. Please note that you will be asked to specify native formats and extractors after adding the interaction.

Create Native Event Type

After adding the interaction and specifying the native formats and extractors, you will be able to create the native event and event body elements.

Interaction

Name **Consume a message**
Is Inbound **True**

In Record Type

Name **JMS Text Message**

Interaction Questions

Name of the JMS queue or topic (value of \${DestinationName}) **SEND.QUEUE**
Use JMS message listener? **No**

1. Review the details. The **Create Native Event Type** box is automatically selected. If selected, this starts a wizard that enables you to select a translation method, and create a native event, an application event, and body elements for both event types. If you deselect this box, you can separately create this modeling metadata at a later time.
2. Click **Apply**.

This adds the adapter interaction and creates a corresponding Oracle record type. The Oracle record represents the input or output to an adapter interaction. It represents the conceptual boundary between Oracle Application Server ProcessConnect and the application being accessed by the adapter.

The Specify Native Format page appears.

The record type elements for which to create native event body elements appear in the **Record Type Element** column. For this example, three record types for the JMS adapter appear.

Specify Native Format

Please specify a native format and extractor for each record type element and choose Apply. Since a value is set by default, please verify that the correct native format and extractor are specified.

* Indicates required field

Record Type Element	Native Format	Extractor
JmsProperties	* XSD	* XSD
JmsHeaders	* XSD	* XSD
Payload	* XSD	* XSD

1. Select a native format for each record element from the **Native Format** list. Up to three native formats can be available. For some records, only one choice may be available. The selections available depend on the specific adapter record elements for which you are selecting a native format.

See [Chapter 8, "Oracle Application Server ProcessConnect Technology Adapters"](#) for details on which native formats are applicable to each record element. With the JMS Adapter, for example, the record elements JmsHeaders and JmsProperties can only have the native format XSD, whereas the payload record element can be any of the following native formats:

- **XSD**
If your native message format uses XML
- **Token Substituted Text**
For specifying the subject and body of alert e-mail messages
- **D3L**
If your native message format is not XML, but is instead a format of structured records of bytes, characters, or both

Be careful changing the native format of all record elements supported by a given adapter; this causes an undefined action to occur during runtime.

The screen refreshes to display your selection in the **Extractor** list. For example, if you select XSD in the **Native Format** list, XSD automatically appears in the **Extractor** list. Based on your native format selection, the extractor determines which type of translator to use.

2. Click **Apply**.

The page that appears next is based on whether the Create Native Event Type box was selected on the Add Interaction : Review page.

If the Create Native Event Type Box Was...	Then...	Go To...
Selected	The Create Native Event Type page appears.	"Creating Native and Application Event Types and Body Elements" on page 11-27
Not selected	The Interaction Details page appears.	"Viewing an Adapter Interaction" on page 11-36 Note: You can also create native and application event types and body elements for this interaction at a later time.

See Also: The following sections for specific details about these native formats:

- [Chapter 8, "Oracle Application Server ProcessConnect Technology Adapters"](#) for details about when a native format can be used for a particular Oracle record element.
- ["XSD"](#) on page A-3
- ["Data Definition Description Language"](#) on page A-37
- ["Token Substituted Text"](#) on page A-124

Creating Native and Application Event Types and Body Elements

The Create Native Event Type page appears. This is the first page of a wizard from which to create native events, application events, and body elements for both from the Oracle record type elements.

1. Enter a unique and recognizable native event type name in the **Name** field.

The interaction and Oracle record type also display on this page.

2. Click **Next**.

The Create Event Body Element : *record_type* page appears, where *record_type* is the record type in the native format. This page displays details such as the following:

- Event body element name
- Native event type name entered in Step 1 on page 11-27
- Native format selected in Step 1 on page 11-26
- Translator type based on the native format selected in Step 1 on page 11-26

This page appears for each Oracle record element.

3. If a data payload record element from which to create a body element appears, perform Steps 3a through 3c to specify the datatypes file. Otherwise, go to Step 4. Some record elements (such as some header record elements) automatically define their datatypes and do not prompt you for details.

Note: This wizard prompts you for details to create event body elements for each Oracle record type element. At some point in this process, you may be prompted to specify the details described in Step 3 if one of your record type elements contains payload datatypes. An exception to this is the Advanced Queuing adapter's Object Queue adapter exchange protocol, which automatically defines payload details and does not prompt you to specify any information.

- a. Go to the **Native Datatype** section. This section displays two selections (**Create New** and **Use Existing**). **Use Existing** may be disabled if there are no existing datatypes detected by Oracle Application Server ProcessConnect. In this case, you must specify a new datatype format file by performing the steps in Step b. **Use Existing** enables you to reuse datatypes when creating a native event. **Use Existing** is a selectable option in the following situations:
- * When you are adding an interaction that uses the same adapter exchange protocol and same native format as a previously added interaction
 - * When the native datatypes are implicitly defined by the adapter

- b. If you select **Create New**, perform the following tasks to specify a new format datatype file:
 - * Enter the native datatype name in the **Name** field.
 - * Click **Browse** next to the **Content** field.
 - * Select a native format file from the Select File page.
Your selection appears in the **Content** field.
- c. If you select **Use Existing**, perform the following tasks to specify an existing datatype file.
 - * Select an existing native format file from the **Name** list.
 - * Click **Next**.

4. Go to the **Translator Properties** section at the bottom of the page.

The fields that display in this section are based on the native format and translator selected in Step 1 on page 11-26.

5. See the following section based on the native format and translator you selected:

Native Format and Translator	See Section
XSD	"Providing XSD Details" on page 11-30
Token Substituted Text	"Providing Token Substituted Text Details" on page 11-31
D3L	"Providing D3L Details" on page 11-32

Providing XSD Details Provide responses to the following questions.

1. Enter the following details to create an event body element. For example, the following questions can display if you selected the XSD translator in Step 1 on page 11-26. You may also not be prompted for any questions. An asterisk (*) indicates a required field.

Field	Description
Preserve Namespaces for Native Instances *	<ul style="list-style-type: none"> ■ Select Yes when a party expects an XML document with namespaces. Note: Yes is the default selection. If you specify Yes and your XML document does <i>not</i> have namespaces, no error occurs. This is because there were no namespaces to preserve. This action is essentially the same as specifying No. ■ Select No if your XSD does not have namespaces. ■ Select No when a party expects an XML document without namespaces even if the XSD includes namespaces in it. If you select No and your XSD has namespaces, native event validation must not be enabled. Note: If you want to enable native event validation, use a separate DTD or use an XSD without namespaces.
DocType for Native Instances *	<p>Select one of the following:</p> <ul style="list-style-type: none"> ■ SYSTEM Causes Oracle Application Server ProcessConnect to look for a private DTD at a system location that you specify in Step 4. ■ PUBLIC Causes Oracle Application Server ProcessConnect to look for a private DTD in a public location that you specify in Step 4. ■ XMLSchema Uses an XSD that you specify in Step 4.

Note: Additional questions can appear based on your selections.

2. Click **Next**.

The Create Event Body Element : *record_type* page refreshes to display additional questions based on your selection in the **DocType for Native Instances** list in Step 1.

3. Go to the **Translator Properties** section of the page.
4. Provide answers to the following questions.

If You Selected...	Then...
SYSTEM	<ol style="list-style-type: none"> 1. Enter a private DTD in a system location in the DTD System Location field. For example, entering <code>subjects.dtd</code> results in <code><!DOCTYPE document SYSTEM "subjects.dtd"></code>.
PUBLIC	<ol style="list-style-type: none"> 1. Enter a private DTD in a public location in the DTD Public Location field. For example, <code>-//W3C//DTD HTML 4.0 Transitional//EN</code> 2. Enter a URI in the DTD Public URI field. For example, <code>http://www.w3.org/TR/REC-html40/loose.dtd</code> This results in <code><!DOCTYPE HTML PUBLIC "-//W3C//DTD HTML 4.0 Transitional//EN" "http://www.w3.org/TR/REC-html40/loose.dtd"></code>
XMLSchema	<ol style="list-style-type: none"> 1. Enter the XSD in the XML Schema Location field.

5. Click **Next**.
6. Repeat these steps for any remaining record types for which you are prompted.
7. Go to the ["Review the Create Native Event Type Details"](#) on page 11-32.

Providing Token Substituted Text Details Provide responses to the following questions.

1. Enter the following details to create an event body element. The following questions display if you selected the Token Substituted Text translator in Step 1 on page 11-26. An asterisk (*) indicates a required field.
2. Enter a namespace in the **Namespace for Application Type to be Created** field. This can be a new or existing namespace.
3. Click **Next**.
4. Go to the ["Review the Create Native Event Type Details"](#) on page 11-32.

Providing D3L Details Provide responses to the following questions.

1. Enter the following details to create an event body element. The following questions display if you selected the D3L translator in Step 1 on page 11-26. An asterisk (*) indicates a required field.
2. Enter a namespace in the **Namespace for Application Datatype to be created** field. This can be a new or existing namespace.
3. Click Browse to select additional D3L definition files for the **Additional D3L Definitions** field. Use this field to provide the name of a `definitions` D3L file, which contains importable definitions that can be referenced (and thus not defined in) the `main message` D3L file.
4. Click **Next**.
5. Go to the "[Review the Create Native Event Type Details](#)" on page 11-32.

See Also: "[Additional D3L Sample Files and DTD](#)" on page A-90 for details about both types of D3L files

Review the Create Native Event Type Details

The Create Native Event Type: Review page appears when all body elements have been created. For example, the following page displays if you selected a JMS adapter interaction. Note that three event body elements (**JmsProperties**, **JmsHeaders**, and **Payload**) are to be created. **Payload** contains the native datatypes. For this example, the JMS adapter supplies the native format definitions (XSDs in this case) for the Oracle record elements `JmsHeaders` and `JmsProperties`.

Create Native Event Type: Review

Cancel Back Step 5 of 5

Please review the native event type details and choose Finish to create the native event type.

Native Event Type

Native Event Type **NE_JMS**
Record Type **SEND.QUEUE_Text_Record**

Event Body Elements

JmsProperties

Translator Properties :

Preserve Namespaces for Native Instances **Yes**
Doctype for Native Instances **None**

JmsHeaders

Translator Properties :

Preserve Namespaces for Native Instances **Yes**
Doctype for Native Instances **None**

Payload

Native Datatype

Name **SEND.QUEUE_JmsProperties**

Translator Properties :

Preserve Namespaces for Native Instances **Yes**
Doctype for Native Instances **None**

1. Review your selections or click **Back** on the wizard to make changes. Do not click **Back** on your browser.
2. Click **Finish** to specify a translator and create the native event, application event, and native and application event body elements.

When complete, the Native Event Types page appears.

- The native event type name you specified in Step 1 on page 11-27 appears in the **Name** column of the Native Event Types page.

- a. Click the name to display the Native Event Type Details page. The details page displays the event body elements that you created in previous steps.

Native Event Type Details : NE_JMS

Details

Name **NE_JMS**
 Application Event **NE_JMS**
 Record Type **SEND.QUEUE.Text.Record**
 Description

Event Map

Condition **Unspecified**

Event Body Elements

Name	Record Type Element
JmsHeaders	JmsHeaders
JmsProperties	JmsProperties
Payload	Payload

- The application event name displays next to **Application Event** in the **Details** section of the Native Event Type Details page.
 - a. Click the name to display the Application Event Type Details page.
 - b. Click **Expand All** in the **Event Body Elements** section to display the application datatypes that were derived from the native format definition file (for example, an XSD or D3L file).
- The record type displays next to **Record Type** in the **Details** section.
 - a. Click the name to display each record type element. Corresponding native event and application event body elements were created from these record elements.

See Also:

- ["Modeling Metadata Design"](#) on page 3-15 for conceptual details about Oracle records, native event types, application event types, and event body elements
- ["Creating a Native Event Type"](#) on page 11-40 if you deselected the **Create Native Event Type** box in Step 1 on page 11-25 that starts a wizard to create a native event, application event, and event body elements
- [Appendix A, "Native Formats and Translators"](#) for additional details about the XSD, D3L, and token substituted text native formats described briefly in Step 1 on page 11-26

Deleting an Adapter Interaction

If an adapter interaction is part of an integration designed up through the business process, then attempting to delete the adapter interaction before deleting other modeling metadata results in error messages appearing. Ensure that you delete the modeling metadata in the following order:

1. Delete the event transformation maps.
2. Delete the business event.
3. Delete the translation and transformation binding roles. If you created your modeling metadata with the modeling wizards, these roles are named after the role naming convention you specified when prompted. For example, if you entered **notification** as the role naming convention, the translation role is named **notification-TL** and the transformation role is named **notification-TX**.
4. Delete the native event.
5. Delete the native role.
6. Delete the interaction.

Follow these instructions to delete an adapter interaction:

To delete an adapter interaction:

1. Ensure that you followed the instructions in ["Accessing Adapter Interaction Management Tasks"](#) on page 11-6 to access the page for deleting an adapter interaction.

2. Click **Yes** when prompted to delete an adapter interaction.

The adapter interaction is deleted and the Interactions page appears.

Viewing an Adapter Interaction

Follow these instructions to view an adapter interaction:

To view an adapter interaction:

1. Ensure that you followed the instructions in "[Accessing Adapter Interaction Management Tasks](#)" on page 11-6 to access the page for viewing an adapter interaction.

The Interaction Details page for the selected adapter interaction appears.

Interaction Details : Consume a message

Delete

Details

Name	Consume a message
Adapter Exchange Protocol	TextMessage Payload
Group Name	Consume
Is Inbound	True
In Record Type	SEND.QUEUE.Text.Record

Interaction Parameters

Parameter	Value
PayloadType	1
UseMessageListener	No
DestinationName	SEND.QUEUE

2. View specific details, including the direction and adapter exchange protocol selected. The **Group Name** that appears is the interaction group that displayed in the expanded list when you originally added the adapter interaction in Step 5 on page 11-8.

This page, as with the Interactions page shown in [Figure 11-1](#) on page 11-4, enables you to delete the selected adapter interaction.

3. Click the record type name next to **Record Type** to display the Record Type Details page. From this page, you can:
 - Create a native event to use with this adapter interaction and record type
 - Delete a native event type

See Also:

- "Creating a Native Event Type" on page 11-40
- "Deleting a Native Event Type" on page 11-42

Managing Native Event Types

The Oracle Application Server ProcessConnect user interface tool enables you to perform the native event type management tasks shown in [Figure 11-3](#) and [Figure 11-4](#). These tasks are described in detail in this section. A native event is created from an adapter interaction. A native event is the Oracle Application Server ProcessConnect internal implementation of the business data contained in an Oracle record. The body elements of the native event contain the various sections of the wire message, such as payloads, headers, or attachments. The representation of the wire message content is unchanged.

Figure 11-3 Native Event Type Management Tasks (Part 1 of 2)

Native Event Types

Native Event Types

Create

Name	Delete
ApproveOrder	
Exception	
FailureNotification	
PurchaseOrderConfirmation	
PurchaseOrderStatusNotification	
ReceiptAcknowledgment	
RequestPurchaseOrder	
ServiceRequest	
supplierpo	

Correlations

[Return to Top](#)

Create

Correlating Native Event Type	Correlated Native Event Type	Details	Update	Delete
ReceiptAcknowledgment	RequestPurchaseOrder			
ReceiptAcknowledgment	PurchaseOrderConfirmation			
ReceiptAcknowledgment	PurchaseOrderStatusNotification			
ReceiptAcknowledgment	FailureNotification			

Selecting a native event type in the **Name** column of the **Native Event Types** section causes a details page such as that shown in [Figure 11-4](#) to appear.

Figure 11-4 Native Event Type Management Tasks (Part 2 of 2)

[Native Event Type Details : Exception](#)

Details

Name	Exception
Application Event	Exception
Record Type	Exception
Description	NativeEventType for Exception

Event Map

Condition **Unspecified**

Event Body Elements

Name	Record Type Element
Attachment	Attachment
Header	Header
Service Content	Service Content

[Table 11-3](#) identifies the native event type management tasks shown in [Figure 11-3](#) and [Figure 11-4](#) and provides references to procedures for performing these tasks.

Table 11-3 Native Event Type Management Tasks

Page Elements	Management Task	First See Section...	Then See Section...
Create button in Native Event Types page of Figure 11-3	Create a native event type	"Accessing Native Event Type Management Tasks" on page 11-39	"Creating a Native Event Type" on page 11-40
Delete column in Native Event Types page of Figure 11-3	Delete a native event type		"Deleting a Native Event Type" on page 11-42
Name column in Native Event Types page of Figure 11-3	View a native event type		"Viewing a Native Event Type" on page 11-42

Table 11-3 (Cont.) Native Event Type Management Tasks

Page Elements	Management Task	First See Section...	Then See Section...
Record Type Elements column in Native Event Type Details page of Figure 11-4	View a record type element	"Accessing Native Event Type Management Tasks" on page 11-39	"Viewing a Record Type Element" on page 11-43
Event Body Elements column in Native Event Type Details page of Figure 11-4	View an event body element		"Viewing an Event Body Element" on page 11-44
Event Body Elements column in Native Event Type Details page of Figure 11-4	Add event body element validation		"Adding Native Event Body Element Validation" on page 11-45

See Also: ["Native Events"](#) on page 3-20 for additional conceptual details

Accessing Native Event Type Management Tasks

Follow these instructions to access the native event type management tasks shown in [Figure 11-3](#) on page 11-37 and [Figure 11-4](#) on page 11-38:

To access native event type management tasks:

1. Select the **Modeling** tab.
2. Select the **Event Types** tab.
3. Select **Native Event Types**.

The Native Event Types page appears. (See [Figure 11-3](#) on page 11-37.)

4. Select a task to perform and see the referenced section for instructions:

To...	Then...	See Section...
Create a native event type	Click Create .	"Creating a Native Event Type" on page 11-40
Delete a native event type	Select a specific native event type in the Delete column.	"Deleting a Native Event Type" on page 11-42
View a native event type	Select a specific native event type in the Name column.	"Viewing a Native Event Type" on page 11-42
View a record type element	Select a specific native event type in the Name column.	"Viewing a Record Type Element" on page 11-43
View an event body element	Select a specific native event type in the Name column.	"Viewing an Event Body Element" on page 11-44
Add event body element validation	Select a specific native event type in the Name column for which to validate an event body element.	"Adding Native Event Body Element Validation" on page 11-45

Creating a Native Event Type

Follow these instructions to create a native event type to which to assign an existing adapter interaction and translator. During native event type creation, you also create an application event, and create native and application event body elements for the various sections of the wire message, such as header details, attachments, and service content (payload data).

Note: Follow these instructions if you want to use an existing adapter interaction and record type with this native event. If the adapter interaction to use with this native event does not exist, you must first add the adapter interaction. See ["Adding an Adapter Interaction"](#) on page 11-7 for instructions.

To create a native event type:

1. Ensure that you followed the instructions in "[Accessing Native Event Type Management Tasks](#)" on page 11-39 to access the page for creating a native event type.

The Create Native Event Type page appears. This is the first page of a wizard that enables you to create a native event type, specify a translator, create an application event type, and create native and application event body elements for the various sections of the wire message (such as the payload, header, and attachment).

2. Enter the following details to create a native event type. An asterisk (*) indicates a required field.

Field	Description
Name *	Enter a unique and recognizable name for the native event type.
Interaction *	Select an adapter interaction to associate with this native event (for example, an interaction named PurchaseOrderConfirmation or an interaction that retrieves a text file from an HTTP server). You added this interaction and specified a translator in " Adding an Adapter Interaction " on page 11-7.
Record Type *	The page refreshes to display the record type associated with the selected adapter interaction (for example, record type PurchaseOrderConfirmation if that was your selection from the Interaction list). The record type name is part of the interaction name (it displays in the brackets). For example, for the Advanced Queuing adapter, the following can display: Interaction Dequeue from AQ_EXPENSE(AQ_ECXMSG_Record) - Inbound Record Type AQ_ECXMSG_Record

3. Click **Next**.

The Create Event Body Element : *record_type* page appears, where *record_type* is the record type in the native format.

4. See Step 2 of "[Creating Native and Application Event Types and Body Elements](#)" on page 11-27 to create a native event, an application event, and body elements for the various sections of the native format (wire) message, such as header details, attachments, and payload data (service content).

Deleting a Native Event Type

If a native event type is part of an integration designed up through the business process, then attempting to delete the native event type before deleting other modeling metadata results in error messages appearing. Ensure that you delete the modeling metadata in the following order:

1. Delete the event transformation maps.
2. Delete the business event.
3. Delete the translation and transformation binding roles.
4. Delete the native event.
5. Delete the native role.

Follow these instructions to delete a native event type:

Caution: All event body elements of the selected native event type are also deleted.

To delete a native event type:

1. Follow the instructions in "[Accessing Native Event Type Management Tasks](#)" on page 11-39 to access the page for deleting a native event type.
2. Click **Yes** when prompted to delete a native event type.

The native event type is deleted and the Native Event Types page appears.

Viewing a Native Event Type

Follow these instructions to view details about a specific native event type:

To view a native event type:

1. Ensure that you followed the instructions in "[Accessing Native Event Type Management Tasks](#)" on page 11-39 to access the page for viewing a native event type.

The Native Event Type Details page for the selected native event type appears.

Native Event Type Details : Exception

Details

Name	Exception
Application Event	Exception
Record Type	Exception
Description	NativeEventType for Exception

Event Map

Condition **Unspecified**

Event Body Elements

Name	Record Type Element
Attachment	Attachment
Header	Header
Service Content	Service Content

- View specific details, including the event body elements and their corresponding Oracle record types. Note that no native datatypes appear in these event body elements. This is because Oracle Application Server ProcessConnect does not understand native datatypes.
- If you click the name next to **Record Type** in the **Details** section, you access a page that lists the record type elements and native event types for this record type.

This page, as with the Native Event Types page shown in [Figure 11-3](#) on page 11-37, enables you to delete the selected native event type.

- Click **Return to List** to return to the Native Event Types page.

Viewing a Record Type Element

Native events are created from record types. Follow these instructions to view details about a specific record type element:

To view a record type element:

- Ensure that you followed the instructions in "[Accessing Native Event Type Management Tasks](#)" on page 11-39 to access the page for viewing a record type element.

The Native Event Type Details page appears. (See [Figure 11-4](#) on page 11-38.)

2. Go to the **Event Body Elements** section.
3. Click a specific record type element in the **Record Type Element** column.

The Record Type Element Details page for the selected record type element appears.

[Record Type Element Details: Service Content](#)

Details	
Name	Service Content
Native Format	XSD
Extractor	XSD
Description	RecordTypeElement for Service Content

4. View specific details, such as the name, native format of the record type, and the extractor associated with this record type.
5. Click **Return to List** to return to the Native Event Type Details page.

See Also: ["Create and View the Native and Application Events and Body Elements"](#) on page 8-6 for additional details about record types

Viewing an Event Body Element

Follow these instructions to view details about a specific event body element:

To view an event body element:

1. Ensure that you followed the instructions in ["Accessing Native Event Type Management Tasks"](#) on page 11-39 to access the page for viewing an event body element.

The Native Event Type Details page appears. (See [Figure 11-4](#) on page 11-38.)

2. Go to the **Event Body Elements** section.
3. Click a specific event body element in the **Name** column.

The Event Body Element Details page for the selected event body element appears.

Event Body Element Details : Attachment

Validate

Details

Name **Attachment**

Description

Validations

Update

Name	Revision
(No validations found.)	

4. View specific details.
5. Click **Return to List** to return to the Native Event Type Details page.

Adding Native Event Body Element Validation

Follow these instructions to add validation to a native event body element. This ensures that the native event body element is validated when it is invoked at runtime when a wire message is received. If validation fails, the native event is not translated into an application event, and an error message displays onscreen.

To add native event body element validation:

1. Ensure that you followed the instructions in "[Accessing Native Event Type Management Tasks](#)" on page 11-39 to access the page for adding native event body element validation.

The Native Event Type Details page appears. (See [Figure 11-4](#) on page 11-38.)

2. Go to the **Event Body Elements** section.
3. Click a specific native event body element in the **Name** column.

The Event Body Element Details page for the selected event body element appears.

4. Go to the **Validations** section.

Click **Update**.

The Specify Validation for Native Event Body Element page appears.

5. Select the validation to assign to the event body element from the **Available Validations** list (for example, **XSD**).
6. Use the > arrow to add the validation to the **Selected Validations** list.
7. Click **Apply**.

The Event Body Element Details page for the selected event body element now displays the added validation and revision number.

See Also: "[Native Event Validation](#)" on page 3-22 for additional conceptual details

Managing Native Event Correlations

The Oracle Application Server ProcessConnect user interface tool enables you to perform the native event correlation management tasks shown in [Figure 11-5](#). These tasks are described in detail in this section.

Figure 11-5 Native Event Correlation Management Tasks

Native Event Types

Native Event Types

[Create](#)

Name	Delete
Exception	
FailureNotification	
PurchaseOrderConfirmation	
PurchaseOrderStatusNotification	
ReceiptAcknowledgment	
RequestPurchaseOrder	
ims_consume_expense_ET	

Correlations

[Return to Top](#)

[Create](#)

Correlating Native Event Type	Correlated Native Event Type	Details	Update	Delete
ReceiptAcknowledgment	RequestPurchaseOrder			
ReceiptAcknowledgment	PurchaseOrderConfirmation			
ReceiptAcknowledgment	PurchaseOrderStatusNotification			
ReceiptAcknowledgment	FailureNotification			
Exception	RequestPurchaseOrder			
Exception	PurchaseOrderConfirmation			
Exception	PurchaseOrderStatusNotification			
Exception	FailureNotification			

Correlation Details : ReceiptAcknowledgment->RequestPurchaseOrder

Details

Correlating Native Event Type **ReceiptAcknowledgment**
 Correlated Native Event Type **RequestPurchaseOrder**
 Directional **True**
 Condition **Header/inReplyTo/MessageID = Header/MessageID**
 State **Draft**

Native event correlation is an expression that defines when two native event instances are related; for example, a correlating (initiating) native event purchase order request (NE_PO in [Figure 11-6](#)) and a correlated (target) native event purchase order acknowledgment (NE_POA in [Figure 11-6](#)). Native event correlation ensures that the correct native event instances are matched and provided to the corresponding native role instances.

Figure 11-6 *Native Event Correlation*

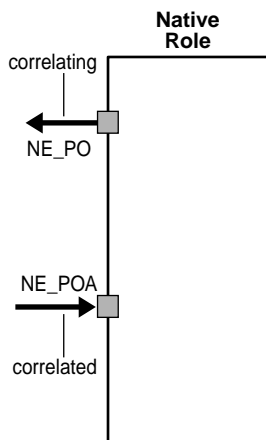

Table 11-4 identifies the native event correlation management tasks shown in Figure 11-5 and provides references to procedures for performing these tasks.

Table 11-4 Native Event Correlation Management Tasks

Page Elements	Management Task	First See Section...	Then See Section...
Create button in Correlations section of Native Event Types page in Figure 11-5	Create a native event correlation	"Accessing Native Event Correlation Management Tasks" on page 11-49	"Creating a Native Event Correlation" on page 11-50
Delete column in Correlations section of Native Event Types page in Figure 11-5	Delete a native event correlation		"Deleting a Native Event Correlation" on page 11-52
Update column in Correlations section of Native Event Types page in Figure 11-5	Update a native event correlation		"Updating a Native Event Correlation" on page 11-52
Details column in Correlations section of Native Event Types page in Figure 11-5	View a native event correlation		"Viewing a Native Event Correlation" on page 11-53

See Also: "Native Event Correlation" on page 3-26 for additional conceptual details

Accessing Native Event Correlation Management Tasks

Follow these instructions to access the native event correlation management tasks shown in Figure 11-5 on page 11-47:

To access native event correlation management tasks:

1. Select the **Modeling** tab.
2. Select the **Event Types** tab.
3. Select **Native Event Types**.

The Native Event Types page appears. (See the upper page of Figure 11-5 on page 11-47.)

4. Go to the **Correlations** section.

5. Select a task to perform and see the referenced section for instructions:

To...	Then...	See Section...
Create a native event correlation	Click Create .	"Creating a Native Event Correlation" on page 11-50
Delete a native event correlation	Select a specific native event correlation in the Delete column.	"Deleting a Native Event Correlation" on page 11-52
Update a native event correlation	Select a specific native event correlation in the Update column.	"Updating a Native Event Correlation" on page 11-52
View a native event correlation	Select a specific native event correlation in the Details column.	"Viewing a Native Event Correlation" on page 11-53

Creating a Native Event Correlation

Follow these instructions to create a native event correlation:

To create a native event correlation:

1. Ensure that you followed the instructions in ["Accessing Native Event Correlation Management Tasks"](#) on page 11-49 to access the page for creating a native event correlation.

The Create Correlation: Native Event Types page appears.

2. Enter the following details to create a native event correlation. An asterisk (*) indicates a required field.

Field	Description
Correlating Native Event Type *	Select a correlating (initiating) native event by clicking the flashlight (for example, RequestPurchaseOrder).
Correlated Native Event Type *	Select a correlated (target) native event by clicking the flashlight (for example, PurchaseOrderConfirmation).
Directional	Select Unspecified , False , or True . If True is selected, then correlation is applied only to the correlating (initiating) native event type (for example, RequestPurchaseOrder). You then need to select a correlating native event type for RequestPurchaseOrder, which now becomes the correlated (target) event type.

3. Click **Next**.
The Create Correlation: Correlation Condition appears.
4. Select **Condition expression not specified**.
5. Click **Update** to create a new native event correlation.
The Create Condition Expression page appears.

Create Condition Expression

Cancel Apply

Select the correlating event type item, the operator, and select the correlated event type item and select Apply.
* Indicates required field

Correlating Native Event Type

Expand All | Collapse All

⊕ Event Body Elements

Select	Focus Name	Type
<input type="radio"/>	Event Body Elements	
<input type="radio"/>	▶ Service Content	ReceiptAcknowledgment
<input type="radio"/>	▶ Header	IpCorrelationHeader
<input type="radio"/>	▶ Attachment	B2BAttachment

Operator

* Unspecified ▼

Correlated Native Event Type

Expand All | Collapse All

⊕ Event Body Elements

Select	Focus Name	Type
<input type="radio"/>	Event Body Elements	
<input type="radio"/>	▶ Service Content	Pip3A4PurchaseOrderRequest
<input type="radio"/>	▶ Header	IpCorrelationHeader
<input type="radio"/>	▶ Attachment	B2BAttachment

6. Click **Expand All** for both columns to display all elements or select an individual section such as **Service Content** (the data payload) to display only those elements.
7. Select the left correlating operand (the initiating native event) from the **Correlating Native Event Type** section (for example, **ReceiptAcknowledgment**).
8. Select the right correlated operand (the target native event) from the **Correlated Native Event Type** section (for example, **RequestPurchaseOrder**).
9. Select the = (equal) operator from the **Operator** list.
10. Click **Apply**.
The created native event correlation condition displays in the Create Correlation : Correlation Condition page.
11. Click **Apply**.
The Correlation Details page describes details about the new native event correlation.

[Correlation Details : ReceiptAcknowledgment->RequestPurchaseOrder](#)

Details

Correlating Native Event Type	ReceiptAcknowledgment
Correlated Native Event Type	RequestPurchaseOrder
Directional	True
Condition	Header.inReplyTo/MessageID = Header.MessageID
State	Draft

12. Click **Return to List** to return to the Native Event Types page.

Deleting a Native Event Correlation

Follow these instructions to delete a native event correlation:

To delete a native event correlation:

1. Follow the instructions in "[Accessing Native Event Correlation Management Tasks](#)" on page 11-49 to access the page for deleting a native event correlation.
2. Click **Yes** when prompted to delete a native event correlation.

The native event correlation is deleted and the Native Event Types page appears.

Updating a Native Event Correlation

Follow these instructions to update a native event correlation:

To update a native event correlation:

1. Follow the instructions in "[Accessing Native Event Correlation Management Tasks](#)" on page 11-49 to access the page for updating a native event correlation.

The Update Correlation: Native Event Types page appears.

2. Select the condition expression to update.
3. Click **Update**.

The Update Correlation: Correlation Condition page appears.

4. Update your selection from the **Directional** list. (See Step 2 on page 11-50 for a list of fields you can update.)
5. Click **Next**.

The Update Correlation: Correlation Condition page appears.

6. Click **Update** to update the condition expression.
The Update Condition Expression page appears.
7. Make appropriate changes.
8. Click **Apply**.
The native event correlation is updated and the Update Correlation: Correlation Condition page appears.

Viewing a Native Event Correlation

Follow these instructions to view details about a specific native event correlation:

To view a native event correlation:

1. Ensure that you followed the instructions in "[Accessing Native Event Correlation Management Tasks](#)" on page 11-49 to access the page for viewing a native event correlation.

The Native Event Correlation Details page for the selected native event correlation appears.

[Correlation Details : ReceiptAcknowledgment->RequestPurchaseOrder](#)

Details

Correlating Native Event Type	ReceiptAcknowledgment
Correlated Native Event Type	RequestPurchaseOrder
Directional	True
Condition	Header.inReplyTo/MessageID = Header.MessageID
State	Draft

2. View specific details, including the condition that must be satisfied to correlate the two native events.
This page, as with the Native Event Types page shown in [Figure 11-5](#) on page 11-47, enables you to delete or update the selected native event correlation.
3. Click **Return to List** to return to the Native Event Types page.

Managing Event Maps

The Oracle Application Server ProcessConnect user interface tool enables you to perform the event map management tasks shown in [Figure 11-7](#). These tasks are described in detail in this section.

Figure 11-7 Event Map Management Tasks

Native Event Type Details : Exception

Details

Name	Exception
Application Event	Exception
Record Type	Exception
Description	NativeEventType for Exception

Event Map

Condition **Unspecified**

Event Body Elements

Name	Record Type Element
Attachment	Attachment
Header	Header
Service Content	Service Content

Native Event Type Details : Exception

Details

Name	Exception
Application Event	Exception
Record Type	Exception
Description	NativeEventType for Exception

Event Map

Condition **Attachment/Attachment/ID = 2.0**

Event Body Elements

Name	Record Type Element
Attachment	Attachment
Header	Header
Service Content	Service Content

The purpose of an event map is to select a native event type from a record at runtime when there are multiple possible native event types for the record. If there is one native event type for the record, then no event map condition expression is required. If there are multiple native events for a record, then an event map must be defined for each native event. It must be ensured that the event maps for a given record are mutually exclusive so that the correct native event type is chosen. If you do not want a native event to be used or the event type is only used for outbound interactions, then you can define an event map to always evaluate to false (for example, checking for a value that can never exist in the message).

Figure 11–8 provides an example of a single Oracle record with two native event types.

Figure 11–8 Event Mapping

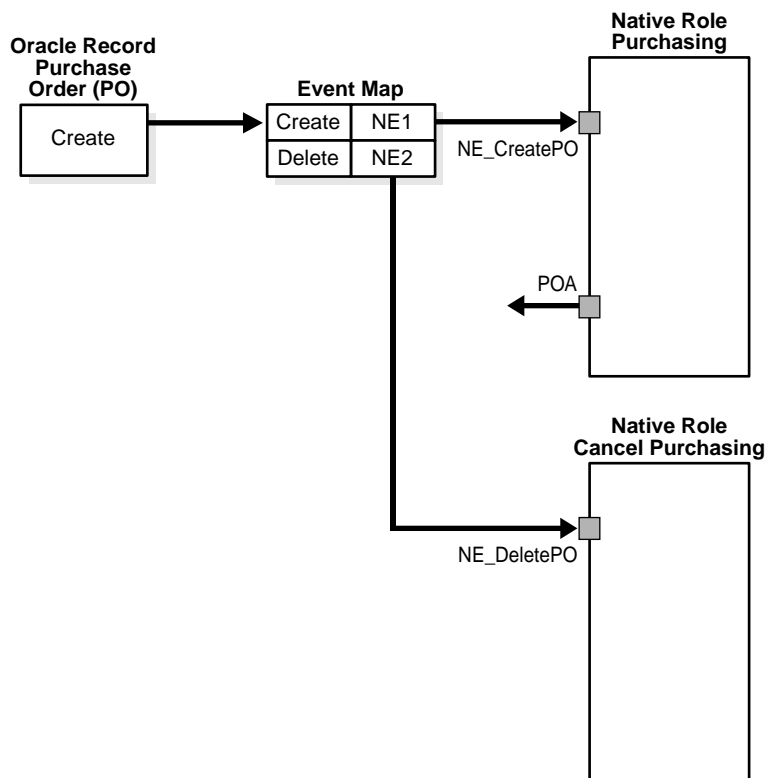

Table 11-5 identifies the event map management tasks shown in Figure 11-7 on page 11-54 and provides references to procedures for performing these tasks.

Table 11-5 Event Map Management Tasks

Native Event Type Details Page Elements	Management Task	First See Section...	Then See Section...
Create button in Event Map section in upper page of Figure 11-7	Create an event map	"Accessing Event Map Management Tasks" on page 11-56	"Creating an Event Map" on page 11-57
Delete button in Event Map section in lower page of Figure 11-7	Delete an event map		"Deleting an Event Map" on page 11-58
Update button in Event Map section in lower page of Figure 11-7	Update an event map		"Updating an Event Map" on page 11-59
Event Map section in lower page of Figure 11-7	View an event map		"Viewing an Event Map" on page 11-59

See Also: "Event Maps" on page 3-26 for additional conceptual details

Accessing Event Map Management Tasks

Follow these instructions to access the event map management tasks shown in Figure 11-7 on page 11-54:

To access event map management tasks:

1. Select the **Modeling** tab.
2. Select the **Event Types** tab.
3. Select **Native Event Types**.

The Native Event Types page appears. (See Figure 11-5 on page 11-47.)

4. Select a specific native event type in the **Name** column.

The Native Event Type Details page appears. (See the upper page of Figure 11-7 on page 11-54.)

5. Go to the **Event Map** section.

6. Select a task to perform and see the referenced section for instructions:

To...	Then...	See Section...
Create an event map	Click Create . This button only displays if there are no event maps.	"Creating an Event Map" on page 11-57
Delete an event map	Click Delete . This button only displays if event maps currently exist.	"Deleting an Event Map" on page 11-58
Update an event map	Click Update . This button only displays if event maps currently exist.	"Updating an Event Map" on page 11-59
View an event map	View the details to the left of the Delete button.	"Viewing an Event Map" on page 11-59

Creating an Event Map

Follow these instructions to create an event map:

To create an event map:

1. Ensure that you followed the instructions in ["Accessing Event Map Management Tasks"](#) on page 11-56 to access the page for creating an event map.
The Create Event Map page appears.
2. Select **Condition expression not specified**.
3. Click **Update** to create a new event map.
The Create Condition Expression page appears.
4. Select an operator from the **Operator** list.
5. Perform the following steps based on the operator you selected.

If You Selected...	Then...
=	<ol style="list-style-type: none"> 1. Click Expand All in the Native Event Type section to display all event body elements for this native event type. 2. Select an element from the Native Event Type section. 3. Enter a value in the Constant Value field.

If You Selected...	Then...
Exists	<ol style="list-style-type: none"> 1. Click Expand All in the Native Event Type section to display all event body elements for this native event type. 2. Select an event body element in the Native Event Type section. For XML, this causes a check for any element present in the XSD to occur.

6. Click **Apply**.

The Create Event Map page displays the new event map.

7. Click **Apply**.

The Native Event Type Details page describes details about the native event type, its event body elements, and its new event map.

Native Event Type Details : Exception

Details

Name	Exception
Application Event	Exception
Record Type	Exception
Description	NativeEventType for Exception

Event Map

Condition **Attachment/AttachmentID = 2.0**

Event Body Elements

Name	Record Type Element
Attachment	Attachment
Header	Header
Service Content	Service Content

8. Click **Return to List** to return to the Native Event Types page.

Deleting an Event Map

Follow these instructions to delete an event map:

To delete an event map:

1. Follow the instructions in "[Accessing Event Map Management Tasks](#)" on page 11-56 to access the page for deleting an event map.

2. Click **Yes** when prompted to delete an event map.
The event map is deleted and the Native Event Type Details page appears.

Updating an Event Map

Follow these instructions to update an event map:

To update an event map:

1. Follow the instructions in "[Accessing Event Map Management Tasks](#)" on page 11-56 to access the page for updating an event map.

The Update Event Map page appears.

2. Select the condition expression to update.
3. Click **Update**.
The Update Condition Expression page appears.
4. Make appropriate changes.
5. Click **Apply**.

The event map is updated and the Native Event Type Details page appears.

Viewing an Event Map

Follow these instructions to view details about a specific event map:

To view an event map:

1. Ensure that you followed the instructions in "[Accessing Event Map Management Tasks](#)" on page 11-56 to access the page for viewing an event map.

Event map details display to the left of the **Update** button. For example, the event map shown in the lower page of [Figure 11-7](#) on page 11-54 shows a constant value of 2.0 assigned to the **Attachment/ID** element of the **Attachment** event body element.

Viewing Application Event Types

The Oracle Application Server ProcessConnect user interface tool enables you to view application event types. Application event types cannot be deleted or updated. Application event types are automatically created in the inbound or outbound direction when you add an adapter interaction or create a native event. For Oracle Application Server ProcessConnect to process the contents of native event body elements, the contents must be re-represented in an interpretable syntactic format. This interpretable format is called the application format. After the native event is represented as the corresponding application event, Oracle Application Server ProcessConnect can make decisions based on it, or transform it. For the outbound direction, application event types are transformed from business event types.















Follow these instructions to view application events:

To view application events:

1. Select the **Modeling** tab.
2. Select the **Event Types** tab.
3. Select **Application Event Types**.

The Application Event Types page displays the available application events.

Application Event Types

Name	Update	Delete
Exception		
FailureNotification		
PurchaseOrderConfirmation		
PurchaseOrderStatusNotification		
ReceiptAcknowledgment		
RequestPurchaseOrder		
ims consume expense ET		

Shortcuts

[Add Interaction](#)
[Import Datatype](#)
[Create Event Transformation Map](#)
[Event Transformation Maps](#)

4. Click a specific application event type in the **Name** column.
The details page for the selected application event type appears.
5. Go to the **Event Body Elements** section.
6. Click **Expand All** to expand all event body elements or select a specific event body element to expand.

Application Event Type Details : jms_consume_expense_ET

Delete Update

Details

Name **jms_consume_expense_ET**

Description

State **Draft**

Event Body Elements

[Return to Top](#)

Create

Expand All | Collapse All

Event Body Elements

Focus Name	Type	Datatype	Cardinality	Update	Delete
Event Body Elements					
▼ JmsHeaders		JmsHeaderType			
JMSCorrelationID	Scalar	string			
JMSDeliveryMode	Scalar	integer			
JMSExpiration	Scalar	long			
JMSMessageID	Scalar	string			
JMSPriority	Scalar	integer			
JMSRedelivered	Scalar	boolean			
JMSType	Scalar	string			
JMSTimestamp	Scalar	long			
▼ Payload		expense_type			
▼ employee	Compound	employee_type	[1, 1]		
name	Scalar	string			
▼ manager	Compound	manager_type	[1, 1]		
name	Scalar	string			
id	Scalar	integer			
id	Scalar	integer			
costcenter	Scalar	string			
purpose	Scalar	string			
▼ lineitem	Compound	lineitem_type	[1, 1]		
date	Scalar	date			
amount	Scalar	double			
currency	Scalar	string			
type	Scalar	string			
justification	Scalar	string			
expensegroup	Scalar	string			
receiptmissing	Scalar	boolean			
status	Scalar	string			
id	Scalar	integer			
▼ JmsProperties		JmsPropertiesType			

- View specific details. The application event datatype details for the event body elements named **JmsHeaders** and **Payload** are expanded; for example, scalar or compound for the type and string or double for the datatype).

Application events contain no native formats. The particular native format of the expense application cannot be identified, and any specific syntactic properties have been removed.

See Also:

- ["Managing Adapter Interactions"](#) on page 11-4 (available from the **Shortcuts** section)
- ["Importing XSD Datatypes"](#) on page 10-51 (available from the **Shortcuts** section)
- ["Managing Event Type Transformation Maps"](#) on page 13-5 (available from the **Shortcuts** section)
- ["Creating a Native Event Type"](#) on page 11-40
- ["Application Events and Translation"](#) on page 3-30 for additional conceptual details

Managing Business Event Types

The Oracle Application Server ProcessConnect user interface tool enables you to perform the business event type management tasks shown in [Figure 11-9](#). These tasks are described in detail in this section. A business event establishes a common event structure and vocabulary across all parties. Business events are completely removed from any party-specific properties, including data structure and vocabulary. All related events from all parties follow the same structure and the same vocabulary once they are translated and transformed into business events. The event body element of the business event contains a complete set of business data. You create an event body element inside a business event that contains the business event datatypes used by all parties in an integration. The business event type can be viewed as a superset of all the corresponding party-specific application datatypes.

Figure 11-9 Business Event Type Management Tasks

Business Event Types Create

Name	Update	Delete
jms_consume_expense_ET		

Shortcuts

- [Add Interaction](#)
- [Import Datatype](#)
- [Create Event Transformation Map](#)
- [Event Transformation Maps](#)

Business Event Type Details : [jms_consume_expense_ET](#)

Delete Update

Details

Name **jms_consume_expense_ET**

Description

State **Draft**

Event Body Elements [Return to Top](#)

Create

[Expand All](#) | [Collapse All](#)

Event Body Elements						
Focus	Name	Type	Datatype	Cardinality	Update	Delete
▼	Event Body Elements					
⊕	▶ Payload		notification_type			

Table 11-6 identifies the business event type management tasks shown in Figure 11-9 and provides references to procedures for performing these tasks.

Table 11-6 Business Event Type Management Tasks

Business Event Types Page Elements	Management Task	First See Section...	Then See Section...
Shortcuts section in Business Event Types page of Figure 11-9	Take shortcuts to add an adapter interaction, import datatypes, and manage transformations	N/A	<ul style="list-style-type: none"> ▪ "Adding an Adapter Interaction" on page 11-7 ▪ "Importing XSD Datatypes" on page 10-51 ▪ Chapter 13, "Managing Transformations"
Create button in Business Event Types page of Figure 11-9	Create a business event type	"Accessing Business Event Type Management Tasks" on page 11-65	"Creating a Business Event Type" on page 11-66
Delete column in Business Event Types page of Figure 11-9	Delete a business event type		"Deleting a Business Event Type" on page 11-67
Update column in Business Event Types page of Figure 11-9	Update a business event type		"Updating a Business Event Type" on page 11-67
Name column in Business Event Types page of Figure 11-9 (To access the details page in the lower page of Figure 11-9)	View a business event type		"Viewing a Business Event Type" on page 11-68
Create button in Business Event Type Details page of Figure 11-9	Create an event body element		"Creating an Event Body Element" on page 11-69

Table 11–6 (Cont.) Business Event Type Management Tasks

Business Event Types Page Elements	Management Task	First See Section...	Then See Section...
Delete column in Business Event Type Details page of Figure 11–9	Delete an event body element		"Deleting an Event Body Element" on page 11-70
Update column in Business Event Type Details page of Figure 11–9	Update an event body element		"Updating an Event Body Element" on page 11-70
Event Body Elements column in Business Event Type Details page of Figure 11–9	View an event body element		"Viewing an Event Body Element" on page 11-71

See Also:

- ["Business Events"](#) on page 3-37 for additional conceptual details
- [Chapter 9, "Creating Metadata with the Modeling Wizards"](#) to automatically create a business event

Accessing Business Event Type Management Tasks

Follow these instructions to access the business event type management tasks shown in [Figure 11–9](#) on page 11-63:

To access business event type management tasks:

1. Select the **Modeling** tab.
2. Select the **Event Types** tab.

The Business Event Types page appears. (See the upper page of [Figure 11–9](#) on page 11-63.)

3. Select a task to perform and see the referenced section for instructions:

To...	Then...	See Section...
Create a business event type	Click Create .	"Creating a Business Event Type" on page 11-66
Delete a business event type	Select a specific business event type in the Delete column.	"Deleting a Business Event Type" on page 11-67
Update a business event type	Select a specific business event type in the Update column.	"Updating a Business Event Type" on page 11-67
View a business event type	Select a specific business event type in the Name column.	"Viewing a Business Event Type" on page 11-68
Create an event body element	Select a specific business event type in the Name column for which to create an event body element.	"Creating an Event Body Element" on page 11-69
Delete an event body element	Select a specific business event type in the Name column for which to delete an event body element.	"Deleting an Event Body Element" on page 11-70
Update an event body element	Select a specific business event type in the Name column for which to update an event body element.	"Updating an Event Body Element" on page 11-70
View an event body element	Select a specific business event type in the Name column for which to view an event body element.	"Viewing an Event Body Element" on page 11-71

Creating a Business Event Type

Follow these instructions to create a business event type:

To create a business event type:

1. Ensure that you followed the instructions in ["Accessing Business Event Type Management Tasks"](#) on page 11-65 to access the page for creating a business event type.

The Create Business Event Type page appears.

2. Enter the following details to create a business event type. An asterisk (*) indicates a required field.

Field	Description
Name *	Enter a unique and recognizable name for the business event type.
Description	Provide a description of the business event type.

3. Click **Apply**.

The business event type is created and the Business Event Type Details page for the created business event type appears.

Deleting a Business Event Type

Follow these instructions to delete a business event type:

Caution: All event body elements of the selected business event type are also deleted.

To delete a business event type:

1. Follow the instructions in "[Accessing Business Event Type Management Tasks](#)" on page 11-65 to access the page for deleting a business event type.
2. Click **Yes** when prompted to delete a business event type.

The business event type is deleted and the Business Event Types page appears.

Updating a Business Event Type

Follow these instructions to update a business event type:

To update a business event type:

1. Follow the instructions in "[Accessing Business Event Type Management Tasks](#)" on page 11-65 to access the page for updating a business event type.

The Update Business Event Type page appears.

2. Make appropriate changes. (See Step 2 on page 11-67 for a list of fields you can update.)
3. Click **Apply**.

The business event type is updated and the Business Event Types page for the updated business event type appears.

Viewing a Business Event Type

Follow these instructions to view details about a specific business event type:

To view a business event type:

1. Ensure that you followed the instructions in "[Accessing Business Event Type Management Tasks](#)" on page 11-65 to access the page for viewing a business event type.

The Business Event Type Details page for the selected business event type appears.

Business Event Type Details : `jms_consume_expense_ET`

[Delete](#) [Update](#)

Details

Name `jms_consume_expense_ET`

Description

State **Draft**

Event Body Elements

[Return to Top](#)

[Create](#)

[Expand All](#) | [Collapse All](#)

⊕ Event Body Elements

Focus	Name	Type	Datatype	Cardinality	Update	Delete
	Event Body Elements					
⊕	Payload		notification_type			
	from	Scalar	string			
	to	Scalar	string			
	subject	Scalar	string			
	arrival_date	Scalar	date			
⊕	status	Compound	status_type	[1, 1]		
	message	Scalar	string			
	code	Scalar	string			
	modified_date	Scalar	date			
	id	Scalar	integer			

2. View specific details, in particular the event body element datatypes of the business event body element.

This page, as with the Business Event Types page shown in the upper page of [Figure 11-9](#) on page 11-63, enables you to delete or update the selected business event type.

3. Click **Return to List** to return to the Business Event Types page.

Creating an Event Body Element

The business event body element contains the business datatypes. Follow these instructions to create an event body element:

To create an event body element:

1. Follow the instructions in "[Accessing Business Event Type Management Tasks](#)" on page 11-65 to access the page for creating an event body element.

The Business Event Type Details page for the selected business event type appears. (See the lower page of [Figure 11-9](#) on page 11-63.)

2. Go to the **Event Body Elements** section.
3. Click **Create**.

The Create Event Body Element page appears.

4. Enter the following details to create an event body element. An asterisk (*) indicates a required field.

Field	Description
General	
<ul style="list-style-type: none"> ▪ Name * 	Enter a unique and recognizable name for the event body element.
Datatype	
<ul style="list-style-type: none"> ▪ Classification * 	Core datatypes are primitive datatypes. Business datatypes are derived from core datatypes. Select Core Datatype if the event body element requires a primitive datatype. Select Business Datatype if the event body element does not require a primitive datatype.
<ul style="list-style-type: none"> ▪ Namespace * 	Select the namespace for this datatype.

Field	Description
<ul style="list-style-type: none"> ■ Name * 	Select a datatype name included in this namespace by clicking the flashlight next to the Name field.

5. Click **Apply**.

You are returned to the Business Event Type Details page. The business event type now includes the event body element and its namespace and business datatypes.

Deleting an Event Body Element

Follow these instructions to delete an event body element:

To delete an event body element:

1. Follow the instructions in "[Creating an Event Body Element](#)" on page 11-69 to access the page for deleting an event body element.

The Business Event Type Details page for the selected business event type appears. (See the lower page of [Figure 11-9](#) on page 11-63.)

2. Go to the **Event Body Elements** section.
3. Select a specific event body element to delete in the **Delete** column.
4. Click **Yes** when prompted to delete an event body element.

The event body element is deleted and the Business Event Type Details page appears.

Updating an Event Body Element

Follow these instructions to update an event body element:

To update an event body element:

1. Follow the instructions in "[Creating an Event Body Element](#)" on page 11-69 to access the page for updating an event body element.

The Business Event Type Details page for the selected business event type appears.

2. Go to the **Event Body Elements** section.

3. Select a specific event body element to update in the **Update** column.
The Update Event Body Element page appears.
4. Make appropriate changes. (See Step 4 on page 11-69 for a list of fields you can update.)
5. Click **Apply**.
The event body element is updated and the Business Event Type Details page for the event body element appears.

Viewing an Event Body Element

Follow these instructions to view details about a specific event body element:

To view an event body element:

1. Follow the instructions in "[Creating an Event Body Element](#)" on page 11-69 to access the page for viewing an event body element.
The Business Event Type Details page for the selected business event type appears.
2. Go to the **Event Body Elements** section.
3. Select a specific event body element to view in the **Name** column.
The Event Body Element Details page for the selected event body element appears.

Event Body Element Details : Payload

Details

General

Name **Payload**

Datatype

Name [notification_type](#)

Namespace <http://www.oracle.com/jpdemo>

4. View specific details. The **Name** link displays the Datatype Details page for the selected datatype. The **Namespace** link displays the Namespace Details page for the selected namespace.

This page, as with the Business Event Type Details page shown in [Figure 11-9](#) on page 11-63, enables you to delete or update the selected event body element.

5. Click **Return to Event Type Details** to return to the Business Event Type Details page.

Common User Errors

The following are common interaction and event type user errors.

- Ensure that any interactions you created for testing purposes are deleted before you attempt to create a configuration. If you forget to delete them, you receive validation errors.
- If an adapter interaction is part of an integration designed up through the business process, then attempting to delete the adapter interaction before deleting other modeling metadata results in error messages appearing. Ensure that you delete the modeling metadata in the order described in "[Deleting an Adapter Interaction](#)" on page 11-35.
- Do not use the **Back** or **Forward** buttons of your Web browser when using the wizard to create native events, application events, and body elements. Instead, use the **Next** and **Back** buttons on the wizard.
- If a native event type is part of an integration designed up through the business process, then attempting to delete the native event type before deleting other modeling metadata results in error messages appearing. Ensure that you delete the modeling metadata in the order described in "[Deleting a Native Event Type](#)" on page 11-42. See "[Design-Time Troubleshooting of Modeling Metadata Dependencies](#)" on page 22-9 for additional details about how to delete modeling metadata.

Chapter Summary

This chapter describes how to manage adapter interactions and takes you through the steps for adding an Advanced Queuing, E-Mail, File/FTP, HTTP, JMS, Oracle Database, and Web Service adapter interaction. Managing native event types, native event correlations, event maps, application event types, and business event types are also discussed.

Managing Business Processes and Roles

This chapter describes the business process and role management tasks required to design an integration. This chapter contains these topics:

- [Business Process and Role Management Tasks Overview](#)
- [Business Process and Role Management Tasks Graphical View](#)
- [Business Process and Role Creation Methods](#)
- [Viewing the Metadata Modeling Diagrams](#)
- [Managing Business Processes](#)
- [Managing Role Types](#)
- [Managing Role Ports](#)
- [Managing Role Data Flow](#)
- [Managing Steps](#)
- [Managing Step Ports](#)
- [Managing Step Data Flow](#)
- [Managing Step Control Flow](#)
- [Managing Condition Expressions in Steps](#)
- [Designing Roles to Ensure Proper Validation](#)
- [Role Runtime Behavior](#)
- [Common User Errors](#)
- [Chapter Summary](#)

See Also: ["Modeling Metadata Design"](#) on page 3-15 for conceptual details about business processes, role types, ports, data flows, steps, and control flows

Business Process and Role Management Tasks Overview

The Oracle Application Server ProcessConnect user interface tool enables you to perform the business process and role management tasks required for integrations. These tasks consist of managing the components in [Figure 12-1](#) and [Figure 12-2](#).

Figure 12–1 Business Process and Role Management Tasks (Part 1 of 2)

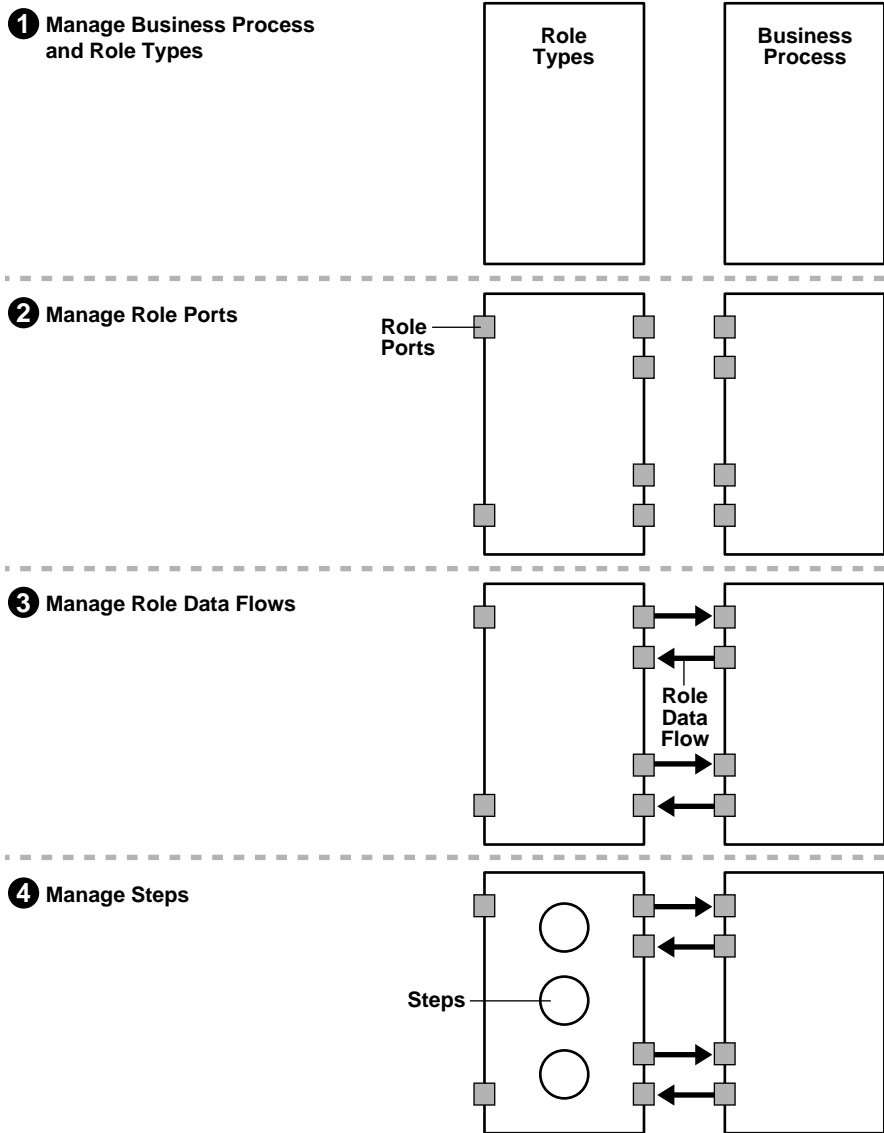
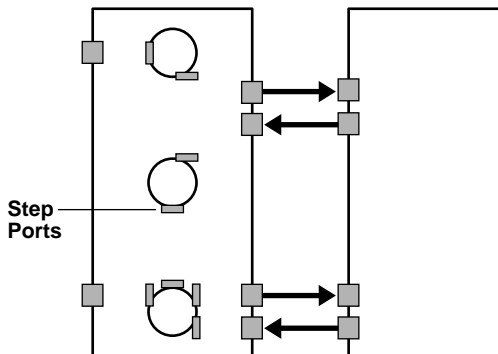
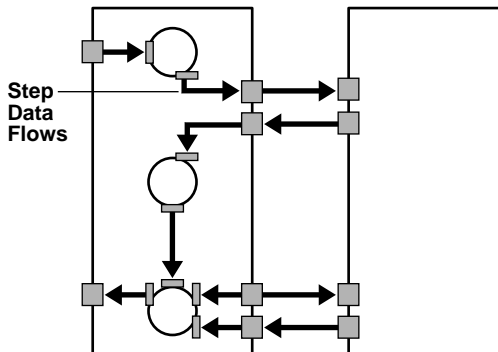

Figure 12-2 Business Process and Role Management Tasks (Part 2 of 2)

5 Manage Step Ports



6 Manage Step Data Flows



7 Manage Step Control Flows

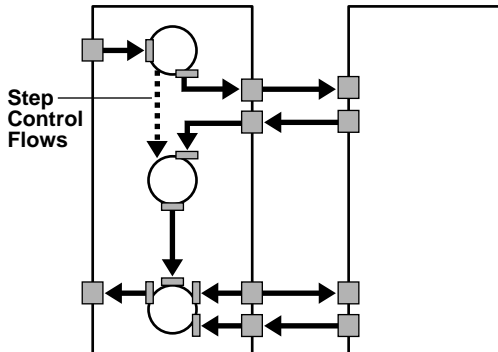

After design is complete and the integration is deployed, these components enable the business process to be executed and events to flow from role to role.

Table 12–1 describes each component shown in Figure 12–1 and Figure 12–2 and provides references for more information. You must perform these tasks to define the role type and business process portions of an integration.

Table 12–1 Role and Business Process Management Tasks

Key	Component	Description	See Section...
1	Business process	The business process spans all parties (each a separate spoke) in an integration to implement business logic and manage the movement of business events. Create one business process for an integration.	"Managing Business Processes" on page 12-33 "Business Process" on page 3-44
1	Role types	Roles define how events are executed. Create at least one of each role type for each party participating in an integration (native role, translation binding role, application role, transformation binding role, and business role). These role types comprise a spoke.	"Managing Role Types" on page 12-40 "Native-Level Concepts" on page 3-15 "Application-Level Concepts" on page 3-30 "Business-Level Concepts" on page 3-37
2	Role ports	Role ports represent an input or output parameter of a role containing events. Role ports of different roles are connected together by role data flow. This enables events to move from role to role. Create role ports for all role types.	"Managing Role Ports" on page 12-48 "Role Ports" on page 3-28
3	Role data flows	Role data flows connect the role ports of roles together, which enable events to move through roles. Create role data flows for all role types.	"Managing Role Data Flow" on page 12-58 "Data Flow" on page 3-29
4	Steps	Steps define the execution logic in a role. Create steps within all role types.	"Managing Steps" on page 12-70 "Steps" on page 3-28

Table 12–1 (Cont.) Role and Business Process Management Tasks

Key	Component	Description	See Section...
5	Step ports	Step ports work with data flows to connect steps inside roles together. Step ports also work with data flows to connect incoming role ports to incoming step ports and outgoing step ports to outgoing role ports. Create steps ports for all steps.	"Managing Step Ports" on page 12-87 "Step Ports" on page 3-29
6	Step data flows	Step data flows connect the ports of steps together and the ports of steps and roles together. This enables events to move through steps and roles.	"Managing Step Data Flow" on page 12-95 "Data Flow" on page 3-29
7	Step control flows	Control flows between steps indicate the execution order of steps. Control flows connect directly to steps and do not use step ports.	"Managing Step Control Flow" on page 12-102 "Control Flow" on page 3-29

Business Process and Role Management Tasks Graphical View

The Oracle Application Server ProcessConnect user interface tool enables you to perform the management tasks shown in [Figure 12–1](#) and [Figure 12–2](#) and described in [Table 12–1](#). [Figure 12–3](#) through [Figure 12–5](#) provide a high-level overview of the location of these management tasks within the Oracle Application Server ProcessConnect user interface tool, with references provided to the management task key number shown in [Table 12–1](#). The locations of these management tasks are described in detail throughout this chapter.

Figure 12-3 displays the business process and role management tasks identified by key number one in Figure 12-1.

Figure 12-3 Business Process and Role Management Tasks Graphical View (Part 1 of 3)

Business Processes

Search

Name	Integration Diagram	Event Flow Diagram	Process Diagram	Update	Delete	
approve-BP						<input type="button" value="Create"/>

Shortcuts

- Create End-To-End Basic Integration
- Add End-To-End Basic Event Flow
- Create Spoke
- Add Event Flow
- [Import Datatype](#)
- [Business Datatypes](#)
- [Create Business Event Type](#)
- [Business Event Types](#)

Native Roles

Search

Name	Integration Diagram	Event Flow Diagram	Process Diagram	Update	Delete	
approval-NR						<input type="button" value="Create"/>
expense-NR						

Shortcuts

- [Create Native Event Type](#)
- [Native Event Types](#)
- Add End-To-End Basic Event Flow
- Create Spoke
- Add Event Flow

The upper page of Figure 12-4 displays the data port, data flow group, and step management tasks identified by key numbers two, three, and four, respectively, in Figure 12-1. The lower page of Figure 12-4 displays the step port and step control flow management tasks identified by key numbers five and seven, respectively, in Figure 12-2.

Figure 12-5 displays the step data flow management tasks identified by key number six in Figure 12-2.

Figure 12-4 Business Process and Role Management Tasks Graphical View (Part 2 of 3)

Native Role Details : expense-NR

[Delete](#) [Update](#)

Details

Description
State **Draft**

Data Ports

[Return to Top](#)

[Create](#)

Name	Direction	Event	Interaction	bound in data flow group	Update	Delete
expense-IN	Input	NE : expense	ReadFile(expense) - Inbound			
expense-OUT	Output	NE : expense		expense-NR-TL		

Data Flow Groups

[Return to Top](#)

[Create](#)

Name	Other Role	Role Type	Update	Delete
expense-NR-TL	expense-TL	Binding Role		

Steps

[Return to Top](#)

[Create](#)

Name	Type	Update	Delete
End	End		
Passthrough expense	Pass-through		
Start	Start		

Step Details : Passthrough expense

[Delete](#) [Update](#)

Details

Type Pass-through
Role expense-NR
Role Type Native Role
Description
State **Draft**

Data Ports

[Return to Top](#)

[Create](#)

Name	Direction	Event	Datatype	Update	Delete
expense-IN	Input	NE : expense			
expense-OUT	Output	NE : expense			

Control Flows

[Return to Top](#)

[Create](#)

Sequence	Step	Guard Value	Update	Delete
after	Start			
before	End			

Figure 12–5 Business Process and Role Management Tasks Graphical View (Part 3 of 3)

Data Port Details : expense-OUT

Delete Update

Details

Description
 Owner (Step) Passthrough expense
 Owner Type Pass-through
 Direction Output
 Event Type expense
 Classification Native Event Type
 State **Draft**

Data Flows

Return to Top

Create

Direction	Port	Owner	Owner Type	Delete
flows to	expense-OUT	expense-NR	Native Role	
flows to	expense-OUT	expense-NR	Native Role	

Diagrams

Return to Top

[Event Flow Diagram](#)
[Process Diagram](#)
[Step Binding Diagram](#)

Data Port Details : expense-OUT

Delete Update

Details

Description
 Owner (Role) expense-NR
 Owner Type Native Role
 Direction Output
 Event expense
 Classification Native Event Type
 State **Draft**

Data Flows Between Roles

TIP To create a data flow with a port in another role, you must create or update a DataFlowGroup

Direction	Port	Owner	Owner Type	Data Flow Group	Delete
flows to	expense-IN	expense-TL	Binding Role	expense-NR-TL	

Data Flows Within Role

Create

Direction	Port	Owner	Owner Type	Delete
flows from	expense-OUT	Passthrough expense	Pass-through	
flows from	expense-OUT	Passthrough expense	Pass-through	

Diagrams

[Event Flow Diagram](#)
[Process Diagram](#)

Business Process and Role Creation Methods

The Oracle Application Server ProcessConnect user interface tool provides two methods for creating business process and role modeling metadata:

- You can quickly create business process and role modeling metadata by using several modeling wizards that prompt you for answers to basic questions and, based on these answers, create the rest of the modeling metadata for you. This method is quicker, but does not provide you with the flexibility of manual creation. For example, you may want to create more complex steps in roles than those automatically created by the modeling wizards.
- You can manually create business process and role modeling metadata by following the procedures described in this chapter. These procedures enable you to define all parts of business process and role modeling metadata. This method offers flexibility, but takes time to complete.

Select a creation method based on your level of modeling metadata design expertise and the needs of your environment. A common method is to first use the modeling wizards to create the modeling metadata, including the business process and roles with default steps, ports, and data flows. You can then manually modify and create additional modeling metadata to add more complex processing.

Note: If you want to use data flow criteria, you can either manually create all roles or start with the Create Spoke wizard, delete the business role, and use data flow criteria with the existing business role

See Also:

- ["Managing Role Data Flow"](#) on page 12-58 for details about data flow criteria
- [Chapter 9, "Creating Metadata with the Modeling Wizards"](#) for instructions on using the modeling wizards

Viewing the Metadata Modeling Diagrams

The Oracle Application Server ProcessConnect user interface tool includes several modeling metadata diagrams that provide a graphical view of your integration. As you create, update, or delete modeling metadata, these diagrams are updated to reflect your changes. Oracle recommends that you view these graphics frequently when creating or changing modeling metadata for an integration. [Table 12-2](#) lists these diagrams and the locations from which they can be accessed. When you access these diagrams, additional options are provided for accessing more detailed graphical views of modeling metadata, and for creating, updating, and deleting modeling metadata.

Table 12-2 Accessing the Modeling Metadata Diagrams

Accessible From...	Integration Diagram	Process Diagram	Event Flow Diagram	Step Binding Diagram	See...
Diagram columns at top of Business Processes page	Yes	Yes	Yes	No	Upper page of Figure 12-15 on page 12-34
Diagram columns at top of <i>type</i> Roles page where <i>type</i> is either Native, Application, Business, or Binding	Yes	Yes	Yes	No	Upper page of Figure 12-16 on page 12-40
Links at bottom of Business Process Details : <i>name</i> page where <i>name</i> is the business process name	Yes	Yes	Yes	No	Lower page of Figure 12-15 on page 12-34
Links at bottom of <i>type</i> Role Details : <i>name</i> page	Yes	Yes	Yes	No	Lower page of Figure 12-16 on page 12-40
Links at bottom of Data Port Details : <i>name</i> page (for role ports)	No	Yes	Yes	No	Lower page of Figure 12-17 on page 12-48
Links at bottom of Data Flow Group Details : <i>name</i> page	Yes	No	Yes	No	"Viewing a Role Data Flow" on page 12-69
Links at bottom of Step Details : <i>name</i> page	No	Yes	Yes	Yes	"Viewing a Step" on page 12-86
Links at bottom of Data Port Details : <i>name</i> page (for step ports)	No	Yes	Yes	Yes	"Viewing a Step Port" on page 12-94

Accessing the Metadata Modeling Diagrams

Follow these instructions to access the metadata modeling diagrams:

- [Accessing the Diagrams from the Business Processes or Roles Pages](#)
- [Accessing the Diagrams from the Business Process Details : Name and Role Name Pages](#)
- [Accessing the Diagrams from the Data Port Details : Name Page \(For Role Ports\)](#)
- [Accessing the Diagrams from the Data Flow Group Details : Name Page](#)
- [Accessing the Diagrams from the Step Details : Name Page](#)
- [Accessing the Diagrams from the Data Port Details : Name Page \(For Step Ports\)](#)
- [Accessing Diagram Details](#)

Accessing the Diagrams from the Business Processes or Roles Pages

1. Select the **Modeling** tab.
2. Select to view either a business process or role.

To View a...	Select the...	Go To Step...
Business Process	Business Processes tab to access the Business Processes page	4
Role	Roles tab to access the Business Roles page	3

3. If you want to view a specific type of role, select one of the following types at the top of the page:
 - **Application Roles**
 - **Native Roles**
 - **Binding Roles**
4. Select the metadata modeling diagram to view from the **Integration Diagram**, **Event Flow Diagram**, or **Process Diagram** column at the top of the page.
5. See "[Accessing Diagram Details](#)" on page 12-14 to access diagram details about your selection.

Accessing the Diagrams from the Business Process Details : *Name* and Role *Name* Pages

1. Follow the instructions in "[Accessing the Diagrams from the Business Processes or Roles Pages](#)" on page 12-12 to access the Business Processes or Roles page.
2. Select a specific business process or role in the **Name** column.
3. Select the metadata modeling diagram to view from the **Integration Diagram**, **Event Flow Diagram**, or **Process Diagram** links at the bottom of the page.
4. See "[Accessing Diagram Details](#)" on page 12-14 to access diagram details about your selection.

Accessing the Diagrams from the Data Port Details : *Name* Page (For Role Ports)

1. Follow the instructions in "[Accessing the Diagrams from the Business Processes or Roles Pages](#)" on page 12-12 to access the Business Processes or Roles page.
2. Select a specific business process or role in the **Name** column.
3. Select a specific role port in the **Name** column of the **Data Ports** section.
4. Select the **Event Flow Diagram** or **Process Diagram** links at the bottom of the page.
5. See "[Accessing Diagram Details](#)" on page 12-14 to access diagram details about your selection.

Accessing the Diagrams from the Data Flow Group Details : *Name* Page

1. Follow the instructions in "[Accessing the Diagrams from the Business Processes or Roles Pages](#)" on page 12-12 to access the Business Processes or Roles page.
2. Select a specific business process or role in the **Name** column.
3. Select a specific role port in the **Name** column of the **Data Flow Groups** section.
4. Select the metadata modeling diagram to view from the **Integration Diagram** or **Event Flow Diagram** links at the bottom of the page.
5. See "[Accessing Diagram Details](#)" on page 12-14 to access diagram details about your selection.

Accessing the Diagrams from the Step Details : *Name* Page

1. Follow the instructions in "[Accessing the Diagrams from the Business Processes or Roles Pages](#)" on page 12-12 to access the Business Processes or Roles page.
2. Select a specific business process or role in the **Name** column.
3. Select a specific step in the **Name** column of the **Steps** section.
4. Select the metadata modeling diagram to view from the **Process Diagram**, **Event Flow Diagram**, or **Step Binding Diagram** list at the bottom of the page.
5. See "[Accessing Diagram Details](#)" on page 12-14 to access diagram details about your selection.

Accessing the Diagrams from the Data Port Details : *Name* Page (For Step Ports)

1. Follow the instructions in "[Accessing the Diagrams from the Business Processes or Roles Pages](#)" on page 12-12 to access the Business Processes or Roles page.
2. Select a specific business process or role in the **Name** column.
3. Select a specific step in the **Name** column of the **Steps** section.
4. Select a specific step port in the **Name** column of the **Data Ports** section.
5. Select the metadata modeling diagram to view from the **Process Diagram**, **Event Flow Diagram**, or **Step Binding Diagram** links at the bottom of the page.
6. See "[Accessing Diagram Details](#)" on page 12-14 to access diagram details about your selection.

Accessing Diagram Details

See the following sections for details about the diagram type you selected:

If You Selected...	Description	See...
Integration Diagram	Displays the roles and business process in an integration	"Viewing an Integration Diagram" on page 12-15
Event Flow Diagram	Displays events moving through the selected business process or role	"Viewing an Event Flow Diagram" on page 12-18
Process Diagram	Displays events, steps, ports, data flows, and control flows for the selected business process or role	"Viewing a Process Diagram" on page 12-23

If You Selected...	Description	See...
Step Binding Diagram	Displays the current state of a step, including its step ports, role ports, and data flows	"Viewing a Step Binding Diagram" on page 12-28

Viewing an Integration Diagram

Follow these instructions to view an Integration Diagram:

To view an Integration Diagram:

1. Ensure that you followed the instructions in ["Accessing the Metadata Modeling Diagrams"](#) on page 12-12 to access the page for viewing an Integration Diagram.

The Integration Diagram displays the selected business process or role.

[Figure 12-6](#) shows the Integration diagram for the approve-BP business process early in the design stage.

Figure 12-6 Early Stages of Integration Diagram

Integration Diagram For Business Process : approve-BP

Diagram Actions

Select activity and click on diagram object.

Action:

Display Options

Modify display options and choose Refresh.

Scale (%) Refresh

Agreement Native Role Binding Role Application Role Binding Role Business Role Business Process Business Role Binding Role Application Role Binding Role Native Role Agreement



approve-BP

As you add additional roles, these changes are reflected in the Integration Diagram. For example, creating two spokes of roles, role ports, data flows, steps, step ports, and control flow with the business process approve-BP in the middle causes the changes shown in [Figure 12-7](#) to display in the Integration Diagram.

Figure 12-7 Later Stages of Integration Diagram

Integration Diagram For Business Process : approve-BP

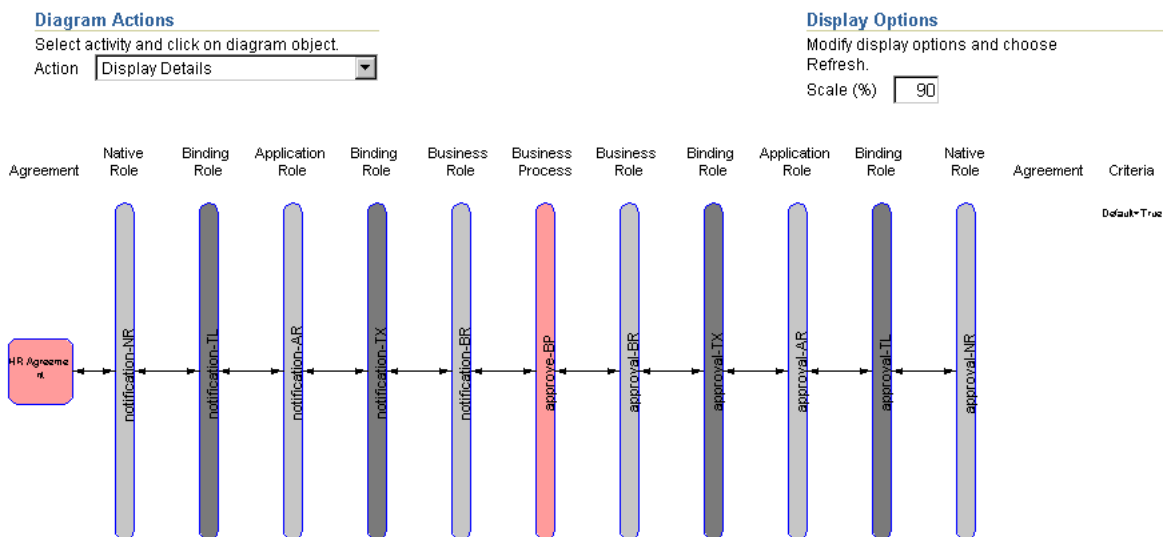

2. If the native role in your integration is currently part of an agreement (notification-NR in this example), click the **Agreement** icon beneath the **Agreement** header to display the details page for the agreement. (See left side of [Figure 12-7](#).) If the native role is not currently part of an agreement (approval-NR in this example), only the **Agreement** header appears. (See right side of [Figure 12-7](#).)
3. View specific details or select a task from the **Action** list of the **Diagram Actions** section and click a role in the diagram:

Action	Description	See Section...
Display Details (default selection)	Displays the details page for the role or business process	"Viewing a Business Process" on page 12-38 or "Viewing a Role" on page 12-46
Drill Down to Event Flow diagram	Displays the Event Flow Diagram for the selected role or business process	"Viewing an Event Flow Diagram" on page 12-18
Drill Down to Process Diagram	Displays the Process Diagram for the selected role or business process	"Viewing a Process Diagram" on page 12-23 or "Viewing a Role" on page 12-46
Create Spoke	Starts the Create Spoke wizard, which enables you to create a single spoke (extending from the native role to this business process) and a single event flow	"Creating a Single Spoke" on page 9-23
Delete Spoke	Deletes the spoke of which this business process or role is a part. The business process is not deleted. Note: Select a role to delete other than the business process. This is because the business process does not uniquely define a spoke. (It is in the middle of several spokes.)	"Deleting a Spoke" on page 9-40

Note: Enter a value in the **Scale (%)** field of the **Display Options** section and click **Refresh** to adjust the diagram size. This is beneficial when the size of the diagram is too large to fit on one page.

4. Check the Integration Diagram frequently as you create modeling metadata. This helps ensure that you create and connect all of the necessary roles.

Viewing an Event Flow Diagram

Follow these instructions to view an Event Flow Diagram:

To view an Event Flow Diagram:

1. Ensure that you followed the instructions in "[Accessing the Metadata Modeling Diagrams](#)" on page 12-12 to access the page for viewing an Event Flow Diagram.

The Event Flow Diagram displays the selected business process or role.

[Figure 12-8](#) shows the Event Flow diagram for the approve-BP business process early in the design stage.

Figure 12-8 Early Stages of Event Flow Diagram

Event Flow Diagram For Business Process : approve-BP

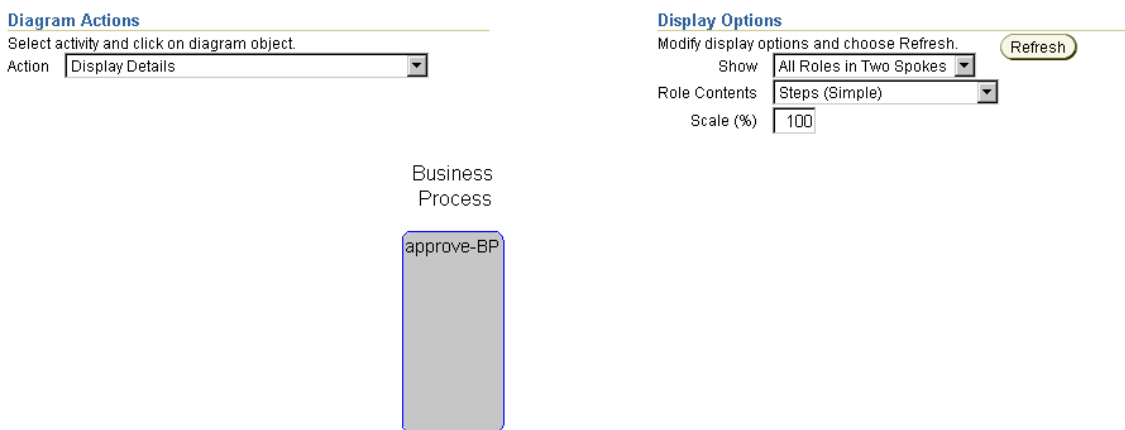

As you create additional roles and role steps, these changes are reflected in the Event Flow Diagram. For example, if you perform the following tasks:

- Create an approval-BR business role, approval-TX transformation binding role, and approval-AR application role
- Create appropriate steps inside all three roles and the business process
- Connect all roles and steps with ports and data flows

These tasks cause the changes shown in [Figure 12-9](#) to display in the Event Flow Diagram. Incomplete modeling metadata displays in red, such as a business event with no event body element or a transformation step with no defined event transformation maps. You must complete this modeling metadata before it can be included in a deployed configuration.

Figure 12-9 Later Stages of Event Flow Diagram

Event Flow Diagram For Business Process : approve-BP

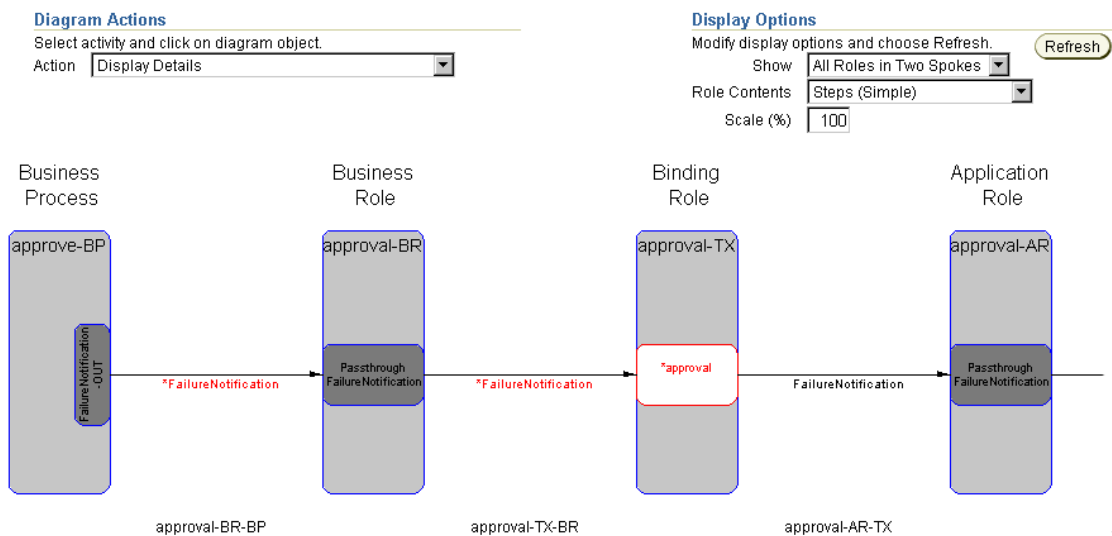

- View specific details or select a task from the **Action** list in the **Diagram Actions** section and click a step or a role in the diagram. The Event Flow Diagram provides several options for viewing different aspects of the integration.

Action	Description
Display Details (default selection)	Displays the details page for the selected role, step, business event, or adapter interaction
Drill Down to Process or Step Binding diagram	Displays the Process Diagram if you click a role or the Step Binding Diagram if you click a step or port

Action	Description
Create Spoke	Starts the Create Spoke wizard, which enables you to create a single spoke (extending from the native role to the business process) and a single event flow
Add Event Flow	Starts the Add Event Flow wizard, which enables you to add an additional event flow to a single spoke extending from the native role to the business process
Add End-To-End Basic Event Flow	Starts the Add End-To-End Basic Event Flow wizard, which enables you to add an event flow to two existing spokes
Delete Spoke	Deletes the spoke of which this business process or role is a part. The business process is not deleted; you must separately delete it. Note: Select a role to delete other than the business process. This is because the business process does not uniquely define a spoke. (It's in the middle of several spokes.)

3. Perform other appropriate tasks in the **Display Options** section and click **Refresh**:

Action	Description
Show	Select either of the following: <ul style="list-style-type: none"> ■ All Roles in Two Spokes Displays all roles, steps, and events in two spokes (this diagram can be very long) ■ Role and Adjacent Roles Displays the selected role and both of the role's adjacent role neighbors
Role Contents	Select either of the following: <ul style="list-style-type: none"> ■ Steps (Simple) Displays simple steps in the role. Simple steps have only one input data flow from a role port and one output data flow to a role port. For more complicated steps, only the role port appears. ■ Ports Displays all inbound and outbound ports for the roles ■ Complete Process Diagram Displays a comprehensive view of modeling metadata, including all steps, data flows, control flows, and ports. This creates a large diagram that can take a long time to appear.

Action	Description
Scale	Enter a value in the Scale (%) field to adjust the diagram size. This is beneficial when the size of the diagram is too large to fit on one page. A smaller scale also helps performance because the smaller the diagram, the more quickly it displays onscreen.

4. If you have created multiple spokes using the same business process that you want to view, the two spokes that initially display are based on how you accessed the Event Flow Diagram. For example, if you performed the following steps:
 - Clicked on a role in the Integration Diagram, the spoke that includes that role and a default spoke appear.
 - Added an event flow using the modeling wizards, the spokes included in that event flow appear.
5. Perform the following steps to display additional spokes:
 - a. Select **All Roles in Two Spokes** from the **Show** list.
 - b. Click **Refresh**.

The Event Flow Diagram refreshes to display the **Spoke (left side)** and **Spoke (right side)** lists.

Event Flow Diagram For Business Process : approve-BP

Spokes

Select spokes to display and choose Refresh.

Spoke (left side)

Spoke (right side)

Diagram Actions

Select activity and click on diagram object.

Action

Display Options

Modify display options and choose Refresh.

Show

Role Contents

Scale (%)

Both lists display the same native roles of the current business process.

- c. Select the native roles of the spokes you want to view from both lists.
- d. Click **Refresh**.

The Event Flow Diagram refreshes to show the two selected spokes.

6. If you want to view a specific role and its adjacent roles in a spoke, perform the following step:

- a. Select **Role and Adjacent Roles** from the **Show** list.
- b. Click **Refresh**.

The Event Flow Diagram refreshes to display the **Role** list.

Event Flow Diagram For Business Process : approve-BP

Roles

Select role to display and choose Refresh.

Role

Diagram Actions

Select activity and click on diagram object.

Action

Display Options

Modify display options and choose Refresh.

Show

Role Contents

Scale (%)

- c. Select the role to view.
- d. Click **Refresh**.

The Event Flow Diagram refreshes to show the selected role and its adjacent neighbor roles.

7. Check the Event Flow Diagram and its diagram tasks and display options frequently as you create modeling metadata. This helps ensure that you create and connect all of the necessary events, roles, and role steps.

Note: A link at the bottom of the Event Flow Diagram enables you to access the Integration Diagram.

Viewing a Process Diagram

Follow these instructions to view a Process Diagram:

To view a Process Diagram:

1. Ensure that you followed the instructions in "[Accessing the Metadata Modeling Diagrams](#)" on page 12-12 to access the page for viewing a Process Diagram.

When fully created, the Process Diagram displays events, steps, ports, data flows, and control flows for the selected business process or role. **Figure 12-10** shows the Process Diagram for the approve-BP business process early in design.

Figure 12-10 Early Stages of Process Diagram

Process Diagram For Business Process : approve-BP

Diagram Actions

Select Action and Click on Diagram Object:

Action

Display Options

Modify display options and choose Refresh.

Show Event and Datatype Names

Scale (%)

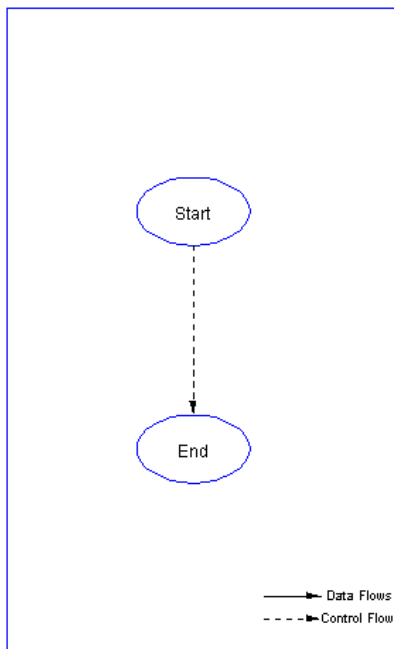

Note: Each business process or role automatically includes a Start and End step.

As you add steps, ports, data flows, and control flows to the business process or role, these changes are reflected in the Process Diagram. Unbound step and role ports for which data flow is not yet defined (such as return code ports of transformation, translation, or condition steps) appear. For example, creating the SetParty step, role data flows, step data flows, control flows, and events causes the changes shown in [Figure 12-11](#) to display in the Process Diagram.

Figure 12-11 Later Stages of Process Diagram

Process Diagram For Business Process : approve-BP

Diagram Actions

Select Action and Click on Diagram Object:

Action

Display Options

Modify display options and choose Refresh.

Show Event and Datatype Names

Scale (%)

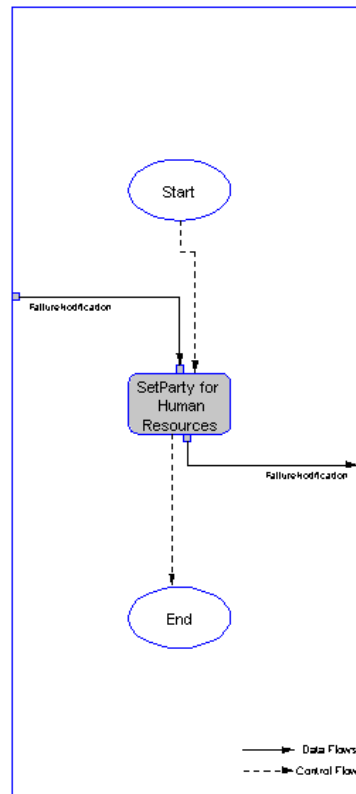

Incomplete modeling metadata displays in red, such as unbound step ports with no defined data flows or a SetParty step in a business process that must be updated with a destination party. You must complete this modeling metadata before it can be included in a deployed configuration.

2. View specific details in the Process Diagram or select a task from the **Action** list in the **Diagram Actions** section and click the step or port that you want to manage in the role:

Action	Description	See Also
Display Details (Step or Port)	Click the step, step port, or role port to display the details page for a step or port.	"Viewing a Step" on page 12-86 "Viewing a Step Port" on page 12-94 "Viewing a Role Port" on page 12-55
Drill Down to Step Bindings Diagram	Click the step, step port, or role port to display the Step Binding Diagram.	"Viewing a Step Binding Diagram" on page 12-28
Create Step	Click the step after which you want the new step inserted.	"Creating a Step" on page 12-81
Create Step Port	Click the step or step port to display the page for creating a step port. If you click a role port, an error message appears.	"Creating a Step Port" on page 12-91
Create Role Port	Click anywhere to display the page for creating a role port.	"Creating a Role Port" on page 12-52
Update (Step or Port)	Click the step, step port, or role port to display the page for updating a step, step port, or role port, respectively.	"Updating a Step" on page 12-85 "Updating a Step Port" on page 12-93 "Updating a Role Port" on page 12-54
Delete (Step or Port)	Click the step, step port, or role port to display the page for deleting a step, step port, or role port, respectively.	"Deleting a Step" on page 12-85 "Deleting a Step Port" on page 12-93 "Deleting a Role Port" on page 12-54

Action	Description	See Also
Create Data Flow	Click the unbound step port or role port (such as a return code port) to display the page for creating a data flow to another port. If the port is already data flow-bound, an error message appears. If you click a step, the step details page displays all data ports for this step. You must choose the port for which to create a data flow.	"Creating a Data Flow Between a Role Port and a Step Port" on page 12-56 "Creating a Role Data Flow Group" on page 12-62 "Creating a Step Data Flow" on page 12-98
Delete Data Flow	<p>Click the step port or role port to display the details page for your selection. From this page, choose the data flow to delete.</p> <p>Click the step to display the details page for the step. From this page, choose the port, then choose the data flow to delete.</p>	"Deleting a Data Flow Between a Role Port and a Step Port" on page 12-57 "Deleting a Role Data Flow" on page 12-67 "Deleting a Step Data Flow" on page 12-100
Create Control Flow	Click the step or step port to display the page for creating a control flow to another step. If you click a role port, an error message appears.	"Creating a Step Control Flow" on page 12-105
Delete Control Flow	Click the step or step port to display the details page for your selection. From this page, choose the control flow to delete. If you click a role port, an error message appears.	"Deleting a Step Control Flow" on page 12-107

When you click **Apply** or **Cancel** on an action page (create, update, or delete page) you are returned to the Process Diagram. A confirmation or error message appears at the top of the diagram to indicate whether the apply action was successful or not. If successful, the diagram reflects the modification that was made.

3. Perform other appropriate tasks in the **Display Options** section:

Action	Description
Show Event and Datatype Names (default selection)	Displays the event and datatype names used in the business process or role (for example, displays the incoming and outgoing events). This is a larger diagram because all names appear. If you deselect this box, the event and datatype names do not appear.
Scale	Enter a value in the Scale (%) field and click Refresh to adjust the diagram size. This is beneficial when the size of the diagram is too large to fit on one page. A smaller scale also helps performance because the smaller the diagram, the more quickly it displays onscreen.

Note: Links at the bottom of the Process Diagram also enable you to access the Integration Diagram and Event Flow Diagram.

4. Check the Process Diagram frequently as you create modeling metadata. This helps ensure that you create and connect all of the necessary steps, data flows, and control flows in a business process or role.

Viewing a Step Binding Diagram

Follow these instructions to view a step binding diagram:

To view a step binding diagram:

1. Ensure that you followed the instructions in "[Accessing the Metadata Modeling Diagrams](#)" on page 12-12 to access the page for viewing a step binding diagram.

The Step Binding Diagram page displays the current state of a step, including its step ports, role ports, and data flows. In [Figure 12-12](#), the SetParty step displays early after creation. A destination party has been set in the SetParty step (named Human Resources), but no events or data flows have been defined.

Figure 12–12 Early Stages of Step Binding Diagram

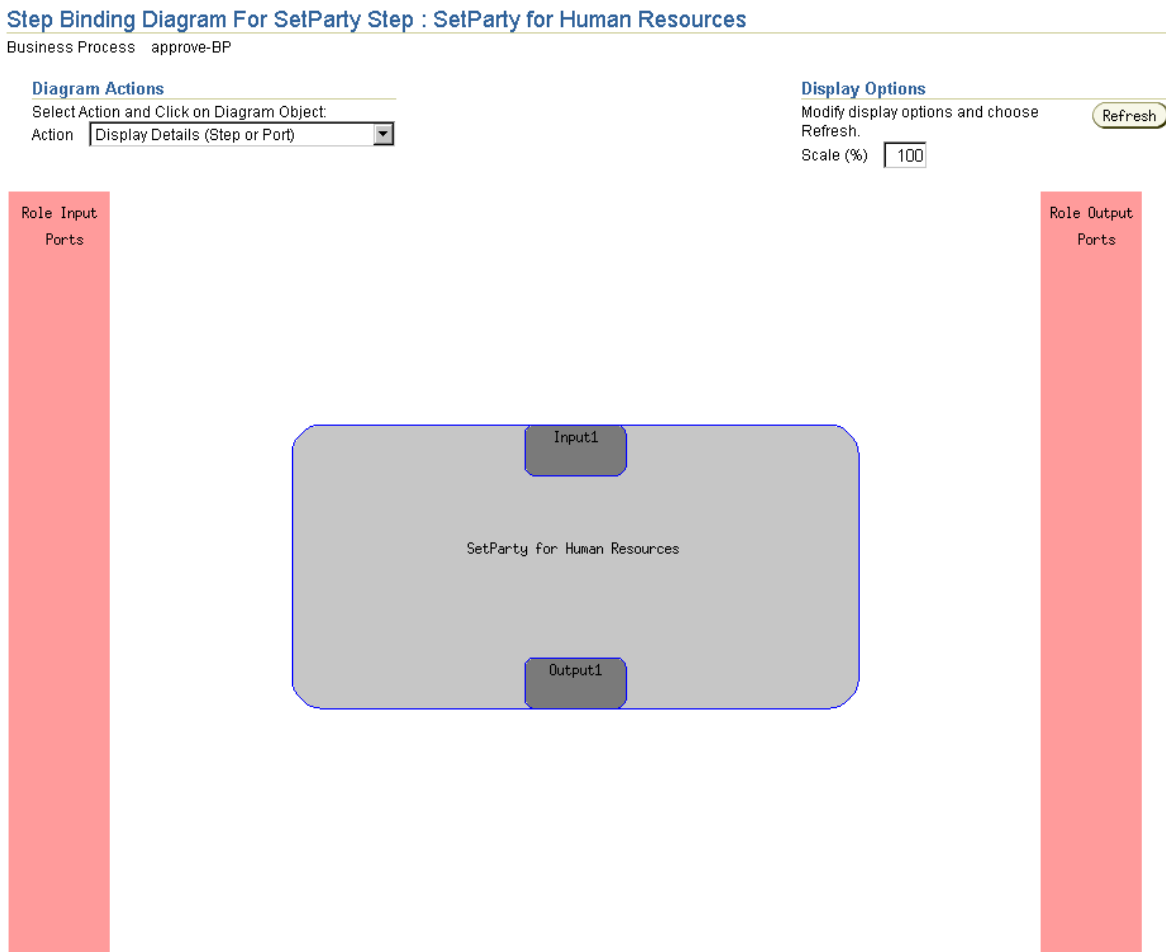

As you add additional steps, step ports, role ports, and role data flow to an integration, these changes are reflected in the Step Binding Diagram. For example, creating the FailureNotification-IN and FailureNotification-OUT step ports and role ports, and connecting these step ports to these role ports with role data flows causes the changes shown in [Figure 12–13](#) to display in the Step Binding Diagram.

Figure 12–13 Later Stages of Step Binding Diagram

Step Binding Diagram For SetParty Step : SetParty for Human Resources

Business Process approve-BP

Diagram Actions

Select Action and Click on Diagram Object

Action

Display Options

Modify display options and choose Refresh.

Scale (%)

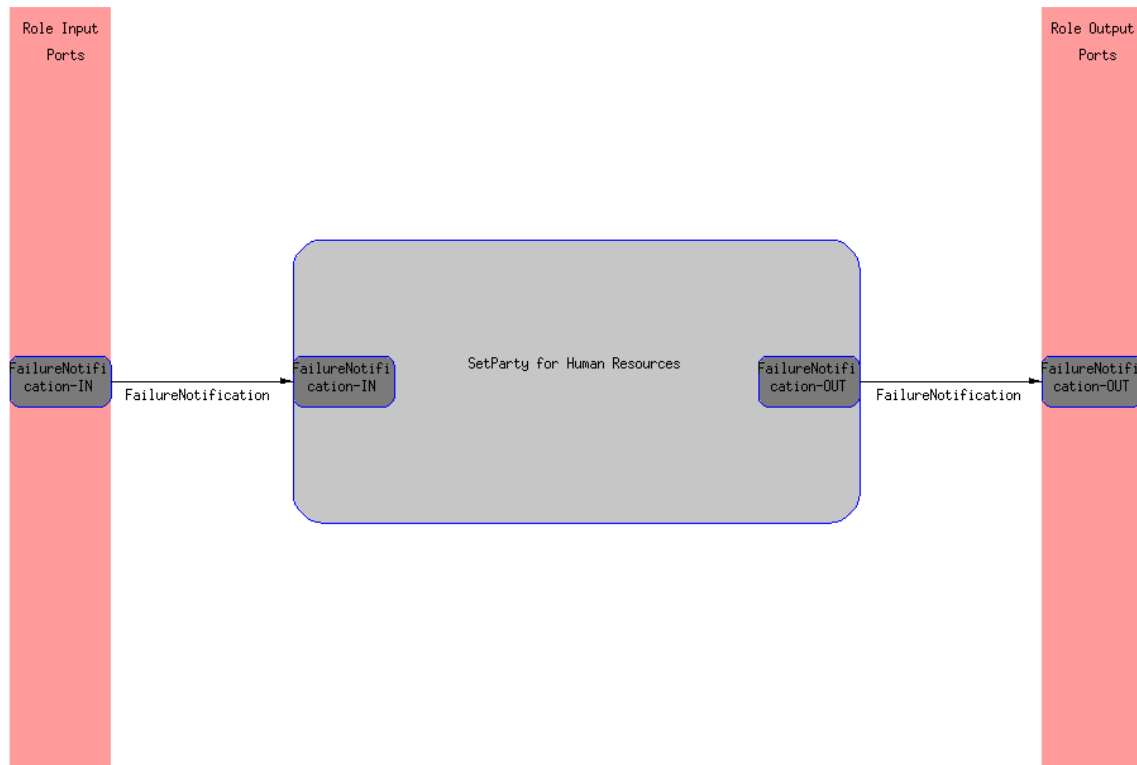

2. View specific details or select a task and click an element in the diagram:

Action	Description	See Also
Display Details (Step or Port)	Click the step, step port, or role port to display the details page for a step or port.	"Viewing a Step" on page 12-86 "Viewing a Step Port" on page 12-94 "Viewing a Role Port" on page 12-55
Display Another Step Bindings Diagram	Click to display the step binding diagram for the selected step	This section
Create Step Port	Click the step or step port to display the page for creating a step port. If you click a role port, an error message appears.	"Creating a Step Port" on page 12-91
Update (Step or Port)	Click the step, step port, or role port to display the page for updating a step, step port, or role port, respectively.	"Updating a Step" on page 12-85 "Updating a Step Port" on page 12-93 "Updating a Role Port" on page 12-54
Delete (Step or Port)	Click the step, step port, or role port to display the page for deleting a step, step port, or role port, respectively.	"Deleting a Step" on page 12-85 "Deleting a Step Port" on page 12-93 "Deleting a Role Port" on page 12-54
Create Data Flow	Click the unbound step port or role port (such as a return code port) to display the page for creating a data flow to another port. If the port is already data flow-bound, an error message appears. If you click a step, the step details page displays all data ports for this step. You must choose the port for which to create a data flow.	"Creating a Data Flow Between a Role Port and a Step Port" on page 12-56 "Creating a Role Data Flow Group" on page 12-62 "Creating a Step Data Flow" on page 12-98

Action	Description	See Also
Delete Data Flow	<p>Click the step port or role port to display the details page for your selection. From this page, choose the data flow to delete.</p> <p>Click the step to display the details page for the step. From this page, choose the port, then choose the data flow to delete.</p>	<p>"Deleting a Data Flow Between a Role Port and a Step Port" on page 12-57</p> <p>"Deleting a Role Data Flow" on page 12-67</p> <p>"Deleting a Step Data Flow" on page 12-100</p>

Note: Enter a value in the **Scale (%)** field of the **Display Options** section and click **Refresh** to adjust the diagram size. This is beneficial when the size of the diagram is too large to fit on one page.

When you click **Apply** or **Cancel** on an action page (create, update, or delete page) you are returned to the Step Binding Diagram. A confirmation or error message appears at the top of the diagram to indicate whether the apply action was successful or not. If successful, the diagram reflects the modification that was made.

3. Check the Step Binding Diagram frequently as you create modeling metadata. This helps ensure that you create and connect all of the necessary steps, step ports, role ports, and role data flow.

Managing Business Processes

The Oracle Application Server ProcessConnect user interface tool enables you to perform the business process management tasks shown in [Figure 12-14](#) and [Figure 12-15](#). These tasks are described in detail in this section. The business process is the center of the integration and implements the business logic and manages business events. The business process hides the unique characteristics of each party in an integration. The business process can contain all types of steps except translation steps. Ports in business processes can only be bound to business events. No port in a business process can be bound to a native event or application event.

Figure 12-14 Business Process Management Tasks (Part 1 of 2)

The screenshot shows the 'Business Processes' management interface. At the top left, there is a search bar with a dropdown menu set to 'All' and a 'Go' button. To the right of the search bar is a 'Create' button. Below the search bar is a table with the following columns: Name, Integration Diagram, Event Flow Diagram, Process Diagram, Update, and Delete. The first row in the table has the name 'approve-BP' and icons for each of the diagram types. To the right of the table is a 'Shortcuts' panel containing several links with icons: 'Create End-To-End Basic Integration', 'Add End-To-End Basic Event Flow', 'Create Spoke', 'Add Event Flow', 'Import Datatype', 'Business Datatypes', 'Create Business Event Type', and 'Business Event Types'.

Name	Integration Diagram	Event Flow Diagram	Process Diagram	Update	Delete
approve-BP					

Selecting a business process in the **Name** column causes a details page such as that shown in [Figure 12-15](#) to appear.

Figure 12-15 Business Process Management Tasks (Part 2 of 2)

Business Process Details : approve-BP

[Delete](#) [Update](#)

Details

Description

State **Draft**

Data Ports

[Return to Top](#)

[Create](#)

Name	Direction	Event	bound in data flow group	Update	Delete
expense-BE-IN	Input	BE : expense-BE	expense-BR-BP		
expense-BE-OUT	Output	BE : expense-BE	notification-BR-BP		

Data Flow Groups

[Return to Top](#)

[Create](#)

Name	Other Role	Role Type	Update	Delete
expense-BR-BP	expense-BR	Business Role		
notification-BR-BP	notification-BR	Business Role		

Steps

[Return to Top](#)

[Create](#)

Name	Type	Update	Delete
End	End		
Passthrough expense-BE	Pass-through		
Start	Start		

Diagrams

[Return to Top](#)

- [Integration Diagram](#)
- [Event Flow Diagram](#)
- [Process Diagram](#)

Table 12-3 identifies the business process management tasks shown in Figure 12-14 and Figure 12-15 and provides references to procedures for performing these tasks.

Table 12-3 Business Process Management Tasks

Business Processes Page Elements	Management Task	First See Section...	Then See Section...
Shortcuts section in Business Processes page of Figure 12-14	Take a shortcut to: <ul style="list-style-type: none"> Create modeling metadata with the modeling wizards Manage event types and datatypes 	N/A	<ul style="list-style-type: none"> "Modeling Wizards Concepts Overview" on page 9-2 "Managing Business Datatypes" on page 10-13 "Importing XSD Datatypes" on page 10-51 "Managing Business Event Types" on page 11-63
Create button in Business Processes page of Figure 12-14	Create a business process	"Accessing Business Process Management Tasks" on page 12-36	"Creating a Business Process" on page 12-36
Delete column in Business Processes page of Figure 12-14	Delete a business process		"Deleting a Business Process" on page 12-37
Update column in Business Processes page of Figure 12-14	Update a business process		"Updating a Business Process" on page 12-37
Name column in Business Processes page of Figure 12-14 (To access the details page shown in Figure 12-15)	View details about a business process		"Viewing a Business Process" on page 12-38

Note: The Oracle Application Server ProcessConnect user interface tool views business processes and roles as the same type of component. Therefore, most pages for managing the steps, ports, data flows, and control flows of a business process begin with the word *Role*.

See Also: ["Business Process"](#) on page 3-44 for conceptual details about business processes

Accessing Business Process Management Tasks

Follow these instructions to access the business process management tasks shown in [Figure 12-14](#) on page 12-33 and [Figure 12-15](#) on page 12-34:

To access business process management tasks:

1. Select the **Modeling** tab.
2. Select the **Business Processes** tab.

The Business Processes page appears. (See [Figure 12-14](#) on page 12-33.)

3. Select a task to perform and see the referenced section for instructions:

To...	Then...	See Section...
Create a business process	Click Create .	"Creating a Business Process" on page 12-36
Delete a business process	Select a specific business process in the Delete column.	"Deleting a Business Process" on page 12-37
Update a business process	Select a specific business process in the Update column.	"Updating a Business Process" on page 12-37
View details about a business process	Select a specific business process in the Name column.	"Viewing a Business Process" on page 12-38

Creating a Business Process

Follow these instructions to create a business process:

To create a business process:

1. Ensure that you followed the instructions in ["Accessing Business Process Management Tasks"](#) on page 12-36 to access the page for creating a business process.

The Create Business Process page appears.

2. Enter a unique and recognizable name for the business process in the **Name** field (for example, `approve-BP`).
3. Enter an optional description in the **Description** field.

4. Click **Apply**.

The business process is created and the Business Process Details : *name* page for the new business process appears. This page enables you to manage ports, data flows, and steps, and view diagrams of the business process. From the step page (accessible from the Business Process Details : *name* page), you can manage step ports, step data flows, and step control flows.

5. View a graphical status of the business process by selecting the following diagrams at the bottom of the Business Process Details : *name* page.

Diagram	See Section...
Integration Diagram	"Viewing an Integration Diagram" on page 12-15
Event Flow Diagram	"Viewing an Event Flow Diagram" on page 12-18
Process Diagram	"Viewing a Process Diagram" on page 12-23

Deleting a Business Process

Follow these instructions to delete a business process:

Caution: Deleting a business process also deletes any associated steps, data ports, data flow groups, and control flow.

To delete a business process:

1. Ensure that you followed the instructions in ["Accessing Business Process Management Tasks"](#) on page 12-36 to access the page for deleting a business process.
2. Click **Yes** when prompted to delete a business process.

The business process is deleted and the Business Processes page appears.

Updating a Business Process

Follow these instructions to update a business process:

To update a business process:

1. Ensure that you followed the instructions in ["Accessing Business Process Management Tasks"](#) on page 12-36 to access the page for updating a business process.

The Update Business Process page appears.

2. Make appropriate changes. (See Step 2 on page 12-36 through Step 3 on page 12-36 of "[Creating a Business Process](#)" for a list of fields that you can update.)
3. Click **Apply**.

The business process is updated and the Business Process Details : *name* page for the updated business process appears.

Viewing a Business Process

Follow these instructions to view details about a specific business process:

To view a business process:

1. Ensure that you followed the instructions in "[Accessing Business Process Management Tasks](#)" on page 12-36 to access the page for viewing a business process.

The Business Process Details : *name* page appears for the selected business process.

Business Process Details : approve-BP

Delete Update

Details

Description
State **Draft**

Data Ports

Return to Top

Create

Name	Direction	Event	bound in data flow group	Update	Delete
expense-BE-IN	Input	BE : expense-BE	expense-BR-BP		
expense-BE-OUT	Output	BE : expense-BE	notification-BR-BP		

Data Flow Groups

Return to Top

Create

Name	Other Role	Role Type	Update	Delete
expense-BR-BP	expense-BR	Business Role		
notification-BR-BP	notification-BR	Business Role		

Steps

Return to Top

Create

Name	Type	Update	Delete
End	End		
Passthrough expense-BE	Pass-through		
Start	Start		

Diagrams

Return to Top

- [Integration Diagram](#)
- [Event Flow Diagram](#)
- [Process Diagram](#)

2. View specific details, including the role ports (under the **Data Ports** section), data flow (under the **Data Flow Groups** section), and steps (under the **Steps** section) associated with this business process. This page, as with the Business Processes page shown in [Figure 12-14](#) on page 12-33, enables you to delete or update the selected business process.
3. Click **Return to List** to return to the Business Processes page.

Managing Role Types

The Oracle Application Server ProcessConnect user interface tool enables you to perform the role management tasks shown in Figure 12–16. These tasks are described in detail in this section. Each task applies to all roles, regardless of the role type you are creating. Regardless of whether you are managing a native, application, business, translation binding, or transformation binding role, the same management pages appear. Only the page titles are different.

Figure 12–16 Role Management Tasks

Native Roles

Search

Name	Integration Diagram	Event Flow Diagram	Process Diagram	Update	Delete
approval-NR					
expense-NR					

Shortcuts

- Create Native Event Type
- Native Event Types
- Add End-To-End Basic Event Flow
- Create Spoke
- Add Event Flow

Native Role Details : [expense-NR](#)

Details

Description
State **Draft**

Data Ports

[Return to Top](#)

Name	Direction	Event	Interaction	bound in data flow group	Update	Delete
expense-IN	Input	NE : expense	ReadFile(expense) - Inbound			
expense-OUT	Output	NE : expense		expense-NR-TL		

Data Flow Groups

[Return to Top](#)

Name	Other Role	Role Type	Update	Delete
expense-NR-TL	expense-TL	Binding Role		

Steps

[Return to Top](#)

Name	Type	Update	Delete
End	End		
Passthrough expense	Pass-through		
Start	Start		

Diagrams

[Return to Top](#)

- [Integration Diagram](#)
- [Event Flow Diagram](#)
- [Process Diagram](#)

This section briefly describes each role type you can create:

- [Native Role](#)
- [Translation Binding Role](#)
- [Application Role](#)
- [Transformation Binding Role](#)
- [Business Role](#)

Native Role

Native roles manage the interaction between native events. Pass-through steps and consume steps are typically used in native roles. Since the syntax of a native event is not known to Oracle Application Server ProcessConnect, transformations, conditions, and other steps cannot be performed. In most cases, the native event is passed through to the binding role for translation. Native roles can also be used to ignore native events that are not necessary for the integration (for example, acknowledgment events being sent as part of a protocol). In such cases, a consume step can be used in the native role to consume (prevent further processing from occurring) the event and not pass it onto the translation binding role.

Ports in native roles can only be bound to native events. No port in a native role can be bound to an application event or business event.

See Also: ["Native Roles"](#) on page 3-23

Translation Binding Role

Translation binding roles operate as a bridge between native and application roles. This role translates the native event to an application event, and vice versa. This role can also consume native events and perform error processing for translations. For this reason, a translation binding role typically contains translation steps, consume steps, and conditions steps.

Additionally, a translation binding role can generate acknowledgments. In these cases, the translation binding role can contain transformation steps and split steps.

See Also: ["Translation Binding Role"](#) on page 3-34

Application Role

As with native events, application events are processed in a specific order. The order is determined by the construction of the application role. The application role usually contains pass-through steps and consume steps. Application roles can also generate acknowledgments instead of the translation binding role. Application role ports can only be bound to application events. No port in an application role can be bound to a native event or business event.

See Also: ["Application Roles"](#) on page 3-33

Transformation Binding Role

Transformation binding roles act as a bridge between business roles and application roles. This role transforms an application event to a business event, and vice versa. This role can also consume application events and perform the error processing for transformations. For this reason, a transformation binding role typically contains transformation steps, consume steps, split steps, and condition steps. A transformation binding role can also be used in event addressing (using event header rules) and in the creation of new events.

Transformation binding role ports that are bound to an application role through a data flow can only be connected to application events. Transformation binding role ports bound to a business role through a data flow can only be connected to business events.

See Also: ["Transformation Binding Role"](#) on page 3-41

Business Role

As with native events and application events, business events must be processed in a predetermined order. A business role describes the processing of business events. The business role also isolates the business process from the rest of the processing and determines the branching of events (see data flow criteria). The business role typically contains pass-through steps and consume steps. This role can also contain transformation steps to generate new business events.

Business role ports can only be bound to business events. No port in a business role can be bound to a native event or application event.

See Also: ["Business Roles"](#) on page 3-40

Table 12-4 identifies the role management tasks shown in Figure 12-16 on page 12-40 and provides references to procedures for performing these tasks.

Table 12-4 Role Management Tasks

Roles Page Elements	Management Task	First See Section...	Then See Section...
Shortcuts section in Native Roles page of Figure 12-16	Take a shortcut to: <ul style="list-style-type: none"> Create business process and role metadata with the modeling wizards Manage event types and datatypes 	N/A	<ul style="list-style-type: none"> "Modeling Wizards Concepts Overview" on page 9-2 "Managing Native Event Types" on page 11-37
Create button in Native Roles page of Figure 12-16	Create a role	"Accessing Role Management Tasks" on page 12-44	"Creating a Role" on page 12-44
Delete column in Native Roles page of Figure 12-16	Delete a role		"Deleting a Role" on page 12-45
Update column in Native Roles page of Figure 12-16	Update a role		"Updating a Role" on page 12-46
Name column in Native Roles page of Figure 12-16 (To access the details page shown in the lower page of Figure 12-16)	View details about a role		"Viewing a Role" on page 12-46

See Also: The following sections for conceptual details about the different roles types:

- "Native Roles" on page 3-23
- "Application Roles" on page 3-33
- "Translation Binding Role" on page 3-34
- "Business Roles" on page 3-40
- "Transformation Binding Role" on page 3-41

Accessing Role Management Tasks

Follow these instructions to access the role management tasks shown in [Figure 12-16](#) on page 12-40:

To access role management tasks:

1. Select the **Modeling** tab.
2. Select the **Roles** tab.
The Business Roles page appears by default.
3. If you want to manage a role other than a business role, select one of the following types at the top of the page:
 - **Application Roles**
 - **Native Roles**
 - **Binding Roles**
4. Select a task to perform and see the referenced section for instructions:

To...	Then...	See Section...
Create a role	Click Create .	"Creating a Role" on page 12-44
Delete a role	Select a specific role in the Delete column.	"Deleting a Role" on page 12-45
Update a role	Select a specific role in the Update column.	"Updating a Role" on page 12-46
View details about a role	Select a specific role in the Name column.	"Viewing a Role" on page 12-46

Creating a Role

Follow these instructions to create a role:

To create a role:

1. Ensure that you followed the instructions in ["Accessing Role Management Tasks"](#) on page 12-44 to access the page for creating a role.

The Create *type* Role page appears.

where *type* is native, application, binding, or business.

2. Enter a unique and recognizable name for the role in the **Name** field (for example, `expense-NR`).
3. Enter an optional description in the **Description** field.
4. Click **Apply**.

The role is created and the *type* Role Details : *name* page for the new role appears. This page enables you to manage ports, data flows, and steps, and view diagrams of the role. From the step page (accessible from the *type* Role Details : *name* page), you can manage step ports, step data flows, and step control flows.

5. View a graphical status of the role by selecting the following diagrams at the bottom of the *type* Role Details : *name* page.

Diagram	See Section...
Integration Diagram	"Viewing an Integration Diagram" on page 12-15
Event Flow Diagram	"Viewing an Event Flow Diagram" on page 12-18
Process Diagram	"Viewing a Process Diagram" on page 12-23

6. Repeat these steps to create any necessary translation binding, application, transformation binding, and business roles.

Deleting a Role

Follow these instructions to delete a role:

Caution: Deleting a role also deletes any associated steps, data ports, data flow groups, and control flow.

To delete a role:

1. Ensure that you followed the instructions in ["Accessing Role Management Tasks"](#) on page 12-44 to access the page for deleting a role.
2. Click **Yes** when prompted to delete a role.

The role is deleted and the *type* Role page appears.

Updating a Role

Follow these instructions to update a role:

To update a role:

1. Ensure that you followed the instructions in "[Accessing Role Management Tasks](#)" on page 12-44 to access the page for updating a role.

The Update *type* Role page appears.

2. Make appropriate changes. (See Step 2 on page 12-45 through Step 3 on page 12-45 of "[Creating a Role](#)" for a list of fields that you can update.)
3. Click **Apply**.

The role is updated and the *type* Role Details : *name* page for the updated role appears.

Viewing a Role

Follow these instructions to view details about a specific role:

To view a role:

1. Ensure that you followed the instructions in "[Accessing Role Management Tasks](#)" on page 12-44 to access the page for viewing a role.

The *type* Role Details : *name* page appears for the selected role (in this example, a native role).

Native Role Details : expense-NR

[Delete](#) [Update](#)

Details

Description
State **Draft**

Data Ports

[Return to Top](#)

[Create](#)

Name	Direction	Event	Interaction	bound in data flow group	Update	Delete
expense-IN	Input	NE : expense	ReadFile(expense) - Inbound			
expense-OUT	Output	NE : expense		expense-NR-TL		

Data Flow Groups

[Return to Top](#)

[Create](#)

Name	Other Role	Role Type	Update	Delete
expense-NR-TL	expense-TL	Binding Role		

Steps

[Return to Top](#)

[Create](#)

Name	Type	Update	Delete
End	End		
Passthrough expense	Pass-through		
Start	Start		

Diagrams

[Return to Top](#)

[Integration Diagram](#)
[Event Flow Diagram](#)
[Process Diagram](#)

- View specific details, including the role ports (under the **Data Ports** section), data flow (under the **Data Flow Groups** section), and steps (under the **Steps** section) associated with this role.

This page, as with the *type* Roles page shown in the upper figure of [Figure 12-16](#) on page 12-40, enables you to delete or update the selected role.

- Click **Return to List** to return to the *type* Roles page.

Managing Role Ports

The Oracle Application Server ProcessConnect user interface tool enables you to perform the role port management tasks shown in Figure 12–17. These tasks are described in detail in this section. Role ports represent an input or output parameter of a role containing events. Role ports of roles are connected together by role data flow. This enables events to move from role to role.

Figure 12–17 Role Port Management Tasks (Part 1 of 2)

Native Role Details : expense-NR

[Delete](#) [Update](#)

Details

Description
State **Draft**

Data Ports

[Return to Top](#)

[Create](#)

Name	Direction	Event	Interaction	bound in data flow group	Update	Delete
expense-IN	Input	NE : expense	ReadFile(expense) - Inbound			
expense-OUT	Output	NE : expense		expense-NR-TL		

Data Flow Groups

[Return to Top](#)

[Create](#)

Name	Other Role	Role Type	Update	Delete
expense-NR-TL	expense-TL	Binding Role		

Steps

[Return to Top](#)

[Create](#)

Name	Type	Update	Delete
End	End		
Passthrough expense	Pass-through		
Start	Start		

Selecting a role port in the **Name** column of the **Data Ports** section causes a details page such as that shown in [Figure 12–18](#) to appear.

Figure 12–18 Role Port Management Tasks (Part 2 of 2)

Data Port Details : expense-OUT

Delete Update

Details

Description
 Owner (Role) expense-NR
 Owner Type Native Role
 Direction Output
 Event expense
 Classification Native Event Type
 State **Draft**

Data Flows Between Roles

 **TIP** To create a data flow with a port in another role, you must create or update a DataFlowGroup

Direction	Port	Owner	Owner Type	Data Flow Group	Delete
flows to	expense-IN	expense-TL	Binding Role	expense-NR-TL	

Data Flows Within Role

Create

Direction	Port	Owner	Owner Type	Delete
flows from	expense-OUT	Passthrough expense	Pass-through	

Table 12-5 identifies the role port management tasks shown in Figure 12-17 and Figure 12-18 and provides references to procedures for performing these tasks.

Table 12-5 Role Port Management Tasks

Page Elements	Management Task	First See Section...	Then See Section...
Create button in Data Ports section of Figure 12-17	Create a role port	"Accessing Role Port Management Tasks" on page 12-51	"Creating a Role Port" on page 12-52
Delete column in Data Ports section of Figure 12-17	Delete a role port		"Deleting a Role Port" on page 12-54
Update column in Data Ports section of Figure 12-17	Update a role port		"Updating a Role Port" on page 12-54
Name column in Data Ports section of Figure 12-17 (To access details page shown in Figure 12-18)	View details about a role port		"Viewing a Role Port" on page 12-55
Create button in Data Flows Within Role section of Figure 12-18	Create a data flow between a role port and a step port		"Creating a Data Flow Between a Role Port and a Step Port" on page 12-56
Delete column in Data Flows Within Role section of Figure 12-18	Delete a data flow between a role port and a step port		"Deleting a Data Flow Between a Role Port and a Step Port" on page 12-57

See Also:

- "Role Ports" on page 3-28 for conceptual details about role ports
- "Creating a Role Data Flow Group" on page 12-62 for creating a data flow between roles like that shown in the **Data Flows Between Roles** section of the Data Port Details : *name* page shown in Figure 12-18 on page 12-49
- The Manage Role Ports section of Figure 12-1 on page 12-3 for the graphical location of role ports

Accessing Role Port Management Tasks

Follow these instructions to access the role port management tasks shown in [Figure 12-17](#) on page 12-48 and [Figure 12-18](#) on page 12-49:

To access role port management tasks:

1. Select the **Modeling** tab.
2. Select the appropriate tab:

If You Select the...	This Page Appears...	Go To Step...
Roles tab	Business Roles page	3
Business Processes tab	Business Processes page	4

3. If you want to manage a role other than a business role, select one of the following types at the top of the page:
 - **Application Roles**
 - **Native Roles**
 - **Binding Roles**
4. Select the specific role or business process on which to manage role ports in the **Name** column.

The details page for the selected role or business process appears.

5. Go to the **Data Ports** section. (See [Figure 12-17](#) on page 12-48.)
6. Select a task to perform and see the referenced section for instructions:

To...	Then...	See Section...
Create a role port	Click Create .	"Creating a Role Port" on page 12-52
Delete a role port	Select a specific role port in the Delete column.	"Deleting a Role Port" on page 12-54
Update a role port	Select a specific role port in the Update column.	"Updating a Role Port" on page 12-54
View details about a role port	Select a specific role port in the Name column.	"Viewing a Role Port" on page 12-55

To...	Then...	See Section...
Create a data flow within a role	Select a specific role port in the Name column with which to create a data flow with a step port.	"Creating a Data Flow Between a Role Port and a Step Port" on page 12-56
Delete a data flow within a role	Select a specific role port in the Name column from which to delete a data flow with a step port.	"Deleting a Data Flow Between a Role Port and a Step Port" on page 12-57

You can also manage some aspects of role ports from within a Process Diagram or Step Binding Diagram.

See Also: ["Viewing a Process Diagram"](#) on page 12-23 and ["Viewing a Step Binding Diagram"](#) on page 12-28 for details on role port management capabilities

Creating a Role Port

Follow these instructions to create a role port:

To create a role port:

1. Ensure that you followed the instructions in ["Accessing Role Port Management Tasks"](#) on page 12-51 to access the page for creating a role port.

The Create Data Port on Role *name* page appears.

2. Enter a unique and recognizable role port name in the **Name** field. (for example, `expense-OUT`)
3. Enter an optional description.
4. Select **Input** or **Output** from the **Direction** list. For example, select **Input** for this role port to receive inbound event data.
5. If you want to automatically create two ports with a pass-through step in between, select the **with pass-through** box.

Pass-through steps send events to the next role without any processing. These steps are useful when no processing other than sending events is required. This option automatically creates two ports in the role:

- The first port accepts an inbound event and passes it through a pass-through step.
- The second port receives the event on the other side of the pass-through step and passes it to the outbound port of the role.

If you do not select this box, you must manually create the second port and the step in between at a later time.

6. Go to the **Assign Port Type** section to select an event (or native role interaction) for this port.
7. Select either **Application Event**, **Business Event**, or **Native Event** from the **Classification** list. For example, if you are creating a port for a native role, select **Native Event Type**.
8. Click the flashlight next to the **Name** field of the **Assign Port Type** section.
9. Select the event type and click **Select**. For example, select **expense**.
Your selection appears in the **Name** field.
10. If you are creating a role port for a native role, you can select an interaction from the **Interaction** list. The **Interaction** list contains only complete interactions. This selection assigns the native event to the port. A port associated with an interaction sends and receives events to and from the adapter. Ports not associated with an interaction send and receive events to and from the translation binding role. In these cases, the ports are associated with a data flow group.
11. Click **Apply**.
The role port is created and the Data Port Details : *name* page for the new role port of the role appears.
12. Select **Event Flow Diagram** at the bottom of the Data Port Details : *name* page.
13. Select **Ports** from the **Role Contents** list in the **Display Options** section and click **Refresh** to display graphical details about the role port.
14. Repeat these steps to create any necessary ports.

Deleting a Role Port

Follow these instructions to delete a role port:

To delete a role port:

Caution: Deleting a role port also deletes the data flows to another role or to a step within a role or business process.

1. Ensure that you followed the instructions in "[Accessing Role Port Management Tasks](#)" on page 12-51 to access the page for deleting a role port.
2. Click **Yes** when prompted to delete a role port.

The role port is deleted and the *type* Role Details : *name* page appears.

Updating a Role Port

Note: If you change the event type of a port, but the port has a data flow to another port of a different event type, then an error occurs. You must first update the event type of the other port or delete the data flow between the ports.

Follow these instructions to update a role port:

To update a role port:

1. Ensure that you followed the instructions in "[Accessing Role Port Management Tasks](#)" on page 12-51 to access the page for updating a role port.

The Update Data Port on Role *name* page appears.

2. Make appropriate changes. (See Step 2 on page 12-52 through Step 10 on page 12-52 of "[Creating a Role Port](#)" for a list of fields that you can update.)
3. Click **Apply**.

The role port is updated and the Data Port Details : *name* page for the updated role port appears.

Viewing a Role Port

Follow these instructions to view details about a specific role port:

To view a role port:

1. Ensure that you followed the instructions in "[Accessing Role Port Management Tasks](#)" on page 12-51 to access the page for viewing a role port.

The Data Port Details : *name* page for the selected role port appears.

Data Port Details : expense-OUT

Delete Update

Details

Description
 Owner (Role) expense-NR
 Owner Type Native Role
 Direction Output
 Event expense
 Classification Native Event Type
 State **Draft**

Data Flows Between Roles

TIP To create a data flow with a port in another role, you must create or update a DataFlowGroup

Direction	Port	Owner	Owner Type	Data Flow Group	Delete
flows to	expense-IN	expense-TL	Binding Role	expense-NR-TL	

Data Flows Within Role

Create

Direction	Port	Owner	Owner Type	Delete
flows from	expense-OUT	Passthrough expense	Pass-through	

2. View specific details, including the role ports in another role with which this role port is associated and the step ports in this role with which this role port is associated. If this is a native role port associated with an interaction, an **Interaction** field appears under the **Details** section.

This page, as with the *type* Role Details : *name* page shown in [Figure 12-17](#) on page 12-48, enables you to delete or update the selected role port.

Creating a Data Flow Between a Role Port and a Step Port

Follow these instructions to create a data flow between a role port and a step port:

To create a data flow between a role port and a step port:

1. Ensure that you followed the instructions in "[Accessing Role Port Management Tasks](#)" on page 12-51 to access the page for creating a data flow between a role port and a step port.

The Data Port Details : *name* page appears. (See [Figure 12–18](#) on page 12-49.)

2. Go to the **Data Flows Within Role** section.
3. Click **Create**.

The Create Data Flow page appears with a list of compatible ports. Ports that are compatible for data flow have the following characteristics:

- There is a compatible direction. For example, if the port on the role is an input port, then the port on the step must also be an input port (the same direction).
- They must be of the same event type, or a port that has no event type can be data flow-bound to a port with any (or no) datatype.
- The step port must not already be data flow-bound to any other port.

When a data flow is created between a port to which a datatype or event type is already assigned and a port to which no type is assigned, the port with no assigned type inherits the type of the assigned port (either datatype or event type).

4. Select the step with which to create a data flow in the **Select** column (for example, a step port called **expense-OUT** in a pass-through step).
5. Click **Apply**.

The Data Port Details : *name* page appears. The data flow you created appears in the **Data Flows Within Role** section.

6. If this is a Data Port Details : *name* page for a step, select **Process Diagram** or **Step Binding Diagram** at the bottom of the page. If this is a Data Port Details : *name* page for a role, select **Process Diagram** at the bottom of the page.
7. Click inside the **expense-OUT** role port.

The Step Binding diagram displays the **expense-OUT** output role port connected through a data flow with the **expense-OUT** step port of a pass-through step.

8. Repeat these steps to create any necessary data flows within this role or on other roles.

Deleting a Data Flow Between a Role Port and a Step Port

Follow these instructions to delete a data flow between a role port and a step port:

To delete a role port a data flow between a role port and a step port:

1. Ensure that you followed the instructions in "[Accessing Role Port Management Tasks](#)" on page 12-51 to access the page for deleting a data flow.

The Data Port Details : *name* page appears.

2. Go to the **Data Flows Within Role** section.
3. Select a data flow within a role to delete in the **Delete** column.
4. Click **Yes** when prompted to delete a data flow between a role port and a step port.

The data flow is deleted and the Data Port Details : *name* page appears.

Managing Role Data Flow

The Oracle Application Server ProcessConnect user interface tool enables you to perform the role data flow management tasks shown in [Figure 12–19](#). These tasks are described in detail in this section. Role data flows connect the role ports of roles together, which enable events to move from role to role.

Figure 12–19 Role Data Flow Management Tasks

Native Role Details : expense-NR [Delete](#) [Update](#)

Details

Description
State **Draft**

Data Ports [Return to Top](#) [Create](#)

Name	Direction	Event	Interaction	bound in data flow group	Update	Delete
expense-IN	Input	NE : expense	ReadFile(expense) - Inbound			
expense-OUT	Output	NE : expense		expense-NR-TL		

Data Flow Groups [Return to Top](#) [Create](#)

Name	Other Role	Role Type	Update	Delete
expense-NR-TL	expense-TL	Binding Role		

Steps [Return to Top](#) [Create](#)

Name	Type	Update	Delete
End	End		
Passthrough expense	Pass-through		
Start	Start		

Diagrams [Return to Top](#)

[Integration Diagram](#)
[Event Flow Diagram](#)
[Process Diagram](#)

A data flow group is a collection of role data flows between any two given roles. During runtime, data flow groups route events when a role can be connected to more than one role. Data flow criteria is used by the runtime to choose the data flow to use when the same port is the source for more than one data flow.

For example, a company's purchasing system is connected to two trading partners (for this example, TP1 and TP2). If both trading partners use the same business-to-business (B2B) protocol, purchase order processing is the same and the same set of roles is used. A third trading partner is then added that uses a different protocol. For the third trading partner, a different transformation, translation, and set of roles are required. In this case, purchase order processing is the same until transformation is performed. The business role outbound port is connected to a port of a transformation binding role (named TBR1, for example). When a third partner is added (for this example, TP3), the same outbound port of the business role must be connected to a port of a different transformation binding role (named TBR2, for example) containing the new transformation.

Data flow criteria enables you to achieve this requirement. For example, there are two data flow groups:

- DFG1 (between the business role and the first transformation binding role named TBR1)
- DFG2 (between the business role and the second transformation binding role named TBR2)

During design, you specify the conditions during which to use DFG1 and during which to use DFG2. These conditions are specified by setting a data flow criteria for the data flow group. In this scenario, DFG2 is used by the third trading partner (TP3) only.

DFG1 is used by trading partners TP1 and TP2. The data flow criteria for DFG2 is set to the third trading partner. There is no criteria required for DFG1, as this is the default.

If an additional branch is required, the same procedure is followed. When more than one data flow group is associated with a criteria, the priority is also specified. Oracle Application Server ProcessConnect then executes the criteria in the same order for every integration. Oracle Application Server ProcessConnect currently supports only simple party-based criteria.

[Table 12-6](#) identifies the role port management tasks shown in [Figure 12-19](#) on page 12-58 and provides references to procedures for performing these tasks.

Table 12-6 Role Data Flow Management Tasks

Page Elements	Management Task	First See Section...	Then See Section...
Create button in Data Flow Groups section of Figure 12-19	Create a role data flow group	"Accessing Role Data Flow Management Tasks" on page 12-60	"Creating a Role Data Flow Group" on page 12-62
Delete column in Data Flow Groups section of Figure 12-19	Delete a role data flow		"Deleting a Role Data Flow" on page 12-67
Update column in Data Flow Groups section of Figure 12-19	Update a role data flow		"Updating a Role Data Flow" on page 12-67
Other Role column in Data Flow Groups section of Figure 12-19	View the other role to which the role data flow is connected		"Viewing the Other Role Connected to the Role Data Flow" on page 12-68
Name column in Data Flow Groups section of Figure 12-19	View details about a role data flow		"Viewing a Role Data Flow" on page 12-69

See Also:

- ["Data Flow"](#) on page 3-29 for conceptual details about role data flow
- The Manage Role Data Flows section of [Figure 12-1](#) on page 12-3 for the graphical location of role data flows

Accessing Role Data Flow Management Tasks

Follow these instructions to access the role data flow management tasks shown in [Figure 12-19](#) on page 12-58:

To access role data flow management tasks:

1. Select the **Modeling** tab.

2. Select the appropriate tab:

If You Select the...	This Page Appears...	Go To Step...
Roles tab	Business Roles page	3
Business Processes tab	Business Processes page	4

3. If you want to manage a role other than a business role, select one of the following types at the top of the page:
 - **Application Roles**
 - **Native Roles**
 - **Binding Roles**
4. Select the specific role or business process on which to manage role data flow in the **Name** column.
The details page for the selected role or business process appears.
5. Go to the **Data Flow Groups** section. (See [Figure 12-19](#) on page 12-58.)
6. Select a task to perform and see the referenced section for instructions:

To...	Then...	See Section...
Create a role data flow group	Click Create .	"Creating a Role Data Flow Group" on page 12-62
Delete a role data flow	Select a specific role data flow in the Delete column.	"Deleting a Role Data Flow" on page 12-67
Update a role data flow	Select a specific role data flow in the Update column.	"Updating a Role Data Flow" on page 12-67
View the other role to which the role data flow is connected	Select a specific role in the Other Role column.	"Viewing the Other Role Connected to the Role Data Flow" on page 12-68
View details about a role data flow	Select a specific role data flow in the Name column.	"Viewing a Role Data Flow" on page 12-69

Creating a Role Data Flow Group

A data flow group is a collection of all the data flows between two roles. Two roles are bound both by a data flow group (as seen in the Integration Diagram) and by one or more data flows (as seen in the Event Flow Diagram).

Two roles have only a single data flow group between them. You use the Create Data Flow Group page described in this section to create a data flow group and one or more data flows. If you need to add more data flows after the data flow group is created, use the Update Data Flow Group page described in "[Updating a Role Data Flow](#)" on page 12-67. Data flows within a role (that is, role to step and step to step data flows) are not grouped into data flow groups. These data flows belong to the role itself.

If you are creating a data flow group between a business role and a transformation binding role, you can also optionally provide a data flow criteria for this group. This feature enables the business role to be data flow-bound more than once to different transformation binding roles (in different data flow groups with different data flow criteria for each). A data flow criteria is defined by specifying a party (application or trading partner) and a priority value that determines the order of execution. For example, your organization may be conducting business with two parties. One party has slightly different transformation requirements than the other party. You can create one data flow group from the business role that branches to one transformation binding role for one party, and another data flow group that branches to another transformation binding role for the other party. You specify a priority value for the data flow group of the party that you want to execute first. For the other party, known as the default data flow group, you do not specify a priority value. The Integration Diagram shows this role branching and displays the criteria for each branch.

You can set the party before (the typical method) or during design time for data flow criteria. If you know the party at design time, use the SetParty step and explicitly route an event to an outbound spoke. If the party is not known at design time, use the transformation step in the transformation binding role of the inbound spoke to set the party into the event header, and then use the data flow criteria on the data flow group between the outbound business role and (multiple) outbound transformation binding roles to choose the correct spoke by party.

Follow these instructions to create a role data flow group and one or more data flows, and also to optionally create a data flow criteria between a business role and a transformation binding role.

To create a role data flow group:

1. Ensure that you followed the instructions in "[Accessing Role Data Flow Management Tasks](#)" on page 12-60 to access the page for creating a role data flow group.

The first Create Data Flow Group page appears.

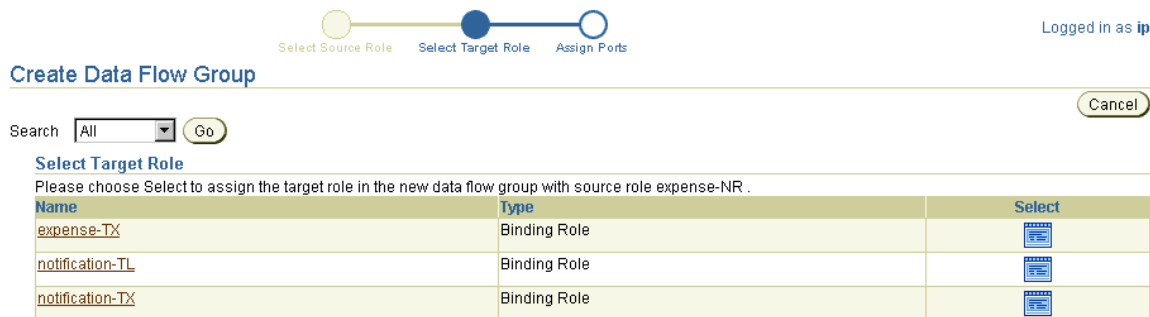

This page enables you to select the target role to connect with a data flow group to the source role selected in Step 4 on page 12-61 (for this example, native role **approval-NR**). After complete, the data flow group connects the role port of this role (the source role) and the role port of another role (the target role).

2. Select a target role in the **Select** column. The list is filtered to display only those roles to which the data flow group for this role can connect. For example:

Source Role	Possible Target Role
Native role	Binding roles
Binding role	Native roles, application roles, and business roles
Application role	Binding roles
Business role	Binding roles and business processes
Business process	Business roles

3. If, for example, the specified direction is for inbound events, and the out port is for native role **expense-NR** role, select the **expense-TL** translation binding role for the target role.

The second Create Data Flow Group page appears. The fields that display are based on the type of roles for which you are creating a data flow group.

4. If you are creating a data flow group between any roles except for a business role and a transformation binding role, perform Step 4a through Step 4c. Otherwise, go to Step 5.

Create Data Flow Group

Enter data flow attributes and then assign ports.

* Indicates required field

* Name

Description

Assign Ports

Please choose a target port for the source ports and choose Create Data Flow Group.

Event	Available Ports on Role expense-NR	Direction	Available Ports on Role expense-TX
NE : expense	expense-IN	Input from	<input type="text" value="No compatible unbound ports"/>

- a. Enter a name for the data flow group to connect the role port of the source role **expense-NR** and the role port of the target role (**expense-NR-TL** for this example).
 - b. Enter an optional description.
 - c. Go to Step 6.
5. If you are creating a data flow group between a business role and a transformation binding role, perform Step 5a through Step 5e to create a data flow criteria.

Create Data Flow Group

Cancel Create Data Flow Group

Enter data flow attributes and then assign ports.

* Indicates required field

Name

Description

Criteria

Select Data Flow Group Criteria (default data flow group has no criteria)

Party

Priority

Assign Ports

Please choose a target port for the source ports and choose Create Data Flow Group.

Event	Available Ports on Role approval-BR	Direction	Available Ports on Role Read_File-TX
BE : expense	expense-OUT	Output to	<input type="text" value="No compatible unbound ports"/>
BE : expense	expense2-OUT	Output to	<input type="text" value="No compatible unbound ports"/>

- a. Enter a name for the data flow group to connect the source role and target role.
- b. Enter an optional description.
- c. If you want to use data flow criteria, select a party from the **Party** list (an application or trading partner).
- d. If you want to use data flow criteria, enter a unique numeric value in the **Priority** field. Entering a value of 1 ensures that this data flow group is executed first. Note that you must leave the **Priority** field blank for at least one data flow group. For example, if you are creating three data flow groups, leave the **Priority** field blank for one of the data flow groups; this becomes the default data flow group.
- e. Go to Step 6.

6. Go to the **Assign Ports** section. For each port in the source role, a list of target role ports that are compatible for data flow is provided. Compatible for data flow means that the ports have the following characteristics:
 - There is a compatible direction. For example, if the port on one role is an input port, then the port on the other role must be an output port, and vice versa.
 - They must be of the same event type, or a port that has no event type can be data flow-bound to a port with any (or no) datatype.
 - The port must not already be data flow-bound to another role port. The only exception is a data flow group between a business role and a transformation binding role, which allows the same port in the business role to be data flow-bound more than once to ports in different binding roles (in different data flow groups that have different data flow criteria for each).

When a data flow is created between a port to which a datatype or event type is already assigned and a port to which no type is assigned, the port with no assigned type inherits the type of the assigned port (either datatype or event type).

7. Select a role port for the target role from the **Available Ports on Role *target_role*** list. This is the target role you selected in Step 2.

Selection	Description
No compatible unbound ports	Displays when the selected target role has no ports that match the rules described in Step 6 on page 12-66.
Create new role port	Creates a new port on the target role and creates the data flow to it. The created port is compatible in that it has the same event type as the source port and is of the opposite direction.
Create new role ports with pass-through step	The same as Create new role port , plus it creates the pass-through step, the step ports, the role port on the other side, and the data flow groups between the step and role ports.

8. Click **Create Data Flow Group**.

This creates a data flow group between the role port of the source role and the role port of the target role. The Data Flow Group Details : *name* page for the created data flow appears.

See Also: ["Creating an Event Header Rule"](#) on page 13-78

Deleting a Role Data Flow

Follow these instructions to delete a role data flow:

To delete a role data flow:

Caution: Deleting a role data flow can leave role ports disconnected.

1. Ensure that you followed the instructions in ["Accessing Role Data Flow Management Tasks"](#) on page 12-60 to access the page for deleting a role data flow.
2. Click **Yes** when prompted to delete a role data flow.

The role data flow is deleted and the *type* Role Details : *name* page appears.

Updating a Role Data Flow

You can update role data flow from this page by adding new data flows or deleting data flows by deselecting them. Follow these instructions to update a role data flow:

To update a role data flow:

1. Ensure that you followed the instructions in ["Accessing Role Data Flow Management Tasks"](#) on page 12-60 to access the page for updating a role data flow.

The Update Data Flow Group page appears.

2. Make appropriate changes. (See Step 2 on page 12-63 through Step 7 on page 12-66 of ["Creating a Role Data Flow Group"](#) for a list of fields that you can update.)
3. Click **Update Data Flow Group**.

The role data flow is updated and the Data Flow Group Details : *name* page for the updated role data flow appears.

Viewing the Other Role Connected to the Role Data Flow

Follow these instructions to view details about the other role (the target role) connected to the role data flow:

To view the other role connected to the role data flow:

1. Ensure that you followed the instructions in "[Accessing Role Data Flow Management Tasks](#)" on page 12-60 to access the page for viewing the target role connected with role data flow to the source role.

The *type* Role Details : *name* page appears (for example, if the other role was a binding role):

Binding Role Details : expense-TL

[Delete](#) [Update](#)

Details

Description
State **Draft**

Data Ports

[Return to Top](#)

[Create](#)

Name	Direction	Event	bound in data flow group	Update	Delete
expense-IN	Input	NE : expense	expense-NR-TL		
expense-OUT	Output	AE : expense	expense-TL-AR		

Data Flow Groups

[Return to Top](#)

[Create](#)

Name	Other Role	Role Type	Update	Delete
expense-NR-TL	expense-NR	Native Role		
expense-TL-AR	expense-AR	Application Role		

Steps

[Return to Top](#)

[Create](#)

Name	Type	Update	Delete
End	End		
Start	Start		
Translate expense	Translation Step		

Diagrams

[Return to Top](#)

[Integration Diagram](#)
[Event Flow Diagram](#)
[Process Diagram](#)

2. View specific details, including the other role connected to the current role by the role data flow group, by clicking a role in the **Other Role** column.

Viewing a Role Data Flow

Follow these instructions to view details about a specific role data flow:

To view a role data flow:

1. Ensure that you followed the instructions in "[Accessing Role Data Flow Management Tasks](#)" on page 12-60 to access the page for viewing a role data flow.

The Data Flow Group Details : *name* page for the selected role data flow appears.

Data Flow Group Details : approval-NR-TL

Details

Description
 from Role approval-NR
 to Role approval-TL

Data Flows [Return to Top](#)

To create or update a data flow choose Update for the data flow group.

Owner	Port	Event	Direction	Port	Owner	Owner Type	Delete
approval-NR	RequestPurchaseOrder-OUT	NE : RequestPurchaseOrder	flows to	RequestPurchaseOrder-IN	approval-TL	Binding Role	

Diagrams [Return to Top](#)

[Integration Diagram](#)
[Event Flow Diagram](#)

2. View specific details, including the roles with which this role data flow is associated. This page enables you to perform the following tasks from this page:
 - a. Delete a data flow group by clicking **Delete** at the top of the page. Deleting the data flow group also deletes all the data flows belonging to it.
 - b. Update a data flow by clicking **Update**. The Update Data Flow group page enables you to add new data flows or delete data flows by deselecting them.
 - c. Delete an individual data flow by clicking **Delete** in the **Delete** column.

Managing Steps

The Oracle Application Server ProcessConnect user interface tool enables you to perform the step management tasks shown in [Figure 12–20](#). These tasks are described in detail in this section.

Figure 12–20 Step Management Tasks

Native Role Details : expense-NR [Delete](#) [Update](#)

Details

Description
State **Draft**

Data Ports [Return to Top](#)

[Create](#)

Name	Direction	Event	Interaction	bound in data flow group	Update	Delete
expense-IN	Input	NE : expense	ReadFile(expense) - Inbound			
expense-OUT	Output	NE : expense		expense-NR-TL		

Data Flow Groups [Return to Top](#)

[Create](#)

Name	Other Role	Role Type	Update	Delete
expense-NR-TL	expense-TL	Binding Role		

Steps [Return to Top](#)

[Create](#)

Name	Type	Update	Delete
End	End		
Passthrough expense	Pass-through		
Start	Start		

Diagrams [Return to Top](#)

[Integration Diagram](#)
[Event Flow Diagram](#)
[Process Diagram](#)

Each role and business process consists of a set of steps. A step defines execution logic that is applied to one or more events or control flows and data flows in a role. There are two types of steps:

- Steps that process events: pass-through, translation, transformation, condition, consume, split, and SetParty
- Steps that manage control flows: Start, End, Or, and And

Some of these steps have ports that represent the input and output parameters. Steps with ports can have data flows associated with these ports. In addition, steps can have incoming and outgoing control flows.

See Also: ["Data Flow"](#) on page 3-29 and ["Control Flow"](#) on page 3-29

Types of Steps

This section provides details about each step type that you can create and design:

- [Start Step](#)
- [End Step](#)
- [Pass-through Step](#)
- [Transformation Step](#)
- [Translation Step](#)
- [Condition Step](#)
- [SetParty Step](#)
- [Consume Step](#)
- [Split Step](#)
- [Or Step](#)
- [And Step](#)

Start Step

This step is a pseudo-step that indicates the start of a role. It is automatically created when a new role is created.

Supported Ports This step has no IN ports and no OUT ports.

Supported Control Flows and Data Flows There can be any number of outgoing control flows from this step. This step can have no incoming control flows or data flows.

Supported Roles This step must exist in every role in the integration.

Execution This step is executed after the role has an event on its initiating IN port.

End Step

This step indicates completion of role processing. This step is automatically created when a new role is created.

Supported Ports This step has no IN ports and no OUT ports.

Supported Control Flows and Data Flows There can be any number of incoming control flows coming into this step. This step cannot have any outgoing control flows or data flows.

Supported Roles This step must exist in every role in the integration.

Execution This step is executed after all incoming control flows have been executed. After execution of this step, the role processing is complete and the role instance is marked as `WorkflowComplete`. If all events on the outbound ports of the role have been picked up as well, then the role instance is `Complete`.

Pass-through Step

This step passes through the event or datatype on its IN port to its OUT port. The event contents are not altered.

See Also: ["Error Handling with Step Return Code Ports"](#) on page 21-4 for an example of a role that uses a pass-through step

Supported Ports This step has exactly one IN port and one OUT port. These ports can be associated with an event type or a datatype. Both the IN port and the OUT port must be associated with the same event type or datatype.

Supported Control Flows and Data Flows This step can have one incoming data flow and one outgoing data flow. There can be any number of incoming control flows and outgoing control flows.

Supported Roles This step is typically used in the native role, application role, or business role if there is no party-specific event processing required. This step can be used in other roles, if required.

Execution This step is executed after all incoming control flows and data flows have executed. The event or datatype moves to the OUT port if the step successfully executes.

Transformation Step

This step transforms a set of events or datatypes into another set of events or datatypes. This step is associated with a transformation map. The transformation map parameters must correspond to the types on the IN ports and OUT ports. The events or datatypes to be transformed are on the IN ports. The new events or datatypes created after transformation are put on the OUT ports.

See Also: ["Error Handling with Step Return Code Ports"](#) on page 21-4 for an example of a role that uses a transformation step

Supported Ports This step can have multiple IN ports and multiple OUT ports. These ports can be associated with an event type or a datatype (based on the return values from the transformation map). This step also has a return code port that is associated with the returnCode datatype.

Supported Control Flows and Data Flows This step can have any number of incoming control flows and outgoing control flows. Each IN port must have an incoming data flow. Each OUT port must have an outgoing data flow. Data flow from the return code port is optional.

Supported Roles This step can only operate on application datatypes or event types, or business datatypes or event types. This step is ideally used only in the transformation binding role, but it can be used in all roles except the native role.

Execution This step is executed after all incoming control flows and data flows have executed. The transformation map is invoked when there is data on all the IN ports. After the transformation step has executed, the return code port is populated with a datatype that indicates success or failure. If transformation is successful, the OUT ports and return code port are populated. If there is a failure, the OUT ports are not filled; only the return code port is populated with a datatype containing the error code and error message. The events or datatypes on the IN port are marked as consumed.

Translation Step

This step translates a native event type or datatype to an application event type or datatype, and vice versa. The IN port must be associated with the event or datatype to be translated. The OUT port must be associated with the translated event or datatype. The translation step converts the syntax from the native format to the interpretable application format, or vice versa.

The new event or datatype created after translation is put on the OUT ports.

See Also: ["Application Events and Translation"](#) on page 3-30 for additional details about translation

Supported Ports This step has one IN port and two OUT ports. There is one OUT port for the translated event or datatype and one for the return code port (which is associated with the returnCode datatype).

The IN and OUT ports can be associated with native or application event types or datatypes. If the IN port is associated with a native event type, the OUT port must be associated with the application event, and vice versa. You cannot have a datatype associated with the IN port and an event type associated with the OUT port. Both ports must be associated with either datatypes or event types.

Supported Control Flows and Data Flows This step can have one incoming data flow and one outgoing data flow. There can be any number of incoming control flows and outgoing control flows. Data flow from the return code port is optional.

Supported Roles This step is typically used in the translation binding role.

Execution This step is executed after all incoming control flows and data flows have executed. The translation is done when there is a data or event instance on the IN port. After the translation step has executed, the return code port is populated with a datatype that indicates success or failure. If translation is successful, both the OUT port and return code port are populated. If there is a failure, the OUT port is not filled, only the return code port is populated with a datatype containing the error code and error message. The event on the IN port is consumed.

Condition Step

This step evaluates a specific condition on an event type or datatype. This step is associated with a condition expression. The datatype for the IN port is automatically selected based on the datatype or event type used by the condition expression. After the condition expression is evaluated, one of the outgoing control flows (either true or false) is executed.

See Also:

- ["Designing Roles to Ensure Proper Validation"](#) on page 12-121 for examples of roles that use condition steps
- ["Error Handling with Step Return Code Ports"](#) on page 21-4 for an example of a role that uses a condition step

Supported Ports This step has one IN port and one OUT port (other than the return code port). This OUT port is a return code port associated with the returnCode datatype. The IN port can be associated with an application or business event or datatype. This is automatically selected based on the condition expression used for the step.

Supported Control Flows and Data Flows This step must have one incoming data flow. There can be any number of incoming control flows and exactly two outgoing control flows: one for true guard value and one for false guard value. Data flow from the return code port is optional.

Supported Roles This step can only operate on application datatypes or event types, or business datatypes or event types. This step is ideally used only in the transformation binding role, but can be used in all roles except the native role.

Execution This step is executed after all incoming control flows and data flows have executed. The condition expression is evaluated when there is a data or event instance on the IN port. After the condition step has executed, the return code port is populated with a datatype that indicates success or failure. If expression evaluation is complete, based on the result (true or false), one of the outgoing control flows is executed. If there is a failure when evaluating the condition expression, the outgoing control flow is not executed and the return code port is populated with a datatype containing the error code and error message.

SetParty Step

This step sets a specific destination party (application or trading partner) for an event type or datatype.

See Also: ["Selecting the Destination Party in the SetParty Step"](#) on page 7-35 for an example of a role that uses a SetParty step

Supported Ports This step has exactly one IN port and one OUT port. These ports can be associated with an event type or a datatype. Both the IN port and the OUT port are associated with the same event type or datatype.

Supported Control Flows and Data Flows This step can have one incoming data flow and one outgoing data flow. There can be any number of incoming control flows and outgoing control flows.

Supported Roles This step is typically used in the business role or business process.

Execution This step is executed after all incoming control flows and when there is data on the IN port. The event type or datatype header is updated with the destination party and then moved to the OUT port.

Consume Step

This step consumes and prevents further processing of an event or datatype. The IN port must be associated with the event or datatype to be consumed. This step is typically used to consume acknowledgments.

See Also: ["Acknowledgment Consumption and Generation"](#) on page 3-35 for an example of a role that uses a consume step

Supported Ports This step has one IN port and no OUT ports.

Supported Control Flows and Data Flows This step must have one incoming data flow. There are no outgoing data flows from this step. There can be any number of incoming control flows and outgoing control flows.

Supported Roles This step can operate on any type of event or datatype, and can be used in any role.

Execution This step is executed after all incoming control flows have executed and when there is data on the IN port. The incoming event is marked as consumed and further processing is disabled.

Split Step

This step makes multiple copies of an event. The event on the IN port is copied and the new events are placed on each of the OUT ports.

See Also: ["Error Handling with Step Return Code Ports"](#) on page 21-4 for an example of a role that uses a split step

Supported Ports This step has one IN port and multiple OUT ports. The IN port can be associated with an event or datatype.

Supported Control Flows and Data Flows Each IN port must have an incoming data flow. Each OUT port must have an outgoing data flow. There can be any number of incoming control flows and outgoing control flows.

Supported Roles This step can operate on any type of event or datatype, and can be used in any role.

Execution This step is executed after all incoming control flows have executed and when there is data on the IN port. The incoming event is marked as consumed and copies of the event are placed on the OUT ports.

Or Step

This step waits for at least one incoming control flow. The step is executed as soon as one of the incoming control flows is executed.

Supported Ports This step has no IN ports or OUT ports.

Supported Control Flows and Data Flows This step can have any number of incoming control flows and outgoing control flows. This step does not have any data flows.

Supported Roles This step can be used in any role.

Execution This step is executed after any incoming control flow has executed. In all other steps, the steps are executed only when all the incoming control flows have executed. This is the only case where the step is executed after any one of the incoming control flows. Ensure that the incoming control flows are coming from mutually exclusive paths. Otherwise, the role processing is not deterministic.

See Also: ["Designing Roles to Ensure Proper Validation"](#) on page 12-121 for examples of roles that use Or steps.

And Step

This step waits for all incoming control flows, and executes after all incoming control flows have executed. This step is not typically required since all steps (except an Or step), implicitly provide AND step behavior for the incoming control flows.

Supported Ports This step has no IN ports or OUT ports.

Supported Control Flows and Data Flows This step can have any number of incoming control flows and outgoing control flows. This step does not have any data flows.

Supported Roles This step can be used in any role.

Execution This step is executed after all of the incoming control flows have executed. Ensure that the incoming control flows are not coming from mutually exclusive paths. Otherwise, this step may never execute and role processing may halt here.

Table 12-7 identifies the step management tasks shown in Figure 12-20 on page 12-70 and provides references to procedures for performing these tasks.

Table 12-7 Step Management Tasks

Page Elements	Management Task	First See Section...	Then See Section...
Create button in Steps section of Figure 12-20	Create a step	"Accessing Step Management Tasks" on page 12-79	"Creating a Step" on page 12-81
Delete column in Steps section of Figure 12-20	Delete a step		"Deleting a Step" on page 12-85
Update column in Steps section of Figure 12-20	Update a step		"Updating a Step" on page 12-85
Name column in Steps section of Figure 12-20	View details about a step		"Viewing a Step" on page 12-86

See Also:

- "Steps" on page 3-28 for conceptual details about steps
- The Manage Steps section of Figure 12-1 on page 12-3 for the graphical location of steps

Accessing Step Management Tasks

Follow these instructions to access the step management tasks shown in Figure 12-20 on page 12-70:

To access step management tasks:

1. Select the **Modeling** tab.
2. Select the appropriate tab:

If You Select the...	This Page Appears...	Go To Step...
Roles tab	Business Roles page	3
Business Processes tab	Business Processes page	4

3. If you want to manage a role other than a business role, select one of the following types at the top of the page:
 - **Application Roles**
 - **Native Roles**
 - **Binding Roles**
4. Select the specific role or business process on which to manage a step in the **Name** column.

The details page for the selected role or business process appears.

5. Go to the **Steps** section. (See [Figure 12-20](#) on page 12-70.)
6. Select a task to perform and see the referenced section for instructions:

To...	Then...	See Section...
Create a step	Click Create .	"Creating a Step" on page 12-81
Delete a step	Select a step in the Delete column.	"Deleting a Step" on page 12-85
Update a step	Select a specific step in the Update column.	"Updating a Step" on page 12-85
View details about a step	Select a specific step in the Name column.	"Viewing a Step" on page 12-86

You can also manage steps from within a Process Diagram or Step Binding Diagram.

See Also: ["Viewing a Process Diagram"](#) on page 12-23 and ["Viewing a Step Binding Diagram"](#) on page 12-28 for details on step management

Creating a Step

Follow these instructions to create a step:

Note: Each business process or role automatically includes a Start and End step to indicate the beginning and end of a step. You cannot manually create these two steps. These steps have no in and out ports.

To create a step:

1. Ensure that you followed the instructions in "[Accessing Step Management Tasks](#)" on page 12-79 to access the page for creating a step.

The Create Step in Role *name* page appears.

2. Enter a unique and recognizable name for the step in the **Name** field (for example, `Passthrough_expense`).
3. Enter an optional description in the **Description** field.
4. Review the following step types. The step types available for creation are based on the type of role or business process in which you are creating the step.

Step	Native Role	Translation Binding Role	Application Role	Transformation Binding Role	Business Role	Business Process
And	Yes	Yes	Yes	Yes	Yes	Yes
Condition	No	Yes	Yes	Yes	Yes	Yes
Consume	Yes	Yes	Yes	Yes	Yes	Yes
Or	Yes	Yes	Yes	Yes	Yes	Yes
Pass-through	Yes	Yes	Yes	Yes	Yes	Yes
SetParty	No	No	No	No	Yes	Yes
Split	Yes	Yes	Yes	Yes	Yes	Yes
Transformation	No	Yes	Yes	Yes	Yes	Yes
Translation	No	Yes	Yes	Yes	No	No

5. Select a step from the **Type** list based on the types described in ["Types of Steps"](#) on page 12-71 (for this example, **Pass-through** is selected).

The page refreshes based on the step type selected in Step 5.

For most steps that have both an input and output port, the ports must have the same event type or datatype. For example, a SetParty step or pass-through step have input and output ports of the same event or datatype. The only exceptions to this are the transformation and translation steps, which can convert the event or datatype between the in and out ports.

6. If you selected one of the following steps, additional lists appear and prompt you for a selection.
7. Make a selection from the list for your step type. Otherwise, go to Step 8.

If You Select...	Then...
Condition step	Select the condition expression to use from the Condition Expression list. A port is created for each parameter in the condition expression. This is the condition expression you created in "Managing Condition Expressions in Steps" on page 12-108.
SetParty Step	Select the destination party (trading partner or application) to use from the Party list. See Also: "Creating an Application" on page 15-5 and "Creating a Remote Trading Partner" on page 26-9 (The host trading partner automatically displays for selection in the Party list.)
Transformation Step	Select the datatype transformation map (for example, copy:from=string->to=string) to use from the Transformation Map list. A port is created for each parameter in the transformation map. See Also: "Managing Transformation Statements" on page 13-29

8. Go to the **Control Flows** section. Control flows between steps define the execution order of steps. The number of **after** and **before** sections of the **Sequence** lists that display are based on the step type you selected.
9. Select the step sequence to use. For example, if you are creating a pass-through step, select the **Start** step from the **after** section of the **Sequence** list and the **End** step from the **before** section of the **Sequence** list. This places the pass-through step after the Start step and before the End step in the role.

Field	Description
Sequence after Step	Select a step. The step you select is executed before the step you selected in Step 5.
Sequence before Step	Select a step. The step you select is executed after the step you selected in Step 5.
Guard Value Note: This field only displays for a condition step.	<p>A guard value is only required for a condition step for the before section of the Sequence list. This means that the value only has meaning on a control flow that is going out of a condition step.</p> <ul style="list-style-type: none"> ▪ True If the condition expression evaluates to true, use this control flow. ▪ False If the condition expression evaluates to false, use this control flow. <p>After control flow creation, the guard value displays in the Guard Value column of the Control Flows section, as shown in Figure 12-23 on page 12-102.</p>

10. Click **Apply**.

The step is created and the Step Details : *name* page appears. Step type-specific metadata also appears in the **Details** section of the Step Details : *name* page. (See the page in "[Viewing a Step](#)" on page 12-86 for an example.) Some step types include links to other pages. For example, the transformation step includes a link to the Transformation Map Details page for the transformation map selected in Step 7.

Based on the type of step created, various input ports (named Input1), output ports (named Output1 and Output2), or return code ports are also automatically created. These ports have no event type or datatype assigned to them. The ports must have an assigned type before they can be included in a deployed configuration. A port with no assigned type often inherits the type of a port to which it is data flow-bound (either datatype or event type) or the type of another port in the same step.

The following table lists the ports automatically created.

For This Step...	Input1 Port Created?	Output1 Port Created?	Output2 Port Created?	Return Code Port Created?
And ¹	No	No	No	No
Condition	Yes	No	No	Yes
Consume	Yes	No	No	No
Or ¹	No	No	No	No
Pass-through	Yes	Yes	No	No
SetParty	Yes	Yes	No	No
Split	Yes	Yes	Yes	No
Translation	Yes	Yes	No	Yes
Transformation	Yes	Yes	No	Yes

¹ No ports are created; only control flows, which do not use ports, are used with this step type.

11. Select **Step Binding Diagram**, **Event Flow Diagram**, and **Process Diagram** at the bottom of the Step Details : *name* page to view graphical details about the step, including role ports, step ports, steps, and events.
12. Repeat these steps to create any necessary steps for this role or other roles.

See Also: ["Creating a Step Port"](#) on page 12-91 to create additional step ports

Deleting a Step

Follow these instructions to delete a step:

Caution: Deleting a step also deletes its control flows, ports, and data flows, and can leave other steps unconnected.

To delete a step:

1. Ensure that you followed the instructions in "[Accessing Step Management Tasks](#)" on page 12-79 to access the page for deleting a step.
2. Click **Yes** when prompted to delete a step.

The step is deleted and the *type* Role Details : *name* page appears.

Updating a Step

You can update step-specific details. For example, for a SetParty step, you can change the party with which the step is associated by selecting a different party from the list. For a transformation step, if you chose a different transformation map, a new set of ports are created that correspond to the new map parameters. The data flows of the old ports are reconnected to the new ports if the event type or datatype of the ports match. The old ports are then deleted. The same situation also applies for condition steps and conditional expressions.

Follow these instructions to update a step:

To update a step:

1. Ensure that you followed the instructions in "[Accessing Step Management Tasks](#)" on page 12-79 to access the page for updating a step.

The Update Step in Role *name* page appears.

2. Make appropriate changes. (See Step 2 on page 12-81 through Step 5 on page 12-82 of "[Creating a Step](#)" for a list of fields that you can update.)
3. Click **Apply**.

The step is updated and the Step Details : *name* page appears.

Viewing a Step

Follow these instructions to view details about a specific step:

To view a step:

1. Ensure that you followed the instructions in "[Accessing Step Management Tasks](#)" on page 12-79 to access the page for viewing a step.

The Step Details : *name* page appears.

Step Details : Passthrough expense

[Delete](#) [Update](#)

Details

Type Pass-through
 Role expense-NR
 Role Type Native Role
 Description
 State **Draft**

Data Ports

[Return to Top](#)

[Create](#)

Name	Direction	Event	Datatype	Update	Delete
expense-IN	Input	NE : expense			
expense-OUT	Output	NE : expense			

Control Flows

[Return to Top](#)

[Create](#)

Sequence	Step	Guard Value	Update	Delete
after	Start			
before	End			

Diagrams

[Return to Top](#)

[Event Flow Diagram](#)
[Process Diagram](#)
[Step Binding Diagram](#)

This page enables you to view details about a step. The **Data Ports** section of this page lists the data ports for the role. This page, as with the *type* Role Details : *name* page shown in [Figure 12-20](#) on page 12-70, enables you to delete or update the selected step.

Note: If this is a transformation step, the **Details** section at the top of the Step Details : *name* page includes a link to the transformation map you created. Click the transformation map to access its details page. If this is a SetParty step, the destination party also displays in the **Details** section at the top of the Step Details : *name* page

Managing Step Ports

The Oracle Application Server ProcessConnect user interface tool enables you to perform the step port management tasks shown in [Figure 12-21](#). These tasks are described in detail in this section. Step ports are the input and output parameters of steps in roles. Step ports work with data flows and control flows to connect steps in roles together. Step ports also work with data flows to connect incoming role ports to incoming step ports and outgoing step ports to outgoing role ports.

Figure 12–21 Step Port Management Tasks

Step Details : Passthrough expense

[Delete](#) [Update](#)

Details

Type Pass-through
 Role expense-NR
 Role Type Native Role
 Description
 State **Draft**

Data Ports

[Return to Top](#)

[Create](#)

Name	Direction	Event	Datatype	Update	Delete
expense-IN	Input	NE : expense			
expense-OUT	Output	NE : expense			

Control Flows

[Return to Top](#)

[Create](#)

Sequence	Step	Guard Value	Update	Delete
after	Start			
before	End			

Diagrams

[Return to Top](#)

[Event Flow Diagram](#)
[Process Diagram](#)
[Step Binding Diagram](#)

Data Port Details : expense-OUT

[Delete](#) [Update](#)

Details

Description
 Owner (Step) Passthrough expense
 Owner Type Pass-through
 Direction Output
 Event Type expense
 Classification Native Event Type
 State **Draft**

Data Flows

[Return to Top](#)

[Create](#)

Direction	Port	Owner	Owner Type	Delete
flows to	expense-OUT	expense-NR	Native Role	
flows to	expense-OUT	expense-NR	Native Role	

Diagrams

[Return to Top](#)

[Event Flow Diagram](#)
[Process Diagram](#)
[Step Binding Diagram](#)

Table 12–8 identifies the step port management tasks shown in Figure 12–21 and provides references to procedures for performing these tasks.

Table 12–8 Step Port Management Tasks

Step Details Page Elements	Management Task	First See Section...	Then See Section...
Create button in Data Ports section of Figure 12–21	Create a step port	"Accessing Step Port Management Tasks" on page 12-89	"Creating a Step Port" on page 12-91
Delete column in Data Ports section of Figure 12–21	Delete a step port		"Deleting a Step Port" on page 12-93
Update column in Data Ports section of Figure 12–21	Update a step port		"Updating a Step Port" on page 12-93
Name column in Data Ports section of Figure 12–21 (To access the details page in the lower page of Figure 12–21)	View details about a step port		"Viewing a Step Port" on page 12-94

See Also:

- "Step Ports" on page 3-29 for conceptual details about step ports
- The Manage Step Ports section of Figure 12–2 on page 12-4 for the graphical location of step ports

Accessing Step Port Management Tasks

Follow these instructions to access the step port management tasks shown in Figure 12–21 on page 12-88:

To access step port management tasks:

1. Select the **Modeling** tab.

2. Select the appropriate tab:

If You Select the...	This Page Appears...	Go To Step...
Roles tab	Business Roles page	3
Business Processes tab	Business Processes page	4

3. If you want to manage a role other than a business role, select one of the following types at the top of the page:
 - **Application Roles**
 - **Native Roles**
 - **Binding Roles**
4. Select the specific role or business process on which to manage role data flow in the **Name** column.
The details page for the selected role or business process appears.
5. Go to the **Steps** section. (See [Figure 12-20](#) on page 12-70.)
6. Select the specific step in the **Name** column.
The Step Details : *name* page appears.
7. Go to the **Data Ports** section. (See the upper page of [Figure 12-21](#) on page 12-88.)
8. Select a task to perform and see the referenced section for instructions:

To...	Then...	See Section...
Create a step port	Click Create .	"Creating a Step Port" on page 12-91
Delete a step port	Select a specific step port in the Delete column.	"Deleting a Step Port" on page 12-93
Update a step port	Select a specific step port in the Update column.	"Updating a Step Port" on page 12-93
View details about a step port	Select a specific step port in the Name column.	"Viewing a Step Port" on page 12-94

You can also manage some aspects of step ports from within a Process Diagram or Step Binding Diagram.

See Also: "[Viewing a Process Diagram](#)" on page 12-23 and "[Viewing a Step Binding Diagram](#)" on page 12-28 for details on step port management capabilities

Creating a Step Port

Several default step ports are automatically created when you create a step. You can also create additional step ports, as needed. Follow these instructions to create a step port:

Note: If you are creating a step port on a consume or a condition step, the port can only be an input port.

You cannot create step ports on an And step or an Or step. These steps only use control flows, which do not require step ports.

To create a step port:

1. Ensure that you followed the instructions in "[Accessing Step Port Management Tasks](#)" on page 12-89 to access the page for creating a step port.

The Create Data Port on Step Details : *name* page appears.

2. Enter a unique and recognizable role port name in the **Name** field (for example, `expense-OUT`).
3. Enter an optional description.
4. If you are creating a step port on a transformation step that has a transformation map assigned to it, follow Step 4a through Step 4c. Otherwise, go to Step 5.
 - a. Go to the **Assign Port Type** section.
 - b. Select a map parameter from the list. If you select a parameter, the direction and the datatype of the port are determined by the parameter selected.
 - c. Go to Step 11.

5. If you are creating a step port on a condition step that has a condition expression assigned to it, follow Step 5a through Step 5c. Otherwise, go to Step 6. Since a condition step only permits a single input port, the direction is automatically selected and cannot be changed.
 - a. Go to the **Assign Port Type** section.
 - b. Select a condition parameter from the list. The datatype of the port is determined by the parameter selected.
 - c. Go to Step 11.
6. If you are creating a step port on any other step type, select **Input** or **Output** from the **Direction** list. For example, select **Input** for this step port to receive inbound event data. Since a consume step only permits a single input port, the direction is automatically selected and cannot be changed.
7. Go to the **Assign Port Type** section.
8. Select **Datatype** or **Event Type** from the **Type** list.

The page refreshes to display additional fields.
9. If you selected **Datatype**, perform Step 9a through Step 9e. Otherwise, go to Step 10.
 - a. Select either **Application Datatype**, **Business Datatype**, or **Native Datatype** from the **Classification Class** list. For example, if you are creating a step port for a native role, select **Native Datatype**.
 - b. Select a namespace for the datatype from the **Namespace** list.
 - c. Click the flashlight next to the **Name** field of the **Assign Port Type** section.
 - d. Select the datatype and click **Select**.

Your selection appears in the **Name** field.
 - e. Go to Step 11.
10. If you selected **Event Type**, perform Step 10a through Step 10c.
 - a. Select either **Application Event**, **Business Event**, or **Native Event** from the **Classification Class** list. For example, if you are creating a step port for a native role, select **Native Event**.

- b. Click the flashlight next to the **Name** field of the **Assign Port Type** section.
- c. Select the event type and click **Select**.

Your selection appears in the **Name** field.

11. Click **Apply**.

The step port is created, and you are returned to the Step Details : *name* page.

12. Select **Step Binding Diagram** at the bottom of the Step Details : *name* page to view graphical details about the step port.
13. Repeat these steps to create any necessary step ports for this step or other steps.

Deleting a Step Port

Follow these instructions to delete a step port:

Caution: Deleting a step port also deletes data flow for this port, and can leave other ports unconnected.

To delete a step port:

1. Ensure that you followed the instructions in "[Accessing Step Port Management Tasks](#)" on page 12-89 to access the page for deleting a step port.
2. Click **Yes** when prompted to delete a step port.

You are returned to the Step Details : *name* page.

Updating a Step Port

Follow these instructions to update a step port:

To update a step port:

1. Ensure that you followed the instructions in "[Accessing Step Port Management Tasks](#)" on page 12-89 to access the page for updating a step port.

The Update Data Port on Step *name* page appears.

2. Make appropriate changes. (See Step 2 on page 12-91 through Step 10c on page 12-93 of "Creating a Step Port" for a list of fields that you can update.)
3. Click **Apply**.

The step port is updated and the Data Port Details : *name* page appears.

Viewing a Step Port

Follow these instructions to view details about a specific step port:

To view a step port:

1. Ensure that you followed the instructions in "Accessing Step Port Management Tasks" on page 12-89 to access the page for viewing a step port.

The Data Port Details : *name* page appears.

Data Port Details : expense-OUT

[Delete](#) [Update](#)

Details

Description
 Owner (Step) Passthrough expense
 Owner Type Pass-through
 Direction Output
 Event Type expense
 Classification Native Event Type
 State **Draft**

Data Flows

[Return to Top](#)

[Create](#)

Direction	Port	Owner	Owner Type	Delete
flows to	expense-OUT	expense-NR	Native Role	
flows to	expense-OUT	expense-NR	Native Role	

Diagrams

[Return to Top](#)

[Event Flow Diagram](#)
[Process Diagram](#)
[Step Binding Diagram](#)

This page enables you to view details about a step port. This page, as with the Step Details : *name* page shown in the upper page of [Figure 12-21](#) on page 12-88, enables you to delete or update the selected step port.

Managing Step Data Flow

The Oracle Application Server ProcessConnect user interface tool enables you to perform the step data flow management tasks shown in [Figure 12–22](#). These tasks are described in detail in this section. Step data flows connect the ports of steps together, which enable events to move through steps.

Figure 12–22 Step Data Flow Management Tasks

Data Port Details : Transform2-OUT

[Delete](#) [Update](#)

Details

Description
 Owner (Step) **Transform RequestPurchaseOrder**
 Owner Type **Transformation Step**
 Direction **Output**
 Event Type **RequestPurchaseOrder**
 Classification **Business Event Type**
 EventMap Parameter **RequestPurchaseOrder-OUT**
 State **Draft**

Data Flows

[Return to Top](#)

[Create](#)

Direction	Port	Owner	Owner Type	Delete
flows to	input1	Split-OUT	Split Step	

Diagrams

[Return to Top](#)

[Event Flow Diagram](#)
[Process Diagram](#)
[Step Binding Diagram](#)

Data Port Details : Input1

[Delete](#) [Update](#)

Details

Description
 Owner (Step) **Split-OUT**
 Owner Type **Split Step**
 Direction **Input**
 Event Type **RequestPurchaseOrder**
 Classification **Business Event Type**
 State **Draft**

Data Flows

[Return to Top](#)

[Create](#)

Direction	Port	Owner	Owner Type	Delete
flows from	Transform2-OUT	Transform RequestPurchaseOrder	Transformation Step	

Diagrams

[Return to Top](#)

[Event Flow Diagram](#)
[Process Diagram](#)
[Step Binding Diagram](#)

Table 12-9 identifies the step data flow management tasks shown in Figure 12-22 and provides references to procedures for performing these tasks.

Table 12-9 Step Data Flow Management Tasks

Page Elements	Management Task	First See Section...	Then See Section...
Create button in upper page of Figure 12-22	Create a step data flow	"Accessing Step Data Flow Management Tasks" on page 12-97	"Creating a Step Data Flow" on page 12-98
Delete column in upper page of Figure 12-22	Delete a step data flow		"Deleting a Step Data Flow" on page 12-100
Port column in upper page of Figure 12-22 (To access the details page in the lower page of Figure 12-22)	View the target port for the step data flow		"Viewing the Target Port of a Step Data Flow" on page 12-100

See Also:

- ["Data Flow"](#) on page 3-29 for conceptual details about step data flow
- ["Viewing a Business Process"](#) on page 12-38 or ["Viewing a Role"](#) on page 12-46 (this page is accessible from the **Owner** column of the **Data Flows** section in the upper page of [Figure 12-22](#) on page 12-95)
- The Manage Step Data Flow section of [Figure 12-2](#) on page 12-4 for the graphical location of step data flows
- ["Managing Role Ports"](#) on page 12-48 for details about the tasks available from the **Data Flows Within Role** section shown in the lower page of [Figure 12-17](#) on page 12-48

Accessing Step Data Flow Management Tasks

Follow these instructions to access the step data flow management tasks shown in [Figure 12-22](#) on page 12-95:

To access step data flow management tasks:

1. Select the **Modeling** tab.
2. Select the appropriate tab:

If You Select the...	This Page Appears...	Go To Step...
Roles tab	Business Roles page	3
Business Processes tab	Business Processes page	4

3. If you want to manage a role other than a business role, select one of the following types at the top of the page:
 - **Application Roles**
 - **Native Roles**
 - **Binding Roles**
4. Select the specific role or business process on which to manage role data flow in the **Name** column.
The details page for the selected role or business process appears.
5. Go to the **Steps** section. (See [Figure 12-20](#) on page 12-70.)
6. Select a specific step in the **Name** column.
The Step Details : *name* page for the selected step appears. (See the upper page of [Figure 12-21](#) on page 12-88.)
7. Go to the **Data Ports** section.
8. Select a specific step port in the **Name** column.
The Data Port Details : *name* page for the selected data port appears. (See the upper page of [Figure 12-22](#) on page 12-95.)

9. Select a task to perform and see the referenced section for instructions:

To...	Then...	See Section...
Create a step data flow	Click Create .	"Creating a Step Data Flow" on page 12-98
Delete a step data flow	Select a specific step data flow in the Delete column.	"Deleting a Step Data Flow" on page 12-100
View the target port for the step data flow	Select a step port in the Port column.	"Viewing the Target Port of a Step Data Flow" on page 12-100

You can also manage some aspects of step data flows from within a Process Diagram or Step Binding Diagram.

See Also: ["Viewing a Process Diagram"](#) on page 12-23 and ["Viewing a Step Binding Diagram"](#) on page 12-28 for details on step data flow management capabilities

Creating a Step Data Flow

You can create step data flows for all steps with the exception of an And step and an Or step. Follow these instructions to create a step data flow:

To create a step data flow:

1. Ensure that you followed the instructions in ["Accessing Step Data Flow Management Tasks"](#) on page 12-97 to access the page for creating a step data flow.

The Create Data Flow page appears.

A step port can be data flow-bound to either a role port or another step port. For a role port, the direction of the ports is the same. For example, an input step port is bound to an input role port, whereas an input step port is bound to an output step port.

2. Click **Select** for the step port with which to create a step data flow for this step port. For example, you may want to create a step data flow to a split step in this role. The list of ports contains only compatible ports. Compatible for data flow means that the ports have the following:
 - There is a compatible direction. For example, if the port on one step is an input port, then the port on the other step must be an output port, and vice versa.
 - They must be of the same event type, or a port that has no event type can be data flow-bound to a port with any (or no) datatype.

When a data flow is created between a port to which a datatype or event type is already assigned and a port to which no type is assigned, the port with no assigned type inherits the type of the assigned port (either datatype or event type).

3. Click **Apply**.

The step data flow is created and the Data Port Details : *name* page appears.
4. Select the **Process Diagram**, **Event Flow Diagram**, or **Step Binding Diagram** at the bottom of the Step Details : *name* page to view graphical details about the step data flow.
5. Repeat these steps to create any necessary step data flow for this step or other steps.

Deleting a Step Data Flow

Follow these instructions to delete a step data flow:

Caution: Deleting a step data flow can leave ports unconnected.

To delete a step data flow:

1. Ensure that you followed the instructions in "[Accessing Step Data Flow Management Tasks](#)" on page 12-97 to access the page for deleting a step data flow.
2. Click **Yes** when prompted to delete a step data flow.

You are returned to the Data Port Details : *name* page.

Viewing the Target Port of a Step Data Flow

Follow these instructions to view details about the target port of a step data flow:

To view the target port of a step data flow:

1. Ensure that you followed the instructions in "[Accessing Step Data Flow Management Tasks](#)" on page 12-97 to access the page for viewing the target port of a step data flow.

The Data Port Details : *name* page appears.

Data Port Details : Input1

[Delete](#) [Update](#)

Details

Description
 Owner (Step) **Split-OUT**
 Owner Type **Split Step**
 Direction **Input**
 Event Type **RequestPurchaseOrder**
 Classification **Business Event Type**
 State **Draft**

Data Flows

[Return to Top](#)

[Create](#)

Direction	Port	Owner	Owner Type	Delete
flows from	Transform2-OUT	Transform_RequestPurchaseOrder	Transformation Step	

Diagrams

[Return to Top](#)

[Event Flow Diagram](#)
[Process Diagram](#)
[Step Binding Diagram](#)

This page enables you to view details about the target port of a step data flow. In this example, the target port is part of a step.

Managing Step Control Flow

The Oracle Application Server ProcessConnect user interface tool enables you to perform the step control flow management tasks shown in [Figure 12–23](#). These tasks are described in detail in this section. Control flows between steps indicate the execution order of steps. You can also create step control flows when you create a step.

Figure 12–23 Step Control Flow Management Tasks

Step Details : Passthrough expense

[Delete](#) [Update](#)

Details

Type Pass-through
 Role expense-NR
 Role Type Native Role
 Description
 State **Draft**

Data Ports

[Return to Top](#)

[Create](#)

Name	Direction	Event	Datatype	Update	Delete
expense-IN	Input	NE : expense			
expense-OUT	Output	NE : expense			

Control Flows

[Return to Top](#)

[Create](#)

Sequence	Step	Guard Value	Update	Delete
after	Start			
before	End			

Diagrams

[Return to Top](#)

[Event Flow Diagram](#)
[Process Diagram](#)
[Step Binding Diagram](#)

Table 12-10 identifies the step control flow management tasks shown in Figure 12-23 and provides references to procedures for performing these tasks.

Table 12-10 Step Control Flow Management Tasks

Step Details Page Elements	Management Task	First See Section...	Then See Section...
Create button in Control Flows section of Figure 12-23	Create a step control flow	"Accessing Step Control Flow Management Tasks" on page 12-104	"Creating a Step Control Flow" on page 12-105
Delete column in Control Flows section of Figure 12-23	Delete a step control flow		"Deleting a Step Control Flow" on page 12-107
Update column in Control Flows section of Figure 12-23	Update a step control flow		"Updating a Step Control Flow" on page 12-107

See Also:

- "Creating a Step Control Flow" on page 12-105 for details about the **Guard Value** column of the **Control Flows** section in Figure 12-23
- "Control Flow" on page 3-29 for conceptual details about step control flows
- The Manage Control Data Flows section of Figure 12-2 on page 12-4 for the graphical location of step control flows

Accessing Step Control Flow Management Tasks

Follow these instructions to access the step control flow management tasks shown in [Figure 12-23](#) on page 12-102:

To access step control flow management tasks:

2. Select the appropriate tab:

If You Select the...	This Page Appears...	Go To Step...
Roles tab	Business Roles page	3
Business Processes tab	Business Processes page	4

3. If you want to manage a role other than a business role, select one of the following types at the top of the page:

- **Application Roles**
- **Native Roles**
- **Binding Roles**

4. Select the specific role or business process on which to manage role data flow in the **Name** column.

The details page for the selected role or business process appears.

5. Go to the **Steps** section. (See [Figure 12-20](#) on page 12-70.)

6. Select a specific step in the **Name** column.

The Step Details : *name* page for the selected step appears. (See [Figure 12-23](#) on page 12-102.)

7. Go to the **Control Flows** section.

8. Select a task to perform and see the referenced section for instructions:

To...	Then...	See Section...
Create a step control flow	Click Create	"Creating a Step Control Flow" on page 12-105
Delete a step control flow	Select a specific step control flow in the Delete column.	"Deleting a Step Control Flow" on page 12-107
Update a step control flow	Select a specific step control flow in the Update column.	"Updating a Step Control Flow" on page 12-107

You can also manage control flow from within a Process Diagram.

See Also: ["Viewing a Process Diagram"](#) on page 12-23

Creating a Step Control Flow

Follow these instructions to create a step control flow:

To create a step control flow:

1. Ensure that you followed the instructions in ["Accessing Step Control Flow Management Tasks"](#) on page 12-104 to access the page for creating a step control flow.

The Create Control Flow for Step *name* page appears.

2. Select the step sequence to use.

Field	Description
Sequence *	Select the order in which to perform this step (either after or before).
Step *	Select the step to perform in sequence with the step you are creating.

Field	Description
<p>Guard Value</p> <p>Note: This field only displays if you are creating a step control flow for a condition step.</p>	<p>A guard value is only required for a condition step if before is selected from the Sequence list. This means that the value only has meaning on a control flow that is going out of a condition step.</p> <ul style="list-style-type: none"> ▪ True If the condition expression evaluates to true, use this control flow. ▪ False If the condition expression evaluates to false, use this control flow. <p>After control flow creation, the guard value displays in the Guard Value column of the Control Flows section in Figure 12-23 on page 12-102.</p>

3. Click **Apply**.

The step control flow is created and the Step Details : *name* page appears.

4. Click **Process Diagram** at the bottom of the Step Details : *name* page to view the step control flow. The guard value displays on the **Process Diagram** as T (for true), F (for false), or E (for error) when the language is English.

5. Repeat these steps to create any necessary control flows for this step or other steps.

Note: Control flows do not have ports. Only data flows require ports.

Deleting a Step Control Flow

Follow these instructions to delete a step control flow:

Caution: Deleting a control flow can leave other steps unconnected.

To delete a step control flow:

1. Ensure that you followed the instructions in "[Accessing Step Control Flow Management Tasks](#)" on page 12-104 to access the page for deleting a step control flow.
2. Click **Yes** when prompted to delete a step control flow.

The step control flow is deleted and the Step Details : *name* page appears.

Updating a Step Control Flow

Follow these instructions to update a step control flow:

To update a step control flow:

1. Ensure that you followed the instructions in "[Accessing Step Control Flow Management Tasks](#)" on page 12-104 to access the page for updating a step control flow.

The Update Control Flow on Step *name* page appears.

2. Make appropriate changes. (See Step 2 of "[Creating a Step Control Flow](#)" on page 12-105 for a list of fields that you can update.)
3. Click **Apply**.

The step control flow is updated and the Step Details : *name* page appears.

Managing Condition Expressions in Steps

The Oracle Application Server ProcessConnect user interface tool enables you to perform the condition expression management tasks shown in [Figure 12-24](#). These tasks are described in detail in this section. Condition expressions enable you to define that a specific action be performed in a condition step based on the result of an expression. For example, you can specify that a specific condition be performed if the price field of a purchase order is over a specific number, such as notifying a second approver before the purchase order can be approved.

Figure 12-24 Condition Expression Management Tasks

Condition Expressions

Search

Name	Expression	Update	Delete
exp1			
IsReturnCodeSuccess			

Condition Expression Details : exp1

Details

Name **exp1**

Expression

State **Draft**

[Return to Top](#)

Condition Parameters

Name	Type	Update	Delete
p1	string		
p2	Problem		

Table 12-11 identifies the condition expression management tasks shown in Figure 12-24 and provides references to procedures for performing these tasks.

Table 12-11 Condition Expression Management Tasks

Page Elements	Management Task	First See Section...	Then See Section...
Create button in Condition Expressions page of Figure 12-24	Create a condition expression	"Accessing Condition Expression Management Tasks" on page 12-110	"Creating a Condition Expression" on page 12-111
Delete column in Condition Expressions page of Figure 12-24	Delete a condition expression		"Deleting a Condition Expression" on page 12-112
Update column in Condition Expressions page of Figure 12-24	Update a condition expression		"Updating a Condition Expression" on page 12-112
Name column in Condition Expressions page of Figure 12-24 (To access the details page in the lower page of Figure 12-24)	View details about a condition expression		"Viewing a Condition Expression" on page 12-113
Create button in Condition Parameters section of Condition Expression Details page of Figure 12-24	Create a condition parameter		"Creating a Condition Parameter" on page 12-114
Delete column in Condition Expression Details page of Figure 12-24	Delete a condition parameter		"Deleting a Condition Parameter" on page 12-115
Update column in Condition Expression Details page of Figure 12-24	Update a condition parameter		"Updating a Condition Parameter" on page 12-115
Create button in Details section in Condition Expression Details page of Figure 12-24	Build a condition expression		"Building a Condition Expression" on page 12-116
Name column in Condition Expression Details page of Figure 12-24	View a condition parameter		"Viewing a Condition Parameter" on page 12-119

See Also: The following sections for viewing datatype and event type details that are accessible from the **Type** column of the **Condition Parameters** section in the lower page of [Figure 12-24](#) on page 12-108:

- ["Viewing a Complex Datatype"](#) on page 10-22 or ["Viewing a Scalar Datatype"](#) on page 10-43
- ["Viewing a Business Event Type"](#) on page 11-68

Accessing Condition Expression Management Tasks

Follow these instructions to access the condition expression management tasks shown in [Figure 12-24](#) on page 12-108:

To access condition expression management tasks:

1. Select the **Modeling** tab.
2. Select the **Condition Expressions** tab.

The Condition Expressions page appears. (See the upper page of [Figure 12-24](#) on page 12-108.)

3. Select a task to perform and see the referenced section for instructions:

To...	Then...	See Section...
Create a condition expression	Click Create .	"Creating a Condition Expression" on page 12-111
Delete a condition expression	Select a specific condition expression in the Delete column.	"Deleting a Condition Expression" on page 12-112
Update a condition expression	Select a specific condition expression in the Update column.	"Updating a Condition Expression" on page 12-112
View details about a condition expression	Select a specific condition expression in the Name column.	"Viewing a Condition Expression" on page 12-113
Create a condition parameter	Select a specific condition expression in the Name column for which to create a condition parameter.	"Creating a Condition Parameter" on page 12-114

To...	Then...	See Section...
Delete a condition parameter	Select a specific condition expression in the Name column for which to delete a condition parameter.	"Deleting a Condition Parameter" on page 12-115
Update a condition parameter	Select a specific condition expression in the Name column for which to update a condition parameter.	"Updating a Condition Parameter" on page 12-115
Build a condition expression with a condition parameter	Select a specific condition expression in the Name column with which to build an expression. Note: You cannot build a condition expression if there are no condition parameters.	"Building a Condition Expression" on page 12-116
Viewing a condition parameter	Select a specific condition expression in the Name column for which to view a condition parameter.	"Viewing a Condition Parameter" on page 12-119

Creating a Condition Expression

Follow these instructions to create a condition expression:

To create a condition expression:

1. Ensure that you followed the instructions in "[Accessing Condition Expression Management Tasks](#)" on page 12-110 to access the page for creating a condition expression.

The Create Condition Expression page appears.

2. Enter a unique and recognizable name for the condition expression in the **Name** field.
3. Click **Apply**.

The condition expression is created and the Condition Expression Details page for the created condition expression appears.

See Also: ["Creating a Condition Parameter"](#) on page 12-114 to add condition parameters to the condition expression

Deleting a Condition Expression

Follow these instructions to delete a condition expression:

Note: Deleting a condition expression also deletes all of its condition parameters.

When you delete a condition step associated with a condition expression, the associated ports and map parameters are also removed.

To delete a condition expression:

1. Ensure that you followed the instructions in ["Accessing Condition Expression Management Tasks"](#) on page 12-110 to access the page for deleting a condition expression.
2. Click **Yes** when prompted to delete a condition expression.

The condition expression is deleted and the Condition Expressions page appears.

Updating a Condition Expression

Follow these instructions to update a condition expression:

To update a condition expression:

1. Ensure that you followed the instructions in ["Accessing Condition Expression Management Tasks"](#) on page 12-110 to access the page for updating a condition expression.

The Update Condition Expression page appears.

2. Make appropriate changes. (See Step 2 on page 12-111 of "[Creating a Condition Expression](#)" for a list of fields that you can update.)
3. Click **Apply**.

The condition expression is updated and the Condition Expression Details page for the updated condition expression appears.

Viewing a Condition Expression

Follow these instructions to view details about a specific condition expression:

To view a condition expression:

1. Ensure that you followed the instructions in "[Accessing Condition Expression Management Tasks](#)" on page 12-110 to access the page for viewing a condition expression.

The Condition Expression Details page for the selected condition expression appears.

Condition Expression Details : exp1

Delete Update

Details





Name **exp1**

Expression Create

State **Draft**

Condition Parameters [Return to Top](#)

Create

Name	Type	Update	Delete
p1	string		
p2	Problem		

2. View specific details, including details about the condition parameters created for this condition expression. You use the condition parameters to build a condition expression.

This page, as with the Condition Expressions page shown in the upper page of [Figure 12-24](#) on page 12-108, enables you to delete or update the selected condition expression.

3. Click **Return to List** to return to the Condition Expressions page.

Creating a Condition Parameter

Follow these instructions to create a condition parameter for a condition expression:

To create a condition parameter:

1. Ensure that you followed the instructions in "[Accessing Condition Expression Management Tasks](#)" on page 12-110 to access the page for creating a condition parameter.

The Condition Expression Details page for the selected condition expression appears.

2. Go to the **Condition Parameters** section. (See the lower page of [Figure 12-24](#) on page 12-108.)

3. Click **Create**.

The Create Condition Parameter page appears.

4. Enter a unique and recognizable parameter name in the **Name** field of the **General** section.

5. Select **Datatype** or **Event Type** from the **Type** list of the **Type** section.

The page refreshes to display additional fields.

6. If you selected **Datatype**, perform Steps 6a through Steps 6d.

- a. Select **Application Datatype**, **Business Datatype**, or **Core Datatype** from the **Classification** list.

- b. Select a namespace for the datatype from the **Namespace** list.

- c. Select a datatype name by clicking the flashlight next to the **Name** field.

- d. Click **Apply**.

7. If you selected **Event Type**, perform Steps 7a through Steps 7c.

- a. Select **Application Event Type** or **Business Event Type** from the **Classification** list.

- b. Select an event type name by clicking the flashlight next to the **Name** field.

- c. Click **Apply**.

The condition parameter is created and the Condition Parameter details page for the created condition parameter appears.

8. Create additional condition parameters, if needed. Only one is required to build a condition expression.

See Also: ["Building a Condition Expression"](#) on page 12-116 to build a condition expression of condition parameters

Deleting a Condition Parameter

Follow these instructions to delete a condition parameter:

To delete a condition parameter:

1. Ensure that you followed the instructions in ["Accessing Condition Expression Management Tasks"](#) on page 12-110 to access the page for deleting a condition parameter.

The Condition Expression Details page for the selected condition expression appears.

2. Go to the **Condition Parameters** section. (See the lower page of [Figure 12-24](#) on page 12-108.)
3. Select a specific condition parameter to delete in the **Delete** column.
4. Click **Yes** when prompted to delete a condition parameter.

The condition parameter is deleted and the Condition Parameter Details page appears.

Updating a Condition Parameter

Follow these instructions to update a condition parameter:

To update a condition parameter:

1. Ensure that you followed the instructions in ["Accessing Condition Expression Management Tasks"](#) on page 12-110 to access the page for updating a condition parameter.

The Condition Expression Details page for the selected condition expression appears.

2. Go to the **Condition Parameters** section. (See the lower page of [Figure 12-24](#) on page 12-108.)
3. Select a specific condition parameter to update in the **Update** column.
The Update Condition Parameter page appears.
4. Make appropriate changes. (See Step 4 on page 12-114 through Step 7 on page 12-114 of "[Creating a Condition Parameter](#)" for a list of fields you can update.)
5. Click **Apply**.
The condition parameter is updated and the Condition Parameter Details page for the updated condition parameter appears.

Building a Condition Expression

Follow these instructions to build a condition expression. This expression uses the condition parameters created in "[Creating a Condition Parameter](#)" on page 12-114.

Note: You must first create at least one condition parameter before you can build a condition expression.

To build a condition expression:

1. Ensure that you followed the instructions in "[Accessing Condition Expression Management Tasks](#)" on page 12-110 to access the page for building a condition expression.
The Condition Expression Details page for the selected condition expression appears.
2. Go to the **Condition Parameters** section. (See the lower page of [Figure 12-24](#) on page 12-108.)
3. Click **Create** in the **Details** section.
The Create Condition page appears.
4. Select **Condition expression not specified**.
5. Click **Update** to build a new condition expression.

The Create Expression page appears.

- Click **Expand All** for both columns to display all condition parameters.

Create Expression

Cancel Apply

Select the left operand, the operator, the right operand and choose Apply.

* Indicates required field

Left Operand

Expand All | Collapse All

Condition Parameters

Select	Focus	Name	Type
<input type="radio"/>		Condition Parameters	
<input type="radio"/>		p1	string
<input checked="" type="radio"/>	<input checked="" type="checkbox"/>	p2	bet1
<input type="radio"/>		ebe1	string

Operator

* Unspecified

Right Operand

Constant
 Variable

Expand All | Collapse All

Condition Parameters

Select	Focus	Name	Type
<input type="radio"/>		Condition Parameters	
<input type="radio"/>		p1	string
<input checked="" type="radio"/>	<input checked="" type="checkbox"/>	p2	bet1
<input type="radio"/>		ebe1	string

- Select an element in the **Left Operand** section.

Note: You can only select parameters of scalar datatypes as left and right operands.

- Perform one of the following tasks in the **Right Operand** section:

If You Want To...	Then...
Enter a value	Click Constant and enter a value in the Constant field. For example, enter 50 for a scalar integer parameter named amount . Note: Only left operands can be assigned constant values.
Select a parameter	Click Variable and select a parameter from the list of elements. For example, enter a parameter whose value is a company named ABCCompany for a scalar string parameter named ebe1 .

9. Select an operator from the **Operator** list:

- != (not equal to)
- < (less than)
- <= (less than or equal to)
- = (equal to)
- > (greater than)
- >= (greater than or equal to)
- Exists

10. Click **Apply**.

The condition expression is built.

Create Condition

Use the table below to build the condition. To create or update a condition expression, select a condition expression and choose Update. To create a subcondition, select a condition expression and choose Insert AND or Insert OR. To delete a subcondition or a condition expression, select a subcondition or a condition expression and choose Delete. When finished choose Apply.

Select condition expression and ...
Delete
Insert AND
Insert OR

[Expand All](#) | [Collapse All](#)

⊕ Condition

Select	Focus	Condition Expression	Update
⊖		▼ Condition	
⊕		p2/ebe1 = ABCCompany	

11. If you want to add more complicated logic to this condition expression, click **Insert AND** or **Insert OR**.

You can now select this condition expression when creating a condition step type in a role on the Create Step in Role *name* page:

Create Step in Role br1

Please enter the step parameter(s) and choose Apply. Cancel Apply

* Indicates required field

* Name

Description

* Type Condition Step

Condition Expression parameter in the condition expression

- Unspecified
- expl
- IsReturnCodeSuccess

Cancel Apply

See Also: ["Creating a Step"](#) on page 12-81 for instructions on creating a condition step type and selecting a condition expression (for this example, condition expression **expl** appears)

Viewing a Condition Parameter

Follow these instructions to view a condition parameter:

To view a condition parameter:

1. Ensure that you followed the instructions in ["Accessing Condition Expression Management Tasks"](#) on page 12-110 to access the page for viewing a condition parameter.
The Condition Expression Details page for the selected condition expression appears.
2. Go to the **Condition Parameters** section. (See the lower page of [Figure 12-24](#) on page 12-108.)
3. Select a specific condition parameter to view in the **Name** column.
The Condition Parameter Details page appears.

Condition Parameter Details : RETURN_CODE

Delete Update

Details	
Name	RETURN_CODE
Datatype	returnCode
Namespace	

4. View specific details, including details including the datatype or namespace that can be associated with this parameter.

This page, as with the Condition Expression Details page shown in the lower page of [Figure 12-24](#) on page 12-108, enables you to delete or update the selected condition parameter.

5. Click **Return to List** to return to the Condition Expression Details page.

Designing Roles to Ensure Proper Validation

This section provides examples of valid and invalid step, port, data flow, and control flow designs. Methods for avoiding these design problems are also described.

This section contains these topics:

- [Loops](#)
- [Invalid Or Steps](#)
- [Invalid And Steps](#)
- [Invalid Merging of Data Flows from Step Ports to Role Port](#)
- [Invalid Merging of Data Flows Between Role Ports](#)
- [Current Modeling Restrictions](#)

Loops

A loop is a series of steps connected either through data flows or control flows in which the last step connects back to the first step. Loops can be inside a single role or can span multiple roles. Do not create loops when designing steps in roles even though the Oracle Application Server ProcessConnect user interface tool does not prevent you from this activity. If you create loops, integration validation fails when you attempt to create a configuration to deploy.

Figure 12-25 shows a loop within a single transformation binding role. The highlighted data flow and control flow between Transformation 1 and Transformation 2 of Figure 12-25 identifies the invalid loop.

Figure 12-25 *Loops Within a Single Role*

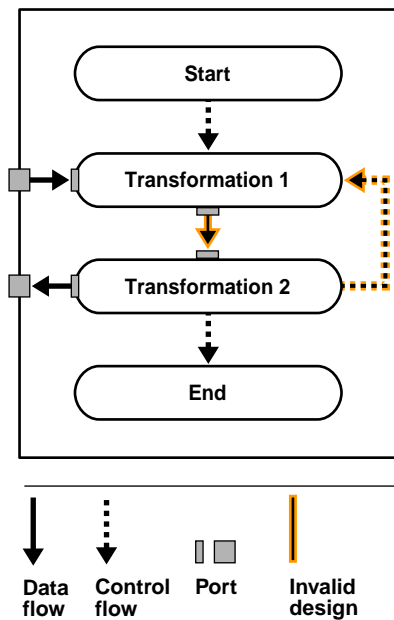
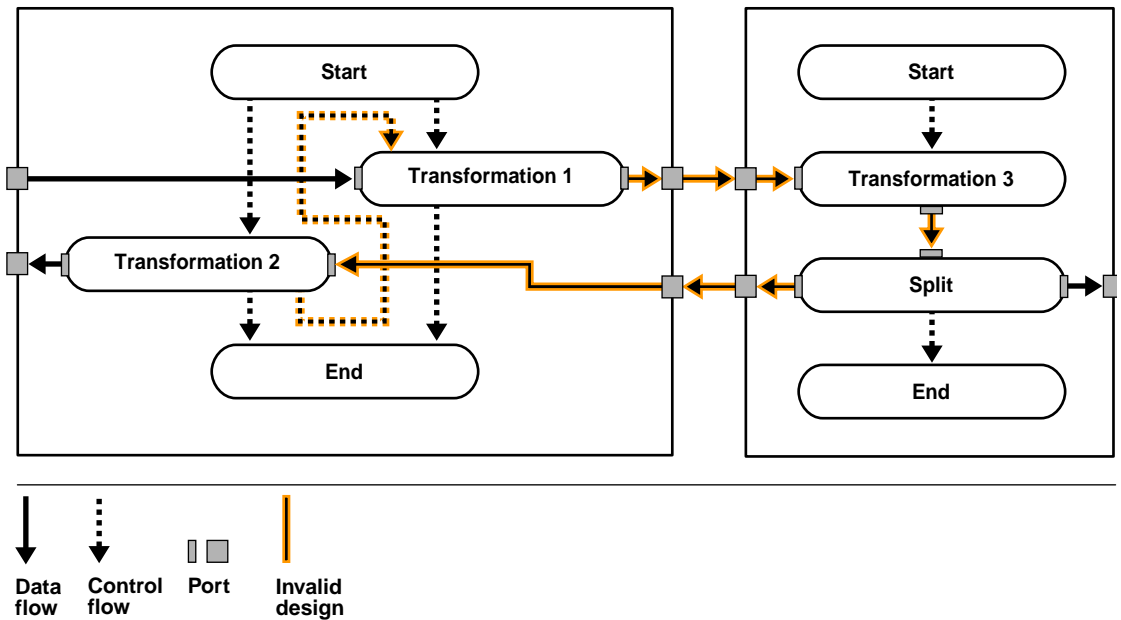

Figure 12–26 shows a loop that spans a transformation binding role and a business role. The highlighted data flow and control flow between Transformation 1, Transformation 3, Split, and Transformation 2 identifies the invalid loop.

Figure 12–26 Loops Spanning Multiple Roles



Invalid Or Steps

To ensure valid use of Or steps, only design mutually-exclusive control flows going into an Or step. Mutually-exclusive flows are a set of paths, with only one path possible at runtime. Valid Or steps prevent race conditions from occurring at runtime, which prevent nondeterminicity in the system.

Note: A condition step is the only means of introducing mutual exclusiveness in flows. Use Or steps only to merge paths coming directly or indirectly out of a condition step.

Invalid And Steps

To ensure valid use of And steps, only design nonmutually-exclusive data flows or control flows going into an And step. Nonmutually-exclusive control flows are paths that can be taken simultaneously at runtime. Valid And steps prevent infinite waits at these steps, which cannot execute because all of the incoming flows do not occur.

Note: Use And steps only to merge parallel paths not coming directly or indirectly out of a condition step.

Invalid Merging of Data Flows from Step Ports to Role Port

To ensure valid merging of data flows, do not design nonmutually-exclusive data flows going into one port. Nonmutually exclusive data flows are paths that can be taken simultaneously at runtime. Valid merging of data flows prevents repopulating of a currently-populated port.

This section provides detailed examples of valid and invalid Or steps, And steps, and mergings of data flows from step ports to role ports. [Figure 12-27](#) provides an example of step design within a business process that is then described in detail.

Figure 12-27 Step Design

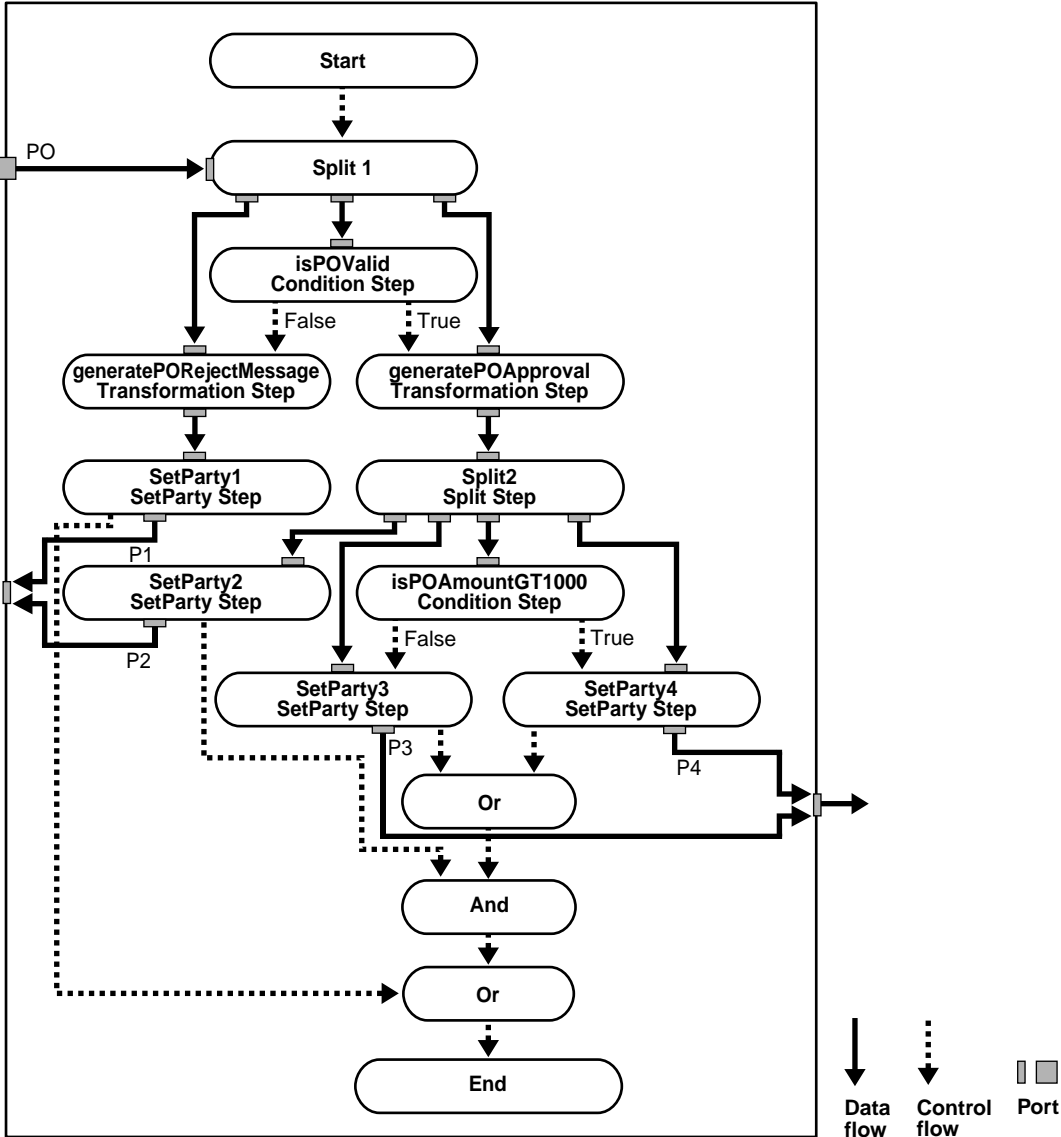

In [Figure 12-27](#) shows the following details:

- All paths along the isPOValid condition step (false) path are mutually exclusive with all paths along the isPOValid condition step (true) path (meaning that only one isPOValid condition step path (either true or false) is taken at runtime).
- All paths along the isPOValid condition step (false) path are nonmutually exclusive among themselves as long as there are no more condition steps encountered along the path (meaning that all paths are taken simultaneously at runtime).
- All paths along the isPOValid condition step (true) path to the isPOAmountGT1000 condition step path are nonmutually exclusive. After that, all paths along the isPOAmountGT1000 condition step (true) path are mutually exclusive with all paths of the isPOAmountGT1000 condition step (false) path.

[Table 12-12](#) shows the mutually exclusive and nonmutually exclusive paths in [Figure 12-27](#).

Table 12–12 Mutually Exclusive and Nonmutually Exclusive Paths

Mutually Exclusive Paths	Nonmutually Exclusive Paths
<ul style="list-style-type: none"> ■ isPOValid (false) and isPOValid (true) ■ isPOValid (false)/generatePORejectMessage and isPOValid (true)/generatePOApproval ■ isPOValid (false)/generatePORejectMessage and isPOValid (true)/generatePOApproval/Split2/isPOAmount GT1000 (true)/SetParty4 ■ isPOValid (false)/generatePORejectMessage and isPOValid (true)/generatePOApproval/Split2/isPOAmount GT1000 (false)/SetParty3 ■ isPOValid (false)/generatePORejectMessage/SetParty1 and isPOValid (true)/generatePOApproval/Split2/SetParty2 ■ isPOValid (false)/generatePORejectMessage/SetParty1 and isPOValid (true)/generatePOApproval/Split2/isPOAmount GT1000 (false)/SetParty3 ■ isPOValid (true)/generatePOApproval/Split2/isPOAmount GT1000 (false)/SetParty3 and isPOValid (true)/generatePOApproval/Split2/isPOAmount GT1000 (true)/SetParty4 	<ul style="list-style-type: none"> ■ isPOValid (true)/generatePOApproval/Split2/SetParty2 and isPOValid (true)/generatePOApproval/Split2/isPOAmount GT1000 (false)/SetParty3 ■ isPOValid (true)/generatePOApproval/Split2/SetParty2 and isPOValid (true)/generatePOApproval/Split2/isPOAmount GT1000 (false)/SetParty4

If you want to connect all SetParty steps in [Figure 12-27](#) to an End step, [Table 12-13](#) describes the invalid possibilities.

Table 12-13 Connecting SetParty Steps to an End Step - Invalid Possibilities

Connection Tasks	Reason for Status
1. Connect all four SetParty steps to an End Step	<p>There are mutually exclusive paths coming into an End step that are invalid. For example:</p> <ul style="list-style-type: none"> ▪ isPOValid (false)/generatePORejectMessage/SetParty1 and isPOValid (true)/generatePOApproval/Split2/SetParty2
1. Connect all four SetParty steps to an Or step	<p>There are nonmutually exclusive paths coming into an Or Step that are invalid. For example:</p> <ul style="list-style-type: none"> ▪ isPOValid (true)/generatePOApproval/Split2/SetParty2 and isPOValid (true)/generatePOApproval/Split2/isPOAmountGT1000 (false)/SetParty3
2. Connect the Or step to an End step	
1. Connect SetParty1 and SetParty2 to an Or step (Or1)	<p>The status of these steps is as follows:</p> <ul style="list-style-type: none"> ▪ Or1 step (Valid) <p>All paths coming from SetParty1 are mutually exclusive with all paths coming from SetParty2.</p> <ul style="list-style-type: none"> ▪ Or2 step (Valid) <p>All paths coming from SetParty3 are mutually exclusive with all paths from SetParty4.</p> <ul style="list-style-type: none"> ▪ End step (Invalid) <p>Not all paths coming from Or1 are nonmutually exclusive with those from Or2. This is the same as saying that a path exists from Or1 that is mutually exclusive with a path from Or2. This can result in an infinite wait at runtime. For example:</p> <p>isPOValid (false)/generatePORejectMessage/SetParty1 and isPOValid (true)/generatePOApproval/Split2/isPOAmountGT1000 (false)/SetParty3</p>
2. Connect SetParty3 and SetParty4 to another Or step (Or2)	
3. Connect the two Or steps to the End step	

If you want to connect all SetParty steps in [Figure 12-27](#) to an End step, [Table 12-14](#) describes the valid possibilities.

Table 12-14 Connecting SetParty Steps to an End Step - Valid Possibilities

Connection Tasks	Reason for Status
1. Connect SetParty3 and SetParty4 to an Or Step (Or1)	The status of these steps is as follows: <ul style="list-style-type: none"> Or1 step (Valid)
2. Connect SetParty2 and Or1 to an And Step (And1)	Paths coming from SetParty3 are mutually exclusive with paths from SetParty4. <ul style="list-style-type: none"> And1 step (Valid)
3. Connect SetParty1 and And1 to an Or Step (Or2)	All paths coming from Or1 are nonmutually exclusive with all paths from SetParty2. <ul style="list-style-type: none"> Or2 (Valid)
4. Connect Or2 to End Step	Paths coming from SetParty1 are mutually exclusive with paths from And1. <ul style="list-style-type: none"> End (Valid) <p>All paths are coming from only Or2 and are nonmutually exclusive.</p>

If all four SetParty steps in [Figure 12-27](#) have their own outbound role port (named p1, p2, p3, p4), [Table 12-15](#) describes valid and invalid methods for merging data flows from the step ports on to a role port.

Table 12-15 SetParty Steps with Outbound Role Port

Connection Tasks	Status	Reason for Status
Connect p1, p2, p3, and p4 to one outbound role port using four different data flows	Invalid	Data flows from SetParty2 and SetParty3 (and therefore from p2 and p3) are nonmutually exclusive. At runtime, there can potentially be more than one event placed on the same port, which is illegal.
Connect p1 and p2 to one outbound role port	Valid	Paths from SetParty1 and SetParty2 (and therefore from p1 and p2) are mutually exclusive.
Connect p2 and p4 to one outbound role port	Invalid	Data flows from SetParty2 and SetParty4 (and therefore from p2 and p4) are nonmutually exclusive.
Connect p3 and p4 to one outbound role port	Valid	Paths from SetParty3 and SetParty4 (and therefore from p3 and p4) are mutually exclusive.

Invalid Merging of Data Flows Between Role Ports

This section describes the invalid merging of data flows from role ports on different transformation binding roles (that is, different spokes) to one role port on a business role in the inbound direction.

Do not merge data flows coming from various spokes, whose corresponding native roles are correlated, to one inbound role port on the business role. This is to prevent repopulating of an already-populated inbound role port on the business role. Correlated native roles mean that it is possible for the two spokes to be part of one coordination at runtime. Therefore, the possibility exists for repopulating the business role port. [Figure 12-28](#) shows this behavior.

Figure 12-28 *Native Event Correlation with Multiple Spokes*

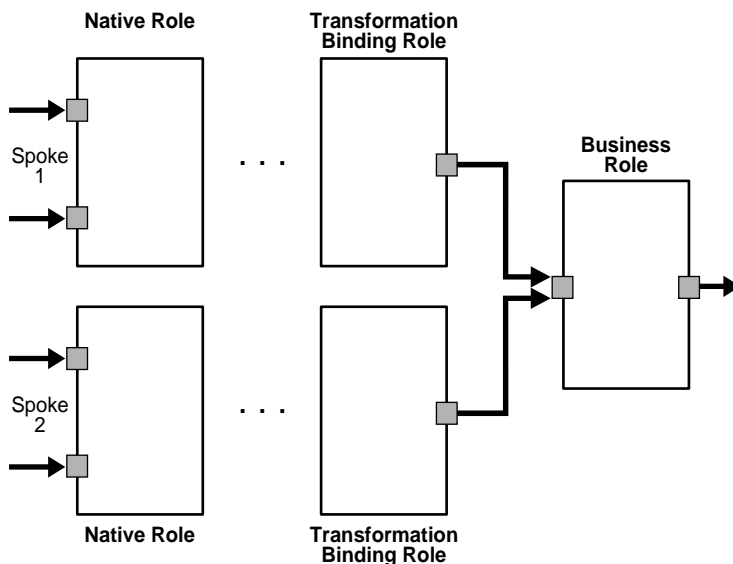

If correlation exists between any native events across native roles of different spokes, the above role design is invalid.

If no correlation exists between any native events across native roles of different spokes, the above role design is valid.

Current Modeling Restrictions

There may be situations in which you know that given paths are mutually exclusive, but Oracle Application Server ProcessConnect does not. Oracle Application Server ProcessConnect therefore mandates that an And step be used in place of an Or step, which you may think is the correct choice. However, this action results in an infinite wait. In cases where this infinite wait cannot be avoided, design your steps so that this wait happens only at the End step and that there are no processing steps following this potentially indefinitely-waiting And step.

This results in the corresponding role instances not closing since their corresponding End steps have not executed. Consequently, the corresponding coordinations are also never closed. For these coordinations, you must explicitly close them through the **Reports** tab pages. [Figure 12-29](#) shows this behavior:

Figure 12-29 Modeling Restrictions

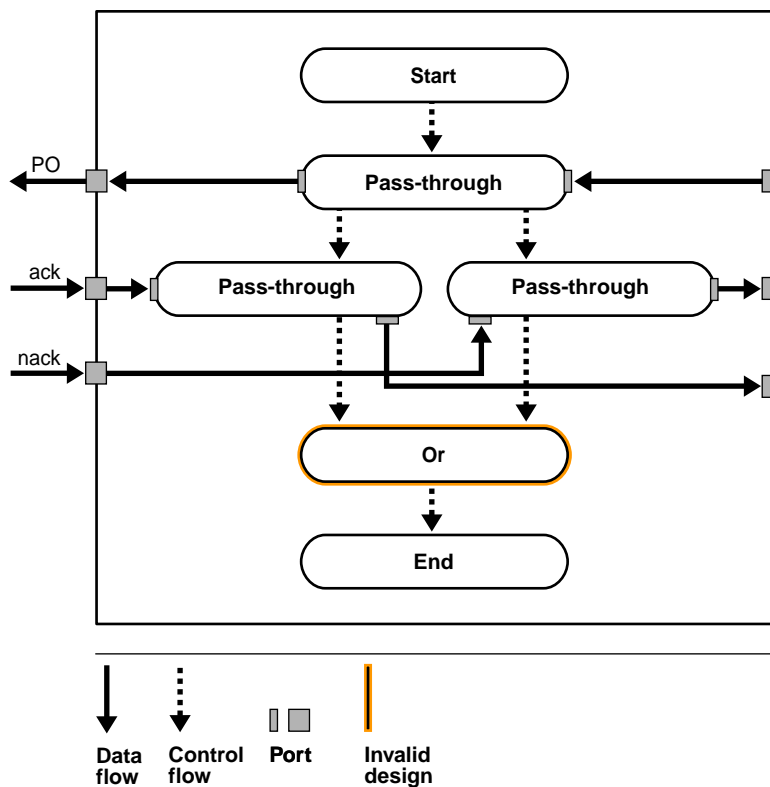

Assume only one of the ack or nack data flow always comes into Oracle Application Server ProcessConnect. There is currently no method in Oracle Application Server ProcessConnect to capture mutual exclusiveness properly across events entering Oracle Application Server ProcessConnect. Therefore, Oracle Application Server ProcessConnect assumes that both ack and nack always enter Oracle Application Server ProcessConnect. Consequently, Oracle Application Server ProcessConnect detects the design in [Figure 12-29](#) as invalid. [Figure 12-30](#) provides an example of how to validly design this situation without using an Or step.

Figure 12-30 Valid Role Data Flows

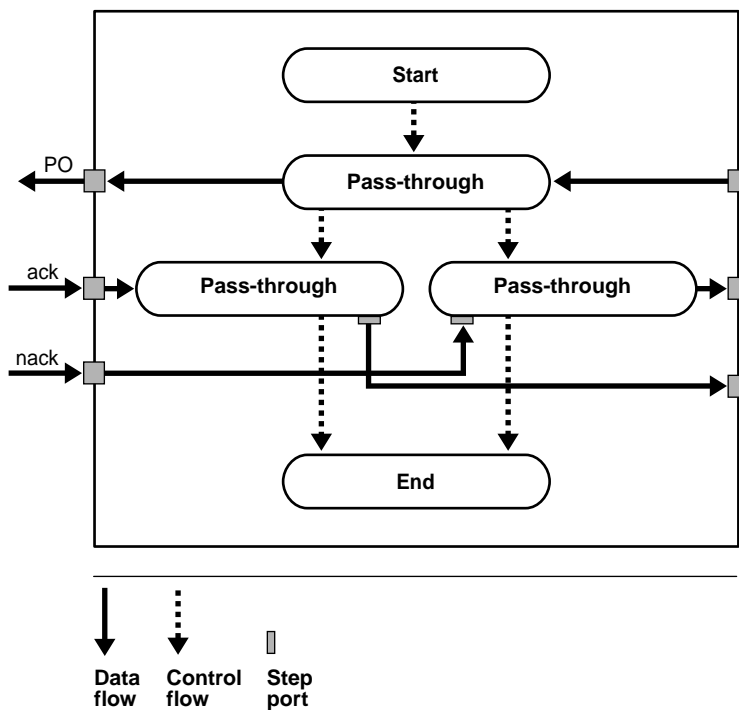

See Also: [Chapter 23, "Creating Reports"](#)

Role Runtime Behavior

This section describes the behavior of roles during runtime. This section contains these topics:

- [Coordination](#)
- [Error Handling](#)

Coordination

A coordination represents the execution of the business transaction represented by the business process. A coordination consists of the full set of role instances and event instances bound to a specific business process.

A native event instance is created from the wire message received by the adapter framework. As the event is processed by various roles in Oracle Application Server ProcessConnect, the appropriate role instances are created. The event can be translated into an application event instance and transformed into a business event instance before executing the business process.

The coordination is created when the initiating native event instance for the business process is raised by the adapter framework and picked up by the native role. As the event instance is being processed through the various roles, role instances are created for each of the role types in the business process. When a new native event is raised by the adapter framework, native event correlation is performed to match it with other native events that have been raised before this event.

There are two possibilities:

- If a correlated native event is not found, then the adapter framework tries to determine if there is a native role that can accept this event at its inbound port. This is done using the agreements between the party (application or trading partner) and native roles. If a native role is found, then a coordination is created. If a native role is not found, then an error occurs.
- If a correlated native event is found, then the newly-raised native event instance is sent to the same native role instance (and coordination) as the original native event instance. In this scenario, the new event instance joins the existing coordination.

The coordination is automatically closed when all the role instances are complete and there are no event instances waiting to be processed on any of the role ports.

The coordination may not close in one of the following scenarios:

- Scenario 1

If all the events required by the business process have not been received; therefore, some of the steps have not been executed.

- Scenario 2

If there is an error during the execution of any steps. If there is a system error during processing of the event or datatype instance, the operation is automatically retried. If there is a domain error that has not been designed, then coordination processing halts. The step does not produce an event on its OUT port and there is a returnCode datatype with the error message on the return code port. In this case, Oracle Application Server ProcessConnect automatically aborts the coordination.

- Scenario 3

If there is an error in the way the roles have been designed, leading to a step that is waiting forever for data or events to appear. For example, if you have a condition step with two control flows (one for true and one for false), and these control flows are eventually connected to an AND step. In this case, there are mutually exclusive paths leading to an AND step, and this step never executes.

If the coordination is open and no new events are expected (as previously described in Scenario 1), then you can gracefully close the coordination from the Process Monitoring reports page in the design tool.

The coordination may also be open because of one of the error scenarios previously described in Scenario 2 and Scenario 3. In this case, the coordination must be aborted. This can be performed using the Process Monitoring reports page.

See Also:

- ["Event Types and Event Instances"](#) on page 3-16
- ["Native Event Correlation"](#) on page 3-26
- [Chapter 3, "Oracle Application Server ProcessConnect Concepts"](#) for additional details on event instances and role instances
- [Chapter 23, "Creating Reports"](#) for additional details about closing and aborting coordinations

Error Handling

If any errors occur during the processing of an event, Oracle Application Server ProcessConnect logs and handles the error depending on whether it is a system error or domain error.

See Also:

- [Chapter 21, "Oracle Application Server ProcessConnect Error Handling"](#) for additional details on diagnosing runtime problems and handling errors
- [Chapter 23, "Creating Reports"](#)

Common User Errors

The following are common business process and role management user errors.

- Ensure that you updated the SetParty step to point to the destination party in the agreement.
- Verify that data flow groups are created only between roles that can have data flows between them. For example, a translation binding role can only have data flows to either native roles or application roles. Verify this by clicking the integration diagram for each modeled business process.
- Modeling metadata must be deleted in a specific order. Otherwise, you receive errors. See "[Design-Time Troubleshooting of Modeling Metadata Dependencies](#)" on page 22-9 for details.

Chapter Summary

This chapter describes how to manage business processes and roles, which includes managing role types, role ports, role data flow, steps, step ports, step data flow, and step control flow, as well as managing condition expressions in steps. With condition steps, you can define an action based on the evaluation of an expression. Role design to ensure proper validation and the behavior of role during runtime are also discussed.

Managing Transformations

This chapter describes transformation concepts and management tasks for designing an integration.

This chapter contains these topics:

- [Transformation Overview](#)
- [Transformation Maps Overview](#)
- [Managing Event Type Transformation Maps](#)
- [Managing Datatype Transformation Maps](#)
- [Transformation Statements Overview](#)
- [Managing Transformation Statements](#)
- [Domain Value Maps](#)
- [Common User Errors](#)
- [Chapter Summary](#)

Note: Do not use the **Back** and **Forward** buttons of your Web browser when creating transformation rules.

Transformation Overview

Different parties in an integration use a different structure for and a different vocabulary in their business messages. For example, an address can be presented in a single string by one party while it can be divided into street, city, and other details by another party. For business vocabulary, one party can use the term *item* in its purchase order while another party can use the term *component* in its purchase order. This creates a message structure and vocabulary mismatch between the two parties. Transformation eliminates such a structure and vocabulary mismatch by mapping one party's message to that of the other.

Before a business message can be mapped to one with a different structure and vocabulary, the logic for such a mapping must be designed. For example, it must be specified that one party's address with a separate street, city, and other details must be joined together into a single string for another party. This logic comprises a transformation map. Oracle Application Server ProcessConnect provides an easy-to-use, graphical way of defining these maps.

Where does transformation fit in into the overall integration picture? A transformation map is associated with a transformation step within a role responsible for mapping messages with different semantics. Transformation steps are typically defined in transformation binding roles to map an application event type to a business event type, and vice versa, but they can also be used within application roles or business roles and can operate over datatypes and event types.

See Also:

- ["Transformation"](#) on page 3-39 and ["Transformation Binding Role"](#) on page 3-41 for conceptual details about transformation binding roles
- [Chapter 7, "Tutorial of an Integration within an Enterprise"](#) for a tutorial that describes how to create transformation maps
- ["Transformation Step"](#) on page 12-73 for conceptual details about transformation steps
- ["Creating a Step"](#) on page 12-81 for instructions on creating a transformation step
- [Appendix B, "Transformation Rules"](#) for descriptions of transformation rules, event header rules, and domain value map rules listed in this chapter

Transformation Maps Overview

A transformation map is the Oracle Application Server ProcessConnect structure that defines the transformation logic. A map transforms sources to targets, both of which can either be event types or datatypes. A single source typically gets transformed to a single target, but a map is free to have multiple sources and targets. You can use two types of transformation maps, depending on the types of sources and targets being transformed:

- [Event Type Transformation Maps](#)
- [Datatype Transformation Maps](#)

Event Type Transformation Maps

This section provides an example of an event type transformation map.

Assume you want to transform an invoice to a purchase order, both of which are event types. You do this by defining an event type transformation map, which defines a mapping between event types.

Formally, an event type transformation map defines mappings across event types and datatypes, including the following types of mapping:

- Event type to event type
- Event type to datatype
- Datatype to event type

Event type transformation maps can also transform a combination of an event type and a datatype to the same type of combination, or split an event type into a datatype and an event type. In short, any combination of these types is possible as long as at least one event type is involved:

- Event type + datatype to event type + datatype
- Event type to event type + datatype

Datatype Transformation Maps

This section provides an example of a datatype transformation map.

Assume you want to transform only a line item from an invoice to an item in a purchase order. You can do this in the map that transforms the invoice to the purchase order by individually mapping each required element from the line item to an element in the item. However, if you want to reuse this mapping elsewhere, you define a separate datatype transformation map.

Datatype transformation maps define mappings across datatypes. These maps are typically invoked from other maps though they can also be directly associated with transformation steps. Datatype transformation maps can either be:

- System-defined maps

System-defined maps are a library of pre-existing maps included with Oracle Application Server ProcessConnect that operate on core datatypes such as strings and integers, and provide core mapping functionality. Examples of such maps are `copyString`, `concatString`, and `addInteger`. You cannot edit or delete system-defined datatype transformation maps.

- User-defined maps

You can also define your own new datatype transformation maps in much the same way as you define event type transformation maps. User-defined maps can only have datatypes as sources and targets:

- Datatype to datatype
- Datatype + datatype to datatype

Managing Event Type Transformation Maps

The Oracle Application Server ProcessConnect user interface tool enables you to perform the event type transformation map management tasks shown in [Figure 13–1](#) and [Figure 13–2](#). These tasks are described in detail in this section.

Figure 13–1 Event Type Transformation Map Management Tasks (Part 1 of 2)

Event Transformation Maps				Create	Shortcuts
Name	Source Parameter Types	Target Parameter Types	Update	Delete	Application Event Types Create Business Event Type Business Event Types
Transform Payload	notification_type	expense_type			
env_test	envelope				

Transformation Map Details: Transform Payload

[Delete](#) [Update](#) [Modify Sources and Targets](#)

Use the section below to create transformation statements. To create a statement select the statement type, the datatype transformation map type, the datatype transformation map and the sources and targets and choose Append or Insert. Append creates a statement at the end of the statement list. If the selected statement is part of a block (if, else if, iterator), append creates a statement at the end of the selected block. Insert creates a statement before the selected statement.

[Expand All](#) | [Collapse All](#)

Select Focus	Statements	Type	Update	Delete
<input type="radio"/>	Statements			
<input type="radio"/>	concat(firstString=Payload-IN/PAYLOAD/Ad/Title ,secondString=Payload-IN/PAYLOAD/Ad/Text --->resultString=Payload-OUT/Ad/Title)	Rule		

Statement Type

Datatype Transformation Map Type

Necessary for rule statements only

Datatype Transformation Map

Necessary for rule statements only

TIP Append creates a statement at the end of the statement list. If the selected statement is part of a block (if, else if, iterator), append creates a statement at the end of the selected block. Insert creates a statement before the selected statement.

[Append](#) [Insert](#)

[Select All](#) | [Select None](#) | [Expand All](#) | [Collapse All](#)

Select Focus	Source Items	Type	Mapped
<input type="checkbox"/>	Sources		
<input type="checkbox"/>	Event Type Parameters		
<input type="checkbox"/>	Payload-IN	Payload	
<input type="checkbox"/>	PAYLOAD	Ad_Request	
<input type="checkbox"/>	Action	string	
<input type="checkbox"/>	Function_Type	string	
<input type="checkbox"/>	Date	dateTime	
<input type="checkbox"/>	HR_Contact_FirstName	string	
<input type="checkbox"/>	HR_Contact_LastName	string	
<input type="checkbox"/>	(Anonymous)	(Anonymous)	

[Select All](#) | [Select None](#) | [Expand All](#) | [Collapse All](#)

Select Focus	Target Items	Type	Mapped
<input type="checkbox"/>	Targets		
<input type="checkbox"/>	Event Type Parameters		
<input type="checkbox"/>	Payload-OUT	Payload	
<input type="checkbox"/>	Ad	AdType	
<input type="checkbox"/>	Datatype Parameters		
<input type="checkbox"/>	Map Variables		

Selecting **Modify Sources and Targets** in [Figure 13-1](#) causes a Modify Sources and Targets page such as that shown in [Figure 13-2](#) to appear.

Figure 13-2 Event Type Transformation Map Management Tasks (Part 2 of 2)

Modify Sources and Targets

Event Transformation Map Transform Payload

Sources

Name	Type	Update	Delete
Payload-IN	Payload		

Targets

Name	Type	Update	Delete
Payload-OUT	Payload		

[Table 13-1](#) identifies the event type transformation map management tasks shown in [Figure 13-1](#) and [Figure 13-2](#) and provides references to procedures for performing these tasks.

Table 13-1 Event Type Transformation Map Management Tasks

Page Elements	Management Task	First See Section...	Then See Section...
Shortcuts section in Event Transformation Maps page of Figure 13-1	Take a shortcut to manage business and application event types	N/A	" Viewing Application Event Types " on page 11-60 and " Managing Business Event Types " on page 11-63
Create button in Event Transformation Maps page of Figure 13-1	Create an event type transformation map	" Accessing Event Type Transformation Map Management Tasks " on page 13-8	" Creating an Event Type Transformation Map " on page 13-9
Delete column in Event Transformation Maps page of Figure 13-1	Delete an event type transformation map		" Deleting an Event Type Transformation Map " on page 13-13
Update column in Event Transformation Maps page of Figure 13-1	Update an event type transformation map		" Updating an Event Type Transformation Map " on page 13-13

Table 13–1 (Cont.) Event Type Transformation Map Management Tasks

Page Elements	Management Task	First See Section...	Then See Section...
Target Parameter Types column in Event Transformation Maps page of Figure 13–1	View details about an event type transformation map target	"Accessing Event Type Transformation Map Management Tasks" on page 13-8	"Viewing a Complex Datatype" on page 10-22 "Viewing a Scalar Datatype" on page 10-43
Source Parameter Types column in Event Transformation Maps page of Figure 13–1	View details about an event type transformation map source		"Viewing a Complex Datatype" on page 10-22 "Viewing a Scalar Datatype" on page 10-43
Name column in Event Transformation Maps page of Figure 13–1 (To access details page shown in lower page of Figure 13–1)	View details about an event type transformation map		"Viewing an Event Type Transformation Map" on page 13-14
Create button in Modify Sources and Targets page of Figure 13–2	Create an initial or additional source or target		"Creating Additional Sources or Targets" on page 13-17
Delete column in Modify Sources and Targets page of Figure 13–2	Delete sources and targets		"Deleting Sources and Targets" on page 13-18
Update column in Modify Sources and Targets page of Figure 13–2	Update sources and targets		"Updating Sources and Targets" on page 13-19
Type column in Modify Sources and Targets page of Figure 13–2	View event type source and target types		"Viewing Application Event Types" on page 11-60 "Viewing a Business Event Type" on page 11-68
Name column in Modify Sources and Targets page of Figure 13–2	View event type transformation map sources and targets		"Viewing an Event Type Transformation Map Parameter" on page 13-20

Accessing Event Type Transformation Map Management Tasks

Follow these instructions to access the event type transformation map management tasks shown in [Figure 13-1](#) on page 13-5 and [Figure 13-2](#) on page 13-6:

To access event type transformation map management tasks:

1. Select the **Modeling** tab.
2. Select the **Transformations** tab.

The Event Transformation Maps page appears. (See the upper page of [Figure 13-1](#) on page 13-5.)

3. Select a task to perform and see the referenced section for instructions:

To...	Then...	See Section...
Create an event type transformation map	Click Create .	"Creating an Event Type Transformation Map" on page 13-9
Delete an event type transformation map	Select a specific event type transformation map in the Delete column.	"Deleting an Event Type Transformation Map" on page 13-13
Update an event type transformation map	Select a specific event type transformation map in the Update column.	"Updating an Event Type Transformation Map" on page 13-13
View details about an event type transformation map target	Select a specific event type transformation map target in the Target Parameter Types column.	"Viewing a Complex Datatype" on page 10-22 "Viewing a Scalar Datatype" on page 10-43
View details about an event type transformation map source	Select a specific event type transformation map source in the Source Parameter Types column.	"Viewing a Complex Datatype" on page 10-22 "Viewing a Scalar Datatype" on page 10-43
View details about an event type transformation map	Select a specific event type transformation map name in the Name column.	"Viewing an Event Type Transformation Map" on page 13-14
Create an initial or additional source or target	Select a specific event type transformation map name in the Name column for which to create sources or targets.	"Creating Additional Sources or Targets" on page 13-17

To...	Then...	See Section...
Delete sources and targets	Select a specific event type transformation map name in the Name column for which to delete sources or targets.	"Deleting Sources and Targets" on page 13-18
Update sources and targets	Select a specific event type transformation map name in the Name column for which to update sources or targets.	"Updating Sources and Targets" on page 13-19
View event type sources and target types	Select a specific event type transformation map name in the Name column for which to view source or target types.	"Viewing Application Event Types" on page 11-60 "Viewing a Business Event Type" on page 11-68
View event type transformation map sources and targets	Select a specific event type transformation map name in the Name column for which to view sources or targets.	"Viewing an Event Type Transformation Map Parameter" on page 13-20

Creating an Event Type Transformation Map

Follow these instructions to create an event type transformation map:

To create an event type transformation map:

1. Ensure that you followed the instructions in ["Accessing Event Type Transformation Map Management Tasks"](#) on page 13-8 to access the page for creating an event type transformation map.
The Create Event Transformation Map page appears.
2. Enter a unique and recognizable event type transformation map name in the **Name** field.
3. Select if you want to create a single source and single target for this event type transformation map at this time (for example, a source application event type and a target business event type). You can also perform this task at a later time. You can also add additional sources and targets to this event type transformation map at a later time.

If You Select...	Then Go to...
Define Source and Target Later	Step 10. Note: You can define initial or additional sources or targets later by following the instructions in " Creating Additional Sources or Targets " on page 13-17.
Specify Source and Target	Step 4.

- Go to the **Source** section.
- Enter the following details to create an event type transformation map source. An asterisk (*) indicates a required field.

Field	Description
Name *	Enter a unique and recognizable source name (for example, PO).
Description	Enter a source description.
Type *	Select Datatype or Event Type as the source type.

The page refreshes based on your selection of **Datatype** or **Event Type** from the **Type** list.

- Provide responses to the following questions based on your selection in Step 5. An asterisk (*) indicates a required field.

If You Selected...	Then...
Datatype	<ol style="list-style-type: none"> Select Application Datatype, Business Datatype, or Core Datatype from the Classification list. * Select a namespace from the Namespace list. Click the flashlight to select a datatype for the Name field. *
Event Type	<ol style="list-style-type: none"> Select Application Event Type or Business Event Type from the Classification list. * Click the flashlight to select a specific event type for the Name field. *

7. Go to the **Target** section.
8. Enter the following details to create an event type transformation map target. An asterisk (*) indicates a required field.

Field	Description
Name *	Enter a unique and recognizable target name (for example, Invoice).
Description	Enter a target description.
Type *	Select Datatype or Event Type as the target type.

The page refreshes based on your selection of **Datatype** or **Event Type** in the **Type** field.

9. Provide responses to the following questions based on your selection in Step 8. An asterisk (*) indicates a required field.

If You Selected...	Then...
Datatype	<ol style="list-style-type: none"> 1. Select Application Datatype, Business Datatype, or Core Datatype from the Classification list. * 2. Select a namespace from the Namespace list. 3. Click the flashlight to select a datatype for the Name field. *
Event Type	<ol style="list-style-type: none"> 1. Select Application Event Type or Business Event Type from the Classification list. * 2. Click the flashlight to select a specific event type for the Name field. *

10. Click **Apply**.

The event type transformation map is created and the Transformation Map Details page for the new event type transformation map appears.

Transformation Map Details: Transform Expense

Use the section below to create transformation statements. To create a statement select the statement type, the datatype transformation map type, the datatype transformation map and the sources and targets and choose Append or Insert. Append creates a statement at the end of the statement list. If the selected statement is part of a block (if, else if, iterator), append creates a statement at the end of the selected block. Insert creates a statement before the selected statement.

[Expand All](#) | [Collapse All](#)

⊕ Statements			
Select Focus	Statements	Type	Update
<input type="checkbox"/>	▼ Statements		

Statement Type

Datatype Transformation Map Type

Necessary for rule statements only

Datatype Transformation Map

Necessary for rule statements only

TIP Append creates a statement at the end of the statement list. If the selected statement is part of a block (if, else if, iterator), append creates a statement at the end of the selected block. Insert creates a statement before the selected statement.

[Select All](#) | [Select None](#) | [Expand All](#) | [Collapse All](#)

⊕ Sources			
Select Focus	Source Items	Type	Mapped
<input type="checkbox"/>	▼ Sources		
<input type="checkbox"/>	⊕ ▶ Event Type Parameters		
<input type="checkbox"/>	⊕ ▶ Datatype Parameters		
<input type="checkbox"/>	⊕ ▶ Map Variables		
<input type="checkbox"/>	⊕ ▶ Iterators		

[Select All](#) | [Select None](#) | [Expand All](#) | [Collapse All](#)

⊕ Targets			
Select Focus	Target Items	Type	Mapped
<input type="checkbox"/>	▼ Targets		
<input type="checkbox"/>	⊕ ▶ Event Type Parameters		
<input type="checkbox"/>	⊕ ▶ Datatype Parameters		
<input type="checkbox"/>	⊕ ▶ Map Variables		

You can now add transformation map statements.

See Also:

- ["Transformation Statements Overview"](#) on page 13-27 for instructions on assigning rule, IF condition, ELSE condition, domain value map rule, event header rule, iterator, and map variable statements to the sources and targets of an event type transformation map
- ["Creating Additional Sources or Targets"](#) on page 13-17 to create initial or multiple sources and targets for the event type transformation map

Deleting an Event Type Transformation Map

Follow these instructions to delete an event type transformation map:

Note: You cannot delete a transformation map if it is currently associated with a step in a role (for example, if an event type transformation map called **PO_to_Invoice** is associated with a transformation step in a transformation binding role).

To delete an event type transformation map:

1. Ensure that you followed the instructions in "[Accessing Event Type Transformation Map Management Tasks](#)" on page 13-8 to access the page for deleting an event type transformation map.

The Delete Transformation Map page appears.

2. Click **Yes** when prompted to delete the event type transformation map.

The event type transformation map is deleted and the Event Transformation Maps page appears.

Updating an Event Type Transformation Map

Follow these instructions to update an event type transformation map:

To update an event type transformation map:

1. Ensure that you followed the instructions in "[Accessing Event Type Transformation Map Management Tasks](#)" on page 13-8 to access the page for updating an event type transformation map.

The Update Transformation Map page appears.

2. Make appropriate changes to the event type transformation map name. No other details for the event type transformation map can be updated from this page.

3. Click **Apply**.

The event type transformation map is updated and the Transformation Map Details page for the updated event type transformation map appears.

Viewing an Event Type Transformation Map

Note: You can also access an event transformation details page from the **Details** section of a transformation step details page. The **Transformation Map** section of the **Details** section of the transformation step details page displays the transformation map you created and associated with the role. Click the transformation map link to access its details page.

Follow these instructions to view details about a specific event type transformation map:

To view an event type transformation map:

1. Ensure that you followed the instructions in "[Accessing Event Type Transformation Map Management Tasks](#)" on page 13-8 to access the page for viewing an event type transformation map.

The Transformation Map Details page for the selected event type transformation map appears (in this example, an event type transformation map named **Transform Payload**).

Transformation Map Details: Transform Payload

Delete Update Modify Sources and Targets

Use the section below to create transformation statements. To create a statement select the statement type, the datatype transformation map type, the datatype transformation map and the sources and targets and choose Append or Insert. Append creates a statement at the end of the statement list. If the selected statement is part of a block (if, else if, iterator), append creates a statement at the end of the selected block. Insert creates a statement before the selected statement.

[Expand All](#) | [Collapse All](#)

Statements		Type	Update	Delete
<input type="checkbox"/>	▼ Statements			
<input type="checkbox"/>	concat(firstString=Payload-IN/PAYLOAD/Ad/Title ,secondString=Payload-IN/PAYLOAD/Ad/Text ---->resultString=Payload-OUT/Ad/Title)	Rule		

Statement Type:

Datatype Transformation Map Type:
Necessary for rule statements only

Datatype Transformation Map:
Necessary for rule statements only

TIP Append creates a statement at the end of the statement list. If the selected statement is part of a block (if, else if, iterator), append creates a statement at the end of the selected block. Insert creates a statement before the selected statement. Append Insert

[Select All](#) | [Select None](#) | [Expand All](#) | [Collapse All](#)

Sources		Type	Mapped
<input type="checkbox"/>	▼ Sources		
<input type="checkbox"/>	▼ Event Type Parameters		
<input type="checkbox"/>	▼ Payload-IN	Payload	
<input type="checkbox"/>	▼ PAYLOAD	Ad_Request	
<input type="checkbox"/>	Action	string	
<input type="checkbox"/>	Function_Type	string	
<input type="checkbox"/>	Date	dateTime	
<input type="checkbox"/>	HR_Contact_FirstName	string	
<input type="checkbox"/>	HR_Contact_LastName	string	
<input type="checkbox"/>	▶ (Anonymous)	(Anonymous)	

[Select All](#) | [Select None](#) | [Expand All](#) | [Collapse All](#)

Targets		Type	Mapped
<input type="checkbox"/>	▼ Targets		
<input type="checkbox"/>	▼ Event Type Parameters		
<input type="checkbox"/>	▼ Payload-OUT	Payload	
<input type="checkbox"/>	▶ Ad	AdType	
<input type="checkbox"/>	▶ Datatype Parameters		
<input type="checkbox"/>	▶ Map Variables		

This details page, as with the Event Transformation Maps page shown in the upper page of [Figure 13-1](#) on page 13-5, enables you to delete or update the selected event type transformation map from the **Delete** and **Update** buttons that display at the top right and bottom right sections.

2. View specific details about any statements assigned to this event type transformation map. Statements display near the top of the page in the **Statements** table.
3. Go to the **Sources** table and **Targets** table.

4. Click a specific source or target item to expand or click **Expand All** in the **Sources** table and **Targets** table to expand both lists. Note that when you expand a specific event type parameter, all its body elements appear beneath.
 - a. If you created a mapping from a source application event type to a target business event type, expand **Event Type Parameters** in both the **Sources** and **Targets** columns to display all events.
 - b. Expand the source application event (for example, **Payload-IN** in the figure in Step 1) and the target business event (for example, **Payload-OUT** in the figure in Step 1) to display their event body elements.
 - c. Expand the event body elements of both events (**PAYLOAD** for **Payload-IN** and **Ad** for **Payload-OUT** in the figure in Step 1). This displays the source and target datatypes of both event body elements for which you can create mappings.

Note: The source application event body element (**Payload-IN** in this example) and its datatypes that display here are the same ones that display in the following location:

1. Click **Modeling > Event Types > Application Event Types**.
2. Click the specific application event (for example, **Payload**) in the **Name** column.
3. Go to the **Event Body Elements** section and click **Expand All** to display the same source datatypes.

The target business event body element (**Payload-OUT** in this example) and its datatypes that display here are the same ones that display in the following location:

1. Click **Modeling > Event Types**.
 2. Click the specific business event (for example, **Ad**) in the **Name** column.
 3. Go to the **Event Body Elements** section and click **Expand All** to display the same target datatypes.
-
-

See Also: ["Managing Transformation Statements"](#) on page 13-29 for a complete description of the functionality available in the Event Transformation Map Details page

Creating Additional Sources or Targets

Follow these instructions to create additional sources and targets to the transformation map:

To create additional sources and targets:

1. Ensure that you followed the instructions in "[Accessing Event Type Transformation Map Management Tasks](#)" on page 13-8 to access the page for creating additional sources and targets.

The Transformation Map Details page appears.

2. Click **Modify Sources and Targets**.

The Modify Sources and Targets page appears.

3. Click **Create** in either the **Sources** section or **Targets** section, depending on which type you want to create.

The Create Event Transformation Map Parameter page appears.

4. Enter a unique and recognizable name in the **Name** field.

5. Select **Datatype** or **Event Type** from the **Type** list.

The page refreshes based on your selection of **Datatype** or **Event Type** in the **Type** field.

6. Provide responses to the following questions based on your selection in Step 5. An asterisk (*) indicates a required field.

If You Selected...	Then...
Datatype	<ol style="list-style-type: none"> 1. Select Application Datatype, Business Datatype, or Core Datatype from the Classification list. 2. Select a namespace from the Namespace list. 3. Click the flashlight to select a datatype for the Name field.
Event Type	<ol style="list-style-type: none"> 1. Select Application Event Type or Business Event Type from the Classification list. 2. Click the flashlight to select a specific event type for the Name field.

7. Click **Apply**.
The Modify Sources and Targets page appears.
8. Click **Return To Map Details**.
The Transformation Map Details page appears.

Deleting Sources and Targets

Follow these instructions to delete sources and targets:

Note: Event transformation map parameters can only be deleted if they are not being used in any transformation statements.

To delete sources and targets:

1. Ensure that you followed the instructions in "[Accessing Event Type Transformation Map Management Tasks](#)" on page 13-8 to access the page for deleting sources and targets.
The Transformation Map Details page appears.
2. Click **Modify Sources and Targets**.
The Modify Sources and Targets page appears.
3. Select a specific source or target to delete in the **Delete** column.
4. Click **Yes** when prompted to delete the selected source or target.
The source or target is deleted and the Modify Sources and Targets page appears.
5. Click **Return To Map Details**.
The Transformation Map Details page appears.

Updating Sources and Targets

Follow these instructions to update sources and targets:

Note: Event transformation map parameters can only be updated if they are not being used in any transformation statements.

To update sources and targets:

1. Ensure that you followed the instructions in "[Accessing Event Type Transformation Map Management Tasks](#)" on page 13-8 to access the page for updating sources and targets.

The Transformation Map Details page appears.

2. Click **Modify Sources and Targets**.

The Modify Sources and Targets page appears.

3. Select a specific source or target to update in the **Update** column.

The Update Event Transformation Map Parameter page appears.

4. Select **Datatype** or **Event Type** from the **Type** list.

The page refreshes based on your selection of **Datatype** or **Event Type** in the **Type** field.

5. Provide responses to any of the following questions based on your selection in Step 4.

If You Selected...	Then...
Datatype	<ol style="list-style-type: none"> 1. Select Application Datatype, Business Datatype, or Core Datatype from the Classification list. 2. Select a namespace from the Namespace list. 3. Click the flashlight to select a datatype for the Name field.
Event Type	<ol style="list-style-type: none"> 1. Select Application Event Type or Business Event Type from the Classification list. 2. Click the flashlight to select a specific event type for the Name field.

6. Click **Apply**.

The source or target is updated and the Modify Sources and Targets page appears.

7. Click **Return To Map Details**.

The Transformation Map Details page appears.

Viewing an Event Type Transformation Map Parameter

Follow these instructions to view details about a specific event type transformation map parameter:

To view an event type transformation map parameter:

1. Ensure that you followed the instructions in "[Accessing Event Type Transformation Map Management Tasks](#)" on page 13-8 to access the page for viewing an event type transformation map parameter.

The Transformation Map Details page appears.

2. Click **Modify Sources and Targets**.

The Modify Sources and Targets page appears.

3. Select a specific event type transformation map parameter source or target to view in the **Name** column.

The Event Transformation Map Parameter Details page appears.

[Event Transformation Map Parameter Details: Payload-IN](#)

Details

Name	Payload-IN
Description	
Source Or Target	Source
Event Type	Payload

4. View specific details about the parameter. This page, as with the Modify Sources and Targets page, enables you delete or update the selected source or target parameter.
5. Click **Return to List** to return to the Modify Sources and Targets page.

Managing Datatype Transformation Maps

The Oracle Application Server ProcessConnect user interface tool enables you to perform the datatype transformation map management tasks shown in [Figure 13-3](#). These tasks are described in detail in this section. The maps that appear in the Datatype Transformation Maps page in [Figure 13-3](#) also display in the **Datatype Transformation Map** list that appears on the Transformation Map Details page. (See [Figure 13-1](#) on page 13-5.)

Figure 13-3 Datatype Transformation Map Management Tasks

Datatype Transformation Maps

Search

Previous Next

Name	Source Parameter Types	Target Parameter Types	Update	Delete
copyString	string	string		
copy	string	string		
copyXmlOpaque	xmlOpaque	xmlOpaque		
copy	xmlOpaque	xmlOpaque		
concatString	string	string		
expandString	string string	string string		
subString	string integer integer	string		
subStringFrom	string integer	string		
stringLength	string	integer		
stringIndexOf	string string	integer		

Previous Next

Shortcuts

- [Application Datatypes](#)
- [Import Datatype](#)
- [Business Datatypes](#)

Table 13-2 identifies the datatype transformation map management tasks shown in Figure 13-3 and provides references to procedures for performing these tasks.

Table 13-2 Datatype Transformation Map Management Tasks

Data Transformation Maps Page Elements	Management Task	First See Section...	Then See Section...
Shortcuts section of Figure 13-3	Take a shortcut to view application datatypes, import XSD datatypes, and manage business datatypes	N/A	<ul style="list-style-type: none"> ▪ "Managing Application Datatypes" on page 10-55 ▪ "Importing XSD Datatypes" on page 10-51 ▪ "Managing Business Datatypes" on page 10-13
Create button of Figure 13-3	Create a datatype transformation map	"Accessing Datatype Transformation Map Management Tasks" on page 13-23	"Creating a Datatype Transformation Map" on page 13-24
Delete column of Figure 13-3	Delete a datatype transformation map		"Deleting a Datatype Transformation Map" on page 13-24
Update column of Figure 13-3	Update a datatype transformation map		"Updating a Datatype Transformation Map" on page 13-25
Target Parameter Types column of Figure 13-3	View details about a target datatype parameter		"Viewing a Complex Datatype" on page 10-22 "Viewing a Scalar Datatype" on page 10-43
Source Parameter Types column of Figure 13-3	View details about a source datatype parameter		"Viewing a Complex Datatype" on page 10-22 "Viewing a Scalar Datatype" on page 10-43
Name column of Figure 13-3	View details about a datatype transformation map		"Viewing a Datatype Transformation Map" on page 13-25

Accessing Datatype Transformation Map Management Tasks

Follow these instructions to access the datatype transformation map management tasks shown in [Figure 13-3](#) on page 13-21:

To access datatype transformation map management tasks:

1. Select the **Modeling** tab.
2. Select the **Transformations** tab.
3. Select **Datatype Transformation Maps**.

The Datatype Transformation Maps page appears.

4. Select a task to perform and see the referenced section for instructions:

To...	Then...	See Section...
Create a datatype transformation map	Click Create .	"Creating a Datatype Transformation Map" on page 13-24
Delete a datatype transformation map	Select a specific datatype transformation map in the Delete column.	"Deleting a Datatype Transformation Map" on page 13-24
Update a datatype transformation map	Select a specific datatype transformation map in the Update column.	"Updating a Datatype Transformation Map" on page 13-25
View details about a target datatype parameter	Select a specific datatype transformation map target in the Target Parameter Types column.	"Viewing a Complex Datatype" on page 10-22 "Viewing a Scalar Datatype" on page 10-43
View details about a source datatype parameter	Select a specific datatype transformation map source in the Source Parameter Types column.	"Viewing a Complex Datatype" on page 10-22 "Viewing a Scalar Datatype" on page 10-43
View details about a datatype transformation map	Select a specific user-defined datatype transformation map name in the Name column.	"Viewing a Datatype Transformation Map" on page 13-25

Creating a Datatype Transformation Map

Follow these instructions to create a datatype transformation map:

To create a datatype transformation map:

1. Ensure that you followed the instructions in "[Accessing Datatype Transformation Map Management Tasks](#)" on page 13-23 to access the page for creating a datatype transformation map.

The Create Datatype Transformation page appears.

2. Enter a unique and recognizable datatype transformation name in the **Name** field.
3. Click **Apply**.

The datatype transformation map is created and the Transformation Map Details page appears. You can now perform additional tasks, such as assigning transformation statements.

See Also: Step 1 on page 13-25 for the **Datatype Transformation Map** list from which the datatype transformation map can be selected

Deleting a Datatype Transformation Map

The system-defined datatype transformation maps included with Oracle Application Server ProcessConnect cannot be deleted. You can only delete a datatype transformation map that you created. In addition, the map can only be deleted if it is not currently being invoked from another transformation map or is associated with a transformation step. If you attempt to delete a datatype transformation map under these circumstances, an error displays.

Follow these instructions to delete a datatype transformation map:

To delete a datatype transformation map:

1. Ensure that you followed the instructions in "[Accessing Datatype Transformation Map Management Tasks](#)" on page 13-23 to access the page for deleting a datatype transformation map.
2. Click **Yes** when prompted to delete a datatype transformation map.

The statement is deleted and the Datatype Transformation Map Details page appears.

Updating a Datatype Transformation Map

System-defined datatype transformation maps included with Oracle Application Server ProcessConnect cannot be updated. You can only update a datatype transformation map that you created. Follow these instructions to update a datatype transformation map:

To update a datatype transformation map:

1. Ensure that you followed the instructions in "[Accessing Datatype Transformation Map Management Tasks](#)" on page 13-23 to access the page for updating a datatype transformation map.

The Update Transformation Map page appears.

2. Make appropriate changes to the datatype transformation map name. No other details for the datatype transformation map can be updated from this page.
3. Click **Apply**.

The datatype transformation map name is updated and the Datatype Transformation Map Details page for the updated datatype transformation map appears.

Viewing a Datatype Transformation Map

Follow these instructions to view a user-defined datatype transformation map:

To view a datatype transformation map:

1. Ensure that you followed the instructions in "[Accessing Datatype Transformation Map Management Tasks](#)" on page 13-23 to access the page for viewing a datatype transformation map.

The Transformation Map Details page for the selected datatype transformation map appears.

Transformation Map Details: copyGlobalNPAd

Use the section below to create transformation statements. To create a statement select the statement type, the datatype transformation map type, the datatype transformation map and the sources and targets and choose Append or Insert. Append creates a statement at the end of the statement list. If the selected statement is part of a block (if, else if, iterator), append creates a statement at the end of the selected block. Insert creates a statement before the selected statement.

[Expand All](#) | [Collapse All](#)

⊕ Statements

Select Focus Statements		Type	Update	Delete
<input type="radio"/>	▼ Statements			
<input type="radio"/>	copy(from=Ad Type/Title ---->to=Ad_Type/Title)	Rule		
<input type="radio"/>	copy(from=Ad Type/Text ---->to=Ad_Type/Text)	Rule		

Statement Type:

Datatype Transformation Map Type:

Datatype Transformation Map:

Necessary for rule statements only

TIP Append creates a statement at the end of the statement list. If the selected statement is part of a block (if, else if, iterator), append creates a statement at the end of the selected block. Insert creates a statement before the selected statement.

[Select All](#) | [Select None](#) | [Expand All](#) | [Collapse All](#)

⊕ Sources

Select Focus	Source Items	Type	Mapped
<input type="checkbox"/>	▼ Sources		
<input type="checkbox"/>	⊕ ▶ Event Type Parameters		
<input type="checkbox"/>	⊕ ▶ Datatype Parameters		
<input type="checkbox"/>	⊕ ▶ Map Variables		
<input type="checkbox"/>	⊕ ▶ Iterators		

[Select All](#) | [Select None](#) | [Expand All](#) | [Collapse All](#)

⊕ Targets

Select Focus	Target Items	Type	Mapped
<input type="checkbox"/>	▼ Targets		
<input type="checkbox"/>	⊕ ▶ Event Type Parameters		
<input type="checkbox"/>	⊕ ▶ Datatype Parameters		
<input type="checkbox"/>	⊕ ▶ Map Variables		

- View specific details. The datatype transformation map in this example is user-defined. Several transformation rule statements have been assigned to this datatype transformation map. (See the **Statements** section.)
- Click **Return to List** to return to the Datatype Transformation Maps page.

Transformation Statements Overview

Transformation statements are the logical operations to use when mapping the contents of sources and targets. [Table 13-3](#) describes the many different statement types available for mapping.

Note: You cannot create a transformation statement until at least one source or target parameter for the transformation map is defined.

Table 13-3 Statement Types

Statement Type	Description	See Section...
Rule	<p>Enables you to perform mapping functions between sources and targets. The mapping between source and target is performed by selecting a datatype transformation map. For example:</p> <ul style="list-style-type: none"> ▪ <code>copy:from=string->to=string</code> to copy a source datatype string to a target datatype string ▪ <code>concatString:firstString=string,secondString=string->resultString=String</code> to concatenate two source datatype strings to a target datatype string 	<p>"Transformation Rules" on page 13-30</p> <p>"Transformation Rules Case Study: Basic Transformations Using Rules" on page 13-41</p>
IF Condition	<p>Statements associated with a condition are executed if the condition evaluates successfully. For example, you can specify to have a different set of statements executed based on whether a quantity ordered in a purchase order is greater than or less than three. Different types of statements such as rules, domain value map rules, and event header rules can be associated with a condition. You can also create complex conditions by combining condition expressions with AND and OR logical operators.</p>	<p>"Transformation Conditions" on page 13-45</p> <p>"Transformation Condition Case Study: Converting Importance to Featured/Ordinary Ad" on page 13-55</p>
ELSE Condition	<p>You can add an ELSE condition to an existing IF Condition. You can then associate the ELSE condition with rules, domain value map rules, and event header rules.</p>	
Iterator	<p>Enables you to specify a set of mappings for source items that can occur multiple times in the instance. For example, you can loop through multiple occurrences of a complex datatype named <code>LineItem</code> and perform a specific set of actions on the line items. Iterators can be associated with rules, domain value map rules, event header rule statements, and map variable statements that get executed for every occurrence of the source item being iterated.</p>	<p>"Transformation Iterators" on page 13-58</p> <p>"Iterator Case Study: Transforming Ad Request with an Unbounded Number of Ads" on page 13-62</p>

Table 13–3 (Cont.) Statement Types

Statement Type	Description	See Section...
Map variable	<p>Enables you to define a global variable to use across multiple statements. A typical usage is for function chaining, where you take the output of one invoked function as an input to another function.</p> <p>For example, you can create a map variable and copy a person's first name to the variable. You then append a space character and concatenate the variable with the person's last name and store it in the target. The variable can then be used across multiple statements.</p> <p>Other usage scenarios are for building an item through multiple rules before inserting it in the targets.</p>	<p>"Transformation Map Variables" on page 13-70</p> <p>"Map Variable Case Study: Using Map Variables to Create a Formatted Name" on page 13-74</p>
Event header rule	<p>Enables you to access or set header data in a source or target. For example, you can:</p> <ul style="list-style-type: none"> ■ Get data from the header of a source and map it to target data. ■ Set header data in the target from data in the source. <p>For example, you can map data from the header of an incoming event into a target item such as a fax number by accessing the from party through a header rule and then getting the appropriate contact information for the party through another rule.</p>	<p>"Event Header Rules" on page 13-77</p> <p>"Event Header Rules Case Study: Sending to the Correct Target Newspaper" on page 13-82</p>
Domain value map rule	<p>Domain value map rules are used to map one party's vocabulary standards to another party's vocabulary standards. For example, this enables you to map the source item US to the target item United States by looking up the value for the target based on the value for the source and party of the event.</p> <p>See Also: "Domain Value Maps" on page 13-83 for procedures on creating domain values and parties</p>	<p>"Domain Value Maps" on page 13-83</p> <p>"Domain Value Map Case Study: Changing Ad Vocabulary" on page 13-110</p>

Managing Transformation Statements

The Oracle Application Server ProcessConnect user interface tool enables you to perform the transformation statement management tasks shown in Figure 13-4. These tasks are described in detail in this section.

Figure 13-4 Transformation Statement Management Tasks

Transformation Map Details: Transform Payload

Delete Update Modify Sources and Targets

Use the section below to create transformation statements. To create a statement select the statement type, the datatype transformation map type, the datatype transformation map and the sources and targets and choose Append or Insert. Append creates a statement at the end of the statement list. If the selected statement is part of a block (if, else if, iterator), append creates a statement at the end of the selected block. Insert creates a statement before the selected statement.

Expand All | Collapse All

Statements		Type	Update	Delete
<input type="checkbox"/>	▼ Statements			
<input type="checkbox"/>	▶ IF (Payload-IN/arrival_date = 2002)	IF Condition		
<input type="checkbox"/>	lookupByColumns(inValue=Payload-IN/subject --->outValue=Payload-OUT/employee/managername)	Domain Value Map Rule		

Statement Type: (Dropdown menu open showing: Rule, Unspecified, Rule, IF Condition, ELSE Condition, Iterator, Domain Value Map Rule, Event Header Rule, Map Variable)

Datatype Transformation Map Type: (Dropdown menu open showing: Rule, Unspecified, Rule, IF Condition, ELSE Condition, Iterator, Domain Value Map Rule, Event Header Rule, Map Variable)

Datatype Transformation Map: (Dropdown menu open showing: Rule, Unspecified, Rule, IF Condition, ELSE Condition, Iterator, Domain Value Map Rule, Event Header Rule, Map Variable)

TIP Append creates a statement at the end of the selected statement. If the selected statement is part of a block (if, else if, iterator), append creates a statement before the selected statement.

Append Insert

Select All | Select None | Expand All | Collapse All

Sources		Source Items	Type	Mapped
<input type="checkbox"/>	▼ Sources			
<input type="checkbox"/>	▶ Event Type Parameters			
<input type="checkbox"/>	▶ Payload-IN	Payload		
<input type="checkbox"/>	▶ PAYLOAD	Ad_Request		
<input type="checkbox"/>	Action	string		
<input type="checkbox"/>	Function_Type	string		
<input type="checkbox"/>	Date	dateTime		
<input type="checkbox"/>	HR_Contact_FirstName	string		
<input type="checkbox"/>	HR_Contact_LastName	string		
<input type="checkbox"/>	▶ (Anonymous)	(Anonymous)		
<input type="checkbox"/>	description	string		
<input type="checkbox"/>	▶ Ad	AdType		
<input type="checkbox"/>	Title	string		<input checked="" type="checkbox"/>
<input type="checkbox"/>	Text	string		<input checked="" type="checkbox"/>
<input type="checkbox"/>	Ad_ID	integer		

Select All | Select None | Expand All | Collapse All

Targets		Target Items	Type	Mapped
<input type="checkbox"/>	▼ Targets			
<input type="checkbox"/>	▶ Event Type Parameters			
<input type="checkbox"/>	▶ Payload-OUT	Payload		
<input type="checkbox"/>	▶ Ad	AdType		
<input type="checkbox"/>	Title	string		<input checked="" type="checkbox"/>
<input type="checkbox"/>	Text	string		<input checked="" type="checkbox"/>
<input type="checkbox"/>	▶ Datatype Parameters			
<input type="checkbox"/>	▶ Map Variables			

[Table 13–4](#) identifies the transformation statement management tasks shown in [Figure 13–4](#).

Table 13–4 Transformation Statement Management Tasks

Transformation Map Details Page Elements	Management Task
Statement Type list	Create a transformation statement (rule, IF condition, ELSE condition, iterator, domain value map rule, event header rule, or map variable).
Delete column in Statements section	Delete a transformation statement.
Update column in Statements section	Update a transformation statement.
Statements list in Statements section	View a transformation statement.

Transformation Rules

This section describes transformation rules, the most basic type of transformation statement.

Assume you want to combine the state CA and zip 94043 into CA 94043. This is a simple task; all you must do is invoke a system-defined datatype transformation map named `concatString`, which concatenates CA and 94043 into a single CA 94043. This invocation is called a transformation rule.

A transformation rule is the most basic form of transformation statement, and only invokes other datatype transformation maps. These invoked datatype transformation maps can be user-defined or system-defined maps.

See Also:

- ["Datatype Transformation Maps"](#) on page 13-4
- [Table 13–3](#) on page 13-27 for an additional description of transformation rules

Accessing Transformation Rule Management Tasks

Follow these instructions to access the transformation rule management tasks shown in [Figure 13-4](#) on page 13-29:

To access transformation rule management tasks:

1. Select the **Modeling** tab.
2. Select **Transformations**.

The Event Transformation Maps page appears.

3. Select a specific event transformation map in the **Name** column.

The Transformation Map Details page for the selected event transformation map appears (for this example, event transformation map **Transform Payload**). (See [Figure 13-4](#) on page 13-29.)

4. Select a task to perform and see the referenced section for instructions:

To...	Then...	See Section...
Create a transformation rule	Go to the Statement Type list.	"Creating a Transformation Rule" on page 13-32
Delete a transformation rule	Select a specific transformation rule to delete in the Delete column.	"Deleting a Transformation Rule" on page 13-40
Update a transformation rule	Select a specific transformation rule to update in the Update column.	"Updating a Transformation Rule" on page 13-41
View details about a transformation rule	View a specific transformation rule in the Statements section.	"Transformation Statements Overview" , Figure 13-4 on page 13-29

Note: Statements can be part of other statements (in which case, they are executed as part of that statement) or they can be standalone statements. Statements are executed in the order in which they appear in the **Statements** list.

Creating a Transformation Rule

Follow these instructions to create a transformation rule:

To create a transformation rule:

1. Ensure that you followed the instructions in "[Accessing Transformation Rule Management Tasks](#)" on page 13-31 to access the page for creating a transformation rule.
2. Select **Rule** from the **Statement Type** list.
3. Select a map type from the **Datatype Transformation Map Type** list:
 - **System Defined**
Pre-existing maps provided by Oracle Application Server ProcessConnect
 - **User Defined**
Maps that you created by following the instructions in "[Creating a Datatype Transformation Map](#)" on page 13-24

This list is only for use when creating transformation rules.
4. Go to the **Sources** table and **Targets** table at the bottom of the page. (See [Figure 13-4](#) on page 13-29.)
5. Click specific source and target items or click **Expand All** in both the **Sources** table and **Targets** table to display all selections.

Note: Clicking **Expand All** can take some time.

Depending on the sources and targets and datatype transformation map rule that you select, different pages can appear to prompt you for information to create a transformation rule.

6. See the following table for an overview of what pages appear after you select the sources and targets and select either **Append** or **Insert**. Examples are provided for each type.

If You Select...	And Select a Datatype Transformation Map...	For Example...	See Section...
A single source and a single target	That maps evenly to a single source and a single target (that is, you select a datatype transformation map that contains a single source and a single target)	<ol style="list-style-type: none"> 1. Select a single source integer id and a single target integer identification. 2. Select copy:from=integer->to=integer from the Datatype Transformation Map list, which evenly maps a single source and target integer. 	"Mapping a Single Source and a Single Target" on page 13-33
Multiple sources and targets, for example, two sources and a single target	That maps evenly, for example, to two sources and a single target (that is, you select a datatype transformation map that contains two sources and a single target)	<ol style="list-style-type: none"> 1. You select two source strings first_name and last_name and one target string name. 2. Select ConcatString:firstString=string,secondString=string->resultString=string from the Datatype Transformation Map list, which evenly maps two source strings to one target string. 	"Mapping Multiple Sources and Targets" on page 13-35
Any or no combination of sources and targets	That does not evenly map to the combination of sources and targets you selected (that is, you select two sources and a single target, then select a datatype transformation map that contains only one source and one target)	<ol style="list-style-type: none"> 1. Select two source strings employee and department and one target string emp_dept. 2. Select copy:from=string->to=string from the Datatype Transformation Map list. or 1. Select no source or target strings. 2. Select a rule from the Datatype Transformation Map list. Since the mapping is not clear, a page displays that enables you to explicitly map your sources and targets. This page also enables you to define numeric values for your sources and targets. 	"Explicitly Mapping Sources and Targets" on page 13-37

Mapping a Single Source and a Single Target

Follow these instructions to map a single source and target to a datatype transformation map that evenly maps a single source to a single target:

1. Select the source item bound to the source parameter of the datatype transformation map invoked from the rule (For example, using the sources shown in [Figure 13-4](#) on page 13-29):

- a. Navigate within the **Sources** table to the Event Type Parameters.
 - b. Navigate to the event type item **Payload-IN**.
 - c. Navigate to the event body element **PAYLOAD**.
 - d. Navigate to the datatype member **Ad**.
 - e. Select the string **Title**.
2. Select the target item bound to the target parameter of the datatype transformation map invoked from the rule (For example, using the targets shown in [Figure 13-4](#) on page 13-29):
 - a. Navigate within the **Targets** table to the Event Type Parameters.
 - b. Navigate to the event item **Payload-OUT**.
 - c. Navigate to the datatype member **Ad**.
 - d. Select the string **Title**.
3. Select the datatype transformation map to be invoked from the **Datatype Transformation Map** list. For example, select **copy:from=string->to=string**. This rule copies the contents of the single source string **Title** to the single target string **Title**.
4. Select where to place the new statement in the **Statements** list.
 - a. Click **Append** to create a statement at the end of the statement list. If the selected statement is part of a block (for example, IF, ELSE IF, or iterator), **Append** creates a statement at the end of the selected block.
or
 - b. Select a specific statement in the **Statements** list and click **Insert**. This inserts the new statement before the selected statement.
5. If the mapping between the selected target and source items and the parameters of the invoked datatype transformation map can be determined, the Transformation Map Details page is refreshed with the rule statement placed at the end of the **Statements** list (if **Append** was selected):

Transformation Map Details: Transform Payload

Delete Update Modify Sources and Targets

Use the section below to create transformation statements. To create a statement select the statement type, the datatype transformation map type, the datatype transformation map and the sources and targets and choose Append or Insert. Append creates a statement at the end of the statement list. If the selected statement is part of a block (if, else if, iterator), append creates a statement at the end of the selected block. Insert creates a statement before the selected statement.

[Expand All](#) | [Collapse All](#)

Statements		Type	Update	Delete
<input type="radio"/>	Statements			
<input type="radio"/>	concat(firstString=Payload-IN/PAYLOAD/Ad/Title ,secondString=Payload-IN/PAYLOAD/Ad/Text --->resultString=Payload-OUT/Ad/Title)	Rule		
<input type="radio"/>	copy(from=Payload-IN/PAYLOAD/Ad/Title --->to=Payload-OUT/Ad/Title)	Rule		

6. If the mapping between the selected target and source items and the parameters of the invoked datatype transformation map cannot be determined, a page displays that enables you to explicitly map your sources and targets. See ["Explicitly Mapping Sources and Targets"](#) on page 13-37.

Mapping Multiple Sources and Targets

Follow these instructions to map multiple sources and targets to a datatype transformation map that evenly maps to multiple sources and targets.

1. Select the source items bound to the source parameter of the datatype transformation map invoked from the rule (For example, using the sources shown in [Figure 13-4](#) on page 13-29):
 - a. Navigate within the **Sources** table to the Event Type Parameters.
 - b. Navigate to the event type item **Payload-IN**.
 - c. Navigate to the event body element **PAYLOAD**.
 - d. Select the string **HR_Contact_FirstName**.
 - e. Select the string **HR_Contact_LastName**.
2. Select the target item bound to the target parameter of the datatype transformation map invoked from the rule (For example, using the targets shown in [Figure 13-4](#) on page 13-29):
 - a. Navigate within the **Targets** table to the Event Type Parameters.
 - b. Navigate to the event item **Payload-OUT**.
 - c. Navigate to the datatype **Ad**.

- d. Select the string **Title**.
3. Select the datatype transformation map to invoke from the **Datatype Transformation Map** list. For example, select **ConcatString:firstString=string,secondString=string->resultString=string**. This statement concatenates the two sources strings to the one target string **Title**.
4. Select where to place the new statement in the **Statements** list.
 - a. Click **Append** to create a statement at the end of the statement list. If the selected statement is part of a block (for example, IF, ELSE IF, or iterator), **Append** creates a statement at the end of the selected block.
 - or
 - b. Select a specific statement in the **Statements** list and click **Insert**. This inserts the new statement before the selected statement.

The Add Transformation Rule page appears.

Add Transformation Rule

Cancel Apply

Select the appropriate rule signature for the datatype transformation map and choose Apply.

Datatype Transformation Map





Rule Signature

Select Source(s)	Target(s)
<input type="radio"/> firstString = Sources/Event Type Parameters/Payload-IN/PAYLOAD/HR_Contact_FirstName secondString = Sources/Event Type Parameters/Payload-IN/PAYLOAD/HR_Contact_LastName	resultString = Targets/Event Type Parameters/Payload-OUT/Ad/Title
<input type="radio"/> firstString = Sources/Event Type Parameters/Payload-IN/PAYLOAD/HR_Contact_LastName secondString = Sources/Event Type Parameters/Payload-IN/PAYLOAD/HR_Contact_FirstName	resultString = Targets/Event Type Parameters/Payload-OUT/Ad/Title

5. Select the order in which to concatenate the two source strings (either first name first or last name first).
6. Click **Apply**.

The page refreshes to display the selected source and target parameters of the datatype transformation map in the **Statements** section.

[Expand All](#) | [Collapse All](#)

Statements			
Select	Focus	Statements	Type Update Delete
<input type="radio"/>		Statements	
<input type="radio"/>		concat(firstString=Payload-IN/PAYLOAD/Ad/Title ,secondString=Payload-IN/PAYLOAD/Ad/Text --->resultString=Payload-OUT/Ad/Title)	Rule  
<input type="radio"/>		concatString(firstString=Payload-IN/PAYLOAD/HR_Contact_FirstName ,secondString=Payload-IN/PAYLOAD/HR_Contact_LastName --->resultString=Payload-OUT/Ad/Title)	Rule  

Explicitly Mapping Sources and Targets

Follow these instructions to explicitly map multiple sources and targets with a datatype transformation map. You explicitly set your targets and sources if the mapping cannot be automatically determined.

Note: If you want to explicitly map your sources and targets, do not select any initially. Instead, select the datatype transformation map you want to use and click **Append** or **Insert**. This takes you to a page to explicitly map your sources and targets. You also have the option of entering numeric values with sources and targets from the page.

In this example, the following selections are made:

- A single source integer in the **Sources** table and two target integers in the **Targets** table
- The **copyInteger:from=integer->to=integer** datatype transformation map from the **Datatype Transformation Map** list, which *only* maps a single source to a single target

Since these selections do not map evenly, the mapping cannot be determined. The Add Transformation Rule page that appears is an estimate of what it is believed you want to map.

Add Transformation Rule

[Cancel](#) [Apply](#)

Select the datatype transformation map to use for the rule. Select a source or target and choose the appropriate Bind button to bind the item to the rule signature. When all rule signature sources and targets have been bound, choose Apply.

* Indicates required field

Datatype Transformation Map Type

Datatype Transformation Map

Rule Signature

Map **copy**

Source(s)

from integer unspecified [Bind](#)

Target(s)

to integer unspecified [Bind](#)

Sources and Targets

[Return to Top](#)

Constant Value

[Expand All](#) | [Collapse All](#)

Select	Focus	Source Items	Type	Mapped
<input type="checkbox"/>		Sources		
<input type="checkbox"/>	<input type="checkbox"/>	Event Type Parameters		
<input type="checkbox"/>	<input type="checkbox"/>	Datatype Parameters		
<input type="checkbox"/>	<input type="checkbox"/>	Payload-IN	notification_type	
<input type="checkbox"/>		from	string	
<input type="checkbox"/>		to	string	
<input type="checkbox"/>		subject	string	
<input type="checkbox"/>		arrival_date	date	
<input type="checkbox"/>	<input type="checkbox"/>	status	status_type	
<input type="checkbox"/>		modified_date	date	
<input type="checkbox"/>		id	integer	
<input type="checkbox"/>	<input type="checkbox"/>	Map Variables		
<input type="checkbox"/>	<input type="checkbox"/>	Iterators		

[Expand All](#) | [Collapse All](#)

Select	Focus	Target Items	Type	Mapped
<input type="checkbox"/>		Targets		
<input type="checkbox"/>	<input type="checkbox"/>	Event Type Parameters		
<input type="checkbox"/>	<input type="checkbox"/>	Datatype Parameters		
<input type="checkbox"/>	<input type="checkbox"/>	Payload-OUT	expense_type	
<input type="checkbox"/>	<input type="checkbox"/>	employee	employee_type	
<input type="checkbox"/>		name	string	
<input type="checkbox"/>	<input type="checkbox"/>	manager	manager_type	
<input type="checkbox"/>		id	integer	
<input type="checkbox"/>		costcenter	string	
<input type="checkbox"/>		purpose	string	
<input type="checkbox"/>	<input type="checkbox"/>	lineitem	lineitem_type	
<input type="checkbox"/>		status	string	
<input type="checkbox"/>		id	integer	
<input type="checkbox"/>	<input type="checkbox"/>	Map Variables		

1. If you do not want to perform this mapping, click **Cancel** and return to "Creating a Transformation Rule" on page 13-32 to restart. If this mapping is what you intended, perform Steps 2 through 8.
2. Click a specific source item to expand or click **Expand All** to expand the entire **Sources** table.

3. Select the source items bound to the source parameter of the datatype transformation map invoked from the rule:
 - a. Navigate within the **Sources** table to the Event Type Parameters.
 - b. Navigate to the event type item **Payload-IN**.
 - c. Select the integer **id**.

Note: You also have the option of entering a value in the **Constant Value** field.

4. Click **Bind** next to **from integer**.

Your selection replaces the word **unspecified** (with **Payload-IN/id**).
5. Click a specific target item to expand or click **Expand All** to expand the entire **Targets** table.
6. Select the target items bound to the target parameter of the datatype transformation map invoked from the rule:
 - a. Navigate within the **Targets** table to the Event Type Parameters.
 - b. Navigate to **employee**.
 - c. Select the integer **id**.
7. Click **Bind** next to **to integer**.

Your selection replaces the word **unspecified** (with **Payload-OUT/employee/id**).

The previously-disabled **Apply** button is enabled.

Datatype Transformation Map Type

Datatype Transformation Map

Rule Signature

Map **copy**

Source(s)

from integer Payload-IN/id

Target(s)

to integer Payload-OUT/employee/id

Sources and Targets

Constant Value

[Expand All](#) | [Collapse All](#)

Sources			
Select	Focus	Source Items	Type
<input type="checkbox"/>		▼ Sources	
<input type="checkbox"/>	<input type="checkbox"/>	▼ Event Type Parameters	
<input type="checkbox"/>	<input type="checkbox"/>	▼ Datatype Parameters	
<input type="checkbox"/>	<input type="checkbox"/>	▼ Payload-IN	notification_type
<input type="checkbox"/>		from	string
<input type="checkbox"/>		to	string
<input type="checkbox"/>		subject	string
<input type="checkbox"/>		arrival_date	date
<input type="checkbox"/>	<input type="checkbox"/>	▶ status	status_type
<input type="checkbox"/>		modified_date	date
<input type="checkbox"/>		id	integer
<input type="checkbox"/>	<input type="checkbox"/>	▼ Map Variables	
<input type="checkbox"/>	<input type="checkbox"/>	▼ Iterators	

[Expand All](#) | [Collapse All](#)

Targets			
Select	Focus	Target Items	Type
<input type="checkbox"/>		▼ Targets	
<input type="checkbox"/>	<input type="checkbox"/>	▼ Event Type Parameters	
<input type="checkbox"/>	<input type="checkbox"/>	▼ Datatype Parameters	
<input type="checkbox"/>	<input type="checkbox"/>	▼ Payload-OUT	expense_type
<input type="checkbox"/>	<input type="checkbox"/>	▼ employee	employee_type
<input type="checkbox"/>		name	string
<input type="checkbox"/>	<input type="checkbox"/>	▶ manager	manager_type
<input type="checkbox"/>		id	integer
<input type="checkbox"/>		costcenter	string
<input type="checkbox"/>		purpose	string
<input type="checkbox"/>	<input type="checkbox"/>	▶ lineitem	lineitem_type
<input type="checkbox"/>		status	string
<input type="checkbox"/>		id	integer

8. Click **Apply**.

The Transformation Map Details page appears with the new rule added in the **Statements** list.

Deleting a Transformation Rule

Follow these instructions to delete a transformation rule:

To delete an transformation rule:

1. Ensure that you followed the instructions in "[Accessing Transformation Rule Management Tasks](#)" on page 13-31 to access the page for deleting a transformation rule.

2. Click **Yes** when prompted to delete the transformation rule.

The transformation rule is deleted and the Event Transformation Map Details page appears.

Updating a Transformation Rule

Follow these instructions to update a transformation rule:

To update a transformation rule:

1. Ensure that you followed the instructions in "[Accessing Transformation Rule Management Tasks](#)" on page 13-31 to access the page for updating a transformation rule.

The Update Transformation Rule page appears. (See "[Creating a Transformation Rule](#)" on page 13-32 for a list of fields you can update.)

2. Make appropriate changes.
3. Click **Apply**.

The statement is updated and the Transformation Map Details page appears.

Transformation Rules Case Study: Basic Transformations Using Rules

This section provides an example of using transformation rules, based on modeling metadata you created when using the tutorial in [Chapter 7, "Tutorial of an Integration within an Enterprise"](#).

Phase A of the tutorial described in [Chapter 7, "Tutorial of an Integration within an Enterprise"](#) included an example of transformation mapping where one transformation rule each was created for inbound and outbound transformations. This tutorial extends those maps with additional transformation rules.

Extending the First Transformation (HR Ad to Common View)

1. Select **Modeling > Transformations**.
2. Select **HR Ad to Common View** in the **Name** column.

Converting the Date The date from the source must be converted to a string. The rule you select in this section returns the string representation of the input `dateTime` in the required format.

1. Select **format:date=dateTime,formatPattern=string->resultString=string** from the **Datatype Transformation Map** list.
2. Click **Append**.
3. Click **Expand All** for both the **Sources** table and the **Targets** table.
4. Select **Date** in the **Sources** table.
5. Click **Bind date dateTime** for the source.
6. Enter the pattern `yyyy-mm-dd` in the **Constant Value** field.
7. Click **Bind** for **formatPattern sting** for the source.
8. Select **Date** in the **Targets** table.
9. Click **Bind** for **resultString string** for the target.

The **Rule Signature** section displays your selections.

Rule Signature

Map **format**

Source(s)

date dateTime HR New Ad-IN/PAYLOAD/Date **Bind**
 formatPattern string yyyy-mm-dd **Bind**

Target(s)

resultString string yyyy-mm-dd **Bind**

10. Click **Apply**.





The rule statement displays at the bottom of the **Statements** list.

Transformation Map Details: HR Ad to Common View

Delete **Update** **Modify Sources and Targets**

Use the section below to create transformation statements. To create a statement select the statement type, the datatype transformation map type, the datatype transformation map and the sources and targets and choose Append or Insert. Append creates a statement at the end of the statement list. If the selected statement is part of a block (if, else if, iterator), append creates a statement at the end of the selected block. Insert creates a statement before the selected statement.

[Expand All](#) | [Collapse All](#)





Statements			
Select	Focus	Statements	
<input type="radio"/>		▼ Statements	
<input type="radio"/>		copy(from=HR New Ad-IN/PAYLOAD/Ad_ID --->to=HR New Ad-OUT/Ad/Ad_ID)	Rule  
<input type="radio"/>		format(date=HR New Ad-IN/PAYLOAD/Date ,formatPattern=yyyy-mm-dd --->resultString=yyy-mm-dd)	Rule  

Copy First Name and Last Name The first and last names of the contact must be mapped to target first and last names.

1. Select **HR_Contact_FirstName** in the **Sources** table.
2. Select **HR_Contact_FirstName** in the **Targets** table.
3. Select **copy:from=string ->to=string** from the **Datatype Transformation Map** list.
4. Create **Append**.
5. Select **HR_Contact_LastName** in the **Sources** table.
6. Select **HR_Contact_LastName** in the **Targets** table.
7. Select **copy:from=string ->to=string** from the **Datatype Transformation Map** list.
8. Click **Append**.

The rule statements display at the bottom of the **Statements** list.

[Expand All](#) | [Collapse All](#)

Statements			
Select	Focus	Statements	
Type	Update	Delete	
<input type="radio"/>		▼ Statements	
<input type="radio"/>		copy(from=HR New Ad-IN/PAYLOAD/Ad_ID --->to=HR New Ad-OUT/Ad/Ad_ID)	Rule  
<input type="radio"/>		format(formatPattern=yyy-mmm-dd ,date=HR New Ad-IN/PAYLOAD/Date --->resultString=yyy-mmm-dd)	Rule  
<input type="radio"/>		copy(from=HR New Ad-IN/PAYLOAD/HR_Contact_FirstName --->to=HR New Ad-OUT/Ad/HR_Contact_FirstName)	Rule  
<input type="radio"/>		copy(from=HR New Ad-IN/PAYLOAD/HR_Contact_LastName --->to=HR New Ad-OUT/Ad/HR_Contact_LastName)	Rule  

Extending the Second Transformation (Common View to Global NP Ad)

1. Select **Modeling > Transformations**.
2. Select **Common View to Global NP Ad** in the **Name** column.
3. Click **Expand All** for both the **Sources** table and the **Targets** table.

Placing a Value in the Action Field You must place a value into the **Action** field, which is not in the business event. Do this by using the copy string rule and entering a value in the **Constant Value** field.





1. Select **Rule** in the **Statement Type** list.
2. Select **copy:from=string->to=string** from the **Datatype Transformation Map** list.
3. Click **Append**.
4. Expand all targets in the **Targets** table.
5. Select the **Action** element in the **Targets** table.
6. Click **Bind** for **to string**.
7. Enter Global NP Ad in the **Constant Value** field.
8. Click **Bind** for **from string**.
9. Click **Apply**.

Date You must map the date.

1. Select **Modeling > Transformations**.
2. Select **Common View to Global NP Ad** in the **Name** column.
3. Select **copy:from=string->to=string** from the **Datatype Transformation Map** list.
4. Select **Date** in the **Sources** table.
5. Select **Date** in the **Targets** table.
6. Click **Append**.

The rule statement displays at the bottom of the **Statements** list.

[Expand All](#) | [Collapse All](#)

Statements			
Select	Focus	Statements	
Type	Update	Delete	
<input checked="" type="radio"/>		▼ Statements	
<input type="radio"/>		copy(from=Global NP Ad --->to=Global NP Ad-OUT/PAYLOAD/Action)	Rule  
<input type="radio"/>		copy(from=HR New Ad-IN/Ad/Date --->to=Global NP Ad-OUT/PAYLOAD/Date)	Rule  

Transformation Conditions

Using a transformation rule, you can only invoke another map unconditionally. Assume you only want to copy an item amount that is greater than five. If the amount does not satisfy this condition, you want to copy zero. You perform these tasks with a transformation condition.

A condition is defined by comparing values with familiar comparison operators (=, !=, <, <=, >, >=, and exists). Exists checks whether or not a particular element exists in the instance. Even if a particular element exists, its value may be null; in which case, you can use = or != to compare the value to null. Conditions can be further combined by using logical AND and OR operators to obtain conditions of an arbitrary complexity.

Transformation statements can be defined to be executed only if the condition is evaluated to true (IF). Similarly, statements can be defined for execution in case of a condition being evaluated to false (ELSE).

See Also: [Table 13-3](#) on page 13-27 for an additional description of transformation conditions

Accessing Transformation Condition Management Tasks

Follow these instructions to access the transformation condition management tasks shown in [Figure 13-4](#) on page 13-29:

To access transformation condition management tasks:

1. Select the **Modeling** tab.
2. Select **Transformations**.

The Event Transformation Maps page appears.

3. Select a specific event transformation map in the **Name** column.

The Transformation Map Details page for the selected event transformation map appears (for this example, event transformation map **Transform Payload**). (See [Figure 13-4](#) on page 13-29.)

- Select a task to perform and see the referenced section for instructions:

To...	Then...	See Section...
Create an IF condition	Go to the Statement Type list.	" Creating an IF Condition " on page 13-46
Create an ELSE condition	Go to the Statement Type list.	" Creating an ELSE Statement " on page 13-52
Associate a statement with an IF condition or ELSE condition	Go to the Statement Type list.	" Associating a Statement with an IF Condition or ELSE Condition " on page 13-52
Remove a statement from an IF condition or ELSE condition	Go to the Statements table.	" Removing a Statement from an IF Condition or ELSE Condition " on page 13-54
Delete an IF or ELSE condition	Select a specific condition to delete in the Delete column.	" Deleting an IF or ELSE Condition " on page 13-54
Update an IF condition	Select a specific condition to update in the Update column.	" Updating an IF Condition " on page 13-54
View details about a condition	View a specific condition in the Statements section.	" Transformation Statements Overview ", Figure 13-4 on page 13-29

Creating an IF Condition

Follow these instructions to create an initial IF condition, insert an AND condition, and insert an OR condition.

To create an IF condition:

- Ensure that you followed the instructions in "[Accessing Transformation Condition Management Tasks](#)" on page 13-45 to access the page for creating an IF condition.
- Select **IF Condition** from the **Statement Type** list.

3. Select where to place the new statement in the **Statements** list.
 - a. Click **Append** to create a statement at the end of the statement list. If the selected statement is part of a block (for example, IF, ELSE IF, or iterator), **Append** creates a statement at the end of the selected block.
or
 - b. Select a specific statement in the **Statements** list and click **Insert**. This inserts the new statement before the selected statement.

The Create Transformation Condition page appears.

Creating an Initial IF Condition

Follow these instructions to create an initial IF condition:

1. Click the **Select** button for the **Condition expression not specified** message.
2. Click **Update**.

The Create Condition Expression page appears.

3. Click specific source items to expand or click **Expand All** for the **Sources** list.
4. Select a left operand (for example, a parameter representing a quantity).
5. Select an operator from the **Operator** list (for example, > if the condition expression you are building is to identify a quantity greater than a certain number):
 - **!=** (not equal to)
 - **<** (less than)
 - **<=** (less than or equal to)
 - **=** (equal to)
 - **>** (greater than)
 - **>=** (greater than or equal to)
 - **Exists**

Condition expressions can be defined across two source items or between a source and a constant value. (This example uses a constant value.) Condition expressions cannot access a target item. For this example, a constant value is defined.

If you select an operator other than **Exists**, the **Right Operand** table appears.

Create Condition Expression

Please enter the condition expression parameter(s) and choose Apply.
 * Indicates required field

Left Operand	Operator	Right Operand																																																																																												
<div style="border: 1px solid #ccc; padding: 5px;"> <p style="margin: 0;">Expand All Collapse All</p> <p style="margin: 0;">+ Sources</p> <table border="1" style="width: 100%; border-collapse: collapse;"> <thead> <tr> <th style="width: 5%;">Select</th> <th style="width: 5%;">Focus</th> <th style="width: 70%;">Name</th> <th style="width: 15%;">Type</th> </tr> </thead> <tbody> <tr><td><input type="radio"/></td><td></td><td>▼ Sources</td><td></td></tr> <tr><td><input type="radio"/></td><td><input type="checkbox"/></td><td>▼ Event Type Parameters</td><td></td></tr> <tr><td><input type="radio"/></td><td><input type="checkbox"/></td><td>▼ Datatype Parameters</td><td></td></tr> <tr><td><input type="radio"/></td><td><input type="checkbox"/></td><td>▼ Payload-IN</td><td>notification_type</td></tr> <tr><td><input type="radio"/></td><td></td><td>from</td><td>string</td></tr> <tr><td><input type="radio"/></td><td></td><td>to</td><td>string</td></tr> <tr><td><input type="radio"/></td><td></td><td>subject</td><td>string</td></tr> <tr><td><input type="radio"/></td><td></td><td>arrival_date</td><td>date</td></tr> <tr><td><input type="radio"/></td><td><input type="checkbox"/></td><td>▼ status</td><td>status_type</td></tr> <tr><td><input type="radio"/></td><td></td><td>message</td><td>string</td></tr> <tr><td><input type="radio"/></td><td></td><td>code</td><td>string</td></tr> <tr><td><input type="radio"/></td><td></td><td>modified_date</td><td>date</td></tr> <tr><td><input type="radio"/></td><td></td><td>id</td><td>integer</td></tr> <tr><td><input type="radio"/></td><td><input type="checkbox"/></td><td>▼ Map Variables</td><td></td></tr> <tr><td><input type="radio"/></td><td><input type="checkbox"/></td><td>▼ Iterators</td><td></td></tr> </tbody> </table> </div>	Select	Focus	Name	Type	<input type="radio"/>		▼ Sources		<input type="radio"/>	<input type="checkbox"/>	▼ Event Type Parameters		<input type="radio"/>	<input type="checkbox"/>	▼ Datatype Parameters		<input type="radio"/>	<input type="checkbox"/>	▼ Payload-IN	notification_type	<input type="radio"/>		from	string	<input type="radio"/>		to	string	<input type="radio"/>		subject	string	<input type="radio"/>		arrival_date	date	<input type="radio"/>	<input type="checkbox"/>	▼ status	status_type	<input type="radio"/>		message	string	<input type="radio"/>		code	string	<input type="radio"/>		modified_date	date	<input type="radio"/>		id	integer	<input type="radio"/>	<input type="checkbox"/>	▼ Map Variables		<input type="radio"/>	<input type="checkbox"/>	▼ Iterators		<div style="border: 1px solid #ccc; padding: 5px;"> <p style="margin: 0;">* ></p> </div>	<div style="border: 1px solid #ccc; padding: 5px;"> <p style="margin: 0;">Constant <input style="width: 150px;" type="text"/></p> <p style="margin: 0;">Variable Expand All Collapse All</p> <div style="border: 1px solid #ccc; padding: 5px; margin-top: 5px;"> <p style="margin: 0;">+ Sources</p> <table border="1" style="width: 100%; border-collapse: collapse;"> <thead> <tr> <th style="width: 5%;">Select</th> <th style="width: 5%;">Focus</th> <th style="width: 70%;">Name</th> <th style="width: 15%;">Type</th> </tr> </thead> <tbody> <tr><td><input type="radio"/></td><td></td><td>▼ Sources</td><td></td></tr> <tr><td><input type="radio"/></td><td><input type="checkbox"/></td><td>▶ Event Type Parameters</td><td></td></tr> <tr><td><input type="radio"/></td><td><input type="checkbox"/></td><td>▼ Datatype Parameters</td><td></td></tr> <tr><td><input type="radio"/></td><td><input type="checkbox"/></td><td>▶ Payload-IN</td><td>notification_type</td></tr> <tr><td><input type="radio"/></td><td><input type="checkbox"/></td><td>▶ Map Variables</td><td></td></tr> <tr><td><input type="radio"/></td><td><input type="checkbox"/></td><td>▶ Iterators</td><td></td></tr> </tbody> </table> </div> </div>	Select	Focus	Name	Type	<input type="radio"/>		▼ Sources		<input type="radio"/>	<input type="checkbox"/>	▶ Event Type Parameters		<input type="radio"/>	<input type="checkbox"/>	▼ Datatype Parameters		<input type="radio"/>	<input type="checkbox"/>	▶ Payload-IN	notification_type	<input type="radio"/>	<input type="checkbox"/>	▶ Map Variables		<input type="radio"/>	<input type="checkbox"/>	▶ Iterators	
Select	Focus	Name	Type																																																																																											
<input type="radio"/>		▼ Sources																																																																																												
<input type="radio"/>	<input type="checkbox"/>	▼ Event Type Parameters																																																																																												
<input type="radio"/>	<input type="checkbox"/>	▼ Datatype Parameters																																																																																												
<input type="radio"/>	<input type="checkbox"/>	▼ Payload-IN	notification_type																																																																																											
<input type="radio"/>		from	string																																																																																											
<input type="radio"/>		to	string																																																																																											
<input type="radio"/>		subject	string																																																																																											
<input type="radio"/>		arrival_date	date																																																																																											
<input type="radio"/>	<input type="checkbox"/>	▼ status	status_type																																																																																											
<input type="radio"/>		message	string																																																																																											
<input type="radio"/>		code	string																																																																																											
<input type="radio"/>		modified_date	date																																																																																											
<input type="radio"/>		id	integer																																																																																											
<input type="radio"/>	<input type="checkbox"/>	▼ Map Variables																																																																																												
<input type="radio"/>	<input type="checkbox"/>	▼ Iterators																																																																																												
Select	Focus	Name	Type																																																																																											
<input type="radio"/>		▼ Sources																																																																																												
<input type="radio"/>	<input type="checkbox"/>	▶ Event Type Parameters																																																																																												
<input type="radio"/>	<input type="checkbox"/>	▼ Datatype Parameters																																																																																												
<input type="radio"/>	<input type="checkbox"/>	▶ Payload-IN	notification_type																																																																																											
<input type="radio"/>	<input type="checkbox"/>	▶ Map Variables																																																																																												
<input type="radio"/>	<input type="checkbox"/>	▶ Iterators																																																																																												

6. Click specific target items to expand or click **Expand All** for the **Targets** list.
7. Enter a value in the **Constant** field (for example, 50).

Note: You can also select **Variable** and choose anything from the list of sources.

8. Click **Apply**.
The condition appears in the Create Transformation Condition page.
9. Click the **Select** button for the new condition.

Inserting an AND Condition

Follow these instructions to insert an AND condition within an IF condition:

1. Click **Insert AND**.
The following condition is created:

Create Transformation Condition

Use the table below to build the condition. To create or update a condition expression, select a condition expression and choose Update. To create a subcondition, select a condition expression and choose Insert AND or Insert OR. To delete a subcondition or a condition expression, select a subcondition or a condition expression and choose Delete. When finished choose Apply.

Condition is currently invalid

Select condition expression and ...

[Expand All](#) | [Collapse All](#)

Condition

Select Focus	Condition Expression	Update
<input type="radio"/>	▼ Condition	
<input checked="" type="radio"/>	▼ Subcondition	
<input type="radio"/>	Payload-IN/Id > 50	
<input type="radio"/>	AND	
<input type="radio"/>	Condition expression not specified.	

2. Click the **Select** button for the **Condition expression not specified** message.
3. Click **Update**.
4. Repeat Steps 4 through 8 on page 13-47 to create the other subcondition for the AND condition (for this example, a subcondition that specifies to check for any quantity ordered in 2002).

The AND condition appears in the Create Transformation Condition page:

Create Transformation Condition

[Cancel](#) [Apply](#)

Use the table below to build the condition. To create or update a condition expression, select a condition expression and choose Update. To create a subcondition, select a condition expression and choose Insert AND or Insert OR. To delete a subcondition or a condition expression, select a subcondition or a condition expression and choose Delete. When finished choose Apply.

Select condition expression and ... [Delete](#) [Insert AND](#) [Insert OR](#)

[Expand All](#) | [Collapse All](#)

⊕ Condition

Select	Focus	Condition Expression	Update
<input type="radio"/>		▼ Condition	
<input checked="" type="radio"/>	<input type="checkbox"/>	▼ Subcondition	
<input type="radio"/>		Payload-IN/Id > 50	
<input type="radio"/>		AND	
<input type="radio"/>		Payload-IN/arrival_date = 2002	

5. Click the **Select** button for the new condition.

Inserting an OR Condition Follow these instructions to insert an OR condition within an IF condition:

1. Click **Insert OR**.

The following condition is created:

Create Transformation Condition

[Cancel](#) [Apply](#)

Use the table below to build the condition. To create or update a condition expression, select a condition expression and choose Update. To create a subcondition, select a condition expression and choose Insert AND or Insert OR. To delete a subcondition or a condition expression, select a subcondition or a condition expression and choose Delete. When finished choose Apply.

Condition is currently invalid

Select condition expression and ... [Delete](#) [Insert AND](#) [Insert OR](#)

[Expand All](#) | [Collapse All](#)

⊕ Condition

Select	Focus	Condition Expression	Update
<input type="radio"/>		▼ Condition	
<input checked="" type="radio"/>	<input type="checkbox"/>	▼ Subcondition	
<input type="radio"/>	<input checked="" type="checkbox"/>	▼ Subcondition	
<input type="radio"/>		Payload-IN/Id > 50	
<input type="radio"/>		AND	
<input type="radio"/>		Payload-IN/arrival_date = 2002	
<input type="radio"/>		OR	
<input type="radio"/>		Condition expression not specified.	

2. Click the **Select** button for the **Condition expression not specified** message.
3. Click **Update**.
4. Repeat Steps 4 through 8 on page 13-47 to create the other subcondition for the OR condition (for this example, a subcondition that specifies to check for any quantity ordered in 1998).

The OR nested block condition appears in the Create Transformation Condition page:

Create Transformation Condition

Cancel Apply

Use the table below to build the condition. To create or update a condition expression, select a condition expression and choose Update. To create a subcondition, select a condition expression and choose Insert AND or Insert OR. To delete a subcondition or a condition expression, select a subcondition or a condition expression and choose Delete. When finished choose Apply.

Select condition expression and ...
Delete Insert AND Insert OR

[Expand All](#) | [Collapse All](#)

⊕ Condition

Select	Focus	Condition Expression	Update
<input type="radio"/>		▼ Condition	
<input checked="" type="radio"/>	⊕	▼ Subcondition	
<input type="radio"/>	⊕	▼ Subcondition	
<input type="radio"/>		Payload-IN/id > 50	
<input checked="" type="radio"/>		AND	
<input type="radio"/>		Payload-IN/arrival_date = 2002	
<input checked="" type="radio"/>		OR	
<input type="radio"/>		Payload-IN/arrival_date = 1998	

5. Click **Apply**.
6. The Transformation Map Details page displays the IF condition statements in the **Statements** list.

You can also delete any of the suconditions by selecting the specific condition in the **Select** column and clicking **Delete**.

Creating an ELSE Statement

Note: You must first create an IF statement before you can create an ELSE statement.

1. Ensure that you followed the instructions in "[Accessing Transformation Condition Management Tasks](#)" on page 13-45 to access the page for creating an ELSE statement.
2. Select **ELSE Condition** from the **Statement Type** list.
3. Select an IF condition in which to place the ELSE condition in the **Statements** list and click **Append**.

The ELSE condition is placed in the IF statement.

4. Expand the IF statement to see the ELSE statement.

[Expand All](#) | [Collapse All](#)

Statements					
Select Focus		Statements	Type	Update	Delete
		▼ Statements			
		▼ IF (Payload-IN/arrival_date = 2002)	IF Condition		
		ELSE	ELSE Condition		

You can now create additional statement types as part of this ELSE condition.

Associating a Statement with an IF Condition or ELSE Condition

You can associate other transformation statements with IF and ELSE conditions. This example describes how to associate a rule statement with both conditions. These statements are executed if the condition evaluates to true at runtime.

Note: You cannot currently move statements around in a condition. If you must do this, first delete and recreate the statement in the appropriate location within the condition.

To associate a rule statement with an IF or ELSE condition:

1. Ensure that you followed the instructions in "[Accessing Transformation Condition Management Tasks](#)" on page 13-45 to access the page for associating a rule statement with an IF or ELSE condition.
2. Select the IF block with which to associate the rule statement.
3. Select **Rule** from the **Statement Type** list.
4. Create a rule statement by following the instructions in "[Creating a Transformation Rule](#)" on page 13-32. For this example, single target and source strings are selected and the **copy:from=string->to=string** datatype transformation map is selected.
5. Click **Append** to include this rule as part of the IF Condition.

[Expand All](#) | [Collapse All](#)

Statements					
Select	Focus	Statements	Type	Update	Delete
<input type="radio"/>		▼ Statements			
<input type="radio"/>	<input checked="" type="checkbox"/>	▼ IF (Payload-IN/arrival_date = 2002)	IF Condition		
<input type="radio"/>		copy(from=Payload-IN/id ---->to=Payload-OUT/employee/id)	Rule		
<input type="radio"/>		ELSE	ELSE Condition		

6. Select the ELSE block with which to associate the transformation statement.
7. Select **Rule** from the **Statement Type** list.
8. Create a rule statement by following the instructions in "[Creating a Transformation Rule](#)" on page 13-32. For this example, single target and source strings are selected and the **copy:from=string->to=string** datatype transformation map is selected.
9. Click **Append** to include this rule as part of the ELSE Condition.

[Expand All](#) | [Collapse All](#)

Statements					
Select	Focus	Statements	Type	Update	Delete
<input type="radio"/>		▼ Statements			
<input type="radio"/>	<input checked="" type="checkbox"/>	▼ IF (Payload-IN/arrival_date = 2002)	IF Condition		
<input type="radio"/>		copy(from=Payload-IN/id ---->to=Payload-OUT/employee/id)	Rule		
<input type="radio"/>	<input checked="" type="checkbox"/>	▼ ELSE	ELSE Condition		
<input type="radio"/>		copy(from=Payload-IN/id ---->to=Payload-OUT/employee/manager/id)	Rule		

Removing a Statement from an IF Condition or ELSE Condition

You can remove transformation statements from IF and ELSE conditions. This example describes how to associate a rule statement with both conditions.

To remove a statement from an IF condition or ELSE condition:

1. Ensure that you followed the instructions in "[Accessing Transformation Condition Management Tasks](#)" on page 13-45 to access the page for removing transformation statements from IF and ELSE conditions.
2. Select a specific statement in a condition to delete in the **Delete** column (for example, the statement that is part of the ELSE condition shown in Step 9 on page 13-53).
3. Click **Yes** when prompted to delete the statement.

The statement is deleted and the Transformation Map Details page appears.

Deleting an IF or ELSE Condition

Follow these instructions to delete an IF or ELSE condition:

To delete an IF or ELSE condition:

1. Ensure that you followed the instructions in "[Accessing Transformation Condition Management Tasks](#)" on page 13-45 to access the page for deleting an IF or ELSE condition.
2. Click **Yes** when prompted to delete the condition.

The condition is deleted and the Transformation Map Details page appears.

Updating an IF Condition

Follow these instructions to update an IF condition:

To update an IF condition:

1. Ensure that you followed the instructions in "[Accessing Transformation Condition Management Tasks](#)" on page 13-45 to access the page for updating an IF condition.

The Update Transformation Condition page appears.

2. Make appropriate changes based on the statement selected. (See "[Creating an IF Condition](#)" on page 13-46 for a list of fields you can update.)
3. Click **Apply**.

The statement is updated and the Transformation Map Details page appears.

Transformation Condition Case Study: Converting Importance to Featured/Ordinary Ad

This section provides an example of using transformation conditions, based on modeling metadata you created when using the tutorial in [Chapter 7, "Tutorial of an Integration within an Enterprise"](#).





This example describes how a specific ad becomes a featured ad in a newspaper if its importance is rated as greater than five. If not, its importance is rated as an ordinary ad.

Creating an IF-ELSE Condition

1. Select **Modeling > Transformations**.
2. Select **HR Ad to Common View** in the **Name** column.
3. Select **IF Condition** from the **Statement Type** list.
4. Click **Append**.
5. Select **Update** for **Condition expression not specified**.
6. Click **Expand All** for the **Left Operand** table.
7. Select **Importance**.
8. Select **>** from the **Operator** list. The page refreshes to display the **Right Operand** table.
9. Enter 5 in the **Constant** field.
10. Click **Apply**.
11. Click **Apply** on the Create Transformation Condition page.

The IF condition displays at the bottom of the **Statements** list:

[Expand All](#) | [Collapse All](#)

Statements			
Select	Focus	Statements	
Type	Update	Delete	
<input checked="" type="radio"/>		Statements	
<input type="radio"/>		copy(from=HR New Ad-IN/PAYLOAD/Ad_ID --->to=HR New Ad-OUT/Ad/Ad_ID)	Rule  
<input type="radio"/>		format(formatPattern=yyy-mm-dd ,date=HR New Ad-IN/PAYLOAD/Date --->resultString=yyy-mm-dd)	Rule  
<input type="radio"/>		copy(from=HR New Ad-IN/PAYLOAD/HR_Contact_FirstName --->to=HR New Ad-OUT/Ad/HR_Contact_FirstName)	Rule  
<input type="radio"/>		copy(from=HR New Ad-IN/PAYLOAD/HR_Contact_LastName --->to=HR New Ad-OUT/Ad/HR_Contact_LastName)	Rule  
<input type="radio"/>		IF (HR New Ad-IN/PAYLOAD/Importance > 5)	IF Condition  

12. Select the newly-created IF condition in the **Statements** table.

13. Select **ELSE Condition** from the **Statement Type** list.

14. Click **Append**.

An ELSE condition is added beneath the IF condition.

Associating Statements with IF-ELSE Blocks

1. Select the **IF condition** in the **Statements** list.

2. Select **Rule** in the **Statement Type** list.

3. Select **copy:from=boolean->to=boolean** from the **Datatype Transformation Map** list.

4. Click **Append**.

5. Click **Expand All** for both the **Sources** table and the **Targets** table.

6. Select **Featured** in the **Targets** table.

7. Click **Bind** for **to boolean** under **Targets**.

8. Enter `true` in the **Constant Value** field.

9. Click **Bind** for **from boolean** under **Sources**.

The **Rule Signature** section displays your selection.

Rule Signature

Map **copy**

Source(s)

from boolean true 

Target(s)

to boolean HR New Ad-OUT/Ad/Featured 

10. Click **Apply**.
11. Expand the IF Condition in the **Statements** list.
The condition statement displays.

Expand All | Collapse All

Select	Focus	Statements	Type	Update	Delete
<input type="radio"/>		▼ Statements			
<input type="radio"/>		copy(from=HR New Ad-IN/PAYLOAD/Ad_ID --->to=HR New Ad-OUT/Ad/Ad_ID)	Rule		
<input type="radio"/>		format(formatPattern=yyy-mm-dd ,date=HR New Ad-IN/PAYLOAD/Date --->resultString=yyy-mm-dd)	Rule		
<input type="radio"/>		copy(from=HR New Ad-IN/PAYLOAD/HR_Contact_FirstName --->to=HR New Ad-OUT/Ad/HR_Contact_FirstName)	Rule		
<input type="radio"/>		copy(from=HR New Ad-IN/PAYLOAD/HR_Contact_LastName --->to=HR New Ad-OUT/Ad/HR_Contact_LastName)	Rule		
<input checked="" type="radio"/>		▼ IF (HR New Ad-IN/PAYLOAD/Importance > 5)	IF Condition		
<input type="radio"/>		copy(from=true --->to=HR New Ad-OUT/Ad/Featured)	Rule		
<input type="radio"/>		ELSE	ELSE Condition		

12. Select the ELSE Condition.
13. Select **Rule** in the **Statement Type** list.
14. Select **copy:from=boolean->to=boolean** from the **Datatype Transformation Map** list.
15. Click **Append**.
16. Click **Expand All** for both the **Sources** table and the **Targets** table.
17. Select **Featured** in the **Targets** table.
18. Click **Bind** for **to boolean**.
19. Enter `false` in the **Constant Value** field.
20. Click **Bind** for **from boolean**.
21. Click **Apply**.
22. Expand the IF and ELSE conditions in the **Statements** list.
The conditions appear at the bottom of the list.

[Expand All](#) | [Collapse All](#)

Statements					
Select	Focus	Statements	Type	Update	Delete
<input type="radio"/>		▼ Statements			
<input type="radio"/>		copy(from=HR New Ad-IN/PAYLOAD/Ad_ID --->to=HR New Ad-OUT/Ad/Ad_ID)	Rule		
<input type="radio"/>		format(formatPattern=yyy-mm-dd ,date=HR New Ad-IN/PAYLOAD/Date --->resultString=yyy-mm-dd)	Rule		
<input type="radio"/>		copy(from=HR New Ad-IN/PAYLOAD/HR_Contact_FirstName --->to=HR New Ad-OUT/Ad/HR_Contact_FirstName)	Rule		
<input type="radio"/>		copy(from=HR New Ad-IN/PAYLOAD/HR_Contact_LastName --->to=HR New Ad-OUT/Ad/HR_Contact_LastName)	Rule		
<input type="radio"/>		▼ IF (HR New Ad-IN/PAYLOAD/Importance > 5)	IF Condition		
<input type="radio"/>		copy(from=true --->to=HR New Ad-OUT/Ad/Featured)	Rule		
<input type="radio"/>		▼ ELSE	ELSE Condition		
<input type="radio"/>		copy(from=false --->to=HR New Ad-OUT/Ad/Featured)	Rule		

Transformation Iterators

You may want to repeatedly perform a certain action (for example, invoke a certain map). Assume you want to transform all line items in an invoice to items in a purchase order. You use an iterator that enables you to loop over all line items and transform them. Defining a transformation iterator involves picking the item and value over which to iterate and specifying the transformation rules to be executed during each iteration.

See Also: [Table 13-3](#) on page 13-27 for an additional description of iterators

Accessing Iterator Management Tasks

Follow these instructions to access the iterator management tasks shown in [Figure 13-4](#) on page 13-29:

To access iterator management tasks:

1. Select the **Modeling** tab.
2. Select **Transformations**.

The Event Transformation Maps page appears.

3. Select a specific event transformation map in the **Name** column.

The Transformation Map Details page for the selected event transformation map appears (for this example, event transformation map **Transform Payload**). (See [Figure 13-4](#) on page 13-29.)

4. Select a task to perform and see the referenced section for instructions:

To...	Then...	See Section...
Create an iterator	Go to the Statement Type list.	" Creating an Iterator " on page 13-59
Delete an iterator	Select a specific iterator to delete in the Delete column.	" Deleting an Iterator " on page 13-61
Update an iterator	Select a specific iterator to update in the Update column.	" Updating an Iterator " on page 13-61
View details about an iterator	View a specific iterator in the Statements section.	" Transformation Statements Overview ", Figure 13-4 on page 13-29

Creating an Iterator

Follow these instructions to create an iterator:

Note: When you create a rule, you can select an iterator or any of the fields underneath it. In addition, only the rules within the iterator must select the iterator or its fields as source.

To create an iterator:

1. Ensure that you followed the instructions in "[Accessing Iterator Management Tasks](#)" on page 13-58 to access the page for creating an iterator.
2. Select **Iterator** from the **Statement Type** list.

3. Select where to place the new statement in the **Statements** list.
 - a. Click **Append** to create a statement at the end of the statement list. If the selected statement is part of a block (for example, IF, ELSE IF, or iterator), **Append** creates a statement at the end of the selected block.
 - or
 - b. Select a specific statement in the **Statements** list and click **Insert**. This inserts the new statement before the selected statement.

The Create Iterator page appears.

Create Iterator

Cancel Apply

Select an array field and choose Apply.
 * Indicates required field

* Name

Iterator

Expand All | Collapse All

Select	Focus	Name	Type	Mapped
<input type="radio"/>		▼ Sources		
<input type="radio"/>	<input type="checkbox"/>	▶ Event Type Parameters		
<input type="radio"/>	<input type="checkbox"/>	▶ Datatype Parameters		
<input type="radio"/>	<input type="checkbox"/>	▶ Map Variables		

4. Click a specific source parameter to expand or click **Expand All** to expand the entire list.
5. Enter a unique and recognizable iterator name in the **Name** field (for example, **Ad Iterator**).
6. Select a specific source parameter to identify the array over which to iterate.

Note: Only items with maximum occurrences greater than one are allowed for iterators. Only those items have the **Select** button enabled.

7. Click **Apply**.

The Transformation Map Details page displays the iterator in the **Statements** list.

The **Ad Iterator** iterator also appears in the **Sources** table of the Transformation Map Details page, where it can be included in rule statements defined within the iterator.

You can create rules within an iterator that are executed as many times as the number of items in the array associated with the iterator. Create these rules as part of a user-defined datatype transformation map. That way, the rules are part of an independent datatype transformation map. Do not create a set of independent rules beneath the iterator.

Deleting an Iterator

Follow these instructions to delete an iterator:

To delete an iterator:

1. Ensure that you followed the instructions in "[Accessing Iterator Management Tasks](#)" on page 13-58 to access the page for deleting an iterator.
2. Click **Yes** when prompted to delete the iterator.

The iterator is deleted and the Transformation Map Details page appears.

Updating an Iterator

Follow these instructions to update an iterator:

To update an iterator:

1. Ensure that you followed the instructions in "[Accessing Iterator Management Tasks](#)" on page 13-58 to access the page for updating an iterator.

The Update Iterator page appears.

2. Make appropriate changes. (See "[Creating an Iterator](#)" on page 13-59 for a list of fields you can update.)

3. Click **Apply**.

The iterator is updated and the Transformation Map Details page appears.

Iterator Case Study: Transforming Ad Request with an Unbounded Number of Ads

This section provides an example of using iterators, based on modeling metadata you created when using the tutorial in [Chapter 7, "Tutorial of an Integration within an Enterprise"](#). Since the number of ads to be copied is unbounded, you must create an iterator to copy them.

Note: You must invoke a separate user-defined datatype map from within an iterator to map a complex target member of multiple occurrences from a complex source member of multiple occurrences.

See Also: See ["Not Creating a Submap to Populate a Multiple Occurrence Target Member"](#) on page 14-12 for details about invoking a separate user-defined datatype map from within an iterator

Creating an Iterator for the Inbound Direction

To iterate over the unbound complex datatype Ad, you must first create a datatype transformation map for the **HR Ad to Common View** event transformation map.

Create a datatype transformation map:

1. Select **Modeling > Transformations**.
2. Select **Datatype Transformation Maps**.
3. Click **Create**.
4. Enter `copyHRAd` in the **Name** field.
5. Click **Apply**.

Create a source for the datatype transformation map:

1. Click **Modify Sources and Targets**.
2. Click **Create** in the **Sources** section.
3. Enter `HR Ad Type` in the **Name** field.
4. Select **Application Datatype** from the **Classification** list.
5. Select `http://www.oracle.com/human_resources` from the **Namespace** list.

6. Use the flashlight icon to select **AdType** for the **Name** field.
7. Click **Apply**. The Modify Sources and Targets page appears.

Create a target for the datatype transformation map:

1. Click **Create** in the **Targets** section.
2. Enter Ad Type in the **Name** field.
3. Select **Business Datatype** from the **Classification** list.
4. Leave the **Namespace** list selection as **Unspecified**.
5. Use the flashlight icon to select **AdType** for the **Name** field.

Note: You can quickly search by entering Ad% in the blank field and clicking **Go** (% is the wildcard variable).

6. Click **Apply**.

The Modify Sources and Targets page displays the following details:

Modify Sources and Targets

Datatype Transformation Map **copyHRAd**

Sources

Name	Datatype	Update	Delete
HR Ad Type	AdType		

[Create](#)

Targets

Name	Datatype	Update	Delete
Ad Type	AdType		

[Return to Top](#)

[Create](#)

7. Click **Return to Map Details**.

Create two rules to copy the two strings in this datatype:





1. Click **Expand All** for both the **Sources** table and the **Targets** table.
2. Select **Title** in the **Sources** table.
3. Select **Title** in the **Targets** table.

4. Select **copy:from=string->to=string** from the **Datatype Transformation Map** list.
5. Click **Append**.
6. Select **Text** in the **Sources** table.
7. Select **Text** in the **Targets** table.
8. Select **copy:from=string->to=string** from the **Datatype Transformation Map** list.
9. Click **Append**.

The statements display in the **Statements** list.

Expand All | Collapse All

⊕ Statements

Select	Focus	Statements	Type	Update	Delete
<input checked="" type="radio"/>		▼ Statements			
<input type="radio"/>		copy(from=Ad_Type/Title --->to=Ad_Type/Title)	Rule		
<input type="radio"/>		copy(from=Ad_Type/Text --->to=Ad_Type/Text)	Rule		

Return to the event transformation map:

1. Select **Modeling > Transformations**.
2. Select **HR Ad to Common View**.
3. Click **Expand All** for both the **Sources** table and the **Targets** table.
4. Select **Iterator** in the **Statement Type** list.
5. Click **Append**.
6. Enter *Ad Iterator* in the **Name** field.
7. Click **Expand All** in the **Iterator** table.
8. Select **Ad**.
9. Click **Apply**.
10. Select **Modeling > Transformations**.
11. Select **HR Ad to Common View**.

Create a rule to iterate over HR Ad using the datatype transformation map:

1. Select the statement **FOR Ad Iterator in HR New Ad-IN/PAYLOAD/Ad** in the **Statements** section.

Expand All | Collapse All

Statements				
Select Focus	Statements	Type	Update	Delete
	▼ Statements			
	copy(from=HR New Ad-IN/PAYLOAD/Ad_ID --->to=HR New Ad-OUT/Ad/Ad_ID)	Rule		
	format(date=HR New Ad-IN/PAYLOAD/Date ,formatPattern=yyyy-mm-dd --->resultString=yyyy-mm-dd)	Rule		
	▶ IF (HR New Ad-IN/PAYLOAD/Importance > 5)	IF Condition		
	FOR Ad Iterator in HR New Ad-IN/PAYLOAD/Ad	Iterator		

2. Select **Rule** from the **Statement Type** list.
3. Select **User Defined** from the **Datatype Transformation Map Type** list.
4. Select **copyHRAd:HR Ad=AdType->Ad Type=AdType** from the **Datatype Transformation Map** list.
5. Click **Append**.
6. Click **Expand All** for both the **Sources** table and the **Targets** table.
7. Select **Ad Iterator** from the **Sources** table.
8. Click **Bind** for **HR Ad Type AdType**.
9. Select **Ad** from the **Targets** table.
10. Click **Bind** for **Ad Type AdType**.

The **Rule Signature** section displays your selections.

Datatype Transformation Map Type

Datatype Transformation Map

Rule Signature

Map **copyHRAd**

Source(s) **Target(s)**

















HR Ad Type AdType Ad Iterator Ad Type AdType HR New Ad-OUT/Ad/Ad

11. Click **Apply**.

12. Expand the **FOR Ad Iterator** statement.

The iterator contents display at the bottom of the **Statements** list.

[Expand All](#) | [Collapse All](#)

Statements			
Select	Focus	Statements	
			Type Update Delete
<input type="radio"/>		Statements	
<input type="radio"/>		copy(from=HR New Ad-IN/PAYLOAD/Ad_ID --->to=HR New Ad-OUT/Ad/Ad_ID)	Rule  
<input type="radio"/>		format(formatPattern=yyy-mm-dd ,date=HR New Ad-IN/PAYLOAD/Date --->resultString=yyy-mm-dd)	Rule  
<input type="radio"/>		copy(from=HR New Ad-IN/PAYLOAD/HR_Contact_FirstName --->to=HR New Ad-OUT/Ad/HR_Contact_FirstName)	Rule  
<input type="radio"/>		copy(from=HR New Ad-IN/PAYLOAD/HR_Contact_LastName --->to=HR New Ad-OUT/Ad/HR_Contact_LastName)	Rule  
<input type="radio"/>		 IF (HR New Ad-IN/PAYLOAD/Importance > 5)	IF Condition  
<input type="radio"/>		FOR Ad Iterator in HR New Ad-IN/PAYLOAD/Ad	Iterator  
<input type="radio"/>		copyHRAd(HR Ad Type=Ad Iterator--->Ad Type=HR New Ad-OUT/Ad/Ad)	Rule  

Creating an Iterator for the Outbound Direction

These steps are identical to those in "[Creating an Iterator for the Inbound Direction](#)" on page 13-62. The only difference is that you map from the common view to the global newspaper domain in the steps.

Create a datatype transformation map:

1. Select **Modeling > Transformations**.
2. Select **Datatype Transformation Maps**.
3. Click **Create**.
4. Enter `copyGlobalNPAd` in the **Name** field.
5. Click **Apply**.

Create a source for the datatype transformation map:

1. Click **Modify Sources and Targets**.
2. Click **Create** in the **Sources** section.
3. Enter `Ad Type` in the **Name** field.
4. Select **Business Datatype** from the **Classification** list.
5. Leave the **Namespace** list selection as **Unspecified**.

- Use the flashlight icon to select **AdType** for the **Name** field.

Note: Search by entering Ad% in the blank field and clicking **Go**.

- Click **Apply**.

Create a target for the datatype transformation map:

- Click **Create** in the **Targets** section.
- Enter Ad_Type in the **Name** field.
- Select **Application Datatype** from the **Classification** list.
- Select **http://www.oracle.com/global_newspaper** from the **Namespace** list.
- Use the flashlight icon to select **AdType** for the **Name** field.

Note: Search by entering Ad% in the blank field and clicking **Go**.

- Click **Apply**.

The Modify Sources and Targets page displays the following details:

Modify Sources and Targets

Datatype Transformation Map **copyGlobalNPAd**

Sources

Name	Datatype	Update	Delete
Ad_Type	AdType		

[Create](#)

Targets

Name	Datatype	Update	Delete
Ad_Type	AdType		

[Return to Top](#)
[Create](#)

- Click **Return to Map Details**.

Create two rules to copy the two strings in this datatype:

1. Click **Expand All** for both the **Sources** table and the **Targets** table.
2. Select **copy:from=string->to=string** from the **Datatype Transformation Map** list.
3. Select **Title** in the **Sources** table.
4. Select **Title** in the **Targets** table.
5. Click **Append**.
6. Select **copy:from=string->to=string** from the **Datatype Transformation Map** list.
7. Select **Text** in the **Sources** table.
8. Select **Text** in the **Targets** table.
9. Click **Append**.

Return to the event transformation map:

1. Select **Modeling > Transformations**.
2. Select **Common View to Global NP Ad** from the **Name** column.
3. Click **Expand All** for both the **Sources** table and the **Targets** table.
4. Select **Iterator** from the **Statement Type** list.
5. Click **Append**.
6. Enter **Ad Iterator** in the **Name** field.
7. Click **Expand All** in the **Iterator** table.
8. Select **Ad**.
9. Click **Apply**.

Return to the event transformation map:

1. Select **Modeling > Transformations**.
2. Select **Common View to Global NP Ad** in the **Name** column.

Create a rule to iterate over AdType using the datatype transformation map:

1. Select **FOR Ad Iterator in HR New Ad-IN/Ad/Ad** in the **Statements** table.
2. Select **Rule** in the **Statement Type** list.
3. Select **User Defined** from the **Datatype Transformation Map Type** list.
4. Select **copyGlobalNPAd:AdType->Ad_Type=AdType** from the **Datatype Transformation Map** list.
5. Click **Append**.
6. Click **Expand All** for both the **Sources** table and the **Targets** table.
7. Select **Ad Iterator** in the **Sources** table.
8. Click **Bind** for the **Ad Type AdType** source.
9. Select **Ad** in the **Targets** table.
10. Click **Bind** for the **Ad_Type AdType** target.

The **Rule Signature** section displays your selection.

Rule Signature

Map **copyGlobalNPAd**

Source(s)

Ad Type AdType Ad Iterator **Bind**

Target(s)

Ad_Type AdType Global NP Ad-OUT/PAYLOAD/Ad **Bind**

11. Click **Apply**.

The iterator statement displays at the bottom of the **Statements** list.

[Expand All](#) | [Collapse All](#)

Statements				Type	Update	Delete
<input checked="" type="radio"/>		▼ Statements				
<input type="radio"/>		copy(from=Global NP Ad --->to=Global NP Ad-OUT/PAYLOAD/Action)		Rule		
<input type="radio"/>		copy(from=HR New Ad-IN/Ad/Date --->to=Global NP Ad-OUT/PAYLOAD/Date)		Rule		
<input type="radio"/>		FOR Ad Iterator in HR New Ad-IN/Ad/Ad		Iterator		
<input type="radio"/>		copyGlobalNPAd(Ad Type=Ad Iterator--->Ad_Type=Global NP Ad-OUT/PAYLOAD/Ad)		Rule		

Transformation Map Variables

If you invoke a transformation rule to transform a source to a target, you cannot do anything further with the target. There may, however, be situations in which you want to save the result of an invocation. For example, you have a transformation condition that tests whether the target of a previous rule invocation has a certain value. Or, you want to use the target of one rule as the source of another rule. In these cases, use a map variable to save the results of a transformation. Use the map variable later in transformation conditions or transformation rules.

Map variables can only be used globally, and not locally. This means that map variables must be unique and accessible everywhere in the map. For example, you cannot define a map variable within a transformation condition and only use it with that condition.

See Also: [Table 13-3](#) on page 13-27 for an additional description of map variables

Accessing Map Variable Management Tasks

Follow these instructions to access the map variable management tasks shown in [Figure 13-4](#) on page 13-29:

To access map variable management tasks:

1. Select the **Modeling** tab.
2. Select **Transformations**.

The Event Transformation Maps page appears.

3. Select a specific event transformation map in the **Name** column.

The Transformation Map Details page for the selected event transformation map appears (for this example, event transformation map **Transform Payload**). (See [Figure 13-4](#) on page 13-29.)

4. Select a task to perform and see the referenced section for instructions:

To...	Then...	See Section...
Create a map variable	Go to the Statement Type list.	"Creating a Map Variable" on page 13-71
Use a map variable in a rule	Go to the Statement Type list.	"Using a Map Variable in a Rule" on page 13-73

To...	Then...	See Section...
Delete a map variable	Select a specific map variable to delete in the Delete column.	"Deleting a Map Variable" on page 13-73
Update a map variable	Select a specific map variable to update in the Update column.	"Updating a Map Variable" on page 13-74
View details about a map variable	View a specific map variable in the Statements section.	"Transformation Statements Overview", Figure 13-4 on page 13-29

Creating a Map Variable

1. Ensure that you followed the instructions in "[Accessing Map Variable Management Tasks](#)" on page 13-70 to access the page for creating a map variable.
2. Select **Map Variable** from the **Statement Type** list.
3. Click **Append** to create the statement in the **Statements** list.

Note: Regardless of selecting **Insert** or **Append**, map variables always display at the top of the **Statements** list.

The Create Map Variable page appears.

Create Map Variable

Please enter map variable values and choose Apply.

* Indicates required field

General

* Name

Datatype

* Classification

Namespace

* Name

Click the flashlight to select a datatype

- Enter the following details to create a map variable. An asterisk (*) indicates a required field.

Field	Description
Name *	Enter a unique and recognizable map variable name.
Classification *	Select Application Datatype , Business Datatype , or Core Datatype .
Namespace	Select a datatype namespace.
Name *	Click the flashlight and select a datatype name.

- Click **Apply**.

Map variables are always global, and are placed in both the **Sources** table and **Targets** table. See the map variable named **Map_Var1**.

[Expand All](#) | [Collapse All](#)

⊕ Statements

Select	Focus	Statements	Type	Update	D
<input type="radio"/>		▼ Statements			
<input type="radio"/>		Map_Var1	Map Variable		
<input type="radio"/>	⊕	▶ IF (Payload-IN/arrival_date = 2002)	IF Condition		

Statement Type

Datatype Transformation Map Type
Necessary for rule statements only

Datatype Transformation Map
Necessary for rule statements only

TIP Append creates a statement at the end of the statement list. If the selected statement is part of a block (if, else if, iterator), append creates a statement at the end of the selected block. Insert creates a statement before the selected statement.

[Select All](#) | [Select None](#) | [Expand All](#) | [Collapse All](#)

Select	Focus	Source Items	Type	Mapped
<input type="checkbox"/>		▼ Sources		
<input type="checkbox"/>	⊕	▶ Event Type Parameters		
<input type="checkbox"/>	⊕	▶ Datatype Parameters		
<input type="checkbox"/>	⊕	▼ Map Variables		
<input type="checkbox"/>	⊕	▶ Map_Var1	notification_type	
<input type="checkbox"/>	⊕	▶ Iterators		

[Select All](#) | [Select None](#) | [Expand All](#) | [Collapse All](#)

Select	Focus	Target Items	Type
<input type="checkbox"/>		▼ Targets	
<input type="checkbox"/>	⊕	▶ Event Type Parameters	
<input type="checkbox"/>	⊕	▶ Datatype Parameters	
<input type="checkbox"/>	⊕	▼ Map Variables	
<input type="checkbox"/>	⊕	▶ Map_Var1	notification_type

The map variable can be used in all statement types.

Using a Map Variable in a Rule

Follow these instructions to use a map variable in a rule:

To use a map variable in a rule:

1. Ensure that you followed the instructions in "[Accessing Map Variable Management Tasks](#)" on page 13-70 to access the page for using a map variable in a rule.
2. Select **Rule** from the **Statement Type** list.
3. Select the datatype transformation map to be invoked from the **Datatype Transformation Map** list.
4. Select where to place the new statement in the **Statements** list.
 - a. Click **Append** to create a statement at the end of the statement list. If the selected statement is part of a block (for example, IF, ELSE IF, or iterator), **Append** creates a statement at the end of the selected block.

or
 - b. Select a specific statement in the **Statements** list and click **Insert**. This inserts the new statement before the selected statement.
5. Select a map variable as either the source or target in the rule.
6. Click **Apply**.

Deleting a Map Variable

Follow these instructions to delete a map variable:

To delete a map variable:

1. Ensure that you followed the instructions in "[Accessing Map Variable Management Tasks](#)" on page 13-70 to access the page for deleting a map variable.
2. Click **Yes** when prompted to delete the map variable.

The map variable is deleted and the Transformation Map Details page appears. The map variable is removed from the **Statements** list and from the **Sources** table and **Targets** table.

Updating a Map Variable

Follow these instructions to update a map variable:

To update a map variable:

1. Ensure that you followed the instructions in "[Accessing Map Variable Management Tasks](#)" on page 13-70 to access the page for updating a map variable.

The Update Map Variable page appears.

2. Make appropriate changes based on the map variable selected. (See "[Creating a Map Variable](#)" on page 13-71 for a list of fields you can update.)
3. Click **Apply**.

The map variable is updated and the Transformation Map Details page appears.

Map Variable Case Study: Using Map Variables to Create a Formatted Name

This section provides an example of using map variables, based on modeling metadata you created when using the tutorial in [Chapter 7, "Tutorial of an Integration within an Enterprise"](#).

You create a map variable named **Name** in this section, then copy the first name to the variable. You then append a space character and concatenate the variable with the last name and store it in the target.

1. Select **Modeling > Transformations**.
2. Select **Common View to Global NP Ad** in the **Name** column.
3. Select **Map Variable** from the **Statement Type** list.
4. Click **Append**.
5. Enter **Name** in the **Name** field.
6. Select **Core Datatype** from the **Classification** list.
7. Leave the **Namespace** list selection as **Unspecified**.
8. Use the flashlight icon to select **string** for the **Name** field.
9. Click **Apply**.

Assign a value to a map variable (first name appended by a space):

1. Ensure **Rule** is selected in the **Statement Type** list.
2. Select the **concat:firstString=string,secondString=string->resultString=string** from the **Data Type Transformation Map** list.
3. Click **Append**.
4. Click **Expand All** in the **Sources** table and **Targets** table.
5. Select **HR_Contact_FirstName** in the **Sources** table.
6. Click **Bind** for **firstString string**.
7. Select map variable **Name** in the **Targets** table.
8. Click **Bind** for **resultString string**.
9. Enter a single blank space in the **Constant Value** field.
10. Click **Bind** for **secondString string**.

The **Rule Signature** section displays your selections.

Rule Signature

Map **concat**

Source(s)

firstString string

HR New Ad-IN/Ad/HR_Contact_FirstName

Bind

secondString string

Bind

Target(s)

resultString string

Name

Bind

11. Click **Apply**.

The map variable statement displays at the bottom of the **Statements** list.

[Expand All](#) | [Collapse All](#)

Statements		Type
<input checked="" type="radio"/>	Statements	
<input type="radio"/>	Name	Map Variable
<input type="radio"/>	copy(from=Global NP Ad --->to=Global NP Ad-OUT/PAYLOAD/Action)	Rule
<input type="radio"/>	copy(from=HR New Ad-IN/Ad/Date --->to=Global NP Ad-OUT/PAYLOAD/Date)	Rule
<input type="radio"/>	FOR Ad Iterator in HR New Ad-IN/Ad/Ad	Iterator
<input type="radio"/>	copyGlobalNPAd(Ad Type=Ad Iterator--->Ad_Type=Global NP Ad-OUT/PAYLOAD/Ad)	Rule
<input type="radio"/>	concat(firstString=HR New Ad-IN/Ad/HR_Contact_FirstName ,secondString= --->resultString=Name)	Rule

Use the map variable (concatenate the variable with the last name):

1. Ensure **Rule** is selected in the **Statement Type** list.
2. Select the **concat:firstString=string,secondString=string->resultString=string** from the **DataType Transformation Map** list.
3. Click **Append**.
4. Select map variable **Name** in the **Sources** table.
5. Click **Bind** for **firstString string**.
6. Select **HR_Contact_LastName** in the **Sources** table.
7. Click **Bind** for **secondString string**.
8. Select **HR_Contact_Name** in the **Targets** table.
9. Click **Bind** for **resultString string**.

The **Rule Signature** section displays your selections.

Rule Signature

Map **concat**

Source(s)

firstString string Name **Bind**

secondString string HR New Ad-IN/Ad/HR_Contact_LastName **Bind**

Target(s)

resultString string Global NP Ad-OUT/PAYLOAD/HR_Contact_Name **Bind**

10. Click Apply.

The map variable statement displays at the bottom of the **Statements** list.

Expand All | Collapse All

⊕ Statements

Select	Focus	Statements	Type
<input checked="" type="radio"/>		▼ Statements	
<input type="radio"/>		Name	Map Variable
<input type="radio"/>		copy(from=Global NP Ad --->to=Global NP Ad-OUT/PAYLOAD/Action)	Rule
<input type="radio"/>		copy(from=HR New Ad-IN/Ad/Date --->to=Global NP Ad-OUT/PAYLOAD/Date)	Rule
<input type="radio"/>		FOR Ad Iterator in HR New Ad-IN/Ad/Ad	Iterator
<input type="radio"/>		copyGlobalNPAd(Ad Type=Ad Iterator--->Ad_Type=Global NP Ad-OUT/PAYLOAD/Ad)	Rule
<input type="radio"/>		concat(firstString=HR New Ad-IN/Ad/HR_Contact_FirstName ,secondString= --->resultString=Name)	Rule
<input type="radio"/>		concat(firstString=Name,secondString=HR New Ad-IN/Ad/HR_Contact_LastName --->resultString=Global NP Ad-OUT/PAYLOAD/HR_Contact_Name)	Rule

Event Header Rules

In addition to the actual content body, events also include headers that contain details like the originating party and target party. Event header rules enable you to set or retrieve these header details through system-defined event header functions. For example, suppose an event destination is the party Oracle. Use an event header rule that invokes the event header function called `setToParty` and pass it Oracle.

Note: After getting the party, you can retrieve more information about the party by invoking other rules.

See Also:

- [Table 13-3](#) on page 13-27 for an additional description of event header rules
- ["Event Header Rule Design"](#) on page 14-46 for details about getting a party and retrieving more information about the party by invoking other rules

Accessing Event Header Rule Management Tasks

Follow these instructions to access the event header rule management tasks shown in [Figure 13-4](#) on page 13-29:

To access event header rule management tasks:

1. Select the **Modeling** tab.
2. Select **Transformations**.

The Event Transformation Maps page appears.

3. Select a specific event transformation map in the **Name** column.

The Transformation Map Details page for the selected event transformation map appears (for this example, event transformation map **Transform Payload**). (See [Figure 13-4](#) on page 13-29.)

4. Select a task to perform and see the referenced section for instructions:

To...	Then...	See Section...
Create an event header rule	Go to the Statement Type list.	"Creating an Event Header Rule" on page 13-78
Delete an event header rule	Select a specific event header rule to delete in the Delete column.	"Deleting an Event Header Rule" on page 13-81
Update an event header rule	Select a specific event header rule to update in the Update column.	"Updating an Event Header Rule" on page 13-81
View an event header rule	View a specific event header rule in the Statements section.	"Transformation Statements Overview" , Figure 13-4 on page 13-29

Creating an Event Header Rule

Follow these instructions to create an event header rule:

To create an event header rule:

1. Ensure that you followed the instructions in ["Accessing Event Header Rule Management Tasks"](#) on page 13-77 to access the page for creating an event header rule.
2. Select **Event Header Rule** from the **Statement Type** list.
3. Select where to place the new statement in the **Statements** list.
 - a. Click **Append** to place the new statement as a standalone entry at the end of the **Statements** list.
 - or
 - b. Select a specific statement in the **Statements** list and click **Insert**. This inserts the new statement as a mapping statement of the selected statement.

The Create Event Header Rule page appears.

4. Select the event header rule from the **Event Header Rule** list. These rules are described in "Event Header Rules" on page B-40.
 - setToParty
 - setFromParty
 - getToParty
 - getFromParty
5. If you select a **get** event header function, the page refreshes to display details such as the following:

Create Event Header Rule

Select the source event from where the header value will be retrieved and the target event item which will receive the value and choose Apply.
 * Indicates required field

* Event Header Rule

Source Event

Expand All | Collapse All

⊕ Sources

Select	Focus	Name	Type	Mapped
<input type="radio"/>		▼ Sources		
<input type="radio"/>	⊕	▶ Event Type Parameters		
<input type="radio"/>	⊕	▶ Datatype Parameters		
<input type="radio"/>	⊕	▶ Map Variables		
<input type="radio"/>	⊕	▶ Iterators		

Destination Field

Expand All | Collapse All

⊕ Targets

Select	Focus	Name	Type	Mapped
<input type="radio"/>		▼ Targets		
<input type="radio"/>	⊕	▶ Event Type Parameters		
<input type="radio"/>	⊕	▼ Datatype Parameters		
<input type="radio"/>	⊕	▼ Invoice		
<input type="radio"/>		GlobalProductIdentifier	Scalar	
<input type="radio"/>	⊕	▶ PartnerProductIdentification	Compound	
<input type="radio"/>	⊕	▶ Map Variables		

- a. Click a specific source item to expand or click **Expand All** to expand the entire source list.
- b. Select the source event from where the header value is retrieved by selecting the corresponding event type parameter from **Source Event** table.
- c. Click a specific target item to expand or click **Expand All** to expand the entire target list.
- d. Select the target item to receive the header value from the **Destination Field** Table.

- e. Click **Apply**.
- 6. If you select a **set** event header function, the page refreshes to display details such as the following. The parameter associated with **set** event header functions is a target event.

Create Event Header Rule

Cancel

Select the source event from where the header value will be retrieved and the target event item which will receive the value and choose Apply.

* Indicates required field

* Event Header Rule

Source Field

Expand All | Collapse All

⊕ Sources

Select	Focus	Name	Type	Mapped
<input type="radio"/>		▼ Sources		
<input type="radio"/>	<input type="checkbox"/>	▶ Event Type Parameters		
<input type="radio"/>	<input type="checkbox"/>	▼ Datatype Parameters		
<input type="radio"/>		▼ PO		
<input type="radio"/>	<input type="checkbox"/>	▶ comments	Compound	
<input type="radio"/>	<input type="checkbox"/>	▶ ContractInformation	Compound	
<input type="radio"/>	<input type="checkbox"/>	▶ countryOfOrigin	Compound	
<input type="radio"/>	<input type="checkbox"/>	▶ CustomerInformation	Compound	
<input type="radio"/>	<input type="checkbox"/>	▶ DocumentLineReference	Compound	
<input type="radio"/>	<input type="checkbox"/>	▶ expediteReferenceIdentifier	Compound	
<input type="radio"/>		GlobalProductUnitOfMeasureCode	Scalar	
<input type="radio"/>		GlobalPurchaseOrderFillPriorityCode	Scalar	
<input type="radio"/>	<input type="checkbox"/>	▶ installAt	Compound	
<input type="radio"/>	<input type="checkbox"/>	▶ isDropShip	Compound	

Target Event

Expand All | Collapse All

⊕ Targets

Select	Focus	Name	Type	Mapped
<input type="radio"/>		▼ Targets		
<input type="radio"/>	<input type="checkbox"/>	▶ Event Type Parameters		
<input type="radio"/>	<input type="checkbox"/>	▶ Datatype Parameters		
<input type="radio"/>	<input type="checkbox"/>	▶ Map Variables		

- a. Click a specific source item to expand or click **Expand All** to expand the entire source list.
- b. Select the source item from which the header value is being set from the **Source Field Table**.
- c. Click a specific target item to expand or click **Expand All** to expand the entire target list.

- d. Select the target event whose header value is being set by selecting the corresponding event type parameter from the **Target Event** table
- e. Click **Apply**.

Deleting an Event Header Rule

Follow these instructions to delete an event header rule:

To delete an event header rule:

1. Ensure that you followed the instructions in "[Accessing Event Header Rule Management Tasks](#)" on page 13-77 to access the page for deleting an event header rule.
2. Click **Yes** when prompted to delete the event header rule.

The event header rule is deleted and the Transformation Map Details page appears.

Updating an Event Header Rule

Follow these instructions to update an event header rule:

To update an event header rule:

1. Ensure that you followed the instructions in "[Accessing Event Header Rule Management Tasks](#)" on page 13-77 to access the page for updating an event header rule.

The Update Event Header Rule page appears.

2. Make appropriate changes based on the event header rule selected. (See "[Creating an Event Header Rule](#)" on page 13-78 for a list of fields you can update.)
3. Click **Apply**.

The event header rule is updated and the Transformation Map Details page appears.

Event Header Rules Case Study: Sending to the Correct Target Newspaper

This section provides an example of using event header rules, based on modeling metadata you created when using the tutorial in [Chapter 7, "Tutorial of an Integration within an Enterprise"](#). When multiple newspapers are added, you must set the target party in the header of the Ad Request that identifies the newspaper to which it is to be sent. Since there is currently only one newspaper (Global Newspaper), you set the party to Global Newspaper in this example:

1. Select **Modeling > Transformations**.
2. Select **Common View to Global NP Ad** in the **Name** column.
3. Select **Event Header Rule** in the **Statement Type** list.
4. Click **Append**.
5. Select **setToParty** from the **Event Header Rule** list.
6. Click **Expand All** in the **Target Event** section.
7. Enter **Global Newspaper** in the **Constant Value** field.
8. Select **Global NP Ad-OUT** in the **Target Event** section.
9. Click **Apply**.

The event header rule displays at the bottom of the **Statements** list.

[Expand All](#) | [Collapse All](#)

Statements		Type
<input checked="" type="radio"/>	Statements	
<input type="radio"/>	Name	Map Variable
<input type="radio"/>	copy(from=Global NP Ad --->to=Global NP Ad-OUT/PAYLOAD/Action)	Rule
<input type="radio"/>	copy(from=HR New Ad-IN/Ad/Date --->to=Global NP Ad-OUT/PAYLOAD/Date)	Rule
<input type="radio"/>	FOR Ad Iterator in HR New Ad-IN/Ad/Ad	Iterator
<input type="radio"/>	copyGlobalNPAd(Ad Type=Ad Iterator--->Ad_Type=Global NP Ad-OUT/PAYLOAD/Ad)	Rule
<input type="radio"/>	concat(firstString=HR New Ad-IN/Ad/HR_Contact_FirstName ,secondString= --->resultString=Name)	Rule
<input type="radio"/>	concat(firstString=Name,secondString=HR New Ad-IN/Ad/HR_Contact_LastName --->resultString=Global NP Ad-OUT/PAYLOAD/HR_Contact_Name)	Rule
<input type="radio"/>	setToParty(toPartyName=Global Newspaper)	Event Header Rule

Domain Value Maps

This section contains the following topics:

- [Domain Value Maps Overview](#)
- [Managing Domain Value Maps](#)
- [Managing Domain Columns and Parties](#)
- [Managing Domain Value Map Columns and Rows](#)
- [Domain Value Map Rules](#)
- [Domain Value Map Case Study: Changing Ad Vocabulary](#)

See Also: ["Transformation"](#) on page 3-39 for conceptual details about domain value maps

Domain Value Maps Overview

Parties participating in integrations (trading partners or applications) in different regions of the world use different currency standards, different methods for representing country codes, and other details in their messages. Oracle Application Server ProcessConnect includes a feature known as domain value maps that enables you to map one party's vocabulary standards to another party's vocabulary standards. This enables parties to send and receive messages while continuing to use their regional terminologies.

Domain value maps are used in the context of transformations and are executed when application events are transformed into business events, and vice versa.

[Figure 13-5](#) and [Table 13-5](#) provide an overview of key domain value map components described in this section. For domain ipdev, success is defined as a string named true. For domain APPS, success is defined as a string named Yes.

Figure 13–5 Domain Value Map Key Components

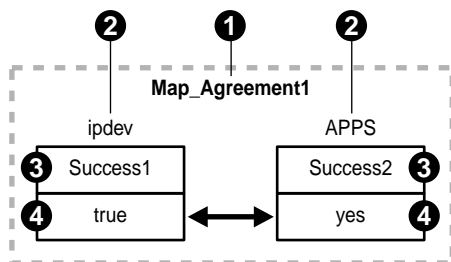

Table 13–5 Domain Value Map Key Components

Key	Component	Description
1	Domain value map	The map that identifies the: <ul style="list-style-type: none"> Domain value map columns (and their domain parties) participating in an integration Domain value map rows that define the mapping between the vocabularies
2	Domain party	After a mapping of vocabularies is defined, parties can subscribe to the vocabulary that is relevant to them.
3	Domain value map columns	The specific domain columns indicating a vocabulary for a specific domain value map
4	Domain value map rows	The vocabulary you assign to domain value map columns

The domain value map that you create in this section displays in the **Domain Value Map** list of the Create Domain Value Map Rule page shown in Step 3 on page 13-106.

See Also: ["Creating a Domain Value Map Rule"](#) on page 13-106 for instructions on creating a domain value map rule in an event transformation map

Managing Domain Value Maps



The Oracle Application Server ProcessConnect user interface tool enables you to perform the domain value map management tasks shown in [Figure 13-6](#). These tasks are described in detail in this section. The domain value map is the agreement that, when complete, identifies the:

- Domain value map columns (and their domain parties)
- Domain value map rows that define the vocabulary to map between domain parties

Figure 13-6 Domain Value Map Management Tasks

Domain Value Maps





Domain Value Maps

Name	Update	Delete
Map_Agreement1		

Create

Domain Columns

[Return to Top](#)

Name	Business Domain	Update	Delete
Success1	True		
Success2	False		

Create

Table 13–6 identifies the domain value map management tasks shown in Figure 13–6 and provides references to procedures for performing these tasks.

Table 13–6 Domain Value Map Management Tasks

Domain Value Maps Page Elements	Management Task	First See Section...	Then See Section...
Create button in Domain Value Maps section of Figure 13–6	Create a domain value map	"Accessing Domain Value Map Management Tasks" on page 13-86	"Creating a Domain Value Map" on page 13-87
Delete column in Domain Value Maps section of Figure 13–6	Delete a domain value map		"Deleting a Domain Value Map" on page 13-88
Update column in Domain Value Maps section of Figure 13–6	Update a domain value map		"Updating a Domain Value Map" on page 13-88
Name column in Domain Value Maps section of Figure 13–6	View details about a domain value map		"Viewing a Domain Value Map" on page 13-89

Accessing Domain Value Map Management Tasks

Follow these instructions to access the domain value map management tasks shown in Figure 13–6 on page 13-85:

To access domain value map management tasks:

1. Select the **Modeling** tab.
2. Select the **Transformations** tab.
3. Select **Domain Value Maps**.

The Domain Value Maps page appears. (See Figure 13–6 on page 13-85.)

4. Go to the **Domain Value Maps** section.

5. Select a task to perform and see the referenced section for instructions:

To...	Then...	See Section...
Create a domain value map	Click Create .	"Creating a Domain Value Map" on page 13-87
Delete a domain value map	Select a specific domain value map in the Delete column.	"Deleting a Domain Value Map" on page 13-88
Update a domain value map	Select a specific domain value map in the Update column.	"Updating a Domain Value Map" on page 13-88
View details about a domain value map	Select a specific domain value map in the Name column.	"Viewing a Domain Value Map" on page 13-89

Creating a Domain Value Map

Follow these instructions to create a domain value map:

To create a domain value map:

1. Ensure that you followed the instructions in ["Accessing Domain Value Map Management Tasks"](#) on page 13-86 to access the page for creating a domain value map.

The Create Domain Value Map page appears.

2. Enter a name for the domain value map in the **Name** field (for this example, Map_Agreement1 is entered).

3. Click **Apply**.

The domain value map is created and the Domain Value Map Details page for the created domain value map appears.

See Also: ["Creating a Domain Column"](#) on page 13-92 to create a domain column to assign to a domain value map

Deleting a Domain Value Map

Follow these instructions to delete a domain value map:

To delete a domain value map:

1. Ensure that you followed the instructions in "[Accessing Domain Value Map Management Tasks](#)" on page 13-86 to access the page for deleting a domain value map.
2. Click **Yes** when prompted to delete a domain value map.

The domain value map is deleted and the Domain Value Maps page appears.

Updating a Domain Value Map

Follow these instructions to update a domain value map:

To update a domain value map:

1. Ensure that you followed the instructions in "[Accessing Domain Value Map Management Tasks](#)" on page 13-86 to access the page for updating a domain value map.

The Update Domain Value Maps page appears.

2. Make appropriate changes. (See Step 2 on page 13-87 of "[Creating a Domain Value Map](#)" for a list of fields you can update.)
3. Click **Apply**.

The domain value map is updated and the Domain Value Map Details page for the updated domain value map appears.

Viewing a Domain Value Map

Follow these instructions to view a domain value map:

To view a domain value map:

1. Ensure that you followed the instructions in "[Accessing Domain Value Map Management Tasks](#)" on page 13-86 to access the page for viewing a domain value map.

The Domain Value Map Details page for the selected domain value map appears.

Domain Value Map Details : Map_Agreement1

Delete Update

Details



Name **Map_Agreement1**
State **Draft**

Domain Value Map Columns

Name	Business Domain	Remove
Success1	True	
Success2	False	

Add

Domain Value Map Rows

Success1	Success2	Update	Delete
true	yes		

Create

2. View specific details, including the associated domain value map column and row details.

This page, as with the Domain Value Maps page shown in [Figure 13-6](#) on page 13-85, enables you to delete or update the selected domain value map.

3. Click **Return to List** to return to the Domain Value Maps page.

Managing Domain Columns and Parties

The Oracle Application Server ProcessConnect user interface tool enables you to perform the domain column and party management tasks shown in [Figure 13-7](#). These tasks are described in detail in this section. Domain columns define the column name and its datatype (such as a string). You assign domain parties (such as an organization name) to domain columns.

Figure 13-7 Domain Column and Party Management Tasks

Domain Value Maps

Domain Value Maps

Name	Update	Delete
Map_Agreement1		

[Create](#)

Domain Columns

[Return to Top](#)

Name	Business Domain	Update	Delete
Success1	True		
Success2	False		

[Create](#)

Domain Column Details : Success1

[Delete](#) [Update](#)

Details

General

Name **Success1**
 Business Domain **True**
 State **Draft**

Datatype

Name [string](#)
 Namespace

Domain Parties

[Return to Top](#)

Name	Remove
aqapp	

[Add](#)

Table 13-7 identifies the domain column and party management tasks shown in Figure 13-7 and provides references to procedures for performing these tasks.

Table 13-7 Domain Column and Party Management Tasks

Domain Value Maps Page Elements	Management Task	First See Section...	Then See Section...
Create button in the Domain Columns section of Figure 13-7	Create a domain column	"Accessing Domain Column and Party Management Tasks" on page 13-91	"Creating a Domain Column" on page 13-92
Delete column in the Domain Columns section of Figure 13-7	Delete a domain column		"Deleting a Domain Column" on page 13-94
Update column in the Domain Columns section of Figure 13-7	Update a domain column		"Updating a Domain Column" on page 13-94
Name column in the Domain Columns section of Figure 13-7 (To access the details page shown in the lower page of Figure 13-7)	View details about a domain column		"Viewing a Domain Column" on page 13-95
Add button in the Domain Parties section of Figure 13-7	Add a domain party		"Adding a Domain Party" on page 13-95
Remove column in the Domain Parties section of Figure 13-7	Remove a domain party		"Removing a Domain Party" on page 13-97

Accessing Domain Column and Party Management Tasks

Follow these instructions to access the domain column and party management tasks shown in Figure 13-7 on page 13-90:

To access domain column and party management tasks:

1. Select the **Modeling** tab.
2. Select the **Transformations** tab.
3. Select **Domain Value Maps**.

The Domain Value Maps page appears. (See the upper page of [Figure 13-7](#) on page 13-90.)

4. Go to the **Domain Columns** section.
5. Select a task to perform and see the referenced section for instructions:

To...	Then...	See Section...
Create a domain column	Click Create .	"Creating a Domain Column" on page 13-92
Delete a domain column	Select a specific domain column in the Delete column.	"Deleting a Domain Column" on page 13-94
Update a domain column	Select a specific domain column in the Update column.	"Updating a Domain Column" on page 13-94
View details about a domain column	Select a specific domain column in the Name column.	"Viewing a Domain Column" on page 13-95
Add a domain party	Select a specific domain column in the Name column for which to add a domain party.	"Adding a Domain Party" on page 13-95
Remove a domain party	Select a specific domain column in the Name column for which to remove a domain party.	"Removing a Domain Party" on page 13-97

Creating a Domain Column

Follow these instructions to create a domain column:

To create a domain column:

1. Ensure that you followed the instructions in ["Accessing Domain Column and Party Management Tasks"](#) on page 13-91 to access the page for creating a domain column.

The Create Domain Column page appears.

2. Enter the following details to create a domain column. An asterisk (*) indicates a required field.

Field	Description
Name *	Enter a unique and recognizable name for the domain column (for this example, Success1 is entered).
Business Domain	Select Yes or No .

A business domain identifies the common vocabulary domain (that is, the domain associated with the business events that is common across different domains and parties).

Exactly one domain column with **Business Domain** set to **Yes** can be associated with a domain value map (through the creation of domain value map columns).

Domain value map functions used in transformation such as `lookupBusinessViewDomain` and `lookupPartyDomain` refer to this business domain column. For example, `lookupBusinessViewDomain` first finds the domain value map row containing the specified `inValue` for the domain column associated and returns the value in that row associated to the business domain column.

Similarly, `lookupPartyViewDomain` first finds the domain value map row containing the specified `inValue` associated with a business domain column and then returns the value in that row associated to the domain column for the specified party.

Note: For this Oracle Application Server ProcessConnect release, only the string datatype is available. For this reason, you cannot select a datatype classification, namespace, or name on the Create Domain Column page. Click **Modeling > Datatypes > Core Datatypes** for details about the string datatype.

3. Click **Apply**.

The domain column is created and the Domain Column Details page for the created domain column appears. (See the lower page of [Figure 13-7](#) on page 13-90.)

4. Repeat the steps in this section to create a second domain column. For this example, a domain column named Success2 is created.

When complete, you have two domain columns (Success1 and Success2) of datatype string.

See Also: ["Adding a Domain Party"](#) on page 13-95 for assigning parties in an integration to domain columns

Deleting a Domain Column

Follow these instructions to delete a domain column:

To delete a domain column:

1. Ensure that you followed the instructions in ["Accessing Domain Column and Party Management Tasks"](#) on page 13-91 to access the page for deleting a domain column.
2. Click **Yes** when prompted to delete a domain column.

The domain column is deleted and the Domain Value Maps page appears.

Updating a Domain Column

Follow these instructions to update a domain column:

To update a domain column:

1. Ensure that you followed the instructions in ["Accessing Domain Column and Party Management Tasks"](#) on page 13-91 to access the page for updating a domain column.

The Update Domain Column page appears.

2. Make appropriate changes. (See Step 2 on page 13-93 of ["Creating a Domain Column"](#) for a list of fields you can update.)
3. Click **Apply**.

The Domain Column Details page for the updated domain column appears.

Viewing a Domain Column

Follow these instructions to view a domain column:

To view a domain column:

1. Ensure that you followed the instructions in "[Accessing Domain Column and Party Management Tasks](#)" on page 13-91 to access the page for viewing a domain column.

The Domain Column Details page for the selected domain column appears.

Domain Column Details : Success1

Details

General

Name **Success1**
 Business Domain **True**
 State **Draft**

Datatype

Name string
 Namespace

Domain Parties

Name	Remove
aqapp	

2. View specific details, including details about domain parties assigned to the selected domain column.

This page, as with the Domain Value Maps page shown in the upper page of [Figure 13-7](#) on page 13-90, enables you to delete or update the selected domain column.

3. Click **Return to List** to return to the Domain Value Maps page.

Adding a Domain Party

Follow these instructions to associate a party with a domain column:

To add a domain party:

1. Ensure that you followed the instructions in "[Accessing Domain Column and Party Management Tasks](#)" on page 13-91 to access the page for adding a domain party.

The Domain Column Details page appears. (See the lower page of [Figure 13-7](#) on page 13-90.) For this example, Success1 is the domain column selected.

2. Go to the **Domain Parties** section.
3. Click **Add**.

The Create Domain Party page appears.

Create Domain Party

Please enter the domain party parameter(s) and choose Apply.

* Indicates required field

* Party

Unspecified

aqapp

ip

ipdev

[Modeling](#) | [Profiles](#) | [Deployment](#) | [Reports](#) | [Administration](#) | [Home](#) | [Help](#) | [Logout](#)
Copyright © 2002, 2003, Oracle Corporation. All rights reserved.

4. Select a party name (an application or trading partner) from the **Party** list. For this example, a party named **aqapp** is selected.
5. Click **Apply**.
The domain party is added and the Domain Column Details page for the selected domain column appears. (See the lower page of [Figure 13-7](#) on page 13-90.)
6. Repeat the steps in this section to add a second domain party (for this example, **Success2** is selected as the domain column in which to add the second domain party, which is named **ipdev**).

When complete, you have two domain columns with the following details:

Domain Column	Domain Party
Success1	aqapp
Success2	ipdev

7. Click **Return to List** to return to the Domain Value Maps page.

See Also:

- ["Adding a Domain Value Map Column"](#) on page 13-101 to assign domain columns to domain value map columns
- ["Creating an Application"](#) on page 15-5 for instructions on creating parties (applications) that are selectable on the Create Domain Party page
- ["Creating a Remote Trading Partner"](#) on page 26-9 for instructions on creating parties (trading partners) that are selectable on the Create Domain Party page

Removing a Domain Party

Follow these instructions to remove a domain party:

To remove a domain party:

1. Ensure that you followed the instructions in ["Accessing Domain Column and Party Management Tasks"](#) on page 13-91 to access the page for removing a domain party.
2. Go to the **Domain Parties** section.
3. Click **Remove** for the specific party.
4. Click **Yes** when prompted to delete a domain party.

The domain party is deleted and the Domain Column Details page appears.

Managing Domain Value Map Columns and Rows

The Oracle Application Server ProcessConnect user interface tool enables you to perform the domain value map column and row management tasks shown in the lower page of [Figure 13-8](#) on page 13-98. These tasks are described in detail in this section. Domain value map columns identify the domain columns (and their domain parties) of a specific domain value map. Domain value map rows identify the vocabulary you assign to domain value map columns.

Figure 13–8 Domain Value Map Column and Row Management Tasks

Domain Value Maps

Domain Value Maps

Create

Name	Update	Delete
Map_Agreement1		

Domain Columns

[Return to Top](#)

Create

Name	Business Domain	Update	Delete
Success1	True		
Success2	False		

Domain Value Map Details : [Map_Agreement1](#)

Delete Update

Details

Name **Map_Agreement1**
State **Draft**

Domain Value Map Columns

Add

Name	Business Domain	Remove
Success1	True	
Success2	False	

Domain Value Map Rows

Create

Success1	Success2	Update	Delete
true	yes		

Table 13–8 identifies the domain value map column and row management tasks shown in the lower page of Figure 13–8 and provides references to procedures for performing these tasks.

Table 13–8 Domain Value Map Column and Row Management Tasks

Domain Value Map Details Page	Management Task	First See Section...	Then See Section...
Add button in Domain Value Map Columns section of Figure 13–8	Add a domain value map column	"Accessing Domain Value Map Column and Row Management Tasks" on page 13-100	"Adding a Domain Value Map Column" on page 13-101
Remove column in Domain Value Map Columns section of Figure 13–8	Remove a domain value map column		"Removing a Domain Value Map Column" on page 13-101
Create button in Domain Value Map Rows section of Figure 13–8	Create a domain value map row		"Creating a Domain Value Map Row" on page 13-102
Delete button in Domain Value Map Rows section of Figure 13–8	Delete a domain value map row		"Deleting a Domain Value Map Row" on page 13-103
Update button in Domain Value Map Rows section of Figure 13–8	Update a domain value map row		"Updating a Domain Value Map Row" on page 13-103

See Also: "[Viewing a Domain Column](#)" on page 13-95 to view column name details accessible from the **Name** column of the **Domain Value Map Columns** section of the lower page of [Figure 13–8](#) on page 13-98

Accessing Domain Value Map Column and Row Management Tasks

Follow these instructions to access the domain value map column and party management tasks shown in the lower page of [Figure 13-8](#) on page 13-98:

To access domain value map column and row management tasks:

1. Select the **Modeling** tab.
2. Select the **Transformations** tab.
3. Select **Domain Value Maps**.

The Domain Value Maps page appears. (See the upper page of [Figure 13-8](#) on page 13-98.)

4. Go to the **Domain Value Maps** section.
5. Select a specific domain value map in the **Name** column (for this example, **Map_Agreement1** is selected).

The Domain Value Map Details page for the selected domain value map appears. (See the lower page of [Figure 13-8](#) on page 13-98.) For this example, **Map_Agreement1** is the domain value map selected.

6. Select a task to perform and see the referenced section for instructions:

To...	Then...	See Section...
Add a domain value map column	Click Add in the Domain Value Map Columns section.	"Adding a Domain Value Map Column" on page 13-101
Remove a domain value map column	Select a specific domain value map column in the Remove column of the Domain Value Map Columns section.	"Removing a Domain Value Map Column" on page 13-101
Create a domain value map row	Click Create in the Domain Value Map Rows section.	"Creating a Domain Value Map Row" on page 13-102
Delete a domain value map row	Select a specific domain value map row in the Delete column of the Domain Value Map Rows section.	"Deleting a Domain Value Map Row" on page 13-103
Update a domain value map row	Select a specific domain value map row in the Update column of the Domain Value Map Rows section.	"Updating a Domain Value Map Row" on page 13-103

Adding a Domain Value Map Column

Follow these instructions to associate a domain column with the domain value map:

To add a domain value map column:

1. Ensure that you followed the instructions in "[Accessing Domain Value Map Column and Row Management Tasks](#)" on page 13-100 to access the page for adding a domain value map column.

The Create Domain Value Map Column page appears.

2. Select the domain column to be associated with the domain value map from the **Domain Column** list (for this example, **Success1** is selected). You created the domain column in "[Creating a Domain Column](#)" on page 13-92.
3. Click **Apply**.

The Domain Value Map Details page appears with the added domain value map column. (See the lower page of [Figure 13-8](#) on page 13-98.)

4. Repeat these steps to add a second domain value map column (for this example, domain column **Success2** is selected).

When complete, the domain value map **Map_Agreement1** is associated with the two domain columns.

Domain Value Map	Domain Column	Domain Party
Map_Agreement1	Success1	aqapp
	Success2	ipdev

See Also: "[Creating a Domain Value Map Row](#)" on page 13-102 to define the datatype values to associate between the domain parties

Removing a Domain Value Map Column

Follow these instructions to remove a domain value map column:

To remove a domain value map column:

1. Ensure that you followed the instructions in "[Accessing Domain Value Map Column and Row Management Tasks](#)" on page 13-100 to access the page for removing a domain value map column.

2. Click **Yes** when prompted to remove a domain value map column.

The domain value map column is removed and the Domain Value Map Details page appears.

Creating a Domain Value Map Row

Follow these instructions to create a domain value map row:

To create a domain value map row:

1. Ensure that you followed the instructions in "[Accessing Domain Value Map Column and Row Management Tasks](#)" on page 13-100 to access the page for creating a domain value map row.

The Create Domain Value Map Row page appears.

2. Enter a value in the first domain column (for this example, a string value of `true` is entered).
3. Enter a value for the second domain column (for this example, a string value of `Yes` is entered).
4. Click **Apply**.

The Domain Value Map Details page for the domain value map **Map_Agreement1** appears with datatype mapping complete between domain column **Success1** (and its party **aqapp**) and domain column **Success2** (and its party **ipdev**).

Domain Value Map Details : Map_Agreement1

Delete Update

Details

Name **Map_Agreement1**
State **Draft**

Domain Value Map Columns

Add

Name	Business Domain	Remove
Success1	True	
Success2	False	

Domain Value Map Rows

Create

Success1	Success2	Update	Delete
true	yes		

Every value in a column or set of columns (key) must be unique. This means that no two rows of a table can have duplicate values in a specified column or set of columns.

5. Click **Return to List** to return to the Domain Value Maps page.

See Also: ["Creating a Domain Value Map Rule"](#) on page 13-106 for instructions on assigning a domain value map to a transformation

Deleting a Domain Value Map Row

Follow these instructions to delete a domain value map row:

To delete a domain value map row:

1. Ensure that you followed the instructions in ["Accessing Domain Value Map Column and Row Management Tasks"](#) on page 13-100 to access the page for deleting a domain value map row.
2. Click **Yes** when prompted to delete a domain value map row.

The domain value map row is deleted and the Domain Value Map Details page appears.

Updating a Domain Value Map Row

To update a domain value map row:

1. Ensure that you followed the instructions in ["Accessing Domain Value Map Column and Row Management Tasks"](#) on page 13-100 to access the page for updating a domain value map row.

The Update Domain Value Map Row page appears.

2. Make appropriate changes. (See Step 2 on page 13-102 through Step 3 on page 13-102 of ["Creating a Domain Value Map Row"](#) for a list of fields you can update.)
3. Click **Apply**.

The Domain Value Map Details page for the updated domain value map appears.

Domain Value Map Rules

After you have created a domain value map, how do you look up its value? As mentioned in "[Creating a Domain Column](#)" on page 13-92, one column is always defined as the business domain. Values can be mapped between a party and the business domain, and vice versa, but not directly between two parties. For example, given a value and a party using it, you can look up the domain value map to find the corresponding value in the business domain. This happens during the inbound transformation phase. The party is obtained by looking up the `fromParty` of the event. Alternatively, given the business domain value and a party for which you want the corresponding value, you can look up the domain value map to find the party-specific value. This happens during the outgoing transformation. The party is obtained by looking up the `toParty` in the event header. The in-built functions for performing domain value map lookups are:

- For inbound directions:
 - `lookupBusinessViewDomain`

Given the party name and the value to be looked up, this function returns the corresponding value from the business view (common view) domain.
 - `lookupBusinessViewDomainWithDefaultValue`

Given the party name and the value to be looked up, this function returns the corresponding value from the business view (common view) domain. If a corresponding value for the `inValue` is not found in the business view, the value corresponding to the input parameter `defaultValue` is returned.
- For outbound directions:
 - `lookupPartyDomain`

Given the party name and the value to be looked up, this function returns the corresponding value from the party domain.
 - `lookupPartyDomainWithDefaultValue`

Given the party name and the value to be looked up, this function returns the corresponding value from the party domain. If a corresponding value for the `inValue` is not found in the party domain, the value corresponding to the input parameter `defaultValue` is returned.

See Also:

- [Table 13-3](#) on page 13-27 for an additional description of domain value map rules
- ["Domain Value Map Rules"](#) on page B-41

Accessing Domain Value Map Rule Management Tasks

Follow these instructions to access the domain value map rule management tasks shown in [Figure 13-4](#) on page 13-29:

To access domain value map rule management tasks:

1. Select the **Modeling** tab.
2. Select **Transformations**.

The Event Transformation Maps page appears.

3. Select a specific event transformation map in the **Name** column.

The Transformation Map Details page for the selected event transformation map appears (for this example, event transformation map **Transform Payload**). (See [Figure 13-4](#) on page 13-29.)

4. Select a task to perform and see the referenced section for instructions:

To...	Then...	See Section...
Create a domain value map rule	Go to the Statement Type list.	"Creating a Domain Value Map Rule" on page 13-106
Delete a domain value map rule	Select a specific domain value map rule to delete in the Delete column.	"Deleting a Domain Value Map Rule" on page 13-109
Update a domain value map rule	Select a specific domain value map rule to update in the Update column.	"Updating a Domain Value Map Rule" on page 13-109
View a domain value map rule	View a specific domain value map rule in the Statements section.	"Transformation Statements Overview" , Figure 13-4 on page 13-29

Creating a Domain Value Map Rule

1. Ensure that you followed the instructions in "[Accessing Domain Value Map Rule Management Tasks](#)" on page 13-105 to access the page for creating a domain value map rule.
2. Select **Domain Value Map Rule** from the **Statement Type** list.
3. Select where to place the new statement in the **Statements** list.
 - a. Click **Append** to create a statement at the end of the statement list. If the selected statement is part of a block (for example, IF, ELSE IF, or iterator), **Append** creates a statement at the end of the selected block.
 - or
 - b. Select a specific statement in the **Statements** list and click **Insert**. This inserts the new statement before the selected statement.

The Create Domain Value Map Rule page appears.

Create Domain Value Map Rule

Select the domain value map function and the domain value map and bind the appropriate parameters.

[Cancel](#) [Apply](#)

* Indicates required field

* Domain Value Map

Rule Signature

* Domain Value Map Function

▲ Rule is currently incomplete

Map **Unspecified**

Sources and Targets

[▲ Return to Top](#)

Constant Value

[Expand All](#) | [Collapse All](#)

Sources			
Select Focus	Name	Type	Mapped
<input type="radio"/>	▼ Sources		
<input type="radio"/>	▶ Event Type Parameters		
<input type="radio"/>	▶ Datatype Parameters		
<input type="radio"/>	▶ Map Variables		
<input type="radio"/>	▶ Iterators		

[Expand All](#) | [Collapse All](#)

Targets			
Select Focus	Name	Type	Mapped
<input type="radio"/>	▼ Targets		
<input type="radio"/>	▶ Event Type Parameters		
<input type="radio"/>	▶ Datatype Parameters		
<input type="radio"/>	▶ Map Variables		

4. Select the function from the **Domain Value Map Function** list. These functions are described in "[Domain Value Map Rules](#)" on page B-41.
 - lookupPartyDomainWithDefaultValue
 - lookupPartyDomain
 - lookupBusinessViewDomainWithDefaultValue
 - lookupBusinessViewDomain

For this example, **lookupBusinessViewDomain** is selected.

The page refreshes to display source and target parameters in the **Rule Signature** section.

5. Select the domain value map from the **Domain Value Map** list (for this example, **MessageItems**). **MessageItems** defines two domain parties. One party uses the term *car* for a product. The other party uses the term *vehicle* for a product.

Based on your selections in Steps 4 and 5, the page refreshes to display the following details:

Create Domain Value Map Rule

[Cancel](#) [Apply](#)

Select the domain value map function and the domain value map and bind the appropriate parameters.

* Indicates required field

* Domain Value Map

Rule Signature

* Domain Value Map Function

Source(s)

Party string unspecified
 inValue string unspecified

Target(s)

outValue string unspecified

Sources and Targets

[Return to Top](#)

Constant Value

[Expand All](#) | [Collapse All](#)

Select	Focus	Name	Type	Mapped
<input type="checkbox"/>		Sources		
<input type="checkbox"/>	<input type="checkbox"/>	▶ Event Type Parameters		
<input type="checkbox"/>	<input type="checkbox"/>	▶ Datatype Parameters		
<input type="checkbox"/>	<input type="checkbox"/>	▶ Map Variables		
<input type="checkbox"/>	<input type="checkbox"/>	▶ Iterators		

[Expand All](#) | [Collapse All](#)

Select	Focus	Name	Type	Mapped
<input type="checkbox"/>		Targets		
<input type="checkbox"/>	<input type="checkbox"/>	▶ Event Type Parameters		
<input type="checkbox"/>	<input type="checkbox"/>	▶ Datatype Parameters		
<input type="checkbox"/>	<input type="checkbox"/>	▶ Map Variables		

1. Enter `AQ_A` as the party name in the **Constant Value** field. The party name you enter is the domain party name you selected in "Adding a Domain Party" on page 13-95.
2. Click **Bind** for the source **Party string**.
3. Click specific source and target items or click **Expand All** in both the **Sources** table and **Targets** table to display all selections.
4. Select the source items bound to the source parameter of the datatype transformation map invoked from the rule. In this example, the following selections are made:
 - a. Navigate within the **Sources** table to the Event Type Parameters.
 - b. Navigate to the event type parameter **MessageIn-IN**.
 - c. Navigate to the event body element **MSG**.
 - d. Select the string **ITEM**.
 - e. Click **Bind** for the source **inValue string**.
5. Select the target item bound to the target parameter of the datatype transformation map invoked from the rule. In this example, the following selection is made:
 - a. Navigate within the **Targets** table to the Event Type Parameters.
 - b. Navigate to the event parameter **MessageIn-IN-OUT**.
 - c. Navigate to the event body element **message**.
 - d. Select the string **ITEM**.
 - e. Click **Bind** for the target **outValue string**.

The following bindings appear.

Update Domain Value Map Rule

Select the domain value map function and the domain value map and bind the appropriate parameters.

* Indicates required field

* Domain Value Map

Rule Signature

* Domain Value Map Function

Source(s)

Party string `AQ_A`
 inValue string `MessageIn-IN/MSG/ITEM`

Target(s)

outValue string `MessageIn-OUT/message/ITEM`

6. Click **Apply**.

The Transformation Map Details page displays the domain value map rule.

[Expand All](#) | [Collapse All](#)

Statements					
Select	Focus	Statements	Type	Update	Delete
<input type="radio"/>		▼ Statements			
<input type="radio"/>		copy(from=MessageIn-IN/MSG/ID --->to=MessageIn-OUT/message/ID)	Rule		
<input type="radio"/>		lookupBusinessViewDomain(Party=AQ_A ,inValue=MessageIn-IN/MSG/ITEM ---->outValue=MessageIn-OUT/message/ITEM)	Domain Value Map Rule		
<input type="radio"/>		copy(from=MessageIn-IN/MSG/AMOUNT --->to=MessageIn-OUT/message/AMOUNT)	Rule		

Deleting a Domain Value Map Rule

Follow these instructions to delete a domain value map rule:

To delete a domain value map rule:

1. Ensure that you followed the instructions in "[Accessing Domain Value Map Rule Management Tasks](#)" on page 13-105 to access the page for deleting a domain value map rule.
2. Click **Yes** when prompted to delete the domain value map rule.

The domain value map rule is deleted and the Transformation Map Details page appears.

Updating a Domain Value Map Rule

Follow these instructions to update a domain value map rule:

To update a domain value map rule:

1. Ensure that you followed the instructions in "[Accessing Domain Value Map Rule Management Tasks](#)" on page 13-105 to access the page for updating a domain value map rule.
The Update Domain Value Map Rule page appears.
2. Make appropriate changes based on the domain value map rule selected. (See "[Creating a Domain Value Map Rule](#)" on page 13-106 for a list of fields you can update.)
3. Click **Apply**.

The domain value map rule is updated and the Transformation Map Details page appears.

Domain Value Map Case Study: Changing Ad Vocabulary

This section provides an example of using domain value map rules, based on modeling metadata you created when using the tutorial in [Chapter 7, "Tutorial of an Integration within an Enterprise"](#). The tutorial uses different vocabulary to refer to an advertisement. For example, HR uses *Ad*, the global newspaper uses *Advertisement*, and the local newspaper uses *Commercial*. Domain value maps enable you to manage different vocabularies.

Creating Domain Columns

You first create three domain columns.

1. Select **Modeling > Transformations > Domain Value Maps**.
2. Click **Create** in the **Domain Columns** section.
3. Enter HR `Depts` in the **Name** field.
4. Select **No** from the **Business Domain** list.
5. Click **Apply**.
6. Click **Add** in the **Domain Parties** section.
7. Select **Human Resources** from the list.
8. Click **Apply**.
9. Click **Return to List**.
10. Click **Create** in the **Domain Columns** section.
11. Enter NP `Type1` in the **Name** field.
12. Select **No** from the **Business Domain** list.
13. Click **Apply**.
14. Click **Add** in the **Domain Parties** section.
15. Select **Global Newspaper** from the list.
16. Click **Apply**.
17. Click **Return to List**.







18. Click **Create** in the **Domain Columns** section.
19. Enter `Common` in the **Name** field.
20. Select **Yes** from the **Business Domain** list.
21. Click **Apply**.

Creating a Domain Value Map

1. Select **Modeling > Transformations > Domain Value Maps**.

The Domain Value Maps page appears, and displays the three domain columns you created.

Domain Value Maps

Domain Value Maps			
			Create
Name		Update	Delete
(No domain value maps found.)			
Domain Columns			
			Return to Top
Create			
Name	Business Domain	Update	Delete
Common	True		
HR_Depts	False		
NP_Type1	False		

2. Click **Create** in the **Domain Value Maps** section.
3. Enter `Ad Terminology` in the **Name** field.
4. Click **Apply**.
5. Click **Add** in the **Domain Value Map Columns** section.
6. Select **HR Depts** from the **Domain Column** list.
7. Click **Apply**.
8. Click **Add** in the **Domain Value Map Columns** section.
9. Select **NP Type1** from the **Domain Column** list.
10. Click **Apply**.
11. Click **Add** in the **Domain Value Map Columns** section.

12. Select **Common** from the **Domain Column** list.
13. Click **Apply**.
14. Click **Create** in the **Domain Value Map Rows** section.
15. Enter **Ad** in the **HR Depts** field.
16. Enter **Commercial** in the **Common** field.
17. Enter **Advertisement** in the **NP Type1** field.
18. Click **Apply**.

The Domain Value Map Details page displays your selections.

Domain Value Map Details : Ad Terminology

[Delete](#) [Update](#)

Details

Name **Ad Terminology**
State **Draft**

Domain Value Map Columns

[Add](#)

Name	Business Domain	Remove
HR Depts	False	
NP Type1	False	
Common	True	

Domain Value Map Rows

[Create](#)

HR Depts	NP Type1	Common	Update	Delete
Ad	Advertisement	Commercial		

Creating an Incoming Domain Value Map Rule

1. Select **Modeling > Transformations**.
2. Select **HR Ad to Common View** in the **Name** field.
3. Select **Domain Value Map Rule** from the **Statement Type** list.
4. Click **Append**.
5. Select **Ad Terminology** from the **Domain Value Map** list.
6. Select **lookupBusinessViewDomain** from the **Domain Value Map Function** list. The page refreshes.

7. Click **Expand All** for both the **Sources** table and the **Targets** table.
8. Select **Content_Type** in the **Sources** table.
9. Click **Bind** for **inValue** string.
10. Select **Content_Type** in the **Targets** table.
11. Click **Bind** for **outValue** string.
12. Enter **Human Resources** in the **Constant Value** field.
13. Click **Bind** for **Party** string.

The **Rule Signature** section displays your selections.

Rule Signature

* Domain Value Map Function

Source(s)	Target(s)
Party string Human Resources <input type="button" value="Bind"/>	outValue string HR New Ad-OUT/Ad/Content_Type <input type="button" value="Bind"/>
inValue string HR New Ad-IN/PAYLOAD/Content_Type <input type="button" value="Bind"/>	

14. Click **Apply**.

The domain value map rule statement displays at the bottom of the **Statements** list.

[Expand All](#) | [Collapse All](#)

Statements		Type	Update	Delete
	Statements			
	copy(from=HR New Ad-IN/PAYLOAD/Ad_ID ---->to=HR New Ad-OUT/Ad/Ad_ID)	Rule		
	format(formatPattern=yyy-mm-dd ,date=HR New Ad-IN/PAYLOAD/Date ---->resultString=yyy-mm-dd)	Rule		
	copy(from=HR New Ad-IN/PAYLOAD/HR_Contact_FirstName ---->to=HR New Ad-OUT/Ad/HR_Contact_FirstName)	Rule		
	copy(from=HR New Ad-IN/PAYLOAD/HR_Contact_LastName ---->to=HR New Ad-OUT/Ad/HR_Contact_LastName)	Rule		
	IF (HR New Ad-IN/PAYLOAD/Importance > 5)	IF Condition		
	FOR Ad Iterator in HR New Ad-IN/PAYLOAD/Ad	Iterator		
	copyHRAd(HR Ad Type=Ad Iterator---->Ad Type=HR New Ad-OUT/Ad/Ad)	Rule		
	lookupBusinessViewDomain(Party=Human Resources ,inValue=HR New Ad-IN/PAYLOAD/Content_Type ---->outValue=HR New Ad-OUT/Ad/Content_Type)	Domain Value Map Rule		

Creating an Outgoing Domain Value Map Rule

1. Select **Modeling > Transformations**.
2. Select **Common View to Global NP Ad** in the **Name** field.
3. Select **Domain Value Map Rule** in the **Statement Type** list.
4. Click **Append**.
5. Select **Ad Terminology** from the **Domain Value Map** list.
6. Select **lookupPartyDomain** from the **Domain Value Map Function** list. The page refreshes.
7. Click **Expand All** for both the **Sources** table and the **Targets** table.
8. Select **Content_Type** in the **Sources** table.
9. Click **Bind** for **inValue string**.
10. Select **Content_Type** in the **Targets** table.
11. Click **Bind** for **outValue string**.
12. Enter **Global Newspaper** in the **Constant Value** field.
13. Click **Bind** for **Party string**.

The **Rule Signature** section displays your selections.

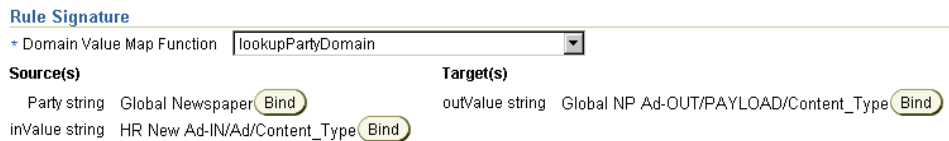

14. Click **Apply**.

The domain value map rule statement displays at the bottom of the **Statements** list.

[Expand All](#) | [Collapse All](#)

Statements		Type	Update	Delete
<input type="radio"/>	▼ Statements			
<input type="radio"/>	Name	Map Variable		
<input type="radio"/>	copy(from=Global NP Ad --->to=Global NP Ad-OUT/PAYLOAD/Action)	Rule		
<input type="radio"/>	copy(from=HR New Ad-IN/Ad/Date --->to=Global NP Ad-OUT/PAYLOAD/Date)	Rule		
<input type="radio"/>	FOR Ad Iterator in HR New Ad-IN/Ad/Ad	Iterator		
<input type="radio"/>	copyGlobalNPAd(Ad Type=Ad Iterator--->Ad_Type=Global NP Ad-OUT/PAYLOAD/Ad)	Rule		
<input type="radio"/>	concat(firstString=HR New Ad-IN/Ad/HR_Contact_FirstName ,secondString= --->resultString=Name)	Rule		
<input type="radio"/>	concat(firstString=Name,secondString=HR New Ad-IN/Ad/HR_Contact_LastName --->resultString=Global NP Ad-OUT/PAYLOAD/HR_Contact_Name)	Rule		
<input type="radio"/>	setToParty(toPartyName=Global Newspaper)	Event Header Rule		
<input type="radio"/>	lookupPartyDomain(Party=Global Newspaper ,inValue=HR New Ad-IN/Ad/Content_Type --->outValue=Global NP Ad-OUT/PAYLOAD/Content_Type)	Domain Value Map Rule		

Common User Errors

See [Chapter 14, "Advanced Transformations Design"](#) for details about user transformation design errors.

Chapter Summary

This chapter describes how you use transformations to reconcile the different structures and vocabularies used by the parties in an integration. Event and datatype transformation maps and domain value maps are defined. Management tasks for these map types are provided. Transformation statements, the logical statements to use when mapping the sources and targets of parties, are defined. Management tasks for transformation statements are also provided.

Case studies on using basic transformation rules, transformation conditions, event header rules, map variables, and domain value map rules are provided.

Advanced Transformations Design

This chapter describes how to design advanced transformations. Common transformation errors and transformation limitations are also described.

This chapter contains these topics:

- [Implicit Conversion Support](#)
- [Common User Errors in Transformation Design](#)
- [Transformation Design Limitations](#)
- [Transformation Iterator Design](#)
- [Nesting Design](#)
- [Transformation Map Variable Design](#)
- [Event Header Rule Design](#)
- [Domain Value Map Design](#)
- [Miscellaneous Designs](#)
- [Chapter Summary](#)

See Also:

- [Chapter 13, "Managing Transformations"](#)
- [Appendix B, "Transformation Rules"](#)

Implicit Conversion Support

Transformation supports implicit conversions between datatypes. Implicit datatype conversions are carried out between datatypes without any explicit datatype conversion function being called. This enables you to use variables and parameters of one type where another type is expected.

The following implicit datatype conversions are supported by transformation:

- Any type can be converted to a string

Any Oracle Application Server ProcessConnect core datatype can be converted to a string datatype implicitly. For example, a source item of an integer datatype can be converted to a string datatype without explicitly invoking a datatype transformation map for conversion.

- Derived type to base type, and vice versa

A source and target item of a scalar datatype can be bound to the source and target of the invoked transformation map, which can be any of its base types (upcasting). Scalar datatypes can be inherited only by restriction. Therefore, the subtype is always a specialized form of the base type. For example, consider the type hierarchy of a token derived from a string. A token can be assigned to a string because it is a specialized form of a string.

Similarly, a source item and target item of a scalar type can be bound to the source and target of the invoked transformation map, which can be one of its subtypes (downcasting) (for example, assigning a string to a token). In future releases, this feature may not be supported.

In addition to both of these implicit datatype conversions, there are a number of numeric implicit conversions possible:

- Integer to double, to decimal, and to float
- Float to decimal and to double
- Decimal to double and to float

These conversions are allowed since there is no loss of data. Implicit conversion is applicable to both source and target parameters.

["Example 1: Implicit Conversion for Source and Target Parameters"](#) on page 14-3 and ["Example 2: Implicit Conversion of Source and Target Parameters in the Same Datatype Transformation Map"](#) on page 14-4 illustrate the implicit conversion scenarios in transformation maps. These examples help you identify the correct

datatype transformation map to invoke in places where implicit conversions are allowed. An entire list of implicit and explicit conversions allowed by transformation can be viewed in [Table 14-1](#) on page 14-7.

Note: For source parameters, the implicit conversion rules are applied from a datatype of event type parameters or datatype parameters or map variables to a datatype of a source parameter of the datatype transformation map. For target parameters, the rules are applied vice versa (that is, implicit conversion rules are applied from a datatype of a source of the datatype transformation map to a datatype of event type parameters or datatype parameters or map variables).

Example 1: Implicit Conversion for Source and Target Parameters

In [Figure 14-1](#), the total of Invoice, which is of type `double`, gets copied to the total of PO, which is of type `string`.

Figure 14-1 Implicit Conversion of Source and Target Parameters

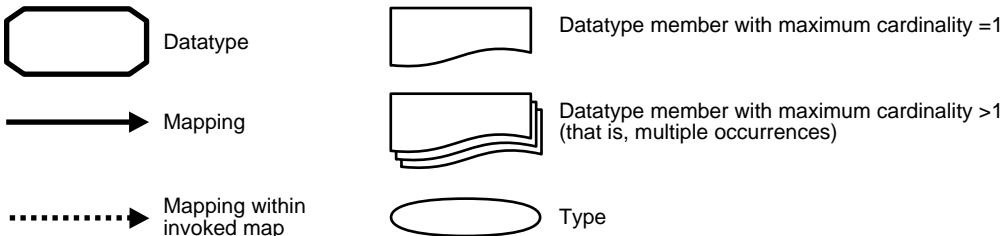
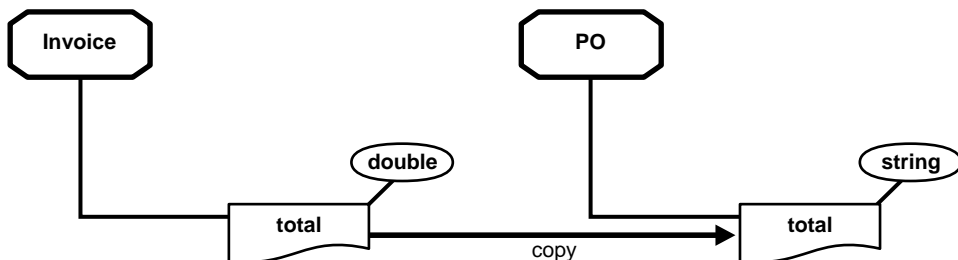

To perform the transformation operation in [Figure 14-1](#), you must select the appropriate `copy` datatype transformation map to be invoked. In this case, there are two valid datatype transformation maps that can be invoked:

- `copy(from=string -> to=string)`
- `copy(from=double -> to=double)`

Selecting the first `copy` transformation map results in implicit conversion of a source parameter. In this case, the `total` member of `Invoice` of type `double` is bound to the source parameter `from` of the `copy` datatype transformation map of type `string`. This is a valid binding since a `double` datatype can be implicitly converted to a `string` datatype. The target binding does not need conversion since their datatypes are the same.

Selecting the second `copy` transformation map results in implicit conversion of a target parameter. In this case, the `total` member of `PO` of type `string` is bound to a target parameter of a datatype transformation map of type `double`. This is a valid binding since a `double` datatype can be implicitly converted to a `string` datatype. The source parameter does not need conversion since their datatypes are the same.

[Figure 14-1](#) illustrates two important points:

- Implicit conversion for source parameters
- Implicit conversion for target parameters

Mapping Logic

```
{  
  ...  
  copy (from= Invoice::/total) -> (to= PO::/total);  
  ...  
}
```

Example 2: Implicit Conversion of Source and Target Parameters in the Same Datatype Transformation Map

In [Figure 14-2](#), the `price` of `Line-Item`, which is of type `float`, is multiplied with `quantity`, which is of type `integer`, to obtain the total. The total obtained is copied to the `item-total` of `Item` which is of type `string`.

Figure 14–2 Implicit Conversion of Source and Target Parameters in the Same Datatype Transformation Map

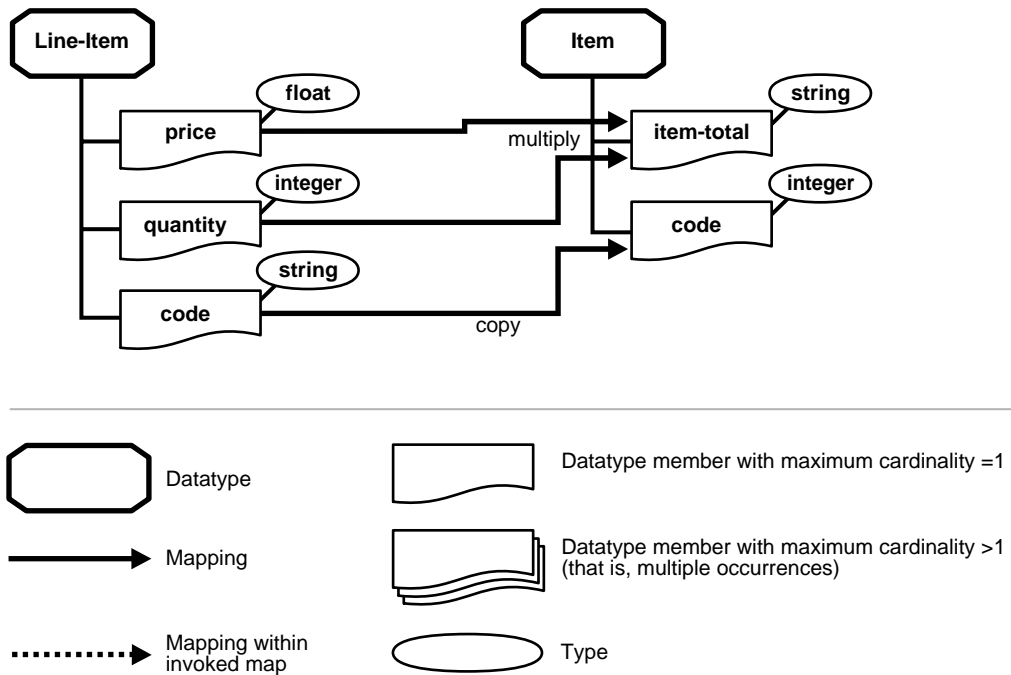

To perform this transformation, the following datatype transformation map is invoked:

```
multiply(first=float, second=float -> result=float) ;
```

In this case, `price` is bound to the first source parameter for the datatype transformation map and `quantity` to the second source parameter. For the target parameter `result`, the `item-total` is bound. The quantity of `Line-Item`, which is of type `integer`, gets implicitly converted to datatype `float` of the second parameter. The result, which is of type `float`, is implicitly converted to a `string` type.

Mapping Logic

```
{
  ...
  multiply (first = Line-Item::/price, second= Line-Item::/ Quantity) -> (to=
    Item::/Item-Total);
  ...
}
```

Invalid Case

In [Figure 14-2](#), the code of `Line-Item`, which is of type `string`, is copied to the code of `Item`, which is of type `integer`. To perform this transformation invocation, the following `copy` datatype transformation map is invalid since, there is no implicit conversion from the source item, code of `Line-Item`, which is of type `string` to the source of the `copy` datatype transformation map, which is of type `integer`.

```
copy(from=integer -> to=integer);
```

Invalid Mapping Logic

```
{
  ...
  copy (from= Line-Item::/Code) -> (to= Item::/Code);
  ...
}
```

To invoke the `copy` datatype transformation map, you must first convert the code of `Line-Item` to a value of datatype `integer`. Invoking the datatype transformation map `stringToInteger` with the code bound to the source and a map variable (for example, `integerValue` of type `integer` bound to the target) results in the required conversion. This map variable, `integerValue`, can then be substituted in place of the source item code in this datatype transformation map.

Valid Mapping Logic

```
{
  ...
  stringToInteger(sourceString= Line-Item::/Code) -> (resultInteger=
    integerValue);
  copy (from = integerValue) -> (to= Item::/Code);
  ...
}
```

Table 14–1 shows the datatype conversion matrix of allowable implicit and explicit conventions. The following naming conversions are used.

- IMPL = Implicit
- EXP = Explicit
- EXP(NS) = Explicit (not supported)
- N/A = Not applicable

Table 14–1 Datatype Conversion Matrix

From \ To	String	Binary String	dateTime	decimal	double	float	xml Opaque	integer	Boolean	character
string	IMPL	EXP (NS)	EXP (string ToDateT ime)	EXP (strin gToDec imal)	EXP (stri ngToD ouble)	EXP (stri ngToF loat)	N/A	EXP (stri ngToI ntege r)	EXP (string ToBoole an)	EXP (string ToChara cter)
binary string	IMPL	N/A	N/A	EXP(NS)	EXP(NS)	EXP(NS)	N/A	EXP(NS)	N/A	N/A
dateTime	IMPL	EXP (NS)	---	N/A	N/A	N/A	N/A	N/A	N/A	N/A
decimal	IMPL	EXP (NS)	N/A	---	IMPL	IMPL	N/A	EXP (deci malTo Integ er)	N/A	N/A

Table 14–1 (Cont.) Datatype Conversion Matrix

From \ To	String	Binary String	dateTime	decimal	double	float	xml Opaque	integer	Boolean	character
double	IMPL	EXP (NS)	N/A	EXP (doubleToDecimal)	---	EXP (doubleToFloat)	N/A	EXP (doubleToInteger)	N/A	N/A
float	IMPL	EXP (NS)	N/A	IMPL	IMPL	IMPL	N/A	EXP (floatToInteger)	N/A	N/A
xmlOpaque	IMPL	N/A	N/A	N/A	N/A	N/A	---	N/A	N/A	N/A
integer	IMPL	EXP (NS)	N/A	IMPL	IMPL	IMPL	N/A	---	N/A	N/A
Boolean	IMPL	N/A	N/A	N/A	N/A	N/A	N/A	N/A	---	N/A
character	IMPL	N/A	N/A	N/A	N/A	N/A	N/A	N/A	N/A	N/A

Common User Errors in Transformation Design

This section describes common user errors in designing transformations.

This section contains these topics:

- [Not Checking for the Existence of an Optional Datatype Member](#)
- [Not Checking for the Existence of a Datatype Member of the Model Group Choice](#)
- [Not Defining an Iterator to Access a Datatype Member with Multiple Occurrences](#)
- [Not Creating a Submap to Populate a Multiple Occurrence Target Member](#)
- [Incrementally Populating a Complex Datatype Using Submaps](#)
- [Not Populating Mandatory Target Members](#)

Not Checking for the Existence of an Optional Datatype Member

You must check for the existence of an optional datatype member of any datatype in the instance. If the member is not present in the source instance, and there is a rule for copying the source item to the target item, an empty element is created in the target instance.

Example

Under datatype `Address`, `street1` is an optional member.

Incorrect Design

The incorrect design is to copy the source without checking for the existence of the datatype member in the source instance. The following transformation rule:

```
copy( from=street1 -> to= street1)
```

creates an empty `street1` element in the target instance. For example, the source instance:

```
<Address>  
</Address>
```

results in the following target instance:

```
<Address>
  <street1/>
</Address>
```

Correct Design

Use the `Exists` function to check for existence of the optional datatype member in the instance. This prevents having an empty element in the target instance:

```
if ( Exists ( street1 ) )
{
  copy( from =street1 -> to= street1);
}
```

Not Checking for the Existence of a Datatype Member of the Model Group Choice

Check for the existence of any datatype member of a datatype whose model group is choice in the instance as an optional member. If the member is not present in the source instance, an empty element is created in the target instance.

Example

The `street1` and `street2` datatypes under datatype `Address` are choice members.

Incorrect Design

The incorrect design is to copy without checking for the existence of the members in the source instance. The following transformation rule:

```
copy( from=street1 -> to= street1);
copy( from=street2 -> to= street2);
```

creates an empty `street1` or `street2` element in the target instance. For example, the source instance:

```
<Address>
  <street1>Oracle Parkway</street1>
</Address>
```

or

```
<Address>
  <street2>Oracle Parkway</street2>
</Address>
```

results in the following target instance:

```
<Address>
  <street1>Oracle Parkway</street1>
  <street2/>
</Address>
```

or

```
<Address>
  <street1/>
  <street2>Oracle Parkway</street2>
</Address>
```

Correct Design

Use the `Exists` function to check for the existence of an optional datatype member of a datatype in the instance. This avoids the creation of an empty element in the target instance.

Mapping Logic

```
if ( Exists ( street1 ) )
{
  copy( from=street1 -> to= street1);
}
if ( Exists( street2 ) )
{
  copy( from=street2 -> to= street2);
}
```

See Also: ["Creating a Complex Datatype"](#) on page 10-19 for conceptual details about the choice model group

Not Defining an Iterator to Access a Datatype Member with Multiple Occurrences

If you have a datatype member of multiple occurrences, you must access it with an iterator. Otherwise, you receive a runtime error if there are multiple elements in the instance. This error typically occurs when you either do not know that the member being accessed has multiple occurrences, or you wrongly assume that you are accessing the first (or last) instance of the datatype member by default.

Example

Target `Address` has multiple streets mapped from multiple source streets in source `Addr`.

Incorrect Design

You are unaware that `Addr` has source streets (`st`) of multiple occurrences. For example:

```
CopyAddrToAddress (Addr fromAddr -> Address toAddress)
{
    copy(from=fromAddr::./st -> to=toAddress::./street);
}
```

You receive a runtime error if `st` appears multiple times in the `Addr` instance.

Correct Design

The correct design is to use an iterator:

```
CopyAddrToAddress (Addr fromAddr -> Address toAddress)
{
    for each(streets=fromAddr::./st) {
        copy(from=iterator streets -> to=toAddress::./street)
    }
}
```

Not Creating a Submap to Populate a Multiple Occurrence Target Member

Transformation mandates the invocation of a separate user-defined datatype map from within an iterator to map a complex target member of multiple occurrences from a complex source member of multiple occurrences. A common error is to create direct mappings to complex target members within an iterator without invoking a separate datatype transformation map. In this case, the execution results in creation of a target structure that is unintended and does not match the

corresponding type definition. This causes failure in native event validation or in later transformations.

Example

The target purchase order with multiple complex members of type `item` is mapped from source `Invoice` with multiple complex members of type `line-item`. Each target `item`'s content (`identifier`, `quantity`, and `cost`) is mapped from the corresponding source `line-item` content (`id`, `qty`, and `cost`).

Figure 14-3 shows this scenario.

Figure 14-3 *Populating a Multiple Occurrence Target Member*

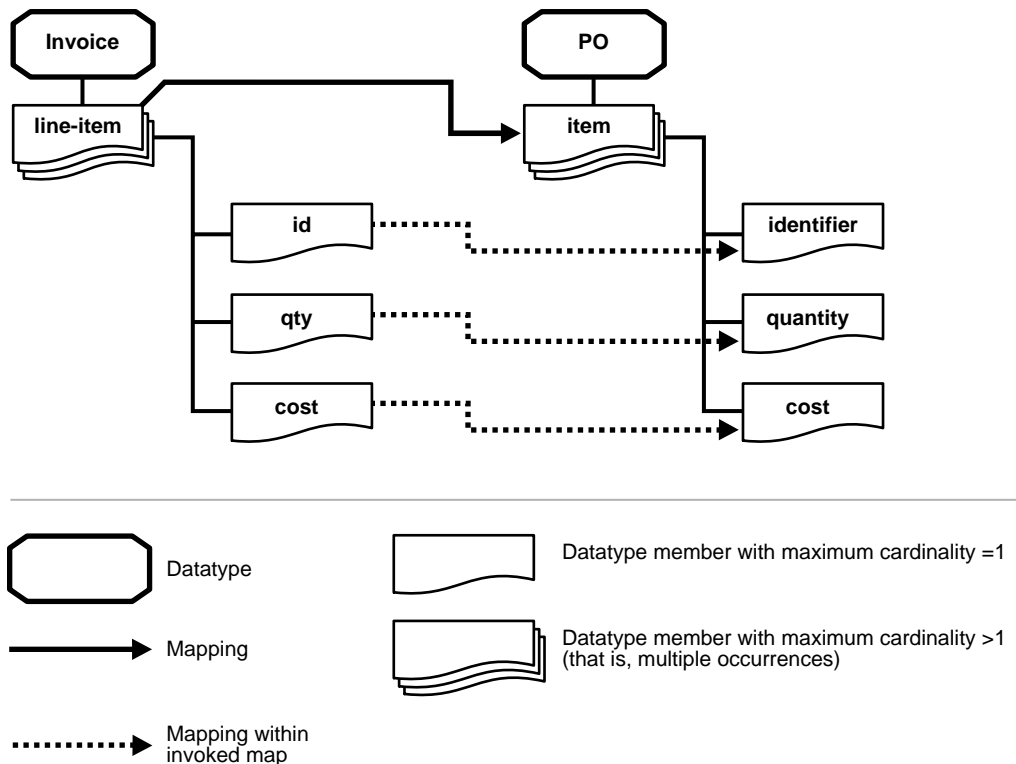

Incorrect Design

The incorrect design is to create direct mappings to complex target members within an iterator without invoking a separate datatype transformation map, as depicted in the following mapping logic:

```
for each (lineItems = inv:./line-item)
{
  copy (from=iterator line-items:./id -> to=po:./item/identifier);
  copy (from=iterator line-items:./qty -> to=po:./item/quantity);
}
```

This creates a single item with as many `identifier` and `quantity` values as the number of source line-items. For example, this source instance:

```
<invoice>
  <line-item>
    <id>001</id>
    <qty>1</qty>
  </line-item>
  <line-item>
    <id>002</id>
    <qty>2</qty>
  </line-item>
</invoice>
```

results in the following target instance:

```
<po>
  <body>
    <item>
      <identifier>001</identifier>
      <identifier>002</identifier>
      <quantity>1</quantity>
      <quantity>2</quantity>
    </item>
  </body>
</po>
```

Correct Design

An invocation of a separate datatype transformation map is required within the iterator to fully populate the target item before adding to the target PO. This is so that it does not require updating with child content (for example, `quantity` and `cost`) later.

The datatype transformation map invoked within the iterator maps the members of the target item from the members of the source line-item. For example:

```
copyInvoiceToPO (Invoice inv -> PO po)
{
  ....
  for each (lineItems = inv:./line-item) {
    copyLineItemToItem (lineItem=iterator line-items -> item=po:./item);
  }
  ....
}

copyLineItemToItem (lineItem srcLineItem -> item targetItem)
{
  copy (from=srcLineItem:./id -> to= targetItem:./identifier);
  copy (from=srcLineItem:./qty -> to= targetItem:./quantity);
  copy (from=srcLineItem:./cost -> to= targetItem:./cost);
}
```

Incrementally Populating a Complex Datatype Using Submaps

Transformation does not support incremental populating of a complex datatype using submaps. If you invoke a submap that passes in a complex datatype as a target parameter, a new instance of that complex datatype is created by that submap invocation. If the same complex datatype parameter is passed to several submaps, a new instance is created every time. If using submaps, therefore, populate the complex datatype only once. It is permissible to populate the members of the complex datatype one-by-one by calling submaps. The error typically occurs when you bunch several members together and create submaps to populate those sets of members.

Example

You want to transform a detailed address to a summarized address. A detailed address has the following format:

```
<address>
  <street1>106 Main Street</street1>
  <street2>Apt #200</street2>
  <city>Anytown</city>
  <state>CA</state>
  <zip>10011</zip>
</address>
```

A summarized address has the following format:

```
<address>
  <street>106 Main Street, Apt #200<street>
  <location>Anytown, CA 10011</location>
</address>
```

Incorrect Design

The incorrect design is to pass the same target address to two submaps expecting that they populate different parts of the address.

```
mapAddress (DetailedAddress sourceAddr -> SummaryAddress targetAddr)
{
    mapStreetAddress(addr1=sourceAddr -> addr2=targetAddr);
    mapLocation(addr1=sourceAddr -> addr2=targetAddr);
}

mapStreetAddress(DetailedAddress addr1 -> SummaryAddress addr2)
{
    //concatenates street1 and street2 and populates the
    // street in addr2
}

mapLocation(DetailedAddress addr1 -> SummaryAddress addr2)
{
    // concatenates city, state and zip and populates the
    // location in addr2
}
```

Correct Design

The correct design is to pass only the members of the target address to the submaps.

```
mapAddress (DetailedAddress sourceAddr -> SummaryAddress targetAddr)
{
    formStreetAddress(addr1=sourceAddr ->
        street=targetAddr:./street);
    formLocation(addr1=sourceAddr ->
        location=targetAddr:./location);
}

formStreetAddress(DetailedAddress addr1 -> string street)
{
    // concatenates street1 & street2 and returns result
}

formLocation(DetailedAddress addr1 -> string location)
{
    // concatenates city, state & zip and returns result
}
```

Not Populating Mandatory Target Members

All mandatory datatype members of a target datatype must be populated. Otherwise, transformation generates an invalid target instance.

Example

street1 is a mandatory member under datatype Address.

Incorrect Design

The incorrect design is to have no rule defined or no rule executed at runtime for the mandatory datatype member of the target datatype model.

Correct Design

There is currently no alternative other than ensuring that all target mandatory datatype members get populated with the map. The user interface tool shows the members mapped by a transformation map that helps determine if any mandatory target member remains unmapped.

Transformation Design Limitations

This section describes transformation limitations.

This chapter contains these topics:

- [Only Global Map Variables are Supported](#)
- [Transformation Statements Cannot be Moved in the User Interface Tool](#)
- [No Overwrite Ability for Target Members](#)
- [NOT Operator is Unsupported](#)

Only Global Map Variables are Supported

The Oracle Application Server ProcessConnect user interface tool currently only supports global scope variables within transformation statements. You cannot define a variable within a transformation block in a map (for example, within a transformation iterator or a transformation condition). A map variable is accessible throughout the map and can be used from within any block in the map.

Example

Assume that you must compute the total cost of all the line-items within an invoice (if there are any line-items in the source). You go over each of these line-items and add the price of each into a temporary variable that is initialized to zero. Finally, you copy the total price into the `totalCost` field within the purchase order (PO).

```
copyInvoicePOMap [DatatypeMap](AppEventDatatype Invoice invoice ->
BusinessEventDatatype PO po)
{
  if(Exists(invoice:./lineitem) {
int totalPrice;
  copy(from=0->to=variable totalPrice);
for each (lineItems = invoice:./line-item) {
  copy(from=line-item:./price -> to=item:./price);
  copy(from=line-item:./quantity -> to=item:./quantity);
  add(first=line-item:./price second=variable totalPrice ->
result=totalPrice);
  }
copy(from=variable totalPrice->to=po:./totalCost);
}
}
```

Workaround

Declare `totalPrice` outside all transformation blocks within the map; in this case, outside the `Exists` condition in which it was declared.

```
copyInvoicePOMap [DatatypeMap](AppEventDatatype Invoice invoice ->
BusinessEventDatatype PO po)
{
    int totalPrice;

    if(Exists(invoice:../lineitem) {

        copy(from=0->to=variable totalPrice);
        for each (lineItems = invoice:../line-item) {
            copy(from=line-item:../price->to=item:../price);
            copy(from=line-item:../quantity->to=item:../quantity);
            add(first=line-item:../price second=variable totalPrice->result=totalPrice);
        }
        copy(from=variable totalPrice->to=po:../totalCost);
    }
}
```

Transformation Statements Cannot be Moved in the User Interface Tool

You cannot currently change the position of already-defined transformation statements in the Oracle Application Server ProcessConnect user interface tool. You can only define new rules to add to the end of the list of statements, or inserted within the list of statements.

Example

Assume you have the following set of statements:

```
for each (lineItems = invoice:../line-item) {
    if ((line-item:../quantity >= 5) OR (line-item:../line-total > 1000)) {
        copy(from=line-item:../quantity -> to=item:../quantity);
    }
    concat(firstString=variable tmpId,secondString=line-item:../description ->
resultString=item:../uid);
}
```

You then decide to copy the field `quantity` to the target even though the quantity is less than five. This means you must move the related `copy` operation outside the IF condition. This is not currently possible in the Oracle Application Server ProcessConnect user interface tool.

Workaround

Delete the `copy` statement from the set of transformation statements. Then, insert a new statement for performing the copy above the IF condition.

No Overwrite Ability for Target Members

After you have populated a member of the target, you cannot overwrite it. To populate any member, you have to invoke some type of rule; since every rule invocation results in a new instance being created, you are creating multiple instances of the member if you invoke the rule multiple times. After you have initialized the member with a given instance, however, you cannot overwrite that instance.

Example

While mapping an invoice to a purchase order, you want to determine whether to apply a discount to the purchase order. You have multiple condition statements that, if true, result in a discount being applied:

```
if (invoice:./total > X) {
    subtractInteger(first=invoice:./total, second=1000, result=po:./total);
}

if (invoice:./quantity > Y) {
    subtractInteger(first=invoice:./total, second=500, result=po:./total);
}
...
```

If it is possible that more than one condition can evaluate to true, you receive a result that was not intended. Multiple total elements get created in the purchase order, each with a particular discount applied.

Workaround

The only workaround is to ensure that a particular rule that populates a member gets executed only once. In this example, structure your logic so that the conditions are mutually exclusive (that is, only one of them evaluates to true at runtime).

NOT Operator is Unsupported

This section describes NOT operator workarounds.

Description

You cannot currently use the logical NOT operator while defining condition expressions. The only logical operators supported by transformation are `=`, `!=`, `<`, `<=`, `>`, `>=`, and `Exists`. To combine simple condition expressions to create more complex ones, the AND and OR operators can be used.

Example

You want `rule1` to be invoked if the following condition is true:

```
NOT((a > 5) OR (b <= 2))
```

Otherwise, you want `rule2` to be invoked. You ideally want to design it as follows:

```
if (NOT((a > 5) OR (b <= 2))) {  
    rule1;  
} else {  
    rule2;  
}
```

However, the NOT operator is currently unsupported, and you must design this scenario differently.

Workaround

You can substitute the rules in the IF and ELSE blocks and remove the NOT operator. This results in:

```
if ((a > 5) OR (b <= 2)) {  
    rule2;  
} else {  
    rule1;  
}
```

Although this strategy works, it is not useful for the majority of cases where you do not have an ELSE block with which to start. For example, if the original condition is as follows:

```
if (NOT((a > 5) OR (b <= 2))) {  
    rule1;  
}
```

you cannot convert this as follows:

```
if ((a > 5) OR (b <= 2)) {  
  
} else {  
    rule1;  
}
```

This is because transformation does not permit empty blocks such as the IF block shown in this example.

The workaround is typically to use logical arithmetic to negate the condition. You can use the following rule to negate the condition:

$\text{NOT}(a \text{ OR } b) = \text{NOT } a \text{ AND NOT } b$

Therefore:

$\text{NOT}((a > 5) \text{ OR } (b <= 2)) \rightarrow \text{NOT } (a > 5) \text{ AND NOT}(b <= 2) \rightarrow (a <= 5) \text{ AND } (b > 2)$

You can write the condition as follows:

```
if ((a <= 5) AND (b > 2)) {  
    rule1;  
} else {  
    rule2;  
}
```

The one case where this logical negation of the condition fails is in the case of the operator `Exists`. If you want to model the following:

```
if (NOT(Exists(a))) {  
    rule1;  
}
```

Use the following workaround:

```
boolean exists_var;

if (Exists(a)) {
    exists_var=true;
} else {
    exists_var=false;
}

if (exists_var = false) {
    rule1;
}
```

Transformation Iterator Design

This section describes how to design advanced transformation iterator scenarios.

This section contains these topics:

- [Multiple Occurrence Target Members from Multiple Occurrence Source Members](#)
- [Single Occurrence Target Members from Multiple Occurrence Source Members](#)
- [Structure Flattening Iterations \(Nested Iterators\)](#)

Note: The term multiple occurrence members is used to describe datatype members with a maximum cardinality greater than one that can have corresponding multiple occurrences in the instance.

See Also: ["Transformation Iterators"](#) on page 13-58

Multiple Occurrence Target Members from Multiple Occurrence Source Members

This section describes structure-preserving mappings. These are mappings in which the datatype structure of the target is exactly the same as that of the source.

- [Target Member of Scalar Datatype](#)
- [Target Member of Complex Datatype](#)
- [Different Target Members Mapped from the Same Source Member](#)
- [Nested Multiple Occurrence Members in the Target Datatype](#)

Target Member of Scalar Datatype

A multiple occurrence scalar target member is mapped from a multiple occurrence scalar source member.

Example Target `Address` has multiple streets mapped from multiple source streets in source `Addr`, as shown in [Figure 14-4](#).

Figure 14-4 Target Member of Scalar Datatype

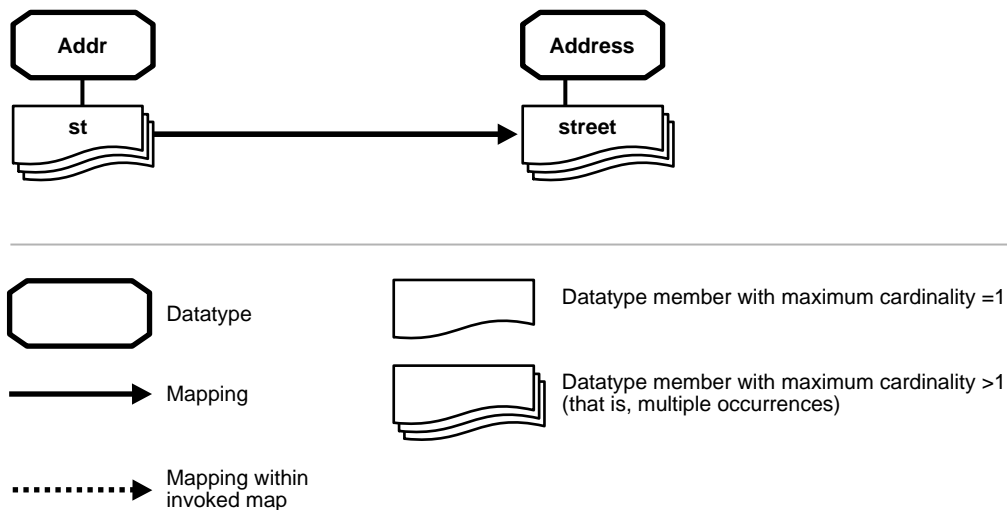

Mapping Logic

```
CopyAddrToAddress (Addr fromAddr -> Address toAddress)
{
  for each(streets=fromAddr::st) {
    copy(from=iterator streets -> to=toAddress::street)
  }
}
```

Target Member of Complex Datatype

A multiple occurrence complex target member is mapped from a multiple occurrence complex source member.

Example Target PO with multiple items is mapped from source Invoice with multiple line-items. Each target item's contents (identifier, quantity, and cost) are mapped from the corresponding source line-item content (id, qty, and cost), as shown in [Figure 14-5](#).

Figure 14-5 Target Member of Complex Datatype

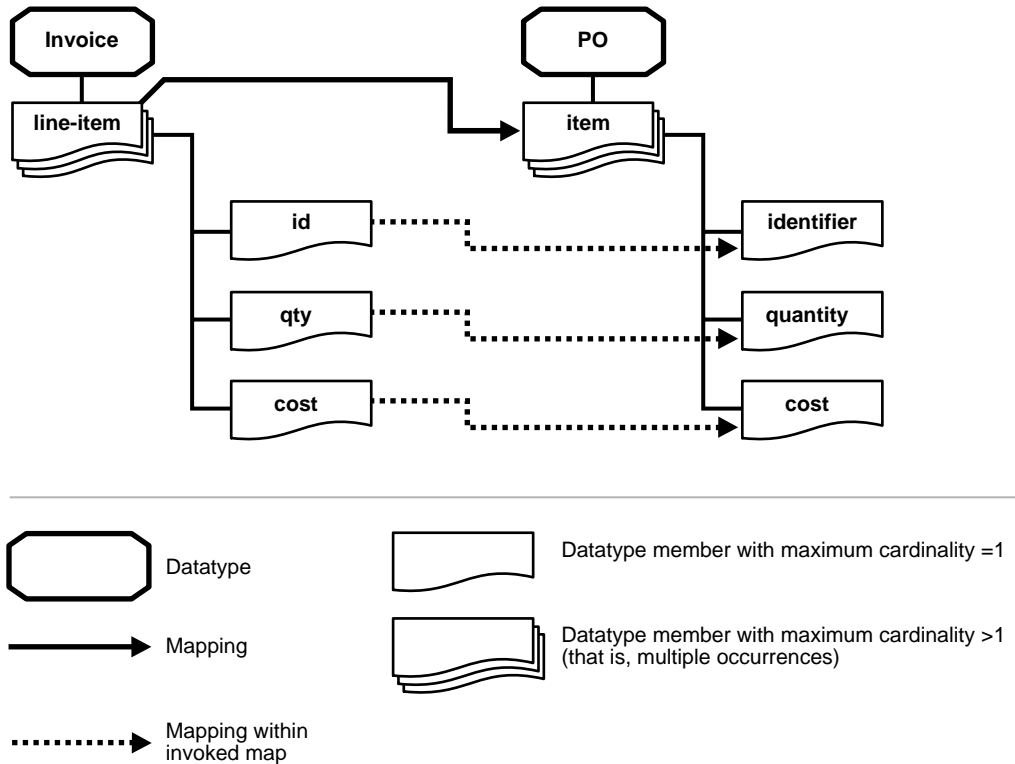

Mapping Logic Invocation of a separate datatype transformation map is required within the iterator to fully populate the target item before adding to the target PO.

The datatype transformation map invoked within the iterator maps the members of the target `item` from the members of the source `line-item`.

```
copyInvoiceToPO (Invoice inv -> PO po)
{
  ....
  for each (lineItems = inv:./line-item) {
    copyLineItemToItem (srcLineItem=iterator line-items ->
      targetItem=po:./item);
  }
  ....
}

copyLineItemToItem (lineItem srcLineItem -> item targetItem)
{
  copy (from=srcLineItem::id -> to= targetItem/identifier);
  copy (from=srcLineItem::qty -> to= targetItem/quantity);
  copy (from=srcLineItem::cost -> to= targetItem/ cost);
}
```

Different Target Members Mapped from the Same Source Member

A source member with multiple occurrences is mapped to two different target members with multiple occurrences based on a condition. For example, a source invoice has multiple line-items that each have a member called `availability`. This member's value indicates whether the line-item is in stock or not. The target `GroupedPO` has a structure where all the in-stock line-items are grouped under `inStock` and the out of stock items are grouped under `outOfStock`, as shown in [Figure 14-6](#).

Figure 14–6 Different Target Members Mapped from the Same Source Member

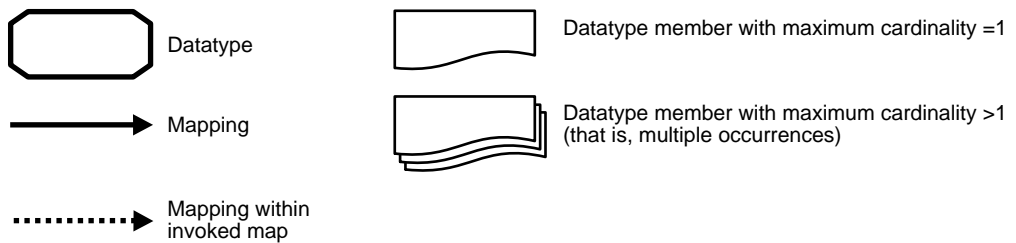
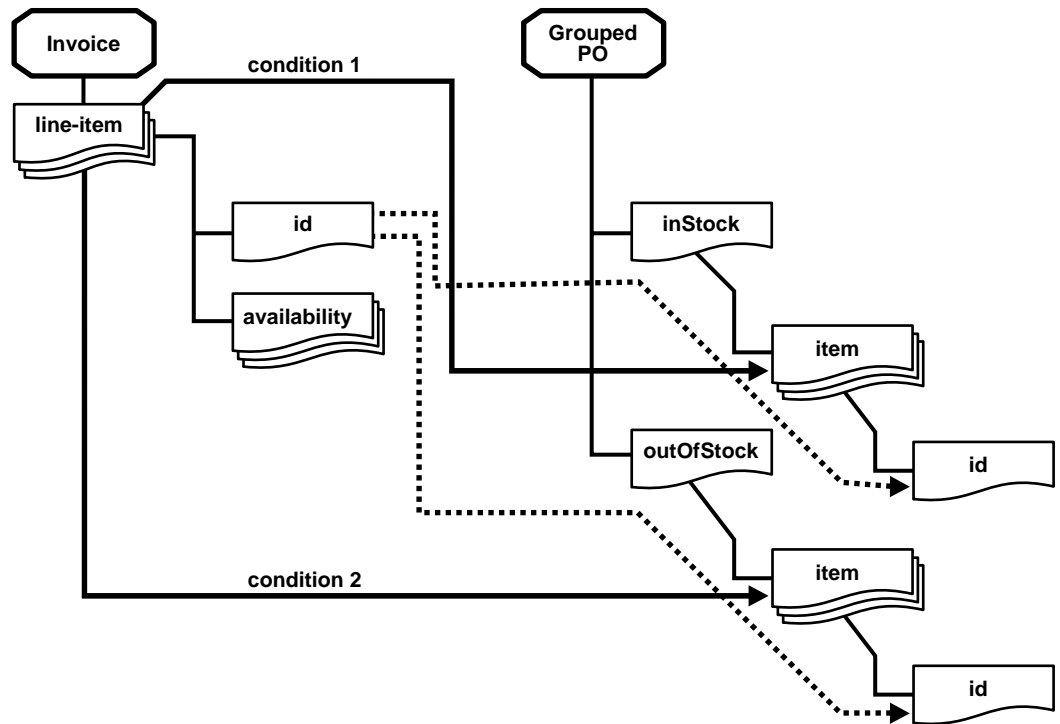

Mapping Logic A condition must be defined within the iteration of the source line-item to complete the mapping to the appropriate target member.

```
copyInvoiceToPO (Invoice inv -> GroupedPO po)
{
  ....
  for each (line-items = inv::items) {
    if (iterator line-items::availability =
        'inStock') {
      // copy the line-item to items under inStock
      copy(from=iterator line-items::name -> to=po::./inStock/item::name);
      ....
    }
    else {
      if (iterator line-items:: availability =
          'outOfStock') {
        // define the mapping for buyer
        copy(from=iterator line-items::name -> to=po::./outofStock/item::name);
        ....
      }
    }
  }
}
```

Nested Multiple Occurrence Members in the Target Datatype

Multiple occurrence target datatype members are of a complex datatype that has additional multiple occurrence members. These target members are mapped from source members having a similar structure of nested multiple occurrences.

Example Target PO has multiple items that each contain multiple descriptions. PO is mapped from a similarly-structured source Invoice that has multiple line-items. Each line-item has a complex datatype member of multiple occurrences called desc. Each desc has a lang member. [Figure 14-7](#) shows this scenario.

Figure 14-7 Nested Multiple Occurrence Members in Target

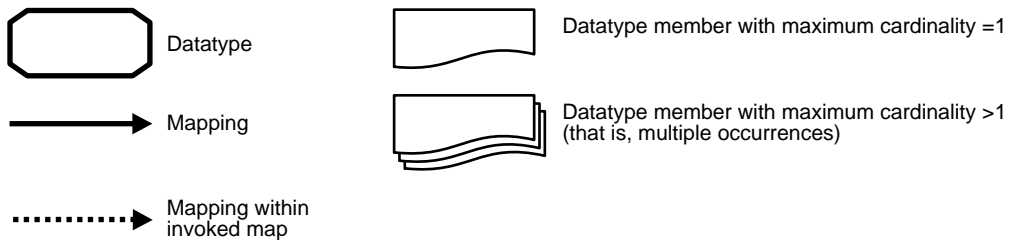
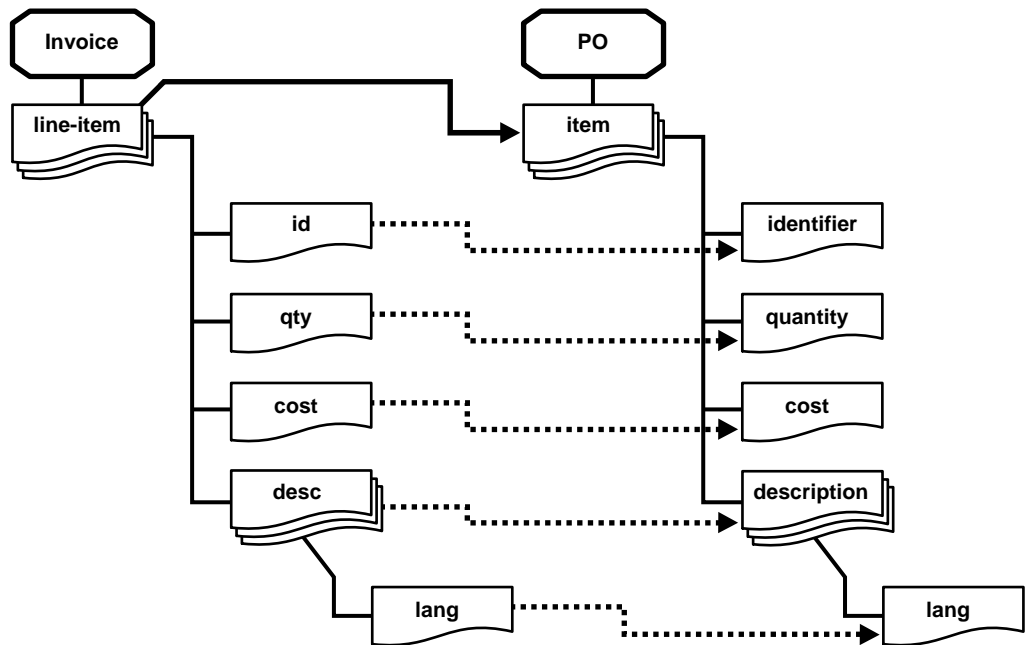

Mapping Logic Invocation of a datatype transformation map is required within an iterator over the outer multiple occurrence source member. The invoked datatype transformation map also has another iterator over the nested multiple occurrence source member.

```
copyInvoiceToPO (Invoice inv -> PO po)
{
  ....
  for each (lineItems = inv::./line-item) {
    copyLineItemToItem (from=iterator line-items -> to=po::./item);
  }
  ....
}

copyLineItemToItem (lineItem srcLineItem -> item targetItem)
{
  copy (from=srcLineItem::id -> to= targetItem/identifier);
  copy (from=srcLineItem::qty -> to= targetItem/quantity);
  copy (from=srcLineItem::cost -> to= targetItem/ cost);
  for each (descs = srcLineItem::desc) {
    copyDescToDescription (from=iterator descs -> to=targetItem::description);
  }
}

copyDescToDescription (desc srcDesc -> description targetDescription) {
  copy (from= srcDesc::lang -> to= targetDescription::lang);
}
```

Single Occurrence Target Members from Multiple Occurrence Source Members

This section describes mappings to a single occurrence target member from a multiple occurrence source member that require a way to select the specific source member to be mapped.

- [Data-Based Condition](#)
- [Position-Based Condition](#)
- [User Discretion - Direct Mapping without an Iteration](#)
- [Cumulative Computation](#)

Data-Based Condition

A particular multiple occurrence source member is selected based on a condition over the source data and mapped to a single occurrence target member.

Example Source Invoice has multiple party datatype members with a type value within it indicating the kind of party. The target member has single buyer and seller members.

The target member `buyer` of target `PO` is mapped from the source multiple occurrence `party` of `Invoice` whose `type` is set to `purchaser`. Similarly, `seller` is mapped from `party` with a `type` of `supplier`, as shown in [Figure 14-8](#).

Figure 14-8 Data-Based Condition

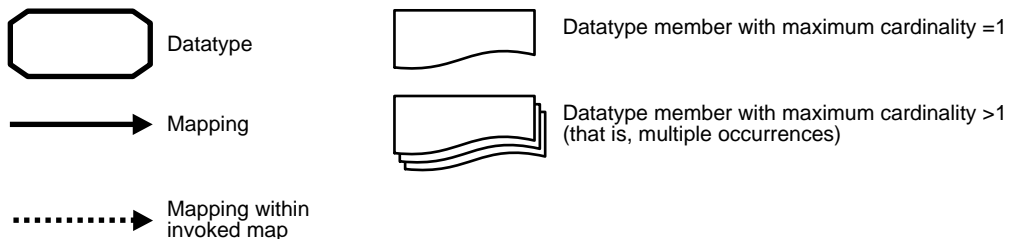
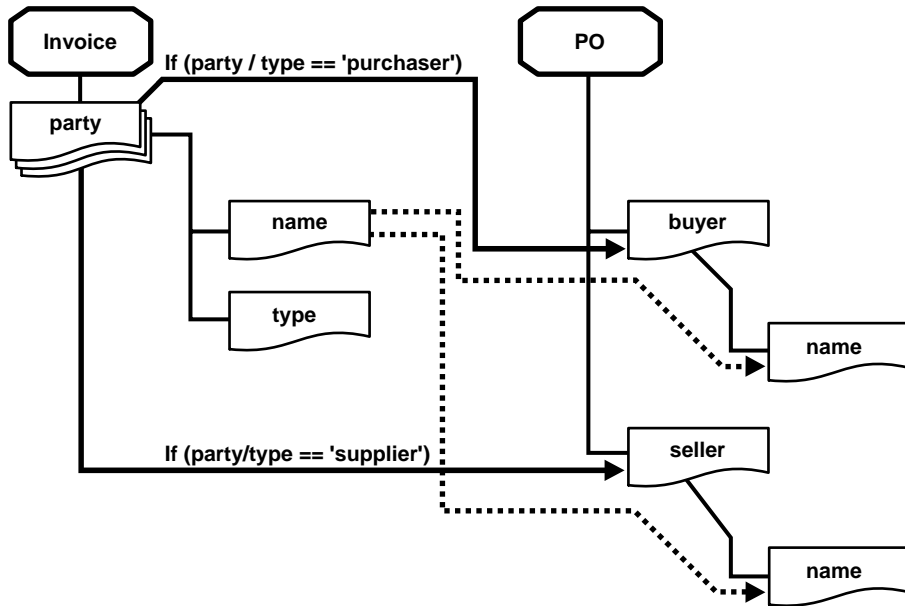

Mapping Logic A condition must be defined within the iterator to verify the type of `Party` being iterated over for the appropriate mapping.

```
copyInvoiceToPO (Invoice inv -> PO po)
{
  ....
  for each (parties = inv::party) {
    if (iterator parties::type = 'purchaser') {
      // define the mapping for buyer
      copy(from=iterator parties::name ->
          to=po:../buyer/name);
      ....
    }
    else {
      if (iterator parties::type = 'supplier')
        // define the mapping for seller
        copy(from=iterator parties::name ->
            to=po:../seller/name);
      ....
    }
  }
}
```

Position-Based Condition

A particular multiple occurrence source member is selected based on its position in the source instance and mapped to a single occurrence target member.

Example The source `Party` contains multiple contact information, but only the first contact information is mapped to the target `Party` that contains only single contact information.

Figure 14–9 shows this scenario.

Figure 14–9 *Position-Based Condition*

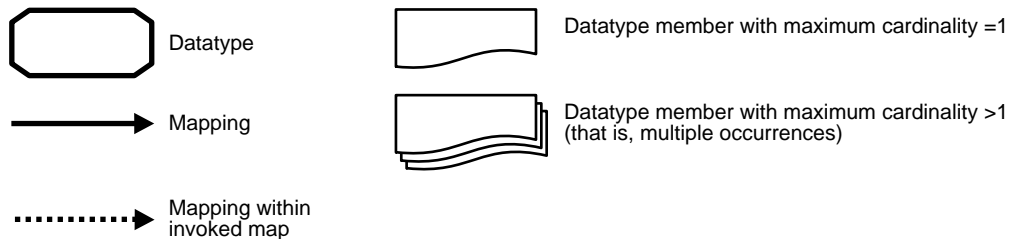
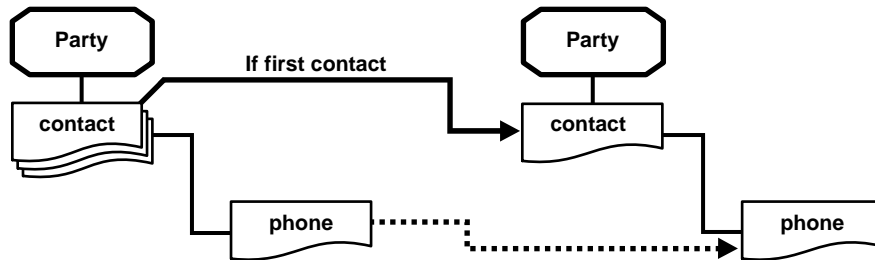

Mapping Logic Transformation does not currently provide access to the position of the current item within the iterator. Therefore, you must explicitly define a map variable to keep track of the first item (`contact`) in the iteration and copy it to the target.

```
copy (Party srcParty -> Party targetParty)
{
  // declare a map variable
  int iteratorPosition ;
  ....
  // initialize the map variable
  copy (from='0' -> to=variable iteratorPosition);

  // iterate over the contacts
  for each (contact = srcParty::contact) {
    if (variable iteratorPosition = '0') {
      // copy the current contact being iterated to the target contact
      copy(iterator contact, targetParty::contact);
    }
  }
}
```

```

.....
}
// increment the iterator position
add(firstInteger= iteratorPosition,
    SecondInteger='1' ->
    to= iteratorPosition);
}
}

```

User Discretion - Direct Mapping without an Iteration

Even though the type definition states that a particular source member has multiple occurrences, the actual instances may not have more than one occurrence. In such a case, you can directly copy this source member without using an iterator.

If the instance has multiple occurrences and you have mapped it without using an iterator, you receive a runtime error. Therefore, the usage of this pattern shown in [Figure 14–10](#) is discouraged.

Figure 14–10 User Discretion - Direction Mapping without Iteration

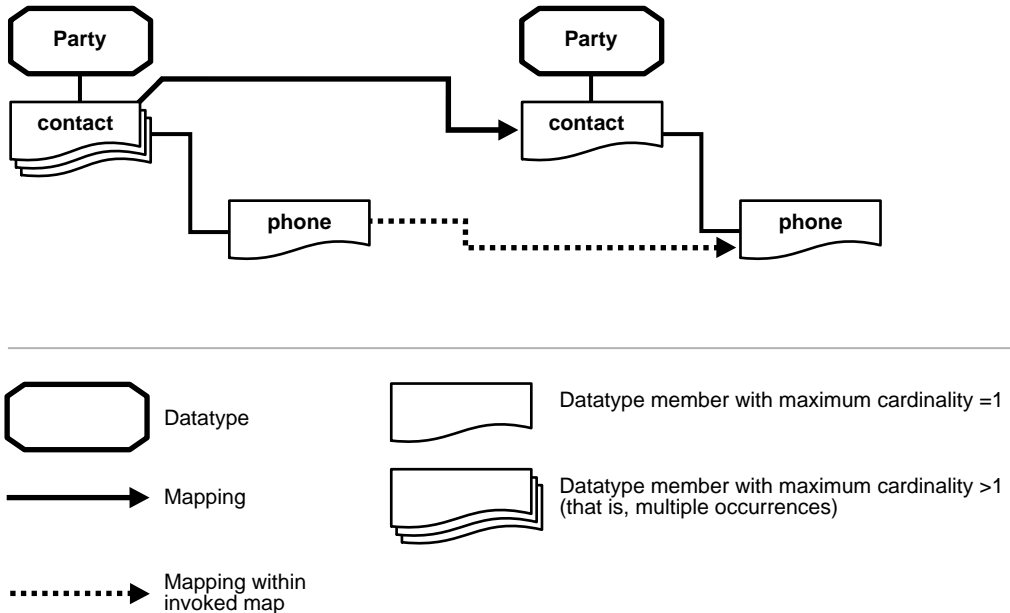

Example As with the previous example, the source `Party` has member contact information with potential multiple occurrences, but the actual instances always have single occurrences of contact information that is mapped to the target contact.

Mapping Logic The single source contact is directly mapped to the target contact without use of iterations.

```
copy (Party srcParty -> Party targetParty)
{
    copy(srcParty::contact -> targetParty::contact);
    ....
}
```

Cumulative Computation

The multiple occurrences of a source member are iterated over to perform a cumulative computation (such as summation and average) on the values being iterated over.

Example Target `PO` has a `totalAmount` type that is computed by iterating and summing up all the source line totals, as shown in [Figure 14–11](#).

Figure 14–11 Cumulative Computation

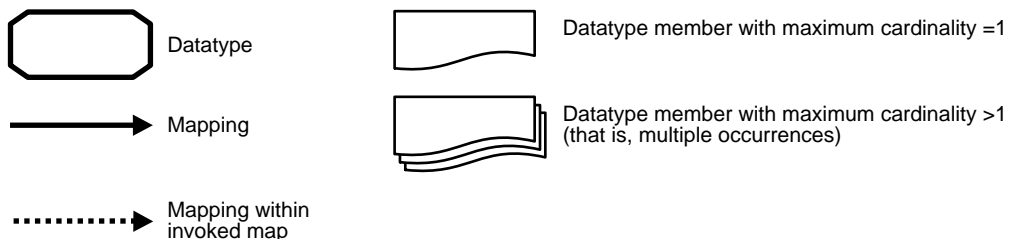
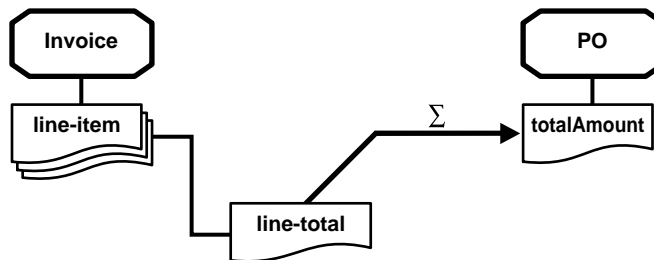

Mapping Logic A map variable is declared for `invoiceTotal`. Iteration is defined over a source `line-item` within which each `line-total` is added to `invoiceTotal`. At the end of the iteration, the `invoiceTotal` is copied to the target `totalAmount`.

```
copyInvoiceToPO (Invoice inv -> PO po)
{
  // the map variable for the total
  int invoiceTotal;
  ...

  for each (lineItems = inv:./line-item) {
    // add line-total to invoice total
    add(firstInteger=iterator line-items:./line-total) ,
      SecondInteger=variable invoiceTotal ->
      to= variable invoiceTotal);
  }
  //copy the computed invoice total to the po totalAmount
  copy(from=variable invoiceTotal ->
      to=po:totalAmount);
}
```

Structure Flattening Iterations (Nested Iterators)

This scenario refers to the case where a multiple occurrence complex datatype has further multiple occurrence members. Such nested source members are mapped to a target with only one level of multiple occurrence members; that is, the multiple occurrence target datatype member does not have any further child members with multiple occurrences. Such mappings require the source nested structure to be flattened out by a Cartesian product of the source members.

Example The source `ComputersByVendor` has multiple vendor types that each have a list of the supported operating system types (identified by `OS` in the following example). The target has a flattened list of `computer` types with each computer having the vendor and `OS`.

Sample Source Instance:

```
<computersByVendor>
  <vendor>
    <name>Gateway</name>
    <OS>Windows</OS>
    <OS>Linux</OS>
  </vendor>
</computersByVendor>
```

```

        <name>Dell</name>
        <OS>Windows</OS>
        <OS>Linux</OS>
    </vendor>
    <vendor>
        <name>Sun</name>
        <OS>Linux</OS>
        <OS>Solaris</OS>
    </vendor>
</computersByVendor>

```

Sample Target Instance:

```

<computerFlatList>
  <computer>
    <Vendor><name>GateWay</name></Vendor>
    <OS><name>Windows</name></OS>
  </computer>

  <computer>
    <Vendor><name>GateWay</name></Vendor>
    <OS><name>Linux</name></OS>
  </computer>

  <computer>
    <Vendor><name>Dell</name></Vendor>
    <OS><name>Windows</name></OS>
  </computer>

  <computer>
    <Vendor><name>Dell</name></Vendor>
    <OS><name>Linux</name></OS>
  </computer>
  <computer>
    <Vendor><name>Sun</name></Vendor>
    <OS><name>Linux</name></OS>
  </computer>

  <computer>
    <Vendor><name>Sun</name></Vendor>
    <OS><name>Solaris</name></OS>
  </computer>
</computerFlatList>

```

Figure 14–12 shows this scenario.

Figure 14–12 Structure Flattening Iterations

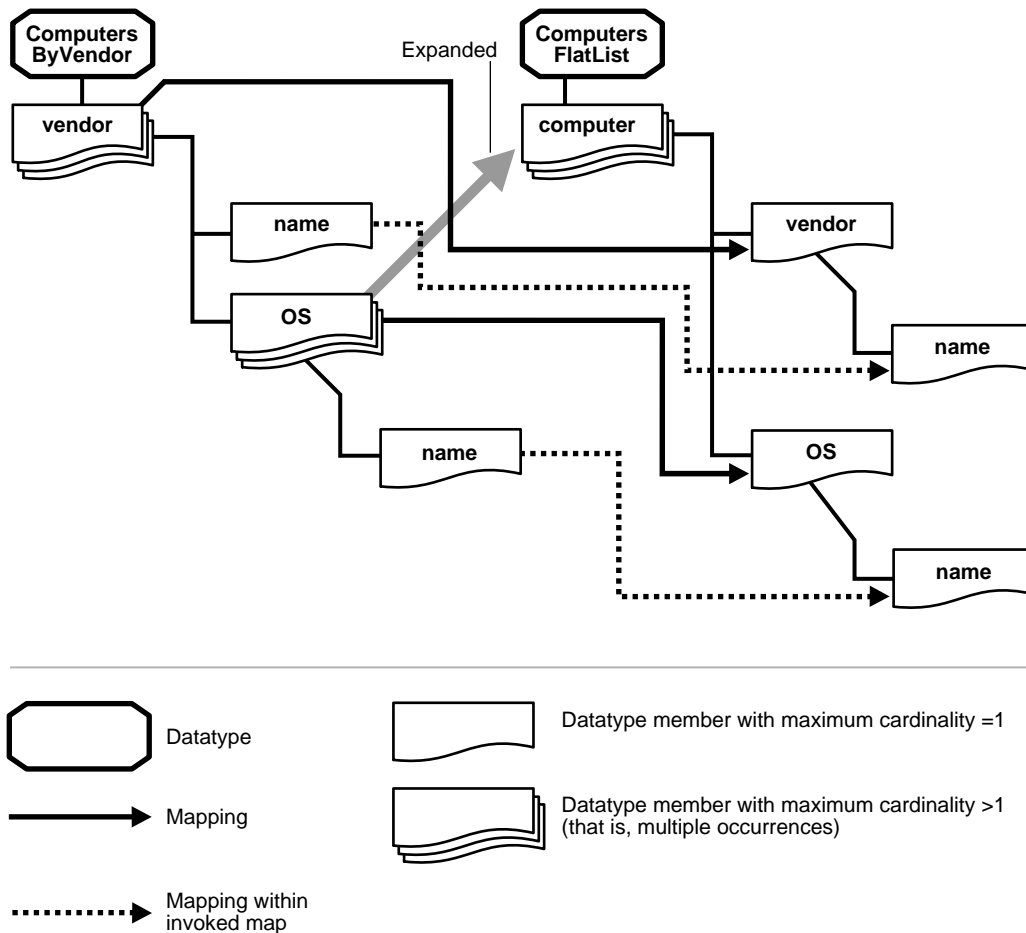

Mapping Logic This mapping requires the definition of an iterator over the `vendor` that contains another (nested) iterator over all the operating system (OS) types of the current `vendor`.

A map invoked within the inner iterator can perform the Cartesian product by accessing the current OS name (from the inner iterator) and the current `vendor`

name (from the outer iterator) and invoke a datatype transformation map that creates a target computer with the OS name and vendor name.

```
copyFlatComputerListToComputersByVendor
  (ComputersByVendor computerByVendor) ->
  (FlatComputerList flatComputerList)
{
  // iterate over the vendors
  for each (vendors = computerByVendor::Vendor) {
    // iterate over the OS's of the current vendor
    // requires accessing the current item of the
    // outer iterator to define the items to iterate
    // over for the inner iterator
    for each (OSs = iterator[vendors]::OS) {
      mapComputer
        (oSName=iterator[OSs]::name,
         vendorName=iterator[vendors]::name) ->
        (computer=flatComputerList::computer);
    }
  }

mapComputer (String osName, String vendorName) ->
  (Computer computer)
{
  copy(from=vendorName) -> (to=computer::vendor/name);
  copy(from=osName) -> (to=computer::OS/name);
}
```

Nesting Design

This section describes advanced nesting scenarios.

This section contains these topics:

- [Iteration within a Condition](#)
- [Condition within a Condition](#)

See Also:

- ["Different Target Members Mapped from the Same Source Member"](#) on page 14-26 for details about a condition within an iteration
- ["Nested Multiple Occurrence Members in the Target Datatype"](#) on page 14-28 for details about an iteration within an iteration

Iteration within a Condition

This section describes mapping of multiple source members to a target based on a condition.

Example

If the total amount is more that \$10,000 under the source `invoice`, then iterate over the line-items and increase the quantity by 1 for all line-items whose quantity is greater than 50, as shown in [Figure 14-13](#).

Figure 14–13 Iteration without a Condition

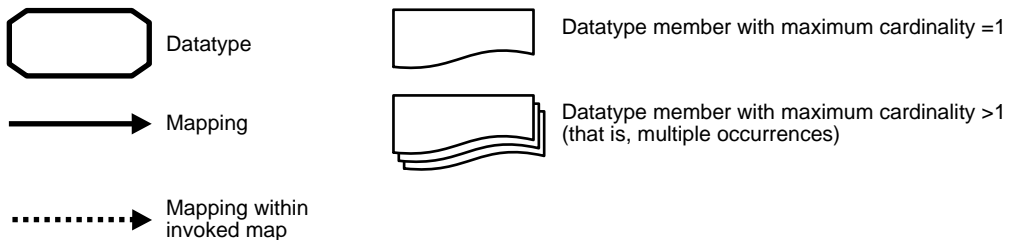
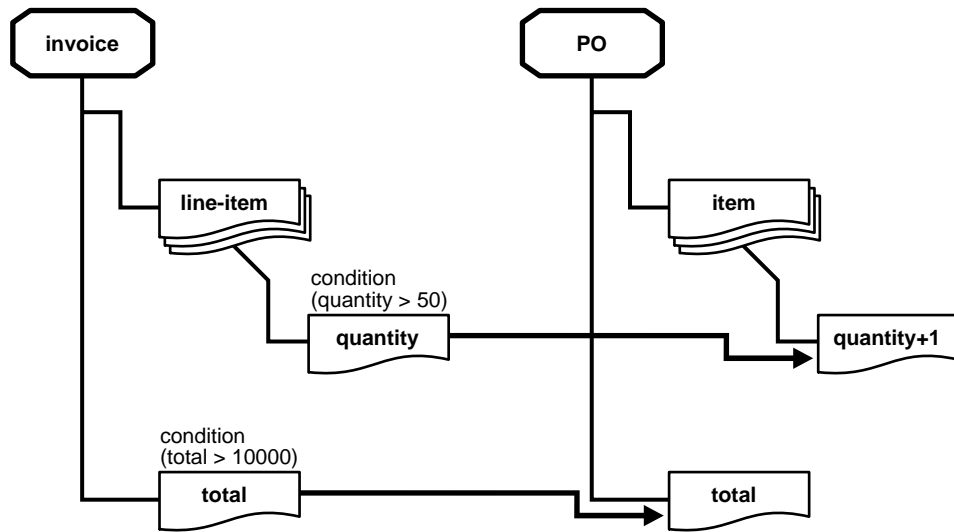

Mapping Logic

The mapping requires a condition on the element `total` under the `invoice` element. Iterate over the `line-item` for all the instances where the total amount is greater than \$10,000.

For all elements whose `quantity` is greater than 50, increment the `line-item` by 1 within each `line-item`.

```
If( inv:../line-item/total > 10000 )
{
    int totalQuantity;
    ...

    for each (lineItems = invoice:../line-item) {

        if( iterator line-items::quantity > 50 )

            {
                add(first=iterator line-items::quantity,
                    second=1 -> result= variable totalQuantity);

                //copy the computed total quantity to the po quantity
                copy(from=variable totalQuantity ->
                    to=po:..item/quantity);
            }

    }

}
```

Condition within a Condition

A second condition is evaluated based on a value computed after the first condition evaluation.

Example

If `street1` and `street2` are not null under `Address`, (the first condition), concatenate these two strings. If the concatenated string's length is greater than 8, do a substring of length 8.

Figure 14-14 shows this scenario.

Figure 14-14 Condition within a Condition

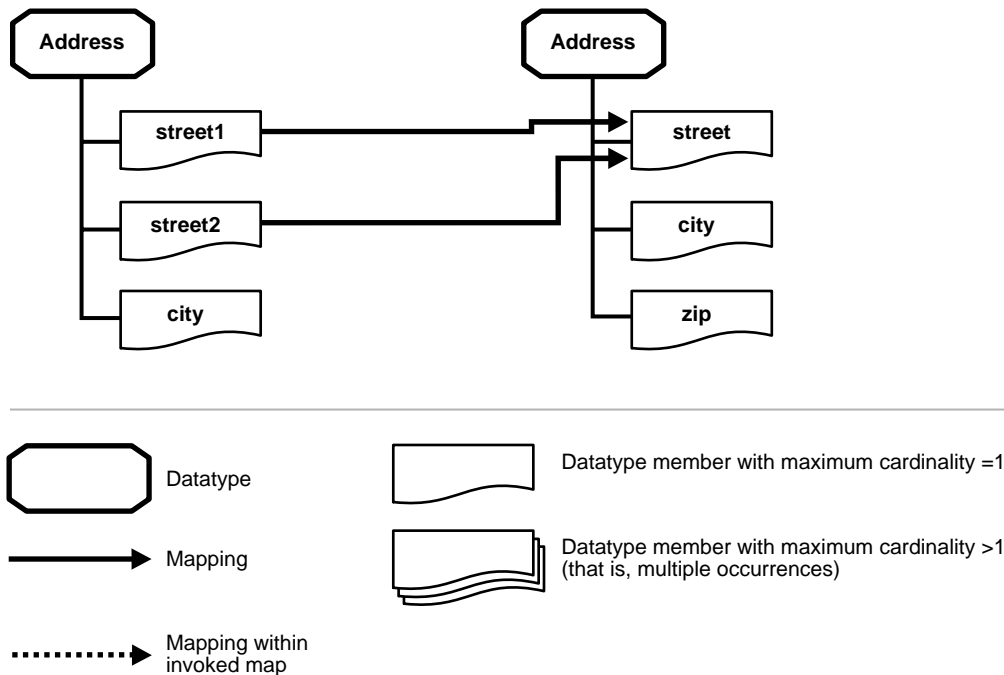

Mapping Logic

This mapping requires a condition to verify that the values of `street1` and `street2` are not null. If the respective values are not null, concatenate `street1` and `street2`. The inner condition must check for a length greater than 8 characters. A substring operation is performed if the concatenated string has a length greater than 8 characters.

```
if ( street1 != null && street2 != null )
{
    concatenatedStreet = concat ( street1 , street2 );
    if ( concatenatedStreet.size() > 8 )
    {
        resultStreet = subString ( concatenatedStreet ,8);
        copy(from= resultStreet -> to=street);
    }
}
```

```

        copy(from= concatenatedStreet -> to=street);
    }

```

Although this example uses simple rules within the control flow constructs, domain value map and event header rules can also be used.

Transformation Map Variable Design

This section describes how to design advanced transformation map variable scenarios.

See Also:

- ["Transformation Map Variables"](#) on page 13-70
- ["Cumulative Computation"](#) on page 14-35 for a cumulative computation scenario using a map variable

Reuse (Preservation of State)

Map variables can also preserve the results of a computation, enabling it to be used in multiple places.

Example

A source Invoice has a Seller, Buyer, and Distributor, while a target PO has a Supplier, Purchaser, and Distributor. They map as shown in [Table 14-2](#).

Table 14-2 Mapping

Invoice	->	PO
Seller	->	Supplier
Buyer	->	Purchaser
Distributor	->	Distributor

All three sources in Invoice (Seller, Buyer, and Distributor) have an address that has `street1` and `street2`, while the corresponding addresses in PO have only one field for street. An Invoice address is transformed to a PO address using `concatString` and other transformation maps.

The `Distributor` is usually the same as the `Seller`. In these cases, you can use map variables to perform the address computation once and use it in multiple places, as shown in "Mapping Logic":

Mapping Logic

The mapping logic is as follows:

```
copyInvoiceToPO (Invoice inv -> PO po)
{
    // the map variable for the address
    Address poSupplierAddr;

    concatString(firstString=inv::Seller::./address/street1,
secondString=inv::Seller::./address/street2, resultString=variable
poSupplierAddr::./street);

    copyString(from=variable poSupplierAddr, to=po::Supplier::./address);

    if (inv::Seller::./name = inv::Distributor::./name) {
        copyString(from=variable poSupplierAddr, to=po::Supplier::./address);
    }
}
```

Event Header Rule Design

This section describes how to design advanced event header rules.

See Also: ["Event Header Rules"](#) on page 13-77

Retrieving Contact/Identifier Information after Getting the Party

Retrieve the name of the from party using the event header rule `getFromParty`. Use the retrieved value to then retrieve the contact information of the party by using the transformation rule `getPartyContactInformation`.

Mapping Logic This example retrieves the name of the from party from the event header into a map variable `FromPartyNameMapVariable` by invoking the event header rule `getFromParty`.

It then retrieves the party's Email by invoking the transformation map `getPartyContactInformation`. The global business identifier identified by the data universal numbering system (DUNS) number is also retrieved by invoking the transformation map `getPartyContactInformation`.

```
string FromPartyNameMapVariable;
    getFromParty (fromParty=FromPartyNameMapVariable);
getPartyContactInformation (partyName = FromPartyNameMapVariable,
contactInfoType = 'Email' -> contactInfo = Ad_request/HR_Contact_Email);
//Note: assuming HR_Contact_Email to be next in //sequence after HR_Contact_
Name
getPartyContactInformation (partyName = FromPartyNameMapVariable,
partyIdentificationType = 'Contact Name' -> partyIdentification = Ad_request/HR_
Contact_Name)
```

Domain Value Map Design

This section describes how to design advanced domain value maps.

See Also: ["Event Header Rules"](#) on page 13-77

Multiple Party to Single Domain Relationship

In a domain value map, multiple parties can be associated with the same domain (column). A domain value map example is provided in the hiring process tutorial described in [Chapter 7, "Tutorial of an Integration within an Enterprise"](#). Assume you have many local newspapers and many global newspapers. Specifically, The Mercury and The Chronicle are of type Local Newspaper, and The Tribune and The Herald are of type Global Newspaper. Now suppose, the HR App, the local newspapers, and the global newspapers all have different terms for an advertisement. This is shown in [Figure 14-15](#).

Figure 14-15 Domain-Party Relationship

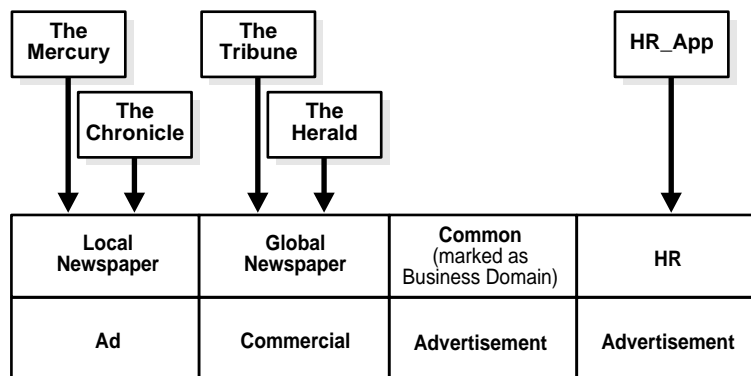

Mapping Logic To look up the common terminology given the description used by the HR App, you use the following:

```
HrAdToCommonView[EventTypeMap] (AppEventType HR_Ad -> BusEventType Common_Ad)
{
    lookupBusinessViewDomain (Party=HR_App, inValue=description ->
        outValue=description) in DVM AdTerminology;
}
```

See Also: ["Domain Value Map Rules"](#) on page 13-104

Miscellaneous Designs

This section describes the mapping scenarios where the source and target structure have different levels of nesting of datatype members with multiple occurrences.

This section contains these topics:

- [Constructs with Anonymous Members](#)
- [Choice](#)
- [Referring to the Entire Map Parameter](#)
- [Multiple Datatype Members with the Same Name](#)

Constructs with Anonymous Members

For nested choices or sequences, inner choices or sequences are modeled as anonymous members. Anonymous members cannot be mapped to any target as they are not present in the instance.

See Also: ["Creating a Complex Datatype"](#) on page 10-19 for conceptual details about the choice and sequence model groups

Constructs with Anonymous Members Example

The phone or e-mail are mapped under the choice member of the `Ad_Request` datatype. The choice member cannot be mapped to something else. In addition, any source member cannot be mapped to the target choice member.

Mapping Logic

The mapping logic is as follows:

```
copy(from=../[3]/phone -> to=../[3]/phone)
```

Figure 14–16 shows this scenario.

Figure 14–16 Constructs with Anonymous Members

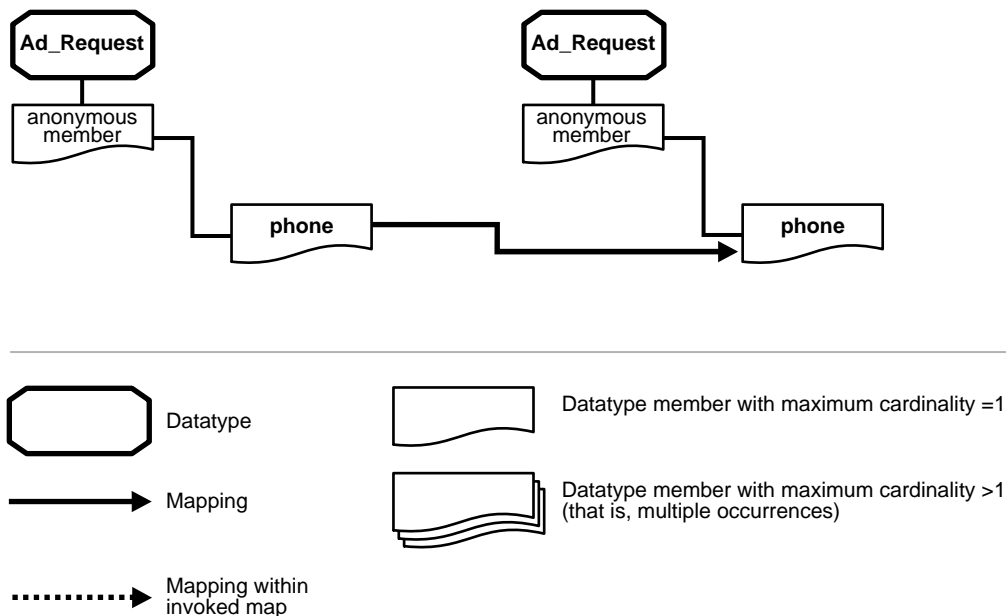

Choice

A member of a datatype with a model group of choice must be checked for existence in the instance.

Example The `street1` and `street2` datatype members are under the `ADDRESS` datatype whose model group is choice. Therefore, in the instance either `street1` or `street2` appear, but not both. Before copying `street1` or `street2` to the target, its existence can be checked in the instance.

```

if ( Exists ( street1 ) )
{
    copy( from = street1 -> to = street1);
}
else if (Exists ( street2)
{
    copy( from = street2 -> to = street2);
}

```

Referring to the Entire Map Parameter

Assume a datatype transformation map takes a complex datatype map parameter. This scenario describes a case where such a map invokes another submap with the entire complex datatype as a map parameter.

Example

When another submap is invoked with the same source or target parameter in a map, no path expression is required. Assume `street` is of multiple cardinality within the `Addr` complex datatype map parameter. You invoke a submap `copyStreet` that iterates over all the `street` members in the source and copies them to the target.

Mapping Logic

The mapping logic is as follows:

```
copyAddress(AppDatatype Addr src -> AppDatatype Address target)
{
    copyStreet(src=Addr -> target=Address);
}
```

Multiple Datatype Members with the Same Name

There can be scenarios where more than one datatype member with the same name is present under a datatype (in the instance, they are known as siblings) and different transformation rules are defined for each. Although they appear under the same parent in the instance, Oracle Application Server ProcessConnect differentiates between them and executes only the rule defined for the respective member.

Multiple Members with the Same Name Example

The `Address` datatype's model group is sequence and it has two members with the same name of `URL` separated by another mandatory member (`Name`). These two members can have different transformation rules. Transformation can correctly determine the association during runtime.

Mapping Logic

The mapping logic is as follows:

```
copyAddresses[DatatypeMap](AppDatatype Addr src -> AppDatatype Address
target)
{
  copyString(from=Address::./URL[1] -> to=Addr::./URL);
  copyString(from=Address::./URL[2] -> to=Addr::./contact/URL);
}
```

Figure 14–17 shows this scenario.

Figure 14–17 Multiple Datatype Members with the Same Name

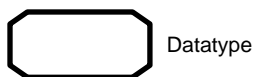
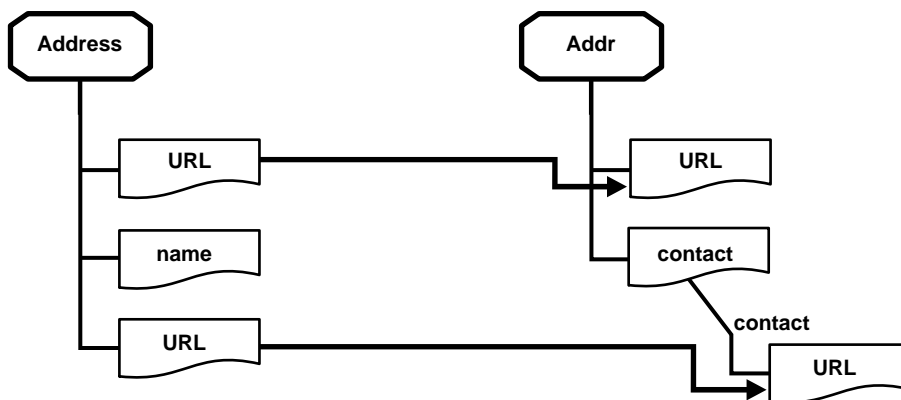

Datatype



Datatype member with maximum cardinality =1



Mapping



Datatype member with maximum cardinality >1
(that is, multiple occurrences)



Mapping within
invoked map

Chapter Summary

This chapter describes both troubleshooting and advanced topics in transformation design. Troubleshooting topics include common user errors (for example, not checking for the existence of an optional datatype member) and limitations on a transformation design (for example, only global map variables are supported). Advanced topics include how to design scenarios with iteration, nesting, and map variables (such as map variables that can preserve the results of a computation).

Part IV

Administrator Management Tasks

This part describes management tasks that a business or systems administrator of integrations performs with the Oracle Application Server ProcessConnect user interface tool.

This part contains the following chapters:

- [Chapter 15, "Managing Applications and Application Agreements"](#)
- [Chapter 16, "Creating and Deploying a Configuration"](#)
- [Chapter 17, "Administering Integrations with the User Interface Tool"](#)
- [Chapter 18, "System Management with Oracle Enterprise Manager"](#)
- [Chapter 19, "Performance Tuning"](#)
- [Chapter 20, "Oracle Application Server ProcessConnect Security"](#)
- [Chapter 21, "Oracle Application Server ProcessConnect Error Handling"](#)
- [Chapter 22, "Oracle Application Server ProcessConnect Troubleshooting"](#)

Managing Applications and Application Agreements

This chapter describes the application and application agreement tasks required to design an integration within an enterprise.

This chapter contains these topics:

- [Application and Application Agreement Overview](#)
- [Managing Applications](#)
- [Managing Adapters and Delivery Channels](#)
- [Managing Application Agreements](#)
- [Managing Native Roles in Application Agreements](#)
- [Managing Application and Agreement Validation and Approval](#)
- [Common User Errors](#)
- [Chapter Summary](#)

See Also:

- ["Exporting Profile Data to an XML File"](#) on page 5-15 for details on exporting applications and application agreements to XML files for approval through the **Export** button
- ["Viewing the State of Modeling Metadata and Profile Data on the Details Page"](#) on page 5-17 for details on the **Draft**, **Validate**, **Pending Approval**, and **Approved** states that display on application and application agreement details pages

Application and Application Agreement Overview

The Oracle Application Server ProcessConnect user interface tool enables you to perform the application and application agreement management tasks required for integrations within an enterprise. These tasks consist of creating, adding, viewing, updating, removing, and deleting profile data. [Table 15-1](#) describes the components shown in [Figure 15-1](#) and provides references for more details. You must perform these tasks to define the applications and application agreements of an integration.

Figure 15-1 Application and Application Agreement Management Tasks

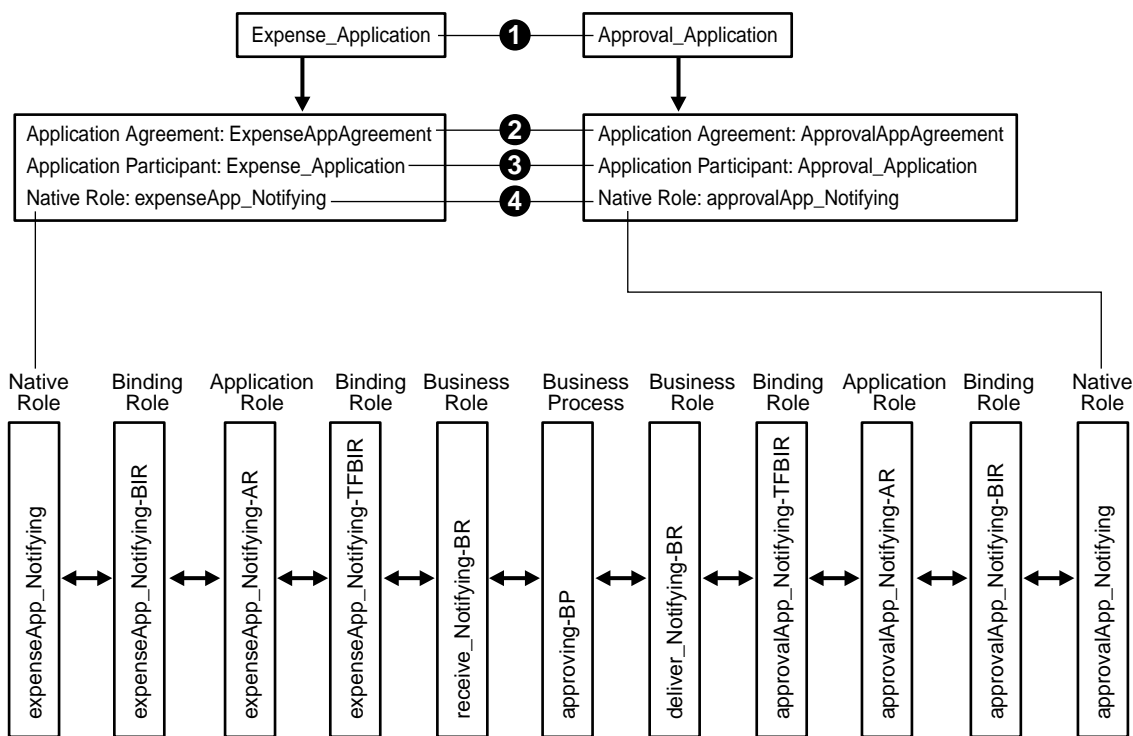

Table 15–1 Application Agreement Management Tasks (Within an Enterprise)

Key	Component	Description	See Section...
1	Applications (and adapters)	<p>You create applications to participate in an integration within an enterprise. For example, you create Expense_Application and Approval_Application.</p> <p>You also assign an adapter and create its delivery channel to use with each application. The delivery channel describes the delivery, security, and endpoint details for messages. For example, you assign the AQ adapter and its delivery channel to the Expense_Application and the FTP adapter and its delivery channel to the Approval_Application.</p>	<p>"Managing Applications" on page 15-4</p> <p>"Managing Adapters and Delivery Channels" on page 15-9</p>
2	Application agreement	You create an application agreement for each application. For example, you create ExpenseAppAgreement and ApprovalAppAgreement.	"Managing Application Agreements" on page 15-29
3	Application agreement participant	When you create an application agreement, you assign one application to each application agreement as a participant. For example, you assign Expense_Application to ExpenseAppAgreement and Approval_Application to ApprovalAppAgreement.	"Managing Application Agreements" on page 15-29
4	Application agreement native role	<p>You assign one native role to each application agreement.</p> <p>For example, you assign native role expenseApp_Notifying to ExpenseAppAgreement and native role approvalApp_Notifying to ApprovalAppAgreement. This links your modeling metadata (roles, business processes, transformations, event types, datatypes, interactions, and condition expressions) with your profile data (applications, application agreements, adapters, and delivery channels).</p>	"Managing Native Roles in Application Agreements" on page 15-41

After you create your applications and application agreements, you validate and officially approve them before including them in a deployed configuration.

See Also:

- ["Applications and Adapters"](#) on page 3-51 for conceptual details
- ["Agreements"](#) on page 3-57 for conceptual details

Managing Applications

The Oracle Application Server ProcessConnect user interface tool enables you to perform the application management tasks shown in [Figure 15–2](#). These tasks are described in detail in this section.

Figure 15–2 Application Management Tasks

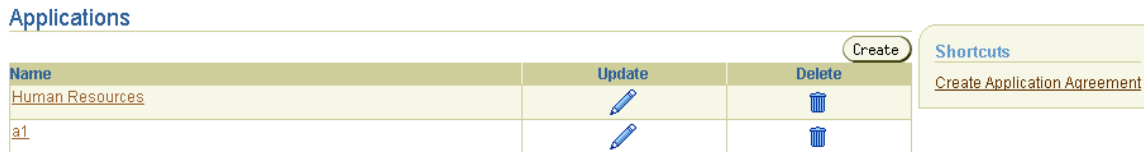

[Table 15–2](#) identifies the application management tasks shown in [Figure 15–2](#) and provides references to procedures for performing these tasks.

Table 15–2 Application Management Tasks

Applications Page Elements	Management Task	First See Section...	Then See Section...
Shortcuts sections in Figure 15–2	Take shortcuts to create an application agreement	"Accessing Application Agreement Management Tasks" on page 15-31	"Creating an Application Agreement" on page 15-32
Create button in Figure 15–2	Create an application		"Creating an Application" on page 15-5
Delete column in Figure 15–2	Delete an application		"Deleting an Application" on page 15-6
Update column in Figure 15–2	Update an application		"Updating an Application" on page 15-6
Name column in Figure 15–2	View details about an application		"Viewing an Application" on page 15-7

Accessing Application Management Tasks

Follow these instructions to access the application management tasks shown in [Figure 15-2](#) on page 15-4:

To access application management tasks:

1. Select the **Profiles** tab.
2. Select the **Applications** tab.
The Applications page appears.
3. Select a task to perform and see the referenced section for instructions:

To...	Then...	See Section...
Create an application	Click Create .	"Creating an Application" on page 15-5
Delete an application	Select a specific application in the Delete column.	"Deleting an Application" on page 15-6
Update an application	Select a specific application in the Update column.	"Updating an Application" on page 15-6
View details about an application	Select a specific application name in the Name column.	"Viewing an Application" on page 15-7

Creating an Application

Follow these instructions to create an application:

To create an application:

1. Ensure that you followed the instructions in ["Accessing Application Management Tasks"](#) on page 15-5 to access the page for creating an application.
The Create Application page appears.

2. Enter the following details to create an application. An asterisk (*) indicates a required field.

Field	Description
Name *	Enter a unique and recognizable application name (for example, Human Resources).
Description	Enter an application description.
Application Type	Select the application type. The application type is a folder in which to place the application. This field is required if you want to include an application in a deployed configuration. Several application types are included with Oracle Application Server ProcessConnect. You can also create application types that display in this list. See Also: "Creating an Application Type" on page 17-37

3. Click **Apply**.

The application is created and the Application Details page for the new application appears.

Deleting an Application

Follow these instructions to delete an application:

To delete an application:

1. Ensure that you followed the instructions in ["Accessing Application Management Tasks"](#) on page 15-5 to access the page for deleting an application.
2. Select **Yes** when prompted to delete an application.

The application is deleted and the Applications page appears.

Updating an Application

Follow these instructions to update an application:

To update an application:

1. Ensure that you followed the instructions in ["Accessing Application Management Tasks"](#) on page 15-5 to access the page for updating an application.

The Update Application page appears.

2. Make appropriate changes. (See Step 2 of "[Creating an Application](#)" on page 15-6 for a list of fields you can update.)
3. Click **Apply**.

The application is updated and the Application Details page for the updated application appears.

Viewing an Application

Follow these instructions to view details about a specific application:

To view an application:

1. Ensure that you followed the instructions in "[Accessing Application Management Tasks](#)" on page 15-5 to access the page for viewing an application.

The Application Details page for the selected application appears.

Application Details : Human Resources

Validate Export Delete Update

Details



Description
 Application Type **HTTP**
 State **Draft**

Adapter Types [Return to Top](#)

Name	Adapter Provider	Remove
HTTP Adapter	Oracle	



[Add](#)

Approvers [Return to Top](#)

Person	Send For Approval Date	Approval Date	Update	Delete
jq	5/7/03			

[Add](#)

Associated Agreements [Return to Top](#)

Name	Update	Delete
Expense Agreement		

2. View specific details, including the following:
 - Adapter type (for example, HTTP) associated with this application
 - Persons assigned to approve the profile data of this application
 - Agreements with which this application is associated

The state is **Draft** for this agreement (See the **Details** section). Depending on the current state of an agreement, different buttons can also display. If the state is **Pending Approval**, the **Validate** button is replaced with the **Send for Approval** button. If the state is **Approved**, no button displays.

This page, as with the Applications page shown in [Figure 15-2](#) on page 15-4, enables you to delete or update the selected application.

3. Click **Return to List** to return to the Applications page.

See Also: The following sections for instructions on performing the following tasks:

- ["Exporting Profile Data to an XML File"](#) on page 5-15 for details on exporting applications to XML files for approval through the **Export** button
- ["Viewing the State of Modeling Metadata and Profile Data on the Details Page"](#) on page 5-17 for details on the various states that display in details pages such as the Application Details page and how to assign an approver to an application
- ["Managing Organizations"](#) on page 25-11 to create a user that you assign as an approver of an application and a method by which to contact this user when their approval is required

Managing Adapters and Delivery Channels

The Oracle Application Server ProcessConnect user interface tool enables you to perform the adapter and delivery channel management tasks shown in [Figure 15-3](#). Adapters enable communication between parties with their different interfaces and Oracle Application Server ProcessConnect. Delivery channels describe delivery, security, and endpoint details for messages delivered between parties. These tasks are described in detail in this section.

Figure 15-3 Adapter and Delivery Channel Management Tasks

Application Details : Human Resources Validate Export Delete Update

Details
Description
Application Type **HTTP**
State **Draft**

Adapter Types Return to Top Add

Name	Adapter Provider	Remove
HTTP Adapter	Oracle	

Approvers Return to Top Add

Person	Send For Approval Date	Approval Date	Update	Delete
ip	5/7/03			

Associated Agreements Return to Top Add

Name	Update	Delete
Expense Agreement		

Adapter Type Details : HTTP Adapter Remove

Details
Adapter Provider **Oracle**

Delivery Channels Return to Top Create

Name	Update	Delete
DC1		

Table 15-3 identifies the adapter and delivery channel management tasks shown in Figure 15-3 and provides references to procedures for performing these tasks.

Table 15-3 Adapter and Delivery Channel Management Tasks

Page Elements	Management Task	First See Section...	Then See Section...
Add button in Adapter Types section of the Application Details page of Figure 15-3	Add an adapter to an application	"Accessing Adapter and Delivery Channel Management Tasks" on page 15-10	"Adding an Adapter to an Application" on page 15-12
Remove column in Adapter Types section of the Application Details page of Figure 15-3	Remove an adapter from an application		"Removing an Adapter from an Application" on page 15-13
Name column in Adapter Types section of the Application Details page of Figure 15-3 (To access the details page shown in the lower page of Figure 15-3)	View details about an adapter		"Viewing an Adapter" on page 15-13
Create button in Delivery Channels section of the Adapter Type Details page of Figure 15-3	Create an application delivery channel		"Creating an Application Delivery Channel" on page 15-14
Delete column in Delivery Channels section of the Adapter Type Details page of Figure 15-3	Delete an application delivery channel		"Deleting an Application Delivery Channel" on page 15-26
Update column in Delivery Channels section of the Adapter Type Details page of Figure 15-3	Update an application delivery channel		"Updating an Application Delivery Channel" on page 15-26
Name column in Delivery Channels section of the Adapter Type Details page of Figure 15-3	View details about an application delivery channel		"Viewing an Application Delivery Channel" on page 15-27

Accessing Adapter and Delivery Channel Management Tasks

Follow these instructions to access the adapter and delivery channel management tasks shown in Figure 15-3 on page 15-9:

To access adapter management tasks:

1. Select the **Profiles** tab.
2. Select the **Applications** tab.

The Applications page appears.

3. Select a specific application in the **Name** column.

The Application Details page for the specific application appears.

4. Go to the **Adapter Types** section. (See the upper page of [Figure 15-3](#) on page 15-9.)
5. Select a task to perform and see the referenced section for instructions:

To...	Then...	See Section...
Add an adapter to an application	Click Add .	"Adding an Adapter to an Application" on page 15-12
Remove an adapter from an application	Select a specific adapter in the Remove column.	"Removing an Adapter from an Application" on page 15-13
View details about an adapter	Select a specific adapter name in the Name column.	"Viewing an Adapter" on page 15-13
Create an application delivery channel	Select the specific adapter name in the Name column for which to create a delivery channel.	"Creating an Application Delivery Channel" on page 15-14
Delete an application delivery channel	Select the specific adapter name in the Name column that includes the delivery channel to delete.	"Deleting an Application Delivery Channel" on page 15-26
Update an application delivery channel	Select the specific adapter name in the Name column that includes the delivery channel to update.	"Updating an Application Delivery Channel" on page 15-26
View details about an application delivery channel	Select the specific adapter name in the Name column that includes the delivery channel to view.	"Viewing an Application Delivery Channel" on page 15-27

Adding an Adapter to an Application

Follow these instructions to add an adapter to an application:

To add an adapter to an application:

1. Ensure that you followed the instructions in "[Accessing Adapter and Delivery Channel Management Tasks](#)" on page 15-10 to access the page for adding an adapter to an application.

The Add Adapter Type page appears.

2. Select the type of adapter to use with this application from the **Type** list:

- Advanced Queuing (AQ) adapter
- E-Mail adapter
- File/FTP adapter
- HTTP adapter
- Java Message Service (JMS) adapter
- Oracle Database (DB) adapter
- Web Service adapter

Depending on what you installed, additional application adapters may appear in this list:

- PeopleSoft 8 adapter
- SAP R/3 adapter
- Siebel 2000 adapter
- J.D. Edwards OneWorld XE adapter
- VSAM adapter
- CICS adapter
- IMS/TM adapter
- IMS/DB adapter
- Tuxedo adapter
- Adapters not included with Oracle Application Server ProcessConnect, but available from other partners.

3. Click **Apply.**

The adapter is added to the application and the Adapter Type Details page for the added adapter appears.

You can add additional adapters to the application. During runtime, however, only one adapter and its delivery channel (which defines the delivery, security, and endpoint details of the adapter) can be used with an application in an agreement.

See Also: The following Web site for additional details about JMS:

<http://java.sun.com/products/jms/>

Removing an Adapter from an Application

Follow these instructions to remove an adapter from an application:

To remove an adapter from an application:

1. Ensure that you followed the instructions in "[Accessing Adapter and Delivery Channel Management Tasks](#)" on page 15-10 to access the page for removing an adapter from an application.
2. Select **Yes** when prompted to remove the selected adapter.

The adapter is removed and the Application Details page for the selected application appears.

Viewing an Adapter

Follow these instructions to view details about a specific adapter:

To view an adapter:

1. Ensure that you followed the instructions in "[Accessing Adapter and Delivery Channel Management Tasks](#)" on page 15-10 to access the page for viewing an adapter.

The Adapter Type Details page for the selected adapter appears.

Adapter Type Details : HTTP Adapter

Remove

Details
Adapter Provider **Oracle**

Delivery Channels Return to Top

Create

Name	Update	Delete
DC1		

2. View specific details, including the delivery channel for this adapter.
This page, as with the Application Details page shown in the upper page of [Figure 15-3](#) on page 15-9, enables you to remove the selected adapter.
3. Click **Return to List** to return to the Application Details page for the selected application.

Creating an Application Delivery Channel

Follow these instructions to create an application delivery channel for an adapter:

Note: The application delivery channels that you create in this section appear as selections when you add an application delivery channel to an agreement in "[Adding an Application Delivery Channel to an Application Agreement](#)" on page 15-37.

To create an application delivery channel:

1. Ensure that you followed the instructions in "[Accessing Adapter and Delivery Channel Management Tasks](#)" on page 15-10 to access the page for creating an application delivery channel.
The Adapter Type Details page for the selected adapter appears.
2. Go to the **Delivery Channels** section. (See the lower page of [Figure 15-3](#) on page 15-9.)
3. Click **Create**.

See the following section or document (for application adapters) based on the selected adapter type:

For Adapter Type...	See Section...
AQ adapter	"Creating an Advanced Queuing Adapter Delivery Channel" on page 15-16
E-Mail adapter	"Creating an E-Mail adapter Delivery Channel" on page 15-17
File/FTP adapter	"Creating a File/FTP Adapter Delivery Channel" on page 15-18
HTTP adapter	"Creating an HTTP Adapter Delivery Channel" on page 15-20
JMS adapter	"Creating a JMS Adapter Delivery Channel" on page 15-22
Oracle DB adapter (also known as Oracle Database adapter)	"Creating an Oracle Database Delivery Channel" on page 15-24
Web Service adapter	"Creating a Web Service Delivery Channel" on page 15-25
PeopleSoft 8 adapter	<i>Oracle Application Server Integration Adapter for PeopleSoft 8 User's Guide</i>
SAP R/3 adapter	<i>Oracle Application Server Integration Adapter for SAP R/3 User's Guide</i>
Siebel 2000 adapter	<i>Oracle Application Server Integration Adapter for Siebel 2000 User's Guide</i>
J.D. Edwards OneWorld XE adapter	<i>Oracle Application Server Integration Adapter for J.D. Edwards OneWorld XE User's Guide</i>
VSAM adapter	<i>Oracle Application Server Integration Adapter for VSAM Installation and User's Guide</i>
CICS adapter	<i>Oracle Application Server Integration Adapter for CICS Installation and User's Guide</i>
IMS/TM adapter	<i>Oracle Application Server Integration Adapter for IMS/TM Installation and User's Guide</i>
IMS/DB adapter	<i>Oracle Application Server Integration Adapter for IMS/DB Installation and User's Guide</i>
Tuxedo adapter	<i>Oracle Application Server Integration Adapter for Tuxedo Installation and User's Guide</i>

Note: When creating a delivery channel, do not use environmental variables when specifying parameters (for example, \$ORACLE_HOME).

Creating an Advanced Queuing Adapter Delivery Channel

The Create Delivery Channel page appears.

1. Enter the following details to create a delivery channel. The database for which you define connection details on this page is the application (spoke) database of your application. An asterisk (*) indicates a required field.

Field	Description	Example
Name *	Enter a unique and recognizable delivery channel name.	ExpenseApp Queue DC
JDBC driver to use to connect to database (Thin/OCI)	Select the JDBC driver to use for database connections.	Thin (default value) or OCI
Database SID (if Thin) or TNS alias (if OCI)	Select the database system identifier (SID) or enter a Transparent Network Substrate (TNS) alias, also known as the net service name.	ORCL (default SID value)
Database hostname (if Thin)	Enter the name of the host on which the database is installed.	myhost.us.oracle.com
Database TNS Listener port (if thin)	Enter the database listener port.	1521
Number of milliseconds between connection retries	Accept the default selection or enter a different value.	15000 (default value)
Username for connecting to the spoke database	Enter the database username.	dbapp
Password for connecting to the spoke database	Enter the password for the database username.	dbapp
Name of database schema where queues are located	Enter the schema name where the queues are created.	pc_queue_schema

2. Click **Apply**.

The delivery channel is created and the Delivery Channel Details page for the created delivery channel appears.

Creating an E-Mail adapter Delivery Channel

The Create Delivery Channel page appears.

1. Enter the following details to create a delivery channel. An asterisk (*) indicates a required field. If you define both inbound and outbound interactions for the E-Mail adapter, you must also define inbound and outbound delivery channel parameters. If you only define interactions in one direction, such as inbound, you only define inbound delivery channel parameters. The inbound or outbound direction of a delivery channel parameter is identified in the following table.

Field	Description	Example
Name *	Enter a unique and recognizable delivery channel name.	Initiating SMTP DC
SMTP server hostname (outbound)	Enter the hostname of the SMTP server to which Oracle Application Server ProcessConnect sends outbound messages.	smtp.acme.com
IMAP server hostname (inbound)	Enter the hostname of the IMAP server from which Oracle Application Server ProcessConnect receives inbound messages.	imap.acme.com
Polling interval in milliseconds (inbound)	Enter the time interval in milliseconds during which Oracle Application Server ProcessConnect polls the IMAP server for inbound messages.	60000 (default value)

Field	Description	Example
E-mail address	<p>Enter an e-mail address based on the direction of the interaction.</p> <p>For the outbound direction, enter the e-mail address of the recipient of messages sent by Oracle Application Server ProcessConnect.</p> <p>For the inbound direction, the address you enter helps filter incoming e-mails. For example, if you only accept e-mail from joe at foo, set this to joe@foo.com. When an e-mail is received, its from header or reply-To header is compared to this e-mail address.</p>	<code>your_app@foo.com</code>
Reply-To: e-mail address (outbound)	Enter the e-mail address to which an external (outbound) party replies when sending inbound messages to the IMAP server.	<code>imap_server@foo.com</code>
Inbox name (inbound)	Enter the IMAP Inbox name into which inbound e-mail messages are placed.	INBOX (default value)
IMAP server username	Enter the username for the IMAP server from which Oracle Application Server ProcessConnect receives messages.	<code>imap_username</code>
IMAP server password	Enter the IMAP password.	<code>imap_password</code>

2. Click **Apply**.

The delivery channel is created and the Delivery Channel Details page for the created delivery channel appears.

Creating a File/FTP Adapter Delivery Channel

The Create Delivery Channel page appears.

1. Enter the following details to create a delivery channel. Fields that only apply to the FTP part of the File/FTP adapter are identified. Fields that are not identified as FTP-only apply to both parts. An asterisk (*) indicates a required field.

Field	Description	Example
Name *	Enter a unique and recognizable delivery channel name.	Initiating FTP DC
File or FTP mode	Select the mode you want to use (either File or FTP).	FTP
FTP server hostname (FTP mode only)	Enter the hostname of the FTP server from which Oracle Application Server ProcessConnect receives messages.	ftphost.us.oracle.com
FTP server port (FTP mode only)	Enter the port on the FTP server.	21 (default value)
Polling interval in milliseconds (inbound)	Enter the time interval in milliseconds during which Oracle Application Server ProcessConnect polls the FTP server for inbound messages. Enter a value greater than zero.	60000 (default value)
FTP server username (FTP mode only)	Enter the username for the FTP server.	ftphost_user
FTP server password (FTP mode only)	Enter the password of the FTP server username.	ftphost_password
Base directory	<p>Enter the absolute directory path where messages are sent or received. For FTP mode of the File/FTP adapter, this is a directory on the FTP server. For File mode of the File/FTP adapter, this is a directory accessible from the local host.</p> <p>Notes: Do not use the \$ORACLE_HOME variable when specifying a base directory.</p>	<p>/Oracle/Ora_904/ip/human_resources</p> <p>This directory path is related to the relative path you specify for an incoming files directory in "Adding a File/FTP Adapter Interaction" on page 11-14. That directory can be under human_resources.</p>

2. Click **Apply**.

The delivery channel is created and the Delivery Channel Details page for the created delivery channel appears.

Creating an HTTP Adapter Delivery Channel

The Create Delivery Channel page appears.

1. Enter the following details to create a delivery channel. An asterisk (*) indicates a required field. If you define both inbound and outbound interactions for the HTTP adapter, you must also define inbound and outbound delivery channel parameters. If you only define interactions in one direction, such as inbound, you only define inbound delivery channel parameters. The inbound or outbound direction of a delivery channel parameter is identified in the following table.

Field	Description	Example
Name *	Enter a unique and recognizable delivery channel name.	Initiating HTTP DC
Root URL (outbound) - for example, http://www.oracle.com	Enter the URL of the outgoing HTTP server to which to send messages.	http://www.outboundmessages.com
Proxy server hostname (outbound)	Enter the hostname of the proxy server.	httpost.us.oracle.com
Proxy server port (outbound)	Enter the port number of the proxy server.	80 (default value)
Proxy server username (outbound)	Enter the proxy server username.	httpproxy_user
Proxy server password (outbound)	Enter the password of the proxy server username.	httpproxy_password
RMI instance name (inbound)	Enter the remote method invocation (RMI) instance name. This must match the name of the host on which the HTTP adapter is installed. The HTTP adapter serves as the RMI server.	iphttp (default value)
RMI port (inbound)	Enter the RMI registry port for communicating with the servlet. This port number must match with the setting in the web.xml file.	1100 (default value)

Field	Description	Example
Remote username for filtering (inbound)	Enter the username and the realm of the security realm.	joe@foo where joe is the username and foo is the realm of which joe is a member.
Authentication type (outbound)	Select the authentication type to use for outbound messages.	BASIC (default value) or DIGEST
Authentication username (outbound)	Enter the authentication type username to use for outbound messages.	authetype_user
Authentication password (outbound)	Enter the password of the authentication type username	authetype_password
Authentication security realm (outbound)	Enter the authentication security realm to use for outbound messages.	ipt
Oracle Wallet location (outbound)	Enter the directory path and name of the wallet file. Specify the location if you are using secure HTTP.	/private/username/certificate.txt
Oracle Wallet password (outbound)	Enter the Oracle Wallet Manager password. Specify the password if you specified an Oracle Wallet location.	mywallet_password
SSL handshake cipher suite (outbound)	Enter the cipher suite used in the secure connection.	SSL_RSA_WITH_RC4_128_SHA

2. Click **Apply**.

The delivery channel is created and the Delivery Channel Details page for the created delivery channel appears.

Creating a JMS Adapter Delivery Channel

1. Enter the following details to create a delivery channel. An asterisk (*) indicates a required field.

Field	Description	Example
Name *	Enter a unique and recognizable delivery channel name.	ExpenseApp JMS Destination DC
JNDI location or Java class name for JMS connection factory	Enter the JNDI location or Java class name for the JMS connection factory.	java:comp/resource/JMS_e2e/QueueConnectionFactory
JMS vendor specific properties to pass to connection factory	<p>Enter the JMS vendor-specific properties to pass to the connection factory.</p> <p>When the JNDI location or Java class name for JMS connection factory property is assigned a Java class name (connection factory implementation class), this property enables the invocation of vendor-specific setter methods on the specified connection factory implementation class. The property contains zero or more name and value pairs separated by a semicolon. Each name must match a setter method (without the prefix <code>setXX</code>), and the value becomes the argument to the <code>setXX</code> method.</p>	<p>The property value <code>Host=myhost.com;Port=1414</code> causes the JMS adapter to invoke the following two setter methods:</p> <ul style="list-style-type: none"> ■ <code>vendorQueueConnectionFactory.setHost("myhost.com");</code> ■ <code>vendorQueueConnectionFactory.setPort(1414);</code> <p>Note: The JMS adapter determines the argument type at runtime.</p>
Default username for creating JMS connections	Enter the username for creating JMS connections.	jms_username
Default password for creating JMS connections	Enter the password for the username.	jms_password
Is this a JMS topic connection factory	Select whether or not this is a JMS topic connection factory.	Yes or No
JNDI location of or Java class name for the JMS destination	Enter the JNDI location of or Java class name for the JMS destination.	java:comp/resource/JMS_e2e/Queues/\${DestinationName}

Field	Description	Example
JMS vendor specific properties used to instantiate the JMS destination	<p>Enter the JMS vendor-specific properties to instantiate the JMS destination.</p> <p>When the JNDI location of or Java class name for the JMS destination property is assigned a Java class name (queue or topic implementation class), this property enables the invocation of vendor-specific setter methods on the specified destination (queue and topic) implementation class. The property contains zero or more name and value pairs separated by a semicolon. Each name must match a setter method (without the prefix <code>setXX</code>) and the value becomes the argument to the <code>setXX</code> method. (See the example for the JMS vendor-specific properties to pass to connection factory property.)</p>	<p>When the JNDI location of or Java class name for the JMS destination property is assigned a vendor-specific destination URI (for example, <code>queue:///\${DestinationName}</code>), this property is appended to the former, and the destination (queue or topic) is created through the JMS API <code>javax.jms.Session.createQueue()</code> or <code>javax.jms.Session.createTopic()</code>. For example, if the following three are set:</p> <ul style="list-style-type: none"> ■ JNDI location of or Java class name for the JMS destination property is: <code>queue:///\${DestinationName}</code> ■ The JMS vendor-specific properties used to instantiate the JMS destination property is: <code>?targetClient=1</code> ■ The DestinationName is: <code>SEND.QUEUE</code> <p>Then the following destination is created:</p> <pre>queueSession.createQueue ("queue:///SEND.QUEUE?targetClient=1");</pre> <p>Note: The <code>\${DestinationName}</code> substring in bullet one is replaced by the <code>DestinationName</code> value in bullet three that you provided while creating a JMS interaction.</p>
JMS username	Enter the JMS username.	<code>jms_user</code>
JMS password	Enter the password for the JMS username.	<code>jms_user</code>
JMS Acknowledge Mode	Select the JMS acknowledge mode to use.	AUTO_ACKNOWLEDGE (default value), CLIENT_ACKNOWLEDGE , or DUPS_OK_ACKNOWLEDGE

See Also: The following Web site for additional details about JMS:

<http://java.sun.com/products/jms/>

2. Click **Apply**.

The delivery channel is created and the Delivery Channel Details page for the created delivery channel appears.

Creating an Oracle Database Delivery Channel

1. Enter the following details to create a delivery channel. The database for which you define connection details on this page is the application (spoke) database of your application. An asterisk (*) indicates a required field.

Field	Description	Example
Name *	Enter a unique and recognizable delivery channel name.	EmpReadDB DC
Database hostname (if Thin)	Enter the hostname of the database (required for thin JDBC driver only).	myhost.us.oracle.com
Database TNS listener port (if Thin)	Enter the TNS listener port for the database (required for thin JDBC driver only).	1521
Database SID (if Thin) or TNS alias (if OCI)	Select the database system identifier (SID) or enter a Transparent Network Substrate (TNS) alias, also known as a net service name.	ORCL (default value)
JDBC driver to use to connect to the database (Thin/OCI)	Select the JDBC driver to use for database connections.	Thin (default value) or OCI
Number of milliseconds between connection retries	Enter the number of milliseconds to wait before retrying the connection if the database goes down.	15000
Username for connecting to the spoke database	Enter the database username with which to connect.	dbapp
Password for connecting to the spoke database	Enter the password for the database username.	dbapp
Name of schema where database objects are located	Enter the database schema owning the database objects for this delivery channel.	db_schema

2. Click **Apply**.

The delivery channel is created and the Delivery Channel Details page for the created delivery channel appears.

Creating a Web Service Delivery Channel

1. Enter the following details to create a delivery channel. An asterisk (*) indicates a required field.

Field	Description	Example
Name *	Enter a unique and recognizable delivery channel name.	Inbound WebService DC
Proxy server¹ hostname	Enter the hostname of the proxy server.	httphost.us.ora cle.com
Proxy server port¹	Enter the port number of the proxy server.	80 (default value)
Proxy server username¹	Enter the proxy server username.	httpproxy_user
Proxy server password¹	Enter the password of the proxy server username.	httpproxy_ password
Web Service port name or URL	Enter a Web service port name or a URL beginning with http:// or https://. Note: Even though this field is not identified as required, you still need to enter a port name or URL.	http://foo-sun. us.oracle.com:8 888/ip-test_ server-context- root/Hotel?WSDL
Authentication username¹	Enter the authentication type username to use for outbound messages.	authntype_user
Authentication password¹	Enter the password of the authentication type username.	authntype_ password
Authentication security realm¹	Enter the authentication security realm to use for outbound messages.	ipt
Oracle Wallet Location¹	Enter the directory path and name of the wallet file. Specify the location if you are using secure HTTP.	private/username/ certificate.t xt

Field	Description	Example
Oracle Wallet password¹	Enter the Oracle Wallet Manager password. Specify the password if you specified an Oracle Wallet location.	mywallet_ password

¹ This is the same parameter as with the HTTP adapter in "[Creating an HTTP Adapter Delivery Channel](#)" on page 15-20.

2. Click **Apply**.

The delivery channel is created and the Delivery Channel Details page for the created delivery channel appears.

Deleting an Application Delivery Channel

Follow these instructions to delete an application delivery channel:

To delete an application delivery channel:

1. Ensure that you followed the instructions in "[Accessing Adapter and Delivery Channel Management Tasks](#)" on page 15-10 to access the page for deleting an application delivery channel.

The Adapter Type Details page for the selected adapter type appears.

2. Go to the **Delivery Channels** section. (See the lower page of [Figure 15-3](#) on page 15-9.)
3. Select the application delivery channel to delete in the **Delete** column.
4. Select **Yes** when prompted to delete the application delivery channel.

The application delivery channel is deleted and the Adapter Type Details page for the selected adapter type appears.

Updating an Application Delivery Channel

Follow these instructions to update an application delivery channel:

To update an application delivery channel:

1. Ensure that you followed the instructions in "[Accessing Adapter and Delivery Channel Management Tasks](#)" on page 15-10 to access the page for updating an application delivery channel.

The Adapter Type Details page for the selected adapter type appears.

2. Go to the **Delivery Channels** section. (See the lower page of [Figure 15-3](#) on page 15-9.)
3. Select the application delivery channel to update in the **Update** column.
The Update Delivery Channel page appears.
4. Make appropriate changes. The following sections describe the fields you can update for each adapter.

For Adapter Type...	See Section...
Advanced Queuing adapter	"Creating an Advanced Queuing Adapter Delivery Channel" on page 15-16
E-Mail adapter	"Creating an E-Mail adapter Delivery Channel" on page 15-17
File/FTP adapter	"Creating a File/FTP Adapter Delivery Channel" on page 15-18
HTTP adapter	"Creating an HTTP Adapter Delivery Channel" on page 15-20
JMS adapter	"Creating a JMS Adapter Delivery Channel" on page 15-22
Oracle Database adapter	"Creating an Oracle Database Delivery Channel" on page 15-24
Web Service adapter	"Creating a Web Service Delivery Channel" on page 15-25

5. Click **Apply**.
The application delivery channel is updated and the Delivery Channel Details page for the updated delivery channel appears.

Viewing an Application Delivery Channel

Follow these instructions to view details about a specific application delivery channel:

To view an application delivery channel:

1. Ensure that you followed the instructions in ["Accessing Adapter and Delivery Channel Management Tasks"](#) on page 15-10 to access the page for viewing an application delivery channel.

The Adapter Type Details page for the selected adapter appears.

2. Go to the **Delivery Channels** section. (See the lower page of [Figure 15-3](#) on page 15-9.)
3. Select the application delivery channel to view in the **Name** column.

The Delivery Channel Details page for the selected delivery channel appears (in this example, for the HTTP adapter):

Delivery Channel Details : DC1

[Delete](#) [Update](#)

Details

Root URL for the outbound messages	http://www.outboundmessages.com
Proxy host name	httphost.us.oracle.com
Proxy port number	80
Proxy user	httpproxy_user
Proxy password	<hidden>
RMI instance name	iphhttp
RMI port	1100
Remote user name for filtering incoming message	joe@foo
Authentication type (for outbound messages)	BASIC
User name used in authentication (for outbound messages)	authentype_user
User password used in authentication (for outbound messages)	<hidden>
Security realm used in authentication (for outbound messages)	ipt
Oracle Wallet location (for outbound messages)	/private/joe/certificate.txt
Oracle Wallet password (for outbound messages)	<hidden>
Cipher suite used in SSL handshaking (for outbound messages)	

4. View specific details about delivery, security, and endpoint settings for the delivery channel.

This page, as with the Adapter Type Details page shown in the lower page of [Figure 15-3](#) on page 15-9, enables you to delete and update the selected application delivery channel.

5. Click **Return to List** to return to the Adapter Type Details page for the selected adapter.

Managing Application Agreements

The Oracle Application Server ProcessConnect user interface tool enables you to perform the application agreement management tasks shown in [Figure 15-4](#). These tasks are described in detail in this section.

Figure 15-4 Application Agreement Management Tasks

Application Agreements

Name	State	Update	Delete
Expense Agreement	Draft		

[Create](#) [Shortcut](#)
[Create Application](#)

Agreement Details: Expense_Agreement

[Validate](#) [Export](#) [Delete](#) [Update](#)

Details

Agreement Id **1**
 Description
 Effective From Date
 Effective To Date
 State **Draft**

Application Participants [Return to Top](#)

Application Participant [Human Resources](#)

Native Roles [Return to Top](#)

Name	Remove
SR_NativeRole	

[Add](#)

Approvers [Return to Top](#)

Person	Send For Approval Date	Approval Date	Update	Delete
iq	5/8/03	5/22/03		

[Add](#)

Application Participant Details: Human Resources

Details

Application **Human Resources**

Delivery Channels Used [Return to Top](#)

Name	Update	Remove
DC1		

[Add](#)

Table 15-4 identifies the application agreement management tasks shown in Figure 15-4 and provides references to procedures for performing these tasks.

Table 15-4 Application Agreement Management Tasks

Page Elements	Management Task	First See Section...	Then See Section...
Shortcuts section of Application Agreements page of Figure 15-4	Take a shortcut to create an application	"Accessing Application Management Tasks" on page 15-5	"Creating an Application" on page 15-5
Create button of Application Agreements page of Figure 15-4	Create an application agreement	"Accessing Application Agreement Management Tasks" on page 15-31	"Creating an Application Agreement" on page 15-32
Delete column of Application Agreements page of Figure 15-4	Delete an application agreement		"Deleting an Application Agreement" on page 15-33
Update column of Application Agreements page of Figure 15-4	Update an application agreement		"Updating an Application Agreement" on page 15-34
Name column of Application Agreements page of Figure 15-4 (To access the Agreement Details page shown in the middle page of Figure 15-4)	View details about an application agreement		"Viewing an Application Agreement" on page 15-34
Application Participants section of Agreement Details page of Figure 15-4 (To access the Application Participant Details page shown in the lower page of Figure 15-4)	View details about an application agreement participant		"Viewing an Application Agreement Participant" on page 15-36
Add button of Agreement Participant Details page of Figure 15-4	Add an application delivery channel to an application agreement		"Adding an Application Delivery Channel to an Application Agreement" on page 15-37

Table 15–4 (Cont.) Application Agreement Management Tasks

Page Elements	Management Task	First See Section...	Then See Section...
Remove column of Agreement Participant Details page of Figure 15–4	Remove an application delivery channel from an application agreement	"Accessing Application Agreement Management Tasks" on page 15-31	"Removing an Application Delivery Channel from an Application Agreement" on page 15-38
Update column of Agreement Participant Details page of Figure 15–4	Update an application delivery channel in an application agreement		"Updating an Application Delivery Channel in an Application Agreement" on page 15-38
Name column of Agreement Participant Details page of Figure 15–4	View details about an application delivery channel in an application agreement		"Viewing an Application Delivery Channel in an Application Agreement" on page 15-39

Accessing Application Agreement Management Tasks

Follow these instructions to access the application agreement management tasks shown in [Figure 15–4](#) on page 15-29:

To access application agreement management tasks:

1. Select the **Profiles** tab.
2. Select the **Agreements** tab.
The Application Agreements page appears.
3. Select a task to perform and see the referenced section for instructions:

To...	Then...	See Section...
Create an application agreement	Click Create .	"Creating an Application Agreement" on page 15-32
Delete an application agreement	Select a specific application agreement in the Delete column.	"Deleting an Application Agreement" on page 15-33
Update an application agreement	Select a specific application agreement in the Update column.	"Updating an Application Agreement" on page 15-34

To...	Then...	See Section...
View details about an application agreement	Select a specific application agreement in the Name column.	"Viewing an Application Agreement" on page 15-34
View details about an application agreement participant	Select a specific application agreement in the Name column for which to view an agreement participant.	"Viewing an Application Agreement Participant" on page 15-36
Add an application delivery channel to an application agreement	Select a specific application agreement in the Name column to which to add an application delivery channel.	"Adding an Application Delivery Channel to an Application Agreement" on page 15-37
Remove an application delivery channel from an application agreement	Select a specific application agreement in the Name column from which to remove an application delivery channel.	"Removing an Application Delivery Channel from an Application Agreement" on page 15-38
Update an application delivery channel in an application agreement	Select a specific application agreement in the Name column for which to update an application delivery channel.	"Updating an Application Delivery Channel in an Application Agreement" on page 15-38
View details about an application delivery channel in an application agreement	Select a specific application agreement in the Name column for which to view an application delivery channel.	"Viewing an Application Delivery Channel in an Application Agreement" on page 15-39

See Also: ["Agreements"](#) on page 3-57 for conceptual details about agreements.

Creating an Application Agreement

Follow these instructions to create an application agreement:

To create an application agreement:

1. Ensure that you followed the instructions in ["Accessing Application Agreement Management Tasks"](#) on page 15-31 to access the page for creating an application agreement.

The Create Agreement screen appears.

2. Enter the following details to create an application agreement. An asterisk (*) indicates a required field.

Field	Description
Name *	Enter a unique and recognizable application agreement name.
Agreement Id	Enter an agreement identifier.
Description	Enter a description for the application agreement.
Effective From Date	Select the calendar icon to access a table for selecting an agreement beginning date. If no date is specified, the agreement is always effective.
Effective To Date	Select the calendar icon to access a table for selecting an agreement ending date. If no date is specified, the agreement is always effective. Oracle Application Server ProcessConnect does not process events sent by parties if they are not within the date range specified by the agreement.
Application Participant *	Select the application to associate with this agreement as a participant (for example, Human Resources). If no selections are available, you must first create an application. See Also: "Creating an Application" on page 15-5

3. Click **Apply**.

The application agreement is created and the Agreement Details page for the new application agreement appears.

Deleting an Application Agreement

Follow these instructions to delete an application agreement:

To delete an application agreement:

1. Ensure that you followed the instructions in ["Accessing Application Agreement Management Tasks"](#) on page 15-31 to access the page for deleting an application agreement.
2. Select **Yes** when prompted to delete an application agreement.

The application agreement is deleted and the Application Agreements page appears.

Updating an Application Agreement

Follow these instructions to update an application agreement:

To update an application agreement:

1. Ensure that you followed the instructions "[Accessing Application Agreement Management Tasks](#)" on page 15-31 to access the page for updating an application agreement.

The Update Agreement page appears.

2. Make appropriate changes, including changing the participant in the application agreement. (See Step 2 on page 15-33 for a list of fields you can update.)
3. Click **Apply**.

The agreement is updated and the Agreement Details page for the updated application agreement appears.

Viewing an Application Agreement

Follow these instructions to view details about a specific application agreement:

To view an application agreement:

1. Ensure that you followed the instructions in "[Accessing Application Agreement Management Tasks](#)" on page 15-31 to access the pages for viewing an application agreement.

The Agreement Details page for the selected application agreement appears.

Agreement Details: Expense_Agreement

Validate Export Delete Update

Details

Agreement Id **1**
 Description
 Effective From Date
 Effective To Date
 State **Draft**

Application Participants

[Return to Top](#)

Application Participant [Human Resources](#)

Native Roles



[Return to Top](#)

Name	Remove
SR_NativeRole	

Add

Approvers

[Return to Top](#)

Person	Send For Approval Date	Approval Date	Update	Delete
ip	5/8/03	5/22/03		

Add

- View specific details, including the following:
 - Applications associated as participants in this application agreement
 - Native role associated with this application agreement
 - Persons assigned to approve the profile data of this agreement

The state is **Draft** for this agreement (See the **Details** section and also the **State** column in the Application Agreements page in the middle page of [Figure 15-4](#) on page 15-29). Depending on the current state of an agreement, different buttons and additional sections can also display. If the state is **Pending Approval**, the **Validate** button is replaced with the **Send for Approval** button. If the state is **Approved**, no button displays.

This page, as with the Agreements page shown in [Figure 15-4](#) on page 15-29, enables you to delete or update an application agreement.

- Click **Return to List** to return to the Application Agreements page.

See Also: The following sections for instructions on performing the following tasks:

- ["Exporting Profile Data to an XML File"](#) on page 5-15 for details on exporting application agreements to XML files for approval
- ["Viewing the State of Modeling Metadata and Profile Data on the Details Page"](#) on page 5-17 for details on the various states that display in details pages such as the Agreement Details page and how to assign an approver to an agreement
- ["Managing Organizations"](#) on page 25-11 to create a user that you assign as an approver to an agreement and a method by which to contact this user when their approval is required

Viewing an Application Agreement Participant

Follow these instructions to view details about a specific application agreement participant:

To view an application agreement participant:

1. Ensure that you followed the instructions in ["Accessing Application Agreement Management Tasks"](#) on page 15-31 to access the page for viewing an application agreement.

The Agreement Details page for the selected application agreement appears.

2. Go to the **Application Participants** section.
3. Click the application participant name.

The Application Participant Details page for the selected application agreement participant appears.

Application Participant Details: Human Resources

Details		
Application Human Resources		
Delivery Channels Used		Return to Top
	Add	
Name	Update	Remove
DC1		

- View specific details, including the delivery channel for this application participant.
- Click **Return to List** to return to the Agreement Details page.

Adding an Application Delivery Channel to an Application Agreement

Follow these instructions to add an application delivery channel:

To add an application delivery channel:

- Ensure that you followed the instructions in "[Accessing Application Agreement Management Tasks](#)" on page 15-31 to access the page for viewing an application agreement.

The Agreement Details page for the selected application agreement appears.

- Go to the **Application Participants** section.
- Click the application participant name.

The Application Participant Details page for the selected application participant appears.

- Go to the **Delivery Channels Used** section. (See the lower page of [Figure 15-4](#) on page 15-29.)
- Click **Add**.

The Add Participant Delivery Channel page appears.

- Select a delivery channel from the **Delivery Channel** list. The selections that appear were created in "[Creating an Application Delivery Channel](#)" on page 15-14.

7. Click **Apply**.

You are returned to the Application Participant Details page for the selected application participant.

Removing an Application Delivery Channel from an Application Agreement

Follow these instructions to remove an application delivery channel:

To remove an application delivery channel:

1. Ensure that you followed the instructions in "[Accessing Application Agreement Management Tasks](#)" on page 15-31 to access the page for viewing an application agreement.

The Agreement Details page for the selected application agreement appears.

2. Go to the **Application Participants** section.
3. Click the application participant name.

The Application Participant Details page for the selected application agreement participant appears.

4. Go to the **Delivery Channels Used** section. (See the lower page of [Figure 15-4](#) on page 15-29.)
5. Select a specific application delivery channel in the **Remove** column.
6. Click **Yes** when prompted to remove an application delivery channel.
7. The delivery channel is removed and you are returned to the Application Participant Details page for the selected application agreement participant.

Updating an Application Delivery Channel in an Application Agreement

Follow these instructions to update an application delivery channel:

1. Ensure that you followed the instructions in "[Accessing Application Agreement Management Tasks](#)" on page 15-31 to access the page for viewing an application agreement.

The Agreement Details page for the selected application agreement appears.

2. Go to the **Application Participants** section.
3. Click the application participant name.

The Application Participant Details page for the selected application agreement participant appears.

4. Go to the **Delivery Channels Used** section. (See the lower page of [Figure 15-4](#) on page 15-29.)
5. Select a specific delivery channel in the **Update** column.
The Update Participant Delivery Channel page appears.
6. Make appropriate changes. (See Step 6 of "[Adding an Application Delivery Channel to an Application Agreement](#)" on page 15-37 for a list of fields you can update.)
7. Click **Apply**.
The delivery channel is updated and the Delivery Channel Details page for the updated delivery channel appears.

Viewing an Application Delivery Channel in an Application Agreement

Follow these instructions to view an application delivery channel:

1. Ensure that you followed the instructions in "[Accessing Application Agreement Management Tasks](#)" on page 15-31 to access the page for viewing an application agreement.
The Agreement Details page for the selected application agreement appears.
2. Go to the **Application Participants** section.
3. Click the application participant name.
The Application Participant Details page for the selected application agreement participant appears.
4. Go to the **Delivery Channels Used** section. (See the lower page of [Figure 15-4](#) on page 15-29.)
5. Select a specific delivery channel in the **Name** column.
The Participant Delivery Channel Details page for the selected delivery channel appears (in this example, for the HTTP adapter):

Participant Delivery Channel Details: DC1

Remove Update

Details

Participant Delivery Channel	DC1
Root URL for the outbound messages	http://www.outboundmessages.com
Proxy host name	httphost.us.oracle.com
Proxy port number	80
Proxy user	httpproxy_user
Proxy password	<hidden>
RMI instance name	iphttp
RMI port	1100
Remote user name for filtering incoming message	joe@foo
Authentication type (for outbound messages)	BASIC
User name used in authentication (for outbound messages)	authentype_user
User password used in authentication (for outbound messages)	<hidden>
Security realm used in authentication (for outbound messages)	ipt
Oracle Wallet location (for outbound messages)	/private/joe/certificate.txt
Oracle Wallet password (for outbound messages)	<hidden>
Cipher suite used in SSL handshaking (for outbound messages)	

6. View specific details about delivery, security, and endpoint settings for the delivery channel. The word **Participant** displays in the page title when you view a delivery channel assigned to an application agreement.

This page, as with the Application Participant Details page shown in the lower page of [Figure 15-4](#) on page 15-29, enables you to remove or update the selected application agreement participant.

7. Click **Return to List** to return to the Application Participant Details page.

Managing Native Roles in Application Agreements

The Oracle Application Server ProcessConnect user interface tool enables you to perform the application agreement native role management tasks shown in [Figure 15–5](#). The native role implements the application’s behavior. These tasks are described in detail in this section.

Figure 15–5 Application Agreement Native Role Management Tasks

[Agreement Details: Expense_Agreement](#) Validate Export Delete Update

Details

Agreement Id **1**
 Description
 Effective From Date
 Effective To Date
 State **Draft**

Application Participants [Return to Top](#)

Application Participant [Human Resources](#)

Native Roles [Return to Top](#)

Name	Remove	
SR_NativeRole		Add

Approvers [Return to Top](#)



Person	Send For Approval Date	Approval Date	Update	Delete
lg	5/8/03	5/22/03		

Table 15-5 identifies the application agreement native role management tasks shown in Figure 15-5 and provides references to procedures for performing these tasks.

Table 15-5 Application Agreement Native Role Management Tasks

Page Elements	Management Task	First See Section...	Then See Section...
Add button in Native Roles section in Figure 15-5	Add an application agreement native role	"Accessing Application Agreement Native Role Management Tasks" on page 15-42	"Adding an Application Agreement Native Role" on page 15-43
Remove column in Native Roles section in Figure 15-5	Remove an application agreement native role		"Removing an Application Agreement Native Role" on page 15-43

Accessing Application Agreement Native Role Management Tasks

Follow these instructions to access the application agreement native role management tasks shown in Figure 15-5 on page 15-41:

To access application agreement native role management tasks:

1. Select the **Profiles** tab.
2. Select the **Agreements** tab.
The Application Agreements page appears.
3. Select a specific application agreement in the **Name** column.
The Agreement Details page for the selected agreement appears.
4. Go to the **Native Roles** section. (See Figure 15-5 on page 15-41.)
5. Select a task to perform and see the referenced section for instructions:

To...	Then...	See Section...
Add an application agreement native role	Click Add .	"Adding an Application Agreement Native Role" on page 15-43
Remove an application agreement native role	Select a specific application agreement native role in the Remove column.	"Removing an Application Agreement Native Role" on page 15-43

See Also: ["Native Roles"](#) on page 3-23 for conceptual details

Adding an Application Agreement Native Role

Follow these instructions to add a native role to an application agreement:

To add an application agreement native role:

1. Ensure that you followed the instructions in ["Accessing Application Agreement Native Role Management Tasks"](#) on page 15-42 to access the page for adding an application agreement native role.

The Add Native Role page appears.

2. Select a native role from the **Native Role** list. The native roles that appear were created automatically with the modeling wizards in [Chapter 9, "Creating Metadata with the Modeling Wizards"](#) or manually in ["Creating a Role"](#) on page 12-44.

3. Click **Apply**.

The application agreement native role is added to the application agreement and the Agreement Details page for the selected application agreement appears.

Removing an Application Agreement Native Role

Follow these instructions to remove an application agreement native role:

To remove an application agreement native role:

1. Ensure that you followed the instructions in ["Accessing Application Agreement Native Role Management Tasks"](#) on page 15-42 to access the page for removing an application agreement native role.

2. Click **Yes** when prompted to remove an application agreement native role.

The application agreement native role is removed and the Agreement Details page for the selected application agreement appears.

Managing Application and Agreement Validation and Approval

After completing the tasks described previously in this chapter, the profile data of applications (such as adapter and delivery channel characteristics) and application agreements (such as the participants and native role characteristics) must be validated and approved before it can be included in a deployed configuration. Approval typically involves assigning persons to approve the profile data, exporting the profile data to XML files, and submitting the files to the assigned approvers for review and eventual approval. The validation and approval tasks are performed from **Validation**, **Send for Approval**, **Export**, and **Approve** buttons that display at various stages in the top right sections of the following pages:

- The Application Details page shown in the upper page of [Figure 15-3](#) on page 15-9
- The Agreement Details page shown in the middle page of [Figure 15-4](#) on page 15-29

[Table 15-6](#) identifies the application and application agreement validation and approval tasks and provides references to procedures for performing these tasks. All tasks with the exception of Task 4 are performed with the Oracle Application Server ProcessConnect user interface tool.

Table 15-6 Application and Application Agreement Validation and Approval Tasks

Task	See Section...
1. Validate the application and application agreement	"Validated State for Modeling Metadata and Profile Data" on page 5-19
2. Select persons to approve the application and application agreement	"Pending Approval State for Profile Data" on page 5-20
3. Export the application and application agreement to XML files	"Exporting Profile Data to an XML File" on page 5-15
4. Send the XML files to persons for approval	
5. Specify a date by which persons must complete their approval or disapproval of the application and application agreement	"Update the Approver" on page 5-22
6. Officially approve the application and application agreement when all persons have approved	"Approval State for Profile Data" on page 5-22

Common User Errors

The following are common application and application agreement user errors.

- Ensure that any delivery channel parameters you specified are correct. For example, if your delivery channel required specifying parameters for a database, ensure that the database is running and the username and password you specified can successfully connect to the database. If your delivery channel required that you specify a directory path, ensure that the path is correct.
- Verify that all agreements and applications have been assigned an approver and have been approved. Look at the details pages of each application and agreement and verify that none of the following buttons are present:
 - Validate
 - Send for Approval
 - Approve
- Verify that all agreements have a native role defined. Look at the details of each agreement and verify that the correct native role is listed for that particular agreement.
- Select an application type when creating an application. This selection is required if you want to include an application in a deployed configuration.
- Ensure that the **Effective From Date** and **Effective To Date** values that you select when creating an application agreement are in the correct calendar range. Oracle Application Server ProcessConnect does not process events sent by parties if they are not within the date range specified by the agreement.

Chapter Summary

This chapter first describes how you create an application. You then assign an adapter to the application and create a delivery channel for the application that describes the communication capabilities (such as message exchange and security details) of the adapter. You then create an application agreement to which you assign the application. You also assign a native role to the application agreement to link your modeling metadata to your profile data. You must also validate and approve your application and application agreement before either can be included in a configuration.

Creating and Deploying a Configuration

This chapter describes how to create and deploy a configuration of an end-to-end integration that consists of the modeling metadata and profile data you created.

This chapter contains these topics:

- [Configuration Overview](#)
- [Creating a Configuration](#)
- [Deploying a Configuration](#)
- [Discarding a Configuration](#)
- [Exporting a Configuration](#)
- [Chapter Summary](#)

Note: When creating and deploying a configuration, you do not need to manually restart the adapter framework or integration manager.

Configuration Overview

This section contains these topics:

- [What is a Configuration?](#)
- [Configuration Creation Overview](#)

What is a Configuration?

A configuration consists of a complete, validated, and consistent set of modeling metadata and profile data in Oracle Application Server ProcessConnect. This set is identified based on the business processes that you design. The identification of modeling metadata and profile data included in the set depends on the lifecycle state of the agreements for the profile data and on the business processes for the modeling metadata.

Creating a configuration means you intend to deploy the business process that has been designed. Deployment of a configuration results in Oracle Application Server ProcessConnect being ready to perform actual business as designed.

See Also: [Chapter 3, "Oracle Application Server ProcessConnect Concepts"](#)

Configuration Creation Overview

You must use the Oracle Application Server ProcessConnect user interface tool to perform the following configuration tasks:

1. Create and validate a configuration of an integration that consists of the following:
 - Modeling metadata consisting of interactions, business processes, datatypes, event types, transformations, roles, and condition expressions
 - Profile data consisting of agreements (trading partner or application), parties (trading partners or applications), adapters, organizations, cooperations, delivery, security, and endpoint details

When you create a configuration, the integrity of the modeling metadata and profile data is validated to ensure that it is consistent and complete. If validation is successful, the configuration is created.

You can deploy the configuration immediately after validation or at a later time. Options are also available for discarding (deleting) the configuration or

exporting the modeling metadata and profile data that comprise a configuration to an XML file.

2. Deploy the configuration from the design-time repository to the runtime repository. All business processes in the design-time repository are included in this configuration. Only one configuration can be deployed at a time. Therefore, any currently-running configuration is automatically quiesced and retired. You can also stop a running configuration instead of quiescing it.

See Also: The following chapters for additional details about configuration and validation concepts:

- ["Create and Deploy a Configuration"](#) on page 3-58
- ["Viewing the State of Modeling Metadata and Profile Data on the Details Page"](#) on page 5-17

Creating a Configuration

Follow these instructions to create a configuration:

To create a configuration:

1. Click **Deployment**.

The Configuration page appears. All current configurations and their state appear in the **Configurations** section and all business processes included in configurations and their state appear in the **Business Processes** section.

Configuration

Create

Last Deployment:

To create a configuration for all business processes choose Create.

Configurations

Configuration	State	Created
(No configurations found.)		

Business Processes

Business Process	State
Placing Ad	Draft

When you create a configuration, all business processes and their deployable units are included in the configuration. A configuration consists of a set of deployable units, one for each business process. Each deployable unit corresponds to a complete, validated, and consistent set of related modeling metadata and profile data for a business process.

For example, if you created two separate end-to-end integrations, each with their own business process, both are included in your configuration. If configuration creation is successful, both can be deployed. Ensure that any business processes that you create are part of a completely created, end-to-end integration of modeling metadata and profile data.

Note: Only approved agreements can be included in the deployment unit and, therefore, in the configuration. Configuration creation is successful with at least one agreement in the approved state. If you have more than one agreement in your business process, ensure that all are in the approved state. If you fail to approve the second agreement, the configuration is created without this agreement and the corresponding parties are unable to deliver messages.

The state of a configuration displays in the **State** column of the **Configurations** section:

Configuration State	Description
Validated	The modeling metadata and profile data of an integration have been successfully validated to ensure that it is correct and complete and a configuration has been created. The configuration is ready for deployment. Only valid configurations can exist; invalid configurations cannot be created.
Active	The business processes included in the configuration are available for execution of business in the Oracle Application Server ProcessConnect runtime repository. Incoming messages are accepted based on your design in each of the business processes and processed accordingly.
Discarded	A configuration has been discarded. This occurred when you selected the Discard button on the Configuration page.
Retired	A configuration has been quiesced and retired. This occurs when you deploy another configuration. This action causes any currently-running configurations to be quiesced and retired.

The state of business processes included in a configuration displays in the **State** column of the **Business Processes** section:

Business Process State	Description
Validated	The business process is part of a configuration that has been successfully validated to ensure that it is correct and complete and a configuration has been created. The configuration is now ready for deployment.
Deployed	The business process is part of a configuration that has been successfully deployed to the runtime repository.
Draft	The business process has been modified after it was part of a discarded or deployed configuration.

2. Click **Create**.

The Create Configuration page appears.

3. Enter a unique and recognizable name for the configuration in the **Configuration Name** field. A configuration name can be no more than 30 characters in length. If you enter a previously-used name for a configuration that is currently deployed or has been discarded, you receive an error and are prompted to enter a different name.

4. Click **Apply**.

The Creating Configuration page appears. Messages display onscreen indicating that a configuration is being built and validated to ensure correctness and completeness of the modeling metadata and profile data in your integration. Configuration creation can take some time based on the complexity of your integration.

5. See the following section based on whether or not configuration creation is successful:

If Configuration Creation Is...	See Section...
Successful	"Successful Configuration Creation and Validation" on page 16-6
Unsuccessful	"Unsuccessful Configuration Creation and Validation" on page 16-7

Successful Configuration Creation and Validation

If configuration creation and validation are successful, the following message displays at the top of the page:

Creation and validation of configuration *name* successful

where *name* is the configuration name you entered in Step 3 of "Creating a Configuration" on page 16-3.

The Configuration page displays **Validated** in the **State** column for both the configuration (**Approving V1** in this example) and its business process(es) (**approving-BP** in this example).

Configuration

Deploy Discard Export

Last Deployment:

To deploy a validated configuration choose Deploy. To discard a validated configuration choose Discard. To export a validated configuration choose Export.

Configurations

Configuration	State	Created
Approving V1	Validated	5/19/03

Business Processes

Business Process	State
approving-BP	Validated

At this point, you cannot update or delete the following modeling metadata and profile data in a successfully created and validated configuration:

- Adapters
- Adapter interactions
- Agreements (trading partner or application)
- Applications
- Trading partners

You receive an error if you attempt to make changes. If you must make changes, first deploy or discard the configuration.

See one of the following sections based on the task you want to perform next:

To...	See Section...
Deploy a configuration	"Deploying a Configuration" on page 16-9
Discard a configuration	"Discarding a Configuration" on page 16-12
Export a configuration	"Exporting a Configuration" on page 16-12

Unsuccessful Configuration Creation and Validation

If configuration creation and validation are unsuccessful, the Validation Results - Deployable Business Process page appears. The following example is of an error that occurred because there was no approved agreement included in the configuration:

Validation Results - Deployable Business Process

 Invalid set of Objects

Validation Errors

1. AIP-16020: The business process TST_Eventmap1 must have at least one approved agreement.
2. AIP-16020: The business process TST_EventMap2 must have at least one approved agreement.

[Return To Deployment](#)

The following error message types can appear:

- A Collection is invalid error message with a specific error
- An error message describing the reason for failure, for example:

AIP-16020: The business process *name* must have at least one agreement .

where *name* is the business process name.

AIP-16012: Parameter : name is unique for object Configuration. The name for the configuration is already used. Even if discarded, you can't use it.

This error occurred because the configuration name had been previously used.

AIP-16386: The business role *name* must have at least one outbound data flow group associated with it.

AIP-16661: The port *name* of role *name* must be owned by a data flow group that contains another port connected to a different role

This error occurred because the business role has a role port without a data flow group to a transformation binding role. You must create this data flow group.

- Out-of-memory errors that occur if the OC4J instance is running with a low amount of heap size and there are other concurrent users. The heap size can be increased from within Oracle Enterprise Manager.
- Other validation error messages. Some of the more common user errors include the following:
 - You forget to update the SetParty step.
 - You forget to approve all the agreements in the defined business process.
 - You create interactions for testing and forget to delete them, resulting in validation errors.

The Validation Results - Deployable Business Process page now becomes the default deployment page that appears when you select the **Deployment** tab, and remains so until you correct the error. After you correct the error and want to try creating the configuration again, select **Return To Deployment** on this page. This displays the main Deployment page shown in "[Creating a Configuration](#)" on page 16-3. You can attempt to create a configuration again.

See Also: "[Design Tool Performance](#)" on page 19-15 for instructions on increasing the heap size in Oracle Enterprise Manager

Deploying a Configuration

This section contains these topics:

- [Configuration Deployment Overview](#)
- [Deploying a Validated Configuration](#)

Configuration Deployment Overview

Configuration deployment consists of deploying the designed and validated business processes and the corresponding set of modeling metadata and profile data to the runtime repository. Corresponding adapters are started and available to send and receive messages.

Whenever a new, initiating message is received, it is accepted and a new coordination is created. This event and message are therefore processed within the context of a coordination. All subsequent events created belong to this coordination. For a given business process, there are as many coordinations as the number of initiating, inbound messages received. Correlated events do not result in creation of a new coordination; instead, events are accepted within an existing coordination. After the event is processed, the coordination is closed.

For this Oracle Application Server ProcessConnect release, only one active configuration is permitted at any given time. Deployment of a new configuration results in the quiescing of the old, currently-running configuration. Quiescing is a state in which a configuration accepts only noninitiating events and messages. This state essentially lets the ongoing business complete processing in accordance with the old configuration. After all coordinations in a quiescing configuration are closed (that is, all events and messages are processed), the configuration is retired.

You can also stop a quiescing configuration by clicking the **Abort Quiescing Configuration** button that displays onscreen, which aborts the current event and message processing and deploys the new configuration. This results in all open coordinations being aborted in the quiescing configuration.

After the old configuration is retired, the new configuration becomes active. All adapters used in the old configuration are automatically stopped as part of the adapter framework process and the adapters used in the new configuration are automatically started. If some adapters are common to both the old and new configurations, they are automatically restarted.

See Also:

- ["Runtime Instance Behavior"](#) on page 3-48
- ["Role Runtime Behavior"](#) on page 12-133
- [Chapter 18, "System Management with Oracle Enterprise Manager"](#) for instructions on manually starting and stopping the adapter framework through Oracle Enterprise Manager or Oracle Process Management and Notification (OPMN)

Deploying a Validated Configuration

To access the page for deploying a configuration, a successfully validated configuration must exist. See ["Successful Configuration Creation and Validation"](#) on page 16-6 for an example of the Configuration page that appears.

Follow these instructions to deploy a configuration:

To deploy a configuration:

1. Click **Deploy**.

The Deployment page appears.

2. Select a business intelligence logging level from the **BI Reporting Level** list:

Level	Description
High	Creates instance data for all roles, ports, steps, transition instances, and event instances. High (the default selection) enables you to create detailed business reports about a configuration through the Reports tab, but can also have an impact on runtime performance.
Medium	Creates role, step, and port instance data. Data flow and control flow instance data is not created.
Low	Creates simple role data (that is, roles with only one step). Process role, composite step, port, and data flow instances data are not created. Pass-through steps are ignored. Low provides better performance. Note: All reports may not run successfully, as only a minimal amount of modeling metadata and profile data is available for creating reports when Low is selected.

3. Click **Apply**.

The Deploying Configuration page appears and displays deployment progress.

Only one configuration can be active at a time. Therefore, any currently running configuration is automatically quiesced and retired. You also have the option of aborting the running configuration instead of quiescing it by clicking the **Abort Quiescing Configuration** button that displays onscreen. These are the two methods for stopping a deployed configuration.

If deployment is successful, the Configuration page displays the **Last Deployment** field with the date at which the configuration was deployed. The **State** field of the **Configurations** section displays **Active** for the deployed configuration. The **State** field of the **Business Processes** section displays **Deployed** for the deployed business process(es) of the active configuration.

Configuration

Create

Last Deployment: **Approving V2 on 2003-05-19 14:11:08.0**

To create a configuration for all business processes choose Create.

Configurations

Configuration	State	Created
Approving V1	Discarded	5/19/03
Approving V2	Active	5/19/03

Business Processes

Business Process	State
approving-BP	Deployed

Deployment can be unsuccessful. For example, system errors or out-of-memory errors can cause deployment to fail.

You can now manage and create reports about your deployed configuration.

See Also:

- [Chapter 18, "System Management with Oracle Enterprise Manager"](#)
- [Chapter 23, "Creating Reports"](#)

Discarding a Configuration

You can discard a configuration that is no longer needed or because you want to change the modeling metadata or profile data included in the configuration. To access the page for discarding a configuration, a successfully validated configuration must exist. See "[Successful Configuration Creation and Validation](#)" on page 16-6 for an example of the Configuration page that appears.

Follow these instructions to discard a configuration:

To discard a configuration:

1. Click **Discard**.

The configuration is discarded and is no longer available for deployment. The status of the configuration changes to **Discarded** in the **State** column. The modeling metadata and profile data that comprise the configuration (such as the business process or a trading partner agreement) are not deleted.

Exporting a Configuration

You can export the modeling metadata and profile data that comprise a configuration to an XML file to send to an approver for review. To access the page for exporting a configuration, a successfully validated configuration must exist. See "[Successful Configuration Creation and Validation](#)" on page 16-6 for an example of the Configuration page that appears.

Follow these instructions to export a configuration to an XML file:

To export a configuration:

1. Click **Export**.
2. Enter a file name to which to export the modeling metadata and profile data that comprise a configuration when prompted.

Export can take some time based on the size of the configuration.

You can later re-import the modeling metadata and profile data that comprise a configuration as follows:

- a. Click the **Administration** tab.
- b. Click **Management**.
- c. Click **Browse** in the **Import** section to access the file to import.
- d. Select the file.

e. Click **Import**.

The modeling metadata and profile data that comprise the configuration are re-imported, but the status of its business process reverts to **Draft** in the **State** field. You must recreate the configuration.

See Also: ["Exporting and Importing Integrations"](#) on page 17-53 for details about importing an integration

Common User Errors

The following are common deployment user errors.

- Ensure that any business processes that you create are part of a completely created, end-to-end integration of modeling metadata and profile data. This is because when you create a configuration, all business processes and their deployable units are included in the configuration.
- Only approved agreements can be included in the deployment unit and, therefore, in the configuration. Configuration creation is successful with at least one agreement in the approved state. If you have more than one agreement in your business process, ensure that all are in the approved state. If you fail to approve the second agreement, the configuration is created without this agreement and the corresponding parties are unable to deliver messages.
- Ensure that you delete any interactions that were created for testing purposes. If you do not, you receive validation errors when attempting to create a configuration.

Chapter Summary

This chapter describes how to create and deploy a configuration (the complete, validated, and consistent set of modeling metadata and profile data). It also discusses error messages you can receive when creating a configuration, as well as how to discard configurations and export configurations to a file.

Administering Integrations with the User Interface Tool

This chapter describes how to administer Oracle Application Server ProcessConnect with the Oracle Application Server ProcessConnect user interface tool.

This chapter contains these topics:

- [Administering Oracle Application Server ProcessConnect with the User Interface Tools](#)
- [Administering Adapters](#)
- [Managing the Adapter Framework Instance](#)
- [Administering Native Formats](#)
- [Administering Translators](#)
- [Administering Application Types](#)
- [Viewing Business Protocols](#)
- [Viewing Collaborations](#)
- [Administering Contact Types](#)
- [Viewing Digital Envelopes](#)
- [Viewing Digital Signatures](#)
- [Administering Trading Partner Identification Types](#)
- [Exporting and Importing Integrations](#)
- [Chapter Summary](#)

Administering Oracle Application Server ProcessConnect with the User Interface Tools

Within Oracle Application Server ProcessConnect, there are two types of administration tasks that you perform:

- Administration tasks associated with adding adapters and other details specific to a particular integration. These tasks are performed from the Oracle Application Server ProcessConnect user interface tool (and are described in this chapter).
- Administration tasks that are systemwide such as configuring an integration manager or adapter framework instance, or starting up or shutting down the integration manager. These tasks are performed from within Oracle Enterprise Manager. Those tasks are described in [Chapter 18, "System Management with Oracle Enterprise Manager"](#).

There are broadly five classes of tasks to perform when defining an integration from within the administration facilities of Oracle Application Server ProcessConnect. These tasks are classified as follows:

- Tasks involved with adapters associated with an integration, including administering the adapters and the adapter framework instances
- Tasks associated with endpoint administration within the enterprise, including administering application types and contact types
- Tasks associated with administering business-to-business (B2B) communication facilities, including viewing business protocols, viewing collaborations, viewing digital envelopes, viewing digital signatures, and administering trading partner identification types
- Tasks associated with administering native formats and their translators
- Tasks associated with exporting and importing integrations

The Oracle Application Server ProcessConnect user interface tool enables you to perform the administration tasks shown in [Figure 17-1](#) and [Figure 17-2](#). References to instructions for performing these tasks are listed in [Table 17-1](#) and [Table 17-2](#):

Figure 17-1 User Interface Tool Modeling Configuration Administration Tasks

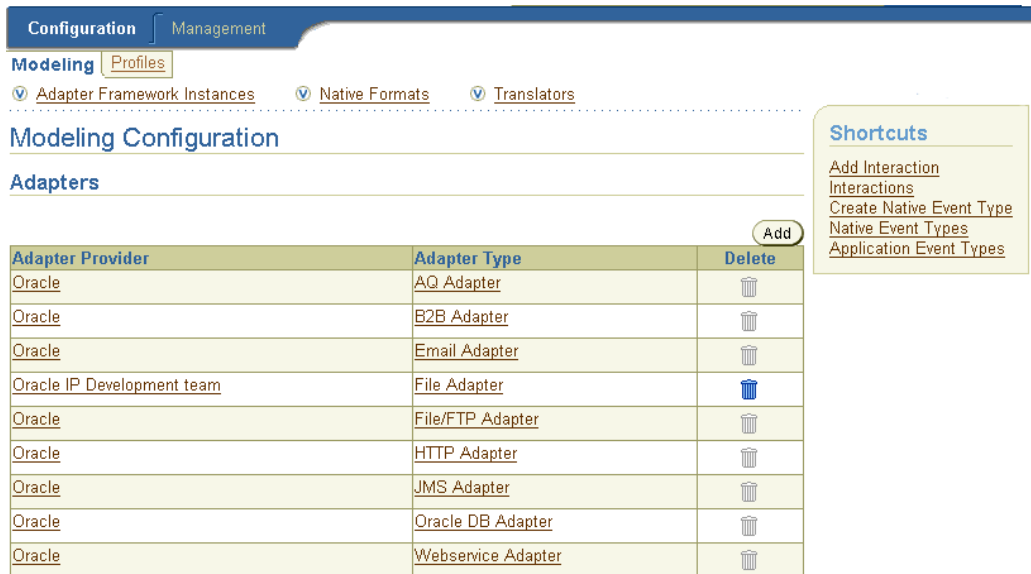

Table 17-1 User Interface Tool Modeling Configuration Administration Tasks

Modeling Configuration Page Section	See Section...
Adapters	"Administering Adapters" on page 17-5
Adapter Framework Instances	"Managing the Adapter Framework Instance" on page 17-13
Native Formats	"Administering Native Formats" on page 17-16
Translators	"Administering Translators" on page 17-29

Figure 17-2 User Interface Tool Profiles Configuration and Management Administration Tasks

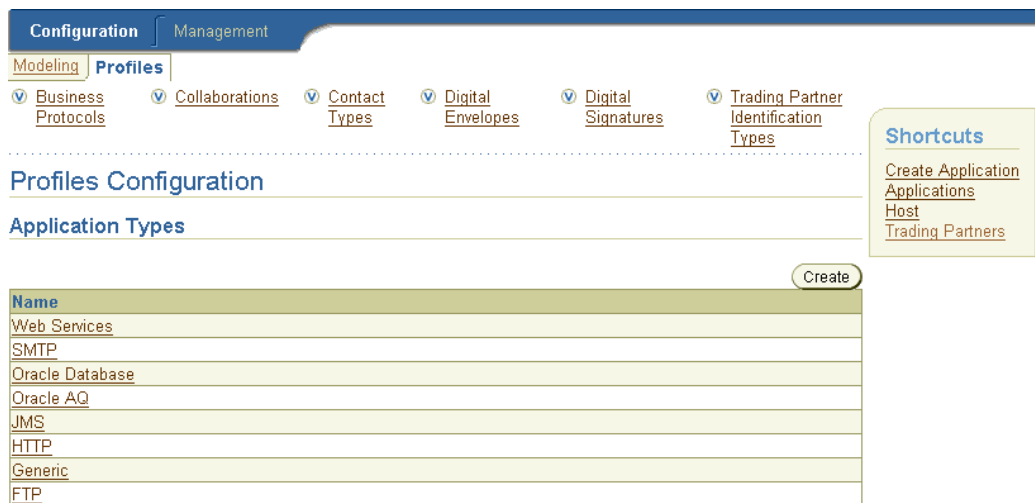

Table 17-2 User Interface Tool Profiles Configuration and Management Administration Tasks

Profiles Configuration	
Page Section	See Section...
Application Types	"Administering Application Types" on page 17-35
Business Protocols	"Viewing Business Protocols" on page 17-38
Collaborations	"Viewing Collaborations" on page 17-40
Contact Types	"Administering Contact Types" on page 17-42
Digital Envelopes	"Viewing Digital Envelopes" on page 17-47
Digital Signatures	"Viewing Digital Signatures" on page 17-48
Trading Partner Identification Types	"Administering Trading Partner Identification Types" on page 17-49
Management tab	"Exporting and Importing Integrations" on page 17-53

Note: Oracle Application Server ProcessConnect includes a prepackaged set of adapters, contact types, native formats, translators, application types, and trading partner identification types that cannot be updated or deleted. You can also create your own contact types, application types, adapters, native formats, translators, and trading partner identification types.

Administering Adapters

The Oracle Application Server ProcessConnect user interface tool enables you to perform the adapter administration tasks shown in [Figure 17-3](#). These tasks are described in detail in this section. Adapters provide the connectivity that enables applications and their different interfaces to be included in an integration. Oracle Application Server ProcessConnect includes a prepackaged set of adapters that cannot be updated or deleted. You can also create and delete your own custom adapters.

Figure 17-3 Adapter Administration Tasks

Modeling Configuration

Adapters Add

Adapter Provider	Adapter Type	Delete
Oracle	AQ Adapter	
Oracle	B2B Adapter	
Oracle	Email Adapter	

Shortcuts

- [Add Interaction Interactions](#)
- [Create Native Event Type Native Event Types](#)
- [Application Event Types](#)

Adapter Type Details : AQ Adapter Delete

Details

Name **AQ Adapter**
 Description **Adapter for Oracle AQ**
 Revision **1.0**

Adapter Error Codes Return to Top

Error String	Error Domain	Delete
(No adapter error codes found.)		

[Create](#)

Adapter Provider Details : Oracle

Details

Name **Oracle**
 Description

Adapter Types

Name	Delete
AQ Adapter	
B2B Adapter	
Email Adapter	

Table 17-3 identifies the adapter administration tasks shown in Figure 17-3 and provides references to procedures for performing these tasks.

Table 17-3 Adapter Administration Tasks

Page Elements	Administration Task	First See Section...	Then See Section...
Shortcuts section of Adapters section of Figure 17-3	Take shortcuts to add an interaction to an adapter, create a native event, or view application events	N/A	"Managing Adapter Interactions" on page 11-4 "Managing Native Event Types" on page 11-37 "Viewing Application Event Types" on page 11-60
Add button of Adapters section of Figure 17-3	Add an adapter	"Accessing Adapter Administration Tasks" on page 17-8	"Adding an Adapter" on page 17-9
Delete column of Adapters section of Figure 17-3	Delete an adapter		"Deleting an Adapter" on page 17-10
Adapter Type column of Adapters section of Figure 17-3 (To access the Adapter Type Details page shown in the middle page of Figure 17-3)	View details about an adapter		"Viewing an Adapter" on page 17-10
Adapter Provider column of Adapters section of Figure 17-3 (To access the Adapter Provider Details page shown in the lower page of Figure 17-3)	View details about an adapter provider		"Viewing an Adapter Provider" on page 17-11
Create button of Adapter Error Codes section of Figure 17-3	Create an adapter error message code		"Creating an Adapter Error Message Code" on page 17-11

Accessing Adapter Administration Tasks

Follow these instructions to access the adapter administration tasks shown in [Figure 17-3](#) on page 17-6:

To access adapter administration tasks:

1. Select the **Administration** tab.
2. Select the **Configuration** tab.

The **Adapters** section appears at the top of the page. (See the upper page of [Figure 17-3](#) on page 17-6.) The adapters that appear include the following:

- Adapters automatically installed with Oracle Application Server ProcessConnect (such as the Advanced Queuing adapter or E-Mail adapter)
 - Adapters you selectively installed during installation (such as the SAP adapter or PeopleSoft adapter)
 - Custom adapters that you manually added
3. Select a task to perform and see the referenced section for instructions:

To...	Then...	See Section...
Add an adapter	Click Add .	"Adding an Adapter" on page 17-9
Delete an adapter	Select a specific adapter in the Delete column.	"Deleting an Adapter" on page 17-10
View details about an adapter	Select a specific adapter in the Adapter Type column.	"Viewing an Adapter" on page 17-10
View details about an adapter provider	Select a specific adapter provider in the Adapter Provider column.	"Viewing an Adapter Provider" on page 17-11
Create an adapter error message code	Select a specific adapter in the Adapter Type column for which to create an error message code	"Creating an Adapter Error Message Code" on page 17-11

Adding an Adapter

You can also add an adapter to Oracle Application Server ProcessConnect. If this is a custom adapter that you manually built, you must add the adapter to the Oracle Application Server ProcessConnect instance. Follow these instructions to add an adapter:

To add an adapter:

1. Ensure that you followed the instructions in "[Accessing Adapter Administration Tasks](#)" on page 17-8 to access the page for adding an adapter.
The Add Adapter page appears.
2. Enter a class name of the adapter in the **Class Name** field (for example, `oracle.tip.adapter.file.myadapter`). You must include the package to which the class belongs. Ensure also that the adapter class file is included in the system CLASSPATH.
3. Click **Apply**.

The adapter is added. The adapter can now be selected in the following locations in the Oracle Application Server ProcessConnect user interface tool:

- On the Add Adapter Type page, where the adapter can be associated with an application (accessible through **Profiles > Applications > *application_name* > Adapter Types > Add**)
- On the Add Interaction : Select Adapter Type page, where the adapter can be associated with an interaction (accessible through **Modeling > Interactions > Add**)

See Also: The following sections for instructions on managing adapters:

- "[Adding an Adapter Interaction](#)" on page 11-7 to add an interaction to an adapter
- "[Adding an Adapter to an Application](#)" on page 15-12 to associate an adapter with an application

Deleting an Adapter

Follow these instructions to delete an adapter:

To delete an adapter:

1. Ensure that you followed the instructions in "[Accessing Adapter Administration Tasks](#)" on page 17-8 to access the page for deleting an adapter.
2. Click **Yes** when prompted to delete an adapter.

The adapter is deleted and the Modeling Configuration page appears. This deletes the adapter from Oracle Application Server ProcessConnect.

Viewing an Adapter

Follow these instructions to view an adapter:

To view an adapter:

1. Ensure that you followed the instructions in "[Accessing Adapter Administration Tasks](#)" on page 17-8 to access the page for viewing an adapter.

The Adapter Type Details page for the selected adapter appears (for example, the Advanced Queuing adapter).

Adapter Type Details : AQ Adapter

Details

Name **AQ Adapter**
 Description **Adapter for Oracle AQ**
 Revision **1.0**

Adapter Error Codes

Error String	Error Domain	
(No adapter error codes found.)		

2. View specific details.

This page, as with the **Adapters** section shown in the upper page of [Figure 17-3](#) on page 17-6, enables you to delete the selected adapter.

3. Click **Return to List** to return to the Modeling Configuration page.

Viewing an Adapter Provider

Each adapter belongs to a specific adapter provider. For example, the Advanced Queuing adapter belongs to Oracle. Follow these instructions to view an adapter provider:

To view an adapter provider:

1. Ensure that you followed the instructions in "[Accessing Adapter Administration Tasks](#)" on page 17-8 to access the page for viewing an adapter provider.



The Adapter Provider Details page for the selected adapter provider appears (for example, for Oracle). All the adapters associated with this provider appear.

Adapter Provider Details : Oracle

Details

Name **Oracle**
Description

Adapter Types

Name	Delete
AQ Adapter	
B2B Adapter	
Email Adapter	

2. View specific details.

This page, as with the **Adapters** section shown in the upper page of [Figure 17-3](#) on page 17-6, enables you to delete the adapter (if you created it).

3. Click **Return to List** to return to the Adapters page.

Creating an Adapter Error Message Code

Follow these instructions to create an adapter error message code for an adapter:

To create an adapter error message code:

1. Ensure that you followed the instructions in "[Accessing Adapter Administration Tasks](#)" on page 17-8 to access the page for creating an adapter error message code.

The Adapter Type Details page appears.

2. Click Create.

The Create Adapter Error Code page appears.

3. Enter the following details to create an adapter error message code. An asterisk (*) indicates a required field.

Field	Description
Error String *	Enter an adapter error message code.
Error Domain *	Select an error type: <ul style="list-style-type: none">■ Domain These are errors that impact an event in a specific Oracle Application Server ProcessConnect middle-tier instance. An example of a domain error occurrence is when the runtime system uses an incorrectly created event transformation map.■ System These are errors that impact the entire system, and not just Oracle Application Server ProcessConnect. Examples of system error occurrences include a database being down, a disk being full, or network connectivity problems.

4. Click Apply.

The adapter error message code is created and the Adapter Type Details page with the new adapter error message code appears.

Managing the Adapter Framework Instance

The Oracle Application Server ProcessConnect user interface tool enables you to either specify that all applications or a specific group of applications use the adapter framework instance. The adapter framework communicates between the runtime system and various adapters to send and receive data in the form of native events. This feature is useful for load balancing. For example, single integration manager and adapter framework instances can be used to communicate with multiple Oracle Database adapters. Each adapter also communicates with a specific database. By separating the adapter framework from the integration manager and the adapters, Oracle Application Server ProcessConnect enables you to load balance requests across the different adapter instances and integration manager instances for scalability.

To update the adapter framework instance:

1. Select the **Administration** tab.
2. Select the **Configuration** tab.
3. Select **Adapter Framework Instances**.

The **Adapter Framework Instances** section appears.

Adapter Framework Instances

[Return to Top](#)

Name	Update
ip_dsunram25.us.oracle.com	

4. Select a task to perform and see the referenced section for instructions:

To...	Then...	See Section...
Update an adapter framework instance	Select a specific adapter framework instance in the Update column.	" Updating an Adapter Framework Instance " on page 17-14
View details about an adapter framework instance	Select a specific adapter framework instance in the Name column.	" Viewing an Adapter Framework Instance " on page 17-15

Updating an Adapter Framework Instance

Follow these instructions to update an adapter framework instance:

To update an adapter framework instance:

1. Ensure that you followed the instructions in "[Managing the Adapter Framework Instance](#)" on page 17-13 to access the page for updating an adapter framework instance.

The Adapter Framework Instance Update page appears.

2. Enter the following details to update the adapter framework instance.
3. If you want to use the adapter framework instance with only specific applications, deselect the **Application Override** box. This action overrides the choice of using this adapter framework instance with all applications.

If you deselected **Application Override**, the page refreshes to display a list of available applications. If **Application Override** is already deselected, the lists described in the following steps already appear.

4. Select the specific applications to use with this adapter framework instance from the **Available Applications** list. These applications are the same ones that appear under **Profiles > Applications**.
5. Click **Move** to move a single application or **Move All** to move all applications to the **Selected Applications** list.
6. Click **Apply**.

The adapter framework instance is updated and the Adapter Framework Instances Details page appears.

7. Click **Return to List** to return to the Modeling Configuration page.

Viewing an Adapter Framework Instance

Follow these instructions to view an adapter framework instance:

To view an adapter framework instance:

1. Ensure that you followed the instructions in "[Managing the Adapter Framework Instance](#)" on page 17-13 to access the page for viewing an adapter framework instance.

The Adapter Framework Instance Details page for the selected adapter framework instance appears.

[Adapter Framework Instance Details : ip.dsunram25.us.oracle.com](#)

Name **ip.dsunram25.us.oracle.com**

Application Override **true**

2. View specific details, including whether this adapter framework instance has been set to **true**, which means this adapter framework works with all applications. If **false** displays, this adapter framework instance has been configured to work with only specific applications that you selected.
3. Click **Return to List** to return to the Modeling Configuration page.

Administering Native Formats

The Oracle Application Server ProcessConnect user interface tool enables you to perform the native format administration tasks shown in [Figure 17-4](#) on page 17-17. These tasks are described in detail in this section. The native format messages must be converted to or translated into a format understood by Oracle Application Server ProcessConnect. Translation involves a syntactic conversion of the message from the native format into an XML format understood by Oracle Application Server ProcessConnect. A native format is therefore associated with a translator that translates the native event to an application event, and vice versa. Oracle Application Server ProcessConnect includes a prepackaged set of native formats that cannot be updated or deleted:

- **XSD**
For native message formats that use XML
- **Token Substituted Text**
For specifying the subject and body of alert e-mail messages
- **D3L**
For native message formats that are not XML, but are instead a format of structured records of bytes, characters, or both

You can also create your own custom native formats. Associated with the custom native format, you also must create a custom translator or select an existing translator. These tasks are described in this section.

Figure 17-4 Native Format Administration Tasks

Native Formats [Return to Top](#)

[Create](#)

Name
test
XSD
Token Substituted Text
D3L
AppFormat

Native Format Details : AppFormat

Details

Name **AppFormat**
 Revision **1.0**
 Description 

Adapter Exchange Protocols [Return to Top](#)

[Add](#)

Name	Remove
(No adapter exchange protocols found.)	

Translators [Return to Top](#)

[Add](#)

Name	Remove
(No translators found.)	

Validations [Return to Top](#)

[Create](#)

Name	Update	Delete
(No validations found.)		

Table 17-4 identifies the native format administration tasks shown in Figure 17-4 and provides references to procedures for performing these tasks.

Table 17-4 Native Format Administration Tasks

Page Elements	Administration Task	First See Section...	Then See Section...
Create button of Native Formats section of Figure 17-4	Create a native format	"Accessing Native Format Administration Tasks" on page 17-19	"Creating a Native Format" on page 17-20
Name column of Native Formats section of Figure 17-4 (To access the Native Format Details page shown in the lower page of Figure 17-4)	View details about a native format		"Viewing a Native Format" on page 17-21
Add button of Adapter Exchange Protocols section of Figure 17-4	Add an adapter exchange protocol to a native format		"Adding an Adapter Exchange Protocol to a Native Format" on page 17-22
Remove column of Adapter Exchange Protocols section of Figure 17-4	Remove an adapter exchange protocol from a native format		"Removing an Adapter Exchange Protocol from a Native Format" on page 17-23
Add button of Translators section of Figure 17-4	Add a translator to a native format		"Adding a Translator to a Native Format" on page 17-24
Remove column of Translators section of Figure 17-4	Remove a translator from a native format		"Removing a Translator from a Native Format" on page 17-24
Create button of Validations section of Figure 17-4	Create validation for a native format		"Creating Validation for a Native Format" on page 17-25
Delete column of Validations section of Figure 17-4	Delete validation from a native format		"Deleting Validation from a Native Format" on page 17-26
Update column of Validations section of Figure 17-4	Update validation of a native format		"Updating Validation of a Native Format" on page 17-26
Name column of Validations section of Figure 17-4	View details about validation of a native format		"Viewing Validation of a Native Format" on page 17-27
Name column of Translators section of Figure 17-4	View details about a translator of a native format	"Viewing a Translator of a Native Format" on page 17-27	

Note: You can update native format validations, but you cannot update adapter exchange protocols and translators.

See Also: [Appendix A, "Native Formats and Translators"](#) for descriptions of the XSD, D3L, and token substituted text native formats included with Oracle Application Server ProcessConnect

Accessing Native Format Administration Tasks

Follow these instructions to access the native format administration tasks shown in [Figure 17-4](#) on page 17-17:

To access native format administration tasks:

1. Select the **Administration** tab.
2. Select the **Configuration** tab.
3. Select **Native Formats**.

The **Native Formats** section appears. (See the upper page of [Figure 17-4](#) on page 17-17.)

4. Select a task to perform and see the referenced section for instructions:

To...	Then...	See Section...
Create a native format	Click Create .	"Creating a Native Format" on page 17-20
View details about a native format	Select a specific native format in the Name column.	"Viewing a Native Format" on page 17-21
Add an adapter exchange protocol to a native format	Select a specific native format in the Name column to which to add an adapter exchange protocol.	"Adding an Adapter Exchange Protocol to a Native Format" on page 17-22
Remove an adapter exchange protocol from a native format	Select a specific native format in the Name column from which to remove an adapter exchange protocol.	"Removing an Adapter Exchange Protocol from a Native Format" on page 17-23

To...	Then...	See Section...
Add a translator to a native format	Select a specific native format in the Name column to which to add a translator.	"Adding a Translator to a Native Format" on page 17-24
Remove a translator from a native format	Select a specific native format in the Name column from which to remove a translator.	"Removing a Translator from a Native Format" on page 17-24
Create validation for a native format	Select a specific native format in the Name column for which to create validation.	"Creating Validation for a Native Format" on page 17-25
Delete validation from a native format	Select a specific native format in the Name column from which to delete validation.	"Deleting Validation from a Native Format" on page 17-26
Update validation of a native format	Select a specific native format in the Name column to which to update validation.	"Updating Validation of a Native Format" on page 17-26
View details about validation of a native format	Select a specific native format in the Name column for which to view validation.	"Viewing Validation of a Native Format" on page 17-27
View details about a translator of a native format	Select a specific native format in the Name column for which to view a translator.	"Viewing a Translator of a Native Format" on page 17-27

Creating a Native Format

Follow these instructions to create a native format:

To create a native format:

1. Ensure that you followed the instructions in ["Accessing Native Format Administration Tasks"](#) on page 17-19 to access the page for creating a native format.

The Create Native Format page appears.

2. Enter the following details to create a native format. An asterisk (*) indicates a required field.

Field	Description
Name *	Enter a unique and recognizable native format name.
Revision *	Enter a revision number for the native format. Note: You can have two native formats of the same name, but they must be of a different revision.
Description	Enter a description.

3. Click **Apply**.

The native format is created and the Native Format Details page for the new native format appears. The native format now appears as a selectable native format when you create a native event type.

See Also:

- "[Managing Adapter Interactions](#)" on page 11-4 to select a native format during the same session in which you are adding an interaction
- "[Managing Native Event Types](#)" on page 11-37 to select a native format during a separate session from that in which you added an interaction

Viewing a Native Format

Follow these instructions to view details about a native format:

To view a native format:

1. Ensure that you followed the instructions in "[Accessing Native Format Administration Tasks](#)" on page 17-19 to access the page for viewing a native format.

The Native Format Details page for the selected native format appears (for example, a custom native format called **AppFormat**).

Native Format Details : AppFormat

Details

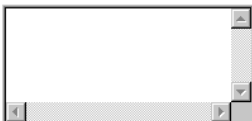
Name **AppFormat**
 Revision **1.0**
 Description 

Adapter Exchange Protocols

[Return to Top](#)

Name	Remove
(No adapter exchange protocols found.)	

[Add](#)

Translators

[Return to Top](#)

Name	Remove
(No translators found.)	

[Add](#)

Validations

[Return to Top](#)

Name	Update	Delete
(No validations found.)		

[Create](#)

2. View specific details and perform specific tasks from this page.
3. Click **Return to List** to return to the Modeling Configuration page.

Adding an Adapter Exchange Protocol to a Native Format

The adapter exchange protocol is the logical grouping of interactions (its capabilities) for an adapter. For example, an Oracle Database adapter may have three adapter exchange protocols. The adapter exchange protocol determines the questions you are prompted to answer. You select an adapter exchange protocol when adding an interaction. Follow these instructions to add an adapter exchange protocol to a native format:

To add an adapter exchange protocol to a native format:

1. Ensure that you followed the instructions in "[Accessing Native Format Administration Tasks](#)" on page 17-19 to access the page for adding an adapter exchange protocol to a native format.

The Native Format Details page for the selected native format appears.

2. Go to the **Adapter Exchange Protocols** section. (See the lower page of [Figure 17-4](#) on page 17-17.)
3. Click **Add**.
The Add Adapter Exchange Protocol to Native Format page appears.
4. Select an adapter exchange protocol from the **Adapter Exchange Protocol** list.
5. Click **Apply**.
The adapter exchange protocol is added and the Native Format Details page appears.

Removing an Adapter Exchange Protocol from a Native Format

Follow these instructions to remove an adapter exchange protocol from a native format:

To remove an adapter exchange protocol from a native format:

1. Ensure that you followed the instructions in "[Accessing Native Format Administration Tasks](#)" on page 17-19 to access the page for removing an adapter exchange protocol from a native format.
The Native Format Details page for the selected native format appears.
2. Go to the **Adapter Exchange Protocols** section. (See the lower page of [Figure 17-4](#) on page 17-17.)
3. Select a specific adapter exchange protocol in the **Remove** column.
4. Click **Yes** when prompted to remove the adapter exchange protocol.
The adapter exchange protocol is removed and the Native Format Details page appears. Removed adapter exchange protocols can be added again at a later time.

Adding a Translator to a Native Format

A native format is associated with a translator. A translator translates a native event into an application event, and vice versa. The translator that you use is based on the native format of your message (known as the wire message). Follow these instructions to add a translator to a native format:

To add a translator to a native format:

1. Ensure that you followed the instructions in "[Accessing Native Format Administration Tasks](#)" on page 17-19 to access the page for adding a translator to a native format.

The Native Format Details page for the selected native format appears.

2. Go to the **Translators** section. (See the lower page of [Figure 17-4](#) on page 17-17.)
3. Click **Add**.

The Add Translator to Native Format page appears.

4. Select a translator from the **Translator** list.
5. Click **Apply**.

The translator is added and the Native Format Details page appears.

Removing a Translator from a Native Format

Follow these instructions to remove a translator from a native format:

To remove a translator from a native format:

1. Ensure that you followed the instructions in "[Accessing Native Format Administration Tasks](#)" on page 17-19 to access the page for removing a translator from a native format.

The Native Format Details page for the selected native format appears.

2. Go to the **Translators** section. (See the lower page of [Figure 17-4](#) on page 17-17.)
3. Select a specific translator to remove in the **Remove** column.
4. Click **Yes** when prompted to remove the translator.

The translator is removed and the Native Format Details page appears. Removed translators can be added again at a later time.

Creating Validation for a Native Format

Follow these instructions to create native event validation for a native format:

To create validation for a native format:

1. Ensure that you followed the instructions in "[Accessing Native Format Administration Tasks](#)" on page 17-19 to access the page for creating validation for a native format.

The Native Format Details page for the selected native format appears.

2. Go to the **Validations** section. (See the lower page of [Figure 17-4](#) on page 17-17.)
3. Click **Create**.

The Create Validation For Native Format page appears.

4. Enter the following details to create native format validation. An asterisk (*) indicates a required field.

Field	Description
Name *	Enter a unique and recognizable native format validation name.
Validation Class Name	Enter the validation class name.
Revision *	Enter a revision number for the native format validation.

5. Click **Apply**.

The validation is added to the native format and the Native Format Details page appears.

See Also: "[Native Event Validation](#)" on page 3-22

Deleting Validation from a Native Format

Follow these instructions to delete validation from a native format:

To delete validation of a native format:

1. Ensure that you followed the instructions in "[Accessing Native Format Administration Tasks](#)" on page 17-19 to access the page for deleting validation from a native format.

The Native Format Details page for the selected native format appears.

2. Go to the **Validations** section. (See the lower page of [Figure 17-4](#) on page 17-17.)
3. Select a specific validation to delete in the **Delete** column.
4. Click **Yes** when prompted to delete the validation from the native format.

The validation is deleted and the Native Format Details page appears.

Updating Validation of a Native Format

To update validation of a native format:

1. Ensure that you followed the instructions in "[Accessing Native Format Administration Tasks](#)" on page 17-19 to access the page for updating validation of a native format.

The Native Format Details page for the selected native format appears.

2. Go to the **Validations** section. (See the lower page of [Figure 17-4](#) on page 17-17.)
 3. Select a specific validation to update in the **Update** column.
- The Update Validation page appears.

4. Make appropriate changes. (See Step 4 of "[Creating Validation for a Native Format](#)" on page 17-25 for a list of fields that you can update.)
5. Click **Apply**.

The validation is updated and the Native Format Details page for the updated native format appears.

Viewing Validation of a Native Format

To view validation of a native format:

1. Ensure that you followed the instructions in "[Accessing Native Format Administration Tasks](#)" on page 17-19 to access the page for viewing validation of a native format.

The Native Format Details page for the selected native format appears.

2. Go to the **Validations** section. (See the lower page of [Figure 17-4](#) on page 17-17.)

3. Select a specific validation to view in the **Name** column.

The Validation Details page appears.

Validation Details : XSD

[Delete](#) [Update](#)

Details

Name	XSD
Validation Class Name	oracle.tip.ts.validation.xsd.XSDValidator
Revision	1.0
Native Format	XSD
State	Draft

4. View specific details.

This page, as with the Native Format Details page shown in the lower page of [Figure 17-4](#) on page 17-17, enables you to delete or update the selected validation of the native format.

5. Click **Return to List** to return to the Native Format Details page.

Viewing a Translator of a Native Format

To view a translator of a native format:

1. Ensure that you followed the instructions in "[Accessing Native Format Administration Tasks](#)" on page 17-19 to access the page for viewing a translator of a native format.

The Native Format Details page for the selected native format appears.

2. Go to the **Translators** section. (See the lower page of [Figure 17-4](#) on page 17-17.)

3. Select a specific native format translator to view in the **Name** column (for example, **XSD**).

The Translator Details page appears.

Translator Details : XSD

Delete

Details

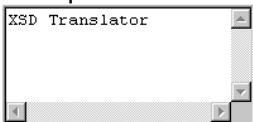
Name	XSD
Version	1.0
Converter Class Name	oracle.tip.ts.translation.xsd.converter.XSDConnectionlessMetaDataInteraction
In Translator Class Name	oracle.tip.ts.translation.xsd.translator.XSDInboundTranslator
Out Translator Class Name	oracle.tip.ts.translation.xsd.translator.XSDOutboundTranslator
Description	
State	Validated

Native Formats

[Return to Top](#)

Add

Name	Remove
XSD	

4. View specific details.

This page, as with the Native Format Details page shown in the lower page of [Figure 17-4](#) on page 17-17, enables you to delete the selected native format translator.

5. Click **Return to List** to return to the Native Format Details page.

Administering Translators

A translator translates a native event into an application event, and vice versa. The translator that you select to use is based on the native format of your message (known as the wire message). The Oracle Application Server ProcessConnect user interface tool enables you to perform the translator administration tasks shown in [Figure 17-5](#). These tasks are described in detail in this section. Oracle Application Server ProcessConnect includes a prepackaged set of translators that cannot be deleted. However, you can create and delete your own custom translators.

Figure 17-5 *Translator Administration Tasks*

Translators
[Return to Top](#)

[Create](#)

Name	Delete
D3L	
Token Substituted Text	
XSD	

Translator Details : XSD
[Delete](#)

Details

Name	XSD
Version	1.0
Converter Class Name	oracle.tip.ts.translation.xsd.converter.XSDConnectionlessMetaDataInteraction
In Translator Class Name	oracle.tip.ts.translation.xsd.translator.XSDInboundTranslator
Out Translator Class Name	oracle.tip.ts.translation.xsd.translator.XSDOutboundTranslator
Description	<div style="border: 1px solid #ccc; padding: 5px; min-height: 40px;"> XSD Translator </div>
State	Validated

Native Formats
[Return to Top](#)

[Add](#)

Name	Remove
XSD	

[Table 17-5](#) identifies the translator administration tasks shown in [Figure 17-5](#) and provides references to procedures for performing these tasks.

Table 17-5 *Translator Administration Tasks*

Page Elements	Administration Task	First See Section...	Then See Section...
Create button of Translators section of Figure 17-5	Create a translator	"Accessing Translator Administration Tasks" on page 17-30	"Creating a Translator" on page 17-31
Delete column of Translators section of Figure 17-5	Delete a translator		"Deleting a Translator" on page 17-33
Name column of Translators section of Figure 17-5 (To access the Translator Details page shown in the lower page of Figure 17-5)	View details about a translator		"Viewing a Translator" on page 17-33
Add button of Native Formats section of Figure 17-5	Add a native format to a translator		"Adding a Native Format to a Translator" on page 17-34
Remove column of Native Formats section of Figure 17-5	Remove a native format from a translator		"Removing a Native Format from a Translator" on page 17-34

See Also: ["Administering Native Formats"](#) on page 17-16 for instructions on performing the administration tasks available under the **Name** column of the **Native Formats** section of the Translation Details page shown in the lower page of [Figure 17-5](#) on page 17-29

Accessing Translator Administration Tasks

Follow these instructions to access the translator administration tasks shown in [Figure 17-5](#) on page 17-29:

To access translator administration tasks:

1. Select the **Administration** tab.
2. Select the **Configuration** tab.
3. Select **Translators**.

The **Translators** section appears. (See the upper page of [Figure 17-5](#) on page 17-29.)

4. Select a task to perform and see the referenced section for instructions:

To...	Then...	See Section...
Create a translator	Click Create .	"Creating a Translator" on page 17-31
Delete a translator	Select a specific translator in the Delete column.	"Deleting a Translator" on page 17-33
View details about a translator	Select a specific translator in the Name column.	"Viewing a Translator" on page 17-33
Add a native format to a translator	Select a specific translator in the Name column to which to add a native format	"Adding a Native Format to a Translator" on page 17-34
Remove a native format from a translator	Select a specific translator in the Name column from which to remove a native format	"Removing a Native Format from a Translator" on page 17-34

Creating a Translator

A translator is associated with a converter, an inbound translator, and an outbound translator. Follow these instructions to add a translator and its associated converter, inbound translator, and outbound translator:

To create a translator:

1. Ensure that you followed the instructions in ["Accessing Translator Administration Tasks"](#) on page 17-30 to access the page for creating a translator.

The Create Translator page appears.

2. Enter the following details to create a translator. An asterisk (*) indicates a required field.

Field	Description
Name *	Enter a unique and recognizable translator name.
Version	Enter a version number for the translator (if any).

Field	Description
Converter Class Name	Enter a converter class name. The converter creates the application body element types from the native body element types at design time. It is also used for creating business datatypes given the filename that has the definition for the datatypes.
In Translator Class Name	Enter a class name for inbound translations. The inbound translator translates native events to application events.
Out Translator Class Name	Enter a class name for outbound translations. The outbound translator translates application events to native events.
Description	Enter a description.

Note: The **In Translator Class Name** and **Out Translator Class Name** fields are not designated as required fields. However, if you do not provide details for these fields, your translator does not work.

3. Click **Apply**.

The translator is created and the Translator Details page for the new translator appears. The translator now appears as a selectable type when you create a native event type.

See Also:

- ["Managing Adapter Interactions"](#) on page 11-4 to select a translator during the same session in which you are adding an interaction
- ["Managing Native Event Types"](#) on page 11-37 to select a translator during a separate session from that in which you added an interaction

Deleting a Translator

Follow these instructions to delete a translator:

To delete a translator:

1. Ensure that you followed the instructions in "[Accessing Translator Administration Tasks](#)" on page 17-30 to access the page for deleting a translator.
2. Click **Yes** when prompted to delete the translator.

The translator is deleted and the Modeling Configuration page appears.

Viewing a Translator

1. Ensure that you followed the instructions in "[Accessing Translator Administration Tasks](#)" on page 17-30 to access the page for viewing a translator.

The Translator Details page appears.

Translator Details : XSD Delete

Details

Name	XSD
Version	1.0
Converter Class Name	oracle.tip.ts.translation.xsd.converter.XSDConnectionlessMetaDataInteraction
In Translator Class Name	oracle.tip.ts.translation.xsd.translator.XSDInboundTranslator
Out Translator Class Name	oracle.tip.ts.translation.xsd.translator.XSDOutboundTranslator
Description	<div style="border: 1px solid gray; padding: 5px; min-height: 40px;">XSD Translator</div>
State	Validated

Native Formats Return to Top

Name	Remove
XSD	

Add

2. View specific details.

This page, as with the **Translators** section of the Modeling Configuration page shown in the upper page of [Figure 17-5](#) on page 17-29, enables you to delete the selected translator.

The **Name** column of the **Native Formats** section of the Translator Details page provides you with an additional access method for performing native format administration tasks.

See Also: ["Administering Native Formats"](#) on page 17-16 for instructions on performing native format administration tasks

Adding a Native Format to a Translator

A translator is associated with a native format. Native format support enables you to import messages in their native (wire message) format into Oracle Application Server ProcessConnect event body elements. Follow these instructions to add a native format to a translator:

To add a native format to a translator:

1. Ensure that you followed the instructions in ["Accessing Translator Administration Tasks"](#) on page 17-30 to access the page for adding a native format to a translator.

The Translator Details page for the selected translator appears.

2. Go to the **Native Formats** section. (See the lower page of [Figure 17-5](#) on page 17-29.)
3. Click **Add**.

The Add Native Format to Translator page appears.

4. Select a native format from the **Native Format** list.
5. Click **Apply**.

The native format is added and the Translator Details page appears.

Removing a Native Format from a Translator

Follow these instructions to remove a native format from a translator:

To remove a native format from a translator:

1. Ensure that you followed the instructions in ["Accessing Translator Administration Tasks"](#) on page 17-30 to access the page for removing a native format from a translator.

The Translator Details page for the selected translator appears.

2. Go to the **Native Formats** section. (See the lower page of [Figure 17-5](#) on page 17-29.)
3. Select a specific native format to remove in the **Remove** column.
4. Click **Yes** when prompted to remove the native format.

The native format is removed and the Translator Details page appears. Removed native formats can be added again at a later time.

Administering Application Types

The Oracle Application Server ProcessConnect user interface tool enables you to perform the application type administration tasks shown in [Figure 17-6](#). These tasks are described in detail in this section. An application type is a method of grouping applications into an entity that can be used for reporting purposes. When you create an application, you select an application type in which to group the application. Oracle Application Server ProcessConnect includes a prepackaged set of application types that cannot be updated or deleted. However, you can create your own custom application types.

Figure 17-6 Application Type Administration Tasks

The screenshot displays the Oracle Application Server ProcessConnect user interface for application type administration. At the top, there are navigation tabs: Business Protocols, Collaborations, Contact Types, Digital Envelopes, Digital Signatures, and Trading Partner Identification Types. Below these tabs, the main content area is divided into two sections: Profiles Configuration and Application Types. The Application Types section is currently active, showing a table of application types. A 'Create' button is located at the top right of the table. On the right side of the interface, there is a 'Shortcuts' panel with links to 'Create Application Applications Host Trading Partners'.

Name
Web Services
SMTP
Oracle Database
Oracle AQ
JMS
HTTP
Generic
FTP

Table 17-6 identifies the application type administration tasks shown in **Figure 17-6** and provides references to procedures for performing these tasks.

Table 17-6 Application Type Administration Tasks

Page Elements	Administration Task	First See Section...	Then See Section...
Shortcuts section of Figure 17-6	Take shortcuts to manage applications, host trading partners, and remote trading partners	N/A	" Managing Applications " on page 15-4 " Managing Trading Partner Identifications " on page 25-4 " Managing Remote Trading Partners " on page 26-6
Create button of Application Types section of Figure 17-6	Create an application type	" Accessing Application Type Administration Tasks " on page 17-36	" Creating an Application Type " on page 17-37
Name column of Application Types section of Figure 17-6	View details about an application type		" Viewing an Application Type " on page 17-37

Accessing Application Type Administration Tasks

Follow these instructions to access the application type administration tasks shown in **Figure 17-6** on page 17-35:

To access application type administration tasks:

1. Select the **Administration** tab.
2. Select the **Configuration** tab.
3. Select **Profiles**.

The **Application Types** section displays at the top of the page. (See **Figure 17-6** on page 17-35.)

- Select a task to perform and see the referenced section for instructions:

To...	Then...	See Section...
Create an application type	Click Create .	" Creating an Application Type " on page 17-37
View details about an application type	Select a specific application type in the Name column.	" Viewing an Application Type " on page 17-37

Creating an Application Type

Follow these instructions to create an application type:

To create an application type:

- Ensure that you followed the instructions in "[Accessing Application Type Administration Tasks](#)" on page 17-36 to access the page for creating an application type.

The Create Application Type page appears.

- Enter a unique and recognizable application type name in the **Name** field.
- Click **Apply**.

The application type is created and the Profiles Configuration page appears. The application type now appears as a selectable application type in the Create Application page.

See Also: "[Creating an Application](#)" on page 15-5 for instructions on selecting an application type when creating an application

Viewing an Application Type

Follow these instructions to view details about an application type:

To view an application type:

- Ensure that you followed the instructions in "[Accessing Application Type Administration Tasks](#)" on page 17-36 to access the page for viewing an application type.

The Application Type Details page for the selected application type appears.

Application Type Details : Generic

Applications

Name	Status
Gloabl Newspaper	
Human Resources	

Shortcuts

[Create Application](#)

- View specific details, including any applications to which the application type is assigned in the **Name** column. A shortcut to the page for creating an application, during which you assign an application type to an application, is also provided.
- Click **Return to List** to return to the Profiles Configuration page.

Viewing Business Protocols

The Oracle Application Server ProcessConnect user interface tool enables you to view details about the available business protocols. The business protocol identifies the implementation guidelines to use for the reliable transport of business document messages between trading partners (essentially the capabilities of the trading partner). One such example is RosettaNet Implementation Framework (RNIF), version 1.1 using the RosettaNet Document Protocol. You select a business protocol to use in the Add Business Protocol page (accessible by clicking **Profiles > Host > Cooperations > Business Protocols** for the host trading partner and **Profiles > Trading Partners > *trading_partner_name* > Cooperations > Business Protocols** for remote trading partners). Follow these instructions to view business protocols.

To view business protocols:

- Select the **Administration** tab.
- Select the **Configuration** tab.
- Select **Profiles**.
- Select **Business Protocols**.

The **Business Protocols** section appears.

Business Protocols

[Return to Top](#)

Name	Description
RosettaNet-RNIF1.1-PIP	Business Protocol using RosettaNet-RNIF1.1-PIP
RosettaNet-RNIF2.0-PIP	Business Protocol using RosettaNet-RNIF-PIP

5. Select a specific business protocol to view from the **Name** column (for example, **RosettaNet-RNIF2.0-PIP**).

The Business Protocol Details page for the selected business protocol appears.

Business Protocol Details : RosettaNet-RNIF2.0-PIP

Details

Document Protocol	RosettaNet - V02.00
Exchange Protocol	RosettaNet - V02.00
Process Protocol	PIP - 2.0

6. View specific details, including the document, exchange, and process protocols that comprise the business protocol.
7. Click the link to the right of **Document Protocol**.

The Document Protocol Details page for the selected document protocol appears (for example, RosettaNet).

8. See "[Viewing a Document Protocol](#)" on page 25-45 for specific details about the document protocol.
9. Click **Return to List** to return to the Business Protocol Details page.
10. Click the link to the right of **Exchange Protocol**.

The Exchange Protocol Details page for the selected exchange protocol appears.

11. See "[Viewing an Exchange Protocol](#)" on page 25-46 for specific details about the exchange protocol.
 12. Click **Return to List** to return to the Business Protocol Details page.
 13. Click the link to the right of **Process Protocol**.
- The Process Protocol Details page appears.
14. See "[Viewing a Process Protocol](#)" on page 25-49 for specific details about the process protocol.
 15. Click **Return to List** to return to the Business Protocol Details page.

See Also:

- ["Adding a Business Protocol"](#) on page 25-45 for instructions on adding a business protocol to a trading partner and definitions of the document, exchange, and process protocols that comprise a business protocol
- The RosettaNet home page for more details on RosettaNet concepts discussed in this section:

<http://www.rosettanet.org>

Viewing Collaborations

The Oracle Application Server ProcessConnect user interface tool enables you to view available collaborations. Follow these instructions to view collaborations. Collaborations identify the actors (roles played in a business collaborations, such as buyer or seller) and business transactions available with each partner interface process (PIP).

To view collaborations:

1. Select the **Administration** tab.
2. Select the **Configuration** tab.
3. Select **Profiles**.
4. Select **Collaborations**.

The **Collaborations** section appears.

Collaborations

[Return to Top](#)

Name	Revision
0A1	V02.00
3A4	V02.00
3A6	V02.00

5. Select a specific collaboration to view from the **Name** column (for example, **3A4** for PIP3A4).

The Collaboration Details page for the selected business collaboration appears.

Collaboration Details : 3A4

Details

Revision	V02.00
Description	This PIP enables a buyer to issue a purchase order and obtain a quick response from the provider that acknowledges which of the purchase order product line items are accepted, rejected or pending
Code	Request Purchase Order
Signal Published	true
Time To Perform	1440
Process Protocol	PIP

Actors

[Return to Top](#)

Name
Buyer
Seller

Business Transactions

[Return to Top](#)

Name	Revision
Request Purchase Order	2.0

- View specific details.
- Go to the **Actors** section.
- Select a specific actor to view from the **Name** column (for example, **buyer**).

Actor Details : Buyer

Details

Description	An employee or organization that buys products for a partner type in the supply chain.
Service Name	Buyer Service

- View specific details. The actor identifies the role played by a trading partner in a business collaboration (such as buyer or seller).
- Click **Return to List** to return to the Collaboration Details page.
- Go to the **Business Transactions** section.
- Select a specific business transaction to view from the **Name** column.

Business Transaction Details : Request Purchase Order

Details

Description	This activity issues a purchase order to a seller. The seller acknowledges at the line level if the purchase order is accepted, rejected or pending
Revision	2.0
Time To Perform	1440
From Actor	Buyer
To Actor	Seller
Process Protocol	PIP
Requesting Action	Purchase Order Request Action
Responding Action	Purchase Order Confirmation Action

13. View specific details. The business transactions define the rules that actors (such as buyer and seller) agree to follow when exchanging business documents.
14. Click **Return to List** to return to the Profiles Configuration page.

See Also: ["Creating a Supported Actor"](#) on page 25-34 for instructions on assigning an actor (role) to a trading partner

Administering Contact Types

The Oracle Application Server ProcessConnect user interface tool enables you to perform the contact type administration tasks shown in [Figure 17-7](#). These tasks are described in detail in this section. The contact type is the method for contacting persons (such as a phone number or e-mail address) when specific activity within Oracle Application Server ProcessConnect occurs, such as a person needs to approve an agreement. Oracle Application Server ProcessConnect includes a prepackaged set of contact types that cannot be updated or deleted. You can also create and update your own custom contact types.

Figure 17-7 Contact Type Administration Tasks

[Contact Types](#) [Return to Top](#)

[Create](#)





Name	Update
Phone	
Fax	
Email	
Contact Name	

Table 17-7 identifies the contact type administration tasks shown in Figure 17-7 and provides references to procedures for performing these tasks.

Table 17-7 Contact Type Administration Tasks

Page Elements	Administration Task	First See Section...	Then See Section...
Create button of Contact Types section of Figure 17-7	Create a contact type	"Accessing Contact Type Administration Tasks" on page 17-44	"Creating a Contact Type" on page 17-44
Update column of Contact Types section of Figure 17-7	Update a contact type		"Updating a Contact Type" on page 17-45
Name column of Contact Types section of Figure 17-7	View details about a contact type		"Viewing a Contact Type" on page 17-45

Accessing Contact Type Administration Tasks

Follow these instructions to access the contact type administration tasks shown in [Figure 17-7](#) on page 17-42:

To access contact type administration tasks:

1. Select the **Administration** tab.
2. Select the **Configuration** tab.
3. Select **Profiles**
4. Select **Contact Types**.

The **Contact Types** section appears. (See [Figure 17-7](#) on page 17-42.)

- Select a task to perform and see the referenced section for instructions:

To...	Then...	See Section...
Create a contact type	Click Create .	"Creating a Contact Type" on page 17-44
Update a contact type	Select a specific contact type in the Update column.	"Updating a Contact Type" on page 17-45
View details about a contact type	Select a specific contact type in the Name column.	"Viewing a Contact Type" on page 17-45

Creating a Contact Type

Follow these instructions to create a contact type:

To create a contact type:

- Ensure that you followed the instructions in ["Accessing Contact Type Administration Tasks"](#) on page 17-43 to access the page for creating a contact type.

The Create Contact Type page appears.

- Enter the following details to create a contact type. An asterisk (*) indicates a required field.

Field	Description
Name *	Enter a unique and recognizable contact type name.
Description	Enter a description.

- Click **Apply**.

The contact type is created and the Contact Type Details page for the new contact type appears. The contact type now appears as a selectable contact type in the Create Contact Information page (accessible through **Profiles > Host > Organization > Contact Information** for the host trading partner and **Profiles > Trading Partners > *trading_partner_name* > Organization > Contact Information** for remote trading partners).

See Also:

- ["Creating Person Contact Details"](#) on page 25-20 for instructions on creating contact details
- ["Viewing the State of Modeling Metadata and Profile Data on the Details Page"](#) on page 5-17 for details about approvers

Updating a Contact Type

Follow these instructions to update a contact type:

To update a contact type:

1. Ensure that you followed the instructions in ["Accessing Contact Type Administration Tasks"](#) on page 17-43 to access the page for updating a contact type.

The Update Contact Type page appears.

2. Make appropriate changes. (See Step 2 of ["Creating a Contact Type"](#) on page 17-44 for a list of fields that you can update.)
3. Click **Apply**.

The contact type is updated and the Contact Type Details page for the updated contact type appears.

Viewing a Contact Type

Follow these instructions to view details about a contact type:

To view a contact type:

1. Ensure that you followed the instructions in ["Accessing Contact Type Administration Tasks"](#) on page 17-43 to access the page for viewing a contact type.

The Contact Type Details page for the selected contact type appears (for example, for e-mail):

Contact Type Details : Email

Delete Update

Details

Description **Email Address**

Contact Information [Return to Top](#)

Contact Type	Value	Details	Update	Delete
(No contact information found which uses the specific contact type.)				

- View specific details. This contact type is now selectable under **Profiles > Host > Organization** for the host trading partner or **Profiles > Trading Partners > trading_partner_name > Organization** for remote trading partners. If you select this type, you are prompted to enter a value, such as an e-mail address, to assign to this type.

This page, as with the **Contact Types** section of the Profiles Configuration page shown in [Figure 17-7](#) on page 17-42, enables you to delete or update the selected contact type.

- Click **Return to List** to return to the Profiles Configuration page.

See Also: ["Creating Person Contact Details"](#) on page 25-20 to assign a value, such as an e-mail address or phone number, to this contact type

Viewing Digital Envelopes

The Oracle Application Server ProcessConnect user interface tool enables you to view digital envelopes. Digital envelopes are the packaging method for a digital signature. Follow these instructions to view digital envelopes.

To view digital envelopes:

1. Select the **Administration** tab.
2. Select the **Configuration** tab.
3. Select **Profiles**.
4. Select **Digital Envelopes**.

The **Digital Envelopes** section appears.

Digital Envelopes [Return to Top](#)

Search

Name	Revision	Protocol
SMIME 3.0 with DES	3.0	SMIME
SMIME 2.0 with DES	2.0	SMIME
SMIME 3.0 with 3DES	3.0	SMIME
SMIME 2.0 with 3DES	2.0	SMIME
SMIME 3.0 with RC2-40	3.0	SMIME
SMIME 2.0 with RC2-40	2.0	SMIME
SMIME 3.0 with RC2-64	3.0	SMIME
SMIME 2.0 with RC2-64	2.0	SMIME
SMIME 3.0 with RC2-128	3.0	SMIME
SMIME 2.0 with RC2-128	2.0	SMIME

5. Select a specific digital envelope to view from the **Name** column.

The Digital Envelope Details page for the selected digital envelope appears (for example, for SMIME 3.0 with DES):

Digital Envelope Details : SMIME 3.0 with DES

Details

Revision **3.0**
 Protocol Name **SMIME**
 Encryption Algorithm **DES**

6. View specific details.
7. Click **Return to List** to return to the Profiles Configuration page.

See Also: ["Creating a Document Exchange"](#) on page 25-67 for instructions on selecting a digital envelope to use in a document exchange of a trading partner

Viewing Digital Signatures

The Oracle Application Server ProcessConnect user interface tool enables you to view digital signatures. Follow these instructions to view digital signatures. A digital signature is created when a public key algorithm signs the sender's message with the sender's private key. The digital signature ensures that the document is authentic, has not been forged by another party, has not been altered, and cannot be repudiated by the sender.

To view digital signatures:

1. Select the **Administration** tab.
2. Select the **Configuration** tab.
3. Select **Profiles**.
4. Select **Digital Signatures**.

The **Digital Signatures** section appears.

Digital Signatures [Return to Top](#)

Search

Name	Revision	Protocol
SMIME 3.0 with SHA - RSA	3.0	SMIME
SMIME 2.0 with SHA - RSA	2.0	SMIME
SMIME 3.0 with SHA - DSA	3.0	SMIME
SMIME 2.0 with SHA - DSA	2.0	SMIME
SMIME 3.0 with MD5 - RSA	3.0	SMIME
SMIME 2.0 with MD5 - RSA	2.0	SMIME

5. Select a specific digital signature to view from the **Name** column.

The Digital Signature Details page for the selected digital signature appears (for example, for SMIME 3.0 with SHA - RSA):

Digital Signature Details : SMIME 3.0 with SHA - RSA

Details

Revision	3.0
Protocol Name	SMIME
Hash Function Algorithm	SHA1
Signature Algorithm	RSA

6. View specific details.
7. Click **Return to List** to return to the Profiles Configuration page.

See Also: "[Creating a Document Exchange](#)" on page 25-67 for instructions on selecting a digital signature to use in a document exchange of a trading partner

Administering Trading Partner Identification Types

The Oracle Application Server ProcessConnect user interface tool enables you to perform the trading partner identification type administration tasks shown in [Figure 17-8](#). These tasks are described in detail in this section. The trading partner identification type is a value that uniquely identifies a trading partner, such as a data universal numbering system (DUNS) number. You can define other types of trading partner identification types. Oracle Application Server ProcessConnect includes a prepackaged set of trading partner identification types that cannot be updated or deleted. You can also create your own custom trading partner identification types.

Figure 17-8 *Trading Partner Identification Type Administration Tasks*

Trading Partner Identification Types [Return to Top](#)

[Create](#)

Name	System Identifier
EDI Location Code	True
DUNS	True

Table 17-8 identifies the trading partner identification type administration tasks shown in Figure 17-8 and provides references to procedures for performing these tasks.

Table 17-8 Trading Partner Identification Type Administration Tasks

Page Elements	Administration Task	First See Section...	Then See Section...
Create button of Trading Partner Identification Types section of Figure 17-8	Create a trading partner identification type	"Accessing Trading Partner Identification Type Administration Tasks" on page 17-50	"Creating a Trading Partner Identification Type" on page 17-51
Name column of Trading Partner Identification Types section of Figure 17-8	View details about a trading partner identification type		"Viewing a Trading Partner Identification Type" on page 17-52

Accessing Trading Partner Identification Type Administration Tasks

Follow these instructions to access the trading partner identification type administration tasks shown in Figure 17-8 on page 17-49:

To access trading partner identification type administration tasks:

1. Select the **Administration** tab.
2. Select the **Configuration** tab.
3. Select **Profiles**.
4. Select **Trading Partner Identification Types**.

The **Trading Partner Identification Types** section appears. (See Figure 17-8 on page 17-49.)

5. Select a task to perform and see the referenced section for instructions:

To...	Then...	See Section...
Create a trading partner identification type	Click Create .	"Creating a Trading Partner Identification Type" on page 17-51
View details about a trading partner identification type	Select a specific trading partner identification type in the Name column.	"Viewing a Trading Partner Identification Type" on page 17-52

Creating a Trading Partner Identification Type

Follow these instructions to create a trading partner identification type:

To create a trading partner identification type:

1. Ensure that you followed the instructions in "[Accessing Trading Partner Identification Type Administration Tasks](#)" on page 17-50 to access the page for creating a trading partner identification type.

The Create Trading Partner Identification Type page appears.

2. Enter the following details to create a trading partner identification type. An asterisk (*) indicates a required field.

Field	Description
Name *	Enter a unique and recognizable trading partner identification type name.
Description	Enter a description.
System Identifier	Select Unspecified , True , or False . Select True for the system identifier to identify the given trading partner.

3. Click **Apply**.

The trading partner identification type is created and the Trading Partner Identification Type Details page appears. The trading partner identification type appears as a selection on the Create Trading Partner Identification page (accessible through **Profiles > Host > Create** for the host trading partner and **Profiles > Trading Partners > *trading_partner_name* > Create** for remote trading partners).

See Also: "[Creating Trading Partner Identification](#)" on page 25-8 for instructions on selecting a trading partner identification type

Viewing a Trading Partner Identification Type

Follow these instructions to view details about a trading partner identification type:

To view a trading partner identification type:

1. Ensure that you followed the instructions in "[Accessing Trading Partner Identification Type Administration Tasks](#)" on page 17-50 to access the page for viewing a trading partner identification type.

The Trading Partner Identification Type Details page for the selected trading partner identification type appears.

2. View specific details.

Trading Partner Identification Type Details : DUNS

[Delete](#) [Update](#)

Details

Description **Dun & Bradstreet Global Business Identifier**
 System Identifier **True**

Trading Partner Identifications

[Return to Top](#)

Trading Partner Identification Type	Value	Details	Update	Delete
(No trading partner identifications found which use the specific trading partner identification type.)				

3. Click **Return to List** to return to the Profiles Configuration page.

Exporting and Importing Integrations

The Oracle Application Server ProcessConnect user interface tool enables you to create integrations that consist of modeling metadata and profile data. An integration created with the Oracle Application Server ProcessConnect user interface tool is stored in the design-time repository. You can export and import the contents of an integration to and from a file. This enables you to export an integration from one repository and import it into another repository.

There are several methods for using export and import:

- In high availability environments, you can back up specific configurations from your design-time repository.
- For migrating from a test environment to a production environment, you can import configurations tested in a staging environment into production environments.

Oracle Application Server ProcessConnect supports three types of export:

- The export feature accessible under the **Administration** tab (and described in this section) exports the latest versions of all profile data and modeling metadata to a file.
- The configuration export feature accessible under the **Deployment** tab exports only the business process and related profile data and modeling metadata that are included in a specific configuration.
- The export feature accessible from the Host page, application details pages, trading partner details pages, and agreement details pages exports the profile data associated with those pages to XML files that can then be submitted to assigned approvers for review and eventual approval. The XSDs for these XML files are included in the exported document.

Note the following details about importing and exporting the latest versions of all the profile data and modeling metadata to a file (first and second bullet points):

- Export does not include the adapter framework instance. This instance is created during Oracle Application Server ProcessConnect installation. If you export profile data and modeling metadata from one repository and import it into another repository, you must reassociate all the applications and trading partners with the adapter framework instance in the new repository. This is not required if the **Application Override** check box on the Adapter Framework Instance Update page is selected; this action sets

Application Override to true (which displays on the Adapter Framework Instances Details page).

- Person passwords are not updated if you import profile data and modeling metadata into a repository where the person and password already exist, even if the password was different when the export file was created.

If a specific person existed when the export file was created, but does not exist in the repository into which the profile data and modeling metadata are being imported, the person and password are imported into the new repository. However, if a specific person and password exist in both the repository and the file to be imported, the password is not imported; it remains the same as before import.

Only person passwords are not imported; passwords for any delivery channels or connections are imported.

- The wallet password for the host trading partner is not exported or imported. This password must be created manually by following the instructions under the **Profiles > Host** tab.
- Do not use the Oracle Application Server ProcessConnect export and import features for backup or recovery of the Oracle Application Server Metadata Repository. Oracle Application Server ProcessConnect uses two schemas in the metadata repository: `ip` and `owf_mgr`. Both schemas have additional metadata and runtime state not included in the Oracle Application Server ProcessConnect export file. Use the Oracle database import and export utilities to back up these schemas.

See Also:

- ["Exporting a Configuration"](#) on page 16-12 for instructions on exporting a configuration
- ["Exporting Profile Data to an XML File"](#) on page 5-15 for instructions on exporting profile data to a file
- ["Managing the Adapter Framework Instance"](#) on page 17-13 for instructions on managing the application override value
- ["Managing Persons"](#) on page 25-13 for instructions on creating persons and assigning passwords
- ["Managing the Host Trading Partner Wallet Password"](#) on page 25-90 for instructions on creating a wallet password for the host trading partner
- *Oracle Application Server 10g Administrator's Guide* for details about Oracle Application Server backup and recovery
- *Oracle9i Backup and Recovery Concepts* available on the Oracle Technology Network Web site for additional details about backup and recovery strategies:

<http://otn.oracle.com>

Follow these instructions to export and import integrations:

To export and import integrations:

1. Select the **Administration** tab.
2. Select the **Management** tab.
3. Select a task to perform and see the referenced section for instructions:

To...	Then...	See Section...
Export integrations to a file	Click Export .	"Exporting an Integration" on page 17-56
Import integrations from a file	Click Browse .	"Importing an Integration" on page 17-56

Exporting an Integration

The entire and most recent contents of the integration are copied to a file named `export.xml` that you are prompted to open or download to a directory location.

Note: Depending on the size of the integration, this process can take time.

See Also:

- ["Exporting Profile Data to an XML File"](#) on page 5-15 for details about additional Oracle Application Server ProcessConnect export functionality that enables you to export profile data (such as applications and agreements) to an XML file for submittal to persons for approval
- ["Exporting a Configuration"](#) on page 16-12 for instructions on exporting the contents of a configuration to a file

Importing an Integration

Caution: An integration exported to a file represents a copy of the current modeling metadata and profile data. This file is no longer accessible for changes with the Oracle Application Server ProcessConnect user interface tool until it is imported back into Oracle Application Server ProcessConnect.

If you continue to make changes to the integration with the Oracle Application Server ProcessConnect user interface tool, then import the exported file (the contents of which are now older), the following occurs:

- New data created with the Oracle Application Server ProcessConnect user interface tool after the file was exported is left untouched after the file is imported.
 - Data updated or deleted after the file was exported is overwritten with the older contents of the imported file.
-
-

The File Upload page appears.

1. Select a file to upload and click **Open**.

Your selection appears in the **Input File** field.

2. Click **Import**.

The Import Status page appears. A clock displays onscreen saying that the import is being processed.

The entire contents of the file are loaded into their previous locations in the design-time repository and display in the Oracle Application Server ProcessConnect user interface tool. You cannot import parts of the file. A message appears indicating that the import completed successfully.

If an import fails, then the changes are rolled back and the design-time repository remains unchanged. A message appears indicating that the import was unsuccessful.

Chapter Summary

This chapter describes how to use the user interface tool for the following tasks:

- Modeling configuration administration of adapters, adapter framework instances, native formats, and translators
- Profiles configuration administration of application types, contact types, and trading partner identification types and viewing of business protocols, collaborations, digital envelopes, and digital signatures
- Exporting and importing of integrations

System Management with Oracle Enterprise Manager

This chapter provides an overview of Oracle Application Server ProcessConnect monitoring and administration tasks that you can perform from Oracle Enterprise Manager.

This chapter contains these topics:

- [Oracle Enterprise Manager Monitoring and Administration Overview](#)
- [Managing and Monitoring a Middle-Tier Instance from Oracle Enterprise Manager Application Server Control](#)
- [Starting and Stopping Oracle Application Server ProcessConnect Components with OPMN](#)
- [Additional Oracle Application Server and Oracle Application Server ProcessConnect Management Tasks](#)
- [Changing Port Numbers](#)
- [Chapter Summary](#)

See Also:

- [Chapter 19, "Performance Tuning"](#) for details about using Oracle Enterprise Manager to manage Oracle Application Server ProcessConnect performance
- *The Oracle Application Server 10g Administrator's Guide* for details about using Oracle Enterprise Manager to manage Oracle Application Server

Oracle Enterprise Manager Monitoring and Administration Overview

Figure 18–1 provides a high-level overview of how Oracle Application Server ProcessConnect (called OracleAS ProcessConnect) is managed.

Figure 18–1 Monitoring and Management with Oracle Enterprise Manager

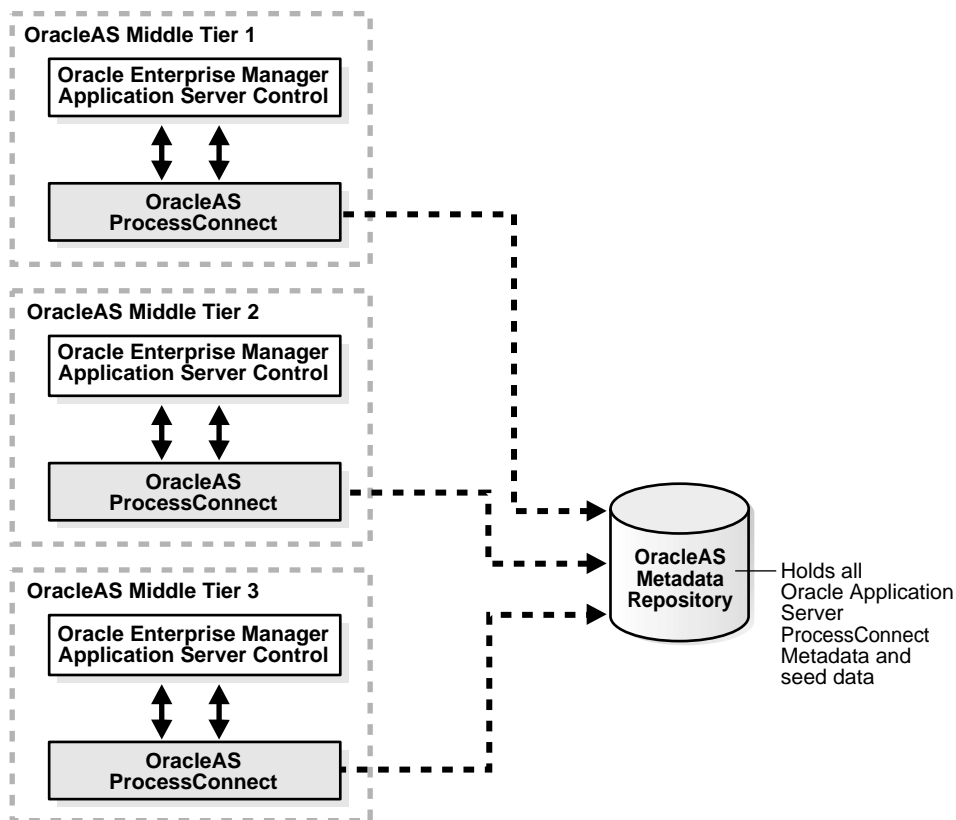

In [Figure 18-1](#), Oracle Application Server ProcessConnect is installed on three Oracle Application Server middle tiers that connect to an Oracle Application Server Metadata Repository.

The Oracle Enterprise Manager Application Server Control is designed to provide local monitoring and administration tasks on an Oracle Application Server ProcessConnect middle-tier instance basis. The Oracle Enterprise Manager Application Server Control also provides real-time systems monitoring details such as up and down status, current CPU and memory consumption, and current performance status on the instance.

Oracle Application Server ProcessConnect Management Concepts and Components

This section describes the following Oracle Application Server ProcessConnect management concepts and components:

- [Oracle Application Server Metadata Repository](#)
- [Oracle Application Server ProcessConnect Instance](#)
- [Integration Manager](#)
- [Adapter Framework](#)
- [OC4J Instance for Oracle Application Server ProcessConnect](#)

Oracle Application Server Metadata Repository

The Oracle Application Server Metadata Repository contains all the profile data and modeling metadata required for an integration. The Oracle Application Server Metadata Repository can be installed either through OracleAS Infrastructure 10g or with the Repository Configuration Assistant. Every Oracle Application Server ProcessConnect middle-tier instance requires a connection to the Oracle Application Server Metadata Repository to work properly.

See Also: *Oracle Application Server ProcessConnect Installation Guide* for Oracle Application Server Metadata Repository installation concepts

Oracle Application Server ProcessConnect Instance

An Oracle Application Server ProcessConnect middle-tier instance is a logical grouping of the integration manager, adapter framework, and an Oracle Application Server Containers for J2EE (OC4J) instance for Oracle Application Server ProcessConnect. There is one Oracle Application Server ProcessConnect middle-tier instance for each Oracle home. When you install Oracle Application Server ProcessConnect, you install an Oracle Application Server ProcessConnect instance and its subcomponents: integration manager, adapter framework, and the OC4J instance for Oracle Application Server ProcessConnect.

Integration Manager

The integration manager is a standalone Java process that executes all integration processes and invokes a set of services required as events move through Oracle Application Server ProcessConnect.

Adapter Framework

The adapter framework is a standalone Java process that is responsible for both invoking adapter services and receiving data from adapters.

OC4J Instance for Oracle Application Server ProcessConnect

The OC4J instance hosts the Oracle Application Server ProcessConnect user interface tool used for creating integrations, generating reports, managing trading partners, and other integration aspects. The OC4J instance also hosts a number of adapters required for integration.

See Also: The *Oracle Application Server 10g Administrator's Guide* for details about troubleshooting OC4J instance issues

Oracle Enterprise Manager Application Server Control Tasks

You can perform the following local monitoring and administration tasks from the Oracle Enterprise Manager Application Server Control:

- Start and stop the Oracle Application Server ProcessConnect integration manager, adapter framework, and OC4J instance components running in each Oracle Application Server middle-tier instance.
- View the current running status (started or stopped) and memory and CPU usage for the integration manager, adapter framework, and OC4J instance running in each Oracle Application Server middle-tier instance.

- View and edit Oracle Application Server ProcessConnect configuration parameters. The online help lists all configuration parameter properties, including descriptions, default values, and allowed ranges.
- View integration manager and adapter framework performance.
- View integration manager and adapter framework log files.
- Access the Oracle Application Server ProcessConnect user interface tool for designing and deploying integrations.

See Also: ["Managing and Monitoring a Middle-Tier Instance from Oracle Enterprise Manager Application Server Control"](#) on page 18-5

Managing and Monitoring a Middle-Tier Instance from Oracle Enterprise Manager Application Server Control

Follow these instructions to access Oracle Application Server ProcessConnect from the Oracle Enterprise Manager Application Server Control.

To access Oracle Application Server ProcessConnect from the Oracle Enterprise Manager Application Server Control:

1. Go to the following URL:

`http://hostname:port/`

where:

- *hostname* is the name of the host on which the Oracle Application Server ProcessConnect middle-tier instance is installed
 - *port* was the number assigned when you installed Oracle Application Server ProcessConnect. At the end of installation, the port number displayed onscreen.
2. Enter the following login details when prompted:

Field	Description
Username	Enter <code>ias_admin</code>
Password	Enter the password you specified during J2EE and Web Cache installation and Oracle Application Server ProcessConnect installation for the <code>ias_admin</code> user.

Note: If you have multiple Oracle Application Server middle-tier instances installed on a single host, you need to specify different Oracle Enterprise Manager ports for each instance. See the `portlist.ini` file in the `$ORACLE_HOME/install` directory for a list of which ports are currently in use.

The Oracle Application Server home page appears:

Application Server: midtier.isunrak27

Home [J2EE Applications](#) [Ports](#) [Infrastructure](#) Page Refreshed Jun 12, 2003 5:10:23 PM

General



Status: **Partially Up**
 Host: **isunrak27**
 Installation Type: **J2EE and Web Cache**
 Oracle Home: **/private/iptest/OraHome1**

CPU Usage



Application Server (1%)
 Idle (85%)
 Other (14%)

Memory Usage



Application Server (17% 175MB)
 Free (10% 101MB)
 Other (73% 748MB)

System Components

Select All | Select None

Select Name	Status	Start Time	CPU Usage (%)	Memory Usage (MB)
<input type="checkbox"/> home	↓			
<input type="checkbox"/> HTTP_Server	↓			
<input type="checkbox"/> OC4J_Demos	↓			
<input type="checkbox"/> OC4J_ProcessConnect	↓			
<input type="checkbox"/> ProcessConnect	↑	Jun 12, 2003 10:26:38 AM	1.06	118.06

TIP This table contains only the enabled components of the application server. Only components that have the checkbox enabled can be started or stopped.

Related Links: [Process Management](#)

Home [J2EE Applications](#) [Ports](#) [Infrastructure](#)

3. Select a management task to perform and see the referenced section for instructions.

Page Elements	Management Task	See Also
Name list of System Components section	Select the Oracle Application Server ProcessConnect middle-tier instance to monitor and administer from the Oracle Enterprise Manager Application Server Control	" Oracle Application Server ProcessConnect Monitoring and Administration Tasks " on page 18-8 for an overview of Oracle Application Server ProcessConnect tasks you can perform
Process Management link (at bottom)	Select Process Management to view and edit the <code>opmn.xml</code> file.	" Oracle Process Management Notification Management " on page 18-14
Ports link (at bottom)	Select Ports to view ports assigned to Oracle Application Server ProcessConnect and other Oracle Application Server components	" Oracle Application Server ProcessConnect Port Management " on page 18-14
Infrastructure link (at bottom)	Select Infrastructure to review and modify details about the relationship between this Oracle Application Server instance and the rest of your enterprise.	" Oracle Application Server and Enterprise Relationship Management " on page 18-16

See Also: *Oracle Application Server 10g Administrator's Guide* for instructions on changing the `ias_admin` username password

Oracle Application Server ProcessConnect Monitoring and Administration Tasks

Figure 18–2 shows the Oracle Application Server ProcessConnect middle-tier instance page that displays after selecting the specific instance in Step 3 on page 18-7. You can perform the following monitoring and administration tasks.

Figure 18–2 Oracle Application Server ProcessConnect Middle-Tier Instance Page

[Application Server: iasmid.dsunram11.us.oracle.com](#) > [ProcessConnect Instance: iasmid.dsunram11.us.oracle.com_ProcessConnect_Instance](#)
[ProcessConnect Instance: iasmid.dsunram11.us.oracle.com_ProcessConnect_Instance](#) Refreshed at Monday, April 21, 2003 12:54:26 PM PDT

<p>Summary</p>  <table border="0"> <tr><td>Status</td><td>Up</td><td>Stop All Restart All</td></tr> <tr><td>Version</td><td>9.0.4</td><td></td></tr> <tr><td>Host</td><td>dsunram11.us.oracle.com</td><td></td></tr> <tr><td>Oracle Home</td><td>#home/guest/iasmid</td><td></td></tr> </table>	Status	Up	Stop All Restart All	Version	9.0.4		Host	dsunram11.us.oracle.com		Oracle Home	#home/guest/iasmid		<p>Adapter Framework</p>  <table border="0"> <tr><td>Status</td><td>Up</td><td>Stop Restart</td></tr> <tr><td>Start Time</td><td>Monday, April 21, 2003 12:38:40 AM PDT</td><td></td></tr> <tr><td>CPU Usage</td><td>0.23 %</td><td></td></tr> <tr><td>Memory Usage</td><td>101.77 MB</td><td></td></tr> </table>	Status	Up	Stop Restart	Start Time	Monday, April 21, 2003 12:38:40 AM PDT		CPU Usage	0.23 %		Memory Usage	101.77 MB							
Status	Up	Stop All Restart All																													
Version	9.0.4																														
Host	dsunram11.us.oracle.com																														
Oracle Home	#home/guest/iasmid																														
Status	Up	Stop Restart																													
Start Time	Monday, April 21, 2003 12:38:40 AM PDT																														
CPU Usage	0.23 %																														
Memory Usage	101.77 MB																														
<p>OC4J Instance</p>  <table border="0"> <tr><td>Status</td><td>Up</td><td>Stop Restart</td></tr> <tr><td>Name</td><td>iasmid.dsunram11.us.oracle.com_OC4J_ProcessConnect</td><td></td></tr> <tr><td>Start Time</td><td>Monday, April 21, 2003 12:38:40 AM PDT</td><td></td></tr> <tr><td>CPU Usage</td><td>0.009 %</td><td></td></tr> <tr><td>Memory Usage</td><td>119.94 MB</td><td></td></tr> <tr><td>Related Links</td><td>ProcessConnect UI Tool</td><td></td></tr> </table>	Status	Up	Stop Restart	Name	iasmid.dsunram11.us.oracle.com_OC4J_ProcessConnect		Start Time	Monday, April 21, 2003 12:38:40 AM PDT		CPU Usage	0.009 %		Memory Usage	119.94 MB		Related Links	ProcessConnect UI Tool		<p>Integration Manager</p>  <table border="0"> <tr><td>Status</td><td>Up</td><td>Stop Restart</td></tr> <tr><td>Start Time</td><td>Monday, April 21, 2003 12:38:40 AM PDT</td><td></td></tr> <tr><td>CPU Usage</td><td>2.66 %</td><td></td></tr> <tr><td>Memory Usage</td><td>109.62 MB</td><td></td></tr> </table>	Status	Up	Stop Restart	Start Time	Monday, April 21, 2003 12:38:40 AM PDT		CPU Usage	2.66 %		Memory Usage	109.62 MB	
Status	Up	Stop Restart																													
Name	iasmid.dsunram11.us.oracle.com_OC4J_ProcessConnect																														
Start Time	Monday, April 21, 2003 12:38:40 AM PDT																														
CPU Usage	0.009 %																														
Memory Usage	119.94 MB																														
Related Links	ProcessConnect UI Tool																														
Status	Up	Stop Restart																													
Start Time	Monday, April 21, 2003 12:38:40 AM PDT																														
CPU Usage	2.66 %																														
Memory Usage	109.62 MB																														

Administration

[Performance](#) [Server Properties](#) [Integration Manager Log File](#) [Adapter Framework Log File](#)

Table 18–1 identifies the tasks that you can perform. These tasks are further described in the online help available by clicking **Help** in the top right corner of each page.

Table 18–1 Oracle Enterprise Manager Application Server Control Monitoring and Administration Tasks

Page Elements	Management Task
Summary section	View an overall status of the integration manager, adapter framework, and OC4J instance components on this middle-tier instance. For the overall status to display as Up , all three components must be running.
Summary section	Click Stop All to stop the integration manager, adapter framework, and OC4J instance together.
Summary section	Click Restart All to restart the integration manager, adapter framework, and OC4J instance together.
Adapter Framework, Integration Manager, or OC4J Instance section	Click Stop to stop a specific component (either integration manager, adapter framework, or OC4J instance). Each component has its own Stop button.
Adapter Framework, Integration Manager, or OC4J Instance section	Click Restart to restart a specific component (either integration manager, adapter framework, or OC4J instance). Each component has its own Restart button.
Adapter Framework Log File link (at bottom)	Click to access a page from which to view adapter framework log files. See Also: " Oracle Application Server ProcessConnect Log Files " on page 18-10
Integration Manager Log File link (at bottom)	Click to access a page from which to view integration manager log files. See Also: " Oracle Application Server ProcessConnect Log Files " on page 18-10
ProcessConnect UI Tool link (in OC4J Instance section)	Click to access the Oracle Application Server ProcessConnect user interface tool login page from which you can design and deploy an integration.
Server Properties link (at bottom)	Click to access a page from which you can view and edit Oracle Application Server ProcessConnect configuration parameters in the metadata repository. See Also: " Oracle Application Server ProcessConnect Middle-Tier Instance Configuration Parameters " on page 18-11
Performance link (at bottom)	Click to access a page from which you can view integration manager and adapter framework performance. See Also: " Oracle Application Server ProcessConnect Middle-Tier Instance Performance " on page 18-13

See Also: *The Oracle Application Server 10g Administrator's Guide* for details about viewing log files and troubleshooting OC4J instance issues

Oracle Application Server ProcessConnect Log Files

Oracle Application Server components such as Oracle Application Server ProcessConnect generate log files describing all types of events, including startup and shutdown details, errors, warning messages, access details on HTTP requests, and so on. You can view adapter framework and integration manager log files for Oracle Application Server ProcessConnect (for this example, integration manager logs are selected).

1. Ensure that you followed the instructions in "[Oracle Application Server ProcessConnect Monitoring and Administration Tasks](#)" on page 18-8 to access the page for viewing log files.

The View Logs page appears.

View Logs

Page Refreshed Jun 12, 2003 5:00:20 PM

Log Files [Search Log Repository](#)

The Log Files tab lists the log files for this application server. View a log file by clicking on the Log File name in the search results table.

Advanced Search Simple Search

Available Components

- BC4J
- DCM
- Enterprise Manager
- HTTP_Server
- Log Loader
- OC4J_Demos
- OC4J_ProcessConnect**
- OPMN
- Universal Installer
- home

Selected Components

ProcessConnect

Filter By Log File Attributes

Attribute	Value	Delete
Component Name	Integration Manager	
Log File Attribute	OPMN Process Set	Add Another Row

Results: 1 Log Entries Retrieved

Component Type	Component Name	Log Type	Log File	Modified	Size (bytes)
ProcessConnect	Integration Manager	Process	log.xml	June 12, 2003 10:24:20 AM PDT	6753

2. Select components for which to generate log details in the **Available Components** list.
3. Use the **Move** arrows to move selected components to the **Selected Components** list.
4. Click **Search**.
A list of log files appears in the **Results** table.
5. Click a specific log to view in the **Log File** column.

See Also: *Oracle Application Server 10g Administrator's Guide* and the online help for details about viewing log files

Oracle Application Server ProcessConnect Middle-Tier Instance Configuration Parameters

You can edit parameters settings for logging levels, security, number of role threads, trading partner (B2B) properties, and so on. These parameters also display in a file called `tip.properties`. However, Oracle recommends that you edit these parameters only through the Server Properties page. Do not edit these parameters by accessing the `tip.properties` file from the directory path location and using an ASCII editor. [Figure 18-3](#) shows the upper portion of the page for viewing and editing configuration parameters.

Figure 18–3 Oracle Application Server ProcessConnect Middle-Tier Instance Configuration Parameters Page

Server Properties

Logging Properties

Log Type	<input type="text" value="ojdl"/>
Base Log Directory	<input type="text" value="/private/sabburi/midtier/ip/log"/>
Maximum Log Segment Size (bytes)	<input type="text" value="10000000"/>
Generic Log Level	<input type="text" value="ERROR"/>
Adapter Framework Log Level	<input type="text" value="ERROR"/>
Integration Manager Log Level	<input type="text" value="ERROR"/>
User Interface Log Level	<input type="text" value="ERROR"/>
Logger Threads	<input type="text" value="1"/>

B2B Properties

RMI Port	<input type="text" value="1110"/>
RMI Instance	<input type="text" value="IP"/>
Workflow Listeners	<input type="text" value="1"/>
ProcessConnect Listeners	<input type="text"/>
Workflow Agent Name	<input type="text" value="OUTAGENT"/>
Wallet Location	<input type="text" value="file:/etc/ORACLE/WALLETS/sabburi/ora_wallet.txt/ora_wallet.txt"/>
Proxy Host	<input type="text"/>
Proxy Port	<input type="text"/>
Continue Validation On Error	<input type="text" value="true"/>

Import Properties

Import Directory	<input type="text" value="/private/sabburi/midtier/ip/import"/>
------------------	---

See Also: The online help for a description of parameters you can edit, their range of values, and the default values

Oracle Application Server ProcessConnect Middle-Tier Instance Performance

You can view details about integration manager and adapter framework performance in a specific Oracle Application Server ProcessConnect middle-tier instance, including:

- Transformation details, such as the average time to process a transformation, the maximum and minimum times to process a transformation, the size of the last transformation processed, and the number of transformations performed since the integration manager was started
- Translation details, such as the average time to process a translation, the maximum and minimum times to process a translation, the size of the last translation processed, and the number of translations performed since the integration manager was started
- Active application and trading partner details, such as the adapter used, the application name, the direction of the adapter interaction, the average adapter processing time, number of events processed, and number of event errors occurring since the adapter framework was started.

Figure 18–4 shows the performance page for a specific Oracle Application Server ProcessConnect middle-tier instance.

Figure 18–4 Oracle Application Server ProcessConnect Middle-Tier Instance Performance Page

The following performance statistics are calculated since startup of each component.

Integration Manager Performance

Transformation Performance

Average Transformation Time (msec)	7526.0
Maximum Transformation Time (msec)	9469
Minimum Transformation Time (msec)	5583
Size Of Last Transformation (bytes)	5222
Transformations Performed	2

Translation Performance

Average Translation Time (msec)	4884.5
Maximum Translation Time (msec)	7838
Minimum Translation Time (msec)	1931
Size Of Last Translation (bytes)	5222
Translations Performed	2

Adapter Framework Performance

Active Applications

Adapter	Application	Direction	Average Adapter Processing Time (msecs)	Events Processed
File_Adapter	FILEAPP1	Outbound	129.0	1
File_Adapter	FILEAPP1	Inbound	12964.0	1

Active Trading Partners

Adapter	Application	Direction	Average Adapter Processing Time (msecs)	Events Processed

Oracle Process Management Notification Management

You can access the `opmn.xml` file to modify the configuration of Oracle Process Management and Notification (OPMN). OPMN manages Oracle HTTP Server and OC4J processes within an application server instance, and passes events from different component instances to components interested in receiving them.

1. Ensure that you selected **Process Management** in Step 3 of "[Managing and Monitoring a Middle-Tier Instance from Oracle Enterprise Manager Application Server Control](#)" on page 18-5 to access the page for viewing and changing the `opmn.xml` file.

The Process Management page displays the contents of the `opmn.xml` file. You can perform various management tasks by modifying the properties in the `opmn.xml` file, including the following:

- Configuring timeout and retry values for stop, start, and restart operations
 - Configuring environment variables and options to send to components when you start or restart components
 - Setting logging levels for OPMN log files
2. Click the online help for additional details.

See Also: *Oracle Application Server 10g Administrator's Guide* for details about OPMN and the `opmn.xml` file

Oracle Application Server ProcessConnect Port Management

You can view Oracle Application Server ProcessConnect and Oracle Application Server component ports, and change some Oracle Application Server ports. However, it is strongly recommended that you not change Oracle Application Server ProcessConnect ports for this release.

1. Ensure that you selected **Ports** in Step 3 of "[Managing and Monitoring a Middle-Tier Instance from Oracle Enterprise Manager Application Server Control](#)" on page 18-5 to access the page for viewing and changing component ports.

The page listing component ports appears.

2. Click the **Component** title in the **Component** column to alphabetically arrange the order of ports by name.

The integration manager, adapter framework, and B2B components of Oracle Application Server ProcessConnect display the following details:

Component ▾	Type	Port In Use	Suggested Port Range	Configure
ProcessConnect	Integration Manager DMS Port	8777	8777-8900	
ProcessConnect	Adapter Framework DMS Port	8778	8777-8900	
ProcessConnect	B2B Engine RMI Port	1110	1110-1120	

- View details about ports, including the current port number and range of available ports.
- Click the **Configure** column for a port that you want to change. Only ports with the pencil icon in the **Configure** column can be changed.
- Follow the instructions on the page that displays to change the component port. Click the online help for additional details.

If you install additional application adapters included on the Oracle Application Server ProcessConnect software CD-ROM, the following components and port numbers also display in this list:

Component	Assigned Port Range	Default Port Number
Actional Agent ¹	20300 - 20350	20300
Actional Listener ¹	4550 - 4599	4550
Attunity Adapters (Legacy Adapters) ²	2550 - 2577	2552

¹ Actional agent and listener ports apply to the Oracle Application Server Integration Adapter for SAP R/3, Oracle Application Server Integration Adapter for Peoplesoft 8, Oracle Application Server Integration Adapter for Siebel 2000, and Oracle Application Server Integration Adapter for J.D. Edwards.

² Attunity adapter ports apply to the Oracle Application Server Integration Adapter for IM/STM, Oracle Application Server Integration Adapter for IMS/DB, Oracle Application Server Integration Adapter for CICS Adapter, Oracle Application Server Integration Adapter for VSAM Adapter, and the Oracle Application Server Integration Adapter for Tuxedo.

See Also: "[Port Changing Error Message](#)" on page 18-19 for the type of error message you receive if you attempt to start Oracle Application Server ProcessConnect components, but another component is already using the assigned port

Oracle Application Server and Enterprise Relationship Management

You can view and change details about the relationship between the selected Oracle Application Server instance and the rest of your enterprise. For example, you can view or change the Oracle Application Server Metadata Repository schema and passwords used by your Oracle Application Server components.

1. Ensure that you selected **Infrastructure** in Step 3 of "[Managing and Monitoring a Middle-Tier Instance from Oracle Enterprise Manager Application Server Control](#)" on page 18-5 to access the page for managing the following details about the selected Oracle Application Server instance and the rest of your enterprise:

Section	Enables You To...
Identity Management	Associate the Oracle Application Server instance with an initial Oracle Internet Directory instance or change an association to a different Oracle Internet Directory instance
Database Managed Oracle Application Server Clusters	Use Oracle Application Server clusters
Metadata Repository	Review or modify the Oracle Application Server Metadata Repository schema and passwords used by the Oracle Application Server components

2. Click the online help for additional details.

See Also: *Oracle Application Server 10g Administrator's Guide* for specific details

Starting and Stopping Oracle Application Server ProcessConnect Components with OPMN

You can also start and stop the adapter framework, integration manager, and OC4J instance components of Oracle Application Server ProcessConnect from the operating system command prompt using OPMN.

To stop the adapter framework, integration manager, and OC4J instance individually:

1. Enter the following commands at your operating system command prompt to stop the adapter framework, integration manager, and OC4J instance.

```
prompt> opmnctl stopproc process-type=AdapterFramework
```

```
prompt> opmnctl stopproc process-type=IntegrationManager
```

```
prompt> opmnctl stopproc process-type=OC4J_ProcessConnect
```

To start the adapter framework, integration manager, and OC4J instance individually:

1. Enter the following commands at your operating system command prompt to start the adapter framework, integration manager, and OC4J instance.

```
prompt> opmnctl startproc process-type=AdapterFramework
```

```
prompt> opmnctl startproc process-type=IntegrationManager
```

```
prompt> opmnctl startproc process-type=OC4J_ProcessConnect
```

To start and stop the adapter framework, integration manager, and OC4J instance together:

1. Enter the following commands at your operating system command prompt to start or stop the adapter framework, integration manager, and OC4J instance together.

```
prompt> opmnctl startproc ias-component=ProcessConnect
```

```
prompt> opmnctl stopproc ias-component=ProcessConnect
```

See Also: The *Oracle Application Server 10g Administrator's Guide* located in the Oracle Application Server 10g Documentation Library for details on OPMN

Additional Oracle Application Server and Oracle Application Server ProcessConnect Management Tasks

[Table 18–2](#) describes additional Oracle Application Server administration tasks that also relate to Oracle Application Server ProcessConnect. References to documentation that describes these tasks are also provided.

Table 18–2 Additional Oracle Enterprise Manager Tasks

Task	See Also
Configure an Oracle Application Server instance to use Infrastructure Services.	<i>Oracle Application Server 10g Administrator's Guide</i>
Installing and configuring Oracle Application Server for high availability (including Oracle Application Server Cold Failover Cluster and Oracle Application Server Active Failover Cluster)	<i>Oracle Application Server 10g Installation Guide</i>
Changing internet protocol (IP) addresses and hostnames for an Oracle Application Server host	<i>Oracle Application Server 10g Administrator's Guide</i>
Viewing and changing ports	<i>Oracle Application Server 10g Administrator's Guide</i> "Oracle Application Server ProcessConnect Port Management" on page 18-14 "Changing Port Numbers" on page 18-19
Using the dynamic host configuration protocol (DHCP) in Windows and Linux environments.	<i>Oracle Application Server 10g Administrator's Guide</i>
Configuring Oracle HTTP Server for secure socket layer (SSL) and secure HTTP	<i>Oracle HTTP Server Administrator's Guide</i>
Configuring OC4J for secure socket layer (SSL) and secure HTTP	<i>Oracle Application Server 10g Security Guide</i>
Configuring fire walls and load balancing	<i>Oracle Application Server 10g High Availability Guide</i>

Changing Port Numbers

Oracle Enterprise Manager uses dynamic monitoring services (DMS) ports to gather performance data about Oracle Application Server components. For this release, Oracle Application Server ProcessConnect does not seamlessly support the use of dynamic ports. Instead, static port numbers assigned during installation are used for gathering performance data. Changing a port number is a complicated procedure. Oracle strongly recommends that you do not change port numbers. Instead, find the process that uses the integration manager or adapter framework ports, and stop that process (or whatever else is required to free that port). However, if you must change the port number, follow the instructions in this section.

This section contains these topics:

- [Port Changing Error Message](#)
- [Modifying Ports](#)

See Also:

- *Oracle Application Server 10g Performance Guide* for additional details about DMS
- "[Oracle Application Server ProcessConnect Monitoring and Administration Tasks](#)" on page 18-8 for instructions on stopping Oracle Application Server ProcessConnect processes

Port Changing Error Message

This error message occurs when you attempt to start Oracle Application Server ProcessConnect components, but another component is already using the assigned port:

```
isunrak21(17:45:03):/private/sabburi/m13/opmn/bin % opmnctl startproc
process-type=IntegrationManager
opmnctl: starting opmn managed processes...
```

```
=====
opmn id=isunrak21:6200
  0 of 1 processes started.

ias-instance id=m13.isunrak21

+++++
ias-component/process-type/process-set:
```

```
ProcessConnect/IntegrationManager/m13.isunrak21
```

```
Error
--> Process (pid=0)
    failed to start a managed process after the maximum retry limit
    no port available from the port range
    no port available from the port range
    Log:
    none
```

Modifying Ports

If you must change the port number, follow these instructions.

1. Make backup copies of the `opmn.xml` and `targets.xml` files to be modified in these procedures before you begin.
2. Stop all OPMN and Oracle Enterprise Manager processes:

```
emctl stop em
opmnctl stopall
```

3. Open the `$ORACLE_HOME/opmn/conf/opmn.xml` file.
4. Modify the `range` attribute of the `port` element for the corresponding Oracle Application Server ProcessConnect component.

```
<process-type id="IntegrationManager"
  module-id="integration-manager"working-dir="$ORACLE_HOME/ip">
  <port id="dms" range="8777"/>
  <process-set id="m14_midtier.isunrak23" numprocs="1"/>
  <start timeout="3600"/>
  <stop timeout="3600"/>
</process-type>
<process-type id="AdapterFramework" module-id="adapter-framework"
  working-dir="$ORACLE_HOME/ip">
  <port id="dms" range="8778"/>
  <process-set id="m14_midtier.isunrak23" numprocs="1"/>
  <start timeout="3600"/>
  <stop timeout="3600"/>
</process-type>
```

5. Open `$ORACLE_HOME/sysman/emd/targets.xml` and go to the integration manager or adapter framework section.

6. Change the "HTTPPort" attribute to the port you specified in opmn.xml in Step 4.

```
<Target TYPE="oracle_processconnect_im" NAME="m14_midtier.isunrak23_
IntegrationManager"
  VERSION="3.0">
  <Property NAME="OracleHome" VALUE="" />
  <Property NAME="HTTPPort" VALUE="8777" />
  <Property NAME="HTTPMachine" VALUE="isunrak23" />
  <Property NAME="OPMNPport" VALUE="6003" />
  <CompositeMembership>
    <MemberOf TYPE="oracle_processconnect_instance"
NAME="m14_midtier.isunrak23_ProcessConnect_Instance" />
  </CompositeMembership>
</Target>

<Target TYPE="oracle_processconnect_af" NAME="m14_midtier.isunrak23_
AdapterFramework"
  VERSION="3.0">
  <Property NAME="OracleHome" VALUE="/home/msarma/M14_
midtier/OracleHome" />
  <Property NAME="EmptyOracleHome" VALUE="" />
  <Property NAME="HTTPPort" VALUE="8778" />
  <Property NAME="HTTPMachine" VALUE="isunrak23" />
  <Property NAME="OPMNPport" VALUE="6003" />
  <Property NAME="OidRepSchemaName" VALUE="IP" />
  <CompositeMembership>
    <MemberOf TYPE="oracle_processconnect_instance"
NAME="m14_midtier.isunrak23_ProcessConnect_Instance" />
  </CompositeMembership>
</Target>
```

7. Run the following command:

```
$ORACLE_HOME/dcm/bin/dcmctl updateConfig
```

8. Restart OPMN (and the Oracle Enterprise Manager Application Server Control, if you are using it).

```
opmnctl startall
emctl start iasconsole
```

See Also: *Oracle Application Server 10g Administrator's Guide* for details about integration manager and adapter framework port ranges

Chapter Summary

This chapter explains how to use Oracle Enterprise Manager to manage Oracle Application Server ProcessConnect (for example, starting and stopping the integration manager, adapter framework, or OC4J instance components, viewing log files, viewing log files, or editing configuration parameters).

Performance Tuning

This chapter describes how to manage the performance of components of the Oracle Application Server ProcessConnect, including the adapter framework, integration manager, and metadata repository.

This chapter contains these topics:

- [Performance Factors in Oracle Application Server ProcessConnect](#)
- [Components of an Oracle Application Server ProcessConnect Instance](#)
- [Diagnosing Performance Issues in Oracle Application Server ProcessConnect](#)
- [Adapter Framework Performance](#)
- [Tuning the Adapter Framework](#)
- [Tuning Technology Adapters](#)
- [Integration Manager Performance](#)
- [Tuning the Integration Manager](#)
- [Design Tool Performance](#)
- [Metadata Repository Tuning](#)

Performance Factors in Oracle Application Server ProcessConnect

ProcessConnect performance is affected by the following:

- The number of events being processed
- The number of steps and the complexity of the steps involved in processing each event
- The size and complexity of the events themselves

In general, when ProcessConnect is required to process a large number of events, in which each event has a large number of steps to process, a bottleneck is likely to occur in either the adapter framework or the integration manager. When ProcessConnect is required to parse, translate, and transform very large events, a bottleneck is likely to occur in either the translation binding role or the transformation binding role.

The following sections discuss bottlenecks in ProcessConnect components and tuning you can do to the components.

Components of an Oracle Application Server ProcessConnect Instance

In an Oracle Application Server ProcessConnect instance, the adapter framework, integration manager, and Oracle Application Server Containers for J2EE (OC4J) communicate with the back-end Oracle Application Server Metadata Repository (an Oracle database). These components are shown in [Figure 19-1](#).

Figure 19–1 Oracle Application Server ProcessConnect Components

Application Server: [iasmid.dsunram11.us.oracle.com](#) > ProcessConnect Instance: [iasmid.dsunram11.us.oracle.com_ProcessConnect_Instance](#)
ProcessConnect Instance: [iasmid.dsunram11.us.oracle.com_ProcessConnect_Instance](#)
 Refreshed at Friday, May 2, 2003 4:40:58 PM PDT

Summary		Adapter Framework	
Status	Up	Status	Up
Version	9.0.4	Start Time	Friday, May 2, 2003 7:03:11 AM PDT
Host	dsunram11.us.oracle.com	CPU Usage	0 %
Oracle Home	/home/guest/iasmid	Memory Usage	79.79 MB
OC4J Instance		Integration Manager	
Status	Up	Status	Up
Name	iasmid.dsunram11.us.oracle.com_OC4J_ProcessConnect	Start Time	Friday, May 2, 2003 7:03:11 AM PDT
Start Time	Friday, May 2, 2003 7:03:11 AM PDT	CPU Usage	0 %
CPU Usage	0 %	Memory Usage	82.05 MB
Memory Usage	114 MB	Administration	
Related Links	ProcessConnect UI Tool	Performance	Server Properties
		Integration Manager Log File	Adapter Framework Log File

An adapter framework instance communicates with one or more parties using the party's respective adapter. For example, an adapter framework instance that communicates with an application that uses Oracle Advance Queuing will use the Advanced Queuing adapter. The adapter framework is responsible for receiving inbound messages and delivering outbound messages to the adapters.

The integration manager is responsible for executing the business processes (which include roles and steps) for all deployed and active configurations.

See Also: [Chapter 18, "System Management with Oracle Enterprise Manager"](#) for information about the OC4J instance

Diagnosing Performance Issues in Oracle Application Server ProcessConnect

To ensure that Oracle Application Server ProcessConnect meets the requirements for performance and scalability required by mission-critical systems, ProcessConnect and its various services—the adapter framework, the integration manager, and translation and transformation services—are designed to be stateless. All states are written to the ProcessConnect runtime repository. As a result, ProcessConnect and its various services can be configured to meet additional scalability and throughput requirements by adding threads or instances depending

on where the bottleneck is. You can configure these parameters from the Server Properties link on the ProcessConnect instance page of the Oracle Enterprise Manager Application Server Control. Oracle Enterprise Manager Application Server Control can be used to diagnose performance and scalability bottlenecks.

To diagnose performance bottlenecks within ProcessConnect:

1. Use Oracle Enterprise Manager Application Server Control to examine CPU and memory usage.
2. If CPU usage is high, that is, if more than 80% of the CPU is consumed, then there is a resource bottleneck, which can be either the adapter framework or integration manager.
3. Use the ProcessConnect instance page from the Oracle Enterprise Manager Application Server Control to examine the CPU consumed by the adapter framework and integration manager to determine which one is the potential bottleneck.
4. Click the Performance link (under the Administration section) for performance statistics on translation, transformation, active applications, and active trading partners.

The following sections describe adapter framework, integration manager, and design tool performance and tuning.

Adapter Framework Performance

Adapter framework performance is affected by:

- The number of adapter types loaded
- The rate at which messages are entering and leaving the system

These factors affect memory and CPU usage for the adapter framework instance. You can view memory and CPU usage in the Oracle Enterprise Manager Application Server Control, as shown in [Figure 19-1](#).

See Also: [Chapter 18, "System Management with Oracle Enterprise Manager"](#)

Each adapter framework instance has one or more threads to handle inbound and outbound messages. The inbound threads are created by the specific adapter and are not controlled by the adapter framework. Refer to specific adapter documentation to tune the performance of incoming messages.

See Also: ["Applications and Adapters"](#) on page 3-51 for a discussion of adapters, and the following adapter-specific documents on controlling inbound threads:

- *Oracle Application Server Integration Adapter for CICS Installation and User's Guide*
- *Oracle Application Server Integration Adapter for IMS/DB Installation and User's Guide*
- *Oracle Application Server Integration Adapter for IMS/TM Installation and User's Guide*
- *Oracle Application Server Integration Adapter for J.D. Edwards OneWorld XE User's Guide*
- *Oracle Application Server Integration Adapter for PeopleSoft 8 User's Guide*
- *Oracle Application Server Integration Adapter for SAP R/3 User's Guide*
- *Oracle Application Server Integration Adapter for Siebel 2000 User's Guide*
- *Oracle Application Server Integration Adapter for Tuxedo Installation and User's Guide*
- *Oracle Application Server Integration Adapter for VSAM Installation and User's Guide*

The adapter framework outbound processor threads pick up messages that have been processed by the integration manager and deliver them to the adapters. You can configure adapter parameters by editing the `OutboundProcessorThreads` property. Access the parameters from the Server Properties link of the Oracle Enterprise Manager Application Server Control ProcessConnect instance page.

See Also: ["Oracle Enterprise Manager Application Server Control Tasks"](#) on page 18-4

As [Figure 19-2](#) shows (in the bottom portion), you can view adapter framework performance details in Oracle Enterprise Manager Application Server Control.

Figure 19–2 Adapter Interaction and Performance Details

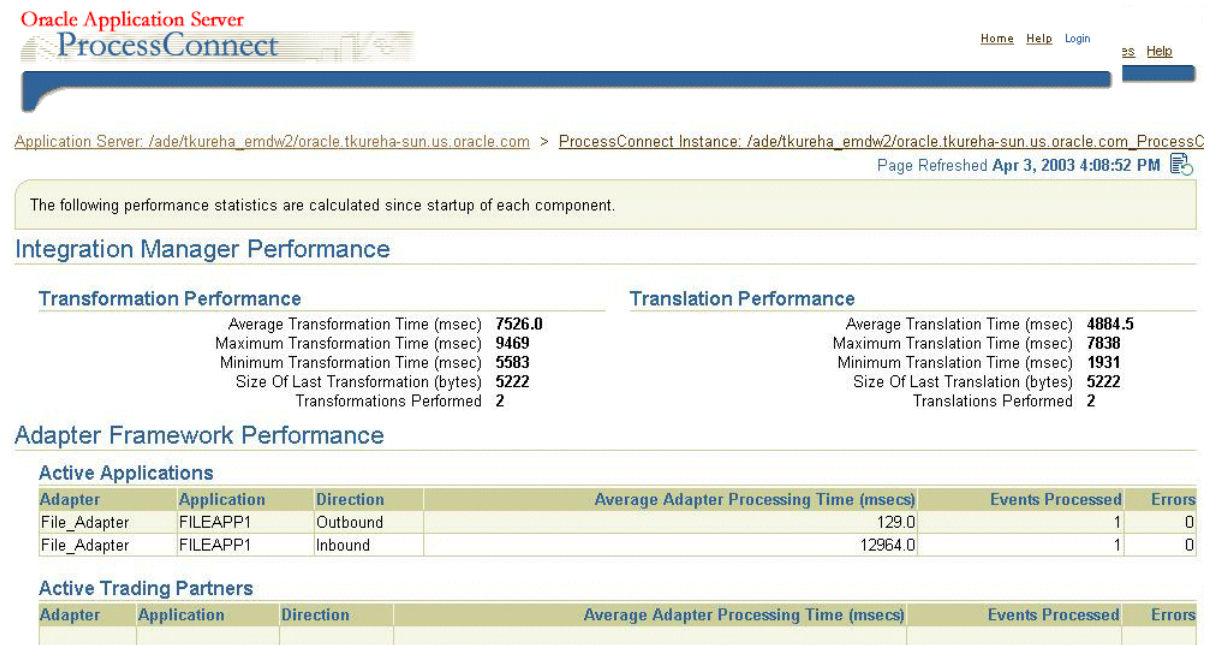

Tuning the Adapter Framework

Adapter framework performance can be tuned by appropriately setting the Java Virtual Machine (JVM) memory size and the number of outbound processor threads. If the message rate is high and the adapter framework is not processing messages at an acceptable rate, then you can tune the adapter framework as described in ["Increasing JVM Memory for the Adapter Framework"](#) on page 19-7.

If the adapter framework CPU usage is high, you may need additional adapter framework instances on different hosts connecting to the same Oracle Application Server Metadata Repository.

See Also: *Oracle Application Server ProcessConnect Installation Guide* for installing adapter framework instances

Increasing JVM Memory for the Adapter Framework

Figure 19–3 shows the Oracle Enterprise Manager Application Server Control, with the Process Management link at the bottom of the screen.

Figure 19–3 Oracle Enterprise Manager Application Server Control

Application Server: /ade/iptest_em01/oracle.dsunram24.us.oracle.com
 Application Server: /ade/iptest_em01/oracle.dsunram24.us.oracle.com

Home [J2EE Applications](#) [Ports](#) [Infrastructure](#)

Page Refreshed May 22, 2003 2:31:09 PM

General



Status **Partially Up**
 Host [dsunram24.us.oracle.com](#)
 Oracle Home **/ade/iptest_em01/oracle**

CPU Usage



Application Server (1%)
 Idle (66%)
 Other (33%)

Memory Usage



Application Server (19% 394MB)
 Free (31% 638MB)
 Other (50% 1,016MB)

System Components

Select All | Select None

Select	Name	Status	Start Time	CPU Usage (%)	Memory Usage (MB)
<input type="checkbox"/>	home	↓			
<input type="checkbox"/>	HTTP_Server	↑	May 20, 2003 4:11:17 PM	0.02	27.46
<input checked="" type="checkbox"/>	JServ	↓			
<input type="checkbox"/>	OC4J_EM	↑	May 20, 2003 4:11:28 PM	0.79	267.03
<input checked="" type="checkbox"/>	OID	↓			
<input type="checkbox"/>	ProcessConnect	↓			
<input type="checkbox"/>	WebCache	↓			

TIP This table contains only the enabled components of the application server. Only components that have the checkbox enabled can be started or stopped.

Related Links [Process Management](#)

To increase JVM memory, from the Oracle Enterprise Manager Application Server Control, do the following:

1. Click Process Management.
2. In the `opmn.xml` file window, increase the heap size by changing 512 to 1024, as shown in line 4:

```
1 <process-type id="AdapterFramework" module-id="adapter-framework"
```

```
working-dir="$ORACLE_HOME/ip">
2  <module-data>
3  <category id="start-parameters">
4  <data id="java-parameters" value="-Xms8M -Xmx1024M"/>
    .
    .
    .
</process-type>
```

Increasing the Outbound Processor Threads

Increasing the number of outbound processor threads can improve performance when the adapter framework CPU usage is less than 60%.

To increase the number of outbound processor threads, from the Oracle Enterprise Manager Application Server Control, do the following:

1. Click ProcessConnect from the System Components table.
2. If the adapter framework CPU usage is less than 60%, click Server Properties.
3. Increase the number in the Outbound Processor Threads field (under Advanced Properties).

The property should be set between 1 and 5.

Tuning Technology Adapters

How you use the technology adapters affects the performance and scalability of Oracle Application Server ProcessConnect. This section discusses the best practices for using the most commonly used adapters—the Advanced Queuing (AQ) adapter, the Oracle Database adapter, and the File/FTP adapter.

See Also: [Chapter 8, "Oracle Application Server ProcessConnect Technology Adapters"](#) for adapter details

Advanced Queuing Adapter

The following guidelines apply to the Advanced Queuing adapter:

- In general, raw queues perform better. If you are using Oracle Object queues or Oracle Object queues with a payload field, the complexity of the object affects performance. For example, the larger the number of LOBS in the object, the more performance will decrease.

See Also: *Oracle Streams Advanced Queuing User's Guide and Reference*

- Multiconsumer queues may be slower than single-consumer queues because of the extra processing involved in multiconsumer queues.
- In Oracle Application Server ProcessConnect, two parameters can be tuned for better performance:
 - The maximum time in milliseconds to block waiting for an event :
`oracle.tip.runtime.eventselector_timeout=n`
Setting this to a high value improves performance, but increases the time it takes to shut down the integration manager.
 - The number of inbound threads for the Advanced Queuing adapter :
`oracle.tip.af.aq.threads=n`
Setting this to a high value improves performance if multiple processors are available.

Oracle Database Adapter

The following guidelines apply to the Oracle Database adapter:

- Performance is affected by the structure of the table. The simpler the fields of the table, the faster it processes at runtime.
- Optimizing the query defined in the inbound interaction that retrieves the records in the inbound direction (at runtime) improves performance.
- If the update option is chosen for an inbound interaction, then specify the required columns explicitly in the `SELECT` clause of the SQL statement defining the interaction. This excludes the status columns that are updated by the adapter and improves performance.

File/FTP Adapter

The following guidelines apply to the inbound interaction when using the File/FTP adapter:

- Choose a polling interval that closely reflects the rate of incoming files. If files are coming in quickly, then the default polling interval of 60 seconds may be too slow.

- For the number of files retrieved per polling interval parameter, specify a number that is greater than or equal to the number of files expected to come in. Choosing a number that is far less than the rate of incoming files results in poor performance.

Integration Manager Performance

As [Figure 19–1](#) shows, you can view memory and CPU usage for the integration manager in the Oracle Enterprise Manager Application Server Control.

Integration manager performance is affected by the following:

- The complexity of the role in the business process, particularly the number of transformation and translation steps
- The size of the messages
- The rate at which messages enter the system
- The BI reporting level set during configuration deployment

Using Enterprise Manager to Configure the Number of Threads

The integration manager has five thread pools for role processing and error handling. You can configure the number of threads in each pool by editing the following parameters. In general, increasing the values of the following parameters can improve performance, although performance increases are bounded by the capacity of your computer to handle many threads. Access the parameters from the **Server Properties** link of Oracle Enterprise Manager Application Server Control.

- Native role threads

Native Role Threads handle the steps in the native roles. The number of threads should be between 1 and 5. The default is 2.

- Binding role threads

Binding Role Threads handle the steps in the translation and transformation binding roles. This thread pool should have at least double the number of threads in the other pools; that is, it should be between 2 and 10. The default is 4.

- Application role threads

Application Role Threads execute the steps in the application roles. This number should be between 1 and 5. The default is 2.

- **Business role threads**

`Business Role Threads` execute the steps in the business roles. This number should be between 1 and 5. The default is 2.

- **Business process role threads**

`Business Process Role Threads` execute the steps in the business process roles. This number should be between 1 and 5. The default is 2.

- **System logger thread**

`System Logger Threads` are used to log system errors. This should be set between 1 and 3. The default is 1.

- **Event selector timeout**

`oracle.tip.runtime.eventselector_timeout`

This parameter determines the maximum time the role processor threads block waiting for an event. Setting this to a high value (30-60 seconds) improves performance, but increases the time it takes to shut down the integration manager. The default is 5 seconds.

See Also: [Chapter 18, "System Management with Oracle Enterprise Manager"](#)

Using Enterprise Manager to View Transformation and Translation Performance

In general, transformation and translation are the most CPU- and memory-intensive operations in the integration manager. You can view transformation and translation performance in Oracle Enterprise Manager Application Server Control, as shown in [Figure 19-4](#). Based on the transformation and translation performance, you can determine if the number of binding role threads in the `Binding Role Threads` parameter should be increased.

Figure 19–4 Transformation and Translation Performance

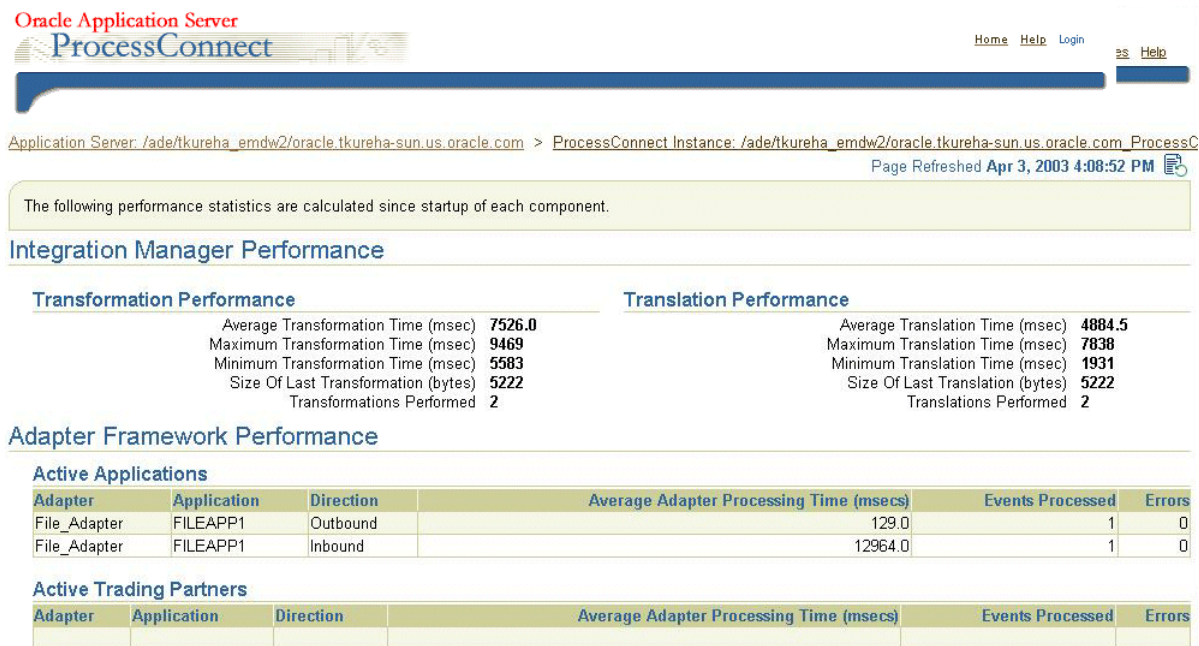

Tuning the Integration Manager

If the integration manager is not processing messages at an acceptable rate, then you can do the following:

- Monitor transformation and translation performance
- Increase the number of concurrent transformations and translations
- Choose the appropriate BI reporting level during deployment
- Add more integration manager instances

You can monitor transformation and translation performance through Oracle Enterprise Manager Application Server Control, as shown in [Figure 19–4](#). In general, transformation and translation performance depend on the size of the message and the number of transformation rules. For large messages, you may need to increase the JVM memory for the integration manager. The required memory is as follows:

100 x number of binding role threads x size of payload (in MB)

Increasing JVM Memory for the Integration Manager

To increase JVM memory, from the Oracle Enterprise Manager Application Server Control (see [Figure 19-3](#)), do the following:

1. Click Process Management.

The `opmn.xml` file window is displayed.

Application Server: iasmid.isunrak21 > Process Management

Process Management



Warning

No validation is done on the correctness of any edits you make to the `opmn.xml` file. Be sure you carefully check you before proceeding.

This configuration file is located at `/private/sabburi/midtier/opmn/conf/opmn.xml`

```
<variable id="CLASSPATH" value="$ORACLE_HOME/ip/adapters/midregacyadapters.jar" append="true" />
<variable id="CLASSPATH" value="$ORACLE_HOME/ip/adapters/lib/appadapters.jar" append="true" />
<variable id="CLASSPATH" value="$ORACLE_HOME/ip/config" append="true" />
</environment>
<process-type id="IntegrationManager" module-id="integration-manager" working-dir="$ORACLE_HOME/ip">
  <module-data>
    <category id="start-parameters">
      <data id="java-parameters" value="-Xms8M -Xmx512M" />
    </category>
    <category id="stop-parameters">
      <data id="java-parameters" value="-Xms8M -Xmx512M" />
    </category>
  </module-data>
  <port id="dms" range="8777" />
</process-type>
```

2. In the `opmn.xml` file window, increase the heap size by changing 512 to 1024, as shown in line 4:

```
1 <process-type id="IntegrationManager" module-id="integration-manager"
working-dir="$ORACLE_HOME/ip">
2   <module-data>
3     <category id="start-parameters">
4       <data id="java-parameters" value="-Xms8M -Xmx1024M" />
      .
      .
      .
    </process-type>
```

Increasing the Binding Role Threads

Increasing the number of concurrent translations and transformations by increasing the number the binding role threads can also improve performance.

To increase the number of binding role threads, from the Oracle Enterprise Manager Application Server Control do the following:

1. Click ProcessConnect from the System Components table.
2. Click Server Properties.
3. Increase the number in the Binding Role Threads field.

The property should be set between 2 and 10.

See Also: ["Binding role threads"](#) on page 19-10

If the application roles, native roles, business roles, and business process roles have complex roles, then you may need to increase the size of their respective thread pools.

See Also: ["Using Enterprise Manager to Configure the Number of Threads"](#) on page 19-10

Finally, to improve performance, you can add integration manager instances connecting to the same Oracle Application Server Metadata Repository if the integration manager CPU usage is greater than 80%.

See Also: *Oracle Application Server ProcessConnect Installation Guide* for installing integration manager instances

Setting the Appropriate BI Reporting Level

The BI reporting level controls the amount of instance state that is logged by the integration manager while executing the deployed business processes. This information is used by the ProcessConnect process monitoring and activity monitoring reports. By default the BI reporting level is set to high during deployment. When the BI reporting level is set to high, all reports are fully functional. Setting the BI reporting level to low reduces database activity and hence gives better performance. In some cases there can be up to a 2x performance improvement with a low BI reporting level. However, in this mode, some reports are not available.

See Also: [Chapter 23, "Creating Reports"](#) for details on the reports available with various BI levels

Design Tool Performance

The design tool runs as part of the OC4J instance. The performance of the design tool is determined by the number of concurrent users and the complexity of the integration scenario.

Creating and deploying configurations are memory-intensive tasks. These tasks can take around 5 to 20 minutes. If the tasks are considerably slower, then you may need to increase the JVM heap size (the default is 512M) for the OC4J instance.

Increasing JVM Memory for the OC4J Instance

To increase JVM memory, from the Oracle Enterprise Manager Application Server Control (see [Figure 19-3](#)), do the following:

1. Click Process Management.
2. In the `opmn.xml` file window, increase the heap size by changing 512 to 1024, as shown in line 4:

```

1 <process-type id="OC4J_ProcessConnect" module-id="OC4J">
2   <module-data>
3     <category id="start-parameters">
4       <data id="java-options"
value="-Djava.security.policy=/private/sabburi/midtier/j2ee/OC4J_
ProcessConnect/config/java2.policy-Djava.awt.headless=true -Xms32M
-Xmx1024M"/>
       .
       .
       .
     </category>
   </module-data>
 </process-type>

```

If you have memory starvation or contention issues, you can do the following:

1. If you are not executing any active configurations, shut down the integration manager and adapter framework.
2. Design and deploy your configurations.
3. Restart the integration manager and adapter framework.

If Oracle Identity Management is not used and if the OracleAS Infrastructure 10g runs on the same machine, you can do the following:

1. In the Oracle home corresponding to the back-end infrastructure repository, shut down all OPMN-managed processes related to the OracleAS Infrastructure 10g. (If Oracle Identity Management is used, then the OPMN-managed OID and OC4J security processes are required for ProcessConnect to run.)

Metadata Repository Tuning

The Oracle Application Server ProcessConnect database schema and integration metadata are stored in the metadata repository of OracleAS Infrastructure 10g. The metadata repository is used by the Oracle Application Server ProcessConnect design tool and runtime components to access the integration metadata and record execution state. Hence it is critical that the infrastructure database is tuned for maximum performance.

See Also: *Oracle9i Database Performance Guide and Reference, Part IV*, for details on gathering database performance statistics using the STATSPACK tool

The following are most relevant for ProcessConnect performance:

- [Memory Configuration](#)
- [I/O Contention](#)
- [Undo and Temporary Tablespaces](#)

Memory Configuration

Proper sizing and effective use of the Oracle memory caches greatly improve database performance.

- The `shared_pool` parameter controls the memory available for the library cache and the dictionary cache. This should be set to at least 35 MB for optimal performance.
- The `db_cache_size` parameter controls the memory available for the buffer cache. This memory is used to cache blocks read from disk. This should be set to at least 50 MB for good performance.

I/O Contention

By default, the repository database is installed on a single disk. If your ProcessConnect integration is I/O constrained, you may see some benefit by distributing the I/O across multiple disks.

On Solaris, use `iostat -xtcn` to see the per-disk activity. If the disk containing the repository database is 50% or more busy, then it is a good candidate for I/O distribution. The redo logs probably generate the most I/O, so try moving them to a different disk first. You can also use `statspack` to identify tablespaces with high I/O activity that may also be candidates for moving to different disks.

Undo and Temporary Tablespaces

Oracle provides automatic undo management, which automates the management of undo data. A database running in automatic undo management mode transparently creates and manages undo segments. Oracle strongly recommends using automatic undo management, because it significantly simplifies database management and in general gives better performance.

Configuring the temporary tablespace helps optimize disk sort performance. This involves choosing good storage clauses and the correct type of tablespace to use for sorting.

See Also: *Oracle9i Database Performance Guide and Reference, Part III*, for details on configuring the database for good performance

Oracle Application Server ProcessConnect Security

The ability to control user access to Web content and to protect your site against people breaking into your system is critical. This chapter describes the architecture and configuration of security for Oracle Application Server ProcessConnect.

This chapter contains these topics:

- [About Oracle Application Server ProcessConnect Security](#)
- [Configuring Oracle Application Server Security Framework for Oracle Application Server ProcessConnect](#)
- [Configuring Oracle Application Server ProcessConnect Security](#)
- [Chapter Summary](#)

See Also: The following documents for additional details about security:

- *Oracle Application Server 10g Security Guide* provides an overview of Oracle Application Server security and its core functionality
- *Oracle Identity Management Concepts and Deployment Planning Guide* for identity provides guidance for administrators of the Oracle security infrastructure

About Oracle Application Server ProcessConnect Security

This section describes the Oracle Application Server ProcessConnect security model. This section contains these topics:

- [Classes of Users and Their Privileges](#)
- [Resources Protected](#)
- [Authorization and Access Enforcement](#)
- [Use of Oracle Application Server Security Services](#)
- [Use of Oracle Identity Management Infrastructure](#)
- [Security for Oracle Application Server ProcessConnect Extensibility](#)

Classes of Users and Their Privileges

A single user named `admin` is automatically created during Oracle Application Server ProcessConnect installation. The password you specify for the Oracle Application Server administrator named `ias_admin` when prompted during Oracle Application Server ProcessConnect installation also becomes the initial password for the `admin` user.

The `admin` user consists of a single default user role named `Administrator`. The `Administrator` role consists of the use cases (privileges) that enable the `admin` user to use the Oracle Application Server ProcessConnect user interface tool to design, deploy, and manage integrations. The `Administrator` role is the only user role available with Oracle Application Server ProcessConnect. The `admin` user can create additional users to which to assign the `Administrator` role. A default organization name is also automatically created during Oracle Application Server ProcessConnect installation. This name is used to uniquely identify your organization or company. Along with the `admin` username and password, the organization name is required for connecting to the Oracle Application Server ProcessConnect user interface tool.

You can also administer portions of Oracle Application Server ProcessConnect through the Oracle Enterprise Manager Application Server Control. The password you specify for the Oracle Application Server administrator named `ias_admin` when prompted during Oracle Application Server ProcessConnect installation also becomes the initial password to use when logging in with the Oracle Enterprise Manager `ias_admin` username.

See Also: The following sections for instructions on performing these tasks:

- ["Creating a Person"](#) on page 25-16 to create additional users of the Oracle Application Server ProcessConnect user interface tool
- ["Adding a User Role to a Host Trading Partner Person"](#) on page 25-23 to add the Administrator role to a user
- ["Updating a Person"](#) on page 25-18 to update the admin user password
- ["Managing Organizations"](#) on page 25-11 to update the organization name
- [Chapter 18, "System Management with Oracle Enterprise Manager"](#) to monitor and administer Oracle Application Server ProcessConnect through Oracle Enterprise Manager

Resources Protected

The following security is provided for protecting resources:

- The modeling metadata and profile data that you design with the Oracle Application Server ProcessConnect user interface tool are protected by both the admin username and password and by the security provided by the Oracle database.
- Network messaging can be secured and encrypted using Oracle Advanced Security. Network messaging can also be secured by using secure HTTP for the Oracle Application Server ProcessConnect user interface tool.
- Adapters that enable communication between applications and Oracle Application Server ProcessConnect use the underlying security of their protocols (such as HTTP, FTP, and SMTP) to restrict access to data.
- Spoke (application) databases to which applications connect to access data are protected by username and password credentials that you specify when configuring a delivery channel for an application
- The messages that trading partners send and receive during integrations between enterprises are protected by the following levels of security:
 - Digital envelopes
 - Digital signatures for host and remote trading partners
 - Secure HTTP (using secure socket layer (SSL)) and client authentication

- Encrypted wallet password for a host trading partner

See Also: "[Oracle Application Server ProcessConnect Security Configuration](#)" on page 20-7 for an overview of security configuration for integrations between enterprises

Authorization and Access Enforcement

When you attempt to access the Oracle Application Server ProcessConnect user interface tool, you are prompted for a username, password, and `organization` name. Without knowledge of this connection information, you cannot access the user interface tool to design, deploy, and manage integrations within an enterprise and between enterprises.

Use of Oracle Application Server Security Services

Oracle Application Server provides a series of security services. Oracle Application Server ProcessConnect uses SSL. You can use SSL for securing connections between host and remote trading partners. SSL uses a public key infrastructure to provide authentication and data integrity. HTTP client security is also provided through SSL.

Secure HTTP can also be used to secure the Oracle Application Server ProcessConnect user interface tool.

See Also: *Oracle Application Server 10g Security Guide* for a description of Oracle Application Server security services

Use of Oracle Identity Management Infrastructure

This initial release of Oracle Application Server ProcessConnect does not require use of Oracle Identity Management infrastructure features; Oracle Identity Management is optionally selectable for use during Oracle Application Server ProcessConnect installation and is only used for product-specific password verifiers.

Security for Oracle Application Server ProcessConnect Extensibility

This initial release of Oracle Application Server ProcessConnect does not support any special security extensibility.

Configuring Oracle Application Server Security Framework for Oracle Application Server ProcessConnect

This section describes Oracle Application Server security options to configure to use Oracle Application Server ProcessConnect. This section contains these topics:

- [Oracle Application Server ProcessConnect Security Framework Configuration Issues](#)
- [Identity Management Configuration Issues Specific to Oracle Application Server ProcessConnect](#)

Oracle Application Server ProcessConnect Security Framework Configuration Issues

The Oracle Application Server ProcessConnect and Oracle Workflow schemas are protected by passwords created during OracleAS Infrastructure 10g installation. These schemas are stored in the metadata repository of OracleAS Infrastructure 10g to which you configure access during Oracle Application Server ProcessConnect installation. In addition, the data you design, deploy, and manage with Oracle Application Server ProcessConnect user interface tool is stored in this same metadata repository of OracleAS Infrastructure 10g.

See Also:

- *Oracle Application Server 10g Security Guide* for OracleAS Infrastructure 10g and Oracle Application Server security details, including how to configure the Oracle HTTP Server with secure HTTP
- *Oracle Application Server Containers for J2EE Security Guide*

Identity Management Configuration Issues Specific to Oracle Application Server ProcessConnect

This initial release of Oracle Application Server ProcessConnect does not use the identity management infrastructure. Therefore, there are no identity management configuration issues and options.

Configuring Oracle Application Server ProcessConnect Security

This section provides an overview of Oracle Application Server ProcessConnect installation and configuration issues. This section contains these topics:

- [Oracle Application Server ProcessConnect Installation](#)
- [Oracle Application Server ProcessConnect Security Configuration](#)
- [Host Trading Partner Password Encryption in High Availability Environments](#)
- [Configuration Issues and Options to Use for Oracle Application Server Security Framework](#)

Oracle Application Server ProcessConnect Installation

While you do not specify security parameters when installing Oracle Application Server ProcessConnect, the Oracle Application Server administrator must know the following information to install Oracle Application Server ProcessConnect:

- The name of the host on which the OracleAS Infrastructure 10g installation to use as the metadata repository is installed
- The specific OracleAS Infrastructure 10g installation on that specific host that includes the Oracle Application Server ProcessConnect schema
- The Oracle Application Server ProcessConnect and Oracle Workflow schema passwords automatically created during OracleAS Infrastructure 10g installation
- The `ias_admin` password specified during J2EE and Web Cache installation, which is used as the initial password for the Oracle Application Server ProcessConnect admin user and for the Oracle Enterprise Manager `ias_admin` user
- The `organization` name automatically assigned during Oracle Application Server ProcessConnect installation

See Also: *Oracle9 Application Server ProcessConnect Installation Guide* for installation instructions

Oracle Application Server ProcessConnect Security Configuration

You configure security with the Oracle Application Server ProcessConnect user interface tool after installation. Oracle Application Server ProcessConnect provides the following levels of security:

- [Application Delivery Channels](#)
- [Digital Envelopes](#)
- [Digital Signatures for Host and Remote Trading Partners](#)
- [Secure HTTP and Client Authentication](#)
- [Encrypted Wallet Passwords for Host Trading Partners](#)

See Also: ["Managing Trading Partner Agreements"](#) on page 26-14 to create a trading partner agreement to which to assign a trading partner with its delivery channel characteristics

Application Delivery Channels

Adapters enable communication between applications and Oracle Application Server ProcessConnect. The adapter of an application includes its own delivery channel security characteristics that you must define (such as login credentials for accessing hosts and backend databases). Oracle Application Server ProcessConnect stores information such as passwords in encrypted format. [Table 20-1](#) provides an overview of the tasks.

Table 20-1 *Application Delivery Channel Tasks*

Task	See...
Add an adapter to an application	"Adding an Adapter to an Application" on page 15-12
Add a delivery channel to an adapter	"Creating an Application Delivery Channel" on page 15-14

See Also: ["Managing Application Agreements"](#) on page 15-29 to create an application agreement to which to assign an application with its adapter of delivery channel characteristics

Digital Envelopes

You can create encrypted business messages with a remote trading partner's certificate. [Table 20–2](#) provides an overview of the tasks.

Table 20–2 Remote Trading Partner Certificate Tasks

Task	See...
Perform the following tasks when creating a remote trading partner certificate for a digital envelope, digital signature, or SSL certificate. <ul style="list-style-type: none"> ■ Enter a remote certificate name in the Name field. ■ Enter a certificate directory location in the Certificate Location field. 	Step 2 of "Creating a Remote Trading Partner Certificate" on page 25-53
Perform the following tasks when creating a document exchange: <ul style="list-style-type: none"> ■ Select the remote certificate from the Encryption Credential list. ■ Select a digital envelope from the Digital Envelope list. 	Step 2 of "Creating a Document Exchange" on page 25-67
Perform the following tasks when creating a delivery channel: <ul style="list-style-type: none"> ■ Select the document exchange with the remote certificate from the Document Exchange list. ■ Select Yes from the Encryption Enabled list if you are using RosettaNet Implementation Framework 2.0. 	Step 2 of "Creating a Delivery Channel" on page 25-75

You can then assign the delivery channel to a trading partner participating in a trading partner agreement.

See Also: ["Adding a Delivery Channel to a Trading Partner Agreement Participant" on page 26-26](#)

Digital Signatures for Host and Remote Trading Partners

You can use digital signatures with host and remote trading partners. The digital signature ensures that the message is authentic. [Table 20–3](#) provides an overview of the tasks for configuring digital signatures.

Table 20–3 Digital Signatures

Task	See...
<p>Perform the following tasks when creating a document exchange:</p> <ul style="list-style-type: none"> ▪ Select a digital signature from the Digital Signature list. ▪ If you are configuring a remote trading partner, select a signing credential (a remote certificate) from the Signing Credential list. 	<p>Step 2 of "Creating a Document Exchange" on page 25-67</p>
<p>Select Yes from the following lists when creating a delivery channel:</p> <ul style="list-style-type: none"> ▪ Is Non-Repudiation of Origin Required ▪ Is Non-Repudiation of Receipt Required <p>If you select Yes from the Is Non-Repudiation of Receipt Required list, you must also select Yes from the Is Non-Repudiation of Origin Required list.</p> <p>In a trading partner agreement, both the host and remote trading partners must have the same values for Is Non-Repudiation of Origin Required and Is Non-Repudiation of Receipt Required.</p>	<p>Step 2 of "Creating a Delivery Channel" on page 25-75</p>

Secure HTTP and Client Authentication

You can use SSL to secure connections between host and remote trading partners. You can use SSL with or without client authentication. [Table 20–4](#) provides an overview of the tasks for configuring SSL. There are three parts to configuring SSL that must be performed in this order:

- Configure SSL outside of Oracle Application Server ProcessConnect and Oracle Application Server
- Configure SSL for Oracle Application Server
- Configure SSL for Oracle Application Server ProcessConnect

Table 20–4 SSL

Part	Task	See...
1	Configure SSL outside of Oracle Application Server ProcessConnect and Oracle Application Server	"Setting Up SSL for the Oracle Application Server ProcessConnect B2B Adapter" on page 20-11
2	Configure SSL for Oracle Application Server	<ul style="list-style-type: none"> ■ <i>Oracle Application Server 10g Administrator's Guide</i> ■ <i>Oracle Application Server 10g Security Guide</i>
3	Configure SSL for Oracle Application Server ProcessConnect: Select Yes from the Transport Security Enabled list when creating a delivery channel. Perform the following tasks when creating a protocol endpoint:	<p>Step 2 of "Creating a Delivery Channel" on page 25-75</p> <ul style="list-style-type: none"> ■ Select Yes from the Client Authentication Enabled list to specify client authentication for host and remote trading partners Step 4 of "Creating a Transport" on page 25-59 ■ Select HTTP 1.0 (Secure) or HTTP 1.1 (Secure) from the Transport Protocol list. Step 2 of "Creating a Protocol Endpoint" on page 25-86 ■ Select SSL from the Security Specification list. Step 4 of "Creating a Protocol Endpoint" on page 25-86 ■ If host client authentication is enabled, select a remote trading partner certificate from the Certificate list. Step 5 of "Creating a Protocol Endpoint" on page 25-86

Setting Up SSL for the Oracle Application Server ProcessConnect B2B Adapter Before configuring trading partners to use SSL in the Oracle Application Server ProcessConnect user interface tool, you must set up SSL. The B2B adapter enables trading partners to communicate. Use the B2B adapter in either of two modes:

- As an HTTP server

This mode is configured through SSL settings in the Oracle HTTP Server `httpd.conf` file, as described in the *Oracle Application Server 10g Security Guide*

- As an HTTP client

1. Import a trading partner's CA authority into Oracle Wallet Manager.

Note: Oracle Wallet Manager allows only base64 files to be imported. Use Internet Explorer or another tool to convert a nonbase64 encoded certificate to base64.

2. Export the entire wallet into a text file. This file requires a `.txt` extension.
3. Place this file in the same location as the original wallet file.
4. Specify the location for this `.txt` file with the **Wallet Location** parameter in the Oracle Application Server ProcessConnect configuration parameters. These parameters can be accessed and modified from the **Server Properties** page of the Oracle Enterprise Manager Application Server Control.

See Also: [Chapter 18, "System Management with Oracle Enterprise Manager"](#) for instructions on accessing the Oracle Enterprise Manager Application Server Control

Troubleshooting SSL Setup Follow these instructions to troubleshoot SSL setup:

Use the browser to connect to the secure HTTP URL. Upon successful connection, the following details are viewable:

- If you are using Internet Explorer, select **File > Properties** from the main menu. The connection information appears. A **Certificates** button that displays certificate information also appears.
- You may get a confirmation page from the remote server.

Verifying SSL Client Authentication Follow these instructions to verify SSL client authentication:

- Using the Netscape browser:
 1. Import an Oracle Wallet by selecting **Communicator > Tools > Security Info > Certificates > Yours > Import a Certificate** from the main menu.
 2. Connect to the secure HTTP URL.
- Using the Internet Explorer browser:

Internet Explorer does not recognize the .p12 file generated using Oracle Wallet. Perform these steps to import the Oracle Wallet:

 1. Import the Oracle Wallet by selecting **Communicator > Tools > Security Info > Certificates > Yours > Import a Certificate** from the main menu.
 2. Export the Oracle Wallet by selecting **Communicator > Tools > Security Info > Certificates > Yours > Export**.
 3. Import this Oracle Wallet into Internet Explorer and try connecting to the secure HTTP URL.

Encrypted Wallet Passwords for Host Trading Partners

Oracle Application Server ProcessConnect uses an Oracle Wallet for storing private and public keys. A wallet password is required for accessing an Oracle Wallet. You create an initial wallet password and an Oracle Wallet with Oracle Wallet Manager. The wallet password is stored in encrypted format in the Oracle Application Server Metadata Repository. This wallet is used for digital envelopes, digital signatures, and SSL. [Table 20-5](#) provides an overview of the tasks to perform in the Oracle Application Server ProcessConnect user interface tool after you create the wallet password and Oracle Wallet:

Table 20-5 Host Trading Partner Wallet Password

Task	See...
Create a host trading partner wallet password	"Creating a Host Trading Partner Wallet Password" on page 25-91 Note: Enter the same wallet password that you created in Oracle Wallet Manager. If you later change the wallet password in Oracle Wallet Manager, you must also update the password in the Oracle Application Server ProcessConnect user interface tool.
Specify the directory location for the wallet file	"Oracle Application Server ProcessConnect Monitoring and Administration Tasks" on page 18-8 to access the Oracle Application Server ProcessConnect configuration parameters (under the Server Properties section) with Oracle Enterprise Manager. The Wallet Location parameter in this file enables you to specify the directory location for the wallet file.

Host Trading Partner Password Encryption in High Availability Environments

Oracle Application Server ProcessConnect provides a feature that automatically encrypts the host trading partner's Oracle Application Server ProcessConnect passwords through use of an obfuscated, encryption key created during installation. If you want to change this key value, do so during Oracle Application Server ProcessConnect downtime, as all passwords within the Oracle Application Server ProcessConnect schema are re-encrypted. A new encryption key is then created.

If Oracle Application Server ProcessConnect is part of a high availability or disaster recovery configuration and you want to change the encryption key, you must perform the following procedures:

1. Follow the instructions in "[Managing and Monitoring a Middle-Tier Instance from Oracle Enterprise Manager Application Server Control](#)" on page 18-5 to log in to the Oracle Enterprise Manager Application Server Control and access the primary Oracle Application Server ProcessConnect instance.
2. Shut down the adapter framework, integration manager, and OC4J instance subcomponents on the primary system on which Oracle Application Server ProcessConnect is installed.
3. Go to the **Security Key** parameter on the **Server Properties** page:

Security Properties

Re-encrypt ProcessConnect Repository's Security Data

Security Key

4. Make the following changes:
 - a. Check the **Re-encrypt ProcessConnect Repository's Security Data** box.
 - b. Change the encryption key in the **Security Key** field.

This action re-encrypts the Oracle Application Server ProcessConnect schema passwords.
5. Click **Apply**.
6. Go to the secondary (or backup) system of which Oracle Application Server ProcessConnect is a part.
7. Repeat Steps 2 and 3 on the secondary system.

8. Enter the same encryption key in the **Security Key** field as you did in Step 4b. However, do *not* check the **Re-encrypt ProcessConnect Repository's Security Data** box.
9. Repeat Steps 6 through 8 for additional secondary systems.
10. Restart the primary and secondary systems.

Configuration Issues and Options to Use for Oracle Application Server Security Framework

You can enable encryption between Oracle Application Server ProcessConnect and the Oracle Application Server Metadata Repository by setting several Oracle Net configuration parameters. For example, you can encrypt JDBC with the following `sqlnet.ora` parameters:

```
sqlnet.encryption_server=accepted
sqlnet.encryption_client=requested
sqlnet.encryption_types_server=(RC4_40)
sqlnet.encryption_types_client=(RC4_40)
sqlnet.crypto_seed = "-kdje83kkep39487dvmlqEPTbxxe70273"
```

See Also: *Oracle Advanced Security Administrator's Guide* available on the Oracle Technology Network:

<http://otn.oracle.com/>

Chapter Summary

This chapter describes the security provisions of Oracle Application Server ProcessConnect including, for example, automatic encryption of the host trading partner's Oracle Application Server ProcessConnect passwords by using an obfuscated encryption key created during installation. Protection of Oracle Application Server ProcessConnect and Oracle Workflow schemas during OracleAS Infrastructure 10g installation is also discussed.

Oracle Application Server ProcessConnect Error Handling

This chapter describes how to detect and handle system and domain errors in Oracle Application Server ProcessConnect runtime components.

This chapter contains these topics:

- [Domain and System Error Handling](#)
- [Where Do I Find Runtime Error Details?](#)
- [Typical Adapter Framework and Integration Manager Errors](#)
- [Alert E-Mail Message Format](#)
- [Chapter Summary](#)

See Also: The following sections for additional details on viewing Oracle Application Server ProcessConnect errors:

- [Chapter 18, "System Management with Oracle Enterprise Manager"](#) for instructions on viewing log files and alerts through Oracle Enterprise Manager
- ["Design-Time Troubleshooting of Modeling Metadata Dependencies"](#) on page 22-9
- ["Error Status Report"](#) on page 23-17 for instructions on creating error reports for analysis
- [Appendix C, "Error Codes"](#) for a list of Oracle Application Server ProcessConnect error codes and messages

Domain and System Error Handling

This section describes administrator types and errors, provides domain error modeling examples, and describes the implications of role and event instances being in an error state.

This section contains these topics:

- [Administrator Types](#)
- [Types of Errors](#)
- [Error Handling with Step Return Code Ports](#)
- [Implications of Role Instances and Event Instances Being in an Error State](#)

Administrator Types

This section describes tasks typically performed by the following administrators:

- [System Administrator](#)
- [Business Administrator](#)

System Administrator

The system administrator manages Oracle Application Server ProcessConnect components and monitors and diagnoses the Oracle Application Server ProcessConnect runtime behavior.

The system administrator must ensure the following:

- An active runtime configuration exists and the adapter framework instance is deployed
- The Oracle Application Server ProcessConnect integration manager and adapter framework components start up and shut down correctly

Business Administrator

The business administrator monitors and diagnoses the semantic correctness of an integration.

The business administrator must ensure the following:

- A configuration is deployed
- The profile data is correct
- All adapters within the integration are started

Types of Errors

Oracle Application Server ProcessConnect distinguishes between two types of errors:

- Domain errors

These errors occur because of incorrect metadata or profile data. For example:

- A translation step fails because the translator was unable to convert a native event to an application event
- A transformation step fails because the transformation map was unable to be applied to a given event
- The adapter framework did not execute an inbound interaction because a native role was not identified
- The content of the event does not match the designed event type

- System errors

These errors occur because of system failures. For example:

- The end system or application is not available for execution of an inbound or outbound interaction
- A repository is down or out of resources (full tablespace, not enough temporary space, not enough undo space, and so on)
- Delivery of an event to a party for which no adapter framework has yet been started

The fundamental difference between domain errors and system errors is that you can design domain errors as part of normal business process modeling. This is achieved by providing special error ports on steps where domain errors occur. These ports are then populated with either success or failure values. You can then design the error case.

Note that in fixing a domain error, you as the modeler must typically modify metadata information (or the business administrator must modify the profile data), which requires redeployment of the business process.

In contrast, a system error correction typically does not involve redeployment of the business process.

Error Handling with Step Return Code Ports

The Oracle Application Server ProcessConnect user interface tool enables you to automatically create a step return code port that captures domain error details in the following role steps:

- Translation step
- Transformation step
- Condition step

The step return code port is automatically created as an outbound step port when you create a condition, translation, or transformation step. This port connects only to other step ports because it has a datatype, and never to role ports because role ports require event types. [Figure 21-1](#) shows a step return code port in a transformation step of a transformation binding role and all other required steps. While the example shown in [Figure 21-1](#) includes a transformation step, the step return code port in a translation step requires you to create similar functionality.

Figure 21–1 Step Return Code Port in a Transformation Step of a Transformation Binding Role

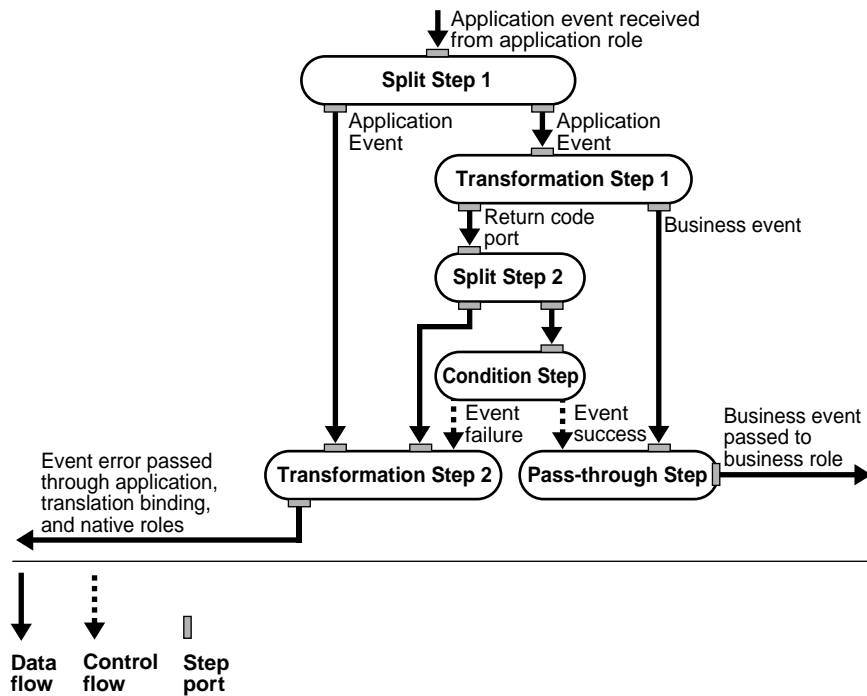

Note: Ensure that the step return code port error handling you create is simple so that it does not result in domain errors. For example, avoid using domain value maps without defaults in Transformation Step 2 in [Figure 21-1](#).

Table 21–1 describes the step return code port and step activity shown in Figure 21–1. The step return code port is automatically created when you create a transformation, translation, or condition step. You must manually create all other steps, step ports, and data flows shown in Figure 21–1 and described in Table 21–1.

Table 21–1 Step Return Code Port in a Transformation Step of a Transformation Binding Role

Step or Port	Description
Split step 1	Delivers the same inbound event to two transformation steps
Transformation step 1	Transforms the event to a business event
Return code port of transformation step 1	Captures the status of the event transformation (either success or failure)
Split step 2	Receives the transformation status (either success or failure) from the return code port and passes it onto the condition step.
Condition step	<p>Receives the transformation status (either success or failure) from the return code port and processes one of the two outgoing control flows:</p> <ul style="list-style-type: none"> ▪ If the transformation succeeded, the event success control flow is processed, which results in the subsequent execution of the pass-through step ▪ If the transformation failed, the event failure control flow is processed, which results in the subsequent execution of transformation step 2 <p>The condition step includes a preseeded condition expression named <code>isReturnCodeSuccess</code> that tests for event success or failure.</p>
Pass-through step	Receives the event from transformation step 1, but this step is processed only if the event success control flow was taken, indicating that transformation succeeded. In this case, the event is passed to the business role for additional processing.
Transformation step 2	Receives the event from the split step, but this step is processed only if the event failure control flow was taken, indicating that transformation failed. In this case, transformation step 2 creates and passes an application event to the application role, translation binding role, native role, and onto, for example, an E-Mail adapter for delivery to the business administrator.

Creating a Step Return Code Port

Table 21-2 describes the tasks to create the steps, step ports, and data flows shown in Figure 21-1 on page 21-5. References are provided to the procedures for performing these tasks. If you create a step return code port in a translation step, you must perform similar tasks.

Table 21-2 Step Return Code Port Tasks

Task	See Also...
1. Create transformation step 1. 2. Create the remaining steps shown in Figure 21-1 on page 21-5: Split step 1 and split step 2 Transformation step 2 Condition step Pass-through step Note: The step return code port is automatically created as an outbound port to another step on the condition step and on both transformation and translation steps.	<ul style="list-style-type: none"> ■ Chapter 9, "Creating Metadata with the Modeling Wizards" to automatically create the initial transformation step as part of a spoke ■ "Creating a Step" on page 12-81 to manually create all steps <p>Note: The modeling wizards only create an initial transformation or translation step in a role. Manually create the second step.</p>
3. Create step ports, control flows, and data flows as needed for all steps.	<ul style="list-style-type: none"> ■ "Creating a Step Port" on page 12-91 ■ "Creating a Step Data Flow" on page 12-98 ■ "Creating a Step Control Flow" on page 12-105 <p>Note: The modeling wizards only create an initial transformation step's data flow or step port. Manually create all remaining step ports, control flows, and data flows.</p>

See Also: ["Creating an Alert E-Mail Message Native Format"](#) on page 21-19 for additional tasks to perform if you want to include error details in an e-mail message, including creating all remaining roles of a spoke for an integration, creating the E-Mail adapter interaction, specifying token substituted text as the native format, and creating an application agreement

Additional Domain Error Modeling Examples

Figure 21-2 shows an additional example of how domain error modeling appears in the Process Diagram for a translation binding role.

Figure 21-2 Modeling Domain Errors in a Translation Binding Role

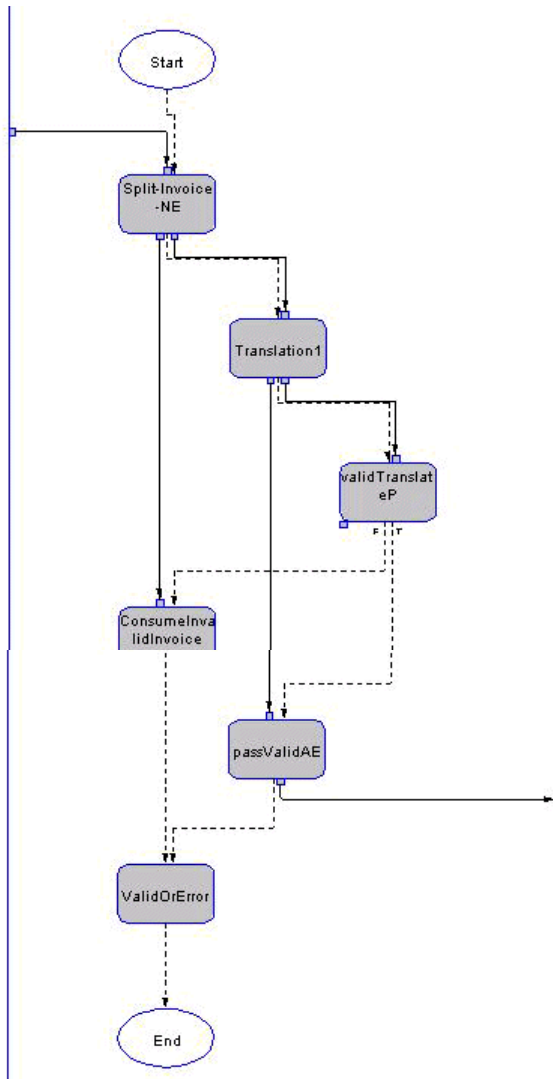
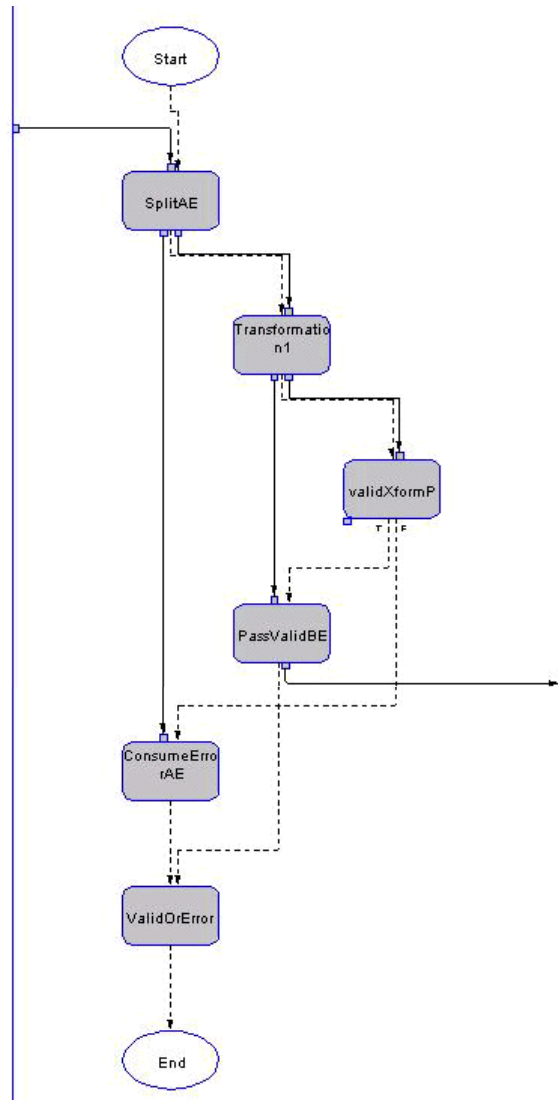

Figure 21-3 shows an additional example of how domain error modeling appears in the Process Diagram for a transformation binding role.

Figure 21-3 Modeling Domain Errors in a Transformation Binding Role



See Also:

- ["Error Handling with Step Return Code Ports"](#) on page 21-4 for an example of how steps such as these can be designed
- [Chapter 12, "Managing Business Processes and Roles"](#) for details about creating steps, ports, control flows, and data flows

Implications of Role Instances and Event Instances Being in an Error State

As described in [Chapter 3, "Oracle Application Server ProcessConnect Concepts"](#) and [Chapter 12, "Managing Business Processes and Roles"](#), a coordination represents the execution of the business transaction represented by the modeled business process. A coordination consists of the full set of role instances and event instances that are bound to a specific business process. A native event instance is created from the wire message received by the adapter framework. As the event is processed by various roles in Oracle Application Server ProcessConnect, the appropriate role instances are created. The event can be translated into an application event instance and transformed into a business event instance before executing the business process. The various event instances and role instances and their states are described in [Chapter 3, "Oracle Application Server ProcessConnect Concepts"](#).

An event instance is set to an error state in the following scenarios:

- A native event instance (that is correlated to another native event) is raised by the adapter but the adapter framework cannot determine a port to send this native event to because:
 - The correlated native event was received earlier and therefore there is not another port for this native event being raised. For example, assume an acknowledgment (ack) for a purchase order is sent; this error occurs if the ack is sent for the second time.
 - The coordination corresponding to the correlated native event is in an aborted or closed state

- A native event instance (that is not correlated to another native event; meaning this is an initiating native event) is being raised by the adapter, but the adapter framework cannot determine a native role to process this native event. This is because there is no valid effective agreement for the native role responsible for accepting this native event.
 - For example, assume a purchase order is sent. The native role that has an initiating port of the purchase order type is ProcessPONativeRole. However, assume ProcessPONativeRole is part of an agreement with effective agreement dates of 04/01/2003 to 04/30/2003. Based on the current date, this agreement is not effective or valid. Therefore, a native role cannot be instantiated.
- A translation step in one of the binding roles that encounters a domain error. The corresponding input event is then put into an error state.
- A transformation step in one of the roles that encounters a domain error. The corresponding input events are then put into an error state.
- Another event in the same coordination (may be or may not be in the same role instance) causes the coordination to be put into an aborted state.

When the native event is set to an error state while being raised by the adapter, there is no corresponding role instance associated with it. Therefore, there is no impact on states of any role instances or coordinations. However, when an event is set to an error state because of a domain error in one of the steps you designed, the subsequent processing depends on the designed behavior, which can be one of the following:

- You have designed the domain error modeling in anticipation of this error by:
 - Creating a data flow between the return code port of this step and an input port of a condition step that uses the preseeded condition expression (isReturnCodeSuccess) to determine if the current step succeeded or not. The condition step itself is connected to two different steps for the two possible outcomes.

In this case, the input event into the current step is set to an error state and the execution of the steps continues along the false path out of the condition step. There is no impact on the state of the current role instance or the current coordination
- You have not designed the domain error modeling (that is, the return code port of this step is not connected to any other port).

- In this case, the current role instance and the current coordination are set to the aborted state. All subsequent processing in all roles in this coordination halts.

For example, say a createPO event (POID: 123) runs into a transformation error. A subsequent updatePO (POID: 123) event that is correlated to the createPO event cannot then be raised after the createPO (ID: 123) event runs into the transformation error because this results in the corresponding role instance and the coordination being put into an aborted state.

Assuming that updatePO (POID: 123) was raised before the transformation error, the native event is raised successfully. However, the native, application, and business events corresponding to the updatePO event are subsequently set to an error state depending on when the transformation error occurs and which role is processing updatePO at that time.

For system errors such as a database going down due to insufficient memory or tablespace problems, Oracle Application Server ProcessConnect retries periodically until it succeeds. You do not need to design for these errors.

Where Do I Find Runtime Error Details?

This section describes the various methods for detecting and handling errors that can occur during the execution of the business process.

Oracle Application Server ProcessConnect captures various runtime error details. [Table 21-3](#) describes where to look for this information.

Table 21-3 Runtime Errors

Area	Description	See Also
Oracle Application Server ProcessConnect user interface tool error reports	<p>Error reports are useful for diagnosing errors directly related to event processing in roles and steps, such as:</p> <ul style="list-style-type: none"> ■ A translator failed to translate a native event to an application event ■ A transformation step failed because of a type mismatch in the event body data ■ A condition step failed evaluating the condition expression ■ A SetParty step failed because of an attempt to set a nonexistent party name 	<p>"Error Status Report" on page 23-17 to create a report</p> <p>"Monitoring Current Errors in an Integration" on page 23-38 for an error report example</p>
Oracle Application Server ProcessConnect user interface tool event status and details reports	<p>Event status reports can be generated using the event state as a filter. This enables you to create a report for events in an error state. In the details section of the report, you can navigate through the errored event predecessor events to identify the origin and context of the errored event (role step and port information, and so on).</p>	<p>"Event Status Report" on page 23-8 to create a report</p> <p>"Monitoring iProcurement Process Status" on page 23-32 for event status report examples</p>
Oracle Application Server ProcessConnect user interface tool coordination status and details reports	<p>Coordination status reports can be quickly generated to identify erroneous business transactions. The details section of the report lists all the roles and event instances involved in a coordination.</p>	<p>"Coordination Status Report" on page 23-13 to create a report</p> <p>"Monitoring Coordination Details" on page 23-36 for a coordination status report example</p>

Table 21–3 (Cont.) Runtime Errors

Area	Description	See Also
Oracle Application Server ProcessConnect system metrics through the Oracle Enterprise Manager Application Server Control	<p>You can use the Oracle Enterprise Manager monitoring functions to check for errors. For example, you can check the following:</p> <ul style="list-style-type: none"> ▪ The status of the Oracle Application Server ProcessConnect integration manager and adapter framework components (either up or down) ▪ The number of errored events for each adapter 	<p>"Oracle Application Server ProcessConnect Monitoring and Administration Tasks" on page 18-8 to access the Oracle Enterprise Manager Application Server Control from which you can view Oracle Application Server ProcessConnect status and adapter framework metrics</p>
Oracle Application Server ProcessConnect log and system exception files through the Oracle Enterprise Manager Application Server Control	<p>Errors occurring during operation of the integration manager and adapter framework are logged to component specific log files and as system exceptions in the runtime repository. In contrast to the preceding errors, these errors are not directly related to event processing:</p> <ul style="list-style-type: none"> ▪ A SQL error occurred while accessing the Oracle Application Server ProcessConnect repository ▪ An adapter failed to establish a connection with the EIS 	<p>"Oracle Application Server ProcessConnect Monitoring and Administration Tasks" on page 18-8 to access the Oracle Enterprise Manager Application Server Control from which you can view log files</p>
Oracle Application Server ProcessConnect log files through the Oracle Enterprise Manager Application Server Control	<p>Fatal JVM errors preventing the integration manager and adapter framework from continuing are logged to OC4J log files in the \$ORACLE_HOME/opmn/logs directory. The naming conventions for these files are as follows:</p> <ul style="list-style-type: none"> ▪ ProcessConnect~IntegrationManager~instance_name for the integration manager ▪ ProcessConnect~AdapterFramework~instance_name for the adapter framework 	<p>"Oracle Application Server ProcessConnect Monitoring and Administration Tasks" on page 18-8 to access the Oracle Enterprise Manager Application Server Control, from which you can view OC4J log files</p>

See Also:

- [Chapter 18, "System Management with Oracle Enterprise Manager"](#)
- [Chapter 23, "Creating Reports"](#)

Typical Adapter Framework and Integration Manager Errors

Table 21–4 describes typical adapter framework errors.

Table 21–4 Common Adapter Framework Errors

Error	Reason	Where To Look	Action
Oracle Application Server ProcessConnect adapter framework component is not starting	There are several possible reasons, including: <ul style="list-style-type: none"> ■ An environment issue (a missing jar file) ■ The repository is down ■ The adapter framework instance name is not in the design-time repository 	Use the Oracle Enterprise Manager Application Server Control to check the Oracle Process Management Notification (OPMN) log for errors	Fix and restart the adapter framework
Oracle Application Server ProcessConnect adapter framework component terminates unexpectedly	A Oracle Application Server ProcessConnect component is terminated (for example, the adapter framework or integration manager) in the case of fatal JVM errors (for example, if a jar file was not found or there was an internal VM error)	Use the Oracle Enterprise Manager Application Server Control to check the OC4J log	Fix and restart the adapter framework
No adapter is started by the adapter framework	The adapter framework does not start adapters in the following cases: <ul style="list-style-type: none"> ■ The adapter framework active runtime configuration does not exist ■ The adapter framework instance is not yet deployed ■ No effective agreement is found for the adapter 	Use the Deployment tab to check for an active configuration or use the Oracle Enterprise Manager Application Server Control to check for errors in the adapter framework log file	Deploy a configuration and monitor if the adapters start after deployment If the adapters exist, but there is no agreement, create an agreement and redeploy the configuration
There is no effective agreement between the native role and the party	The current date is not within the time interval specified with the Effective From Date and Effective To Date fields of the agreement	Adapter framework log files, which are viewable from the Oracle Enterprise Manager Application Server Control	Create a new agreement and redeploy the configuration

See Also:

- [Chapter 18, "System Management with Oracle Enterprise Manager"](#)
- [Chapter 23, "Creating Reports"](#)

Table 21–5 describes typical integration manager errors.

Table 21–5 Common Integration Manager Errors

Error	Reason	Where To Look	Action
Oracle Application Server ProcessConnect integration manager component is not starting	There are several possible reasons, including an environment issue (a missing jar file) a repository being down, and so on.	Check the OC4J log for errors	Fix and restart the integration manager
Oracle Application Server ProcessConnect integration manager component terminates unexpectedly	A Oracle Application Server ProcessConnect component is terminated (for example, the adapter framework or integration manager) in the case of fatal JVM errors (for example, if a jar file was not found or there was an internal VM error).	Check the OC4J log	Fix and restart the integration manager
A translation step failed in the translation binding role	The translator was unable to convert the native event data to the designed application event.	The Oracle Application Server ProcessConnect user interface tool error report or event status report	Check the translator error message and take appropriate actions
A transformation step failed in the transformation binding role	A transformation map was unable to be applied due to a type mismatch	Oracle Application Server ProcessConnect user interface tool error report or event status report	Check the error message in the error report and take appropriate actions
A condition step failed in the binding role	The condition expression was unable to be evaluated	Oracle Application Server ProcessConnect user interface tool error report or event status report	Check the error message in the error report and take appropriate actions

See Also:

- [Chapter 18, "System Management with Oracle Enterprise Manager"](#)
- [Chapter 23, "Creating Reports"](#)

Alert E-Mail Message Format

You can send an alert e-mail through the E-Mail adapter. This e-mail typically contains the following details:

- Business process name
- Step name
- Error code
- Source event identifier (that is, the purchase order identifier)

Alert e-mails consist of a subject and message body. [Example 21-1](#) shows an alert e-mail example:

Example 21-1 Alert E-Mail Example

```
FROM: ip@oracle.com
SUBJECT: my_po_bp.transform_po transformation failure
```

```
Transformation step transform_po failed in business process my_po_bp for
purchase order #12345 with error:
Error -: AIP-10422: Transformation step callout failed during
execution:
oracle.tip.ts.transformation.api.exception.DomainResourceException:
Error -: AIP-14004: Error in invoking domain value function
lookupBusinessViewDomain.
```

Where...	Is...
Business process name	my_po_bp
Step name	transform_po

Where...	Is...
Error code	Error -: AIP-10422: Transformation step callout failed during execution: oracle.tip.ts.transformation.api.exception.DomainResourceException: Error -: AIP-14004: Error in invoking domain value function lookupBusinessViewDomain.
Source event identifier	#12345

To produce the alert e-mail, you must create a transformation to produce the appropriate event type for delivery through the E-Mail adapter. In most cases, the transformation occurs in a context event such as a purchase order so that the message is customized with contextual information.

Alert e-mails consist of subject and message bodies. The token substituted text native format supports the specification of alert e-mail subject and message bodies. Token substituted text is free-form text interspersed with tokens representing values that can be completed at runtime. The token substituted text converter creates an application datatype with members for each of the tokens. You define a transformation to populate these values. The token substituted text translator substitutes the values into the text for outbound messages and parses the message for the token values for inbound messages.

See Also: ["Token Substituted Text"](#) on page A-124 for examples of how to define token values in subject and message bodies of alert e-mails

Creating an Alert E-Mail Message Native Format

[Table 21–6](#) describes the tasks to perform to create an alert e-mail message native format. References are provided to procedures for performing these tasks.

Table 21–6 *Tasks for the Alert E-Mail Message Native Format*

Task	See Also...
1. Add an E-Mail adapter outbound interaction by selecting Send E-mail(E-MailRecord) and providing answers to specific questions when prompted.	<ul style="list-style-type: none"> ▪ "Adding an E-Mail Adapter Interaction" on page 11-13
2. Select token substituted text as the native format when prompted.	<ul style="list-style-type: none"> ▪ "Review the Adapter Interaction Details" on page 11-25
3. Specify a token substituted text namespace when prompted.	<ul style="list-style-type: none"> ▪ "Providing Token Substituted Text Details" on page 11-31
4. Create the remaining roles of a spoke for your integration (native roles, binding roles, application roles, business roles, and business process)	<p>Either of the following chapters:</p> <ul style="list-style-type: none"> ▪ Chapter 9, "Creating Metadata with the Modeling Wizards" to automatically create roles and a business process ▪ Chapter 12, "Managing Business Processes and Roles" to manually create roles and a business process
5. Create an application and application agreement that uses the E-Mail adapter.	<p>Chapter 15, "Managing Applications and Application Agreements"</p>
6. Create an event transformation map for the return code. The map is for populating the application event type created for the E-Mail adapter interaction. Values can be constant, come from the return code, or come from the initial instance. Do not rely on initial instance values, as they may have caused the system error in the first place.	<ul style="list-style-type: none"> ▪ "Managing Transformation Statements" on page 13-29

Note: You can also use the Oracle Database adapter to log errors to a database table. To do this, you must create an application agreement and adapter interaction that includes the Oracle Database adapter.

Chapter Summary

This chapter describes the following details:

- Two types of errors: domain errors (errors due to incorrect metadata or profile data) and system errors (errors due to system failures)
- How to design a step return code port in a condition, transformation, or translation step that captures domain error details
- Role and event instance error state implications
- Where to look for runtime error details
- Typical adapter framework and integration manager errors and corrective actions
- Creating e-mail messages containing error alerts using the E-Mail adapter

Oracle Application Server ProcessConnect Troubleshooting

This chapter describes Oracle Application Server ProcessConnect troubleshooting methodologies.

This chapter contains these topics:

- [Runtime Troubleshooting Methods](#)
- [Performing Runtime Troubleshooting](#)
- [Design-Time Troubleshooting of Modeling Metadata Dependencies](#)
- [Additional Troubleshooting Documentation](#)
- [Chapter Summary](#)

Runtime Troubleshooting Methods

Oracle Application Server ProcessConnect provides several methods for troubleshooting errors:

- [Log Files](#)
- [Business Intelligence Logging Levels](#)
- [Reports](#)

Log Files

Oracle Application Server ProcessConnect generates adapter framework and integration manager log files describing all types of events, including startup and shutdown details, errors, warning messages, access details on HTTP requests, and so on. You can view the log files in either of two ways:

- With Oracle Enterprise Manager (strongly recommended)
- With a command line editor
 - The adapter framework log file is located in the `$ORACLE_HOME/ip/log/af/log.xml` file.
 - The integration manager log file is located in the `$ORACLE_HOME/ip/log/im/log.xml` file.

After installation, the adapter framework and integration manager are automatically started with `error` as the logging level. To view errors in, for example, translation or transformation, the logging must be set to `debug`. This can be done in the Oracle Enterprise Manager Application Server Control as follows:

1. Select the Oracle Application Server ProcessConnect middle-tier instance.
2. Select the **Server Properties** link.
3. Change the settings of parameters with `oracle.tip.DiagnosticLevel` in their name from `error` to `debug`.

See Also:

- ["Oracle Application Server ProcessConnect Log Files"](#) on page 18-10 for instructions on accessing log files through Oracle Enterprise Manager
- ["Oracle Application Server ProcessConnect Middle-Tier Instance Configuration Parameters"](#) on page 18-11 for instructions on changing logging levels to `debug`

Business Intelligence Logging Levels

When you prepare to deploy a configuration, you can select a business intelligence logging level. The level that you set impacts the detail of the reports you can later create when your configuration is deployed. The available settings and the details that they create are as follows:

- **High** creates instance data for all roles, ports, steps, transition instances, and event instances, but can have an impact on runtime performance.
- **Medium** creates data for role, step, and port instance data, and has less of an impact on runtime performance.
- **Low** creates data for roles with only one step (typically, a pass-through step), but provides better runtime performance.

See Also: ["Deploying a Validated Configuration"](#) on page 16-10 for the following details:

- Specific descriptions of each logging level
- Instructions on setting a business intelligence logging level

Reports

Oracle Application Server ProcessConnect provides a series of report creation wizards that enable you to track the movement of events and business processes and identify errors.

- **Process monitoring reports**
Show the current status of events, coordinations showing how far events have progressed in an integration, domain and system errors and associated events, collaborations, and business messages in an integration. They are best used to either monitor the status of events or business processes or debug the progress of a specific deployed integration.
- **Process optimization reports**
Monitor business process efficiency
- **Activity monitoring reports**
Analyze specific business activities across integration objects

See Also: [Chapter 23, "Creating Reports"](#)

Performing Runtime Troubleshooting

This section provides an overview of how to troubleshoot an error in Oracle Application Server ProcessConnect.

This section contains these topics:

- [Creating an Error Status Report](#)
- [Creating a Coordination Status Report](#)
- [Creating an Event Status Report](#)
- [Using the IP.tip_rtlog table](#)
- [Troubleshooting Use Case](#)

Creating an Error Status Report

Error status reports contain any domain or system errors and the associated events.

1. Create an error status report.
 - a. Select **Reports > Process Monitoring**.
 - b. Select **Error Status**.
 - c. Optionally click the calendar icon for the **Start Date** field to select a date at which to begin gathering report data.
 - d. Click **Finish**.

2. The Summary Report of the Error Status Report page displays the number of errors occurring in the past week.
3. Click **Details**. The Details Report of the Error Status Report page appears.

The **Event Timestamp** column indicates when the error first occurred. The **Last Occurred Timestamp** column indicates the last time the error occurred. The **Retry Count** column indicates the number of retries that were attempted to recover from the error.

4. Click **Details** in the **Details** column.

The Error Details page displays specific details about the error, including error class, code, and message.

Creating a Coordination Status Report

Coordination status reports show how far an event has progressed.

1. Create a coordination status report to determine if any errors occurred:
 - a. Select **Reports > Process Monitoring**.
 - b. Select **Coordination Status**.
 - c. Optionally click the calendar icon for the **Start Date** field to select a date at which to begin gathering report data.
 - d. Click **Finish**. The Summary Report page displays the number of coordinations for the business processes in the configuration.
 - e. Click **Details** for more information. The Details Report page appears, and displays the following coordination state information:

State	Description
aborted	Coordination processing has been aborted. For example, a transformation failed.
closed	Coordination processing has completed.
open	Coordination processing is occurring. This state can remain open for a while if you are waiting for an acknowledgment.

- f. Click the **Details** page of any coordinations that display as **aborted**.
The Coordination Details page displays only the roles to which the event progressed. For example, it may stop at the translation binding role.
- g. Click **Expand All** to display the last action the event attempted to do, but failed. For example, if the last role to which the event progressed was a translation binding role, then the last step that the event made it to may be the translation step. This can indicate that a translation error occurred.

Creating an Event Status Report

1. Create an event status report to determine if the event made it to the integration manager:
 - a. Select **Reports > Process Monitoring**.
 - b. Click **Specify Event**.
 - c. Optionally click the calendar icon for the **Start Date** field to select a date at which to begin gathering report data.
 - d. Select the event type classification and event name to track.
 - e. Click **Finish**.

If the adapter framework created the native event successfully, there is at least one event that made it to the integration manager.
 - f. Click **Details** for more information.
2. If the event did not make it to the integration manager:
 - a. Check the adapter framework log file from the Oracle Enterprise Manager Application Server Control by following the instructions in "[Managing and Monitoring a Middle-Tier Instance from Oracle Enterprise Manager Application Server Control](#)" on page 18-5.
 - b. Search for AIP (the prefix for error message codes).
3. If the event made it to the integration manager:
 - a. Follow the event through the reports created in Step 1 to identify the problem.
 - b. Check the integration manager log.
 - c. Search for AIP. If the event is not in the integration manager log, it may be a system error.
4. Resolve the problem based on your findings in Step 2 or 3.

Using the IP.tip_rtlog table

When the `oracle.tip.DiagnosticLevel` is set to debug, Oracle Application Server ProcessConnect records activities occurring in the Oracle Application Server Metadata Repository in the `IP.tip_rtlog` table. The `$ORACLE_HOME/ip/admin/iprtcln.sql` script can be run to place the contents of the table in a log file and delete the selected entries from the table. The script must be run as the `ip` Oracle Application Server ProcessConnect schema user.

This script requires three parameters:

- The name of the log file with the absolute path. By default, this creates an `im_db.log` file in the current directory.
- The date up to which the entries in the table must be selected
- An option to delete the selected entries

Enter the following syntax at the command prompt:

```
sqlplus ip/ip_password@net_service_name @$ORACLE_HOME/ip/admin/iprtcln.sql
```

where `ip_password` is the password for the Oracle Application Server ProcessConnect schema in the Oracle Application Server Metadata Repository and `net_service_name` is the Oracle net service name for connecting to the Oracle Application Server Metadata Repository.

For example:

```
sqlplus ip/ip@iasdb @$ORACLE_HOME/ip/admin/iprtcln.sql
```

After the contents are placed in a log file, search for `ORA-` (the prefix for errors occurring in the metadata repository). If you see entries with `ORA-`, contact Oracle Support Services.

Troubleshooting Use Case

[Chapter 7, "Tutorial of an Integration within an Enterprise"](#) describes how to create an integration within an enterprise. Included in this chapter is "[Task 6: Troubleshooting Any Errors with Log Files and Reports](#)" on page 7-43, which provides specific details on how to troubleshoot problems that can occur. Oracle recommends that you read this section.

Design-Time Troubleshooting of Modeling Metadata Dependencies

This section describes modeling metadata dependencies to understand as you design and troubleshoot an integration. Note the following modeling metadata dependencies:

- Modeling metadata can reference other metadata.
- Modeling metadata must be created before it can be used as a reference by other modeling metadata.
- All modeling metadata can be created without the need to reference any other metadata at creation time.
- Deleting modeling metadata requires that all references to it are removed first.

Note the following special cases:

- Some modeling metadata also deletes the metadata it references (for example, when an application event type is deleted, its datatypes are also deleted).
- Some objects can be deleted even if they are referenced by other modeling metadata or profile data (for example, deleting a native role also removes its reference from any agreements with which it is associated).

This section provides specific information on these type of dependencies:

- [Modeling Metadata Dependency Graphical View](#)
- [Application Event Dependency Example](#)
- [Modeling Metadata Dependency Cases](#)
- [Common Modeling Metadata Dependency Error Examples](#)

Modeling Metadata Dependency Graphical View

Figure 22–1 shows this modeling metadata dependency. For example, to delete an event type, you must first remove any references in the event map, correlation, role port, step port, condition expression, and event transformation map. If you attempt to delete the event type before removing these associations, you receive an error.

Figure 22–1 Metadata Dependencies

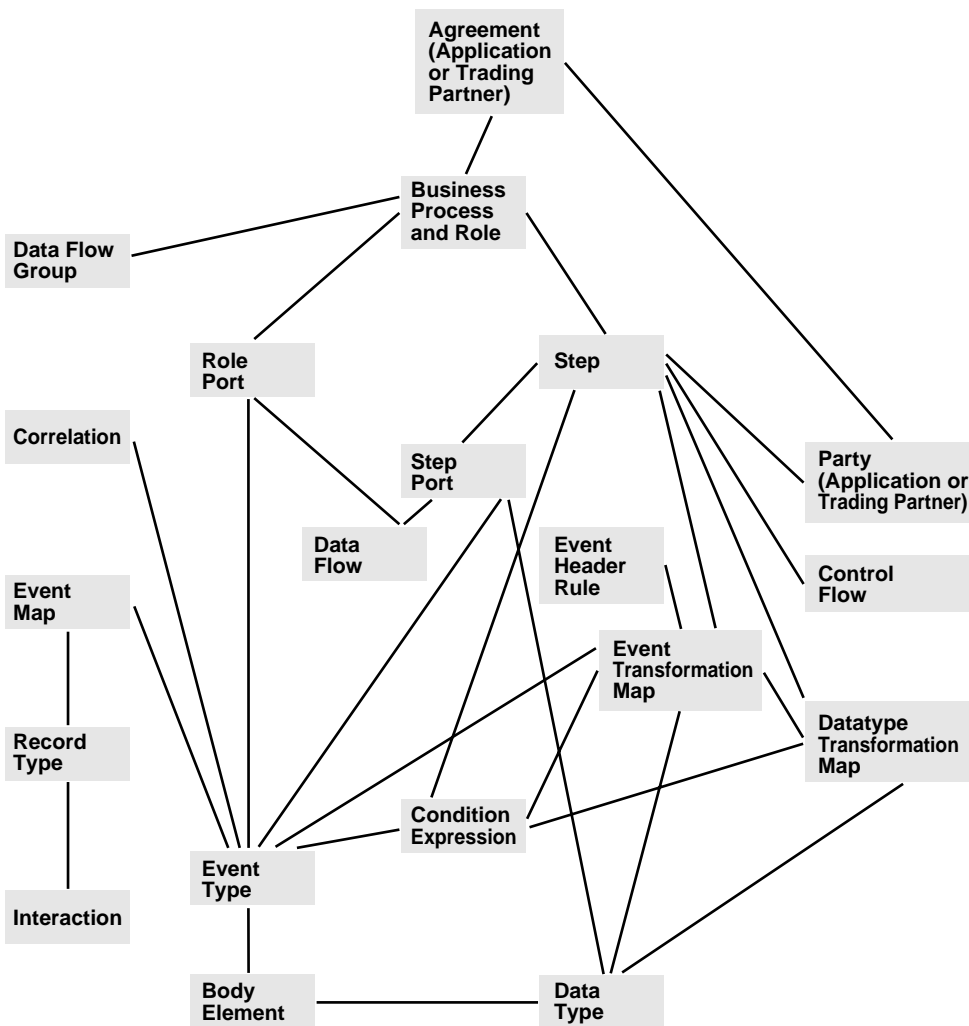

Application Event Dependency Example

This section provides an example of dependencies between modeling metadata.

An application event is created by the translator when defining the native event.

Note the following modeling metadata dependencies between the native event and the application event:

- You cannot directly delete an application event.
- You must delete the native event to delete the application event (that is, there is a one-to-one relationship between the native event and application event).
- Deleting a native event (and its application event) is only possible when both are not used elsewhere. Examples of places in which the native event and application event can be used include the following:
 - Role ports
 - Step ports
 - Event transformation maps
 - Condition expressions
- Deleting an application event also deletes application event datatypes (this is a special case)
- Deleting an application event is impossible when application event datatypes are used in step ports, datatype transformation maps, or condition expressions.
- Updating a native event, native event datatype, application event, or application event datatype is not possible. You can only update by first deleting and then recreating.
- Deleting an interaction requires that no native event refers to it
- Deleting a role is allowable (that is, if it only uses other modeling metadata, but is never used by modeling metadata)

Modeling Metadata Dependency Cases

The same methodology (that is, some modeling metadata cannot be deleted before their references have been removed) must be applied to rest of the modeling metadata and some profile data. In addition, there are special cases where these dependencies are slightly different. [Table 22-1](#) describes these dependencies and special cases.

Table 22-1 *Dependency Cases*

Modeling Metadata	Dependency
Event transformation maps	Before deleting an event transformation map, remove all references to it from the transformation steps and event header rules transformation map.
Datatype transformation maps	Before deleting a datatype transformation map, all references to it must be removed from the event transformation maps and transformation steps.
Condition expressions	Before deleting a condition expression, all references to it must be removed from the condition steps, event transformation maps, and datatype transformation maps.
Control flow	Can always be deleted from the step details page
Data flow	Can always be deleted from the data port details page or the step port details page
Data flow group	Can always be deleted from the business process details page or role details page
Native event correlation	Can always be deleted from the native event types details page
Role port	Special case: can always be deleted, but also deletes all data flows related to it
Step port	Special case: can always be deleted, but also deletes all data flows related to it
Event map	Can always be deleted from the native event types details page
Interaction	Before deleting an interaction, the event map referencing its record type must be deleted from the native event type details page.
Business process and role types	<p>Can always be deleted.</p> <p>Special case 1:</p> <ul style="list-style-type: none"> ■ Deleting a business process or any of the role types also deletes all the referenced data flow groups, role ports, steps, control flows, step ports, and data flows <p>Special case 2:</p> <ul style="list-style-type: none"> ■ Deleting a native role removes the reference to it from any agreement.

Table 22–1 *Dependency Cases*

Modeling Metadata	Dependency
Application	Before deleting an application, the application agreement and SetParty steps referencing that application must be updated.
Application Agreement	Can always be deleted
Events	Before deleting any event type, the following modeling metadata must not reference it: event map, native event correlation, role port, step port, condition expression and, event transformation map. See " Native Event Type " on page 22-13 for additional details about native event type dependencies.

Native Event Type

Before deleting the native event type, perform the following tasks:

- The event map specified in the native event type details must be deleted.
- The native event correlation referencing the native event type must be deleted (it is not possible to update it and change the native event type).
- All role ports referencing the native event type must be updated.
- All step ports referencing the native event type must be updated.

Special Case 1 Deleting the native event type also deletes the corresponding application event type (also note that application event types cannot be deleted directly). This means that before deleting the native event type:

- All role ports referencing the application event type must be updated.
- All step ports referencing the application event type must be updated.
- All event transformation maps referencing the application event type must be updated.
- All condition expressions referencing the application event type must be updated.

Special Case 2 Deleting the native event type and application event type also deletes its body elements and associated native datatypes and application datatypes. This means that before deleting the native event type:

- All datatype transformation maps referencing the associated application datatypes must be updated.

- All event transformation maps referencing the associated application datatypes must be updated.
- All step ports referencing the native datatypes and associated application datatypes must be updated.

Common Modeling Metadata Dependency Error Examples

This section provides examples of the types of errors you can receive when attempting to delete modeling metadata that is associated with other modeling metadata.

Example 22–1 Deleting a Native Event

Error

An error occurred when deleting the native event type.

```
Error-: AIP-16015: Delete of Application Event Type failed with error: Cannot delete Event Body Element which is referenced by Event Body Item
```

```
Error-: AIP-16011: Cannot delete Event Body Element which is referenced by Event Body Item
```

Solution

You cannot delete the native event because it is referenced in an event map. First delete the event map for the native event. This same error can also refer to a condition expression or transformation map reference.

Example 22–2 Deleting an Interaction

Error

An error occurred when deleting the interaction.

```
Error-: AIP-16015: Delete of Interaction failed with error: Cannot delete Interaction Usage which is referenced by Port
```

```
Error-: AIP-16011: Cannot delete Interaction Usage which is referenced by Port
```

Solution

You cannot delete the interaction, because another native role and native event are using it. First delete any modeling metadata referencing the native roles and native

events. Then delete the native roles and native events. After that, you can delete the interaction.

Example 22–3 Deleting an Event Transformation Map

Error

An error occurred when deleting the transformation map {0}.

```
Error-: AIP-16015: Delete of Event Transformation Map failed with error: Cannot delete Event Map Parameter which is referenced by Event Header Rule
```

```
Error-: AIP-16011: Cannot delete Event Map Parameter which is referenced by Event Header Rule
```

Solution

You cannot delete the event transformation map, because it is associated with an event header rule. You must first remove the event header rule association, and then delete the event transformation map.

Example 22–4 Deleting an Application

There are two objects that can reference an application: an agreement (the application agreement) and a step (the SetParty Step). The following example describes the errors for both cases:

Problem

The following error occurs when you attempt to delete an application that is being referenced in a SetParty Step:

```
Error -: AIP-16015: Delete of Application failed with error: Cannot delete Application which is referenced by Set Party Step
```

```
Error -: AIP-16011: Cannot delete Application which is referenced by Set Party Step
```

The application is referenced in a SetParty step in either the business process or one of the roles.

Solution

Remove all references to the application:

1. Locate the SetParty step that is referencing the application you tried to delete.

2. Update the SetParty step and change the party to a different party; for example, select **Unspecified**.
3. Delete the application.

Problem

The other object that can reference an application is an application agreement. The following error occurs when you attempt to delete an application that is being referenced in an application agreement:

```
Error -: AIP-16015: Delete of Application failed with error: Cannot delete Application which is referenced by Application Participant
```

```
Error -: AIP-16011: Cannot delete Application which is referenced by Application Participant
```

The application is a participant in an application agreement.

Solution

1. Locate the application agreement referencing the application you attempted to delete.
2. Update the application agreement and change the application participant; for example, select **Unspecified**.
3. Delete the application.

Additional Troubleshooting Documentation

Oracle Application Server ProcessConnect provides references to error resolution, error handling, and good design practices information in this User Guide and the Application Adapter Guides.

Troubleshooting Details in the User Guide

[Table 22-2](#) describes troubleshooting details in the User Guide.

Table 22-2 *Troubleshooting and Error Handling Details*

Topic	Section
Tutorial troubleshooting methods Note: The troubleshooting methods described in the tutorial can be used in all situations	"Task 6: Troubleshooting Any Errors with Log Files and Reports" on page 7-43
Technology adapter diagnostics and troubleshooting details:	
<ul style="list-style-type: none"> ▪ Advanced Queuing adapter ▪ E-Mail adapter ▪ File/FTP adapter ▪ HTTP adapter ▪ JMS adapter ▪ Oracle Database adapter ▪ Web Service adapter 	<ul style="list-style-type: none"> ▪ "Advanced Queuing Adapter Diagnostics and Troubleshooting" on page 8-21 ▪ "E-Mail Adapter Diagnostics and Troubleshooting" on page 8-37 ▪ "File/FTP Adapter Diagnostics and Troubleshooting" on page 8-43 ▪ "HTTP Adapter Diagnostics and Troubleshooting" on page 8-54 ▪ "JMS Adapter Diagnostics and Troubleshooting" on page 8-70 ▪ "Oracle Database Adapter Diagnostics and Troubleshooting" on page 8-87 ▪ "Web Service Adapter Diagnostics and Troubleshooting" on page 8-99
Common errors when using the modeling wizards	"Common Modeling Wizard Errors" on page 9-41
Common role design errors	"Designing Roles to Ensure Proper Validation" on page 12-121
Common transformation design errors and transformation design limitations	Chapter 14, "Advanced Transformations Design"

Table 22–2 (Cont.) Troubleshooting and Error Handling Details

Topic	Section
Deployment topics:	
■ Reasons for the unsuccessful creation of a configuration	"Unsuccessful Configuration Creation and Validation" on page 16-7
■ Setting business intelligence reporting levels in a configuration	"Deploying a Validated Configuration" on page 16-10
Oracle Enterprise Manager topics:	
■ Accessing log files	"Oracle Application Server ProcessConnect Log Files" on page 18-10
■ Changing logging configuration parameter settings	"Oracle Application Server ProcessConnect Middle-Tier Instance Configuration Parameters" on page 18-11
Error handling topics, including:	
■ Types of errors	"Types of Errors" on page 21-3
■ Creating a step return code port that captures domain error details	"Error Handling with Step Return Code Ports" on page 21-4
■ Role and event instance error state implications	"Implications of Role Instances and Event Instances Being in an Error State" on page 21-10
■ Where to look for runtime error details	"Where Do I Find Runtime Error Details?" on page 21-13
■ Typical adapter framework and integration manager errors and corrective actions	"Typical Adapter Framework and Integration Manager Errors" on page 21-15
■ Creating alert e-mail messages	"Alert E-Mail Message Format" on page 21-17
Error, business process, and event reports, including use case examples	Chapter 23, "Creating Reports"

Troubleshooting Details in the Application Adapter Guides

Troubleshooting details are also included in the documentation set for the application adapters. [Table 22–3](#) references the documentation in which to look for each adapter.

Table 22–3 Third Party Application Adapter Troubleshooting Documentation

Adapter	Documentation
PeopleSoft 8 adapter	<i>Oracle Application Server Integration Adapter for PeopleSoft 8 User's Guide</i>
SAP R/3 adapter	<i>Oracle Application Server Integration Adapter for SAP R/3 User's Guide</i>
Siebel 2000 adapter	<i>Oracle Application Server Integration Adapter for Siebel 2000 User's Guide</i>
J.D. Edwards OneWorld XE adapter	<i>Oracle Application Server Integration Adapter for J.D. Edwards OneWorld XE User's Guide</i>
VSAM adapter	<i>Oracle Application Server Integration Adapter for VSAM Installation and User's Guide</i>
CICS adapter	<i>Oracle Application Server Integration Adapter for CICS Installation and User's Guide</i>
IMS/TM adapter	<i>Oracle Application Server Integration Adapter for IMS/TM Installation and User's Guide</i>
IMS/DB adapter	<i>Oracle Application Server Integration Adapter for IMS/DB Installation and User's Guide</i>
Tuxedo adapter	<i>Oracle Application Server Integration Adapter for Tuxedo Installation and User's Guide</i>

Chapter Summary

This chapter describes the various methods for troubleshooting errors (viewing log files, setting business intelligence log levels, and creating reports). A use case that describes how to use these methods to troubleshoot an error is also provided.

Modeling metadata in an integration must be deleted in a specific order in Oracle Application Server ProcessConnect. A graphical view shows the dependencies between modeling metadata. A table describing the order in which to delete modeling metadata and profile data and error messages of how not to delete modeling metadata are also provided.

References to troubleshooting details provided throughout this User Guide and the Application Adapters Guides are also provided.

Part V

Analyst Management Tasks

This part describes management tasks that an analyst of integrations performs with the Oracle Application Server ProcessConnect user interface tool.

This part contains the following chapter:

- [Chapter 23, "Creating Reports"](#)

Creating Reports

This chapter describes how to create Oracle Application Server ProcessConnect reports.

This chapter contains these topics:

- [Reports Overview](#)
- [Creating Process Monitoring Reports](#)
- [Creating Activity Monitoring Reports](#)
- [Creating Process Optimization Reports](#)
- [Specifying the Layout of Your Report](#)
- [Reviewing Your Selections Before Creation](#)
- [Reviewing Your Output](#)
- [Report Creation Examples](#)
- [Common User Errors](#)
- [Chapter Summary](#)

Note: Do not use the **Back** or **Forward** buttons of your Web browser when creating reports. Instead, use the **Back** and **Next** buttons specifically provided by the report creation pages. This ensures that the correct information displays in each page.

See Also:

- [Chapter 3, "Oracle Application Server ProcessConnect Concepts"](#) for conceptual details about events and coordinations
- [Chapter 21, "Oracle Application Server ProcessConnect Error Handling"](#) for additional details about error states

Reports Overview

Business data exists in the runtime repository as business processes are executed. The Oracle Application Server ProcessConnect user interface tool enables you to query this information to see what is occurring and to perform business analysis. You can query this information in several different ways based on the type that you want. Specifically, you can query for information such as events, business processes, and errors. For example, you create a query for the total and average values of purchase orders in the last month. For these types of information, Oracle Application Server ProcessConnect also enables you to either see the status of a specific event or the aggregate status on a group of events.

This section contains these topics:

- [Configuration Support in Reports](#)
- [Process Monitoring Reports](#)
- [Activity Monitoring](#)
- [Process Optimization](#)

Note: Some report creation pages include lists that enable you to make multiple selections (for example, the **Event State** list, **Coordination** list, **Party** list, and **Available Fields** list). To do this, hold down the Ctrl key while making multiple selections.

See Also: ["Deploying a Configuration"](#) on page 16-9 for instructions on selecting a report logging level before deploying a configuration

Configuration Support in Reports

The first page of questions that displays for each report is the Parameters page. The values (such as the event types) available for selection on this page are based on the selected configuration. By default, these values are from the latest deployed configuration. However, you can also select **Unspecified** or select a different configuration from the **Configuration Name** list. In both these cases, the page refreshes to display values (such as business processes) applicable to your selection. To see the list of event types available with your selection, you must then click **Specify Event** and click the flashlight.

This section describes the values available with each configuration selection:

- [Values Available when the Default Configuration is Selected](#)
- [Values Available when Unspecified is Selected](#)
- [Values Available when a Different Configuration is Selected](#)

Values Available when the Default Configuration is Selected

The following values are available for selection when the default configuration is selected. This is the selected configuration when you initially access the Parameters page:

- The list of values available for selection are from the latest deployed configuration.
- The event types that display for selection when you click the flashlight next to the **Name** field on the Parameters page are from the latest deployed configuration. For Event Status, Coordination Status, and Error Status reports, the **Name** field displays after you select **Specify Event**. For Event Analysis reports, the field automatically displays.
- The event type structure that displays in the **Event Content Query Expression** and **Event Fields** sections of the Event Content page for both the Event Status and Activity Monitoring reports is from the latest deployed configuration.
- The business process structure that displays in the two Port pages of the Coordination Analysis report is from the latest deployed configuration.
- All queries are executed against the latest deployed configuration.

Values Available when Unspecified is Selected

The following values are available for selection when you select **Unspecified** from the **Configuration Name** list:

- The list of values available for selection are from all configurations, with any duplicate names removed.
- The event types that display for selection when you click the flashlight next to the **Name** field on the Parameters page are from the latest deployed configuration. For Event Status, Coordination Status, and Error Status reports, the **Name** field displays after you select **Specify Event**. For Event Analysis reports, the field automatically displays.
- The event type structure that displays in the **Event Content Query Expression** and **Event Fields** sections of the Event Content page for both the Event Status and Activity Monitoring reports is from the latest deployed configuration.
- The business process structure that displays in the two Port pages of the Coordination Analysis report is from the latest deployed configuration.
- All queries are executed against all configurations.

Values Available when a Different Configuration is Selected

The following values are available for selection when you select a specific configuration (for example, **i_Procure_v1**) from the **Configuration Name** list:

- The list of values available for selection are from the **i_Procure_v1** configuration.
- The event types that display for selection when you click the flashlight next to the **Name** field on the Parameters page are from the **i_Procure_v1** configuration. For Event Status, Coordination Status, and Error Status reports, the **Name** field displays after you select **Specify Event**. For Event Analysis reports, the field automatically displays.
- The event type structure that displays in the **Event Content Query Expression** and **Event Fields** sections of the Event Content page for both the Event Status and Activity Monitoring reports is from the **i_Procure_v1** configuration.
- The business process structure that displays in the two Port pages of the Coordination Analysis report is from the **i_Procure_v1** configuration.
- All queries are executed against the **i_Procure_v1** configuration.

Process Monitoring Reports

The Oracle Application Server ProcessConnect user interface tool enables you to create process monitoring (also known as status) reports. Status reports show the current status of events, coordinations, errors, collaborations, and business messages in an integration.

They are best used to either monitor the status of events or business processes or debug the progress of a specific deployed integration.

Status reports provide a snapshot of the integration process. The following types of status reports are provided:

- **Events**

Event status reports provide information on the status of events. For example, these reports can identify what has occurred with a specific purchase order received from a procurement system that has not yet been placed in the general ledger. This enables you to see whether events are active, consumed, in an error state, or waiting for instance processing.
- **Coordinations**

Coordination status reports provide information on the status of a specific coordination. For example, these reports can identify all coordinations with a specific trading partner within a specific period of time. This enables you to see whether specific coordinations have aborted, closed, or remained open.
- **Errors**

Error status reports enable you to view details about errors occurring in an integration. You can create reports that provide details on all errors or you can create reports that provide details about a specific type of error (for example, the error type, error class, and error code).
- **Collaborations**

Collaboration reports enable you to generate reports about the collaboration name (such as RosettaNet partner interface process (PIP) 01A, 3A4, or 3A6) in an integration.
- **Business messages**

Business message status reports enable you to identify details about the sending trading partner in an integration, such as their collaboration name, actor role (for example, buyer or seller), protocol message identification (ID), and exchange protocol (RosettaNet).

See Also:

- ["Creating Process Monitoring Reports"](#) on page 23-7 for procedural instructions on creating process monitoring reports

The following examples of creating process monitoring reports:

- ["Monitoring iProcurement Process Status"](#) on page 23-32
- ["Monitoring Coordination Details"](#) on page 23-36
- ["Monitoring Current Errors in an Integration"](#) on page 23-38

Activity Monitoring

Activity monitoring reports analyze specific business activities across integration objects (for example, the total number of event instances sent by a specific party during this quarter).

See Also:

- ["Creating Activity Monitoring Reports"](#) on page 23-23 for procedural instructions on creating activity monitoring reports
- ["Monitoring the Total and Average Amount of Desktop Personal Computers for this Month"](#) on page 23-39 for an example of an activity monitoring report

Process Optimization

Process optimization reports monitor business process efficiency (for example, the response time for orders placed by a specific party during the last month).

See Also:

- ["Creating Process Optimization Reports"](#) on page 23-28 for procedural instructions on creating process optimization reports
- ["Monitoring Business Process Efficiency"](#) on page 23-44 for an example of a process optimization report

Creating Process Monitoring Reports

Process monitoring reports monitor the current state of an integration object (for example, an event instance).

The following process monitoring reports are provided:

- [Event Status Report](#)
- [Coordination Status Report](#)
- [Error Status Report](#)
- [Collaboration Status Report](#)
- [Business Message Status Report](#)

There are a number of elements of information in process monitoring reports that you can choose to specify. Some information is necessary to run or create the report. Other parameters are advanced and optional and designed to enable you to further narrow the scope of a query.

Process monitoring reports are structured in a consistent manner. On the first page, you can choose to specify mandatory and optional parameters necessary to create the report. Other advanced parameters can be specified on a second page, if necessary. Final pages enable you to specify the layout of your report information and view a summary of the report to create.

Event Status Report

Follow these instructions to create an event status report. The pages that appear are part of a wizard in which you enter information that appears in a final report.

[Table 23–1](#) provides an overview of the pages that appear.

Table 23–1 *Event Status Report Pages Overview*

Page	Description
Event Report: Parameters	<p>A page that consists of two sections:</p> <ul style="list-style-type: none"> ▪ A section for specifying basic parameters such as a report name, start and end dates for gathering data, event type classification (native, application, or business), event type names, and event states (active, consumed, error, or wait). While only the report name is mandatory, specifying these other parameters enables you to narrow the scope of your report. ▪ An advanced section for specifying optional parameters such as the business process, coordination state (aborted, closed, or open), parties involved in the agreement, and configuration name.
Event Report: Event Content	<p>A page that enables you to specify querying events based on content (such as querying for all purchase order amounts over \$1000). You can also specify the event fields to display in the report.</p>
Event Report: Layout	<p>A page that enables you to specify the layout of information in your report, such as specifying the column names and order of their appearance in the report.</p>
Event Report: Review	<p>A page that enables you to review your selections before creating the report.</p>

To create an event status report:

1. Select the **Reports** tab.
2. Select the **Process Monitoring** tab.
3. Select **Event Status**.

Specify Event Status Report Parameters

The Event Report: Parameters page appears.

1. Enter a unique and recognizable name in the **Name** field or accept the default name of **Event Status Report**. This is the only mandatory field on this page.
2. Click the calendar icon for the **Start Date** field to select a date at which to begin gathering report data.
3. Click the calendar icon for the **End Date** field to select a date at which to stop gathering report data.
4. If you want to specify a specific event classification and event type name, click the **Specify Event** box. The page refreshes to display the following fields:
 - a. Select **Application Event Type**, **Business Event Type**, or **Native Event Type** from the **Classification** list.
 - b. Click the flashlight to select the specific event type name for the **Name** field. Only event type names that are part of a deployed configuration display in this list; event types that are only in the design-time repository do not appear.

Note: You must use the flashlight to select an event type name. Do not manually enter a name in the **Name** field.

- c. If you want to specify querying events (for example, query for all purchase order amounts over \$1000) based on content or to select event fields for your report, select the **Specify Event content** box and ensure that you specified an event type name in Step 4b.

5. Select an event state from the **Event State** list or select **Unspecified** to select all event states:

State	Description
Active	The event is currently processing.
Consumed	Event processing has completed. The event can no longer be used. Consumed events are only used for correlation or during monitoring. A consumed event cannot be copied or sent for additional processing.
Error	An error occurred during the event lifecycle.
Wait	The event is potentially out of order and cannot currently be processed.

The wizard page that displays next is based on selections you made in Step 4 and are about to make on this Event Report: Parameters page.

6. See the following sections based on your selections:

If You...	Then...
Want to specify advanced report parameters	<ol style="list-style-type: none"> 1. Click Show Advanced Report Options. 2. Go to "Specify Advanced Event Status Report Parameters" on page 23-11.
Selected a specific event type name in Step 4b and selected the Specify Event content box in Step 4c on page 23-9	<ol style="list-style-type: none"> 1. Click Next. 2. Go to "Specify Event Contents" on page 23-12.
Do not want to perform either of these tasks	<ol style="list-style-type: none"> 1. Click Next. 2. Go to "Specifying the Layout of Your Report" on page 23-30.

Specify Advanced Event Status Report Parameters

1. Select the business process for which to create a report from the **Business Process** list.
2. Select a status from the **Coordination State** list. If you select **Unspecified**, all coordination states are included in the report.

State	Description
aborted	Coordination processing has been aborted.
closed	Coordination processing has completed.
open	Coordination processing is occurring.

3. Select the sending party from the **From Party** list. Only parties included in deployed configurations appear.
4. Select the receiving party from the **To Party** list. Only parties included in deployed configurations appear.
5. Select the configuration for which to create a report from the **Configuration Name** list. See "[Configuration Support in Reports](#)" on page 23-3 for details about the type of information that appears in fields based on your selection.
6. Click **Next**.
7. See the following section based on your selections.

If You...	Then...
Selected a specific event type name in Step 4b and selected the Specify Event content box in Step 4c on page 23-9	Go to " Specify Event Contents " on page 23-12.
Did not perform this task	Go to " Specifying the Layout of Your Report " on page 23-30.

Specify Event Contents

If you selected a specific event type name in Step 4b and selected the **Specify Event content** box in Step 4c on page 23-9, the Event Report: Event Content page appears. This page enables you to create conditional expressions on event content (for example, query for purchase order amounts over \$1000) and select event fields for the summary and detail reports.

1. Go to the **Event Content Query Expression** section.
2. Select **Condition expression not specified**.
3. Click **Update** to build a new condition.

The Create Condition Expression page appears.

4. Click **Expand All** or select a specific entry to expand in the **Left Operand** column to display the contents of the selected event.
5. Select a name.
6. Select an operator from the **Operator** list (for example, =):
 - != (not equal to)
 - < (less than)
 - <= (less than or equal to)
 - = (equal to)
 - > (greater than)
 - >= (greater than or equal to)
7. Enter a value in the **Right Operand** field.
8. Click **Apply**.

The results display onscreen.

9. Go to the **Event Fields** section.
10. Click **Expand All** or select a specific entry to expand.
11. If you want, you can select the event fields to use in the summary report and details reports. A later page in this wizard enables you to specify the order in which these fields display in the reports.

These fields provide the following functionality:

- **Summary Report Grouping**

Select **Yes** to include this event field in the summary report.

- **Detail Report Inclusion**

Select **Yes** to include this event field in the details reports.

- **Alias**

Use the default alias or specify a different name to use as the column name in the report.

12. Click **Next**.

13. Go to "[Specifying the Layout of Your Report](#)" on page 23-30.

Coordination Status Report

Follow these instructions to create a coordination status report. The pages that appear are part of a wizard in which you enter information that appears in a final report.

[Table 23–2](#) provides an overview of the pages that appear.

Table 23–2 Coordination Status Report Pages Overview

Page	Description
Coordination Report: Parameters	<p>A page that consists of two sections:</p> <ul style="list-style-type: none"> ■ A section for specifying basic parameters such as a report name, start and end dates for gathering data, business process, and coordination state (aborted, closed, or open). While only the report name is mandatory, specifying these other parameters enables you to narrow the scope of your report. ■ An advanced section for specifying parameters such as the event type classification (native, application, or business), event type names, event state (active, consumed, error, or wait), parties involved in the agreement, and configuration name.
Coordination Report: Layout	A page that enables you to specify the layout of information in your report, such as specifying the column names and order of their appearance in the report.
Coordination Report: Review	A page that enables you to review your selections before creating the report.

To create a coordination status report:

1. Select the **Reports** tab.
2. Select the **Process Monitoring** tab.
3. Select **Coordination Status**.

Specify Coordination Status Report Parameters

The Coordination Report: Parameters page appears.

1. Enter a unique and recognizable name in the **Name** field or accept the default name of **Coordination Status Report**. This is the only mandatory field on this page.
2. Click the calendar icon for the **Start Date** field to select a date at which to begin gathering report data.
3. Click the calendar icon for the **End Date** field to select a date at which to stop gathering report data.
4. Select the business process for which to create a report from the **Business Process** list.
5. Select a status from the **Coordination State** list. If you select **Unspecified**, all coordination states are included in the report.

State	Description
aborted	Coordination processing has been aborted.
closed	Coordination processing has completed.
open	Coordination processing is occurring.

6. See the following section based on whether you want to specify advanced report parameters.

If You...	Then...
Want to specify advanced report parameters	<ol style="list-style-type: none"> 1. Click Show Advanced Report Options. 2. Go to "Specify Advanced Coordination Status Report Parameters" on page 23-15.
Do not want to specify advanced report parameters	<ol style="list-style-type: none"> 1. Click Next. 2. Go to "Specifying the Layout of Your Report" on page 23-30.

Specify Advanced Coordination Status Report Parameters

1. If you want to specify a specific event, click the **Specify Event** box and perform Steps 1a through 1b. You must perform these steps if you want to go to the next page in this wizard.
 - a. Select the **Application Event Type**, **Business Event Type**, or **Native Event Type** from the **Classification** list.
 - b. Click the flashlight to select the specific event type name for the **Name** field. Only event type names that are part of a deployed configuration display in this list; event types that are only in the design-time repository do not appear.

Note: You must use the flashlight to select an event type name. Do not manually enter a name in the **Name** field.

2. Select an event state from the **Event State** list or select **Unspecified** to select all event states:

State	Description
Active	The event is currently processing.
Consumed	Event processing has completed. The event can no longer be used. Consumed events are only used for correlation or during monitoring. A consumed event cannot be copied or sent for additional processing.
Error	An error occurred during the event lifecycle.
Wait	The event is potentially out of order and cannot currently be processed.

3. Select the sending party from the **From Party** list. Only parties included in deployed configurations appear.
4. Select the receiving party from the **To Party** list. Only parties included in deployed configurations appear.
5. Select the configuration for which to create a report from the **Configuration Name** list. See "[Configuration Support in Reports](#)" on page 23-3 for details about the type of information that appears in fields based on your selection.
6. Click **Next**.
7. Go to "[Specifying the Layout of Your Report](#)" on page 23-30.

Error Status Report

Follow these instructions to create an error status report. The pages that appear are part of a wizard in which you enter information that appears in a final report.

[Table 23–3](#) provides an overview of the pages that appear.

Table 23–3 *Error Status Report Pages Overview*

Page	Description
Error Report: Parameters	<p>A page that consists of two sections:</p> <ul style="list-style-type: none"> ■ A section for specifying basic parameters such as a report name, start and end dates for gathering data, error class (system or domain), error code, and error message. While only the report name is mandatory, specifying these other parameters enables you to narrow the focus of your report. ■ An advanced section for specifying optional parameters such as event type classification (native, application, or business), event type name, business process, coordination state (aborted, closed, or open), parties involved in the agreement, and configuration name.
Error Report: Error Event Content	A page that enables you to specify querying events based on content.
Error Report: Layout	A page that enables you to specify the layout of information in your report, such as specifying the column names and order of their appearance in the report.
Error Report: Review	A page that enables you to review your selections before creating the report.

To create an error status report:

1. Select the **Reports** tab.
2. Select the **Process Monitoring** tab.
3. Select **Error Status**.

Specify Error Status Report Parameters

The Error Report: Parameters page appears.

1. Enter a unique and recognizable name in the **Name** field or accept the default name of **Error Status Report**. This is the only mandatory field on this page.
2. Click the calendar icon for the **Start Date** field to select a date at which to begin gathering report data.
3. Click the calendar icon for the **End Date** field to select a date at which to stop gathering report data.
4. Select a specific error class or select **Unspecified** for all error classes in the **Error Class** list:
 - **Domain**
 These are errors that impact events in a specific Oracle Application Server ProcessConnect middle-tier instance. An example of a domain error occurrence is when the runtime system uses an incorrectly-created event transformation map.
 - **System**
 These are errors that impact the entire system, and not just Oracle Application Server ProcessConnect. Examples of system error occurrences include a database being down, a disk being full, or network connectivity problems.
5. Enter specific error codes for which to search in the **Error Code** field (separated by commas) or leave this field blank to search for all errors.
6. Enter a specific error message in the **Error Message** field for which to search or leave this field blank to search for all errors.
7. See the following section based on whether you want to specify advanced report parameters.

If You...	Then...
Want to specify advanced report parameters	<ol style="list-style-type: none"> 1. Click Show Advanced Report Options. 2. Go to "Specify Advanced Error Status Report Parameters" on page 23-19.
Do not want to specify advanced report parameters	<ol style="list-style-type: none"> 1. Click Next. 2. Go to "Specifying the Layout of Your Report" on page 23-30.

Specify Advanced Error Status Report Parameters

1. If you want to specify a specific event, click the **Specify Event** box and perform Steps 1a through 1b. Otherwise, go to Step 2.
 - a. Select the **Application Event Type**, **Business Event Type**, or **Native Event Type** from the **Classification** list.
 - b. Click the flashlight to select the specific event type name for the **Name** field. Only event type names that are part of a deployed configuration display in this list; event types that are only in the design-time repository do not appear. If you want to specify querying events based on content on a later page, ensure that you specify an event type name.

Note: You must use the flashlight to select an event type name. Do not manually enter a name in the **Name** field.

2. Select the business process for which to create a report from the **Business Process** list.
3. Select a status from the **Coordination State** list. If you select **Unspecified**, all coordination states are included in the report.

State	Description
aborted	Coordination processing has been aborted.
closed	Coordination processing has completed.
open	Coordination processing is occurring.

4. Select the sending party from the **From Party** list. Only parties included in deployed configurations appear.
5. Select the receiving party from the **To Party** list. Only parties included in deployed configurations appear.
6. Select the configuration for which to create a report from the **Configuration Name** list. See "[Configuration Support in Reports](#)" on page 23-3 for details about the type of information that appears in fields based on your selection.

7. See the following section based on your selection at Step 1 on page 23-19.

If You...	Then...
Selected the Specify Event box in Step 1 and selected a specific event type name in Step 1b on page 23-19	<ol style="list-style-type: none"> 1. Click Next. 2. Go to "Specify Event Contents" on page 23-20.
Did not perform this task	<ol style="list-style-type: none"> 1. Click Next. 2. Go to "Specifying the Layout of Your Report" on page 23-30.

Specify Event Contents

If you selected the **Specify Event** box in Step 1 and selected a specific event type name in Step 1b on page 23-19, the Error Report: Error Event Content page appears. This page enables you to create conditional expressions on event content.

1. Go to the **Event Content Query Expression** section.
2. Select **Condition expression not specified**.
3. Click **Update** to build a new condition.
The Create Condition Expression page appears.
4. Click **Expand All** or select a specific entry to expand in the **Left Operand** column to display the contents of the selected event.
5. Select a name.
6. Select an operator from the **Operator** list (for example, =):
 - != (not equal to)
 - < (less than)
 - <= (less than or equal to)
 - = (equal to)
 - > (greater than)
 - >= (greater than or equal to)
7. Enter a value in the **Right Operand** field.

8. Click **Apply**.
The results display onscreen.
9. Click **Next**.
10. Go to "[Specifying the Layout of Your Report](#)" on page 23-30.

Collaboration Status Report

Follow these instructions to create a collaboration status report. The pages that appear are part of a wizard in which you enter information that appears in a final report.

To create a collaboration status report:

1. Select the **Reports** tab.
2. Select the **Process Monitoring** tab.
3. Select **Collaboration Status**.

Specify Report Parameters

The Collaboration Report: Parameters page appears.

1. Enter the following details:

Field	Description
Collaboration Name	Select the collaboration name (for example, 0A1 , 3A4 , or 3A6).
Protocol Collaboration ID	Enter the protocol message ID.
Configuration Name	Select the configuration name.

2. Click **Finish**.
3. Go to "[Reviewing Your Output](#)" on page 23-31.

Business Message Status Report

Follow these instructions to create a business message status report. The pages that appear are part of a wizard in which you enter information that appears in a final report.

To create a business message status report:

1. Select the **Reports** tab.
2. Select the **Process Monitoring** tab.
3. Select **Business Message Status**.

Specify Report Parameters

The Business Message Report: Parameters page appears.

1. Enter the following details:

Field	Description
Sending Trading Partner	Select the trading partner sending the message.
Collaboration Name	Select the collaboration name of the trading partner (for example, 0A1 , 3A4 , or 3A6). Your selection causes only those actors applicable to the collaboration name to display in the Actor field.
Actor	Select the actor type for the collaboration name you selected in the Collaboration Name list: <ul style="list-style-type: none"> ▪ Buyer ▪ Seller ▪ Failure Report Administrator ▪ PIP Failure Notifier
Protocol Message ID	Enter the protocol message ID.
Exchange Protocol	Select RosettaNet.
Configuration Name	Select the configuration name.

2. Click **Finish**.
3. Go to ["Reviewing Your Output"](#) on page 23-31

Creating Activity Monitoring Reports

Activity monitoring reports analyze specific business activities across integration objects (for example, the total number of event instances sent by a specific party during this quarter).

Follow these instructions to create an activity monitoring report. The pages that appear are part of a wizard in which you enter information that appears in a final report.

Table 23–4 provides an overview of the pages that appear.

Table 23–4 Activity Monitoring Report Pages Overview

Page	Description
Event Analysis Report: Parameters	<p>A page that consists of two sections:</p> <ul style="list-style-type: none"> ▪ A section for specifying basic parameters such as a report name, start and end dates for gathering data, event type classification (native, application, or business), event type name, and event state (active, consumed, error, or wait). The report name, event type classification (native, application, or business), and event type name are mandatory. You can also specify other parameters to narrow the scope of your report. ▪ An advanced section for specifying optional parameters such as business process, the coordination state (aborted, closed, or open), the parties involved in the agreement, and the configuration name.
Event Analysis Report: Event Content	A page that enables you to specify querying events based on content.
Event Analysis Report: Layout	A page that enables you to specify the layout of information in your report, such as specifying the column names and order of their appearance in the report.
Event Analysis Report: Review	A page that enables you to review your selections before creating the report.

To create an activity monitoring report:

1. Select the **Reports** tab.
2. Select the **Activity Monitoring** tab.

Specify Activity Monitoring Report Parameters

The Event Analysis Report: Parameters page appears.

1. Enter a unique and recognizable name in the **Name** field or accept the default name of **Event Analysis Report**. This is a mandatory field.
2. Click the calendar icon for the **Start Date** field to select a date at which to begin gathering report data.
3. Click the calendar icon for the **End Date** field to select a date at which to stop gathering report data.
4. Select the **Application Event Type**, **Business Event Type**, or **Native Event Type** from the **Classification** list. This is a mandatory field.
5. Click the flashlight to select the specific event type name for the **Name** field. Only event type names that are part of a deployed configuration display in this list; event types that are currently in the design-time repository do not appear. This is a mandatory field. You must select a name or you cannot go to the next page in this wizard.

Note: You must use the flashlight to select an event type name. Do not manually enter a name in the **Name** field.

6. Select an event state from the **Event State** list or select **Unspecified** to select all event states:

State	Description
Active	The event is currently processing.
Consumed	Event processing has completed. The event can no longer be used. Consumed events are only used for correlation or during monitoring. A consumed event cannot be copied or sent for additional processing.
Error	An error occurred during the event lifecycle.
Wait	The event is potentially out of order and cannot currently be processed.

The wizard page that displays next is based on selections you made in Step 5 or are about to make on this Event Analysis Report: Parameters page.

7. See the following sections based on your selections:

If You...	Then...
Want to specify advanced report parameters	<ol style="list-style-type: none"> 1. Click Show Advanced Report Options. 2. Go to "Specify Advanced Activity Monitoring Report Parameters" on page 23-25. <p>Note: You cannot access these advanced parameters until you use the flashlight to select an event type name for the Name field in Step 5 on page 23-24.</p>
Selected a specific event type name in Step 5 on page 23-24 and do not want to specify advanced report parameters	<ol style="list-style-type: none"> 1. Click Next. 2. Go to "Specify Event Contents" on page 23-26.

Specify Advanced Activity Monitoring Report Parameters

1. Select the business process for which to create a report from the **Business Process** list.
2. Select a status from the **Coordination State** list. If you select **Unspecified**, all coordination states are included in the report.

State	Description
aborted	Coordination processing has been aborted.
closed	Coordination processing has completed.
open	Coordination processing is occurring.

3. Select the sending party from the **From Party** list. Only parties included in deployed configurations appear.
4. Select the receiving party from the **To Party** list. Only parties included in deployed configurations appear.
5. Select the configuration for which to create a report from the **Configuration Name** list. See "[Configuration Support in Reports](#)" on page 23-3 for details about the type of information that appears in fields based on your selection.

Specify Event Contents

If you selected a specific event type name in Step 5 on page 23-24, the Event Analysis Report: Event Content page appears. This page enables you to create conditional expressions on event content and select event fields and their aggregation type for the summary and details reports.

1. Go to the **Event Content Query Expression** section.
2. Select **Condition expression not specified**.
3. Click **Update** to build a new condition.

The Create Condition Expression page appears.

4. Click **Expand All** or select a specific entry to expand in the **Left Operand** column to display the contents of the selected event.
5. Select a name.
6. Select an operator from the **Operator** list (for example, =):
 - != (not equal to)
 - < (less than)
 - <= (less than or equal to)
 - = (equal to)
 - > (greater than)
 - >= (greater than or equal to)
7. Enter a value in the **Right Operand** field.
8. Click **Apply**.

The results display onscreen.
9. Click **Next**.
10. Go to the **Event Fields** section.
11. Click **Expand All** or select a specific entry to expand.
12. If you want, you can select the event fields to use in the summary report and details reports. A later page in this wizard enables you to specify the order in which these fields display in the reports.

These fields provide the following functionality:

- **Aggregation Type**

Select **Average** to calculate the average, **Sum** to add the total amount, or **Both** to perform both calculations on the condition expression you created in Steps 4 through 8 on page 23-26.

Note: Ensure that the string fields selected for **Sum** or **Average** have numeric content. Otherwise, blank **Sum** and **Average** columns appear in the final report.

- **Summary Report Grouping**

Select **Yes** to include this event field in the summary report.

- **Detail Report Inclusion**

Select **Yes** to include this event field in the details reports.

- **Alias**

Use the default alias or specify a different name to use as the column name in the report.

13. Click **Next**.

14. Go to "[Specifying the Layout of Your Report](#)" on page 23-30.

Creating Process Optimization Reports

Process optimization reports monitor business process efficiency (for example, the response time for orders placed by a specific party during the last month).

Follow these instructions to create a process optimization report. The pages that appear are part of a wizard in which you enter information that appears in a final report.

To create a process optimization report:

1. Select the **Reports** tab.
2. Select the **Process Optimization** tab.

[Table 23–5](#) provides an overview of the pages that appear.

Table 23–5 *Process Optimization Report Pages Overview*

Page	Description
Coordination Analysis Report: Parameters	A mandatory page for specifying basic parameters such as a report name, start and end dates for gathering data, business process, coordination state (aborted, closed, or open), and configuration name. While only the report name is mandatory, specifying these other parameters enables you to narrow the focus of your report.
Coordination Analysis Report: Ports	A page on which you must specify a specific role or step port as the first port endpoint for collecting data.
Coordination Analysis Report: Ports	A page on which you must specify a specific role or step port as the second port endpoint for collecting data.
Coordination Analysis Report: Layout	A page that enables you to specify the layout of information in your report, such as specifying the column names and order of their appearance in the report.
Coordination Analysis Report: Review	A page that enables you to review your selections before creating the report.

Specify Process Optimization Report Parameters

The Coordination Analysis Report: Parameters page appears.

1. Enter a unique and recognizable name in the **Name** field or accept the default name of **Coordination Analysis Report**. This is the only mandatory field on this page.
2. Click the calendar icon for the **Start Date** field to select a date at which to begin gathering report data.
3. Click the calendar icon for the **End Date** field to select a date at which to stop gathering report data.
4. Select the business process for which to create a report from the **Business Process** list.
5. Select a status for the business process from the **Coordination State** list. If you select **Unspecified**, all coordination states are included in the report.

State	Description
aborted	Coordination processing has been aborted.
closed	Coordination processing has completed.
open	Coordination processing is occurring.

6. Select the configuration for which to create a report from the **Configuration Name** list. See "[Configuration Support in Reports](#)" on page 23-3 for details about the type of information that appears in fields based on your selection.
7. Click **Next**.

Specify the First Port

The first Coordination Analysis Report: Ports page appears.

1. Click a specific business process to expand or click **Expand All** to display all role ports and step ports integrated with this business process.
2. Select a specific port as the first endpoint for collecting report data. This is a mandatory task.
3. Select the sending party from the **From Party** list. Only parties included in deployed configurations appear.

Specify a Second Port

The second Coordination Analysis Report: Ports page appears.

1. Click a specific business process to expand or click **Expand All** to display all role ports and step ports integrated with this business process.
2. Select a specific port as the second endpoint for collecting report data. This is a mandatory task. Your port selections determine the total amount of time it takes for an event to enter one port and exit through the other port. This is useful for determining the efficiency of your business process.
3. Select the outgoing party from the **From Party** list. Only parties included in deployed configurations appear.
4. Click **Next**.
5. Go to "[Specifying the Layout of Your Report](#)" on page 23-30.

Specifying the Layout of Your Report

The Report: Layout page appears and enables you to specify the layout of information in your report. The fields available for selection are based on your selections in the Parameters page and any additional fields you selected in the Event Content page. The left-most column that you specify in your layout determines the method by which information is sorted in your report. If you want to change the order by which information is sorted, then switch the column order on this page.

Column headers displaying in top-to-bottom order in the **Selected Fields** lists described in this section appear in left-to-right order, respectively, in the final summary and details reports.

1. Go to the **Grouping Fields** section to select summary report column headers.
2. Select the column headers in the **Available Fields** list.
3. Click **Move** to copy a column header or **Move All** to copy all column headers to the **Selected Fields** list.
4. Go to the **Details Fields** section to select details report column headers.
5. Select the column headers in the **Available Fields** list.
6. Click **Move** to copy a column header or **Move All** to copy all column headers to the **Selected Fields** list.

7. Enter optional comments in the **Comments** field. These comments appear under the report title.
8. Click **Next**.
9. Go to "[Reviewing Your Selections Before Creation](#)" on page 23-31 to review your selections.

Reviewing Your Selections Before Creation

The Report: Review page appears. The selections that you have made on previous pages of the wizard appear.

1. Review your selections. If you want to make changes, click the **Back** button provided by the wizard.
2. Click **Finish** when satisfied with your selections.
3. Go to "[Reviewing Your Output](#)" on page 23-31.

Reviewing Your Output

See one of the following sections based on the type of report you created:

- [Reviewing Business Message and Collaboration Status Report Output](#)
- [Reviewing the Report Output for All Others](#)

See Also: "[Report Creation Examples](#)" on page 23-32

Reviewing Business Message and Collaboration Status Report Output

The report is generated and displays onscreen. You cannot customize the fields that display in these types of reports. The summary report provides links to instance data reports.

Reviewing the Report Output for All Others

The report is generated and displays onscreen. Separate tables display for the summary and detail reports with the column headers you selected in the Report: Layout page. The summary report provides links to the details report. The details report provides additional links to instance data in the **Details** column.

Report Creation Examples

This section provides examples of creating reports.

[Table 23–6](#) lists the report examples provided:

Table 23–6 *Report Examples*

Report Type	Example
Process Monitoring:	
▪ Event Status	"Monitoring iProcurement Process Status" on page 23-32
▪ Coordination Status	"Monitoring Coordination Details" on page 23-36
▪ Error Status	"Monitoring Current Errors in an Integration" on page 23-38
Activity Monitoring	"Monitoring the Total and Average Amount of Desktop Personal Computers for this Month" on page 23-39
Process Optimization	"Monitoring Business Process Efficiency" on page 23-44

See Also: ["Creating Reports"](#) on page 7-44 to create a report as part of the tutorial

Monitoring iProcurement Process Status

This example describes how to monitor the status of iProcurement purchase orders moving through Oracle Application Server ProcessConnect during a specific time period.

1. Select **Reports > Process Monitoring**.
2. Enter a unique and recognizable name in the **Name** field or accept the default name.
3. Click the calendar icon for the **Start Date** field to select the date of one month ago.
4. Leave the **End Date** field blank to indicate today's date.
5. Click the **Specify Event** box.
6. Select **Application Event Type** from the **Classification** list.
7. Click the flashlight to select the specific event type name for the **Name** field. For this example, an event named **ServiceRequest** is selected.

The Event Report: Parameters page displays your selections:



Event Report: Parameters

Cancel Step 1 of 4 Next Finish

Parameters are used to define the 'where' clause of the query that is used to generate this report. Please specify parameters for this report and choose Next. Choose Finish to generate the report.

* Name

Date Range

Start Date 
End Date 

Event

Specify Event

Select if you want to specify an event classification, event type, or event content

Classification

Name 

Click the flashlight to select an event type

Specify Event content

Select if you want to specify querying event(s) based on content or to select event fields in your report

Event State
Active
Consumed
Error
Wait

Select an event state or select Unspecified for all event states

8. Click **Finish**.

The Summary Report of the Event Status Report page appears and indicates that six iProcurement purchase order requests were processed in the last month.

Event Status Report

Summary Report

Summary Report: number of events for specified group(s)







Number of events (%)	Details
6 (100%)	

9. Click **Details** to display the Details page.

Event Status Report

Details Report

Details Report

Event Classification	Event Name	Event State	Event Timestamp	Details
Application Event Type	ServiceRequest	Consumed	July 14, 2003 4:21:07 PM	
Application Event Type	ServiceRequest	Consumed	July 16, 2003 3:34:04 PM	
Application Event Type	ServiceRequest	Consumed	July 17, 2003 3:06:09 PM	
Application Event Type	ServiceRequest	Consumed	July 17, 2003 3:10:09 PM	
Application Event Type	ServiceRequest	Consumed	July 16, 2003 3:09:04 PM	
Application Event Type	ServiceRequest	Consumed	July 16, 2003 3:36:05 PM	

This page displays the application event types consumed with each of the six purchase order requests over the past month. Since these events have all completed processing, their state display as consumed. The times at which these events were created also display in the **Event Timestamp** column.

10. Click **Details for a specific event classification.**

This details page displays the roles and steps that processed this event, their current status, and the time the event was last modified in that role or step. Details about the predecessor (native) and successor (business) events for the selected event (application) also display.

Event Details

Event Type Class	Application Event Type
Event Type	ServiceRequest
Is Inbound	Yes
From Party	Siebel Services
Role or Step Port	ServiceRequests-TX/Services_AEtoBE/ServiceRequest-IN
From Role	ServiceRequests-AR
From Role State	Completed
Current Role	ServiceRequests-TX
Current Role State	Completed

Status

This table displays the roles and steps that processed this event, their status and the time the event was last modified in that role or step.

[Expand All](#) | [Collapse All](#)

⊕ Role or Step			
Focus Name	Type	Status	Timestamp
▼ Role or Step			
⊕ ▶ ServiceRequests-TL	Binding Role	Completed	July 16, 2003 3:36:05 PM
⊕ ▶ ServiceRequests-AR	Application Role	Completed	July 16, 2003 3:36:06 PM
⊕ ▶ ServiceRequests-TX	Binding Role	Completed	July 16, 2003 3:36:06 PM

Predecessor Events

This table displays the predecessor events for this event, their event type class, the time they were last updated and the role or step port they are currently in.

Name	Event Type Class	Timestamp	Role or Step Port
ServiceRequest	Native Event Type	July 16, 2003 3:36:03 PM	ServiceRequests-TL/Translate ServiceRequest/ServiceRequest-IN

Successor Events

This table displays the successor events for this event, their event type class, the time they were last updated and the role or step port they are currently in.

Name	Event Type Class	Timestamp	Role or Step Port
ServicesRequest	Business Event Type	July 16, 2003 3:36:06 PM	iProcure/CreatePO/ServicesRequestIn-IN

Deployment Details

Configuration	iProcure_v1
Deployed On	May 2, 2003 12:00:00 AM

If this is an event details report for a native event, **Correlated To** and **Correlated By** sections display details about any initiating and target native event instances that have been correlated. An **Event Payload** window also displays the contents of the native format file (for example, the contents of an XML file).

Monitoring Coordination Details

This example describes how to monitor coordination details.

1. Select **Reports > Process Monitoring > Coordination Status**.
2. Enter a unique and recognizable name in the **Name** field or accept the default name.
3. Click the calendar icon for the **Start Date** field to select the date of one week ago.
4. Leave the **End Date** field blank.
5. Click **Finish**.

The Summary Report of the Coordination Status Report page appears.

Coordination Status Report

Summary Report

Summary Report: number of coordinations for specified group(s)

Business Process	Number of coordinations (%)
iProcure	47 (100%)

The total number of coordinations processed in the last week appears.

6. Click **Details**.

The Details Report of the Coordination Status Report page appears.

Coordination Status Report

Details Report

Details Report: iProcure

Coordination State	Coordination Timestamp	Details
closed	July 14, 2003 4:21:40 PM	
closed	July 16, 2003 3:09:20 PM	
closed	July 16, 2003 3:34:15 PM	
closed	July 16, 2003 3:36:20 PM	
closed	July 17, 2003 3:06:24 PM	
closed	July 17, 2003 3:10:19 PM	

A timestamp indicates when coordination processing completed.

7. Click **Details** for a specific coordination.

A second Coordination Details page appears. The upper portion of this page displays details such as the roles within this coordination, the steps within those roles, their current status, and their creation time.

Coordination Details

Coordination State **closed**
 Coordination Timestamp **July 14, 2003 4:21:40 PM**

Status

This table displays the roles in this coordination, the steps within those roles, their state and the time when they were created.

[Expand All](#) | [Collapse All](#)

⊕ Role or Step				
Focus	Name	Type	Status	Timestamp
	▼ Role or Step			
⊕	▶ ServiceRequests-NR	Native Role	Completed	July 14, 2003 4:21:03 PM
⊕	▶ ServiceRequests-TL	Binding Role	Completed	July 14, 2003 4:21:06 PM
⊕	▶ ServiceRequests-AR	Application Role	Completed	July 14, 2003 4:21:11 PM
⊕	▶ ServiceRequests-TX	Binding Role	Completed	July 14, 2003 4:21:11 PM
⊕	▶ ServiceRequests-BR	Business Role	Completed	July 14, 2003 4:21:15 PM
⊕	▶ IProcure	Business Process	Completed	July 14, 2003 4:21:16 PM
⊕	▶ SupplierPO-BR	Business Role	Completed	July 14, 2003 4:21:27 PM
⊕	▶ PORecord-BR	Business Role	Completed	July 14, 2003 4:21:27 PM
⊕	▶ PORecord-TX	Binding Role	Completed	July 14, 2003 4:21:28 PM
⊕	▶ SupplierPO-TX	Binding Role	Completed	July 14, 2003 4:21:29 PM
⊕	▶ PORecord-AR	Application Role	Completed	July 14, 2003 4:21:33 PM
⊕	▶ PORecord-TL	Binding Role	Completed	July 14, 2003 4:21:34 PM
⊕	▶ SupplierPO-AR	Application Role	Completed	July 14, 2003 4:21:34 PM
⊕	▶ SupplierPO-TL	Binding Role	Completed	July 14, 2003 4:21:35 PM
⊕	▶ PORecord-NR	Native Role	Completed	July 14, 2003 4:21:36 PM
⊕	▶ SupplierPO-NR	Native Role	Completed	July 14, 2003 4:21:37 PM

8. Expand a specific role to display additional report details about steps.

The lower portion of this page displays the events in this coordination, their event classification, and the role or step port in which they were processed.

Coordination Events

This table displays the events in this coordination, their class type and the role or step port they are currently in.

Name	Event Type Class	Role or Step Port
HR New Ad	Native Event Type	HR Placing New Ad-TL/Translate HR New Ad/HR New Ad-IN
HR New Ad	Application Event Type	HR Placing New Ad-TX/Transform HR New Ad/HR New Ad-IN
Ad Request	Business Event Type	Placing Ad at Global NP-TX/Transform HR New Ad/HR New Ad-IN
Global NP Ad	Application Event Type	Placing Ad at Global NP-TL/Translate Global NP Ad/Global NP Ad-IN
Global NP Ad	Native Event Type	Placing Ad at Global NP-NR/Passthrough Global NP Ad/Global NP Ad-OUT

Deployment Details

Configuration **test3**
 Deployed On **July 28, 2003 12:00:00 AM**

Monitoring Current Errors in an Integration

This example describes how to identify the event errors that have occurred during a specific period of time.



1. Select **Reports > Process Monitoring > Error Status**.
2. Enter a unique and recognizable name in the **Name** field or accept the default name.
3. Click the calendar icon for the **Start Date** field to select the date of one week ago.
4. Leave the **End Date** field blank to indicate today's date.
5. Click **Finish**. The Summary Report of the Error Status Report page displays the number of errors occurring in the past week.
6. Click **Details**. The Details Report of the Error Status Report page appears.

The **Error Timestamp** column indicates when the error first occurred. The **Last Occurred Timestamp** column indicates the last time the error occurred. The **Retry Count** column indicates the number of retries that were attempted to recover from the error.

Error Status Report

Details Report

Details Report

Error Code	Error Class	Error Timestamp	Last Occurred Timestamp	Retry Count	Business Process	Coordination State	Event Classification	Event Name	Event State	Event Timestamp	Details
AIP-10253	System	August 20, 2003 5:18:18 PM	August 20, 2003 5:18:18 PM	0							
AIP-10430	System	August 20, 2003 5:18:17 PM	August 20, 2003 5:18:17 PM	0							

If this is a domain error associated with an event, two additional links can appear along with the link in the **Details** column. These additional links provide access to the Event Instance Details page and the Coordinations Instance details page.

7. Click **Details** in the **Details** column.

The Error Details page displays specific details about the error, including error class, code, and message. In this example, a system error occurred.

Error Details

Error Class	System
Error Code	AIP-10253
Error Message	Error -: AIP-10253: Error processing an event: Error -: AIP-10016: A JMS error has occurred while retrieving a token from the databus: oracle.jms.AQjmsException: JMS-120: Dequeue failed

Monitoring the Total and Average Amount of Desktop Personal Computers for this Month

This example describes how to monitor the total and average amount of purchase orders over a specific time period.

1. Select the **Reports > Activity Monitoring**.
2. Enter a unique and recognizable name in the **Name** field or accept the default name.
3. Click the calendar icon for the **Start Date** field to select the date of one month ago.
4. Leave the **End Date** field blank to indicate today's date.
5. Select **Application Event Type** from the **Classification** list.
6. Click the flashlight to select the specific event type name for the **Name** field. For this example, **supplierpo** is selected.

The Event Analysis Report: Parameters page displays your selections:

Event Analysis Report: Parameters

Cancel Step 1 of 4 Next

Parameters are used to refine the query used to generate the report. Please specify the report name and parameter(s) and choose Next.

* Name

Date Range

Start Date 

End Date 

Event

* Classification

* Name 

Click the flashlight to select an event type

Event State

Select an event state or select Unspecified for all event states

[▶ Show Advanced Report Options](#)

7. Click Next.

The Event Analysis Report: Event Content page appears.

8. Go to the Event Content Query Expression section.

9. Click the Select button for Condition expression not specified.

10. Click Update.

The Create Condition Expression page appears.

11. Click Expand All or select a specific entry to expand in the Left Operand section.

12. Select total.

13. Select > from the Operator list.

14. Enter 500 in the Right Operand field.

The Create Condition Expression page displays the following selections:

Left Operand **Operator** **Right Operand**

[Expand All](#) | [Collapse All](#)

⊕ supplierpo

Select	Focus	Name	Type	Mapped
<input type="radio"/>		▼ supplierpo		false
<input checked="" type="radio"/>	⊕	▼ PAYLOAD	supplierpotype	false
<input checked="" type="radio"/>	⊕	▼ shipTo	USAddress	false
<input type="radio"/>		street	string	false
<input type="radio"/>		city	string	false
<input type="radio"/>		state	string	false
<input type="radio"/>		zip	decimal	false
<input type="radio"/>		country	NMTOKEN	false
<input type="radio"/>		comment	string	false
<input type="radio"/>		doctype	string	false
<input type="radio"/>		docno	string	false
<input type="radio"/>		status	string	false
<input checked="" type="radio"/>		total	decimal	false

15. Click **Apply**.

You are returned to the Event Analysis Report: Event Content page. The condition you created displays in the **Event Content Query Expression** section. This condition finds the purchase orders over \$500.

Event Content Query Expression

Use the table below to build the condition. To create or update a condition expression, select a condition expression and choose Update.

Select condition expression and ... Delete

[Expand All](#) | [Collapse All](#)

⊕ /supplierpotype/total > 500

Select	Focus	Condition Expression	Update
<input type="radio"/>		▶ /supplierpotype/total > 500	

- Go to the **Event Fields** section of the Event Analysis Report: Event Content page.
- Click **Expand All** or select a specific entry to expand.
- Select **Both** in the **Aggregation Type** column for **total**. This selection compiles the average and the total sum of purchase orders over \$500.

19. Select **Yes** for **ProductName** in the **Summary Report Grouping** column.

20. Select **Yes** in the **Detail Report Inclusion** column for **doctype**, **productName**, and **total**.

The Event Report: Event Content page displays the following selections:

Expand All | Collapse All

⊕ supplierpo

Focus Name	Type	Aggregation Type	Summary Report Grouping	Detail Report Inclusion	Alias
▼ supplierpo					
⊕ ▼ PAYLOAD	supplierpotype				
⊕ ▼ shipTo	USAddress				
street	string	None	No	No	Street
city	string	None	No	No	City
state	string	None	No	No	State
zip	decimal	None	No	No	Zip
country	NMTOKEN		No	No	Country
comment	string	None	No	No	Comment
doctype	string	None	No	Yes	Doctype
docno	string	None	No	No	Docno
status	string	None	No	No	Status
total	decimal	Both	No	Yes	Total
⊕ ▼ items	Item				
productName	string	None	Yes	Yes	Productname
quantity	(Anonymous)		No	No	Quantity
USPrice	decimal	None	No	No	Usprice
shipDate	date		No	No	Shipdate
partNum	SKU		No	No	Partnum
orderDate	date		No	No	Orderdate

21. Click **Next**.

22. Go to the **Grouping Fields** section.

23. Select **Productname** in the **Available Fields** section.

24. Click **Move**.

25. Go to the **Details Fields** section.

26. Select **Doctype** and **Total** in the **Available Fields** section.

27. Click **Move**.

The Event Analysis Report: Layout page displays your selections:

Grouping Fields

Select the fields to use for grouping the summary report. These fields will appear as columns, in the order they appear in the 'Selected Fields' report. The summary report will be sorted by the first selected field.

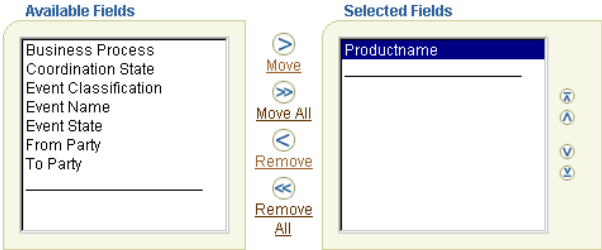

Details Fields

Select the fields to appear as columns in the detail reports. These fields will appear as columns, in the order they appear in the 'Selected Fields' reports. Each detail report will be sorted by the first selected field.

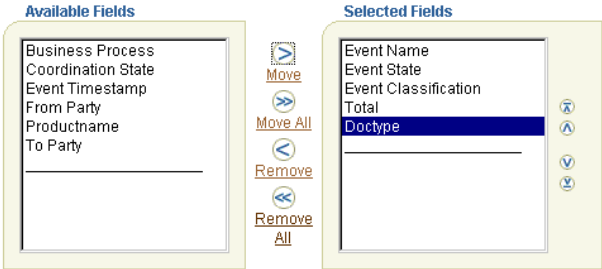

28. Click Finish.

The Summary Report of the Event Status Report page displays the results. The **Productname** column appears because you selected it in Step 23 on page 23-42. The **Total Sum** and **Total Average** columns display because you selected both in Step 18 on page 23-41.

Event Analysis Report

Summary Report

Summary Report: aggregation of events for specified group(s)



Productname	Total Sum	Total Average	Number of events (%)
Desktop PC	2400	800	3 (100%)

29. Click **Details** for additional details. The **Total** and **Doctype** columns display because you selected **Both** in Step 26 on page 23-42.

Event Analysis Report

Details Report

Details Report: Desktop PC

Event Name	Event State	Event Classification	Total	Doctype	Details
supplierpo	Consumed	Application Event Type	800	"Direct Order - "2233	
supplierpo	Consumed	Application Event Type	800	"Direct Order - "2233	
supplierpo	Consumed	Application Event Type	800	"Direct Order - "2233	

Monitoring Business Process Efficiency

This example describes how to monitor the efficiency of your business process by identifying the total amount of time it takes for an event to be processed from one end to another.

1. Select the **Reports > Process Optimization**.
2. Enter a unique and recognizable name in the **Name** field or accept the default name.
3. Click the calendar icon for the **Start Date** field to select the date of one month ago.
4. Leave the **End Date** field blank to indicate today's date.
5. Click **Next**.

The Coordination Analysis Report: Ports page appears.

6. Click **Expand All** or select a specific entry to expand.

7. Select the first port endpoint for collecting information (in this example, the **Global NP Ad-IN** port of native role **Placing Ad at Global NP-NR** is selected):

Select Port 1
Select port 1 from one of the ports on the role or from ports in the steps within the role.

[Expand All](#) | [Collapse All](#)

⊕ Business Process

Select Focus Name	Type	Event Type
⊖ Business Process		
⊕ ⊖ Placing Ad	Business Process	
⊕ ▶ Delivering E-Mail BR-AR	Application Role	
⊕ ▶ Delivering E-Mail BR-BR	Business Role	
⊕ ▶ Delivering E-Mail BR-NR	Native Role	
⊕ ▶ Delivering E-Mail BR-TL	Binding Role	
⊕ ▶ Delivering E-Mail BR-TX	Binding Role	
⊕ ▶ HR Placing New Ad-AR	Application Role	
⊕ ▶ HR Placing New Ad-BR	Business Role	
⊕ ▶ HR Placing New Ad-NR	Native Role	
⊕ ▶ HR Placing New Ad-TL	Binding Role	
⊕ ▶ HR Placing New Ad-TX	Binding Role	
⊕ ▶ Placing Ad	Business Process	
⊕ ▶ Placing Ad at Global NP-AR	Application Role	
⊕ ▶ Placing Ad at Global NP-BR	Business Role	
⊕ ⊖ Placing Ad at Global NP-NR	Native Role	
⊕ Global NP Ad-IN	Inbound	Global NP Ad

8. Click Next.

- Select the second port endpoint for collecting information (for this example, the **Global NP Ad-OUT** port of native role **Placing Ad at Global NP-NR** is selected):

Select Port 2

Select port 2 from one of the ports on the role or from ports in the steps within the role.

[Expand All](#) | [Collapse All](#)

Business Process			
Select Focus Name	Type	Event Type	
Business Process			
Placing Ad	Business Process		
▶ Delivering E-Mail-AR	Application Role		
▶ Delivering E-Mail-BR	Business Role		
▶ Delivering E-Mail-NR	Native Role		
▶ Delivering E-Mail-TL	Binding Role		
▶ Delivering E-Mail-TX	Binding Role		
▶ HR Placing New Ad-AR	Application Role		
▶ HR Placing New Ad-BR	Business Role		
▶ HR Placing New Ad-NR	Native Role		
▶ HR Placing New Ad-TL	Binding Role		
▶ HR Placing New Ad-TX	Binding Role		
▶ Placing Ad	Business Process		
▶ Placing Ad at Global NP-AR	Application Role		
▶ Placing Ad at Global NP-BR	Business Role		
▼ Placing Ad at Global NP-NR	Native Role		
Global NP Confirmation-IN	Inbound		Global NP Confirmation
Global NP Ad-OUT	Outbound		Global NP Ad

- Click **Next**.

The Event Analysis Report: Layout page appears.

- Go to the **Grouping Fields** section.
- Make appropriate selections in the **Available Fields** section.
- Click **Move**.
- Go to the **Details Fields** section.
- Make appropriate selections in the **Available Fields** section.
- Click **Move**.

The Coordination Analysis Report: Layout page displays your selections:

Grouping Fields

Select the fields to use for grouping the summary report. These fields will appear as columns, in the order they appear in the 'Selected Fields' list, in the summary report. The summary report will be sorted by the first selected field.



Details Fields

Select the fields to appear as columns in the detail reports. These fields will appear as columns, in the order they appear in the 'Selected Fields' list, in the detail reports. Each detail report will be sorted by the first selected field.

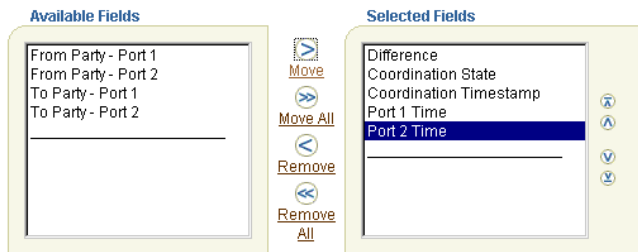

17. Click Finish.





The Summary Report of the Coordination Analysis Report page appears. Note the amount of time it takes to process from the inbound native role to the outbound native role.

Coordination Analysis Report

Port 1 **Placing Ad/Placing Ad at Global NP-NR/Global NP Ad-IN**
 Port 2 **Placing Ad/Placing Ad at Global NP-NR/Global NP Ad-OUT**

Summary Report

Summary Report: aggregation of the time difference between two event instances that were raised on role/step ports in the same coordination for the specified group(s)

From Party - Port 1	From Party - Port 2	Coordination State	Total Time	Average Time	Number of events in ending port (%)	Details
Global Newspaper	Global Newspaper	closed	0	0	1 (16.67%)	
Global Newspaper	Human Resources	closed	44 min(s) 37 sec(s) 985 msec (s)	44 min(s) 37 sec(s) 985 msec (s)	1 (16.67%)	
Human Resources	Global Newspaper	closed	44 min(s) 37 sec(s) 985 msec (s)	44 min(s) 37 sec(s) 985 msec (s)	1 (16.67%)	
Human Resources	Human Resources	closed	0	0	3 (50%)	

18. Click **Details** for a specific entry (for this example, the second entry).

The Details Report of the Coordination Analysis Report page appears.

Coordination Analysis Report

Port 1 **Placing Ad/Placing Ad at Global NP-NR/Global NP Ad-IN**
 Port 2 **Placing Ad/Placing Ad at Global NP-NR/Global NP Ad-OUT**

Details Report

Details Report: Global Newspaper, closed, Human Resources

Difference	Coordination State	Coordination Timestamp	Port 1 Time	Port 2 Time	Details
44 min(s) 37 sec(s) 985 msec(s)	closed	July 23, 2003 10:58:19 PM	July 23, 2003 10:58:53 PM	July 23, 2003 11:43:31 PM	

19. Click **Details**.

An additional Details Report of the Coordination Details page appears.

20. Expand specific roles to display greater detail.

The upper portion of this page displays the following information.

Coordination Details

Coordination State **closed**
 Coordination Timestamp **July 23, 2003 11:44:04 PM**

Status

This table displays the roles in this coordination, the steps within those roles, their state and the time when they were created.

[Expand All](#) | [Collapse All](#)

⊕ Role or Step				
Focus Name	Type	Status	Timestamp	
▼ Role or Step				
⊕ ▶ HR Placing New Ad-NR	Native Role	Completed	July 23, 2003 10:58:19 PM	
⊕ ▶ HR Placing New Ad-TL	Binding Role	Completed	July 23, 2003 10:58:23 PM	
⊕ ▶ HR Placing New Ad-AR	Application Role	Completed	July 23, 2003 10:58:29 PM	
⊕ ▶ HR Placing New Ad-TX	Binding Role	Completed	July 23, 2003 10:58:30 PM	
⊕ ▶ HR Placing New Ad-BR	Business Role	Completed	July 23, 2003 10:58:34 PM	
⊕ ▶ Placing Ad	Business Process	Completed	July 23, 2003 10:58:37 PM	
⊕ ▼ Placing Ad at Global NP-BR	Business Role	Completed	July 23, 2003 10:58:40 PM	
Passthrough HR New Ad			July 23, 2003 10:58:40 PM	
Passthrough Ad Confirmation			July 23, 2003 11:43:44 PM	
⊕ ▶ Placing Ad at Global NP-TX	Binding Role	Completed	July 23, 2003 10:58:42 PM	
⊕ ▶ Placing Ad at Global NP-AR	Application Role	Completed	July 23, 2003 10:58:46 PM	
⊕ ▶ Placing Ad at Global NP-TL	Binding Role	Completed	July 23, 2003 10:58:48 PM	
⊕ ▶ Placing Ad at Global NP-NR	Native Role	Completed	July 23, 2003 10:58:53 PM	
⊕ ▶ Delivering E-Mail-BR	Business Role	Completed	July 23, 2003 11:43:53 PM	
⊕ ▶ Delivering E-Mail-TX	Binding Role	Completed	July 23, 2003 11:43:53 PM	
⊕ ▶ Delivering E-Mail-AR	Application Role	Completed	July 23, 2003 11:43:58 PM	
⊕ ▶ Delivering E-Mail-TL	Binding Role	Completed	July 23, 2003 11:43:59 PM	
⊕ ▶ Delivering E-Mail-NR	Native Role	Completed	July 23, 2003 11:44:02 PM	

Note that within the business role, a pass-through step took a significant amount of time to process. This may be because an approval was required due to the purchase order being over a specific amount.

The lower portion of this page displays coordination event and deployment details.

Coordination Events

This table displays the events in this coordination, their class type and the role or step port they are currently in.

Name	Event Type Class	Role or Step Port
HR New Ad	Native Event Type	HR Placing New Ad-TL/Translate HR New Ad/HR New Ad-IN
HR New Ad	Application Event Type	HR Placing New Ad-TX/Transform HR New Ad/HR New Ad-IN
Ad Request	Business Event Type	Placing Ad at Global NP-TX/Transform HR New Ad/HR New Ad-IN
Global NP Ad	Application Event Type	Placing Ad at Global NP-TL/Translate Global NP Ad/Global NP Ad-IN
Global NP Ad	Native Event Type	Placing Ad at Global NP-NR/Passthrough Global NP Ad/Global NP Ad-OUT

Deployment Details

Configuration **iProcure_v1**
 Deployed On **May 2, 2003 12:00:00 AM**

Common User Errors

The following are common user report user errors.

- When creating an activity monitoring report, ensure that the string fields selected for **Sum** or **Average** have numeric content on the Event Analysis Report: Event Content page. Otherwise, blank **Sum** and **Average** columns appear in the final report.
- Ensure that you have a deployed configuration running when you attempt to create a report. You cannot create reports if a configuration is not deployed.

Chapter Summary

This chapter describes how to create reports and provides the following report creation examples:

- An event status report that identifies iProcurement purchase orders
- A coordination status report that identifies coordination details
- An error status report that identifies the current errors in an integration
- An activity monitoring reports that identifies the total and average amount of desktop personal computers purchased this month
- A process optimization reports that identifies business process efficiency

Part VI

RosettaNet Solutions

This part describes how to use the RosettaNet business protocol with Oracle Application Server ProcessConnect.

This part contains the following chapters:

- [Chapter 24, "RosettaNet B2B Protocol Standard"](#)
- [Chapter 25, "Managing Host and Remote Trading Partner Capabilities"](#)
- [Chapter 26, "Managing Trading Partners and Trading Partners Agreements"](#)

RosettaNet B2B Protocol Standard

This chapter describes the RosettaNet business-to-business (B2B) protocol standard and its implementation of trading partner agreements, and how Oracle Application Server ProcessConnect provides support for both.

This chapter contains these topics:

- [What is a B2B Protocol Standard?](#)
- [What Is RosettaNet?](#)
- [Oracle Application Server ProcessConnect Support for RosettaNet](#)
- [What Is a Trading Partner Agreement?](#)
- [Oracle Application Server ProcessConnect Support for Trading Partner Agreements](#)
- [RosettaNet and Oracle Application Server ProcessConnect Terminology Differences](#)
- [Chapter Summary](#)

See Also:

- The RosettaNet home page for more details on RosettaNet concepts discussed in this chapter:
<http://www.rosettanet.org>
- [Chapter 25, "Managing Host and Remote Trading Partner Capabilities"](#) for instructions on managing trading partner capabilities
- [Chapter 26, "Managing Trading Partners and Trading Partners Agreements"](#) for instructions on managing trading partner agreements

What is a B2B Protocol Standard?

B2B integrations enable trading partners to communicate with other trading partners outside an enterprise and over a network. B2B integrations use B2B protocol standards. B2B protocol standards provide guidelines for trading partners to follow when conducting business between enterprises. One B2B protocol standard is RosettaNet. [Figure 24-1](#) shows RosettaNet's role in a B2B integration.

Figure 24-1 RosettaNet Role in a B2B Integration

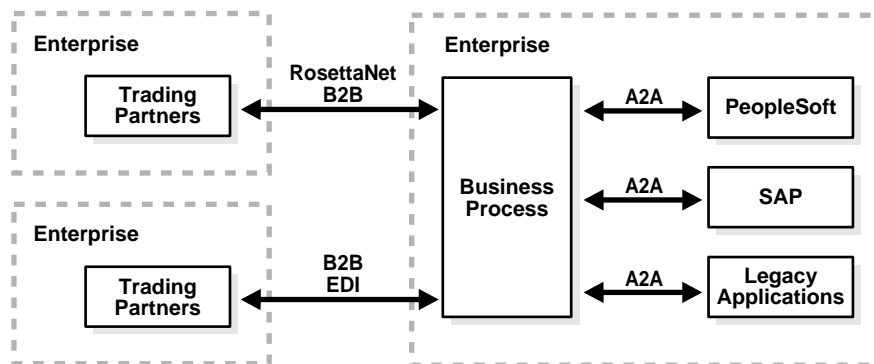

This chapter provides key details about the RosettaNet B2B protocol.

See Also:

- [Figure 24-4, "Oracle Application Server ProcessConnect in a B2B Integration"](#) on page 24-12 for details on how Oracle Application Server ProcessConnect support is integrated into [Figure 24-1](#)
- ["Executing the Adapter Framework: Overview"](#) on page 4-9 for additional details on how a B2B protocol standard is integrated into the Oracle Application Server ProcessConnect architecture

What Is RosettaNet?

RosettaNet is a group of leading technology companies that have created and implemented a common set of nonproprietary, XML-based, e-business standards. These standards define how trading partners conduct business through the exchange of business documents over the Internet.

The following sections describe key details about RosettaNet, as shown in [Figure 24-2](#):

- [Partner Interface Processes](#)
- [RosettaNet Implementation Framework](#)
- [RosettaNet Dictionaries](#)
- [RosettaNet Validation](#)

Figure 24-2 Key RosettaNet Standards

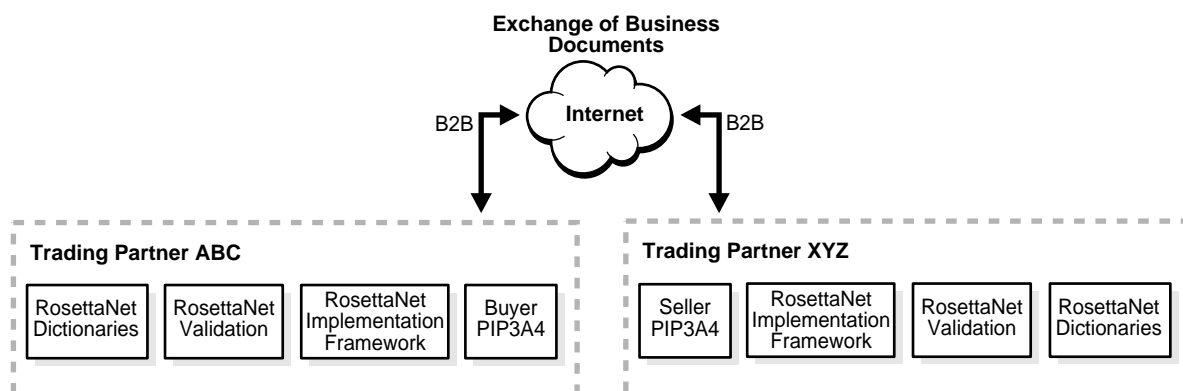

See Also: ["Oracle Application Server ProcessConnect Support for RosettaNet"](#) on page 24-12 for details on how Oracle Application Server ProcessConnect supports these key RosettaNet details

RosettaNet Implementation Framework

The RosettaNet Implementation Framework (RNIF) defines implementation guidelines for creating software applications that provide for the reliable transport of partner interface processes (PIPs) in XML-format business documents between trading partners. Guidelines are provided for transport, routing, packaging, security, signals, and trading partner agreements.

These sections describe features of the following RNIF versions:

- [RNIF Version 1.1](#)
- [RNIF Version 2.0](#)

See Also: ["Oracle Application Server ProcessConnect Support for the RosettaNet Implementation Framework"](#) on page 24-12 for additional details on how Oracle Application Server ProcessConnect supports RNIF implementation guidelines

RNIF Version 1.1

[Table 24–1](#) describes several RNIF version 1.1 implementation guidelines.

Table 24–1 *RNIF Version 1.1 Guidelines*

Guideline	Description
Transport	Supports the secure HTTP transport protocol for delivering business messages between trading partners
Packaging	Supports the RosettaNet Object (RNO) format
Authorization	Ensures that a message sender is authorized to send the subject message to the receiving partner
Authentication	Requires a message sender to digitally sign a message

Table 24–1 (Cont.) RNIF Version 1.1 Guidelines

Guideline	Description
Nonrepudiation	<p>Provides absolute evidence that a specific action occurred. This ensures that an originating trading partner cannot deny having sent a message and a receiving partner cannot deny having received a message. The following nonrepudiation types are available:</p> <ul style="list-style-type: none"> ▪ Nonrepudiation of origin requires a message sender to digitally sign a message. This protects against attempts by a sender to deny sending a message. The message recipient must store the message for an agreed-on period of time (typically three to seven years). ▪ Nonrepudiation of receipt requires a message recipient to send back a digitally-signed acknowledgment. The message recipient must store both the receipt and the original message for an agreed-on period of time (typically three to seven years). This protects against any attempt by a message recipient to deny receiving a message.

See Also: Version 1.1 of the *RosettaNet Implementation Framework: Core Specification* available at the RosettaNet home page:

<http://www.rosettanet.org>

RNIF Version 2.0

[Table 24–2](#) describes several RNIF version 2.0 implementation guidelines.

Table 24–2 RNIF Version 2.0 Guidelines

Guideline	Description
Transport	Supports multiple transport protocols (such as secure HTTP and SMTP) for delivering business messages between trading partners
Packaging	Supports the multi-purpose internet mail extensions (MIME) format
Authorization	Ensures that a message sender is authorized to send the subject message to the receiving partner
Authentication	Requires a message sender to digitally sign a message
Encryption	Ensures that messages transmitted can be seen only by the expected recipient, who is able to decrypt and extract the business data Note: Encryption is not available with RNIF version 1.1.

Table 24–2 (Cont.) RNIF Version 2.0 Guidelines

Guideline	Description
Nonrepudiation	<p>Provides absolute evidence that a specific action occurred. This ensures that an originating trading partner cannot deny having sent a message and a receiving partner cannot deny having received a message. The following nonrepudiation types are available:</p> <ul style="list-style-type: none"> <li data-bbox="525 413 1272 517">■ Nonrepudiation of origin requires a message sender to digitally sign a message. This protects against attempts by a sender to deny sending a message. The message recipient must store the message for an agreed-on period of time (typically three to seven years). <li data-bbox="525 534 1272 690">■ Nonrepudiation of receipt requires a message recipient to send back a digitally-signed acknowledgment. The message recipient must store both the receipt and the original message for an agreed-on period of time (typically three to seven years). This protects against any attempt by a message recipient to deny receiving a message.

See Also: Version 2.0 of the *RosettaNet Implementation Framework: Core Specification* available at the RosettaNet home page:

<http://www.rosettanet.org>

Partner Interface Processes

This section contains the following PIP topics:

- [What Is a Partner Interface Process?](#)
- [PIP Components](#)
- [PIP Classifications](#)
- [PIP Message Flow Example](#)

What Is a Partner Interface Process?

The exchange of business data between trading partners is the fundamental purpose of PIPs. PIPs are specialized, XML-based dialogs that define the structure, sequence of steps, role (buyer and seller) activities, data elements, values, and value types for each business document message exchanged between trading partners. Conformance to these specifications enables trading partners to achieve the business objective.

PIPs require the following:

- A definite business outcome (for example, the receipt of a purchase order from a trading partner)
- A role to perform at least one activity (for example, a buyer role requests a purchase order from a seller role and a seller role submits a purchase order acknowledgment to the buyer role)
- A measurable unit of work that can be connected to other PIPs to achieve a larger business outcome (for example, one PIP involves a buyer role requesting and receiving a purchase order from a seller role, while another PIP is coordinated with the first PIP to send a failure notification message to a buyer role if a purchase order is not received from the seller role)

Trading partners agree on the set of PIPs to support to conduct business. Each partner must fulfill their specific requirements of the PIP. If one trading partner does not fulfill all requirements, then the business transaction is voided for all participating PIP trading partners.

PIP Components

PIPs consist of the following major views:

- **Business operational view (BOV)**
Describes the flow between roles as they perform business activities
- **Functional service view (FSV)**
Describes the design of and interactions between network components as they execute a PIP. Network components are also known as services, and include buyers and sellers.
- **Implementation framework view (IFV)**
Describes the message structures of actions performed by roles (for example, the XML DTDs and message guidelines) and communication requirements for network components (for example, for the use of Secure Socket Layer (SSL) and digital signatures)

PIP Classifications

PIPs are classified into clusters, segments, and individual PIPs. The following PIP clusters are provided:

- Cluster 0: RosettaNet Support
- Cluster 1: Partner, Product, and Service Review
- Cluster 2: Product Introduction
- Cluster 3: Order Management
- Cluster 4: Inventory Management
- Cluster 5: Marketing Information Management
- Cluster 6: Service and Support
- Cluster 7: Manufacturing

Each cluster is subdivided into segments. Each segment includes individual PIPs. Individual PIPs contain one or more activities, which specify actions to be performed.

For example, [Table 24–3](#) identifies PIP3A4 features.

Table 24–3 PIP3A4 Features

Element	Description
3	Order management cluster, which lets trading partners: <ul style="list-style-type: none"> ■ Order catalog products ■ Create custom orders ■ Manage product distribution and delivery ■ Support product returns and financial transactions
3A	Quote and order entry segment
3A4	Specific PIP type. This PIP supports the: <ul style="list-style-type: none"> ■ Submittal of a purchase order by a buyer ■ Submittal of an acceptance purchase order by a seller ■ Ability of a buyer to cancel or change a purchase order based on the acknowledgment response

PIP Message Flow Example

Figure 24–3 shows the message flow when a buyer and seller use PIP3A4 V02.00. This PIP enables a buyer to request a purchase order and a seller to acknowledge if the order request is accepted, rejected, or pending. An acknowledgment can also include details about delivery expectations. A purchase order acceptance is typically sent after checks for price and availability occur.

Figure 24–3 RosettaNet PIP3A4 Message Flow

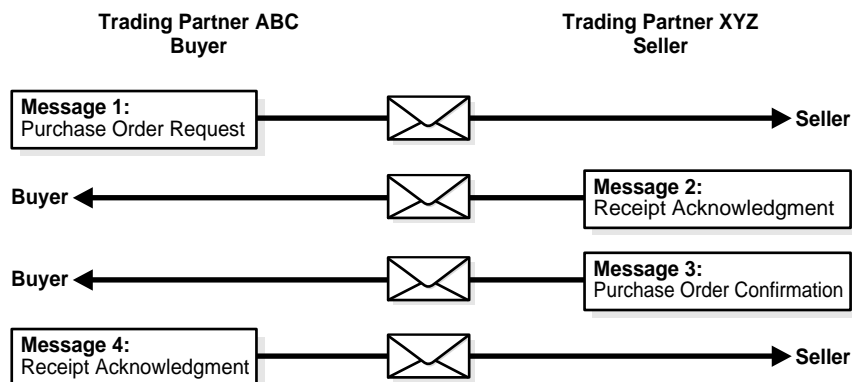

See Also:

- "Oracle Application Server ProcessConnect Support for Partner Interface Processes" on page 24-14 for additional details on how Oracle Application Server ProcessConnect supports PIPs
- The search facility of the RosettaNet home page for more details on PIPs:

<http://www.rosettanet.org>

RosettaNet Dictionaries

The RosettaNet dictionaries define and describe a common set of properties for use in PIP messages. These properties define a common vocabulary for conducting business. This ensures that the data exchanged between trading partners is consistent, overlapping efforts of trading partners are eliminated, and confusion caused by the uniquely defined terminology of each trading partner is reduced. Two dictionary types are provided:

- **Business Dictionary**

Designates the properties used in basic business transactions between trading partners. The Business Dictionary defines the business properties, business data entities, and fundamental business data entities in PIP messages.

- **Technical Dictionary**

Provides properties for defining products and services. The Technical Dictionary eliminates the need for trading partners to use separate dictionaries when implementing PIPs.

For example, if two trading partners are engaged in a business transaction involving the sale of personal computers, the Technical Dictionary describes the computer features in a text document, such as:

- Amount of RAM
- Amount of hard disk space
- Number of CPUs

Note: The RosettaNet Technical Dictionary is not currently supported with Oracle Application Server ProcessConnect.

See Also:

- ["Oracle Application Server ProcessConnect Support for RosettaNet Dictionaries"](#) on page 24-15 for additional details on how Oracle Application Server ProcessConnect supports the RosettaNet dictionaries
- The search facility of the RosettaNet home page for more details on the RosettaNet Business Dictionary and the RosettaNet Technical Dictionary:

<http://www.rosettanel.org>

RosettaNet Validation

RosettaNet validation compares the elements in RosettaNet XML-format business documents to the requirements specified in the RosettaNet Message Guideline specification to determine their validity. This specification defines requirements for details such as element datatypes, element lengths, element value lists, and element cardinality. PIPs that require RosettaNet dictionary validation are also validated when a dictionary is present.

The minimum validation-level requirements on the sections of a RosettaNet XML-format business document are as follows. These requirements cover the preamble, delivery header, service header, and service content sections of a document. Documents not following one or more of these requirements are identified as invalid.

1. The XML-format business document requires compliance with its DTD.
2. Elements with datatypes, lengths, or both that are specified in the RosettaNet Message Guideline specification require validation against this specification.
3. An element's list of values specified in the entity instance list in the corresponding RosettaNet Message Guideline specification requires validation against this specification.
4. If the Message Guideline specification defines the cardinality specification of an element differently from the corresponding DTD specification, the Message Guideline specification takes precedence.
5. If a PIP requires dictionary validation, and a dictionary is included, the service content requires validation against the dictionary as a part of action performance.
6. Cross-tag validation is based on message guidelines.

See Also:

- ["Oracle Application Server ProcessConnect Support for RosettaNet Validation"](#) on page 24-15 for additional details on how the Oracle Application Server ProcessConnect supports RosettaNet validation
- *RosettaNet Implementation Framework: Core Specification* available at the RosettaNet home page for more details on validation rules, preambles, delivery headers, service headers, and service contents:

<http://www.rosettanet.org>

Oracle Application Server ProcessConnect Support for RosettaNet

Oracle Application Server ProcessConnect provides RosettaNet B2B protocol standard support with the B2B adapter. [Figure 24-4](#) shows the role of the B2B adapter in a B2B integration.

Figure 24-4 Oracle Application Server ProcessConnect in a B2B Integration

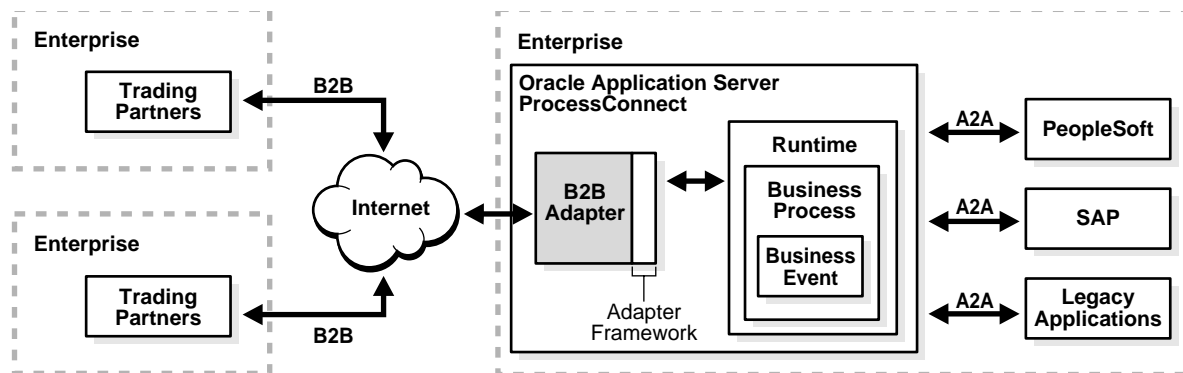

The B2B adapter is a plug-in component to the Oracle Application Server ProcessConnect adapter framework. The adapter framework enables communication between the Oracle Application Server ProcessConnect runtime system (the component that executes integrations) and various adapters. These adapters enable Oracle Application Server ProcessConnect to communicate with applications and trading partners, enabling integration types such as B2B to be executed. The B2B adapter supports the features of the RosettaNet B2B protocol standard.

See Also: The following documentation for additional details about adapters and the adapter framework:

- ["B2B Protocol Adapters"](#) on page 3-55 for additional details on Oracle Application Server ProcessConnect support for business protocol adapters
- ["Executing the Adapter Framework: Overview"](#) on page 4-9

Oracle Application Server ProcessConnect Support for the RosettaNet Implementation Framework

Oracle Application Server ProcessConnect supports the following RNIF versions:

- [RNIF Version 1.1](#)
- [RNIF Version 2.0](#)

See Also: ["Adding a Business Protocol"](#) on page 25-45 for instructions on adding RNIF 1.1 or RNIF 2.0 support

RNIF Version 1.1

[Table 24-4](#) describes several RNIF version 1.1 features supported by the B2B adapter during Oracle Application Server ProcessConnect runtime.

Table 24-4 *RNIF Version 1.1 Guidelines*

Feature	Description
Transport	Supports the HTTP and secure HTTP transport protocols for delivering business data messages between trading partners
Packaging	Supports the RNO format
Authorization	Receives an incoming message and uses the identity of the message sender to determine which services the sender can perform
Authentication	Requires a message sender to digitally sign a message
Nonrepudiation	Provides absolute evidence that a specific action occurred. Two nonrepudiation types are supported by the B2B adapter: <ul style="list-style-type: none"> ■ Nonrepudiation of origin ■ Nonrepudiation of receipt

RNIF Version 2.0

[Table 24-5](#) describes several RNIF version 2.0 features supported by the B2B adapter during Oracle Application Server ProcessConnect runtime.

Table 24-5 *RNIF Version 2.0 Guidelines*

Feature	Description
Transport	Supports the HTTP and secure HTTP transport protocols for delivering business data messages between trading partners
Packaging	Supports RINIF 2.0 MIME packaging
Authorization	Receives an incoming message and uses the identity of the message sender to determine which services the sender can perform
Authentication	Requires a message sender to digitally sign a message

Table 24–5 (Cont.) (Cont.) RNIF Version 2.0 Guidelines

Feature	Description
Encryption	Ensures that messages being transmitted can only be seen by the expected recipient, who is able to decrypt and extract the business data
Nonrepudiation	Provides absolute evidence that a specific action occurred. Two nonrepudiation types are supported by the B2B adapter: <ul style="list-style-type: none"> ▪ Nonrepudiation of origin ▪ Nonrepudiation of receipt

Oracle Application Server ProcessConnect Support for Partner Interface Processes

The B2B adapter supports the RosettaNet PIPs shown in [Table 24–6](#).

Table 24–6 PIPs Supported by the B2B Adapter

PIP	Type	Version	This PIP Supports the...
0A1	Notification of Failure	V02.00	Detection by either involved party of the failure of a business activity to complete successfully
3A4	Request Purchase Order	V02.00	Following sequence of events: <ul style="list-style-type: none"> ▪ Submittal of a purchase order request by a buyer ▪ Submittal of a receipt acknowledgment confirmation by a seller ▪ Submittal of a purchase order confirmation by a seller ▪ Submittal of receipt of a purchase order confirmation by a buyer
3A6	Distribute Order Status	V02.00	Sellers to send the status of open orders to buyers

See Also:

- ["Creating a Supported Actor"](#) on page 25-34 for instructions on assigning a role to a trading partner (such as the role of a seller using PIP3A4 with RNIF 2.0)
- ["Creating a Trading Partner Agreement"](#) on page 26-15 for instructions on creating a trading partner agreement
- ["Oracle Application Server ProcessConnect Support for Trading Partner Agreements"](#) on page 24-21
- The Oracle Technology Network (OTN) for instructions on downloading the supported RosettaNet PIPs shown in [Table 24-6](#):

<http://otn.oracle.com>

The RosettaNet PIPs are *not* prepackaged with Oracle Application Server ProcessConnect.

Oracle Application Server ProcessConnect Support for RosettaNet Dictionaries

Oracle Application Server ProcessConnect supports the RosettaNet Business Dictionary described in ["RosettaNet Dictionaries"](#) on page 24-10. The RosettaNet Technical Dictionary is not currently supported. Only PIP2A9 (not supported by Oracle Application Server ProcessConnect) currently uses the RosettaNet Technical Dictionary.

Oracle Application Server ProcessConnect Support for RosettaNet Validation

Oracle Application Server ProcessConnect supports RosettaNet validation, as described in ["RosettaNet Validation"](#) on page 24-11. This support is preseeded in Oracle Application Server ProcessConnect and cannot be changed. RosettaNet Business Dictionary validation of RosettaNet documents is also supported. RosettaNet Technical Dictionary validation of RosettaNet documents is not currently supported.

What Is a Trading Partner Agreement?

A trading partner agreement is an electronic agreement that defines the way in which two trading partners agree to interact when performing an agreed-on business collaboration. An example of a business collaboration is RosettaNet PIP3A4 (purchase order request), where one trading partner acts as the role of buyer to request a purchase order and another trading partner acts as the role of seller to send a purchase order acceptance. (See "[PIP Message Flow Example](#)" on page 24-9 for details.) Trading partner agreements essentially define the terms and agreements that enable business documents to be exchanged between trading partners.

The trading partner agreement is independent of the internal processes executed at each trading partner's individual site. The trading partner agreement does not expose the internal processes of a trading partner to other trading partners.

The contents of a trading partner agreement include the following elements. Each element includes data essential to a trading partner agreement. After these elements of data are fully defined, you assign them to a trading partner agreement.

- [What Are Trading Partners?](#)
- [What Are Collaborations?](#)

[Figure 24-5](#) provides a specific example of trading partner agreement elements and the types of data that can be defined in these elements.

Figure 24-5 Trading Partner Agreement Example

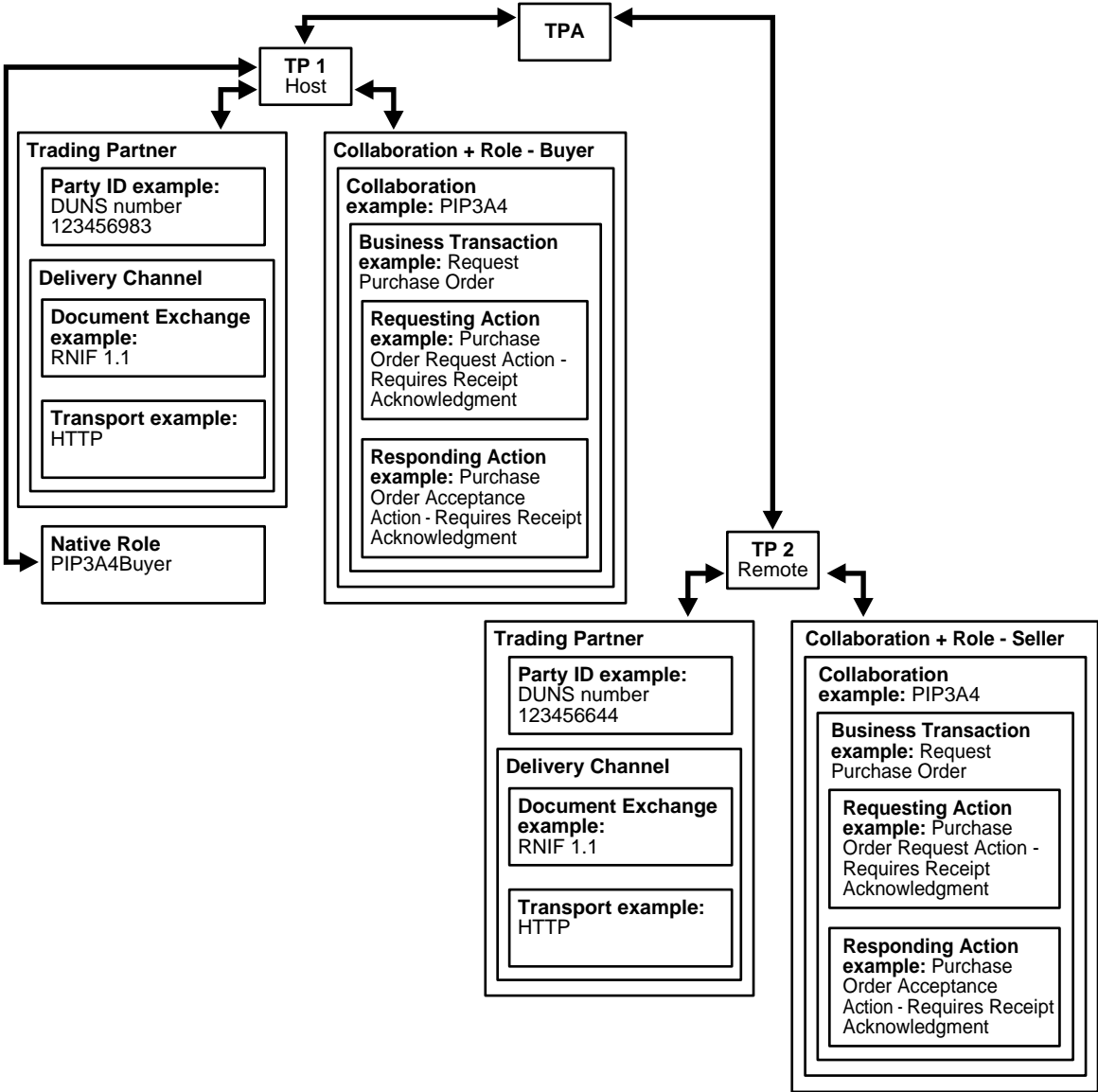

What Are Trading Partners?

A trading partner is an organization or enterprise that engages in business transactions with another trading partner. The trading partner agreement captures the agreed-on capabilities of both trading partners to conduct a business transaction. Trading partners include the following elements of data for identification and communication capabilities:

- [Party ID](#)
- [Delivery Channel](#)

Party ID

The party ID defines the agreed-on identification to be used to conduct the business collaboration. RosettaNet sends the party ID data as part of the business protocol header. One example is the data universal numbering system (DUNS) number. Trading partners must obtain a DUNS number themselves. Other examples can include an e-mail address or any other standard that a company decides to use.

Delivery Channel

The delivery channel describes the communication capabilities. To conduct a business collaboration, messages must be exchanged in a sequence. Messages must follow an agreed-on, predefined exchange mechanism and must be sent over an agreed-on transport. Message exchange details are defined by the document exchange. The delivery channel also provides security details to ensure a secure message exchange. These capabilities are described in the following sections:

- [Document Exchange Protocol](#)
- [Transport](#)

See Also: ["Business Collaboration"](#) on page 24-20

Document Exchange Protocol The document exchange provides data about the supported exchange protocol. The document exchange layer receives a business document, encrypts it (if specified), adds a digital signature for nonrepudiation (if specified), and sends it to the transport for transmission to the other trading partner. The document exchange elements essentially describe a trading partner's message receiving characteristics. Examples of document exchange types include the following:

- RNIF 1.1
- RNIF 2.0

See Also: ["RosettaNet Implementation Framework"](#) on page 24-4 for a description of RNIF capabilities

Transport The transport is responsible for message delivery using the selected transport protocol. The transport defines the trading partner's capabilities with regards to the following:

- Communication protocols that enable trading partners to interact (for example, HTTP, SMTP, and FTP)
- Transport security for inbound and outbound messages transported over the communication protocol used

What Are Collaborations?

Collaborations describe how message processing occurs, including the message exchange order, the documents exchanged, role exchange order, and the actions. Collaborations consist of business activities. Business activities are conducted between the roles authorized to participate in a collaboration. A business activity can be either a business transaction or a business collaboration. Collaborations include the following elements of data that you assign to a trading partner agreement:

- [Business Transaction](#)
- [Business Collaboration](#)
- [Roles](#)
- [Business Actions](#)

Business Transaction

A business transaction is a unit of business conducted by two or more trading partners that generates a definite state of success or failure. A business transaction is conducted between two parties playing opposite roles in a transaction. The roles are always an initiating role (the *from* role) and a responding role (the *to* role). Trading partners participate in the business collaboration through roles. The business transactions are sequenced to occur in a predefined order.

A business transaction consists of a set of business data and business signal exchanges between trading partners that occur in an agreed-on format, sequence, and time period. If any of the agreements are violated, the transaction is terminated and all business data and business signal exchanges are discarded.

For example, a trading partner acting as the role of buyer submits a purchase order request message to a trading partner acting as the role of seller. The trading partner acting as the role of seller receives the message and delivers a purchase order response message acknowledging the receipt.

Business Collaboration

A business collaboration consists of a set of roles (buyer and seller) collaborating through a set of agreed-on business transactions by exchanging business documents. Trading partners participate in a business collaboration through roles. This business collaboration must achieve a specified outcome.

PIPs are mapped to business collaborations. Examples of business collaborations include the following:

- PIP3A4
- PIP3A6

See Also:

- ["Partner Interface Processes"](#) on page 24-6
- ["Oracle Application Server ProcessConnect Support for Partner Interface Processes"](#) on page 24-14 for definitions of PIP0A1, PIP3A4, and PIP3A6

Roles

Roles represent the actors (such as a buyer and seller) authorized to participate in a collaboration (for example, PIP3A4). A collaboration includes the following:

- Two roles (for example, there is a buyer role and a seller role for PIP3A4)
- One or more business transactions

Business Actions

The business actions define the documentation types to be exchanged. For example, the following business actions occur when a request purchase order business transaction is initiated by a buyer role and responded to by a seller role:

- One requesting action (for example, a purchase order requesting action called purchase order request action that uses the purchase order request document type)

- One responding action (for example, a purchase order acceptance action called purchase order response action that uses the purchase order acceptance document type)

Oracle Application Server ProcessConnect Support for Trading Partner Agreements

Oracle Application Server ProcessConnect provides support for the elements comprising a trading partner agreement. This section first describes Oracle Application Server ProcessConnect support for trading partner agreement elements and then provides an overview of how the Oracle Application Server ProcessConnect user interface tool supports these elements.

This section contains these topics:

- [Oracle Application Server ProcessConnect Support for Trading Partners](#)
- [Oracle Application Server ProcessConnect Support for Collaborations](#)

Oracle Application Server ProcessConnect Support for Trading Partners

The B2B adapter supports the following elements:

- [Party ID](#)
- [Delivery Channel](#)

Party ID

The B2B adapter uses the party ID to identify the trading partner agreement. The Oracle Application Server ProcessConnect user interface tool identifies the party ID through the concept of the trading partner identification type. Examples of trading partner identification type include a DUNS number, an e-mail address, or any identifier that you chose to use.

See Also: The following sections for instructions on performing these tasks:

- ["Creating Trading Partner Identification"](#) on page 25-8 to select a trading partner identifier
- ["Administering Trading Partner Identification Types"](#) on page 17-49 to create a trading partner identifier that can be selected

Delivery Channel

The B2B adapter supports the following elements of data:

- [Document Exchange Protocol](#)
- [Transport](#)

See Also: The following sections for instructions on performing these tasks:

- ["Managing Delivery and Security"](#) on page 25-50 to create delivery channels, document exchanges, transport parameters, and remote trading partner certificates
- ["Creating a Protocol Endpoint"](#) on page 25-86 to assign a transport protocol and an endpoint address (such as a Web site) to a trading partner

Document Exchange Protocol The B2B adapter supports the document exchange features shown in [Table 24-7](#). These features are included with RNIF 1.1 and RNIF 2.0 unless otherwise stated.

Table 24-7 Document Exchange Features Supported by the B2B Adapter

Feature	Description
Delivery semantics	Supports the following message delivery semantics between trading partners: <ul style="list-style-type: none"> ■ Guaranteed (once and only once) message delivery
Acknowledgment mode	Supports the asynchronous mode for recipients of messages. In asynchronous mode, acknowledgments are sent back in a separate transport connection in which the message was received.
Acknowledgment level	Supports acknowledgment messages sent at the following levels: <ul style="list-style-type: none"> ■ Transport level (such as at the HTTP or secure HTTP transport level) ■ Business protocol level
Time to acknowledge level	If an acknowledgment does not arrive before the expiration time, the B2B adapter sends the request or response again.
Packaging	The B2B adapter supports RosettaNet requirements for packaging, formatting, encrypting (for RNIF 2.0 only), and signing messages.

Table 24–7 (Cont.) Document Exchange Features Supported by the B2B Adapter

Feature	Description
Messaging formats	The B2B adapter supports RNO for RNIF 1.1 and MIME for RNIF 2.0.
Digitally secure messages	The B2B adapter supports digitally secure messages. Some of the message packaging aspects supported by the B2B adapter include: <ul style="list-style-type: none"> ▪ Messaging format ▪ Verification of digital signatures, message encryption and decryption, and enveloping for the digital signature formats (S/MIME) of digitally secure messages.

Transport The transport is responsible for message delivery using the selected transport protocol. The B2B adapter uses the HTTP and secure HTTP transport communication protocols.

For outgoing messages sent from the B2B adapter to a trading partner, the B2B adapter calls the transport with the message to send and provides the necessary transport protocol-specific bindings. For incoming messages received from a trading partner, the transport receives the messages and calls the B2B adapter with the received message and transport binding data for processing. The transport binding data specifies the protocol-specific status data and a list of protocol headers with their values.

Oracle Application Server ProcessConnect Support for Collaborations

Oracle Application Server ProcessConnect provides support for collaborations. Collaborations consist of business activities. Business activities are conducted between the roles authorized to participate in a collaboration. The B2B adapter supports the following elements.

- [Business Transaction](#)
- [Business Collaboration](#)
- [Roles](#)
- [Business Actions](#)

Business Transaction

A business transaction consists of a request message (for example, a request purchase order) and an optional response message (for example, respond to a

purchase order request). The B2B adapter provides support for one business transaction. The B2B adapter supports request and response messages. The B2B adapter enforces the time limit to perform the business transaction.

Business Collaboration

The B2B adapter provides the following additional collaboration support:

- Validates the state of a collaboration. A collaboration defines a set of business transactions. Messages are exchanged based on the collaboration definition.
- Enforces the trading partner agreement-specified collaboration limits. A trading partner agreement can specify the maximum number of collaborations allowed and the maximum number of concurrent collaborations allowed for that trading partner agreement.
- Supports the PIPs shown in "[Oracle Application Server ProcessConnect Support for Partner Interface Processes](#)" on page 24-14

Roles

Roles represent the actors (such as a buyer and seller) authorized to participate in a collaboration (for example, PIP3A4). The B2B adapter provides support for roles.

See Also: "[Creating a Supported Actor](#)" on page 25-34 for instructions on assigning a role to a trading partner (such as the role of a seller using PIP3A4 with RNIF 2.0)

Business Actions

The B2B adapter provides support for actions through the concept of business actions. The business action defines the documentation types to be exchanged.

RosettaNet and Oracle Application Server ProcessConnect Terminology Differences

RosettaNet and Oracle Application Server ProcessConnect differ slightly in the use of terminology. [Table 24–8](#) identifies these differences.

Table 24–8 Terminology Differences

RosettaNet Terminology	Oracle Application Server ProcessConnect Terminology
PIP	Collaboration
Role, collaboration name, and collaboration revision	<p>Supported actor</p> <p>The supported actor comprises the role, collaboration name, and collaboration revision of a trading partner. You select the supported actor in the Oracle Application Server ProcessConnect user interface tool. The supported actor consists of three elements. For example, Buyer - 3A4 - V02.00 is one type of supported actor that is available. This actor consists of the following parts:</p> <ul style="list-style-type: none"> ■ Actor name (buyer role) ■ PIP collaboration name (3A4) ■ Collaboration revision (V02.00)
Activity	Business transaction
Action	Business action

Chapter Summary

This chapter describes Oracle Application Server ProcessConnect support for the following RosettaNet features:

- RNIF
- PIPs
- RosettaNet dictionaries
- RosettaNet validation

Oracle Application Server ProcessConnect support for trading partner agreements is also described.

Managing Host and Remote Trading Partner Capabilities

This chapter describes the host and remote trading partner identification, organization, cooperation, delivery, security, and endpoint capability tasks required to design an integration between enterprises. The host trading partner uses the Oracle Application Server ProcessConnect user interface tool to define the capabilities for all trading partners (both host and remote). The host trading partner consults with the remote trading partner to obtain the necessary details.

This chapter contains these topics:

- [Host and Remote Trading Partner Management Tasks Overview](#)
- [Defining Host and Remote Trading Partner Capabilities](#)
- [Managing Trading Partner Identifications](#)
- [Managing Organizations](#)
- [Managing Cooperations](#)
- [Managing Delivery and Security](#)
- [Managing Endpoints](#)
- [Managing the Host Trading Partner Wallet Password](#)
- [Managing Host and Remote Trading Partner Profile Data Validation and Approval](#)
- [Chapter Summary](#)

Host and Remote Trading Partner Management Tasks Overview

The Oracle Application Server ProcessConnect user interface tool enables you to perform the trading partner management tasks required for an integration between enterprises. These tasks consist of creating, viewing, updating, and deleting host and remote trading partner profile data. [Table 25-1](#) describes each trading partner task and provides references for more details.

Table 25-1 Host Management Tasks

Task	Description	See Section...
Identity	This enables you to define a trading partner identification value that uniquely distinguishes your organization.	"Managing Trading Partner Identifications" on page 25-4
Organization	This enables you to define the Oracle Application Server ProcessConnect person for designing an integration, the persons who can approve agreements, and the method by which to contact persons and organizations.	"Managing Organizations" on page 25-11
Cooperations (The result of a correct setup of collaborations)	This enables you to define: <ul style="list-style-type: none"> ▪ The trading partner's role (known as the actor) in a business collaboration (for example, Buyer - 3A4 -2.0, for RosettaNet PIP3A4) ▪ The business protocol to use. The business protocol consists of process, exchange, and document protocols. For example, if you are using RosettaNet, the business protocol includes: <ul style="list-style-type: none"> RosettaNet partner interface process (PIP) (process protocol) RosettaNet business signals and headers (exchange protocol) RosettaNet protocol (document protocol) 	"Managing Cooperations" on page 25-30
Delivery and security	This enables you to define a delivery channel to use. A delivery channel consists of one document exchange and one transport: <ul style="list-style-type: none"> ▪ A document exchange defines the exchange mechanism using the exchange protocol, such as RosettaNet 2.0. You can choose to add additional security, including encryption credentials (such as a certificate) and digital signatures (such as SMIME 3.0 with SHA-RSA). ▪ A transport defines endpoints and associated security, such as secure HTTP using secure socket layer (SSL). <p>You can also define certificates and endpoints used by the document exchange and transport.</p>	"Managing Delivery and Security" on page 25-50
Endpoints	This enables you to define the following: <ul style="list-style-type: none"> ▪ The trading partner endpoint address (such as a Web site) ▪ The transport protocol (such as HTTP or secure HTTP) 	"Managing Endpoints" on page 25-79

Defining Host and Remote Trading Partner Capabilities

The tasks described in this chapter enable you to define the host and remote trading partner capabilities. The host trading partner is the organization in which Oracle Application Server ProcessConnect is installed. The remote trading partner is the organization outside your enterprise with whom to conduct business.

These capabilities define how a trading partner is identified, the cooperations (collaborations) of a trading partner, the delivery and security characteristics of a trading partner, and the endpoints of a trading partner. After you define this profile data, you can create a trading partner agreement between the host and remote trading partners.

The host trading partner consults with the remote trading partner to obtain the necessary details and uses the Oracle Application Server ProcessConnect user interface tool to define the capabilities for both host and remote trading partners. While the concepts are nearly all the same, the access method into the Oracle Application Server ProcessConnect user interface tool by which you define host and remote trading partners is different, as shown in [Table 25-2](#). This is because some of the host trading partner details are created during installation.

Table 25-2 Access Methods for Defining Host and Remote Trading Partners

For The...	Perform These Steps...
Host trading partner	<ol style="list-style-type: none"> 1. Select the Host tab. <p>The Host - <i>name</i> page appears, along with the Organization, Cooperations (collaborations), Delivery and Security, and Endpoints sections that enable you to define the capabilities described in this chapter for the host trading partner.</p>
Remote trading partner	<ol style="list-style-type: none"> 1. Select the Trading Partners tab. 2. Click Create. 3. Create a remote trading partner and click Apply. <p>The Trading Partner Details page appears, along with the Organization, Cooperations (collaborations), Delivery and Security, and Endpoints sections that enable you to define the capabilities described in this chapter for the remote trading partner.</p>

See Also: ["Creating Remote Trading Partner Identification"](#) on page 26-12 for instructions on creating remote trading partners

Managing Trading Partner Identifications

The Oracle Application Server ProcessConnect user interface tool enables you to perform the trading partner identification management tasks shown in [Figure 25-1](#) and [Figure 25-2](#). [Figure 25-1](#) shows the host trading partner and [Figure 25-2](#) shows the remote trading partner. These tasks are described in detail in this section. The trading partner identification uniquely identifies the trading partner whose capabilities are described in a trading partner agreement.

Figure 25-1 Trading Partner Identification Management Tasks (Part 1 of 2)

Host - CompanyXYZ

Validate Export Update

Details

Description

Wallet Password Create

State **Draft**

Trading Partner Identifications [Return to Top](#)

Create

Trading Partner Identification Type	Value	Details	Update	Delete
DUNS	453900780			

Approvers [Return to Top](#)

Add

Person	Send For Approval Date	Approval Date	Update	Delete
(No approvers found.)				

Associated Agreements [Return to Top](#)

Name	State	Update	Delete
(No agreements found.)			

Figure 25–2 Trading Partner Identification Management Tasks (Part 2 of 2)

Trading Partner Details : CompanyABC123

[Validate](#)
[Export](#)
[Delete](#)
[Update](#)

Details

Description

State **Draft**

Trading Partner Identifications [Return to Top](#)

[Create](#)

Trading Partner Identification Type	Value	Details	Update	Delete
DUNS	123456789			

Approvers [Return to Top](#)

There are no persons available or no additional persons available for approval.

[Add](#)

Person	Send For Approval Date	Approval Date	Update	Delete
(No approvers found.)				

Associated Agreements [Return to Top](#)

Name	State	Update	Delete
(No agreements found.)			

Table 25–3 identifies the trading partner identification management tasks shown in Figure 25–1 and Figure 25–2 and provides references to procedures for performing these tasks.

Table 25–3 Trading Partner Identification Management Tasks

Page Elements	Management Task	First See Section...	Then See Section...
Update buttons at top or bottom of either Figure 25–1 or Figure 25–2	Update the trading partner name and description	"Accessing Trading Partner Identification Management Tasks" on page 25-7	"Updating the Trading Partner Name and Description" on page 25-8
Create buttons in Trading Partner Identifications section of either Figure 25–1 or Figure 25–2	Create trading partner identification		"Creating Trading Partner Identification" on page 25-8

Table 25–3 (Cont.) Trading Partner Identification Management Tasks

Page Elements	Management Task	First See Section...	Then See Section...
Delete columns in Trading Partner Identifications section of either Figure 25–1 or Figure 25–2	Delete trading partner identification	"Accessing Trading Partner Identification Management Tasks" on page 25-7	"Deleting Trading Partner Identification" on page 25-9
Update columns in Trading Partner Identifications section of either Figure 25–1 or Figure 25–2	Update trading partner identification		"Updating Trading Partner Identification" on page 25-10
Details columns in Trading Partner Identifications section of either Figure 25–1 or Figure 25–2	View details about trading partner identification		"Viewing Trading Partner Identification" on page 25-10

See Also:

- ["Party ID"](#) on page 24-18 for additional conceptual details about trading partner identification
- ["Creating a Remote Trading Partner"](#) on page 26-9
- ["Managing the Host Trading Partner Wallet Password"](#) on page 25-90 for details about the **Wallet Password** section that displays on the Host - *name* page shown in the top page of [Figure 25–1](#) on page 25-4

Accessing Trading Partner Identification Management Tasks

Follow these instructions to access the host and remote trading partner identification management tasks shown in [Figure 25-1](#) on page 25-4 and [Figure 25-2](#) on page 25-5:

To access trading partner identification management tasks:

1. Select the **Profiles** tab.
2. Perform the following steps based on the type of trading partner to manage.

For a...	Perform These Steps...
Remote trading partner	<ol style="list-style-type: none"> 1. Select the Trading Partners tab. 2. Select a specific trading partner in the Name column of the Trading Partners page.
Host trading partner	<ol style="list-style-type: none"> 1. Select the Host tab.

3. Select a task to perform and see the referenced section for instructions:

To...	Then...	See Section...
Update the trading partner name and description	Click Update at the top or bottom of the page.	" Updating the Trading Partner Name and Description " on page 25-8
Create trading partner identification	Click Create in the Trading Partner Identifications section.	" Creating Trading Partner Identification " on page 25-8
Delete trading partner identification	Select the specific trading partner identification in the Delete column of the Trading Partner Identifications section.	" Deleting Trading Partner Identification " on page 25-9
Update trading partner identification	Select the specific trading partner identification in the Update column of the Trading Partner Identifications section.	" Updating Trading Partner Identification " on page 25-10
View details about trading partner identification	Select the specific trading partner identification in the Details column of the Trading Partner Identifications section.	" Viewing Trading Partner Identification " on page 25-10

Updating the Trading Partner Name and Description

The trading partner organization name that appears was initially defined through the following methods:

- For a host trading partner, the name that appears as the *name* in the Host - *name* page shown in [Figure 25-1](#) on page 25-4 is automatically created and named `organization` during Oracle Application Server ProcessConnect installation.
- For a remote trading partner, the name that appears as the *name* in the Trading Partner Details : *name* page shown in [Figure 25-2](#) on page 25-5 is the name you entered when creating a remote trading partner in "[Creating a Remote Trading Partner](#)" on page 26-9.

Follow these instructions to update the trading partner name and description:

To update the trading partner name and description:

1. Ensure that you followed the instructions in "[Accessing Trading Partner Identification Management Tasks](#)" on page 25-7 to access the page for updating the trading partner name and description.

If you are updating the host trading partner name and description, the Update Host page appears. If you are updating the remote trading partner name and description, the Update Trading Partner page appears.

2. Make appropriate changes to the name and description.
3. Click **Apply**.

The trading partner name is updated.

Creating Trading Partner Identification

Follow these instructions to create trading partner identification:

To create trading partner identification:

1. Ensure that you followed the instructions in "[Accessing Trading Partner Identification Management Tasks](#)" on page 25-7 to access the page for creating trading partner identification.

The Create Trading Partner Identification page appears.

2. Enter the following details to create trading partner identification. An asterisk (*) indicates a required field.

Field	Description
Trading Partner Identification Type*	Select a type from the available values. One available type is DUNS (data universal numbering system). This type, known formally as a D-U-N-S Number, is a unique, sequentially-generated, nine-digit number that you obtain from Dun and Bradstreet.
Value *	Enter a value for the selected type. For example, if DUNS is your type, enter the DUNS number.
Description	Provide an optional description.

3. Click **Apply**.

The trading partner identification is created and the Trading Partner Identification Details page for the new trading partner identification appears.

See Also: ["Creating a Trading Partner Identification Type"](#) on page 17-51 to create your own identification types to display as selectable types in the Create Trading Partner Identification page

Deleting Trading Partner Identification

Follow these instructions to delete trading partner identification:

To delete trading partner identification:

1. Ensure that you followed the instructions in ["Accessing Trading Partner Identification Management Tasks"](#) on page 25-7 to access the page for deleting trading partner identification.
2. Click **Yes** when prompted to delete trading partner identification.

The trading partner identification is deleted.

Updating Trading Partner Identification

Follow these instructions to update trading partner identification:

To update trading partner identification:

1. Ensure that you followed the instructions in "[Accessing Trading Partner Identification Management Tasks](#)" on page 25-7 to access the page for updating trading partner identification.

The Update Trading Partner Identification page appears.

2. Make appropriate changes. (See Step 2 of "[Creating Trading Partner Identification](#)" on page 25-9 for a list of fields that you can update.)
3. Click **Apply**.

Trading partner identification is updated and the Trading Partner Identification Details page for the updated trading partner identification appears.

Viewing Trading Partner Identification

Follow these instructions to view details about trading partner identification:

To view trading partner identification:

1. Ensure that you followed the instructions in "[Accessing Trading Partner Identification Management Tasks](#)" on page 25-7 to access the pages for viewing trading partner identification.

The Trading Partner Identification Details page for the selected trading partner identification appears.

Trading Partner Identification Details : 123456789

Delete Update

Details

Trading Partner Identification Type	DUNS
Value	123456789

2. View specific details (in this example, details about the DUNS number appear).

These pages, as with the Host - *name* and Trading Partner Details : *name* pages shown in [Figure 25-1](#) on page 25-4 and [Figure 25-2](#) on page 25-5, respectively, enable you to delete or update trading partner identification.



Managing Organizations

The Oracle Application Server ProcessConnect user interface tool enables you to perform the organization management tasks shown in [Figure 25-3](#). These tasks are described in detail in this section.



Figure 25-3 Organization Management Tasks

Organization : ipdev

People Create

Name	Update	Delete
ip		

Contact Information [Return to Top](#) Create

Contact Type	Value	Details	Update	Delete
Email	jj@myaddress.com			

This section describes the following organization management tasks:

- **Managing Persons**

You can create two person types under the **People** section:

- Host trading partner person
- Remote trading partner person

Both person types are created from the Organization page shown in [Figure 25-3](#). The method by which you access the Organization page determines the type of person that you can create, as shown in [Table 25-4](#).

Table 25-4 Person Types

To Create a...	Select...
Host trading partner person	Profiles > Host > Organization > People > Create
Remote trading partner person	Profiles > Trading Partners > <i>trading_partner_name</i> > Organization > People > Create where <i>trading_partner_name</i> is a specific remote trading partner that you select in the Name column.

These two person types have different capabilities, as shown in [Table 25-5](#).

Table 25-5 Person Capabilities

Capability	Host Trading Partner Person	Remote Trading Partner Person
Can connect to and use the Oracle Application Server ProcessConnect user interface tool to: <ul style="list-style-type: none"> ■ Manage (create, view, update, and delete) profile data and modeling metadata in integrations ■ Deploy and administer integrations ■ Generate business intelligence reports <p>Note: The Administrator role must be assigned to a person before they can connect to and use the Oracle Application Server ProcessConnect user interface tool.</p>	Yes	No
Can add user roles and use cases (privileges) to the person type	Yes	No
Can appear in a list of potential approvers from which they can be selected to approve profile data such as agreements	Yes	Yes

You can assign a method for contacting this person (such as a phone number or e-mail address) from the Person Details page. (See the lower page of [Figure 25-4](#) on page 25-13.)

- [Managing Organization Contact Details](#)

You can also assign a method for contacting an organization in the **Contact Information** section (such as a phone number or e-mail address). This contact method can then be used later for trading partner communication.

See Also: ["Viewing the State of Modeling Metadata and Profile Data on the Details Page"](#) on page 5-17 for details about agreement approvers

Managing Persons

The Oracle Application Server ProcessConnect user interface tool enables you to perform the person management tasks shown in [Figure 25-4](#). These tasks are described in detail in this section.

Figure 25-4 Person Management Tasks

Organization : ipdev

People Create

Name	Update	Delete
ip		

Contact Information [Return to Top](#) Create

Contact Type	Value	Details	Update	Delete
Email	jj@myaddress.com			

Person Details : ip Delete Update

Details

Password ***** Update

Description

State **Draft**

Contact Information Create

Contact Type	Value	Details	Update	Delete
(No contact information found for the specific person.)				

User Roles

No additional user roles exist. Addition of user roles not possible. Add

Name	Remove
Administrator	

Table 25-6 identifies the person management tasks shown in Figure 25-4 and provides references to procedures for performing these tasks.

Table 25-6 Person Management Tasks

Page Elements	Management Task	First See Section...	Then See Section...
Create button in People section of Figure 25-4	Create a person	"Accessing Person Management Tasks" on page 25-15	"Creating a Person" on page 25-16
Delete column in People section of Figure 25-4	Delete a person		"Deleting a Person" on page 25-18
Update column in People section of Figure 25-4	Update a person		"Updating a Person" on page 25-18
Name column in People section of Figure 25-4 (To access the Person Details page shown in lower page of Figure 25-4)	View details about a person and update the password		"Viewing a Person and Updating the Password" on page 25-18
Create button in Contact Information section of Figure 25-4	Create person contact details		"Creating Person Contact Details" on page 25-20
Delete column in Contact Information section of Figure 25-4	Delete person contact details		"Deleting Person Contact Details" on page 25-21
Update column in Contact Information section of Figure 25-4	Update person contact details		"Updating Person Contact Details" on page 25-21
Details column in Contact Information section of Figure 25-4	View person contact details		"Viewing Person Contact Details" on page 25-22
Add button in User Roles section of Figure 25-4	Add a user role to a host trading partner person		"Adding a User Role to a Host Trading Partner Person" on page 25-23
Remove column in User Roles section of Figure 25-4	Remove a user role from a host trading partner person	"Removing a User Role from a Host Trading Partner Person" on page 25-24	
Name column in User Roles section of Figure 25-4	View user role and use case group details	"Viewing User Role and Use Case Group Details" on page 25-24	

Accessing Person Management Tasks

Follow these instructions to access the person management tasks shown in [Figure 25-4](#) on page 25-13:

To access person management tasks:

1. Select the **Profiles** tab.
2. Perform the following steps based on the type of person you want to manage:

For a...	Perform These Steps...
Remote trading partner person	<ol style="list-style-type: none"> 1. Select the Trading Partners tab. 2. Select a specific trading partner in the Name column of the Trading Partners page.
Host trading partner person	<ol style="list-style-type: none"> 1. Select the Host tab.

3. Select **Organization**.

The Organization : *name* page appears.

4. Go to the **People** section.
5. Select a task to perform and see the referenced section for instructions:

To...	Then...	See Section...
Create a person	Click Create .	"Creating a Person" on page 25-16
Delete a person	Select a specific person in the Delete column.	"Deleting a Person" on page 25-18
Update a person	Select a specific person in the Update column.	"Updating a Person" on page 25-18
View details about a person and update the password	Select a specific person in the Name column.	"Viewing a Person and Updating the Password" on page 25-18
Create person contact details	Select a specific person in the Name column for which to create contact details.	"Creating Person Contact Details" on page 25-20

To...	Then...	See Section...
Delete person contact details	Select a specific person in the Name column that includes the contact details to delete.	"Deleting Person Contact Details" on page 25-21
Update person contact details	Select a specific person in the Name column that includes the contact details to update.	"Updating Person Contact Details" on page 25-21
View person contact details	Select a specific person in the Name column that includes the contact details to view.	"Viewing Person Contact Details" on page 25-22
Add a user role to a host trading partner person	Select a specific host trading partner person in the Name column to which to add a user role.	"Adding a User Role to a Host Trading Partner Person" on page 25-23
Remove a user role from a host trading partner person	Select a specific host trading partner person in the Name column from which to remove a user role.	"Removing a User Role from a Host Trading Partner Person" on page 25-24
View user role and use case group details	Select a specific person in the Name column that includes the user role and use case group details to view.	"Viewing User Role and Use Case Group Details" on page 25-24

Creating a Person

Follow these instructions to create a person:

To create a person:

1. Ensure that you followed the instructions in ["Accessing Person Management Tasks"](#) on page 25-15 to access the page for creating a person.

The Create Person page appears.

2. Enter the following details to create a person. An asterisk (*) indicates a required field.

Field	Description
Name *	Enter a unique and recognizable person name.
Password	Enter a password. Note: If you are creating a remote trading partner person, then you can ignore this field. If you are creating a host trading partner person, enter a password if you want to later add the user role that enables you to connect to and use the Oracle Application Server ProcessConnect user interface tool.
Description	Provide an optional description.

3. Click **Apply**. The password (if entered) is stored in encrypted form.

The person is created and the Person Details page for the new person appears. If this is a host trading partner person, the **User Roles** section appears at the bottom of the page. (See the lower page of [Figure 25-4](#) on page 25-13.) This section enables you to add the user role to the person. If this is a remote trading partner person, the **User Roles** section does not appear.

This person (for both host and remote trading partner person) can now be added to the list of approvers for profile data such as agreements, applications, and trading partners.

See Also: The following sections for details on how this person appears in the list of potential approvers for a trading partner agreement:

- ["Viewing a Trading Partner Agreement"](#) on page 26-17
- ["Viewing an Application Agreement"](#) on page 15-34
- ["Viewing the State of Modeling Metadata and Profile Data on the Details Page"](#) on page 5-17 for additional details about approvers

Deleting a Person

Follow these instructions to delete a person:

To delete a person:

1. Ensure that you followed the instructions in "[Accessing Person Management Tasks](#)" on page 25-15 to access the page for deleting a person.
2. Click **Yes** when prompted to delete a person.

The person is deleted and the Organization : *name* page appears.

Updating a Person

You can update the name or description of a person from this page. Follow these instructions to update a person:

To update a person:

1. Ensure that you followed the instructions in "[Accessing Person Management Tasks](#)" on page 25-15 to access the page for updating a person.

The Update Person page appears.

2. Make appropriate changes to the person name or description.
3. Click **Apply**.

The person is updated and the Person Details page for the updated person appears.

Viewing a Person and Updating the Password

Follow these instructions to view details about a specific person and update the password:

To view a person and update the password:

1. Ensure that you followed the instructions in "[Accessing Person Management Tasks](#)" on page 25-15 to access the page for viewing a person and updating the password.

The Person Details page for the selected person appears (for this example, a person named **ip**). For this example, a host trading partner person is shown because the **User Roles** section appears at the bottom of the page; for remote trading partners, this field does not appear.

Person Details : ip

Details

Password *****

Description

State **Draft**

Contact Information

Contact Type	Value	Details	Update	Delete
(No contact information found for the specific person.)				

User Roles

 No additional user roles exist. Addition of user roles not possible.

Name	Remove
Administrator	

- View specific details. Since the **Administrator** role is the only role available and is currently assigned to the user **ip**, the **Add** button is disabled. No additional roles can be assigned.

This page, as with the Organization : *name* page shown in the upper page of [Figure 25-4](#) on page 25-13, enables you to delete or update the selected person.

Note: You cannot create use case groups. Use case groups consist of use cases. Use cases are the privileges assigned to user roles.

- Click **Update** next to the password to update the password of a person. If the host trading partner person has the **Administrator** role (and therefore connection privileges to the Oracle Application Server ProcessConnect user interface tool), the password is mandatory. For remote trading partner persons (which do not have the **Administrator** role), the password is not mandatory. The Update Person Password page appears.

4. Enter the following details to update a person password. An asterisk (*) indicates a required field.

Field	Description
New Password *	Enter a new password.
Confirm New Password *	Enter the new password a second time.

5. Click **Apply**.
The password is updated and the Person Details page appears.
6. Click **Return to List** to return to the Organization : *name* page.

Creating Person Contact Details

Follow these instructions to create person contact details:

To create person contact details:

1. Ensure that you followed the instructions in "[Accessing Person Management Tasks](#)" on page 25-15 to access the page for creating person contact details.
The Person Details page for the selected person appears.
2. Go to the **Contact Information** section. (See the lower page of [Figure 25-4](#) on page 25-13.)
3. Click **Create**.
The Create Contact Information page appears.
4. Enter the following details to create person contact details. An asterisk (*) indicates a required field.

Field	Description
Contact Type *	Select one of the available types (Phone , Email , Fax , or Contact Name) or your own contact type. See Also: " Creating a Contact Type " on page 17-44 to create your own contact type to display as a selectable type in the Create Contact Information page.
Value	Enter a value for the selected contact type. For example, if you select Phone as the contact type, enter a phone number in this field.

Note: Contact type creation does not cause a person to be automatically contacted when a specific condition occurs, such as the need to approve an agreement. You must manually contact a person through the selected contact type method.

5. Click **Apply**.

The contact details are created and the Contact Information Details page for the new contact details appears.

Deleting Person Contact Details

Follow these instructions to delete person contact details:

To delete person contact details:

1. Ensure that you followed the instructions in "[Accessing Person Management Tasks](#)" on page 25-15 to access the page for deleting person contact details.

The Person Details page for the selected person appears.

2. Go to the **Contact Information** section. (See the lower page of [Figure 25-4](#) on page 25-13.)
3. Select the person contact details to delete in the **Delete** column.
4. Click **Yes** when prompted to delete person contact details.

The person contact details are deleted and the Organization : *name* page appears.

Updating Person Contact Details

Follow these instructions to update person contact details:

To update a person contact details:

1. Ensure that you followed the instructions in "[Accessing Person Management Tasks](#)" on page 25-15 to access the page for updating person contact details.

The Person Details page for the selected person appears.

2. Go to the **Contact Information** section. (See the lower page of [Figure 25-4](#) on page 25-13.)

3. Select the person contact details to update in the **Update** column.
The Update Contact Information page appears.
4. Make appropriate changes. (See Step 4 of "[Creating Person Contact Details](#)" on page 25-20 for a list of fields that you can update.)
5. Click **Apply**.
The person contact details are updated and the Contact Information Details page for the updated person contact details appears.

Viewing Person Contact Details

Follow these instructions to view details about specific person contact details:

To view person contact details:

1. Ensure that you followed the instructions in "[Accessing Person Management Tasks](#)" on page 25-15 to access the page for viewing person contact details.
The Person Details page for the selected person appears.
2. Go to the **Contact Information** section. (See the lower page of [Figure 25-4](#) on page 25-13.)
3. Select the person contact details to view in the **Details** column.
The Contact Information Details page for the selected person contact details appears.

[Contact Information Details : jj@myaddress.com - Email](#)

Delete Update

Details

Contact Type [Email](#)
Value [jj@myaddress.com](#)

4. View specific details.
These pages, as with the Person Details page shown in the lower page of [Figure 25-4](#) on page 25-13, enable you to delete or update the selected person contact details.

Adding a User Role to a Host Trading Partner Person

You can add a user role to a host trading partner person, but not to a remote trading partner person. A user role is the group of related use cases (privileges) that permit a person to connect to and perform tasks with the Oracle Application Server ProcessConnect user interface tool. Follow these instructions to add a user role to a person:

To add a user rule to a host trading partner person:

1. Follow the instructions in "[Accessing Person Management Tasks](#)" on page 25-15 to access the page for adding a user role to a host trading partner person.

The Person Details page for the selected host trading partner person appears.

2. Go to the **User Roles** section. (See the lower page of [Figure 25-4](#) on page 25-13.)
3. Click **Add** to add a user role to the host trading partner person.

The Create User Role Enrollment page appears.

4. Select **Administrator** from the **User Role** list. This is the only role available.
5. Click **Apply**.

The Person Details page for the host trading partner person appears. If the person does not have a password, you receive an error and the user role is not added.

6. Click **Apply**.

The Person Details page appears.

See Also: "[Updating a Person](#)" on page 25-18 if you need to add a password to the host trading partner person

Removing a User Role from a Host Trading Partner Person

You can remove a user role from a host trading partner person, but not from a remote trading partner person (they have none). Follow these instructions to remove a user role from a person:

Caution: If you remove a user role from a host trading partner person, that person no longer has privileges to connect to and perform any tasks with the Oracle Application Server ProcessConnect user interface tool.

To remove a user rule from a host trading partner person:

1. Follow the instructions in "[Accessing Person Management Tasks](#)" on page 25-15 to access the page for removing a user role from a host trading partner person.
The Person Details page for the selected host trading partner person appears.
2. Go to the **User Roles** section. (See the lower page of [Figure 25-4](#) on page 25-13.)
3. Select a user role to remove in the **Remove** column.
4. Click **Yes** when prompted to remove the user role.
The user role is removed and the Person Details page appears.

Viewing User Role and Use Case Group Details

User roles consist of use case groups that include the use cases (privileges) that permit a person to connect to and perform tasks with the Oracle Application Server ProcessConnect user interface tool. As a small example, the **Administrator** user role contains many uses cases, such as:

- `updateTranslationStep`
This use case enables you to update the modeling metadata of a translation step, as described in "[Updating a Step](#)" on page 12-85
- `createTransportEndpoint`
This use case enables you to create the profile data for a transport, as described in "[Creating an Endpoint](#)" on page 25-82

Note: You cannot create, delete, or update user roles or use case groups.

Follow these instructions to view the user role and its associated use case group details:

To view user role and use case group details:

1. Ensure that you followed the instructions in "[Accessing Person Management Tasks](#)" on page 25-15 to access the page for viewing user role and use case group details.

The Person Details page for the selected person appears.

2. Go to the **User Roles** section.
3. Select a specific user role to view in the **Name** column.

The User Role Details page for the selected user role appears.

User Role Details : Administrator

Details

Description Admin role

State **Draft**

Use Case Groups

Name

All USECASEGROUP

4. View specific details.
5. Click the use case group in the **Name** column of the **Use Case Groups** section to view the specific use case assigned to the use case group of the user role.
6. Click **Return to List** to return to the User Role Details page.
7. Click **Return to List** to return to the Person Details page.

Managing Organization Contact Details

The Oracle Application Server ProcessConnect user interface tool enables you to perform the organization contact details management tasks shown in [Figure 25-5](#). These tasks are described in detail in this section. The contact method details for the organization can then be used later for trading partner communication.

Figure 25-5 Organization Contact Details Management Tasks

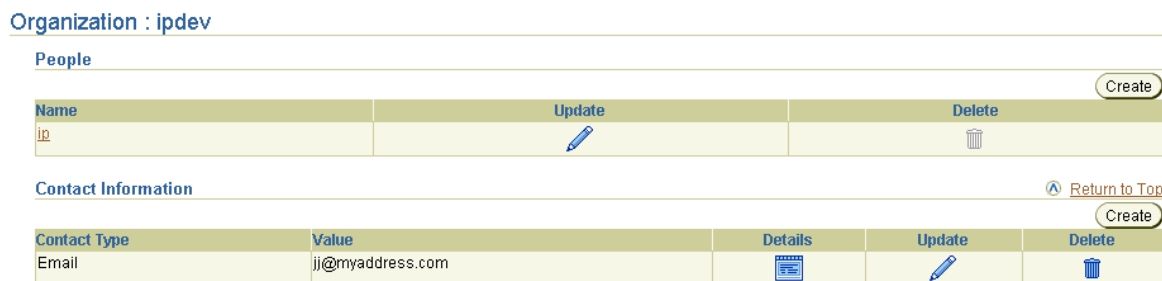

[Table 25-7](#) identifies the organization contact details management tasks shown in [Figure 25-5](#) and provides references to procedures for performing these tasks.

Table 25-7 Organization Contact Details Management Tasks

Page Elements	Management Task	First See Section...	Then See Section...
Create button in Contact Information section of Figure 25-5	Create organization contact details	" Accessing Organization Contact Management Tasks " on page 25-27	" Creating Organization Contact Details " on page 25-28
Delete column in Contact Information section of Figure 25-5	Delete organization contact details		" Deleting Organization Contact Details " on page 25-28
Update column in Contact Information section of Figure 25-5	Update organization contact details		" Updating Organization Contact Details " on page 25-29
Details column in Contact Information section of Figure 25-5	View organization contact details		" Viewing Organization Contact Details " on page 25-29

Accessing Organization Contact Management Tasks

Follow these instructions to access the organization contact management tasks shown in [Figure 25-5](#) on page 25-26:

To access organization contact management tasks:

1. Select the **Profiles** tab.
2. Perform the following steps based on the type of trading partner to manage.

For a...	Perform These Steps...
Remote trading partner	<ol style="list-style-type: none"> 1. Select the Trading Partners tab. 2. Select a specific trading partner in the Name column of the Trading Partners page.
Host trading partner	<ol style="list-style-type: none"> 1. Select the Host tab.

3. Select **Organization**.

The Organization : *name* page appears.

4. Go to the **Contact Information** section.
5. Select a task to perform and see the referenced section for instructions:

To...	Then...	See Section...
Create organization contact details	Click Create .	"Creating Organization Contact Details" on page 25-28
Delete organization contact details	Select specific contact details in the Delete column.	"Deleting Organization Contact Details" on page 25-28
Update organization contact details	Select specific contact details in the Update column.	"Updating Organization Contact Details" on page 25-29
View organization contact details	Select specific contact details in the Details column.	"Viewing Organization Contact Details" on page 25-29

Creating Organization Contact Details

Follow these instructions to create organization contact details:

To create organization contact details:

1. Ensure that you followed the instructions in "[Accessing Organization Contact Management Tasks](#)" on page 25-27 to access the page for creating organization contact details.

The Create Contact Information page appears.

2. Enter the following details to create organization contact details. An asterisk (*) indicates a required field.

Field	Description
Contact Type *	Select Phone, Email, Fax, or Contact Name . See Also: " Creating a Contact Type " on page 17-44 to create your own contact type to display as a selectable type in the Create Contact Information page.
Value	Enter a value for the selected contact type. For example, if you select Phone as the contact type, enter a phone number in this field.

3. Click **Apply**.

The organization contact details are created and the Contact Information Details page for the new contact details appears.

Deleting Organization Contact Details

Follow these instructions to delete organization contact details:

To delete organization contact details:

1. Ensure that you followed the instructions in "[Accessing Organization Contact Management Tasks](#)" on page 25-27 to access the page for deleting organization contact details.
2. Click **Yes** when prompted to delete organization contact details.

The organization contact details are deleted and the Organization : *name* page appears.

Updating Organization Contact Details

Follow these instructions to update organization contact details:

To update organization contact details:

1. Ensure that you followed the instructions in "[Accessing Organization Contact Management Tasks](#)" on page 25-27 to access the page for updating organization contact details.

The Update Contact Information page appears.

2. Make appropriate changes. (See Step 2 of "[Creating Organization Contact Details](#)" on page 25-28 for a list of fields that you can update.)
3. Click **Apply**.

The organization contact details are updated and the Contact Information Details page for the updated organization contact details appears.

Viewing Organization Contact Details

Follow these instructions to view details about specific organization contact details:

To view organization contact details:

1. Ensure that you followed the instructions in "[Accessing Organization Contact Management Tasks](#)" on page 25-27 to access the page for viewing organization contact details.

The Contact Information Details page for the selected organization contact details appears.

[Contact Information Details : jj@myaddress.com - Email](#)

Details

Contact Type	Email
Value	jj@myaddress.com

2. View specific details.

These pages, as with the Organization : *name* page shown in [Figure 25-5](#) on page 25-26, enable you to delete or update the selected organization contact details.

Managing Cooperations

The Oracle Application Server ProcessConnect user interface tool enables you to perform the cooperation (collaboration) management tasks shown in [Figure 25–6](#). Cooperations are the result of a correct configuration setup of collaborations. These tasks are described in detail in this section.

Figure 25–6 Cooperation Management Tasks

Cooperations : ipdev

Supported Actors (Collaborations) Create

Collaboration	Actor	Revision	Details	Update	Delete
3A4	Buyer	V02.00			

Business Protocols Return to Top

Name	Exchange Protocol	Document Protocol	Remove
RosettaNet-RNIF1.1-PIP	RosettaNet - 01.10	RosettaNet - V02.00	

This section describes the following cooperation management tasks:

- **Managing Supported Actors**

After trading partner capabilities are defined (for example, RNIF, version 2.0), you can define more specific trading partner capabilities in a business collaboration (such as the role played by a trading partner, for example, Buyer - 3A4 V02 or Seller - 3A4 V02.00).
- **Managing Business Protocols**

The business protocol identifies the implementation guidelines for the reliable transport of business document messages between trading partners (essentially the capabilities of the trading partner). One example of a business protocol is RNIF, version 2.0 using the RosettaNet Document Protocol. This business protocol consists of three protocols:

 - Exchange protocol

Defines the exchange mechanism (for example, headers and signals)
 - Document protocol

Defines the document types, such as RosettaNet

- Process protocol
 Defines how documents are exchanged (for example, PIP collaborations)

See Also: "[Viewing Business Protocols](#)" on page 17-38



Managing Supported Actors

The Oracle Application Server ProcessConnect user interface tool enables you to perform the supported actor management tasks shown in [Figure 25-7](#). These tasks are described in detail in this section. The supported actor defines the capabilities of a trading partner in a business collaboration (such as buyer or seller).

Figure 25-7 Supported Actor Management Tasks

Cooperations : ipdev

Supported Actors (Collaborations) Create

Collaboration	Actor	Revision	Details	Update	Delete
3A4	Buyer	V02.00			

Business Protocols [Return to Top](#) Add

Name	Exchange Protocol	Document Protocol	Remove
RosettaNet-RNIF1.1-PIP	RosettaNet - 01.10	RosettaNet - V02.00	

Table 25–8 identifies the supported actor management tasks shown in Figure 25–7 and provides references to procedures for performing these tasks.

Table 25–8 Supported Actor Management Tasks

Page Elements	Management Task	First See Section...	Then See Section...
Create button in Supported Actors (Collaborations) section of Figure 25–7	Create a supported actor	"Accessing Supported Actor Management Tasks" on page 25-32	"Creating a Supported Actor" on page 25-34
Delete column in Supported Actors (Collaborations) section of Figure 25–7	Delete a supported actor		"Deleting a Supported Actor" on page 25-35
Update column in Supported Actors (Collaborations) section of Figure 25–7	Update a supported actor		"Updating a Supported Actor" on page 25-35
Details column in Supported Actors (Collaborations) section of Figure 25–7	View a supported actor for a host trading partner		"Viewing a Supported Actor for a Host Trading Partner" on page 25-36
	View a supported actor for a remote trading partner		"Viewing a Supported Actor for a Remote Trading Partner" on page 25-38
Details column in Supported Actors (Collaborations) section of Figure 25–7	Update validation rules states for a host trading partner	"Updating Validation Rules States for a Host Trading Partner" on page 25-40	
	Update validation rules states for a remote trading partner	"Updating Validation Rules States for a Remote Trading Partner" on page 25-40	

Accessing Supported Actor Management Tasks

Follow these instructions to access the supported actor management tasks shown in [Figure 25–7](#) on page 25-31:

To access supported actor management tasks:

1. Select the **Profiles** tab.

2. Perform the following steps based on the type of trading partner to manage.

For a...	Perform These Steps...
Remote trading partner	<ol style="list-style-type: none"> 1. Select the Trading Partners tab. 2. Select a specific trading partner in the Name column of the Trading Partners page.
Host trading partner	<ol style="list-style-type: none"> 1. Select the Host tab.

3. Select **Cooperations**.

The Cooperations : *name* page appears.

4. Go to the **Supported Actors** section.
5. Select a task to perform and see the referenced section for instructions:

To...	Then...	See Section...
Create a supported actor	Click Create .	"Creating a Supported Actor" on page 25-34
Delete a supported actor	Select a specific supported actor in the Delete column.	"Deleting a Supported Actor" on page 25-35
Update a supported actor	Select a specific supported actor in the Update column.	"Updating a Supported Actor" on page 25-35
View details about a supported actor for a host trading partner	Select a specific supported actor in the Details column of a host trading partner	"Viewing a Supported Actor for a Host Trading Partner" on page 25-36
View details about a supported actor for a remote trading partner	Select a specific supported actor in the Details column of a remote trading partner	"Viewing a Supported Actor for a Remote Trading Partner" on page 25-38
Update validation rules states for a host trading partner	Select a specific supported actor for which to update the validation rules states in the Details column of a host trading partner	"Updating Validation Rules States for a Host Trading Partner" on page 25-40

To...	Then...	See Section...
Update validation rules states for a remote trading partner	Select a specific supported actor for which to update the validation rules states in the Details column of a remote trading partner	"Updating Validation Rules States for a Remote Trading Partner" on page 25-40

Creating a Supported Actor

Follow these instructions to define a trading partner's capabilities by creating a supported actor:

To create a supported actor:

1. Ensure that you followed the instructions in ["Accessing Supported Actor Management Tasks"](#) on page 25-32 to access the page for creating a supported actor.

The Create Supported Actor page appears.

2. Enter the following details to create the capabilities of a supported actor. An asterisk (*) indicates a required field.

Field	Description
Actor *	<p>Select the actor capabilities from the following list:</p> <ul style="list-style-type: none"> ▪ Unspecified ▪ Buyer - 3A4 - V02.00 ▪ Buyer - 3A6 - V02.00 ▪ Failure Report Administrator - 0A1 - V02.00 ▪ PIP Failure Notifier - 0A1 - V02.00 ▪ Seller - 3A4 - V02.00 ▪ Seller - 3A6 - V02.00 <p>Note: The value for the Actor field consists of three elements. In the case of RosettaNet, for example, Buyer - 3A4 - V02.00 consists of the actor name (Buyer), partner interface process (PIP) collaboration name (3A4), and collaboration revision (V02.00).</p>
Time To Perform	<p>Enter the time limit in which a response is expected. If this time limit is exceeded, then it results in an error. For example, with RosettaNet, this error condition is handled as an out-of-band error (PIP0A1).</p>

A supported actor represents the capability of a trading partner. The native role defines the external behavior for a business process. In this case, this is the behavior the trading partner exhibits while performing that business function (for example, buyer or seller).

3. Click [Apply](#).

The supported actor is created and the Supported Actor Details page for the new supported actor appears.

See Also:

- [Chapter 24, "RosettaNet B2B Protocol Standard"](#) for details on PIPs
- ["Managing Native Roles in Trading Partner Agreements"](#) on page 26-30 for details on native roles in trading partner agreements

Deleting a Supported Actor

Follow these instructions to delete a supported actor:

To delete a supported actor:

1. Ensure that you followed the instructions in ["Accessing Supported Actor Management Tasks"](#) on page 25-32 to access the page for deleting a supported actor.
2. Click **Yes** when prompted to delete a supported actor.

The supported actor is deleted and the Cooperations : *name* page appears.

Updating a Supported Actor

Follow these instructions to update a supported actor:

To update a supported actor:

1. Ensure that you followed the instructions in ["Accessing Supported Actor Management Tasks"](#) on page 25-32 to access the page for updating a supported actor.

The Update Supported Actor page appears.

2. Make appropriate changes. (See Step 2 of ["Creating a Supported Actor"](#) on page 25-34 for a list of fields that you can update.)

3. Click **Apply**.

The supported actor is updated and the Supported Actor Details page for the updated supported actor appears.

Viewing a Supported Actor for a Host Trading Partner

Follow these instructions to view details about a specific supported actor for a host trading partner:

To view a supported actor for a host trading partner:

1. Ensure that you followed the instructions in "[Accessing Supported Actor Management Tasks](#)" on page 25-32 to access the page for viewing a supported actor of a host trading partner.

The Supported Actor Details page for the selected supported actor appears (in this example, for a RosettaNet actor). The upper section of the page displays the following details:

Supported Actor Details : Buyer - 3A4 - V02.00

[Delete](#) [Update](#)

Details

Actor [Buyer](#)
 Collaboration [3A4](#)
 Revision **V02.00**
 Time To Perform

Validation Rules For Purchase Order Request Action

[Update](#)











⏪ Previous 1-10 of 317 Next 10 ⏩

Tag Number	Xpath	State	Details
2	fromRole/PartnerRoleDescription/ContactInformation	True	
3	fromRole/PartnerRoleDescription/ContactInformation/contactName/FreeFormText	True	
4	fromRole/PartnerRoleDescription/ContactInformation/EmailAddress	True	
5	fromRole/PartnerRoleDescription/ContactInformation/facsimileNumber/CommunicationsNumber	True	
6	fromRole/PartnerRoleDescription/ContactInformation/telephoneNumber/CommunicationsNumber	True	
7	fromRole/PartnerRoleDescription/GlobalPartnerRoleClassificationCode	True	
10	fromRole/PartnerRoleDescription/PartnerDescription/BusinessDescription/GlobalBusinessIdentifier	True	
11	fromRole/PartnerRoleDescription/PartnerDescription/BusinessDescription/GlobalSupplyChainCode	True	
12	fromRole/PartnerRoleDescription/PartnerDescription/GlobalPartnerClassificationCode	True	
13	GlobalDocumentFunctionCode	True	

⏪ Previous 1-10 of 317 Next 10 ⏩

The lower section of the page displays the following details:

Validation Rules For Purchase Order Confirmation Action

Tag Number	Xpath	State	Details
2	fromRole/PartnerRoleDescription/ContactInformation	True	
3	fromRole/PartnerRoleDescription/ContactInformation/contactName/FreeFormText	True	
4	fromRole/PartnerRoleDescription/ContactInformation/EmailAddress	True	
5	fromRole/PartnerRoleDescription/ContactInformation/facsimileNumber/CommunicationsNumber	True	
6	fromRole/PartnerRoleDescription/ContactInformation/telephoneNumber/CommunicationsNumber	True	
7	fromRole/PartnerRoleDescription/GlobalPartnerRoleClassificationCode	True	
10	fromRole/PartnerRoleDescription/PartnerDescription/BusinessDescription/GlobalBusinessIdentifier	True	
11	fromRole/PartnerRoleDescription/PartnerDescription/BusinessDescription/GlobalSupplyChainCode	True	
12	fromRole/PartnerRoleDescription/PartnerDescription/GlobalPartnerClassificationCode	True	
13	GlobalDocumentFunctionCode	True	

2. View specific details, including the validation rules associated with the supported actor. The **Xpath** is extracted from the document type definition (DTD) file. A path is provided to each element.
3. Click **Details** to access the rule associated with the element.

Validation Rule Details : 2

Details

Tag Number 2
 Xpath fromRole/PartnerRoleDescription/ContactInformation
 Element Name ContactInformation
 Is Enabled True

Description **RN_Tag-2: The element /Pip3A4PurchaseOrderRequest/fromRole/PartnerRoleDescription/ContactInformation is required**

4. Click **Return to List** to return to the Supported Actor Details page.
5. Click **Return to List** to return to the Cooperations : *name* page.

Viewing a Supported Actor for a Remote Trading Partner

Follow these instructions to view details about a specific supported actor for a remote trading partner:

To view a supported actor for a remote trading partner:

1. Ensure that you followed the instructions in "[Accessing Supported Actor Management Tasks](#)" on page 25-32 to access the page for viewing a supported actor for a remote trading partner.

The Supported Actor Details page for the selected supported actor appears (in this example, for a RosettaNet actor). The upper section of the page displays the following details:

Supported Actor Details : Seller - 3A4 - V02.00

[Delete](#) [Update](#)

Details

Actor [Seller](#)
 Collaboration [3A4](#)
 Revision [V02.00](#)
 Time To Perform

Validation Rules For Purchase Order Request Action

[Update](#)











Previous 1-10 of 317 Next 10

Tag Number	Xpath	State	Override State	Details
2	fromRole/PartnerRoleDescription/ContactInformation	True	Default	Details
3	fromRole/PartnerRoleDescription/ContactInformation/contactName/FreeFormText	True	Default	Details
4	fromRole/PartnerRoleDescription/ContactInformation/EmailAddress	True	Default	Details
5	fromRole/PartnerRoleDescription/ContactInformation/facsimileNumber/CommunicationsNumber	True	Default	Details
6	fromRole/PartnerRoleDescription/ContactInformation/telephoneNumber/CommunicationsNumber	True	Default	Details
7	fromRole/PartnerRoleDescription/GlobalPartnerRoleClassificationCode	True	Default	Details
10	fromRole/PartnerRoleDescription/PartnerDescription/BusinessDescription/GlobalBusinessIdentifier	True	Default	Details
11	fromRole/PartnerRoleDescription/PartnerDescription/BusinessDescription/GlobalSupplyChainCode	True	Default	Details
12	fromRole/PartnerRoleDescription/PartnerDescription/GlobalPartnerClassificationCode	True	Default	Details
13	GlobalDocumentFunctionCode	True	Default	Details

Previous 1-10 of 317 Next 10

The lower section of the page displays the following details:

Validation Rules For Purchase Order Confirmation Action

Tag Number	Xpath	State	Override State	Details
2	fromRole/PartnerRoleDescription/ContactInformation	True	Default	
3	fromRole/PartnerRoleDescription/ContactInformation/contactName/FreeFormText	True	Default	
4	fromRole/PartnerRoleDescription/ContactInformation/EmailAddress	True	Default	
5	fromRole/PartnerRoleDescription/ContactInformation/facsimileNumber/CommunicationsNumber	True	Default	
6	fromRole/PartnerRoleDescription/ContactInformation/telephoneNumber/CommunicationsNumber	True	Default	
7	fromRole/PartnerRoleDescription/GlobalPartnerRoleClassificationCode	True	Default	
10	fromRole/PartnerRoleDescription/PartnerDescription/BusinessDescription/GlobalBusinessIdentifier	True	Default	
11	fromRole/PartnerRoleDescription/PartnerDescription/BusinessDescription/GlobalSupplyChainCode	True	Default	
12	fromRole/PartnerRoleDescription/PartnerDescription/GlobalPartnerClassificationCode	True	Default	
13	GlobalDocumentFunctionCode	True	Default	

- View specific details, including the validation rules associated with the supported actor. The **Xpath** is extracted from the document type definition (DTD) file. A path is provided to each element.
- Click **Details** to access the rule associated with the element.

Validation Rule Details : 2

Details

Tag Number	2
Xpath	fromRole/PartnerRoleDescription/ContactInformation
Element Name	ContactInformation
Is Enabled	True
Override Is Enabled	Default
Description	RN_Tag-2: The element /Pip3A4PurchaseOrderRequest/fromRole/PartnerRoleDescription/ContactInformation is required

- Click **Return to List** to return to the Supported Actor Details page.
- Click **Return to List** to return to the Cooperations : *name* page.

Updating Validation Rules States for a Host Trading Partner

You can enable or disable specific validation rules states for the supported actor. Follow these instructions to update the validation rules states of a host trading partner:

To update the validation rules states of a host trading partner:

1. Ensure that you followed the instructions in "[Accessing Supported Actor Management Tasks](#)" on page 25-32 to access the page for updating the validation rules states of a host trading partner.
2. Click **Update** in the appropriate validation rules section of the Supported Actor Details page.

The Update Validation Rules State page appears.

3. Select the tag number of the rule approvers in the **Enabled Rules** list. The tag number uniquely identifies each validation rule and appears in the far left column of the Supported Actor Details page shown in "[Viewing a Supported Actor for a Host Trading Partner](#)" on page 25-36.
4. Use the > arrow to move appropriate rules to the **Disabled Rules** list.
5. If you want to enable specific validation rules that are currently disabled, use the < arrow to move appropriate rules from the **Disabled Rules** list to the **Enabled Rules** list.
6. Click **Apply**.

The validation rules are updated and the Supported Actor Details page for the updated supported actor appears. Validation rules that are enabled display as **True** in the **State** column. Validation rules that are disabled display as **False** in the **State** column.

Updating Validation Rules States for a Remote Trading Partner

You can enable or disable specific validation rules states for the supported actor. Follow these instructions to update the validation rules states of a remote trading partner:

To update the validation rules states of a remote trading partner:

1. Ensure that you followed the instructions in "[Accessing Supported Actor Management Tasks](#)" on page 25-32 to access the page for updating the validation rules states of a remote trading partner.

2. Click **Update** in the appropriate validation rules section of the Supported Actor Details page.

The Update Validation Rules State page appears.

3. Select the tag number of the rule approvers in the **Available Rules** list. The tag number uniquely identifies each validation rule and appears in the far left column of the Supported Actor Details page shown in "[Viewing a Supported Actor for a Remote Trading Partner](#)" on page 25-38.
4. Use the > arrow to move appropriate rules to the **Disabled Rules (Override)** list.
5. If you want to enable specific validation rules that are currently disabled, use the < arrow to move appropriate rules from the **Disabled Rules (Override)** list to the **Available Rules** list.
6. Click **Apply**.

The validation rules are updated and the Supported Actor Details page for the updated supported actor appears. Validation rules that are enabled display as **True** in the **State** column. Validation rules that are disabled display as **False** in the **State** column.



Managing Business Protocols

The Oracle Application Server ProcessConnect user interface tool enables you to perform the business protocol management tasks shown in [Figure 25-8](#). These tasks are described in detail in this section.

Figure 25-8 Business Protocol Management Tasks

Cooperations : ipdev

Supported Actors (Collaborations)

Collaboration	Actor	Revision	Details	Update	Delete
3A4	Buyer	V02.00			

Create

Business Protocols

[Return to Top](#)

Name	Exchange Protocol	Document Protocol	Remove
RosettaNet-RNIF1.1-PIP	RosettaNet - 01.10	RosettaNet - V02.00	

Add

Business Protocol Details : RosettaNet-RNIF2.0-PIP

Details

Document Protocol [RosettaNet - V02.00](#)
 Exchange Protocol [RosettaNet - V02.00](#)
 Process Protocol [PIP - 2.0](#)

Table 25–9 identifies the business protocol management tasks shown in Figure 25–8 and provides references to procedures for performing these tasks.

Table 25–9 Business Protocol Management Tasks

Page Elements	Management Task	First See Section...	Then See Section...
Add button in Business Protocols section of Figure 25–8	Add a business protocol	"Accessing Business Protocol Management Tasks" on page 25-43	"Adding a Business Protocol" on page 25-45
Remove column in Business Protocols section of Figure 25–8	Remove a business protocol		"Removing a Business Protocol" on page 25-45
Document Protocol column in Business Protocols section of Figure 25–8	View details about a document protocol		"Viewing a Document Protocol" on page 25-45
Exchange Protocol column in Business Protocols section of Figure 25–8	View details about an exchange protocol		"Viewing an Exchange Protocol" on page 25-46
Name column in Business Protocols section of Figure 25–8 (To access the Business Protocol Details page shown in the lower page of Figure 25–8)	View details about a business protocol		"Viewing a Business Protocol" on page 25-48
Process Protocol link of Business Protocol Details page of Figure 25–8	View details about a process protocol		"Viewing a Process Protocol" on page 25-49

Accessing Business Protocol Management Tasks

Follow these instructions to access the business protocol management tasks shown in Figure 25–8 on page 25-42:

To access business protocol management tasks:

1. Select the **Profiles** tab.

- Perform the following steps based on the type of trading partner to manage.

For a...	Perform These Steps...
Remote trading partner	<ol style="list-style-type: none"> Select the Trading Partners tab. Select a specific trading partner in the Name column of the Trading Partners page.
Host trading partner	<ol style="list-style-type: none"> Select the Host tab.

- Select **Cooperations**.

The Cooperations : *name* page appears.

- Go to the **Business Protocols** section.
- Select a task to perform and see the referenced section for instructions:

To...	Then...	See Section...
Add a business protocol	Click Add .	"Adding a Business Protocol" on page 25-45
Remove a business protocol	Select a specific business protocol in the Remove column.	"Removing a Business Protocol" on page 25-45
View details about a document protocol	Select a specific document protocol in the Document Protocol column.	"Viewing a Document Protocol" on page 25-45
View details about a exchange protocol	Select a specific exchange protocol in the Exchange Protocol column.	"Viewing an Exchange Protocol" on page 25-46
View details about a business protocol	Select a specific business protocol in the Name column.	"Viewing a Business Protocol" on page 25-48
View details about a process protocol	Select a specific business protocol in the Name column.	"Viewing a Process Protocol" on page 25-49

See Also: The RosettaNet home page for more details on RosettaNet concepts discussed in this section:

<http://www.rosettanet.org>

Adding a Business Protocol

Follow these instructions to add a business protocol:

To add a business protocol:

1. Ensure that you followed the instructions in "[Accessing Business Protocol Management Tasks](#)" on page 25-43 to access the page for adding a business protocol.

The Add Business Protocol page appears.

2. Select a business protocol from the **Business Protocol** list:

- RosettaNet-RNIF1.1-PIP
- RosettaNet-RNIF2.0-PIP

3. Click **Apply**.

The business protocol is added and the Cooperations : *name* page appears.

Removing a Business Protocol

Follow these instructions to remove a business protocol:

To remove a business protocol:

1. Ensure that you followed the instructions in "[Accessing Business Protocol Management Tasks](#)" on page 25-43 to access the page for removing a business protocol.

2. Click **Yes** when prompted to remove a business protocol.

The business protocol is removed and the Cooperations : *name* page appears.

Viewing a Document Protocol

Follow these instructions to view details about a specific document protocol:

To view a document protocol:

1. Ensure that you followed the instructions in "[Accessing Business Protocol Management Tasks](#)" on page 25-43 to access the page for viewing a document protocol.

The Document Protocol Details page appears.

Document Protocol Details : RosettaNet

Details

Description **RosettaNet Document Protocol**
 Revision **02.00**
 Namespace
 Is Validation Enabled **False**

Document Type

[Return to Top](#)
 Previous 1-5 of 5 Next

Name	Description
Exception	Exception Document type
Failure Notification	Notification of Failure Document Type
Purchase Order Confirmation	Purchase Order Confirmation Document Type
Receipt Acknowledgment	ReceiptAcknowledgment Document type
Request Purchase Order	Purchase Order Request Document Type

Parameters

[Return to Top](#)
 Previous 0-0 of 0 Next

Name	Description
(No Parameters found.)	

2. View specific details about the document types associated with the business protocol.

Viewing an Exchange Protocol

An exchange protocol defines the protocol by which data is exchanged, such as RosettaNet - 01.00 or RosettaNet - 02.00. Follow these instructions to view details about a specific exchange protocol:

To view an exchange protocol:

1. Ensure that you followed the instructions in "[Accessing Business Protocol Management Tasks](#)" on page 25-43 to access the page for viewing an exchange protocol.

The Exchange Protocol Details page appears. The upper section of the page displays the following details:

Exchange Protocol Details : RosettaNet

Details

Description	RosettaNet Implementation Framework 1.1
Implementation Class	oracle.tip.adapter.b2b.docexchange.mif11.DocumentExchangePlugin
Is Non-Repudiation of Origin Required	False
Is Non-Repudiation of Receipt Required	False
Number Of Retries	3
Time To Acknowledge	120
Namespace	
Packaging Protocol	RNIF1.1
Packaging Id	mif11Packaging

Business Signals

[Return to Top](#)

Name	Revision
General Exception	1.1
Receipt Acknowledgment	1.1
Receipt Acknowledgment Exception	1.1

Protocol Elements

[Return to Top](#)

Name	Can Be Encrypted	Datatype
Preamble	false	Preamble Header - RNIF 1.1
ServiceHeader	false	Service Header - RNIF 1.1

Supported Transport Protocols

[Return to Top](#)

Name	Description	Revision
HTTP	HTTP protocol as defined by W3C.	1.0
HTTP	SSL over HTTP protocol as defined by W3C.	1.0
HTTP	HTTP protocol as defined by W3C.	1.1
HTTP	SSL over HTTP protocol as defined by W3C.	1.1

The lower section of the page displays the following details:

Supported Security Specifications

[Return to Top](#)

Name	Protocol Name	Revision
SMIME 3.0 with SHA - RSA	SMIME	3.0
SMIME 3.0 with MD5 - RSA	SMIME	3.0
SMIME 2.0 with SHA - RSA	SMIME	2.0
SMIME 2.0 with MD5 - RSA	SMIME	2.0
SSL	SSL	3.0

Parameters

[Return to Top](#)

Name	Description
GlobalSupplyChainCode	Global Supply Chain Code
GlobalPartnerClassificationCode	Global Partner Classification Code

2. View specific details about the exchange protocol associated with the business protocol, including the following:
 - The **Business Signals** section shows the RosettaNet-defined exception messages and the RosettaNet-defined acknowledgment signals to exchange to confirm receipt of messages.
 - The **Protocol Elements** section shows the headers for this version of RNIF.
 - The **Supported Transport Protocols** section shows the supported transports for this version of RNIF.
 - The **Supported Security Specifications** section shows the supported signing and encryption features.
 - The **Parameters** section shows the supported parameters for this RNIF version.

Viewing a Business Protocol

Follow these instructions to view details about a specific business protocol:

To view a business protocol:

1. Ensure that you followed the instructions in "[Accessing Business Protocol Management Tasks](#)" on page 25-43 to access the page for viewing a business protocol.

The Business Protocol Details page appears.

Business Protocol Details : RosettaNet-RNIF2.0-PIP

Details

Document Protocol [RosettaNet - V02.00](#)
 Exchange Protocol [RosettaNet - V02.00](#)
 Process Protocol [PIP - 2.0](#)

2. View specific details about the three protocols that comprise the business protocol.

Viewing a Process Protocol

A process protocol defines the protocol used to exchange documents, such as through a RosettaNet PIP. Follow these instructions to view details about a specific process protocol:

To view a process protocol:

1. Ensure that you followed the instructions in "[Accessing Business Protocol Management Tasks](#)" on page 25-43 to access the page for viewing a process protocol.
2. Click the link to the right of **Process Protocol**. (See the lower page of [Figure 25-8](#) on page 25-42.)

The Process Protocol Details page appears.

Process Protocol Details : PIP

[Delete](#) [Update](#)

Details

Description **RosettaNet PIPS**
 Revision **2.0**
 Namespace

3. View specific details about the process protocol.

Managing Delivery and Security

The Oracle Application Server ProcessConnect user interface tool enables you to perform the delivery and security management tasks shown in [Figure 25–9](#). These tasks are described in detail in this section.

Figure 25–9 Delivery and Security Management Tasks

Delivery and Security : Remote_TP

Shortcut

[Create Protocol Endpoint](#)

Certificates				
Name	Certificate Location	Update	Delete	Create
CP1	file:/private/joe/c/certificate.txt			

Transports				
Name	Transport Mode	Update	Delete	Create
TP1	Sync			

Document Exchanges				
Name	Validation Enabled	Update	Delete	Create
DE1				

Delivery Channels				
Name	Transport	Document Exchange	Update	Delete
DC1				

This section describes the following delivery and security management tasks:

- [Managing Remote Trading Partner Certificates](#)
- [Managing Transports](#)
- [Managing Document Exchanges](#)
- [Managing Delivery Channels](#)

See Also:

- [Chapter 20, "Oracle Application Server ProcessConnect Security"](#) for an overview of Oracle Application Server ProcessConnect security features
- [Chapter 24, "RosettaNet B2B Protocol Standard"](#) for certificates, transports, document exchanges, and delivery channels details

Managing Remote Trading Partner Certificates

The Oracle Application Server ProcessConnect user interface tool enables you to perform the remote trading partner certificate management tasks shown in [Figure 25–10](#). These tasks are described in detail in this section. A certificate securely binds an identity such as a trading partner to a public key. A certificate is created when a trading partner's public key is signed by a trusted identity known as a certificate authority (CA). This certificate ensures that the trading partner's profile data is correct and that the public key actually belongs to that trading partner during business transactions.

Figure 25–10 Remote Trading Partner Certificate Management Tasks

Delivery and Security : Remote_TP

Shortcut

[Create Protocol Endpoint](#)

Certificates [Create](#)

Name	Certificate Location	Update	Delete
CP1	file:/private/joe/certificate.bt		

Transports [Return to Top](#) [Create](#)

Name	Transport Mode	Update	Delete
TP1	Sync		

Document Exchanges [Return to Top](#) [Create](#)

Name	Validation Enabled	Update	Delete
DE1			

Delivery Channels [Return to Top](#) [Create](#)

Name	Transport	Document Exchange	Update	Delete
DC1				

Note: The **Create** button in the **Certificates** section displays only for remote trading partners (that is, when you access this page by selecting **Profiles > Trading Partners > trading_partner_name > Delivery and Security**). If you select **Profiles > Host > Delivery and Security >**, you do not see a **Create** button. Host trading partners instead create a wallet password and specify a directory location through an alternative method.

See Also: ["Managing the Host Trading Partner Wallet Password"](#) on page 25-90 for details about wallet passwords and wallet directory locations for the host trading partner

[Table 25-10](#) identifies the remote trading partner certificate management tasks shown in [Figure 25-10](#) and provides references to procedures for performing these tasks.

Table 25-10 Remote Trading Partner Certificate Management Tasks

Page Elements	Management Task	First See Section...	Then See Section...
Create button in Certificates section of Figure 25-10	Create a remote trading partner certificate	"Accessing Remote Trading Partner Certificate Management Tasks" on page 25-52	"Creating a Remote Trading Partner Certificate" on page 25-53
Delete column in Certificates section of Figure 25-10	Delete a remote trading partner certificate		"Deleting a Remote Trading Partner Certificate" on page 25-54
Update column in Certificates section of Figure 25-10	Update a remote trading partner certificate		"Updating a Remote Trading Partner Certificate" on page 25-54
Name column in Certificates section of Figure 25-10	View a remote trading partner certificate		"Viewing a Remote Trading Partner Certificate" on page 25-55

See Also: ["Managing the Host Trading Partner Wallet Password"](#) on page 25-90 for instructions on creating a wallet password and wallet directory location for a host trading partner

Accessing Remote Trading Partner Certificate Management Tasks

Follow these instructions to access the remote trading partner certificate management tasks shown in [Figure 25-10](#) on page 25-51:

To access remote trading partner certificate management tasks:

1. Select the **Profiles** tab.
2. Select the **Trading Partners** tab.
3. Select a specific remote trading partner name in the **Name** column.
4. Select **Delivery and Security**.

The Delivery and Security : *name* page appears.

5. Go to the **Certificates** section. (See [Figure 25–10](#) on page 25-51.)
6. Select a task to perform and see the referenced section for instructions:

To...	Then...	See Section...
Create a remote trading partner certificate	Click Create .	" Creating a Remote Trading Partner Certificate " on page 25-53
Delete a remote trading partner certificate	Select a specific remote trading partner certificate in the Delete column.	" Deleting a Remote Trading Partner Certificate " on page 25-54
Update a remote trading partner certificate	Select a specific remote trading partner certificate in the Update column.	" Updating a Remote Trading Partner Certificate " on page 25-54
View details about a remote trading partner certificate	Select a specific remote trading partner certificate in the Name column.	" Viewing a Remote Trading Partner Certificate " on page 25-55

Creating a Remote Trading Partner Certificate

Follow these instructions to create a remote trading partner certificate:

To create a remote trading partner certificate:

1. Ensure that you followed the instructions in "[Accessing Remote Trading Partner Certificate Management Tasks](#)" on page 25-52 to access the page for creating a remote trading partner certificate.

The Create Certificate page appears.

2. Enter the following details to create a remote trading partner certificate. An asterisk (*) indicates a required field.

Field	Description
Name *	Enter a unique and recognizable name for the remote trading partner certificate.

Field	Description
Certificate Location	<p>Enter the remote trading partner certificate location directory path. This is typically a file or HTTP URL. Use the following conventions for specifying files and URLs:</p> <pre>file:/private/username/certificate.txt</pre> <pre>http://hostname:port/certificate.txt</pre> <p>You must enter details in this field to use a remote trading partner certificate.</p>

3. Click *Apply*.

The remote trading partner certificate is created and the Certificate Details page for the new remote trading partner certificate appears. You assign this remote trading partner certificate to a document exchange with the Oracle Application Server ProcessConnect user interface tool.

See Also: ["Creating a Document Exchange"](#) on page 25-67

Deleting a Remote Trading Partner Certificate

Follow these instructions to delete a remote trading partner certificate:

To delete a remote trading partner certificate:

1. Ensure that you followed the instructions in ["Accessing Remote Trading Partner Certificate Management Tasks"](#) on page 25-52 to access the page for deleting a remote trading partner certificate.
2. Click **Yes** when prompted to delete a remote trading partner certificate.

The remote trading partner certificate is deleted and the Delivery and Security : *name* page appears.

Updating a Remote Trading Partner Certificate

Follow these instructions to update a remote trading partner certificate:

To update a remote trading partner certificate:

1. Ensure that you followed the instructions in ["Accessing Remote Trading Partner Certificate Management Tasks"](#) on page 25-52 to access the page for updating a remote trading partner certificate.

The Update Certificate page appears.

2. Make appropriate changes. (See Step 2 of "[Creating a Remote Trading Partner Certificate](#)" on page 25-53 for a list of fields that you can update.)

3. Click **Apply**.

The certificate is updated and the Certificate Details page for the updated remote trading partner certificate appears.

Viewing a Remote Trading Partner Certificate

Follow these instructions to view details about a specific remote trading partner certificate:

To view a remote trading partner certificate:

1. Ensure that you followed the instructions in "[Accessing Remote Trading Partner Certificate Management Tasks](#)" on page 25-52 to access the page for viewing a remote trading partner certificate.

The Certificate Details page for the selected certificate appears.

Certificate Details : CP1

Delete Update

Details

Certificate Location `file://private/joe/certificate.txt`

2. View specific details.

This page, as with the Delivery and Security : *name* page shown in [Figure 25-10](#) on page 25-51, enables you to delete or update the selected certificate.

3. Click **Return to List** to return to the Delivery and Security : *name* page.

Managing Transports

The Oracle Application Server ProcessConnect user interface tool enables you to perform the transport management tasks shown in [Figure 25–11](#). These tasks are described in detail in this section. The transport defines the properties specific to a given usage of a protocol endpoint. The transport is responsible for message delivery using the selected transport protocol (such as HTTP 1.1) and protocol endpoint address. Endpoints are trading partner addresses (such as a URI). Protocol endpoints are a combination of an endpoint address (such as URI `http://server.partner.com:5555/submit/rnmsg`), a specific transport protocol (such as HTTP 1.1), and security (such as secure HTTP 1.1).

Figure 25–11 Transport Management Tasks

Delivery and Security : Remote_TP

Shortcut

[Create Protocol Endpoint](#)

Certificates [Return to Top](#) [Create](#)

Name	Certificate Location	Update	Delete
CP1	file:/private/joe/certificate.bt		

Transports [Return to Top](#) [Create](#)

Name	Transport Mode	Update	Delete
TP1	Sync		

Document Exchanges [Return to Top](#) [Create](#)

Name	Validation Enabled	Update	Delete
DE1			

Delivery Channels [Return to Top](#) [Create](#)

Name	Transport	Document Exchange	Update	Delete
DC1				

Transport Details : TP1 [Delete](#) [Update](#)

Details

Transport Mode

Transport Endpoints [Return to Top](#) [Create](#)

Only one transport endpoint can be defined. Creation of additional transport endpoints not allowed.

Transport	Protocol Endpoint	Details	Update	Delete
TP1	http://server.partner.com:5555/submit/rnmsg - HTTP - 1.1			

Table 25-11 identifies the transport management tasks shown in Figure 25-11 and provides references to procedures for performing these tasks.

Table 25-11 Transport Management Tasks

Page Elements	Management Task	First See Section...	Then See Section...
Shortcuts section of Figure 25-11	Take a shortcut to create a protocol endpoint	"Accessing Protocol Endpoint Management Tasks" on page 25-85	"Creating a Protocol Endpoint" on page 25-86
Create button in Transports section of Figure 25-11	Create a transport	"Accessing Transport Management Tasks" on page 25-57	"Creating a Transport" on page 25-59
Delete column in Transports section of Figure 25-11	Delete a transport		"Deleting a Transport" on page 25-60
Update column in Transports section of Figure 25-11	Update a transport		"Updating a Transport" on page 25-60
Name column in Transports section of Figure 25-11 (To access the Transport Details page shown in the lower page of Figure 25-11)	View a transport		"Viewing a Transport" on page 25-60
Delete column of Transport Details page of Figure 25-11	Delete a transport endpoint		"Deleting a Transport Endpoint" on page 25-61
Update column of Transport Details page of Figure 25-11	Update a transport endpoint		"Updating a Transport Endpoint" on page 25-61
Details column of Transport Details page of Figure 25-11	View a transport endpoint		"Viewing a Transport Endpoint" on page 25-62

Accessing Transport Management Tasks

Follow these instructions to access the transport management tasks shown in Figure 25-11 on page 25-56:

To access transport management tasks:

1. Select the **Profiles** tab.

- Perform the following steps based on the type of trading partner to manage.

For a...	Perform These Steps...
Remote trading partner	<ol style="list-style-type: none"> Select the Trading Partners tab. Select a specific trading partner in the Name column of the Trading Partners page.
Host trading partner	<ol style="list-style-type: none"> Select the Host tab.

- Select **Delivery and Security**.

The Delivery and Security : *name* page appears.

- Go to the **Transports** section. (See the upper part of [Figure 25-11](#) on page 25-56.)
- Select a task to perform and see the referenced section for instructions:

To...	Then...	See Section...
Create a transport	Click Create .	"Creating a Transport" on page 25-59
Delete a transport	Select a specific transport in the Delete column.	"Deleting a Transport" on page 25-60
Update a transport	Select a specific transport in the Update column.	"Updating a Transport" on page 25-60
View details about a transport	Select a specific transport in the Name column.	"Viewing a Transport" on page 25-60
Delete a transport endpoint	Select a specific transport in the Name column for which to delete a transport endpoint.	"Deleting a Transport Endpoint" on page 25-61
Update a transport endpoint	Select a specific transport in the Name column for which to update a transport endpoint.	"Updating a Transport Endpoint" on page 25-61
View a transport endpoint	Select a specific transport in the Name column for which to view a transport endpoint.	"Viewing a Transport Endpoint" on page 25-62

Creating a Transport

You can create a single transport. You must first create a protocol endpoint before you can create a transport. If you have not yet creating a protocol endpoint, the **Create** button in the **Transports** section is disabled. Follow these instructions to create a transport:

To create a transport:

1. Ensure that you followed the instructions in "[Accessing Transport Management Tasks](#)" on page 25-57 to access the page for creating a transport.

The Create Transport page appears.

2. Enter the following details to create a transport. An asterisk (*) indicates a required field.

Field	Description
Name *	Enter a unique and recognizable transport name.
Transport Mode	Select Sync only.

3. Go to the **Transport Endpoint** section.
4. Enter the following details to create a transport endpoint. An asterisk (*) indicates a required field.

Field	Description
Protocol Endpoint *	Select a protocol endpoint comprising a transport protocol and trading partner endpoint address. You created a protocol endpoint in " Creating a Protocol Endpoint " on page 25-86.
Transport Timeout	Enter the amount of time in minutes in which a transport must complete before timing out.
Client Authentication Enabled	Select Yes or No . If you select Yes , you need valid client credentials for a remote trading partner to access an endpoint. If you select Yes , the remote trading partner must select a certificate in Step 5 of the Create Protocol Endpoint page on page 25-87.
Base64 Encoding Enabled	Select Yes or No . Set this to Yes only for transports that do not support binary delivery.

5. Click **Apply**.

The transport is created and the Transport Details page for the new transport appears.

Deleting a Transport

Follow these instructions to delete a transport:

To delete a transport:

1. Ensure that you followed the instructions in "[Accessing Transport Management Tasks](#)" on page 25-57 to access the page for deleting a transport.
2. Click **Yes** when prompted to delete a transport.

The transport is deleted and the Delivery and Security : *name* page appears.

Updating a Transport

Follow these instructions to update a transport:

To update a transport:

1. Ensure that you followed the instructions in "[Accessing Transport Management Tasks](#)" on page 25-57 to access the page for updating a transport.

The Update Transport page appears.

2. Make appropriate changes. (See Step 4 of "[Creating a Transport](#)" on page 25-59 for a list of fields that you can update.)
3. Click **Apply**.

The transport is updated and the Transport Details page for the updated transport appears.

Viewing a Transport

Follow these instructions to view details about a specific transport:

To view a transport:

1. Ensure that you followed the instructions in "[Accessing Transport Management Tasks](#)" on page 25-57 to access the page for viewing a transport.

The Transport Details page for the selected transport appears, and displays the transport endpoints defined for this transport.

Transport Details : TP1

Delete Update

Details
Transport Mode

Transport Endpoints [Return to Top](#)

⚠ Only one transport endpoint can be defined. Creation of additional transport endpoints not allowed.

Create

Transport	Protocol Endpoint	Details	Update	Delete
TP1	http://server.partner.com:5555/submit/rnmsg - HTTP - 1.1			

2. View specific details.

This page, as with the Delivery and Security : *name* page shown in [Figure 25-11](#) on page 25-56, enables you to delete or update the selected transport.

3. Click **Return to List** to return to the Delivery and Security : *name* page.

Deleting a Transport Endpoint

Follow these instructions to delete a transport endpoint:

To delete a transport endpoint:

1. Ensure that you followed the instructions in "[Accessing Transport Management Tasks](#)" on page 25-57 to access the page for deleting a transport endpoint.

The Transport Details page appears.

2. Go to the **Transport Endpoints** section.
3. Select the transport endpoint to delete in the **Delete** column.
4. Click **Yes** when prompted to delete a transport endpoint.

The transport is deleted and the Transport Details page appears.

Updating a Transport Endpoint

Follow these instructions to update a transport endpoint:

To update a transport endpoint:

1. Ensure that you followed the instructions in "[Accessing Transport Management Tasks](#)" on page 25-57 to access the page for updating a transport endpoint.

The Transport Details page appears.

2. Go to the **Transport Endpoints** section.
3. Select the transport endpoint to update in the **Update** column.

The Update Transport Endpoint page appears.

4. Make appropriate changes. (See Step 4 of "[Creating a Transport](#)" on page 25-59 for a list of fields that you can update.)
5. Click **Apply**.

The transport endpoint is updated and the Transport Endpoint Details page for the updated transport endpoint appears.

Viewing a Transport Endpoint

Follow these instructions to view details about a specific transport endpoint:

To view a transport endpoint:

1. Ensure that you followed the instructions in "[Accessing Transport Management Tasks](#)" on page 25-57 to access the page for viewing a transport endpoint.

The Transport Details page appears.

2. Go to the **Transport Endpoints** section.
3. Select the transport endpoint to view in the **Details** column.

The Transport Endpoint Details page for the selected transport endpoint appears, and displays the transport endpoint defined for this transport.

[Transport Endpoint Details : www.myapp124abc.com - HTTP - 1.1](#)

Delete Update

Details

Protocol Endpoint [www.myapp124abc.com - HTTP - 1.1](#)
Transport Timeout
Client Authentication Enabled
Base64 Encoding Enabled

4. View specific details.

This page, as with the Transport Details page shown in the lower page of [Figure 25-11](#) on page 25-56, enables you to delete or update the selected transport endpoint.

5. Click **Return to List** to return to the Transport Details page.

Managing Document Exchanges

The Oracle Application Server ProcessConnect user interface tool enables you to perform the document exchange management tasks shown in [Figure 25–12](#) and [Figure 25–13](#). These tasks are described in detail in this section. The document exchange describes the supported exchange protocol (such as RosettaNet 1.1), certificate encryption and signing, digital envelopes and signatures, and RosettaNet validation support. The document exchange uses these capabilities to exchange messages with a trading partner.

Figure 25–12 Document Exchange Management Tasks (Part 1 of 2)

Delivery and Security : Remote_TP

Shortcut

[Create Protocol Endpoint](#)

Certificates [Return to Top](#) [Create](#)

Name	Certificate Location	Update	Delete
CP1	file:/private/joe/certificate.txt		

Transports [Return to Top](#) [Create](#)

Name	Transport Mode	Update	Delete
TP1	Sync		

Document Exchanges [Return to Top](#) [Create](#)

Name	Validation Enabled	Update	Delete
DE1			

Delivery Channels [Return to Top](#) [Create](#)

Name	Transport	Document Exchange	Update	Delete
DC1				

Selecting a document exchange in the **Name** column of the **Document Exchanges** section causes details pages such as that shown in **Figure 25-13** to appear.

Figure 25-13 Document Exchange Management Tasks (Part 2 of 2)

Document Exchange Details : DE1

Validate Delete Update

Details

Exchange Protocol [RosettaNet - V02_00](#)
 Encryption Credential [CP1](#)
 Signing Credential [CP1](#)
 Digital Envelope [SMIME 3.0 with DES](#)
 Digital Signature [SMIME 3.0 with SHA - DSA](#)
 Validation Enabled **True**

Exchange Protocol Override Elements

Name	Encryption Override Value	Update
ServiceHeader		

Exchange Protocol Parameters

Name	Default Value	Override Value	Update
GlobalSupplyChainCode	Information Technology		
GlobalPartnerClassificationCode	Carrier		

Delivery Channels

Create

Name	Transport	Document Exchange	Update	Delete
DC1		DE1		

Table 25-12 identifies the document exchange management tasks shown in Figure 25-12 and Figure 25-13 and provides references to procedures for performing these tasks.

Table 25-12 Document Exchange Management Tasks

Page Elements	Management Task	First See Section...	Then See Section...
Create button in Document Exchanges section of Figure 25-12	Create a document exchange	"Accessing Document Exchange Management Tasks" on page 25-66	"Creating a Document Exchange" on page 25-67
Delete column in Document Exchanges section of Figure 25-12	Delete a document exchange		"Deleting a Document Exchange" on page 25-69
Update column in Document Exchanges section of Figure 25-12	Update a document exchange		"Updating a Document Exchange" on page 25-69
Name column in Document Exchanges section of Figure 25-12 (To access the Document Exchange Details page shown in Figure 25-13)	View details about a document exchange		"Viewing a Document Exchange" on page 25-70
Update column in Exchange Protocol Override Elements section of Figure 25-13	Update exchange protocol override elements		"Updating Exchange Protocol Override Elements" on page 25-71
Update column in Exchange Protocol Parameters section of Figure 25-13	Update exchange protocol parameters		"Updating Exchange Protocol Parameters" on page 25-71

See Also: "Managing Delivery Channels" on page 25-73 for instructions on managing the delivery channel shown in the Document Exchange Details page of Figure 25-13 on page 25-64

Accessing Document Exchange Management Tasks

Follow these instructions to access the document exchange management tasks shown in [Figure 25–12](#) on page 25-63 and [Figure 25–13](#) on page 25-64:

To access document exchange management tasks:

1. Select the **Profiles** tab.
2. Perform the following steps based on the type of trading partner to manage.

For a...	Perform These Steps...
Remote trading partner	<ol style="list-style-type: none"> 1. Select the Trading Partners tab. 2. Select a specific trading partner in the Name column of the Trading Partners page.
Host trading partner	<ol style="list-style-type: none"> 1. Select the Host tab.

3. Select **Delivery and Security**.

The Delivery and Security : *name* page appears.

4. Go to the **Document Exchanges** section.
5. Select a task to perform and see the referenced section for instructions:

To...	Then...	See Section...
Create a document exchange	Click Create .	"Creating a Document Exchange" on page 25-67
Delete a document exchange	Select a specific document exchange in the Delete column.	"Deleting a Document Exchange" on page 25-69
Update a document exchange	Select a specific document exchange in the Update column.	"Updating a Document Exchange" on page 25-69
View details about a document exchange	Select a specific document exchange in the Name column.	"Viewing a Document Exchange" on page 25-70
Update exchange protocol override elements	Select a specific document exchange in the Name column for which to update exchange protocol override elements.	"Updating Exchange Protocol Override Elements" on page 25-71
Update exchange protocol parameters	Select a specific document exchange in the Name column for which to update document exchange protocol parameters.	"Updating Exchange Protocol Parameters" on page 25-71

Creating a Document Exchange

Follow these instructions to create a document exchange:

To create a document exchange:

1. Ensure that you followed the instructions in "[Accessing Document Exchange Management Tasks](#)" on page 25-66 to access the page for creating a document exchange.

The Create Document Exchange page appears. Some selections that you make on this page are related to selections that you must make on the Create Delivery Channel page in "[Creating a Delivery Channel](#)" on page 25-75. Those relationships are described in this table.

2. Enter the following details to create a document exchange. An asterisk (*) indicates a required field.

Field	Description
Name *	Enter a unique and recognizable name for the document exchange.
Exchange Protocol	Select RosettaNet - 01.10 or RosettaNet - V02.00 . Note: The exchange protocol you select must match with the one selected in " Adding a Business Protocol " on page 25-45.
Encryption Credential	Select Unspecified or a certificate created in " Creating a Remote Trading Partner Certificate " on page 25-53. Note: If you are using RNIF 1.1, do not select a credential. If you select an encryption credential, you must also select a digital envelope from the Digital Envelope list.
Signing Credential	Select Unspecified or a certificate created in " Creating a Remote Trading Partner Certificate " on page 25-53. Note: If you select a signing credential, you must also select a digital signature from the Digital Signature list.
Digital Envelope	Select Unspecified , SMIME 3.0 with DES , SMIME 2.0 with DES , SMIME 3.0 with 3DES , SMIME 2.0 with 3DES , SMIME 3.0 with RC2-40 , SMIME 2.0 with RC2-40 , SMIME 3.0 with RC2-64 , SMIME 2.0 with RC2-64 , SMIME 3.0 with RC2-128 , or SMIME 2.0 with RC2-128 as the valid digital envelope. Note: If you select Yes in the Encryption Enabled field in Step 2 of the Create Delivery Channel page on page 25-76, you must also select a digital envelope. If you are using RNIF 1.1, do not select an envelope. If you select a digital envelope, you must also select an encryption credential from the Encryption Credential list for the remote trading partner only.

Field	Description
Digital Signature	<p>Select Unspecified, SMIME 3.0 with SHA-RSA, SMIME 2.0 with SHA-RSA, SMIME 3.0 with SHA-DSA, SMIME 2.0 with SHA-DSA, SMIME 3.0 with MD5-RSA, or SMIME 2.0 with MD5-RSA as the valid digital signature.</p> <p>Note: If you select a digital signature, you must also select a signing credential for the remote trading partner only from the Signing Credential list. If you select Yes in either the Is Non-Repudiation of Origin Required or Is Non-Repudiation of Receipt Required list on the Create Delivery Channel page in Step 2 on page 25-76, you must also select a digital signature.</p>
Validation Enabled	Select Unspecified, No, or Yes . Selecting No disables RosettaNet Document validation.

3. Click **Apply**.

The document exchange is created and the Document Exchange Details page for the new document exchange appears.

See Also:

- ["Managing Remote Trading Partner Certificates"](#) on page 25-51
- ["RosettaNet Validation"](#) on page 24-11
- ["Oracle Application Server ProcessConnect Support for RosettaNet Validation"](#) on page 24-15

Deleting a Document Exchange

Follow these instructions to delete a document exchange:

To delete a document exchange:

1. Ensure that you followed the instructions in "[Accessing Document Exchange Management Tasks](#)" on page 25-66 to access the page for deleting a document exchange.
2. Click **Yes** when prompted to delete a document exchange.

The document exchange is deleted and the Delivery and Security : *name* page appears.

Updating a Document Exchange

Follow these instructions to update a document exchange:

To update a document exchange:

1. Ensure that you followed the instructions in "[Accessing Document Exchange Management Tasks](#)" on page 25-66 to access the page for updating a document exchange.

The Update Document Exchange page appears.

2. Make appropriate changes. (See Step 2 of "[Creating a Document Exchange](#)" on page 25-67 for a list of fields that you can update.)
3. Click **Apply**.

The document exchange is updated and the Document Exchange Details page for the updated document exchange appears.

Viewing a Document Exchange

Follow these instructions to view details about a specific document exchange:

To view a document exchange:

1. Ensure that you followed the instructions in "[Accessing Document Exchange Management Tasks](#)" on page 25-66 to access the page for viewing a document exchange.

The Document Exchange Details page for the selected document exchange appears.

Document Exchange Details : DE1

Validate Delete Update

Details

Exchange Protocol [RosettaNet - V02.00](#)
 Encryption Credential [CP1](#)
 Signing Credential [CP1](#)
 Digital Envelope [SMIME 3.0 with DES](#)
 Digital Signature [SMIME 3.0 with SHA - DSA](#)
 Validation Enabled **True**

Exchange Protocol Override Elements

Name	Encryption Override Value	Update
ServiceHeader		

Exchange Protocol Parameters

Name	Default Value	Override Value	Update
GlobalSupplyChainCode	Information Technology		
GlobalPartnerClassificationCode	Carrier		

Delivery Channels

Create

Name	Transport	Document Exchange	Update	Delete
DC1		DE1		

2. View specific details or manage exchange protocol settings or delivery channels. The delivery channels that use the specified document exchange are listed.

This page, as with the Delivery and Security : *name* page shown in the upper page of [Figure 25-12](#) on page 25-63, enables you to delete or update the selected document exchange.

3. Click **Return to List** to return to the Delivery and Security : *name* page.

See Also: "[Managing Delivery Channels](#)" on page 25-73 for instructions on managing delivery channels

Updating Exchange Protocol Override Elements

This section only appears if RosettaNet 2.0 is the exchange protocol being used. Follow these instructions to update exchange protocol override elements for service header encryption:

To update exchange protocol override elements:

1. Ensure that you followed the instructions in "[Accessing Document Exchange Management Tasks](#)" on page 25-66 to access the page for updating exchange protocol override elements.
2. Go to the **Exchange Protocol Override Elements** section.
3. Select a specific exchange protocol override element in the **Update** column. The **Update Protocol Encryption Override** page appears.
4. Select **Yes**, **No**, or **Unspecified** from the **Encryption Override Value** list.
5. Click **Apply**.

The exchange protocol override element is updated and the Document Exchange Details page displays your selection in the **Encryption Override Value** column.

Updating Exchange Protocol Parameters

An exchange protocol (for example, RosettaNet 2.0) includes its own set of parameters. Some parameters have default values. You can override these parameters so that they are applicable only to a specific trading partner. For example, RNIF 2.0 includes a parameter named **GlobalSupplyChainCode** that has a default value of **Information Technology**. You can override this setting with a value unique to a trading partner, such as **Electronic Components**.

Follow these instructions to update exchange protocol parameters:

To update exchange protocol parameters:

1. Ensure that you followed the instructions in "[Accessing Document Exchange Management Tasks](#)" on page 25-66 to access the page for updating exchange protocol parameters.
2. Go to the **Exchange Protocol Parameters** section.

3. Select a specific exchange protocol parameter in the **Update** column.
The Update Exchange Protocol Parameter Value page appears.
4. Enter a value in the **Override Value** column.
5. Click **Apply**.
The exchange protocol parameter is updated and the Document Exchange Details page for the updated exchange parameter appears.
6. If you want to return to the default value, perform the following steps:
 - a. Click **Update**.
 - b. Remove the value in the **Override Value** field.
 - c. Click **Apply**

Managing Delivery Channels

The Oracle Application Server ProcessConnect user interface tool enables you to perform the delivery channel management tasks shown in [Figure 25–14](#). These tasks are described in detail in this section. The delivery channel describes whether security characteristics such as nonrepudiation, response modes, and encryption are required. The delivery channel also identifies the transport (with its trading partner endpoint address and transport protocol) and document exchange (with its exchange protocol, such as RosettaNet 1.1), certificate encryption and signing details, digital envelop and signature details, and RosettaNet validation support details.

Figure 25–14 Delivery Channel Management Tasks

Delivery and Security : Remote_TP

Shortcut

[Create Protocol Endpoint](#)

Certificates [Return to Top](#) [Create](#)

Name	Certificate Location	Update	Delete
CP1	file:/private/joe/certificate.bt		

Transports [Return to Top](#) [Create](#)

Name	Transport Mode	Update	Delete
TP1	Sync		

Document Exchanges [Return to Top](#) [Create](#)

Name	Validation Enabled	Update	Delete
DE1			

Delivery Channels [Return to Top](#) [Create](#)

Name	Transport	Document Exchange	Update	Delete
DC1				

[Table 25-13](#) identifies the delivery channel management tasks shown in [Figure 25-14](#) and provides references to procedures for performing these tasks.

Table 25-13 Delivery Channel Management Tasks

Page Elements	Management Task	First See Section...	Then See Section...
Create button in Delivery Channels section of Figure 25-14	Create a delivery channel	"Accessing Delivery Channel Management Tasks" on page 25-74	"Creating a Delivery Channel" on page 25-75
Delete column in Delivery Channels section of Figure 25-14	Delete a delivery channel		"Deleting a Delivery Channel" on page 25-77
Update column in Delivery Channels section of Figure 25-14	Update a delivery channel		"Updating a Delivery Channel" on page 25-78
Name column in Delivery Channels section of Figure 25-14	View details about a delivery channel		"Viewing a Delivery Channel" on page 25-78

See Also: The following sections for instructions on creating components required by the delivery channel:

- ["Creating a Transport"](#) on page 25-59
- ["Creating a Document Exchange"](#) on page 25-67
- ["Viewing a Document Exchange"](#) on page 25-70 (this page is accessible from the **Document Exchange** column of the **Delivery Channels** section in [Figure 25-14](#) on page 25-73)

Accessing Delivery Channel Management Tasks

Follow these instructions to access the delivery channel management tasks shown in [Figure 25-14](#) on page 25-73:

To access delivery channel management tasks:

1. Select the **Profiles** tab.

2. Perform the following steps based on the type of trading partner to manage.

For a...	Perform These Steps...
Remote trading partner	<ol style="list-style-type: none"> 1. Select the Trading Partners tab. 2. Select a specific trading partner in the Name column of the Trading Partners page.
Host trading partner	<ol style="list-style-type: none"> 1. Select the Host tab.

3. Select **Delivery and Security**.

The Delivery and Security : *name* page appears.

4. Go to the **Delivery Channels** section.
5. Select a task to perform and see the referenced section for instructions:

To...	Then...	See Section...
Create a delivery channel	Click Create .	"Creating a Delivery Channel" on page 25-75
Delete a delivery channel	Select a specific delivery channel in the Delete column.	"Deleting a Delivery Channel" on page 25-77
Update a delivery channel	Select a specific delivery channel in the Update column.	"Updating a Delivery Channel" on page 25-78
View details about a delivery channel	Select a delivery channel in the Name column.	"Viewing a Delivery Channel" on page 25-78

Creating a Delivery Channel

Follow these instructions to create a delivery channel:

To create a delivery channel:

1. Ensure that you followed the instructions in ["Accessing Delivery Channel Management Tasks"](#) on page 25-74 to access the page for creating a delivery channel.

The Create Delivery Channel page appears. Some selections that you make on this page are related to selections that you must make on the Create Document Exchange page in ["Creating a Document Exchange"](#) on page 25-67. Those relationships are described in this section.

2. Enter the following details to create a delivery channel. An asterisk (*) indicates a required field.

Field	Description
Name *	Enter a unique and recognizable name for the delivery channel.
Document Exchange	Select a document exchange created in " Creating a Document Exchange " on page 25-67. The delivery channel requires one document exchange, which identifies the exchange protocol (for example, RosettaNet 1.1), certificate encryption and signing details, digital envelop and signature details, and RosettaNet validation support details.
Transport	Select a transport created in " Creating a Transport " on page 25-59. The delivery channel requires one transport, which identifies the transport protocol and trading partner endpoint address.
Acknowledgment Mode	Select Async only.
Global Usage Code	Select Test or Production . This specifies the usage of the delivery channel. If it is set to Test , then the delivery channel is used only for testing purposes. If it is set to Production , then it is used only for production purposes.
Is Non-Repudiation of Origin Required¹	Select No or Yes only. If Yes is selected, the action message must be digitally signed. Note: If you select Yes , you must also select a digital signature in the Digital Signature field in Step 2 of the Create Document Exchange page on page 25-67.
Is Non-Repudiation of Receipt Required¹	Select No or Yes only. If Yes is selected, the acknowledgment must be digitally signed. Note: If you select Yes , you must also select a digital signature in the Digital Signature field in Step 2 of the Create Document Exchange page on page 25-67.
Encryption Enabled¹	Select No or Yes only. Note: If you are using RNIF 1.1, do not make a selection. If you select Yes , you must also select a digital envelope in the Digital Envelope field in Step 2 of the Create Document Exchange page on page 25-67.

Field	Description
Transport Security Enabled	Select No , Yes , or Unspecified .
Time to Acknowledgment	Enter a value in minutes. This value specifies the time in which an acknowledgment message must be received. If an acknowledgment is not received, an error message is returned.
Retry Count	Enter a value. This value specifies the amount of time to wait before retrying.

¹ You must select either **Yes** or **No** if you want to include these delivery channel details in a trading partner agreement of a deployed configuration. If you instead select **Unspecified**, validation of the configuration fails.

3. Click **Apply**.

The delivery channel is created and the Delivery Channel Details page for the new delivery channel appears.

See Also: [Chapter 24, "RosettaNet B2B Protocol Standard"](#) for descriptions of the types of details you defined in Step 2 on page 25-76

Deleting a Delivery Channel

Follow these instructions to delete a delivery channel:

To delete a delivery channel:

1. Ensure that you followed the instructions in "[Accessing Delivery Channel Management Tasks](#)" on page 25-74 to access the page for deleting a delivery channel.
2. Click **Yes** when prompted to delete a delivery channel.

The delivery channel is deleted and the Delivery and Security : *name* page appears.

Updating a Delivery Channel

Follow these instructions to update a delivery channel:

To update a delivery channel:

1. Ensure that you followed the instructions in "[Accessing Delivery Channel Management Tasks](#)" on page 25-74 to access the page for updating a delivery channel.

The Update Delivery Channel page appears.

2. Make appropriate changes. (See Step 2 of "[Creating a Delivery Channel](#)" on page 25-75 for a list of fields that you can update.)
3. Click **Apply**.

The delivery channel is updated and the Delivery Channel Details page for the updated delivery channel appears.

Viewing a Delivery Channel

Follow these instructions to view details about a specific delivery channel:

To view a delivery channel:

1. Ensure that you followed the instructions in "[Accessing Delivery Channel Management Tasks](#)" on page 25-74 to access the page for viewing a delivery channel.

The Delivery Channel Details page for the selected delivery channel appears.

Delivery Channel Details : DC1

Delete Update

Details

Name	DC1
Document Exchange	DE1
Transport	TP1
Acknowledgement Mode	Async
Global Usage Code	
Is Non-Repudiation of Receipt Required	True
Is Non-Repudiation of Origin Required	True
Encryption Enabled	False
Transport Security Enabled	True
Time To Acknowledgement	
Retry Count	

2. View specific details.

This page, as with the Delivery and Security : *name* page shown in [Figure 25-14](#) on page 25-73, enables you to delete or update the selected delivery channel.

3. Click **Return to List** to return to the Delivery and Security : *name* page.

Managing Endpoints

The Oracle Application Server ProcessConnect user interface tool enables you to perform the endpoint management tasks shown in [Figure 25–15](#). These tasks are described in detail in this section.

Figure 25–15 *Endpoint Management Tasks*

Endpoints : ipdev

Protocol Endpoints

Endpoint	Transport Protocol	Details	Update	Delete
http://server.partner.com:5555/submit/rnmsg	HTTP - 1.1			

Endpoints

Endpoints are global to all trading partners

[Return to Top](#)

URI	Update	Delete
http://server.partner.com:5555/submit/rnmsg		

This section describes the following endpoint management tasks:

- [Managing Endpoints](#)
- [Managing Protocol Endpoints](#)

Endpoints are trading partner addresses (a combination of the trading partner server, port, and any additional parameters required to send and receive messages) that are global to all trading partners. Protocol endpoint addresses apply only to a specific trading partner. Protocol endpoints are a combination of a specific endpoint address (such as `http://server.partner.com:5555/submit/rnmsg`), a specific transport protocol (such as HTTP 1.1), and security (such as secure HTTP 1.1). You can create an endpoint during creation of a protocol endpoint. You can then create and assign a protocol endpoint to a transport. The transport can then be assigned to a delivery channel.

See Also: ["Creating a Transport"](#) on page 25-59

Managing Endpoints

The Oracle Application Server ProcessConnect user interface tool enables you to perform the endpoint management tasks shown in [Figure 25–16](#). These tasks are described in detail in this section.

Figure 25–16 *Endpoint Management Tasks*

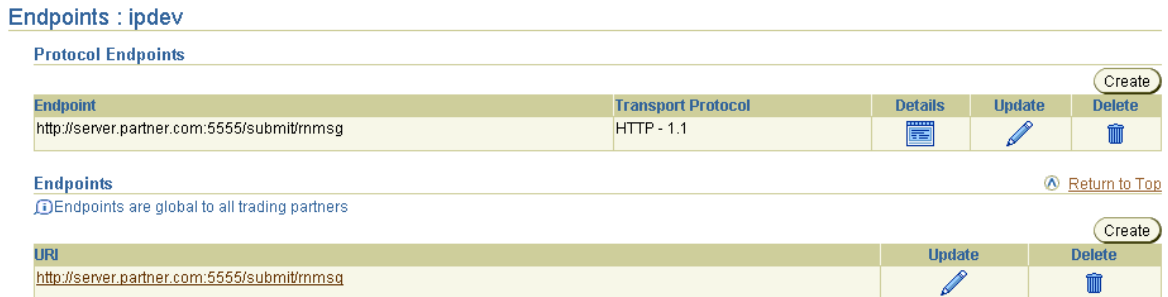

[Table 25–14](#) identifies the endpoint management tasks shown in [Figure 25–16](#) and provides references to procedures for performing these tasks.

Table 25–14 *Endpoint Management Tasks*

Page Elements	Management Task	First See Section...	Then See Section...
Create button in Endpoints section of Figure 25–16	Create an endpoint	"Accessing Endpoint Management Tasks" on page 25-81	"Creating an Endpoint" on page 25-82
Delete column in Endpoints section of Figure 25–16	Delete an endpoint		"Deleting an Endpoint" on page 25-82
Update column in Endpoints section of Figure 25–16	Update an endpoint		"Updating an Endpoint" on page 25-83
URI column in Endpoints section of Figure 25–16	View details about an endpoint		"Viewing an Endpoint" on page 25-83

See Also: ["Managing Endpoints"](#) on page 25-79 for details on the differences between endpoints and protocol endpoints

Accessing Endpoint Management Tasks

Follow these instructions to access the endpoint management tasks shown in [Figure 25-16](#) on page 25-80:

To access endpoint management tasks:

1. Select the **Profiles** tab.
2. Perform the following steps based on the type of trading partner to manage.

For a...	Perform These Steps...
Remote trading partner	<ol style="list-style-type: none"> 1. Select the Trading Partners tab. 2. Select a specific trading partner in the Name column of the Trading Partners page.
Host trading partner	<ol style="list-style-type: none"> 1. Select the Host tab.

3. Select **Endpoints**.

The Endpoints : *name* page appears.

4. Go to the **Endpoints** section.
5. Select a task to perform and see the referenced section for instructions:

To...	Then...	See Section...
Create an endpoint	Click Create .	"Creating an Endpoint" on page 25-82
Delete an endpoint	Select a specific endpoint in the Delete column.	"Deleting an Endpoint" on page 25-82
Update an endpoint	Select a specific endpoint in the Update column.	"Updating an Endpoint" on page 25-83
View details about an endpoint	Select a specific endpoint in the URI column.	"Viewing an Endpoint" on page 25-83

Creating an Endpoint

Follow these instructions to create an endpoint:

To create an endpoint:

1. Ensure that you followed the instructions in "[Accessing Endpoint Management Tasks](#)" on page 25-81 to access the page for creating an endpoint.

The Create Endpoint page appears.

2. Enter the following details to create an endpoint. An asterisk (*) indicates a required field.

Field	Description
URI *	Enter an endpoint address where a trading partner can send and receive messages. An endpoint address is a combination of the trading partner server, port, and any additional parameters required to send and receive messages (for example, <code>http://server.partner.com:5555/submit/rnmsg</code>).
Description	Provide an optional description.

3. Click **Apply**.

The endpoint is created and the Endpoint Details page for the new endpoint appears.

Deleting an Endpoint

Follow these instructions to delete an endpoint:

To delete an endpoint:

1. Ensure that you followed the instructions in "[Accessing Endpoint Management Tasks](#)" on page 25-81 to access the page for deleting an endpoint.
2. Click **Yes** when prompted to delete an endpoint.

The endpoint is deleted and the Endpoints : *name* page appears.

Updating an Endpoint

Follow these instructions to update an endpoint:

To update an endpoint:

1. Ensure that you followed the instructions in "[Accessing Endpoint Management Tasks](#)" on page 25-81 to access the page for updating an endpoint.

The Update Endpoint page appears.

2. Make appropriate changes. (See Step 2 of "[Creating an Endpoint](#)" on page 25-82 for a list of fields that you can update.)

3. Click **Apply**.

The endpoint is updated and the Endpoint Details page for the updated endpoint appears.

Viewing an Endpoint

Follow these instructions to view details about a specific endpoint:

To view an endpoint:

1. Ensure that you followed the instructions in "[Accessing Endpoint Management Tasks](#)" on page 25-81 to access the page for viewing an endpoint.

The Endpoint Details page for the selected endpoint appears and displays the protocol endpoints that use the specified endpoint.

Endpoint Details : <http://server.partner.com:5555/submit/rnmsg>

[Delete](#) [Update](#)

Details

Description

State **Draft**

Protocol Endpoints

[Return to Top](#)

[Create](#)

Endpoint	Transport Protocol	Details	Update	Delete
http://server.partner.com:5555/submit/rnmsg	HTTP - 1.1			

2. View specific details.

This page, as with the Endpoints : *name* page shown in [Figure 25-16](#) on page 25-80, enables you to delete or update the selected endpoint.

3. Click **Return to List** to return to the Endpoints : *name* page.

Managing Protocol Endpoints

The Oracle Application Server ProcessConnect user interface tool enables you to perform the protocol endpoint management tasks shown in [Figure 25-17](#). These tasks are described in detail in this section.

Figure 25-17 Protocol Endpoint Management Tasks

Endpoints : ipdev

Protocol Endpoints

Create

Endpoint	Transport Protocol	Details	Update	Delete
http://server.partner.com:5555/submit/rnmsg	HTTP - 1.1			

Endpoints

[Return to Top](#)

Endpoints are global to all trading partners

Create

URI	Update	Delete
http://server.partner.com:5555/submit/rnmsg		

Table 25-15 identifies the protocol endpoint management tasks shown in Figure 25-17 and provides references to procedures for performing these tasks.

Table 25-15 Protocol Endpoint Management Tasks

Page Elements	Management Task	First See Section...	Then See Section...
Create button in Protocol Endpoints section of Figure 25-17	Create a protocol endpoint	"Accessing Protocol Endpoint Management Tasks" on page 25-85	"Creating a Protocol Endpoint" on page 25-86
Delete column in Protocol Endpoints section of Figure 25-17	Delete a protocol endpoint		"Deleting a Protocol Endpoint" on page 25-88
Update column in Protocol Endpoints section of Figure 25-17	Update a protocol endpoint		"Updating a Protocol Endpoint" on page 25-88
Details column in Protocol Endpoints section of Figure 25-17	View details about a protocol endpoint		"Viewing a Protocol Endpoint" on page 25-89

See Also: "Managing Endpoints" on page 25-79 for details on the differences between protocol endpoints and endpoints

Accessing Protocol Endpoint Management Tasks

Follow these instructions to access the protocol endpoint management tasks shown in Figure 25-17 on page 25-84:

To access endpoint management tasks:

1. Select the **Profiles** tab.
2. Perform the following steps based on the type of trading partner to manage.

For a...	Perform These Steps...
Remote trading partner	<ol style="list-style-type: none"> 1. Select the Trading Partners tab. 2. Select a specific trading partner in the Name column of the Trading Partners page.
Host trading partner	<ol style="list-style-type: none"> 1. Select the Host tab.

3. Select **Endpoints**.

The Endpoints : *name* page appears.

4. Go to the **Protocol Endpoints** section. (See [Figure 25-17](#) on page 25-84.)

5. Select a task to perform and see the referenced section for instructions:

To...	Then...	See Section...
Create a protocol endpoint	Click Create .	"Creating a Protocol Endpoint" on page 25-86
Delete a protocol endpoint	Select a specific protocol endpoint in the Delete column.	"Deleting a Protocol Endpoint" on page 25-88
Update a protocol endpoint	Select a specific protocol endpoint in the Update column.	"Updating a Protocol Endpoint" on page 25-88
View details about a protocol endpoint	Select a specific protocol endpoint in the Details column.	"Viewing a Protocol Endpoint" on page 25-89

Creating a Protocol Endpoint

Follow these instructions to create a protocol endpoint:

To create a protocol endpoint:

1. Ensure that you followed the instructions in ["Accessing Protocol Endpoint Management Tasks"](#) on page 25-85 to access the page for creating a protocol endpoint.

The Create Protocol Endpoint page appears.

2. Select a transport protocol from the **Transport Protocol** list. If you are the host trading partner, do not select **HTTP 1.1 (Secure)** or **HTTP 1.0 (Secure)**.

Based on your selection, the page may refresh to display additional fields in which to enter details.

- See the following step based on the transport protocol selected in Step 2.

If You Selected...	Go to...
<ul style="list-style-type: none"> ▪ HTTP 1.1 (Secure) ▪ HTTP 1.0 (Secure) 	Step 4.
<ul style="list-style-type: none"> ▪ HTTP 1.1 ▪ HTTP 1.0 ▪ Unspecified 	Step 6.

- Select **SSL - 3.0** from the **Security Specification** list.
- If you are creating a protocol endpoint for a remote trading partner, select a certificate from the **Certificate** list. This is the certificate that you created in "[Creating a Remote Trading Partner Certificate](#)" on page 25-53. If you enabled host client authentication by selecting **Yes** in the **Client Authentication Enabled** list of Step 4 of the Create Transport page on page 25-59, select a certificate.
- Go to the **Endpoint** section.
- Select an endpoint to use from the **Endpoint** list.
- See the following step based on the endpoint selected in Step 7.

If You Selected...	Go to...
Create New	Step 9
Use Existing	Step 11

- Enter the following details to create an endpoint. An asterisk (*) indicates a required field.

Field	Description
URI *	Enter an endpoint address where a trading partner can send and receive messages. An example is a Web page address, such as <code>http://server.partner.com:5555/submit/rnmsg</code> .
Description	Provide an optional description.

10. Go to Step 12.
11. Select an existing endpoint from the **Name** list.
12. Click **Apply**.

The endpoint is created and the Protocol Endpoint Details page for the new protocol endpoint appears.

Deleting a Protocol Endpoint

Follow these instructions to delete a protocol endpoint:

To delete a protocol endpoint:

1. Ensure that you followed the instructions in "[Accessing Protocol Endpoint Management Tasks](#)" on page 25-85 to access the page for deleting a protocol endpoint.
2. Click **Yes** when prompted to delete a protocol endpoint.

The protocol endpoint is deleted and the Endpoints : *name* page appears.

Updating a Protocol Endpoint

Follow these instructions to update a protocol endpoint:

To update a protocol endpoint:

1. Ensure that you followed the instructions in "[Accessing Protocol Endpoint Management Tasks](#)" on page 25-85 to access the page for updating a protocol endpoint.

The Update Protocol Endpoint page appears.

2. Make appropriate changes. (See "[Creating a Protocol Endpoint](#)" on page 25-86 for a list of fields that you can update.)
3. Click **Apply**.

The protocol endpoint is updated and the Protocol Endpoint Details page for the updated protocol endpoint appears.

Viewing a Protocol Endpoint

Follow these instructions to view details about a specific protocol endpoint:

To view a protocol endpoint:

1. Ensure that you followed the instructions in "[Accessing Protocol Endpoint Management Tasks](#)" on page 25-85 to access the page for viewing a protocol endpoint.

The Protocol Endpoint Details page for the selected protocol endpoint appears, and displays the transport endpoints that use the specified protocol endpoint.

Protocol Endpoint Details : <http://server.partner.com:5555/submit/rnmsg> - HTTP - 1.1

Details		Delete	Update	Shortcut
Endpoint	http://server.partner.com:5555/submit/rnmsg	Create Transport		
Transport Protocol	HTTP - 1.1			

2. View specific details or click **Create Transport** in the **Shortcuts** section to create a transport to which you assign this protocol endpoint.

This page, as with the Endpoints : *name* page shown in [Figure 25-17](#) on page 25-84, enables you to delete or update the selected protocol endpoint.

3. Click **Return to List** to return to the Endpoints : *name* page.

Managing the Host Trading Partner Wallet Password

The Oracle Application Server ProcessConnect user interface tool enables you to perform the host trading partner wallet password management tasks shown in [Figure 25–18](#). These tasks are described in detail in this section. A wallet is a container in which certificates and trusted certificates are stored and managed. These data structures securely store a user private key, a user certificate, and a set of trusted certificates. A wallet password opens the user's wallet.

Figure 25–18 Host Trading Partner Wallet Password Management Tasks



[Table 25–16](#) identifies the host trading partner wallet password management tasks shown in [Figure 25–18](#) and provides references to procedures for performing these tasks.

Table 25–16 Host Trading Partner Wallet Password Management Tasks

Page Elements	Management Task	See Section...
Create button	Create a wallet password	"Creating a Host Trading Partner Wallet Password" on page 25-91
Update button	Update a wallet password	"Updating a Host Trading Partner Wallet Password" on page 25-92

Creating a Host Trading Partner Wallet Password

You must first create an initial wallet password when you create the Oracle Wallet with Oracle Wallet Manager. After that, you can create a host trading partner wallet password on this page in the Oracle Application Server ProcessConnect user interface tool. Follow these instructions to create a host trading partner wallet password:

To create a host trading partner wallet password:

1. Select the **Profiles** tab.
2. Select the **Host** tab.

The Host - *name* page appears, where *name* is the trading partner organization in which Oracle Application Server ProcessConnect is installed. (See [Figure 25–18](#) on page 25-90.)

3. Click **Create** to the right of **Wallet Password** in the **Details** section.

The Create Host Wallet Password page appears.

4. Enter the following details to create trading partner identification. An asterisk (*) indicates a required field.

Field	Description
New Wallet Password	Enter the same wallet password that you created in Oracle Wallet Manager.
Confirm Wallet Password	Enter the same wallet password a second time.

5. Click **Apply**. The password is stored in encrypted format. You can specify the directory for the wallet location with the Oracle Application Server ProcessConnect **Wallet Location** configuration parameter.

The **Create** button to the right of **Wallet Password** in the **Details** section now always displays as the **Update** button.

See Also: "[Oracle Enterprise Manager Application Server Control Tasks](#)" on page 18-4 for instructions on accessing the **Server Properties** page of Oracle Enterprise Manager to specify the wallet directory location with the **Wallet Password** parameter

Updating a Host Trading Partner Wallet Password

If you later update the wallet password in Oracle Wallet Manager, you must also update the password with the same value in the Oracle Application Server ProcessConnect user interface tool. Follow these instructions to update a host trading partner wallet password:

Note: You cannot update the wallet password in the Oracle Application Server ProcessConnect user interface tool without first updating it in Oracle Wallet Manager.

To update a host trading partner wallet password:

1. Select the **Profiles** tab.
2. Select the **Host** tab.

The Host - *name* page appears, where *name* is the trading partner organization hosting Oracle Application Server ProcessConnect. (See [Figure 25-18](#) on page 25-90.)

3. Click **Update** to the right of **Wallet Password** in the **Details** section.

The Update Host Wallet Password page appears.

4. Make appropriate changes. (See Step 4 of "[Creating a Host Trading Partner Wallet Password](#)" on page 25-91 for a list of fields that you can update.) Ensure that the password matches the one you specified in Oracle Wallet Manager.
5. Click **Apply**.

The host trading partner wallet password is updated and the Host - *name* page appears.

Managing Host and Remote Trading Partner Profile Data Validation and Approval

After completing the tasks described previously in this chapter, the profile data of host and remote trading partners (trading partner identifications, organization, cooperation, delivery, security, and endpoint details) must be validated and approved before it can be included in a deployed configuration. Approval typically involves assigning persons to approve the profile data, exporting the profile data to XML files, and submitting the files to the assigned approvers for review and eventual approval. The validation and approval tasks are performed from **Validation**, **Send for Approval**, **Export**, and **Approve** buttons that display at various stages in the top right sections of the following pages:

- The Host - *name* page shown in [Figure 25-1](#) on page 25-4
- The Trading Partner Details page shown in [Figure 25-2](#) on page 25-5

[Table 25-17](#) identifies the host and remote trading partner validation and approval tasks and provides references to procedures for performing these tasks. All tasks with the exception of Task 4 are performed with the Oracle Application Server ProcessConnect user interface tool.

Table 25-17 *Host and Remote Trading Partner Validation and Approval Tasks*

Task	See Section...
1. Validate the host and remote trading partner profile data	"Validated State for Modeling Metadata and Profile Data" on page 5-19
2. Select persons to approve the host and remote trading partner profile data	"Pending Approval State for Profile Data" on page 5-20
3. Export the host and remote trading partner profile data to XML files	"Exporting Profile Data to an XML File" on page 5-15
4. Send the XML files to persons for approval	
5. Specify a date by which by which persons must complete their approval or disapproval of the host and remote trading partner profile data	"Update the Approver" on page 5-22
6. Officially approve the host and remote trading partner profile data	"Approval State for Profile Data" on page 5-22

Chapter Summary

This chapter describes the identification, organization, cooperation, delivery, security, and endpoint tasks for managing host and remote trading partners. The host trading partner uses the user interface tool to define the capabilities for both host and remote trading partners.

Managing Trading Partners and Trading Partners Agreements

This chapter describes the trading partner and trading partner agreement tasks required to design an integration between enterprises.

This chapter contains these topics:

- [Trading Partner Agreement Overview](#)
- [Managing Remote Trading Partners](#)
- [Managing Trading Partner Agreements](#)
- [Managing Trading Partner Agreement Participants](#)
- [Managing Native Roles in Trading Partner Agreements](#)
- [Managing Trading Partner and Agreement Validation and Approval](#)
- [Common User Errors](#)
- [Chapter Summary](#)

See Also:

- [Chapter 25, "Managing Host and Remote Trading Partner Capabilities"](#) for instructions on defining host and remote trading partner capabilities
- ["Viewing the State of Modeling Metadata and Profile Data on the Details Page"](#) on page 5-17 for details on the **Draft**, **Validate**, **Pending Approval**, and **Approved** states that display on trading partner and trading partner agreement details pages

Trading Partner Agreement Overview

The Oracle Application Server ProcessConnect user interface tool enables you to perform the trading partner and trading partner agreement management tasks required for integrations between enterprises. These tasks consist of creating, adding, viewing, updating, removing, and deleting profile data. A minimum of two agreement types must be defined for the host trading partner to conduct business:

- [Trading Partner Agreement](#)
- [Application Agreement](#)

If you have more than two trading partners, additional agreements can also be defined.

See Also:

- [Chapter 9, "Creating Metadata with the Modeling Wizards"](#) through [Chapter 13, "Managing Transformations"](#) for designing modeling metadata (including native roles)
- [Chapter 15, "Managing Applications and Application Agreements"](#)

Trading Partner Agreement

Table 26–1 describes the profile data shown in Figure 26–1 and provides references for more details. You must perform these tasks to define the trading partners and trading partner agreement of an integration.

Figure 26–1 Trading Partner and Trading Partner Agreement Management Tasks

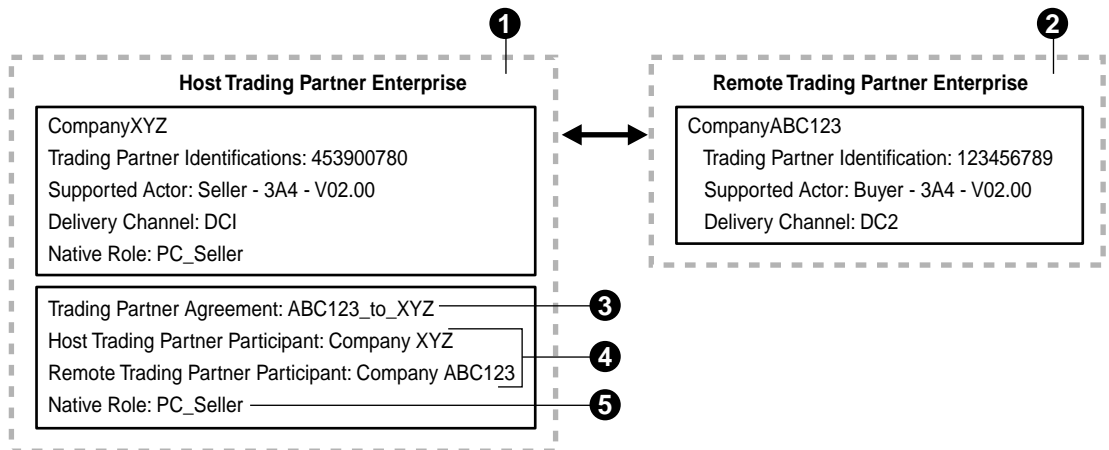

Table 26–1 Trading Partner and Trading Partner Agreement Management Tasks

Key	Component	Description	See Section...
1	Host trading partner	The company in which Oracle Application Server ProcessConnect is installed (for example, CompanyXYZ). As the host trading partner, you must define your company's trading partner identification, organization, cooperation, delivery, security, and endpoint capabilities.	Chapter 25, "Managing Host and Remote Trading Partner Capabilities"
2	Remote trading partner	The company with which the host trading partner wants to conduct business (for example, CompanyABC123). The remote trading partner does not require access to the Oracle Application Server ProcessConnect user interface tool. Instead, the host trading partner consults with the remote trading partner to obtain the necessary details and defines their identification, organization, cooperation, delivery, security, and endpoint capabilities.	" Creating Remote Trading Partner Identification " on page 26-12 Chapter 25, "Managing Host and Remote Trading Partner Capabilities"

Table 26–1 (Cont.) Trading Partner and Trading Partner Agreement Management Tasks

Key	Component	Description	See Section...
3	Trading partner agreement	The host trading partner creates a trading partner agreement (for example, trading partner agreement ABC123_to_XYZ).	"Managing Trading Partner Agreements" on page 26-14
4	Trading partner agreement participants	The host trading partner assigns both itself and the remote trading partner as participants to a trading partner agreement (for example, it assigns host trading partner CompanyXYZ and remote trading partner CompanyABC123 to trading partner agreement ABC123_to_XYZ).	"Managing Trading Partner Agreement Participants" on page 26-20
5	Trading partner agreement native role	The host trading partner assigns their own native role to the trading partner agreement (for example, it assigns native role PC_Seller to trading partner agreement ABC123_to_XYZ). The native role implements the host trading partner's behavior.	"Managing Native Roles in Trading Partner Agreements" on page 26-30

After you create your trading partners and trading partner agreement, you validate and officially approve them before including them in a deployed configuration.

See Also:

- ["Managing Trading Partner and Agreement Validation and Approval"](#) on page 26-33 for details on validating and approving trading partners and trading partner agreements
- ["Trading Partners"](#) on page 3-56 for conceptual details
- ["Agreements"](#) on page 3-57 for conceptual details
- ["What Is a Trading Partner Agreement?"](#) on page 24-16 for conceptual details

Application Agreement

You must also create an application agreement between the host trading partner (CompanyXYZ) and its host back-end application (Back_application_1), as shown in [Figure 26-2](#).

Figure 26-2 Application and Application Agreement Management Tasks

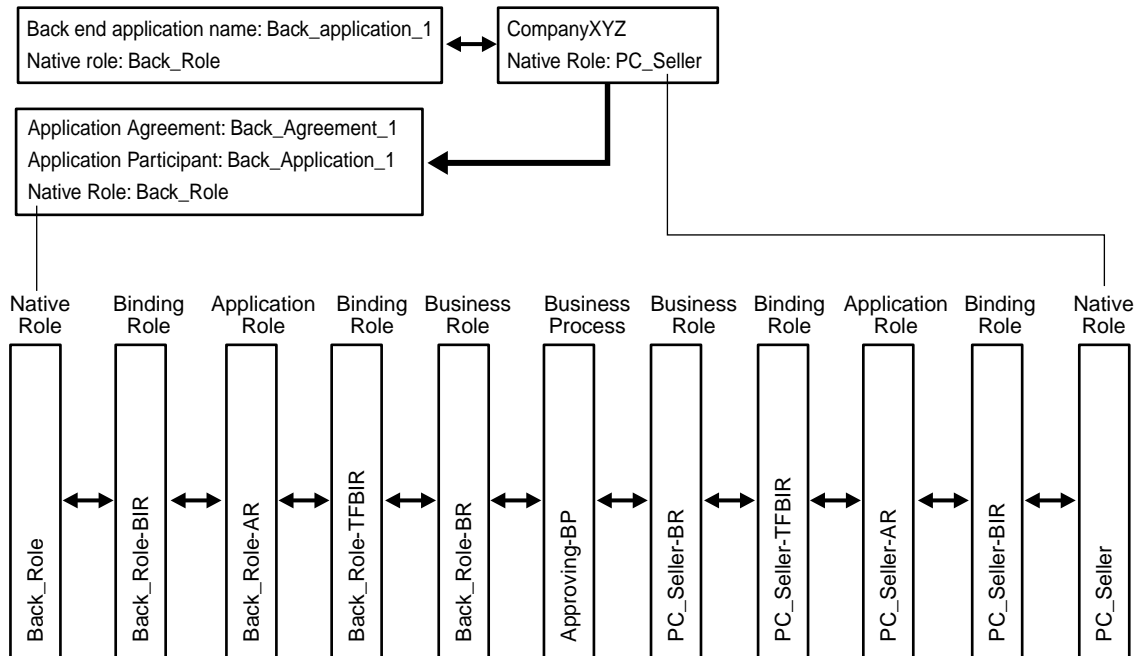

When complete, you have two agreements for an integration between enterprises:

- One trading partner agreement (ABC123_to_XYZ) between the host (CompanyXYZ) and remote (CompanyABC123) trading partners and the native role (PC_Seller) of the host trading partner (CompanyXYZ), as shown in [Figure 26-1](#) on page 26-3
- One application agreement (Back_Agreement_1) that defines the back-end application (Back_application_1) and its native role (for example, Back_Role), as shown in [Figure 26-2](#) on page 26-5

Managing Remote Trading Partners

The Oracle Application Server ProcessConnect user interface tool enables you to perform the remote trading partner management tasks shown in Figure 26–3. The remote trading partner is the party outside of the enterprise of the host trading partner (and its installation of Oracle Application Server ProcessConnect). These tasks are described in detail in this section.

Figure 26–3 Remote Trading Partner Management Tasks

Logged in as ip

Trading Partners

Create

Name	Update	Delete
CompanyABC123		
CompanyXYZ		

Shortcut
[Create Trading Partner Agreement](#)

Logged in as ip

[Organization](#)
[Cooperations](#)
[Delivery and Security](#)
[Endpoints](#)

[Trading Partner Identifications](#)
[Approvers](#)
[Associated Agreements](#)

Trading Partner Details : CompanyABC123

Validate
Export
Delete
Update

Details

Description

State **Draft**

Trading Partner Identifications

Return to Top
Create

Trading Partner Identification Type	Value	Details	Update	Delete
DUNS	123456789			

Approvers

Return to Top
Add

There are no persons available or no additional persons available for approval.

Person	Send For Approval Date	Approval Date	Update	Delete
(No approvers found.)				

Associated Agreements

Return to Top

Name	State	Update	Delete
CompanyABC123_CompanyXYZ	Draft		

Table 26-2 identifies the remote trading partner management tasks shown in Figure 26-3 and provides references to procedures for performing these tasks.

Table 26-2 Remote Trading Partner Management Tasks

Page Elements	Management Task	First See Section...	Then See Section...
Shortcuts section in Trading Partners page of Figure 26-3	Take a shortcut to create a remote trading partner agreement	"Accessing Trading Partner Agreement Management Tasks" on page 26-15	"Creating a Trading Partner Agreement" on page 26-15
Create button of Trading Partners page of Figure 26-3	Create a remote trading partner	"Accessing Remote Trading Partner Management Tasks" on page 26-8	"Creating a Remote Trading Partner" on page 26-9
Delete column of Trading Partners page of Figure 26-3	Delete a remote trading partner		"Deleting a Remote Trading Partner" on page 26-10
Update column of Trading Partners page of Figure 26-3	Update a remote trading partner		"Updating a Remote Trading Partner" on page 26-10
Name column of Trading Partners page of Figure 26-3 (To access the Trading Partner Details page shown in the lower page of Figure 26-3)	View details about a remote trading partner		"Viewing a Remote Trading Partner" on page 26-10
Create button in the Trading Partner Identifications section of Figure 26-3	Create remote trading partner identification		"Creating Remote Trading Partner Identification" on page 26-12

See Also: [Chapter 25, "Managing Host and Remote Trading Partner Capabilities"](#) for details about the trading partner management tasks available from the **Organization**, **Cooperations**, **Delivery and Security**, and **Endpoints** sections that appear at the top of the lower page of [Figure 26-3](#) on page 26-6

Accessing Remote Trading Partner Management Tasks

Follow these instructions to access the remote trading partner management tasks shown in [Figure 26-3](#) on page 26-6:

To access remote trading partner management tasks:

1. Select the **Profiles** tab.
2. Select the **Trading Partners** tab.
The Trading Partners page appears.
3. Select a task to perform and see the referenced section for instructions:

To...	Then...	See Section...
Create a remote trading partner	Click Create .	"Creating a Remote Trading Partner" on page 26-9
Delete a remote trading partner	Select a specific trading partner in the Delete column.	"Deleting a Remote Trading Partner" on page 26-10
Update a remote trading partner	Select a specific trading partner in the Update column.	"Updating a Remote Trading Partner" on page 26-10
View details about a remote trading partner	Select a specific trading partner name in the Name column.	"Viewing a Remote Trading Partner" on page 26-10
Create remote trading partner identifications	Select a specific remote trading partner name in the Name column to which to add remote trading partner identification, organization, cooperation, delivery, security, and endpoint capabilities.	"Creating Remote Trading Partner Identification" on page 26-12

Creating a Remote Trading Partner

Follow these instructions to create a remote trading partner:

To create a remote trading partner:

1. Ensure that you followed the instructions in "[Accessing Remote Trading Partner Management Tasks](#)" on page 26-8 to access the page for creating a remote trading partner.

The Create Trading Partner page appears.

2. Enter the following details to create a remote trading partner. An asterisk (*) indicates a required field.

Field	Description
Name *	Enter a unique and recognizable name for the remote trading partner.
Description	Enter a description for the remote trading partner.

3. Click **Apply**.

The remote trading partner is created and the Trading Partner Details page for the new remote trading partner appears. Links to the **Organization**, **Cooperations**, **Delivery and Security**, and **Endpoints** sections also display at the top of the page.

Note: You do not need to create a host trading partner. The host trading partner automatically exists. The name for the host trading partner appears on the Host - *name* page when you click the **Host** tab. When you add a participant to a trading partner agreement in "[Adding Trading Partner Agreement Participants](#)" on page 26-23, both the remote trading partner and the host trading partner are selectable as possible participants in the agreement.

See Also: [Chapter 25, "Managing Host and Remote Trading Partner Capabilities"](#) for details about the trading partner management tasks available from the **Organization**, **Cooperations**, **Delivery and Security**, and **Endpoints** sections

Deleting a Remote Trading Partner

Follow these instructions to delete a remote trading partner:

To delete a remote trading partner:

1. Ensure that you followed the instructions in "[Accessing Remote Trading Partner Management Tasks](#)" on page 26-8 to access the page for deleting a remote trading partner.
2. Click **Yes** when prompted to delete a remote trading partner.

The remote trading partner is deleted and the Trading Partners page appears.

Updating a Remote Trading Partner

Follow these instructions to update a remote trading partner:

To update a remote trading partner:

1. Ensure that you followed the instructions in "[Accessing Remote Trading Partner Management Tasks](#)" on page 26-8 to access the page for updating a remote trading partner.

The Update Trading Partner page appears.

2. Make appropriate changes. (See Step 2 on page 26-9 for a list of fields you can update.)
3. Click **Apply**.

The remote trading partner is updated and the Trading Partners Details page for the updated remote trading partner appears.

Viewing a Remote Trading Partner

Follow these instructions to view details about a specific remote trading partner:

To view a remote trading partner:

1. Ensure that you followed the instructions in "[Accessing Remote Trading Partner Management Tasks](#)" on page 26-8 to access the page for viewing a remote trading partner.

The Trading Partner Details page for the selected remote trading partner appears.

Organization Cooperations Delivery and Security Endpoints

Logged in as ip

Trading Partner Identifications Approvers Associated Agreements

Trading Partner Details : CompanyABC123

Validate Export Delete Update

Details

Description

State **Draft**

Trading Partner Identifications [Return to Top](#)

Create

Trading Partner Identification Type	Value	Details	Update	Delete
DUNS	123456789			

Approvers [Return to Top](#)

There are no persons available or no additional persons available for approval.

Add

Person	Send For Approval Date	Approval Date	Update	Delete
(No approvers found.)				

Associated Agreements [Return to Top](#)

Name	State	Update	Delete
CompanyABC123_CompanyXYZ	Draft		

2. View specific details, including the following:

- Trading partner identification type and value of the remote trading partner
- Persons assigned to approve the profile data of this remote trading partner
- Agreements with which this remote trading partner is associated

This page, as with the Trading Partners page shown in the upper page of [Figure 26-3](#) on page 26-6, enables you to delete or update the selected remote trading partner.

Links to the **Organization, Cooperations, Delivery and Security, and Endpoints** sections also display at the top of the page. See the following sections for instructions on defining this profile data for the remote trading partner.

For...	See Section...
Organization tasks	"Managing Organizations" on page 25-11
Cooperations tasks	"Managing Cooperations" on page 25-30
Delivery and Security tasks	"Managing Delivery and Security" on page 25-50
Endpoint tasks	"Managing Endpoints" on page 25-79

3. Click **Return to List** to return to the Trading Partners page.

See Also:

- ["Viewing the State of Modeling Metadata and Profile Data on the Details Page"](#) on page 5-17 for details on the **Draft, Validate, Pending Approval, and Approved** states that display on trading partner details pages and how to assign an approver to a trading partner
- ["Managing Trading Partner Agreements"](#) on page 26-14
- ["Managing Trading Partner and Agreement Validation and Approval"](#) on page 26-33

Creating Remote Trading Partner Identification

Follow these instructions to create remote trading partner identification and define trading partner capabilities, such as organization, cooperations, delivery, security, and endpoints.

This profile data must be defined for all trading partners participating in a trading partner agreement (for example, the host trading partner with Oracle Application Server ProcessConnect installed in their enterprise and all remote trading partner participants located in other enterprises).

To create remote trading partner identification:

1. Ensure that you followed the instructions in "[Accessing Remote Trading Partner Management Tasks](#)" on page 26-8 to access the page for creating trading partner identification.

The Trading Partner Details page for the selected trading partner appears.

2. Go to the **Trading Partner Identifications** section. (See the lower page of [Figure 26-3](#) on page 26-6.)

3. Click **Create**.

The Create Trading Partner Identification page displays the fields for creating trading partner identification.

4. See "[Creating Trading Partner Identification](#)" on page 25-8 for trading partner identification creation instructions.

Managing Trading Partner Agreements

The Oracle Application Server ProcessConnect user interface tool enables you to perform the trading partner agreement management tasks shown in [Figure 26-4](#). The trading partner agreement defines the way in which the host and remote trading partners agree to interact when performing an agreed-on business collaboration. These tasks are described in detail in this section.

Figure 26-4 Trading Partner Agreement Management Tasks

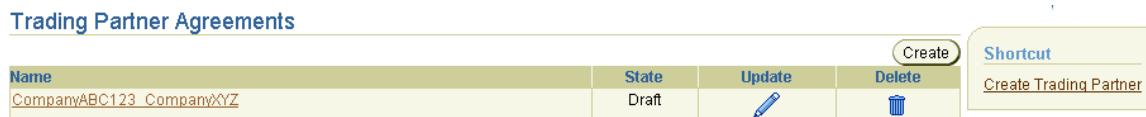

[Table 26-3](#) identifies the trading partner agreement management tasks shown in [Figure 26-4](#) and provides references to procedures for performing these tasks.

Table 26-3 Trading Partner Agreement Management Tasks

Page Elements	Management Task	First See Section...	Then See Section...
Shortcut section of Figure 26-4	Take a shortcut to create a trading partner	"Accessing Remote Trading Partner Management Tasks" on page 26-8	"Creating a Remote Trading Partner" on page 26-9
Create button of Figure 26-4	Create a trading partner agreement	"Accessing Trading Partner Agreement Management Tasks" on page 26-15	"Creating a Trading Partner Agreement" on page 26-15
Delete column of Figure 26-4	Delete a trading partner agreement		"Deleting a Trading Partner Agreement" on page 26-16
Update column of Figure 26-4	Update a trading partner agreement		"Updating a Trading Partner Agreement" on page 26-17
Name column of Figure 26-4	View details about a trading partner agreement		"Viewing a Trading Partner Agreement" on page 26-17

Accessing Trading Partner Agreement Management Tasks

Follow these instructions to access the trading partner agreement management tasks shown in [Figure 26-4](#) on page 26-14:

To access trading partner agreement management tasks:

1. Select the **Profiles** tab.
2. Select the **Agreements** tab.
3. Select **Trading Partner Agreements**.

The Trading Partner Agreements page appears. (See [Figure 26-4](#) on page 26-14.)

4. Select a task to perform and see the referenced section for instructions:

To...	Then...	See Section...
Create a trading partner agreement	Click Create .	"Creating a Trading Partner Agreement" on page 26-15
Delete a trading partner agreement	Select a specific trading partner agreement in the Delete column.	"Deleting a Trading Partner Agreement" on page 26-16
Update a trading partner agreement	Select a specific trading partner agreement in the Update column.	"Updating a Trading Partner Agreement" on page 26-17
View details about a trading partner agreement	Select a specific trading partner agreement in the Name column.	"Viewing a Trading Partner Agreement" on page 26-17

Creating a Trading Partner Agreement

Follow these instructions to create a trading partner agreement:

To create a trading partner agreement:

1. Ensure that you followed the instructions in ["Accessing Trading Partner Agreement Management Tasks"](#) on page 26-15 to access the page for creating a trading partner agreement.

The Create Agreement screen appears.

2. Enter the following details to create a trading partner agreement. An asterisk (*) indicates a required field.

Field	Description
Name *	Enter a unique and recognizable name for the trading partner agreement.
Agreement Id	Enter an agreement identifier. This field is mandatory if you want to include this trading partner agreement in a deployed configuration.
Description	Enter a description for the trading partner agreement.
Effective From Date	Select the calendar icon to enter an agreement beginning date. If no date is specified, the agreement is always effective.
Effective To Date	Select the calendar icon to enter an agreement ending date. If no date is specified, the agreement is always effective.
Invocation Limit	Enter a value for the maximum number of times the collaboration can be invoked. If you do not enter a value, there is no limit on the number of invocations.
Concurrent Conversations	Enter a value for the maximum number of concurrent collaboration instances that can be in progress.

3. Click **Apply**.

The trading partner agreement is created and the Agreement Details page for the new trading partner agreement appears.

Deleting a Trading Partner Agreement

Follow these instructions to delete a trading partner agreement:

To delete a trading partner agreement:

1. Ensure that you followed the instructions in "[Accessing Trading Partner Agreement Management Tasks](#)" on page 26-15 to access the page for deleting a trading partner agreement.
2. Click **Yes** when prompted to delete a trading partner agreement.

The trading partner agreement is deleted and the Trading Partner Agreements page appears.

Updating a Trading Partner Agreement

Follow these instructions to update a trading partner agreement:

To update a trading partner agreement:

1. Ensure that you followed the instructions in "[Accessing Trading Partner Agreement Management Tasks](#)" on page 26-15 to access the page for updating a trading partner agreement.

The Update Agreement page appears.

2. Make appropriate changes. (See Step 2 on page 26-16 for a list of fields you can update.)

3. Click **Apply**.

The agreement is updated and the Agreement Details page for the updated trading partner agreement appears.

Viewing a Trading Partner Agreement

Follow these instructions to view details about a specific trading partner agreement:

To view a trading partner agreement:

1. Ensure that you followed the instructions in "[Accessing Trading Partner Agreement Management Tasks](#)" on page 26-15 to access the pages for viewing a trading partner agreement.

The Agreement Details page for the selected trading partner agreement appears.

Agreement Details: CompanyABC123_CompanyXYZ

Validate Export Delete Update

Details

Agreement Id	123-1
Description	Trading partner agreement between CompanyABC123 and CompanyXYZ
Effective From Date	3/31/03
Effective To Date	6/27/03
Invocation Limit	1
Concurrent Conversations	2
State	Draft

Trading Partner Participants

[Return to Top](#)

Add

Name	Actor	Update	Remove
CompanyABC123	Buyer - 3A4 - V02.00		
CompanyXYZ	Seller - 3A4 - V02.00		

Native Roles

[Return to Top](#)

Add

Name	Remove
SR_NativeRole	

Approvers

[Return to Top](#)

There are no persons available or no additional persons available for approval.

Add

Person	Send For Approval Date	Approval Date	Update	Delete
(No approvers found.)				

- View specific details, including the trading partner participants and native role of the trading partner agreement, and persons assigned to approve the profile data of this trading partner agreement. This page, as with the Trading Partner Agreements page shown in [Figure 26-4](#) on page 26-14, enables you to delete or update a trading partner agreement.

The state is **Draft** for this agreement (See the **Details** section). Depending on the current state of an agreement, different buttons and additional sections can also display. If the state is **Pending Approval**, the **Validate** button is replaced with the **Send for Approval** button. If the state is **Approved**, no button displays.

- Click **Return to List** to return to the Trading Partner Agreements page.

See Also: These sections for instructions on performing the following tasks:

- ["Managing Organizations"](#) on page 25-11 to create a user that you assign as an approver to an agreement and a method by which to contact this user when their approval is required
- ["Viewing the State of Modeling Metadata and Profile Data on the Details Page"](#) on page 5-17 for details about the states that display on agreement details pages and how to assign an approver to an agreement

Managing Trading Partner Agreement Participants

The Oracle Application Server ProcessConnect user interface tool enables you to perform the trading partner agreement participant management tasks shown in [Figure 26–5](#). You assign both the host and remote trading partners to the trading partner agreement as participants in the agreement. These tasks are described in detail in this section.

Figure 26–5 Trading Partner Agreement Participant Management Tasks

Agreement Details: CompanyABC123_CompanyXYZ Validate Export Delete Update

Details

Agreement Id **123-1**
 Description **Trading partner agreement between CompanyABC123 and CompanyXYZ**
 Effective From Date **3/31/03**
 Effective To Date **6/27/03**
 Invocation Limit **1**
 Concurrent Conversations **2**
 State **Draft**

Trading Partner Participants [Return to Top](#)

Name	Actor	Update	Remove
CompanyABC123	Buyer - 3A4 - V02.00		
CompanyXYZ	Seller - 3A4 - V02.00		

[Return to Top](#) Add

Native Roles [Return to Top](#)

Name	Remove
SR_NativeRole	

[Return to Top](#) Add

Approvers [Return to Top](#)

There are no persons available or no additional persons available for approval.

Person	Send For Approval Date	Approval Date	Update	Delete
(No approvers found.)				

[Return to Top](#) Add

Trading Partner Participant Details: CompanyABC123 Remove Update

Details

Trading Partner Identification **123456789**
 Actor **Buyer - 3A4 - V02.00**

Delivery Channels Used [Return to Top](#)

Name	Update	Remove
DC1		

[Return to Top](#) Add

Table 26-4 identifies the trading partner agreement participant management tasks shown in Figure 26-5 and provides references to procedures for performing these tasks.

Table 26-4 Trading Partner Agreement Participant Management Tasks

Page Elements	Management Task	First See Section...	Then See Section...
Add button of Trading Partner Participants section of Figure 26-5	Add trading partner agreement participants	"Accessing Trading Partner Agreement Participant Management Tasks" on page 26-15	"Adding Trading Partner Agreement Participants" on page 26-23
Remove column of Trading Partner Participants section of Figure 26-5	Remove a trading partner agreement participant		"Removing a Trading Partner Agreement Participant" on page 26-25
Update column of Trading Partner Participants section of Figure 26-5	Update a trading partner agreement participant		"Updating a Trading Partner Agreement Participant" on page 26-25
Name column of Trading Partner Participants section of Figure 26-5 (To access the Trading Partner Participant Details page shown in the lower page of Figure 26-5)	View details about a trading partner agreement participant		"Viewing a Trading Partner Agreement Participant" on page 26-26
Add button of Delivery Channels Used section of Figure 26-5	Add a delivery channel to a trading partner agreement participant		"Adding a Delivery Channel to a Trading Partner Agreement Participant" on page 26-26
Remove column of Delivery Channels Used section of Figure 26-5	Remove a delivery channel from a trading partner agreement participant		"Removing a Delivery Channel from a Trading Partner Agreement Participant" on page 26-27
Update column of Delivery Channels Used section of Figure 26-5	Update a delivery channel of a trading partner agreement participant		"Updating a Delivery Channel of a Trading Partner Agreement Participant" on page 26-28
Name column of Delivery Channels Used section of Figure 26-5	View details about a delivery channel of a trading partner agreement participant		"Viewing a Delivery Channel of a Trading Partner Agreement Participant" on page 26-28

Accessing Trading Partner Agreement Participant Management Tasks

Follow these instructions to access the trading partner agreement participant management tasks shown in [Figure 26-5](#) on page 26-20:

To access trading partner agreement participant management tasks:

1. Select the **Profiles** tab.
2. Select the **Agreements** tab.
3. Select **Trading Partner Agreements**.

The Trading Partner Agreements page appears. (See [Figure 26-4](#) on page 26-14.)

4. Select a specific trading partner agreement in the **Name** column.

The Agreement Details page for the selected trading partner agreement appears. (See the upper page of [Figure 26-5](#) on page 26-20.)

5. Go to the **Trading Partner Participants** section.
6. Select a task to perform and see the referenced section for instructions:

To...	Then...	See Section...
Add trading partner agreement participants	Click Add .	"Adding Trading Partner Agreement Participants" on page 26-23
Remove a trading partner agreement participant	Select a specific trading partner agreement participant in the Remove column.	"Removing a Trading Partner Agreement Participant" on page 26-25
Update a trading partner agreement participant	Select a specific trading partner agreement participant in the Update column.	"Updating a Trading Partner Agreement Participant" on page 26-25
View details about a trading partner agreement participant	Select a specific trading partner agreement participant name in the Name column.	"Viewing a Trading Partner Agreement Participant" on page 26-26

To...	Then...	See Section...
Add a delivery channel to a trading partner agreement participant	Select a specific trading partner agreement participant name to which to add a delivery channel in the Name column.	"Adding a Delivery Channel to a Trading Partner Agreement Participant" on page 26-26
Remove a delivery channel from a trading partner agreement participant	Select a specific trading partner agreement participant name for which to remove a delivery channel in the Name column.	"Removing a Delivery Channel from a Trading Partner Agreement Participant" on page 26-27
Update a delivery channel of a trading partner agreement participant	Select a specific trading partner agreement participant name for which to update a delivery channel in the Name column.	"Updating a Delivery Channel of a Trading Partner Agreement Participant" on page 26-28
View details about a delivery channel of a trading partner agreement participant	Select a specific trading partner agreement participant name for which to view a delivery channel in the Name column.	"Viewing a Delivery Channel of a Trading Partner Agreement Participant" on page 26-28

Adding Trading Partner Agreement Participants

Follow these instructions to add the host and remote trading partners as participants in a trading partner agreement:

To add trading partner agreement participants:

1. Ensure that you followed the instructions in ["Accessing Trading Partner Agreement Participant Management Tasks"](#) on page 26-22 to access the page for adding trading partner agreement participants.

The Add Trading Partner Participant page appears.

- Enter the following details to add the first trading partner agreement participant. An asterisk (*) indicates a required field.

Field	Description
Trading Partner *	<p>Select the name of the trading partner agreement participant.</p> <p>For a remote trading partner, this is the trading partner created in "Creating a Remote Trading Partner" on page 26-9.</p> <p>The host trading partner name that displays in this list is the name that appears on the Host - <i>name</i> page when you click the Host tab.</p>
Trading Partner Identification *	<p>Select the trading partner agreement identification. If no selections are available, you must first create trading partner identification.</p> <p>For a remote trading partner, this is the identification type you create in "Creating Remote Trading Partner Identification" on page 26-12.</p> <p>For a host trading partner, this is the identification type you create in "Creating Trading Partner Identification" on page 25-8.</p>
Supported Actor*	<p>Select the trading partner agreement participant's role (for example, select buyer - 3A4 - V02.00 if the participant is acting as the buyer). If no selections are available, you must first create a supported actor.</p> <p>For both remote and host trading partners, this is the supported actor role you select in "Creating a Supported Actor" on page 25-34.</p> <p>See Also: Step 2 on page 25-34 for a definition of the sections (for example, buyer - 3A4 - V02.00) comprising the agreement participant's role.</p>

- Click **Apply**.

The trading partner agreement participant is added and the Trading Partner Participant Details page for the new trading partner agreement participant appears.

- Click **Return to List** at the bottom of the page.
- Return to the **Trading Partner Participants** section.
- Click **Add**.
- Repeat Step 2 and Step 3 to add an additional trading partner participant. For example, if you initially added the host trading partner as a participant, add the remote trading partner as a participant this time.

Removing a Trading Partner Agreement Participant

Follow these instructions to remove a trading partner agreement participant:

To remove a trading partner agreement participant:

1. Ensure that you followed the instructions in "[Accessing Trading Partner Agreement Participant Management Tasks](#)" on page 26-22 to access the page for removing a trading partner agreement participant.
2. Click **Yes** when prompted to remove a trading partner agreement participant.

The trading partner agreement participant is removed and the Agreement Details page for the selected agreement appears.

Updating a Trading Partner Agreement Participant

Follow these instructions to update a trading partner agreement participant:

To update a trading partner agreement participant:

1. Ensure that you followed the instructions in "[Accessing Trading Partner Agreement Participant Management Tasks](#)" on page 26-22 to access the page for updating a trading partner agreement participant.

The Update Trading Partner Participant page appears.

2. Make appropriate changes. (See Step 2 on page 26-24 for a list of fields you can update.)
3. Click **Apply**.

The trading partner agreement participant is updated and the Trading Partner Participant Details page for the selected trading partner agreement participant appears.

Viewing a Trading Partner Agreement Participant

Follow these instructions to view details about a specific trading partner agreement participant:

To view a trading partner agreement participant:

1. Ensure that you followed the instructions in "[Accessing Trading Partner Agreement Participant Management Tasks](#)" on page 26-22 to access the page for viewing a trading partner agreement participant.

The Trading Partner Participant Details page for the selected trading partner agreement participant appears.

Trading Partner Participant Details: CompanyABC123



[Remove](#) [Update](#)

Details

Trading Partner Identification **123456789**
 Actor **Buyer - 3A4 - V02.00**

Delivery Channels Used

[Return to Top](#)

Name	Update	Remove
DC1		

[Add](#)

2. View specific details, including the delivery channel used by the trading partner participant, the identification value, and the supported actor.

This page, as with the Agreement Details page shown in the upper page of [Figure 26-5](#) on page 26-20, enables you to remove or update the selected trading partner agreement participant.

3. Click **Return to List** to return to the Agreement Details page for the selected trading partner agreement.

Adding a Delivery Channel to a Trading Partner Agreement Participant

Follow these instructions to add a delivery channel to a trading partner agreement participant. The delivery channel describes whether security characteristics such as nonrepudiation and encryption are required. The delivery channel also identifies one transport and one document exchange.

Note: A delivery channel must already be created before you can add it to a trading partner participant.

To add a delivery channel to a trading partner agreement participant:

1. Ensure that you followed the instructions in "[Accessing Trading Partner Agreement Participant Management Tasks](#)" on page 26-22 to access the page for adding a delivery channel to a trading partner agreement participant.

The Trading Partner Participant Details page for the selected trading partner agreement participant appears.

2. Go to the **Delivery Channels Used** section. (See the lower page of [Figure 26-5](#) on page 26-20.)
3. Click **Add**.

The Add Participant Delivery Channel page appears.

4. Select a delivery channel from the available list. If no selections are available, you must first create a delivery channel by following the instructions in "[Creating a Delivery Channel](#)" on page 25-75.
5. Click **Apply**.

You are returned to the Trading Partner Participant Details page for the selected trading partner participant.

Removing a Delivery Channel from a Trading Partner Agreement Participant

Follow these instructions to remove a delivery channel from a trading partner agreement participant:

To remove a delivery channel from a trading partner agreement participant:

1. Ensure that you followed the instructions in "[Accessing Trading Partner Agreement Participant Management Tasks](#)" on page 26-22 to access the page for removing a delivery channel from a trading partner agreement participant.

The Trading Partner Participant Details page for the selected trading partner agreement participant appears.

2. Go to the **Delivery Channels Used** section. (See the lower page of [Figure 26-5](#) on page 26-20.)
3. Select a specific delivery channel in the **Remove** column.

4. Click **Yes** when prompted to remove a trading partner delivery channel.

The delivery channel is removed and you are returned to the Trading Partner Participant Details page for the selected trading partner participant.

Updating a Delivery Channel of a Trading Partner Agreement Participant

Follow these instructions to update a delivery channel of a trading partner agreement participant:

To update a delivery channel of a trading partner agreement participant:

1. Ensure that you followed the instructions in "[Accessing Trading Partner Agreement Participant Management Tasks](#)" on page 26-22 to access the page for updating a delivery channel of a trading partner agreement participant.

The Trading Partner Participant Details page for the selected trading partner agreement participant appears.

2. Go to the **Delivery Channels Used** section. (See the lower page of [Figure 26-5](#) on page 26-20.)

3. Select a specific delivery channel in the **Update** column.

The Update Participant Delivery Channel page appears.

4. Make appropriate changes. (See Step 4 on page 26-27 for a list of fields you can update.)

5. Click **Apply**.

The trading partner agreement participant is updated and the Trading Partner Participant Details page for the selected trading partner agreement participant delivery channel appears.

Viewing a Delivery Channel of a Trading Partner Agreement Participant

Follow these instructions to view details about a delivery channel of a trading partner agreement participant:

To view a delivery channel of a trading partner agreement participant:

1. Ensure that you followed the instructions in "[Accessing Trading Partner Agreement Participant Management Tasks](#)" on page 26-22 to access the page for viewing a delivery channel of a trading partner agreement participant.

The Trading Partner Participant Details page for the selected trading partner agreement participant appears.

2. Go to the **Delivery Channels Used** section. (See the lower page of [Figure 26-5](#) on page 26-20.)
3. Select a specific delivery channel in the **Name** column.

The Participant Delivery Channel Details page for the selected trading partner agreement participant delivery channel appears.

Participant Delivery Channel Details: DC1

[Remove](#) [Update](#)

Details

Participant Delivery Channel	DC1
Document Exchange	DE1
Transport	TP1
Acknowledgement Mode	Async
Global Usage Code	Test
Is Non-Repudiation of Receipt Required	False
Is Non-Repudiation of Origin Required	False
Encryption Enabled	False
Transport Security Enabled	False
Time To Acknowledgement	
Retry Count	

4. View specific details.

This page, as with the Trading Partner Participant Details page shown in the lower page of [Figure 26-5](#) on page 26-20, enables you to remove or update the delivery channel of the selected trading partner agreement participant.

5. Click **Return to List** to return to the Trading Partner Participant Details page for the selected trading partner agreement.

Managing Native Roles in Trading Partner Agreements

The Oracle Application Server ProcessConnect user interface tool enables you to perform the trading partner agreement native role management tasks shown in [Figure 26-6](#). The native role implements the trading partner’s behavior. You assign the native role of the host trading partner to the trading partner agreement. These tasks are described in detail in this section.

Figure 26-6 Trading Partner Agreement Native Role Management Tasks

[Agreement Details: CompanyABC123_CompanyXYZ](#) Validate Export Delete Update

Details

Agreement Id	123-1
Description	Trading partner agreement between CompanyABC123 and CompanyXYZ
Effective From Date	3/31/03
Effective To Date	6/27/03
Invocation Limit	1
Concurrent Conversations	2
State	Draft

Trading Partner Participants [Return to Top](#) Add

Name	Actor	Update	Remove
CompanyABC123	Buyer - 3A4 - V02.00		
CompanyXYZ	Seller - 3A4 - V02.00		

Native Roles [Return to Top](#) Add

Name	Remove
SR_NativeRole	

Approvers [Return to Top](#) Add

There are no persons available or no additional persons available for approval.

Person	Send For Approval Date	Approval Date	Update	Delete
(No approvers found.)				

Table 26-5 identifies the trading partner agreement native role management tasks shown in Figure 26-6 and provides references to procedures for performing these tasks.

Table 26-5 Trading Partner Agreement Native Role Management Tasks

Page Elements	Management Task	First See Section...	Then See Section...
Add button of Native Roles section	Adding a trading partner agreement native role	"Accessing Trading Partner Agreement Native Role Management Tasks" on page 26-31	"Adding a Trading Partner Agreement Native Role" on page 26-32
Remove column of Native Roles section	Removing a trading partner agreement native role		"Removing a Trading Partner Agreement Native Role" on page 26-33

See Also: "Native Roles" on page 3-23 for conceptual details

Accessing Trading Partner Agreement Native Role Management Tasks

Follow these instructions to access the trading partner agreement native role management tasks shown in Figure 26-6 on page 26-30:

To access trading partner agreement native role management tasks:

1. Select the **Profiles** tab.
2. Select the **Agreements** tab.
3. Select **Trading Partner Agreements**.
The Trading Partner Agreements page appears.
4. Select a specific trading partner agreement in the **Name** column.
The Agreement Details page for the selected trading partner agreement appears. (See Figure 26-6 on page 26-30.)
5. Go to the **Native Roles** section.

6. Select a task to perform and see the referenced section for instructions:

To...	Then...	See Section...
Add a trading partner agreement native role	Click Add .	"Adding a Trading Partner Agreement Native Role" on page 26-32
Remove a trading partner agreement native role	Select a specific trading partner agreement native role in the Remove column.	"Removing a Trading Partner Agreement Native Role" on page 26-33

Adding a Trading Partner Agreement Native Role

Follow these instructions to add a native role to a trading partner agreement:

Note: A native role for the host trading partner must already be created before you can add it to a trading partner agreement.

To add a trading partner agreement native role:

1. Ensure that you followed the instructions in ["Accessing Trading Partner Agreement Native Role Management Tasks"](#) on page 26-31 to access the page for adding a trading partner agreement native role.

The Add Native Role page appears.

2. Select a native role from the **Native Role** list.
3. Click **Apply**.

The trading partner agreement native role is assigned to the trading partner agreement and the Agreement Details page for the selected trading partner agreement appears.

See Also: ["Creating a Role"](#) on page 12-44 to manually create a native role or [Chapter 9, "Creating Metadata with the Modeling Wizards"](#) to automatically create a native role along with other modeling metadata

Removing a Trading Partner Agreement Native Role

Follow these instructions to remove a trading partner agreement native role:

To remove a trading partner agreement native role:

1. Ensure that you followed the instructions in "[Accessing Trading Partner Agreement Native Role Management Tasks](#)" on page 26-31 to access the page for removing a trading partner agreement native role.
2. Select **Yes** when prompted to remove a trading partner agreement native role.

The trading partner agreement native role is removed and the Agreement Details page for the selected trading partner agreement appears.

Managing Trading Partner and Agreement Validation and Approval

After completing the tasks described previously in this chapter, the profile data of trading partners (such as trading partner identification or supported actor characteristics) and trading partner agreements (such as the participants, native role, and delivery channel characteristics) must be validated and approved before it can be included in a deployed configuration. Approval typically involves assigning persons to approve the profile data, exporting the profile data to XML files, and submitting the files to the assigned approvers for review and eventual approval. The validation and approval tasks are performed from **Validation**, **Send for Approval**, **Export**, and **Approve** buttons that display at various stages in the top right sections of the following pages:

- The Trading Partner Details page shown in the lower page of [Figure 26-3](#) on page 26-6
- The Agreement Details page shown in the upper page of [Figure 26-5](#) on page 26-20

Table 26–6 identifies the trading partner and trading partner agreement validation and approval tasks and provides references to procedures for performing these tasks. All tasks with the exception of Task 4 are performed with the Oracle Application Server ProcessConnect user interface tool.

Table 26–6 *Trading Partner and Trading Partner Agreement Validation and Approval Tasks*

Task	See Section...
1. Validate the trading partner and trading partner agreement	"Validated State for Modeling Metadata and Profile Data" on page 5-19
2. Select persons to approve the trading partner and trading partner agreement	"Pending Approval State for Profile Data" on page 5-20
3. Export the trading partner and trading partner agreement to XML files	"Exporting Profile Data to an XML File" on page 5-15
4. Send the XML files to persons for approval	
5. Specify a date by which by which persons must complete their approval or disapproval of the trading partner and trading partner agreement	"Update the Approver" on page 5-22
6. Officially approve the trading partner and trading partner agreement when all persons have approved	"Approval State for Profile Data" on page 5-22

Common User Errors

The following are common trading partner and trading partner agreement user errors:

- Verify that all trading partner and trading partner agreements have been assigned an approver and have been approved. Look at the details pages of each trading partner and trading partner agreement and verify that none of the following buttons are present:
 - Validate
 - Send for Approval
 - Approve

- Verify that all trading partner and trading partner agreement have a native role defined. Look at the details of each agreement and verify that the correct native role is listed for that particular agreement.
- Ensure that you have exactly two trading partners assigned to a trading partner agreement. Specify only one local trading partner.

Chapter Summary

This chapter first describes how you create a remote trading partner. You then create a trading partner agreement to which you assign both the host and remote trading partners as participants. You also add a delivery channel to a participant. The native role of the host trading partner must also be assigned to this agreement.

Part VII

Reference

This part describes Oracle Application Server ProcessConnect reference information.

This part contains the following appendices:

- [Appendix A, "Native Formats and Translators"](#)
- [Appendix B, "Transformation Rules"](#)
- [Appendix C, "Error Codes"](#)
- [Appendix D, "Jacada Integrator Adapter for Legacy Systems"](#)

Native Formats and Translators

This appendix describes the native formats and translators supported with Oracle Application Server ProcessConnect.

This appendix contains these topics:

- [Native Format and Translation Overview](#)
- [XSD](#)
- [Data Definition Description Language](#)
- [D3L File Structure](#)
- [Token Substituted Text](#)
- [Appendix Summary](#)

Native Format and Translation Overview

Oracle Application Server ProcessConnect provides prepackaged support for the following native formats and translators:

- [XSD](#)
- [Data Definition Description Language](#)
- [Token Substituted Text](#)

This support provides the following features:

- [Native Event Type and Native Event Body Element Creation](#)
- [Datatype Creation](#)

Native Event Type and Native Event Body Element Creation

The Oracle Application Server ProcessConnect user interface tool enables you to select document definitions specified in native formats when adding an interaction. Oracle Application Server ProcessConnect uses these document definitions to create a native event type and native event body elements. For example, if you select an XSD document that consists of a header, payload data, and attachment, Oracle Application Server ProcessConnect creates a native event type for the document and separate native event body elements for the header, payload data, and attachment. The XSD native format is also associated with an XSD translator, which translates the native event type and native event body elements into application event type and application event body elements for inbound messages, and translates application event type and application event body elements into native event type and native event body elements for outbound messages.

See Also: The following sections for instructions on selecting a native format:

- ["Adding an Adapter Interaction"](#) on page 11-7 to select a native format for native event types and native event body elements during the same session in which you add an interaction
- ["Creating a Native Event Type"](#) on page 11-40 to select a native format for native event types and native event body elements during a separate session from that in which you created an interaction

Datatype Creation

You can use the Oracle Application Server ProcessConnect user interface tool to import XSD native format datatypes by specifying the file that contains the datatype definitions.

See Also: ["Importing XSD Datatypes"](#) on page 10-51 for instructions on importing an XSD datatype file.

XSD

You can import XMLSchema definition (XSD) datatype files into Oracle Application Server ProcessConnect. While Oracle Application Server ProcessConnect does provide XSD support, there are XSD tags and attributes that are ignored, not supported, or supported only through workarounds. In addition, other XSD datatypes, datatype members, and attributes can only be added to Oracle Application Server ProcessConnect through XSD files and not through the Oracle Application Server ProcessConnect user interface tool.

The following sections describe Oracle Application Server ProcessConnect-specific characteristics for importing XSD datatype files:

- [Ignored XSD Tags and Attributes](#)
- [Unsupported Tags](#)
- [Reference to an Empty Group](#)
- [Invalid XSDs](#)
- [Attributes with Unsupported Values](#)
- [Unsupported XML Instance Constructs](#)
- [Naming Restrictions](#)
- [XSD Support Unavailable through Oracle Application Server ProcessConnect User Interface Tool](#)

See Also:

- ["Importing XSD Datatypes"](#) on page 10-51 for instructions on importing the XSD datatypes file and selecting the XSD native format and translator
- ["Adding an Adapter Interaction"](#) on page 11-7 for instructions on selecting the XSD native format for native event types and native event body elements
- The following Web site for additional details about XSD and the XMLSchema:

<http://www.w3.org/XML/Schema>

Ignored XSD Tags and Attributes

The following XSD tags are ignored by Oracle Application Server ProcessConnect. Importing an XSD file that contains these tags does not cause errors. The tags are simply ignored.

- `annotation`
- `appinfo`
- `documentation`
- `field`
- `key`
- `keyref`
- `notation`
- `redefine`
- `selector`
- `unique`
- `whiteSpace`

Note: The `whiteSpace` facet only applies to application datatypes. Therefore, it is ignored when importing business types.

Table A-1 lists the XSD attributes ignored by Oracle Application Server ProcessConnect. Importing an XSD file that contains these attributes does not cause errors. The attributes are simply ignored.

Table A-1 Ignored XSD Attributes

Attribute	Element Types	Description
abstract	complexType	Mandates usage of a derived type in the instance, typically using <code>xsi:type</code> .
block	complexType, element	Prevents type substitution in the instance
blockDefault	schema	Schema level default attribute corresponding to a <code>complexType</code> attribute <code>block</code>
default	attribute, element	Default and fixed values are only applicable to scalar members. If a member element has <code>minOccurs</code> or <code>maxOccurs</code> other than 1, then it is created as a compound member to preserve the cardinality. In this case, the default value, if any, is not preserved. The default attribute occurs either in the member element or in the global element to which the member refers.
final	complexType, element	Controls derivation of a subtype (that is, only by extension, restriction, or none)
finalDefault	schema	Schema level default attribute corresponding to the <code>complexType</code> attribute <code>final</code>
fixed	attribute, element	The <code>fixed</code> attribute (like <code>default</code>) only applies to scalar members. If a member element has <code>minOccurs</code> or <code>maxOccurs</code> other than 1, its fixed value (specified either in the member or in the global element to which the member refers) is not preserved.
id	Every element except <code>appinfo</code> and <code>choice</code>	<code>id</code> attributes are not preserved in Oracle Application Server ProcessConnect.
<code>xml:lang</code>	schema, documentation	Natural language of the document
version	schema	Schema version number

Unsupported Tags

You receive error messages if any of the following tags appear in an XMLSchema file being imported. This section describes existing workarounds for these tags.

- [all with minOccurs="0"](#)
- [anyAttribute](#)
- [choice or sequence with minOccurs="0", maxOccurs Greater than 1 Except If parent is choice or sequence, or Both](#)
- [complexContent or complexType with mixed="true"](#)
- [list](#)
- [union](#)
- [restriction \(simpleContent\) if the base attribute refers to a simpleType or if it has a locally defined base simpleType](#)
- [restriction \(simpleContent\) that restricts any facets of its base complexType](#)

[all with minOccurs="0"](#)

This section contains the following topics:

- [Unsupported Structure](#)
- [Workaround](#)

Unsupported Structure `all` has attribute `minOccurs` with allowed values of 0 and 1, and attribute `maxOccurs` that must have a value of 1. Since `all` can only occur at the top level of `complexType`, and cardinality is not supported for `complexType`, `minOccurs="0"` is not supported.

Unsupported XSD Fragment:

```
<xs:complexType name="unsupported_3_1">
  <xs:all minOccurs="0">
    <xs:element name="m1" type="xs:int" minOccurs="0"/>
    <xs:element name="m2" type="xs:string"/>
    <xs:element name="m3" type="xs:string"/>
  </xs:all>
</xs:complexType>
```

Corresponding Valid Instances:

```
<unsupported_3_1/>

<unsupported_3_1>
  <m2>foo</m2>
  <m3>bar</m3>
</unsupported_3_1>

<unsupported_3_1>
  <m1>123</m1>
  <m2>foo</m2>
  <m3>bar</m3>
</unsupported_3_1>
```

Workaround Change the minimum cardinality of each member to 0. This enables all originally valid instances to remain valid. However, this causes some instances that are not valid according to the original XSD to now become valid. This is because the original XSD fragment required that either all member elements with `minOccurs="1"` occur in the instance, or no member elements occur in the same instance, regardless of cardinality.

Modified XSD Fragment:

```
<xs:complexType name="workaround_3_1">
  <xs:all>
    <xs:element name="m1" type="xs:int" minOccurs="0"/>
    <xs:element name="m2" type="xs:string" minOccurs="0"/>
    <xs:element name="m3" type="xs:string" minOccurs="0"/>
  </xs:all>
</xs:complexType>
```

Corresponding Valid Instances:

All the valid instances from "[Corresponding Valid Instances:](#)" on page A-7 are still valid according to the modified XSD. However, the following invalid instances according to the original XSD are now also valid.

```
<workaround_3_1>
  <!-- according to the original, if the all group occurs, it must
        contain both m2 and m3 -->
  <m2>foo</m2>
</workaround_3_1>

<workaround_3_1>
  <!-- according to the original, if the all group occurs, it must
        contain both m2 and m3 -->
  <m1>123</m1>
  <m3>bar</m3>
</workaround_3_1>
```

anyAttribute

This section contains the following topics:

- [Unsupported Structure](#)
- [Workaround](#)

Unsupported Structure There is no support for attribute wildcards. No occurrence of `anyAttribute` is allowed in an XSD document.

Workaround There is no current workaround. Remove and replace all occurrences of `anyAttribute` from the XSD file with explicit declarations of the expected attributes.

choice or sequence with minOccurs="0", maxOccurs Greater than 1 Except If parent is choice or sequence, or Both

This section contains the following topics:

- [Unsupported Structure](#)
- [Workaround](#)

Unsupported Structure Complex datatypes do not have cardinality; only their members do. If a choice or sequence group appears at the top level of a `complexType` (that is, its parent is `complexType`, restriction, extension, or group), it becomes the direct content of its parent complex datatype. There is no member that points to it, and thus no way to preserve the cardinality.

```
<xs:complexType name="unsupported_3_2_1">
  <xs:choice minOccurs="0" maxOccurs="2">
    <xs:element name="member1" type="xs:string"/>
    <xs:element name="member2" type="xs:string"/>
  </xs:choice>
</xs:complexType>
```

```
<xs:complexType name="unsupported_3_2_2">
  <xs:sequence maxOccurs="unbounded">
    <xs:element name="member1" type="xs:int"/>
  </xs:sequence>
</xs:complexType>
```

Workaround Nest the block, complete with its `minOccurs` and `maxOccurs`, inside a sequence. This way, the original block is created as an anonymous complex datatype that has a compound member with the appropriate cardinality referencing it. This workaround does not impact the set of valid instances.

```
<xs:complexType name="unsupported_3_2_1">
  <xs:sequence>
    <xs:choice minOccurs="0" maxOccurs="2">
      <xs:element name="member1" type="xs:string"/>
      <xs:element name="member2" type="xs:string"/>
    </xs:choice>
  </xs:sequence>
</xs:complexType>
```

```
<xs:complexType name="unsupported_3_2_2">
  <xs:sequence>
    <xs:sequence maxOccurs="unbounded">
      <xs:element name="member1" type="xs:int"/>
    </xs:sequence>
  </xs:sequence>
</xs:complexType>
```

complexContent or complexType with mixed="true"

This section contains the following topics:

- [Unsupported Structure](#)
- [Workaround](#)

Unsupported Structure `mixed="true"` in an XSD type means that the corresponding instance can have unrestricted simple content, complex content as specified in the type, or a mixture of both. There is no workaround for instances with mixed content. If instances either always have simple content or always have complex content, then there is a workaround.

Unsupported XSD Fragments:

```
<xs:complexType name="text" mixed="true">
  <xs:sequence>
    <xs:element name="header" type="xs:string" minOccurs="0"/>
    <xs:element name="note" type="xs:string" minOccurs="0"
      maxOccurs="unbounded"/>
    <xs:element name="footer" type="xs:string" minOccurs="0"/>
  </xs:sequence>
</xs:complexType>
```

Corresponding Valid Instances:

Since all member elements have `minOccurs="0"`, an instance containing only scalar data is valid:

```
<text>here is some plain text</text>
```

It is also valid for the instance to contain only complex content:

```
<text>
  <header>text begins</header>
  <footer>text ends</footer>
</text>
```

There is no support or workaround for mixed content instances such as this one in Oracle Application Server ProcessConnect:

```
<text>this text has no header, two notes, <note>note 1</note>, and <note>note
2</note>, and a footer <footer>end</footer></text>
```

Workaround Determine first whether instance data always has simple or complex content.

Workaround for instances that always have simple content:

If the `mixed` attribute occurs in a `complexType` tag, replace the `complexType` with a `simpleType` that restricts `anySimpleType`. For example, replace this mixed content type:

```
<xs:complexType name="text" mixed="true">
  <xs:sequence>
    <xs:element name="header" type="xs:string" minOccurs="0"/>
    <xs:element name="note" type="xs:string" minOccurs="0"
      maxOccurs="unbounded"/>
    <xs:element name="footer" type="xs:string" minOccurs="0"/>
  </xs:sequence>
</xs:complexType>
```

with the following:

```
<xs:simpleType name="text">
  <xs:restriction base="xs:anySimpleType"/>
</xs:simpleType>
```

If `mixed` occurs in a `complexContent` tag, replace `complexContent` with a `simpleContent` extension. Set the base to `anySimpleType`. Add all attributes of `complexContent` and its base type to `simpleContent`. For example, replace this mixed content type:

```
<xs:complexType name="baseType">
  <xs:all>
    <xs:element name="name" type="xs:string" minOccurs="0"/>
  </xs:all>
  <xs:attribute name="sku" type="xs:string"/>
</xs:complexType>

<xs:complexType name="mixedType">
  <xs:complexContent mixed="true">
    <xs:extension base="baseType">
      <xs:sequence>
        <xs:element name="type" type="xs:string" minOccurs="0"/>
      </xs:sequence>
      <xs:attribute name="id" type="xs:short"/>
    </xs:extension>
  </xs:complexContent>
</xs:complexType>
```

with the following:

```
<xs:complexType name="mixedType">
  <xs:simpleContent>
    <xs:extension base="xs:anySimpleType">
      <xs:attribute name="sku" type="xs:string"/>
      <xs:attribute name="id" type="xs:short"/>
    </xs:extension>
  </xs:simpleContent>
</xs:complexType>
```

Workaround for instances that always have complex content:

If every instance has complex content, remove the `mixed="true"` attribute. Using the examples in the previous section, the workarounds are as follows:

```
<xs:complexType name="text">
  <xs:sequence>
    <xs:element name="header" type="xs:string" minOccurs="0"/>
    <xs:element name="note" type="xs:string" minOccurs="0"
      maxOccurs="unbounded"/>
    <xs:element name="footer" type="xs:string" minOccurs="0"/>
  </xs:sequence>
</xs:complexType>
```

and

```
<xs:complexType name="mixedType">
  <xs:complexContent>
    <xs:extension base="baseType">
      <xs:sequence>
        <xs:element name="type" type="xs:string" minOccurs="0"/>
      </xs:sequence>
      <xs:attribute name="id" type="xs:short"/>
    </xs:extension>
  </xs:complexContent>
</xs:complexType>
```

list

This section contains the following topics:

- [Unsupported Structure](#)
- [Workaround](#)

Unsupported Structure The `list` tag cannot occur in any XSD file being imported.

Workaround There is no current workaround. All `list` types must be removed from the XSD file.

union

This section contains the following topics:

- [Unsupported Structure](#)
- [Workaround](#)

Unsupported Structure The `union` tag cannot occur in any XSD being imported.

Workaround There is no current workaround. All `union` types must be removed from the XSD file.

restriction (simpleContent) if the base attribute refers to a simpleType or if it has a locally defined base simpleType

This section contains the following topics:

- [Unsupported Structure](#)
- [Workaround](#)

Unsupported Structure `simpleContent`, both restriction and extension, is modeled as a complex datatype. Complex datatypes can only be derived by restriction from other complex datatypes, and not from scalar datatypes. Therefore, the base type of a `simpleContent` restriction must be a `complexType`.

```
<xs:complexType name="unsupported_3_4_1">
  <xs:simpleContent>
    <xs:restriction base="xs:string">
      <xs:attribute name="foo" type="xs:string"/>
    </xs:restriction>
  </xs:simpleContent>
</xs:complexType>

<xs:complexType name="unsupported_3_4_2">
  <xs:simpleContent>
    <xs:restriction>
      <xs:simpleType>
        <xs:restriction base="xs:string">
          <xs:length value="4"/>
        </xs:restriction>
      </xs:simpleType>
      <xs:attribute name="bar" type="xs:string"/>
    </xs:restriction>
  </xs:simpleContent>
</xs:complexType>
```

Workaround Declare a new `complexType` with `simpleContent` that extends the base `simpleType`. If the `simpleType` is locally defined, then it must be moved and defined as a global type. This new `complexType` can then be used as the base type for the original `simpleContent` restriction.

```
<xs:complexType name="helper_3_4_1">
  <xs:simpleContent>
    <xs:extension base="xs:string"/>
  </xs:simpleContent>
</xs:complexType>

<xs:complexType name="unsupported_3_4_1">
  <xs:simpleContent>
    <xs:restriction base="helper_3_4_1">
      <xs:attribute name="foo" type="xs:string"/>
    </xs:restriction>
  </xs:simpleContent>
</xs:complexType>

<xs:simpleType name="simplehelper_3_4_2">
  <xs:restriction base="xs:string">
    <xs:length value="4"/>
  </xs:restriction>
</xs:simpleType>

<xs:complexType name="helper_3_4_2">
  <xs:simpleContent>
    <xs:extension base="simplehelper_3_4_2"/>
  </xs:simpleContent>
</xs:complexType>

<xs:complexType name="unsupported_3_4_2">
  <xs:simpleContent>
    <xs:restriction base="helper_3_4_2">
      <xs:attribute name="bar" type="xs:string"/>
    </xs:restriction>
  </xs:simpleContent>
</xs:complexType>
```

restriction (simpleContent) that restricts any facets of its base complexType

This section contains the following topics:

- [Unsupported Structure](#)
- [Workaround](#)

Unsupported Structure Since complex datatypes do not have facets, the restriction of facets in `simpleContent` is not supported. Therefore, restriction cannot have any of the following content: `enumeration`, `length`, `maxExclusive`, `maxInclusive`, `maxLength`, `minExclusive`, `minInclusive`, `minLength`, `pattern`, `totalDigits`, `fractionDigits`, and `whiteSpace`. This section describes only the case where the base type is a `complexType` with `simpleContent`. If the base type is a `simpleType`, see ["restriction \(simpleContent\) if the base attribute refers to a simpleType or if it has a locally defined base simpleType"](#) on page A-13.

```
<xs:simpleType name="simpleBase">
  <xs:restriction base="xs:string">
    <xs:minLength value="2"/>
    <xs:maxLength value="8"/>
  </xs:restriction>
</xs:simpleType>

<xs:complexType name="complexBase">
  <xs:simpleContent>
    <xs:extension base="simpleBase">
      <xs:attribute name="id" type="xs:short"/>
    </xs:extension>
  </xs:simpleContent>
</xs:complexType>

<xs:complexType name="unsupported_3_5">
  <xs:simpleContent>
    <xs:restriction base="complexBase">
      <xs:maxLength value="6"/>
    </xs:restriction>
  </xs:simpleContent>
</xs:complexType>
```

Workaround You cannot preserve the inheritance tree along with the appropriate facets and attributes. Instead, remove the facets from the derived type. If the type must have those facets, then perform the following tasks:

1. Define a new `simpleType` with the exact facets needed.
2. Define a new `complexType` with `simpleContent` that extends the `simpleType`.

3. Use the `complexType` as the base type for the `simpleContent` restriction.

In this case, all attributes must be explicitly declared in the restriction.

Workaround 1 (Removing facets):

```
<xs:complexType name="unsupported_3_5">
  <xs:simpleContent>
    <xs:restriction base="complexBase"/>
  </xs:simpleContent>
</xs:complexType>
```

Workaround 2 (Redefining the type):

```
<xs:simpleType name="simpleBase2">
  <xs:restriction base="simpleBase">
    <xs:maxLength value="6"/>
  </xs:restriction>
</xs:simpleType>

<xs:complexType name="complexBase2">
  <xs:simpleContent>
    <xs:extension base="simpleBase2"/>
  </xs:simpleContent>
</xs:complexType>

<xs:complexType name="unsupported_3_5">
  <xs:simpleContent>
    <xs:restriction base="complexBase2">
      <xs:attribute name="id" type="xs:short"/>
    </xs:restriction>
  </xs:simpleContent>
</xs:complexType>
```

Reference to an Empty Group

Unlike the other unsupported structures, this one is not detected by the XSD converter. Before importing any XSDs, check for this structure. If a native event is created from an XSD with empty groups, a runtime error occurs during translation.

Unsupported Structure

References to group definitions with no members are not supported for this Oracle Application Server ProcessConnect release. In the following example, LOCALADDR is a valid group, but EMPTY_GROUP and EMPTY_CONTENT are both empty and therefore are unsupported groups. The global element USAddress is unsupported because it references unsupported groups.

Unsupported XSD Fragment

```
<xs:group name="LOCALADDR">
  <xs:sequence>
    <xs:element name="street" type="xs:string"/>
    <xs:element name="aptNo" type="xs:string" minOccurs="0"/>
  </xs:sequence>
</xs:group>
<xs:group name="EMPTY_GROUP"/>
<xs:group name="EMPTY_CONTENT">
  <xs:sequence/>
</xs:group>

<xs:element name="LocalAddress">
  <xs:complexType>
    <xs:group ref="LOCALADDR"/>
  </xs:complexType>
</xs:element>
<xs:element name="USAddress">
  <xs:complexType>
    <xs:sequence>
      <xs:group ref="EMPTY_CONTENT"/>
      <xs:group ref="LOCALADDR"/>
      <xs:element name="city" type="xs:string"/>
      <xs:element name="state" type="xs:string"/>
      <xs:group ref="EMPTY_GROUP"/>
    </xs:sequence>
  </xs:complexType>
</xs:element>
```

Corresponding Valid Instances

```
<LocalAddress>
  <street>500 Oracle Pkwy</street>
</LocalAddress>

<USAddress>
  <street>500 Oracle Pkwy</street>
  <city>Redwood Shores</city>
  <state>CA</state>
</USAddress>
```

Workaround

The workaround is to remove all references to the empty groups. This has no impact on the set of valid instances. The group definitions do not need to be removed. In the preceding example, `LocalAddress` remains the same, and the references to `EMPTY_CONTENT` and `EMPTY_GROUP` are removed from `USAddress`.

Modified XSD Fragment

```
<xs:element name="USAddress">
  <xs:complexType>
    <xs:sequence>
      <xs:group ref="LOCALADDR"/>
      <xs:element name="city" type="xs:string"/>
      <xs:element name="state" type="xs:string"/>
    </xs:sequence>
  </xs:complexType>
</xs:element>
```

Corresponding Valid Instances

The same instances are valid with the workaround as with the original XSD.

Invalid XSDs

These sections describes procedures permitted by the XMLSchema, but that cannot be matched to an instance. Workarounds are provided.

- [Nondeterministic choice Block](#)
- [Nondeterministic sequence Block](#)
- [Deterministic XSD Constructs with lookahead](#)

Nondeterministic choice Block

This structure occurs when a choice contains two or more elements with the same qualified name. Validation error AIP-16744 appears if this structure is encountered in the XSD file.

This section contains these topics:

- [Unsupported Structure](#)
- [Workaround](#)

Note: These workarounds are only applicable for XSD files used for creating application datatypes.

Unsupported Structure If a datatype with two identically named choice members is created from an XSD file, there is no way to determine an exact match from instance XML to either of the members.

```
<xsd:complexType Name="Buyer">
  <xsd:choice>
    <xsd:element name="Name" type="xsd:string"/>
    <xsd:element name="Name" type="xsd:string"/>
  </xsd:choice>
</xsd:complexType>
```

"Name " can be matched to either of the "Name " members in the XSD.

```
<Buyer>
  <Name>Rakesh</Name>
</Buyer>
```

Workaround The second "Name " datatype member is redundant and must be removed. This does not impact the set of valid instances.

```
<xsd:complexType Name="Buyer">
  <xsd:choice>
    <xsd:element name="Name" type="xsd:string"/>
  </xsd:choice>
</xsd:complexType>
```

Nondeterministic sequence Block

This occurs when a `sequence` contains two or more elements with the same qualified name with no mandatory `elements` between them, and the first occurrence has a cardinality other than `[1,1]`. In this case, it is not always possible to determine the element to which an instance matches. Validation error `AIP-16744` appears if such a structure is encountered in the XSD file.

The following sections provide examples of the ways in which this can occur in an XSD file. The workaround in each case is to combine the elements into a single element by adding up the different `minOccurs` and `maxOccurs`.

- [Unsupported XSD Fragments and Workarounds: Example 1 \(First element has `minOccurs="0"`\)](#)
- [Workaround](#)
- [Unsupported XSD Fragments and Workarounds: Example 2 \(Both occurrences have `maxOccurs="unbounded"`\)](#)
- [Workaround](#)
- [Unsupported XSD Fragments and Workarounds: Example 3 \(Both have `maxOccurs="2"`\)](#)
- [Workaround](#)

Note: These workarounds are only applicable for XSD files used for creating application datatypes.

Unsupported XSD Fragments and Workarounds: Example 1 (First element has minOccurs="0")

Unsupported XSD Fragments:

In this example, Buyer1 has two optional "Name" elements, and Buyer2 has one optional and one required "Addr" element:

```
<xs:complexType Name="Buyer">
  <xs:sequence>
    xs:element name="Buyer1">
      <xs:complexType>
        <xs:sequence>
          <xs:element name="Name" minOccurs="0" type="xsd:string"/>
          <xs:element name="Name" minOccurs="0" type="xsd:string"/>
        </xs:sequence>
      </xs:complexType>
    </xs:element>
    <xs:element name="Buyer2">
      <xs:complexType>
        <xs:sequence>
          <xs:element name="Addr" minOccurs="0" type="xsd:string"/>
          <xs:element name="Addr" maxOccurs="2" type="xsd:string"/>
        </xs:sequence>
      </xs:complexType>
    </xs:element>
  </xs:sequence>
</xs:complexType>
```

If there was a mandatory element with a different name in between the two "Name" elements, then that XSD construct is deterministic and valid in Oracle Application Server ProcessConnect.

```
<xsd:complexType Name="ValidBuyer">
  <xsd:sequence>
    <xsd:element name="Name" minOccurs="0" type="xsd:string"/>
    <xsd:element name="Pid" type="xsd:string"/>
    <xsd:element name="Name" minOccurs="0" type="xsd:string"/>
  </xsd:sequence>
</xsd:complexType>
```

Corresponding Instance XML:

In this corresponding instance of `Buyer`, "Name" can match to either of the "Name" members under `Buyer1`, and the first "Addr" can match to either "Addr" member under `Buyer2`.

```
<Buyer>
  <Buyer1>
    <Name>Rakesh</Name>
  </Buyer1>
  <Buyer2>
    <Addr>500 Oracle Pkwy</Addr>
    <Addr>Redwood Shores</Addr>
  </Buyer2>
</Buyer>
```

In this instance of `ValidBuyer`, "Name" matches exactly to the first "Name" member element.

```
<ValidBuyer>
  <Name>Rakesh</Name>
  <Pid>1234</Pid>
</ValidBuyer>
```

Workaround Combine the redundant members into a single member, which makes the datatype deterministic and valid in Oracle Application Server ProcessConnect. This workaround does not impact the set of valid instances.

To determine the cardinality of the member, add the cardinalities of the original members. In the example, both "Name" elements have a cardinality of [0, 1]. Therefore the consolidated "Name" element has a cardinality of [0, 2]. The "Addr" elements have cardinalities [0, 1] and [1, 2], so the consolidated "Addr" element has a cardinality of [1, 3].

```
<xs:complexType Name="Buyer">
  <xsd:sequence>
    <xs:element name="Buyer1">
      <xs:complexType>
        <xsd:sequence>
          <xs:element name="Name" minOccurs="0" maxOccurs="2"
            type="xsd:string"/>
        </xsd:sequence>
      </xs:complexType>
    </xs:element>
    <xs:element name="Buyer2">
      <xs:complexType>
        <xsd:sequence>
          <xs:element name="Addr" minOccurs="1" maxOccurs="3"
            type="xsd:string"/>
        </xsd:sequence>
      </xs:complexType>
    </xs:element>
  </xsd:sequence>
</xs:complexType>
```

Unsupported XSD Fragments and Workarounds: Example 2 (Both occurrences have maxOccurs="unbounded")

Unsupported XSD Fragments:

```
<xsd:complexType Name="Buyer">
  <xsd:sequence>
    <xsd:element name="Name" maxOccurs="unbounded" type="xsd:string"/>
    <xsd:element name="Name" minOccurs="0" maxOccurs="unbounded"
      type="xsd:string"/>
    <xsd:element name="Name" minOccurs="0" maxOccurs="unbounded"
      type="xsd:string"/>
  </xsd:sequence>
</xsd:complexType>
```

If the XSD construct has another mandatory element in between, then that XSD construct is deterministic and valid in Oracle Application Server ProcessConnect.

```
<xsd:complexType Name="ValidBuyer">
  <xsd:sequence>
    <xsd:element name="Name" maxOccurs="unbounded" type="xsd:string"/>
    <xsd:element name="Pid" maxOccurs="unbounded" type="xsd:string"/>
    <xsd:element name="Name" maxOccurs="unbounded" type="xsd:string"/>
  </xsd:sequence>
</xsd:complexType>
```

Corresponding Instance XML:

The second "Name" instance can be matched to any of the "Name" elements in Buyer.

```
<Buyer>
  <Name>Rakesh</Name>
  <Name>Ram</Name>
</Buyer>
```

Each instance can be exactly matched here to its corresponding element:

```
<ValidBuyer>
  <Name>Rakesh</Name>
  <Name>Ram</Name>
  <Pid>1234</Pid>
  <Name>Aninda</Name>
</ValidBuyer>
```

Workaround Combine the redundant members into a single member, which makes the datatype deterministic and valid in Oracle Application Server ProcessConnect. This workaround does not impact the set of valid instances.

Replace all the redundant members with a single member that has the combined cardinality of all the redundant elements. In the example, the original cardinalities are [1, unbounded), [0, unbounded), and [0, unbounded), so the combined cardinality is [1, unbounded).

```
<xsd:complexType Name="Buyer">
  <xsd:sequence>
    <xsd:element name="Name" minOccurs="1" maxOccurs="unbounded"
      type="xsd:string"/>
  </xsd:sequence>
</xsd:complexType>
```

Unsupported XSD Fragments and Workarounds: Example 3 (Both have maxOccurs="2")

Unsupported XSD Fragment:

```
<xsd:complexType Name="Buyer">
  <xsd:sequence>
    <xsd:element name="Name" maxOccurs="2" type="xsd:string"/>
    <xsd:element name="Name" maxOccurs="2" type="xsd:string"/>
  </xsd:sequence>
</xsd:complexType>
```

Corresponding Instance XML:

name2 matches to both "Name" elements.

```
<Buyer>
  <Name>name1</Name>
  <Name>name2</Name>
  <Name>name3</Name>
</Buyer>
```

Workaround:

Replace the two "Name" elements with a single "Name" element having their combined cardinality.

```
<xsd:complexType Name="Buyer">
  <xsd:sequence>
    <xsd:element name="Name" minOccurs="2" maxOccurs="4"
      type="xsd:string"/>
  </xsd:sequence>
</xsd:complexType>
```

Deterministic XSD Constructs with lookahead

XSD constructs result in instances with some elements that cannot be correctly matched to an Oracle Application Server ProcessConnect datatype member by looking at a single instance element. Subsequent instance elements must be checked. These XSD constructs cause validation error AIP-16744. This section contains the following topics:

- [Unsupported Structure](#)
- [Workaround](#)

Note: These workarounds are only applicable for XSD files used for creating application datatypes.

Unsupported Structure In this XSD file, complex type "AttachRef" has a choice of "FileName" and a sequence of "FileName" and "URI". In instance XML, "FileName" can be matched to an XSD element based on the presence of "URI". This requires lookahead on the instance XML at runtime that is not currently done.

```
<xsd:complexType name="AttachRef" >
  <xsd:choice>
    <xsd:element name="FileName" type="xsd:string"/>
    <xsd:sequence>
      <xsd:element name="FileName" type="xsd:string"/>
      <xsd:element name="URI" type="xsd:string" />
    </xsd:sequence>
  </xsd:choice>
</xsd:complexType>

<xsd:complexType name="Name">
  <xsd:choice>
    <xsd:sequence>
      <xsd:element name="First" type="xsd:string"/>
      <xsd:element name="Middle" type="xsd:string" />
    </xsd:sequence>
    <xsd:sequence>
      <xsd:element name="First" type="xsd:string"/>
      <xsd:element name="Nickname" type="xsd:string" />
    </xsd:sequence>
  </xsd:choice>
</xsd:complexType>
```

Corresponding Instance XML:

In the following instance, "FileName" must be matched to the "FileName" element that is directly under "Attachref".

```
<AttachRef>
  <FileName>a.xml</FileName>
</AttachRef>
```

"FileName" must be matched here to the "FileName" element under sequence because "URI" cannot be the next element in the instance for the top-level "FileName".

```
<AttachRef>
  <FileName>a.xml</FileName>
  <URI>http://www.oracle.com</URI>
</AttachRef>
```

For these kind of constructs, instance elements cannot be matched correctly without looking ahead at the subsequence elements that are not currently supported in Oracle Application Server ProcessConnect.

Workaround Take the common part of the different choice members and put this as the first element in a sequence. Then create a new choice that has a member for each of the remainders of the original choice members, and add this as the second element in the sequence. This does not impact the set of valid instances.

In the first example, the top level choice block is replaced with a sequence that has two elements. The first element is the redundant "FileName". The second element is a choice between "URI" and nothing, which can be designed as an optional choice block with a single element, or more simply as an optional element.

```
<xsd:complexType name="AttachRef" >
  <xsd:sequence>
    <xsd:element name="FileName" type="xsd:string"/>
    <xsd:element name="URI" type="xsd:string" minOccurs="0"/>
  </xsd:sequence>
</xsd:complexType>
```

In the second example, the top level choice block is replaced with a sequence that has two elements. The first element is the redundant "First". The second element is a choice between "Middle" and "Nickname".

```
<xsd:complexType name="Name" >
  <xsd:sequence>
    <xsd:element name="First" type="xsd:string"/>
    <xsd:choice>
      <xsd:element name="Middle" type="xsd:string"/>
      <xsd:element name="Nickname" type="xsd:string"/>
    </xsd:choice>
  </xsd:sequence>
</xsd:complexType>
```

Attributes with Unsupported Values

Table A-2 lists the attributes with unsupported values. An error occurs if any of these attributes having an unsupported value are encountered in an XMLSchema document.

Table A-2 *Attributes with Unsupported Values*

Attribute	Element Types	Unsupported Values	Description
mixed	complexContent, complexType	true	A value of true indicates that a corresponding instance can have character data and the declared child elements.
nillable	element	true	Attribute within element declaration to signify whether null elements are allowed (that is, corresponding <code>xsi:nil="true"</code> in the instance).
processContents	any type	lax, strict	Attribute indicating validation level for replacement elements. Since the XMLSchema default for this attribute is strict, every wildcard must explicitly set it to the only allowed value, skip.

Unsupported XML Instance Constructs

The following constructs are not supported by Oracle Application Server ProcessConnect in XML instances.

- `xsi:type`
- `xsi:nil`

`xsi:type`

This attribute occurs within an instance element and specifies the actual type of the instance element. If `xsi:type` is present in an XML instance that contains elements declarations of the actual type, it causes the following runtime translation exception errors:

```
Error -: AIP-10412: Translation step failed during execution:
Error -: AIP-14114: Translation error occurred in translator
oracle.tip.ts.translation.xsd.translator.XSDInboundTranslator :
oracle.tip.ts.exception.DomainResourceException: Error -: AIP-14117: Input XML
is invalid current element nib of namespace Null can not appear in XML
Instance after ink from namespace Null according to the datatype model
```

There is no current workaround.

```
<billTo xsi:type="unsupported">
  <name>Robert Smith</name>
  <street>8 Oak Avenue</street>
  <city>Old Town</city>
  <state>PA</state>
  <zip>95819</zip>
</billTo>
```

`xsi:nil`

This attribute within an instance element is used to indicate explicitly that the element has a null value. Runtime translation exception error AIP-14117 appears if this tag is encountered in an instance. There is no current workaround.

```
<shipDate xsi:nil="true"></shipDate>
```

Naming Restrictions

simpleType and complexType

Within a namespace, names must be unique across simpleTypes and complexTypes. However, a simpleType or complexType can have the same name as an attribute, element, group, or attributeGroup.

Example of Invalid XSD The following is an example of an unsupported XSD file.

```
<xs:schema targetNamespace="http://www.oracle.com/ipdemo"
  xmlns="http://www.oracle.com/ipdemo"
  xmlns:xs="http://www.w3.org/2001/XMLSchema">
  <xs:simpleType name="foo">
    <xs:restriction base="xs:anySimpleType"/>
  </xs:simpleType>
  <xs:complexType name="foo">
    <xs:all>
      <xs:element name="bar" type="xs:string"/>
    </xs:all>
  </xs:complexType>
</xs:schema>
```

Example of Supported XSD The following is an example of a supported XSD file.

```
<xs:schema targetNamespace="http://www.oracle.com/ipdemo"
  xmlns="http://www.oracle.com/ipdemo"
  xmlns:xs="http://www.w3.org/2001/XMLSchema">
  <xs:simpleType name="foo">
    <xs:restriction base="xs:anySimpleType"/>
  </xs:simpleType>
  <xs:element name="foo" type="foo"/>
</xs:schema>
```

element, attribute, group, and attributeGroup

Within a namespace, names must be unique across global elements, attributes, groups, and attributeGroups. If this occurs in an XSD file, the names must be changed.

Unsupported XSD Example The following is an example of an unsupported XSD file.

```
<xs:schema targetNamespace="http://www.oracle.com/ipdemo"
  xmlns="http://www.oracle.com/ipdemo"
  xmlns:xs="http://www.w3.org/2001/XMLSchema">
  <xs:element name="bar" type="xs:integer"/>
  <xs:attribute name="bar">
    <xs:simpleType>
      <xs:restriction base="xs:string">
        <xs:length value="4"/>
      </xs:restriction>
    </xs:simpleType>
  </xs:attribute>

  <xs:attributeGroup name="type">
    <xs:attribute name="size" type="xs:nonNegativeInteger"/>
    <xs:attribute name="style" type="xs:string"/>
  </xs:attributeGroup>
  <xs:attribute name="type" type="xs:string"/>

  <xs:group name="color">
    <xs:sequence>
      <xs:element name="r" type="unsignedShort"/>
      <xs:element name="g" type="unsignedShort"/>
      <xs:element name="b" type="unsignedShort"/>
    </xs:sequence>
  </xs:group>
  <xs:attributeGroup name="color">
    <xs:attribute name="red" type="xs:string"/>
    <xs:attribute name="green" type="xs:string"/>
    <xs:attribute name="blue" type="xs:string"/>
  </xs:attributeGroup>
  <xs:element name="root">
    <xs:complexType>
      <xs:sequence>
        <xs:group ref="color"/>
        <xs:element ref="bar"/>
      </xs:sequence>
      <xs:attribute ref="type"/>
      <xs:attributeGroup ref="type"/>
      <xs:attribute ref="bar"/>
      <xs:attributeGroup ref="color"/>
    </xs:complexType>
  </xs:element>
</xs:schema>
```

Workaround

If one of the objects in a name conflict is a `group` or `attributeGroup`, change the name of that object. `group` and `attributeGroup` names are not used in instances. Otherwise, the conflict is between an element and an attribute. In this case, if the attribute has a locally defined type, move this type definition to a top-level type named `simpleType`. Then, remove the attribute declaration and change all attribute references to local attributes with the name and type of the original attribute declaration.

These workarounds do not impact the set of valid instances.

```
<xs:schema targetNamespace="http://www.oracle.com/ipdemo"
  xmlns="http://www.oracle.com/ipdemo"
  xmlns:xs="http://www.w3.org/2001/XMLSchema">

  <xs:element name="bar" type="xs:integer"/>
  <xs:simpleType name="bar">
    <xs:restriction base="xs:string">
      <xs:length value="4"/>
    </xs:restriction>
  </xs:simpleType>

  <xs:attributeGroup name="typeAttrGroup">
    <xs:attribute name="size" type="xs:nonNegativeInteger"/>
    <xs:attribute name="style" type="xs:string"/>
  </xs:attributeGroup>
  <xs:attribute name="type" type="xs:string"/>

  <xs:group name="colorGroup">
    <xs:sequence>
      <xs:element name="r" type="unsignedShort"/>
      <xs:element name="g" type="unsignedShort"/>
      <xs:element name="b" type="unsignedShort"/>
    </xs:sequence>
  </xs:group>
  <xs:attributeGroup name="colorAttrGroup">
    <xs:attribute name="red" type="xs:string"/>
    <xs:attribute name="green" type="xs:string"/>
    <xs:attribute name="blue" type="xs:string"/>
  </xs:attributeGroup>
```

```
<xs:element name="root">
  <xs:complexType>
    <xs:sequence>
      <xs:group ref="colorGroup"/>
      <xs:element ref="bar"/>
    </xs:sequence>
    <xs:attribute ref="type"/>
    <xs:attributeGroup ref="typeAttrGroup"/>
    <xs:attribute name="bar" type="bar"/>
    <xs:attributeGroup ref="colorAttrGroup"/>
  </xs:complexType>
</xs:element>
</xs:schema>
```

XSD Support Unavailable through Oracle Application Server ProcessConnect User Interface Tool

This section describes XSD datatypes, datatype members, and attributes that can only be added to Oracle Application Server ProcessConnect through XSD files and not through the Oracle Application Server ProcessConnect user interface tool.

Derived Datatypes

The following tags enable you to create derived datatypes:

- `extension`

The Oracle Application Server ProcessConnect user interface tool cannot create complex datatypes that are extensions of other datatypes. Use the `extension` element in XSD files to perform this task.

- `restriction`

The Oracle Application Server ProcessConnect user interface tool cannot create complex datatypes that are restrictions of other complex datatypes. Use the `restriction` element in XSD files to perform this task. However, the Oracle Application Server ProcessConnect user interface tool does support the creation of scalar datatypes that are restrictions of other scalar datatypes.

Datatypes

- **Anonymous**

The Oracle Application Server ProcessConnect user interface tool cannot create anonymous datatypes. Use XSD files to perform this task by not specifying names for datatype definitions.

- **Abstract**

The Oracle Application Server ProcessConnect user interface tool cannot create abstract datatypes. Use XSD files to perform this task by setting the attribute `abstract` to be `true` for datatype definitions.

- **Reference Only**

The Oracle Application Server ProcessConnect user interface tool cannot create reference-only datatypes. Use XSD files to perform this task by specifying datatype definitions within top-level (global) element definitions.

Those datatypes defined within global element definitions become reference-only datatypes.

- **Member Group Type**

The Oracle Application Server ProcessConnect user interface tool cannot create member-group-type datatypes. Use XSD files to perform this task by defining substitution groups. A member-group-type datatype is created out of each substitution group.

Datatype Members

- **Element/Attribute**

The Oracle Application Server ProcessConnect user interface tool cannot create datatype members of type `Attribute`. Use XSD files to define attributes for complex datatypes.

- **Anonymous**

The Oracle Application Server ProcessConnect user interface tool cannot create anonymous datatype members. Use XSD files to specify names for elements of complex datatype definitions.

- Qualified

The Oracle Application Server ProcessConnect user interface tool cannot create qualified datatype members. Use XSD files to do so by qualifying elements or attributes; that is, specifying `targetNamespace` and setting `elementFormDefault`, `attributeFormDefault`, or both to be `qualified` or setting `form` to be `qualified` individually for elements and attributes.

- Member Group Head

The Oracle Application Server ProcessConnect user interface tool cannot create member-group-head datatype members. Use XSD files to do so by defining substitution groups. A member-group-head datatype member is created out of each nonabstract substitution group.

Data Definition Description Language

Oracle Application Server ProcessConnect supports the use of native formats that adhere to the standards of the data definition description language (D3L).

This section contains these topics:

- [About D3L](#)
- [Wire Message Format and D3L File Example](#)

About D3L

This section defines and describes when D3L is used.

What Is D3L?

D3L is an XML-based message description language that describes the structure that a native, non-XML format message (known as the wire message) must follow to communicate with Oracle Application Server ProcessConnect.

When Is D3L Used?

Not all parties in an integration use XML as their native message payload format. Parties also use other native formats in their wire messages, which are best described as structured records of bytes, characters, or both. For these native formats to be successfully translated into a format understood by other parties, the content of their messages must follow a predefined, structured set of rules.

D3L provides both a predefined, structured set of rules and translation capabilities for the native format of wire messages. Specifically, D3L provides:

- An XML-based message description language that describes the contents of wire messages
- A D3L translator that uses the instructions defined in the D3L file to translate the native event and its event body elements into an application event (XML) and its event body elements for inbound messages, and vice versa for outbound messages.

The D3L descriptions must comply with a syntax defined by the D3L document type definition (DTD). D3L enables you to describe the record layout of binary, string, structured, and sequence data. Use D3L only when the number of fields in the underlying wire message is fixed and known. D3L is not suitable for:

- Descriptions of arbitrarily structured data (like regular XML)
- Conditional data structures, which require nontrivial token look-ahead to parse.

See Also:

- ["Wire Message Format and D3L File Example"](#) on page A-38
- ["Supported D3L Datatypes"](#) on page A-43
- ["D3L DTDs"](#) on page A-96 for the two DTD files available for use

Wire Message Format and D3L File Example

This section provides an example of how the contents of a wire message are described in a D3L file. This file can then be specified after you select D3L as your translator in the Oracle Application Server ProcessConnect user interface tool.

Satisfying these requirements enables a native event and native event body elements to be created from the wire message content and then successfully translated into an application event (XML) and its event body elements.

See Also: [Chapter 11, "Managing Adapter Interactions and Event Types"](#) for instructions on selecting D3L as a translator and specifying a D3L file

Wire Message Contents Description in a D3L File

This example shows a party's wire message (named `price`) that contains payload data for updating the price of personal computer model number 2468 to 199.99. Logically, the wire message can be described as using the following format and structure:

```
message ::= <action> <model> <price>
```

Where...	Is...
<action>	UPDATE_PRICE
<model>	2468
<price>	199.99

The runtime payload data must strictly follow the structure defined in a D3L file (for this example, `price.xml`) for the D3L translator to translate it into an application event. [Figure A-1](#) shows how a D3L file (`price.xml`) defines the exact structure that the wire message `price` must follow to define the three preceding elements of payload data (now with pertinent delimiters introduced).

Figure A-1 Wire Message Payload Data and D3L File Syntax

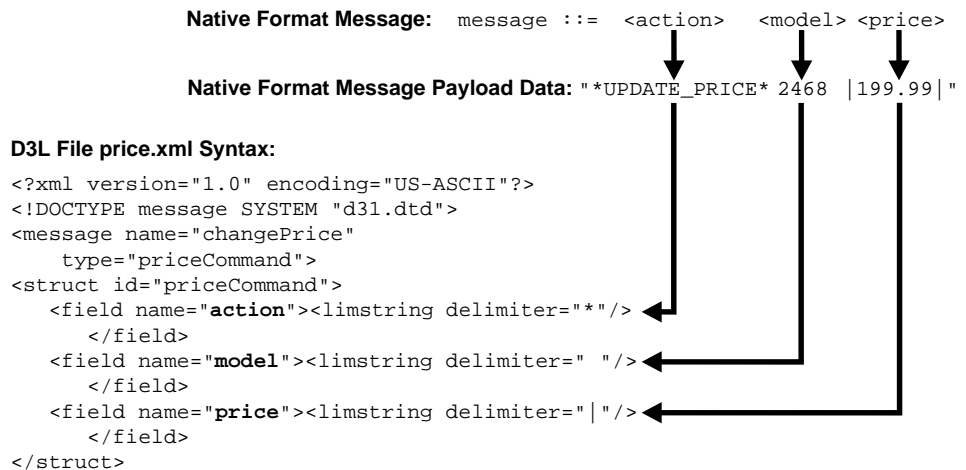

All three payload data elements are defined as strings with different delimiters for separating their data.

See Also: ["Delimited Strings - limstring"](#) on page A-49 for a description of `limstring` code

D3L File Structure

This section contains these topics:

- [D3L File Structure Example](#)
- [Supported D3L Datatypes](#)
- [Data Padding Usage](#)
- [Comma-Separated Values File Parsing with D3L](#)
- [Oracle Application Server ProcessConnect Enhancements to D3L](#)
- [Additional D3L Sample Files and DTD](#)

D3L File Structure Example

This section describes the contents of a sample D3L file named `book_reply.xml`. The `book_reply.xml` message has the following logical structure:

- `replyFlight = AirportCodeFrom AirportCodeTo Itineraries`
- `Itineraries = { ItinRecord }`
- `ItinRecord = DepartureTime ArrivalTime`
- `DepartureTime = DateTimeRecord`
- `ArrivalTime = DateTimeRecord`
- `DateTimeRecord = "MMDDYY"`

Note how the `<message>` attribute `type` refers to the top-level structure of the message definition. A line-by-line walkthrough of the meaning of each line in the D3L definition is shown in this section.

```

1 <?xml version="1.0" encoding="US-ASCII"?>
2 <!DOCTYPE message SYSTEM "d3l.dtd">
3 <message name="replyFlight" type="BookingReplyType">
4
5     <unsigned4 id="u4" />
6     <unsigned2 id="u2" />
7     <struct id="DateTimeRecord">
8         <field name="DateInfo">
9             <date format="MMDDYY">
10                <pfxstring id="datstr" length="u4" />
11            </date>
12        </field>
13        <field name="TimeHour"><limstring delimiter="*" /></field>
14        <field name="TimeMinute"><limstring delimiter="*" /></field>
15    </struct>
16    <struct id="ItinRecord">
17        <field name="DepartureTime"><typeref type="DateTimeRecord" /></field>
18        <field name="ArrivalTime"><typeref type="DateTimeRecord" /></field>
19    </struct>
20    <pfxarray id="ItinArray" length="u2">
21        <typeref type="ItinRecord" />
22    </pfxarray>
23    <struct id="BookingReplyType">
24        <field name="AirportCodeFrom"><limstring delimiter="*" /></field>
25        <field name="AirportCodeTo"><limstring delimiter="*" /></field>
26        <field name="Itineraries"><typeref type="ItinArray" /></field>
27    </struct>
28 </message>

```

Lines 1 through 2

These lines define standard information, such as the Prolog and Document Type Declaration (DTD) that must always be these values (for example, specifying `d3l.dtd` as the DTD). The encoding can vary according to the locale.

Lines 3 through 4

These lines define the following:

- Message element attribute name (value `replyFlight`) equals the application event datatype name, which is used when this D3L definition is specified when creating a native event type
- Message element attribute type (value `BookingReplyType`) names the top-level structure that is defined in subsequent lines of this D3L file

See Also: ["Creating Native and Application Event Types and Body Elements"](#) on page 11-27

Lines 5 through 6

These lines define an unsigned, four-byte integer and unsigned, two-byte integer. These datatype declarations are named `u4` and `u2`, respectively, so they can be referred to later. Because they are declarations, they do not directly map to data in the native language, but are instead used in `typesets` for increased maintainability.

Lines 7 through 15

These lines define the fields of a structure named `DateTimeRecord`:

- Field `DateInfo` defines a date format of `MMDDYY` consisting of a length prefixed string (length stored as an unsigned, binary, four-byte integer).
- Field `TimeHour` defines a string delimited by the character `*`.
- Field `TimeMinute` defines a string delimited by the character `*`.

Lines 16 through 19

These lines define the fields of the structure named `ItinRecord`:

- Fields `DepartureTime` and `ArrivalTime` both consist of the `DateTimeRecord` structure defined in ["Lines 7 through 15"](#) on page A-42, referencing it through `typerefs`.

Lines 20 through 22

These lines define a length-prefixed array named `InitArray`, where each array element is of type `ItinRecord`. The length is stored ahead of the array contents as a two-byte, unsigned, binary integer.

Lines 23 through 27

These lines define the fields of the message structure `BookingReplyType` (which satisfies the `BookingReplyType` type reference in the message document element, as shown in "[Lines 3 through 4](#)"):

- Field `AirportCodeFrom` is a string delimited by the character `*` on both sides.
- Field `AirportCodeTo` is a string delimited by the character `*`.
- Field `Itineraries` is a field of type `ItinArray` (which is an array of `ItinRecord`) (See "[Lines 16 through 19](#)" and "[Lines 20 through 22](#)" on page A-43).

Supported D3L Datatypes

D3L supports the following datatypes and declarations in a D3L file:

- [Signed and Unsigned Integers](#)
- [Floating Point Numbers](#)
- [Strings and Dates](#)
- [Structures](#)
- [Sequences and Arrays](#)

Signed and Unsigned Integers

D3L supports signed and unsigned integers that can be one, two, four, or eight octets (bytes) in size, and in big- or little-endian byte ordering. D3L also supports byte position alignment.

Example A-1 Quantity Field

```
<field name="quantity">  
  <unsigned4 endian="big" align="6"/>  
</field>
```

The field "quantity" defines a four-byte, unsigned, binary integer, using big (default) endian, and at an alignment of six bytes. For example, D3L ensures that the reading or writing of this integer starts at a position in the buffer, so that $position \bmod alignment = 0$.

Note: *Little-endian* means that the low-order byte of the number is stored in memory at the lowest address, and the high-order byte is stored at the highest address. *Big-endian* means that the high-order byte of the number is stored in memory at the lowest address, and the low-order byte is stored at the highest address.

Data Example for Example A-1:

Byte addresses (hex):

00 01 02 03 04 05 06 07 08 09 0A 0B

Byte (hex):

00 00 00 00 00 00 **80** **FF** **FF** **FF** 00 00

Parsed value (dec):

$$\begin{array}{cccc} \text{quantity} = & 128 \times 256^3 & + & 255 \times 256^2 & + & 255 \times 256^1 & + & 255 \times 256^0 & = & 2164260863 \\ & \mathbf{80} & & \mathbf{FF} & & \mathbf{FF} & & \mathbf{FF} & & \end{array}$$
Example A-2 Weight and Length Field

```
<field name="weight"> <unsigned2 align="3"/> </field>  
<field name="length"> <unsigned2 align="3"/> </field>
```

The fields "weight" and "length" define two two-byte unsigned, binary integers, using big-endian, and at an alignment of three bytes.

Data Example for Example A-2:*Byte addresses (hex):*.. 07 08 09 0A 0B 0C 0D 0E ..*Byte (hex):*.. 00 00 **EE 88** 00 **22 F0** 00 ..*Parsed value (dec):* $\text{weight} = 238 \times 256^1 + 136 \times 256^0 = 61064$ $\text{length} = 34 \times 256^1 + 240 \times 256^0 = 8944$ **Example A-3 Temperature, Pressure, and Wind Fields**

```

<field name="temperature"> <signed2 endian="little" />          </field>
<field name="pressure">    <unsigned4 endian="big" />           </field>
<field name="wind">       <unsigned2 endian="little" align="4" /> </field>

```

The field "temperature" defines a two-byte, signed, binary integer, using little-endian, and no alignment.

The field "pressure" defines a four-byte, unsigned, binary integer, using big-endian, and no alignment.

The field "wind" defines a two-byte, unsigned, binary integer, using little-endian, and a four-byte alignment.

Data Example for Example A-3:

Byte addresses (hex):

.. 60 61 62 63 64 65 66 67 68 69 ..

Byte (hex):

.. **EF FE** 00 00 **04 0A** 00 00 **3C 00** ..
 ^ ^ ^
 little end *big end* *alignment*

Parsed value (dec):

temperature = $256 \times 256 - (239 \times 256^0 + 254 \times 256^1) = -273$
pressure = $4 \times 256^1 + 10 \times 256^0 = 1034$
wind = $60 \times 256^0 + 0 \times 256^1 = 60$

Floating Point Numbers

D3L supports single and double-precision, IEEE format, floating-point data. Single-precision, floating point numbers (known as floats) take up four bytes. Double-precision, floating point numbers (known as doubles) take up eight bytes.

Example A-4 Distance and Age Fields

```
<field name="distance"> <double align="6"/> </field>  
<field name="age">      <float />              </field>
```

The field "distance" defines an eight-byte, double-float (floating-point value according to the IEEE 754 floating-point double precision bit layout), at an alignment of six bytes.

The field "age" defines a four-byte, single-float (floating-point value according to the IEEE 754 floating-point single precision bit layout).

Note: The IEEE 754 floating-point format is parsed and produced by the following Java class methods:

- `java.io.DataInput.readFloat()`
 - `java.io.DataInput.readDouble()`
 - `java.io.DataOutput.writeFloat()`
 - `java.io.DataOutput.writeDouble()`
-
-

Data Example for [Example A-4](#):

Byte addresses (hex):

```
.. 77 78 79 7A 7B 7C 7D 7E 7F 80 81 xx xx ..
```

Byte (hex):

```
00 00 D2 47 D3 CE 16 2A B1 A1 5E 5D 6B 0B ..
      ^ double                ^ float
```

Parsed value (dec):

```
distance = 1 x 1038
age = 1 x 1018
```

Strings and Dates

D3L supports the following string types:

- Constant length strings (without delimiters, and with optional padding to fill out empty spaces at the beginning or end of the string)
- Delimited strings (can be delimited by an arbitrary delimiter character)
- Length-prefixed strings (where the length prefix is an unsigned, numeric type). Unsigned numeric types are one of the binary integer types described in "[Signed and Unsigned Integers](#)" on page A-43 or are a number stored as a string.
- Optionally-quoted strings terminated by a specified character.
- Strings terminated by a delimiter defined by an enclosing `limarray` structure.

- Seven date formats keep information stored as a string in one of the supported formats with any separator character between month, date, and year.
- Numbers not defined as binary data, but as strings. Any one of the three string formats can define a number (either an integer or a floating-point entity).

Constant Length String - padstring This section provides an example:

Example A-5 Constant length strings - padstring

```
<field name="CURRENCY_CODE">
  <padstring length="4" padchar=" " padstyle="tail"/>
</field>
<field name="COUNTRY_CODE">
  <padstring length="2" padchar="" padstyle="none"/>
</field>
<field name="TO_USD_RATE">
  <padstring length="12" padchar="0" padstyle="head"/>
</field>
```

The field "CURRENCY_CODE" defines a fixed length string of four characters. Any blank (" ") characters (pads) near the end (padstyle="tail") of the string are not considered part of the data value.

The field "COUNTRY_CODE" defines a fixed length string of two characters. Since padstyle is "none", all characters in this field are part of the data value.

The field "TO_USD_RATE" defines a fixed length string of 12 characters. Any zeros ("0" pads) at the beginning (padstyle="head") of the string are not considered part of the data value.

Data Example for Example A-5:

Native byte (character) stream:

```
GBP UK000012550.00
```

Parsed values:

```
CURRENCY_CODE = 'GBP'
COUNTRY_CODE  = 'UK'
TO_USD_RATE   = '12550.00'
```

Delimited Strings - limstring This section provides an example:

Example A-6 Delimited strings - limstring

```
<field name="State">    <limstring delimiter="." /> </field>
<field name="Region">  <limstring delimiter="." /> </field>
<field name="City">    <limstring delimiter="|" /> </field>
<field name="Landmark"> <limstring delimiter="|" /> </field>
<field name="Street">  <limstring delimiter="+" /> </field>
```

The five fields "State", "Region", "City", "Landmark", and "Street" are delimited strings each respectively enclosed by ".", ".", "|", "|", and "+".

Data Example for Example A-6:

Native byte (character) stream:

```
.FL..Florida Keys.|Key West||Ernest Hemingway Museum|+Whitehead St.+
```

Parsed values:

```
State = 'FL'
Region = 'Florida Keys'
City = 'Key West'
Landmark = 'Ernest Hemingway Museum'
Street = 'Whitehead St.'
```

Length Prefixed Strings - pfxstring This section provides an example:

Example A-7 Length prefixed strings - pfxstring

```
<unsigned1 id="ubyte1" />
<unsigned2 id="ubyte2" endian="little" />
<struct>
  <field name="user">    <pfxstring length="ubyte1" /> </field>
  <field name="encr_user"> <pfxstring length="ubyte2" /> </field>
```

The field "user" defines a string, the length of which is defined by a one-byte binary integer preceding the string contents.

The field "encr_user" defines a string, the length of which is defined by a two-byte, little-endian, binary integer preceding the string contents. Note that the value of the length attribute must refer to a datatype declaration done somewhere else in the D3L definition.

Data Example for Example A-7:

Byte addresses (hex):

```
00 01 02 03 04 05 06 07 08 09 0A 0B 0C 0D 0E 0F 10 11 12
```

Characters:

```
03 j o e 0D 00 D U Z a c . 1 H K V m I Y
```

Parsed values:

```
user = 'joe'  
encr_user = 'DUZac.1HKVmIY'
```

Terminated Strings - termstring This section provides an example:

Example A-8 Optionally-Quoted Terminated Strings - termstring

```
<field name="product"> <termstring endchar=","/> </field>  
<field name="ordered"> <termstring endchar=","/> </field>  
<field name="inventory"> <termstring endchar=","/> </field>  
<field name="backlog"> <termstring endchar=","/> </field>  
<field name="listprice"> <termstring endchar="\n"/> </field>
```

The first four fields each are populated with input characters until the terminating/ending character (endchar) is encountered (", "). The last field is ended with a line feed.

Data Example for Example A-8:

Native byte (character) stream:

```
1020,16,18,,1580.00<LF>
```

Parsed values:

```
product = '1020'
ordered = '16'
inventory = '18'
backlog = ''
listprice = '1580.00'
```

Note: The backlog field is empty.

Optionally-Quoted Terminated Strings - qtdtermstring This section provides an example:

Example A-9 Optionally-Quoted Terminated Strings - qtdtermstring

```
<struct id="PersonInfo" quote=''>
  <field name="PersonName"> <qtdtermstring endchar="," /> </field>
  <field name="Address"> <qtdtermstring endchar="," /> </field>
  <field name="DOB"> <qtdtermstring endchar="," /> </field>
  <field name="Telephone"> <qtdtermstring endchar="\n"/> </field>
</struct>
```

Data Example for Example A-9:

The preceding D3L definition (code) parses each of the following input lines:

Native byte (character) stream:

```
"Smith, John", "1 Old Street, Old Town, Manchester", "0161-499-1717"
Fred, "2 Old Street, Old Town, Manchester", "20-08-1954", "0161-499-1718"
"Smith, Bob",,, 0161-499-1719
```

The parsed values are not listed here. Note, however, that commas within quotation marks are not treated as delimiters. The `quote` attribute can also be defined as an attribute to the `qtdtermstring` element. For example:

```
<qtdtermstring quote="*" endchar="," />
```

It can also be defined globally at the root element message level. For example:

```
<message name="my_msg" quote="" ...>
```

If no `quote` attribute is defined anywhere, D3L defaults to using a double quote (") as the quotation character when parsing any `qtdtermstring`. As a general rule, the `quote` attribute definition in nearest proximity (structurally) of a `qtdtermstring` takes precedence.

Simple Strings - `simplestring` This section provides an example:

Example A-10 Simple strings - `simplestring`

```
<limarray id="CSV_Type" contchar="," endchar="\n">
  <simplestring />
</limarray>
<struct>
  <field name="CSV"> <typeref type="CSV_Type" /> </field>
```

The field "CSV" references a type declaration "CSV_Type" that is a delimited array where array members are separated by commas (the continuation character `contchar=","`) and ended by the ending character line feed (`endchar="\n"`)

Data Example for [Example A-10](#):

Native byte (character) stream:

```
5,18,2.5,255,78.75,9
```

Parsed values:

```
name[] = { '5', '18', '2.5', '255', '78.75', '9' }
```

Dates This section provides an example:

Example A-11 Dates - date

```
<field name="StartDate">
  <date format="MMDDYY"> <termstring endchar="\n"/> </date>
</field>
<field name="EndDate">
  <date format="DDMMYY"> <termstring endchar="\n"/> </date>
</field>
<field name="Milestone">
  <date format="MMDDYYYY"> <termstring endchar="\n"/> </date>
</field>
<field name="DueDate">
  <date format="DDMMYYYY"> <termstring endchar="\n"/> </date>
</field>
```

Data Example for Example A-11:

Byte stream (characters):

```
11/16/02<LF>
24/11/02<LF>
11/20-2002<LF>
23*11*2002<LF>
```

Barsed values:

```
StartDate = Sat Nov 16 00:00:00 PST 2002
EndDate   = Sun Nov 24 00:00:00 PST 2002
Milestone = Wed Nov 20 00:00:00 PST 2002
DueDate   = Sat Nov 23 00:00:00 PST 2002
```

Note: The D3L parser accepts any character between the DD, MM, and YY (YY) characters, and produces the " / " separator.

D3L supports the seven date formats shown in [Table A-3](#).

Table A-3 Supported Data Formats

Value of D3L Format Attribute	Native Message Format	Application Message Format
DDMMYY	dd/MM/yyyy	ISO-8601
DDMMYYYY	dd/MM/yyyy	- " -
MMDDYY	MM/dd/yy	- " -
MMDDYYYY	MM/dd/yyyy	- " -
MMDDYYYY_HHMI	MM/dd/yyyy hh:mm	- " -
MMDDYYYY_HHMISS	MM/dd/yyyy hh:mm:ss	- " -
MMDDYYYY_HHMISS_Z	MM/dd/yyyy hh:mm:ss z	- " -

The information is stored as a string in one of these formats. The application message format (XML) is fully ISO 8601 compliant. For example, if a native message contains the byte stream:

```
"11/24/1965 11:10:00 PST"
```

it is translated to (vice versa for outbound):

```
<starttime>1965-11-25T07:10:00</starttime>
```

assuming the following D3L code prescribed the translation:

```
<field name="starttime">
  <date format="MMDDYYYY_HHMISS_Z">
    <limstring delimiter="' ' />
  </date>
</field>
```

String-Based Numbers - number This section provides an example:

Example A-12 String-Based Numbers - number

```
<unsigned1 id="u1" />
<pfxstring id="HueType" length="u1" />

<struct id="ColorDefinition">
  <field name="Red">
    <number> <padstring length="4" padstyle="head" padchar=" " /> </number>
  </field>
  <field name="Green">
    <number> <pfxstring length="u1" /> </number>
  </field>
  <field name="Blue">
    <number> <limstring delimiter="." /> </number>
  </field>
  <field name="Brightness">
    <number> <termstring endchar="|" /> </number>
  </field>
  <field name="Hue">
    <number> <typeref type="HueType" /> </number>
  </field>
</struct>
```

The declared type "u1" is an unsigned, one-byte integer (0-255). The second type declaration "HueType" is a length prefixed string, where the string length is defined in a one-byte, unsigned, binary integer preceding the string contents.

The field "Red" is a number defined as a fixed-length string of four characters, which can be padded with zeros at the beginning.

The field "Green" is a number defined as a length prefixed string, where the string length is defined in a one-byte, unsigned, binary integer preceding the string contents.

The field "Blue" is a number defined as a ". ." delimited string; the string beginning and ending is demarcated by ". .".

The field "Brightness" is a number defined as a string that is read from the current point until the ending character (" | ") is encountered.

The field "Hue" is a number defined as a string of type "HueType" (defined previously).

Data Example for Example A-12:

Byte addresses (hex) and characters (hex values shown in italics and double digits):

```
00 01 02 03 04 05 06 07 08 09 0A 0B 0C 0D 0E 0F
 0  1  2  8 03  1  2  8  .  2  5  5  .  0  .  7
10 11 12 13 14 15 16 17 18 19 1A 1B 1C 1D 1E
 5  3  3  3  3  | 08 0  .  6  6  6  6  6  6
```

Parsed values:

```
Red = 128.0
Green = 128.0
Blue = 255.0
Brightness= 0.753333
Hue = 0.666666
```

Note: The parsed numbers are always internally treated as doubles (double precision floating point).

Structures

D3L supports structured types; that is, ordered records containing other datatypes (predefined or user-defined). Types can be nested to arbitrary depth. This means you can use structures of sequences of structures of sequences [. . .] to any finite depth. Recursive, self-referencing data structures, however, are not supported in D3L.

All data fields in a message format description must be named. These names are used as Oracle Application Server ProcessConnect datatype (compound) member names. All names within the same structure must be mutually unique.

The first allowable root element within a D3L file is `<message>`. The `message` element must refer to a `<struct>` (through the `IDREF` type attribute) that then becomes the top-level data structure of the message.

Example A–13 ColorDefinition Field

```

<message type="ColorDefinition" name="myEV">
  <unsigned1 id="u1" />
  <pfxstring id="HueType" length="u1" />
  <struct id="ColorDefinition">
    <field name="Red"> ...
    <field name="Green"> ...

```

Note: The top level structure can be placed anywhere in the D3L file (within the scope of the <message> element).

Sequences and Arrays

D3L supports sequences of various types. These include:

- Delimited arrays (with arbitrary separator and terminator characters)
- Length-prefixed arrays (where the length is one of the unsigned, numeric types)
- Fixed-length arrays
- Implicit-length arrays (This datatype consumes all remaining data in the native format message to the end of the buffer.)

The sequence contents can be any other D3L types (predefined or user-defined).

Delimited Arrays - limarray This section provides an example:

Example A–14 Delimited arrays - limarray

```

<field name="members">
  <limarray contchar=";" endchar=".">
    <simplestring/>
  </limarray>
</field>

```

The field "members" becomes an array of data elements separated by semicolons (contchar=";"). The end of the array is marked by a period (endchar="."). Each data element in the array is a (simple) string delimited by delimiters defined by the enclosing array (that is, semicolons (;) and periods (.)).

Data Example for Example A-14:

Native byte (character) stream:

```
John;Steve;Paul;Todd.
```

Parsed values:

```
members[] = { 'John', 'Steve', 'Paul', 'Todd' }
```

Length Prefixed Arrays - pfxarray This section provides an example:

Example A-15 Length prefixed arrays - pfxarray

```
<unsigned2 id="u2" endian="little" align="4" />
<struct>
  <field name="measurements">
    <pfxarray length="u2" > <signed1 /> </pfxarray>
  </field>
```

The field "measurements" becomes an array of signed one-byte binary integers (`signed1`). The number of elements in the array are determined by the unsigned two-byte binary integer ("u2") at the beginning of the array.

Data Example for Example A-15:

Byte addresses (hex):

```
.. 08 09 0A 0B 0C 0D 0E 0F 10 ..
```

Bytes (hex):

```
.. 06 00 FF A2 6C 24 0E 77 ..
```

Values (dec):

```
measurements[] = { -1, -94, 108, 36, 14, 119 }
```

Fixed Length Arrays - fixarray This section provides an example:

Example A-16 Fixed length arrays - fixarray

```
<field name="digits">
  <fixarray length="10">
    <number>
      <termstring endchar="-">
    </number>
  </fixarray>
```

The field "digits" becomes an array of numbers (doubles). Each number element in the native byte format is represented as a string that is terminated by a dash (endchar=" - "). The number of elements in the array must always be 10 (length="10").

Data Example for Example A-16:

Native byte (character) stream:

```
1-2-3-4-5-6-7-8-9-0-
```

Parsed values:

```
digits[] = { 1.0, 2.0, 3.0, 4.0, 5.0, 6.0, 7.0, 8.0, 9.0, 0.0 }
```

Implicit Length Arrays - imparray This section provides an example:

Example A-17 Implicit length arrays - imparray

```
<message name="addOrders" type="OrdersType">

  <number id="Number"> <termstring endchar="," /> </number>
  <number id="Price"> <termstring endchar=";" /> </number>
  <number id="Total"> <termstring endchar="\n"/> </number>

  <struct id="OrderLineType">
    <field name="LineNo"> <typeref type="Number" /> </field>
    <field name="ProductNo"> <typeref type="Number" /> </field>
    <field name="Quantity"> <typeref type="Number" /> </field>
    <field name="LinePrice"> <typeref type="Price " /> </field>
  </struct>
```

```
<struct id="OrderType">
  <field name="OrderTotal"> <typeref type="Total" /> </field>
  <field name="OrderLines">
    <limarray contchar="\n" endchar="\n\n">
      <struct>
        <field name="OrderLine"> <typeref type="OrderLineType" /> </field>
      </struct>
    </limarray>
  </field>
</struct>

<number id="ID"> <termstring endchar="\n" /> </number>

<imparray id="OrdersArrayType">
  <struct>
    <field name="CustomerID"> <typeref type="ID" /> </field>
    <field name="CustomerName"> <termstring endchar="\n" /> </field>
    <field name="Order"> <typeref type="OrderType" /> </field>
  </struct>
</imparray>

<struct id="OrdersType">
  <field name="OrdersArray"> <typeref type="OrdersArrayType" /> </field>
</struct>
</message>
```

The "OrdersType" structure consists of a single field "OrdersArray" that is an implicit array of three fields: "CustomerID", "CustomerName", and "Order" (of type "OrderType"). Since "OrdersArrayType" is an implicit array, it consumes all remaining bytes in the native byte input stream (that is, the size of the array is first known when the input byte stream has been used up).

The field "OrderLines" is a (nested) array, where each array element is of type "OrderLineType". The "OrderLineType" is a structure of four fields: "LineNo", "ProductNo", "Quantity", and "LinePrice".

This abstract structure of the input stream must follow this structure to be parseable:

```
CustomerID
CustomerName
Order:
  OrderTotal
  OrderLines:
    LineNo, ProductNo, Quantity, LinePrice
    LineNo, ProductNo, Quantity, LinePrice
    ...
```

Data Example for [Example A-17](#):

Native byte (character) stream:

```
1234
Boeing
1000
1,555,10,250.00;
2,666,10,750.00;

5678
Lockheed Martin
424
1,555,5,125.00;
2,777,1,100.00;
3,888,2,199.00;
```

Parsed values:

```
{OrdersArray=
  [ { CustomerName=Boeing, CustomerID=1234.0,
    Order=
      { OrderTotal=1000.0,
        OrderLines = [
          {OrderLine={LinePrice=250.0, ProductNo=555.0,
            Quantity=10.0,LineNo=1.0}},
          {OrderLine={LinePrice=750.0, ProductNo=666.0,
            Quantity=10.0,LineNo=2.0}}
        ]
      }
    },
  { CustomerName=Lockheed Martin, CustomerID=5678.0,
    Order=
      { OrderTotal=424.0,
        OrderLines = [
          { OrderLine={LinePrice=125.0, ProductNo=555.0,
            Quantity=5.0, LineNo=1.0}},
          { OrderLine={LinePrice=100.0, ProductNo=777.0,
            Quantity=1.0, LineNo=2.0}},
          { OrderLine={LinePrice=199.0, ProductNo=888.0,
            Quantity=2.0, LineNo=3.0}}
        ]
      }
    }
  ]
}
```

Data Padding Usage

D3L supports data padding. Pads are unnamed gaps in a native format message that satisfy alignment constraints of the underlying native system. Pads are discarded in the Oracle Application Server ProcessConnect application event (XML).

The following D3L example defines a number as a left-aligned string, right-padded with blanks to a field width of 10:

```
<field name="Quantity">
  <number>
    <padstring length="10" padchar=' ' padstyle="tail" />
  </number>
```

The following native byte (character) stream satisfies this format:

```
9876.5_____
```

Pads can also be explicitly defined between fields in a structure by using the `<pad>` element.

The following D3L example shows two fields, which are separated by a pad of size ten.

```
<struct id="PROD">
  <field name="PRODID"> <termstring endchar=";" /> </field>
  <pad length="10" />
  <field name="PRODESC"> <termstring endchar=";" /> </field>
</struct>
```

The following native byte (character) stream satisfies this format:

```
48682HW;~~~~~WASHER AND DRYER;
```

Comma-Separated Values File Parsing with D3L

A comma-separated values (CSV) file consists of multiple lines. Each line contains values separated by commas that end when a (platform-dependent) new line is encountered:

```
a,b,c,d  
1,2,3
```

Two string types, `termstring` and `simplestring`, are available to facilitate the parsing of CSV files.

- `termstring`

String type `termstring` is a variation of `limstring`, but requires only a terminating delimiter and not a beginning delimiter. For example:

```
<termstring endchar="," />
```

This parses any string contents until a comma is encountered.

- `simplestring`

String type `simplestring` is a special datatype only used when the nearest parent structure defines a valid set of delimiters, which for the current data D3L library is limited to `limarray`. For example:

```
<limarray contchar="," endchar="\n">  
  <simplestring />  
</limarray>
```

These string types provide two ways to parse CSV files. The examples provided in the following sections use `imparray` so that input can be any number of elements, lines, or both.

- [CSVs Assigned to Named Fields](#)
- [All CSVs Are Read into an Array](#)

CSVs Assigned to Named Fields

With this method, all CSVs on each line are assigned to named fields (fixed number of fields for each line). [Example A-18](#) provides an example.

Example A-18 CSVs Assigned to Named Fields

```
<message name="createPhone" type="phoneRecord">
  <impparray id="lines">
    <struct>
      <field name="rectype"> <termstring endchar=","/ > </field>
      <field name="quantity"><termstring endchar=","/ > </field>
      <field name="endHour"> <termstring endchar=","/ > </field>
      <field name="endMin"> <termstring endchar=","/ > </field>
      <field name="cost"> <termstring endchar="\n"/> </field>
    </struct>
  </impparray>
  <struct id="phoneRecord">
    <field name="csv"> <typeref type="lines" /> </field>
  </struct>
</message>
```

An example of a native format message payload for [Example A-18](#) can be:

```
4,,9,22,2324.29
''''
55,2342,11,46,728372339.57
```

All CSVs Are Read into an Array

With this method, all CSVs on each line are read into an array (variable number of fields for each line). [Example A-19](#) provides an example.

Example A-19 All CSVs Are Read into an Array

```
<message name="createPhone" type="phoneRecord">
  <limarray id="linearr" contchar="#44" endchar="\n">
    <simplestring />
  </limarray>
  <impararray id="myArray">
    <struct>
      <field name="line"> <typeref type="linearr" /> </field>
    </struct>
  </impararray>
  <struct id="phoneRecord">
    <field name="csv"> <typeref type="myArray" /> </field>
  </struct>
</message>
```

An example of a native format message payload for [Example A-19](#) is as follows:

```
4,,9,22,2324.29
55,2342,11,46,728372339.57
55,2342,11,46,728372339.57,4,,9,22,2324.29
1,2,3,4,5,6,7,8,9,0,1,2,3,4,5,6,7,8,9,0
```

Delimiter Encoding Styles

The delimiters for `limstring`, `termstring`, and `limarray` are enhanced to allow multiple characters, as well as additional encoding styles. The associated ASCII table codes are shown in parentheses:

1. Escaping using `"\"`. This works for `"\r"` (13), `"\n"` (10), `"\t"` (9), and `"\f"` (12).

where:

- (13) is the ASCII code for a carriage return (CR).
- (10) is the ASCII code for a line feed (LF).
- (9) is the ASCII code for a horizontal tab (HT).
- (12) is the ASCII code for a form feed (FF).

2. Escaping ASCII code using "#", for example, "#13".
3. Escaping ASCII hexadecimal code using "#x", for example, "#x0D".
4. End-of-file delimiter "\eof", which maps to a virtual end-of-file character. This delimiter can only be used once. No other fields can follow once it has been used.

[Example A-20](#) provides several examples of delimiter encoding styles.

Example A-20 Delimiter Encoding Styles

```
<termstring endchar="#x2C"/>
<termstring endchar="\n"/>
<limarray id="linear" contchar="," endchar="\r\n">
  <simplestring/>
</limarray>

<termstring id="FileContents" endchar="\eof"/>
```

The "\r\n" on line 3 of [Example A-20](#) represents an MS-DOS-style line break.

Oracle Application Server ProcessConnect Enhancements to D3L

This section describes Oracle Application Server ProcessConnect enhancements to D3L for this release.

This section contains these topics:

- [New D3L Document Type](#)
- [Import Function](#)
- [Field Separators](#)
- [Field Terminators](#)
- [Delimited Array Cardinality](#)
- [Field Optionality](#)
- [Escape Character and Sequences](#)
- [Variables in D3L](#)
- [Assignment Blocks](#)
- [Strict vs. Lenient \(Relaxed\) Translation Modes](#)

- [Type Aliasing](#)
- [Conditional Parsing \(One Token Look Ahead\)](#)
- [Validation - D3L Valid Values](#)
- [Character Set Encoding](#)
- [Importing D3L Datatypes](#)

New D3L Document Type

To enable the splitting of D3L definition files into smaller, more manageable units (modules and separate files), a new document type is introduced: definitions.

This document type is only declarative; that is, it defines types, variables, and other metadata structures, but has no actual message definition.

[Example A-21](#) shows an example:

Example A-21 *supp_defs.xml Definition File*

```
<?xml version="1.0" encoding="UTF-8" ?>
<!DOCTYPE definitions SYSTEM "D3L-definitions.dtd">
<definitions name="SupportingDefinitions">
  <unsigned1 id="u1" />
  ...
  <struct id="CustomerInfoType">
    <field name="CustomerID">
      ...
    </field>
  </struct>
</definitions>
```

If this definition is now linked to (associated with) a D3L message definition, the latter can make references to definitions in the former. [Example A-22](#) shows a D3L file (`order.xml`) that can use declarations defined in `supp_defs.xml`:

Example A-22

```
<?xml version="1.0" encoding="US-ASCII"?>
<!DOCTYPE message SYSTEM "D3L.dtd">
<message name="MyOrders" type="MyOrderType" ...

    <struct id="MyOrderType">
        <field name="CustomerInfo">
            <typeref type="CustomerInfoType" />
        ...
    ...
```

The link or association between the D3L message document and the D3L definitions document is established while answering the questions in the **Translator Properties : D3L Information** section of the Create Event Body Element page when creating the native datatype for the D3L designated event body element. This is shown in [Figure A-2](#).

Figure A-2 Create Event Body Element Page

Create Event Body Element : PAYLOAD

Please enter the translator and native datatype properties, and choose Next. Based on the values entered, additional * Indicates required field

Event Body Element **PAYLOAD**
 Native Event Type **nat_evt_ReadCSVFile**
 Native Format **D3L**
 Translator

Native Datatype

Name **nat_dt_CSVFile**
 Content **/private/murphy/ade/view_storage/murphy_ip/ip/tools/integration/ip/import/expense-instance.xml**

Translator Properties : D3L Information

D3L Information

Namespace for Application Datatype to be created

Additional D3L Definitions

See Also:

- [Example A-49](#) on page A-110 for an example of a D3L DTD definition file
- ["Providing D3L Details"](#) on page 11-32 for instructions on creating D3L event body elements

Import Function

To further promote the modularization of D3L definitions, the `definitions` document type described ["New D3L Document Type"](#) on page A-68 supports a tag that enables you to specify to include (import) another definitions document in the current definitions document. With this feature, the construction shown in [Example A-23](#) is possible:

Example A-23 Import Function

```
<definitions name="...">
  ...
  <import location="more_defs.xml" />
  ...
  <import location="even_more_defs.xml" />
</definitions>
```

The imported file and document must be of type `definitions`. Recursive `includes` are not permitted. If the value of the `location` attribute is not an absolute path name, D3L looks in the following locations (in this order):

1. In the directory from which the imported D3L definition was read
2. In the current directory (of the integration manager process)

The `import` facility enables you to define a hierarchy of definitions:

- `segments.xml`, which imports `fields.xml`
- `fields.xml`, which imports `datatypes.xml`
- and so on

Field Separators

The `struct` element supports an attribute called `separatorchar`. It allows for the declaration of a separator character, which appears between each of the fields in a given `struct`. CSV files typically take advantage of this feature.

[Example A-24](#) shows the following declaration:

Example A-24 Field Separators

```
<struct id="Colors" separatorchar=",">
  <field name="Red"><simplestring /> </field>
  <field name="Green"> <simplestring /> </field>
  <field name="Blue"> <termstring endchar="\n"/> </field>
</struct>
```

This declaration parses the following input:

```
128,128,255
```

that is:

- Red = '128'
- Green = '128'
- Blue = '255'

Note that the last field is a `termstring`. Either the enclosing structure must define a terminating character (like the `endchar` of `limarray`) or the last field must specify a terminating condition. If the last field ("Blue") in [Example A-24](#) is a `simplestring`, there is no terminating condition. This results in the last field being assigned the remainder of the input.

Field Terminators

Similar to the field separator, the `struct` element also supports an attribute called `terminatorchar`. It allows for the declaration of a terminating character, which appears at the end of each field in a given `struct` (for example, sentences).

[Example A-25](#) shows an example:

Example A-25 Field Terminators

```
<struct id="CommandSet" terminatorchar=";">
  <field name="Cmd1"> <simplestring /> </field>
  <field name="Cmd2"> <simplestring /> </field>
  <field name="Cmd3"> <simplestring /> </field>
  <field name="Cmd4"> <simplestring /> </field>
</struct>
```

This declaration parses the following input:

```
configure;startup;runtest;shutdown;
```

Delimited Array Cardinality

To enable the specification of a limit on the number of elements accepted in a `limarray` (delimited array), you can specify the optional attribute `cardinality`.

Without this attribute, a `limarray` is simply parsed until `endchar` is encountered, separating array elements by the `contchar` character.

This `cardinality` attribute can assume the values (in double quotes) shown in [Table A-4](#).

Table A-4 Cardinality Attribute Values

Repetitive Optionality	No	Yes	n (upper bound)
Required	"1"	"+"	"n" (exactly n occurrences)
Optional	"?"	"*"	"+n" (1 up to n occurrences) "*n" (0 up to n occurrences)

[Example A-26](#) shows an example:

Example A-26 Delimited Array Cardinality

```
<struct id="jackpot">
  <field name="numbers">
    <limarray cardinality="*5" endchar=".">
      <simplestring />
    </limarray>
```

Example input:

2~12~23~28.

If the `cardinality` attribute is defined to enable more than one array element (that is, one of the following values: "+", "*", "n", "+n", and "*n"), the continuation character attribute `contchar` can optionally be specified, which marks the separation between array elements. If the attribute is not specified, the default continuation character "~" is used (or whichever character has been assigned to the D3L system variable `d3l_contchar`).

If the array only contains zero or one elements ("?", "1"), the `contchar` attribute is ignored.

If both the `cardinality` and `endchar` attributes are specified, then the `endchar` may occur no sooner than such a time where the `cardinality` criteria has been satisfied.

See Also: ["Variables in D3L"](#) on page A-76

Field Optionality

Fields delimited by separator characters may naturally be empty in the native (wire) message, for example (four phone numbers: work, home, cell, and fax)

650-650-5555,,650-240-1900,

[Example A-27](#) shows a D3L definition that parses this line:

Example A-27 Field Optionality 1

```
<struct "phoneNumbers" terminatorchar=",">
  <field name="Work"> <simplestring /> </field>
  <field name="Fax"> <simplestring /> </field>
  <field name="Home"> <simplestring /> </field>
  <field name="Cell"> <simplestring /> </field>
</struct>
```

This definition fails, since the "Home" and "Fax" fields are being bound to empty values, and by default D3L fields must be bound to nonempty values.

To enable fields to be optional (that is, bound to empty values), the `optionality` attribute is available. It can assume two values:

- Capital "O", which means optional
- Capital "R", which means required

If the `optionality` attribute is not specified, the value "R" is assumed.

To enable the parsing of the phone number native message, the D3L code in [Example A-27](#) must be modified as shown in [Example A-28](#):

Example A-28 Field Optionality 2

```
<struct "phoneNumbers" terminatorchar=",">
  <field name="Work" optionality="O"> <simplestring /> </field>
  <field name="Home" optionality="O"> <simplestring /> </field>
  <field name="Cell" optionality="O"> <simplestring /> </field>
  <field name="Fax" optionality="O"> <simplestring /> </field>
</struct>
```

A field can only be defined with `optionality="O"` if the enclosing `struct` specifies either a `separatorchar` or `terminatorchar` attribute. Otherwise, D3L cannot determine whether or not a field value is present.

Escape Character and Sequences

D3L supports built-in and user-defined escape sequences, which can appear in the input stream (wire message). The built-in escape sequences consist of the (current) escape character followed by a number (ASCII code) in the range 0-127. If the number is preceded by X, it is read as a hexadecimal number. For example:

```
"Character for ASCII code 65 is \65"
"Decimal digits: \X30 \X31 .. \X39"
```

In addition to the built-in escape sequences, you can define your own escape sequences using the structure (top-level element) shown in [Example A-29](#):

Example A-29 *Escape Character and Sequences*

```
<escaped-values-map>
  <value-map native="F" translated="|" />
  <value-map native="C" translated="^" />
</escaped-values-map>
```

When D3L encounters user-defined sequences such as the following:

current_escape_character followed by *value_of_native_attribute*

it replaces the sequence with the value of the `translated` attribute. For example, the following native input stream (assuming the `escaped-values-map` exists):

```
"field1\Fcomp1\Ccomp2\Ffield3"
```

reads as follows:

```
"field1|comp1^comp2|field3"
```

As indicated previously, the default escape character is `\`. The escape character can either prefix the sequence, or enclose the sequence. The escape method is configured in the D3L message element, using the attribute `escaping`:

```
<message name="..." .. escaping="prefixed">
```

This makes the following code parseable:

```
"field separator: \F"
```

while

```
<message name="..." .. escaping="enclosed">
```

needs the escape character on both sides of the sequence:

```
"field separator: \F\"
```

The D3L system variable `d3l_escapechar` contains the current value of the escape character (initially always `\`), but it can be redefined by an `<assignments>` tag.

See Also:

- ["Assignment Blocks"](#) on page A-78 for details about the `<assignments>` tag
- ["Variables in D3L"](#) on page A-76

Variables in D3L

D3L enables you to declare variables, bind values to them at runtime from the input stream, and reference them in syntactic constructs.

Variables are declared in the top-level construct shown in [Example A-30](#):

Example A-30 Variable Declaration

```
<variables>
  <variable id="FieldSep" default="|" maxlen="1" />
  <variable id="CompoSep" default="^" maxlen="1" />
</variables>
```

Variables can be referenced in D3L delimiter attributes by enclosing the variable name with "\$" and ";". For example, if you define the variable `RecordTerm`:

```
<variables>
  <variable name="RecordTerm" default="#10" maxlen="1" />
</variables>
```

it can then be referenced as shown in [Example A-31](#) in a `terminatorchar` attribute:

Example A-31 Variables Referenced in D3L Delimiter Attributes

```
<struct id="ContactInfo" terminatorchar="$RecordTerm;">
  <field name="SurName"><simplestring /> </field>
  <field name="FirstName"> <simplestring /> </field>
  <field name="PhoneNo"> <simplestring /> </field>
</struct>
```

If the `variable` element attribute `default` is missing (from a variable declaration), an empty string is assumed. The `maxlen` attribute must be specified.

D3L defines the following built-in (system) variables, which have predefined meanings:

- `d3l_escapechar`
The default escape character
- `d3l_contchar`
The default continuation character

These variables are automatically defined, as shown in [Example A-32](#):

Example A-32 System Variables

```
<variables>
  <variable name="d3l_escapechar" default="" maxlen="1" />
  <variable name="d3l_contchar" default="" maxlen="1" />
</variables>
```

This example definition is just for documentation purposes; these variables cannot be redefined as shown.

The values of these system variables can be changed at runtime through assignment blocks, as described in ["Assignment Blocks"](#).

Assignment Blocks

Without assignment blocks, variables only assume the value assigned in the variable declaration block, and are of limited value (may be useful for maintenance purposes, where the value of a line feed sequence can be maintained in just one place).

To allow variables to change at runtime, the `assignments` construct is available. It enables you to bind either static values (constants) or substrings from runtime message instances to the (declared) D3L variables.

An `assignments` element can only be referenced (associated) from within the scope of a D3L field (inside a `struct`) by using the `field` element attribute `assign`.

An `assignments` block, which is associated with a certain `field`, can make references to (extract) substrings of the current field value. It is also possible to refer to other fields, which are available in the current context (previously parsed fields in the current message).

The current `field` is referenced with the character sequence `"$;"`. Any previously parsed fields are referenced by the character sequence:

```
"$field_name;"
```

Substrings are referenced either by a single index (*i*) or an index range (*i*₁:*i*₂) right before the ending `" ; "` in a field reference:

- `${0};`
Single (character) index substring (current field)
- `${2:5};`
Index range substring (current field)
- `OtherField[1];`
Single (character) index substring (other field)
- `OtherField[3:4];`
Index range substring (other field)

The `assignments` block for a given field is executed after the field has been fully parsed (that is, assigned a value). Field name references in an assignment to not-yet parsed or nonexistent fields result in the empty string, as do illegal or out-of-range substring expressions.

If a certain assignment order must be enforced (XML does not guarantee any element order), an assignment can be ordered by defining an `order` attribute (a natural number). Order attributes with a lower value are executed before order attributes of higher values.

[Example A-33](#) shows how to use an `assignments` block:

Example A-33 assignments Block

```
<variables>
  <variable name="LineSep" default="." maxlen="1" />
  <variable name="ItemSep" default="," maxlen="1" />
</variables>

<assignments id="GetSeparators">
  <assign variable="ItemSep" value="${1};" order="1" />
  <assign variable="d3l_contchar" value="${3};" order="2" />
  <assign variable="d3l_escapechar" value="${5};" order="3" />
</assignments>
```

Having defined and named the assignments block, it can now be referenced in [Example A-34](#) in a field using the `assign` attribute:

Example A-34 assign Attribute

```
<struct id="MessageEnvelope" terminatorchar="$LineSep;">
  <field name="Separators" assign="GetSeparators">
    <simplestring />
  </field>
  <field name="Header"> <simplestring /> </field>
  ...
</struct>
```

After the field "Separators" has been parsed, the associated `assignments` block "GetSeparators" is triggered and executed. All the value references in the block refer to the current field value ("`$(n);`", with no field name between "`$(`" and "`)`").

If the input stream for the "Separators" field is as follows:

```
$: $$*/$.
```

the following assignments occur:

```
ItemSep = ':'  
d3l_contchar = '*'  
d3l_escapechar = '/'
```

If the `$LineSep` variable was also updated in this `assignments` block (not a typical use case), the subsequent fields in the "MessageEnvelope" struct must be separated by the character assigned to `$LineSep`.

Strict vs. Lenient (Relaxed) Translation Modes

The D3L message root element `<message>` supports an attribute `parsemode` that can either assume the value `lenient` or `strict`:

```
<message name="myNativeType" parsemode="strict | lenient" ...
```

This setting only impacts D3L structs, where fields are separated by a `separatorchar` or `terminatorchar` and where the fields from a certain point and for the rest of the struct are all optional. In addition, the enclosing structure (`struct`, `limarray`) must also declare a separator, so the embedded struct knows when to end.

In `lenient` mode, the trailing optional fields in a struct can be entirely omitted (that is, also including their delimiters). In `strict` `parsemode`, the delimiters have to be present for all fields, even though the field values themselves are empty.

[Example A-35](#) shows an example:

Example A-35 strict vs. lenient

```
<struct id="outer" terminatorchar=".">
  <field name="fields1"> <typeref type="inner" /> </field>
  <field name="fields2"> <typeref type="inner" /> </field>
</struct>

<struct id="inner" separatorchar=",">
  <field name="f1" optionality="R"> <simplestring /> </field>
  <field name="f2" optionality="R"> <simplestring /> </field>
  <field name="f3" optionality="R"> <simplestring /> </field>
  <field name="f4" optionality="R"> <simplestring /> </field>
  <field name="f5" optionality="R"> <simplestring /> </field>
  <field name="f6" optionality="R"> <simplestring /> </field>
  <field name="f7" optionality="O"> <simplestring /> </field>
  <field name="f8" optionality="O"> <simplestring /> </field>
  <field name="f9" optionality="O"> <simplestring /> </field>
</struct>
```

In lenient mode, the following input is parseable:

```
"1,2,3,4,5,6.1,2,3,4,5,6."
```

Note that the values for fields "f7", "f8" and, "f9" are missing, including their delimiters. In strict mode, the field values can still be empty, but the separators must be present:

```
"1,2,3,4,5,6,,,1,2,3,4,5,6,,,"
```

Type Aliasing

To improve the general readability, maintainability, or both of D3L definitions, a type aliasing feature (`typedef`) is available. It enables you to assign other names to already-defined types. It also permits defining type structures without needing to define embedded fields.

[Example A-36](#) shows an example:

Example A-36

```
<termstring id="BaseString" endchar="," />

<typedef id="NameType"> <typeref type="BaseString" /> </typedef>
<typedef id="PhoneType"> <typeref type="BaseString" /> </typedef>

<struct id="ContactType">
  <field name="Name"> <typeref type="NameType" /> </field>
  <field name="Phone"> <typeref type="PhoneType" /> </field>
</struct>

<typedef name="MainContactType">
  <typeref type="ContactType">
</typedef>

<typedef name="SecondaryContactType">
  <typeref type="ContactType">
</typedef>
```

Conditional Parsing (One Token Look Ahead)

This feature provides a limited form of conditional parsing in D3L. It essentially enables you to qualify a D3L `struct` definition with a sequence of bytes or characters. This sequence must occur at the beginning of the `struct` for D3L to start parsing the message according to the `struct`. This starting byte or character sequence can be declared through the `struct` attribute `startswith`.

The D3L definitions shown in [Example A-37](#) are now possible:

Example A-37

```
<struct id="Order" terminatorchar="\n">
  <field name="Header" optionality="R">
    <typeref type="HeaderType" />
  </field>
  <field name="Discount" optionality="O">
    <typeref type="DiscountType" />
  </field>
  <field name="Total" optionality="R">
    <typeref type="TotalType" />
  </field>
</struct>

<struct id="HeaderType" startswith="HDR">
  <field name="CustomerID"> <typeref type="ID" /> </field>
  ...
</struct>

<struct id="DiscountType" startswith="DIS">
  <field name="Percentage"> <typeref type="PCT" /> </field>
  ...
</struct>

<struct id="TotalType" startswith="TOT">
  <field name="TotalAmount"> <typeref type="AMT" /> </field>
  ...
</struct>
```

This code parses an input stream of the following type:

```
HDR00032101...
DIS015.75...
TOT00045000.00...
```

In [Example A-37](#), if the line starting with DIS . . . is missing, the whole Discount field ("DiscountType" struct) is skipped (that is, assigned a blank value).

Validation - D3L Valid Values

D3L provides a limited method for performing validation of native events, essentially validating that specific field contents are valid against a set of valid values.

[Example A-38](#) shows a table (set) of valid values:

Example A-38 D3L Valid Values

```
<validvalues id="table_0267" comment="Days of the week valid values">
  <validvalue comment="Monday">MON</validvalue>
  ...
  <validvalue comment="Friday">FRI</validvalue>
</validvalues>
```

The comments are only for documentation purposes. Through the `id` attribute of the `validvalues` block, you can link it to a field through the field attribute `validvalues`, as shown in [Example A-39](#).

Example A-39 Field Attribute `validvalues`

```
<struct id="VisitingDays" separatorchar=",">
  <field name="StartDay" validvalues="table_0267">
    <simplestring />
  </field>
  <field name="EndDay" validvalues="table_0267">
    <simplestring />
  </field>
</struct>
```

This successfully validates the following native message:

```
WED,FRI
```

But not this native message:

```
WED,SUN
```

If a field contains a nonvalid value, D3L stops the message parsing and reports an error. However, this behavior can be altered slightly by using the attribute `validation` in the D3L message root element.

If this attribute has the value "full" assigned:

```
<message name="Patient" validation="full" ...
```

then all validation errors for the entire native message are reported. If the attribute has the value "first" assigned:

```
<message name="Patient" validation="first" ...
```

then only the first validation error is reported. The first option provides completeness, while the second option provides better performance.

Character Set Encoding

Strings that are part of a native message can be encoded in a character set different from the platform default. For example, the message may contain strings represented in `Shift_JIS`, while the platform default character set is `US-ASCII`.

D3L internally converts all native strings to Unicode. Therefore, whenever the default platform conversion is not sufficient (as is the case if the native strings are represented in `Shift_JIS` on non-Japanese machines), the exact Internet Assigned Numbers Authority (IANA) character set name for strings in the native message must be declared through the attribute `encoding` in the D3L message root element. For example:

```
<message name="Members" encoding="Shift_JIS" ...
```

See Also: The following URL for IANA character set names:

<http://www.iana.org/assignments/character-sets>

Importing D3L Datatypes

When a native event body element (in the Create Event Body Element wizard) is associated with the D3L translator and D3L definition file, Oracle Application Server ProcessConnect creates a corresponding application event datatype in the repository.

This datatype reflects the XML format, which the D3L translator generates while translating (inbound) the native event body element to its corresponding application event body element. The reverse process takes place in the outbound direction.

The following sections describe how to determine the Oracle Application Server ProcessConnect application event datatype, which is created when importing a D3L definition:

- [D3L Scalar Fields](#)
- [Nonscalar D3L fields](#)
- [D3L Structs](#)
- [D3L typedef](#)
- [D3L typeref](#)
- [D3L Import Examples](#)

Note that the datatype can be placed in a specific namespace, as shown in [Figure A-2](#) on page A-69.

See Also: ["Providing D3L Details"](#) on page 11-32 for instructions on creating D3L event body elements

D3L Scalar Fields All scalar D3L fields cause the creation of a scalar Oracle Application Server ProcessConnect datatype member with the name of the `field` name attribute:

```
<field name="PatientName" ..> <scalar-type ... /> </field>
```

If the scalar type of the field is referenced through a `typeref`, the referenced scalar type is looked up (or created if nonexistent and then looked up) and associated as the member type.

Note: Nested `typerefs` are searched until an actual D3L type is found (for example, `simplestring` for scalar types).

Nonscalar D3L fields All nonscalar D3L fields (typerefs to structs or arrays) cause the creation of a complex Oracle Application Server ProcessConnect datatype with the name of the `field name` attribute.

With an array, the values for the complex Oracle Application Server ProcessConnect datatype attributes `minOccurs` and `maxOccurs` depend on the value of the D3L `cardinality` attribute. For example, the following definition:

```
<field name="EVN.7.1">
  <limarray name="EVN.7.1_ARR" cardinality="*">
```

causes the creation of datatype "EVN.7.1" with the following settings:

```
minOccurs = 0
maxOccurs = unlimited
```

The D3L field attribute `optionality` similarly determines the value of `minOccurs` and `maxOccurs` ("R" ~ 1/1, "O" ~ 0/1).

D3L Structs All D3L structs cause the creation of a complex Oracle Application Server ProcessConnect datatype with the name of the `name` attribute and the datatype members named after the field names. The type of each member is either scalar or complex, depending on whether or not the D3L field type is scalar or structured.

```
<struct id="CusType" name="CustomerType" ...
```

For backwards compatibility, if the `struct name` attribute is not present, the `struct id` attribute names the complex datatype.

D3L typedef All D3L typedefs cause the creation of a Oracle Application Server ProcessConnect datatype with the name of the `type` attribute of the `typedef` element:

```
<typedef id="EVN.7.1"> <typedef type="FixedString10" /> ..
```

The created datatype is scalar or complex according to the complexity of the `typedef` datatype.

D3L typedef All D3L typerefs cause the creation of a datatype with the name of the `name` attribute of the referenced D3L type (or the `id` attribute, if the `name` attribute is not present). [Example A-40](#) shows an example.

Example A-40 D3L typerefs

```
<field name="MailAddress">
  <typeref type="AddrTyp" /> ---
...
<struct id="AddrTyp" name="AddressType" ...
```

If a datatype is already present in the Oracle Application Server ProcessConnect design-time repository, D3L simply reuses it (that is, it is not replaced).

Note: As a consequence of this, if an application event datatype must be changed (that is, an additional field must be added), perform one of the following tasks:

- Name the (compound) type to a different name, so a new type is created.
 - Delete the old type before the new D3L datatype is imported.
-
-

D3L Import Examples [Example A-41](#) through [Example A-44](#) show Oracle Application Server ProcessConnect datatypes created from D3L definitions.

Example A-41 D3L Definition Example 1

```
<struct id="ADT-A29" name="ADT-A29.CONTENT" terminatorchar="\r">
  <field name="MSH" optionality="R"> <typeref type="MSH" /> </field>
  <field name="EVN" optionality="R"> <typeref type="EVN" /> </field>
</struct>
```

Oracle Application Server ProcessConnect datatype created from [Example A-41](#):

```
Datatype :ADT-A29.CONTENT ApplicationEvent
  CompoundMember :MSH refersTo=MSH.CONTENT cardinality[1,1]
  CompoundMember :EVN refersTo=EVN.CONTENT cardinality[1,1]
```

It is implied that `MSH.CONTENT` and `EVN.CONTENT` are referring to nonscalar types.

Example A–42 D3L Definition Example 2

```
struct id="MSH" name="MSH.CONTENT" startswith="MSH" separatorchar="|">
  <field name="MSH.1" optionality="R"> <typeref type="FIX1" /> </field>
  <field name="MSH.2" optionality="O"> <typeref type="MSH.2" /> </field>
  <field name="MSH.3" optionality="R"> <typeref type="MSH.3" /> </field>
  <field name="MSH.4" optionality="R"> <typeref type="MSH.4" /> </field>
  <field name="MSH.5">
    <limarray name="MSH.5_ARR" cardinality="*">
      <typeref type="MSH.5" />
    </limarray>
  </field>
  <field name="MSH.6" optionality="R"> <typeref type="MSH.6" />
  </field>
  <field name="MSH.7">
    <limarray name="MSH.7_ARR" cardinality="+">
      <typeref type="MSH.7" />
    </limarray>
  </field>
</struct>
```

Oracle Application Server ProcessConnect datatype created from [Example A–42](#):

```
Datatype :MSH.CONTENT ApplicationEvent
  ScalarMember :MSH.1 scalarType=FIX1
  ScalarMember :MSH.2 scalarType=ST
  CompoundMember :MSH.3 refersTo=MSH.3.CONTENT cardinality[1,1]
  CompoundMember :MSH.4 refersTo=MSH.4.CONTENT cardinality[1,1]
  CompoundMember :MSH.5 refersTo=MSH.5.CONTENT cardinality[0,unlimited]
  CompoundMember :MSH.6 refersTo=MSH.6.CONTENT cardinality[1,1]
  CompoundMember :MSH.7 refersTo=MSH.9.CONTENT cardinality[1,unlimited]
```

It is implied that `MSH.[3,4,6].CONTENT` are referring to nonscalar types.

Example A–43 D3L Definition Example 3

```
<typedef id="MSH.1"> <typeref type="FIX1" /> </typedef>
<typedef id="MSH.2"> <typeref type="ST" /> </typedef>
<typedef id="MSH.3"> <typeref type="IS" /> </typedef>
<typedef id="MSH.4"> <typeref type="ID" /> </typedef>
```

Oracle Application Server ProcessConnect Datatype created from [Example A-43](#):

```
Datatype :FIX1 ApplicationEvent primitiveType:string
Datatype :ST ApplicationEvent primitiveType:string
Datatype :IS ApplicationEvent primitiveType:string
Datatype :ID ApplicationEvent primitiveType:string
```

Example A-44 D3L Definition Example 4

```
<struct id="MSH.3" name="MSH.3.CONTENT" separatorchar="^">
  <field name="MSH.3.1" optionality="R"> <typeref type="MSH.3.1" /> </field>
  <field name="MSH.3.2" optionality="0"> <typeref type="MSH.3.2" /> </field>
  <field name="MSH.3.3" optionality="R"> <typeref type="MSH.3.3" /> </field>
  <field name="MSH.3.4" optionality="R"> <typeref type="MSH.3.4" /> </field>
</struct>
```

Oracle Application Server ProcessConnect datatype created from [Example A-44](#):

```
Datatype :MSH.3.CONTENT ApplicationEvent
ScalarMember :MSH.3.1 scalarType=ST
ScalarMember :MSH.3.2 scalarType=IS
ScalarMember :MSH.3.3 scalarType=ST
ScalarMember :MSH.3.4 scalarType=ID
```

Note how `typeref "MSH.3.1"` resolves to `ST`. This is likely due the following definition elsewhere:

```
<typedef id="MSH.3.1"> <typeref type="ST" /> </typedef>
```

Additional D3L Sample Files and DTD

This section contains these topics:

- [Additional D3L Sample Files](#)
- [D3L DTDs](#)

Additional D3L Sample Files

This section provides some D3L sample files. These example files describe how to use the D3L language to define the content of wire messages.

- [Example One: Sample File with Structure VehicleRegistration](#)
- [Example Two: Sample File with Structure Hierarchy PersonRecord](#)
- [Example Three: Sample File with Structure ProductRecord](#)

Example One: Sample File with Structure VehicleRegistration Sample file `msg-1.xml` represents a structure named `VehicleRegistration`. [Table A-5](#) describes the D3L fields and [Example A-45](#) shows the `msg-1.xml` D3L definition.

Table A-5 *msg-1.xml File Fields*

Field	Description
<code>SizeWeight</code>	A fixed-length array of four signed, one-byte, little-endian integers, each aligned on two-byte boundaries (implying a one-byte padding between elements of the array)
<code>ProductCode</code>	An unsigned, two-byte, big-endian integer aligned on two-byte boundaries
<code>VIN</code>	An unsigned, eight-byte, big-endian integer aligned on two-byte boundaries
<code>PreviousOwners</code>	A length-prefixed array of dates in the <code>MMDDYYYY</code> format (the length of the array is a signed, one-byte, little-endian integer with a two-byte alignment)
<code>Miles</code>	An unsigned, two-byte, big-endian integer with a two-byte alignment
<code>DateProduced</code>	A single date in the <code>MMDDYYYY</code> format

Example A-45 Sample File msg-1.xml with Structure EmployeeRegistration

```

<?xml version="1.0" encoding="US-ASCII"?>
<message type="VehicleRegistration" name="Register">
  <date format="MMDDYY" id="Date_T">
    <padstring id="FixString10_T" length="10" padchar=' ' padstyle="none" />
  </date>
  <struct id="VehicleRegistration">
    <!-- Width x Length x Height x Weight (inch/lb) -->
    <field name="SizeWeight"><typeref type="ShortArray4_T" /></field>
    <field name="ProductCode"><unsigned2 align="2" endian="big" /></field>
    <field name="VIN"><unsigned8 align="2" endian="big" /></field>
    <field name="PreviousOwners"><typeref type="StringArray_T" /></field>
    <field name="Miles"><unsigned2 align="2" endian="big" /></field>
    <field name="DateProduced"><typeref type="Date_T" /></field>
  </struct>
  <fixarray id="ShortArray4_T" length="4">
    <unsigned2 align="2" endian="little" id="" />
  </fixarray>
  <unsigned1 align="2" endian="little" id="Short_T" />
  <pfxarray id="StringArray_T" length="Short_T">
    <typeref type="FixString10_T" />
  </pfxarray>
</message>

```

Note that some type declarations are defined while being used by another structure. Remember that only fields map to actual bytes in the wire message.

The following wire message examples show a hexadecimal and character representation of the same message, which can be parsed by the `msg-1.xml` D3L file:

- Hexadecimal format:

```

0000000 4500 b200 3400 8a0b 30d9 0000 0000 0072
0000020 55ff 0200 4a6f 6e65 732c 502e 2020 536d
0000040 6974 682c 522e 2020 5208 3131 2532 3225
0000060 3139 3939

```

- Character format:

```

0000000 E \0 262 \0 4 \0 212 013 0 331 \0 \0 \0 \0 \0 r
0000020 U 377 002 \0 J o n e s , P . S m
0000040 i t h , R . R \b 1 1 % 2 2 %
0000060 1 9 9 9

```

Example Two: Sample File with Structure Hierarchy PersonRecord Sample file `msg-2.xml` demonstrates a structure hierarchy named `PersonRecord`. [Table A-6](#) describes the D3L fields and [Example A-46](#) shows the `msg-2.xml` D3L definition.

Table A-6 *msg-2.xml File Fields*

Field	Description
Name	A string delimited by a comma
Age	An unsigned, one-byte integer
DOB	A date in MMDDYYYY format, length prefixed by a signed, four-byte integer
Phone	An unsigned, four-byte integer
City	A structure named <code>CityRecord</code> that consists of the following fields: <ul style="list-style-type: none"> ■ Name A string delimited by * ■ State A string delimited by * ■ Country A string delimited by * ■ Population An unsigned, four-byte integer
State	A structure named <code>StateRecord</code> that consists of the following fields: <ul style="list-style-type: none"> ■ Name A string delimited by a space ■ Capital A string delimited by a space ■ Population An unsigned, four-byte integer

Example A-46 Sample File msg-2.xml with Structure PersonRecord

```

<?xml version="1.0" encoding="US-ASCII"?>
<!DOCTYPE message SYSTEM "d3l.dtd">
<message type="PersonRecord" name="Person">
  <signed4 id="s4" />
  <struct id="CityRecord">
    <field name="Name"><limstring delimiter="*" /></field>
    <field name="State"><limstring delimiter="*" /></field>
    <field name="Country"><limstring delimiter="," /></field>
    <field name="Population"><unsigned4 /></field>
  </struct>

  <struct id="StateRecord">
    <field name="Name"><limstring delimiter=" " /></field>
    <field name="Capital"><limstring delimiter=" " /></field>
    <field name="Population"><unsigned4 /></field>
  </struct>

  <struct id="PersonRecord">
    <field name="Name"><limstring delimiter="," /></field>
    <field name="Age"><unsigned1 /></field>
    <field name="DOB">
      <date format="MMDDYYYY">
        <pfxstring id="dobstr" length="s4" />
      </date>
    </field>
    <field name="Phone"><unsigned4 /></field>
    <field name="City"><typeref type="CityRecord" /></field>
    <field name="State"><typeref type="StateRecord" /></field>
  </struct>

</message>

```

The following is a combined hexadecimal and character representation of a native message, which can be parsed by msg-2.xml:

```

000 2c4a 6f68 6e20 446f 652c 1e00 0000 000a  ,John Doe,.....
020 3131 2f32 352f 3139 3635 0000 002c a155  11/25/1965...,U
040 2a50 6f72 746c 616e 642a 2a4f 522a 2c55  *Portland*OR*,U
060 5341 2c00 000f 4240 204f 7265 676f 6e20  SA,...B@_Oregon_
100 2053 616c 656d 2000 003d 0900          _Salem_...

```

Example Three: Sample File with Structure ProductRecord Sample file `msg-3.xml` defines a structure named `ProductRecord`. [Table A-7](#) describes the file fields and [Example A-47](#) shows `msg-3.xml` file contents.

Table A-7 *msg-3.xml File Fields*

Field	Description
Manufacturer	A string delimited by a space
Weight	A single-precision, floating-point number
Widgets	A length-prefixed array of <code>WidgetRecord</code> structures. A <code>WidgetRecord</code> consists of: <ul style="list-style-type: none"> ▪ Name A string delimited by a space ▪ Color A string delimited by a space ▪ Weight A single-precision, floating point number

Example A-47 *Sample File msg-3.xml with Structure ProductRecord*

```
<?xml version="1.0" encoding="US-ASCII"?>

<!DOCTYPE message SYSTEM "d3l.dtd">

<message type="ProductRecord" name="Product">
  <unsigned1 id="u1" />
  <unsigned2 id="u2" />
  <number id="pfxnum">
    <padstring length="8" padchar=" " padstyle="none" />
  </number>
  <pfxarray id="Unsigned1Tab" length="u1">
    <unsigned1 />
  </pfxarray>
  <pfxarray id="Signed4Tab" length="pfxnum">
    <unsigned4 />
  </pfxarray>
  <pfxarray id="StrTab" length="u1">
    <limstring delimiter=" " />
  </pfxarray>
</message>
```

```
</pfxarray>
<struct id="WidgetRecord">
  <field name="Name"><limstring delimiter=" " /></field>
  <field name="Color"><limstring delimiter=" " /></field>
  <field name="Weight"><float /></field>
</struct>
<pfxarray id="WidgetTab" length="u2">
  <typeref type="WidgetRecord" />
</pfxarray>
<struct id="ProductRecord">
  <field name="Manufacturer"><limstring delimiter=" " /></field>
  <field name="Weight"><float /></field>
  <field name="Widgets"><typeref type="WidgetTab" /></field>
</struct>

</message>
```

D3L DTDs

Oracle Application Server ProcessConnect provides two DTDs to which D3L (XML) files must conform. [Example A-48](#) shows the first DTD (`D3L.dtd`) to which D3L (XML) files can conform. This file contains actual message definitions. [Example A-49](#) on page A-110 shows the second DTD file (`D3L-definitions.dtd`). This file contains declarations (importable and by reference), and no actual message definitions. This enables you to divide D3L documents into smaller, more manageable units (modules or separate files).

Example A-48 D3L DTD (D3L.dtd)

```

<?xml version="1.0" encoding="US-ASCII"?>

<!-- ===== -->

<!ENTITY % Name      "CDATA"      >
<!ENTITY % Number    "NMTOKEN"    >
<!ENTITY % Comment    "CDATA"      >

<!ENTITY % IdRef      "CDATA"      >

<!-- ===== -->

<!ENTITY % DocumentationAttributes
"
    name      %Name;          #IMPLIED
    comment   %Comment;       #IMPLIED
"
>

<!ENTITY % GenericAttributes
"
    %DocumentationAttributes;
    id        ID              #IMPLIED
"
>

<!ENTITY % MandatoryGenericAttributes
"
    %DocumentationAttributes;
    id        ID              #REQUIRED
"
>

<!-- NEW -->

<!ELEMENT validvalue EMPTY>
  <!ATTLIST validvalue
    %DocumentationAttributes;
    value     CDATA          #REQUIRED
  >

```

```
<!ENTITY % ValidValues
    "
        validvalue
    "
>

<!ELEMENT validvalues ( %ValidValues; )* >
    <!ATTLIST validvalues
        %GenericAttributes;
    >

<!ENTITY % Optionality
    "( R | O )"
>

<!ENTITY % Cardinality
    "CDATA"
>

<!ENTITY % FieldAttributes
    "
        name          %Name;          #REQUIRED
        comment       %Comment;       #IMPLIED
        id            ID              #IMPLIED
        optionality   %Optionality;   #IMPLIED
        validvalues   IDREF           #IMPLIED
        assign        IDREF           #IMPLIED
    "
>

<!ENTITY % NonTypeAttributes
    "
        name          %Name;          #IMPLIED
        comment       %Comment;       #IMPLIED
    "
>

<!-- ===== -->

<!-- NEW -->
```



```
<!ENTITY % SeparatorChar
"CDATA"
>

<!ENTITY % TerminatorChar
"CDATA"
>

<!ENTITY % StructAttributes
"
%GenericAttributes;
startswith      CDATA          #IMPLIED
separatorchar   %SeparatorChar; #IMPLIED
terminatorchar  %TerminatorChar; #IMPLIED
"
>

<!-- ===== -->

<!ENTITY % Align
"%Number;"
>

<!ENTITY % IntegerSize
"( 1 | 2 | 4 | 8 )"
>

<!ENTITY % Endian
"( big | little )"
>

<!ENTITY % IntegerAttributes
"
%GenericAttributes;
endian %Endian;      'big'
"
>

<!ENTITY % IntegerTypes
" signed1 | unsigned1
| signed2 | unsigned2
| signed4 | unsigned4
| signed8 | unsigned8
"
>
```

```
<!ENTITY % FloatAttributes
"
    %GenericAttributes;
"
>

<!ENTITY % FloatTypes
" float | double
"
>

<!-- ===== -->

<!ENTITY % PadStyle
"( head | tail | none )"
>

<!ENTITY % PadChar
"CDATA"
>

<!ENTITY % DelimiterChar
"CDATA"
>

<!ENTITY % StringAttributes
"
    %GenericAttributes;
"
>

<!ENTITY % SimpleStringAttributes
"
    %StringAttributes;
"
>

<!ENTITY % TerminatedStringAttributes
"
    %StringAttributes;
    endchar %DelimiterChar; #REQUIRED
"
>
```

```

<!ENTITY % PaddedStringAttributes
"
    %StringAttributes;
    length      %Number;          #REQUIRED
    padchar     %PadChar;         #REQUIRED
    padstyle    %PadStyle;        #REQUIRED
    endchar     %PadChar;         #IMPLIED
"
>

<!ENTITY % PrefixedStringAttributes
"
    %StringAttributes;
    length      IDREF            #REQUIRED
"
>

<!ENTITY % DelimitedStringAttributes
"
    %StringAttributes;
    delimiter   %DelimiterChar; #REQUIRED
"
>

<!ENTITY % StringTypes
    "padstring | pfxstring | limstring | termstring | simplestring"
>

<!-- ===== -->

<!ENTITY % DateFormat
    "( DDMYY | DDMYYYY | MMDDYY | MMDDYYYY | MMDDYYYY_HHMMI | MMDDYYYY_HHMISS |
    MMDDYYYY_HHMISS_Z )"
>

<!ENTITY % DateAttributes
"
    %GenericAttributes;
    format      %DateFormat;     #REQUIRED
"
>

<!-- ===== -->

```

```
<!ENTITY % NumberAttributes
"
  %GenericAttributes;
"
>

<!-- ===== -->

<!ENTITY % ArrayAttributes
"
  %GenericAttributes;
"
>

<!ENTITY % FixedArrayAttributes
"
  %ArrayAttributes;
  length      %Number;      #REQUIRED
"
>

<!ENTITY % PrefixedArrayAttributes
"
  %ArrayAttributes;
  length      IDREF          #REQUIRED
"
>

<!ENTITY % DelimitedArrayAttributes
"
  %ArrayAttributes;
  cardinality %Cardinality;  #IMPLIED
  contchar   %DelimiterChar; #IMPLIED
  endchar    %DelimiterChar; #IMPLIED
  delimiter  %DelimiterChar; #IMPLIED
"
>

<!ENTITY % ImplicitArrayAttributes
"
  %ArrayAttributes;
"
>

<!-- ===== -->
```

```
<!ENTITY % ScalarElements
" signed1 | unsigned1
| signed2 | unsigned2
| signed4 | unsigned4
| signed8 | unsigned8
| float | double
| date | number
| padstring
| pfxstring
| limstring
| termstring
| simplestring
"
>

<!-- NEW -->

<!ENTITY % FileName "CDATA" >

<!ELEMENT assign EMPTY >
  <!ATTLIST assign
    %DocumentationAttributes;
    variable %IdRef; #REQUIRED
    value CDATA #REQUIRED
    order %Number; #IMPLIED
  >

<!ENTITY % Assignments
"
  assign
"
>

<!ELEMENT assignments ( %Assignments; )* >
  <!ATTLIST assignments
    %GenericAttributes;
  >

<!ENTITY % Default "CDATA" >

<!ENTITY % MaximumLength
"%Number;"
```

```
>

<!ELEMENT variable EMPTY >
  <!ATTLIST variable
    %MandatoryGenericAttributes;
    default      %Default;          #IMPLIED
    maxlen      %MaximumLength;    "1"
  >

<!ENTITY % VariableDeclaration
  "
    variable
  "
>

<!ELEMENT variables ( %VariableDeclaration; )* >
  <!ATTLIST variables
    %GenericAttributes;
  >

<!ELEMENT value-map EMPTY >
  <!ATTLIST value-map
    %DocumentationAttributes;
    native      CDATA              #REQUIRED
    translated  CDATA              #REQUIRED
  >

<!ENTITY % EscapedValuesMapDeclaration
  "
    value-map
  "
>

<!ELEMENT escaped-values-map ( %EscapedValuesMapDeclaration; )* >
  <!ATTLIST escaped-values-map
    %GenericAttributes;
  >

<!ENTITY % TypeElements
  "%ScalarElements;
  | struct
  | fixarray
```

```
    | pfxarray
    | limarray
    | imparray
    "
>

<!ENTITY % MetaElements
    " assignments
    | escaped-values-map
    | typedef
    | validvalues
    | variables
    "
>

<!-- ===== -->

<!ENTITY % FieldElements
    "%TypeElements;"
>

<!ENTITY % MessageElements
    "%TypeElements; | %MetaElements;"
>

<!ENTITY % StructElements
    "field | pad"
>

<!ENTITY % ArrayElements
    "%ScalarElements; | struct"
>

<!ENTITY % EscapeMethod_Prefix
    "prefixed"
>

<!ENTITY % EscapeMethod_Enclosed
    "enclosed"
>

<!ENTITY % EscapeMethod
    "( %EscapeMethod_Prefix; | %EscapeMethod_Enclosed; )"
>
```

```
<!ENTITY % ParseMode_Strict
    "strict"
>

<!ENTITY % ParseMode_Lenient
    "lenient"
>

<!ENTITY % ParseMode
    "( %ParseMode_Strict; | %ParseMode_Lenient; )"
>

<!ENTITY % ValidationMode_First
    "first"
>

<!ENTITY % ValidationMode_Full
    "full"
>

<!ENTITY % ValidationMode
    "( %ValidationMode_First; | %ValidationMode_Full; )"
>

<!-- ===== -->

<!ELEMENT message ( %MessageElements; )* >
    <!ATTLIST message
        name      %Name;          #REQUIRED
        type      IDREF           #REQUIRED
        comment   %Comment;       #IMPLIED
        id        ID              #IMPLIED
        escaping  %EscapeMethod;   'prefixed'
        parsemode %ParseMode;     'strict'
        validation %ValidationMode; 'first'
        encoding  CDATA           #IMPLIED
    >

<!-- ===== -->

<!ELEMENT struct ( %StructElements; )* >
    <!ATTLIST struct
        %StructAttributes;
    >
```



```
<!-- ===== -->
<!ELEMENT field ( typeref | %FieldElements; ) >
  <!ATTLIST field
    %FieldAttributes;
  >
<!-- ===== -->
<!ELEMENT typedef ( typeref | %TypeElements; ) >
  <!ATTLIST typedef
    %MandatoryGenericAttributes;
    validvalues      IDREF          #IMPLIED
  >
<!-- ===== -->
<!ELEMENT signed1 EMPTY >
  <!ATTLIST signed1
    %IntegerAttributes;
    size      %IntegerSize;  #FIXED  "1"
    align     %Align;        "1"
  >
<!ELEMENT unsigned1 EMPTY >
  <!ATTLIST unsigned1
    %IntegerAttributes;
    size      %IntegerSize;  #FIXED  "1"
    align     %Align;        "1"
  >
<!ELEMENT signed2 EMPTY >
  <!ATTLIST signed2
    %IntegerAttributes;
    size      %IntegerSize;  #FIXED  "2"
    align     %Align;        "2"
  >
<!ELEMENT unsigned2 EMPTY >
  <!ATTLIST unsigned2
    %IntegerAttributes;
    size      %IntegerSize;  #FIXED  "2"
    align     %Align;        "2"
  >
<!ELEMENT signed4 EMPTY >
```

```
<!ATTLIST signed4
    %IntegerAttributes;
    size %IntegerSize; #FIXED "4"
    align %Align;      "4"
>

<!ELEMENT unsigned4 EMPTY >
<!ATTLIST unsigned4
    %IntegerAttributes;
    size %IntegerSize; #FIXED "4"
    align %Align;      "4"
>

<!ELEMENT signed8 EMPTY >
<!ATTLIST signed8
    %IntegerAttributes;
    size %IntegerSize; #FIXED "8"
    align %Align;      "8"
>

<!ELEMENT unsigned8 EMPTY >
<!ATTLIST unsigned8
    %IntegerAttributes;
    size %IntegerSize; #FIXED "8"
    align %Align;      "8"
>

<!-- ===== -->

<!ELEMENT float EMPTY >
<!ATTLIST float
    %FloatAttributes;
    align %Align;      "4"
>

<!ELEMENT double EMPTY >
<!ATTLIST double
    %FloatAttributes;
    align %Align;      "8"
>

<!-- ===== -->

<!ELEMENT padstring EMPTY >
<!ATTLIST padstring
```

```
        %PaddedStringAttributes;
    >

<!ELEMENT pfxstring EMPTY >
    <!ATTLIST pfxstring
        %PrefixedStringAttributes;
    >

<!ELEMENT limstring EMPTY >
    <!ATTLIST limstring
        %DelimitedStringAttributes;
    >

<!-- NEW -->
<!ELEMENT simplestring EMPTY >
    <!ATTLIST simplestring
        %SimpleStringAttributes;
    >

<!ELEMENT termstring EMPTY >
    <!ATTLIST termstring
        %TerminatedStringAttributes;
    >

<!-- ===== -->

<!ELEMENT fixarray ( typeref | %ArrayElements; ) >
    <!ATTLIST fixarray
        %FixedArrayAttributes;
    >

<!ELEMENT pfxarray ( typeref | %ArrayElements; ) >
    <!ATTLIST pfxarray
        %PrefixedArrayAttributes;
    >

<!ELEMENT limarray ( typeref | %ArrayElements; ) >
    <!ATTLIST limarray
        %DelimitedArrayAttributes;
    >

<!ELEMENT imparray ( typeref | %ArrayElements; ) >
    <!ATTLIST imparray
        %ImplicitArrayAttributes;
    >
```

```

<!-- ===== -->

<!ELEMENT date ( typeref | %StringTypes; ) >
  <!ATTLIST date
    %DateAttributes;
  >

<!-- ===== -->

<!ELEMENT number ( typeref | %StringTypes; ) >
  <!ATTLIST number
    %NumberAttributes;
  >

<!-- ===== -->

<!ELEMENT typeref EMPTY >
  <!ATTLIST typeref
    %NonTypeAttributes;
    type %IdRef; #REQUIRED
  >

<!-- ===== -->

<!ELEMENT pad EMPTY >
  <!ATTLIST pad
    %NonTypeAttributes;
    length %Number; #REQUIRED
  >

<!-- ===== -->

```

Example A-49 D3L DTD (D3L-definitions.dtd)

```

<?xml version="1.0" encoding="US-ASCII"?>

<!-- ===== -->

<!ENTITY % Name      "CDATA"      >
<!ENTITY % Number    "NMTOKEN"    >
<!ENTITY % Comment   "CDATA"      >

<!ENTITY % IdRef     "CDATA"      >

```

```
<!-- ===== -->

<!ENTITY % DocumentationAttributes
"
    name      %Name;          #IMPLIED
    comment   %Comment;       #IMPLIED
"
>

<!ENTITY % GenericAttributes
"
    %DocumentationAttributes;
    id        ID              #IMPLIED
"
>

<!ENTITY % MandatoryGenericAttributes
"
    %DocumentationAttributes;
    id        ID              #REQUIRED
"
>

<!-- NEW -->

<!ENTITY % FileName "CDATA"    >

<!ELEMENT validvalue EMPTY>
  <!ATTLIST validvalue
    %DocumentationAttributes;
    value      CDATA          #REQUIRED
  >

<!ENTITY % ValidValues
"
    validvalue
"
>

<!ELEMENT validvalues ( %ValidValues; )* >
  <!ATTLIST validvalues
    %GenericAttributes;
  >
```

```
<!ELEMENT assign EMPTY >
  <!ATTLIST assign
    %DocumentationAttributes;
    variable %IdRef; #REQUIRED
    value CDATA #REQUIRED
    order %Number; #IMPLIED
  >

<!ENTITY % Assignments
"
  assign
"
>

<!ELEMENT assignments ( %Assignments; )* >
  <!ATTLIST assignments
    %GenericAttributes;
  >

<!ENTITY % Default "CDATA" >

<!ENTITY % MaximumLength
"%Number;"
>

<!ELEMENT variable EMPTY >
  <!ATTLIST variable
    %MandatoryGenericAttributes;
    default %Default; #IMPLIED
    maxlen %MaximumLength; "1"
  >

<!ENTITY % VariableDeclaration
"
  variable
"
>

<!ELEMENT variables ( %VariableDeclaration; )* >
  <!ATTLIST variables
    %GenericAttributes;
  >

<!ELEMENT value-map EMPTY >
  <!ATTLIST value-map
    %DocumentationAttributes;
```

```

        native      CDATA      #REQUIRED
        translated  CDATA      #REQUIRED
    >

<!ENTITY % EscapedValuesMapDeclaration
    "
        value-map
    "
>

<!ELEMENT escaped-values-map ( %EscapedValuesMapDeclaration; )* >
    <!ATTLIST escaped-values-map
        %GenericAttributes;
    >

<!-- NEW -->

<!ENTITY % ImportAttributes
    "
        location    %FileName;    #REQUIRED
    "
>

<!ELEMENT import EMPTY >
    <!ATTLIST import
        %ImportAttributes;
    >

<!ENTITY % Optionality
    "( R | O )"
>

<!ENTITY % Cardinality
    "CDATA"
>

<!ENTITY % FieldAttributes
    "
        name          %Name;          #REQUIRED
        comment       %Comment;       #IMPLIED
        id            ID              #IMPLIED
        optionality   %Optionality;   #IMPLIED
        validvalues   IDREF           #IMPLIED
        assign       IDREF           #IMPLIED
    "

```

```
>

<!ENTITY % NonTypeAttributes
"
    name      %Name;          #IMPLIED
    comment  %Comment;       #IMPLIED
"
>

<!-- ===== -->

<!-- NEW -->

<!ENTITY % SeparatorChar
"CDATA"
>

<!ENTITY % TerminatorChar
"CDATA"
>

<!ENTITY % StructAttributes
"
    %GenericAttributes;
    startswith      CDATA          #IMPLIED
    separatorchar   %SeparatorChar; #IMPLIED
    terminatorchar  %TerminatorChar; #IMPLIED
"
>

<!-- ===== -->

<!ENTITY % Align
"%Number;"
>

<!ENTITY % IntegerSize
"( 1 | 2 | 4 | 8 )"
>

<!ENTITY % Endian
"( big | little )"
>

<!ENTITY % IntegerAttributes
```



```
"
    %GenericAttributes;
    endian %Endian;          'big'
"
>

<!ENTITY % IntegerTypes
" signed1 | unsigned1
  | signed2 | unsigned2
  | signed4 | unsigned4
  | signed8 | unsigned8
"
>

<!ENTITY % FloatAttributes
"
    %GenericAttributes;
"
>

<!ENTITY % FloatTypes
" float | double
"
>

<!-- ===== -->

<!ENTITY % PadStyle
" ( head | tail | none )"
>

<!ENTITY % PadChar
"CDATA"
>

<!ENTITY % DelimiterChar
"CDATA"
>

<!ENTITY % StringAttributes
"
    %GenericAttributes;
"
>
```

```
<!ENTITY % PaddedStringAttributes
"
    %StringAttributes;
    length      %Number;          #REQUIRED
    padchar     %PadChar;         #IMPLIED
    padstyle    %PadStyle;       #IMPLIED
    endchar     %PadChar;         #IMPLIED
"
>

<!ENTITY % PrefixedStringAttributes
"
    %StringAttributes;
    length      IDREF            #REQUIRED
"
>

<!ENTITY % DelimitedStringAttributes
"
    %StringAttributes;
    delimiter   %DelimiterChar; #REQUIRED
"
>

<!ENTITY % TerminatedStringAttributes
"
    %StringAttributes;
    endchar     %TerminatorChar; #REQUIRED
"
>

<!ENTITY % StringTypes
    "padstring | pfxstring | limstring | simplestring | termstring"
>

<!-- ===== -->

<!ENTITY % DateFormat
    "( DDMYY | DDMYYYY | MMDDY | MMDDYYYY | MMDDYYYY_HHMM | MMDDYYYY_HHMISS |
    MMDDYYYY_HHMISS_Z )"
>

<!ENTITY % DateAttributes
"
```

```
        %GenericAttributes;
        format %DateFormat;      #REQUIRED
    "
>

<!-- ===== -->

<!ENTITY % NumberAttributes
    "
        %GenericAttributes;
    "
>

<!-- ===== -->

<!ENTITY % ArrayAttributes
    "
        %GenericAttributes;
    "
>

<!ENTITY % FixedArrayAttributes
    "
        %ArrayAttributes;
        length %Number;          #REQUIRED
    "
>

<!ENTITY % PrefixedArrayAttributes
    "
        %ArrayAttributes;
        length IDREF              #REQUIRED
    "
>

<!ENTITY % DelimitedArrayAttributes
    "
        %ArrayAttributes;
        cardinality %Cardinality; #IMPLIED
        contchar %DelimiterChar; #IMPLIED
        endchar %DelimiterChar; #IMPLIED
        delimiter %DelimiterChar; #IMPLIED
    "
>
```

```
<!ENTITY % ImplicitArrayAttributes
"
    %ArrayAttributes;
"
>

<!-- ===== -->

<!ENTITY % ScalarElements
" signed1 | unsigned1
  | signed2 | unsigned2
  | signed4 | unsigned4
  | signed8 | unsigned8
  | float | double
  | date | number
  | padstring
  | pfxstring
  | limstring
  | simplestring
  | termstring
"
>

<!ENTITY % TypeElements
"%ScalarElements;
| struct
| fixarray
| pfxarray
| limarray
| imparray
"
>

<!-- NEW -->

<!ENTITY % MetaElements
" assignments
  | escaped-values-map
  | import
  | typedef
  | validvalues
  | variables
"
>
```

```

<!-- ===== -->

<!ENTITY % FieldElements
    "%TypeElements;"
>

<!-- NEW -->

<!ENTITY % DefinitionElements
    "%TypeElements; | %MetaElements;"
>

<!ENTITY % StructElements
    "field | pad"
>

<!ENTITY % ArrayElements
    "%ScalarElements; | struct"
>

<!-- ===== -->

<!ELEMENT definitions ( %DefinitionElements; )* >
    <!ATTLIST definitions
        name      %Name;          #REQUIRED
        comment   %Comment;       #IMPLIED
        id        ID              #IMPLIED
    >

<!-- ===== -->

<!ELEMENT struct ( %StructElements; )* >
    <!ATTLIST struct
        %StructAttributes;
    >

<!-- ===== -->

<!ELEMENT field ( typeref | %FieldElements; ) >
    <!ATTLIST field
        %FieldAttributes;
    >

<!-- ===== -->

```

```
<!ELEMENT typedef ( typeref | %TypeElements; ) >
  <!ATTLIST typedef
    %MandatoryGenericAttributes;
    validvalues      IDREF          #IMPLIED
  >

<!-- ===== -->

<!ELEMENT signed1 EMPTY >
  <!ATTLIST signed1
    %IntegerAttributes;
    size      %IntegerSize;  #FIXED  "1"
    align     %Align;        "1"
  >

<!ELEMENT unsigned1 EMPTY >
  <!ATTLIST unsigned1
    %IntegerAttributes;
    size      %IntegerSize;  #FIXED  "1"
    align     %Align;        "1"
  >

<!ELEMENT signed2 EMPTY >
  <!ATTLIST signed2
    %IntegerAttributes;
    size      %IntegerSize;  #FIXED  "2"
    align     %Align;        "2"
  >

<!ELEMENT unsigned2 EMPTY >
  <!ATTLIST unsigned2
    %IntegerAttributes;
    size      %IntegerSize;  #FIXED  "2"
    align     %Align;        "2"
  >

<!ELEMENT signed4 EMPTY >
  <!ATTLIST signed4
    %IntegerAttributes;
    size      %IntegerSize;  #FIXED  "4"
    align     %Align;        "4"
  >

<!ELEMENT unsigned4 EMPTY >
  <!ATTLIST unsigned4
```

```
        %IntegerAttributes;
        size    %IntegerSize;    #FIXED  "4"
        align   %Align;          "4"
    >

<!ELEMENT signed8 EMPTY >
  <!ATTLIST signed8
    %IntegerAttributes;
    size    %IntegerSize;    #FIXED  "8"
    align   %Align;          "8"
  >

<!ELEMENT unsigned8 EMPTY >
  <!ATTLIST unsigned8
    %IntegerAttributes;
    size    %IntegerSize;    #FIXED  "8"
    align   %Align;          "8"
  >

<!-- ===== -->

<!ELEMENT float EMPTY >
  <!ATTLIST float
    %FloatAttributes;
    align   %Align;          "4"
  >

<!ELEMENT double EMPTY >
  <!ATTLIST double
    %FloatAttributes;
    align   %Align;          "8"
  >

<!-- ===== -->

<!ELEMENT padstring EMPTY >
  <!ATTLIST padstring
    %PaddedStringAttributes;
  >

<!ELEMENT pfxstring EMPTY >
  <!ATTLIST pfxstring
    %PrefixedStringAttributes;
  >
```

```
<!ELEMENT limstring EMPTY >
  <!ATTLIST limstring
    %DelimitedStringAttributes;
  >

<!-- NEW -->
<!ELEMENT simplestring EMPTY >
  <!ATTLIST simplestring
    %StringAttributes;
  >

<!ELEMENT termstring EMPTY >
  <!ATTLIST termstring
    %TerminatedStringAttributes;
  >

<!-- ===== -->

<!ELEMENT fixarray ( typeref | %ArrayElements; ) >
  <!ATTLIST fixarray
    %FixedArrayAttributes;
  >

<!ELEMENT pfixarray ( typeref | %ArrayElements; ) >
  <!ATTLIST pfixarray
    %PrefixedArrayAttributes;
  >

<!ELEMENT limarray ( typeref | %ArrayElements; ) >
  <!ATTLIST limarray
    %DelimitedArrayAttributes;
  >

<!ELEMENT imparray ( typeref | %ArrayElements; ) >
  <!ATTLIST imparray
    %ImplicitArrayAttributes;
  >

<!-- ===== -->

<!ELEMENT date ( typeref | %StringTypes; ) >
  <!ATTLIST date
    %DateAttributes;
  >
```



```
<!-- ===== -->

<!ELEMENT number ( typeref | %StringTypes; ) >
  <!ATTLIST number
    %NumberAttributes;
  >

<!-- ===== -->

<!ELEMENT typeref EMPTY >
  <!ATTLIST typeref
    %NonTypeAttributes;
    type %IdRef; #REQUIRED
  >

<!-- ===== -->

<!ELEMENT pad EMPTY >
  <!ATTLIST pad
    %NonTypeAttributes;
    length %Number; #REQUIRED
  >

<!-- ===== -->
```

Token Substituted Text

Token substituted text specifies the subject and message bodies of alert e-mail messages used with the step return code port. Token substituted text is free-form text interspersed with tokens representing values that can be filled in at runtime. The token substituted text converter creates an application type that has members for each of the tokens. You then define a transformation to populate these values. This produces the appropriate event type for delivery to an E-Mail adapter. The token substituted text translator substitutes the values into the text for outbound messages and parses the message for the token values for inbound messages.

See Also: The following sections for additional token substituted text tasks:

- ["Creating a Step Return Code Port"](#) on page 21-7 to create a step return code port to receive an alert e-mail in token substituted text format through an E-Mail adapter when a role step fails
- ["Creating an Alert E-Mail Message Native Format"](#) on page 21-19 for an example of using the E-Mail adapter
- ["Managing Transformation Statements"](#) on page 13-29

Definition File

Alert e-mails consist of subject and message bodies. The definition file records the name and definition of the text for subject and message bodies of alert e-mail messages. The file is divided into sections identified by lines starting with #:

```
# ENCODING
  ASCII_based_IANA_character_set

# COMMENT
  comment_text

# NAME
  Datatype_name

# IDENTIFIER
  Identifier_token_value

# DEFINITION
  Definition_including_token_substitutions
```

Where...	Is...
ENCODING	Defines the IANA character set encoding of the file. This optional section must be the first section in the file, and is used if the file is sent or received using a binary transport mechanism. The value must be an ASCII-based character set (for example, UTF-8 or ISO-8859-1). Non-ASCII based character sets such as UTF-16 and UTF-32 are not supported. If a character set is not specified, then the text is encoded using the platform default encoding. (This section is optional.)
COMMENT	Free comment text (This section is optional.)
NAME	The unique name for the alert datatype (This section is mandatory.)
IDENTIFIER	The token value for the special substitution token IDENTIFIER (This section is optional.)
DEFINITION	The text definition containing free-form text and substitution tokens (This section is mandatory.)

The DEFINITION section consists of free-form text where spaces and new lines appear in the output. For inbound translations, the text is parsed as long as the definition matches the start of the text (that is, trailing text is not significant). To indicate the use of a substituted value, the user inserts the following into the text:

{*TOKEN_NAME*}

ROLE_NAME or *STEP_NAME* are examples of tokens.

The following restrictions apply to substituted value use:

- Substituted value tokens must be separated by nonwhite space characters that are not substrings of possible token values.
- A definition cannot end with a token.
- Zero or more tokens can be used within the definition.
- The same token can be used in multiple places. Each use receives the same value.

The token IDENTIFIER has a special meaning because it can uniquely identify the e-mail message type from all others. If you use this token, you must specify the value in the IDENTIFIER section. This is to allow identification of reply e-mails using event maps.

If you want to use a reserved character (#, {, \, and }) in the DEFINITION text, precede it with a backslash (\) as an escape character.

See Also: ["Inbound E-Mail Responses to an Alert E-Mail"](#) on page A-129 for an example of IDENTIFIER use

Subject Body of a Definition File

[Example A-50](#) shows the NAME and DEFINITION sections of the subject body of an alert e-mail. In the DEFINITION section, the tokens *ROLE_NAME* and *STEP_NAME* are substituted with values at runtime.

Example A-50 Subject Body

```
# NAME
TRANSFORM_ALERT_SUBJECT
# DEFINITION
{ROLE_NAME}.{STEP_NAME} transformation failure
```

Message Body of a Definition File

[Example A-51](#) shows the NAME and DEFINITION sections of the message body of an alert e-mail. In the DEFINITION section, the tokens *STEP_NAME*, *ROLE_NAME*, *EVENT_ID*, and *ERROR_CODE* are substituted with values at runtime.

Example A-51 Message Body

```
# NAME
TRANSFORM_ALERT_MESSAGE

# DEFINITION
Transformation step {STEP_NAME} failed in business process {ROLE_NAME}
for purchase order {EVENT_ID} with error {ERROR_CODE}.
```

Token Substituted Text in a Definition File

[Example A-52](#) provides an example in which the subject body tokens shown in [Example A-50](#) and the message body tokens shown in [Example A-51](#) are substituted with values.

Example A-52 Token Substituted Text in Definition File

```
FROM: ip@oracle.com
SUBJECT: my_po_bp.transform_po transformation failure
```

```
Transformation step transform_po failed in business process my_po_bp for
purchase order #12345 with error:
Error -: AIP-10422: Transformation step callout failed during
execution:
oracle.tip.ts.transformation.api.exception.DomainResourceException:
Error -: AIP-14004: Error in invoking domain value function
lookupBusinessViewDomain.
```

The following tokens are substituted with these values at runtime:

- For the subject body tokens shown in [Example A-50](#):
 - *ROLE_NAME* is replaced with the value `my_po_bp`. This value is a constant that comes from the event transformation map.
 - *STEP_NAME* is replaced with the value `transform_po`. This value is a constant that comes from the event transformation map.
- For the message body tokens shown in [Example A-51](#):
 - *STEP_NAME* is replaced with the value `transform_po`. This value is a constant that comes from the event transformation map.
 - *ROLE_NAME* is replaced with the value `my_po_bp`. This value is a constant that comes from the event transformation map.
 - *EVENT_ID* is replaced with the value `#12345`. This value comes from the source purchase order.
 - *ERROR_CODE* is replaced with the value:

```
Error -: AIP-10422: Transformation step callout failed
during execution:
oracle.tip.ts.transformation.api.exception.DomainResourc
eException:
```

Error -: AIP-14004: Error in invoking domain value function lookupBusinessViewDomain.

This value comes from the return code error message.

Token Substituted Text Datatypes and Event Body Elements

The alert e-mail transformation populates the following application datatypes of the subject and message bodies with values. While these datatypes members are optional, Oracle recommends that you populate each with a value.

- For TRANSFORM_ALERT_SUBJECT:
 - ROLE_NAME
 - STEP_NAME
- For TRANSFORM_ALERT_MESSAGE:
 - STEP_NAME
 - ROLE_NAME
 - EVENT_ID
 - ERROR_CODE

The application event consists of two event body elements:

- Subject body (TRANSFORM_ALERT_SUBJECT)
- Message body (TRANSFORM_ALERT_MESSAGE)

Note: For globalization support, you must define the message in localized text and specify a character set encoding, if appropriate. If you want to send an alert in different languages, each localized language requires its own token substituted text definition file and native event type.

Inbound E-Mail Responses to an Alert E-Mail

For inbound e-mail responses to alert e-mails, the `DEFINITION` section requires an additional identifier to uniquely identify the e-mail response through event maps. Create the event map as a check for the existence of the root node. At runtime, this checks for the existence of the identifier.

For an e-mail response, this is typically the start of the subject line, which is a concatenation of `Re:` (or a similar localized reply identifier) and the initial words of the alert subject. A separate definition of the identifier enables you to define a more meaningful datatype name. For example, if the following e-mail is sent as an approval notification:

```
FROM: ip@oracle.com
TO: david.thompson@oracle.com
SUBJECT: Purchase Order number 12345 needs approval
```

```
Purchase Order 12345 for amount 12500.00 requires your approval.
Please reply with the word 'Approve' if you approve, or 'Disapprove'
If this should not be approved.
```

and the response is:

```
FROM: david.thompson@oracle.com
TO: ip@oracle.com
SUBJECT: Re: Purchase Order number 12345 needs approval
```

```
Approve
```

The response subject definition is:

```
# NAME
PO_APPROVAL_RESPONSE_SUBJECT

# IDENTIFIER
Re: Purchase Order

# DEFINITION
{IDENTIFIER} number {PO_ID} needs approval
```

This results in an application datatype for `PO_APPROVAL_RESPONSE_SUBJECT` named `PO_ID`.

Appendix Summary

This appendix describes the prepackaged support provided for the XSD, D3L, and token substituted text native formats and translators.

Transformation Rules

This appendix describes the datatype transformation map rules, event header rules, and domain value map rules included with Oracle Application Server ProcessConnect.

This appendix contains this topic:

- [Transformation Rules](#)
- [Event Header Rules](#)
- [Domain Value Map Rules](#)
- [Appendix Summary](#)

See Also:

- ["Transformation"](#) on page 3-39 and ["Transformation Binding Role"](#) on page 3-41 for conceptual details about transformations
- [Chapter 13, "Managing Transformations"](#) for an overview of transformations; definitions of transformation rules, event header rules, and domain value map rules; and instructions on managing transformations
- [Chapter 14, "Advanced Transformations Design"](#)

Transformation Rules

This section describes the transformation rules included with Oracle Application Server ProcessConnect.

See Also:

- ["Transformation Statements Overview"](#) on page 13-27 for a definition of a transformation rule
- ["Creating a Transformation Rule"](#) on page 13-32 for instructions on selecting a transformation rule as a transformation statement type

add:first=decimal,second=decimal->result=decimal

Enables you to add two decimal values.

- `source first decimal`
The first decimal value to add.
- `source second decimal`
The second decimal value to add.
- `target result decimal`
The result of adding the two decimal values.

This example invokes `add` with decimal values. The result of adding 50.0 to the price is bound to the total:

```
add( first = 50.0 , second = requisition/items/Item/USPrice -> result =  
purchaseorder/total )
```

add:first=float,second=float->result=float

Enables you to add two float values.

- `source first float`
The first source float value to add.
- `source second float`
The second source float value to add.

- `target result float`

The result of adding the two source float values.

This example invokes `add` with float values. The result of adding `packaging weight` and `item weight` is bound to the `total weight`.

```
add( first = freight/weight/packaging, second = freight/weight/item -> result =
freight/weight/total )
```

add:first=integer,second=integer->result= integer

Enables you to add two integer values.

- `source first integer`

The first source integer to add.

- `source second integer`

The second source integer to add.

- `target result integer`

The result of adding the two source integer values.

This example invokes `add` with integer values. This rule increments the map variable `counter` by one.

```
add( first = counter , second = 1 -> result = counter )
```

concat:firstString=string,secondString=string->resultString=string

Enables you to concatenate the second source string to the end of the first source string.

- `source firststring string`

The first source string.

- `source secondstring string`

The second source string.

- `target resultstring string`

The results of concatenating the second source string to the first source string's end.

This example invokes `concat` to concatenate `Addressline1` and `Addressline2` to `ADDRLINE`.

```
concat( firstString = PhysicalAddress/addressLine1/FreeFormText, secondString =  
PhysicalAddress/addressLine2/FreeFormText -> resultString = ADDRESS/ADDRLINE )
```

copy:from=binary->to=binary

Enables you to copy a binary value into the target.

- `source from binary`

The source binary value.

- `target to binary`

The target into which a binary value is copied.

This example invokes the `copy` map to copy a binary value into a target's `LOGICALID` field.

```
copy( source = CONTROLAREA/SENDER/LOGICALID ) ---> ( target =  
CONTROLAREA/RECEIVER/LOGICALID )
```

copy:from=boolean->to=boolean

Enables you to copy a Boolean value into the target.

- `source from boolean`

The source Boolean value.

- `target to boolean`

The target into which a Boolean value is copied.

This example invokes the `copy` map to copy the Boolean value `true` into the target's `STATUSVL` field.

```
copy( source = true -> target = DATAAREA/CONFIRM_BOD/CONFIRM/STATUSVL )
```

copy:from=character->to=character

Enables you to copy a character value into the target.

- `source from character`
The source character value.
- `target to character`
The target into which a character value is copied.

This example invokes the `copy` map to copy the character value 'Z' into the target's `TIMEZONECHAR` field.

```
copy( source = 'Z' -> ( target = CONTROLAREA/DATETIME/TIMEZONECHAR )
```

copy:from=dateTime->to=dateTime

Enables you to copy a `dateTime` value into the target.

- `source from dateTime`
The source `dateTime` value.
- `target to dateTime`
The target into which a `dateTime` value is copied.

This example invokes the `copy` map to copy the `DateTime` value into the target's `DATETIME` field.

```
copy( source = ORDER/EXECUTION/DATETIME -> target = SHIPPING/DATETIME )
```

copy:from=decimal->to=decimal

Enables you to copy a decimal value into the target.

- `source from decimal`
The source decimal value.
- `target to decimal`
The target into which a decimal value is copied.

This example invokes the `copy` map to copy the decimal value `250.0` into the target's `USPrice` field.

```
add( source = 250.0 -> target = requisition/items/Item/USPrice )
```

copy:from=double->to=double

Enables you to copy a double value into the target.

- `source from double`
The source double value.
- `target to double`
The target into which a double value is copied.

This example invokes the `copy` map to copy the value `47.2367895` into the target's `value` field.

```
copy( source = 47.2367895 -> target = currency/USD/value )
```

copy:from=float->to=float

Enables you to copy a float value into the target.

- `source from float`
The source float value.
- `target to float`
The target float to which the value is copied.

This example invokes the `copy` map to copy the value `63.4` into the target's `price` field

```
copy( source = 63.4 -> target = locale/currency/USD/price )
```

copy:from=integer->to=integer

Enables you to copy an integer value into the target.

- `source from integer`
The source integer value.
- `target to integer`
The target integer to which the value is copied.

This example invokes the `copy` map to copy the value 52 into the target's `avgPrice` field.

```
copy( source = 52 -> target = todays/trade/ORCL/avgPrice )
```

copy:from=string->to=string

Enables you to copy a string value into the target.

- `source` from string

The source string to copy.

- `target` to string

The target string to which the value is copied.

This example invokes the `copy` map to copy a string value `Oracle` into the target's `company_name` field.

```
copyString( from='Oracle' -> to= expense-BE/Payload/company_name  
)
```

copy:from=xmlOpaque->to=xmlOpaque

Enables you to copy an `XMLOpaque` value into the target `XMLOpaque`. The `XMLOpaque` type models the XMLSchema datatype `xsd:any`. It can hold strings, numbers, character objects (CLOB), binary objects (BLOB), and so on.

- `source` from `XMLOpaque`

The source `XMLOpaque` value to copy.

- `target` to `XMLOpaque`

The target `XMLOpaque` to which the value is copied.

This example invokes the `copy` map to copy a buyer's address to a purchaser's address. The XMLSchema datatype for `Address` is `xsd:any`.

```
copy( source = Buyer/Address -> target = Purchaser/Address )
```

decimalToInteger:source=decimal->result=integer

Returns the integer value of the source decimal value.

- `source` source decimal
The source decimal value.
- `target` result integer
The integer value of the source decimal value.

This example invokes `decimalToInteger` to convert decimal 23.45 to populate integer 23 in the target field.

```
decimalToInteger( source = 23.45 -> target = Purchaser/invoice/NoOfItems )
```

divide:first=decimal,second=decimal->result=decimal

Returns the result of dividing the first decimal value by the second decimal value.

- `source` first decimal
The first decimal value.
- `source` second decimal
The second decimal value.
- `target` result decimal
The value returned by dividing the first decimal value by the second decimal value.

This example invokes the `divide` map to divide 23.45 by 4.5 and bind the target map variable with the resulting decimal.

```
divide( first = 23.45 , second = 4.5 ) -> ( result = MapVariable )
```

divide:first=float,second=float->result=float

Returns the value of dividing the first float value by the second float value.

- `source` first float
The first float value.
- `source` second float
The second float value.

- `target result float`

The value returned by dividing the first float by the second float.

This example invokes the `divide` map to divide 23.45678 by 4.5 and bind the target map variable with the resulting float.

```
divide( first = 23.45678 , second = 4.5 -> result = MapVariable )
```

divide:first=integer,second=integer->result=integer

Returns the value of dividing the first integer value by the second integer value.

- `source first integer`

The first integer value (the numerator).

- `source second integer`

The second integer value with which to divide (the denominator).

- `target result integer`

The value returned by dividing the first integer by the second integer.

This example invokes the `divide` map to divide 25 by 5 and bind the target map variable with the resulting integer.

```
divide( first = 25 , second = 5 -> result = MapVariable )
```

doubleToDecimal:source=double->result=decimal

Returns the decimal value of the source double value.

- `source source double`

The source double value.

- `target result decimal`

The target decimal value of the source double value.

This example invokes `doubleToDecimal` to convert a double 23.45678 into a decimal value.

```
doubleToDecimal( source = 23.45678976 -> result = MapVariable )
```

doubleToFloat:source=double->result=float

Returns the float value of the source double value.

- `source` `source` `double`
The source double value.
- `target` `result` `float`
The target float value of the source double value.

This example invokes `doubleToFloat` to convert a double `23.45678` into a float value.

```
doubleToFloat( source = 23.45678976 -> result = MapVariable )
```

doubleToInteger:source=double->result=integer

Returns the integer value of the source double value.

- `source` `source` `double`
The source double value.
- `target` `result` `integer`
The target integer value of the source double value.

This example invokes `doubleToInteger` to convert a double `23.45678` into an integer value. The result of this map is `23`.

```
doubleToInteger( source = 23.45678976 -> result = MapVariable )
```

endsWith:sourceString=string,sourceSuffix=string->resultFoundSuffix=boolean

Returns `true` if the `sourceString` is suffixed with the `suffixString`. Otherwise, `false` is returned.

- `source` `sourceString` `string`
The source string.
- `source` `sourceSuffix` `string`
The source suffix string.

- `target resultFoundSuffix boolean`

Returns `true` if the source string ends with the `suffixString`. Otherwise, `false` is returned.

This example invokes `endsWith` to verify if the string `'Hello World'` ends with `'World'`. The result of this map is `true`.

```
endsWith( sourceString = 'HelloWorld' , sourceSuffix = 'World' ->
resultFoundSuffix = MapVariable )
```

endsWith:sourceString=string,sourceSuffix=string,sourceBeginOffset=integer->resultFoundSuffix=boolean

Returns `true` if the source string ends with the `suffixString`.

- `source sourceString string`

The source string.

- `source sourceSuffix string`

The source suffix string.

- `source sourceBeginOffset integer`

The offset from which to start the check for the suffix string within the source string.

- `target resultFoundSuffix boolean`

Returns `true` if the source string ends with the `suffixString`.

This example invokes `endsWith` to verify if the string `'Hello World'` ends with `'World'` starting from character number 5. In this case, it returns `true`.

```
endsWith( sourceString = 'HelloWorld' , sourceSuffix = 'World',
sourceBeginOffset = 5 -> resultFoundSuffix = MapVariable )
```

floatToInteger:source=float->result=integer

Returns the integer value of the source float value.

- `source` `float`
The source float value.
- `target` `result` `integer`
The integer value of the source float value.

This example invokes `floatToInteger` to convert a float `23.45` and bind the resulting integer `23` to the target `MapVariable`.

```
floatToInteger( sourceString = 23.45 -> result = MapVariable )
```

format:date=dateTime,formatPattern=string->resultString=string

Returns the string representation of the input `dateTime` in the required format.

Date and Time Patterns

Date and time formats are specified by date and time pattern strings. Within date and time pattern strings, unquoted letters from A to Z and from a to z are interpreted as pattern letters representing the components of a date or time string. Text can be quoted using single quotes (') so that it is taken literally (' ' represents a single quote). All other characters are not interpreted; they are simply copied into the output string during formatting or matched against the input string during parsing.

The pattern letters shown in [Table B-1](#) are defined (all other characters from A to Z and from a to z are reserved).

Table B-1 *Date and Time Patterns*

Letter	Date or Time Component	Presentation	Examples
G	Era designator	Text	AD
Y	Year	Year	1996; 96
M	Month in year	Month	July; Jul; 07
w	Week in year	Number	27
W	Week in month	Number	2
D	Day in year	Number	189

Table B-1 (Cont.) Date and Time Patterns

Letter	Date or Time Component	Presentation	Examples
d	Day in month	Number	10
F	Day of week in month	Number	2
E	Day in week	Text	Tuesday; Tue
a	Am/pm marker	Text	PM
H	Hour in day (0-23)	Number	0
k	Hour in day (1-24)	Number	24
K	Hour in am/pm (0-11)	Number	0
h	Hour in am/pm (1-12)	Number	12
m	Minute in hour	Number	30
s	Second in minute	Number	55
S	Millisecond	Number	978
z	Time zone	General time zone	Pacific Standard Time; PST; GMT-08:00
Z	Time zone	RFC 822 time zone	-0800
O	Hour in time zone (0-23)	ISO 8601	08
o	Minute in time zone	ISO 8601	45

Pattern letters are usually repeated, as their number determines the exact presentation:

- Text

For formatting, if the number of pattern letters is four or more, the full form is used. Otherwise a short or abbreviated form is used if available. For parsing, both forms are accepted, independent of the number of pattern letters.

- Number

For formatting, the number of pattern letters is the minimum number of digits, and shorter numbers are zero-padded to this amount. For parsing, the number of pattern letters is ignored unless it's needed to separate two adjacent fields.

- Year

For formatting, if the number of pattern letters is two, the year is truncated to two digits. Otherwise, it is interpreted as a number.

- Month

If the number of pattern letters is three or more, the month is interpreted as text. Otherwise, it is interpreted as a number.

- General time zone

Time zones are interpreted as text if they have names. For time zones representing a GMT offset value, the following syntax is used:

```
GMTOffsetTimeZone:
    GMT Sign Hours : Minutes
Sign: one of
    + -
Hours:
    Digit
    Digit Digit
Minutes:
    Digit Digit
Digit: one of
0 1 2 3 4 5 6 7 8 9
```

Hours must be between 0 and 23, and *Minutes* must be between 00 and 59. The format is locale-independent and digits must be taken from the Basic Latin block of the Unicode standard.

For parsing, RFC 822 time zones are also accepted.

- RFC 822 time zone

For formatting, the RFC 822 4-digit time zone format is used:

```
RFC822TimeZone:
    Sign TwoDigitHours Minutes
TwoDigitHours:
    Digit Digit
```

TwoDigitHours must be between 00 and 23. Other definitions are as for general time zones.

For parsing, general time zones are also accepted.

- ISO 8601 time zone

For formatting, the ISO 8601 4-digit time zone format is used:

```
ISO8601TimeZone:
    SignTwoDigitHours:Minutes
TwoDigitHours:
    Digit Digit
```

TwoDigitHours must be between 00 and 23. Other definitions are as for general time zones.

Parameters

- `source date dateTime`
The current system date.
- `source formatPattern string`
The required format of the system date.
- `target resultString string`
Returns the system date in the required format as a string.

This example invokes the format map to format a `dateTime` "1997-05-01T13:20:59.333+5:30" in ISO 8601 format to a format "YYYY-MM" and bind the result string to a `MapVariable`. The result of this map is a string "1997-05".

```
format ( date = 1997-05-01T13:20:59.333+5:30, formatPattern = "yyyy-MM" ) -> (
resultString = MapVariable )
```

format:value=decimal,formatPattern=string->resultString=string

Returns a string representation of the input decimal value in the format specified.

Patterns

DecimalFormat patterns have the following syntax:

```

Pattern:
    PositivePattern
    PositivePattern ; NegativePattern
PositivePattern:
    Prefixopt Number Suffixopt
NegativePattern:
    Prefixopt Number Suffixopt
Prefix:
    any Unicode characters except \uFFFE, \uFFFF, and special characters
Suffix:
    any Unicode characters except \uFFFE, \uFFFF, and special characters
Number:
    Integer Exponentopt
    Integer . Fraction Exponentopt
Integer:
    MinimumInteger
    #
    # Integer
    # , Integer
MinimumInteger:
    0
    0 MinimumInteger
    0 , MinimumInteger
Fraction:
    MinimumFractionopt OptionalFractionopt
MinimumFraction:
    0 MinimumFractionopt
OptionalFraction:
    # OptionalFractionopt
Exponent:
    E MinimumExponent
MinimumExponent:
    0 MinimumExponentopt

```

A pattern contains a positive and negative subpattern, for example, "#,##0.00;(#,##0.00)". Each subpattern has a prefix, numeric part, and suffix. The negative subpattern is optional. If absent, then the positive subpattern prefixed with the localized minus sign (code>'-' in most locales) is used as the negative subpattern. That is, "0.00" alone is equivalent to "0.00;-0.00". If there is an

explicit negative subpattern, it serves only to specify the negative prefix and suffix. The number of digits, minimal digits, and other characteristics are all the same as the positive pattern. That means that "#,##0.0#;(#)" produces precisely the same behavior as "#,##0.0#;(#,##0.0#)".

The prefixes, suffixes, and various symbols used for infinity, digits, thousands separators, decimal separators, and so on can be set to arbitrary values, and they appear properly during formatting. However, ensure that the symbols and strings do not conflict, or parsing is unreliable. For example, either the positive and negative prefixes or the suffixes must be distinct for `DecimalFormat.parse()` to distinguish positive from negative values. (If they are identical, then `DecimalFormat` behaves as if no negative subpattern was specified.) Another example is that the decimal separator and thousands separator must be distinct characters, or parsing is impossible.

The grouping separator is commonly used for thousands, but in some countries it separates ten-thousands. The grouping size is a constant number of digits between the grouping characters, such as 3 for 100,000,000 or 4 for 1,0000,0000. If you supply a pattern with multiple grouping characters, the interval between the last one and the end of the integer is the one used. Therefore, "#,##,###,####" == "#####,####" == "##,####,####".

Special Pattern Characters

Many characters in a pattern are taken literally. They are matched during parsing and output unchanged during formatting. Special characters, however, stand for other characters, strings, or classes of characters. They must be quoted, unless noted otherwise, if they are to appear in the prefix or suffix as literals.

The characters listed in [Table B-2](#) are used in nonlocalized patterns. Localized patterns use the corresponding characters taken from this formatter's `DecimalFormatSymbols` object instead, and these characters lose their special status. Two exceptions are the currency sign and quote, which are not localized.

Table B-2 Special Pattern Characters

Symbol	Location	Localized?	Meaning
0	Number	Yes	Digit
#	Number	Yes	Digit, zero shows as absent
.	Number	Yes	Decimal separator or monetary decimal separator
-	Number	Yes	Minus sign

Table B–2 (Cont.) Special Pattern Characters

Symbol	Location	Localized?	Meaning
,	Number	Yes	Grouping separator
E	Number	Yes	Separates mantissa and exponent in scientific notation. It does not need to be quoted in the prefix or suffix.
;	Subpattern boundary	Yes	Separates positive and negative subpatterns.
%	Prefix or suffix	Yes	Multiply by 100 and show as percentage.
\u2030	Prefix or suffix	Yes	Multiply by 1000 and show as for each mille. (Mille is the equivalent of ten to the power of minus three.)
¤ (\u00A4)	Prefix or suffix	No	Currency sign, replaced by currency symbol. If doubled, it is replaced by the international currency symbol. If present in a pattern, the monetary decimal separator is used instead of the decimal separator.
'	Prefix or suffix	No	Used to quote special characters in a prefix or suffix, for example, "' #' #" formats 123 to "#123". To create a single quote itself, use two in a row: "# o' 'clock".

Scientific Notation

Numbers in scientific notation are expressed as the product of a mantissa and a power of ten. For example, 1234 can be expressed as 1.234×10^3 . The mantissa is often in the range of $1.0 \leq x < 10.0$, but it does not need to be.

`DecimalFormat` can be instructed to format and parse scientific notation only through a pattern. There is currently no factory method that creates a scientific notation format. In a pattern, the exponent character immediately followed by one or more digit characters indicates scientific notation. For example, "0.###E0" formats the number 1234 as "1.234E3".

- The number of digit characters after the exponent character gives the minimum exponent digit count. There is no maximum. Negative exponents are formatted using the localized minus sign, not the prefix and suffix from the pattern. This allows patterns such as "0.###E0 m/s".

- The minimum and maximum number of integer digits are interpreted together:
 - If the maximum number of integer digits is greater than their minimum number and greater than one, it forces the exponent to be a multiple of the maximum number of integer digits, and the minimum number of integer digits to be interpreted as one. The most common use of this is to generate engineering notation, in which the exponent is a multiple of three (for example, "`##0.#####E0`"). Using this pattern, the number 12345 formats to "`12.345E3`", and 123456 formats to "`123.456E3`".
 - Otherwise, the minimum number of integer digits is achieved by adjusting the exponent. For example, 0.00123 formatted with "`00.###E0`" results in "`12.3E-4`".
- The number of significant digits in the mantissa is the sum of the minimum integer and maximum fraction digits, and is not impacted by the maximum integer digits. For example, 12345 formatted with "`##0.##E0`" is "`12.3E3`". To show all digits, set the significant digits count to zero. The number of significant digits does not impact parsing.
- Exponential patterns may not contain grouping separators.

Rounding

Rounding uses half-even rounding for formatting. Use rounding mode to round toward the nearest neighbor unless both neighbors are equidistant. In that case, round toward the even neighbor. For example, if a pattern is "`0000`" and the number to format is 234.55, the resulting formatted value is "`0235`". If the number to format is 234.50, the resulting value is "`0234`". If the number to format is 233.50, the resulting value is "`0234`".

Parameters

- `source value decimal`
The current decimal format.
- `source formatPattern string`
The required format of decimals.
- `target resultString string`
Returns a string representation of the input decimal value formatted to the specified pattern.

This example invokes `format` to convert a decimal `"23.45"` to a format `"##.##"` and bind the resulting string to a `MapVariable`. The result of this map is a string `"23.45"`.

```
format ( value = 23.453, formatPattern = "##.##" -> resultString = MapVariable
)
```

format:value=double,formatPattern=string->resultString=string

Returns a string representation of the input double value in the format specified. Patterns accepted are the same as for the `format` map taking source value decimal.

- `source value double`
The current double format.
- `source formatPattern string`
The required format of double values.
- `target resultString string`
Returns a string representation of the input double value formatted to the specified pattern.

This example invokes `format` to convert a double `"23456.789"` to a format `"##.##E0"` and bind the resulting string to a `MapVariable`. The result of this map is a string `"23.46E3"`.

```
format ( value = 23456.789, formatPattern = "00.00E0" -> resultString =
MapVariable )
```

format:value=float,formatPattern=string->resultString=string

Returns a string representation of the input float value in the format specified. Patterns accepted are the same as for the `format` map taking source value decimal.

- `source value float`
The source float value.
- `source formatPattern string`
The required pattern of float values.
- `target resultString string`

Returns a string representation of the input float value formatted to the specified pattern.

This example invokes `format` to convert a float `234.5` to a format `"##.##"` and bind the resulting string to a `MapVariable`. The result of this map is a string `"234.50"`.

```
format ( value = 23.45, formatPattern = "00.00" ) -> ( resultString =
MapVariable )
```

format:value=integer,formatPattern=integer->resultString=string

Returns an integer in the format specified.

Patterns accepted are the same as the patterns accepted for the `format` map taking a decimal source value.

- `source value integer`
The source integer value.
- `source formatPattern string`
The required format of integer values.
- `target resultString string`
Returns a string representation of the input integer value formatted to the specified pattern.

This example invokes `format` to convert an integer `"234"` to a format `"0000"` and bind the resulting string to a `MapVariable`. The result of this map is a string `"0234"`.

```
format ( value = 234, formatPattern = "0000" -> resultString = MapVariable )
```

generateGUIDString:->GUIDString=string

Enables you to generate a unique global unique identifier (GUID) string.

- `target GUIDString string`
Returns the generated GUID string.

This example invokes the `generateGUIDString` map to get a unique reference ID that is bound to `header/MessageID`.

```
generateGUIDString ( -> GUIDString = header/MessageID )
```

getPartyContactInformation:partyName=string,contactInfoType=string->contactInfo=string

Enables you to get the party name contact information for the source partner name based on `contactInfoType` input.

- `source partyName string`
The source party name.
- `source contactInfoType string`
The type of contact information required (for example, e-mail).
- `target contactInfo string`
The contact information method for the source party string.

This example invokes `getPartyContactInformation` to get 'Email' of the party. The 'Email' is bound to a `MapVariable`.

```
getPartyContactInformation ( partyName = "Oracle IDC", contactInfoType = "Email"  
-> contactInfo = MapVariable )
```

getPartyIdentification:partyName=string,partyIdentificationType=string->partyIdentification=string

Enables you to get the party identification number for the source party name.

- `source partyName string`
The source party name.
- `source partyIdentificationType string`
The party identification method.
- `target partyIdentification string`
The party identification type for the source party value.

This example invokes `getPartyIdentification` to get the "DUNS" number of the party. The DUNS number retrieved is bound to a `MapVariable`.

```
getPartyIdentification ( partyName = "Oracle IDC", partyIdentificationType =  
"DUNS" -> partyIdentification = MapVariable )
```

getSystemDate:->systemDate=dateTime

Returns the system date of the server.

- `target systemDate dateTime`

Returns the system date.

This example invokes `getSystemDate` to get the server's current date. The value retrieved is bound to a `MapVariable`.

```
getSystemDate ( -> systemDate = MapVariable )
```

getTradingPartnerNameFromIdentifier:identifierNumber=string,identifierType=string->tradingPartnerName=string

Returns a partner name given an identification number, given the identification type. If the trading partner name is not found, no exception is raised and no target parameter is set (that is, the result is an implicit null value).

- `source identifierNumber string`

The source identification number.

- `source identifierType string`

The party identification type.

- `target tradingPartnerName string`

Returns the target trading partner name for the source identification number.

This example invokes `getTradingPartnerNameFromIdentifier` to get a trading partner's name, given the trading partner's identifier and identifier type. The value retrieved is bound to a `MapVariable`.

```
getTradingPartnerNameFromIdentifier ( identifierNumber = PAYLOAD/PARTNRIDX ,  
identifierType = "EDI Location Code" -> tradingPartnerName = MapVariable )
```

indexOfString:sourceString=string,searchString=string,beginOffset=integer->resultIndex=integer

Returns the index of a search string within the source string starting from a given start index. If the search string is not found, a value of -1 is returned. The index starts from 0.

- `source sourceString string`

Returns the index of a search string within the source string starting from a given start index.

- `source searchString string`

The string for which to search within the source string.

- `source beginOffset integer`

The index from which to begin the search. The index starts from zero.

- `target resultIndex integer`

The result index. The index is the starting character of the search string within the source string.

This example invokes `indexOfString` to get the index of first occurrence of the search string within the source string beginning from the given offset. The result of this map, 7, is bound to `IndexMapVariable`, a map variable.

```
indexOfString ( sourceString = "123-456-567" , searchString = "-" , beginOffset = 4 -> resultIndex = IndexMapVariable )
```

indexOfString:sourceString=string,searchString=string->resultIndex=integer

Returns the index of the starting character of the search string within the source string. If the search string is not found, a value of -1 is returned. The index starts from 0.

- `source sourceString string`

The source string.

- `source searchString string`

The search string.

- `target resultIndex integer`

The source string in which the index is returned.

This example invokes `stringCompareToIgnoreCase` map to compare two strings while ignoring the case. The result of this map is 6.

```
indexOfString( sourceString = "Hello World" , searchString = "World" ->
resultEquals = MapVariable )
```

lastIndexOfString:sourceString=string,searchString=string->resultIndex=integer

The `resultIndex` has the index of the last (right most) occurrence of the starting character of the `searchString` within the `sourceString`. If the `searchString` is not found within the `sourceString`, the `resultIndex` is -1.

- `source sourceString string`
The source string.
- `source searchString string`
The search string.
- `target resultIndex integer`
The result index. The index is the starting character of the search string within the source string.

This example invokes `lastIndexOfString` to get the index of the last occurrence of the search string within the source string. The result of this map is 12, the start index of the search string.

```
lastIndexOfString ( sourceString = "Hello World World" , serachString = "World"
-> resultString = LastIndexMapVariable )
```

lastIndexOfString:sourceString=string,searchString=string,beginOffset=integer->resultIndex=integer

Returns the index of the last occurrence of the starting character of the `searchString` within the `sourceString` searching backward starting at the specified index. If the `searchString` is not found within the `sourceString`, the `resultIndex` is -1.

- `source sourceString string`
The source string.
- `source searchString string`
The search string.

- `source beginOffset` integer
The index from which to begin the search.
- `target resultIndex` integer
Returns the result index. The index is the starting character of the search string within the source string.

This example invokes `lastIndexOfString` to get the index of the last occurrence of the search string within the source string from the given offset. The result of this map is 6, the start index of the search string.

```
lastIndexOfString( sourceString = "Hello World World" , serachString = "World" ,  
beginOffset = 11 -> resultString = LastIndexMapVariable )
```

leftTrim:sourceString=string->resultString=string

Returns a string with leading white space omitted.

- `source sourceString` string
The source string.
- `target resultString` string
A string with leading white space omitted or, if it has no leading white space, the source string itself.

This example invokes `leftTrim` to get the result string devoid of leading white spaces. The result of this map is "Hello World ".

```
leftTrim( sourceString = "    Hello World " -> resultString = MapVariable )
```

lowerCase:sourceString=string->resultString=string

Returns a string with all letters in lower case.

- `source sourceString` string
The source string.
- `target resultString` string
The resulting string in lower case.

This example invokes `lowerCase` to get the result string in lower case. The result of this map is "hello world".

```
lowerCase( sourceString = "Hello World" -> resultString = MapVariable )
```

multiply:first=decimal,second=decimal->result=decimal

Returns the value of multiplying the first decimal with the second decimal.

- `source first decimal`
The first decimal.
- `source second decimal`
The second decimal.
- `target result decimal`
The value returned by multiplying the first decimal with the second decimal.

This example invokes `multiply` to multiply decimal 12.3 with 45.67, and the result 561.741 is stored in a map variable.

```
multiply( first = 12.3 , second = 45.67 -> result = MapVariable )
```

multiply:first=float,second=float->result=float

Returns the value of multiplying the second float value with the first float value.

- `source first float`
The first source float value.
- `source second float`
The second source float value.
- `target result float`
The value returned by multiplying the first float value with the second float value.

This example invokes the `multiply` map to multiply float 12.345 with 67.890 and store the result of 838.10205 in a map variable.

```
multiply( first = 12.345 , second = 67.890 -> result = MapVariable )
```

multiply:first=integer,second=integer->result=integer

Returns the result of multiplying the first integer with the second integer.

- `source first integer`

The first integer.

- `source second integer`

The second integer with which to multiply.

- `target result integer`

The result of multiplying the first integer with the second integer.

This example invokes the `multiply` map to multiply integer 12 with 3456 and store the result of 41472 in a map variable.

```
multiply( first = 12 , second = 3456 -> result = MapVariable )
```

rightTrim:sourceString=string->resultString=string

Returns a string with trailing white space omitted.

- `source sourceString string`

The source string.

- `target resultString string`

A string with trailing white spaces omitted or, if it has no trailing white space, the source string itself.

This example invokes `rightTrim` to get the result string devoid of trailing white spaces. The result of this map is " Hello World".

```
rightTrim( sourceString = " Hello World " -> resultString = MapVariable )
```

startsWith:sourceString=string,sourcePrefix=string->resultFoundPrefix boolean

Returns `true` if the `sourceString` starts with `prefixString`. Otherwise, `false` is returned.

- `source sourceString string`
The source string.
- `source sourcePrefix string`
The prefix string to check for in the source string.
- `target resultFoundPrefix boolean`
Returns `true` if the source string starts with the prefix string. Otherwise, `false` is returned.

This example invokes `startsWith` to verify if the source string starts with the source prefix. The result of this map is `true`.

```
startsWith( sourceString = "Hi Hello World" , sourcePrefix = "Hi" ->
resultFoundPrefix = MapVariable )
```

startsWith:sourceString=string,sourcePrefix=string,sourceBeginOffset=integer->resultFoundPrefix boolean

Returns `true` if the `prefixString` character sequence is the same as that of the `sourceString` starting from the index specified. Otherwise, `false` is returned.

- `source sourceString string`
The source string.
- `source sourcePrefix string`
The prefix string for which to check.
- `source sourceBeginOffset integer`
The start index to search from within the source string. The index starts from zero.
- `target resultFoundPrefix boolean`
Returns `true` if the source string starts with the prefix string starting from the start index. Otherwise, `false` is returned.

This example invokes `startsWith` to verify if the source string starts with the source prefix from the given offset. The result of this map is `false`.

```
startsWith( sourceString = "Hi Hello World" , sourcePrefix = "Hi" ,  
sourceBeginOffset = 3 -> resultFoundPrefix = MapVariable )
```

stringCompareTo:sourceString=string,sourceCompareTo=string->resultEquals=integer

Enables you to compare two strings lexicographically. The comparison is based on the unicode value of each character in the strings. The character sequence represented by the `sourceString` string is compared lexicographically to the character sequence represented by the `sourceCompareTo` string. The result is a negative integer if `sourceString` lexicographically precedes `sourceCompareTo`. The result is a positive integer if `sourceString` lexicographically follows the `sourceCompareTo` string. The result is zero if the strings are equal.

This is the definition of lexicographic ordering. If two strings are different, then they have different characters at some index that is a valid index for both strings, or their lengths are different, or both. If they have different characters at one or more index positions, let `k` be the smallest such index. The string whose character at position `k` has the smaller value, as determined by using the `<` operator, then lexicographically precedes the other string. In this case, `compareTo` returns the difference of the two character values at position `k` in the two strings; that is, the following value:

```
sourceString.charAt(k) - sourceCompareTo.charAt(k)
```

If there is no index position at which they differ, then the shorter string lexicographically precedes the longer string. In this case, `compareTo` returns the difference of the lengths of the strings; that is, the following value:

```
sourceString.length() - sourceCompareTo.length()
```

- `source sourceString string`
The source string.
- `source sourceCompareTo string`
The string with which to be compared.
- `target resultEquals integer`

The value zero is returned if the argument string is equal to this string. A value less than zero is returned if `sourceString` is lexicographically less than the `sourceCompareTo` string. A value greater than zero is returned if `sourceString` is lexicographically greater than the `sourceCompareTo` string.

This example invokes `stringCompareTo` to compare two strings. The result of this map is `-15`.

```
stringCompareTo( sourceString = "Hello World" , sourceCompareTo = "World Hello"
-> resultEquals = MapVariable )
```

stringCompareToIgnoreCase:sourceString=string,sourceCompareTo=string->resultEquals=integer

Enables you to compare two strings lexicographically, ignoring case differences. This method returns an integer whose sign is that of calling `stringCompareTo` with normalized versions of the strings where case differences have been eliminated.

- `source sourceString string`
The source string.
- `source sourceCompareTo string`
The string with which to be compared.
- `target resultEquals integer`
A negative integer, zero, or a positive integer as the `sourceCompareTo` string is greater than, equal to, or less than `sourceString`, ignoring case considerations.

This example invokes `stringCompareToIgnoreCase` to compare two strings while ignoring the case. The result of this map is `0`.

```
stringCompareToIgnoreCase( sourceString = "Hello World" , sourceCompareTo =
"hello world" -> resultEquals = MapVariable )
```

stringLength:sourceString=string->resultLength=integer

Enables you to compute the length of the source string. The value is copied into the target.

- `source sourceString string`
The source string value.
- `target resultLength integer`
The target integer parameter that holds the length of the source string.

This example invokes `stringLength` to compute the length of the source string. The result of this map is 11.

```
stringLength( sourceString = "Hello World" -> resultEquals = MapVariable )
```

stringToBoolean:source=string->result=boolean

Returns the Boolean value of the source string value.

- `source source string`
The source string value.
- `target result boolean`
The Boolean value of the source string value.

This example invokes `stringToBoolean` to convert a string "true" to a Boolean. The result of this map is Boolean true.

```
stringToBoolean( source = "true" -> result = MapVariable )
```

stringToCharacter:source=string->result=character

Returns the character value of the source string value.

- `source source string`
The source string value.
- `target result character`
The character value of the source string value.

This example invokes `stringToCharacter` to convert a string "C" to a character. The result of this map is a character 'C'.

```
stringToCharacter( source = "C" -> result = MapVariable )
```

stringToDateTime:source=string->result=dateTime

Returns the date and time format for the input source string.

- `source` source string
The source string.
- `target` result dateTime

Returns the date and time format for the source string.

This example invokes `stringToDateTime` to convert an ISO 8601 string to `dateTime`. The result of this map is a `dateTime`.

```
stringToDateTime( source = "2003-05-16" -> result = MapVariable )
```

stringToDateTime:source=string,pattern=string->result=dateTime

Returns the `dateTime` representation by parsing the input string in the given pattern. If the pattern is null, it assumes the source string is in ISO 8601 format.

- `source` source string
The source string.
- `source` pattern string
The pattern to which the source string conforms.
- `target` result dateTime
Returns the date and time format for the source string.

This example invokes `stringToDateTime` to convert a source in ISO 8601 string format to `dateTime`. The result of this map is a `dateTime`.

```
stringToDateTime( source = "2003-05-16 08:24:56.789 GMT+5:30" , pattern =  
"yyyy-MM-dd hh:mm:ss.SSS Z" -> result = MapVariable )
```

stringToDecimal:source=string->result=decimal

Returns the decimal value of the source string.

- `source` source string
The source string.
- `target` result decimal
The decimal value of the source string.

This example invokes `stringToDecimal` to convert a string to a decimal.

```
stringToDecimal( source = "56.789" -> result = MapVariable )
```

stringToDouble:source=string->result=double

Returns the double value of the source string value.

- `source` source string
The source string.
- `target` result double
The double value of the source string value.

This example invokes `stringToDouble` to convert a string to double.

```
stringToDouble( source = "56.8945" -> resultEquals = MapVariable )
```

stringToFloat:source=string->result=float

Returns the float value for the source string value.

- `source` source string
The source string.
- `target` result float
The float value of the source string value.

This example invokes `stringToFloat` to convert a string to double.

```
stringToFloat( source = "56.894567" -> result = MapVariable )
```

stringToInteger:sourceString=string->resultInteger=integer

Returns the integer value for the source string value.

- `source sourceString string`
The source string.
- `target resultInteger integer`
The integer value of the source string value.

This example invokes `stringToInteger` to convert a string to an integer.

```
stringToInteger( sourceString = "56" -> resultInteger = MapVariable )
```

substring:sourceString=string,beginIndex=integer,endIndex=integer->resultString=string

Enables you to copy the portion of the source string specified by the indexes `beginIndex` and `endIndex` into the `resultString`. The result string is composed of characters starting from `beginIndex` to `endIndex - 1`. Character `beginIndex` starts from zero.

- `source sourceString string`
The source string.
- `source beginIndex integer`
The beginning source index (inclusive).
- `source endIndex integer`
The ending source index (exclusive).
- `target resultString string`
The target string that holds the substring value.

This example invokes `stringToInteger` to convert a string to an integer. The result of this map is "Hello Wo".

```
substring( sourceString = "Hello World", beginIndex = 0 , endIndex = 7 ->
resultString = MapVariable )
```

subString:sourceString=string,beginIndex=integer->resultString=string

Enables you to copy the portion of the source string with the starting character at the specified `beginIndex` to the end of the source string into the `resultString`. The character `beginIndex` starts from zero.

- `source sourceString string`
The source string.
- `source beginIndex integer`
The beginning source index (inclusive).
- `target resultString string`
The target string parameter that holds the substring value.

This example invokes `stringToInteger` to convert a string to an integer. The result of this map is "World".

```
subString( sourceString = "Hello World", beginIndex = 6 -> resultString =  
MapVariable )
```

subStringAfter:sourceString=string,delimiter=string->resultString=string

Returns a string with all characters after the specified delimiter string.

- `source sourceString string`
The source string.
- `target delimiter string`
The delimiter string.
- `target resultString string`
The result string.

This example invokes `subStringAfter` to get a string with all characters after the specified delimiter string. The result of this map is "AS".

```
subStringAfter( sourceString = "Oracle 9iAS" , delimiter = "9i" -> resultString  
= MapVariable )
```

subStringBefore:sourceString=string,delimiter=string->resultString=string

Returns a string with all characters before the specified delimiter string.

- `source sourceString string`
The source string.
- `target delimiter string`
The delimiter string.
- `target resultString string`
The result string.

This example invokes `subStringBefore` to get a string with all characters before the specified delimiter string. The result of this map is "Oracle ".

```
subStringBefore( sourceString = "Oracle 9iAS" , delimiter = "9i" -> resultString  
= MapVariable )
```

subtract:first=decimal,second=decimal->result=decimal

Returns the result of subtracting second decimal from the first decimal.

- `source first decimal`
The first decimal.
- `source second decimal`
The second decimal.
- `target result decimal`
The value returned by subtracting the second decimal value from the first decimal value.

This example invokes `subtract` to subtract decimals. The result of this map is decimal 2.0.

```
subtract( first = 12.34, second = 10.34 -> result = MapVariable )
```

subtract:first=float,second=float->result=float

Returns the result of subtracting the second source float value from the first source float value.

- `source first float`
The first source float value.
- `source second float`
The second source float value.
- `target result float`
The value returned by subtracting the second float value from the first float value.

This example invokes the `subtract` map to subtract a float. The result of this map is float 2.0.

```
subtract( first = 12.3456, second = 10.3456 -> result = MapVariable )
```

subtract:first=integer,second=integer->result=integer

Returns the result of subtracting the second integer from the first integer.

- `source first integer`
The first integer from which to subtract.
- `source second integer`
The second integer to subtract from the first integer.
- `target result integer`
The result of subtracting the second integer from the first integer.

This example invokes the `subtract` map to subtract integers. The result of this map is 2.

```
subtract( first = 12, second = 10 -> result = MapVariable )
```

trim:sourceString=string->resultString=string

Returns a string, with leading and trailing white space omitted. White space characters are supported for the following:

- '\t' '\u0009' HORIZONTAL TABULATION
- '\n' '\u000A' NEW LINE,
- '\f' '\u000C' FORM FEED,
- '\r' '\u000D' CARRIAGE RETURN,
- ' ' '\u0020' SPACE

This rule uses these sources and targets.

- source sourceString string

The source string.

- target resultString string

A string, with leading and trailing white space omitted or, if it has no leading or trailing white space, the source string itself.

This example invokes `trim` to remove leading and trailing white spaces. The result of this map is "Oracle IDC".

```
trim( sourceString = "   Oracle IDC   " -> resultString = MapVariable )
```

upperCase:sourceString=string->resultString=string

Returns a string with all letters in upper case.

- source sourceString string

The source string.

- target resultString string

The resulting string with all letters in upper case.

This example invokes `upperCase` to convert lower case letters to upper case letters. The result of this map is "ORACLE 9IAS".

```
stringToInteger( sourceString = "Oracle 9ias" -> resultString = MapVariable )
```

Event Header Rules

This section describes the event header rules included with Oracle Application Server ProcessConnect.

See Also:

- ["Transformation Statements Overview"](#) on page 13-27 for a definition of an event header rule
- ["Creating an Event Header Rule"](#) on page 13-78 for instructions on selecting an event header rule as a statement type

setToParty

Sets the `ToParty` name in the selected event's header.

- `source toPartyName string`

The party name to set in the event header.

This example invokes `setToParty` to set the to party's name in the selected event.

```
setToParty( toPartyName = "IPQ-NHE" )
```

setFromParty

Sets the `FromParty` name in the event header.

- `source fromPartyName string`

The party name to set in the event header.

This example invokes `setFromParty` to set the to party's name in the selected event.

```
setFromParty( fromPartyName = "IPQ-HE" )
```

getToParty

Gets the ToParty name from the event header.

- target toParty string

The ToParty name in the event header.

This example invokes `getToParty` to get the to party's name from the selected event.

```
getToParty( -> toParty = FTP-Initiating-ET-OUT/Payload/to )
```

getFromParty

Gets the FromParty name from the event header.

- target fromParty string

The fromParty name in the event header.

This example invokes `getFromParty` to get the from party's name from the selected event.

```
getFromParty( -> fromParty = FTP-Initiating-ET-OUT/Payload/from )
```

Domain Value Map Rules

This section describes the domain value map rules included with Oracle Application Server ProcessConnect.

See Also:

- ["Transformation Statements Overview"](#) on page 13-27 for a definition of a domain value map rule
- ["Creating a Domain Value Map Rule"](#) on page 13-106 for instructions on selecting a domain value map rule as a statement type
- ["Domain Value Maps"](#) on page 13-83 to manage (create, view, update, and delete domain value maps)

Note: You must create a domain value map before you can select a domain value map rule as a statement type.

lookupPartyDomainWithDefaultValue

Given the party name and the value `inValue` to be looked up, this function returns the corresponding value from the party domain. If a corresponding value for the `inValue` is not found in the party domain, the value corresponding to the input parameter `defaultValue` is returned.

- `source Party` string
The party name.
- `source inValue` string
The input parameter containing the source value.
- `source defaultValue` string
The value to return if the input value cannot be mapped to the party domain.
- `target outValue` string
The return value containing the looked-up value from the party domain.

This example invokes `lookupPartyDomainWithDefaultValue` with a default value of "none". The target is bound to a map variable.

```
lookupPartyDomainWithDefaultValue( InValue = reason/FreeFormText, defaultValue =  
"none" -> outValue = MapVariableReasonCode )
```

lookupPartyDomain

Given the party name and the value to be looked up, this function returns the corresponding value from the party domain.

- `source Party` string
The party name.
- `source InValue` string
The input parameter containing the source value.
- `target outValue` string
The return value containing the looked-up value from the domain party.

This example invokes `lookupPartyDomain` to get the discount day of the month for the given term ID.

```
lookupPartyDomain ( InValue = DATAAREA/PROCESS_PO/POORDERHDR/POTERM/TERMID ->
outValue = Purchasing Order/FinancingTerms/Discounts/discountDay/DayOfMonth )
```

lookupBusinessViewDomainWithDefaultValue

Given the party name and the value to be looked up, this function returns the corresponding value from the business view (common view) domain. If a corresponding value for the `InValue` is not found in the business view, the value corresponding to the input parameter `defaultValue` is returned.

- `source Party` string
The name of the party.
- `source InValue` string
The input value to look up.
- `source defaultValue` string
The value to return if the input value cannot be mapped to the business view domain.
- `target outValue` string
The corresponding value returned after lookup from the business view domain.

This example invokes `lookupBusinessViewDomainWithDefaultValue` with a default value as `"host_trading_partner"`. The target is bound to a path `PARTNRIDX`.

```
lookupBusinessViewDomainWithDefaultValue( Party = MapVariableFromParty, inValue
= "name", defaultValue = "host_trading_partner" -> outValue = PARTNRIDX )
```

lookupBusinessViewDomain

Given the party name and the value to be looked up, this function returns the corresponding value from the business view (common view) domain.

- `source Party` string
The party name.
- `source InValue` string
The input value to look up.
- `target outValue` string
The corresponding value returned after lookup from the business view domain.

This example invokes `lookupBusinessViewDomain` to get the purchase order type given the party and the order type code. The output is bound to a path `DATAAREA/ACKNOWLEDGE_PO/POORDERHDR/POTYPE`.

```
lookupBusinessViewDomain ( Party = MapVariableFromParty, inValue =  
"PurchaseOrder/GlobalPurchaseOrderTypeCode -> outValue = DATAAREA/ACKNOWLEDGE_  
PO/POORDERHDR/POTYPE )
```

Appendix Summary

This appendix describes and provides examples of the transformation rule, event header rules, and domain value map rules.

Error Codes

This appendix lists error messages and causes that are specific to operation of Oracle Application Server ProcessConnect.

This appendix contains these topics:

- [AIP-10000 to AIP-10438 Runtime Error Codes](#)
- [AIP-11000 to AIP-11999 Repository Error Codes](#)
- [AIP-12000 to AIP 12600 Adapter Error Codes](#)
- [AIP-13000 to AIP-16014 Business Logic Layer Error Codes](#)
- [AIP-14000 to AIP-14018 Transformation Error Codes](#)
- [AIP-14100 to AIP-14114 Translation Error Codes](#)
- [AIP-14115 to AIP-14119 XSD Translation Error Codes](#)
- [AIP-14321 to AIP-14325 Event Validation Error Codes](#)
- [AIP-14401 to AIP-14406 Correlation Error Codes](#)
- [AIP-14451 to AIP-14455 Domain Value Map Error Codes](#)
- [AIP-16020 to AIP-17997 Metadata Validation Rules Error Codes](#)
- [AIP-18000 to AIP-18999 Deployment Error Codes](#)
- [AIP-19000 to AIP-19999 UI Modeling Error Codes](#)
- [AIP-50000 to AIP-51999 Transport Error Codes](#)
- [AIP-51801 to AIP-51928 RosettaNet Validation Error Codes](#)

AIP-10000 to AIP-10438 Runtime Error Codes

AIP-10000 thread execution error in thread "{0}"

Cause: An internal error occurred. Contact Oracle Support Services.

AIP-10001 No role processor was found to process the given event instance.

Cause: The associations for the given event instance are not correct. So we cannot assign a role processor to process this event.

AIP-10002 event instance of invalid event type

Cause: The event instance has either invalid or no event type associated.

AIP-10003 event instance in wrong state for role processor

Cause: The event instance is not in RAISED or WAIT state, so it cannot be processed by some role processor.

AIP-10004 invalid bootstrap context

Cause: The context is of wrong type for this bootstrap.

AIP-10005 no bootstrap context

Cause: Attempt to start a runtime component without a context.

AIP-10006 operation not supported

Cause: The runtime factory tried to create a not yet supported object.

AIP-10010 failed to get JDBC connection from repository service

Cause: The JDBC connection could not be retrieved from the repository service.

AIP-10011 A SQL error occurred while accessing the databus.

Cause: The databus cannot be accessed because of a SQL error.

AIP-10012 A JMS error occurred while accessing the databus.

Cause: The databus cannot be accessed because of a JMS error.

AIP-10013 A SQL error occurred while pushing a token to the databus.

Cause: Failed to push an event token to the databus because of a SQL error.

AIP-10014 A JMS error occurred while pushing a token to the databus.

Cause: Failed to push an event token to the databus because of a JMS error.

AIP-10015 A SQL error occurred while retrieving a token from the databus.

Cause: Failed to retrieve an event token from the databus because of a SQL error.

AIP-10016 A JMS error occurred while retrieving a token from the databus.

Cause: Failed to retrieve an event token from the databus because of a JMS error.

AIP-10017 No event instance was found for the given token.

Cause: An internal error occurred in event manager. Contact Oracle Support Services.

AIP-10018 cannot retrieve an event instance for the given token

Cause: An internal error occurred in event manager. Contact Oracle Support Services.

AIP-10050 invalid sensor type

Cause: An internal error occurred. Contact Oracle Support Services.

AIP-10051 invalid state sensor type

Cause: An internal error occurred. Contact Oracle Support Services.

AIP-10052 No DMS process name was specified.

Cause: The DMS spy requires a process name to be specified.

AIP-10053 spy configuration error

Cause: A configuration error occurred while initializing the DMS spy.

AIP-10054 spy publisher error

Cause: A publisher error occurred while initializing the DMS spy.

AIP-10055 system monitor manager not initialized

Cause: The system monitor manager must be initialized before creating a system monitor.

AIP-10070 system log manager not initialized

Cause: The system log manager must be initialized before creating individual system loggers.

AIP-10071 error deleting from the system log

Cause: An internal error occurred in system log manager. Contact Oracle Support Services.

AIP-10072 error updating the system log

Cause: An internal error occurred in system log manager. Contact Oracle Support Services.

AIP-10073 error selecting from the system log

Cause: An internal error occurred in system log manager. Contact Oracle Support Services.

AIP-10074 error truncating the system log

Cause: An internal error occurred in system log manager. Contact Oracle Support Services.

AIP-10100 The event manager failed to update an event instance.

Cause: Failed to update an event instance because of a business logic layer error.

AIP-10101 The event manager failed to update an event instance.

Cause: Failed to update an event instance because of a data validation error.

AIP-10102 The event manager failed to update an event instance.

Cause: Failed to update an event instance because of an optimistic lock error.

AIP-10103 The event manager failed to update an event instance.

Cause: Failed to update an event instance because of an object not found error.

AIP-10104 The event manager failed to update an event instance.

Cause: Failed to update an event instance because of a uniqueness violation error.

AIP-10105 adapter framework instance not set

Cause: The event manager has no adapter framework instance; use the activate method to do this.

AIP-10106 The event manager is already activated.

Cause: The event manager is already activated. Passivate it before you activate it again.

AIP-10107 The event manager is not active.

Cause: The event manager is not active. Activate it first before passivating it.

AIP-10108 The event manager failed to create an event instance.

Cause: Failed to create an event instance because of a business logic layer error.

AIP-10109 The event manager failed to complete the creation of an event instance.

Cause: Failed to complete the creation of an event instance because of missing data.

AIP-10110 The event manager failed to copy an event instance.

Cause: Failed to copy an event instance.

AIP-10111 The event manager failed to raise an event instance.

Cause: Failed to raise an event instance. It is likely that there is an error putting an event token on the databus.

AIP-10112 The event manager failed to get a JDBC connection from the repository service.

Cause: Failed to get a JDBC connection from the repository.

- AIP-10113 The event manager failed to create subscriber "{0}" because of a SQL error.**
Cause: Failed to create subscriber "{0}" because of a SQL error.
- AIP-10114 The event manager failed to create subscriber "{0}" because of a JMS error.**
Cause: Failed to create subscriber "{0}" because of a JMS error.
- AIP-10115 The event manager failed to create subscriber "{0}".**
Cause: Failed to create subscriber "{0}" because no parties were found for the given adapter framework instance.
- AIP-10116 The event manager failed to create subscriber "{0}".**
Cause: Failed to create subscriber "{0}" because query for parties failed.
- AIP-10117 The event manager failed to get the adapter framework instance for ID "{0}".**
Cause: Failed to get the adapter framework instance with ID "{0}".
- AIP-10118 The event manager failed to get an adapter framework instance for ID "{0}".**
Cause: Failed to get the adapter framework instance with ID "{0}".
- AIP-10119 The event manager cannot raise an event of state "{1}".**
Cause: An internal error occurred in event manager. Contact Oracle Support Services.
- AIP-10120 The event manager cannot raise an event with a from role set.**
Cause: An internal error occurred in event manager. Contact Oracle Support Services.
- AIP-10121 The event manager cannot raise an event with no current role.**
Cause: An internal error occurred in event manager. Contact Oracle Support Services.
- AIP-10122 The event manager cannot raise an event on a role other than the native role.**
Cause: An internal error occurred in event manager. Contact Oracle Support Services.
- AIP-10123 The event manager cannot raise an event that is outbound.**
Cause: An internal error occurred in event manager. Contact Oracle Support Services.

AIP-10124 The event manager cannot raise an event with a type other than the native event type.

Cause: An internal error occurred in event manager. Contact Oracle Support Services.

AIP-10125 The event manager cannot raise an event with no current port.

Cause: An internal error occurred in event manager. Contact Oracle Support Services.

AIP-10126 The event manager cannot raise an event with no coordination.

Cause: An internal error occurred in event manager. Contact Oracle Support Services.

AIP-10200 failed to boot integration manager

Cause: Failed to start integration manager.

AIP-10201 Integration manager initialization failed.

Cause: Failed to create subscribers.

AIP-10202 Integration manager initialization failed.

Cause: Cannot find a class to load into integration manager.

AIP-10203 Integration manager initialization failed.

Cause: Cannot find a method from a class to load into integration manager.

AIP-10204 Integration manager initialization failed.

Cause: Cannot instantiate a class to load into integration manager.

AIP-10205 Integration manager initialization failed.

Cause: Invalid access for class to load into integration manager.

AIP-10206 Integration manager initialization failed.

Cause: Invocation target error.

AIP-10207 Integration manager startup failed.

Cause: Cannot start invocation engine.

AIP-10208 Integration manager startup failed.

Cause: Cannot start the integration manager.

AIP-10209 Integration manager restart failed.

Cause: Cannot instantiate a class to load into integration manager.

AIP-10210 Integration manager restart failed.

Cause: Invalid access for class to load into integration manager.

AIP-10211 Integration manager restart failed.

Cause: Invocation target error.

AIP-10212 The integration manager failed to get a JDBC connection.

Cause: Cannot get a JDBC connection from the repository service.

AIP-10213 The integration manager failed to create subscribers.

Cause: A SQL error occurred while trying to create subscribers for the integration manager.

AIP-10214 The integration manager failed to create subscribers.

Cause: A JMS error occurred while trying to create subscribers for the integration manager.

AIP-10215 Telnet daemon I/O error

Cause: An I/O error occurred while initializing the Telnet daemon.

AIP-10216 Telnet error

Cause: An internal error occurred. Contact Oracle Support Services.

AIP-10217 failed to create the system monitor for integration manager

Cause: The integration manager system monitor cannot be created.

AIP-10250 integration manager fatal error

Cause: An internal error occurred in integration manager. Contact Oracle Support Services.

AIP-10251 cannot retrieve event token attributes

Cause: An internal error occurred in integration manager. Contact Oracle Support Services.

AIP-10252 role processor "{0}" transaction error

Cause: An internal error occurred in integration manager. Contact Oracle Support Services.

AIP-10253 error processing an event

Cause: An internal error occurred in integration manager. Contact Oracle Support Services.

AIP-10269 runtime error in processor "{0}"

Cause: An internal error occurred in integration manager. Contact Oracle Support Services.

AIP-10270 A SQL error occurred while applying an algorithm.

Cause: SQL error occurred while applying an algorithm.

AIP-10271 repository error

Cause: A repository error occurred while applying an algorithm.

AIP-10272 business logic error

Cause: A business logic error occurred while applying an algorithm.

AIP-10273 general error

Cause: An error occurred while applying an algorithm.

AIP-10274 unknown error

Cause: An unknown error occurred while applying an algorithm.

AIP-10275 The algorithm failed to update an event instance.

Cause: Failed to update an event instance because of a business logic layer error.

AIP-10276 The algorithm failed to update an event instance.

Cause: Failed to update an event instance because of a data validation error.

AIP-10277 The algorithm failed to update an event instance.

Cause: Failed to update an event instance because of an optimistic lock error.

AIP-10278 The algorithm failed to update an event instance.

Cause: Failed to update an event instance because of an object not found error.

AIP-10279 The algorithm failed to update an event instance.

Cause: Failed to update an event instance because of a uniqueness violation error.

AIP-10280 runtime error

Cause: A runtime error occurred while applying an algorithm.

AIP-10300 error creating data flow instance

Cause: Role manager cannot create data flow instance. More than one data flow group instance found between the from and current roles of the event.

AIP-10301 error creating data flow group instance

Cause: Design error. There should be exactly one data flow group between the from and current ports of the event.

AIP-10302 error creating data flow instance

Cause: Design error. There should be exactly one data flow group between the from and current ports of the event.

AIP-10303 error getting target role

Cause: Design error. More than one target role for an inbound event.

AIP-10400 The invocation engine failed to create a transition instance.

Cause: An internal error occurred in invocation engine. Contact Oracle Support Services.

AIP-10401 The invocation engine failed to create a step instance.

Cause: An internal error occurred in invocation engine. Contact Oracle Support Services.

AIP-10402 The invocation engine failed after creating the step instance but before joining a transition created as part of an earlier invocation.

Cause: An internal error occurred in invocation engine. Contact Oracle Support Services.

AIP-10403 The invocation engine failed when raising a business event after executing the step.

Cause: An internal error occurred in invocation engine. Contact Oracle Support Services.

AIP-10404 The invocation engine failed when trying to query for a step instance given its type.

Cause: An internal error occurred in invocation engine. Contact Oracle Support Services.

AIP-10405 The invocation engine failed when creating data flow instances (isInbound "{0}").

Cause: An internal error occurred in invocation engine. Contact Oracle Support Services.

AIP-10406 The invocation engine failed when querying for a source port instance given the transition type and role instance to look in.

Cause: An internal error occurred in invocation engine. Contact Oracle Support Services.

AIP-10407 The invocation engine failed when querying for a target role port instance given the transition type and role instance to look in.

Cause: An internal error occurred in invocation engine. Contact Oracle Support Services.

AIP-10408 The invocation engine failed when querying for transition instances to join.

Cause: An internal error occurred in invocation engine. Contact Oracle Support Services.

AIP-10409 The invocation engine failed when finding the source step instance for the specified transition type.

Cause: An internal error occurred in invocation engine. Contact Oracle Support Services.

AIP-10410 The invocation engine encountered a step that cannot be executed.

Cause: An internal error occurred in invocation engine. Contact Oracle Support Services.

AIP-10411 The invocation engine failed when putting data (the output of the executed step) on the step output ports.

Cause: An internal error occurred in invocation engine. Contact Oracle Support Services.

AIP-10412 The translation step failed during execution.

Cause: An error occurred during translation of event. Check if content of Oracle record being raised is valid; if valid, contact Oracle Support Services; if not valid, correct and re-raise a new Oracle record with valid content.

AIP-10413 The condition step callout failed during execution.

Cause: An error occurred while executing the condition step. Check if content of Oracle record being raised is valid; if valid, contact Oracle Support Services; if not valid, correct and re-raise a new Oracle record with valid content.

AIP-10414 The condition step failed during execution.

Cause: An error occurred while executing the condition step. Check if content of Oracle record being raised is valid; if valid, contact Oracle Support Services; if not valid, correct and re-raise a new Oracle record with valid content.

AIP-10415 The consume step callout failed during execution.

Cause: An internal error occurred in invocation engine. Contact Oracle Support Services.

AIP-10416 The split step callout failed during execution.

Cause: An internal error occurred in invocation engine. Contact Oracle Support Services.

AIP-10417 The pass-through step callout failed during execution.

Cause: An internal error occurred in invocation engine. Contact Oracle Support Services.

AIP-10418 The set adapter exchange protocol step callout failed during execution.

Cause: An internal error occurred in invocation engine. Contact Oracle Support Services.

AIP-10419 The set adapter type step callout failed during execution.

Cause: An internal error occurred in invocation engine. Contact Oracle Support Services.

AIP-10420 The set party step callout failed during execution.

Cause: An internal error occurred in invocation engine. Contact Oracle Support Services.

AIP-10421 The end step failed during execution.

Cause: An internal error occurred in invocation engine. Contact Oracle Support Services.

AIP-10422 The transformation step callout failed during execution.

Cause: An error occurred during transformation. Check if content of Oracle record being raised is valid; if valid, contact Oracle Support Services; if not valid, correct and re-raise a new Oracle record with valid content.

AIP-10423 The transformation step failed during execution.

Cause: An error occurred during transformation. Check if content of Oracle record being raised is valid; if valid, contact Oracle Support Services; if not valid, correct and re-raise a new Oracle record with valid content.

AIP-10424 The invocation engine failed to create the invocation object from the dequeued token.

Cause: An internal error occurred in invocation engine. Contact Oracle Support Services.

AIP-10425 The translation step failed when creating the target event.

Cause: An internal error occurred in invocation engine. Contact Oracle Support Services.

AIP-10426 The invocation engine failed to fetch the repository connection.

Cause: The invocation engine encountered a DC exception when fetching repository connection through persistency service.

AIP-10427 The invocation engine failed to create a subscriber.

Cause: An internal error occurred in invocation engine. Contact Oracle Support Services.

AIP-10428 The invocation engine failed while initializing the invocation selector object.

Cause: An internal error occurred in invocation engine. Contact Oracle Support Services.

AIP-10429 The invocation engine failed while shutting down the invocation selector object.

Cause: An internal error occurred in invocation engine. Contact Oracle Support Services.

AIP-10430 The invocation engine failed while fetching the next invocation.

Cause: An internal error occurred in invocation engine. Contact Oracle Support Services.

AIP-10431 The invocation engine failed before step execution.

Cause: An internal error occurred in invocation engine. Contact Oracle Support Services.

AIP-10432 The invocation engine failed after step execution.

Cause: An internal error occurred in invocation engine. Contact Oracle Support Services.

AIP-10433 An error occurred while initializing the invocation processor object.

Cause: An error occurred during the initialization of invocation processor object.

AIP-10434 An error occurred in the invocation processor object while committing the transaction.

Cause: An error occurred during transaction commit in invocation processor object.

AIP-10435 An exception occurred while populating the return code port with a domain error.

Cause: An exception occurred while populating the return code port with a domain error.

AIP-10436 An error occurred while executing a step.

Cause: An error occurred during the execution of a step.

AIP-10437 An error occurred while refreshing a repository object.

Cause: An error occurred while refreshing a repository object.

AIP-10438 An error occurred while creating a system monitor object.

Cause: An error occurred during creation of system monitor object.

AIP-11000 to AIP-11999 Repository Error Codes

- AIP-11000 transaction already open**
Cause: Transaction already open.
- AIP-11001 transaction closed**
Cause: Transaction closed.
- AIP-11002 connection already established**
Cause: Connection already established.
- AIP-11003 failed to create connection**
Cause: Failed to create connection.
- AIP-11004 unimplemented feature used**
Cause: Unimplemented feature used.
- AIP-11005 invalid association "{0}"**
Cause: Invalid association "{0}".
- AIP-11006 object not found in association**
Cause: Object not found in association.
- AIP-11007 object deleted**
Cause: Object is deleted.
- AIP-11008 modification not allowed**
Cause: Modification not allowed.
- AIP-11009 connection not opened**
Cause: Connection not opened.
- AIP-11010 infinite loop detected**
Cause: Infinite loop detected.
- AIP-11011 Writing objects to database failed.**
Cause: Writing objects to database failed.
- AIP-11012 Commit failed.**
Cause: Commit failed.
- AIP-11013 Invalid object added to cache.**
Cause: Attempt to add invalid object to cache.
- AIP-11014 Object already exists in cache.**
Cause: Object already exists in cache.
- AIP-11015 Object does not exist "{0}".**
Cause: Object does not exist "{0}".

AIP-11016 SQL error

Cause: SQL error.

AIP-11017 class "{0}" not found

Cause: Class "{0}" not found.

AIP-11018 invalid OID "{0}"

Cause: Invalid Oracle Internet Directory "{0}".

AIP-11019 driver not loaded

Cause: Driver not loaded.

AIP-11020 metadata manager not loaded

Cause: Metadata manager not loaded.

AIP-11021 unknown type of bind variable

Cause: Unknown type of bind variable.

AIP-11022 unable to create GUID

Cause: Unable to create GUID.

AIP-11023 invalid domain value "{0}" for attribute "{1}"

Cause: Invalid domain value "{0}" for attribute "{1}".

AIP-11024 writing to CLOB failed

Cause: Writing to CLOB failed.

AIP-11025 unsupported operation in predicate

Cause: Unsupported operation in predicate.

AIP-11026 Only a query statement is allowed.

Cause: Only query statement is allowed.

AIP-11027 unable to construct base object

Cause: Unable to construct base object.

AIP-11028 invalid cache parameter

Cause: Invalid cache parameter.

AIP-11029 creating rollback or savepoint failed

Cause: Create rollback or savepoint failed.

AIP-11030 transaction rollback failed

Cause: Transaction rollback failed.

AIP-11031 rollback to last savepoint failed

Cause: Rollback to last savepoint failed.

AIP-11032 cache rollback failed

Cause: Cache rollback failed.

AIP-11033 unable to create savepoint

Cause: Unable to create savepoint.

AIP-11034 unable to sort the base object for batch update

Cause: Unable to sort the base object for batch update.

AIP-11035 reading from CLOB failed

Cause: Reading from CLOB failed.

AIP-11036 rollback beyond savepoint

Cause: Rollback beyond savepoint.

AIP-11037 object is updated in database

Cause: Object is updated in database.

AIP-11038 inconsistent metadata

Cause: Inconsistent metadata.

AIP-11039 The object type is different than the required object type.

Cause: Object type is different than required object type.

AIP-11040 The attribute type "{0}" is not supported.

Cause: Attribute type "{0}" is not supported.

AIP-11041 error in querying strong aggregation

Cause: Error in querying strong aggregation.

AIP-11042 A many-to-many association is not supported.

Cause: Many-to-many association is not supported.

AIP-11043 The object is not a first class object.

Cause: Object is not a first class object.

AIP-11044 error while adding object with unsupported state in persistency service

Cause: Error while adding object with unsupported state in persistency service.

AIP-11045 error while locking objects before commit

Cause: Error while locking objects before commit.

AIP-11046 unsupported list

Cause: Unsupported list.

AIP-11047 invalid OID string used to create OID

Cause: Invalid Oracle Internet Directory string used to create Oracle Internet Directory.

AIP-11048 SQL tracing not supported for thin JDBC driver

Cause: SQL tracing not supported for thin JDBC driver.

AIP-11049 "{0}" is not a persisted column. It cannot be used as part of the ordering clause.

Cause: "{0}" is not a persisted column. Cannot be used as part of ordering clause.

AIP-11050 cannot specify null column as part of ordering clause

Cause: Cannot specify null column as part of ordering clause.

AIP-11051 Not all rows are updated.

Cause: Not all rows are updated.

AIP-11052 Writing object "{0}" failed due to constraint violation "{1}".

Cause: Writing objects "{0}" failed due to constraint violation "{1}".

AIP-11053 The CLOB column cannot be used as part of the ordering clause.

Cause: Clob column cannot be used as part of ordering clause.

AIP-11054 The XMLType column cannot be used as part of the ordering clause.

Cause: XMLType column cannot be used as part of ordering clause.

AIP-11055 Persistency service for this object is no longer valid.

Cause: Persistency service for this object is no longer valid.

AIP-11056 Persistency service for this object is no longer valid.

Cause: Persistency service for this object is no longer valid.

AIP-11057 reading/commit LargeString/XMLString before closing writer

Cause: Reading/commit LargeString/XMLString before closing writer.

AIP-11058 cannot call setAttribute() method for LargeString and XMLString

Cause: Cannot call setAttribute() method for the LargeString and XMLString.

AIP-11059 invalid object "{0}" state "{1}" to persist

Cause: Invalid object "{0}" state "{1}" to persist.

AIP-11060 The row has changed in the database.

Cause: Row has changed in database.

AIP-11061 error in audit query

Cause: Error in audit query.

AIP-11062 error in audit delete

Cause: Error in audit delete.

AIP-11063 error enabling audit trigger

Cause: Error enabling audit trigger.

AIP-11064 OID or a class type is required for an audit query.

Cause: Oracle Internet Directory and class type cannot both be null.

AIP-11065 The MetaClass already has an AssociationEnd called "{0}".

Cause: The MetaClass already has an AssociationEnd called "{0}".

AIP-11200 The export service is open.

Cause: Export service is open.

AIP-11201 The export service is closed.

Cause: Export service is closed.

AIP-11202 File name "{0}" does not exist or cannot be created.

Cause: File name "{0}" does not exist or cannot be created.

AIP-11203 error while closing export output file

Cause: Error while closing export output file.

AIP-11204 error while ordering the objects for exporting

Cause: Error while ordering the objects for exporting.

AIP-11205 error while adding object in transaction

Cause: Error while adding object in transaction.

AIP-11206 mandatory attribute "{0}" missing in import

Cause: Mandatory attribute "{0}" missing in import.

AIP-11207 error deleting duplicate rows during import

Cause: Error deleting duplicate rows during import.

AIP-11208 invalid import mode

Cause: Invalid import mode.

AIP-11209 invalid file during import

Cause: Invalid file during import.

AIP-11210 error in import

Cause: Error in import.

AIP-11211 import service open

Cause: Import service open.

AIP-11212 error parsing XML file

Cause: Error in parsing XML file.

AIP-11213 Configuration table rows cannot be exported.

Cause: Configuration table rows cannot be exported.

AIP-11300 The given MetaClass does not exist.

Cause: Given MetaClass does not exist.

AIP-11301 The MetaClass "{0}" does not have the role "{1}".

Cause: The MetaClass "{0}" does not have the role "{1}".

AIP-11302 The MetaClass "{0}" does not have the attribute "{1}".

Cause: The MetaClass "{0}" does not have the attribute "{1}".

AIP-11303 Either role or type must be specified.

Cause: Either role or type must be specified.

AIP-11304 The MetaClass "{0}" is not a dependent type of the DepObject "{1}".

Cause: The MetaClass "{0}" is not a dependent type of the DepObject "{1}".

AIP-11400 "{0}" object is not versionable

Cause: "{0}" object is not versionable.

AIP-11401 error initializing the version service

Cause: Error in initializing the version service.

AIP-11402 Only one version is supported per transaction.

Cause: Only one version is supported for each transaction.

AIP-11403 The "{0}" object cannot be in a created state.

Cause: The "{0}" object cannot be in created state here.

AIP-11404 Versioning is not enabled.

Cause: Versioning is not enabled.

AIP-11405 The import failed while mapping the OID.

Cause: Import failed while mapping the Oracle Internet Directory before importing into database.

AIP-11407 wrong command line arguments: usage "{0}"

Cause: Wrong command line arguments: usage "{0}".

AIP-11408 export not supported for multiple "{0}"

Cause: Export not supported for multiple "{0}" configuration/Deployable BusinessProcess.

AIP-11409 The deployable flag "{0}" is not supported in file "{1}".

Cause: Deployable flag "{0}" is not supported in file "{1}". It should be true/false.

AIP-11410 The attribute or association for "{0}" does not exist in MetaClass "{1}".

Cause: Attribute or association for "{0}" does not exist in MetaClass "{1}".

AIP-11411 The predicate is null for the export business process.

Cause: Predicate is null for the export business process. Unique values are not defined in input file.

AIP-11412 Business process "{0}" is not deployed.

Cause: Exporting business process "{0}" which is not deployed with deployable flag in input file is not supported.

AIP-11413 Model "{0}" does not exist.

Cause: Model "{0}" does not exist in repository.

AIP-11414 Model version "{0}" in the importing repository is higher than export file version "{1}".

Cause: Higher model version "{0}" exists in importing repository than export file version "{1}".

AIP-11415 unable to convert value "{0}" to datatype "{1}"

Cause: Unable to convert value "{0}" to datatype "{1}".

AIP-11416 SAX parser exception while parsing file "{0}"; invalid XML format

Cause: SAX Parser exception while parsing file "{0}". It means invalid XML format.

AIP-11418 Object "{0}" is mandatory or part of a unique key for role "{1}" of object "{2}".

Cause: Object "{0}" is mandatory or part of unique key for role "{1}" of object "{2}".

AIP-11419 Class "{0}" is not instantiable from class "{1}".

Cause: Class "{0}" is not instantiable from class "{1}".

AIP-11420 Class "{0}" is not a first class object. Export is supported for the first class object only.

Cause: Class "{0}" is not first class object. Export only supported for the first class object.

AIP-11421 error converting the XML reserved characters while exporting

Cause: Error while converting the XML reserved characters while exporting.

AIP-11422 Configuration "{0}" is a design type. Exporting a design type configuration is not supported.

Cause: Configuration "{0}" is design type. Exporting design type configuration is not supported.

AIP-11423 File entry "{0}" in the imported compressed file is invalid or contains more than one entry.

Cause: File entry "{0}" in imported compressed file is invalid or more than one entry.

AIP-11424 Object ID "{0}" is referred to before creating the object: error ordering objects during export.

Cause: Object ID "{0}" is referred to before creating the object. Error ordering object during export.

AIP-12000 to AIP 12600 Adapter Error Codes

AIP-12000 cannot find agreement in event "{0}"

Cause: Event has no agreement.

AIP-12001 A local transaction in the resource adapter failed to begin.

Cause: Failure to begin a local transaction in the resource adapter.

AIP-12002 The interaction failed to execute and update.

Cause: Interaction failed to execute and update successfully.

AIP-12003 The interaction failed at execution.

Cause: Interaction failed at execution.

AIP-12004 The connection failed to close.

Cause: Closing connection after processing outbound event.

AIP-12005 The resource adapter failed to commit a local transaction.

Cause: Resource adapter failed to commit local transaction.

AIP-12006 The outbound processor failed to activate the event manager.

Cause: Failure to activate event manager for this adapter framework instance.

AIP-12007 The outbound processor failed to passivate the event manager.

Cause: Failure to passivate event manager for this adapter framework instance.

AIP-12008 The outbound processor failed to create a JCA interaction.

Cause: Failure to create a connection or JCA interaction for the identified event.

AIP-12009 The output record did not convert to an event instance.

Cause: Failure to convert output record from an outbound interaction execution to an event instance.

AIP-12010 An error occurred while activating the outbound event manager.

Cause: An error occurred while activating the outbound event manager.

AIP-12011 An error occurred while fetching the system monitor object.

Cause: An error occurred while fetching the system monitor object.

AIP-12012 An error occurred while ending the native role.

Cause: An error occurred while ending the native role.

AIP-12013 An error occurred during the begin, commit, or rollback of the outbound transaction.

Cause: An error occurred during begin, commit, or rollback of the outbound transaction.

AIP-12014 An error occurred during the persistency service operation.

Cause: An error occurred during persistency service operation.

AIP-12100 The event manager failed to activate in inbound.

Cause: Failed to activate event manager in inbound.

AIP-12101 The Oracle record failed to convert to the event instance.

Cause: Failed to convert Oracle record to event instance.

AIP-12102 failed to get an active configuration status

Cause: Failed to get an active configuration status.

AIP-12103 error in finding correlated events for the inbound event "{0}"

Cause: Error in finding correlated events for the inbound event "{0}".

AIP-12104 Correlated events for the inbound event do not have process role instances.

Cause: Correlated events for the inbound event do not have process role instances.

AIP-12105 Correlated events for the inbound event do not have coordinations.

Cause: Correlated events for the inbound event do not have coordinations.

AIP-12106 No unique native role was found for the inbound event "{0}".

Cause: No unique native role found for the inbound event "{0}".

AIP-12107 The inbound event "{0}" is not native, inbound, or before native role.

Cause: Inbound event "{0}" is not native, inbound or before native role.

AIP-12108 no effective agreement between process role "{0}" and party "{1}"

Cause: No effective agreement between process role "{0}" and party "{1}".

AIP-12109 No initiating or noninitiating process role was found for the inbound event "{0}".

Cause: The adapter framework did not find a native role that could accept the event. This is most likely due to not having a valid agreement for that native role. Ensure that the agreement is approved and that the effective dates are either blank or set to an interval. Another possibility is that a native event was created for the record for which there is not an inbound native role port. If you have multiple native events for the file adapter record, check the event map conditions. It may be that the wrong event map is evaluating to true and there is no inbound role port for this type.

AIP-12110 error creating a new coordination

Cause: Error creating a new coordination.

AIP-12111 error creating a new process role instance

Cause: Error creating a new process role instance.

AIP-12112 no effective agreement between the correlated event process role "{0}" and party "{1}"

Cause: No effective agreement between correlated event's process role "{0}" and party "{1}".

AIP-12113 The configuration is retired. No inbound events can be accepted.

Cause: Configuration is retired. No inbound events can be accepted.

AIP-12114 The configuration is quiescing. No new uncorrelated inbound events can be accepted.

Cause: Configuration is quiescing. No new uncorrelated inbound events can be accepted.

AIP-12115 The configuration is not active and no new coordinations can be created for inbound events.

Cause: Configuration is not active. No new coordinations can be created for inbound events.

AIP-12116 An exception occurred while querying for adapter types.

Cause: Exception occurred while querying for adapter types.

AIP-12117 An exception occurred while querying for parties.

Cause: Exception occurred while querying for parties.

AIP-12118 An exception occurred while querying for the connection parameter value.

Cause: Exception occurred while querying for connection parameter value.

AIP-12119 An exception occurred while querying for the outpost instance, given the inport instance.

Cause: Exception occurred while querying for outpost instance, given inport instance.

AIP-12120 An exception occurred while querying for the process role list.

Cause: Exception occurred while querying for process role list.

AIP-12121 An exception occurred while querying for the effective agreement.

Cause: An exception occurred while querying for the effective agreement.

AIP-12122 An exception occurred while querying for the adapter type.

Cause: Exception occurred while querying for adapter type.

AIP-12123 An exception occurred while querying for inbound interactions.

Cause: Exception occurred while querying for inbound interactions.

AIP-12124 An exception occurred while querying for the B2B adapter type.

Cause: Exception occurred while querying for B2B adapter type.

AIP-12125 An exception occurred while querying for the interaction group.

Cause: An internal error occurred within the adapter framework. Contact Oracle Support Services.

AIP-12126 An exception occurred while querying for the value of the parameter.

Cause: An internal error occurred within the adapter framework. Contact Oracle Support Services.

AIP-12127 An exception occurred while querying for the adapter provider.

Cause: An internal error occurred within the adapter framework. Contact Oracle Support Services.

AIP-12128 An exception occurred while querying for the adapter exchange protocol.

Cause: An internal error occurred within the adapter framework. Contact Oracle Support Services.

AIP-12129 cannot find class

Cause: An internal error occurred within the adapter framework. Contact Oracle Support Services.

AIP-12130 cannot instantiate class

Cause: An internal error occurred within the adapter framework. Contact Oracle Support Services.

AIP-12131 cannot access class

Cause: An internal error occurred within the adapter framework. Contact Oracle Support Services.

AIP-12132 cannot create connection factory

Cause: An internal error occurred within the adapter framework. Contact Oracle Support Services.

AIP-12133 cannot find method

Cause: An internal error occurred within the adapter framework. Contact Oracle Support Services.

AIP-12134 cannot access method

Cause: An internal error occurred within the adapter framework. Contact Oracle Support Services.

AIP-12135 cannot invoke method

Cause: An internal error occurred within the adapter framework. Contact Oracle Support Services.

AIP-12136 An error occurred while setting the correlated events association.

Cause: An internal error occurred within the adapter framework. Contact Oracle Support Services.

AIP-12137 An error occurred while updating the event.

Cause: An internal error occurred within the adapter framework. Contact Oracle Support Services.

AIP-12138 An exception occurred while querying for the record type.

Cause: An internal error occurred within the adapter framework. Contact Oracle Support Services.

AIP-12139 The specified adapter framework instance is invalid.

Cause: An internal error occurred within the adapter framework. Contact Oracle Support Services.

AIP-12140 The specified record type is invalid.

Cause: An internal error occurred within the adapter framework. Contact Oracle Support Services.

AIP-12141 An exception occurred while creating a native event instance from an Oracle record.

Cause: An internal error occurred within the adapter framework. Contact Oracle Support Services.

AIP-12142 An error occurred while raising the inbound event.

Cause: An internal error occurred within the adapter framework. Contact Oracle Support Services.

AIP-12143 error starting a transaction when raising a native event

Cause: An internal error occurred within the adapter framework. Contact Oracle Support Services.

AIP-12144 error committing a transaction when raising a native event

Cause: An internal error occurred within the adapter framework. Contact Oracle Support Services.

AIP-12145 An exception occurred when querying for ports that are ready to receive the specified event type from the specified roles.

Cause: Exception occurred when querying for ports that are ready to receive specified event type from specified roles.

AIP-12146 An exception occurred when querying for ports that can receive the specified event type from the specified roles.

Cause: Exception occurred when querying for ports that can ever receive specified event type from specified roles.

AIP-12147 An exception occurred when querying for ports that are ready to receive the specified event type from the specified coordination.

Cause: Exception occurred when querying for ports that are ready to receive specified event type from specified coordination.

AIP-12148 An exception occurred when querying for ports that can receive the specified event type from the specified coordination.

Cause: Exception occurred when querying for ports that can ever receive specified event type from specified coordination.

AIP-12149 An exception occurred when querying for role types that can receive the specified event type.

Cause: Exception occurred when querying for role types that can receive specified event type.

AIP-12150 An exception occurred when querying for the application.

Cause: An internal error occurred within the adapter framework. Contact Oracle Support Services.

AIP-12151 An exception occurred when querying for the trading partner.

Cause: An internal error occurred within the adapter framework. Contact Oracle Support Services.

AIP-12152 An out-of-order event cannot be raised to runtime.

Cause: An internal error occurred within the adapter framework. Contact Oracle Support Services.

AIP-12200 The adapter cannot get metadata.

Cause: Adapter getMetadata failed.

AIP-12201 cannot get the next event for the outbound processor

Cause: Failed to get the next event for outbound processor.

AIP-12202 cannot consume event "{0}"

Cause: Failed to consume event "{0}".

AIP-12203 cannot set state to "{0}" for event "{1}"

Cause: Failed to set state to "{0}" for event "{1}".

AIP-12204 cannot set to error state for event "{0}"

Cause: Failed to set state to error for event "{0}".

AIP-12205 The adapter type already exists.

Cause: The adapter type already exists.

AIP-12206 cannot create interaction group

Cause: Failed while creating interaction group.

AIP-12207 An error occurred while creating the interaction.

Cause: Failed while creating interaction.

AIP-12208 An error occurred while creating the body and record elements.

Cause: Failed while creating record element and corresponding native and application event body elements.

AIP-12209 An error occurred while getting the parameter values.

Cause: Failed while getting connection parameter used for connection factory or connection specification.

AIP-12210 resource exception from adapter

Cause: Resource exception from adapter while creating interaction.

AIP-12211 cannot initialize the adapter framework

Cause: Failed to initialize the adapter framework.

AIP-12212 cannot create a system monitor

Cause: Failed to create a system monitor in the adapter framework.

AIP-12213 cannot initialize the adapter manager

Cause: Failed to initialize the adapter manager in the adapter framework.

AIP-12214 cannot create a record instance

Cause: An internal error occurred within the adapter framework. Contact Oracle Support Services.

AIP-12500 No adapter framework instance was found for "{0}".

Cause: No adapter framework instance found for "{0}".

AIP-12501 cannot connect to B2B adapter "{0}"

Cause: Cannot connect to B2B adapter "{0}".

AIP-12502 cannot initialize resource adapter "{0}"

Cause: Failed to initialize resource adapter "{0}".

AIP-12503 cannot find the class for resource adapter "{0}"

Cause: Cannot find the class resource adapter "{0}".

AIP-12504 Resource adapter "{0}" caused an invalid access error.

Cause: Resource adapter "{0}" caused an invalid access error.

AIP-12505 cannot start resource adapter "{0}"

Cause: Failed to start resource adapter "{0}".

AIP-12506 cannot stop resource adapter "{0}"

Cause: Failed to stop resource adapter "{0}".

AIP-12507 cannot start B2B adapter "{0}"

Cause: Failed to start B2B adapter "{0}".

AIP-12508 cannot stop B2B adapter "{0}"

Cause: Failed to stop B2B adapter "{0}".

AIP-12509 cannot deactivate resource adapter "{0}"

Cause: Failed to deactivate resource adapter "{0}".

AIP-12600 generic adapter error

Cause: Message logged by adapter.

AIP-13000 to AIP-16014 Business Logic Layer Error Codes

AIP-13000 class not found

Cause: The specified class was not found.

AIP-13001 error getting an instance of the persistency service

Cause: There was an error obtaining an instance of the persistency service.

AIP-13002 SQL error getting the data source

Cause: There was a SQL error while trying to create the data source.

AIP-13003 The object is not a base object.

Cause: The object to be added to the cache is not a base object. Make sure it is a model object.

AIP-13004 A context has already been started.

Cause: The current context must be exited before starting a new one.

AIP-13005 error disconnecting from the persistency service

Cause: An error occurred disconnecting from the persistency service.

AIP-13006 The execution context must be initialized.

Cause: The execution context must be started for each request.

AIP-13007 error reading properties file "{0}"

Cause: There was an error reading the properties file "{0}".

AIP-13100 The parameter "{0}" is null for object "{1}".

Cause: A null parameter is not allowed as a valid value.

AIP-13101 The mandatory attribute "{0}" must be defined.

Cause: The mandatory attribute must be set.

AIP-13102 The attribute "{0}" was not found in object "{1}".

Cause: Attribute with given name does not exist in the object.

AIP-13103 The string length of the attribute "{0}" is more than the maximum allowed length.

Cause: String length cannot be longer than maximum allowed length.

AIP-13104 The string length of the attribute "{0}" is less than the minimum allowed length.

Cause: String length shorter than minimum allowed length.

AIP-13105 Syntax validation failed.

Cause: One of the attributes does not satisfy syntax validation.

AIP-13106 The object "{0}" was previously updated.

Cause: Optimistic lock check determined that the object "{0}" has been updated by someone else in the system.

AIP-13107 The class "{0}" was not found.

Cause: The specified class "{0}" was not found.

AIP-13108 The constructor for class "{0}" was not found.

Cause: The specified constructor for the given class was not found.

AIP-13109 unable to instantiate an instance of class "{0}"

Cause: Unable to instantiate an instance of the specified class.

AIP-13110 no access to the constructor of class "{0}"

Cause: Access to the constructor of the specified class is restricted.

AIP-13111 error invoking the constructor of class "{0}"

Cause: There was an error invoking the constructor of the specified class.

AIP-13112 invalid date range specification

Cause: The start date must occur strictly before the end date.

AIP-13113 Two or more objects do not share the same parent object.

Cause: The objects must share a common parent object to be associated.

AIP-13114 error parsing the connection information

Cause: An error occurred parsing the connection information.

AIP-13115 not in an active transaction

Cause: A transactional operation was attempted while not inside an active transaction.

AIP-13116 The object "{0}" was not found.

Cause: Object "{0}" was not found in the system.

AIP-13117 The seed data was not loaded.

Cause: The seed data must be loaded into the system for the system to be functional.

AIP-13118 internal error in business logic

Cause: An internal error occurred. Contact Oracle Support Services.

AIP-13119 An operation was performed on one or more business objects while not in seed data mode.

Cause: Operation performed on one or more business objects while not in seed data mode.

AIP-13120 unable to set 'IsSeeded' flag in new instance of class "{0}"

Cause: Unable to set 'IsSeeded' flag in new instance of the specified class.

AIP-13200 error adding hosted trading partner

Cause: System does not allow adding more than one hosted trading partner.

AIP-13201 The party already exists.

Cause: Party object name is not unique in the system.

AIP-13202 The party was not found.

Cause: Party was not found in the system.

AIP-13203 Deleting the hosted trading partner is not allowed.

Cause: One hosted trading partner must always exist in the system.

AIP-13204 The party identification already exists.

Cause: A party identification object with the given name already exists within the party.

AIP-13205 The party identification was not found.

Cause: The party identification was not found in the system.

AIP-13206 The contact information was not found.

Cause: The contact information was not found in the system.

AIP-13207 The document exchange was not found.

Cause: The document exchange was not found in the system.

AIP-13208 The delivery channel was not found.

Cause: The delivery channel was not found in the system.

AIP-13209 The transport was not found.

Cause: The transport was not found in the system.

AIP-13210 The contact information already exists.

Cause: The contact information exists in the system.

AIP-13211 The object is not contact information.

Cause: The ID did not map to a contact information object, so there was a ClassCastException.

AIP-13212 The document exchange already exists.

Cause: The document exchange exists in the system.

AIP-13213 The delivery channel already exists.

Cause: The delivery channel exists in the system.

AIP-13214 The transport already exists.

Cause: The transport exists in the system.

AIP-13215 The certificate and document exchange are not from the same trading partner.

Cause: The certificate and document exchange must be part of the same trading partner to be associated.

AIP-13216 The certificate and transport are not from the same trading partner.

Cause: The certificate and transport must be part of the same trading partner to be associated.

AIP-13217 The object is not a trading partner.

Cause: The ID did not map to a trading partner object, so there was a ClassCastException.

AIP-13218 The object is not a party identification.

Cause: The ID did not map to a party identification object, so there was a ClassCastException.

AIP-13219 The object is not a document exchange.

Cause: The ID did not map to a document exchange object, so there was a ClassCastException.

AIP-13220 The object is not a delivery channel.

Cause: The ID did not map to a delivery channel object, so there was a ClassCastException.

AIP-13221 The object is not a transport.

Cause: The ID did not map to a transport object, so there was a ClassCastException.

AIP-13222 The person already exists.

Cause: The person object already exists in the system.

AIP-13223 The person was not found.

Cause: The person was not found in the system.

AIP-13224 The object is not a person.

Cause: The ID did not map to a person object, so there was a ClassCastException.

AIP-13225 The certificate already exists.

Cause: The certificate object already exists in the system.

AIP-13226 The certificate was not found.

Cause: The certificate was not found in the system.

AIP-13227 The object is not a certificate.

Cause: The ID did not map to a certificate object, so there was a ClassCastException.

AIP-13128 The party identification type already exists.

Cause: Party identification type object name is not unique in the system.

AIP-13129 The party identification type must be removed from all party identifications.

Cause: The party identification type cannot be removed if it is currently being used to identify a party identification in the system.

AIP-13130 The party identification type was not found.

Cause: Party identification type was not found in the system.

AIP-13131 The contact type was not found.

Cause: Contact type was not found in the system.

AIP-13132 The contact type already exists.

Cause: Contact type already exists in the system.

AIP-13233 The object is not a party identification type.

Cause: The ID did not map to a party identification type object so there was a ClassCastException.

AIP-13234 The object is not a contact type.

Cause: The ID did not map to a contact type object, so there was a ClassCastException.

AIP-13235 The business protocol cannot be disassociated until related associations are broken.

Cause: The exchange protocol must be disassociated from document exchange of the corresponding party before the business protocol of the same party can be disassociated.

AIP-13236 The protocol element was not associated with the document exchange.

Cause: The given protocol element was not previously associated with the document exchange. The value cannot be retrieved because it does not exist.

AIP-13237 The business protocol was not associated with the party.

Cause: The given business protocol was not previously associated with the party. The objects do not need to be disassociated.

AIP-13238 The exchange protocol was not associated with the party.

Cause: The given exchange protocol was not previously associated with the party through the business protocol. The business protocol of this exchange protocol needs to be associated with the party before the exchange protocol can be associated with the document exchange.

AIP-13239 The document exchange and delivery channel must belong to the same party.

Cause: The document exchange and delivery channel must belong to the same party in order to be associated.

AIP-13240 The transport and delivery channel must belong to the same party.

Cause: The transport and delivery channel must belong to the same party in order to be associated.

AIP-13241 The document exchange associations still exist.

Cause: Document exchange must be disassociated from delivery channel before it can be removed, either by removing the delivery channels or associating new document exchanges with them.

AIP-13242 The certificate associations still exist.

Cause: Certificate must be disassociated from document exchange and transport before it can be removed.

AIP-13243 The transport associations still exist.

Cause: Transport must be disassociated from delivery channel before it can be removed, either by deleting the delivery channel or by associating a new transport with the delivery channel.

AIP-13244 The contact type associations still exist.

Cause: Contact information objects using contact type must be removed before the contact type can be removed.

AIP-13250 The protocol endpoint was not found.

Cause: The protocol endpoint was not found in the system.

AIP-13251 The object is not a protocol endpoint.

Cause: The ID did not map to a protocol endpoint object, so there was a ClassCastException.

AIP-13252 The endpoint was not found.

Cause: The endpoint was not found in the system.

AIP-13253 The object is not an endpoint.

Cause: The ID did not map to an endpoint object, so there was a `ClassCastException`.

AIP-13254 The protocol endpoint already exists.

Cause: The protocol endpoint exists in the system.

AIP-13255 The endpoint already exists.

Cause: The endpoint exists in the system.

AIP-13256 The protocol endpoint that precedes the new protocol endpoint was not found.

Cause: The protocol endpoint, which is supposed to be used as the position to place the new protocol endpoint before, does not exist in the system.

AIP-13300 The agreement already exists.

Cause: Agreement object name is not unique in the system.

AIP-13301 The agreement was not found.

Cause: Agreement was not found in the system.

AIP-13302 The collaboration was already implemented.

Cause: Collaboration is already implemented by the agreement.

AIP-13303 The collaboration was not implemented.

Cause: Collaboration is not implemented by the agreement.

AIP-13304 collaboration dependency error

Cause: Unable to remove collaboration due to object interdependencies.

AIP-13305 The party is not an agreement participant.

Cause: Party is not a participant in the agreement.

AIP-13307 The party is already an agreement participant.

Cause: Party is already an active participant in the agreement.

AIP-13308 The object is not an agreement.

Cause: The ID did not map to an agreement object, so there was a `ClassCastException`.

AIP-13309 An association dependency error occurred.

Cause: An association dependency error occurred.

AIP-13400 The collaboration was not found.

Cause: Collaboration was not found in the system.

AIP-13401 The object is not a collaboration.

Cause: The ID did not map to a collaboration object, so there was a ClassCastException.

AIP-13402 The collaboration already exists.

Cause: Collaboration object name is not unique in the system.

AIP-13500 The process diagram already exists.

Cause: Process diagram exists in the system.

AIP-13501 The process diagram was not found.

Cause: Process diagram was not found in the system.

AIP-13502 The object is not an actor.

Cause: The ID did not map to an actor object, so there was a ClassCastException.

AIP-13503 The actor already exists.

Cause: Actor exists in the system.

AIP-13504 The actor was not found.

Cause: Actor was not found in the system.

AIP-13505 The object is not an actor.

Cause: The ID did not map to an actor object, so there was a ClassCastException.

AIP-13506 The composite step already exists.

Cause: Composite step exists in the system.

AIP-13507 The composite step was not found.

Cause: Composite step was not found in the system.

AIP-13508 The state vertex already exists.

Cause: State vertex exists in the system.

AIP-13509 The state vertex was not found.

Cause: State vertex was not found in the system.

AIP-13510 The object is not a state vertex.

Cause: The ID did not map to a state vertex object, so there was a ClassCastException.

AIP-13600 The business protocol was not found.

Cause: Business protocol not found.

AIP-13601 The exchange protocol was not found.

Cause: Exchange protocol not found.

AIP-13602 The transport protocol was not found.

Cause: Transport protocol was not found in the system.

AIP-13603 The transport protocol already exists.

Cause: Transport protocol already exists in the system.

AIP-13604 The object is not a transport protocol.

Cause: The ID did not map to a transport protocol object, so there was a ClassCastException.

AIP-13605 The business protocol already exists.

Cause: Business protocol already exists in the system.

AIP-13606 The object is not a business protocol.

Cause: The ID did not map to a business protocol object, so there was a ClassCastException.

AIP-13607 The exchange protocol already exists.

Cause: Exchange protocol already exists in the system.

AIP-13608 The object is not an exchange protocol.

Cause: The ID did not map to an exchange protocol object, so there was a ClassCastException.

AIP-13609 The protocol element was not found.

Cause: Protocol element object not found.

AIP-13610 The protocol element already exists.

Cause: Protocol element already exists in the system.

AIP-13611 The document protocol was not found.

Cause: Document protocol object not found.

AIP-13612 The document protocol already exists.

Cause: Document protocol already exists in the system.

AIP-13613 The object is not a document protocol.

Cause: The ID did not map to a document protocol object, so there was a ClassCastException.

AIP-13614 The process protocol was not found.

Cause: Process protocol object not found.

AIP-13615 The process protocol already exists.

Cause: Process protocol already exists in the system.

AIP-13616 The object is not a process protocol.

Cause: The ID did not map to a process protocol object, so there was a ClassCastException.

AIP-13617 The packaging protocol was not found.

Cause: Packaging protocol object not found.

AIP-13618 The packaging protocol already exists.

Cause: Packaging protocol already exists in the system.

AIP-13619 The object is not a packaging protocol.

Cause: The ID did not map to a packaging protocol object, so there was a ClassCastException.

AIP-13620 The packaging ID was not found.

Cause: Packaging ID object not found.

AIP-13621 The object is not a packaging ID.

Cause: The ID did not map to a packaging ID object, so there was a ClassCastException.

AIP-13622 The process protocol and business protocol are not associated.

Cause: There is no association between process protocol and business protocol.

AIP-13623 The secure exchange protocol was not found.

Cause: Secure exchange protocol object not found.

AIP-13624 The secure exchange protocol already exists.

Cause: Secure exchange protocol already exists in the system.

AIP-13625 The object is not a secure exchange protocol.

Cause: The ID did not map to a secure exchange protocol object, so there was a ClassCastException.

AIP-13626 The digital signature already exists.

Cause: Digital signature already exists in the system.

AIP-13627 The digital envelope already exists.

Cause: Digital envelope already exists in the system.

AIP-13628 The algorithm already exists.

Cause: Algorithm already exists in the system.

AIP-13629 The algorithm was not found.

Cause: Algorithm not found.

AIP-13630 The object ID is not an algorithm.

Cause: The ID did not map to a algorithm object, so there was a ClassCastException.

AIP-13631 The digital signature was not found.

Cause: Digital signature not found.

AIP-13632 The object ID is not a digital signature.

Cause: The ID did not map to a digital signature object, so there was a ClassCastException.

AIP-13633 The digital envelope was not found.

Cause: Digital envelope not found.

AIP-13634 The object ID is not digital envelope.

Cause: The ID did not map to a digital envelope object, so there was a ClassCastException.

AIP-13650 The datatype was not found.

Cause: Datatype was not found in the system.

AIP-13651 The datatype already exists.

Cause: Datatype already exists in the system.

AIP-13652 The object is not a datatype.

Cause: The ID did not map to a datatype object, so there was a ClassCastException.

AIP-13653 The datatype member was not found.

Cause: Datatype member was not found in the system.

AIP-13654 The datatype member already exists.

Cause: Datatype member already exists in the system.

AIP-13655 The object is not a datatype member.

Cause: The ID did not map to a datatype member object, so there was a ClassCastException.

AIP-13656 The scalar member is associated with the wrong datatype.

Cause: Scalar member can refer to scalar datatype only.

AIP-13657 A valid value was not found.

Cause: Valid value was not found in the system.

AIP-13658 A valid value already exists.

Cause: Valid value already exists in the system.

AIP-13659 The object is not a valid value.

Cause: The ID did not map to a valid value object, so there was a ClassCastException.

AIP-13660 The event type was not found.

Cause: Event type was not found in the system.

AIP-13661 The event type already exists.

Cause: Event type already exists in the system.

AIP-13662 The object is not an event type.

Cause: The ID did not map to a event type object, so there was a ClassCastException.

AIP-13663 The event body was not found.

Cause: Event body was not found in the system.

AIP-13664 The event body already exists.

Cause: Event body already exists in the system.

AIP-13665 The object is not an event body.

Cause: The ID did not map to a event body object, so there was a ClassCastException.

AIP-13666 The event type class was not found.

Cause: Event type class was not found in the system.

AIP-13667 The event type class already exists.

Cause: Event type class already exists in the system.

AIP-13668 The object is not an event type class.

Cause: The ID did not map to a event type class object, so there was a ClassCastException.

AIP-13669 The protocol object is not an instance of either the business protocol, document protocol, or exchange protocol.

Cause: Datatype object could be associated either with business protocol, document protocol or exchange protocol.

AIP-13670 The instance of the datatype does not match the instance of the scalar member.

Cause: Scalar member could be associated only with scalar datatype.

AIP-13700 The process role was not found.

Cause: Process role was not found in the system.

AIP-13701 The process role already exists.

Cause: Process role already exists in the system.

AIP-13702 The object is not a process role.

Cause: The ID did not map to a process role object, so there was a ClassCastException.

AIP-13703 The data flow group was not found.

Cause: Data flow group was not found in the system.

AIP-13704 The data flow group already exists.

Cause: Data flow group already exists in the system.

AIP-13705 The object is not a data flow group.

Cause: The ID did not map to a data flow group object, so there was a ClassCastException.

AIP-13900 user authentication unsuccessful

Cause: User cannot be authenticated due to invalid user name or password.

AIP-13901 access denied to use case "{0}"

Cause: User does not have privilege to access the use case. Grant appropriate user roles to the user.

AIP-13902 invalid authentication token "{0}"

Cause: The supplied authentication token is invalid.

AIP-13903 The use case group "{0}" already exists.

Cause: Use case group name is not unique in the system.

AIP-13904 The use case "{0}" already exists.

Cause: Use case name is not unique in the system.

AIP-13905 The use case was not found.

Cause: Use case was not found in the system.

AIP-13906 The user role "{0}" already exists.

Cause: User role name is not unique in the system.

AIP-13907 The user role was not found.

Cause: User role was not found in the system.

AIP-13908 The object is not a user role.

Cause: The ID did not map to a user role object.

AIP-13909 The use case "{0}" is not granted to user role "{1}".

Cause: The specified use case has not been granted to the user role.

AIP-13910 The user role "{0}" is not granted to person "{1}".

Cause: The specified user role has not been granted to the person.

AIP-13911 The configuration type was not found.

Cause: Configuration type begin set is not seeded.

AIP-13912 The execution context was not found for the ID.

Cause: Execution context not found.

AIP-13913 The object "{0}" is invalid.

Cause: Object is invalid.

AIP-13950 The XML schema cannot be parsed due to error "{0}".

Cause: The XML schema could not be parsed due to error(s) "{0}".

AIP-13951 exclusive import mode violated: Object "{0}" in "{1}" is defined in the XSD but already exists in the database.

Cause: Exclusive import mode violated: Object "{0}" in "{1}" is defined in the XSD but already exists in the database.

AIP-13952 The attribute "{0}" cannot have the value "{1}".

Cause: Attribute "{0}" cannot have value "{1}".

AIP-13953 failed to get a valid URL from XSD filename "{0}"

Cause: Failed to get a valid URL from XSD filename "{0}".

AIP-13954 error storing the imported document as a string

Cause: Error storing the imported document as a string.

AIP-13955 An XSD cannot import its own target namespace.

Cause: The XML schema imports another XML schema whose namespace is identical. This is not supported by XML schema.

AIP-13956 There must be an XMLNS attribute for each namespace referenced in an import tag.

Cause: The XML schema imports another XML schema; however there is no XMLNS attribute in reference to the imported schema.

AIP-13957 Every input tag in a schema must have a schema location attribute.

Cause: The XML schema includes another schema; however a value is not supplied for the mandatory attribute 'schemaLocation'.

AIP-13958 An XSD that is imported using importString or importStream may not contain an import or include tag.

Cause: The XSD input contains an import or include tag.

AIP-13959 There cannot be a "{0}" in "{2}" and a "{3}" in "{4}" that are both named "{1}".

Cause: The definition of a "{0}" named "{1}" in "{2}" conflicts with the definition of a "{3}" in the same namespace also named "{1}" in "{4}".

AIP-13960 "{0}" is not a valid event type classification for an XSD import.

Cause: "{0}" is not a valid event type classification for an XSD import.

AIP-13961 cannot find the seeded datatype "{1}" in namespace "{2}" with event type class "{3}" to which the XSD type "{0}" maps

Cause: Could not find the seeded datatype "{1}" in namespace "{2}" with event type class "{3}" that the XSD type "{0}" maps to.

AIP-13962 The XSD type "{0}" has no mapping to a datatype for event type class "{1}".

Cause: XSD type "{0}" has no mapping to a datatype for event type class "{1}".

AIP-13963 cannot resolve the canonical path of "{0}"

Cause: Could not resolve the canonical path of "{0}".

AIP-13964 The XSD file "{0}" does not exist.

Cause: XSD file "{0}" does not exist.

AIP-13965 An error occurred while saving XSD "{0}" as a string.

Cause: Error saving XSD "{0}" as a string.

AIP-13966 "{0}" "{1}" in namespace "{2}" is referred to in "{3}" but is not defined.

Cause: "{0}" "{1}" in namespace "{2}" is referred to in "{3}" but never defined.

AIP-13967 The root element "{0}" was not found in the XSD.

Cause: The XML schema does not contain a root element which is required by the XSD converter.

AIP-13968 unsupported XSD tag "{0}" "{1}" encountered

Cause: The XSD importer does not support "{0}" "{1}". Remove this tag or decrease the schema validation level.

AIP-16000 A null parameter cannot be passed into the model validation engine.

Cause: A null parameter cannot be passed into the model validation engine.

AIP-16001 Model validation cannot be processed because of a system error.

Cause: An internal error occurred, so model validation could not be processed.

AIP-16002 no seed data

Cause: Seed data is not loaded.

AIP-16003 The model validation engine cannot resolve the validation context.

Cause: An internal error occurred so engine could not resolve validation context.

AIP-16004 Rule "{0}" in class "{1}" fails while processing.

Cause: An internal error occurred during rule execution.

AIP-16005 The class "{0}" was not found.

Cause: An internal error occurred during execution. The class "{0}" cannot be located.

AIP-16006 The method "{1}" was not found in class "{0}".

Cause: An internal error occurred during execution. The method "{0}" cannot be located in the class "{1}".

AIP-16007 The attributes are not correct in rule "{0}" class "{1}".

Cause: An internal error occurred during rule invocation.

AIP-16008 no access to rule class "{1}"

Cause: An internal error occurred during rule execution. No access to rule class "{1}".

AIP-16009 The "{1}" subject type "{0}" was not found.

Cause: An internal error occurred during execution. The "{1}" subject type "{0}" cannot be located.

AIP-16010 The object "{0}" already exists.

Cause: Object "{0}" already exists in the system.

AIP-16011 The object "{0}" cannot be deleted because object "{1}" refers to it.

Cause: Object "{0}" cannot be deleted because child object "{1}" exists.

AIP-16012 The parameter "{0}" is unique for object "{1}".

Cause: Parameter "{0}" is unique for object "{1}".

AIP-16013 The object "{0}" cannot be updated or created because the parent object "{1}" does not exist.

Cause: Object "{0}" cannot be updated or created because parent object "{1}" does not exist.

AIP-16014 The object "{0}" is a database view. Update/delete/create is not allowed for database views.

Cause: Object "{0}" is database view. Update/delete/create is not allowed for database views.

AIP-14000 to AIP-14018 Transformation Error Codes

AIP-14001 The operand "{0}" does not evaluate to a value.

Cause: Operand "{0}" does not evaluate to a value.

AIP-14002 An instance of the event body element "{0}" was not found in the event instance of type "{1}".

Cause: Instance of event body element "{0}" not found in event instance of type "{1}".

AIP-14003 error in invoking header function "{0}"

Cause: Error in invoking header function "{0}".

AIP-14004 error in invoking domain value function "{0}"

Cause: Error in invoking domain value function "{0}".

AIP-14005 error in invoking a callout datatype transformation map implemented by class "{0}"

Cause: Error in invoking a callout datatype transformation map implemented by class "{0}".

AIP-14006 Data value "{0}" is in an invalid format.

Cause: Data value "{0}" is in an invalid format.

AIP-14007 The XML element "{0}" is expected to contain a text node.

Cause: XML element "{0}" is expected to contain a text node.

AIP-14008 The invalid condition expression "{0}" cannot be evaluated.

Cause: Invalid condition expression "{0}" cannot be evaluated.

AIP-14009 The operand "{0}" results in the selection of multiple items where a single item is expected.

Cause: Operand "{0}" results in selection of multiple items where single item is expected.

AIP-14010 internal error in transformation engine

Cause: Internal Error in Transformation Engine.

AIP-14011 Event Body Element Instance Values of type {0} corresponding to Event Body Element {1} of Event Type {2} not supported.

Cause: Event Body Element Instance Values of type {0} corresponding to Event Body Element {1} of Event Type {2} not supported.

AIP-14012 The transformation map parameter "{0}" instance is not specified while invoking the map.

Cause: Transformation map parameter "{0}" instance not specified while invoking map.

AIP-14013 error evaluating path for the operand "{1}"

Cause: Error in evaluating path for the operand "{1}".

AIP-14014 error in populating return code for transformation

Cause: Error in populating return code for transformation.

AIP-14015 error in accessing XML content of datatype or event instance

Cause: Error in accessing XML content of datatype or event instance.

AIP-14016 error in creating XML content of datatype or event instance

Cause: Error in creating XML content of datatype or event instance.

AIP-14017 error in saving the event or datatype instance corresponding to map parameter

Cause: Error in saving the event or datatype instance corresponding to map parameter.

AIP-14019 Invalid party {0} in SetToParty

Cause: Invalid party in SetToParty.

AIP-14020 Invalid party {0} in SetFromParty

Cause: Invalid party in SetFromParty.

AIP-14100 to AIP-14114 Translation Error Codes

AIP-14100 The converter class "{0}" in translator "{1}" is invalid.

Cause: The converter class "{0}" in translator "{1}" is invalid.

AIP-14101 error getting interaction specification type or interaction specification parameters from converter "{0}"

Cause: Error getting interaction specification type or interaction specification parameters from converter "{0}".

AIP-14102 a system error occurred during translation

Cause: System error occurred during translation.

AIP-14103 invalid event body element "{0}"

Cause: Invalid event body element "{0}".

AIP-14104 invalid application datatype set in OutConverterRecord

Cause: Invalid application datatype set in OutConverterRecord.

AIP-14105 invalid interaction specification "{0}" set in OutConverterRecord

Cause: Invalid interaction specification "{0}" set in OutConverterRecord.

AIP-14106 error getting value from interaction specification for parameter "{0}"

Cause: Error getting value from interaction specification for parameter "{0}".

AIP-14107 invalid event type "{0}"

Cause: Invalid event type "{0}".

AIP-14108 invalid source event body element instance "{0}"

Cause: Invalid source event body element instance "{0}".

AIP-14109 invalid translation direction specified

Cause: Invalid translation direction specified.

AIP-14110 invalid target event body element instance "{0}"

Cause: Invalid target event body element instance "{0}".

AIP-14111 The translator class "{0}" in translator "{1}" is invalid.

Cause: The translator class "{0}" in translator "{1}" is invalid.

AIP-14112 error creating interaction specification using reflection

Cause: Error creating interaction specification using reflection.

AIP-14113 error populating interaction specification with parameter values

Cause: Error populating interaction specification with parameter values.

AIP-14114 A translation error occurred in translator "{0}".

Cause: Translation error occurred in translator "{0}".

AIP-14115 to AIP-14119 XSD Translation Error Codes

AIP-14115 The inbound XML's base datatype is null

Cause: The root element's datatype of the inbound XML is null.

AIP-14116 The base datatype {0} is a scalar datatype, but the inbound XML root type is complex

Cause: The root element's datatype {0} is a scalar datatype, but the inbound XML root element is a complex datatype.

AIP-14117 The inbound XML is invalid, as the current element {0} of namespace {1} cannot appear in the XML instance after {2} from namespace {3} according to the datatype model

Cause: The inbound XML is invalid, as element {0} of namespace {1} cannot appear in the XML instance after {2} from namespace {3} according to the datatype model.

AIP-14118 Element {0}'s datatype member ID is invalid

Cause: Element {0}'s datatype member ID is invalid.

AIP-14119 There is an unsupported XML instance construct {0} within {1} in the native XML

Cause: There is an unsupported XML instance construct {0} within {1} in the native XML.

AIP-14321 to AIP-14325 Event Validation Error Codes

AIP-14321 Native event validation for the native event body element "{0}" failed in validation class "{1}".

Cause: Native event validation for native event instance element "{0}" failed in validation class "{1}".

AIP-14322 Native event validation for the native event body element "{0}" failed because validation class "{1}" cannot be found.

Cause: Native event validation for native event body element "{0}" failed because validation class "{1}" cannot be found.

AIP-14323 Native event validation for the native event body element "{0}" failed because "{1}" cannot be instantiated.

Cause: Native event validation for native event body element "{0}" failed because "{1}" cannot be instantiated.

AIP-14324 Native event validation for the native event body element "{0}" failed because "{1}" is not accessible.

Cause: Native event validation for native event body element "{0}" failed because "{1}" is not accessible.

AIP-14325 Native event validation for native event body element "{0}" to call out class "{1}" failed due to resource exception.

Cause: Native event validation for native event body element "{0}" to call out class "{1}" failed due to resource exception.

AIP-14401 to AIP-14406 Correlation Error Codes

AIP-14401 The number of operands exceeds the maximum for the correlation manager.

Cause: The number of operands exceeds correlation manager maximum specification.

AIP-14402 cannot find body element instance in the event instance

Cause: Could not find body element instance in the event instance.

AIP-14403 SQL exception thrown

Cause: Unexpected error: SQL exception thrown.

AIP-14404 DC exception thrown

Cause: Unexpected error: DC exception thrown.

AIP-14405 cannot find correlated events

Cause: Cannot find correlated events.

AIP-14406 cannot find corresponding native event instance

Cause: Cannot find correlated native event instance.

AIP-14451 to AIP-14455 Domain Value Map Error Codes

AIP-14451 cannot find the target column

Cause: Cannot find the target column.

AIP-14452 cannot find the row in domain value map

Cause: Cannot find the row in the domain value map.

AIP-14453 cannot find the column in domain value map

Cause: Could not find the column in the domain value map.

AIP-14454 No such party exists.

Cause: No such party exists.

AIP-14455 No domain for the party exists.

Cause: No domain for the party exists.

AIP-16020 to AIP-17997 Metadata Validation Rules Error Codes

AIP-16020 The business process {0} must have at least one approved agreement.

Cause: Associate at least one approved agreement with the business process.

AIP-16060 All collaborations within the agreement {0} must have a trading partner participant corresponding to each of its actors.

Cause: For all collaborations used within an agreement, associate both actors of that collaboration to an individual trading partner participant within that agreement. For example, if collaboration A and B are used, and collaboration A has actor 1 and 2, and collaboration B has actors 3 and 4, then there should be 4 trading partner participants, one for 1, one for 2, one for 3, and one for 4.

AIP-16061 The agreement {0} must have at least one native role.

Cause: Associate at least one native role with the agreement.

AIP-16062 The application agreement {0} must have exactly one application participant.

Cause: Provide only one application participant in the application agreement. For example, if the participant is an application participant there should only be one.

AIP-16063 The B2B agreement {0} must have exactly two trading partners.

Cause: In a B2B agreement, please have exactly two trading partners for all the trading partner participants owned by this agreement. For example, SUN and ORACLE can play several roles, but CISCO can not be part of this agreement because only two trading partners are allowed.

AIP-16064 In the B2B agreement {0} only one of the trading partners can be a local trading partner.

Cause: In the B2B agreement, specify only one local trading partner.

AIP-16065 The actor {0} of the hosted trading partner participant {1} must be an actor of a collaboration supported by the agreement {2} through one of its native roles.

Cause: The actor of a hosted trading partner participant must be an actor of a collaboration supported by the agreement through one of its native roles. For example, if Oracle is the hosted trading partner, and there is PIP3A4 buyer and PIPxyy seller associated with the agreement, then there must be two trading partner participants with Oracle as the trading partner, one whose supported actor is buyer, the other whose supported actor is seller.

AIP-16066 The complement of the hosted trading partner's supported actor {0} must be the actor used by the other trading partner for a given native role.

Cause: The complement of the hosted trading partner's supported actor should be the actor used by the other trading partner for a given native role. For example, if Oracle is the hosted trading partner who is playing buyer, then Sun, the remote trading partner, must be playing seller.

AIP-16067 Each application participant in the agreement {0} must have at least one party adapter type that matches the adapter type used by the native role.

Cause: For each application participant in an agreement, specify at least one party adapter type that matches the adapter type used by the native role.

AIP-16068 For the application participant there must be no more than one application delivery channel for every adapter type that matches the adapter type used by the native role.

Cause: For the application participant, specify no more than one application delivery channel for every adapter type that matches the adapter type used by the native role.

AIP-16069 The agreement {0} is only allowed to interact in one business process.

Cause: Allow the agreement to interact in only one business process.

AIP-16070 Both trading partner participants and application participants cannot coexist in the same agreement {0}.

Cause: Either remove the trading partner participants or the application participants from the same agreement.

AIP-16071 Agreement {0} must have one local trading partner.

Cause: Permit only one local trading partner for the B2B agreement.

AIP-16072 Each application participant in the agreement {0} should have at least one application delivery channel for every adapter type that is used.

Cause: For each application participant in an agreement, specify at least one application delivery channel for every adapter type that is used.

AIP-16073 Non-repudiation of origin/non-repudiation of receipt is enabled for trading partner delivery channel {0} but is not enabled for {1}.

Cause: If non-repudiation of origin or non-repudiation of receipt is enabled for one trading partner delivery channel, then the other trading partner delivery channel must also be enabled.

AIP-16074 Hosted trading partner has client authentication enabled, but the remote trading partner transport {1} does not have a security certificate.

Cause: If client authentication is enabled for the hosted trading partner, then there must be a security certificate for the remote trading partner.

AIP-16075 The agreement {0} must have at least one participant.

Cause: Provide at least one participant to the agreement.

AIP-16080 The delivery channel {0} of the trading partner participant must be a trading partner delivery channel.

Cause: If the participant is a trading partner participant the delivery channel must be a trading partner delivery channel.

AIP-16081 The trading partner identification, supported actor and trading partner delivery channel associated with the trading partner participant must be owned by the same trading partner.

Cause: The trading partner identification, supported actor and trading partner delivery channel directly associated with this trading partner participant must be owned by the same trading partner.

AIP-16082 The trading partner participant must have exactly one trading partner identification associated with it.

Cause: Associate a trading partner identification with the trading partner participant.

AIP-16084 There must be an adapter framework instance with trading partner override set to true.

Cause: Create an adapter framework instance whose trading partner override attribute value is true.

AIP-16085 The trading partner {0} participating as {1} in revision {2} of collaboration {3} must have at least one trading partner delivery channel.

Cause: Specify a trading partner delivery channel for the trading partner participant.

AIP-16086 The trading partner {0} participating as {1} in revision {2} of collaboration {3} must have no more than one trading partner delivery channel.

Cause: The trading partner participant must have no more than one trading partner delivery channel.

AIP-16100 The delivery channel {0} of the application participant must be an application delivery channel.

Cause: If the participant is an application participant, then the delivery channel must be an application delivery channel.

AIP-16101 The application delivery channel {0} must be owned by the application specified in the same participant.

Cause: The application delivery channel must be owned by the application specified in the same participant.

AIP-16102 There must be at least one adapter framework instance whose application override is set to true or the application associated with this participant must be associated with at least one adapter framework instance.

Cause: Either have at least one adapter framework instance whose application override is set to true or associate the application associated with this participant with at least one adapter framework instance.

AIP-16140 The trading partner {0} must have at least one trading partner identification.

Cause: Specify a trading partner identification for the trading partner.

AIP-16141 The document protocol parameter value {0} must be associated with the document protocol parameter of the same document protocol that the parent document protocol usage is associated with.

Cause: The document protocol parameter values must be associated with the document protocol parameters of the same document protocol that the parent document protocol usage is associated with.

AIP-16142 The document parameter value {0} must be associated with a document parameter of the same document type {1} that the parent document type usage is associated with.

Cause: A document parameter value must be associated with a document parameter of the same document type that the parent document type usage is associated with.

AIP-16143 The trading partner {0} can have only one association with the domain column for a specific domain value map.

Cause: A party can have only one association with the domain column for a specific domain value map.

AIP-16160 If the trading partner identification type is DUNS, then its value must be a 9 digit string.

Cause: Specify a 9 digit string for the DUNS trading partner identification type.

AIP-16161 If the trading partner identification type is DUNS+4, then its value must be a 13 digit string.

Cause: Specify a 13 digit string for the DUNS+4 trading partner identification type.

AIP-16162 The trading partner identification value {0} is not a unique DUNS number.

Cause: If a trading partner identification is a DUNS number then its value must be unique.

AIP-16180 The trading partner delivery channel {0} must have exactly one transport parameter.

Cause: Specify a transport parameter for the trading partner delivery channel.

AIP-16181 The trading partner delivery channel {0}, document exchange {1} and transport parameter {2} must all belong to the same trading partner.

Cause: The trading partner delivery channel, document exchange and transport parameter must all belong to the same trading partner.

AIP-16182 The transport protocol of the protocol endpoint associated with the trading partner delivery channel {0} via the transport parameter {1} must be one of the transport protocols supported by the exchange protocol of the document exchange of the same trading partner delivery channel.

Cause: The transport protocol of the protocol endpoint associated with the trading partner delivery channel through the transport parameter must be one of the transport protocols supported by the exchange protocol of the document exchange of the same trading partner delivery channel.

AIP-16183 If either non-repudiation of origin or non-repudiation of receipt are true then the document exchange {0} associated with the trading partner delivery channel {1} must have a digital signature.

Cause: If either non-repudiation of origin or non-repudiation of receipt are true then the document exchange associated with the trading partner delivery channel must have a digital signature.

AIP-16184 If encryption is true then the document exchange {0} associated with trading partner delivery channel {1} must have a digital envelope.

Cause: If encryption is true then the document exchange associated with the trading partner delivery channel must have a digital envelope.

AIP-16185 The trading partner delivery channel {0} must have exactly one document exchange.

Cause: A trading partner delivery channel must have exactly one document exchange.

AIP-16186 For trading partner delivery channel {0} header encryption override specified via the document exchange {1} should only be applied to protocol headers with a name of ServiceHeader only if encryption is enabled and the exchange protocol is RosettaNet version 02.00.

Cause: If encryption is true and if the exchange protocol of the document exchange has a name of RosettaNet and a version of 02.00, then a user can enable header encryption override on the protocol header with a name of ServiceHeader only. Note that even if header encryption override is specified for any other protocol header, it will not be encrypted.

AIP-16200 The document exchange {0} must have exactly one ExchangeProtocol.

Cause: Provide an exchange protocol for the document exchange.

AIP-16201 The exchange protocol {0} must be associated with the same trading partner {1} as the document exchange {2} via the business protocol.

Cause: The exchange protocol must be associated with the same trading partner as the document exchange through the business protocol.

AIP-16202 The protocol encryption override elements should map to the protocol elements of the exchange protocol {0} that is associated with the document exchange {1}.

Cause: The protocol encryption override elements should map to the protocol elements of the exchange protocol that is associated with the document exchange.

AIP-16203 The digital signature used within the document exchange {0} must be one of the supported security specifications of that document exchange.

Cause: The digital signature used within a document exchange must be one of the security specifications supported by that document exchange.

AIP-16204 The digital envelope used within the document exchange {0} must be one of the supported security specifications of that document exchange.

Cause: The digital envelope used within a document exchange must be one of the security specifications supported by that document exchange.

AIP-16205 The signing certificate in the document exchange {0} must be present when the digital signature is present.

Cause: If the digital signature is present then the signing certificate must also be present.

AIP-16206 The encryption certificate in the document exchange {0} must be present when the digital envelope is present.

Cause: If the digital envelope is present then the encryption certificate must also be present.

AIP-16207 The exchange protocol parameter value {0} of the document exchange {1} must be associated with an exchange protocol parameter of the same exchange protocol {2} that is associated with that document exchange.

Cause: The exchange protocol parameter values of the document exchange must be associated with exchange protocol parameters of the same exchange protocol that is associated with the document exchange.

AIP-16208 The certificate {0} associated with the document exchange {1} must belong to the same trading partner {2} as that document exchange.

Cause: A certificate associated with a document exchange must belong to the same trading partner as that document exchange.

AIP-16220 The transport parameter {0} must have at least one protocol endpoint.

Cause: Provide a protocol endpoint to the transport parameter.

AIP-16221 The trading partner of the transport parameter {0} must be the same trading partner as that of a certificate associated with an endpoint that is associated with that transport parameter if a certificate exists on that transport protocol.

Cause: The trading partner of the transport parameter must be the same trading partner as that of a certificate associated with an endpoint that is associated with that transport parameter if a certificate exists on that transport protocol.

AIP-16222 The transport parameter {0} must have no more one protocol endpoint.

Cause: Provide exactly one protocol endpoint to the transport parameter.

AIP-16223 The protocol endpoint associated with transport parameter {0} must belong to the same trading partner {1} as that of the transport parameter.

Cause: The protocol endpoint associated with this transport parameter must belong to the same trading partner as that of the transport parameter.

AIP-16240 A protocol endpoint must have an endpoint.

Cause: Provide an endpoint to the protocol endpoint.

AIP-16241 A protocol endpoint must have a certificate associated with it if and only if it has a transport protocol security associated with it.

Cause: If the protocol endpoint has a transport protocol security associated to it, then it must also have a certificate associated to it. Otherwise, it must not have a certificate associated with it.

AIP-16242 A protocol endpoint must have a transport protocol.

Cause: Provide a transport protocol to the protocol endpoint.

AIP-16261 Parameter values specified in the application delivery channel {0} must exist for all connection parameter objects of the adapter type that that application delivery channel is connected to.

Cause: Specify parameter values in the application delivery channel that exist for all connection parameter objects of the adapter type that application delivery channel is connected to.

AIP-16264 The connection parameter value {0} should match its datatype {1}.

Cause: Provide a connection parameter value that matches its datatype. For example, if a connection parameter, port, is of type integer, then the value must be a valid integer.

AIP-16265 The connection parameter value {0} must be one of the domain values of that connection parameter.

Cause: Provide a connection parameter value that is one of the domain values of that connection parameter.

AIP-16280 The connection factory associated with the adapter type {0} must belong to the same adapter provider {1} that the adapter type belongs to.

Cause: Associate a connection factory with the adapter type that belongs to the same adapter provider that the adapter type belongs to.

AIP-16281 The connection spec associated with the adapter type {0} must belong to the same adapter provider.

Cause: Associate a connection spec with the adapter type that belongs to the same adapter provider that the adapter type belongs to.

AIP-16282 The adapter type {0} must have exactly one connection factory associated with it.

Cause: Associate exactly one connection factory with the adapter type.

AIP-16300 If, in the adapter framework instance {0} the application override is set to true, then it must have no party adapter framework instances for applications.

Cause: Either remove all party adapter framework instances for that adapter framework instance's applications or set the application override to false.

AIP-16301 If, in the adapter framework instance {0} the trading partner override is set to true, then it must have no party adapter framework instances for trading partners.

Cause: Either remove all party adapter framework instances for that adapter framework instance's trading partners or set the trading partner override to false.

AIP-16320 For business process {0}, there must be a tree structure to all other nodes.

Cause: From a business process role there must be a tree structure to all other roles. It cannot be a network.

AIP-16321 The native role {0} can only be used with one business process.

Cause: Native roles can only be used with one business process.

AIP-16322 The business process: {0} contains steps (spanning one or more roles) illegally connected in a loop. Step: {1} was detected as being part of the following loop: {2}

Cause: A given business process cannot contain steps connected, using control flows, dataflows within roles and dataflows across roles, such that there is a loop or cycle.

AIP-16323 The business process: {0} contains an invalid OR step: {1}. None of the paths coming into [{1}] from [{2}, {3}] are mutually exclusive and hence will result in runtime race conditions.

Cause: A given business process cannot contain an OR step such that control flows into it are not mutually exclusive. This is to prevent resulting runtime race conditions.

AIP-16324 The business process: {0} contains an invalid step: {1}. The paths shown below coming into [{1}] from [{2}, {3}] are mutually exclusive and hence will result in indefinite wait during runtime. (1) Path: {4}, (2) Path: {5}.

Cause: A given business process cannot contain a step such that control flows into it are mutually exclusive. This is to prevent resulting infinite wait at runtime.

AIP-16325 The business process: {0} contains an invalid port: {1}. None of the paths coming into [{1}] from [{2}, {3}] are mutually exclusive and hence will result in runtime race conditions.

Cause: A given business process cannot contain a port such that dataflows into it are not mutually exclusive. This is to prevent resulting runtime race conditions.

AIP-16340 The process role {0} must have exactly one enclosing composite step that is not a step.

Cause: Every process role must have exactly one enclosing composite step that is not a step.

AIP-16341 The port {0} of business process {1} can accept or send only event types and not datatypes.

Cause: The ports of a business process can accept or send only event types (and not datatypes).

AIP-16342 The event type {0} used in the port of the business process {1} must be of type business event type.

Cause: All of the event types used in the ports of a business process must be business event types.

AIP-16344 The business process {0} must not have any inbound data flow groups associated with it.

Cause: There must be no inbound data flow groups associated with a business process.

AIP-16345 The business process {0} must have at least one outbound data flow group associated with it.

Cause: There must be one or more outbound data flow groups associated with a business process.

AIP-16380 The business role {0} must have exactly one enclosing composite step that is not a step.

Cause: A business role must have exactly one enclosing composite step that is not a step.

AIP-16381 The port {0} of business role {1} can accept or send only event types and not datatypes.

Cause: The ports of a business role can accept or send only event types (and not datatypes).

AIP-16382 The event type {0} used in the port of the business role {1} must be of type business event type.

Cause: All of the event types used in ports of a business role must be business event types.

AIP-16384 The business role {0} must have at least one inbound data flow group associated with it.

Cause: There must be at least one inbound data flow group associated with a business role.

AIP-16386 The business role {0} must have at least one outbound data flow group associated with it.

Cause: There must be at least one outbound data flow group associated with a business role.

AIP-16387 The business role {0} must have no more than one inbound data flow group associated with it.

Cause: There must be no more than one inbound data flow group associated with a business role.

AIP-16388 Business role ports can be data flow bound to multiple binding role ports only if the data flows belong to different data flow groups.

Cause: If there is a port on a business role that has more than one data flow to a port owned by another role, then each such data flow must be owned by a different data flow group and the other roles must be binding roles.

AIP-16389 Data flow criteria is required on the data flow groups to distinguish between multiple binding roles that a business role is associated with.

Cause: If a business role has more than one data flow group that associates it with different binding roles, then each data flow group must have a data flow criteria.

AIP-16390 A data flow criteria with a unique priority among all data flow groups is required on the data flow groups to distinguish between multiple binding roles that a business role is associated with.

Cause: If a business role has more than one data flow group that associates it with different binding roles, then each data flow group must have a data flow criteria with a unique priority among all of the data flow groups.

AIP-16393 The same business role ports must be used in all data flow groups between a business role and different binding roles.

Cause: If a business role has more than one data flow group that associates it with different binding roles, then each data flow group must contain data flows to and from the same business role ports.

AIP-16420 The binding role {0} must have exactly one enclosing composite step that is not a step.

Cause: Every binding role must have exactly one enclosing composite step that is not a step.

AIP-16421 The port {0} of binding role {1} can accept or send only event types and not datatypes.

Cause: The ports of a binding role can accept or send only event types (and not datatypes).

AIP-16422 The event type {0} used in the port of this binding role {1} must be either of type application event type and native event type or of application event type and business event type.

Cause: All of the event types used in the ports of a binding role must be of type application event type and native event type or of type application event type and business event type.

AIP-16424 The binding role {0} must have exactly one inbound data flow group associated with it.

Cause: There can be at most one inbound data flow group associated with a binding role.

AIP-16426 The binding role {0} must have at least one outbound data flow group associated with it.

Cause: A binding role must have at least one outbound data flow group associated with it.

AIP-16428 The binding role {0} must have no more than one inbound data flow group associated with it.

Cause: A binding role can have no more than one inbound data flow group associated with it.

AIP-16460 The application role {0} must have exactly one enclosing composite step that is not a step.

Cause: Every application role must have exactly one enclosing composite step that is not a step.

AIP-16461 The port {0} of application role {1} can accept or send only event types and not datatypes.

Cause: The ports of an application role can accept or send only event types (and not datatypes).

AIP-16462 The event type {0} used in the port of the application role {1} must be of type application event type.

Cause: All of the event types used in the ports of an application role must be of type application event type.

AIP-16464 The application role {0} must have at least one inbound data flow group associated with it.

Cause: There must be at least one inbound data flow group associated with an application role.

AIP-16466 The application role {0} must have at least one outbound data flow group associated with it.

Cause: There must be at least one outbound data flow group associated with an application role.

AIP-16467 The application role {0} must have no more than one inbound data flow group associated with it.

Cause: An application role must not have more than one inbound data flow group associated with it.

AIP-16520 The native role {0} must have exactly one enclosing composite step that is not a step.

Cause: Every native role must have exactly one enclosing composite step that is not a step.

AIP-16521 The port {0} of native role {1} can accept or send only event types and not datatypes.

Cause: The ports of a native role can accept or send only event types (and not datatypes).

AIP-16522 The event type {0} used in the port of the native role {1} must be of type native event type.

Cause: All of the event types used in the ports of a native role must be of type native event type.

AIP-16523 In native role {0}, if there are multiple out facing receiving ports (ports not bound to other ports but to interaction usages) and the non-initiating ports are receiving, then a correlation must be defined between the native event {1} of the non-initiating port {2} and the native event of an initiating port (a port connected to an initiating step).

Cause: Define a correlation expression for the native event of the non-initiating port and the native event of the initiating port.

AIP-16524 The native role {0} must have at least one inbound data flow group associated with it.

Cause: A native role must have at least one inbound data flow group associated with it.

AIP-16525 The port {0} of native role {1} must have a data flow to a binding role port or it must be associated with an interaction.

Cause: Either provide a data flow to a binding role port or associate the port with an interaction.

AIP-16526 The native role {0} must not have any outbound data flow groups associated with it.

Cause: There must not be any outbound data flow groups associated with a native role.

AIP-16527 Port {0} owned by native role {1} must be associated with either two data flows or one data flow and one interaction.

Cause: Ports owned by a native role are associated with either two data flows (to a step port and a port on a binding role) or one data flow (to a step port) and one interaction.

AIP-16529 The interaction usage tied to port {0} must also be tied to another port owned by the same composite step.

Cause: An interaction usage tied to a port must also be tied to another port owned by the same composite step.

AIP-16530 The record type of the native event type of the input port {0} must match the in record type of the inbound interaction it is tied to via the interaction usage.

Cause: A record type of a native event type of an input port must match the in record type of the inbound interaction it is tied to through the interaction usage.

AIP-16531 The record type of the native event type of input port {0} must match the out record type of the outbound interaction it is tied to via the interaction usage.

Cause: A record type of a native event type of an input port must match the out record type of the outbound interaction it is tied to through the interaction usage.

AIP-16532 The record type of the native event type of output port {0} must match the in record type of the outbound interaction that it is tied to via the interaction usage.

Cause: A record type of a native event type of an output port must match the in record type of the interaction that it is tied to through the interaction usage.

AIP-16533 If a port is tied to an interaction usage that is tied to another port, then one port must be out (receiving = false) and the other must be in (receiving = true).

Cause: If a port is tied to an interaction usage that is tied to another port, then one port must be out and the other must be in.

AIP-16534 If a port is tied to an interaction usage that has only an in record type, then the port must be an input port if the interaction is inbound or an output port if the interaction is outbound.

Cause: If a port is tied to an interaction usage that has only an in record type, then the port must be an input port if the interaction is inbound or an output port if the interaction is outbound.

AIP-16535 The native format {0} associated with the event body element {1} of the native event type {2} must be a supported native format through the native role {3}.

Cause: The native format associated with each event body element of a native event type must be a supported native format through the native role.

AIP-16540 The enclosing step {0} associated with role {1} must not be owned by any other step.

Cause: An enclosing step of a role must not be owned by any other step.

AIP-16542 Only one start step is allowed in role {0}.

Cause: Only one start step is allowed in a given role.

AIP-16545 The role {0} must have at least one input port and one output port.

Cause: Provide at least one input port and one output port to the specified role.

AIP-16546 The role {0} must have at least two data flows binding its role ports.

Cause: Provide at least two data flows that bind the ports of the role.

AIP-16548 The port {0} of step {1} owned by role {2} must be associated with that owning composite step as an available port.

Cause: All ports of steps owned by a given role must be associated with that role as available ports.

AIP-16549 The steps within role {0} must not form a loop.

Cause: The steps within a given role must not form a loop.

AIP-16550 The step {0} cannot own another step.

Cause: No step can own another step.

AIP-16560 The passthrough step {0} must have at least one outbound control flow or data flow to another step.

Cause: Provide either an outbound control flow or a data flow for the step to another step.

AIP-16561 The passthrough step {0} can only own a port.

Cause: A passthrough step can only own a port.

AIP-16562 The passthrough step {0} must have at least two ports.

Cause: Provide at least two ports to the passthrough step.

AIP-16563 The passthrough step {0} must have no more than two ports.

Cause: Provide at most two ports to the passthrough step.

AIP-16580 The transformation step {0} must have at least one outbound control flow or data flow to another step.

Cause: Provide either an outbound control flow or a data flow for the step to another step.

AIP-16581 The map parameter {0} associated with the output Port {1} and the transformation map associated with the transformation step {2} must be a target parameter.

Cause: Each output port associated with a transformation step must be associated with an output map parameter that is associated with the transformation map that is associated with the same transformation step.

AIP-16583 The map parameter {0} associated with the input port {1} and the transformation map associated with the transformation step {2} must be a source parameter.

Cause: Each input port associated with a transformation step must be associated with an input map parameter that is associated with the transformation map that is associated with the same transformation step.

AIP-16584 The transformation step {0} can only own ports.

AIP-16585 The transformation step {0} must be associated with exactly one transformation map.

Cause: A transformation step must be associated with exactly one transformation map.

AIP-16586 The map parameter {0} of the transformation map {1} associated with the transformation step {2} must have a port associated with it that is owned by that transformation step.

Cause: A transformation step must own at least one port for each event map parameter and each datatype map parameter.

AIP-16587 The map parameter {0} of the transformation map associated with the transformation step {1} must not have more than one port associated with it that is owned by that transformation step.

Cause: There must be no more than one port for each event map parameter and each datatype map parameter.

AIP-16588 The datatype of datatype map parameter {0} must match the datatype of the port.

Cause: The datatype of a datatype map parameter must match the datatype of the port.

AIP-16589 The datatype or event type of event map parameter {0} must be the same as the datatype or event type of the port.

Cause: The datatype or event type of an event map parameter must be the same as the datatype or event type of the port.

AIP-16590 For an event map parameter associated with a datatype, there must be a datatype associated with a port of the transformation step. Similarly, for an event map parameter associated with an event type, there must be an event type associated with the Port.

Cause: For an event map parameter associated to a datatype, there must be a datatype associated to a port of the transformation step. Similarly, for an event map parameter associated to an event type, there must be an event type associated to the port.

AIP-16591 The transformation step {0} must have one output port marked as a return code port.

Cause: A transformation step must have one return code port.

AIP-16600 The translation step {0} must have at least one outbound control flow or data flow to another step.

Cause: Provide either an outbound control flow or a data flow for the step to another step.

AIP-16604 The translation step {0} can only own ports.

Cause: A translation step can only own ports.

AIP-16606 The translation step {0} must have at least two ports that are not return code ports.

Cause: Provide at least two ports that are not return code ports to the translation step.

AIP-16607 The translation step {0} must have no more than two ports that are not return code ports.

Cause: Provide no more than two ports that are not return code ports to the translation step.

AIP-16608 The translation step {0} must have one output port marked as a return code port.

Cause: A translation step must have one return code port.

AIP-16609 The translation step {0} must own at least one input port and at least one output port that is not a return code port.

Cause: Provide at least one input port and at least one output port that is not a return code port to the translation step.

AIP-16610 The translation step {0} can own at most one input port and at most one output port that is not a return code port.

Cause: A translation step can own at most one input port and at most one output port that is not a return code port.

AIP-16611 If application event {0} is on the outgoing Port {1} of translation step {2} then the native event must be on the incoming port {3}.

Cause: If an application event is on the outgoing port of a translation step, then the native event must be on the incoming port.

AIP-16612 If application event {0} is on the incoming port {1} of translation step {2} then the native event must be on the outgoing port {3}.

Cause: If an application event is on the incoming port of a translation step, then the native event must be on the outgoing port.

AIP-16620 The condition step {0} must have at least one outbound control flow or data flow to another step.

Cause: Provide either an outbound control flow or a data flow for the step to another step.

AIP-16621 The output port {0} of condition step {1} must correspond with an output parameter of the condition it is associated with.

Cause: The output ports of a condition step must correspond with the output parameters of the condition it is associated with.

AIP-16623 The input port {0} of condition step {1} must correspond with the input parameters of the condition it is associated with.

Cause: The input ports of a condition step must correspond with the input parameters of the condition it is associated with.

AIP-16624 The condition step {0} can only own ports.

Cause: A condition step can only own ports.

AIP-16625 The condition step {0} must be associated with exactly one condition expression.

Cause: Association a condition expression with the condition step.

AIP-16626 The condition step {0} must have at least one input port.

Cause: A condition step must have at least one input port.

AIP-16627 The condition step {0} can have at most one input port.

Cause: A condition step can have at most one input port.

AIP-16628 The condition step {0} must have at least two outbound control flows.

Cause: A condition step must have at least two outbound control flows.

AIP-16629 The condition step {0} can have at most two outbound control flows.

Cause: A condition step can have at most two outbound control flows.

AIP-16630 The condition step {0} must have one outbound control flow with guard value set to true or success and one outbound control flow with guard value set to false or failure.

Cause: A condition step must have one outbound control flow with guard value set to true or success and one outbound control flow with guard value set to false or failure.

AIP-16631 The condition step {0} must have one output port marked as a return code port.

Cause: A condition step must have one return code port.

AIP-16640 The validate step {0} must have at least one outbound control flow or data flow to another step.

Cause: Provide either an outbound control flow or a data flow for the step to another step.

AIP-16644 The validate step {0} can only own ports.

Cause: A validate step can only own ports.

AIP-16645 The validate step {0} must be associated with exactly one validation.

Cause: A validate step must be associated with exactly one validation.

AIP-16660 The receiving port {0} of the initiating step {1} is connected to a non-receiving port {2} of the step {3} instead of a receiving port of a role.

Cause: The receiving port of an initiating step must be connected to a receiving role port and not to a non-receiving step port.

AIP-16661 The port {0} of role {1} must be owned by a data flow group that contains another port connected to a different role.

Cause: A role port must be owned by a data flow group that contains another role port that is connected to a neighboring role.

AIP-16662 The port {0} must be associated with either one event type or one datatype, but not both.

Cause: The port is associated to both an event type and a datatype. It should be associated either to the event type or the datatype.

AIP-16663 The composite step associated with port {0} must be the owner of the step that owns the port.

Cause: Every port is associated with the owning composite step of its owning step. This association is set incorrectly. Contact Oracle Support Services.

AIP-16664 The initiating flag of port {0} can only be set to true if that port belongs to the start step or if that port is connected to another port that belongs to the start step.

Cause: The initiating flag is set to true only on a port that belongs to start step or on a port that is connected to a port that belongs to start step.

AIP-16665 The port {0} can only be associated with an interaction if it belongs to a native role.

Cause: A port that is not a native role port cannot be associated with an interaction. Associate this port with the port of another role, and not with an interaction.

AIP-16666 The record type of the native event associated with the receiving port {0} must match the out record type of the inbound interaction with which it is associated.

Cause: The record type of the native event type associated with the port does not match the out record type of the inbound interaction with which it is associated. Make sure the record types are the same.

AIP-16667 The port {0} can only be associated with a datatype if it is not a role port.

Cause: The port is associated with a datatype even though it is associated with a role and not a step. A role port must only be associated with an event type.

AIP-16668 The port {0} must have one source and one target transition. Only outgoing (associated with an interaction) native role ports and outgoing (attached to a binding role port) business role ports involved in branching may not have exactly one source and one target transition.

Cause: This port does not have a source and target transition. Associate this port with two ports, one of which is the source and the other of which is the target.

AIP-16669 The record type of the native event of the output port {0} must match the in record type of the outbound interaction with which it is associated.

Cause: The record type of the native event type associated with the output port does not match the in record type of the outbound interaction with which it is associated. Make sure the record types are the same.

AIP-16670 The port {0} of role {1} must have an event type.

Cause: Associate an event type with the role port.

AIP-16671 The port {0} of step {1} must have either an event type or a datatype.

Cause: Associate either an event type or a datatype with the step port.

AIP-16681 The native event {0} must be associated with a record type.

Cause: A native event must be associated with a record type.

AIP-16682 The native event {0} must be associated with exactly one adapter exchange protocol.

Cause: A native event must be associated with exactly one adapter exchange protocol.

AIP-16683 The event body elements of native event type {0} must be associated one to one with the record type elements of the record type that is associated with that native event type.

Cause: The event body elements of a native event type must be associated one to one with the record type elements of the record type that is associated with that native event type.

AIP-16684 The native event type {0} must point to an application event type.

Cause: A native event type must point to an application event type, and the application event type must point to the same native event type.

AIP-16685 The adapter exchange protocol for native event type {0} must match the adapter exchange protocol for the record type.

Cause: The native event type and the record type must have the same adapter exchange protocol.

AIP-16686 The native event body element {0} of native event type {1} must point to a native datatype.

Cause: Associate a native datatype with the record type element.

AIP-16687 The native event type {0} must point to another event type.

Cause: Associate the native event type with another event type.

AIP-16689 The event body element {0} of native event type {1} is not associated with a translator.

Cause: Associate the event body element of the native event type with a translator.

AIP-16700 Each event body element of the application event type {0} must map to a datatype.

Cause: Map each event body element of the application event type to a datatype.

AIP-16701 The event type classification of datatype {0} associated with event body element {1} must be application event.

Cause: A datatype can only be associated with an event body element whose associated event type is the same as the event type class of the datatype. For example, application datatypes can only be associated with application event body elements.

AIP-16703 Application event type {0} does not have a native event type.

Cause: Associate a native event type with the application event type.

AIP-16704 Application event type {0} does not point to an event type.

Cause: Associate the application event type with an event type.

AIP-16705 The application event type {0} must be associated with an adapter exchange protocol.

Cause: Associate an adapter exchange protocol with the application event type.

AIP-16720 Each event body element of business event type {0} must map to a datatype.

Cause: Map each event body element of the business event type to a datatype.

AIP-16721 The event type classification for datatype {0} associated with the event body element {1} must be the same as the business event type associated with the event body element.

Cause: A datatype can only be associated with an event body element whose associated event type is the same as the event type class of the datatype. For example, business datatypes can only be associated with business event body elements.

AIP-16723 The business event type {0} must not have the application event to native event association.

Cause: The application event to native event association is not permitted on business event types.

AIP-16724 The business event type {0} must not be associated with an adapter exchange protocol.

Cause: Remove the association between the business event type and the adapter exchange protocol.

AIP-16740 Multiple union member datatype intersection objects (associated with one union member) must each in turn be associated with different datatype objects.

Cause: Multiple union member datatype intersection objects (associated with one union member) each in turn should be associated with different datatype objects. For example, the intersections of a union member must each point to different datatypes.

AIP-16741 The complex datatype with name {0}, datatype namespace {1}, event type class {2} and ref type only {3} already exists.

Cause: Each named datatype must have a unique combination of name, datatype namespace, event type class and ref type only.

API-16742 The name of compound member {0} in datatype {1} does not match the name {2} of the ref type only datatype it refers to.

Cause: If the member of a datatype is a ref type only, then the member must have the same name as its type.

AIP-16743 The complex datatype {0} must be a subset of the complex datatype that it is restricted by.

Cause: If complex datatype is derived by restriction from another datatype, then it must be a subset of what the other datatype is. For example, if there is a datatype, SHIRT, that has a complex datatype member, size, that is a choice of int{8, 10} or char{S, M}, and there is also a datatype MY_SHIRT that is derived from SHIRT, then MY_SHIRT can also have a size choice int{8,10}, but it cannot have a size choice int{8,10,12}.

AIP-16744 Complex datatype {0} cannot be handled by translation because an instance cannot be exactly matched to it.

Cause: The complex datatype cannot be handled by translation because an instance cannot be exactly matched to it.

AIP-16745 There can be at most one member with member group head set to true within complex datatype {0}.

Cause: Ensure that there is only one member with member group head set to true in the complex datatype.

AIP-16746 Within complex datatype {0} whose member group type is set to true, there must be at least two members.

Cause: Provide at least two members to the complex datatype.

AIP-16747 Within complex datatype {0} whose member group type is set to true, there must not be any anonymous members.

Cause: Provide names for all members of the complex datatype.

AIP-16748 Complex datatype member {0} in complex datatype {1} must be derived from member group head complex datatype member {2}.

Cause: All complex datatype members within a complex datatype must be derived from the complex datatype member whose isMemberGroupHead value is true.

AIP-16749 Element wildcard member {0} in complex datatype {1} must be the last element member of that datatype.

Cause: If a complex datatype has an element wildcard member, then that member must be the last element member of the complex datatype.

AIP-16760 The default value {0} of scalar member {1} referring to scalar datatype {2} is not a valid value of the enumeration facet associated with that datatype.

Cause: If the default value of a scalar member is set, and its scalar datatype is associated with an enumeration facet, then that facet must have a valid value that equals the default value of the scalar member.

AIP-16761 The scalar member {0} in datatype {1} must be associated with either a scalar datatype or a facet.

Cause: Associate the scalar member with either a scalar datatype or a facet.

AIP-16762 The fixed value {0} of scalar member {1} referring to scalar datatype {2} is not a valid value of the enumeration facet associated with that datatype.

Cause: If the fixed value of a scalar member is set and its scalar datatype is associated with an enumeration facet then that facet must have a valid value that equals the fixed value of that scalar member.

AIP-16763 The scalar datatype {0} must be a subset of the base scalar datatype {1} by which it is restricted.

Cause: A scalar datatype that is derived by restriction from another scalar datatype must be a subset of the scalar datatype by which it is restricted.

AIP-16764 Scalar datatype {0} can have only one facet of type enumeration.

Cause: A scalar datatype can have only one enumeration facet, but this facet can have multiple valid values.

AIP-16767 The scalar datatype {0} cannot own mutually exclusive facets minInclusive and minExclusive.

Cause: A scalar datatype cannot own both a facet with a facet type of minInclusive and a facet with a facet type of minExclusive.

AIP-16768 The scalar datatype {0} cannot own mutually exclusive facets maxInclusive and maxExclusive.

Cause: A scalar datatype cannot own both a facet with a facet type of maxInclusive and a facet with a facet type of maxExclusive.

AIP-16769 The scalar datatype {0} can own at most one facet of each facet type.

Cause: A scalar datatype cannot own more than one facet of a particular facet type.

AIP-16770 For the scalar datatype {0}, the value of its minLength facet must be less than or equal to the value of its maxLength facet.

Cause: If a scalar datatype owns both a minLength facet and a maxLength facet, the minLength facet value must be less than or equal to the maxLength facet value.

AIP-16771 The value of the minInclusive facet of scalar datatype {0} must be less than or equal to the value of its maxExclusive or maxInclusive facet.

Cause: For a scalar datatype that owns a facet with a facet type of minInclusive and one with a facet type of either maxInclusive or maxExclusive, the facet value of the minInclusive facet must be less than or equal to the facet value of the maxInclusive or maxExclusive facet.

AIP-16772 The value of the minExclusive facet of scalar datatype {0} must be less than or equal to the value of its maxExclusive or maxInclusive facet.

Cause: For a scalar datatype that owns a facet with a facet type of minExclusive and one with a facet Type of either maxInclusive or maxExclusive, the facet value of the minExclusive facet must be less than or equal to the facet value of the maxInclusive or maxExclusive facet.

AIP-16773 The scalar datatype with name {0}, datatype namespace {1}, event type class {2} and ref type only {3} already exists.

Cause: Each named datatype must have a unique combination of name, datatype namespace, event type class and ref type only.

AIP-16774 The name of compound member {0} in datatype {1} does not match the name {2} of the ref type only datatype it refers to.

Cause: If the member of a datatype is a ref type only, then the member must have the same name as its type.

AIP-16775 Scalar member {0} in datatype {1} does not match the name of its ref type only scalar type {2}.

Cause: A scalar member must have the same name as its scalar type if its scalar type is ref type only.

AIP-16776 Scalar datatype {0} in namespace {1} must have a base scalar type.

Cause: Every scalar datatype must be derived from one of the core types.

AIP-16780 The array datatype {0} must not refer to itself in any form of a loop.

Cause: An array datatype cannot refer to itself in any form of a loop.

AIP-16781 The array datatype {0} does not refer to a datatype.

Cause: Associate the array datatype with either a complex datatype, scalar datatype or an array datatype.

AIP-16782 The array datatype with name {0}, datatype namespace {1}, event type class {2} and ref type only {3} already exists.

Cause: Each named datatype must have a unique combination of name, datatype namespace, event type class and ref type only.

API-16783 The name of compound member {0} in datatype {1} does not match the name {2} of the ref type only datatype it refers to.

Cause: If the member of a datatype is a ref type only, then the member must have the same name as its type.

AIP-16820 Only one data flow group can exist between two process roles.

Cause: Only one data flow group can exist between two process roles. For example, if there is a process role, R1 and a process role R2, R1 and R2 cannot own two data flow groups that go between R1 and R2. If there is another process role, R3, then R1 is allowed to own a data flow group that goes between R1 and R2, and a data flow group that goes between R1 and R3.

AIP-16821 The data flow group {0} can exist only between the following: (1) A native role as the out role and a binding role as the in role, (2) A binding role as the out role and an application role as the in role, (3) A binding role as the out role and a business role as the in role, (4) A business role as the out role and a business process as the in role, (5) An application role as the out role and a binding role as the in role.

Cause: Connect the data flow group between one of these valid combinations.

AIP-16824 The data flow group {0} must own at least one transition.

Cause: Every data flow group must own at least one transition.

AIP-16825 Every transition owned by the data flow group {0} must be between ports owned by different composite steps.

Cause: Every transition owned by a data flow group must be between ports owned by different composite steps.

AIP-16826 The data flow group {0} can only own a data flow criteria if it associates a business role and a binding role.

Cause: Only a data flow group that associates a business role and a binding role can own a data flow criteria.

AIP-16840 The adapter exchange protocol {0} associated with the data flow criteria must belong to the adapter type also associated with the data flow criteria if it exists.

Cause: The adapter exchange protocol associated with a data flow criteria must belong to the adapter type also associated with the data flow criteria if it exists.

AIP-16841 If an adapter type is associated with the data flow criteria then an adapter exchange protocol must also be associated with the data flow criteria.

Cause: If an adapter type is associated with the data flow criteria then an adapter exchange protocol must also be associated with the data flow criteria.

AIP-16860 A control flow must be between steps, and not ports.

Cause: Connect the control flow between steps. Otherwise, change the control flow to a data flow.

AIP-16861 A control flow must have different steps as its source and target.

Cause: The same step cannot be the source and target of a control flow. Connect the control flow between different steps.

AIP-17862 A control flow cannot be connected to port {0}.

Cause: A control flow cannot be connected to a port. Only data flows can be connected to ports. Connect the control flow between steps.

AIP-16880 A data flow between ports {0} and {1} must be between ports associated with the same datatype or event type.

Cause: Associate the data flow only between ports that are associated with the same datatype or event type.

AIP-16881 The source port {0} and target port {1} of a data flow must be different.

Cause: The same port cannot be the source and the target for a data flow. Connect the data flow between different ports.

AIP-16882 A data flow between ports {0} and {1} must be used in one of the following situations: (1) From a role receiving port to a step receiving port, (2) From an output port of a step to an output port of a role, (3) From an output port of a step to a receiving port of a step and (4) From an output port of a role to a receiving port of a role.

Cause: Make sure that the data flow is used in one of the above situations.

AIP-16883 The ports {0} and {1} of a data flow owned by data flow group {2} must be ports of different roles.

Cause: The data flow owned by a data flow group must be between role ports of different roles.

AIP-16884 A data flow between port {0} of step {1} and port {2} of step {3} within a role must be between ports within the same role. For example, either between steps within the role or between a step port and the role port.

Cause: The source and targets of the data flow within a role must be between ports of steps within the role or between a step port and a role port.

AIP-16900 Person {0} belongs to a remote trading partner and therefore must not have any associations to user enrollment or access control entry.

Cause: Persons belonging to remote trading partners must not be allowed privileged access.

AIP-16920 The application {0} must be associated with an application type.

Cause: Associate the application with an application type.

AIP-16921 The application {0} can have only one association with the domain column for a specific domain value map.

Cause: Provide only one association from the application to the domain column for a specific domain value map.

AIP-16940 The and step {0} must have at least one in control flow and at least one out control flow.

Cause: The and step must have at least one control flow where it is the target and at least one control flow where it is the source.

AIP-16941 The and step {0} must have at least one outbound control flow or data flow to another step.

Cause: Provide either an outbound control flow or a data flow for the step to another step.

AIP-16960 The or step {0} must have at least one in control flow and at least one out control flow.

Cause: The or step must have at least one control flow where it is the target and at least one control flow where it is the source.

AIP-16961 The or step {0} must have at least one outbound control flow or dataflow to another step.

Cause: Provide either an outbound control flow or a data flow for the step to another step.

AIP-16980 The split step {0} must have at least one outbound control flow or dataflow to another step.

Cause: Provide either an outbound control flow or a data flow for the step to another step.

AIP-16982 The split step {0} can only own ports.

Cause: A split step can only own ports.

AIP-16983 The split step {0} must own at least one input port and at least one output port.

Cause: Provide at least one input port and at least one output port to the split step.

AIP-16984 The split step {0} can own at most one input port.

Cause: Provide a single input port to the split step.

AIP-17000 The set adapter type step {0} must have at least one outbound control flow or dataflow to another step.

Cause: Provide either an outbound control flow or a data flow for the step to another step.

AIP-17002 The set adapter type step {0} can only own ports.

Cause: A set adapter type step can only own ports.

AIP-17003 The set adapter type step {0} must be associated with exactly one adapter type.

Cause: Associate an adapter type with the set adapter type step.

AIP-17004 The set adapter type step {0} can own at most one input port and at most one output port.

Cause: Provide at most one input port and at most one output port to the set adapter type step.

AIP-17005 The set adapter type step {0} must own at least one input port and at least one output port.

Cause: Provide at least one input port and at least one output port to the set adapter type step.

AIP-17020 The set party step {0} must have at least one outbound control flow or data flow to another step.

Cause: Provide either an outbound control flow or a data flow for the step to another step.

AIP-17022 The set party step {0} can only own ports.

Cause: A set party step can only own ports.

AIP-17023 The set party step {0} must be associated with exactly one application or trading partner.

Cause: Associate either an application or a trading partner with the set party step.

AIP-17024 The set party step {0} can own at most one input port and at most one output port.

Cause: Provide at most one input port and at most one output port to the set party step.

AIP-17025 The set party step {0} must own at least one input port and at least one output port.

Cause: Provide at least one input port and at least one output port to the set party step.

AIP-17040 The set adapter exchange protocol step {0} must have at least one outbound control flow or data flow to another step.

Cause: Provide either an outbound control flow or a data flow for the step to another step.

AIP-17042 The set adapter exchange protocol step {0} can only own ports.

Cause: A set adapter exchange protocol step can only own ports.

AIP-17043 The set adapter exchange protocol step {0} must be associated with exactly one adapter exchange protocol.

Cause: Associate an adapter exchange protocol with the set adapter exchange protocol step.

AIP-17044 The set adapter exchange protocol step {0} can own at most one input port and at most one output port.

Cause: Provide at most one input port and at most one output port to the set adapter exchange protocol step.

AIP-17045 The set adapter exchange protocol step {0} must own at least one input port and at least one output port.

Cause: Provide at least one input port and at least one output port to the set adapter exchange protocol step.

AIP-17050 The event transformation map {0} must contain at least one map parameter referring to an event type.

Cause: An event transformation map must contain at least one map parameter referring to an event type.

AIP-17060 The datatype transformation map {0} must contain at least one parameter referring to a datatype.

Cause: A datatype transformation map must contain at least one parameter referring to a datatype.

AIP-17061 The datatype transformation map {0} must contain at least one transformation block.

Cause: The datatype transformation map which has been declaratively defined must contain at least one transformation block.

AIP-17080 The transformation statement {0} which is not invoking a map or function within transformation map {1} must contain at least one transformation statement.

Cause: A transformation statement which is not invoking a map or function must own at least one other transformation statement.

AIP-17081 The datatype transformation map {0} has been implemented as a java callout, hence it can not have any transformation statements within it.

Cause: If the datatype transformation map has been implemented as a java callout it can not have any transformation statements within it.

AIP-17082 The transformation statement {0} within transformation map {1} can only be contained within a condition because it is marked to be executed on the false evaluation of a condition.

Cause: A transformation statement marked to be executed on the false evaluation of a condition can only be contained within a condition.

AIP-17090 The transformation rule within transformation map {0} must provide a binding for parameter {1} of the invoked datatype transformation map {2}.

Cause: A transformation rule invoking a datatype transformation map needs to provide bindings for all parameters of the invoked map.

AIP-17100 The condition {0} within transformation map {1} must contain at least one transformation statement.

Cause: A condition must own at least one transformation statement.

AIP-17110 Within transformation statement {0} of transformation map {1}, binding is provided for parameter which does not belong to the invoked datatype transformation map {2}.

Cause: A transformation statement can provide bindings only for parameters of invoked map or function.

AIP-17111 Within transformation statement {0} of transformation map {1} the binding for parameter {2} can be specified in the context of parameter {3} of the owning event Transformation map only if the parameter is associated with a datatype.

Cause: The transformation statement can define the binding in the context of a map parameter of a event transformation map only if the parameter is associated with a datatype.

AIP-17112 The transformation statement {0} within transformation map {1} is referring to a transformation iterator {2} which is not accessible - a transformation statement can refer to a transformation iterator only it is defined within the transformation iterator.

Cause: A transformation statement can refer to a transformation iterator only if the statement has been defined within the transformation iterator.

AIP-17113 Within transformation statement {0} of transformation map {1} the parameter {2} of type {3} is bound to an invoked parameter of incompatible type {4}.

Cause: A parameter of a datatype map can be bound to an item with the same or compatible datatypes.

AIP-17114 Invalid path specified in the binding for parameter {0} within transformation statement{1} of the transformation map {2}.

Cause: The components of the path must logically fit together.

AIP-17115 Incompatible binding from parameter {0} of map {1} within transformation statement {2} to invoked parameter {3} - they must both be either source or target.

Cause: The parameter of the invoked map and the map parameter from which its value is bound must both be either source or target.

AIP-17117 Within transformation statement {0} of transformation map {1}, binding is provided for parameter which does not belong to the invoked event header function.

Cause: A transformation statement invoking a event header function can define bindings only for parameters of invoked function.

AIP-17118 Within transformation statement {0} of transformation map {1} binding is provided for parameter which does not belong to the invoked domain value map function.

Cause: A transformation statement invoking a domain value map function can define bindings only for parameters of invoked function.

AIP-17119 Within transformation iterator or condition expression statement {0} of transformation map {1}, a binding may not be defined for parameters of invoked datatype transformation map, event header function or domain value map function.

Cause: Binding within transformation iterator or condition expression of transformation map may not be for parameters of invoked datatype transformation map, event header function or domain value map function.

AIP-17120 Invalid condition expression {0} within transformation map {1} as condition evaluation supports only scalar values for operator {2}.

Cause: Condition evaluation is supported only for scalar values.

AIP-17121 The transformation statement {0} within transformation map {1} needs to provide a binding for an invoked parameter(s) {2}.

Cause: Bindings need to be provided for all parameters of invoked map or function.

AIP-17125 Within transformation statement {0} of transformation map {1} binding for parameter {2} is invalid as the parameter does not belong to the invoked datatype transformation map {3}.

Cause: A transformation statement can provide bindings only for parameters of invoked map or function.

AIP-17126 Within transformation statement {0} of transformation map {1}, the binding for invoked parameter {2} can be specified in the context of parameter {3} of event transformation map only if the parameter is associated with an event type.

Cause: The transformation statement can define the binding in the context of a map parameter of a Event Transformation Map only if the parameter is associated with a Event type.

AIP-17127 Binding for parameter {0} defined within transformation statement {1} of transformation map {2} refers to an event body element {3} which is not part of the event type {4} associated to the transformation map parameter {5} in whose context the binding is defined.

Cause: Binding defined within transformation statement can only refer to an event body element of the event type of the transformation map parameter.

AIP-17128 Within transformation statement {0} of transformation map {1} the parameter {2} of type {3} is bound to an invoked parameter of incompatible type {4}.

Cause: A parameter of a datatype map can be bound to an item with the same or compatible datatypes.

AIP-17129 Incompatible binding from parameter {0} of map {1} within transformation statement {2} to the invoked parameter {3} - They must both be either source or target.

Cause: The parameter of the invoked map and the map parameter from which its value is bound must both be either source or target.

AIP-17130 Invalid path specified in the binding for parameter {0} within the transformation statement {1} of the transformation map {2}.

Cause: The components of the path must logically fit together.

AIP-17131 Within transformation statement {0} of transformation map {1}, the binding for parameter {2} is invalid as the parameter does not belong to the invoked event header function {3}.

Cause: A transformation statement invoking an event header function can define bindings only for parameters of invoked function.

AIP-17132 Within transformation statement {0} of transformation map {1} binding for parameter {2} is invalid as the parameter does not belong to the invoked domain value map function {3}.

Cause: A transformation statement invoking a domain value map function can define bindings only for parameters of invoked function.

AIP-17133 Within transformation iterator or condition expression statement {0} within transformation map {1}, a binding may not be defined for parameters of invoked datatype transformation map, event header function or domain value map function.

Cause: Binding within transformation iterator or condition expression of transformation map may not be for parameters of invoked datatype transformation map, event header function or domain value map function.

AIP-17134 The transformation statement {0} within transformation map {1} needs to provide a binding for an invoked parameter(s) {2}.

Cause: Bindings need to be provided for all parameters of invoked map or function.

AIP-17135 Only condition expressions which are owned by a transformation rule can be associated with a datatype map parameter.

Cause: Only condition expressions which are owned by a transformation rule can be associated with a datatype map parameter.

AIP-17136 An event header rule associated with a condition expression in transformation map {0} can define bindings only for parameters of event header function.

Cause: An event header rule associated with condition expression in a transformation map can define bindings only for parameters of event header function.

AIP-17137 A domain value map rule {0} associated with a condition expression {1} in transformation map {2} can define bindings only for parameters of domain value map function.

Cause: A domain value map rule associated with a condition expression in a transformation map can define bindings only for parameters of domain value map function.

AIP-17138 A condition expression {0} bound within transformation iterator or condition expression {1} of transformation map {2} may not be for parameters of invoked datatype transformation map, event header function or domain value map function.

Cause: Binding within transformation iterator or condition expression of transformation map may not be for parameters of invoked datatype transformation map, event header function or domain value map function.

AIP-17139 The condition expression {0} can only be owned by another condition expression, transformation condition or correlation.

Cause: A condition expression can only be owned by another condition expression, transformation condition or correlation.

AIP-17140 The condition expression {0} must be binary when it uses a binary operator and unary when it uses a unary operator.

Cause: Provide two operands for a binary condition expression and only one for a unary condition expression.

AIP-17141 Binding within condition expression {0} used by correlation and event map for event type {1} must be a scalar member datatype if the operator is a binary operator.

Cause: Provide a condition expression whose event body items are scalar member datatypes as the operator is a binary operator.

AIP-17142 Only equal-to and not-equal-to operators are supported for boolean datatypes in condition expression {0}.

Cause: Use either an equal-to or not-equal-to operator in the specified condition expression.

AIP-17145 A correlation must be between two native event types.

Cause: Specify two native event types for the correlation.

AIP-17146 The leaf condition expression must be defined as an expression where the left hand side is an event body item from the left event type (e.g. the incoming correlating event type) and the right hand side is an event body item from the right event type (e.g. the correlated event type). For example, POA.id = PO.id and POA.orgunit = PO.orgunit.

Cause: Provide a condition expression where the left hand side is an event body item from the left event type and the right hand side is an event body item from the right event type.

AIP-17147 Condition expression {0} used by correlation between native event {1} and native event {2} cannot have datatype member {3} under datatype {4} in its path specification because more than one more datatype member can appear in instance in same place.

Cause: A condition expression used by a correlation between two native events cannot have a duplicate datatype member.

AIP-17161 Within transformation statement {0} of the transformation map {1} the constant value {2} cannot be bound to invoked parameter {3} of a complex type.

Cause: A constant value may be bound only to a map parameter with a scalar type.

AIP-17162 The format of the constant value {0} within transformation statement {1} of transformation map {2} is not compatible with datatype {3} of invoked parameter {4}.

Cause: The constant value must be in a format corresponding to the datatype of the map parameter to which it is bound.

AIP-17163 Constant value {0} within transformation statement {1} of transformation map {2} cannot be bound to a invoked target parameter {3}.

Cause: Constant values can be used only for binding to source parameters.

AIP-17164 Invalid binding within the transformation statement {0} of transformation map {1} to parameter {2} of datatype transformation map.

Cause: Only operands which are owned by a transformation rule can be associated with a datatype map parameter. For example, the association mapParameter from operand to datatype map parameter can be set only if the operand is owned by a transformation rule.

AIP-17165 An event header rule {0} associated with a constant operand {1} in transformation map {2} can define bindings only for parameters of event header function.

Cause: An event header rule associated with a constant operand in a transformation map can define bindings only for parameters of event header function.

AIP-17166 A domain value map rule {0} associated with a constant operand {1} in transformation map {2} can define bindings only for parameters of domain value map functions.

Cause: A domain value map rule associated with a constant operand in a transformation map can define bindings only for parameters of domain value map function.

AIP-17167 A constant operand {0} bound within transformation iterator or condition expression {1} of transformation map {2} may not be for parameters of invoked datatype transformation map, event header function or domain value map function.

Cause: Binding within transformation iterator or condition expression of transformation map may not be for parameters of invoked datatype transformation map, event header function or domain value map function.

AIP-17200 The consume step {0} can only own ports.

Cause: A consume step can only own ports.

AIP-17201 The consume step {0} must own at least one input port.

Cause: Provide at least one input port to the consume step.

AIP-17202 The consume step {0} can own at most one input port.

Cause: Provide a single input port to the consume step.

AIP-17203 The consume step {0} must not have an output port {1}.

Cause: Remove any output ports from the consume step.

AIP-17204 The consume step {0} must have at least one outbound control flow or dataflow to another step.

Cause: Provide either an outbound control flow or a data flow for the step to another step.

AIP-17250 The domain value map {0} must have exactly one domain column whose business view domain value is true.

Cause: Provide only one domain column with business view domain set to true.

AIP-17251 The domain value map {0} must have at least one domain column whose business view domain value is false.

Cause: Provide at least one domain column with business view domain set to false.

AIP-17252 The domain column name {0} is not unique within the domain value map {1}.

Cause: The names of domain columns within a domain value map must be unique.

AIP-17253 For each domain value map row there must be a domain value map row value for each domain column for map in the domain value map {0}.

Cause: The number of domain value map values for each domain value map row must be equal to the number of domain column for maps.

AIP-17300 The translator {0} must be associated with at least one native format.

Cause: Associate the translator with at least one native format.

AIP-17301 The inbound interaction spec type associated with translator {0} must have a parameter value that is associated with an event body element of a native event type.

Cause: Associate with the translator an inbound interaction spec type that has a parameter value that is associated with an event body element of a native event type.

AIP-17321 The interaction spec type {0} must be either associated with an adapter provider or a translator.

Cause: Associate the interaction spec type with either an adapter provider or a translator.

AIP-17322 The interaction spec type {0} associated with adapter provider {1} has a mandatory parameter {2} that must have a parameter value that is associated with an interaction.

Cause: Provide a parameter value to the interaction spec type and associate it with an interaction.

AIP-17336 The record type {0} must have at least one event map.

Cause: Provide an event map for the record type.

AIP-17337 If the record type {0} has more than one event map then each event map must have a condition expression.

Cause: Provide a condition expression to each event map of the record type.

AIP-17350 The domain value map function associated with the domain value map rule of transformation map {0} of transformation step {1} can only be used in a transformation binding role.

Cause: Domain value map functions must only be used in a transformation binding role.

AIP-17351 The datatype {0} of domain value map function parameter {1} and the datatype {2} of the item associated with the domain value map rule whose transformation map is {3} must be of type string or scalar datatypes implicitly convertible to string.

Cause: The operands of a domain value map rule must be of type string or scalar datatypes implicitly convertible to string.

AIP-17365 Condition expression {0} used by event map between record {1} and native event {2} cannot have datatype member {3} under datatype {4} in its path specification because more than one more datatype member can appear in instance in same place.

Cause: A condition expression used by an event map between a record and a native event cannot have a duplicate datatype member.

AIP-17800 The adapter type {0} resource adapter class name {1} must be in the CLASSPATH.

Cause: Include the resource adapter class name class of the adapter type in the CLASSPATH.

AIP-17801 The resource adapter class name value of adapter type {0} is mandatory at runtime.

Cause: Provide a value for the resource adapter class name attribute of the adapter type.

AIP-17802 The adapter type {0} connectionless metadata {1} must be in the CLASSPATH.

Cause: Include the connectionless metadata of the adapter type in the CLASSPATH.

AIP-17803 The java class name {0} of the connection factory must be in the CLASSPATH.

Cause: Include the java class name of the connection factory in the CLASSPATH.

AIP-17804 The java class name {0} of the connection spec must be in the CLASSPATH.

Cause: Include the java class name of the connection spec in the CLASSPATH.

AIP-17805 The parameter type value of parameter {0} is mandatory at runtime.

Cause: Provide a value for parameter type attribute of the parameter.

AIP-17806 The mandatory value of parameter {0} is mandatory at runtime.

Cause: Provide a value for the mandatory attribute of the parameter.

AIP-17807 The hidden value of parameter {0} is mandatory at runtime.

Cause: Provide a value for the hidden attribute of the parameter.

AIP-17808 The java class name {0} of the interaction spec type must be in the CLASSPATH.

Cause: Include the java class name of the interaction spec type in the CLASSPATH.

AIP-17809 The protocol name value of security specification {0} is mandatory at runtime.

Cause: Provide a value for the protocol name of the security specification.

AIP-17815 The max occurrence value of port {0} must be greater than or equal to zero.

Cause: Provide a value greater than or equal to zero for the max occurrence attribute of the port.

AIP-17816 The receiving value of port {0} is mandatory at runtime.

Cause: Provide a value for the receiving attribute of the port.

AIP-17817 The mandatory value of port {0} is mandatory at runtime.

Cause: Provide a value for the mandatory attribute of the port.

AIP-17818 The recurring value of port {0} is mandatory at runtime.

Cause: Provide a value for the recurring attribute of the port.

AIP-17819 The concurrent conversations value in the agreement {0} must be greater than zero.

Cause: Provide a value for concurrent conversations that is greater than zero.

AIP-17820 The invocation limit value of agreement {0} must be greater than zero.

Cause: Provide a value for invocation limit that is greater than zero.

AIP-17823 The agreement id value of agreement {0} is mandatory at runtime.

Cause: Provide a value for the agreement id attribute of the agreement.

AIP-17825 The agreement id of agreement {0} must be unique.

Cause: Provide a unique value for the agreement id attribute of the agreement.

AIP-17827 The time to acknowledge value of trading partner delivery channel {0} must be greater than or equal to zero.

Cause: Provide a value greater than or equal to zero for the time to acknowledge attribute of the trading partner delivery channel.

AIP-17828 The retry count value of trading partner delivery channel {0} must be greater than or equal to zero.

Cause: Provide a value greater than or equal to zero for the retry count attribute of the trading partner delivery channel.

AIP-17829 The non-repudiation of origin value of trading partner delivery channel {0} is mandatory at runtime.

Cause: Provide a value for the non-repudiation of origin attribute of the trading partner delivery channel.

AIP-17830 The non-repudiation of receipt value of trading partner delivery channel {0} is mandatory at runtime.

Cause: Provide a value for the non-repudiation of receipt attribute of the trading partner delivery channel.

AIP-17832 The acknowledgement mode value of trading partner delivery channel {0} is mandatory at runtime.

Cause: Provide a value for the acknowledgment mode attribute of the trading partner delivery channel.

AIP-17833 The envelope enabled value of trading partner delivery channel {0} is mandatory at runtime.

Cause: Provide a value for the envelope enabled attribute of the trading partner delivery channel.

AIP-17834 The transport security enabled value of trading partner delivery channel {0} is mandatory at runtime.

Cause: Provide a value for the transport security enabled attribute of the trading partner delivery channel.

AIP-17835 The global usage code value of trading partner delivery channel {0} is mandatory at runtime.

Cause: Provide a value for the global usage code attribute of the trading partner delivery channel.

AIP-17836 The time to perform value of the supported actor must be greater than or equal to zero.

Cause: Provide a value greater than or equal to zero for the time to perform attribute of the supported actor.

AIP-17838 The transport mode value of transport parameter {0} is mandatory at runtime.

Cause: Provide a value for the transport mode attribute of the transport parameter.

AIP-17839 The client authentication enabled value of the transport endpoint associated with transport parameter {0} is mandatory at runtime.

Cause: Provide a value for the client authentication enabled attribute of the transport endpoint.

AIP-17840 The system identifier value of trading partner identification type {0} is mandatory at runtime.

Cause: Provide a value for the system identifier attribute of the trading partner identification type.

AIP-17842 The event type class value of datatype {0} in namespace {1} is mandatory at runtime.

Cause: Provide a value for the event type class attribute of the datatype.

AIP-17843 The anonymous value of datatype {0} is mandatory at runtime.

Cause: Provide a value for the anonymous attribute of the datatype.

AIP-17844 The model group value of complex datatype {0} is mandatory at runtime.

Cause: Provide a value for the model group attribute of the complex datatype.

AIP-17845 The minimum cardinality value of compound member {0} in complex datatype {1} is mandatory at runtime.

Cause: Provide a value for the minimum cardinality attribute of the compound member.

AIP-17847 The source or target value of event map parameter {0} belonging to event transformation map {1} is mandatory at runtime.

Cause: Provide a value for the source or target attribute of the event map parameter.

AIP-17848 The source or target value of datatype map parameter {0} belonging to datatype transformation map {1} is mandatory at runtime.

Cause: Provide a value for the source or target attribute of the datatype map parameter.

AIP-17849 The else block value of the transformation statement {0} of transformation map {1} is mandatory at runtime.

Cause: Provide a value for the else block attribute of the transformation.

AIP-17850 The logical operator value of the condition expression {0} is mandatory at runtime.

Cause: Provide a value for the logical operator attribute of the condition expression.

AIP-17851 The directional value of the correlation is mandatory at runtime.

Cause: Provide a value for the directional attribute of the correlation.

AIP-17852 The hosted value of organization {0} is mandatory at runtime.

Cause: Provide a value for the hosted attribute of the organization.

AIP-17853 The priority value of the data flow criteria is mandatory at runtime.

Cause: Provide a value for the priority attribute of the data flow criteria.

AIP-17854 The mandatory value of complex datatype member {0} in complex datatype {1} is mandatory at runtime.

Cause: Provide a value for the mandatory attribute of the complex datatype member.

AIP-17855 The qualified value of complex datatype member {0} in complex datatype {1} is mandatory at runtime.

Cause: Provide a value for the qualified attribute of the complex datatype member.

AIP-17857 The process contents value of wildcard member {0} in complex datatype {1} is mandatory at runtime.

Cause: Provide a value for the process contents attribute of the wildcard member.

AIP-17858 The certificate location value of certificate {0} is mandatory at runtime.

Cause: Provide a value for the certificate location attribute of the certificate.

AIP-17859 The value value of the contact info for party {0} is mandatory at runtime.

Cause: Provide a value for the value attribute of the contact info.

AIP-17860 The converter class name value of translator {0} is mandatory at runtime.

Cause: Provide a value for the converter class name attribute of the translator.

AIP-17901 A control flow cannot be owned by data flow group {0}. Only data flows can be owned by data flow groups.

Cause: Control flows cannot be owned by a data flow group.

AIP-17902 The start step {0} must not have any incoming control flows.

Cause: A start step must not be the target of any control flow. Remove the incoming control flow to the start step.

AIP-17903 The end step {0} must not have any outgoing control flows.

Cause: An end step must not be the target of any control flow. Remove the outgoing control flow from the end step.

AIP-17904 Cannot assign any privileges to person {0} without a password.

Cause: Provide a password to the user with whom privileges are being granted.

AIP-17911 The event type {0} must not be associated with an adapter exchange protocol.

Cause: Business event types must not be associated with an adapter exchange protocol. Remove the association between the event type and the adapter exchange protocol.

AIP-17920 No transition owned by the data flow group {0} can have a guard value.

Cause: Guard values can only be for transitions (control and data flows) within a role. Data flows between roles cannot have guard values. Remove the guard value on the data flows of the given data flow group.

AIP-17922 A transition whose source is {0} must have exactly one target.

Cause: A transition must have exactly one target.

AIP-17923 A transition whose target is {0} must have exactly one source.

Cause: A transition must have exactly one source.

AIP-17931 At least one of either the name of the datatype namespace or the association between that namespace and a datatype must be defined.

Cause: A datatype namespace must have either a name or an association with a datatype.

AIP-17934 A transformation statement cannot be owned by a transformation rule, an event header rule, or a domain value map rule {0} of transformation map {1}.

Cause: A transformation statement cannot be owned by a transformation rule, an event header rule, or a domain value map rule.

AIP-17935 The datatype transformation map {0} has been implemented as a java callout, hence it can not have any transformation statements within it.

Cause: Because the datatype transformation map has been implemented as a java callout, it can not have any transformation statements within it.

AIP-17936 A transformation iterator {0} within transformation map {1} cannot be owned by a transformation statement invoking a rule, an event header function or a domain value map function or a transformation condition.

Cause: A transformation iterator cannot be owned by transformation statement invoking a rule, an event header function or a domain value map function or a transformation condition.

AIP-17938 Neither a condition expression nor a constant operand can be owned by a transformation iterator {0} within transformation map {1}.

Cause: Neither a condition expression nor a constant operand can be owned by a transformation iterator.

AIP-17940 The valid value {0} must be owned by a facet whose facet type is either enumeration or pattern.

Cause: A valid value can only be owned by a facet whose facet type is either enumeration or pattern.

AIP-17942 Only a data flow group between a business role and a binding role can own a data flow criteria.

Cause: Data flow criteria can only be owned by a data flow group that is between a business role and a binding role. Remove the data flow criteria of the given group.

AIP-17946 The step {0} cannot own other steps or ports.

Cause: And state, or state, start and end steps cannot own ports or other steps.

AIP-17947 The record type element {0} of record type {1} must be associated with a native format.

Cause: Associate a native format with the record type element.

AIP-17948 The datatype associated with the domain column {0} must be the core string datatype.

Cause: The datatype associated with domain columns must be the core string datatype.

AIP-17949 The event header function {0} must have exactly one header function parameter.

Cause: Provide exactly one header function parameter to the event header function.

AIP-17950 A transformation statement invoking a event header function {0} within transformation map {1} must have exactly one binding for the invoked parameters.

Cause: A transformation statement invoking a event header function must have exactly one binding for the invoked parameters

AIP-17951 The member group head value in complex datatype member {0} can only be set to true if the owning complex datatype {0} has member group type also set to true.

Cause: If member group head is set to true in a complex datatype member, set the member group type value to true in the owning complex datatype.

AIP-17975 If adapter type {0} needs connection for metadata is false, then connectionless metadata should be set, otherwise it should be set to null.

Cause: If needs connection for metadata is false, then set the connectionless metadata, otherwise set it to null.

AIP-17976 The minimum cardinality of compound member {0} in complex datatype {1} must be less than or equal to its maximum cardinality.

Cause: Specify a value for minimum cardinality that is less than or equal to the value of maximum cardinality.

AIP-17977 The minimum cardinality of array datatype {0} must be less than or equal to its maximum cardinality.

Cause: Specify a value for minimum cardinality that is less than or equal to its maximum cardinality.

AIP-17978 The business action {0} has non-repudiation of receipt enabled but non-repudiation of origin is not enabled.

Cause: Enable non-repudiation of origin for the business action.

AIP-17979 The effective from date of agreement {0} must be less than or equal to its effective to date.

Cause: Specify a from date that is less than or equal to the to date.

AIP-17980 The exchange protocol {0} has non-repudiation of receipt enabled but non-repudiation of origin is not enabled.

Cause: Enable non-repudiation of origin for the exchange protocol.

AIP-17981 If anonymous is true for datatype {0} then the datatype cannot have a name, otherwise it must have one.

Cause: Specify the datatype as either anonymous with no name, or specify a name with the datatype.

AIP-17982 The datatype is anonymous and therefore must have no datatypes derived either by restriction or extension from that datatype.

Cause: Do not derive datatypes from an anonymous datatype.

AIP-17983 A ref type only datatype cannot be anonymous.

Cause: Provide a name to the ref type only datatype.

AIP-17984 Ref type only datatype {0} in namespace {1} cannot have any datatypes derived from it.

Cause: Do not derive datatypes from the ref type only datatype.

AIP-17985 The trading partner delivery channel {0} has non-repudiation of receipt enabled but non-repudiation of origin is not enabled.

Cause: Enable non-repudiation of origin for the trading partner delivery channel.

AIP-17986 The name of the the anonymous complex datatype member {1} in complex datatype {0} must not be set.

Cause: The names of anonymous complex datatype members belonging to complex datatypes must not be set.

AIP-17987 The qualified attribute value {0} in complex datatype member {1} is incompatible with its associated translation metadata {2}.

Cause: A complex datatype member is associated to a translation metadata if and only if the member is qualified.

AIP-17988 The minimum cardinality of wildcard member {0} belonging to the complex datatype {1} must be less than or equal to its maximum cardinality.

Cause: Provide a value for minimum cardinality of the wildcard member that is less than or equal to its maximum cardinality.

AIP-17989 Wildcard member {0} of complex datatype {1} does not have the correct number of datatype namespaces based on the replacement namespace value {2}.

Cause: A wildcard member must have the correct number of datatype namespaces depending on the value of the replacement namespace attribute.

AIP-17990 At least one of either the in translator class name or the out translator class name values of translator {0} are mandatory at runtime.

Cause: Provide a value for at least one of either the in translator class name or out translator class name attributes.

AIP-17991 The remote trading partner {0} must not have a wallet password.

Cause: Only a hosted trading partner can have wallet password. Remove the wallet password from the remote trading partner.

AIP-17992 A wallet password is required for the hosted trading partner {0}.

Cause: For hosted trading partners, wallet passwords are mandatory at runtime. Provide a wallet password to the hosted trading partner.

AIP-17993 The facet of type {0} cannot have a facet value.

Cause: Enumeration and pattern facets cannot have a facet value.

AIP-17994 The facet value {0} is not valid for a facet whose type is {1}.

Cause: The value of a facet must be valid for its particular facet type.

AIP-17995 If member group type is true in complex datatype {0} then ref type only must be true and model group must be CHOICE.

Cause: Change the ref type only value to true and set the model group value to CHOICE in the complex datatype.

AIP-17996 The approval date of an agreement must be on or after the send for approval date.

Cause: Ensure that the approved date for the agreement is on or after the send for approval date.

AIP-17997 Trading partner {0} cannot be a hosted trading partner because there can be only one defined in the system.

Cause: Verify that only one hosted trading partner is defined in the system.

AIP-18000 to AIP-18999 Deployment Error Codes

AIP-18010 Calculation of deployment unit failed.

Cause: Calculation of deployment unit failed.

AIP-18020 error during validation

Cause: An error occurred during validation.

AIP-18030 Deployment unit "{0}" is invalid.

Cause: The deployment unit is invalid.

AIP-18040 execution context not started

Cause: The execution context was not started.

AIP-18050 SQL error during deployment

Cause: SQL error during deployment.

AIP-18060 error writing to buffered stream

Cause: An error occurred while writing to the buffered stream.

AIP-18070 more than one start state

Cause: You can have only one start state.

AIP-18070 no end state for workflow

Cause: At least one end state in the workflow is needed.

AIP-18071 The guard value is not defined for the transition.

Cause: The guard value for the target transition of the conditional step is not defined.

AIP-18080 deploy property "{0}" not found

Cause: Deploy property "{0}" not found.

AIP-18090 The transition object is not an instance of data flow.

Cause: The transition object is not an instance of data flow.

AIP-18100 error uploading workflow file.

Cause: An error occurred while uploading the workflow file.

AIP-18110 The state vertex is not a step or a pseudostate.

Cause: State vertex is not step or pseudostate.

AIP-18120 The state is not a supported state (workflow generation).

Cause: State not supported state (workflow generation).

AIP-18130 error generating workflow

Cause: An error occurred while generating the workflow.

AIP-18140 fatal error during deployment

Cause: Fatal error during deployment.

AIP-19000 to AIP-19999 UI Modeling Error Codes

AIP-19000 The same native role was chosen for both the initiating and invoked spokes. You must choose two different spokes by selecting different native roles.

Cause: The same native role was chosen for both the initiating and invoked spokes. Two different spokes must be chosen by selecting different native roles.

AIP-19001 The interactions for the initiating spoke and the invoked spoke are both inbound. You must select an interaction that is inbound and another that is outbound.

Cause: The interactions for the initiating spoke and the invoked spoke are both inbound. One interaction must be inbound and the other must be outbound.

AIP-19002 The interactions for the initiating spoke and the invoked spoke are both outbound. You must select an interaction that is inbound and another that is outbound.

Cause: The interactions for the initiating spoke and the invoked spoke are both outbound. One interaction must be inbound and the other must be outbound.

AIP-19003 The outbound interaction for the response was not specified. You must select the outbound interaction for the response or check Ignore response.

Cause: The outbound interaction for the response was not specified. You must select the outbound interaction for the response or check Ignore response.

AIP-19004 invalid response interaction. The outbound interaction for the response cannot have an outbound record also.

Cause: Invalid response interaction. The outbound interaction for the response cannot have an outbound record also.

AIP-19005 The business event name was not specified. You must enter a name for the new business event.

Cause: The business event name was not specified. You must enter a name for the new business event.

AIP-19006 The business event was not specified. You must chose an existing business event.

Cause: The business event was not specified. You must chose an existing business event.

AIP-19007 The business event name was not specified for the inbound event flow. You must enter a name for the new business event for the inbound event flow.

Cause: The business event name was not specified for the inbound event flow. You must enter a name for the new business event.

AIP-19008 The business event was not specified for the inbound event flow. You must chose an existing business event for the inbound event flow.

Cause: The business event was not specified for the inbound event flow. You must chose an existing business event for the inbound event flow.

AIP-19009 The transformation map name was not specified. You must enter a name for the new transformation map.

Cause: The transformation map name was not specified. You must enter a name for the new transformation map.

AIP-19010 The transformation map was not specified. You must chose an existing transformation map.

Cause: The transformation map was not specified. You must chose an existing transformation map.

AIP-19011 The transformation map name was not specified for the inbound transformation. You must enter a name for the new transformation map for the inbound transformation.

Cause: The transformation map name was not specified for the inbound transformation. You must enter a name for the new transformation map for the inbound transformation.

AIP-19012 The transformation map was not specified for the inbound transformation. You must chose an existing transformation map for the inbound transformation.

Cause: The transformation map was not specified for the inbound transformation. You must chose an existing transformation map for the inbound transformation.

AIP-19013 The same role naming convention was specified for both spokes. Specify unique role naming conventions for each spoke.

Cause: The same role naming convention was specified for both spokes. Specify unique role naming conventions for each spoke.

AIP-19014 The business process name was not specified. You must enter a name for the new business process.

Cause: The business process name was not specified. You must enter a name for the new business process.

AIP-19015 The business event was not specified. You must chose an existing business process.

Cause: The business event was not specified. You must chose an existing business process.

AIP-19016 attempting to create an event flow for an incomplete spoke. Complete the spoke first or chose a spoke that is already complete.

Cause: Attempting to create an event flow for an incomplete spoke. To be a complete spoke, the spoke must have all roles bound from the native role to the business process. Complete the spoke first or chose a spoke that is already complete.

AIP-19017 The selected interaction is not valid for the port direction (input/output). An inbound interaction must be associated with an input port.

Cause: The selected interaction is not valid for the port direction (input/output). An inbound interaction must be associated with an input port.

AIP-19018 Click the flashlight and select a datatype for this port. Do not type a name.

Cause: Click the flashlight and select a datatype for this port. Do not type a name.

AIP-19019 Click the flashlight and select an event for this port. Do not type a name.

Cause: Click the flashlight and select an event for this port. Do not type a name.

AIP-19020 An event type was not selected. If you chose the pass-through option, an event type must be selected.

Cause: An event type was not selected. If you chose the pass-through option, an event type must be selected.

AIP-19021 The updated port direction is not compatible with the existing data flow from port "{0}" in "{1}". You must either delete the data flow first or chose the opposite direction for the port.

Cause: The updated port direction is not compatible with the existing data flow from port "{0}" in "{1}". You must either delete the data flow first or chose the opposite direction for the port.

AIP-19022 The updated port event type is not compatible with the existing data flow from port "{0}" in "{1}" of event type "{2}". You must either delete the data flow first or chose the same event type for this port.

Cause: The updated port event type is not compatible with the existing data flow from port "{0}" in "{1}" of event type "{2}". You must either delete the data flow first or chose the same event type for this port.

AIP-19023 The updated port datatype is not compatible with the existing data flow from port "{0}" in "{1}" of datatype "{2}". You must either delete the data flow first or chose the same datatype for this port.

Cause: The updated port datatype is not compatible with the existing data flow from port "{0}" in "{1}" of datatype "{2}". You must either delete the data flow first or chose the same datatype for this port.

AIP-19024 Start and end steps cannot be deleted.

Cause: Start and end steps cannot be deleted.

AIP-19025 The direction of the data flow group from the binding role to the application role cannot be determined. Bind the binding role to a native role or a business role first.

Cause: The direction of the data flow group from the binding role to the application role cannot be determined. There is a binding role on both the inbound and outbound side of the application role. Bind the binding role to a native role or a business role first.

AIP-19026 Port "{0}" on role "{1}" is already bound to "{2}" on role "{3}". You must first delete the data flow to this port or select another port.

Cause: Port on role is already bound. Ports on this role can only be data flow bound to one other port. You must first delete the data flow to this port or select another port.

AIP-50000 to AIP-51999 Transport Error Codes

AIP-50000 successful

Cause: Successful.

AIP-50002 successfully received business document from XML gateway

Cause: Successfully received business document from XML gateway (delivery confirmation).

AIP-50003 collaboration initiation error

Cause: Collaboration initiation error.

AIP-50004 collaboration message sequencing error

Cause: Collaboration message sequencing error.

AIP-50005 collaboration abort error

Cause: Collaboration stop error.

AIP-50006 exception received

Cause: Exception received.

AIP-50007 notification of failure received

Cause: Notification of failure received.

AIP-50008 time to perform exceeded

Cause: Time to perform exceeded.

AIP-50009 unable to send

Cause: Unable to send.

AIP-50010 trading partner agreement identification error

Cause: Trading partner agreement identification error.

AIP-50011 message correlation error

Cause: Message correlation error.

AIP-50012 pack/unpack error

Cause: Pack/unpack error.

AIP-50013 security error

Cause: Security error.

AIP-50014 general error

Cause: General error.

AIP-50025 repository error

Cause: Repository error.

AIP-50026 A null parameter cannot be passed as a valid input parameter.

Cause: A null parameter cannot be passed as a valid input parameter.

AIP-50027 unable to write data into output stream

Cause: Unable to write data into output stream.

AIP-50028 unable to read data from input stream

Cause: Unable to read data from input stream.

AIP-50029 runtime error

Cause: Runtime error.

AIP-50030 invalid input parameter

Cause: The parameter which is passed cannot be understood.

AIP-50050 B2B initialization successful

Cause: B2B initialization successful.

AIP-50051 The B2B engine initialization failed.

Cause: The B2B engine initialization failed.

AIP-50052 The B2B engine was already initialized.

Cause: The B2B engine was already initialized.

AIP-50053 The B2B engine was not initialized.

Cause: The B2B engine was not initialized.

AIP-50054 cannot access configuration file

Cause: Cannot access configuration file.

AIP-50055 error in configuration file

Cause: Error in configuration file.

AIP-50056 unknown error

Cause: Unknown error. Contact Oracle Support Services.

AIP-50057 An invalid wallet location was specified for the SSL.

Cause: SSL requires the wallet to be specified in .txt format. The Oracle Wallet needs to be exported to a file and the WRL should have the exported file name.

AIP-50075 cannot find Document Exchange Plugin "{0}"

Cause: Cannot find Document Exchange Plugin "{0}".

AIP-50076 cannot find Packaging Plugin "{0}"

Cause: Cannot find Packaging Plugin "{0}".

AIP-50077 cannot initialize transport

Cause: Cannot initialize transport.

AIP-50078 cannot shut down transport

Cause: Cannot shut down transport.

AIP-50079 transport error

Cause: Transport error.

AIP-50080 protocol identification error

Cause: The B2B adapter is unable to identify the B2B message with its supported protocols.

AIP-50125 error from workflow "{0}"

Cause: Error from workflow "{0}".

AIP-50126 Oracle error while determining workflow agent

Cause: Oracle error while determining workflow agent.

AIP-50127 Oracle error when initializing workflow event subscriptions

Cause: Oracle error when initializing workflow event subscriptions.

AIP-50128 Oracle error when shutting down AQ session pertaining to workflow

Cause: Oracle error when shutting down AQ session pertaining to workflow.

AIP-50129 error when publishing event "{0}" to workflow

Cause: Error when publishing event "{0}" to workflow.

AIP-50130 error when subscribing for workflow events

Cause: Error when subscribing for workflow events.

AIP-50131 error while instantiating the event manager for subscribing to workflow events

Cause: Error while instantiating event manager for subscribing to workflow events.

AIP-50132 exception when collaboration manager received event raised from workflow

Cause: Exception when collaboration manager received event raised from workflow.

AIP-50133 Oracle error when initializing context for publishing events to workflow

Cause: Oracle error when initializing context for publishing events to workflow.

AIP-50134 SQL error accessing collaboration-related tables

Cause: SQL error accessing collaboration-related tables.

AIP-50135 invalid business activity type

Cause: Invalid business activity type.

AIP-50136 Responding activity cannot belong to a new collaboration.

Cause: Responding activity cannot belong to a new collaboration.

AIP-50137 Signal message cannot belong to a new collaboration.

Cause: Signal message cannot belong to a new collaboration.

AIP-50138 Error message cannot belong to a new collaboration.

Cause: Error message cannot belong to a new collaboration.

AIP-50139 invalid direction for signal and error messages

Cause: Invalid direction for signal and error messages.

AIP-50140 SQL exception

Cause: SQL Exception when retrieving workflow event parameters.

AIP-50141 business transaction usage not found for name "{0}"

Cause: Business transaction usage not found for name "{0}".

AIP-50142 collaboration instance not found for Collaboration ID "{0}"

Cause: Collaboration instance not found for Collaboration ID.

AIP-50143 transaction instance not found for Transaction ID "{0}"

Cause: Transaction instance not found for Transaction ID "{0}".

AIP-50144 agreement not found for trading partner agreement ID "{0}"

Cause: Agreement not found for trading partner agreement ID "{0}".

AIP-50145 collaboration "{0}" not found for version "{1}"

Cause: Collaboration "{0}" not found for version "{1}".

AIP-50146 exception thrown by repository

Cause: Exception thrown by repository.

AIP-50147 cannot start collaboration; concurrently executing "{0}" collaborations

Cause: Concurrent collaborations exceeded. Unable to start collaboration.

AIP-50148 cannot start collaboration; maximum collaboration limit of "{0}"

Cause: Maximum collaborations exceeded. Unable to start collaboration.

AIP-50149 cannot map value "{0}" to a valid business transaction state

Cause: Invalid business transaction state.

AIP-50500 trading partner agreement not found for the given input values: from party [ID-ROLE] "{0}", to party [ID-ROLE] "{1}", collaboration name "{2}"

Cause: Unable to identify the trading partner agreement from the given input values.

AIP-50501 trading partner agreement not found for the given input values: from party [NAME-ROLE] "{0}", to party [NAME-ROLE] "{1}", collaboration name "{2}"

Cause: Unable to identify the trading partner agreement from the given input values.

AIP-50502 trading partner agreement details not found for the trading partner agreement ID "{0}"

Cause: Unable to get the trading partner agreement details from the given trading partner agreement ID.

AIP-50503 delivery channel not found for the Trading Partner ID "{0}"

Cause: Unable to get delivery channel details.

AIP-50504 transport endpoint not found for the Trading Partner ID "{0}"

Cause: Unable to get the transport endpoint details.

AIP-50506 cannot find collaboration details for the action name "{0}"

Cause: Unable to find collaboration details for the given action name.

AIP-50507 From role "{0}" in the message is different from role "{1}" in the agreement.

Cause: The from role in message is different from agreement.

AIP-50508 To role "{0}" in the message is different from role "{1}" in the agreement.

Cause: The to role in message is different from agreement.

AIP-50509 From service "{0}" in the message is different from service "{1}" in the agreement.

Cause: The from service in message is different from agreement.

AIP-50510 To service "{0}" in the message is different from service "{1}" in the agreement

Cause: The to service in message is different from agreement.

AIP-50511 Business transaction name "{0}" in the message is different from business transaction name "{1}" in the agreement.

Cause: Business transaction name "{0}" in the message is different from business transaction name "{1}" in the agreement.

AIP-50512 Business transaction revision "{0}" in the message is different from business transaction revision "{1}" in the agreement.

Cause: Business transaction revision "{0}" in the message is different from business transaction revision "{1}" in the agreement.

AIP-50513 Business transaction time to perform "{0}" in the message is different from business transaction time to perform "{1}" in the agreement.

Cause: Business transaction time to perform "{0}" in the message is different from business transaction time to perform "{1}" in the agreement.

AIP-50514 Collaboration name "{0}" in the message is different from collaboration name "{1}" in the agreement.

Cause: Collaboration name "{0}" in the message is different from collaboration name "{1}" in the agreement.

AIP-50515 Collaboration revision "{0}" in the message is different from collaboration revision "{1}" in the agreement.

Cause: Collaboration revision "{0}" in the message is different from collaboration revision "{1}" in the agreement.

AIP-50516 Collaboration code "{0}" in the message is different from collaboration code "{1}" in the agreement.

Cause: Collaboration code "{0}" in the message is different from collaboration code "{1}" in the agreement.

AIP-50517 Collaboration time to perform "{0}" in the message is different from collaboration time to perform "{1}" in the agreement.

Cause: Collaboration time to perform "{0}" in the message is different from collaboration time to perform "{1}" in the agreement.

AIP-50518 The transport protocol "{0}" for the message is different from the transport protocol "{1}" in the agreement.

Cause: The transport protocol "{0}" for the message is different from the transport protocol "{1}" in the agreement.

AIP-50519 The transport protocol version "{0}" for the message is different from the transport protocol version "{1}" in the agreement.

Cause: The transport protocol version "{0}" for the message is different from the transport protocol version "{1}" in the agreement.

AIP-50520 The transport protocol endpoint "{0}" for the message is different from the transport protocol endpoint "{1}" in the agreement.

Cause: The transport protocol endpoint "{0}" for the message is different from the transport protocol endpoint "{1}" in the agreement.

AIP-50521 Acknowledgment mode "{0}" in the message is different from acknowledgment mode "{1}" in the agreement.

Cause: Acknowledgment mode "{0}" in the message is different from acknowledgment mode "{1}" in the agreement.

AIP-50522 Response mode "{0}" in the message is different from response mode "{1}" in the agreement.

Cause: Response mode "{0}" in the message is different from response mode "{1}" in the agreement.

AIP-50523 Document exchange protocol name "{0}" in the message is different from document exchange protocol name "{1}" in the agreement.

Cause: Document exchange protocol name "{0}" in the message is different from document exchange protocol name "{1}" in the agreement.

AIP-50524 Document exchange protocol version "{0}" in message is different from document exchange protocol version "{1}" in the agreement.

Cause: Document exchange protocol version "{0}" in message is different from document exchange protocol version "{1}" in the agreement

AIP-50525 The agreement signature information is null.

Cause: Message non-repudiation is enabled but no signature information is specified.

AIP-50526 The message has been signed using "{0}", which is different from signing protocol "{1}" in the agreement.

Cause: The message has been signed using "{0}", which is different from signing protocol "{1}" in the agreement.

AIP-50527 The signing protocol version "{0}" in the message is different from the signing protocol version "{1}" in the agreement.

Cause: The signing protocol version "{0}" in the message is different from the signing protocol version "{1}" in the agreement.

AIP-50528 The signing algorithm "{0}" in the message is different from the signing algorithm "{1}" in the agreement.

Cause: The signing algorithm "{0}" in the message is different from the signing algorithm "{1}" in the agreement.

AIP-50529 The digest algorithm "{0}" in the message is different from the digest algorithm "{1}" in the agreement.

Cause: The digest algorithm "{0}" in the message is different from the digest algorithm "{1}" in the agreement.

AIP-50530 The signer certificate in the message is different from the certificate in the agreement.

Cause: The signer certificate in the message is different from the certificate in the agreement.

AIP-50531 The agreement envelope information is null.

Cause: Message confidentiality is enabled but no envelope information is specified.

AIP-50532 The message has been enveloped using "{0}", which is different from envelope protocol "{1}" in the agreement.

Cause: The message has been enveloped using "{0}", which is different from envelope protocol "{1}" in the agreement.

AIP-50533 The envelope protocol version "{0}" in the message is different from the envelope protocol version "{1}" in the agreement.

Cause: The envelope protocol version "{0}" in the message is different from the envelope protocol version "{1}" in the agreement.

AIP-50534 The encryption algorithm "{0}" in the message is different from the encryption algorithm "{1}" in the agreement.

Cause: The encryption algorithm "{0}" in the message is different from the encryption algorithm "{1}" in the agreement.

AIP-50535 unable to get the certificate from the given location "{0}"

Cause: Unable to get the certificate from the given location "{0}".

AIP-50536 exchange protocol not found for the given input values: Name "{0}", Revision "{1}"

Cause: Exchange protocol not found for the given input values: Name "{0}", Revision "{1}".

**AIP-50537 more than one exchange protocol found for the given input values:
Name "{0}", Revision "{1}"**

Cause: More than one exchange protocol found for the given input values:
Name "{0}", Revision "{1}".

**AIP-50538 business signal not found for the given input values: Name "{0}",
Revision "{1}"**

Cause: Business signal not found for the given input values: Name "{0}",
Revision "{1}".

**AIP-50539 more than one business signal found for the given input values: Name
"{0}", Revision "{1}"**

Cause: More than one business signal found for the given input values: Name
"{0}", Revision "{1}".

**AIP-50540 The exchange protocol parameter "{0}" value "{1}" in the message is
different from the value "{2}" in the agreement.**

Cause: The exchange protocol parameter "{0}" value "{1}" in the message is
different from the value "{2}" in the agreement.

AIP-50801 failed to construct B2B event with "{0}" : "{1}"

Cause: Failed to construct B2B event with "{0}" : "{1}".

AIP-50802 failed to set B2B event "{0}" : "{1}"

Cause: Failed to set B2B event "{0}" : "{1}".

AIP-50803 failed to get B2B event "{0}"

Cause: Failed to get B2B event "{0}".

**AIP-50804 failed to get JMS Topic "{0}." "{1}" with option "{2}" or create subscriber
"{3}"**

Cause: Failed to get JMS Topic "{0}." "{1}" with option "{2}" or create subscriber
"{3}".

AIP-50805 failed to close JMS Topic "{0}." "{1}" or close subscriber "{2}"

Cause: Failed to close JMS Topic "{0}." "{1}" or close subscriber "{2}".

AIP-50806 failed to publish JMS message to Topic "{0}." "{1}"

Cause: Failed to publish JMS message to Topic "{0}." "{1}".

AIP-50807 JMS Topic "{0}." "{1}" has not been initialized.

Cause: JMS Topic "{0}." "{1}" has not been initialized.

AIP-50808 failed to publish JMS message to Topic "{0}." "{1}"

Cause: Failed to publish JMS message to Topic "{0}." "{1}".

AIP-50809 failed to receive JMS message from Topic "{0}."{1}"

Cause: Failed to receive JMS message from Topic "{0}."{1}".

AIP-50810 failed to initialize database context

Cause: Failed to initialize database context - failed to get transaction from persistency service.

AIP-50811 failed to shut down database context

Cause: Failed to shutdown database context - failed to close persistency service.

AIP-50812 failed to shut down database context

Cause: Failed to shutdown database context - failed to close JDBC connection.

AIP-50814 failed to begin transaction

Cause: Failed to begin transaction.

AIP-50815 failed to commit transaction

Cause: Failed to commit transaction.

AIP-50816 failed to roll back transaction

Cause: Failed to roll back transaction.

AIP-50817 failed to add repository object into transaction

Cause: Failed to add repository object into transaction.

AIP-50818 failed to retrieve system date and time from repository

Cause: Failed to retrieve system date and time from repository.

AIP-50819 failed to insert data into database table "{0}"

Cause: Failed to insert data into database table "{0}".

AIP-50820 failed to close SQL statement or result set after insert data into database table "{0}"

Cause: Failed to close SQL statement or result set after insert data into database table "{0}".

AIP-50821 failed to select rows from database table "{0}"

Cause: Failed to select rows from database table "{0}".

AIP-50822 failed to select rows from database table "{0}" by order

Cause: Failed to select rows from database table "{0}" by order.

AIP-50823 failed to select all rows from database table "{0}"

Cause: Failed to select all rows from database table "{0}".

AIP-50824 failed to delete rows from database table "{0}"

Cause: Failed to delete rows from database table "{0}".

AIP-50825 failed to delete all rows from database table "{0}"

Cause: Failed to delete all rows from database table "{0}".

AIP-50826 failed to update rows to database table "{0}"

Cause: Failed to update rows to database table "{0}".

AIP-50827 failed to initialize catalog in data context

Cause: Failed to initialize catalog in data context.

AIP-50828 failed to initialize JDBC connection pool in data context

Cause: Failed to initialize JDBC connection pool in data context.

AIP-50829 failed to close catalog in data context

Cause: Failed to close catalog in data context.

AIP-50830 failed to close JDBC connection pool in data context

Cause: Failed to close JDBC connection pool in data context.

AIP-50831 failed to retrieve new database context

Cause: Failed to retrieve new database context.

AIP-50832 failed to retrieve new connection from JDBC connection pool

Cause: Failed to retrieve new connection from JDBC connection pool.

AIP-50833 failed to initialize JMS connection or session in data runtime context

Cause: Failed to initialize JMS connection or session in data runtime context.

AIP-50834 failed to close JMS connection or session in data runtime context

Cause: Failed to close JMS connection or session in data runtime context.

AIP-50835 failed to enqueue ADT message into event topic

Cause: Failed to enqueue ADT message into event topic.

AIP-50836 failed to dequeue ADT message from event topic

Cause: Failed to dequeue ADT message from event topic.

AIP-50837 failed to initialize JMS message listener for event topic

Cause: Failed to initialize JMS message listener for event topic.

AIP-50838 failed to shut down JMS message listener for event topic

Cause: Failed to shutdown JMS message listener for event topic.

AIP-50901 failed to find a business message with B2B message ID "{0}"

Cause: Failed to find a business message with B2B message ID "{0}".

AIP-50902 failed to find a wire message with B2B message ID "{0}"

Cause: Failed to find a wire message with B2B message ID "{0}".

AIP-50903 Message "{0}" retry count is zero.

Cause: Message "{0}" retry count is zero.

AIP-50904 Refer to message not found

Cause: Refer to B2B message ID not found.

AIP-50905 collaboration not found

Cause: B2B Collaboration ID not found.

AIP-50906 failed to retrieve XPATH

Cause: Error in extracting XPATH Value.

AIP-50925 unable to raise inbound interaction for Record "{0}"

Cause: Unable to raise inbound interaction.

AIP-51000 general packaging error

Cause: General packaging error.

AIP-51001 packing failed

Cause: Packing failed.

AIP-51002 unpacking failed

Cause: Unpacking failed.

AIP-51003 encoding failed

Cause: Encoding failed.

AIP-51004 decoding failed

Cause: Decoding failed.

AIP-51005 validating packaging metadata information failed

Cause: Validating packaging metadata information failed.

AIP-51006 invalid input parameter

Cause: Invalid input parameter.

AIP-51007 missing packaging metadata information

Cause: Missing packaging metadata information.

AIP-51008 circular dependency in packaging metadata information

Cause: Circular dependency in packaging metadata information.

AIP-51009 missing one or more packaging elements in packaging metadata information

Cause: Missing one or more packaging elements in packaging metadata information.

AIP-51010 missing composite packaging element in packaging metadata information

Cause: Missing composite packaging element in packaging metadata information.

AIP-51011 bad or corrupt packaging metadata information

Cause: Bad or corrupt packaging metadata information.

AIP-51012 missing list of message components

Cause: Missing list of message components.

AIP-51013 missing one or more message components in the list of message components

Cause: Missing one or more message component(s) in the list of message components.

AIP-51014 missing data for message component

Cause: Missing data for message component.

AIP-51015 missing security information

Cause: Missing security information.

AIP-51016 missing signature information

Cause: Missing signature information.

AIP-51017 missing envelope/encryption information

Cause: Missing envelope/encryption information.

AIP-51018 The message is not digitally signed.

Cause: The message is not digitally signed.

AIP-51019 The message is not encrypted.

Cause: The message is not encrypted.

AIP-51020 The signature protocol is not supported.

Cause: The signature protocol is not supported.

AIP-51021 The encryption protocol is not supported.

Cause: The encryption protocol is not supported.

AIP-51022 The digest algorithms do not match.

Cause: The digest algorithms do not match.

AIP-51023 signature information already set for message

Cause: Signature information already set for message.

AIP-51024 envelope information already set for message

Cause: Envelope information already set for message.

AIP-51025 Wallet resource location strings do not match.

Cause: Wallet resource location strings do not match.

AIP-51026 encoding type not supported

Cause: Encoding type not supported.

AIP-51050 Mime content-types do not match.

Cause: Mime content-types do not match.

AIP-51051 Mime content-type parameter lists do not match.

Cause: Mime content-type parameter lists do not match.

AIP-51052 bad or corrupt mime content-type header or information

Cause: Bad or corrupt mime content-type header or information.

AIP-51053 bad or corrupt mime content disposition header or information

Cause: Bad or corrupt mime content disposition header or information.

AIP-51054 missing content-type information

Cause: Missing content-type information.

AIP-51055 missing information for message component

Cause: Missing information for message component.

AIP-51056 missing or unable to read data from message

Cause: Missing or unable to read data from message.

AIP-51057 bad or corrupt message

Cause: Bad or corrupt message.

AIP-51075 missing signer certificate

Cause: Missing signer certificate.

AIP-51076 missing encryption certificate

Cause: Missing encryption certificate.

AIP-51077 missing certificate chain

Cause: Missing certificate chain.

AIP-51078 missing or corrupt digest of the message

Cause: Missing or corrupt digest of the message.

AIP-51079 The S/MIME version is not supported "{0}".

Cause: The S/MIME version is not supported "{0}".

AIP-51080 The signature algorithm is not supported "{0}".

Cause: The signature algorithm is not supported "{0}".

AIP-51081 The digest algorithm is not supported "{0}".

Cause: The digest algorithm is not supported "{0}".

AIP-51082 The encryption algorithm is not supported "{0}".

Cause: The encryption algorithm is not supported "{0}".

AIP-51083 general failure creating S/MIME digital signature

Cause: General failure creating S/MIME digital signature.

AIP-51084 general failure verifying S/MIME digital signature

Cause: General failure verifying S/MIME digital signature.

AIP-51085 general failure encrypting S/MIME message

Cause: General failure encrypting S/MIME message.

AIP-51086 general failure decrypting S/MIME message

Cause: General failure decrypting S/MIME message.

AIP-51087 Creating digest data for S/MIME digital signature failed; "{0}".

Cause: Creating digest data for S/MIME digital signature failed; "{0}".

AIP-51088 Creating S/MIME digital signature failed; "{0}".

Cause: Creating S/MIME digital signature failed; "{0}".

AIP-51089 Verifying S/MIME digital signature failed; "{0}".

Cause: Verifying S/MIME digital signature failed; "{0}".

AIP-51090 Creating S/MIME message recipient list failed; "{0}".

Cause: Creating S/MIME message recipient list failed; "{0}".

AIP-51091 Adding recipient to S/MIME message recipient list failed; "{0}".

Cause: Adding recipient to S/MIME message recipient list failed; "{0}".

AIP-51092 Encrypting S/MIME message failed; "{0}".

Cause: Encrypting S/MIME message failed; "{0}".

AIP-51093 Decrypting S/MIME message failed; "{0}".

Cause: Decrypting S/MIME message failed; "{0}".

AIP-51094 Processing signature information for S/MIME message failed.

Cause: Processing signature information for S/MIME message failed.

AIP-51095 Processing envelope information for S/MIME message failed.

Cause: Processing envelope information for S/MIME message failed.

AIP-51096 More than one signer in the S/MIME digital signature is not supported.

Cause: More than one signer in the S/MIME digital signature is not supported.

AIP-51097 An empty packaging IDs list was passed for the packaging plugin initialization.

Cause: An empty packaging IDs list was passed for the packaging plugin initialization.

AIP-51098 The packaging metadata contains invalid content-type "{0}".

Cause: The packaging metadata contains invalid content-type "{0}".

AIP-51099 not a RosettaNet 1.1 message

Cause: Not a RosettaNet 1.1 message.

AIP-51500 document exchange successful

Cause: Successful operation of the document exchange layer.

AIP-51501 document exchange general initialization failure

Cause: The document exchange protocol adapter failed to initialize.

AIP-51502 document exchange generic shutdown failure

Cause: The document exchange protocol adapter failed to shut down.

AIP-51503 general create message error

Cause: The CreateMessage() method fails to create the protocol specific B2B message.

AIP-51504 general decode incoming message() error

Cause: The DecodeIncomingMessage() method fails to decode the B2B message.

AIP-51505 general validation error

Cause: An unexpected error occurred during validation.

AIP-51550 invalid usage code

Cause: The usage code must be either Production or Test.

AIP-51551 invalid timestamp

Cause: The timestamp used is not in the following format: CCYYMMDDThhmmss.sssZ.

AIP-51552 mismatched PIP binding ID

Cause: The PIP binding ID in the initiating message does not match the PIP binding ID in the response message.

AIP-51553 mismatched PIP code

Cause: The PIP code in the initiating message does not match the PIP code in the response message.

AIP-51554 mismatched PIP instance ID

Cause: The PIP instance ID in the initiating message does not match the PIP Instance ID in the response message.

AIP-51555 mismatched PIP version

Cause: The PIP version in the initiating message does not match the PIP version in the response message.

AIP-51556 The message ID in the initiating message does not match the message ID in the RefTo field of the response message.

Cause: The message ID in the initiating message does not match the message ID in the RefTo field of the response message.

AIP-51557 The PIP binding ID exceeds 255 characters.

Cause: The PIP binding ID exceeds 255 characters. The maximum allowed is 255 characters.

AIP-51558 invalid IsSecureTransportRequired field

Cause: IsSecureTransportRequired can only be 'Yes' or 'No'.

AIP-51559 content-type mismatch

Cause: The content-type in the manifest does not match the content-type associated with the attachment.

AIP-51560 content ID mismatch

Cause: The content ID in the manifest does not match the content ID associated with the attachment.

AIP-51561 mismatched FromService/ToService

Cause: The FromService field in the initiating message does not match the ToService field in the response message.

AIP-51562 mismatched ToService/FromService

Cause: The ToService field in the initiating message does not match the FromService field in the response message.

AIP-51563 mismatched FromRole/ToRole

Cause: The FromRole field in the initiating message does not match the ToRole field in the response message.

AIP-51564 mismatched ToRole/FromRole

Cause: The ToRole field in the initiating message does not match the FromRole field in the response message.

AIP-51565 error initializing XML parser

Cause: An unexpected error occurred while initializing the XML parser.

AIP-51566 parse stream error

Cause: An unexpected error occurred while parsing the input stream.

AIP-51567 invalid content-type

Cause: The subtype of the content-type in the HTTP header has to be either multipart/related or multipart/signed.

AIP-51568 encode error

Cause: An unexpected error occurred while encoding data.

AIP-51569 decode error

Cause: An unexpected error occurred while decoding data.

AIP-51570 form attachment error

Cause: An unexpected error occurred while forming attachment as component data.

AIP-51571 form attachment error

Cause: An unexpected error occurred while forming attachment as XML data.

AIP-51572 error reading input stream

Cause: An unexpected error occurred while reading input stream.

AIP-51700 error during packaging--general error

Cause: An unexpected error occurred during packaging.

AIP-51701 error during action performance--general error

Cause: An unexpected error occurred while servicing the RosettaNet Business Message.

AIP-51702 error during action performance--validating the service content against a PIP-specified dictionary

Cause: An error occurred while servicing the RosettaNet Business Message. The service content fails validation against the PIP-specific dictionary.

AIP-51703 error during unpackaging--general error

Cause: An unexpected error occurred during unpackaging the RosettaNet Business Message.

AIP-51704 error during unpackaging--verifying the signature of the RosettaNet business message

Cause: An error occurred while verifying the signature of the RosettaNet Business Message.

AIP-51705 error during unpackaging--reading the preamble

Cause: An error occurred during unpackaging the RosettaNet Business Message. The preamble cannot be read correctly.

AIP-51706 error during unpackaging--validating the preamble

Cause: An error occurred during unpackaging the RosettaNet Business Message. The preamble is invalid.

AIP-51707 error during unpackaging--reading the delivery header

Cause: An error occurred during unpackaging the RosettaNet Business Message. The delivery header cannot be read correctly.

AIP-51708 error during unpackaging--validating the delivery header

Cause: An error occurred during unpackaging the RosettaNet Business Message. The delivery header is invalid.

AIP-51709 error during unpackaging--reading the service header

Cause: An error occurred during unpackaging the RosettaNet Business Message. The service header cannot be read correctly.

AIP-51710 error during unpackaging--validating the service header

Cause: An error occurred during unpackaging the RosettaNet Business Message. The service header is invalid.

AIP-51711 error during unpackaging--verifying manifest against the attachment body parts

Cause: An error occurred during unpackaging the RosettaNet Business Message. The verification of the manifest in the service header against the actual attachment body parts failed.

AIP-51712 error during unpackaging--validating the message sequence

Cause: An error occurred during unpackaging the RosettaNet Business Message. Validation of the message sequence failed.

AIP-51713 unexpected response type in the HTTP header

Cause: An unexpected error occurred during unpackaging the RosettaNet Business Message. The response type in the HTTP header is not understood.

AIP-51714 error decrypting the message

Cause: An error occurred during unpackaging the RosettaNet Business Message. Decryption of the message failed.

AIP-51715 error during unpackaging--reading the service content

Cause: An error occurred during unpackaging the RosettaNet Business Message. The service content cannot be read correctly.

AIP-51716 error during unpackaging--validating the service content

Cause: An error occurred during unpackaging the RosettaNet Business Message. The service content is invalid.

AIP-51801 to AIP-51928 RosettaNet Validation Error Codes

AIP-51801 The XML document to be validated is empty.

Cause: The XML document to be validated is empty.

AIP-51802 Validation rule ID = "{0}" failed. Node "{1}" is required.

Cause: Validation rule ID = "{0}" failed. Node "{1}" is required.

AIP-51803 Validation rule ID = "{0}" failed. If "{1}", then "{2}" is required.

Cause: Validation rule ID = "{0}" failed. If "{1}", then "{2}" is required.

AIP-51804 Validation rule ID = "{0}" failed. "{1}" must be one of the allowed instance values in message guidelines.

Cause: Validation rule ID = "{0}" failed. "{1}" must be one of the allowed instance values in message guidelines.

AIP-51805 Validation rule ID = "{0}" failed. "{1}" must be in "{2}" format.

Cause: Validation rule ID = "{0}" failed. "{1}" must be in "{2}" format.

AIP-51806 Validation rule ID = "{0}" failed. If "{1}" exists, then sub-node "{2}" is required.

Cause: Validation rule ID = "{0}" failed. If "{1}" exists, then sub-node "{2}" is required.

AIP-51807 Validation rule ID = "{0}" failed. "{1}" must be "{2}".

Cause: Validation rule ID = "{0}" failed. "{1}" must be "{2}".

AIP-51808 The XML parser generated an error while parsing the document. The parser error is "{0}".

Cause: The XML parser generated an error while parsing the document. The parser error is "{0}".

AIP-51809 The XML parser encountered an I/O error while parsing the document. The error is "{0}".

Cause: The XML parser encountered an I/O error while parsing the document. The error is "{0}".

AIP-51810 Validation rules "{0}" failed.

Cause: Validation rules "{0}" failed.

AIP-51811 The document to be validated has no DTD specified.

Cause: The document to be validated has no DTD specified.

AIP-51851 unknown validation constraint

Cause: Unknown validation constraint validated.

AIP-51861 An internal error occurred while validating the document. The internal error code is "{0}".

Cause: An internal error occurred while validating the document. The internal error code is "{0}".

AIP-51901 RN_Tag-"{1}": The element "{2}" must have a value "{3}".

Cause: RN_Tag-"{1}": The element "{2}" must have a value "{3}".

AIP-51902 RN_Tag-"{1}": The element "{2}" must have one of these values: ("{3}").

Cause: RN_Tag-"{1}": The element "{2}" must have one of these values: ("{3}").

AIP-51903 RN_Tag-"{1}": The element "{2}" is required.

Cause: RN_Tag-"{1}": The element "{2}" is required.

AIP-51904 RN_Tag-"{1}": The element "{2}" must be a number with up to 3 digits before and after an optional decimal point.

Cause: RN_Tag-"{1}": The element "{2}" must be a number with up to 3 digits before and after an optional decimal point.

AIP-51905 RN_Tag-"{1}": The value of element "{2}" must be a string with minimum length "{3}".

Cause: RN_Tag-"{1}": The value of element "{2}" must be a string with minimum length "{3}".

AIP-51906 RN_Tag-"{1}": The value of element "{2}" must be a string with length between "{3}" and "{4}".

Cause: RN_Tag-"{1}": The value of element "{2}" must be a string with length between "{3}" and "{4}".

AIP-51907 RN_Tag-"{1}": The element "{2}" must be an integer up to 15 digits.

Cause: RN_Tag-"{1}": The element "{2}" must be an integer up to 15 digits.

AIP-51908 RN_Tag-"{1}": The element "{2}" must be in correct date format (YYYYMMDDZ: where YYYY is the year, MM is the month, DD is the day. Optional character 'Z' indicates that the date is in UTC.

Cause: RN_Tag-"{1}": The element "{2}" must be in correct date format (YYYYMMDDZ: where YYYY is the year, MM is the month, DD is the day. Optional character 'Z' indicates that the date is in UTC.

AIP-51909 RN_Tag-"{1}": The element "{2}" must be in correct date-time format (YYYYMMDDThhmmss.sssZ: where YYYY is year, MM is month, DD is day. Character 'T' separates date and time. hh is hour, mm is minutes, ss.sss is seconds. Optional character 'Z' indicates that the date is in UTC.

Cause: RN_Tag-"{1}": The element "{2}" must be in correct date-time format (YYYYMMDDThhmmss.sssZ: where YYYY is year, MM is month, DD is day. Character 'T' separates date and time. hh is hour, mm is minutes, ss.sss is seconds. Optional character 'Z' indicates that the date is in UTC.

AIP-51910 RN_Tag-"{1}": The value of element "{2}" must be a valid day of the month (an integer between 1 and 31).

Cause: RN_Tag-"{1}": The value of element "{2}" must be a valid day of the month (an integer between 1 and 31).

AIP-51911 RN_Tag-"{1}": The value of element "{2}" must be one of the instance values listed for that element in RosettaNet message guidelines.

Cause: RN_Tag-"{1}": The value of element "{2}" must be one of the instance values listed for that element in RosettaNet message guidelines.

AIP-51912 RN_Tag-"{1}": The value of element "{2}" must be a valid DUNS number (9 digit integer).

Cause: RN_Tag-"{1}": The value of element "{2}" must be a valid DUNS number (9 digit integer).

AIP-51913 The element "{2}" is not allowed.

Cause: The element "{2}" is not allowed.

AIP-51914 RN_Tag-"{1}": The value of element "{2}" must be alphanumeric with minimum string length "{3}".

Cause: RN_Tag-"{1}": The value of element "{2}" must be alphanumeric with minimum string length "{3}".

AIP-51915 RN_Tag-"{1}": The value of element "{2}" must be one of the instance values specified in message guidelines. Also, if the GlobalPurchaseOrderTypeCode is 'Quote to order', then the only allowed value is 'Quote'.

Cause: RN_Tag-"{1}": The value of element "{2}" must be one of the instance values specified in message guidelines. Also, if the GlobalPurchaseOrderTypeCode is 'Quote to order', then the only allowed value is 'Quote'.

AIP-51916 RN_Tag-"{1}": If GlobalPurchaseOrderType is 'Government', then "{2}" is required. Also the value of "{2}" must be from one of the instance values given in message guidelines.

Cause: RN_Tag-"{1}": If GlobalPurchaseOrderType is 'Government', then "{2}" is required. Also the value of "{2}" must be from one of the instance values given in message guidelines.

AIP-51917 RN_Tag-"{1}": The value of element "{2}" must be a 9-digit integer followed by a 4-letter string (DUNS 9+4 location format).

Cause: RN_Tag-"{1}": The value of element "{2}" must be a 9-digit integer followed by a 4-letter string (DUNS 9+4 location format).

AIP-51918 RN_Tag-"{1}": The value of element "{2}" must be a string between 3 and 15 digits (GlobalNationalPostalCode).

Cause: RN_Tag-"{1}": The value of element "{2}" must be a string between 3 and 15 digits (GlobalNationalPostalCode).

AIP-51919 RN_Tag-"{1}": If "{3}", then "{2}" is required.

Cause: RN_Tag-"{1}": If "{3}", then "{2}" is required.

AIP-51920 RN_Tag-"{1}": If "{3}", then "{2}" is required. The value of "{2}" must be one of the instance values listed in RosettaNet message guidelines.

Cause: RN_Tag-"{1}": If "{3}", then "{2}" is required. The value of "{2}" must be one of the instance values listed in RosettaNet message guidelines.

AIP-51921 RN_Tag-"{1}": If "{2}" is specified, then either netTermsDay.DayOfMonth or netTermsDays.CountableAmount is required.

Cause: RN_Tag-"{1}": If "{2}" is specified, then either netTermsDay.DayOfMonth or netTermsDays.CountableAmount is required.

AIP-51922 RN_Tag-"{1}": Either "{2}" or "{3}" is required.

Cause: RN_Tag-"{1}": Either "{2}" or "{3}" is required.

AIP-51923 RN_Tag-"{1}": The value of element "{2}" must be a real number.

Cause: RN_Tag-"{1}": The value of element "{2}" must be a real number.

AIP-51924 RN_Tag-"{1}": The value of element "{2}" must be a string with length between 2-4 (GlobalCarrierCode).

Cause: RN_Tag-"{1}": The value of element "{2}" must be a string with length between 2-4 (GlobalCarrierCode).

AIP-51925 RN_Tag-"{1}": The value of element "{2}" must be a 14-digit integer (GlobalProductIdentifier).

Cause: RN_Tag-"{1}": The value of element "{2}" must be a 14-digit integer (GlobalProductIdentifier).

AIP-51926 RN_Tag-"{1}": The value of element "{2}" must be a real number with up to 13 digits before the decimal point and up to 5 digits after the decimal point (9(13)V9(5)).

Cause: RN_Tag-"{1}": The value of element "{2}" must be a real number with up to 13 digits before the decimal point and up to 5 digits after the decimal point (9(13)V9(5)).

AIP-51927 RN_Tag-"{1}": Element "{2}" is required if the corresponding GlobalBusinessIdentifier is not specified. The value must be a string with nonzero length.

Cause: RN_Tag-"{1}": Element "{2}" is required if the corresponding GlobalBusinessIdentifier is not specified. The value must be a string with nonzero length.

AIP-51928 RN_Tag-"{1}": The value of element "{2}" must be alphanumeric with string length between "{3}" and "{4}".

Cause: RN_Tag-"{1}": The value of element "{2}" must be alphanumeric with string length between "{3}" and "{4}".

Jacada Integrator Adapter for Legacy Systems

With Jacada Integrator®, Oracle Application Server ProcessConnect customers can integrate legacy applications when prebuilt APIs or legacy application source code is not available. Jacada Integrator's J2EE Connector Architecture (JCA) resource adapter for Oracle Application Server ProcessConnect allows applications to create, read, update, and delete records within legacy applications using screen-based access. Jacada Integrator is available from

<http://www.jacada.com/products>

Jacada Integrator documentation is available from the Jacada Web site and from

<http://otn.oracle.com/documentation/>

See Also: [""Related Documentation"](#) on page -lviii for information on accessing the Oracle Technology Network (OTN)

This appendix contains these topics:

- [Jacada Integrator as a JCA Resource Adapter](#)
- [Mapping Application Screens Using MapMaker](#)
- [Jacada Integrator and Java Connector Architecture](#)
- [More Information About Jacada Integrator](#)

Jacada Integrator as a JCA Resource Adapter

The Jacada Integrator JCA resource adapter provides connectivity and transactional capabilities for legacy systems. The resource adapter plugs into the application server, providing connectivity between the legacy system, the application server, and the enterprise application. Legacy application platforms supported by Jacada Integrator include mainframe systems running 3270-based applications, midrange systems (AS/400) running 5250-based applications, Unisys, DEC VAX, Data General, Bull, Amdahl, and various UNIX/Telnet systems running character-based (such as VT100, DG400) applications.

The Jacada Integrator MapMaker development tool provides the automated development environment for legacy systems. The MapMaker tool generates code that describes and automates the interaction with the legacy system in a transactional manner. These transactions are called *methods*, and they are available in the deployed code that resides within the Jacada Integrator JCA resource adapter.

Mapping Application Screens Using MapMaker

MapMaker is a Java-based application included with Jacada Integrator that enables you to create interfaces to legacy applications automatically. These interfaces are then output from MapMaker as Jacada Integrator Java services for use in the J2EE-based environment. MapMaker is designed to simplify the mapping of legacy application screens into Java application logic. This is accomplished by creating a map of the host application, which consists of the application screens, the navigational information required to traverse through the sequence of screens, and the tags and fields included on each legacy screen. This information is stored in a map file and in Java class files that are produced from within MapMaker.

MapMaker supports English and Western European single-byte and Asian double-byte data streams. However, only 7-bit U.S. ASCII is supported for the names of items, such as screen, tag, and field names, log file names, and map and service names. In addition, only alpha characters (A-Z, upper or lower case), should be used as the first character of most names.

Five basic steps are involved in the development process:

- Trail recording
- Screen mapping
- Data field mapping
- Method definition
- Service definition

Trails and Trail Recording

A trail is a linear path of all screens encountered while navigating through a host application in trail recording mode. Each trail is added to the trail repository for the current map, and MapMaker uses these trails to build a comprehensive map of the host application.

Trails contain the following information:

- A snapshot image of each screen in the trail, including any formatted fields
- The keystrokes and AID keys typed into each screen

Trail recording exposes MapMaker to all the host screens that are required for the Jacada Integrator service to interact with the legacy application. Since MapMaker is essentially learning how the host application is controlled, it is important to perform all actions that are required to make the host application perform appropriately at runtime.

A trail is recorded by navigating through the host application. During trail recording, you interact with legacy screens using the terminal emulation capabilities of MapMaker exactly as if you were interacting with the legacy application during normal use. This can be accomplished with a single trail or multiple trails using different paths through the legacy application. You can add new trails to a map at any time. MapMaker combines these into a single map.

During trail recording, a snapshot is created for each screen encountered. As the trail is recorded, user inputs (actions) are mapped to their associated screen snapshots. This provides information necessary for the Jacada Integrator service to navigate from one screen to the next within the legacy application.

Screens and Screen Mapping

Screens are the actual rendered image of the legacy application text-based user interface. Screens are composed of fields and data and are saved within MapMaker's map repository. These screen images are used by Jacada Integrator to navigate through the legacy application.

The screen mapping step begins after the trails have been recorded. During this phase, the trails are analyzed by MapMaker to determine which snapshots have the same formatted field layout. Snapshots with the same formatted field layout are grouped together as one "screen" in the map. This grouping is based entirely on the layout of the screen's fields and is independent of the actual text or content of the fields themselves.

While screen content may vary depending on the user input and the data output from the legacy application, screens are still identified based on their formatted field layout. This means that the Jacada Integrator system is always able to recognize a screen, regardless of the contents of the field.

For example, as you input an account number and get customer data from the Customer Information screen, each time a different account number is input, the same Customer Information screen displays the customer data. The same set of formatted fields is used, but the actual data in the fields is different.

Data Field Mapping

After the screens are correctly recognized, you tell MapMaker which fields contain data to be extracted by the Jacada Integrator service. This is accomplished using data templates and table templates. Data templates and table templates use data fields to identify the fields or areas of the screen to be extracted. Data templates are used as containers that map individual fields on the legacy screen. Table templates are containers that map repeating areas of fields on the legacy screen. Often data on legacy screens is displayed in a table format with a varying number of repeating rows, which continues for several pages. Table templates are used to define boundaries of repeating information. The fields in the first row of the table are mapped as data fields and repeat through the entire area defined by the table template.

Definition of Methods

Methods define how a transaction (for example, opening an account or getting an account balance) is accomplished against the host application. Multiple methods can be created for a single map. Methods define the steps necessary to perform a given transaction against the legacy application by defining the inputs, navigation, data retrieval, and conditional logic needed to perform that transaction.

Method definitions consist of:

- Input variables that allow clients to pass data into the method
- Method steps that perform specific functions when the method is invoked

The following method steps can be defined within a method:

Traverse: Traverse steps instruct the method to traverse from the current screen to another screen.

Fetch: A Fetch step extracts data from the screen based on the specified data template or table template.

Perform: A Perform step instructs the method to perform a specified action.

Write: A Write step is used to input data to the screen based on the specified data template or table template.

UserInteraction: A UserInteraction step allows the user to navigate the host application manually.

Invoke: An Invoke step provides a means to invoke other methods.

JClient3: A JClient3 step provides a means to invoke methods in other Jacada Integrator services.

Thread: A Thread step provides for parallel code execution within the method.

ThreadJoin: A ThreadJoin step provides a method to collect the threads within the method, and a point of convergence for the parallel code.

Set: A Set step provides the user the ability to assign values to global variables and add data to the return map.

IfCondition: The IfCondition step provides a comparison between two objects. If the evaluation of the condition is true, then the steps on the conditional or <branch> link are executed. If the evaluation of the condition is false, then the primary or <next> method logic path continues. If the true/conditional steps are executed, then the primary method logic path resumes after they have completed.

IfElseCondition: The IfElseCondition step provides a comparison between two objects. If the evaluation of the condition is true, then the steps on the conditional or <branch> link are executed. If the evaluation of the condition is false, (the Else part of the condition), then the primary or <next> method logic path continues. If the true/conditional steps are executed, then the primary method logic path is not followed.

ForCondition: The ForCondition step executes the steps on the conditional or <branch> link, in a loop, based on specified initializer, conditional, and increment settings. When the For loop ends, the primary or <next> method logic path continues.

WhileCondition: The WhileCondition step executes the steps on the conditional or <branch> link based on the specified conditional settings. When the While loop ends, the primary or <next> method logic path continues.

DoWhileCondition: The DoWhileCondition step executes the steps on the conditional or <branch> link based on the specified conditional settings. When the DoWhile loop ends, the primary or <next> method logic path continues.

Note: *On Fail* methods can be created to recover from an error and return the host application back to a known state (screen).

Definition of Services

Services are a runtime container for methods. After creating methods, services are created that represent logical groupings of the methods. Multiple services can be created from one map. Services can also define initialize and finalize methods to be executed when the service starts execution or completes execution. A service can also define a home screen, a screen within the legacy application that the service returns to when a method is completed and the client disconnects.

Jacada Integrator and Java Connector Architecture

J2EE Connector Architecture (JCA) defines a standard architecture for connecting the J2EE platform to heterogeneous enterprise information systems (EISs). A resource adapter is defined as the component that plugs into the application server and provides the interface between the connector consumer/client and the EIS.

JCA defines two types of contracts:

- **System Contracts:** A system contract is defined between the resource adapter and application server. The system contract enables adapters to plug into the application server so that the application server can manage system-level services. Examples are contracts for connection pooling, transaction, and security management.
- **Application Contracts:** An application contract is between the application component and the resource adapter. An example is the common client interface API defined in the JCA specification.

Figure D-1 J2EE Connector Architecture

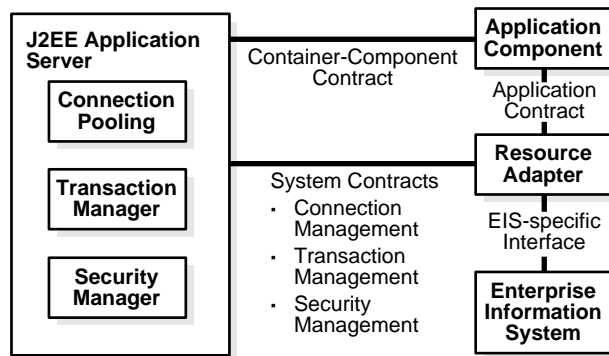

Service Provider Interface

JCA defines the service provider interface (SPI), which is the system contract between the resource adapter and application server. The Jacada Integrator JCA resource adapter implements the SPI as described in the JCA specification, including the following contracts:

- Connection management contracts
- Transaction management contracts
- Security management contracts

Common Client Interface

JCA defines a common client interface (CCI) for EIS access. The CCI defines a standard client API for application components. The CCI enables application components and enterprise application integration frameworks to drive interactions across heterogeneous EISs using a common client API.

The resource adapter exists within the process space of the application server, which interacts and performs connection, transaction, and security management using the system interfaces implemented by the resource adapter. J2EE client applications such as Enterprise JavaBeans, servlets, and JavaServer Pages interact with the resource adapter using the CCI. The resource adapter interacts with the EIS in an EIS-specific manner, which is not defined by JCA.

The Jacada Integrator JCA resource adapter implements the CCI as described in the JCA specification, including the following interfaces:

- ConnectionSpec interface
- Interaction interface
- InteractionSpec interface
- Record interface
- Metadata interface

More Information About Jacada Integrator

To obtain more details about Jacada Integrator, visit

www.jacada.com/products/

Or send an e-mail to

info@jacada.com

Or call one of the following Jacada offices:

Jacada Inc. (North America and Latin America)

400 Perimeter Center Terrace, Suite 100

Atlanta, GA 30346

1-800-773-9574

Jacada Ltd (UK and Europe)

18 Soho Square

London W1D 3QL

+44 (0)20-7025-8077

Jacada Ltd (Germany)

Werner-von-Siemens-Str. 6

86159 Augsburg, Germany

+49-821-262-8344

Glossary

A2A

See [application-to-application](#).

acknowledgment mode

The mode in which recipients receive messages (for example, asynchronous).

actor

See [supported actor](#).

adapter

See [application adapter](#).

adapter exchange protocol

An adapter's logical grouping of interactions (which identifies its capabilities) for a specific protocol. For example, an Oracle database adapter may have three adapter exchange protocols. The adapter exchange protocol determines the questions you are prompted to answer when adding an adapter interaction.

adapter framework

Communicates between the runtime system and various adapters to send and receive data in the form of native events. The adapter framework picks up outbound native events processed by the runtime system and delivers them to appropriate adapters. In addition, the adapter framework raises inbound native events initiated by adapters.

adapter interactions

Define the communication between the Oracle Application Server ProcessConnect runtime system and various adapters to send and receive data. Interactions represent unique actions that can be performed with a specific adapter (such as requesting a purchase order, confirming a purchase order, and so on). For example, an adapter can invoke an inbound interaction named Purchase Order Request(Request Purchase Order)to request a purchase order. This creates an Oracle record, RequestPurchaseOrder native event, RequestPurchaseOrder application event, and event body elements for the various sections of the wire message, such as header details, attachments, and payload.

Add End-To-End Basic Event Flow wizard

Adds an additional event flow to two spokes extending from the native role in the initiating spoke to the native role in the invoked spoke. There are no options for selecting existing business events or transformation maps. All modeling metadata is newly created.

Add Event Flow wizard

Adds an additional event flow to a single spoke extending from the native role to the business process.

Administration tab

A main tab of the Oracle Application Server ProcessConnect user interface tool that enables you to manage and administer Oracle Application Server ProcessConnect, including exporting and importing integrations to and from an XML file, adding adapters, viewing supported business protocols, and managing system types (application, collaborations, contact types, digital envelopes, native formats, translators, and trading partner identification types).

administrator

See business administrator and systems administrator.

agreement type

See [application agreement](#) or [trading partner agreement](#).

agreements

Specific collaborations, roles, and other communication options that describe how parties interact. You create an agreement type. Two types are supported: application agreement and trading partner agreement.

all group

A group type that lets you define the behavior of member datatypes in a runtime instance. All group requires that all complex datatype members appear zero or one times.

analyst

Uses the Oracle Application Server ProcessConnect user interface tool to create and analyze integration reports.

And step

This step waits for all incoming control flows, and executes after all incoming control flows have executed. This step is not typically required since all steps (except an Or step), implicitly provide AND step behavior for the incoming control flows.

application

A type of party that participates in an integration within an enterprise. You create an application and assign it to an application agreement. You also assign an adapter and a delivery channel to use with an application.

application adapter

Provides the connectivity that enables applications and their different interfaces to be included in an integration. Application adapters are written in Java code based on J2EE Connector Architecture that creates the Oracle record enclosing data from a specific application. The application adapter passes the Oracle record to the adapter framework, which communicates with the runtime system.

application agreement

Defines the application and native role to participate in an integration within an enterprise. You create an application agreement for each application (the party) participating in an integration.

application agreement native role

A native role assigned to an application agreement. This is the native role of the party assigned to the application agreement. You assign one native role to each application agreement.

application datatypes

Datatypes whose syntax has been translated into a format recognized by Oracle Application Server ProcessConnect.

application event

Automatically created when you create a native event. For Oracle Application Server ProcessConnect to process the contents of native event body elements, the contents must be re-represented (translated) in an interpretable syntactic format. This interpretable format is the application event. After the native event is represented as the corresponding application event, Oracle Application Server ProcessConnect can extract values from it and can make decisions based on it, or transform it.

application level

Includes the application event and application role.

application role

Hides behavior unique to a party that is not required by a business process. For example, a B2B protocol standard can be required to send acknowledgments. However, a business process may not require receipt of these acknowledgments. The application role can hide these acknowledgments, so that the business process does not receive them.

application type

A method of grouping applications into an entity that can be used for reporting purposes.

application-to-application

A type of integration technology that enables companies to integrate their applications with other applications within the same company boundaries (known as an enterprise). This integration type is also known as enterprise application integration (EAI).

B2B

See [business-to-business](#).

B2B protocol standard

Provides guidelines for trading partners to follow when conducting business between enterprises (across company boundaries). A B2B protocol standard is the common language of data that triggers communication between parties in different enterprises.

body element

See [event body element](#).

business administrator

Defines the profile data of an integration, including applications, adapters, trading partners, agreements, and trading partner organization, cooperation, security, delivery, and endpoint capabilities.

business collaboration

Consists of a set of roles (buyer and seller) collaborating through a set of agreed-on business transactions by exchanging business documents. Trading partners participate in a business collaboration through roles. This business collaboration must achieve a specified outcome.

business datatypes

The datatypes provided with Oracle Application Server ProcessConnect. The different datatypes of applications and trading partners must all be represented as business datatypes to communicate with Oracle Application Server ProcessConnect and participate in integrations.

business dictionary

A RosettaNet dictionary that designates the properties used in basic business transactions between trading partners. The business dictionary defines the business properties and fundamental business data entities in PIP messages.

business document

The name for messages exchanged between trading partners in integrations between enterprises.

business event

Establishes a common event structure and vocabulary across all parties. Business events are created when the transformation binding role semantically transforms the application event into a business event, including recoding of values, renaming of attributes, restructuring of data, derived values, and so on. For example, transformation standardizes the terminology used by an application. One application may use the term *item* on its purchase order. Another application may instead use the term *component*. The business event enables you to standardize on a common term to use (for example, *item*, *component*, or a third term decided by you).

business level

Includes the business event and business role.

business operational view

A RosettaNet partner interface process view that describes the information flow between roles as they perform business activities.

business process

Spans all parties in an integration to coordinate the sending and receiving of data in the form of events. This management ensures that the correct parties send and receive data. Business processes also hide the unique characteristics of each party in an integration.

business protocol

Identifies the implementation guidelines to use for the reliable transport of business document messages between trading partners (such as RosettaNet Implementation Framework, version 1.1). You assign a business protocol to a party in a trading partner agreement. Examples of business protocols available for selection are RosettaNet-RNIF1.1-PIP and RosettaNet-RNIF2.0-PIP.

business protocol adapters

Adapters that enable trading partners to use a business protocol for integrations between enterprises. Oracle Application Server ProcessConnect supports a business protocol adapter known as the B2B adapter that enables trading partners to use the RosettaNet business protocol.

business role

Defines the business behavior of the business event.

business transaction

A unit of business conducted by two or more trading partners that generates a definite state of success or failure. A business transaction is conducted between two parties playing opposite roles in a transaction. The roles are always a requesting role and a responding role.

business-to-business

A type of integration technology that enables companies to extend application-to-application integration between enterprises to integrate trading partners with other trading partners.

certificate

See [remote trading partner certificate](#).

choice group

A group type that lets you define the behavior of member datatypes in a runtime instance. A choice group allows only one complex datatype member to appear. You cannot specify the one to appear; it is randomly selected.

collaboration

Collaborations identify the actors (roles played in a business collaboration, such as buyer or seller) and business transactions available with each partner interface process (PIP).

company boundaries

See [enterprise](#).

complex datatype members

Complex datatype members are defined inside a complex datatype. Datatype members consist of three types: scalar, wildcard, and compound.

complex datatypes

Datatypes that include other datatypes known as complex datatype members. An address is an example of a complex datatype.

compound member

Compound members are very flexible. You can assign complex and scalar datatypes to a compound member. You can assign cardinality to a compound member. For example, you can have a compound section in an expense report called `line_item`. Within this compound section, you can define specific details about the expense report with scalar types specifying the date, the amount, the currency used, and the justification for the expenses incurred.

concurrent conversations

Defines the maximum number of concurrent collaboration instances that can be in progress at any time.

condition statement

A transformation statement type that determines whether the statements associated with the transformation condition execute if the condition evaluates successfully.

Conditions can also be marked to execute only in the event of the condition not evaluating successfully (through an ELSE block). A condition is defined in terms of the operands and evaluated with standard logical operators. Condition expressions

can be further combined by a logical AND operator or OR operator to obtain condition expressions of arbitrary complexity.

condition step

This step evaluates a specific condition on an event type or datatype. This step is associated with a condition expression.

configuration

A collection of modeling and profile metadata that is consistent, complete, and deployable. Creating a configuration enforces the validation rules so that only valid, complete, and consistent data is available in the runtime repository.

consume step

This step consumes and prevents further processing of an event or datatype. The IN port must be associated with the event or datatype to be consumed. This step is typically used to consume acknowledgments.

contact types

The method for contacting persons (such as a phone number or e-mail address) when specific activity within Oracle Application Server ProcessConnect occurs.

control flow

Control flows between steps indicate the execution order of steps. Control flow determines which data goes first, and in which sequential order, instead of sending all data in parallel.

cooperations

The result of a correct setup of collaborations.

coordination

Coordination captures the semantics of a business transaction at runtime. When an event is received from an application or a trading partner, Oracle Application Server ProcessConnect determines if the event instantiates a business transaction (that is, if it instantiates a business process with all its role processing). If this is the case, then it creates a coordination. A coordination has states associated with it. When a coordination is created, its state is set to open.

core datatypes

Prepackaged primitive datatypes provided by Oracle Application Server ProcessConnect.

correlated native event type

The target native event that you select when creating a native event correlation (for example, PurchaseOrderConfirmation).

correlating native event type

The initiating native event that you select when creating a native event correlation (for example, RequestPurchaseOrder).

correlations

See [native event correlation](#).

Create End-To-End Basic Integration wizard

Creates two spokes (with a new business process as the hub) and a single event flow that extends from the initiating spoke's native role to the invoked spoke's native role. Additional (end-to-end) event flows can be added with the Add End-to-End Basic Event Flow wizard. There are no options for selecting existing business events or transformation maps. All metadata is newly created.

Create Spoke wizard

Creates a single spoke (extending from the native role to the business process) and a single event flow.

CRM

See [customer relationship management](#).

customer relationship management

The methodologies, software, and usually Internet capabilities that help an enterprise manage customer relationships in an organized way. For example, an enterprise can build a database about its customers that describes relationships in detail so that management, salespeople, people providing service, and the customer can directly access information, match customer needs with product plans and offerings, remind customers of service requirements, and know what other products a customer has purchased.

D3L

See [data definition description language](#).

data definition description language

An XML-based message description language that describes the structure that a party's native, non-XML formats must follow to communicate with Oracle

Application Server ProcessConnect. These non-XML formats are best described as structured records of bytes, characters, or both. D3L provides both a predefined, structured set of rules and translation capabilities for native, non-XML formats.

data flow

Data flow enables data in the form of native events, application events, and business events to be passed:

- Between steps within a role through step ports (step data flow)
- Outside of a role and onto the next role through role ports (role data flow)

data universal numbering system

A unique, sequentially-generated, nine-digit number that you can assign as the trading partner identification type. You obtain this number from Dun and Bradstreet.

datatype length facet

A facet in a scalar datatype that indicates the number of units of length, where units of length varies depending on the type from which it is being derived. The value of length must be a nonnegative integer.

datatype members

The contents of a complex datatype. There are three datatype members: wildcard, compound, and scalar.

datatype namespace

A mechanism for grouping datatypes. Datatypes can be assigned to namespaces.

datatype transformation map

Define mappings across datatypes. These maps are typically invoked from other maps though they can also be directly associated with transformation steps. Datatype transformation maps can either be:

- System-defined maps
- User-defined maps

delivery channel

Describes the communication capabilities for applications and trading partners (such as message exchange and security details). For trading partners, it can describe characteristics such as nonrepudiation, response modes, and encryption

are required. The delivery channel also identifies one transport (with its trading partner endpoint address and transport protocol) and one document exchange (with its exchange protocol (such as RosettaNet 1.1), certificate encryption and signing details, digital envelop and signature details, and RosettaNet validation support details).

deployment

The process of activating a configuration from the design-time repository to the runtime repository.

Deployment tab

A main tab of the Oracle Application Server ProcessConnect user interface tool that enables you to create, validate, and deploy a configuration.

design-time repository

Stores the modeling metadata and profile data that comprise an integration. The metadata and data represent a design of a specific integration before deployment and execution.

digital envelope

The packaging method for a digital signature.

digital signature

Created when a public key algorithm signs the sender's message with the sender's private key. The digital signature ensures that the document is authentic, has not been forged by another party, has not been altered, and cannot be repudiated by the sender.

document exchange

Describes details such as the supported exchange protocol (such as RosettaNet 1.1), certificate encryption and signing details, digital envelop and signature details, and RosettaNet validation support. The document exchange layer receives a business document, encrypts it (if specified), adds a digital signature for nonrepudiation (if specified), and sends it to the transport layer for transmission to the other trading partner.

domain column

Defines the column name and its namespace and datatype (such as an integer or string). Domain columns are part of the domain value map section. You assign domain parties (such as an organization name) to domain columns.

domain party

The parties in a mapping. You assign domain parties to domain columns. You then assign specific domain columns to the domain value map columns of a specific domain value map (agreement).

domain value map columns

The specific domain columns (and their domain parties) of a specific domain value map. Domain value map columns identify the domain columns (and their domain parties) of a specific domain value map.

domain value map rows

Identifies the terminology that you assign to domain value map columns. For example, domain party ipdev may use the string *true* when acknowledging receipt of a purchase order. Domain party APPS may use the string *yes*. Domain value map rows link this terminology together.

domain value map rule statement

A transformation statement type that enables you to map domain columns and parties to sources and targets.

domain value maps

Enable you to map one party's terminology standards (for example, *car*) to another party's terminology standards (for example, *vehicle*). This enables parties to successfully send and receive messages while continuing to use their regional terminologies, such as differing currency standards.

DUNS

See [data universal numbering system](#).

EAI

See [application-to-application](#).

e-business

The conduct of business over the Internet, such as buying and selling products, servicing customers, and collaborating with other companies, known as trading partners.

EIS

See [enterprise information system](#).

encoding facet

A facet in a scalar datatype that indicates the encoding type of a binary string. This is used in Oracle Application Server ProcessConnect core datatypes to differentiate between the binary types `hexBinary` and `base64Binary`.

encryption credential

The certificate to use for encryption of the document to exchange.

End step

This step indicates completion of role processing.

endpoint

The physical endpoint address of a trading partner, such as a company Web site. The trading partner uses this address to send or receive data. Endpoints are global to all trading partners.

enterprise

The boundaries of a company.

enterprise application integration

See [application-to-application](#).

enterprise information system

Any enterprise-based data storage, retrieval, and (usually) analysis system. Examples include customer relationship management, enterprise resource planning, mainframe transaction processing, databases, and in-house legacy applications.

enterprise resource planning

The broad set of activities supported by multimodule application software that help a manufacturer or other business to manage the important parts of its business, including product planning, parts purchasing, maintaining inventories, interacting with suppliers, providing customer service, and tracking orders. Enterprise resource planning can also include application modules for the finance and human resources aspects of a business. Typically, an enterprise resource planning system uses or is integrated with a relational database system. The deployment of an enterprise resource planning system can involve considerable business process analysis, employee retraining, and new work procedures.

enumeration facet

A facet in a scalar datatype that sets constraints on the value space to a specified set of values.

ERP

See [enterprise resource planning](#).

event abstraction

The process of removing specific party characteristics of an event (such as encryption, encoding, datatypes, purchase order vocabulary, and so on) until none remain and an event is completely in Oracle Application Server ProcessConnect format.

event addressing

Enables you to select the target party with whom to integrate in the SetParty step of the business process.

event body element

Carries a complete set of business data. For example, an airplane purchase order is represented as a body element. A design drawing accompanying the purchase order is placed in another body element. This enables any incoming set of data to be represented appropriately in structured form. This makes it accessible later for content processing.

event flow

The complete path a single event takes through a spoke. An inbound event flow begins with an inbound interaction that produces an inbound native event. As the event flows from the native role to the business process, the native event is translated to an application event and the application event is transformed to a business event. An outbound event flow takes an event in the reverse direction, from a business event in a business process to an outbound interaction bound to the native role.

event flow diagram

Displays a graphical view of a role or business process, its two immediate role or business process neighbors, and the event types flowing between all three.

event header rule statement

A transformation statement type that enables you to:

- Map source data from the header of an incoming event into a target item
- Map target data into the source header of an outgoing event

event instance

An occurrence of an event type. An event instance holds actual business data. For example, a particular purchase order for an airplane or a car is represented as an instance of the event type purchase order.

event map

Defines an expression for each record and determines the specific native event type to use with a given record instance. After the record is available, the event map applies the expression. The expression results in one native event type. An instance of this native event type is then created and populated.

event transformation map

Enables you to define maps that semantically convert an application datatype to a business datatype (and vice versa). You define application datatype and business datatype as sources and targets (depending on the transformation direction) and assign each to a datatype transformation map.

event types

See [events](#).

events

An internal definition of business-relevant data that either arrived from a party or is to be sent to a party.

Event types appear in different formats as they move through Oracle Application Server ProcessConnect. There are three types: native event, application event, and business event. The native event and application event are unique to an individual party. The business event is the common language of data (such as updating a purchase order) that triggers communication with other parties. By this point, all party-unique characteristics are removed.

exchange protocol

A protocol by which data is exchanged, such as RosettaNet - 01.00 or RosettaNet - 02.00.

extractor

Determines which type of native event to create and which type of translator to use.

facet

Enables you to define the constraints (or limitations) of datatypes. You define facets in scalar datatypes.

fraction digits facet

A facet in a scalar datatype that identifies the maximum number of digits in the fractional part of values of datatypes derived from a decimal. The value must be a nonnegative integer.

functional service view

A RosettaNet partner interface process view that describes the design of and interactions between network components as they execute a PIP. Network components are also known as services, and include buyers and sellers.

host trading partner

The organization in which Oracle Application Server ProcessConnect is installed. The host trading partner conducts business with the remote trading partner (the organization outside your enterprise). The remote trading partner does not require access to the Oracle Application Server ProcessConnect user interface tool. The host trading partner must define the capabilities for both host and remote trading partners with the Oracle Application Server ProcessConnect user interface tool.

IDoc

The native format of SAP application messages.

implementation framework view

A RosettaNet partner interface process view that describes the message structures of actions performed by roles (for example, the XML DTDs and message guidelines) and communication requirements for network components (for example, for the use of Secure Socket Layer (SSL) and digital signatures)

inbound

The direction of wire messages received by Oracle Application Server ProcessConnect from outside parties.

initiating native event instance

The initial native event that starts a message exchange.

initiating spoke

A spoke that begins the business transaction and contains the first inbound event and the native role bound to the first inbound interaction.

integration

See [integration technology](#).

integration architect

Plans the design of an integration before the Oracle Application Server ProcessConnect user interface tool is used.

integration diagram

Displays a graphical view of all roles and the business process in an end-to-end integration.

integration import and export

You can export and import the entire contents of an integration to and from an XML file. This enables you to export an integration from one repository and import it into another repository.

integration manager

A runtime system component that coordinates the various subcomponents that execute an integration.

integration participant

See [party](#).

integration point

A business event that triggers communications between parties. For example, the business event to create a purchase order between two trading partners is an integration point.

integration technology

A key requirement for successfully automating e-business activities. Integration technology includes the process of enabling:

- Applications to communicate with other applications that differ in architecture and technology
- Trading partners to communicate with other trading partners

integration types

Integration technologies include several types, such as: application-to-application integration and business-to-business integration.

integrations between enterprises

See [business-to-business](#).

integrations within an enterprise

See [application-to-application](#).

interactions

See [adapter interactions](#).

invoked spoke

A spoke that contains the first outbound event and the native role bound to the first outbound interaction.

iterator

A transformation statement type that enables you to specify looping conditions in statements. For example, you can loop through an array and perform a specific action on the line items in this array.

J2EE

See [Java 2 Environment, Enterprise Edition](#).

J2EE Connector Architecture

A standard architecture for connecting the Java 2 Environment, Enterprise Edition platform to an enterprise information system not written in the Java programming language.

Java 2 Environment, Enterprise Edition

The Java platform for multi-tier, server-oriented, enterprise applications. The basis of J2EE is Enterprise JavaBeans (EJB).

JCA

See [J2EE Connector Architecture](#).

lifecycle management

Enables you to manage the various states in the design and deployment of modeling metadata and profile data (such as draft, validated, pending approval, approval, and deployed).

lifecycle state

The state a business object is in at any given point in time. The set of lifecycle states is based on state changes that must be captured from a business (that is, integration) standpoint.

map variable statement

A transformation statement type that enables you to define a variable to use in multiple statement types.

max exclusive facet

A facet in a scalar datatype that identifies the exclusive upper bound of the value space for a datatype with the ordered property. The value must be in the value space of the base type.

max inclusive facet

A facet in a scalar datatype that identifies the inclusive upper bound of the value space for a datatype with the ordered property. The value must be in the value space of the base type.

max length facet

A facet in a scalar datatype that identifies the maximum number of units of length, where units of length varies depending on the type from which it is being derived. The value must be a nonnegative integer.

metadata

See [modeling metadata](#).

methodology

A set of rules or procedures employed by a discipline. Several methodologies are provided for using the Oracle Application Server ProcessConnect user interface tool to design an integration: adapter-centric and business process-centric.

MIME

See [multipurpose internet mail extensions](#).

min exclusive facet

A facet in a scalar datatype that identifies the exclusive lower bound of the value space for a datatype with the ordered property. The value must be in the value space of the base type.

min inclusive facet

A facet in a scalar datatype that identifies the inclusive lower bound of the value space for a datatype with the ordered property. The value must be in the value space of the base type.

min length facet

A facet in a scalar datatype that identifies the minimum number of units of length, where units of length varies depending on the type from which it is being derived. The value must be a nonnegative integer.

min pattern facet

A facet in a scalar datatype that identifies a constraint on the value space of a datatype that is achieved by constraining the lexical space to literals that match a specific pattern. The value of pattern must be a regular expression.

model group

Defines the behavior of member datatypes in a runtime instance.

modeler

Defines the modeling metadata of an integration, including business process, role types, events types, datatypes, translations, transformations, correlations, and condition expressions. There are three types of modelers: event manager, business process manager, and connection manager.

modeling metadata

The metadata design by a modeler for an integration. Modeling metadata includes business processes, role types, datatypes, event types, translations, transformations, interactions, and condition expressions. In the Oracle Application Server ProcessConnect user interface tool, modeling metadata design capabilities are accessible through the **Modeling** tab.

Modeling tab

A main tab of the Oracle Application Server ProcessConnect user interface tool that enables you to define the metadata that describes how data flows through Oracle

Application Server ProcessConnect, including business process, roles, translations, transformations, event types, datatypes, interactions, and condition expressions.

multipurpose internet mail extensions

An extension of the original Internet e-mail protocol that lets users use the protocol to exchange different kinds of datafiles on the Internet: audio, video, images, application programs, and other kinds, as well as the ASCII handled in the original protocol, the simple mail transfer protocol (SMTP).

namespaces

See [datatype namespace](#).

native datatypes

Datatypes not entirely in the native wire messages format of their sending parties, but instead represented in an Oracle record instance. Native datatypes are automatically created by Oracle Application Server ProcessConnect.

native event

The Oracle Application Server ProcessConnect internal implementation of the business data contained in an Oracle record. Oracle Application Server ProcessConnect receives data in its wire message format from a party and creates a native event. A native event may or may not vary slightly from the wire message received from a party. For example, an SAP IDoc purchase order may or may not have slight variations made to its data such as purchase order packaging, security, datatypes, and so on. The event body elements of the native event contain the various sections of the wire message, such as payloads or attachments.

native event correlation

Ensures that the correct native event instances are matched and provided to the corresponding native role instances. A native event correlation includes an expression that defines when two native event instances are related.

native event instance

After the wire message of a party is represented as an Oracle record instance, the different sections are placed into the different body elements of a native event instance.

native event validation

Validation rules that guarantee the data consistency of wire messages being sent or received. Each native event can be supplemented with native event validation rules

that are invoked at native event instance creation time. If the validation rules are satisfied, then the native event instance is considered consistent and made available for further processing. If at least one validation rule fails, the native event instance is considered inconsistent.

native format

The format in which a datatype appears in the wire message of a party. Oracle Application Server ProcessConnect provides prepackaged support for several native formats (XSD, D3L, and token substituted text).

native level

Includes the native event and native role.

native role

Handles behavior unique to a party. For example, a native role can process error handling information in a method specific to the party.

nonrepudiation

A RosettaNet standard that provides absolute evidence that a specific action occurred. Oracle Application Server ProcessConnect supports two types:

- Nonrepudiation of origin requires a message sender to digitally sign a message. This protects against any attempt by a sender to deny sending a message.
- Nonrepudiation of receipt requires a message recipient to send back a digitally signed acknowledgment. This protects against any attempt by a message recipient to deny receiving a message.

OC4J

See [Oracle Application Server Containers for J2EE](#).

OPMN

See [Oracle Process Management Notification](#).

Or step

This step waits for at least one incoming control flow. The step is executed as soon as one of the incoming control flows is executed.

Oracle event instance

Represents the occurrence of data coming from a party or being sent to a party.

Oracle Process Management Notification

Enables you to monitor Oracle Application Server Metadata Repository processes based on settings in the `opmn.xml` file.

Oracle record

Establishes the conceptual boundary between Oracle Application Server ProcessConnect and a party with an Oracle record. Data in the form of wire messages received from a party is represented as an Oracle record on the Oracle Application Server ProcessConnect system boundary. An Oracle record to be sent to a party is represented as a wire message and sent out. After the wire message is represented as an Oracle record instance, the different sections are placed into the different body elements of a native event instance.

Oracle record instance

When data is received from a party, it is represented in an Oracle record instance. An Oracle record instance represents the occurrence of data received from or sent to a party.

Oracle Application Server Containers for J2EE

A complete set of J2EE containers written entirely in Java that execute on the Java Virtual Machine (JVM) of the standard Java Development Kit (JDK).

Oracle Application Server ProcessConnect

Enables you to successfully design, deploy, monitor, and maintain integrations within an enterprise and integrations between enterprises.

Oracle Application Server ProcessConnect middle-tier instance

A single installation of Oracle Application Server ProcessConnect.

Oracle Wallet

A Java-based application that security administrators use to manage public-key security credentials on clients and servers.

outbound

The direction of messages sent from Oracle Application Server ProcessConnect to outside parties.

packaging

Encapsulates all components of a message into a packaging format (for example, Oracle Application Server ProcessConnect supports the multipurpose internet mail extensions (MIME) format).

participant

See [party](#).

partner interface process

XML-based dialogs that define the specific sequence of steps required to execute a business process (and thus, exchange data) between trading partners. PIPs are XML-based dialogs that define the structure, allowable data elements, values, and value types for each business document message exchanged. Trading partners agree on the set of PIPs to support to conduct business.

party

An application in an application agreement or a trading partner in a trading partner agreement that participates in an integration. A party plays a role in an integration, such as buyer or seller.

party ID

See trading partner identification type.

pass-through step

This step passes through the event or datatype on its IN port to its OUT port. The event contents are not altered.

payload

The data contents of a message (for example, a payload of a purchase order can identify the quantity ordered, the total cost, the product being ordered, and so on).

PIP

See [partner interface process](#).

ports

There are two types of ports:

- The role ports for ports that work with data flows to connect roles together
- The step ports for ports that work with data flows and control flows to connect steps within roles

primitive datatype

A series of basic datatypes, such as strings, integers, floats, and doubles. Oracle Application Server ProcessConnect provides primitive datatype support through the **Core Datatypes** section of the **Datatypes** tab.

process diagram

Displays a graphical view of the steps, data flows, and control flows in a role or business process.

profile data

Includes application, adapter, trading partners, and agreements data, and, for integrations between enterprises, host and remote trading partner organization, cooperation, security, delivery, and endpoint data.

profile management

Ensures that the attributes of the trading agreement are captured for use during a PIP handshake.

Profiles tab

A main tab of the Oracle Application Server ProcessConnect user interface tool that enables you to define the data that describes trading partners, applications, agreements, adapters, and host and remote trading partner organization, cooperation, delivery, security, and endpoints capabilities.

protocol endpoint

Consists of a transport protocol (such as HTTP 1.1) and trading partner endpoint address (such as URI `www.myapp124abc.com`).

quiesce

The process of gracefully shutting down a deployed integration.

records

See [Oracle record](#).

remote trading partner

The organization outside your enterprise with whom to conduct business. The host trading partner must define the capabilities for both host and remote trading partners with the Oracle Application Server ProcessConnect user interface tool.

remote trading partner certificate

A method by which to secure the given exchange of data. A certificate securely binds an identity such as a trading partner to a public key. A certificate is created when a trading partner's public key is signed by a trusted identity known as a certificate authority (CA). This certificate ensures that the trading partner's data is correct and that the public key actually belongs to that trading partner. You select the location of a certificate. This is typically the location for the Oracle Wallet Resource Locator.

Reports tab

A main tab of the Oracle Application Server ProcessConnect user interface tool that enables you to create reports that describe Oracle Application Server ProcessConnect behavior.

repository

See [design-time repository](#) or [runtime repository](#).

RNIF

See [RosettaNet Implementation Framework](#).

role data flow

Connects the role ports of roles together, which enable events to move from role to role.

role port

Represents an input or output parameter of a role containing events. Role ports of roles are connected together by role data flow. This enables events to move from role to role.

role set

See [spoke](#).

roles

Define how events are executed and implement the behavior of parties and the entire integration. The native role, translation binding role, application role, and transformation binding role manage issues unique to parties and manage translation and transformation of event types. The business role implements the behavior of the entire integration.

RosettaNet

A nonprofit organization of leading technology companies that have created and implemented a common set of nonproprietary, XML-based, e-business standards. These standards define how trading partners conduct business through the exchange of business documents over the Internet. Guidelines are provided for transport, routing, packaging, security, signals, and trading partner agreements.

RosettaNet dictionaries

Define and describe a common set of properties for use in PIP messages. These properties define a common vocabulary for conducting business. This ensures that the information exchanged between trading partners is consistent, overlapping efforts of trading partners are eliminated, and confusion caused by the uniquely defined terminology of each trading partner is reduced. Two dictionary types are provided: business dictionary and technical dictionary.

RosettaNet Implementation Framework

Defines the implementation guidelines for the reliable exchange of business data messages (in XML business documents) between trading partners over the Internet.

RosettaNet validation

Compares the elements in RosettaNet XML-format business documents to the requirements specified in the RosettaNet Message Guideline specification to determine their validity. This specification defines requirements for information such as element datatypes, element lengths, element value lists, and element cardinality.

rule statement

A transformation statement type that enables you to perform mapping commands between sources and targets. For example, you can copy a source string named *PartnerName* to a target string named *BuyerName*.

runtime repository

Stores the integration modeling metadata and profile data required to execute an integration.

runtime system

Retrieves the configuration from the runtime repository to create and execute the integration. The runtime system is comprised of several components, including the integration manager, which coordinates integration execution.

S/MIME

See [secure multipurpose internet mail extensions](#).

scalar datatypes

Scalar datatypes can refer to many types, including an integer, a float, a string, an object, and binary information. You can also define facets in scalar datatypes. Facets enable you to define the constraints (or limitations) of datatypes. You cannot assign cardinality to a scalar member. You can only assign scalar datatypes to scalar members.

scalar member

A member of a complex datatype. A scalar can refer to many types, including an integer, a float, a string, an object, and binary information. An address in a message is an example of a complex datatype, with a scalar member that defines address details (such as a zip code, street address, city, and state).

secure multipurpose internet mail extensions

A secure method of sending e-mail. MIME indicates how to organize an electronic message. S/MIME describes how encryption data and a digital certificate can be included as part of the message body.

sequence group

A group that lets you define the behavior of member datatypes in a runtime instance. A sequence group requires that complex datatype members be used in the order in which they are specified. For this release, the order in which they are created is the order in which they are used.

service content

The payload of a message (for example, a payload of a purchase order can identify the quantity ordered, the total cost, the product being ordered, and so on).

SetParty step

This step sets a specific destination party (application or trading partner) for an event type or datatype.

signing credential

Enables you to assign the certificate to use to sign the given document exchange.

split step

This step makes multiple copies of an event.

spoke

Consists of a role set extending from the native role to the business process. Role ports and data flow connect the spoke together. A native role can belong to only a single spoke. This means that a spoke is uniquely identified by its native role.

Multiple spokes connected by a single business process comprise an integration. A business process uniquely identifies an integration.

start step

This step is a pseudo-step that indicates the start of a role.

statements

The logical operations to use when mapping source and target items.

step

The sequence of activities inside a role type. Steps define the execution logic in a role. Different types of logic can be applied to a role, ranging from pass-through step logic where no processing other than sending events is required, to more detailed logic processing, such as conditional branching logic, where you can specify that a specific condition be performed, if the amount field of a purchase order is over a specific number (such as notifying a second approver).

step binding diagram

A diagram that displays the steps inside a role or business process.

step data flow

Connect the ports of steps together, which enable events to move through steps.

step port

Works with data flows and control flows to connect steps in roles together. Step ports also work with data flows to connect incoming role ports to incoming step ports and outgoing step ports to outgoing role ports.

supported actor

Identifies the role played by a trading partner in a business collaboration (such as buyer or seller). You select the trading partner's supported actor role. For example, buyer - 3A4 - V02.00 if the trading partner is acting as a buyer using PIP3A4 and RNIF 2.0. The supported actor is associated with the native role you assign to a trading partner agreement (for example, supported actor Buyer - 3A4 - V02.00 of a

trading partner is associated with native role PIP3A4Buyer that you assign to a trading partner agreement.

systems administrator

Monitors and administers an integration, such as deploying an integration (known as a configuration), starting and stopping processes, and monitoring integration performance.

systems integration consultant

Evaluates if Oracle Application Server ProcessConnect provides a solution for their integration requirements.

technical dictionary

A RosettaNet dictionary that provides properties for defining products and services. The technical dictionary eliminates the need for trading partners to use separate dictionaries when implementing PIPs.

technology stack services

A set of technology stack services automatically invoked by the runtime system during execution of an integration. The technology stack provides the infrastructure services required by the runtime system for integration. The integration manager coordinates integration execution.

token substituted text

Specifies the subject and body of alert e-mail messages. The native format is free-form text interspersed with tokens representing values that must be filled in at runtime.

total digits facet

A facet in a scalar datatype that identifies the total number of digits for a numeric datatype. This is the maximum number of digits in values of datatypes derived from a decimal. The value must be a positive integer.

trading partner

A party that engages in business transactions with another party in an integration between enterprises. You assign a trading partner to a trading partner agreement.

trading partner agreement

An electronic agreement that defines the way in which two trading partners agree to interact when performing an agreed-on business collaboration. An example of a

business collaboration is RosettaNet PIP3A4 (purchase order request), where one trading partner acts as the role of buyer to request a purchase order and another trading partner acts as the role of seller to send a purchase order. Trading partner agreements essentially define the terms and agreements that enable business documents to be exchanged between trading partners.

You define the remote trading partner and native role of the host trading partner to participate in an integration between enterprises.

trading partner agreement native role

The native role of the host trading partner in a trading partner agreement. You also assign the remote trading partner to this trading partner agreement.

trading partner identification type

A value that uniquely identifies a trading partner, such as a data universal numbering system (DUNS) number. You can define other types of trading partner identification types.

transformation

The process of transforming the application event to the business event, and vice versa, including recoding of values, renaming of attributes, restructuring of data, derived values, and so on. For example, transformation standardizes on the terminology used by parties. One application may use the term *item* on its purchase order. Another application may instead use the term *component*.

transformation binding role

Transforms an application event to the common language represented by the business event, and vice versa.

transformation map

The set of all transformation rules necessary to transform a business event from an application event, or vice versa. Transformation maps have any number of sources and targets. Sources and targets can be application events, business events, or datatypes.

transformation rule

Describes how to transform one data item from an application event to a business event, and vice versa.

transformation step

This step transforms a set of events or datatypes into another set of events or datatypes. This step is associated with a transformation map.

translation

The process of translating the native event into an application event, and vice versa. For the data in the native event to be successfully translated, the datatypes being used must match the datatypes that you define.

translation binding role

Translates a native event to an application event, and vice versa.

translation step

This step translates a native event type or datatype to an application event type or datatype, and vice versa.

translator

Translates native datatypes into a format recognized by Oracle Application Server ProcessConnect. The translator that you select to use is based on the native format of your message (known as the wire message). A translator is associated with a converter, an inbound translator, and an outbound translator.

transport endpoint

See endpoint.

transport layer

Responsible for message delivery using the selected transport communication protocol (for example, HTTP). The transport layer defines the trading partner's capabilities with regards to the communication protocol that enables trading partners to interact and enables transport security for inbound and outbound message transport over the communication protocol used.

transport mode

A means by which data is sent or received, such as asynchronous mode.

transport parameter

Responsible for message delivery using the selected transport protocol (such as HTTP 1.1) and protocol endpoint address (such as the Web site of a trading partner).

transport protocol

A protocol that describes how to transport data. Transport protocols include FTP, SMTP, and HTTP.

use cases

The privileges that you assign to a user of the Oracle Application Server ProcessConnect user interface tool.

user interface tool

The Oracle Application Server ProcessConnect tool that enables you to design, deploy, monitor, and manage integrations within an enterprise and integrations between enterprises.

user roles

The group of related use cases (privileges) that permit a user to perform tasks with the Oracle Application Server ProcessConnect user interface tool.

valid value

Facet of a scalar datatype that can contain a range of values. Only the enumeration facet and pattern facet permit a range of values to be assigned.

validation

Ensures that modeling metadata and profile data in an integration is correct and complete before deployment. If the validation rules are satisfied, then the integration is considered consistent. If at least one of the validation rules fails, integration is considered inconsistent. Specific validation levels are provided with Oracle Application Server ProcessConnect, including:

- Native event validation
- Metadata validation, including:
 - Validation during the creation of modeling metadata and profile data
 - Validation before deployment of an integration (when you create the configuration that contains the integration)

white space facet

A facet in a scalar datatype that sets constraints on the value space of types derived from to ensure that the various behaviors specified in the Attribute Value Normalization in XML 1.0 (Second Edition) are realized.

wildcard member

Wildcard members provide for generic functionality. You can use wildcard members during the development phase as placeholder datatypes when you are unsure of the exact datatypes you want to use. Wildcard datatypes can then be replaced at a later time. You can also assign cardinality to a wildcard member. Oracle Application Server ProcessConnect uses XMLOpaque as a datatype of wildcard members.

wire message

The native format of data sent from parties (such as trading partners or applications). Oracle Application Server ProcessConnect does not know this data format. The direction of wire messages coming from parties is called inbound. The direction of wire messages sent to parties is called outbound. Wire messages can contain a number of sections, such as payloads, attachments, or trailers.

XSD

The XMLSchema Definition (XSD) specifies how to formally describe the elements in an Extensible Markup Language (XML) document. Oracle Application Server ProcessConnect provides prepackaged support for XSD.

Index

Symbols

SORACLE_HOME

- restrictions on using when creating a delivery channel, 7-9, 7-11, 15-16

A

abstractions

- at application level, 3-32
- at business level, 3-40
- at native level, 3-21

acknowledgment consumption

- in roles, 3-35

acknowledgment mode

- assigning to a delivery channel, 25-76

acknowledgment time

- enabling in a delivery channel, 25-77

ACKs. *See* acknowledgment consumption

activity monitoring reports

- creating, 23-23
- definition, 23-6
- example, 23-39
- overview of report pages, 23-23

actors. *See* supported actors

adapter error codes, C-20

adapter exchange protocols

- adding to a native format, 17-22
- Advanced Queuing adapter, 8-14
- definition, 3-19
- E-Mail adapter, 8-32
- File/FTP adapter, 8-39
- HTTP adapter, 8-46
- JMS adapter, 8-59

Oracle Database adapter, 8-76

- removing from a native format, 17-23

Web Service adapter, 8-93

adapter framework

- accessing the log files from Oracle Enterprise Manager, 18-8, 18-10

- changing log level settings from Oracle Enterprise Manager, 18-10

- changing log level settings through Oracle Enterprise Manager, 18-8

coordinations, 12-133

- creating native events, 3-22

definition, 4-4, 18-4, 24-12

- information in log files, 22-2

instance, 19-3

Java Virtual Machine, 19-7

- load balancing, 4-9

- log files for monitoring errors, 21-14

performance, 19-4

- responsibilities, 3-49, 4-8, 4-9

- starting and stopping with Oracle Enterprise Manager, 18-8

- starting and stopping with Oracle Process Management and Notification

(OPMN), 18-17

- tuning, 19-6

tutorial example, 7-42, 7-43, 7-45

- typical errors and recovery actions, 21-15

- using the runtime repository, 4-7

- viewing current performance, 18-13

- viewing the current status in Oracle Enterprise Manager, 18-8

adapter framework instance

- load balancing, 17-13

- managing, 17-13
- specifying which applications use an adapter framework instance, 17-13
- updating, 17-14
- viewing, 17-15
- adapter interactions
 - accessing adapter interaction management tasks, 11-6
 - adding, 11-7
 - adding a CICS adapter, 11-10
 - adding a File/FTP adapter interaction, 11-14
 - adding a J.D. Edwards OneWorld XE adapter, 11-10
 - adding a JMS adapter interaction, 11-18
 - adding a PeopleSoft 8 adapter, 11-9
 - adding a Siebel 2000 adapter, 11-10
 - adding a Tuxedo adapter, 11-10
 - adding a VSAM adapter, 11-10
 - adding a Web Service adapter interaction, 11-23
 - adding an Advanced Queuing adapter interaction, 11-11, 11-13
 - adding an E-Mail adapter interaction, 11-13
 - adding an HTTP adapter interaction, 11-16
 - adding an IMS/DB adapter, 11-10
 - adding an IMS/TM adapter, 11-10
 - adding an Oracle Database adapter interaction, 11-20
 - adding an SAP R/3 adapter, 11-9
 - definition, 3-19, 11-2, 11-4
 - deleting, 11-35
 - difficulty in updating, 7-15, 7-19
 - example, 3-20
 - group name, 11-36
 - guidelines for Oracle Database adapter SQL queries, 11-21
 - impact of deleting, 22-12
 - list page overview, 5-34
 - managing, 11-4
 - Oracle record type elements for which to create native event body elements, 11-26
 - overview, 11-2
 - overview of adding, 11-7
 - restrictions on adding the same interaction a second time, 11-10
 - restrictions on deleting, 11-35
 - reviewing your selections prior to creation, 11-25
 - selecting the Create Native Event Type box, 11-25
 - specifying a native format, 11-26
 - tutorial example, 7-14, 7-19
 - tutorial update example, 7-77
 - viewing, 11-36
- adapter providers
 - viewing, 17-11
- adapter use cases
 - Advanced Queuing adapter, 8-27
 - E-Mail adapter, 8-37
 - File/FTP adapter, 8-43
 - HTTP adapter, 8-55
 - JMS adapter, 8-71
 - Oracle Database adapter, 8-88
 - Web Service adapter, 8-100
- adapter-centric methodology
 - definition, 6-3
 - for designing an integration, 6-3
 - when to use, 6-4
- adapters
 - accessing adapter administration tasks, 17-8
 - accessing adapter management tasks, 15-10
 - adding multiple adapters to an application, 15-13
 - adding to an application, 15-12
 - adding to the system, 17-9
 - administering, 17-5
 - Advanced Queuing adapter, 8-11
 - application adapters, 3-53
 - B2B protocol adapters, 3-55
 - concepts, 3-6
 - creating error code messages, 17-11
 - definition, 3-51, 4-9
 - deleting from the system, 17-10
 - documentation, 19-5
 - E-Mail adapter, 8-30
 - example of adding an interaction, 8-5
 - example of creating a delivery channel, 8-4
 - example of viewing native and application event body elements, 8-6
 - example of viewing the interaction, 8-9
 - File/FTP adapter, 8-38

- for Advanced Queuing, 19-8
- for File/FTP, 19-9
- for Oracle Database, 19-9
- HTTP adapter, 8-44
- in application agreements, 15-3
- JMS adapter, 8-58
- managing, 15-9
- Oracle Application Server ProcessConnect support, 3-11
- Oracle Database adapter, 8-75
- overview of adapter chapter layout, 8-2
- performance, 19-4
- prepackaged adapters that cannot be deleted or updated, 17-5
- removing from an application, 15-13
- setting parameters, 19-5, 19-10
- tasks you perform in the user interface tool, 8-4
- technology adapters, 3-51
- tutorial creation example, 7-8, 7-11, 7-69
- viewing, 15-13, 17-10
- Web Service adapter, 8-92
- add button
 - differences with create button, 5-13
- Add End-to-End Basic Event Flow wizard, 9-8
 - adding event flow to two spokes, 9-22
- Add Event Flow wizard, 9-12
 - adding event flow to a single spoke, 9-26
 - tutorial use example, 7-61
- admin password, 20-2
- admin user
 - protects modeling metadata and profile data, 20-3
 - roles and privileges, 20-2
 - username for accessing the user interface tool, 5-2
- administration
 - tasks, 17-2
 - with Oracle Enterprise Manager, 17-2
 - with the user interface tool, 17-2
- administration tab
 - overview of tasks, 5-46
- Administrator role
 - adding to a user of a host trading partner, 25-23
 - required for connecting to the user interface tool, 25-12
 - role for admin user, 20-2
- administrators
 - chapters to read, 1-9, 1-10
 - how to use this guide, 1-3
 - responsibilities, 3-3
- Advanced Queuing adapter, 19-8
 - adapter exchange protocols, 8-14
 - adding a listener port, 15-16
 - adding an adapter interaction, 11-11
 - adding to an application, 15-12
 - additional setup tasks, 8-19
 - application integration and runtime behavior, 8-20
 - benefits of using, 8-12
 - common problems and solutions, 8-22
 - creating a delivery channel, 15-16
 - definition, 3-52
 - delivery channel description, 8-13
 - design-time tasks, 8-15
 - diagnostics and troubleshooting, 8-21
 - errors, 8-18
 - interaction and record naming restrictions, 8-17
 - interaction questions, 11-11
 - limitations, 8-21
 - native event validation failure, 8-18
 - Oracle Object Queue adapter exchange protocol, 8-14
 - Oracle Object Queue adapter exchange protocol naming conventions, 8-15
 - Oracle Object Queue with payload fields adapter exchange protocol, 8-14
 - Oracle Object Queue with payload fields adapter exchange protocol naming conventions, 8-15
 - Oracle record naming conventions, 8-20
 - queue privileges setup tasks, 8-19
 - queue runtime state setup tasks, 8-19
 - RAW Queue adapter exchange protocol, 8-14
 - RAW Queue adapter exchange protocol naming conventions, 8-15
 - specifying a spoke database, 15-16
 - supported Oracle databases, 8-13
 - supported versions, 8-13
 - use case, 8-27
 - use case adapter exchange protocol, 8-29

- use case delivery channel questions, 8-27
- use case delivery channel selection list, 8-28
- use case interaction questions, 8-28
- validation prerequisites, 8-18
- agreements
 - concepts, 3-7
 - displaying in an integration diagram, 12-16
 - lifecycle states, 3-60
 - list page overview, 5-42
 - Oracle Application Server ProcessConnect support, 3-12
 - types, 3-57, 3-58
- agreements tab
 - overview of tasks, 5-42
- alerts
 - e-mail message example, 21-17
 - using token substituted text in e-mails, A-129
- analysts
 - chapters to read, 1-10
 - how to use this guide, 1-3
 - responsibilities, 3-3
- And step
 - cannot create step data flow for, 12-98
 - cannot create step ports for, 12-91
 - definition, 12-78
 - ensuring valid design, 12-124
 - examples of invalid design, 12-124
 - examples of valid design, 12-124
 - execution, 12-78
 - for merging parallel paths, 12-124
 - supported control flows and data flows, 12-78
 - supported ports, 12-78
 - supported roles, 12-78
- application adapters, 3-53
 - managing adapter interactions, 11-4
 - managing delivery channels, 15-9
 - not compatible with Oracle Application Server InterConnect, 3-53
- application agreement approvals
 - overview, 15-44
 - tutorial example, 7-38, 7-40, 7-72
- application agreement native roles
 - accessing application agreement native role management tasks, 15-42
 - adding, 15-43
 - example, 15-3
 - managing, 15-41
 - overview, 15-2
 - removing, 15-43
- application agreement participants
 - adding, 15-33
 - example, 15-3
 - overview, 15-2
 - viewing, 15-36
- application agreements
 - accessing application agreement management tasks, 15-31
 - adding a delivery channel, 15-37
 - adding application participants, 15-33
 - common user errors, 15-45
 - creating, 15-32
 - definition, 3-58
 - deleting, 15-33
 - example, 15-3
 - impact of deleting, 22-13
 - managing, 15-29
 - overview, 15-2
 - removing a delivery channel, 15-38
 - tutorial creation example, 7-36, 7-39, 7-71
 - tutorial validation example, 7-38, 7-40, 7-72
 - updating, 15-34
 - updating a delivery channel, 15-38
 - validation and approval, 15-44
 - viewing, 15-34
 - viewing the lifecycle states, 15-35
- application approval
 - tutorial example, 7-9, 7-12, 7-70
- application datatypes
 - automatically deleted when native event is deleted, 10-55
 - cannot delete with user interface tool, 10-55
 - cannot update with user interface tool, 10-55
 - definition, 3-32
 - examples, 10-7
 - managing, 10-55
 - restrictions on deleting, 10-55
 - supported, 10-3
 - tutorial example, 7-22
 - viewing, 10-55
- application events

- creating, 11-27
- definition, 3-30, 11-3
- rules to follow when deleting, 7-77
- tutorial creation example, 7-15, 7-20, 7-64
- tutorial example of updating an application event, 7-77
- viewing, 11-60
- application participants
 - adding to an application agreement, 15-33
- application role threads, 19-10
- application roles
 - definition, 3-33, 12-42
 - managing, 12-40
- application types
 - accessing application type administration tasks, 17-36
 - adding, 15-6
 - administering, 17-35
 - creating, 17-37
 - required for including an application in a deployed configuration, 15-6
 - tutorial creation example, 7-7, 7-10, 7-69
 - viewing, 17-37
- application validation
 - tutorial example, 7-9, 7-12, 7-70
- application-level concepts
 - of modeling metadata, 3-30
- applications
 - accessing application management tasks, 15-5
 - adding a CICS adapter, 15-12
 - adding a File/FTP adapter, 15-12
 - adding a J.D. Edwards OneWorld XE adapter, 15-12
 - adding a JMS adapter, 15-12
 - adding a PeopleSoft 8 adapter, 15-12
 - adding a Siebel 2000 adapter, 15-12
 - adding a Tuxedo adapter, 15-12
 - adding a VSAM adapter, 15-12
 - adding a Web Service adapter, 15-12
 - adding an Advanced Queuing adapter, 15-12
 - adding an E-Mail adapter, 15-12
 - adding an HTTP adapter, 15-12
 - adding an IMS/DB adapter, 15-12
 - adding an IMS/TM adapter, 15-12
 - adding an Oracle Database adapter, 15-12
 - adding an SAP R/3 adapter, 15-12
 - adding multiple adapters, 15-13
 - common user errors, 15-45
 - creating, 15-5
 - definition, 3-51
 - deleting, 15-6
 - impact of deleting, 22-13
 - in application agreements, 15-3
 - list page overview, 5-41
 - managing, 15-4
 - overview, 15-2
 - tutorial creation example, 7-7, 7-10, 7-69
 - updating, 15-6
 - validation and approval, 15-44
 - viewing, 15-7
 - viewing the lifecycle states, 15-8
- applications tab
 - overview of tasks, 5-41
- application-to-application (A2A) integration
 - challenges, 2-5
 - definition, 2-2
- approval lifecycle state
 - for profile data, 5-22
- approval of an application
 - tutorial example, 7-9, 7-12, 7-70
- approvals
 - exporting profile data to an XML file for approval, 5-15
 - of application agreements, 15-44
 - of applications, 15-44
 - of host trading partner, 25-93
 - of remote trading partners, 25-93
 - of trading partners, 26-33
 - of trading partners agreements, 26-33
 - tutorial example of an application agreement, 7-38, 7-40, 7-72
- approve button
 - on profile data details pages, 5-21
- approved lifecycle state
 - description, 5-18
- approvers
 - adding, 5-20
 - approval process, 5-22
 - deleting, 5-22
 - selecting approvers, 5-20

- updating, 5-22
- architecture
 - of Oracle Application Server ProcessConnect, 4-2
- authentication
 - guidelines, 24-4, 24-5
 - Oracle Application Server, 24-13
 - Oracle Application Server ProcessConnect RosettaNet Implementation Framework (RNIF) version 1.1 support, 24-13, 24-14
- authorization
 - guidelines, 24-4, 24-5
 - Oracle Application Server ProcessConnect RosettaNet Implementation Framework (RNIF) version 1.1 support, 24-13
 - Oracle Application Server ProcessConnect RosettaNet Implementation Framework (RNIF) version 2.0 support, 24-13
- automatic undo management, 19-17

B

- B2B adapter
 - RosettaNet support, 24-12
 - using the RosettaNet B2B protocol standard, 4-8
 - using the runtime repository, 4-7
- B2B integration
 - definition, 2-3
- B2B protocol adapters, 3-55
- B2B protocol standard
 - definition, 24-2
 - Oracle Application Server ProcessConnect support, 24-12
 - RosettaNet, 24-2
- basic authentication
 - with HTTP adapter, 8-50
- big-endian
 - definition, A-44
- binding role threads, 19-14
- browsers
 - accessing the user interface tool, 5-2
 - for accessing the user interface tool, 5-2
 - restrictions on using the browser back and forward buttons, 5-13, 23-1
- business administrators

- chapters to read, 1-9
- error handling, 21-2
- how to use this guide, 1-3
- responsibilities, 3-3
- business collaborations
 - definition, 24-20
 - Oracle Application Server ProcessConnect support, 24-24
- business datatypes
 - common set of business datatypes for integrations between parties, 3-38
 - creation method examples, 10-9
 - definition, 3-38
 - examples, 10-10
 - list page overview, 5-31
 - managing, 10-13
 - preset datatype attributes automatically included from original XSD file, 10-14, 10-23, 10-33, 10-44
 - supported, 10-3
 - tutorial creation example, 7-28, 7-48, 7-49
 - tutorial manual creation example, 7-73
- Business Dictionary
 - of RosettaNet, 24-10
- business domains
 - definition, 13-93, 13-104
- business event body elements
 - creating, 11-69
 - deleting, 11-70
 - tutorial creation example, 7-29, 7-49
 - updating, 11-70
 - viewing, 11-71
- business events
 - accessing business event management tasks, 11-65
 - completely abstract from any party
 - properties, 3-40
 - creating, 11-66
 - definition, 3-37, 11-3
 - deleting, 11-67
 - list page overview, 5-30
 - managing, 11-63
 - represents all corresponding application events of parties, 3-39
 - tutorial manual creation example, 7-48, 7-49

- updating, 11-67
- viewing, 11-68
- business intelligence
 - concepts, 3-7
 - Oracle Application Server ProcessConnect support, 3-12
- business intelligence reporting
 - setting a configuration level, 22-3
 - setting a logging level, 16-12
 - tutorial example, 7-42
- business logic layer error codes, C-27
- business message status reports
 - creating, 23-22
- business process managers
 - chapters to read, 1-8
 - how to use this guide, 1-2
 - responsibilities, 3-2
- business process threads, 19-10
- business process-centric methodology
 - definition, 6-11
 - for designing an integration, 6-11
 - when to use, 6-11
- business processes
 - accessing business process management tasks, 12-36
 - all business processes in design-time repository are included in a configuration, 16-3
 - common user errors, 12-135
 - creating, 12-36
 - creation by modeling wizards or manually, 12-10
 - definition, 3-44, 12-5
 - deleting, 12-37
 - diagrams, 12-11
 - graphical view, 12-6
 - impact of deleting, 12-37, 22-12
 - in a configuration, 16-9
 - managing, 12-33
 - overview, 12-2
 - role in integrations between enterprises, 24-2
 - updating, 12-37
 - viewing, 12-38
 - with multiple spokes, 9-3
- business processes tab
 - overview of tasks, 5-26

- business protocols
 - accessing business protocol management tasks, 25-43
 - adding, 25-45
 - contents of, 25-2
 - definition, 25-30
 - managing, 25-42
 - removing, 25-45
 - RosettaNet-RNIF1.1-PIP, 25-45
 - RosettaNet-RNIF2.0-PIP, 25-45
 - viewing, 17-38, 25-48
- business role threads, 19-10
- business roles
 - definition, 3-40, 12-42
 - list page overview, 5-28
 - managing, 12-40
- business transactions
 - definition, 24-19
 - Oracle Application Server ProcessConnect support, 24-23
- business-level concepts
 - of modeling metadata, 3-37
- business-to-business (B2B) integration
 - challenges, 2-5

C

- CICS adapter
 - adding an adapter interaction, 11-10
 - adding to an application, 15-12
 - creating a delivery channel, 15-15
- classifications
 - of datatypes, 10-2
- clusters
 - in partner interface processes (PIPs), 24-8
- collaboration status reports
 - creating, 23-21
- collaborations
 - assigning a time in which to process, 25-34
 - business collaborations, 24-19, 24-20
 - business transaction, 24-19
 - definition, 24-19
 - viewing, 17-40
- common user errors
 - application and application agreement, 15-45

- business processes and roles, 12-135
- datatypes, 10-65
- deployment, 16-7, 16-13
- events, 11-72
- modeling wizards, 9-41
- trading partner and trading partner agreements, 26-34
- transformation designs, 14-9
- tutorial, 7-43
- complex datatype members
 - accessing complex datatype member tasks, 10-25
 - creating, 10-26
 - deleting, 10-30
 - managing, 10-24
 - tutorial manual creation example, 7-75
 - updating, 10-31
 - viewing, 10-32
- complex datatypes
 - accessing complex datatype tasks, 10-18
 - compound member, 10-15
 - creating, 10-19
 - definition, 10-4
 - deleting, 10-20
 - include complex datatype members, 10-15
 - managing, 10-15
 - model groups, 10-20
 - restrictions on deleting, 10-20
 - scalar member, 10-15
 - tutorial manual creation example, 7-73, 7-75
 - updating, 10-21
 - viewing, 10-22
 - wildcard member, 10-16
- compound members
 - creating, 10-27
 - definition, 10-15
 - deleting, 10-30
 - updating, 10-31
 - viewing, 10-33
- concepts
 - adapters, 3-6
 - agreements, 3-7
 - business intelligence, 3-7
 - correlations, 3-5
 - data flows and control flows, 3-5
 - integrated view of data, 3-4
 - integration, 3-4
 - Oracle Application Server ProcessConnect support for adapters, 3-11
 - Oracle Application Server ProcessConnect support for agreements, 3-12
 - Oracle Application Server ProcessConnect support for an integrated view of data, 3-8
 - Oracle Application Server ProcessConnect support for business intelligence, 3-12
 - Oracle Application Server ProcessConnect support for correlation, 3-9
 - Oracle Application Server ProcessConnect support for data flows and control flows, 3-10
 - Oracle Application Server ProcessConnect support for transformation, 3-11
 - Oracle Application Server ProcessConnect support for translation, 3-10
 - Oracle Application Server ProcessConnect support for validation of native events, 3-11
 - transformations, 3-6
 - translations, 3-5
 - validations, 3-6
- concepts of application-level modeling
 - metadata, 3-30
- concepts of business-level modeling
 - metadata, 3-37
- concepts of native-level modeling metadata, 3-15
- concurrent conversations
 - assigning a value to a trading partner agreement, 26-16
- condition expressions
 - accessing condition expression management tasks, 12-110
 - building a condition parameter, 12-116
 - creating a condition expression, 12-111
 - creating a condition expression for a report, 23-12
 - creating a condition expression for an event map, 11-57
 - creating a condition parameter, 12-114
 - creating an expression for a native event correlation, 11-50

- creating an IF condition for a transformation
 - condition, 13-47
- deleting, 12-112
- deleting a condition parameter, 12-115
- impact of deleting, 22-12
- list page overview, 5-35
- managing, 12-108
- must first create at least one condition
 - parameter, 12-116
- selecting a condition expression while creating a
 - condition step, 12-82
- tutorial creation example, 7-50
- updating, 12-112
- updating a condition parameter, 12-115
- viewing a condition expression, 12-113
- viewing a condition parameter, 12-119
- condition expressions tab
 - overview of tasks, 5-35
- condition parameters
 - building, 12-116
 - creating, 12-114
 - deleting, 12-115
 - must first create one before building a condition
 - expression, 12-116
 - updating, 12-115
 - viewing, 12-119
- condition step
 - can only create input step ports, 12-91
 - definition, 12-75
 - example of use, 21-5
 - execution, 12-75
 - for using mutual exclusiveness in flows, 12-123
 - selecting a condition expression during condition
 - step creation, 12-82
 - selecting a guard value, 12-83
 - step return code port, 21-4
 - supported control flows and data flows, 12-75
 - supported ports, 12-75
 - supported roles, 12-75
 - tutorial creation example, 7-51
- configuration parameters
 - changing in Oracle Enterprise Manager, 18-8, 18-11
 - tutorial example of setting logging level
 - configuration parameters, 7-45
- configuration tab
 - overview of tasks, 5-47
- configurations
 - business process states, 16-5
 - business processes, 16-9
 - creating, 16-3
 - creating for deployment, 16-2
 - creation overview, 16-2
 - definition, 3-58, 16-2
 - deploying, 16-9
 - deployment overview, 16-9
 - discarding, 16-12
 - exporting, 16-12
 - includes all business processes in design-time
 - repository, 16-3
 - list page overview, 5-47
 - overview, 16-2
 - reports support, 23-3
 - setting a business intelligence reporting
 - level, 16-10
 - states, 16-4
 - stopping a deployed configuration, 16-11
 - tutorial example, 7-41, 7-72
 - validations, 16-2
- connection managers
 - chapters to read, 1-6
 - how to use this guide, 1-2
 - responsibilities, 3-2
- consume
 - definition, 3-36
- consume step
 - can only create input step ports, 12-91
 - definition, 3-36, 12-76
 - execution, 12-76
 - supported control flows and data flows, 12-76
 - supported ports, 12-76
 - supported roles, 12-76
 - use of, 3-36
- contact types
 - accessing contact type administration
 - tasks, 17-43
 - administering, 17-42
 - creating, 17-44
 - definition, 17-42
 - prepackaged contact types that you cannot delete

- or update, 17-42
 - updating, 17-45
 - viewing, 17-45
- content types
 - E-Mail adapter, 8-35
 - HTTP adapter, 8-47
- control flows
 - accessing step control flow management tasks, 12-104
 - assigning a guard value, 12-106
 - concepts, 3-5
 - creating, 12-105
 - definition, 3-29, 12-6
 - deleting, 12-107
 - do not have ports, 12-106
 - impact of deleting, 12-107, 22-12
 - managing, 12-102
 - Oracle Application Server ProcessConnect support, 3-10
 - selecting during step creation, 12-82
 - selecting the sequence order of flows, 12-105
 - tutorial creation example, 7-57
 - updating, 12-107
 - using guard values, 3-29
- cooperations
 - definition, 3-56
 - managing, 25-30
 - overview, 25-2
- coordination states
 - closed, 3-50
 - open, 3-50
- coordination status reports
 - creating, 23-13
 - example, 23-36
 - overview of report pages, 23-13
- coordinations
 - creating coordination status reports, 23-13
 - creation, 12-133
 - definition, 3-50, 12-133, 21-10
 - impact of aborting a coordination, 3-49
 - in reports, 23-36
- core datatypes
 - supported, 10-2
 - used with event transformation map rules, 10-2
 - viewing, 10-11

- correlation error codes, C-48
- CPU
 - viewing usage, 19-4
- create button
 - differences with add button, 5-13
- Create End-to-End Basic Integration wizard, 9-6
 - creating two spokes, 9-21
 - tutorial use example, 7-23
- Create Spoke wizard, 9-10
 - creating a single spoke, 9-23
 - tutorial use example, 7-66
- creation methods
 - modeling wizards or manual creation, 12-10

D

- D3L. *See* data definition description language (D3L)
- data definition description language (D3L), 3-34
 - all comma separated values are read into an array, A-66
 - assign attributes, A-79
 - assignment blocks, A-78
 - cardinality attribute values, A-72
 - character set encoding, A-85
 - ColorDefinition field, A-56
 - comma-separated values assigned to named fields, A-65
 - comma-separated values file parsing with D3L, A-64
 - conditional parsing (one token look ahead), A-82
 - constant length strings - padding, A-48
 - D3L document type, A-68
 - D3L DTD, A-96
 - D3L file examples, A-39, A-40, A-91, A-93, A-95
 - D3L scalar fields, A-86
 - D3L structs, A-87
 - D3L typedef, A-87
 - D3L typeref, A-87
 - data padding usage, A-63
 - date formats supported, A-54
 - dates - date, A-53
 - declaration file example, A-96
 - defining events, A-42
 - definition, 3-31, A-37

- definition file, A-68
- delimited array cardinality, A-72
- delimited arrays - limarray, A-57
- delimited strings - limstring, A-49
- delimiter encoding styles, A-66
- distance and age fields, A-46
- escape character and sequences, A-75
- field attribute validvalues, A-84
- field optionality, A-73
- field separators, A-71
- field terminators, A-71
- file structure example, A-40
- fixed length arrays - fixarray, A-59
- floating point numbers, A-46
- implicit length arrays - imparray, A-59
- import examples, A-88
- import function, A-70
- importing D3L datatypes, A-85
- length prefixed arrays - pfxarray, A-58
- length prefixed strings - pfxstring, A-49
- message definition file example, A-96
- nonscalar D3L fields, A-87
- optionally-quoted terminated strings -
 qtdtermstring, A-51
- overview of support, A-37
- prepackaged native format, 17-16
- quantity field, A-44
- sequences and arrays, A-57
- signed and unsigned integers, A-43
- simple strings - simplestring, A-52
- strict vs. lenient (relaxed) translation
 modes, A-80
- string-based numbers - number, A-55
- strings and dates, A-47
- structures, A-56
- supported datatypes, A-43
- supported native format, 10-2
- supported translator, 3-31
- system variables, A-77
- temperature, pressure, and wind fields, A-45
- terminated strings - termstring, A-50
- type aliasing, A-81
- unsuitable D3L formats, A-37
- validation - D3L valid values, A-84
- values in the D3L file, A-42
- variable declaration, A-76
- variables, A-76
- weight and length field, A-44
- when to use, A-37
- wire message examples, A-39, A-92, A-94
- data definition description language (D3L)
 translator
 creating an event body element, 11-32
- data flow criteria
 creating, 12-62
 creation with the modeling wizards or
 manually, 12-10
 definition, 12-58
- data flow groups
 definition, 12-58
 impact of deleting, 12-69, 22-12
- data flows
 concepts, 3-5
 definition, 3-29
 deleting a data flow between a role port and a
 step port, 12-57
 impact of deleting, 22-12
 invalid merging of data flows between role
 ports, 12-130
 invalid merging of data flows from step ports to
 role port, 12-124
 Oracle Application Server ProcessConnect
 support, 3-10
 tutorial creation example, 7-55, 7-56
- data universal numbering system (DUNS)
 assigning as trading partner identification, 25-9
 party ID example, 24-18
- datatype format file
 specifying during native and application event
 creation, 11-28
- datatype namespaces
 accessing namespace tasks, 10-61
 creating, 10-63
 definition, 10-5
 deleting, 10-63
 managing, 10-59
 updating, 10-63
 viewing, 10-64
- datatype transformation maps
 accessing datatype transformation map

- management tasks, 13-23
- creating, 13-24
- definition, 13-4
- deleting, 13-24
- impact of deleting, 22-12
- managing, 13-21
- restrictions on deleting, 13-24
- system-defined maps, 13-4
- system-defined maps cannot be deleted, 13-24
- system-defined maps cannot be updated, 13-25
- updating, 13-25
- user-defined maps, 13-4
- viewing, 13-25

datatypes

- application, 10-3
- application datatype definition, 3-32
- business, 10-3
- business datatype definition, 3-38
- common user errors, 10-65
- complex, 10-4
- core, 10-2
- creating a facet for a scalar datatype, 10-45
- creating a valid value for the enumeration or pattern facet of a scalar datatype, 10-49
- creating complex datatype members, 10-26
- creating complex datatypes, 10-19
- creating compound members, 10-27
- creating namespaces, 10-63
- creating scalar datatypes, 10-41
- creating scalar members, 10-28
- creating wildcard members, 10-29
- deleting a facet of a scalar datatype, 10-47
- deleting a valid value for the enumeration or pattern facet of a scalar datatype, 10-49
- deleting complex datatype members, 10-30
- deleting complex datatypes, 10-20
- deleting compound members, 10-30
- deleting namespaces, 10-63
- deleting scalar datatypes, 10-42
- deleting scalar members, 10-30
- deleting wildcard members, 10-31
- examples of datatype formats, 10-5
- in token substituted text, A-128
- managing application datatypes, 10-55
- managing business datatypes, 10-13
- managing complex datatype members, 10-24
- managing complex datatypes, 10-15
- managing namespaces, 10-59
- managing scalar datatypes, 10-36
- namespaces, 10-5
- native, 10-3
- native datatype definition, 3-23
- overview of support, 10-2
- scalar, 10-4
- specifying a datatype format file during native and application event creation, 11-28
- supported by D3L, A-43
- supported classifications, 10-2
- updating a facet of a scalar datatype, 10-47
- updating a valid value for the enumeration or pattern facet of a scalar datatype, 10-50
- updating complex datatype members, 10-31
- updating complex datatypes, 10-21
- updating compound members, 10-31
- updating namespaces, 10-63
- updating scalar datatypes, 10-43
- updating scalar members, 10-32
- updating wildcard members, 10-32
- viewing a facet of a scalar datatype, 10-48
- viewing application datatypes, 10-55
- viewing complex datatype members, 10-32
- viewing complex datatypes, 10-22
- viewing compound members, 10-33
- viewing core datatypes, 10-11
- viewing namespaces, 10-64
- viewing scalar datatypes, 10-43
- viewing scalar members, 10-34
- viewing the native event validation metadata to be used, 10-58
- viewing the translator of native datatypes, 10-58
- viewing wildcard members, 10-34

datatypes tab

- overview of tasks, 5-31

delete button

- differences with remove button, 5-13

delivery

- managing, 25-50
- overview, 25-2

delivery and security

- definition, 3-56
- managing, 25-50
- overview, 25-2
- delivery channels
 - accessing delivery channel management tasks, 15-10, 25-74
 - adding to a trading partner agreement, 26-26
 - adding to an application agreement, 15-37
 - assigning a document exchange, 25-76
 - assigning a global usage code, 25-76
 - assigning a transport, 25-76
 - assigning an acknowledgment mode, 25-76
 - assigning nonrepudiation, 25-76
 - contents, 24-18, 25-2
 - creating, 25-75
 - creating a CICS adapter delivery channel, 15-15
 - creating a File/FTP adapter delivery channel, 15-18
 - creating a IMS/DB adapter delivery channel, 15-15
 - creating a IMS/TM adapter delivery channel, 15-15
 - creating a J.D. Edwards OneWorld XE adapter delivery channel, 15-15
 - creating a JMS adapter delivery channel, 15-22
 - creating a PeopleSoft 8 adapter delivery channel, 15-15
 - creating a Siebel 2000 adapter delivery channel, 15-15
 - creating a Tuxedo adapter delivery channel, 15-15
 - creating a VSAM adapter delivery channel, 15-15
 - creating an Advanced Queuing adapter delivery channel, 15-16
 - creating an E-Mail adapter delivery channel, 15-17
 - creating an HTTP adapter delivery channel, 15-20
 - creating an Oracle Database adapter delivery channel, 15-24
 - creating an SAP R/3 adapter delivery channel, 15-15
 - creating for an application, 15-14
 - creating Web Service adapter delivery channel, 15-25
 - definition, 24-18, 25-73
 - deleting, 25-77
 - deleting from an application, 15-26
 - document exchange, 24-18, 24-22
 - enabling encryption, 25-76
 - enabling transport security, 25-77
 - entering a retry count, 25-77
 - entering an acknowledgment time, 25-77
 - in application agreements, 15-3
 - managing, 15-9, 25-73
 - Oracle Application Server ProcessConnect support, 24-22
 - removing from a trading partner agreement, 26-27
 - removing from a trading partner agreement participant, 26-28
 - removing from an application agreement, 15-38
 - restrictions on use of \$ORACLE_HOME, 7-9, 7-11
 - transport layer, 24-18
 - tutorial creation example, 7-8, 7-69
 - tutorial example of adding to an application agreement, 7-37, 7-39, 7-71
 - updating, 25-78
 - updating for an application, 15-26
 - updating in an application agreement, 15-38
 - viewing, 25-78
 - viewing for a trading partner agreement participant, 26-28
 - viewing for an application, 15-27
 - viewing in an application agreement, 15-39
- dependencies
 - example of modeling metadata dependencies, 22-9, 22-11, 22-12, 22-14
 - when deleting modeling metadata, 22-11, 22-12, 22-14
- deployed lifecycle state
 - description, 5-18
 - for modeling metadata and profile data, 5-23
- deployment
 - business process states, 16-5
 - common user errors, 16-7, 16-13
 - configuration overview, 16-2
 - definition, 3-58, 4-3

- lifecycle states, 3-64
- of a configuration, 3-58, 16-9
- of business processes in a configuration, 16-9
- of integrations in runtime repository, 4-6
- overview, 16-2, 16-9
- setting a business intelligence reporting level, 16-10
- tutorial example, 7-41, 7-72
- deployment error codes, C-94
- deployment tab
 - overview of tasks, 5-44
- design
 - flexibility of user interface tool, 4-5, 5-12, 6-2
- design concepts
 - adapters, 3-6
 - agreements, 3-7
 - business intelligence, 3-7
 - correlations, 3-5
 - data flows and control flows, 3-5
 - integrated view of data, 3-4
 - integration, 3-4
 - Oracle Application Server ProcessConnect support for adapters, 3-11
 - Oracle Application Server ProcessConnect support for agreements, 3-12
 - Oracle Application Server ProcessConnect support for an integrated view of data, 3-8
 - Oracle Application Server ProcessConnect support for business intelligence, 3-12
 - Oracle Application Server ProcessConnect support for correlations, 3-9
 - Oracle Application Server ProcessConnect support for data flows and control flows, 3-10
 - Oracle Application Server ProcessConnect support for transformation, 3-11
 - Oracle Application Server ProcessConnect support for translation, 3-10
 - Oracle Application Server ProcessConnect support for validation of native events, 3-11
 - transformations, 3-6
 - translations, 3-5
 - validations, 3-6
- design tools, 19-15
 - definition, 4-3, 4-5
 - modeling incomplete metadata and profile data, 5-12
- design-time repository
 - definition, 4-3
 - responsibilities, 4-5
 - stores modeling metadata and profile data prior to deployment, 3-13
- details pages
 - overview, 5-8
- diagnostics
 - Advanced Queuing adapter, 8-21
 - E-Mail adapter, 8-37
 - File/FTP adapter, 8-43
 - HTTP adapter, 8-54
 - JMS adapter, 8-70
 - Oracle Database adapter, 8-87
 - Web Service adapter, 8-99
- diagrams
 - accessing, 12-11, 12-12
 - in user interface tool, 5-10
 - of roles and business processes, 12-11
 - tasks you can perform from an integration diagram, 12-16
 - viewing a process diagram, 12-23
 - viewing a step binding diagram, 12-28
 - viewing an event flow diagram, 12-18
 - viewing an integration diagram, 12-15
- differences
 - between creating and adding commands, 5-13
 - between deleting and removing commands, 5-13
- digital envelopes, 20-3
 - assigning to a document exchange, 25-67
 - viewing, 17-47
- digital signatures, 20-3
 - assigning to a document exchange, 25-68
 - viewing, 17-48
- document exchanges
 - accessing document exchange management tasks, 25-66
 - assigning a digital envelope, 25-67
 - assigning a digital signature, 25-68
 - assigning a signing credential, 25-67
 - assigning an encryption credential, 25-67

- assigning an exchange protocol, 25-67
- assigning to a delivery channel, 25-76
- creating, 25-67
- definition, 24-18, 24-22, 25-2, 25-63
- deleting, 25-69
- enabling RosettaNet validation, 25-68
- managing, 25-63
- Oracle Application Server ProcessConnect support, 24-22
- RosettaNet Implementation Framework (RNIF)
 - example, 24-18, 24-22
 - updating, 25-69
 - viewing, 25-70
- document protocols
 - definition, 25-30
 - viewing, 25-45
- documentation
 - chapters for all users to read, 1-4
 - chapters for analysts to read, 1-10
 - chapters for business administrators to read, 1-9
 - chapters for business process managers to read, 1-8
 - chapters for connection managers to read, 1-6
 - chapters for event managers to read, 1-7
 - chapters for systems administrators to read, 1-10
 - how to use this guide, 1-2
- domain column
 - creating, 13-92
 - deleting, 13-94
 - updating, 13-94
 - viewing, 13-95
- domain columns and parties
 - managing, 13-90
- domain errors
 - definition, 21-3
- domain party
 - adding, 13-95
 - definition, 13-84
 - removing, 13-97
- domain value map
 - advanced transformation designs
 - multiple party to single domain relationship, 14-47
 - case study, 13-110
- domain value map columns
 - adding, 13-101
 - definition, 13-84
 - deleting, 13-101
- domain value map columns and rows
 - managing, 13-97
- domain value map error codes, C-48
- domain value map rows
 - creating, 13-102
 - definition, 13-84
 - deleting, 13-103
 - updating, 13-103
- domain value map rules
 - creating, 13-106
 - definition, 13-28, 13-104
 - deleting, 13-109
 - examples, B-41
 - updating, 13-109
- domain value mapping
 - domain party, 13-84
- domain value maps
 - adding a domain party, 13-95
 - adding domain value map columns, 13-101
 - business domain, 13-93
 - creating, 13-87
 - creating a domain column, 13-92
 - creating domain value map rows, 13-102
 - definition, 3-39, 13-84
 - deleting, 13-88
 - deleting a domain column, 13-94
 - deleting domain value map columns, 13-101
 - deleting domain value map rows, 13-103
 - domain value map, 13-84
 - domain value map columns, 13-84
 - domain value map rows, 13-84
 - managing, 13-85
 - overview, 13-83
 - removing a domain party, 13-97
 - updating, 13-88
 - updating a domain column, 13-94
 - updating domain value map rows, 13-103
 - viewing, 13-89
 - viewing a domain column, 13-95
- draft lifecycle state
 - description, 5-17

for modeling metadata and profile data, 5-18
DUNS. *See* data universal numbering system
(DUNS)

E

e-business

definition, 2-2
importance of, 2-4

ELSE conditions

creating, 13-52
definition, 13-27
deleting, 13-54

e-mail

assigning as the organization contact
information, 25-28

E-Mail adapter

adapter exchange protocols, 8-32
adapter framework instance requirements, 8-36
adding an adapter interaction, 11-13
adding to an application, 15-12
additional setup tasks, 8-36
application integration and runtime
behavior, 8-36
benefits of using, 8-30
content type definition, 8-35
content types, 8-35
creating a delivery channel, 15-17
definition, 3-52
delivery channel description, 8-31
design-time tasks, 8-32
diagnostics and troubleshooting, 8-37
errors, 8-35
event map requirements, 8-35
IMAP server for inbound interactions, 8-31
interaction and record naming restrictions, 8-35
interaction questions, 11-13
limitations, 8-36
Receive E-Mail adapter exchange protocol, 8-32
Receive E-Mail adapter exchange protocol
naming conventions, 8-34
Send E-Mail adapter exchange protocol, 8-32
Send E-Mail adapter exchange protocol naming
conventions, 8-33
SMTP server for outbound interactions, 8-31

support for IMAP4, 8-36
supported versions, 8-31
use case, 8-37
used with token substituted text translator, 3-31
using with alert e-mails, 21-17, A-124
validation prerequisites, 8-35

encryption

enabling in a delivery channel, 25-76
guidelines, 24-5
of host trading partner passwords in high
availability environments, 20-13
of wallet passwords for host trading
partners, 20-12
Oracle Application Server ProcessConnect
RosettaNet Implementation Framework
(RNIF) version 2.0 support, 24-14

encryption credentials

assigning, 25-67

End step

definition, 12-72
execution, 12-72
supported control flows and data flows, 12-72
supported ports, 12-72
supported roles, 12-72

endpoints

accessing endpoint management tasks, 25-81
creating, 25-82
definition, 3-56
deleting, 25-82
entering a URI, 25-82, 25-87
managing, 25-79, 25-80
overview, 25-2
updating, 25-83
viewing, 25-83

enterprise application integration (EAI). *See*
application-to-application (A2A)

environmental variables

restrictions on using when creating a delivery
channel, 15-16

error codes

adapter error codes, C-20
business logic layer error codes, C-27
correlation error codes, C-48
deployment error codes, C-94
domain value map error codes, C-48

- event validation error codes, C-47
- metadata validation rules error codes, C-49
- repository error codes, C-13
- RosettaNet validation error codes, C-119
- runtime error codes, C-2
- transformation error codes, C-42
- translation error codes, C-45
- transport error codes, C-100
- user interface tool modeling error codes, C-96
- error handling
 - alert e-mail message example, 21-17
 - by business administrator, 21-2
 - by system administrator, 21-2
 - checking the Oracle Process Management Notification (OPMN) log, 21-15
 - coordination status reports, 21-13
 - creating a step return code port, 21-7
 - domain error modeling examples, 21-8, 21-9
 - domain errors, 21-2
 - during event processing, 12-135
 - error reports, 21-13
 - event status reports, 21-13
 - finding runtime error details, 21-13
 - implications of role instances and event instances
 - being in an error state, 21-10
 - logs files for integration manager and adapter framework, 21-14
 - logs files for OC4J instance, 21-14
 - monitoring from Oracle Enterprise Manager, 21-14
 - step return code port, 21-4
 - step return code port example, 21-6
 - system errors, 21-2
 - types of errors, 21-3
 - typical adapter framework errors, 21-15
 - typical integration manager errors, 21-16
- error states
 - of role and event instances, 21-10
- error status report
 - example, 23-38
- error status reports
 - creating, 23-17
 - overview of report pages, 23-17
- errors
 - adapter framework, 21-15
 - domain, 21-3
 - integration manager, 21-16
 - system, 21-3
- event addressing
 - with an event header rule, 3-47
 - with the SetParty step, 3-47
- event body elements
 - cannot identify native format of application datatypes, 3-32
 - creating, 11-27
 - creating for business events after modeling wizard creation, 9-37
 - creating if you specified a D3L translator, 11-32
 - creating if you specified a token substituted text translator, 11-31
 - creating if you specified an XSD translator, 11-30
 - definition, 3-16
 - in token substituted text, A-128
 - of native events, 3-20
 - viewing native event body elements, 11-44
- event flow
 - in a spoke, 9-5
- event flow diagrams
 - add event flow from the event flow diagram, 12-20
 - add event flow to two existing spokes, 12-20
 - change the scale, 12-21
 - create a spoke from the event flow diagram, 12-20
 - definition, 12-14
 - delete a spoke, 12-20
 - display a complete process diagram, 12-20
 - display a role and adjacent roles, 12-20
 - display all roles in two spokes, 12-20
 - display details pages of selections, 12-19
 - display ports of roles, 12-20
 - display steps, 12-20
 - drill down to process or step binding diagram, 12-19
 - viewing, 12-18
- event header rules
 - advanced transformation design
 - retrieving contact/identifier information after getting the party, 14-46

- case study, 13-82
- creating, 13-78
- definition, 13-28, 13-77
- examples, B-40
- for addressing parties, 3-47
- tutorial creation example, 7-68
- tutorial use example, 7-68
- updating, 13-81
- event headers
 - contents, 3-16
- event instances
 - behavior during runtime, 3-49
 - creation, 12-133
 - definition, 3-16
 - implications of being in an error state, 21-10
- event managers
 - chapters to read, 1-7
 - how to use this guide, 1-2
 - responsibilities, 3-2
- event maps
 - accessing event map management tasks, 11-56
 - creating, 11-57
 - creating a condition expression for an event map, 11-57
 - definition, 3-26, 11-3, 11-55
 - deleting, 11-58
 - E-Mail adapter requirements, 8-35
 - File/FTP adapter requirements, 8-41
 - HTTP adapter requirements, 8-49
 - impact of deleting, 22-12
 - JMS adapter requirements, 8-63
 - managing, 11-54
 - tutorial creation example, 7-18, 7-22, 7-59, 7-65
 - updating, 11-59
 - viewing, 11-59
- event selector timeout, 19-11
- event states
 - active, 3-49
 - consumed, 3-49
 - error, 3-49
 - wait, 3-49
- event status reports
 - creating, 23-8
 - example, 23-32
 - overview of report pages, 23-8
- event transformation map statements
 - associating a statement with an IF condition or ELSE condition, 13-52
 - creating a domain value map rule, 13-106, 13-109
 - creating a map variable, 13-71
 - creating a transformation rule, 13-32
 - creating an ELSE condition, 13-52
 - creating an event header rule, 13-78
 - creating an IF condition, 13-46
 - creating an iterator, 13-59
 - deleting a domain value map rule, 13-109
 - deleting a map variable, 13-73
 - deleting a transformation rule, 13-40
 - deleting an ELSE condition, 13-54
 - deleting an IF condition, 13-54
 - deleting an iterator, 13-61
 - domain value map case study, 13-110
 - event header rule case study, 13-82
 - iterator case study, 13-62
 - managing, 13-29
 - map variable case study, 13-74
 - removing a statement from an IF condition or ELSE condition, 13-54
 - transformation condition case study, 13-55
 - transformation rule case study, 13-41
 - updating a map variable, 13-74
 - updating a transformation rule, 13-41
 - updating an event header rule, 13-81
 - updating an IF condition, 13-54
 - updating an iterator, 13-61
 - using a map variable in a rule, 13-73
- event transformation maps
 - accessing domain column and party management tasks, 13-91
 - accessing domain value map column and row management tasks, 13-100
 - accessing domain value map management tasks, 13-86
 - accessing domain value map rule management tasks, 13-105
 - accessing event header rule management tasks, 13-77
 - accessing event type transformation map management tasks, 13-8

- accessing iterator management tasks, 13-58
- accessing map variable management tasks, 13-70
- accessing transformation condition management tasks, 13-45
- creating, 13-9
- creating additional sources and targets, 13-17
- definition, 13-3
- deleting, 13-13
- deleting sources and targets, 13-18
- impact of deleting, 13-18, 22-12
- impact of updating, 13-19
- list page overview, 5-33
- managing, 13-5
- tutorial creation example, 7-32, 7-34, 7-52
- tutorial deletion example, 7-79
- updating, 13-13
- updating sources and targets, 13-19
- used with core datatypes, 10-2
- viewing, 13-14
- viewing an event transformation map parameter, 13-20
- event types
 - definition, 3-16
 - structure, 3-16
- event types tab
 - overview of tasks, 5-30
- event validation error codes, C-47
- events
 - accessing business event management tasks, 11-65
 - adding native event body element validation, 11-45
 - application event definition, 3-30
 - business event definition, 3-37
 - common user errors, 11-72
 - creating business event body elements, 11-69
 - creating business events, 11-66
 - creating native events, 11-40
 - defining in a D3L file, A-42
 - definition, 3-16
 - deleting business event body elements, 11-70
 - deleting business events, 11-67
 - deleting native events, 11-42
 - impact of deleting, 22-13

- managing business events, 11-63
- managing native events, 11-37
- native event definition, 3-20
- overview, 11-2
- runtime behavior, 3-49
- states of events during runtime behavior, 3-49
- updating business event body elements, 11-70
- updating business events, 11-67
- viewing application events, 11-60
- viewing business event body elements, 11-71
- viewing business events, 11-68
- viewing native event body elements, 11-44
- viewing native events, 11-42
- exchange protocols
 - assigning, 25-67
 - definition, 25-30
 - RosettaNet - 01.10, 25-67
 - RosettaNet - 02.00, 25-67
 - updating override elements, 25-71
 - updating protocol parameters, 25-71
 - viewing, 25-46
- export
 - an integration to a file, 17-53
 - deleting an approver, 5-22
 - details about exporting an integration to a file, 17-53
 - location on user interface tool, 5-9
 - modeling metadata and profiled data, 5-48
 - of a configuration, 16-12
 - of profile data to an XML file, 5-15
 - only certain profile data details pages have export button, 5-16
 - profile data details pages with export button, 5-16
 - restrictions on export of modeling metadata, 5-15
 - submitting an XML file for approval, 5-21
 - three types of export supported, 17-53
 - updating an approver, 5-22
- export.xml file
 - importing an integration to, 17-56

F

- facets

- creating a valid value for the enumeration or
 - pattern facet of a scalar datatype, 10-49
- creating for a scalar datatype, 10-45
- datatype length, 10-45
- definition, 10-36
- deleting a valid value for the enumeration or
 - pattern facet of a scalar datatype, 10-49
- deleting for a scalar datatype, 10-47
- encoding, 10-45
- enumeration, 10-45
- fraction digits, 10-45
- max exclusive, 10-45
- max inclusive, 10-46
- max length, 10-46
- min exclusive, 10-46
- min inclusive, 10-46
- min length, 10-46
- pattern, 10-46
- total digits, 10-46
- updating a valid value for the enumeration or
 - pattern facet of a scalar datatype, 10-50
- updating for a scalar datatype, 10-47
- viewing for a scalar datatype, 10-48
- white spaces, 10-46

fax

- assigning as the organization contact
 - information, 25-28

File/FTP adapter, 19-9

- adapter exchange protocols, 8-39
- adapter framework instance restrictions, 8-42
- adding an adapter interaction, 11-14
- adding to an application, 15-12
- additional setup tasks, 8-42
- application integration and runtime
 - behavior, 8-42
- benefits of using, 8-38
- creating a delivery channel, 15-18
- definition, 3-52
- delivery channel description, 8-39
- design-time tasks, 8-41
- diagnostics and troubleshooting, 8-43
- errors, 8-41
- event map requirements, 8-41
- file name restrictions, 8-42
- interaction and record naming restrictions, 8-41

- interaction questions, 11-14
- limitations, 8-42
- Read File adapter exchange protocol, 8-40
- Read File adapter exchange protocol naming
 - conventions, 8-41
- tutorial example, 7-8
- use case, 8-43
- validation prerequisites, 8-42
- Write File adapter exchange protocol, 8-40
- Write File adapter exchange protocol naming
 - conventions, 8-41

files

- used in tutorial, 7-82

G

- global usage code
 - assigning to a delivery channel, 25-76
- graphical user interface tool
 - accessing, 5-2
- graphical view
 - of roles and business processes, 12-6
- group name
 - on adapter interactions details page, 11-36
- guard values
 - selecting during condition step creation, 12-83
 - selecting during creation of a step control
 - flow, 12-106
 - tutorial creation example, 7-51
 - use with control flows, 3-29

H

- host list page
 - overview, 5-38
 - overview of cooperations section, 5-39
 - overview of delivery and security section, 5-39
 - overview of endpoints section, 5-39
 - overview of organization section, 5-39
- host tab
 - overview of cooperations section, 5-39
 - overview of delivery and security section, 5-39
 - overview of endpoints section, 5-39
 - overview of organization section, 5-39
 - overview of tasks, 5-38

- host trading partner
 - capabilities, 25-3
 - creating the wallet password, 25-91
 - defines trading partner capabilities for all trading partners, 25-3
 - definition, 3-56
 - example, 26-3
 - management tasks overview, 25-2
 - managing the wallet password, 25-90
 - organization in which Oracle Application Server ProcessConnect is installed, 5-38
 - person capabilities, 25-12
 - person overview, 25-11
 - updating the wallet password, 25-92
 - validation and approval, 25-93
- HTTP
 - assigning to a protocol endpoint, 25-87
- HTTP adapter
 - adapter exchange protocols, 8-46
 - adding a user for basic authentication, 8-50
 - adding an adapter interaction, 11-16
 - adding to an application, 15-12
 - additional setup tasks, 8-50
 - application integration and runtime behavior, 8-52
 - benefits of using, 8-44
 - content type definition, 8-47
 - content types, 8-47
 - creating a delivery channel, 15-20
 - definition, 3-53
 - delivery channel description, 8-46
 - design-time tasks, 8-46
 - diagnostics and troubleshooting, 8-54
 - enabling secure socket layer, 8-50
 - errors, 8-49
 - event map requirements, 8-49
 - interaction and record naming restrictions, 8-49
 - interaction questions, 11-16
 - limitations, 8-54
 - Receive Payload adapter exchange protocol, 8-46
 - Receive Payload adapter exchange protocol naming conventions, 8-47
 - Send Payload adapter exchange protocol, 8-46
 - Send Payload adapter exchange protocol naming

- conventions, 8-48
 - supported versions, 8-45
 - testing, 8-52
 - use case, 8-55
 - use case adapter exchange protocol, 8-57
 - use case delivery channel questions, 8-55
 - use case interaction questions, 8-56
 - using secure HTTP, 8-44
 - validation prerequisites, 8-49
- HTTP/S. *See* secure HTTP

- ias_admin user, 20-2
 - Oracle Enterprise Manager user account, 18-5
- IF conditions
 - creating, 13-46
 - definition, 13-27
 - deleting, 13-54
 - updating, 13-54
- IMAP server
 - inbound E-Mail adapter interactions, 8-34
 - using with the E-Mail adapter, 8-31
- implicit conversion between datatypes
 - support, 14-2
- implicit conversion for source and target parameters
 - support, 14-3
- implicit conversion for source and target parameters in the same datatype transformation map
 - invalid example, 14-6
 - support, 14-4
 - valid example, 14-7
- import
 - an integration from a file, 17-53
 - business datatypes, 3-38
 - only XSD datatypes supported, 10-4, 10-54
 - cautions about importing an integration, 17-56
 - details about importing an integration from a file, 17-53
 - modeling metadata and profile data, 5-48
 - to export.xml file, 17-56
 - tutorial example of business datatypes
 - importing, 7-28, 7-48, 7-49
 - XSD datatypes, 10-51
- IMS/DB adapter

- adding an adapter interaction, 11-10
- adding to an application, 15-12
- creating a delivery channel, 15-15
- IMS/TM adapter
 - adding an adapter interaction, 11-10
 - adding to an application, 15-12
 - creating a delivery channel, 15-15
- inbound processor threads, 19-4, 19-5
- initiating native event instance
 - definition, 3-23
- instance behavior
 - during runtime, 3-48
- instances
 - definition, 18-4
- integrated view of data
 - concepts, 3-4
 - Oracle Application Server ProcessConnect support, 3-8
- integration architect
 - responsibilities, 3-2
- integration diagrams
 - agreement icon, 12-16
 - changing the scale, 12-17
 - creating a spoke from an integration diagram, 12-17
 - definition, 12-14
 - deleting a spoke from an integration diagram, 12-17
 - displaying the details page for a role or business process, 12-17
 - drilling down to a process diagram, 12-17
 - drilling down to an event flow diagram, 12-17
 - tasks you can perform, 12-16
 - viewing, 12-15
- integration manager, 19-2
 - accessing the log files from Oracle Enterprise Manager, 18-8, 18-10
 - changing log level settings from Oracle Enterprise Manager, 18-10
 - changing log level settings through Oracle Enterprise Manager, 18-8
 - definition, 18-4
 - Java Virtual Machine, 19-13
 - log files for monitoring errors, 21-14
 - performance, 19-10
 - responsibilities, 3-49, 4-8
 - starting and stopping with Oracle Enterprise Manager, 18-8
 - starting and stopping with Oracle Process Management and Notification (OPMN), 18-17
 - tuning, 19-12
 - tutorial example, 7-42, 7-44, 7-45
 - typical errors and recovery actions, 21-16
 - viewing current performance, 18-13
 - viewing the current status in Oracle Enterprise Manager, 18-8
- integration technology
 - definition, 2-2
 - types, 2-2
- integrations
 - A2A integration example using Oracle Application Server ProcessConnect, 2-9
 - B2B integration example using Oracle Application Server ProcessConnect, 2-12
 - challenges, 2-5
 - consists of modeling metadata and profile data, 3-13
 - definition, 2-2
 - deployment in runtime repository, 4-6
 - flexibility of user interface tool, 4-5, 5-12, 6-2
 - importance of, 2-4
 - managing, 4-10
 - running, 4-8
 - storage in design-time repository, 4-5
 - storage in runtime repository, 4-7
- interactions. *See* adapter interactions
- interactions tab
 - overview of tasks, 5-34
- internal processing elements
 - native, application, and business levels, 3-27
- invocation limits
 - assigning to a trading partner agreement, 26-16
- I/O contention, 19-17
- iprtcln.sql script
 - log table script, 22-8
- IP.tip_rtlog log table
 - using for troubleshooting, 22-8
- iterators
 - advanced transformation design

- multiple occurrence target members from
 - multiple occurrence source members, 14-23
- single occurrence target members from
 - multiple occurrence source members, 14-30
- structure flattening iterations (nested iterators), 14-36
- case study, 13-62
- creating, 13-59
- creating rules in an iterator as part of a user-defined datatype transformation map that are executed multiple times, 13-61
- definition, 13-27, 13-58
- deleting, 13-61
- updating, 13-61

J

- J2EE Connector Architecture (JCA)
 - adapter architecture, 4-9
 - basis for Oracle record definition, 3-18
- Jacada Integrator, D-1
 - as a JCA resource adapter, D-2
 - documentation, D-1
 - MapMaker, D-2
 - mapping application screens, D-2
 - where to get it, D-1
- Java Virtual Machine, 19-15
 - increasing memory for the adapter framework, 19-7
 - increasing memory for the integration manager, 19-13
 - memory, 19-12
 - setting, 19-6
- J.D. Edwards OneWorld XE adapter
 - adding an adapter interaction, 11-10
 - adding to an application, 15-12
 - creating a delivery channel, 15-15
- JMS adapter
 - adapter exchange protocols, 8-59
 - adding an adapter interaction, 11-18
 - adding to an application, 15-12
 - additional setup tasks, 8-65
 - application integration and runtime

- behavior, 8-69
- benefits of using, 8-58
- BytesMessage Payload adapter exchange protocol, 8-60
- creating a delivery channel, 15-22
- definition, 3-53
- delivery channel description, 8-59
- design-time tasks, 8-61
- diagnostics and troubleshooting, 8-70
- errors, 8-64
- event map requirements, 8-63
- interaction and record naming restrictions, 8-63
- interaction questions, 11-18
- JMSHeaders naming conventions, 8-61
- JMSProperties naming conventions, 8-61
- limitations, 8-70
- MapMessage Payload adapter exchange protocol, 8-60
- Message Payload adapter exchange protocol, 8-60
- Payload naming conventions, 8-62
- StreamMessage Payload adapter exchange protocol, 8-60
- supported versions, 8-59
- TextMessage Payload adapter exchange protocol, 8-60
- use case, 8-71
- use case adapter exchange protocol, 8-74
- use case delivery channel questions, 8-71
- use case interaction questions, 8-72
- using with MQSeries JMS, 8-58, 8-59
- using with Oracle JMS, 8-58
- validation prerequisites, 8-64

JMS providers

- supported JMS adapter
 - using with Oracle JMS, 8-59

JVM

- see* Java Virtual Machine

L

- layout
 - of details in the adapter chapter, 8-2
- lifecycle states
 - approval state for profile data, 5-22

- approved state description, 5-18
- deployed state description, 5-18
- deployed state for modeling metadata and profile data, 5-23
- draft state description, 5-17
- draft state for modeling metadata and profile data, 5-18
- managing modeling metadata and profile data, 3-59
- of a trading partner agreement, 26-18
- of an application, 15-8
- of an application agreement, 15-35
- of host and remote trading partner capabilities, 25-93
- of trading partners, 26-10
- pending approval state description, 5-17
- pending approval state for profile data, 5-20
- states of an agreement, 3-60
- states of deployment, 3-64
- states of modeling metadata, 3-60
- states of profile data, 3-62
- validated state description, 5-17
- validated state for modeling metadata and profile data, 5-19
- viewing modeling metadata and profile data states on the details page, 5-17
- limitations
 - Advanced Queuing adapter, 8-21
 - E-Mail adapter, 8-36
 - File/FTP adapter, 8-42
 - HTTP adapter, 8-54
 - JMS adapter, 8-70
 - Oracle Database adapter, 8-85
 - Web Service adapter, 8-98
- list pages
 - overview, 5-5
- little-endian
 - definition, A-44
- load balancing
 - adapter framework instance, 4-9
 - with the adapter framework instance, 17-13
- log files
 - accessing from Oracle Enterprise Manager, 18-8, 18-10
 - changing log settings from Oracle Enterprise

- Manager, 18-10
 - changing log settings through Oracle Enterprise Manager, 18-8
 - finding runtime errors, 21-13
 - for troubleshooting, 22-2
 - tutorial example, 7-43, 7-45
 - viewing in Oracle Enterprise Manager, 18-10
- logging in
 - to the user interface tool, 5-2
- loops
 - definition, 12-121
 - examples of invalid loop design, 12-122, 12-123
 - restrictions on creating in roles, 12-121

M

- main details pages
 - overview, 5-8
- main list pages
 - overview, 5-5
- management
 - list page overview, 5-48
 - of integrations, 3-65
- management tab
 - overview of tasks, 5-48
- map variables
 - advanced transformation design
 - reuse, 14-44
 - case study, 13-74
 - creating, 13-71
 - definition, 13-28, 13-70
 - deleting, 13-73
 - updating a map variable, 13-74
 - using a map variable in a rule, 13-73
- MapMaker, D-2
- memory
 - configuration, 19-16
 - contention, 19-15
 - requirements, 19-12
 - starvation issues, 19-15
 - viewing in Oracle Enterprise Manager, 19-4
- messages
 - adapter error codes, C-20
 - business logic layer error codes, C-27
 - correlation error codes, C-48

- deployment error codes, C-94
- domain value map error codes, C-48
- event validation error codes, C-47
- inbound, 19-4
- metadata validation rules error codes, C-49
- outbound, 19-4
- repository error codes, C-13
- RosettaNet validation error codes, C-119
- runtime error codes, C-2
- transformation error codes, C-42
- translation error codes, C-45
- transport error codes, C-100
- user interface tool modeling error codes, C-96
- metadata repository
 - tuning, 19-16
- metadata validation rules error codes, C-49
- methodologies
 - adapter-centric methodology, 6-3
 - business process-centric methodology, 6-11
 - flexibility of design, 6-2
 - for using Oracle Application Server ProcessConnect, 6-2
 - when to use the adapter-centric methodology, 6-4
 - when to use the business process-centric methodology, 6-11
- model groups
 - complex datatypes, 10-20
 - in transformations, 14-10, 14-49
- modelers
 - chapters to read, 1-6, 1-7, 1-8
 - how to use this guide, 1-2
 - responsibilities, 3-2
- modeling metadata
 - application-level concepts, 3-30
 - business processes tab
 - overview, 5-26
 - business-level concepts, 3-37
 - condition expressions tab overview, 5-35
 - datatypes tab overview, 5-31
 - definition, 3-13, 4-5
 - dependencies, 22-9
 - dependencies when deleting modeling metadata, 22-11, 22-12, 22-14
 - deployed state, 5-23
 - deploying, 3-58
 - draft state, 5-18
 - event types tab overview, 5-30
 - graphical view of dependencies, 22-10
 - impact of deleting, 22-12
 - interactions tab overview, 5-34
 - lifecycle states, 3-60
 - managing the lifecycle, 3-59
 - modeling incomplete data, 5-12
 - modeling tab
 - overview, 5-24
 - naming conventions, 5-13
 - native-level concepts, 3-15
 - overview, 4-3
 - overview of key components, 3-15
 - restrictions on exporting, 5-15
 - roles tab overview, 5-28
 - transformations tab overview, 5-33
 - tutorial example of manually designing, 7-47
 - validated state, 5-19
- modeling tab
 - overview of tasks, 5-24
- modeling wizards
 - Add End-to-End Basic Event Flow, 9-8
 - Add Event Flow, 9-12
 - adding event flow to a single spoke, 9-26
 - adding event flow to two spokes, 9-22
 - common features, 9-12
 - common user errors, 9-41
 - Create End-to-End Basic Integration wizard, 9-6
 - Create Spoke, 9-10
 - creating a single spoke, 9-23
 - creating event body elements for business events, 9-37
 - creating transformation statements for transformation maps, 9-38
 - creating two spokes, 9-21
 - disabling a native event, 9-18
 - interactions, 9-18
 - modeling metadata name creation, 9-18
 - overview, 9-2, 9-6
 - prerequisites, 9-19
 - reviewing modeling metadata after creation, 9-32
 - reviewing modeling metadata before

- creation, 9-28
 - starting, 9-19
 - tasks to perform after modeling metadata
 - creation, 9-37
 - tutorial creation of modeling metadata, 7-23
 - updating the SetParty step, 9-39
- MQSeries JMS
- using with JMS adapter, 8-58, 8-59
- mutually exclusive paths
- examples, 12-127
 - restrictions on use, 12-131
- mutually-exclusive flows
- definition, 12-123

N

- namespaces. *See* datatype namespaces
- naming conventions
- for modeling metadata and profile data, 5-13
- native datatypes
- definition, 3-23
 - examples, 10-7
 - not understood by Oracle Application Server
 - ProcessConnect, 10-3
 - supported, 10-3
 - viewing the native event validation metadata to use, 10-58
 - viewing the translator, 10-58
- native event body elements
- overview, A-2
- native event correlations
- accessing management tasks, 11-49
 - concepts, 3-5
 - creating, 11-50
 - creating a condition expression, 11-50
 - definition, 3-26, 11-2, 11-48
 - deleting, 11-52
 - error messages, C-48
 - impact of deleting, 22-12
 - initiating native event, 11-50
 - managing, 11-47
 - native event definition, 3-26
- Oracle Application Server ProcessConnect
- support, 3-9
 - restrictions on use, 12-130
- runtime behavior, 12-133
 - target native event, 11-50
 - tutorial creation example, 7-60
 - updating, 11-52
 - use with multiple spokes, 12-130
 - viewing, 11-53
- native event instances
- creation, 12-133
 - definition, 3-20
- native event validation
- adding to a native event, 11-45
 - Advanced Queuing adapter failure, 8-18
 - definition, 3-22
- native events
- accessing native event tasks, 11-39
 - adapter framework, 3-22
 - adding native event body element
 - validation, 11-45
 - body elements, 3-20
 - creating, 11-27, 11-40
 - definition, 3-20, 11-2
 - deleting, 11-42
 - initiating, 3-23
 - managing, 11-37
 - overview, A-2
 - restrictions on deleting, 11-42
 - review details prior to creation, 11-32
 - structure, 3-20
 - tutorial creation example, 7-15, 7-20, 7-64, 7-79
 - tutorial deletion example, 7-79
 - tutorial manual creation example, 7-58
 - viewing, 11-42
 - viewing event body elements, 11-44
- native formats
- accessing native format administration
 - tasks, 17-19
 - adding a translator, 17-24, 17-34
 - adding an adapter exchange protocol, 17-22
 - administering, 17-16
 - creating, 17-20
 - creating validation, 17-25
 - D3L, 17-16, A-37
 - deleting validation, 17-26
 - overview, A-2
 - prepackaged native formats that you cannot

- delete or update, 17-16
- prepackaged with the system, 17-16
- removing a translator, 17-24, 17-34
- removing an adapter exchange protocol, 17-23
- specifying a native format during an adapter interaction, 11-26
- supported, 10-2
- supported value types, 8-11
- token substituted text, 17-16, A-124
- updating validation, 17-26
- viewing, 17-21
- viewing a translator, 17-27
- viewing validation, 17-27
- XSD, 17-16, A-3
- native role threads, 19-10
- native roles
 - adding to a trading partner agreement, 26-32
 - adding to an application agreement, 15-43
 - conventions for inbound and outbound directions, 3-24
 - definition, 3-23, 12-41
 - managing, 12-40
 - managing in application agreements, 15-2, 15-41
 - managing in trading partner agreements, 26-2, 26-30
 - removing from a trading partner agreement, 26-33
 - removing from an application agreement, 15-43
 - tutorial example of adding to an application agreement, 7-37, 7-40, 7-71
 - tutorial example of updating an agreement to use a new native role, 7-81
- native-level concepts
 - of modeling metadata, 3-15
- nested designs
 - advanced transformation designs
 - conditions within a condition, 14-42
 - iterations within a condition, 14-40
- nonmutually exclusive data flows
 - definition, 12-124
- nonmutually exclusive paths
 - examples, 12-127
- nonrepudiation
 - assigning to a delivery channel, 25-76

- guidelines, 24-5, 24-6
- Oracle Application Server ProcessConnect RosettaNet Implementation Framework (RNIF) version 1.1 support, 24-13
- Oracle Application Server ProcessConnect RosettaNet Implementation Framework (RNIF) version 2.0 support, 24-14
- types, 24-5, 24-6

O

- OC4J
 - increasing Java Virtual Machine memory for, 19-15
- OC4J instance
 - definition, 18-4
 - log files for monitoring errors, 21-14
 - starting and stopping with Oracle Enterprise Manager, 18-8
 - starting and stopping with Oracle Process Management and Notification (OPMN), 18-17
 - viewing the current status in Oracle Enterprise Manager, 18-8
- opmn.xml file
 - accessing through Oracle Enterprise Manager, 18-14
- Or step
 - cannot create step data flow for, 12-98
 - cannot create step ports for, 12-91
 - definition, 12-78
 - ensuring valid design, 12-123
 - example of invalid design, 12-124
 - example of valid design, 12-124
 - examples of invalid design, 12-123
 - execution, 12-78
 - execution of logic when first control flow arrives, 3-28
 - supported control flows and data flows, 12-78
 - supported ports, 12-78
 - supported roles, 12-78
 - tutorial creation example, 7-54
 - when to use, 12-123
- Oracle Application Server Metadata Repository
 - definition, 18-3

- Oracle Application Server ProcessConnect
 - A2A integration example, 2-9
 - accessing the user interface tool, 5-2
 - answer to integration challenges, 2-6
 - architecture overview, 4-2
 - business collaboration support, 24-24
 - business transaction support, 24-23
 - delivery channel support, 24-22
 - document exchange support, 24-22
 - partner interface process (PIP) support, 24-14
 - party ID support, 24-21
 - PIP0A1 support, 24-14
 - PIP3A4 support, 24-14
 - PIP3A6 support, 24-14
 - RosettaNet Business Dictionary support, 24-15
 - RosettaNet Implementation Framework (RNIF)
 - support for version 1.1, 24-13
 - RosettaNet Implementation Framework (RNIF)
 - support for version 2.0, 24-13
 - RosettaNet Implementation Framework (RNIF)
 - version 1.1 authentication support, 24-13
 - RosettaNet Implementation Framework (RNIF)
 - version 1.1 authorization support, 24-13
 - RosettaNet Implementation Framework (RNIF)
 - version 1.1 nonrepudiation support, 24-13
 - RosettaNet Implementation Framework (RNIF)
 - version 1.1 packaging support, 24-13
 - RosettaNet Implementation Framework (RNIF)
 - version 1.1 transport support, 24-13
 - RosettaNet Implementation Framework (RNIF)
 - version 2.0 encryption support, 24-14
 - RosettaNet Implementation Framework (RNIF)
 - version 2.0 nonrepudiation support, 24-14
 - RosettaNet Implementation Framework (RNIF)
 - version 2.0 transport support, 24-13
 - RosettaNet Validation support, 24-15
 - support for RosettaNet, 24-12
 - trading partner support, 24-21
 - transport layer support, 24-23
- Oracle Application Server ProcessConnect
 - RosettaNet Implementation Framework (RNIF)
 - version 2.0 support, 24-14
- Oracle Database adapter, 19-9
 - adapter exchange protocols, 8-76
 - adding an adapter interaction, 11-20
 - adding to an application, 15-12
 - additional setup tasks, 8-83
 - application integration and runtime
 - behavior, 8-84
 - benefits of using, 8-75
 - creating a delivery channel, 15-24
 - definition, 3-53
 - delivery channel description, 8-76
 - design-time tasks, 8-78
 - diagnostics and troubleshooting, 8-87
 - errors, 8-82
 - guidelines for adapter interaction SQL
 - queries, 11-21
 - interaction and record naming restrictions, 8-81
 - interaction questions, 11-20
 - limitations, 8-85
 - Read Record from Interface Table adapter
 - exchange protocol, 8-76
 - Read Record from Interface Table record element
 - naming conventions, 8-79
 - Stored Procedure Invocation adapter exchange
 - protocol, 8-77
 - Stored Procedure Invocation record element
 - naming conventions, 8-79
 - supported Oracle databases, 8-75, 8-87
 - supported versions, 8-75
 - use case, 8-88
 - validation prerequisites, 8-82
 - Write Record to Table adapter exchange
 - protocol, 8-77
 - Write Record to Table record element naming
 - conventions, 8-79
- Oracle e-Business Suite and 10.7 and 11i, 3-55
- Oracle Enterprise Manager
 - accessing adapter framework and integration
 - manager log files, 18-8, 18-10
 - administration, 17-2
 - changing adapter framework and integration
 - manager log file settings, 18-8, 18-10
 - changing configuration parameter
 - settings, 18-8, 18-11
 - configuring Oracle Process Management and
 - Notification (OPMN), 18-14
 - for managing integrations, 3-65
 - managing integrations, 4-10

- monitoring for errors, 21-14
- overview of monitoring and administration, 18-2
- starting and stopping the adapter framework, integration manager, and OC4J instance, 18-8
- tasks, 18-4
- viewing adapter framework performance, 18-13
- viewing integration manager performance, 18-13
- viewing ports, 18-14
- viewing transformation performance, 18-13
- viewing translation performance, 18-13
- Oracle JMS
 - using with the JMS adapter, 8-58, 8-59
- Oracle Process Management and Notification (OPMN), 19-13, 19-15
 - configuring, 18-14
 - starting and stopping the adapter framework, integration manager, and OC4J instance, 18-17
- Oracle record type elements
 - create event body elements for, 11-28
 - displaying on-screen, 8-7
 - for which to create native event body elements, 11-26
 - value types, 8-7
- Oracle records
 - associated with the adapter interaction, 11-41
 - creating during an adapter interaction, 11-25
 - definition, 3-17
 - J2EE Connector Architecture (JCA), 3-18
 - representation of wire message, 3-20
- OracleAS Infrastructure 10g, 19-15
- organization contact details
 - creating, 25-28
 - deleting, 25-28
 - managing, 25-26
 - updating, 25-29
 - viewing, 25-29
- organization contact information
 - viewing, 25-22
- organization name
 - default organization name assigned during installation, 5-3, 20-2

- updating, 25-8
- organizations
 - managing, 25-11
 - overview, 25-2
- outbound processor threads, 19-5, 19-8, 19-14

P

- packaging
 - guidelines, 24-4, 24-5
 - Oracle Application Server ProcessConnect RosettaNet Implementation Framework (RNIF) version 1.1 support, 24-13
 - Oracle Application Server ProcessConnect RosettaNet Implementation Framework (RNIF) version 2.0 support, 24-13
- page layout
 - of user interface tool, 5-4
- participants
 - in application agreements, 15-3
 - in trading partner agreements, 26-2
- parties
 - applications or trading partners, 3-13
 - in application agreements, 15-2
 - in trading partner agreements, 26-4
- partner interface processes (PIPs)
 - available from the Oracle Technology Network, 24-15
 - business operational view (BOV), 24-7
 - classifications, 24-8
 - clusters, 24-8
 - components, 24-7
 - definition, 24-6
 - functional service view (FSV), 24-7
 - implementation framework view (IFV), 24-7
 - mapped to business collaborations, 24-20
 - message flow example, 24-9
 - not prepackaged, 24-15
 - Oracle Application Server ProcessConnect PIP0A1 support, 24-14
 - Oracle Application Server ProcessConnect PIP3A4 support PIP3A4
 - Oracle Application Server ProcessConnect support, 24-14
 - Oracle Application Server ProcessConnect

- PIP3A6 support, 24-14
 - Oracle Application ServerS ProcessConnect support, 24-14
 - PIP3A4 features, 24-8
 - segments, 24-8
- party ID
 - data universal numbering system (DUNS)
 - example, 24-18
 - definition, 24-18
 - Oracle Application Server ProcessConnect support, 24-21
 - trading partner identification type, 24-21
- pass-through step
 - definition, 3-28, 12-72
 - example of use, 21-5
 - execution, 12-72
 - supported control flows and data flows, 12-72
 - supported ports, 12-72
 - supported roles, 12-72
- passwords
 - admin user, 20-2
 - assigning to a person, 25-16
 - changing the ias_admin password, 18-7
 - creating the wallet password for a host trading partner, 25-91
 - for accessing the user interface tool, 5-2
 - ias_admin user, 18-5
 - managing the wallet password for a host trading partner, 25-90
 - updating, 25-18
 - updating the wallet password for a host trading partner, 25-92
- pending approval lifecycle state
 - description, 5-17
 - for profile data, 5-20
- PeopleSoft 8 adapter
 - adding an adapter interaction, 11-9
 - adding to an application, 15-12
 - creating a delivery channel, 15-15
- performance
 - adapter framework, 19-4
 - design tool, 19-15
 - integration manager, 19-10
 - overview, 4-7
 - transformations, 19-11
 - translations, 19-11
 - using a single role thread instead of five role threads, 4-7
 - viewing in Oracle Enterprise Manager, 19-4, 19-11
- person contact details
 - creating, 25-20
 - deleting, 25-21
 - updating, 25-21
 - viewing, 25-22
- persons
 - creating, 25-16
 - creating contact details, 25-20
 - deleting, 25-18
 - deleting contact details, 25-21
 - managing, 25-13
 - overview of host and remote trading partner person capabilities, 25-12
 - overview of host and remote trading partner persons, 25-11
 - updating, 25-18
 - updating contact details, 25-21
 - viewing, 25-18
 - viewing contact details, 25-22
- phone
 - assigning as the organization contact information, 25-28
- PIP0A1
 - Oracle Application Server ProcessConnect support, 24-14
- PIP3A4
 - features, 24-8
 - mapped to business collaborations, 24-20
- PIP3A6
 - mapped to business collaborations, 24-20
 - Oracle Application Server ProcessConnect support, 24-14
- PIPs. *See* partner interface processes (PIPs)
- portlist.ini file
 - list of ports in use, 18-6
- ports
 - changing Oracle Application Server ProcessConnect ports, 18-19
 - port changing error message, 18-19
 - portlist.ini file, 18-6

- role port definition, 3-28
- step port definition, 3-29
- strongly recommended not to change Oracle Application Server ProcessConnect ports, 18-19
- viewing through Oracle Enterprise Manager, 18-14
- preset attributes
 - Abstract, 10-23, 10-44
 - Anonymous, 10-23, 10-33, 10-44
 - Element/Attribute, 10-33
 - Member Group Type, 10-23, 10-33, 10-44
 - Qualified, 10-33
 - Reference Only, 10-23, 10-44
- privileges
 - use cases, 3-14
- process diagrams
 - definition, 12-14
 - viewing, 12-23
- process monitoring reports
 - business message status, 23-22
 - collaboration status, 23-21
 - coordination status, 23-13
 - creating, 23-7, 23-8
 - definition, 23-5
 - error status, 23-17
- process optimization reports
 - creating, 23-28
 - definition, 23-6
 - example, 23-44
 - overview of report pages, 23-28
- process protocols
 - definition, 25-30
 - viewing, 25-49
- processor threads
 - see outbound, inbound processor threads
- profile data
 - agreements tab overview, 5-42
 - applications tab overview, 5-41
 - approval state, 5-22
 - definition, 3-13, 4-3, 4-5
 - deployed state, 5-23
 - deploying, 3-58
 - details pages with export button, 5-16
 - draft state, 5-18

- exporting to an XML file, 5-15
- host tab cooperations section overview, 5-39
- host tab delivery and security section overview, 5-39
- host tab endpoints section overview, 5-39
- host tab organization section overview, 5-39
- host tab overview, 5-38
- lifecycle states, 3-62
- managing the lifecycle, 3-59
- modeling incomplete data, 5-12
- naming conventions, 5-13
- overview of key components, 3-51
- pending approval state, 5-20
- profiles tab overview, 5-36
- selecting approvers, 5-20
- trading partners tab overview, 5-40
- validated state, 5-19
- profiles tab
 - overview of tasks, 5-36
- protocol endpoints
 - accessing protocol endpoint management tasks, 25-85
 - assigning HTTP, 25-87
 - assigning secure HTTP, 25-87
 - assigning SSL, 25-87
 - creating, 25-86
 - deleting, 25-88
 - managing, 25-84
 - updating, 25-88
 - viewing, 25-89
- protocols
 - business, 25-42

R

- remote trading partner certificates
 - accessing remote trading partner certificate management tasks, 25-52
 - assigning as a signing credential, 25-67
 - assigning as an encryption credential, 25-67
 - deleting, 25-54
 - for remote trading partners only, 25-51
 - managing, 25-51
 - updating, 25-54
 - viewing, 25-55

- remote trading partner identifications
 - creating, 26-12
- remote trading partners
 - accessing remote trading partner management tasks, 26-8
 - accessing trading partner tasks, 25-3
 - creating, 26-9
 - defining capabilities, 25-3
 - definition, 3-56
 - deleting, 26-10
 - example, 26-3
 - management tasks overview, 25-2
 - managing, 26-6
 - organization outside of host trading partner's enterprise, 5-38
 - person capabilities, 25-12
 - person overview, 25-11
 - updating, 26-10
 - validation and approval, 25-93
 - viewing, 26-10
- remove button
 - differences with delete button, 5-13
- reports
 - activity monitoring reports, 23-6
 - BI reporting level, 19-14
 - business messages overview, 23-2
 - collaborations overview, 23-2
 - configuration support, 23-3
 - creating, 23-7, 23-23, 23-28
 - definitions, 3-66
 - errors, 23-2
 - events overview, 23-2
 - making multiple selections in lists, 23-2
 - of integrations, 3-66
 - only runtime repository events are available for selection, 23-9
 - overview, 4-12, 23-2
 - process monitoring reports, 23-5
 - business message, 23-5
 - collaborations, 23-5
 - coordination status, 23-5
 - error status, 23-5
 - event status, 23-5
 - process optimization reports, 23-6
 - reviewing your output, 23-31
 - reviewing your selections before creation, 23-31
 - setting a business intelligence logging level in a configuration, 16-12
 - specifying the report layout, 23-30
 - tutorial example, 7-44
 - use case examples, 23-32
 - using coordination status reports to diagnose errors, 21-13
 - using error reports to diagnose errors, 21-13
 - using event status reports to diagnose errors, 21-13
- reports tab
 - overview of tasks, 5-45
- repositories
 - definition, 4-7
 - responsibilities, 4-5, 4-6
- repository error codes, C-13
- restrictions
 - on Advanced Queuing adapter interaction and record names, 8-17
 - on E-Mail adapter interaction and record names, 8-35
 - on File/FTP adapter interaction and record names, 8-41
 - on HTTP adapter interaction and record names, 8-49
 - on JMS adapter interaction and record names, 8-63
 - on Oracle Database adapter interaction and record names, 8-81
 - on using the browser back and forward buttons, 5-13
 - on Web Service adapter interaction and record names, 8-97
- retry count
 - enabling in a delivery channel, 25-77
- RNIF. *See* RosettaNet Implementation Framework (RNIF)
- road map
 - chapters for all users to read, 1-4
 - chapters for analysts to read, 1-10
 - chapters for business administrators to read, 1-9
 - chapters for business process managers to read, 1-8
 - chapters for connection managers to read, 1-6

- chapters for event managers to read, 1-7
 - chapters for systems administrators to read, 1-10
 - how to use this guide, 1-2
- role data flows
 - accessing role data flow management tasks, 12-60
 - creating a data flow criteria, 12-62
 - creating a role data flow group, 12-62
 - definition, 12-5
 - deleting, 12-67
 - examples of valid design, 12-132
 - impact of deleting, 12-67
 - managing, 12-58
 - updating, 12-67
 - viewing, 12-69
 - viewing the other role connected to the role data flow, 12-68
- role instances
 - behavior during runtime, 3-49
 - implications of being in an error state, 21-10
- role ports
 - accessing role port management tasks, 12-51
 - creating, 12-52
 - definition, 3-28, 12-5
 - deleting, 12-54
 - deleting a data flow between a role port and a step port, 12-57
 - impact of deleting, 12-54, 22-12
 - invalid merging of data flows between role ports, 12-130
 - managing, 12-48
 - tutorial creation example, 7-55, 7-56
 - updating, 12-54
 - viewing, 12-55
- role states
 - aborted, 3-49
 - AFComplete, 3-49
 - completed, 3-49
 - created, 3-49
 - error, 3-49
 - running, 3-49
 - WorkflowComplete, 3-49
- role threads
 - using a single role thread instead of five role threads, 4-7
- roles
 - accessing role management tasks, 12-44
 - application, 19-10
 - application role definition, 3-33
 - binding, 19-10
 - business, 19-10
 - business role definition, 3-40
 - common user errors, 12-135, 16-7
 - conventions for inbound and outbound directions, 3-24
 - creating, 12-44
 - creation by modeling wizards or manually, 12-10
 - definition, 12-5, 24-19
 - deleting, 12-45
 - designing roles to ensure proper validation, 12-121
 - diagrams, 12-11
 - examples of invalid And Step design, 12-124
 - examples of invalid loop design, 12-122, 12-123
 - examples of invalid Or Step design, 12-123
 - graphical view, 12-6
 - impact of deleting, 12-45, 22-12
 - in collaborations, 24-19
 - managing, 12-40
 - native, 19-10
 - native role definition, 3-23
 - overview, 12-2
 - removing from a person, 25-24
 - restrictions on creating loops, 12-121
 - role port definition, 3-28
 - roles in which steps can be created, 12-81
 - runtime behavior, 3-49, 12-133
 - states of roles during runtime, 3-49
 - step port definition, 3-29
 - transformation binding role definition, 3-41
 - translation binding role definition, 3-34
 - updating, 12-46
 - using acknowledgment consumption, 3-35
 - viewing, 12-46, 25-24
- roles tab
 - overview of tasks, 5-28
- RosettaNet
 - B2B protocol standard, 2-2, 2-6

- B2B protocol standard example, 24-2
- definition, 24-3
- Oracle Application Server ProcessConnect support, 2-6, 2-17, 24-12
- role in a B2B integration, 24-2
- standards, 24-3
- support with B2B adapter, 4-7
- RosettaNet - 01.10
 - exchange protocol, 25-67
- RosettaNet - 02.00
 - exchange protocol, 25-67
- RosettaNet Business Dictionary
 - Oracle Application Server ProcessConnect support, 24-15
- RosettaNet Dictionaries
 - Business Dictionary, 24-10
 - definition, 24-10
 - example of Technical Dictionary, 24-10
 - Technical Dictionary, 24-10
- RosettaNet Implementation Framework (RNIF)
 - definition, 24-4
 - Multi-Purpose Internet Mail Extensions (MIME) format, 24-5
 - Oracle Application Server ProcessConnect support for version 1.1, 24-13
 - Oracle Application Server ProcessConnect support for version 2.0, 24-13
 - RosettaNet Object (RNO) format, 24-4
 - version 1.1 authentication guidelines, 24-4
 - version 1.1 authorization guidelines, 24-4
 - version 1.1 guidelines, 24-4
 - version 1.1 nonrepudiation guidelines, 24-5
 - version 1.1 packaging guidelines, 24-4
 - version 1.1 transport guidelines, 24-4
 - version 2.0 authentication guidelines, 24-5
 - version 2.0 authorization guidelines, 24-5
 - version 2.0 encryption guidelines, 24-5
 - version 2.0 guidelines, 24-5
 - version 2.0 nonrepudiation guidelines, 24-6
 - version 2.0 packaging guidelines, 24-5
 - version 2.0 transport guidelines, 24-5
- RosettaNet Implementation Framework (RNIF)
 - version 2.0 authentication support, 24-13
- RosettaNet Implementation Framework (RNIF)
 - version 2.0 authorization support, 24-13
- RosettaNet Implementation Framework (RNIF)
 - version 2.0 packaging support, 24-13
- RosettaNet Validation
 - Oracle Application Server ProcessConnect support, 24-15
- RosettaNet validation, 25-63
 - definition, 24-11
 - enabling in a document exchange, 25-68
- RosettaNet validation error codes, C-119
- RosettaNet-RNIF1.1-PIP
 - business protocol, 25-45
- RosettaNet-RNIF2.0-PIP
 - business protocol, 25-45
- runtime behavior
 - Advanced Queuing adapter, 8-20
 - coordinations, 3-50
 - E-Mail adapter, 8-36
 - File/FTP adapter, 8-42
 - HTTP adapter, 8-52
 - instance behavior, 3-48
 - JMS adapter, 8-69
 - only one adapter and delivery channel used in an application agreement, 15-13
 - Oracle Database adapter, 8-84
 - states of events, 3-49
 - states of roles, 3-49
- runtime error codes, C-2
- runtime repository
 - definition, 4-4, 4-7
 - responsibilities, 4-6
 - stores modeling metadata and profile data included in a deployed configuration, 3-13
- runtime system
 - definition, 4-4, 4-8
 - deployment overview, 16-9
 - finding error details, 21-13
 - role behavior, 12-133
 - using the runtime repository, 4-7

S

- sample files
 - used in tutorial, 7-82
- SAP R/3 adapter
 - adding an adapter interaction, 11-9

- adding to an application, 15-12
 - creating a delivery channel, 15-15
- scalar datatypes
 - accessing scalar datatype tasks, 10-40
 - creating, 10-41
 - creating a facet, 10-45
 - creating a valid value for the enumeration or pattern facet, 10-49
 - definition, 10-4
 - deleting, 10-42
 - deleting a facet, 10-47
 - deleting a valid value for the enumeration or pattern facet, 10-49
 - facets, 10-36
 - managing, 10-36
 - restrictions on deleting, 10-42
 - updating, 10-43
 - updating a facet, 10-47
 - updating a valid value for the enumeration or pattern facet, 10-50
 - viewing, 10-43
 - viewing a facet, 10-48
- scalar members
 - creating, 10-28
 - definition, 10-15
 - deleting, 10-30
 - updating, 10-32
 - viewing, 10-34
- search facility
 - in user interface tool, 5-14
- secure HTTP
 - assigning to a protocol endpoint, 25-87
 - connecting to the secure HTTP URL, 20-12
 - for secure connections between trading partners, 20-10
 - selecting a transport protocol, 25-86
 - using the HTTP adapter, 8-44
- secure socket layer (SSL), 25-2
 - assigning to a protocol endpoint, 25-87
 - setting up, 20-11
 - troubleshooting setup, 20-11
 - with HTTP adapter, 8-50
- security
 - adapter security settings, 20-3
 - application delivery channels, 20-7
 - authorization and access enforcement, 20-4
 - classes of users and their privileges, 20-2
 - configuration issues, 20-7
 - configuration issues and options, 20-14
 - digital envelopes
 - overview of configuration tasks, 20-8
 - digital signatures
 - overview of configuration tasks, 20-9
 - enabling transport security in a delivery channel, 25-77
 - encrypted wallet passwords for host trading partners, 20-12
 - extensibility, 20-4
 - for trading partners, 20-3
 - host trading partner password encryption in high availability environments, 20-13
 - identity management configuration issues, 20-5
 - installation issues, 20-6
 - managing, 25-50
 - network messaging, 20-3
 - Oracle Application Server security services, 20-4
 - Oracle Identity Management Infrastructure, 20-4
 - overview, 20-2, 25-2
 - resources protected, 20-3
 - secure HTTP, 20-4
 - secure HTTP and client authentication
 - overview of tasks, 20-10
 - security framework configuration issues, 20-5
 - setting up SSL, 20-11
 - verifying SSL client authentication, 20-11
- segments
 - in partner interface processes (PIPs), 24-8
- send for approval button
 - on details pages, 5-19
 - on profile data details pages, 5-20
- sequence
 - selecting the order in which to perform control flows, 12-105
- server properties. *See* configuration parameters
- SetParty step
 - creating for transformation maps after modeling wizard creation, 9-39
 - definition, 3-47, 12-76

- details page displays the destination
 - party, 12-87
 - execution, 12-76
 - for addressing parties, 3-47
 - selecting a destination party while creating a SetParty step, 12-82
 - supported control flows and data flows, 12-76
 - supported ports, 12-76
 - supported roles, 12-76
 - tutorial creation example, 7-35
 - use of, 3-47
- Siebel 2000 adapter
 - adding an adapter interaction, 11-10
 - adding to an application, 15-12
 - creating a delivery channel, 15-15
- signing credentials
 - assigning, 25-67
- SMTP adapter. *See* E-Mail adapter
- SMTP server
 - outbound E-Mail adapter interactions, 8-32
 - using with the E-Mail adapter, 8-31
- split step
 - definition, 12-77
 - example of use, 21-5
 - execution, 12-77
 - supported control flows and data flows, 12-77
 - supported ports, 12-77
 - supported roles, 12-77
 - tutorial creation example, 7-56
- spokes
 - definition, 3-42, 9-2
 - deleting, 9-40
 - multiple spokes with a business process, 9-3
 - tutorial creation example, 7-80
 - tutorial deletion example, 7-78
 - using native event correlation with multiple spokes, 12-130
 - with event flow, 9-5
- SSL. *See* secure socket layer (SSL)
- Start step
 - definition, 12-72
 - execution, 12-72
 - supported control flows and data flows, 12-72
 - supported ports, 12-72
 - supported roles, 12-72
- statements
 - associating a statement with an IF condition or ELSE condition, 13-52
 - creating a map variable, 13-71
 - creating an ELSE condition, 13-52
 - creating an event header rule, 13-78
 - creating an IF Condition, 13-106
 - creating an IF condition, 13-46
 - creating an iterator, 13-59
 - creating rules, 13-32
 - deleting a map variable, 13-73
 - deleting an ELSE condition, 13-54
 - deleting an IF condition, 13-54
 - deleting an iterator, 13-61
 - deleting rules, 13-40
 - domain value map case study, 13-110
 - event header rule case study, 13-82
 - explicitly mapping sources and targets, 13-37
 - iterator case study, 13-62
 - managing, 13-29
 - map variable case study, 13-74
 - mapping a single source and a single target, 13-33
 - mapping multiple sources and targets, 13-35
 - removing a statement from an IF condition or ELSE condition, 13-54
 - restriction on moving statements around in a condition, 13-52
 - restrictions on creating, 13-27
 - transformation condition case study, 13-55
 - transformation rule case study, 13-41
 - updating a domain value map rule, 13-109
 - updating a map variable, 13-74
 - updating an event header rule, 13-81
 - updating an IF condition, 13-54
 - updating an iterator, 13-61
 - updating rules, 13-41
 - using a map variable in a rule, 13-73
- states
 - coordinations, 3-50
 - event, 3-49
 - of a configuration, 16-4
 - role, 3-49
 - viewing modeling metadata and profile data lifecycle states on the details page, 5-17

- step binding diagrams
 - changing the scale, 12-32
 - creating data flow, 12-31
 - creating step ports, 12-31
 - definition, 12-15
 - deleting data flow, 12-32
 - deleting steps or ports, 12-31
 - displaying other step binding diagrams, 12-31
 - displaying step or port details, 12-31
 - updating step ports, 12-31
 - viewing, 12-28
- step control flows *See* control flows
- step data flows
 - accessing step data flow management tasks, 12-97
 - creating, 12-98
 - definition, 12-6
 - deleting, 12-100
 - impact of deleting, 12-100
 - managing, 12-95
 - viewing the target port of a step data flow, 12-100
- step instances
 - behavior during runtime, 3-50
- step ports
 - accessing step port management tasks, 12-89
 - creating, 12-91
 - definition, 3-29, 12-6
 - deleting, 12-93
 - deleting a data flow between a role port and a step port, 12-57
 - impact of deleting, 12-93, 22-12
 - managing, 12-87
 - ports automatically created with each step, 12-84
 - restrictions on creating, 12-91
 - updating, 12-93
 - viewing, 12-94
- step return code port
 - creating, 12-84, 21-7
 - example, 21-6
 - use in error handling, 21-4
- steps
 - accessing step management tasks, 12-79
 - And step, 12-78
 - condition step, 12-75
 - consume step, 12-76
 - creating, 12-81
 - definition, 3-28, 12-5, 12-71
 - deleting, 12-85
 - End step, 12-72
 - examples of invalid And Step design, 12-124
 - examples of invalid Or Step design, 12-123
 - impact of deleting, 12-85
 - invalid design examples, 12-128
 - managing, 12-70
 - mutually exclusive path restrictions, 12-131
 - Or step, 12-78
 - pass-through step, 12-72
 - ports automatically created with each step, 12-84
 - roles in which steps can be created, 12-81
 - runtime behavior, 3-50
 - selecting a condition expression while creating a condition step, 12-82
 - selecting a datatype transformation map while creating a transformation step, 12-82
 - selecting a destination party while creating a SetParty step, 12-82
 - selecting a guard value during condition step creation, 12-83
 - selecting control flows during step creation, 12-82
 - SetParty step, 12-76
 - split step, 12-77
 - Start step, 12-72
 - step return code port creation, 12-84
 - transformation step, 12-73
 - translation step, 12-74
 - types that manage events, 12-71
 - types that process events, 12-71
 - updating, 12-85
 - valid design examples, 12-129
 - viewing, 12-86
- supported actors
 - accessing supported actor management tasks, 25-32
 - assigning a time in which to process a collaboration, 25-34
 - assigning to a trading partner agreement

- participant, 26-24
 - buyer types, 25-34
 - creating, 25-34
 - definition, 25-30
 - deleting, 25-35
 - failure report administrator type, 25-34
 - managing, 25-31
 - PIP failure notifier, 25-34
 - seller types, 25-34
 - updating, 25-35
 - updating validation rules states for a host trading partner, 25-40
 - updating validation rules states for a remote trading partner, 25-40
 - viewing for a host trading partner, 25-36
 - viewing for a remote trading partner, 25-38
- synchronous transport mode
 - assigning, 25-59
- system administrators
 - error handling, 21-2
- system errors
 - definition, 21-3
- system logger threads, 19-11
- system-defined maps
 - cannot delete, 13-24
 - cannot update, 13-25
 - definition, 13-4
- systems administrators
 - chapters to read, 1-10
 - how to use this guide, 1-3
 - responsibilities, 3-3
- systems integration consultant
 - responsibilities, 3-2

T

- tablespaces
 - temporary, 19-17
- Technical Dictionary
 - of RosettaNet, 24-10
- technology adapters, 3-51
 - Advanced Queuing adapter, 3-52, 8-11
 - E-Mail adapter, 3-52, 8-30
 - File/FTP adapter, 3-52, 8-38
 - HTTP adapter, 3-53, 8-44
 - JMS adapter, 3-53, 8-58
 - Oracle Database adapter, 3-53, 8-75
 - Web Service adapter, 3-53, 8-92
- threads
 - application role, 19-10
 - binding role, 19-10, 19-14
 - business process, 19-10
 - business role, 19-10
 - configuring, 19-10
 - inbound processor, 19-4
 - native role, 19-10
 - outbound processor, 19-5, 19-8, 19-14
 - system logger, 19-10
 - using a single role thread instead of five role threads, 4-7
- token substituted text, 3-34
 - datatypes and event body elements, A-128
 - definition, 3-31
 - definition file, A-124
 - inbound e-mail responses to an alert
 - e-mail, A-129
 - message body of a definition file, A-126
 - overview of support, A-124
 - prepackaged native format, 17-16
 - subject body of a definition file, A-126
 - supported native format, 10-2
 - supported translator, 3-31
 - text in a definition file, A-127
 - used in alert e-mail example, 21-17
- token substituted text translator
 - creating an event body element, 11-31
- trading partner agreement delivery channels
 - adding, 26-26
 - removing, 26-27, 26-28
 - updating, 26-28
 - viewing, 26-28
- trading partner agreement native roles
 - accessing trading partner agreement native role management tasks, 26-31
 - adding, 26-32
 - example, 26-4
 - managing, 26-30
 - overview, 26-2
 - removing, 26-33
- trading partner agreement participants

- accessing trading partner agreement participant management tasks, 26-22
- adding, 26-23
- assigning a supported actor, 26-24
- example, 26-4
- managing, 26-20
- overview, 26-2
- removing, 26-25
- updating, 26-25
- viewing, 26-26
- trading partner agreements
 - accessing trading partner agreement management tasks, 26-15
 - assigning a beginning date, 15-33, 26-16
 - assigning a concurrent conversation value, 26-16
 - assigning an ending date, 15-33, 26-16
 - assigning an invocation limit, 26-16
 - common user errors, 26-34
 - contents, 24-16
 - creating, 26-15
 - definition, 3-57, 24-16
 - deleting, 26-16
 - example, 26-4
 - managing, 26-14
 - overview, 26-2
 - updating, 26-17
 - validation and approval, 26-33
 - viewing, 26-17
 - viewing the lifecycle states, 26-18
- trading partner capabilities
 - viewing the lifecycle states, 25-93
- trading partner identification types
 - accessing contact type administration tasks, 17-50
 - administering, 17-49
 - creating, 17-51
 - definition, 17-49
 - party ID, 24-21
 - viewing, 17-52
- trading partner identifications
 - accessing trading partner identification management tasks, 25-7
 - assigning a DUNS number, 25-9
 - creating, 25-8
 - deleting, 25-9
 - managing, 25-4
 - overview, 25-2
 - updating, 25-10
 - viewing, 25-10
- trading partners
 - accessing trading partner tasks, 25-3
 - common user errors, 26-34
 - contents, 24-18
 - cooperations, 3-56
 - definition, 3-56, 24-18
 - delivery and security, 3-56
 - delivery channel, 24-18
 - endpoints, 3-56
 - example, 26-3
 - host and remote capabilities, 25-3
 - host definition, 3-56
 - list page overview, 5-40
 - Oracle Application Server ProcessConnect support, 24-21
 - overview, 26-2
 - party ID, 24-18
 - remote definition, 3-56
 - updating the host organization name, 25-8
 - validation and approval, 26-33
 - viewing the lifecycle states, 26-10
- trading partners tab
 - overview of tasks, 5-40
- transformation binding roles
 - definition, 3-41, 12-42
 - managing, 12-40
- transformation conditions
 - case study, 13-55
 - definition, 13-45
 - restriction on moving statements around in a condition, 13-52
- transformation design errors
 - incrementally populating a complex datatype using submaps, 14-15
 - no checking for the existence of a datatype member of the model group choice, 14-10
 - no checking for the existence of an optional datatype member, 14-9
 - no creating a submap to populate a multiple occurrence target member, 14-12

- no defining an iterator to access a datatype member with multiple occurrences, 14-12
- no populating mandatory target members, 14-17
- transformation design limitations
 - no overwrite ability for target members, 14-20
 - NOT operator is unsupported, 14-21
 - only global map variables are supported, 14-18
 - transformation statements cannot be moved in the user interface tool, 14-19
- transformation error codes, C-42
- transformation map details page in user interface tool, 5-11
- transformation maps
 - overview, 13-3
- transformation rules
 - accessing transformation rules management tasks, 13-31
 - case study, 13-41
 - creating, 13-32
 - definition, 13-27, 13-30
 - deleting, 13-40
 - examples, B-2
 - explicitly mapping sources and targets, 13-37
 - mapping a single source and a single target, 13-33
 - mapping multiple sources and targets, 13-35
 - updating, 13-41
- transformation statements
 - can be part of other statements, 13-31
 - creating for transformation maps after modeling wizard creation, 9-38
 - overview, 13-27
 - restrictions on creating, 13-27
 - tutorial creation example, 7-62, 7-66, 7-81
- transformation step
 - definition, 3-41, 12-73
 - details page links to the associated transformation map, 12-87, 13-14
 - example of use, 21-5
 - execution, 12-73
 - selecting a datatype transformation map while creating a transformation step, 12-82
 - step return code port, 21-4
 - supported control flows and data flows, 12-73
 - supported ports, 12-73
 - supported roles, 12-73
 - tutorial manual creation example, 7-53
 - use of, 3-41
- transformations
 - accessing datatype transformation map management tasks, 13-23
 - accessing domain column and party management tasks, 13-91
 - accessing domain value map column and row management tasks, 13-100
 - accessing domain value map management tasks, 13-86
 - accessing domain value map rule management tasks, 13-105
 - accessing event header rule management tasks, 13-77
 - accessing event type transformation map management tasks, 13-8
 - accessing iterator management tasks, 13-58
 - accessing map variable management tasks, 13-70
 - accessing transformation condition management tasks, 13-45
 - accessing transformation rules management management tasks, 13-31
 - associating a statement with an IF condition or ELSE condition, 13-52
 - common user errors, 14-9
 - concepts, 3-6
 - creating a transformation rule, 13-32
 - creating additional sources and targets, 13-17
 - creating datatype transformation maps, 13-24
 - creating event transformation map domain value map rule statements, 13-106
 - creating event transformation map ELSE condition statements, 13-52
 - creating event transformation map event header rule statements, 13-78
 - creating event transformation map IF condition statements, 13-46
 - creating event transformation map iterator statements, 13-59
 - creating event transformation map variable, 13-71

- creating event transformation maps, 13-9
- definition, 3-39
- deleting datatype transformation maps, 13-24
- deleting event transformation map domain value map rule statements, 13-109
- deleting event transformation map ELSE condition statements, 13-54
- deleting event transformation map IF condition statements, 13-54
- deleting event transformation map iterator statements, 13-61
- deleting event transformation map variable, 13-73
- deleting event transformation maps, 13-13
- deleting sources and targets, 13-18
- deleting transformation rules, 13-40
- domain value map case study, 13-110
- domain value map rule examples, B-41
- domain value maps, 13-83
- event header rule case study, 13-82
- event header rule examples, B-40
- explicitly mapping sources and targets, 13-37
- for correcting vocabulary mismatches, 3-37
- implicit conversion between datatypes support, 14-2
- implicit conversion for source and target parameters, 14-3
- implicit conversion for source and target parameters in the same datatype transformation map, 14-4
- inserting or appending statements, 13-73
- iterator case study, 13-62
- managing datatype transformation maps, 13-21
- managing event transformation map statements, 13-29
- managing event transformation maps, 13-5
- map variable case study, 13-74
- mapping a single source and a single target, 13-33
- mapping multiple sources and targets, 13-35
- miscellaneous designs
 - choice, 14-49
 - constructs with anonymous members, 14-48
 - multiple datatype members with the same name, 14-50
 - referring to the entire map parameter, 14-50
- of datatypes, 3-39
- Oracle Application Server ProcessConnect support, 3-11
- overview, 13-2
- performance, 19-11, 19-12
- removing a statement from an IF condition or ELSE condition, 13-54
- transformation condition case study, 13-55
- transformation rule case study, 13-41
- transformation rule examples, B-2
- updating a map variable, 13-74
- updating datatype transformation maps, 13-25
- updating event transformation map domain value map rule statements, 13-109
- updating event transformation map event header rule statements, 13-81
- updating event transformation map IF condition statements, 13-54
- updating event transformation map iterator statements, 13-61
- updating event transformation maps, 13-13
- updating sources and targets, 13-19
- updating transformation rules, 13-41
- using a map variable in a rule, 13-73
- viewing a datatype transformation map, 13-25
- viewing an event transformation map, 13-14
- viewing an event transformation map parameter, 13-20
- viewing current performance, 18-13
- transformations tab
 - overview of tasks, 5-33
- translation binding roles
 - definition, 3-34, 12-41
 - managing, 12-40
- translation error codes, C-45
- translation step
 - definition, 3-34, 12-74
 - execution, 12-74
 - step return code port, 21-4
 - supported control flows and data flows, 12-74
 - supported ports, 12-74
 - supported roles, 12-74
 - use of, 3-34
- translations

- concepts, 3-5
- creating an event body element if you specified a D3L translator, 11-32
- creating an event body element if you specified a token substituted text translator, 11-31
- creating an event body element if you specified an XSD translator, 11-30
- definition, 3-30
- Oracle Application Server ProcessConnect support, 3-10
- overview, A-2
- performance, 19-11, 19-12
- specifying a datatype format file during native and application event creation, 11-28
- tutorial selection example, 7-15, 7-20, 7-64
- viewing current performance, 18-13
- viewing in a native format, 17-27
- within translation binding roles, 3-34
- translators
 - accessing translator administration tasks, 17-30
 - adding a native format, 17-34
 - adding to a native format, 17-24
 - administrating, 17-29
 - creating, 17-31
 - definition, 17-16
 - deleting, 17-33
 - native format
 - D3L, 11-26
 - token substituted text, 11-26
 - XSD, 11-26
 - prepackaged translators that you cannot delete or update, 17-29
 - removing a native format, 17-34
 - removing from a native format, 17-24
 - supported, 3-31, 10-55, A-2
 - viewing, 17-33
- transport endpoints
 - deleting, 25-61
 - updating, 25-61
 - viewing, 25-62
- transport error codes, C-100
- transport layer
 - Oracle Application Server ProcessConnect support, 24-23
- transport security
 - enabling in a delivery channel, 25-77
- transports
 - accessing transport management tasks, 25-57
 - assigning to a delivery channel, 25-76
 - creating, 25-59
 - definition, 25-2
 - deleting, 25-60
 - guidelines, 24-4, 24-5
 - managing, 25-56
 - Oracle Application Server ProcessConnect RosettaNet Implementation Framework (RNIF) version 1.1 support, 24-13
 - Oracle Application Server ProcessConnect RosettaNet Implementation Framework (RNIF) version 2.0 support, 24-13
 - updating, 25-60
 - using the synchronous transport mode, 25-59
 - viewing, 25-60
- troubleshooting
 - adapter framework errors, 21-15
 - Advanced Queuing adapter, 8-21
 - E-Mail adapter, 8-37
 - File/FTP adapter, 8-43
 - HTTP adapter, 8-54
 - integration manager errors, 21-16
 - JMS adapter, 8-70
 - log files, 22-2
 - Oracle Database adapter, 8-87
 - performing runtime troubleshooting
 - creating a coordination status report, 22-6
 - creating an error status report, 22-5
 - creating an event status report, 22-7
 - using the IP.tip_rtlog log table, 22-8
 - reports, 22-4
 - running the iprtcln.sql script, 22-8
 - setting business intelligence logging levels, 22-3
 - SSL setup, 20-11
 - table of troubleshooting details in the application adapter guides, 22-19
 - table of troubleshooting details in this guide, 22-17
 - tutorial example, 7-43, 7-45
 - use case, 22-8
 - Web Service adapter, 8-99
- tuning

- adapter framework, 19-6
- integration manager, 19-12
- metadata repository, 19-16
- tutorial
 - adding a delivery channel to an application agreement, 7-37, 7-39, 7-71
 - adding a native role to an application agreement, 7-37, 7-40, 7-71
 - adding a spoke with the Create Spoke wizard, 7-66
 - adding an adapter, 7-8, 7-11, 7-69
 - adding an event flow to a spoke with the Add Event Flow wizard, 7-61
 - checking log files, 7-43, 7-45
 - common user errors, 7-43
 - creating a condition expression, 7-50
 - creating a condition step, 7-51
 - creating a data flow, 7-55, 7-56
 - creating a delivery channel, 7-8, 7-69
 - creating a native event, 7-79
 - creating a native event correlation, 7-60
 - creating a native event manually, 7-58
 - creating a role port, 7-55, 7-56
 - creating a split step, 7-56
 - creating a spoke, 7-80
 - creating a transformation statement, 7-62, 7-66, 7-81
 - creating a transformation step manually, 7-53
 - creating an application, 7-7, 7-10, 7-69
 - creating an application agreement, 7-36, 7-39, 7-71
 - creating an event map, 7-18, 7-22, 7-59, 7-65
 - creating an event transformation map, 7-32, 7-34, 7-52
 - creating an interaction, 7-14, 7-19
 - creating an Or step, 7-54
 - creating and deploying a configuration, 7-41, 7-72
 - creating and deploying the initial configuration, 7-6
 - creating application details, 7-7
 - creating business datatypes, 7-28, 7-48, 7-49
 - creating business datatypes manually, 7-73
 - creating complex datatype members manually, 7-75
 - creating complex datatypes manually, 7-75
 - creating modeling metadata with the Create End-to-End Basic Integration wizard, 7-23
 - creating modeling metadata with the modeling wizards, 7-23
 - creating reports, 7-44
 - creating the business event body element, 7-29, 7-49
 - creating the business event manually, 7-48, 7-49
 - creating the native event, translation, and application event, 7-15, 7-20, 7-64
 - deleting a native event, 7-79
 - deleting a spoke, 7-78
 - deleting an event transformation map, 7-79
 - example of adapter-centric methodology, 6-3
 - example of an adapter-centric methodology, 7-2
 - example scenario, 7-2
 - files used, 7-82
 - importing business datatypes, 7-28, 7-48, 7-49
 - manually designing some modeling metadata, 7-47
 - methods of design, 7-6
 - overview of phases, 7-3
 - preparations before starting, 7-5
 - removing a control flow, 7-57
 - required files, 7-5
 - selecting an application type, 7-7, 7-10, 7-69
 - selecting the destination party in the SetParty Step, 7-35
 - sending an agreement for approval, 7-38, 7-40, 7-72
 - sending an application for approval, 7-9, 7-12, 7-70
 - setting business intelligence logging configuration parameters, 7-45
 - setting business intelligence reporting, 7-42
 - setting the party in an event header rule, 7-68
 - testing the results, 7-42, 7-43, 7-72
 - troubleshooting, 7-43, 7-45
 - updating an agreement to use a new native role, 7-81
 - updating an application event, 7-77
 - validating an application, 7-9, 7-12, 7-70
 - validating an application agreement, 7-38, 7-40, 7-72

Tuxedo adapter

- adding an adapter interaction, 11-10
- adding to an application, 15-12
- creating a delivery channel, 15-15

U

URI

- entering as an endpoint, 25-82, 25-87

use case groups

- viewing, 25-24

use cases, 25-12

- definition, 3-14

user errors

- application and application agreement, 15-45
- business processes and roles, 12-135
- datatypes, 10-65
- deployment, 16-7, 16-13
- events, 11-72
- modeling wizards, 9-41
- trading partner and trading partner agreements, 26-34
- transformation designs, 14-9
- tutorial, 7-43

user interface tool

- accessing, 5-2
- adapter tasks you perform, 8-4
- administration, 17-2
- administration tab overview, 5-46
- Administrator role required for use, 25-12
- agreements tab overview, 5-42
- applications tab overview, 5-41
- business process and role diagrams, 5-10
- business processes tab overview, 5-26
- condition expressions tab overview, 5-35
- configuration tab overview, 5-47
- creating, adding, deleting, and removing data, 5-13
- datatypes tab overview, 5-31
- definition, 4-3, 4-5
- deployment tab overview, 5-44
- details pages overview, 5-8
- event types tab overview, 5-30
- exporting profile data to an XML file, 5-15
- flexibility of design, 4-5, 5-12, 6-2

- host tab cooperations section overview, 5-39

- host tab delivery and security section overview, 5-39

- host tab endpoints section overview, 5-39

- host tab organization section overview, 5-39

- host tab overview, 5-38

- interactions tab overview, 5-34

- list pages overview, 5-5

- location of export button, 5-9

- main page, 5-3

- management tab overview, 5-48

- methodologies for using, 6-2

- modeling incomplete information, 5-12

- modeling tab overview, 5-24

- page layout, 5-4

- profile data details pages with export button, 5-16

- profiles tab overview, 5-36

- reports tab overview, 5-45

- restrictions on using the browser back and forward buttons, 5-13

- roles tab overview, 5-28

- searching for data, 5-14

- selecting approvers, 5-20

- trading partners tab overview, 5-40

- transformation map details page, 5-11

- transformations tab overview, 5-33

- user currently logged in, 5-6

- viewing modeling metadata and profile data states on the details pages, 5-17

- user interface tool modeling error codes, C-96

user roles

- removing, 25-24

- viewing, 25-24

user-defined maps

- definition, 13-4

users

- admin user name, 5-2, 20-2

- administrator, 3-3

- analyst, 3-3

- assigning to a person, 25-16

- business administrator, 3-3

- business process manager, 3-2

- chapters for all users to read, 1-4

- chapters for analysts to read, 1-10

- chapters for business administrators to read, 1-9
- chapters for business process managers to read, 1-8
- chapters for connection managers to read, 1-6
- chapters for event managers to read, 1-7
- chapters for systems administrators to read, 1-10
- connection manager, 3-2
- currently logged into the user interface tool, 5-6
- event manager, 3-2
- for accessing the user interface tool, 5-2
- how to use this guide, 1-2
- ias_admin user name, 20-2
- integration architect, 3-2
- modeler, 3-2
- of Oracle Application Server
 - ProcessConnect, 3-2
- systems administrator, 3-3
- systems integration consultant, 3-2

V

- validated lifecycle state
 - description, 5-17
 - for modeling metadata and profile data, 5-19
- validations
 - Advanced Queuing adapter prerequisites, 8-18
 - concepts, 3-6
 - creating for a native format, 17-25
 - deleting a native format, 17-26
 - design roles to ensure proper validations, 12-121
 - E-Mail adapter prerequisites, 8-35
 - File/FTP adapter prerequisites, 8-42
 - HTTP adapter prerequisites, 8-49
 - JMS adapter prerequisites, 8-64
 - native event definition, 3-22
 - of a configuration, 16-2
 - of application agreements, 15-44
 - of applications, 15-44
 - of host trading partner, 25-93
 - of remote trading partners agreements, 25-93
 - of trading partners, 26-33
 - of trading partners agreements, 26-33
 - Oracle Application Server ProcessConnect

- support for native event validation, 3-11
- Oracle Application Server ProcessConnect
 - support for RosettaNet validation, 24-15
- Oracle Database adapter prerequisites, 8-82
- RosettaNet, 24-11
- updating for a native format, 17-26
- viewing in a native format, 17-27
- Web Service adapter prerequisites, 8-98
- value types
 - definition, 8-11
 - supported native formats, 8-11
- VSAM adapter
 - adding an adapter interaction, 11-10
 - adding to an application, 15-12
 - creating a delivery channel, 15-15

W

- wallet passwords
 - creating for a host trading partner, 25-91
 - encrypted for host trading partners, 20-12
 - managing for a host trading partner, 25-90
 - updating for a host trading partner, 25-92
- Web browsers
 - accessing the user interface tool, 5-2
 - for accessing the user interface tool, 5-2
 - restrictions on using the browser back and forward buttons, 5-13, 23-1
- Web Service adapter
 - adapter exchange protocols, 8-93
 - adding an adapter interaction, 11-23
 - adding to an application, 15-12
 - additional setup tasks, 8-98
 - benefits of using, 8-92
 - creating a delivery channel, 15-25
 - definition, 3-53
 - delivery channel description, 8-93
 - design-time tasks, 8-95
 - diagnostics and troubleshooting, 8-99
 - errors, 8-97
 - interaction and record naming restrictions, 8-97
 - interaction questions, 11-23
 - Invoke Web Service Operation adapter exchange protocol, 8-93
 - limitations, 8-98

- record element naming conventions, 8-95
- supported versions, 8-93
- use case, 8-100
- use case adapter exchange protocol, 8-102
- use case delivery channel questions, 8-101
- use case interaction questions, 8-102
- validation prerequisites, 8-98
- wildcard members
 - creating, 10-29
 - definition, 10-16
 - deleting, 10-31
 - updating, 10-32
 - viewing, 10-34
- wire messages
 - contents, 3-17
 - datatypes, 3-23
 - definition, 3-17
 - examples, A-39, A-92, A-94
 - native datatype format, 10-5
- WSDL file
 - specifying during a Web Service adapter interaction, 11-23

X

- XML file
 - export of a configuration, 16-12
 - export of profile data, 5-15
 - submitting to approvers, 5-21
- XSD, 3-34
 - attributes with unsupported values, A-29
 - definition, 3-31
 - example of native datatype format file, 10-5
 - import XSD datatypes, 10-51
 - invalid XSDs
 - deterministic XSD constructs with lookahead, A-26
 - nondeterministic choice Block, A-20
 - nondeterministic sequence Block, A-21
 - naming restrictions
 - element, attribute, group, and attributeGroup, A-31
 - simpleType and complexType, A-31
 - overview of support, A-3
 - prepackaged native format, 17-16

- preset datatype attributes automatically included
 - in business datatypes, 10-14, 10-23, 10-33, 10-44
- reference to an empty group, A-17
- support unavailable through user interface tool datatypes, A-35
 - derived datatype members, A-35
 - derived datatypes, A-34
- supported native format, 10-2
- supported translator, 3-31
- tags unsupported by system, A-6
 - all with minOccurs="0", A-6
 - anyAttribute, A-8
 - choice or sequence with minOccurs="0" and/or maxOccurs greater than 1 except if parent is choice or sequence, A-8
 - complexContent or complexType with mixed="true", A-10
 - list, A-13
 - restriction (simpleContent) if the base attribute refers to a simpleType or if it has a locally defined base simpleType, A-13
 - restriction (simpleContent) that restricts any facets of its base complexType, A-15
 - union, A-13
- unsupported XML instance constructs, A-30
- XSD tags and attributes ignored by Oracle Application Server ProcessConnect, A-4
- XSD translator
 - creating an event body element, 11-30
 - DocType for native instances, 11-30
 - preserve namespaces for native instances, 11-30