

Oracle® Streams
Concepts and Administration
11g Release 1 (11.1)
B28321-03

August 2008

Oracle Streams Concepts and Administration, 11g Release 1 (11.1)

B28321-03

Copyright © 2002, 2008, Oracle. All rights reserved.

Primary Author: Randy Urbano

Contributors: Sundeep Abraham, Geeta Arora, Nimar Arora, Lance Ashdown, Ram Avudaiappan, Sukanya Balaraman, Neerja Bhatt, Ragamayi Bhyravabhotla, Chipper Brown, Diego Cassinera, Debu Chatterjee, Jack Chung, Alan Downing, Jacco Draaijer, Lisa Eldridge, Curt Elsbernd, Yong Feng, Diana Foch, Jairaj Galagali, Lei Gao, Brajesh Goyal, Connie Green, Thuvan Hoang, Sanjay Kaluskar, Ravikanth Kasamsetty, Lewis Kaplan, Joydip Kundu, Anand Lakshminath, Tianshu Li, Jing Liu, Edwina Lu, Raghu Mani, Pat McElroy, Krishnan Meiyappan, Shailendra Mishra, Valarie Moore, Bhagat Nainani, Srikanth Nalla, Anand Padmanaban, Maria Pratt, Arvind Rajaram, Ashish Ray, Abhishek Saxena, Viv Schupmann, Vipul Shah, Neeraj Shodhan, Wayne Smith, Benny Souder, Jim Stamos, Janet Stern, Mahesh Subramaniam, Kapil Surlaker, Bob Thome, Hung Tran, Ramkumar Venkatesan, Byron Wang, Wei Wang, James M. Wilson, Lik Wong, Jingwei Wu, Jun Yuan, David Zhang, Ying Zhang

The Programs (which include both the software and documentation) contain proprietary information; they are provided under a license agreement containing restrictions on use and disclosure and are also protected by copyright, patent, and other intellectual and industrial property laws. Reverse engineering, disassembly, or decompilation of the Programs, except to the extent required to obtain interoperability with other independently created software or as specified by law, is prohibited.

The information contained in this document is subject to change without notice. If you find any problems in the documentation, please report them to us in writing. This document is not warranted to be error-free. Except as may be expressly permitted in your license agreement for these Programs, no part of these Programs may be reproduced or transmitted in any form or by any means, electronic or mechanical, for any purpose.

If the Programs are delivered to the United States Government or anyone licensing or using the Programs on behalf of the United States Government, the following notice is applicable:

U.S. GOVERNMENT RIGHTS Programs, software, databases, and related documentation and technical data delivered to U.S. Government customers are "commercial computer software" or "commercial technical data" pursuant to the applicable Federal Acquisition Regulation and agency-specific supplemental regulations. As such, use, duplication, disclosure, modification, and adaptation of the Programs, including documentation and technical data, shall be subject to the licensing restrictions set forth in the applicable Oracle license agreement, and, to the extent applicable, the additional rights set forth in FAR 52.227-19, Commercial Computer Software--Restricted Rights (June 1987). Oracle USA, Inc., 500 Oracle Parkway, Redwood City, CA 94065.

The Programs are not intended for use in any nuclear, aviation, mass transit, medical, or other inherently dangerous applications. It shall be the licensee's responsibility to take all appropriate fail-safe, backup, redundancy and other measures to ensure the safe use of such applications if the Programs are used for such purposes, and we disclaim liability for any damages caused by such use of the Programs.

Oracle, JD Edwards, PeopleSoft, and Siebel are registered trademarks of Oracle Corporation and/or its affiliates. Other names may be trademarks of their respective owners.

The Programs may provide links to Web sites and access to content, products, and services from third parties. Oracle is not responsible for the availability of, or any content provided on, third-party Web sites. You bear all risks associated with the use of such content. If you choose to purchase any products or services from a third party, the relationship is directly between you and the third party. Oracle is not responsible for: (a) the quality of third-party products or services; or (b) fulfilling any of the terms of the agreement with the third party, including delivery of products or services and warranty obligations related to purchased products or services. Oracle is not responsible for any loss or damage of any sort that you may incur from dealing with any third party.

Contents

Preface	xxv
Audience	xxv
Documentation Accessibility	xxv
Related Documents	xxvi
Conventions	xxvii
What's New in Oracle Streams?	xxix
Oracle Database 11g Release 1 (11.1) New Features in Oracle Streams	xxix
Part I Oracle Streams Concepts	
1 Introduction to Oracle Streams	
Overview of Oracle Streams	1-1
What Can Oracle Streams Do?	1-2
Capture Messages at a Database	1-2
Stage Messages in a Queue	1-3
Propagate Messages from One Queue to Another	1-3
Consume Messages	1-3
Detect and Resolve Conflicts	1-3
Transform Messages	1-4
Track Messages With Oracle Streams Tags	1-4
Share Information With Non-Oracle Databases	1-5
What Are the Uses of Oracle Streams?	1-5
Data Replication	1-5
Data Warehouse Loading	1-6
Database Availability During Upgrade and Maintenance Operations	1-6
Message Queuing	1-6
Event Management and Notification	1-7
Data Protection	1-7
Sample Oracle Streams Configurations	1-8
Sample Hub-and-Spoke Replication Configuration	1-8
Sample Replication Configuration With Downstream Capture	1-10
Sample Replication Configuration That Uses Synchronous Captures	1-10
Sample N-Way Replication Configuration	1-11

Sample Configuration That Performs Capture and Apply in a Single Database	1-12
Sample Messaging Configuration	1-13
Administration Tools for an Oracle Streams Environment	1-14
Oracle-Supplied PL/SQL Packages.....	1-14
DBMS_APPLY_ADM Package	1-14
DBMS_CAPTURE_ADM Package	1-15
DBMS_COMPARISON Package.....	1-15
DBMS_PROPAGATION_ADM Package	1-15
DBMS_RULE Package.....	1-15
DBMS_RULE_ADM Package.....	1-15
DBMS_STREAMS Package.....	1-15
DBMS_STREAMS_ADM Package.....	1-15
DBMS_STREAMS_ADVISOR_ADM Package	1-16
DBMS_STREAMS_AUTH Package.....	1-16
DBMS_STREAMS_MESSAGING Package.....	1-16
DBMS_STREAMS_TABLESPACE_ADM Package	1-16
UTL_SPADV Package	1-16
Oracle Streams Data Dictionary Views.....	1-16
Oracle Streams Tool in the Oracle Enterprise Manager Console.....	1-16
Oracle Streams Documentation Roadmap	1-18
Documentation for Learning About Oracle Streams	1-18
Documentation About Setting Up or Extending an Oracle Streams Environment.....	1-21
Documentation About Managing an Oracle Streams Environment	1-23
Documentation About Monitoring an Oracle Streams Environment	1-25
Documentation About Database Using Oracle Streams for Upgrade and Maintenance	1-27

2 Oracle Streams Information Capture

Ways to Capture Information with Oracle Streams.....	2-1
Implicit Capture	2-1
Capture Processes	2-2
Synchronous Captures	2-2
Explicit Capture.....	2-2
Types of Information Captured with Oracle Streams.....	2-3
Logical Change Records (LCRs).....	2-3
Row LCRs.....	2-4
DDL LCRs	2-5
Extra Information in LCRs.....	2-6
User Messages	2-7
Summary of Information Capture Options With Oracle Streams	2-7
Instantiation in an Oracle Streams Environment	2-8
Implicit Capture with an Oracle Streams Capture Process.....	2-9
Introduction to Capture Processes.....	2-10
Capture Process Rules	2-11
Data Types Captured by Capture Processes	2-12
Types of DML Changes Captured by Capture Processes	2-13
Supplemental Logging in an Oracle Streams Environment	2-13
Local Capture and Downstream Capture	2-14

Local Capture	2-14
Downstream Capture	2-15
SCN Values Related to a Capture Process.....	2-20
Captured SCN and Applied SCN.....	2-20
First SCN and Start SCN	2-20
Oracle Streams Capture Processes and RESTRICTED SESSION	2-22
Capture Process Components	2-22
Capture User	2-23
Capture Process States.....	2-24
Multiple Capture Processes in a Single Database	2-24
Capture Process Checkpoints.....	2-25
Required Checkpoint SCN	2-25
Maximum Checkpoint SCN	2-25
Checkpoint Retention Time	2-26
A New First SCN Value and Purged LogMiner Data Dictionary Information	2-27
ARCHIVELOG Mode and a Capture Process.....	2-28
Capture Process Creation.....	2-29
The LogMiner Data Dictionary for a Capture Process	2-30
The Oracle Streams Data Dictionary	2-34
Capture Process Parameters	2-35
Capture Process Rule Evaluation.....	2-36
Persistent Capture Process Status Upon Database Restart	2-38
Implicit Capture with Synchronous Capture	2-38
Introduction to Synchronous Capture	2-39
Synchronous Capture and Queues.....	2-40
Synchronous Capture Rules	2-40
Data Types Captured by Synchronous Capture.....	2-41
Types of DML Changes Captured by Synchronous Capture	2-42
Capture User for Synchronous Capture	2-42
Multiple Synchronous Captures in a Single Database	2-43
Explicit Capture by Applications	2-43
Types of Messages That Can Be Enqueued Explicitly	2-43
User Messages	2-43
Logical Change Records (LCRs)	2-44
Enqueue Features	2-44

3 Oracle Streams Staging and Propagation

Introduction to Message Staging and Propagation	3-1
Queues	3-1
ANYDATA Queues and Typed Queues.....	3-2
Persistent Queues and Buffered Queues	3-3
Queues and Oracle Streams Clients	3-4
Secure Queues	3-5
Secure Queues and the SET_UP_QUEUE Procedure	3-5
Secure Queues and Oracle Streams Clients	3-6
Transactional and Nontransactional Queues.....	3-7
Commit-Time Queues	3-8

When to Use Commit-Time Queues	3-8
How Commit-Time Queues Work	3-10
Message Propagation Between Queues	3-11
Propagation Rules	3-13
Queue-to-Queue Propagations	3-13
Ensured Message Delivery	3-14
Directed Networks	3-15
Queue Forwarding and Apply Forwarding	3-15
Binary File Propagation.....	3-17
Propagation Jobs	3-17
Propagation Scheduling and Oracle Streams Propagations.....	3-18
Propagation Jobs and RESTRICTED SESSION	3-19
Oracle Streams Data Dictionary for Propagations	3-19
Combined Capture and Apply Optimization	3-20
Combined Capture and Apply Requirements.....	3-20
How to Use Combined Capture and Apply	3-21
How to Determine Whether Combined Capture and Apply Is Being Used.....	3-22
How to Manage the Flow of LCRs From the Capture Process to the Apply Process	3-22
Combined Capture and Apply and Point-in-Time Recovery.....	3-23

4 Oracle Streams Information Consumption

Overview of Information Consumption with Oracle Streams.....	4-1
Ways to Consume Information with Oracle Streams	4-1
Implicit Consumption	4-1
Explicit Consumption.....	4-2
Types of Information Consumed with Oracle Streams	4-2
Captured LCRs.....	4-2
Persistent LCRs.....	4-3
Buffered LCRs	4-3
Persistent User Messages.....	4-3
Buffered User Messages.....	4-4
Summary of Information Consumption Options.....	4-4
Implicit Consumption with an Apply Process	4-5
Introduction to the Apply Process.....	4-5
Apply Process Rules	4-6
Types of Messages That Can Be Processed with an Apply Process	4-6
Message Processing Options for an Apply Process	4-7
Apply LCRs Directly	4-7
Process Messages with Apply Handlers	4-8
Summary of Message Processing Options	4-12
The Source of Messages Applied by an Apply Process.....	4-12
Data Types Applied.....	4-13
Automatic Data Type Conversion During Apply	4-14
Automatic Trimming of Character Data Types During Apply.....	4-15
Automatic Conversion and LOB Data Types	4-16
Oracle Streams Apply Processes and RESTRICTED SESSION	4-16

Apply Process Components	4-16
Reader Server States	4-17
Coordinator Process States	4-17
Apply Server States	4-18
Apply User	4-18
Apply Process Creation.....	4-19
Oracle Streams Data Dictionary for an Apply Process.....	4-20
Apply Process Parameters	4-20
Multiple Apply Processes in a Single Database.....	4-20
Persistent Apply Process Status Upon Database Restart	4-21
The Error Queue.....	4-21
Explicit Consumption with a Messaging Client	4-22
Explicit Consumption with Manual Dequeue	4-23

5 Rules

The Components of a Rule	5-1
Rule Condition.....	5-1
Variables in Rule Conditions.....	5-2
Simple Rule Conditions	5-3
Rule Evaluation Context	5-5
Explicit and Implicit Variables.....	5-5
Evaluation Context Association with Rule Sets and Rules.....	5-6
Evaluation Function	5-7
Rule Action Context.....	5-8
Rule Set Evaluation.....	5-10
Rule Set Evaluation Process.....	5-11
Partial Evaluation.....	5-12
Database Objects and Privileges Related to Rules.....	5-13
Privileges for Creating Database Objects Related to Rules.....	5-14
Privileges for Altering Database Objects Related to Rules	5-14
Privileges for Dropping Database Objects Related to Rules.....	5-14
Privileges for Placing Rules in a Rule Set	5-15
Privileges for Evaluating a Rule Set	5-15
Privileges for Using an Evaluation Context.....	5-15

6 How Rules Are Used in Oracle Streams

Overview of How Rules Are Used in Oracle Streams	6-1
Rule Sets and Rule Evaluation of Messages	6-3
Oracle Streams Client with No Rule Set	6-4
Oracle Streams Client with a Positive Rule Set Only.....	6-4
Oracle Streams Client with a Negative Rule Set Only.....	6-4
Oracle Streams Client with Both a Positive and a Negative Rule Set	6-4
Oracle Streams Client with One or More Empty Rule Sets	6-4
Summary of Rule Sets and Oracle Streams Client Behavior.....	6-5
System-Created Rules.....	6-5
Global Rules.....	6-11

Global Rules Example	6-11
System-Created Global Rules Avoid Empty Rule Conditions Automatically.....	6-13
Schema Rules	6-14
Schema Rule Example	6-15
Table Rules	6-17
Table Rules Example	6-17
Subset Rules	6-19
Subset Rules Example	6-20
Row Migration and Subset Rules	6-23
Subset Rules and Supplemental Logging.....	6-27
Guidelines for Using Subset Rules	6-28
Message Rules.....	6-30
Message Rule Example.....	6-30
System-Created Rules and Negative Rule Sets.....	6-32
Negative Rule Set Example	6-34
System-Created Rules with Added User-Defined Conditions.....	6-35
Evaluation Contexts Used in Oracle Streams	6-37
Evaluation Context for Global, Schema, Table, and Subset Rules.....	6-37
Evaluation Contexts for Message Rules.....	6-38
Oracle Streams and Event Contexts	6-40
Oracle Streams and Action Contexts	6-40
Purposes of Action Contexts in Oracle Streams	6-40
Internal LCR Transformations in Subset Rules	6-41
Information About Declarative Rule-Based Transformations	6-41
Custom Rule-Based Transformations	6-42
Execution Directives for Messages During Apply.....	6-42
Enqueue Destinations for Messages During Apply	6-42
Ensure That Only One Rule Can Evaluate to TRUE for a Particular Rule Condition	6-42
Action Context Considerations for Schema and Global Rules.....	6-43
User-Created Rules, Rule Sets, and Evaluation Contexts.....	6-43
User-Created Rules and Rule Sets	6-44
Rule Conditions for Specific Types of Operations	6-44
Rule Conditions that Instruct Oracle Streams Clients to Discard Unsupported LCRs ..	6-45
Complex Rule Conditions.....	6-46
Rule Conditions with Undefined Variables that Evaluate to NULL.....	6-48
Variables as Function Parameters in Rule Conditions	6-49
User-Created Evaluation Contexts	6-50

7 Rule-Based Transformations

Declarative Rule-Based Transformations	7-1
Custom Rule-Based Transformations	7-2
Custom Rule-Based Transformations and Action Contexts	7-4
Required Privileges for Custom Rule-Based Transformations	7-5
Rule-Based Transformations and Oracle Streams Clients	7-5
Rule-Based Transformations and Capture Processes	7-6
Rule-Based Transformation Errors During Capture by a Capture Process	7-7
Rule Based Transformations and Synchronous Captures.....	7-8

Rule-Based Transformations and Errors During Capture by a Synchronous Capture	7-10
Rule-Based Transformations and Propagations	7-10
Rule-Based Transformation Errors During Propagation	7-12
Rule-Based Transformations and an Apply Process.....	7-12
Rule-Based Transformation Errors During Apply Process Dequeue	7-13
Apply Errors on Transformed Messages.....	7-13
Rule-Based Transformations and a Messaging Client.....	7-14
Rule-Based Transformation Errors During Messaging Client Dequeue	7-15
Multiple Rule-Based Transformations	7-15
Transformation Ordering	7-15
Declarative Rule-Based Transformation Ordering	7-15
Default Declarative Transformation Ordering	7-15
User-Specified Declarative Transformation Ordering	7-17
Considerations for Rule-Based Transformations	7-18

8 Oracle Streams High Availability Environments

Overview of Oracle Streams High Availability Environments	8-1
Protection from Failures	8-1
Oracle Streams Replica Database.....	8-2
Updates at the Replica Database	8-3
Heterogeneous Platform Support.....	8-3
Multiple Character Sets.....	8-3
Mining the Online Redo Logs to Minimize Latency.....	8-3
Greater than Ten Copies of Data	8-3
Fast Failover.....	8-3
Single Capture for Multiple Destinations.....	8-4
When Not to Use Oracle Streams	8-4
Application-Maintained Copies.....	8-4
Best Practices for Oracle Streams High Availability Environments	8-4
Configuring Oracle Streams for High Availability	8-5
Directly Connecting Every Database to Every Other Database.....	8-5
Creating Hub-and-Spoke Configurations	8-5
Local or Downstream Capture with Oracle Streams Capture Processes.....	8-6
Recovering from Failures.....	8-6
Automatic Capture Process Restart After a Failover.....	8-6
Database Links Reestablishment After a Failover.....	8-7
Propagation Job Restart After a Failover.....	8-7
Automatic Apply Process Restart After a Failover	8-7

Part II Oracle Streams Configuration

9 Preparing for and Configuring an Oracle Streams Environment

Configuring an Oracle Streams Administrator	9-1
Setting Initialization Parameters Relevant to Oracle Streams	9-4
Configuring the Oracle Streams Pool	9-9
Using Automatic Memory Management to Set the Oracle Streams Pool Size	9-10

Using Automatic Shared Memory Management to Set the Oracle Streams Pool Size	9-11
Setting the Oracle Streams Pool Size Manually	9-11
Using the Default Setting for the Oracle Streams Pool Size.....	9-11
Configuring Network Connectivity and Database Links	9-12
Configuring Oracle Streams.....	9-13

10 Configuring Implicit Capture

Configuring a Capture Process	10-1
Preparing to Configure a Capture Process	10-3
Configuring a Local Capture Process.....	10-3
Example of Configuring a Local Capture Process Using DBMS_STREAMS_ADM.....	10-4
Example of Configuring a Local Capture Process Using DBMS_CAPTURE_ADM	10-5
Example of Configuring a Local Capture Process with Non-NULL Start SCN	10-6
Configuring a Downstream Capture Process	10-7
Preparing to Transmit Redo Data to a Downstream Database	10-7
Configuring a Real-Time Downstream Capture Process.....	10-10
Configuring an Archived-Log Downstream Capture Process.....	10-16
After Configuring a Capture Process	10-22
Configuring Synchronous Capture.....	10-23
Preparing to Configure a Synchronous Capture	10-23
Configuring a Synchronous Capture Using the DBMS_STREAMS_ADM Package.....	10-24
Configuring a Synchronous Capture Using the DBMS_CAPTURE_ADM Package	10-25
After Configuring a Synchronous Capture	10-27

11 Configuring Queues and Propagations

Configuring Queues	11-1
Creating an ANYDATA Queue	11-1
Creating Oracle Streams Propagations Between ANYDATA Queues	11-3
Example of Configuring a Propagation Using DBMS_STREAMS_ADM	11-4
Example of Configuring a Propagation Using DBMS_PROPAGATION_ADM.....	11-6

12 Configuring Implicit Apply

Overview of Apply Process Creation	12-1
Creating an Apply Process Using the DBMS_STREAMS_ADM Package	12-2
Creating an Apply Process for Captured LCRs.....	12-3
Creating an Apply Process for User Messages	12-4
Creating an Apply Process Using the DBMS_APPLY_ADM Package	12-4
Creating an Apply Process for Captured LCRs with DBMS_APPLY_ADM	12-5
Creating an Apply Process for Persistent LCRs with DBMS_APPLY_ADM.....	12-6
Creating an Apply Process for Persistent User Messages with DBMS_APPLY_ADM	12-7

13 Configuring Oracle Streams Messaging Environments

Wrapping User Message Payloads in an ANYDATA Wrapper and Enqueuing Them.....	13-2
Dequeuing a Payload that Is Wrapped in an ANYDATA Payload	13-3
Configuring a Messaging Client and Message Notification	13-5

Part III Oracle Streams Administration

14 Managing Oracle Streams Implicit Capture

Managing a Capture Process	14-1
Starting a Capture Process	14-2
Stopping a Capture Process	14-2
Managing the Rule Set for a Capture Process	14-3
Specifying a Rule Set for a Capture Process	14-3
Adding Rules to a Rule Set for a Capture Process	14-3
Removing a Rule from a Rule Set for a Capture Process	14-5
Removing a Rule Set for a Capture Process	14-5
Setting a Capture Process Parameter	14-6
Setting the Capture User for a Capture Process	14-7
Managing the Checkpoint Retention Time for a Capture Process	14-7
Setting the Checkpoint Retention Time for a Capture Process to a New Value	14-7
Setting the Checkpoint Retention Time for a Capture Process to Infinite	14-8
Adding an Archived Redo Log File to a Capture Process Explicitly	14-8
Setting the First SCN for an Existing Capture Process	14-8
Setting the Start SCN for an Existing Capture Process	14-9
Specifying Whether Downstream Capture Uses a Database Link	14-10
Dropping a Capture Process	14-11
Managing a Synchronous Capture	14-11
Managing the Rule Set for a Synchronous Capture	14-12
Specifying a Rule Set for a Synchronous Capture	14-12
Adding Rules to a Rule Set for a Synchronous Capture	14-12
Removing a Rule from a Rule Set for a Synchronous Capture	14-13
Setting the Capture User for a Synchronous Capture	14-14
Dropping a Synchronous Capture	14-15
Managing Extra Attributes in Captured LCRs	14-15
Including Extra Attributes in Implicitly LCRs	14-16
Excluding Extra Attributes from Implicitly LCRs	14-16
Switching From a Capture Process to a Synchronous Capture	14-16
Switching from a Synchronous Capture to a Capture Process	14-23

15 Managing Staging and Propagation

Managing Queues	15-1
Enabling a User to Perform Operations on a Secure Queue	15-1
Disabling a User from Performing Operations on a Secure Queue	15-3
Removing a Queue	15-4
Managing Oracle Streams Propagations and Propagation Jobs	15-4
Starting a Propagation	15-5
Stopping a Propagation	15-5
Altering the Schedule of a Propagation Job	15-5
Altering the Schedule of a Propagation Job for a Queue-to-Queue Propagation	15-6
Altering the Schedule of a Propagation Job for a Queue-to-DbLink Propagation	15-6
Specifying the Rule Set for a Propagation	15-7

Specifying a Positive Rule Set for a Propagation	15-7
Specifying a Negative Rule Set for a Propagation	15-7
Adding Rules to the Rule Set for a Propagation.....	15-7
Adding Rules to the Positive Rule Set for a Propagation	15-8
Adding Rules to the Negative Rule Set for a Propagation	15-8
Removing a Rule from the Rule Set for a Propagation.....	15-9
Removing a Rule Set for a Propagation	15-10
Dropping a Propagation.....	15-10

16 Managing Oracle Streams Information Consumption

Starting an Apply Process.....	16-2
Stopping an Apply Process	16-2
Managing the Rule Set for an Apply Process	16-2
Specifying the Rule Set for an Apply Process	16-3
Specifying a Positive Rule Set for an Apply Process	16-3
Specifying a Negative Rule Set for an Apply Process	16-3
Adding Rules to the Rule Set for an Apply Process.....	16-3
Adding Rules to the Positive Rule Set for an Apply Process	16-4
Adding Rules to the Negative Rule Set for an Apply Process	16-4
Removing a Rule from the Rule Set for an Apply Process.....	16-5
Removing a Rule Set for an Apply Process	16-5
Setting an Apply Process Parameter.....	16-6
Setting the Apply User for an Apply Process	16-7
Managing the Message Handler for an Apply Process.....	16-8
Setting the Message Handler for an Apply Process.....	16-8
Unsetting the Message Handler for an Apply Process.....	16-8
Managing the Precommit Handler for an Apply Process.....	16-8
Creating a Precommit Handler for an Apply Process	16-9
Setting the Precommit Handler for an Apply Process.....	16-10
Unsetting the Precommit Handler for an Apply Process.....	16-10
Specifying That Apply Processes Enqueue Messages	16-11
Setting the Destination Queue for Messages that Satisfy a Rule.....	16-11
Removing the Destination Queue Setting for a Rule	16-12
Specifying Execute Directives for Apply Processes	16-12
Specifying that Messages that Satisfy a Rule Are Not Executed.....	16-12
Specifying that Messages that Satisfy a Rule Are Executed	16-13
Managing an Error Handler	16-13
Creating an Error Handler	16-14
Setting an Error Handler	16-17
Unsetting an Error Handler	16-18
Managing Apply Errors.....	16-19
Retrying Apply Error Transactions	16-19
Retrying a Specific Apply Error Transaction.....	16-19
Retrying All Error Transactions for an Apply Process.....	16-21
Deleting Apply Error Transactions	16-22
Deleting a Specific Apply Error Transaction	16-22
Deleting All Error Transactions for an Apply Process	16-22

Dropping an Apply Process	16-22
17 Managing Rules	
Managing Rule Sets	17-2
Creating a Rule Set.....	17-2
Adding a Rule to a Rule Set.....	17-3
Removing a Rule from a Rule Set	17-3
Dropping a Rule Set.....	17-4
Managing Rules	17-4
Creating a Rule	17-4
Creating a Rule Without an Action Context	17-5
Creating a Rule with an Action Context.....	17-6
Altering a Rule.....	17-6
Changing a Rule Condition	17-7
Modifying a Name-Value Pair in a Rule Action Context.....	17-7
Adding a Name-Value Pair to a Rule Action Context.....	17-8
Removing a Name-Value Pair from a Rule Action Context	17-9
Modifying System-Created Rules.....	17-10
Dropping a Rule	17-11
Managing Privileges on Evaluation Contexts, Rule Sets, and Rules	17-11
Granting System Privileges on Evaluation Contexts, Rule Sets, and Rules	17-11
Granting Object Privileges on an Evaluation Context, Rule Set, or Rule	17-12
Revoking System Privileges on Evaluation Contexts, Rule Sets, and Rules	17-12
Revoking Object Privileges on an Evaluation Context, Rule Set, or Rule	17-13
18 Managing Rule-Based Transformations	
Managing Declarative Rule-Based Transformations	18-1
Adding Declarative Rule-Based Transformations	18-1
Adding a Declarative Rule-Based Transformation that Renames a Table	18-1
Adding a Declarative Rule-Based Transformation that Adds a Column.....	18-2
Overwriting an Existing Declarative Rule-Based Transformation	18-3
Removing Declarative Rule-Based Transformations.....	18-4
Managing Custom Rule-Based Transformations	18-5
Creating a Custom Rule-Based Transformation.....	18-5
Altering a Custom Rule-Based Transformation	18-10
Unsetting a Custom Rule-Based Transformation.....	18-11
19 Other Oracle Streams Management Tasks	
Performing Full Database Export/Import in an Oracle Streams Environment	19-1
Removing an Oracle Streams Configuration.....	19-5
20 Troubleshooting an Oracle Streams Environment	
Viewing Oracle Streams Alerts.....	20-1
Troubleshooting Capture Process Problems	20-3
Is Capture Process Creation or Data Dictionary Build Taking a Long Time?.....	20-4

Is the Capture Process Enabled?	20-4
Is the Capture Process Current?	20-5
Are Required Redo Log Files Missing?	20-5
Is a Downstream Capture Process Waiting for Redo Data?	20-6
Are You Trying to Configure Downstream Capture Incorrectly?	20-8
Are You Trying to Configure Downstream Capture Without Proper Authentication?	20-8
Are More Actions Required for Downstream Capture Without a Database Link?	20-9
Troubleshooting Synchronous Capture Problems	20-9
Is a Synchronous Capture Failing to Capture Changes to Tables?	20-9
Troubleshooting Propagation Problems	20-11
Does the Propagation Use the Correct Source and Destination Queue?	20-11
Is the Propagation Enabled?	20-12
Is Security Configured Properly for the ANYDATA Queue?	20-13
ORA-24093 AQ Agent not granted privileges of database user	20-13
ORA-25224 Sender name must be specified for enqueue into secure queues	20-14
Troubleshooting Apply Process Problems	20-14
Is the Apply Process Enabled?	20-14
Is the Apply Process Current?	20-15
Does the Apply Process Apply Captured LCRs?	20-15
Is the Apply Process Queue Receiving the Messages to be Applied?	20-16
Is a Custom Apply Handler Specified?	20-17
Is the AQ_TM_PROCESSES Initialization Parameter Set to Zero?	20-17
Does the Apply User Have the Required Privileges?	20-18
Are There Any Apply Errors in the Error Queue?	20-18
Troubleshooting Problems with Rules and Rule-Based Transformations	20-18
Are Rules Configured Properly for the Oracle Streams Client?	20-19
Checking Schema and Global Rules	20-20
Checking Table Rules	20-20
Checking Subset Rules	20-21
Checking for Message Rules	20-22
Resolving Problems with Rules	20-23
Are Declarative Rule-Based Transformations Configured Properly?	20-24
Are the Custom Rule-Based Transformations Configured Properly?	20-25
Are Incorrectly Transformed LCRs in the Error Queue?	20-26
Checking the Trace Files and Alert Log for Problems	20-26
Does a Capture Process Trace File Contain Messages About Capture Problems?	20-27
Do the Trace Files Related to Propagation Jobs Contain Messages About Problems?	20-27
Does an Apply Process Trace File Contain Messages About Apply Problems?	20-27

Part IV Monitoring Oracle Streams

21 Monitoring an Oracle Streams Environment

Summary of Oracle Streams Static Data Dictionary Views	21-1
Summary of Oracle Streams Dynamic Performance Views	21-3

22 Monitoring the Oracle Streams Topology and Performance

About the Oracle Streams Topology	22-1
About the Oracle Streams Performance Advisor	22-2
Oracle Streams Performance Advisor Data Dictionary Views.....	22-2
Oracle Streams Components and Statistics	22-3
About Stream Paths in an Oracle Streams Topology	22-4
Stream Paths in a Combined Capture and Apply Replication Environment	22-5
Stream Paths in a Replication Environment That Does Not Use Combined Capture and Apply	22-6
About the Information Gathered With the Oracle Streams Performance Advisor	22-8
Gathering Information About the Oracle Streams Topology and Performance	22-9
Viewing the Oracle Streams Topology and Analyzing Oracle Streams Performance	22-10
Viewing the Oracle Streams Topology	22-12
Viewing the Databases in the Oracle Streams Environment.....	22-12
Viewing the Oracle Streams Components at Each Database	22-13
Viewing Each Stream Path in an Oracle Streams Topology	22-15
Viewing Performance Statistics for Oracle Streams Components	22-17
Checking for Bottleneck Components in the Oracle Streams Topology.....	22-18
Viewing Component-Level Statistics.....	22-20
Viewing Session-Level Statistics.....	22-27
Viewing Statistics for the Stream Paths in an Oracle Streams Environment	22-32
Using the UTL_SPADV Package	22-33

23 Monitoring Oracle Streams Implicit Capture

Monitoring a Capture Process	23-1
Displaying the Queue, Rule Sets, and Status of Each Capture Process	23-2
Displaying Change Capture Information About Each Capture Process	23-3
Displaying State Change and Message Creation Time for Each Capture Process	23-4
Displaying Elapsed Time Performing Capture Operations for Each Capture Process	23-5
Displaying Information About Each Downstream Capture Process	23-6
Displaying the Registered Redo Log Files for Each Capture Process	23-7
Displaying the Redo Log Files that Are Required by Each Capture Process.....	23-8
Displaying SCN Values for Each Redo Log File Used by Each Capture Process.....	23-9
Displaying the Last Archived Redo Entry Available to Each Capture Process.....	23-10
Listing the Parameter Settings for Each Capture Process	23-11
Determining the Applied SCN for All Capture Processes in a Database	23-12
Determining Redo Log Scanning Latency for Each Capture Process	23-12
Determining Message Enqueuing Latency for Each Capture Process	23-13
Displaying Information About Rule Evaluations for Each Capture Process	23-14
Determining Which Capture Processes Use Combined Capture and Apply	23-15
Monitoring a Synchronous Capture	23-15
Displaying the Queue and Rule Set of Each Synchronous Capture	23-16
Displaying the Tables For Which Synchronous Capture Captures Changes.....	23-16
Viewing the Extra Attributes Captured by Implicit Capture	23-17

24 Monitoring Oracle Streams Queues and Propagations

Monitoring Queues and Messaging	24-1
Displaying the ANYDATA Queues in a Database.....	24-2
Viewing the Messaging Clients in a Database	24-2
Viewing Message Notifications.....	24-3
Determining the Consumer of Each Message in a Persistent Queue	24-3
Viewing the Contents of Messages in a Persistent Queue	24-4
Monitoring Buffered Queues	24-5
Determining the Number of Messages in Each Buffered Queue	24-6
Viewing the Capture Processes for the LCRs in Each Buffered Queue	24-6
Displaying Information About Propagations that Send Buffered Messages	24-7
Displaying the Number of Messages and Bytes Sent By Propagations	24-8
Displaying Performance Statistics for Propagations that Send Buffered Messages.....	24-9
Viewing the Propagations Dequeueing Messages from Each Buffered Queue.....	24-10
Displaying Performance Statistics for Propagations That Receive Buffered Messages.....	24-11
Viewing the Apply Processes Dequeueing Messages from Each Buffered Queue	24-12
Monitoring Oracle Streams Propagations and Propagation Jobs	24-13
Displaying the Queues and Database Link for Each Propagation.....	24-13
Determining the Source Queue and Destination Queue for Each Propagation	24-14
Determining the Rule Sets for Each Propagation	24-15
Displaying the Schedule for a Propagation Job	24-15
Determining the Total Number of Messages and Bytes Propagated	24-17
Displaying Information About Propagation Senders	24-17
Displaying Information About Propagation Receivers	24-18

25 Monitoring Oracle Streams Apply Processes

Determining the Queue, Rule Sets, and Status for Each Apply Process	25-2
Displaying General Information About Each Apply Process	25-3
Listing the Parameter Settings for Each Apply Process	25-3
Displaying Information About Apply Handlers	25-4
Displaying All of the Error Handlers for Local Apply Processes	25-4
Displaying the Message Handler for Each Apply Process	25-5
Displaying the Precommit Handler for Each Apply Process	25-5
Displaying Information About the Reader Server for Each Apply Process	25-6
Monitoring Transactions and Messages Spilled by Each Apply Process	25-7
Determining Capture to Dequeue Latency for a Message	25-8
Displaying General Information About Each Coordinator Process	25-9
Displaying Information About Transactions Received and Applied	25-10
Determining the Capture to Apply Latency for a Message for Each Apply Process	25-11
Example V\$STREAMS_APPLY_COORDINATOR Query for Latency	25-11
Example DBA_APPLY_PROGRESS Query for Latency	25-12
Displaying Information About the Apply Servers for Each Apply Process	25-12
Displaying Effective Apply Parallelism for an Apply Process	25-14
Viewing Rules that Specify a Destination Queue on Apply	25-14
Viewing Rules that Specify No Execution on Apply	25-15
Determining Which Apply Processes Use Combined Capture and Apply	25-15
Checking for Apply Errors	25-16

Displaying Detailed Information About Apply Errors	25-17
26 Monitoring Rules	
Displaying All Rules Used by All Oracle Streams Clients.....	26-2
Displaying the Oracle Streams Rules Used by a Specific Oracle Streams Client.....	26-4
Displaying the Rules in the Positive Rule Set for an Oracle Streams Client	26-4
Displaying the Rules in the Negative Rule Set for an Oracle Streams Client	26-5
Displaying the Current Condition for a Rule.....	26-6
Displaying Modified Rule Conditions for Oracle Streams Rules.....	26-7
Displaying the Evaluation Context for Each Rule Set	26-8
Displaying Information About the Tables Used by an Evaluation Context.....	26-8
Displaying Information About the Variables Used in an Evaluation Context	26-9
Displaying All of the Rules in a Rule Set	26-9
Displaying the Condition for Each Rule in a Rule Set	26-10
Listing Each Rule that Contains a Specified Pattern in Its Condition.....	26-10
Displaying Aggregate Statistics for All Rule Set Evaluations	26-11
Displaying Information About Evaluations for Each Rule Set.....	26-12
Determining the Resources Used by Evaluation of Each Rule Set	26-13
Displaying Evaluation Statistics for a Rule	26-14
27 Monitoring Rule-Based Transformations	
Displaying Information About All Rule-Based Transformations	27-1
Displaying Declarative Rule-Based Transformations.....	27-2
Displaying Information About ADD COLUMN Transformations	27-4
Displaying Information About RENAME TABLE Transformations.....	27-4
Displaying Custom Rule-Based Transformations	27-5
28 Monitoring Other Oracle Streams Components	
Monitoring Oracle Streams Administrators and Other Oracle Streams Users.....	28-1
Listing Local Oracle Streams Administrators.....	28-2
Listing Users Who Allow Access to Remote Oracle Streams Administrators	28-2
Monitoring the Oracle Streams Pool	28-3
Query Result that Advises Increasing the Oracle Streams Pool Size	28-4
Query Result that Advises Retaining the Current Oracle Streams Pool Size.....	28-5
Query Result that Advises Decreasing the Oracle Streams Pool Size	28-6
Monitoring Compatibility in an Oracle Streams Environment	28-7
Monitoring Compatibility for Capture Processes	28-7
Listing the Database Objects That Are Not Compatible With Capture Processes	28-7
Listing the Database Objects That Have Become Compatible With Capture Processes Recently	28-9
Listing Database Objects and Columns That Are Not Compatible With Synchronous Captures.....	28-11
Monitoring Compatibility for Apply Processes	28-12
Listing Database Objects and Columns That Are Not Compatible With Apply Processes.....	28-12
Listing Columns That Have Become Compatible With Apply Processes Recently.....	28-13

Monitoring Oracle Streams Performance Using AWR and Statspack	28-15
---	-------

Part V Oracle Streams Information Provisioning

29 Information Provisioning Concepts

Overview of Information Provisioning	29-1
Bulk Provisioning of Large Amounts of Information	29-2
Data Pump Export/Import.....	29-3
Transportable Tablespace from Backup with RMAN	29-3
DBMS_STREAMS_TABLESPACE_ADM Procedures	29-3
File Group Repository	29-4
Tablespace Repository.....	29-4
Read-Only Tablespaces Requirement During Export	29-7
Automatic Platform Conversion for Tablespaces	29-7
Options for Bulk Information Provisioning	29-7
Incremental Information Provisioning with Oracle Streams	29-8
On-Demand Information Access	29-9

30 Using Information Provisioning

Using a Tablespace Repository	30-1
Creating and Populating a Tablespace Repository	30-2
Using a Tablespace Repository for Remote Reporting with a Shared File System	30-4
Using a Tablespace Repository for Remote Reporting Without a Shared File System.....	30-9
Using a File Group Repository	30-14

31 Monitoring File Group and Tablespace Repositories

Monitoring a File Group Repository	31-1
Displaying General Information About the File Groups in a Database.....	31-2
Displaying Information About File Group Versions	31-3
Displaying Information About File Group Files	31-3
Monitoring a Tablespace Repository	31-4
Displaying Information About the Tablespaces in a Tablespace Repository.....	31-4
Displaying Information About the Tables in a Tablespace Repository	31-5
Displaying Export Information About Versions in a Tablespace Repository	31-6

Part VI Sample Environments and Applications

32 Single-Database Capture and Apply Example

Overview of the Single-Database Capture and Apply Example	32-1
Prerequisites	32-2

33 Rule-Based Application Example

Overview of the Rule-Based Application.....	33-1
---	------

Part VII **Appendixes**

A How Oracle Streams Works With Other Database Components

Oracle Streams and Oracle Real Application Clusters	A-1
Capture Processes and Oracle Real Application Clusters.....	A-1
Synchronous Capture and Oracle Real Application Clusters	A-2
Combined Capture and Apply and Oracle Real Application Clusters.....	A-2
Queues and Oracle Real Application Clusters	A-3
Propagations and Oracle Real Application Clusters	A-3
Apply Processes and Oracle Real Application Clusters.....	A-4
Oracle Streams and Transparent Data Encryption	A-5
Capture Processes and Transparent Data Encryption.....	A-5
Synchronous Capture and Transparent Data Encryption.....	A-6
Explicit Capture and Transparent Data Encryption	A-6
Queues and Transparent Data Encryption.....	A-6
Propagations and Transparent Data Encryption.....	A-7
Apply Processes and Transparent Data Encryption	A-7
Messaging Clients and Transparent Data Encryption.....	A-7
Manual Dequeue and Transparent Data Encryption.....	A-8
Oracle Streams and Flashback Data Archive	A-8
Oracle Streams and Recovery Manager (RMAN)	A-8
RMAN and Instantiation.....	A-9
RMAN and Archived Redo Log Files Required by a Capture Process.....	A-9
RMAN and Local Capture Processes	A-9
RMAN and Downstream Capture Processes.....	A-10
The Recovery Catalog and Oracle Streams	A-11

B Oracle Streams Restrictions

Capture Process Restrictions	B-1
Unsupported Data Types for Capture Processes	B-1
Unsupported Changes for Capture Processes	B-2
Unsupported Schemas for Capture Processes	B-3
Unsupported DML Changes for Capture Processes.....	B-3
Unsupported DDL Changes for Capture Processes	B-4
Changes Ignored by a Capture Process	B-5
NOLOGGING and UNRECOVERABLE Keywords for SQL Operations	B-5
UNRECOVERABLE Clause for Direct Path Loads.....	B-6
Supplemental Logging Data Type Restrictions	B-6
Capture Processes Do Not Support Oracle Label Security	B-6
Capture Process Interoperability with Oracle Streams Apply Processes	B-6
Synchronous Capture Restrictions	B-7
Synchronous Captures Only Use Table Rules	B-7
Unsupported Data Types for Synchronous Captures	B-7
Unsupported Changes for Synchronous Captures	B-8
Unsupported Schemas for Synchronous Captures.....	B-8
Unsupported DML Changes for Synchronous Captures.....	B-9

Changes Ignored by Synchronous Capture	B-10
Synchronous Capture Rules and the DBMS_STREAMS_ADM Package	B-10
Synchronous Captures Do Not Support Oracle Label Security	B-10
Queue Restrictions	B-11
Explicit Enqueue Restrictions for ANYDATA Queues	B-11
Restrictions for Buffered Messaging	B-11
Triggers and Queue Tables	B-12
Propagation Restrictions	B-12
Connection Qualifiers and Propagations	B-12
Character Set Restrictions for Propagations	B-12
Compatibility Requirements for Queue-To-Queue Propagations	B-12
Apply Process Restrictions	B-12
Unsupported Data Types for Apply Processes	B-13
Unsupported Data Types for Apply Handlers	B-13
Types of DDL Changes Ignored by an Apply Process	B-13
Database Structures in an Oracle Streams Environment	B-14
Current Schema User Must Exist at Destination Database	B-15
Apply Processes Do Not Support Oracle Label Security	B-15
Apply Process Interoperability with Oracle Streams Capture Processes	B-15
Messaging Client Restrictions	B-15
Messaging Clients and Buffered Messages	B-15
Rule Restrictions	B-15
Restrictions for Subset Rules	B-16
Rule-Based Transformation Restrictions	B-16
Unsupported Data Types for Rule-Based Transformations	B-16

C XML Schema for LCRs

Definition of the XML Schema for LCRs	C-1
---	-----

D Online Database Upgrade with Oracle Streams

Overview of Using Oracle Streams in the Database Upgrade Process	D-1
The Capture Database During the Upgrade Process	D-3
Assumptions for the Database Being Upgraded	D-3
Considerations for Job Queue Processes and PL/SQL Package Subprograms	D-4
Preparing for a Database Upgrade Using Oracle Streams	D-4
Preparing to Upgrade a Database with User-defined Types	D-4
Deciding Which Utility to Use for Instantiation	D-5
Performing a Database Upgrade Using Oracle Streams	D-6
Task 1: Beginning the Upgrade	D-6
Task 2: Setting Up Oracle Streams Prior to Instantiation	D-8
The Source Database Is the Capture Database	D-8
The Destination Database Is the Capture Database	D-9
A Third Database Is the Capture Database	D-10
Task 3: Instantiating the Database	D-11
Instantiating the Database Using Export/Import	D-11
Instantiating the Database Using RMAN	D-12
Task 4: Setting Up Oracle Streams After Instantiation	D-14

The Source Database Is the Capture Database	D-14
The Destination Database Is the Capture Database	D-16
A Third Database Is the Capture Database	D-17
Task 5: Finishing the Upgrade and Removing Oracle Streams	D-18

E Online Database Maintenance with Oracle Streams

Overview of Using Oracle Streams for Database Maintenance Operations	E-1
The Capture Database During the Maintenance Operation	E-3
Assumptions for the Database Being Maintained	E-4
Considerations for Job Slaves and PL/SQL Package Subprograms	E-4
Unsupported Database Objects Are Excluded	E-4
Preparing for a Database Maintenance Operation	E-5
Preparing for Downstream Capture	E-5
Preparing for Maintenance of a Database with User-defined Types	E-8
Preparing for Upgrades to User-Created Applications	E-8
Handling Modifications to Schema Objects	E-9
Handling Logical Dependencies	E-10
Deciding Whether to Configure Oracle Streams Directly or Generate a Script	E-10
Deciding Which Utility to Use for Instantiation	E-11
Performing a Database Maintenance Operation Using Oracle Streams	E-12
Task 1: Beginning the Maintenance Operation	E-13
Task 2: Setting Up Oracle Streams Prior to Instantiation	E-13
The Source Database Is the Capture Database	E-14
The Destination Database Is the Capture Database	E-15
A Third Database Is the Capture Database	E-16
Task 3: Instantiating the Database	E-17
Instantiating the Database Using Export/Import	E-17
Instantiating the Database Using the RMAN DUPLICATE Command	E-19
Instantiating the Database Using the RMAN CONVERT DATABASE Command	E-21
Task 4: Setting Up Oracle Streams After Instantiation	E-24
The Source Database Is the Capture Database	E-25
The Destination Database Is the Capture Database	E-26
A Third Database Is the Capture Database	E-26
Task 5: Finishing the Maintenance Operation and Removing Oracle Streams	E-27

Glossary

Index

List of Figures

1-1	Oracle Streams Information Flow.....	1-2
1-2	Sample Hub-and-Spoke Replication Configuration	1-9
1-3	Sample Replication Configuration With Downstream Capture	1-10
1-4	Sample Replication Configuration With Synchronous Captures	1-11
1-5	Sample N-Way Replication Configuration	1-12
1-6	Sample Single Database Capture and Apply Configuration.....	1-13
1-7	Sample Messaging Configuration	1-14
1-8	Streams page in Enterprise Manager	1-17
1-9	Oracle Streams Topology.....	1-17
2-1	Capture Process.....	2-11
2-2	Real-Time Downstream Capture.....	2-16
2-3	Archived-Log Downstream Capture	2-17
2-4	Checkpoint Retention Time Set to 20 Days	2-26
2-5	Start SCN Higher than Reset First SCN.....	2-27
2-6	Start SCN Lower than Reset First SCN.....	2-28
2-7	Deciding Whether to Share a LogMiner Data Dictionary.....	2-34
2-8	Flowchart Showing Capture Process Rule Evaluation.....	2-38
2-9	Synchronous Capture.....	2-39
3-1	Transactional Dependency Violation During Dequeue	3-9
3-2	Inconsistent Browse of Messages in a Queue	3-10
3-3	Propagation from a Source Queue to a Destination Queue.....	3-12
3-4	Example Directed Networks Environment.....	3-15
4-1	Apply Process Message Processing Options	4-7
4-2	Messaging Client.....	4-23
5-1	Rule Set Evaluation.....	5-11
6-1	One Rule Set Can Be Used by Multiple Clients of a Rules Engine	6-2
6-2	Row Migration During Capture by a Capture Process	6-24
6-3	Row Migration During Propagation.....	6-25
6-4	Row Migration During Apply	6-26
6-5	Row Migration During Dequeue by a Messaging Client.....	6-27
7-1	Transformation During Capture by a Capture Process	7-6
7-2	Transformation During Capture by a Synchronous Capture.....	7-9
7-3	Transformation During Propagation	7-11
7-4	Transformation During Apply.....	7-13
7-5	Transformation During Messaging Client Dequeue	7-14
22-1	Oracle Streams Topology with Two Separate Stream Paths	22-6
22-2	Oracle Streams Topology with Multiple Apply Processes for a Single Source	22-7
22-3	Sample Oracle Streams Replication Environment	22-11
30-1	Example Tablespace Repository	30-3
30-2	Attaching Tablespaces with a Shared File System.....	30-5
30-3	Detaching Tablespaces with a Shared File System	30-6
30-4	Attaching Tablespaces Without a Shared File System	30-10
30-5	Example File Group Repository.....	30-15
32-1	Single Database Capture and Apply Example	32-2
D-1	Online Database Upgrade with Oracle Streams.....	D-2
E-1	Online Database Maintenance with Oracle Streams.....	E-3

List of Tables

1-1	Documentation for Learning About Oracle Streams	1-19
1-2	Documentation About Setting Up or Extending an Oracle Streams Environment	1-21
1-3	Documentation About Managing an Oracle Streams Environment	1-23
1-4	Documentation About Monitoring an Oracle Streams Environment	1-26
1-5	Documentation About Data Upgrade and Maintenance With Oracle Streams.....	1-27
2-1	Information Capture Options With Oracle Streams	2-8
2-2	Information About Table t1 in the Primary and LogMiner Data Dictionaries	2-32
3-1	Apply Process Behavior for Transactional and Nontransactional Queues	3-7
4-1	Information Consumption Options with Oracle Streams.....	4-4
4-2	Summary of Message Processing Options	4-12
4-3	Data Type Combinations Converted Automatically During Apply	4-15
4-4	DBMS_STREAMS_ADM and DBMS_APPLY_ADM Apply Process Creation	4-19
6-1	Rule Sets and Oracle Streams Client Behavior	6-5
6-2	Types of Tasks and Rule Levels.....	6-6
6-3	System-Created Rule Conditions Generated by DBMS_STREAMS_ADM Package	6-7
9-1	Initialization Parameters Relevant to Oracle Streams	9-5
14-1	Sample Switch From a Capture Process to a Synchronous Capture	14-17
14-2	Sample Switch From a Synchronous Capture to a Capture Process	14-23
21-1	Oracle Streams Static Data Dictionary Views	21-1
22-1	Position of Each Link in a Sample Stream Path.....	22-4
22-2	How the Oracle Streams Performance Advisor Gathers Information in a Session.....	22-8
22-3	Component-Level Statistics for Oracle Streams Components	22-20
22-4	Session-Level Statistics for Oracle Streams Components	22-28
29-1	Tablespace Repository Procedures.....	29-6
29-2	Options for Moving or Copying Tablespaces.....	29-8
D-1	Supported Capture Database During Upgrade.....	D-3
D-2	Instantiation Methods for Database Upgrade with Oracle Streams.....	D-6
E-1	Instantiation Methods for Database Maintenance with Oracle Streams	E-12

Preface

Oracle Streams Concepts and Administration describes the features and functionality of Oracle Streams. This document contains conceptual information about Oracle Streams, along with information about managing an Oracle Streams environment. In addition, this document contains detailed examples that configure an Oracle Streams capture and apply environment and a rule-based application.

This Preface contains these topics:

- [Audience](#)
- [Documentation Accessibility](#)
- [Related Documents](#)
- [Conventions](#)

Audience

Oracle Streams Concepts and Administration is intended for database administrators who create and maintain Oracle Streams environments. These administrators perform one or more of the following tasks:

- Plan for an Oracle Streams environment
- Configure an Oracle Streams environment
- Administer an Oracle Streams environment
- Monitor an Oracle Streams environment
- Perform necessary troubleshooting activities

To use this document, you must be familiar with relational database concepts, SQL, distributed database administration, Advanced Queuing concepts, PL/SQL, and the operating systems under which you run an Oracle Streams environment.

Documentation Accessibility

Our goal is to make Oracle products, services, and supporting documentation accessible, with good usability, to the disabled community. To that end, our documentation includes features that make information available to users of assistive technology. This documentation is available in HTML format, and contains markup to facilitate access by the disabled community. Accessibility standards will continue to evolve over time, and Oracle is actively engaged with other market-leading technology vendors to address technical obstacles so that our documentation can be

accessible to all of our customers. For more information, visit the Oracle Accessibility Program Web site at <http://www.oracle.com/accessibility/>.

Accessibility of Code Examples in Documentation

Screen readers may not always correctly read the code examples in this document. The conventions for writing code require that closing braces should appear on an otherwise empty line; however, some screen readers may not always read a line of text that consists solely of a bracket or brace.

Accessibility of Links to External Web Sites in Documentation

This documentation may contain links to Web sites of other companies or organizations that Oracle does not own or control. Oracle neither evaluates nor makes any representations regarding the accessibility of these Web sites.

TTY Access to Oracle Support Services

Oracle provides dedicated Text Telephone (TTY) access to Oracle Support Services within the United States of America 24 hours a day, 7 days a week. For TTY support, call 800.446.2398. Outside the United States, call +1.407.458.2479.

Related Documents

For more information, see these Oracle resources:

- *Oracle Streams Replication Administrator's Guide*
- *Oracle Database Concepts*
- *Oracle Database Administrator's Guide*
- *Oracle Database SQL Language Reference*
- *Oracle Database PL/SQL Packages and Types Reference*
- *Oracle Database PL/SQL Language Reference*
- *Oracle Database Utilities*
- *Oracle Database Heterogeneous Connectivity Administrator's Guide*
- *Oracle Streams Advanced Queuing User's Guide*
- The online Help for the Oracle Streams tool in Oracle Enterprise Manager

Many of the examples in this book use the sample schemas of the sample database, which is installed by default when you install Oracle Database. Refer to *Oracle Database Sample Schemas* for information about how these schemas were created and how you can use them yourself.

Printed documentation is available for sale in the Oracle Store at

<http://oraclestore.oracle.com/>

To download free release notes, installation documentation, white papers, or other collateral, please visit the Oracle Technology Network (OTN). You must register online before using OTN; registration is free and can be done at

<http://www.oracle.com/technology/membership/>

If you already have a user name and password for OTN, then you can go directly to the documentation section of the OTN Web site at

<http://www.oracle.com/technology/documentation/>

Conventions

The following text conventions are used in this document:

Convention	Meaning
boldface	Boldface type indicates graphical user interface elements associated with an action, or terms defined in text or the glossary.
<i>italic</i>	Italic type indicates book titles, emphasis, or placeholder variables for which you supply particular values.
monospace	Monospace type indicates commands within a paragraph, URLs, code in examples, text that appears on the screen, or text that you enter.

What's New in Oracle Streams?

This section describes new features of Oracle Streams for Oracle Database 11g Release 1 (11.1) and provides pointers to additional information.

Oracle Database 11g Release 1 (11.1) New Features in Oracle Streams

The following Oracle Streams features are new in Oracle Database 11g Release 1 (11.1):

- [Oracle Streams Topology and Oracle Streams Performance Advisor](#)
- [Automatic Data Type Conversion During Apply](#)
- [Simplified Way to Restore Default Values for Parameters](#)
- [Oracle Streams Supports Tables in a Flashback Data Archive](#)
- [Oracle Streams Supports Virtual Columns](#)
- [New Capture Process Parameter: skip_autofiltered_table_ddl](#)
- [New Apply Process Parameter: rtrim_on_implicit_conversion](#)
- [Synchronous Capture](#)
- [Oracle Streams Support for XMLType Columns](#)
- [Oracle Streams Support for Transparent Data Encryption](#)
- [Split and Merge of a Stream Destination](#)
- [Track LCRs Through a Stream](#)
- [Compare and Converge Shared Database Objects](#)
- [Automated Alerts for Oracle Streams Clients and Thresholds](#)
- [Oracle Streams Jobs Use Oracle Scheduler](#)
- [Notification Improvements](#)
- [New Error Messages for Easier Error Handling](#)
- [Combined Capture and Apply](#)

Oracle Streams Topology and Oracle Streams Performance Advisor

The Oracle Streams topology identifies individual streams of messages and the Oracle Streams components configured in each stream. An Oracle Streams environment typically covers multiple databases, and the Oracle Streams topology provides a comprehensive view of the entire Oracle Streams environment.

The Oracle Streams Performance Advisor reports performance measurements for an Oracle Streams topology, including throughput and latency measurements. The Oracle Streams Performance Advisor also identifies bottlenecks in an Oracle Streams topology so that they can be corrected. In addition, the Oracle Streams Performance advisor examines the Oracle Streams components in an Oracle Streams topology and recommends ways to improve their performance.

See Also: [Chapter 22, "Monitoring the Oracle Streams Topology and Performance"](#)

Automatic Data Type Conversion During Apply

During apply, an [apply process](#) automatically converts certain data types when there is a mismatch between the data type of a column in the row logical change record (row LCR) and the data type of the corresponding column in a table.

See Also: ["Automatic Data Type Conversion During Apply"](#) on page 4-14

Simplified Way to Restore Default Values for Parameters

You can set a capture process parameter to its default value by specifying NULL for the value of the parameter in the `DBMS_CAPTURE_ADM.SET_PARAMETER` procedure. Similarly, you can set an apply process parameter to its default value by specifying NULL for the value of the parameter in the `DBMS_APPLY_ADM.SET_PARAMETER` procedure.

See Also: *Oracle Database PL/SQL Packages and Types Reference*

Oracle Streams Supports Tables in a Flashback Data Archive

In prior releases of Oracle Database, Oracle Streams did not support the replication of changes to tables in a flashback data archive. In Oracle Database 11g Release 1 (11.1) and later, Oracle Streams supports tables in a flashback data archive.

See Also: ["Oracle Streams and Flashback Data Archive"](#) on page A-8

Oracle Streams Supports Virtual Columns

In prior releases of Oracle Database, Oracle Streams did not support the replication of changes to tables with virtual columns. In Oracle Database 11g Release 1 (11.1) and later, Oracle Streams supports tables with virtual columns.

New Capture Process Parameter: `skip_autofiltered_table_ddl`

A new capture process parameter named `skip_autofiltered_table_ddl` enables you to capture data definition language (DDL) changes to database objects for which data manipulation language (DML) changes are automatically filtered.

See Also:

- *Oracle Database PL/SQL Packages and Types Reference* for more information about this capture process parameter
- ["Listing the Database Objects That Are Not Compatible With Capture Processes"](#) on page 28-7
- ["Setting a Capture Process Parameter"](#) on page 14-6

New Apply Process Parameter: `rtrim_on_implicit_conversion`

A new apply process parameter named `rtrim_on_implicit_conversion` determines whether the apply process trims character data during automatic data type conversion.

See Also:

- *Oracle Database PL/SQL Packages and Types Reference* for more information about this apply process parameter
- ["Automatic Data Type Conversion During Apply"](#) on page 4-14
- ["Setting an Apply Process Parameter"](#) on page 16-6

Synchronous Capture

Synchronous capture is a new **Oracle Streams client** that captures data manipulation language (DML) changes made to tables immediately after the changes are committed.

See Also: ["Implicit Capture with Synchronous Capture"](#) on page 2-38

Oracle Streams Support for XMLType Columns

`XMLType` is an Oracle-supplied type that can be used to store and query XML data in the database. Oracle Streams can capture, propagate, and apply changes to `XMLType` data.

Capture processes can capture changes to `XMLType` columns stored as `CLOB` columns, but capture processes cannot capture changes to `XMLType` columns stored object relationally or as binary XML. Apply processes can apply changes to `XMLType` columns stored as `CLOB` columns, stored object relationally, or stored as binary XML.

See Also:

- ["Data Types Captured by Capture Processes"](#) on page 2-12
- ["Data Types Applied"](#) on page 4-13

Oracle Streams Support for Transparent Data Encryption

Oracle Streams supports capturing, propagation, and applying changes to columns that have been encrypted using transparent data encryption. Oracle Streams supports columns that were encrypted at the column level or through tablespace encryption. Tablespace encryption enables you to encrypt an entire tablespace. All objects created in the encrypted tablespace are automatically encrypted, including all columns in the database objects in the tablespace. Once a column is encrypted, whether it is due to column encryption or tablespace encryption, Oracle Streams components handle the column data in the same way.

See Also:

- ["Capture Processes and Transparent Data Encryption"](#) on page A-5
- ["Synchronous Capture and Transparent Data Encryption"](#) on page A-6
- ["Propagations and Transparent Data Encryption"](#) on page A-7
- ["Apply Processes and Transparent Data Encryption"](#) on page A-7

Split and Merge of a Stream Destination

You can easily split off an unavailable replica from a Streams replication configuration. Splitting the stream minimizes the time needed for the replica to "catch up" when it becomes available again. When the replica is caught up, it can be merged back into the original configuration. This feature uses three new procedures in the DBMS_STREAMS_ADM package: SPLIT_STREAMS, MERGE_STREAMS_JOB, and MERGE_STREAMS.

See Also: *Oracle Streams Replication Administrator's Guide*

Track LCRs Through a Stream

The new SET_MESSAGE_TRACKING procedure in the DBMS_STREAMS_ADM package lets you specify a tracking label for logical change records (LCRs) generated by a database session. You can query the new V\$STREAMS_MESSAGE_TRACKING view to track the LCRs through the stream and see how they were processed by each Oracle Streams client.

LCR tracking is useful if LCRs are not being applied as expected by one or more apply processes. When this happens, you can use LCR tracking to determine where the LCRs are stopping in the stream and address the problem at that location.

Also, the new message_tracking_frequency capture process parameter enables you to track LCRs automatically.

See Also:

- *Oracle Streams Replication Administrator's Guide*
- *Oracle Database PL/SQL Packages and Types Reference* for information about the message_tracking_frequency capture process parameter

Compare and Converge Shared Database Objects

A new Oracle-supplied package called DBMS_COMPARISON enables you to compare the rows in a shared database object, such as a table, at two different databases. If differences are found in the database object, then this package can converge the database objects so that they are consistent.

See Also:

- *Oracle Database 2 Day + Data Replication and Integration Guide*
- *Oracle Streams Replication Administrator's Guide*
- *Oracle Database PL/SQL Packages and Types Reference*

Automated Alerts for Oracle Streams Clients and Thresholds

Enterprise Manager automatically alerts you when an **Oracle Streams client** becomes disabled or when Oracle Streams-related threshold that you have defined is crossed.

See Also: "[Viewing Oracle Streams Alerts](#)" on page 20-1

Oracle Streams Jobs Use Oracle Scheduler

In past releases, Oracle Streams used jobs created by the DBMS_JOB package to perform jobs such as propagation and event notification, and the JOB_QUEUE_PROCESSES initialization parameter controlled the number of slave processes that were created.

In Oracle Database 11g Release 1 (11.1), Oracle Streams uses Oracle Scheduler to perform these jobs. Oracle Scheduler automatically tunes the number of slave processes for these jobs based on the load on the computer system, and the `JOB_QUEUE_PROCESSES` initialization parameter is only used to specify the maximum number of slave processes. Therefore, the `JOB_QUEUE_PROCESSES` initialization parameter does not need to be set, unless you want to limit the number of slaves that can be created.

See Also: ["Propagation Jobs"](#) on page 3-17

Notification Improvements

This release introduces the following notification improvements:

- Notification grouping by time
- Better scaling to enable a large number of notifications to be sent simultaneously
- Improved diagnosability of notifications using registration statistics

See Also: *Oracle Streams Advanced Queuing User's Guide*

New Error Messages for Easier Error Handling

The following apply error messages are new in Oracle Database 11g Release 1 (11.1):

- An ORA-26787 error is raised if the row to be updated or deleted does not exist in the target table.
- An ORA-26786 error is raised when the row exists in the target table, but the values of some columns do not match those of the row logical change record (row LCR).

In past releases, an ORA-01403 error was returned in these situations. These new error messages make it easier to handle apply errors in DML handlers and error handlers. If you have existing DML handlers and error handlers, then they you might need to modify them for the current release.

See Also: *Oracle Streams Replication Administrator's Guide*

Combined Capture and Apply

Oracle Streams can improve [propagation](#) efficiency under certain conditions.

See Also: ["Combined Capture and Apply Optimization"](#) on page 3-20

Part I

Oracle Streams Concepts

This part describes conceptual information about Oracle Streams and contains the following chapters:

- [Chapter 1, "Introduction to Oracle Streams"](#)
- [Chapter 2, "Oracle Streams Information Capture"](#)
- [Chapter 3, "Oracle Streams Staging and Propagation"](#)
- [Chapter 4, "Oracle Streams Information Consumption"](#)
- [Chapter 5, "Rules"](#)
- [Chapter 6, "How Rules Are Used in Oracle Streams"](#)
- [Chapter 7, "Rule-Based Transformations"](#)
- [Chapter 8, "Oracle Streams High Availability Environments"](#)

Introduction to Oracle Streams

This chapter briefly describes the basic concepts and terminology related to Oracle Streams. These concepts are described in more detail in other chapters in this book and in the *Oracle Streams Replication Administrator's Guide*.

This chapter contains these topics:

- [Overview of Oracle Streams](#)
- [What Can Oracle Streams Do?](#)
- [What Are the Uses of Oracle Streams?](#)
- [Sample Oracle Streams Configurations](#)
- [Administration Tools for an Oracle Streams Environment](#)
- [Oracle Streams Documentation Roadmap](#)

Overview of Oracle Streams

Oracle Streams enables information sharing. Using Oracle Streams, each unit of shared information is called a **message**, and you can share these messages in a stream. The stream can propagate information within a database or from one database to another. The stream routes specified information to specified destinations. The result is a feature that provides greater functionality and flexibility than traditional solutions for capturing and managing messages, and sharing the messages with other databases and applications. Oracle Streams provides the capabilities needed to build and operate distributed enterprises and applications, data warehouses, and high availability solutions. You can use all of the capabilities of Oracle Streams at the same time. If your needs change, then you can implement a new capability of Oracle Streams without sacrificing existing capabilities.

Using Oracle Streams, you control what information is put into a stream, how the stream flows or is routed from database to database, what happens to messages in the stream as they flow into each database, and how the stream terminates. By configuring specific capabilities of Oracle Streams, you can address specific requirements. Based on your specifications, Oracle Streams can capture, stage, and manage messages in the database automatically, including, but not limited to, data manipulation language (DML) changes and data definition language (DDL) changes. You can also put user-defined messages into a stream, and Oracle Streams can propagate the information to other databases or applications automatically. When messages reach a destination, Oracle Streams can consume them based on your specifications.

[Figure 1-1](#) shows the Oracle Streams information flow.

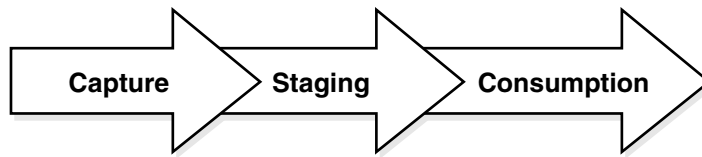
Figure 1–1 Oracle Streams Information Flow

What Can Oracle Streams Do?

The following sections provide an overview of what Oracle Streams can do:

- [Capture Messages at a Database](#)
- [Stage Messages in a Queue](#)
- [Propagate Messages from One Queue to Another](#)
- [Consume Messages](#)
- [Detect and Resolve Conflicts](#)
- [Transform Messages](#)
- [Track Messages With Oracle Streams Tags](#)
- [Share Information With Non-Oracle Databases](#)

Capture Messages at a Database

Oracle Streams provides two ways to capture database changes implicitly: **capture processes** and **synchronous captures**. A capture process can capture DML changes made to tables, schemas, or an entire database, as well as DDL changes. A synchronous capture can capture DML changes made to tables. Rules determine which changes are captured by a capture process or synchronous capture.

Database changes are recorded in the redo log for the database. A capture process captures changes from the redo log and formats each captured change into a **message** called a **logical change record (LCR)**. The messages captured by a capture process are called **captured LCRs**.

A synchronous capture uses an internal mechanism to capture changes and format each captured change into an LCR. The messages captured by a synchronous capture are called **persistent LCRs**.

The **rules** used by a capture process or a synchronous capture determine which changes it captures. When changes are captured by a capture process, the database where changes are generated in the redo log is the **source database**. When changes are captured by a synchronous capture, the database where the synchronous capture is configured is the source database.

A capture process can capture changes locally at the source database, or it can capture changes remotely at a **downstream database**. A synchronous capture can only capture changes locally at the source database. Both a capture process and a synchronous capture enqueue logical change records (LCRs) into a **queue**. When a capture process or a synchronous capture captures changes, it is referred to as **implicit capture**.

Users and applications can also enqueue messages manually. These messages can be LCRs, or they can be messages of a user-defined type called **user messages**. When users and applications enqueue messages manually, it is referred to as **explicit capture**.

Stage Messages in a Queue

Messages are stored (or staged) in a **queue**. These **messages** can be logical change records (LCRs) or user messages. Capture processes and synchronous captures enqueue messages into an **ANYDATA queue**, which can stage messages of different types. Users and applications can enqueue messages into an ANYDATA queue or into a **typed queue**. A typed queue can stage messages of one specific type only.

Propagate Messages from One Queue to Another

Oracle Streams **propagations** can propagate **messages** from one **queue** to another. These queues can be in the same database or in different databases. Rules determine which messages are propagated by a propagation.

Oracle Streams enables you to configure an environment in which changes are shared through **directed networks**. In a directed network, propagated **messages** pass through one or more intermediate databases before arriving at a **destination database** where they are consumed. The messages might or might not be consumed at an intermediate database in addition to the destination database. Using Oracle Streams, you can choose which messages are propagated to each destination database, and you can specify the route messages will traverse on their way to a destination database.

Consume Messages

A **message** is consumed when it is dequeued from a **queue**. An **apply process** can dequeue messages implicitly. A user, application, or **messaging client** can dequeue messages explicitly. The database where messages are consumed is called the **destination database**. In some configurations, the **source database** and the destination database can be the same.

Rules determine which messages are dequeued and processed by an apply process. An apply process can apply messages directly to database objects or pass messages to custom PL/SQL subprograms for processing.

Rules determine which messages are dequeued by a **messaging client**. A messaging client dequeues messages when it is invoked by an application or a user.

Detect and Resolve Conflicts

An **apply process** detects conflicts automatically when directly applying LCRs in a **replication** environment. A **conflict** is a mismatch between the old values in an LCR and the expected data in a table. Typically, a conflict results when the same row in the **source database** and **destination database** is changed at approximately the same time.

When a conflict occurs, you need a mechanism to ensure that the conflict is resolved in accordance with your business rules. Oracle Streams offers a variety of prebuilt conflict handlers. Using these prebuilt handlers, you can define a **conflict resolution** system for each of your databases that resolves conflicts in accordance with your business rules. If you have a unique situation that prebuilt conflict resolution handlers cannot resolve, then you can build your own conflict resolution handlers.

If a conflict is not resolved, or if a handler procedure raises an error, then all **messages** in the transaction that raised the error are saved in the error queue for later analysis and possible reexecution.

See Also:

- *Oracle Streams Replication Administrator's Guide*

Transform Messages

A **rule-based transformation** is any modification to a **message** that results when a **rule** in a **positive rule set** evaluates to TRUE. There are two types of rule-based transformations: declarative and custom.

Declarative rule-based transformations cover a set of common transformation scenarios for row LCRs, including renaming a schema, renaming a table, adding a column, renaming a column, and deleting a column. You specify (or declare) such a transformation using a procedure in the `DBMS_STREAMS_ADM` package. Oracle Streams performs declarative transformations internally, without invoking PL/SQL.

A **custom rule-based transformation** requires a user-defined PL/SQL function to perform the transformation. Oracle Streams invokes the PL/SQL function to perform the transformation. A custom rule-based transformation can modify either **LCRs** or **user messages**. For example, a custom rule-based transformation can change the data type of a particular column in an LCR.

Either type of rule-based transformation can occur at the following times:

- During enqueue of a message by a **capture process**, which can be useful for formatting a message in a manner appropriate for all **destination databases**
- During propagation of a message, which can be useful for transforming a message before it is sent to a specific remote site
- During dequeue of a message by an **apply process** or **messaging client**, which can be useful for formatting a message in a manner appropriate for a specific destination database

When a transformation is performed during apply, an apply process can apply the transformed message directly or send the transformed message to an **apply handler** for processing.

Note:

- A rule must be in a positive rule set for its rule-based transformation to be invoked. A rule-based transformation specified for a rule in a **negative rule set** is ignored by **capture processes**, **propagations**, **apply processes**, and **messaging clients**.
 - Throughout this document, "rule-based transformation" is used when the text applies to both declarative and custom rule-based transformations. This document distinguishes between the two types of rule-based transformations when necessary.
-
-

See Also: [Chapter 7, "Rule-Based Transformations"](#)

Track Messages With Oracle Streams Tags

Every redo entry in the redo log has a **tag** associated with it. The data type of the tag is RAW. By default, when a user or application generates redo entries, the value of the tag is NULL for each redo entry, and a NULL tag consumes no space in the redo entry. The size limit for a tag value is 2000 bytes.

In Oracle Streams, **rules** can have conditions relating to tag values to control the behavior of **Oracle Streams clients**. For example, a tag can be used to determine

whether an LCR contains a change that originated in the local database or at a different database, so that you can avoid **change cycling** (sending an LCR back to the database where it originated). Also, a tag can be used to specify the set of **destination databases** for each LCR. Tags can be used for other LCR tracking purposes as well.

You can specify Oracle Streams tags for redo entries generated by a certain session or by an **apply process**. These tags then become part of the LCRs captured by a **capture process** or **synchronous capture**. Typically, tags are used in Oracle Streams **replication** environments, but you can use them whenever it is necessary to track database changes and LCRs.

See Also:

- *Oracle Streams Replication Administrator's Guide*

Share Information With Non-Oracle Databases

In addition to information sharing between Oracle databases, Oracle Streams supports heterogeneous information sharing between Oracle databases and non-Oracle databases.

See Also:

- *Oracle Streams Replication Administrator's Guide*

What Are the Uses of Oracle Streams?

The following topics briefly describe some of the reasons for using Oracle Streams:

- [Data Replication](#)
- [Data Warehouse Loading](#)
- [Database Availability During Upgrade and Maintenance Operations](#)
- [Message Queuing](#)
- [Event Management and Notification](#)
- [Data Protection](#)

In some cases, Oracle Streams components provide an infrastructure for various features of Oracle.

Data Replication

Oracle Streams can capture data manipulation language (DML) and data definition language (DDL) changes made to database objects and replicate those changes to one or more other databases. An Oracle Streams **capture process** or **synchronous capture** captures changes made to **source database** objects and formats them into LCRs, which can be propagated to **destination databases** and then applied by Oracle Streams **apply processes**.

The destination databases can allow DML and DDL changes to the same database objects, and these changes might or might not be propagated to the other databases in the environment. In other words, you can configure an Oracle Streams environment with one database that propagates changes, or you can configure an environment where changes are propagated between databases bidirectionally. Also, the tables for which data is shared do not need to be identical copies at all databases. Both the structure and the contents of these tables can differ at different databases, and the information in these tables can be shared between these databases.

See Also:

- *Oracle Streams Replication Administrator's Guide* for more information using Oracle Streams for [replication](#)

Data Warehouse Loading

Data warehouse loading is a special case of data [replication](#). Some of the most critical tasks in creating and maintaining a data warehouse include refreshing existing data, and adding new data from the operational databases. Oracle Streams components can capture changes made to a production system and send those changes to a staging database or directly to a data warehouse or operational data store. Oracle Streams capture of redo data with a capture process avoids unnecessary overhead on the production systems. Support for data transformations and user-defined apply procedures enables the necessary flexibility to reformat data or update warehouse-specific data fields as data is loaded. In addition, Change Data Capture uses some of the components of Oracle Streams to identify data that has changed so that this data can be loaded into a data warehouse.

See Also:

- *Oracle Database Data Warehousing Guide* for more information about data warehouses

Database Availability During Upgrade and Maintenance Operations

You can use the features of Oracle Streams to achieve little or no database down time during database upgrade and maintenance operations. Maintenance operations include migrating a database to a different platform, migrating a database to a different character set, modifying database schema objects to support upgrades to user-created applications, and applying an Oracle software patch.

See Also:

- [Appendix D, "Online Database Upgrade with Oracle Streams"](#)
- [Appendix E, "Online Database Maintenance with Oracle Streams"](#)

Message Queuing

Oracle Streams Advanced Queuing (AQ) enables user applications to enqueue [messages](#) into a [queue](#), propagate messages to subscribing queues, notify user applications that messages are ready for [consumption](#), and dequeue messages at the destination. A queue can be configured to stage messages of a particular type only, or a queue can be configured as an ANYDATA queue. Messages of almost any type can be wrapped in an ANYDATA wrapper and staged in ANYDATA queues. Oracle Streams AQ supports all the standard features of message queuing systems, including multiconsumer queues, publish and subscribe, content-based routing, Internet propagation, transformations, and gateways to other messaging subsystems.

You can create a queue at a database, and applications can enqueue messages into the queue explicitly. Subscribing applications or [messaging clients](#) can dequeue messages directly from this queue. If an application is remote, then a queue can be created in a remote database that subscribes to messages published in the source queue. The destination application can dequeue messages from the remote queue. Alternatively, the destination application can dequeue messages directly from the source queue using a variety of standard protocols.

See Also:

- *Oracle Streams Advanced Queuing User's Guide* for more information about Oracle Streams AQ

Event Management and Notification

Business events are valuable communications between applications or organizations. An application can enqueue **messages** that represent events into a **queue** explicitly, or an Oracle Streams **capture process** or **synchronous capture** can capture database events and encapsulate them into messages called LCRs. These messages can be the results of DML or DDL changes. Propagations can propagate messages in a stream through multiple queues. Finally, a user application can dequeue messages explicitly, or an Oracle Streams **apply process** can dequeue messages implicitly. An apply process can reenqueue these messages explicitly into the same queue or a different queue if necessary.

You can configure queues to retain explicitly-enqueued messages after **consumption** for a specified period of time. This capability enables you to use Oracle Streams Advanced Queuing (AQ) as a business event management system. Oracle Streams AQ stores all messages in the database in a transactional manner, where they can be automatically audited and tracked. You can use this audit trail to extract intelligence about the business operations.

Oracle Streams capture processes, synchronous captures, **propagations**, apply processes, and **messaging clients** perform actions based on **rules**. You specify which events are captured, propagated, applied, and dequeued using rules, and a built-in **rules engine** evaluates events based on these rules. The ability to capture events and propagate them to relevant consumers based on rules means that you can use Oracle Streams for event notification. Messages representing events can be staged in a queue and dequeued explicitly by a messaging client or an application, and then actions can be taken based on these events, which can include an e-mail notification, or passing the message to a wireless gateway for transmission to a cell phone or pager.

See Also:

- [Chapter 3, "Oracle Streams Staging and Propagation"](#)
- [Chapter 15, "Managing Staging and Propagation"](#)
- *Oracle Streams Advanced Queuing User's Guide*
- [Chapter 32, "Single-Database Capture and Apply Example"](#) for a sample environment that explicitly dequeues messages

Data Protection

One solution for data protection is to create a local or remote copy of a production database. In the event of human error or a catastrophe, the copy can be used to resume processing.

You can use Oracle Data Guard SQL Apply, a data protection feature that uses some of the same infrastructure as Oracle Streams, to create and maintain a logical standby database, which is a logically equivalent standby copy of a production database. As in the case of Oracle Streams **replication**, a **capture process** captures changes in the redo log and formats these changes into LCRs. These LCRs are applied at the standby databases. The standby databases are open for read/write and can include specialized indexes or other database objects. Therefore, these standby databases can be queried as updates are applied.

It is important to move the updates to the remote site as soon as possible with a logical standby database. Doing so ensures that, in the event of a failure, lost transactions are minimal. By directly and synchronously writing the redo logs at the remote database, you can achieve no data loss in the event of a disaster. At the standby system, the changes are captured and directly applied to the standby database with an **apply process**.

See Also:

- [Chapter 8, "Oracle Streams High Availability Environments"](#)
- *Oracle Data Guard Concepts and Administration* for more information about logical standby databases

Sample Oracle Streams Configurations

Each of the following sections provide an overview of a sample Oracle Streams configuration:

- [Sample Hub-and-Spoke Replication Configuration](#)
- [Sample Replication Configuration With Downstream Capture](#)
- [Sample Replication Configuration That Uses Synchronous Captures](#)
- [Sample N-Way Replication Configuration](#)
- [Sample Configuration That Performs Capture and Apply in a Single Database](#)
- [Sample Messaging Configuration](#)

Sample Hub-and-Spoke Replication Configuration

[Figure 1–2](#) shows a sample hub-and-spoke replication configuration. A hub-and-spoke replication configuration typically is used to distribute information to multiple target databases and to consolidate information from multiple databases to a single database.

A hub-and-spoke replication configuration is one in which a central database, or hub, communicates with one or more secondary databases, or spokes. The spokes do not communicate directly with each other. In a hub-and-spoke replication configuration, the spokes might or might not allow changes to the replicated database objects.

In the sample hub-and-spoke replication configuration shown in [Figure 1–2](#), there is one hub database and two spoke databases. The spoke databases allow changes to the replicated database objects.

Figure 1-2 Sample Hub-and-Spoke Replication Configuration

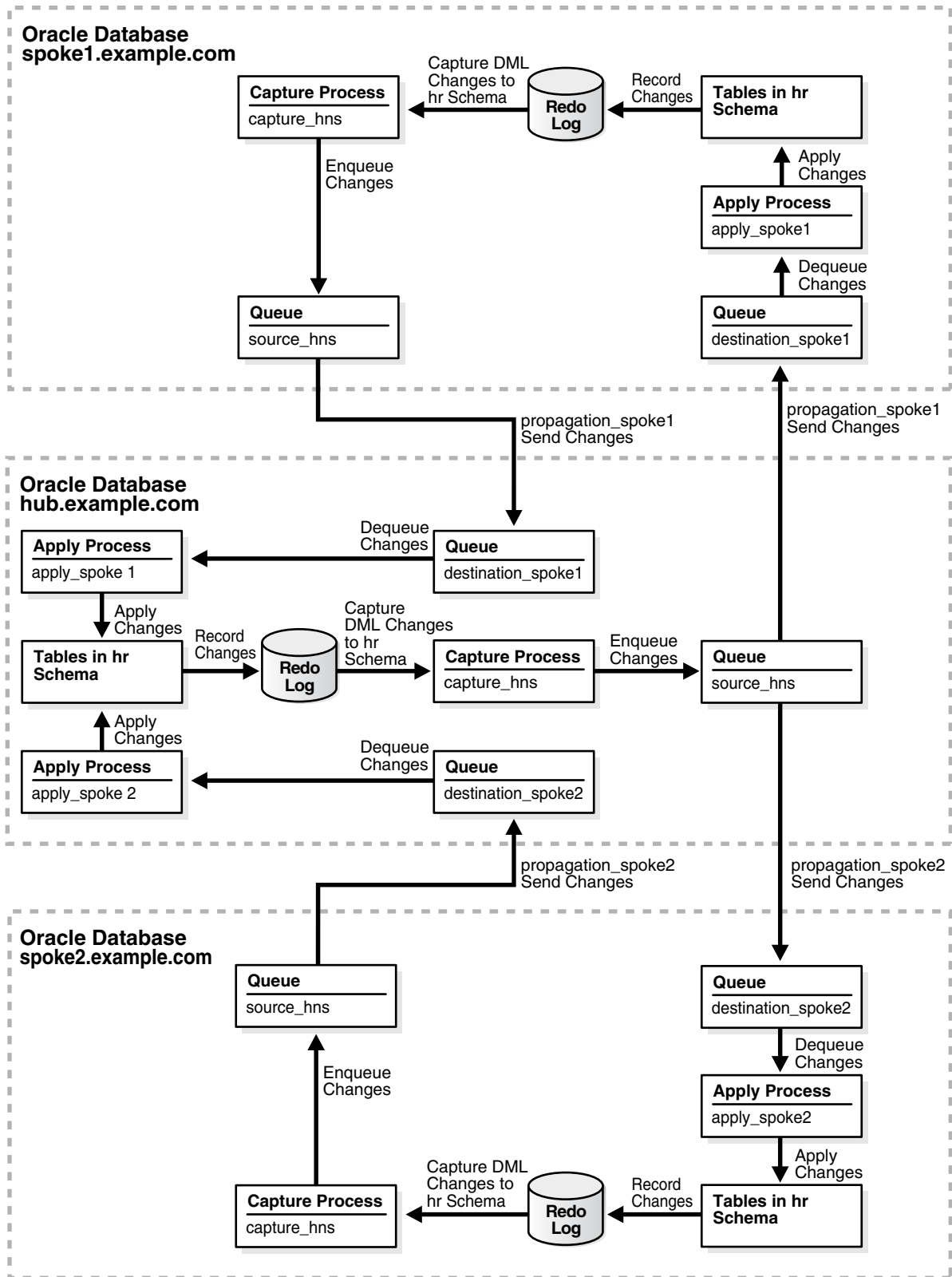

For more information about this configuration, see *Oracle Database 2 Day + Data Replication and Integration Guide*.

Sample Replication Configuration With Downstream Capture

Figure 1–3 shows a sample replication configuration that uses a downstream capture process. Downstream capture means that the capture process runs on a remote database instead of the source database. Using downstream capture removes the capture workload from the production database.

In the sample replication configuration shown in Figure 1–3, the downstream capture process runs at the remote database `dest.example.com`, and the redo data is sent from the source database `src.example.com` to the remote database. At the remote database, a downstream capture process captures the changes in the redo data sent from the source database and an apply process applies these changes to the local database objects.

Figure 1–3 Sample Replication Configuration With Downstream Capture

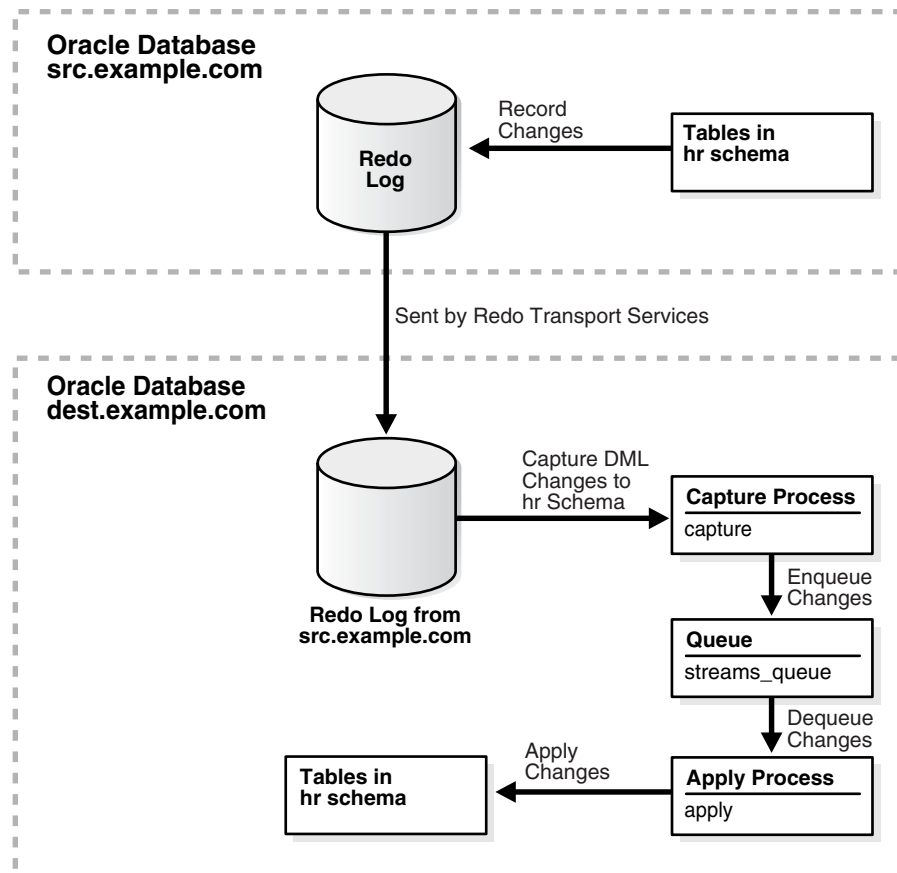

For more information about this configuration, see *Oracle Database 2 Day + Data Replication and Integration Guide*.

Sample Replication Configuration That Uses Synchronous Captures

Figure 1–4 shows a sample replication configuration that uses synchronous captures to capture changes instead of capture processes. You can use a synchronous capture replication configuration to replicate changes to tables with infrequent data changes in a highly active database or in situations where capturing changes from the redo logs is not possible.

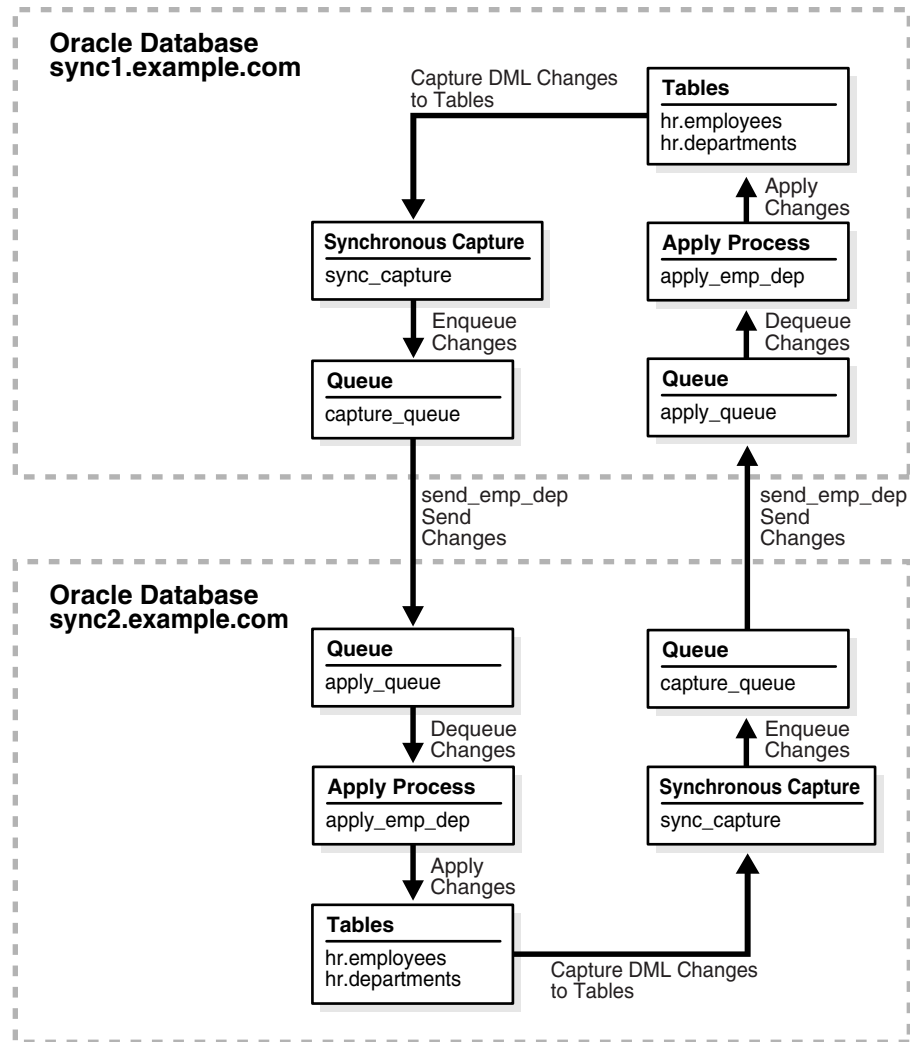
Figure 1–4 Sample Replication Configuration With Synchronous Captures

For more information about this configuration, see *Oracle Database 2 Day + Data Replication and Integration Guide*.

Sample N-Way Replication Configuration

Figure 1–5 shows a sample n-way replication configuration. An n-way replication configuration typically is used in an environment with several peer databases and each database must replicate data with each of the other databases. An n-way replication configuration can provide load balancing, and it can provide failover protection if a single database becomes unavailable.

An n-way replication configuration is one in which each database communicates directly with each other database in the environment. The changes made to replicated database objects at one database are captured and sent directly to each of the other databases in the environment, where they are applied.

In the sample n-way replication configuration shown in Figure 1–5, each of the three databases captures changes to the replicated database objects and sends these changes to the other two databases in the configuration. Apply processes at each database apply the changes sent from the other two databases.

Figure 1-5 Sample N-Way Replication Configuration

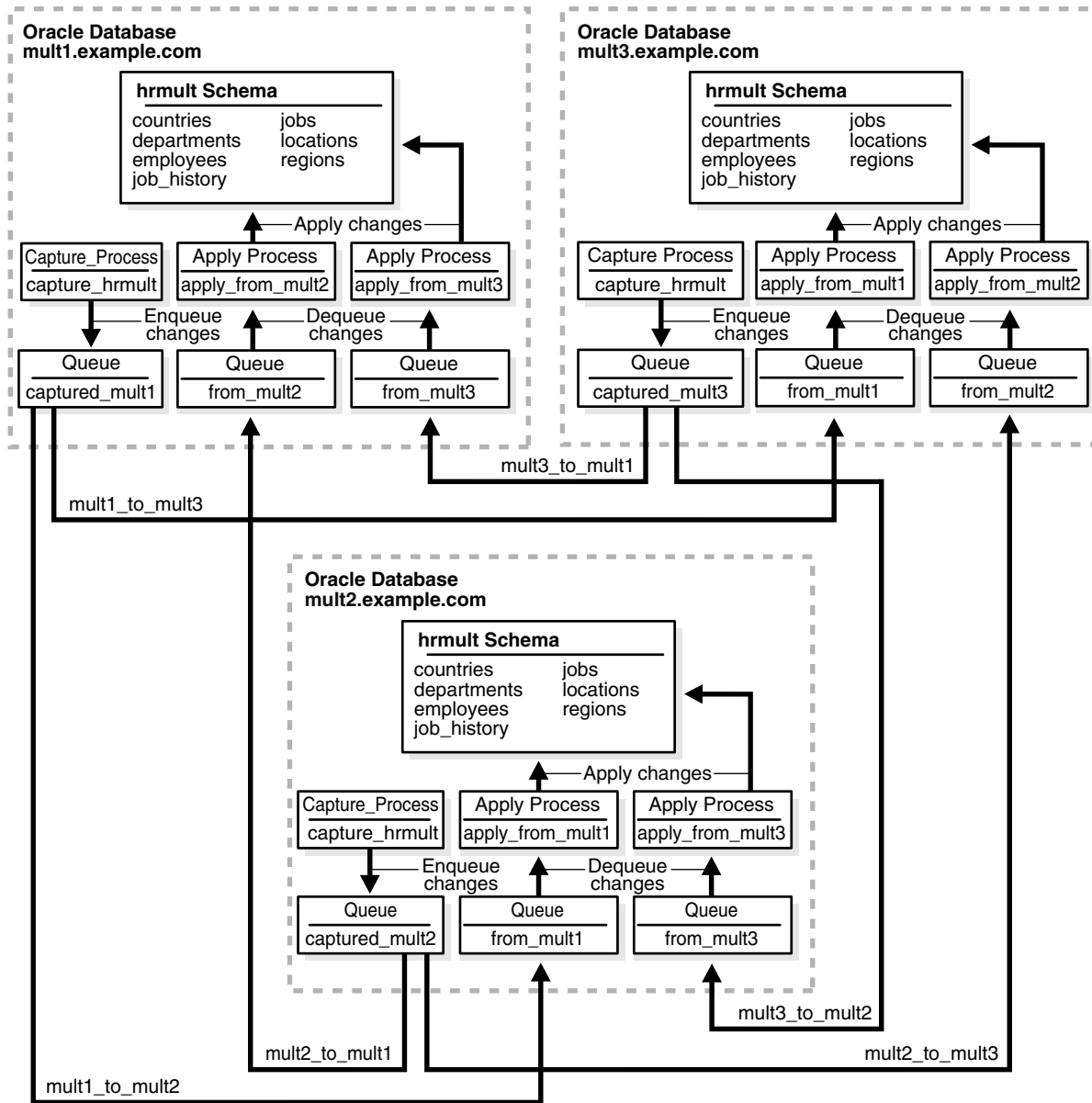

For more information about this configuration, see *Oracle Streams Replication Administrator's Guide*.

Sample Configuration That Performs Capture and Apply in a Single Database

Figure 1-6 shows a sample configuration that captures database changes with a capture process and applies these changes with an apply process in a single database. In this configuration, the apply process reenqueues the changes into the queue for processing by an application. Also, a DML handler inserts rows that were deleted from the `hr.employees` table into a `hr.emp_del` table.

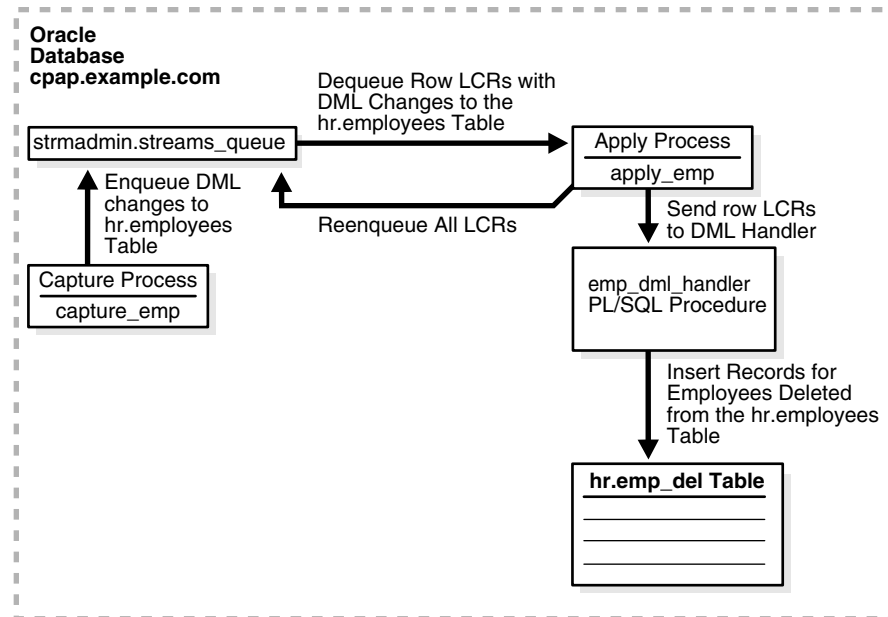
Figure 1–6 Sample Single Database Capture and Apply Configuration

For more information about this configuration, see [Chapter 32, "Single-Database Capture and Apply Example"](#).

Sample Messaging Configuration

[Figure 1–7](#) shows a sample messaging configuration. A messaging configuration sends messages from one queue to another queue. The two queues can be in the same database or in different databases. The messages can be dequeued and processed by applications in a customized way.

In the sample messaging configuration shown in [Figure 1–7](#), a trigger at one database creates and enqueues messages. A propagation sends the messages to another database, where a PL/SQL procedure dequeues the messages and processes them.

Figure 1–7 Sample Messaging Configuration

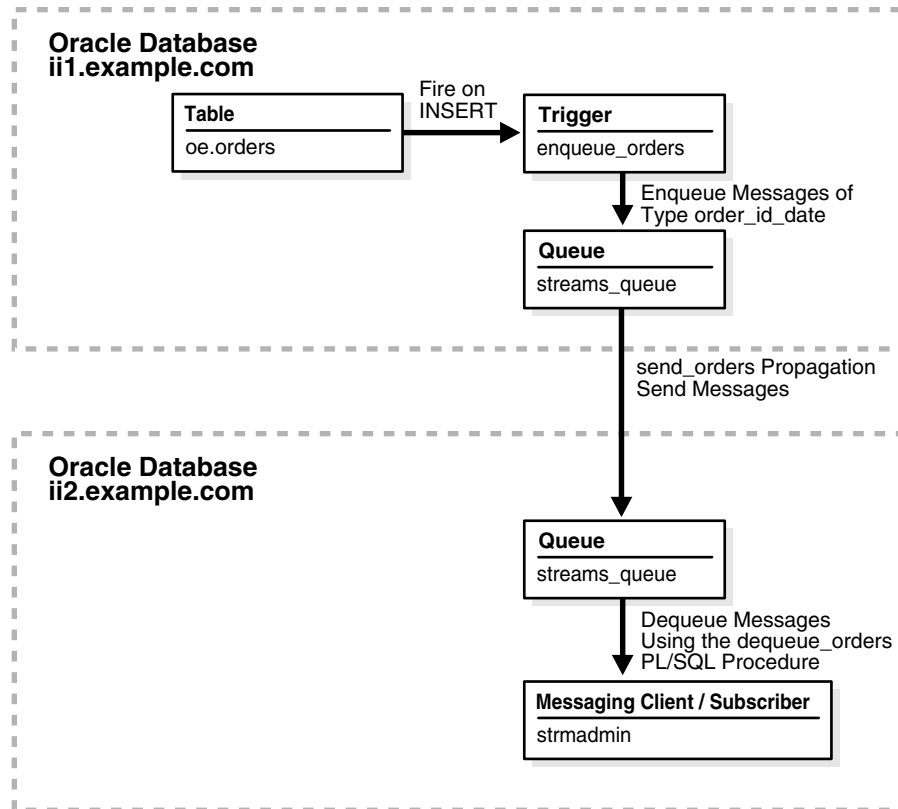

For more information about this configuration, see *Oracle Database 2 Day + Data Replication and Integration Guide*.

Administration Tools for an Oracle Streams Environment

Several tools are available for configuring, administering, and monitoring your Oracle Streams environment. Oracle-supplied PL/SQL packages are the primary configuration and management tools, and the Oracle Streams tool in Oracle Enterprise Manager provides some configuration, administration, and monitoring capabilities to help you manage your environment. Additionally, Oracle Streams data dictionary views keep you informed about your Oracle Streams environment.

Oracle-Supplied PL/SQL Packages

The following Oracle-supplied PL/SQL packages contain procedures and functions for configuring and managing an Oracle Streams environment.

DBMS_APPLY_ADM Package

The DBMS_APPLY_ADM package provides an administrative interface for starting, stopping, and configuring an apply process. This package includes procedures that enable you to configure **apply handlers**, set enqueue destinations for messages, and specify execution directives for messages. This package also provides administrative procedures that set the **instantiation SCN** for objects at a destination database. This package also includes subprograms for configuring **conflict** detection and resolution and for managing apply errors.

DBMS_CAPTURE_ADM Package

The DBMS_CAPTURE_ADM package provides an administrative interface for starting, stopping, and configuring a **capture process**. It also provides an administrative interface for configuring a **synchronous capture**. This package also provides administrative procedures that prepare database objects at the **source database** for **instantiation** at a **destination database**.

DBMS_COMPARISON Package

The DBMS_COMPARISON package provides interfaces to compare and converge database objects at different databases.

DBMS_PROPAGATION_ADM Package

The DBMS_PROPAGATION_ADM package provides an administrative interface for configuring propagation from a **source queue** to a **destination queue**.

DBMS_RULE Package

The DBMS_RULE package contains the EVALUATE procedure, which evaluates a rule set. The goal of this procedure is to produce the list of satisfied rules, based on the data. This package also contains subprograms that enable you to use iterators during rule evaluation. Instead of returning all rules that evaluate to TRUE or MAYBE for an evaluation, iterators can return one rule at a time.

DBMS_RULE_ADM Package

The DBMS_RULE_ADM package provides an administrative interface for creating and managing rules, **rule sets**, and rule **evaluation contexts**. This package also contains subprograms for managing privileges related to rules.

DBMS_STREAMS Package

The DBMS_STREAMS package provides interfaces to convert ANYDATA objects into LCR objects, to return information about Oracle Streams attributes and **Oracle Streams clients**, and to annotate redo entries generated by a session with a **tag**. This tag can affect the behavior of a capture process, a synchronous capture, a propagation, an apply process, or a messaging client whose rules include specifications for these tags in redo entries or LCRs.

DBMS_STREAMS_ADM Package

The DBMS_STREAMS_ADM package provides an administrative interface for adding and removing simple **rules** for **capture processes**, **propagations**, and **apply processes** at the table, schema, and database level. This package also enables you to add rules that control which **messages** a propagation propagates and which messages a **messaging client** dequeues. This package also contains procedures for creating **queues** and for managing Oracle Streams metadata, such as data dictionary information. This package also contains procedures that enable you to configure and maintain an Oracle Streams **replication** environment. This package is provided as an easy way to complete common tasks in an Oracle Streams environment. You can use other packages, such as the DBMS_CAPTURE_ADM, DBMS_PROPAGATION_ADM, DBMS_APPLY_ADM, DBMS_RULE_ADM, and DBMS_AQADM packages, to complete these same tasks, as well as tasks that require additional customization.

DBMS_STREAMS_ADVISOR_ADM Package

The `DBMS_STREAMS_ADVISOR_ADM` package provides an interface to gather information about an Oracle Streams environment and advise database administrators based on the information gathered. This package is part of the Oracle Streams Performance Advisor.

DBMS_STREAMS_AUTH Package

The `DBMS_STREAMS_AUTH` package provides interfaces for granting privileges to and revoking privileges from Oracle Streams administrators.

DBMS_STREAMS_MESSAGING Package

The `DBMS_STREAMS_MESSAGING` package provides interfaces to enqueue messages into and dequeue messages from an `ANYDATA` queue.

DBMS_STREAMS_TABLESPACE_ADM Package

The `DBMS_STREAMS_TABLESPACE_ADM` package provides administrative procedures for creating and managing a tablespace repository. This package also provides administrative procedures for copying tablespaces between databases and moving tablespaces from one database to another. This package uses transportable tablespaces, Data Pump, and the `DBMS_FILE_TRANSFER` package.

UTL_SPADV Package

The `UTL_SPADV` package provides subprograms to collect and analyze statistics for the Oracle Streams components in a distributed database environment. This package uses the Oracle Streams Performance Advisor to gather statistics.

See Also: *Oracle Database PL/SQL Packages and Types Reference* for more information about these packages

Oracle Streams Data Dictionary Views

Every database in an Oracle Streams environment has Oracle Streams data dictionary views. These views maintain administrative information about local **rules**, objects, **capture processes**, **propagations**, **apply processes**, and **messaging clients**. You can use these views to monitor your Oracle Streams environment.

See Also:

- [Chapter 21, "Monitoring an Oracle Streams Environment"](#)
- *Oracle Streams Replication Administrator's Guide* for queries that are useful in an Oracle Streams **replication** environment
- *Oracle Database Reference* for more information about these data dictionary views

Oracle Streams Tool in the Oracle Enterprise Manager Console

To help configure, administer, and monitor Oracle Streams environments, Oracle provides an Oracle Streams tool in the Oracle Enterprise Manager Console. You can also use the Oracle Streams tool to generate Oracle Streams configuration scripts, which you can then modify and run to configure your Oracle Streams environment. The Oracle Streams tool online Help contains the primary documentation for this tool.

[Figure 1–8](#) shows the top portion of the Streams page in Enterprise Manager.

Figure 1–8 Streams page in Enterprise Manager

Figure 1–9 shows the Oracle Streams Topology, which is on the bottom portion of the Streams page in the Enterprise Manager.

Figure 1–9 Oracle Streams Topology**See Also:**

- *Oracle Database 2 Day + Data Replication and Integration Guide*
- The online Help for the Oracle Streams tool in the Oracle Enterprise Manager
- *Oracle Enterprise Manager Concepts*

Oracle Streams Documentation Roadmap

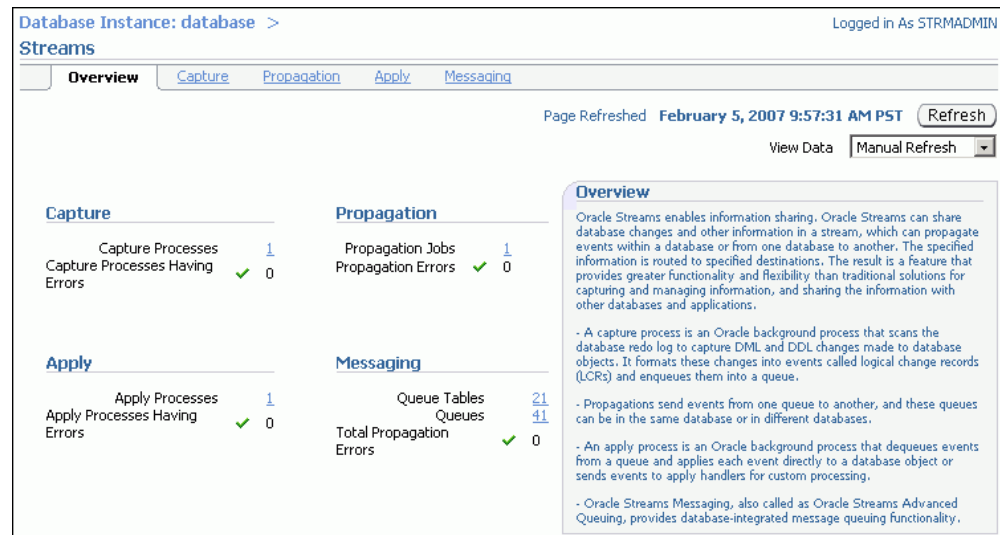
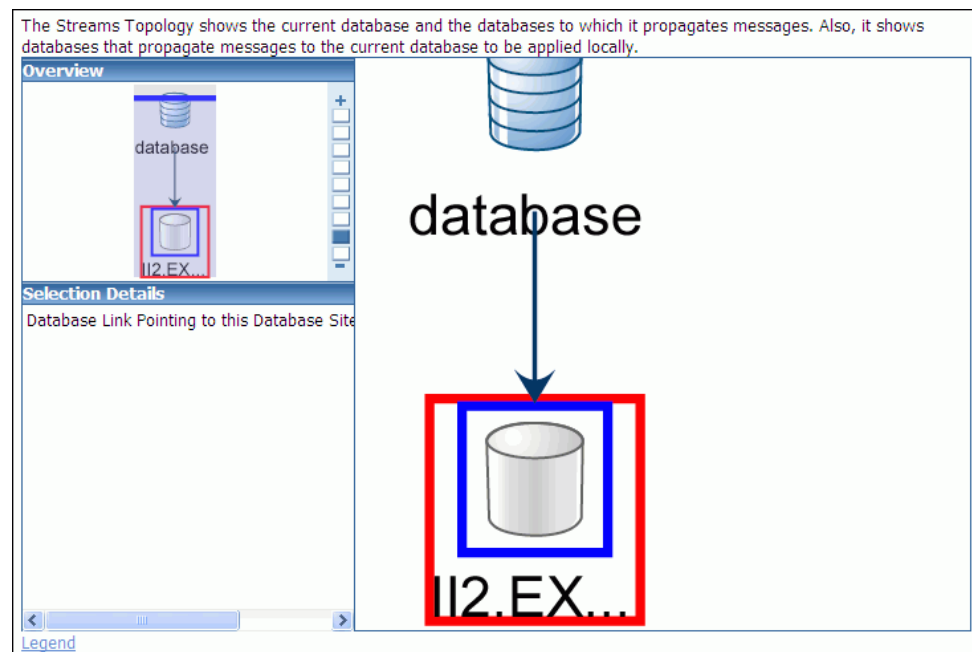
Oracle Streams provides many options for setting up, managing, and monitoring information-sharing environments. This section provides a documentation roadmap to help you find the documentation you need.

The Oracle Streams documentation set includes the following documents:

- *Oracle Database 2 Day + Data Replication and Integration Guide* contains the essential concepts related to Oracle Streams, examples that set up the most common replication and messaging environments, and basic instructions for managing and monitoring Oracle Streams components.
- *Oracle Streams Concepts and Administration* contains detailed conceptual information about Oracle Streams, detailed instructions for managing Oracle Streams components using Oracle-supplied packages, and detailed instructions for monitoring Oracle Streams components with data dictionary views.
- *Oracle Streams Replication Administrator's Guide* contains conceptual information that relates to Oracle Streams replication environments, information about configuring an Oracle Streams replication environment using Oracle-supplied packages, and information about managing an Oracle Streams replication environment using Oracle-supplied packages.
- *Oracle Streams Advanced Queuing User's Guide* contains conceptual information about Oracle Streams messaging (Advanced Queuing) environments, information about configuring a messaging environment, and information about managing a messaging environment using Oracle-supplied packages and other administrative interfaces.
- *Oracle Database PL/SQL Packages and Types Reference* contains reference information about the Oracle-supplied packages and types related to Oracle Streams.
- *Oracle Database Reference* contains reference information about the data dictionary views related to Oracle Streams.
- The Oracle Streams online help in Oracle Enterprise Manager contains instructions for setting up, managing, and monitoring an Oracle Streams environment using Oracle Enterprise Manager.

This documentation roadmap is intended to guide you to the information you need in these documents.

This section contains the following topics:

- [Documentation for Learning About Oracle Streams](#)
- [Documentation About Setting Up or Extending an Oracle Streams Environment](#)
- [Documentation About Managing an Oracle Streams Environment](#)
- [Documentation About Monitoring an Oracle Streams Environment](#)
- [Documentation About Database Using Oracle Streams for Upgrade and Maintenance](#)

Documentation for Learning About Oracle Streams

Before setting up an Oracle Streams environment, it is best to understand the features of Oracle Streams and how you can use them. [Table 1–1](#) helps you find conceptual information about Oracle Streams.

Table 1–1 Documentation for Learning About Oracle Streams

For conceptual information about	See
apply processes	<p><i>Oracle Database 2 Day + Data Replication and Integration Guide</i> for essential information about applying database changes and other types of messages with apply processes</p> <p>"Implicit Consumption with an Apply Process" on page 4-5 for detailed information about apply processes</p> <p><i>Oracle Streams Replication Administrator's Guide</i> for information about apply processes that is specific to replication environments, such as information about applying changes with dependencies and applying DML and DDL changes</p>
capture processes	<p><i>Oracle Database 2 Day + Data Replication and Integration Guide</i> for essential information about capturing database changes that were recorded in the redo log using capture processes</p> <p>"Implicit Capture with an Oracle Streams Capture Process" on page 2-9 for detailed information about capture processes</p> <p><i>Oracle Streams Replication Administrator's Guide</i> for information about capture processes that is specific to replication environments, such as information about supplemental logging</p>
capturing messages with applications (explicit capture)	<p>"Explicit Capture by Applications" on page 2-43 for an overview of capturing messages with applications</p> <p><i>Oracle Database 2 Day + Data Replication and Integration Guide</i> for essential information about capturing messages with applications</p> <p><i>Oracle Streams Advanced Queuing User's Guide</i> for detailed information about capturing messages with applications</p>
combined capture and apply optimization	<p>"Combined Capture and Apply Optimization" on page 3-20 for information about improving performance by sending database changes more efficiently from capture processes to apply processes in a replication environment</p>
comparing and converging data	<p><i>Oracle Database 2 Day + Data Replication and Integration Guide</i> for essential information about how to compare database objects at two different databases and about how to converge differences in these database objects</p> <p><i>Oracle Streams Replication Administrator's Guide</i> for detailed information about comparing database objects at two different databases and converging differences in these database objects</p>
conflicts and conflict resolution	<p><i>Oracle Database 2 Day + Data Replication and Integration Guide</i> for essential information about conflicts that result when changes are made to the same row in two or more replicated tables at nearly the same time, and for essential information about resolving these conflicts automatically</p> <p><i>Oracle Streams Replication Administrator's Guide</i> for detailed information about conflicts and conflict resolution</p>
consuming messages with applications (explicit consumption)	<p>"Explicit Consumption with Manual Dequeue" on page 4-23 for an overview of consuming messages with applications</p> <p><i>Oracle Database 2 Day + Data Replication and Integration Guide</i> for essential information about consuming messages with applications</p> <p><i>Oracle Streams Advanced Queuing User's Guide</i> for detailed information about consuming messages with applications</p>
heterogeneous information sharing	<p><i>Oracle Database 2 Day + Data Replication and Integration Guide</i> for essential information about working with non-Oracle databases</p> <p><i>Oracle Streams Replication Administrator's Guide</i> for detailed information about working with non-Oracle databases</p>

Table 1–1 (Cont.) Documentation for Learning About Oracle Streams

For conceptual information about	See
high availability	Chapter 8, "Oracle Streams High Availability Environments" <i>Oracle Database High Availability Overview</i> for information about your high availability options
information provisioning	Chapter 29, "Information Provisioning Concepts" for information about moving or copying large amounts of information efficiently
instantiation	"Instantiation in an Oracle Streams Environment" on page 2-8 for essential information about preparing database objects for replication at two or more databases <i>Oracle Streams Replication Administrator's Guide</i> for detailed information about instantiation
logical change records (LCRs)	"Logical Change Records (LCRs)" on page 2-3 for information about how Oracle Streams uses messages that describe database changes
messaging clients	"Explicit Consumption with a Messaging Client" on page 4-22
Oracle Streams best practices	<i>Oracle Streams Replication Administrator's Guide</i>
Oracle Streams capabilities	"What Can Oracle Streams Do?" on page 1-2
Oracle Streams interoperability with other Oracle Database components	Appendix A, "How Oracle Streams Works With Other Database Components"
Oracle Streams restrictions	Appendix B, "Oracle Streams Restrictions"
Oracle Streams uses	"What Are the Uses of Oracle Streams?" on page 1-5
propagations	<i>Oracle Database 2 Day + Data Replication and Integration Guide</i> for essential information about sending messages between queues "Message Propagation Between Queues" on page 3-11 for detailed information about propagations
queues	"Queues" on page 3-1 for essential information about how queues store messages <i>Oracle Streams Advanced Queuing User's Guide</i> for detailed information about queues
rules	<i>Oracle Database 2 Day + Data Replication and Integration Guide</i> for essential information about rules and how Oracle Streams uses them Chapter 5, "Rules" for general information about rules Chapter 6, "How Rules Are Used in Oracle Streams" for information about the ways in which rules determine the behavior of Oracle Streams clients
rule-based transformations	<i>Oracle Database 2 Day + Data Replication and Integration Guide</i> for essential information about how rule-based transformations support non-identical replicas of database objects Chapter 7, "Rule-Based Transformations" for detailed information about rule-based transformations

Table 1–1 (Cont.) Documentation for Learning About Oracle Streams

For conceptual information about	See
synchronous captures	<i>Oracle Database 2 Day + Data Replication and Integration Guide</i> for essential information about capturing database changes using synchronous captures "Implicit Capture with Synchronous Capture" on page 2-38 for detailed information about synchronous captures
tags	<i>Oracle Database 2 Day + Data Replication and Integration Guide</i> for essential information about how tags can be used to add additional information to captured database changes <i>Oracle Streams Replication Administrator's Guide</i> for detailed information about tags
user messages	"User Messages" on page 2-7 for essential information about messages that are created and enqueued by users and applications <i>Oracle Streams Advanced Queuing User's Guide</i> for detailed information about user messages

Documentation About Setting Up or Extending an Oracle Streams Environment

You can set up many different types of Oracle Streams environments, and you have several options for setting them up. [Table 1–2](#) helps you find the documentation you need to set up an Oracle Streams environment.

Table 1–2 Documentation About Setting Up or Extending an Oracle Streams Environment

For instructions about	See
setting up an Oracle Streams replication environment using a one-step procedure	<i>Oracle Database 2 Day + Data Replication and Integration Guide</i> for examples that use the one-step procedures in the <code>DBMS_STREAMS_ADM</code> package to set up the most common types of Oracle Streams replication environments <i>Oracle Streams Replication Administrator's Guide</i> for detailed instructions about using the one-step procedures in the <code>DBMS_STREAMS_ADM</code> package, including information about decisions to make and tasks to complete before running a procedure <i>Oracle Database PL/SQL Packages and Types Reference</i> for reference information about the one-step procedures in the <code>DBMS_STREAMS_ADM</code> package
setting up an Oracle Streams replication environment using Oracle Enterprise Manager	Online help for the Oracle Streams setup wizards in Oracle Enterprise Manager <i>Oracle Streams Replication Administrator's Guide</i> for descriptions of the Oracle Streams setup wizards in Oracle Enterprise Manager and instructions for opening them

Table 1–2 (Cont.) Documentation About Setting Up or Extending an Oracle Streams Environment

For instructions about	See
setting up an Oracle Streams replication environment by configuring components individually	<p><i>Oracle Streams Replication Administrator's Guide</i> for step-by-step instructions to set up an Oracle Streams replication environment by configuring individual components in the correct order</p> <p><i>Oracle Database 2 Day + Data Replication and Integration Guide</i> for an example that provides step-by-step instructions for setting up an Oracle Streams replication environment that uses synchronous captures</p> <p><i>Oracle Streams Replication Administrator's Guide</i> for the following examples:</p> <ul style="list-style-type: none"> ■ An example that provides step-by-step instructions for setting up a simple replication environment that replicates changes to a single table ■ An example that provides step-by-step instructions for setting up a heterogeneous replication environment that includes a rule-based transformation ■ An example that provides step-by-step instructions for setting up an n-way replication environment with conflict resolution <p><i>Oracle Database PL/SQL Packages and Types Reference</i> for reference information about the packages that can set up an Oracle Streams replication environment. These packages are described in "Oracle-Supplied PL/SQL Packages" on page 1-14.</p>
extending an Oracle Streams replication environment using a one-step procedure	<p><i>Oracle Database 2 Day + Data Replication and Integration Guide</i> for examples that use the one-step procedures in the DBMS_STREAMS_ADM package to extend the most common types of Oracle Streams replication environments by adding databases and tables</p> <p><i>Oracle Database PL/SQL Packages and Types Reference</i> for reference information about the one-step procedures that can extend an Oracle Streams replication environment</p>
extending an Oracle Streams replication environment by configuring components individually	<p><i>Oracle Streams Replication Administrator's Guide</i> for step-by-step instructions to extend an Oracle Streams replication environment by configuring individual components in the correct order</p> <p><i>Oracle Streams Replication Administrator's Guide</i> for an example that provides step-by-step instructions for extending a heterogeneous replication environment</p> <p><i>Oracle Database PL/SQL Packages and Types Reference</i> for reference information about the packages that can extend an Oracle Streams replication environment. These packages are described in "Oracle-Supplied PL/SQL Packages" on page 1-14.</p>

Table 1–2 (Cont.) Documentation About Setting Up or Extending an Oracle Streams Environment

For instructions about	See
setting up an Oracle Streams messaging environment	<p><i>Oracle Database 2 Day + Data Replication and Integration Guide</i> for the following examples:</p> <ul style="list-style-type: none"> ■ An example that provides step-by-step instructions for setting up a messaging environment that sends messages between databases ■ An example that provides step-by-step instructions for setting up message notifications that inform applications when new messages are in a queue <p><i>Oracle Streams Advanced Queuing User's Guide</i> for detailed instructions about setting up messaging environments</p> <p>"Wrapping User Message Payloads in an ANYDATA Wrapper and Enqueuing Them" on page 13-2</p> <p>"Dequeuing a Payload that Is Wrapped in an ANYDATA Payload" on page 13-3</p> <p>"Configuring a Messaging Client and Message Notification" on page 13-5 for an example that sets up e-mail notifications</p> <p><i>Oracle Database PL/SQL Packages and Types Reference</i> for reference information about the packages used to set up messaging environments, including DBMS_STREAMS_ADM, DBMS_STREAMS_MESSAGING, DBMS_AQADM, and DBMS_AQ</p>
Oracle Streams best practices	<i>Oracle Streams Replication Administrator's Guide</i> for information about the best practices to follow when setting up an Oracle Streams environment
setting up a tablespace repository	"Using a Tablespace Repository" on page 30-1
setting up a file group repository	"Using a File Group Repository" on page 30-14

Documentation About Managing an Oracle Streams Environment

You can use Oracle-supplied PL/SQL packages and Oracle Enterprise Manager to manage an Oracle Streams environment. [Table 1–3](#) helps you find the documentation you need to manage an Oracle Streams environment.

Table 1–3 Documentation About Managing an Oracle Streams Environment

For instructions about managing	See
apply processes	<p><i>Oracle Database 2 Day + Data Replication and Integration Guide</i> for information about starting an apply process, stopping an apply process, and setting apply process parameters using Oracle Enterprise Manager</p> <p>Oracle Enterprise Manager online help for information about managing apply handlers and apply tags using Oracle Enterprise Manager, and about dropping apply processes using Oracle Enterprise Manager</p> <p>Chapter 16, "Managing Oracle Streams Information Consumption" for information about managing apply processes using Oracle-supplied packages</p> <p><i>Oracle Streams Replication Administrator's Guide</i> for information about managing apply processes in a replication environment using Oracle-supplied packages</p>

Table 1–3 (Cont.) Documentation About Managing an Oracle Streams Environment

For instructions about managing	See
capture processes	<p><i>Oracle Database 2 Day + Data Replication and Integration Guide</i> for information about starting a capture process, stopping a capture process, and setting capture process parameters using Oracle Enterprise Manager</p> <p>Oracle Enterprise Manager online help for information about setting a first SCN or start SCN for a capture process using Oracle Enterprise Manager, and about dropping a capture process using Oracle Enterprise Manager</p> <p>"Managing a Capture Process" on page 14-1 for information about managing capture processes using Oracle-supplied packages</p> <p><i>Oracle Streams Replication Administrator's Guide</i> for information about managing supplemental logging</p>
changing the DBID or global name of an Oracle Streams database	<i>Oracle Streams Replication Administrator's Guide</i>
comparing and converging data	<p><i>Oracle Database 2 Day + Data Replication and Integration Guide</i> for essential information about using the DBMS_COMPARISON package and its related data dictionary views</p> <p><i>Oracle Streams Replication Administrator's Guide</i> for detailed information about using the DBMS_COMPARISON package and its related data dictionary views</p>
conflicts and conflict resolution	<i>Oracle Streams Replication Administrator's Guide</i> for information about avoiding conflicts and configuring conflict resolution
export/import and Oracle Streams	"Performing Full Database Export/Import in an Oracle Streams Environment" on page 19-1
information provisioning	Chapter 30, "Using Information Provisioning"
instantiation	<i>Oracle Streams Replication Administrator's Guide</i> for information about performing instantiations
logical change records (LCRs)	<p>"Managing Extra Attributes in Captured LCRs" on page 14-15</p> <p><i>Oracle Streams Replication Administrator's Guide</i></p>
Oracle Streams best practices	<i>Oracle Streams Replication Administrator's Guide</i> for information about the best practices to follow when managing an Oracle Streams environment
Oracle-supplied packages related to Oracle Streams	<i>Oracle Database PL/SQL Packages and Types Reference</i> for reference information about the packages that you can use to manage an Oracle Streams environment. These packages are briefly described in "Oracle-Supplied PL/SQL Packages" on page 1-14.
point-in-time recovery and Oracle Streams	<i>Oracle Streams Replication Administrator's Guide</i>
propagations	<p><i>Oracle Database 2 Day + Data Replication and Integration Guide</i> for information about enabling and disabling propagations using Oracle Enterprise Manager</p> <p>Oracle Enterprise Manager online help for information about scheduling, unscheduling, and dropping propagations using Oracle Enterprise Manager</p> <p>"Managing Oracle Streams Propagations and Propagation Jobs" on page 15-4 for information about managing propagations using Oracle-supplied packages</p> <p><i>Oracle Streams Advanced Queuing User's Guide</i> for information about managing propagations using Oracle-supplied packages and other administrative interfaces</p>

Table 1–3 (Cont.) Documentation About Managing an Oracle Streams Environment

For instructions about managing	See
queues	<p><i>Oracle Database 2 Day + Data Replication and Integration Guide</i> for information about modifying queues and queue tables using Oracle Enterprise Manager</p> <p>Oracle Enterprise Manager online help for information about managing queues, queue tables, and Advanced Queuing transformations using Oracle Enterprise Manager</p> <p><i>Oracle Streams Advanced Queuing User's Guide</i> for information about managing queues using Oracle-supplied packages and other administrative interfaces</p> <p>"Managing Queues" on page 15-1</p>
removing an Oracle Streams configuration	"Removing an Oracle Streams Configuration" on page 19-5
resynchronizing a source database	<i>Oracle Streams Replication Administrator's Guide</i>
rules	<p>Oracle Enterprise Manager online help for information about managing rules using Oracle Enterprise Manager</p> <p>Chapter 17, "Managing Rules" for information about managing rules using Oracle-supplied packages</p>
rule-based transformations	<p>Oracle Enterprise Manager online help for information about managing rule-based transformations using Oracle Enterprise Manager</p> <p>Chapter 18, "Managing Rule-Based Transformations" for information about managing rule-based transformations using Oracle-supplied packages</p>
synchronous captures	"Managing a Synchronous Capture" on page 14-11 for information about managing synchronous captures using Oracle-supplied packages
tags	<i>Oracle Streams Replication Administrator's Guide</i>
troubleshooting	<p><i>Oracle Database 2 Day + Data Replication and Integration Guide</i> for information about responding to Oracle Streams alerts and managing apply errors using Oracle Enterprise Manager</p> <p>Oracle Enterprise Manager online help for information about troubleshooting an Oracle Streams environment using Oracle Enterprise Manager</p> <p>Chapter 20, "Troubleshooting an Oracle Streams Environment" for general information about troubleshooting an Oracle Streams environment</p> <p><i>Oracle Streams Replication Administrator's Guide</i> for information about troubleshooting an Oracle Streams replication environment</p>
unavailable destination database	<i>Oracle Streams Replication Administrator's Guide</i> for information about splitting off an unavailable destination database from a replication environment and merging the database back into the replication environment when it becomes available again

Documentation About Monitoring an Oracle Streams Environment

You primarily use Oracle supplied PL/SQL packages, data dictionary views, and Oracle Enterprise Manager to manage an Oracle Streams environment. [Table 1–4](#) helps you find the documentation you need to manage an Oracle Streams environment.

Table 1–4 Documentation About Monitoring an Oracle Streams Environment

For instructions about monitoring	See
apply processes	<p><i>Oracle Database 2 Day + Data Replication and Integration Guide</i> for information about monitoring apply process properties and statistics using Oracle Enterprise Manager</p> <p>Oracle Enterprise Manager online help for information about monitoring apply process parameters, apply handlers, and apply errors using Oracle Enterprise Manager</p> <p>Chapter 25, "Monitoring Oracle Streams Apply Processes" for information about monitoring apply processes using data dictionary views</p> <p><i>Oracle Streams Replication Administrator's Guide</i> for information about monitoring apply processes in a replication environment using data dictionary views</p>
capture processes	<p><i>Oracle Database 2 Day + Data Replication and Integration Guide</i> for information about monitoring capture process properties and statistics using Oracle Enterprise Manager</p> <p>Oracle Enterprise Manager online help for information about monitoring capture process parameters using Oracle Enterprise Manager</p> <p>"Monitoring a Capture Process" on page 23-1 for information about monitoring capture processes using data dictionary views</p> <p><i>Oracle Streams Replication Administrator's Guide</i> for information about monitoring supplemental logging using data dictionary views</p>
combined capture and apply optimization	<p>"Determining Which Capture Processes Use Combined Capture and Apply" on page 23-15</p> <p>"Determining Which Apply Processes Use Combined Capture and Apply" on page 25-15</p>
compatibility	"Monitoring Compatibility in an Oracle Streams Environment" on page 28-7 for information about listing database objects that are not compatible with Oracle Streams clients
conflicts and conflict resolution	<p><i>Oracle Database 2 Day + Data Replication and Integration Guide</i> for information about viewing update conflict handlers using data dictionary views</p> <p><i>Oracle Streams Replication Administrator's Guide</i> for information about monitoring conflict detection and update conflict handlers using data dictionary views</p>
data dictionary views related to Oracle Streams	Chapter 21–1, "Oracle Streams Static Data Dictionary Views" <i>Oracle Database Reference</i>
information provisioning	Chapter 31, "Monitoring File Group and Tablespace Repositories"
instantiation	<i>Oracle Streams Replication Administrator's Guide</i>
logical change records (LCRs)	<i>Oracle Streams Replication Administrator's Guide</i> for information about tracking LCRs through a stream
messaging	<p><i>Oracle Database 2 Day + Data Replication and Integration Guide</i> for information about viewing the messages in a queue, queue statistics, and queue subscribers using Oracle Enterprise Manager</p> <p><i>Oracle Streams Advanced Queuing User's Guide</i> for information about monitoring messaging environments using data dictionary views</p> <p>"Monitoring Queues and Messaging" on page 24-1</p> <p>"Monitoring Buffered Queues" on page 24-5</p>
Oracle Streams administrators	"Monitoring Oracle Streams Administrators and Other Oracle Streams Users" on page 28-1

Table 1–4 (Cont.) Documentation About Monitoring an Oracle Streams Environment

For instructions about monitoring	See
Oracle Streams pool	"Monitoring the Oracle Streams Pool" on page 28-3
Oracle Streams topology and performance statistics	Chapter 22, "Monitoring the Oracle Streams Topology and Performance"
propagations	<i>Oracle Database 2 Day + Data Replication and Integration Guide</i> for information about monitoring propagation properties and statistics using Oracle Enterprise Manager "Monitoring Oracle Streams Propagations and Propagation Jobs" on page 24-13 for information about monitoring propagations using data dictionary views
rules	Oracle Enterprise Manager online help for information about monitoring rules using Oracle Enterprise Manager Chapter 26, "Monitoring Rules" for information about monitoring rules using data dictionary views
rule-based transformations	Chapter 27, "Monitoring Rule-Based Transformations" for information about monitoring rule-based transformations using data dictionary views
synchronous captures	"Monitoring a Synchronous Capture" on page 23-15 for information about monitoring synchronous captures using data dictionary views Note: Oracle Enterprise Manager currently does not support monitoring synchronous captures.
tags	<i>Oracle Streams Replication Administrator's Guide</i> for information about monitoring tags using data dictionary views

Documentation About Database Using Oracle Streams for Upgrade and Maintenance

You can use Oracle Streams to achieve little or no down time for one-time operations, such as upgrading a database. [Table 1–5](#) helps you find the documentation you need to perform one-time operations with Oracle Streams.

Table 1–5 Documentation About Data Upgrade and Maintenance With Oracle Streams

For instructions about	See
upgrading a database and using Oracle Streams to achieve little or no down time	Appendix D, "Online Database Upgrade with Oracle Streams" for information about using Oracle Streams to perform a database upgrade with little or no down time
performing database maintenance operations and using Oracle Streams to achieve little or no down time	Appendix E, "Online Database Maintenance with Oracle Streams" for information about using Oracle Streams to perform a database maintenance operations with little or no down time. These database maintenance operations include migrating a database to a different platform, migrating a database to a different character set, modifying database schema objects to support upgrades to user-created applications, and applying an Oracle Database software patch or patch set.

Oracle Streams Information Capture

Capturing information with Oracle Streams means creating a **message** that contains the information and enqueueing the message into a **queue**. The captured information can describe a database change, or it can be any other type of information.

The following topics contain conceptual information about capturing information with Oracle Streams:

- [Ways to Capture Information with Oracle Streams](#)
- [Types of Information Captured with Oracle Streams](#)
- [Summary of Information Capture Options With Oracle Streams](#)
- [Instantiation in an Oracle Streams Environment](#)
- [Implicit Capture with an Oracle Streams Capture Process](#)
- [Implicit Capture with Synchronous Capture](#)
- [Explicit Capture by Applications](#)

See Also:

- [Chapter 10, "Configuring Implicit Capture"](#)
- [Chapter 14, "Managing Oracle Streams Implicit Capture"](#)
- ["Troubleshooting Capture Process Problems" on page 20-3](#)
- [Chapter 23, "Monitoring Oracle Streams Implicit Capture"](#)

Ways to Capture Information with Oracle Streams

There are two ways to capture information with Oracle Streams: implicit capture and explicit capture.

- [Implicit Capture](#)
- [Explicit Capture](#)

Implicit Capture

With **implicit capture**, data definition language (DDL) and data manipulation language (DML) changes are captured automatically either by a **capture process** or by **synchronous capture**. A specific type of message called **logical change record (LCR)** describes these database changes. Both a capture process and synchronous capture can filter database changes with user-defined **rules**. Therefore, only changes to specified objects are captured.

The following topics describe capture processes and synchronous captures:

- [Capture Processes](#)
- [Synchronous Captures](#)

Capture Processes

A capture process retrieves change data from the redo log, either by mining the online redo log or, if necessary, by mining archived log files. After retrieving the data, the capture process formats it into an LCR and enqueues it for further processing.

A capture process enqueues information about database changes in the form of messages containing LCRs. A message containing an LCR that was originally captured and enqueued by a capture process is called a **captured LCR**. A capture process always enqueues messages into a buffered queue. A **buffered queue** is the portion of a queue that uses the [Oracle Streams pool](#) to store messages in memory and a queue table to store messages that have spilled from memory.

A capture process is useful in the following situations:

- When you want to capture changes to a relatively large number of tables
- When you want to capture changes to schemas or to an entire database
- When you want to capture DDL changes
- When you want to capture changes at a database other than the source database using downstream capture

See Also:

- ["Implicit Capture with an Oracle Streams Capture Process"](#) on page 2-9
- ["Persistent Queues and Buffered Queues"](#) on page 3-3

Synchronous Captures

Synchronous capture uses an internal mechanism to capture DML changes immediately after they happen. Synchronous capture enqueues information about DML changes in the form of messages containing row LCRs. Synchronous capture enqueues these LCRs into a persistent queue. Synchronous capture always enqueues messages into a persistent queue. A **persistent queue** is the portion of a queue that only stores messages on hard disk in a queue table, not in memory. The messages captured by a synchronous capture are **persistent LCRs**.

Synchronous capture is useful in the following situations:

- For the best performance, when you want to capture DML changes to a relatively small number of tables
- When you want to capture DML changes to a table immediately after these changes are made

See Also:

- ["Implicit Capture with Synchronous Capture"](#) on page 2-38

Explicit Capture

With **explicit capture**, applications generate messages and enqueue them. These messages can be formatted as LCRs, or they can be formatted into different types of

messages for consumption by other applications. Messages can also be enqueued explicitly by an **apply process** or by an **apply handler** for an **apply process**.

Explicit capture is useful in the following situations:

- When applications generate messages that must be processed by other applications.
- When you have a heterogeneous replication environment in which an apply process in an Oracle database applies changes that originated at a non-Oracle database. In this case, an application captures LCRs based on the changes at the non-Oracle database, and these LCRs are processed by an apply process at an Oracle database.

See Also:

- ["Explicit Capture by Applications"](#) on page 2-43
- *Oracle Streams Replication Administrator's Guide* for more information about heterogeneous information sharing with Oracle Streams

Types of Information Captured with Oracle Streams

The following types of information can be captured with Oracle Streams:

- [Logical Change Records \(LCRs\)](#)
- [User Messages](#)

Logical Change Records (LCRs)

An LCR is a **message** with a specific format that describes a database change. There are two types of LCRs: **row LCRs** and **DDL LCRs**. A capture process, synchronous capture, or an application can capture LCRs.

You can capture the following types of LCRs with Oracle Streams:

- A **captured LCR** is an LCR that is captured implicitly by a **capture process** and enqueued into the **buffered queue** portion of an **ANYDATA queue**.
- A **persistent LCR** is an LCR that is enqueued into the **persistent queue** portion of an ANYDATA queue. A persistent LCR can be enqueued in one of the following ways:
 - Captured implicitly by a **synchronous capture** and enqueued
 - Constructed explicitly by an application and enqueued
 - Dequeued by an **apply process** and enqueued by the same apply process using the `SET_ENQUEUE_DESTINATION` procedure in the `DBMS_APPLY_ADM` package

There are no differences between persistent LCRs that were enqueued in any of these ways. That is, a persistent LCR that was captured by a synchronous capture is the same as a persistent LCR that was constructed and enqueued by an application. Further, both of these persistent LCRs are the same as a persistent LCR enqueued by an apply process.

- A **buffered LCR** is an LCR that is constructed explicitly by an application and enqueued into the buffered queue portion of an ANYDATA queue.

The following sections contain information about LCRs:

- [Row LCRs](#)
- [DDL LCRs](#)
- [Extra Information in LCRs](#)

See Also:

- ["Persistent Queues and Buffered Queues"](#) on page 3-3
- *Oracle Streams Replication Administrator's Guide* for information about managing LCRs
- *Oracle Database PL/SQL Packages and Types Reference* for more information about LCR types
- ["Setting the Destination Queue for Messages that Satisfy a Rule"](#) on page 16-11 for more information about the SET_ENQUEUE_DESTINATION procedure

Row LCRs

A row LCR describes a change to the data in a single row or a change to a single LONG column, LONG RAW column, LOB column, or XMLType stored as CLOB column in a row. The change results from a data manipulation language (DML) statement or a piecewise update to a LOB. For example, a single DML statement can insert or merge multiple rows into a table, can update multiple rows in a table, or can delete multiple rows from a table. Applications can also construct LCRs that are enqueued for further processing.

A single DML statement can produce multiple row LCRs. That is, a capture process creates an LCR for each row that is changed by the DML statement. In addition, an update to a LONG, LONG RAW, LOB, or XMLType stored as CLOB column in a single row can result in more than one row LCR.

Each row LCR is encapsulated in an object of LCR\$_ROW_RECORD type and contains the following attributes:

- `source_database_name`: The name of the **source database** where the row change occurred.
- `command_type`: The type of DML statement that produced the change, either INSERT, UPDATE, DELETE, LOB ERASE, LOB WRITE, or LOB TRIM.
- `object_owner`: The schema name that contains the table with the changed row.
- `object_name`: The name of the table that contains the changed row.
- `tag`: A raw **tag** that can be used to track the LCR.
- `transaction_id`: The identifier of the transaction in which the DML statement was run.
- `scn`: The system change number (SCN) at the time when the change was made.
- `old_values`: The old column values related to the change. These are the column values for the row before the DML change. If the type of the DML statement is UPDATE or DELETE, then these old values include some or all of the columns in the changed row before the DML statement. If the type of the DML statement is INSERT, then there are no old values. For UPDATE and DELETE statements, row LCRs created by a capture process can include some or all of the old column values in the row, but row LCRs created by a synchronous capture always contain all of the new column values in the row.

- `new_values`: The new column values related to the change. These are the column values for the row after the DML change. If the type of the DML statement is `UPDATE` or `INSERT`, then these new values include some or all of the columns in the changed row after the DML statement. If the type of the DML statement is `DELETE`, then there are no new values. For `UPDATE` and `INSERT` statements, row LCRs created by a capture process can include some or all of the new column values in the row, but row LCRs created by a synchronous capture always contain all of the new column values in the row.

A row LCR captured by a capture process or synchronous capture can also contain transaction control statements. These row LCRs contain directives such as `COMMIT` and `ROLLBACK`. Such row LCRs are internal and are used by an **apply process** to maintain transaction consistency between a source database and a **destination database**.

DDL LCRs

A DDL LCR describes a data definition language (DDL) change. A DDL statement changes the structure of the database. For example, a DDL statement can create, alter, or drop a database object.

Each DDL LCR contains the following information:

- `source_database_name`: The name of the **source database** where the DDL change occurred.
- `command_type`: The type of DDL statement that produced the change, for example `ALTER TABLE` or `CREATE INDEX`.
- `object_owner`: The schema name of the user who owns the database object on which the DDL statement was run.
- `object_name`: The name of the database object on which the DDL statement was run.
- `object_type`: The type of database object on which the DDL statement was run, for example `TABLE` or `PACKAGE`.
- `ddl_text`: The text of the DDL statement.
- `logon_user`: The logon user, which is the user whose session executed the DDL statement.
- `current_schema`: The schema that is used if no schema is specified for an object in the DDL text.
- `base_table_owner`: The base table owner. If the DDL statement is dependent on a table, then the base table owner is the owner of the table on which it is dependent.
- `base_table_name`: The base table name. If the DDL statement is dependent on a table, then the base table name is the name of the table on which it is dependent.
- `tag`: A raw **tag** that can be used to track the LCR.
- `transaction_id`: The identifier of the transaction in which the DDL statement was run.
- `scn`: The SCN when the change was made.

Note: Both row LCRs and DDL LCRs contain the source database name of the database where a change originated. If **captured LCRs** will be propagated by a **propagation** or applied by an apply process, then, to avoid propagation and apply problems, Oracle recommends that you do not rename the source database after a capture process has started capturing changes.

See Also:

- *Oracle Call Interface Programmer's Guide* for a complete list of the types of DDL statements in the "SQL Command Codes" table
- *Oracle Database PL/SQL Packages and Types Reference*

Extra Information in LCRs

In addition to the information discussed in the previous sections, row LCRs and DDL LCRs optionally can include the following extra information (or LCR attributes):

- `row_id`: The rowid of the row changed in a row LCR. This attribute is not included in DDL LCRs or row LCRs for index-organized tables.
- `serial#`: The serial number of the session that performed the change captured in the LCR.
- `session#`: The identifier of the session that performed the change captured in the LCR.
- `thread#`: The thread number of the instance in which the change captured in the LCR was performed. Typically, the thread number is relevant only in an Oracle Real Application Clusters (Oracle RAC) environment.
- `tx_name`: The name of the transaction that includes the LCR.
- `username`: The name of the current user who performed the change captured in the LCR.

You can use the `INCLUDE_EXTRA_ATTRIBUTE` procedure in the `DBMS_CAPTURE_ADM` package to instruct a capture process or synchronous capture to capture one or more extra attributes.

See Also:

- ["Managing Extra Attributes in Captured LCRs"](#) on page 14-15
- ["Viewing the Extra Attributes Captured by Implicit Capture"](#) on page 23-17
- *Oracle Database PL/SQL Packages and Types Reference* for more information about the `INCLUDE_EXTRA_ATTRIBUTE` procedure
- *Oracle Database PL/SQL Language Reference* for more information about the current user

User Messages

Messages that do not contain LCRs are called **user messages**. User messages can be of any type (except an LCR type). User messages can be created by an application and consumed by an application. For example, a business application might create a user message for each order, and these messages might be processed by another application.

You can capture the following types of user messages with Oracle Streams:

- A **persistent user message** is a non-**LCR message** of a user-defined type that is enqueued into a **persistent queue**. A persistent user message can be enqueued in one of the following ways:
 - Created explicitly by an application and enqueued
 - Dequeued by an **apply process** and enqueued by the same apply process using the `SET_ENQUEUE_DESTINATION` procedure in the `DBMS_APPLY_ADM` package

A persistent user message can be enqueued into the persistent queue portion of an **ANYDATA queue** or a **typed queue**.
- A **buffered user message** is a non-**LCR message** of a user-defined type that is created explicitly by an application and enqueued into a **buffered queue**. A buffered user message can be enqueued into the buffered queue portion of an ANYDATA queue or a typed queue.

Note: Capture processes and synchronous captures never capture user messages.

See Also:

- ["Persistent Queues and Buffered Queues"](#) on page 3-3
- ["Wrapping User Message Payloads in an ANYDATA Wrapper and Enqueuing Them"](#) on page 13-2
- ["Setting the Destination Queue for Messages that Satisfy a Rule"](#) on page 16-11 for more information about the `SET_ENQUEUE_DESTINATION` procedure

Summary of Information Capture Options With Oracle Streams

[Table 2-1](#) summarizes the capture options available with Oracle Streams.

Table 2–1 Information Capture Options With Oracle Streams

Capture Type	Capture Mechanism	Message Types	Enqueued Into	Use When
Implicit Capture with an Oracle Streams Capture Process	Mining of Redo Log	Captured LCRs	Buffered Queue	<p>You want to capture changes to many tables.</p> <p>You want to capture changes to schemas or an entire database.</p> <p>You want to capture DDL changes.</p> <p>You want to capture changes at a downstream database.</p>
Implicit Capture with Synchronous Capture	Internal Mechanism	Persistent LCRs	Persistent Queue	<p>You want to capture DML changes to a small number of tables.</p> <p>You want to capture DML changes immediately after they occur.</p>
Explicit Capture by Applications	Manual Message Creation and Enqueue	Buffered LCRs Persistent LCRs Buffered User Messages Persistent User Messages	Buffered Queue or Persistent Queue	<p>You want to capture user messages that will be consumed by applications.</p> <p>You want to capture LCRs in a heterogeneous replication environment.</p> <p>You want to construct LCRs by using an application instead of by using a capture process or a synchronous capture.</p>

Note: A single database can use any combination of the capture options summarized in the table.

See Also:

- ["Persistent Queues and Buffered Queues"](#) on page 3-3

Instantiation in an Oracle Streams Environment

An Oracle Streams environment can share a database object within a single database or between multiple databases. In an Oracle Streams environment that shares database objects and uses implicit capture to capture changes to the database object, the **source database** is the database where the change originated. The source database is one of the following depending on the type of implicit capture used:

- If a **capture process** captures changes, then the source database is the database where changes to the object are generated in the redo log.
- If **synchronous capture** captures changes, then the source database is the database where synchronous capture is configured.

After changes are captured, they can be applied locally or propagated to other databases and applied at destination databases.

In an Oracle Streams environment that shares database objects, you must instantiate the shared source database objects before changes to them can be dequeued and

processed by an apply process. If a database where changes to the source database objects will be applied is a different database than the source database, then the destination database must have a copy of these database objects.

In Oracle Streams, the following general steps instantiate a database object:

1. Prepare the object for instantiation at the source database.
2. If a copy of the object does not exist at the destination database, then create an object physically at the destination database based on an object at the source database. You can use export/import, transportable tablespaces, or RMAN to copy database objects for instantiation. If the database objects already exist at the destination database, then this step is not necessary.
3. Set the **instantiation SCN** for the database object at the destination database. An instantiation system change number (SCN) instructs an apply process at the destination database to apply only changes that committed at the source database after the specified SCN.

In some cases, Step 1 and Step 3 are completed automatically. For example, when you add **rules** for an object to the **positive rule set** for a capture process by running a procedure in the `DBMS_STREAMS_ADM` package, the procedure prepares the object for instantiation automatically. Also, when you use export/import or transportable tablespaces to copy database objects from a source database to a destination database, instantiation SCNs can be set for these objects automatically during import. Instantiation is required whenever an apply process dequeues **captured LCRs**, even if the apply process sends the LCRs to an **apply handler** that does not execute them.

See Also:

- *Oracle Streams Replication Administrator's Guide* for detailed information about instantiation in an Oracle Streams replication environment

Implicit Capture with an Oracle Streams Capture Process

This section explains the concepts related to the Oracle Streams **capture process**.

This section contains these topics:

- [Introduction to Capture Processes](#)
- [Capture Process Rules](#)
- [Data Types Captured by Capture Processes](#)
- [Types of DML Changes Captured by Capture Processes](#)
- [Supplemental Logging in an Oracle Streams Environment](#)
- [Local Capture and Downstream Capture](#)
- [SCN Values Related to a Capture Process](#)
- [Oracle Streams Capture Processes and RESTRICTED SESSION](#)
- [Capture Process Components](#)
- [Capture User](#)
- [Capture Process States](#)
- [Multiple Capture Processes in a Single Database](#)
- [Capture Process Checkpoints](#)

- [A New First SCN Value and Purged LogMiner Data Dictionary Information](#)
- [ARCHIVELOG Mode and a Capture Process](#)
- [Capture Process Creation](#)
- [The Oracle Streams Data Dictionary](#)
- [Capture Process Parameters](#)
- [Capture Process Rule Evaluation](#)
- [Persistent Capture Process Status Upon Database Restart](#)

Introduction to Capture Processes

Every Oracle database has a set of two or more redo log files. The redo log files for a database are collectively known as the database redo log. The primary function of the redo log is to record all of the changes made to the database.

Redo logs are used to guarantee recoverability in the event of human error or media failure. A **capture process** is an optional Oracle background process that scans the database redo log to capture data manipulation language (DML) and data definition language (DDL) changes made to database objects. When a capture process is configured to capture changes from a redo log, the database where the changes were generated is called the **source database** for the capture process.

When a capture process captures a database change, it converts it into a specific message format called a **logical change record (LCR)**. After capturing an LCR, a capture process enqueues a message containing the LCR into a **queue**. A capture process is always associated with a single ANYDATA queue, and it enqueues messages into this queue only. For improved performance, **captured LCRs** always are stored in a **buffered queue**, which is System Global Area (SGA) memory associated with a queue. You can create multiple queues and associate a different capture process with each queue.

Captured LCRs can be sent to queues in the same database or other databases by propagations. Captured LCRs can also be dequeued by apply processes. In some situations, an optimization enables capture processes to send LCRs to apply processes more efficiently. This optimization is called combined capture and apply.

A capture process can run on its source database or on a remote database. When a capture process runs on its source database, the capture process is a **local capture process**. When a capture process runs on a remote database, the capture process is a **downstream capture process**, and the remote database is called the **downstream database**.

[Figure 2–1](#) shows a capture process capturing LCRs.

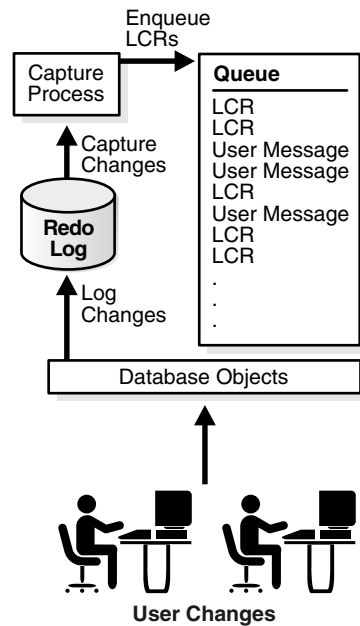
Figure 2-1 Capture Process**Note:**

- A capture process can be associated only with an ANYDATA queue, not with a **typed queue**.
- A capture process and a synchronous capture should not capture changes made to the same table.

See Also:

- "[Logical Change Records \(LCRs\)](#)" on page 2-3
- "[Supplemental Logging in an Oracle Streams Environment](#)" on page 2-13
- "[Combined Capture and Apply Optimization](#)" on page 3-20

Capture Process Rules

A **capture process** either captures or discards changes based on **rules** that you define. Each rule specifies the database objects and types of changes for which the rule evaluates to TRUE. You can place these rules in a **positive rule set** or **negative rule set** for the capture process.

If a rule evaluates to TRUE for a change, and the rule is in the positive rule set for a capture process, then the capture process captures the change. If a rule evaluates to TRUE for a change, and the rule is in the negative rule set for a capture process, then the capture process discards the change. If a capture process has both a positive and a negative rule set, then the negative rule set is always evaluated first.

You can specify capture process rules at the following levels:

- A table rule captures or discards either row changes resulting from DML changes or DDL changes to a particular table. Subset rules are table rules that include a subset of the row changes to a particular table.

- A schema rule captures or discards either row changes resulting from DML changes or DDL changes to the database objects in a particular schema.
- A global rule captures or discards either all row changes resulting from DML changes or all DDL changes in the database.

Note: The capture process does not capture certain types of changes and changes to certain data types in table columns. Also, a capture process never captures changes in the SYS, SYSTEM, or CTXSYS schemas.

See Also:

- [Chapter 5, "Rules"](#)
- [Chapter 6, "How Rules Are Used in Oracle Streams"](#)

Data Types Captured by Capture Processes

When capturing the row changes resulting from DML changes made to tables, a [capture process](#) can capture changes made to columns of the following data types:

- VARCHAR2
- NVARCHAR2
- FLOAT
- NUMBER
- LONG
- DATE
- BINARY_FLOAT
- BINARY_DOUBLE
- TIMESTAMP
- TIMESTAMP WITH TIME ZONE
- TIMESTAMP WITH LOCAL TIME ZONE
- INTERVAL YEAR TO MONTH
- INTERVAL DAY TO SECOND
- RAW
- LONG RAW
- CHAR
- NCHAR
- UROWID
- CLOB with BASICFILE storage
- NCLOB with BASICFILE storage
- BLOB with BASICFILE storage
- XMLType stored as CLOB

Note: Some of these data types might not be supported by Oracle Streams in earlier releases of Oracle Database. If your Oracle Streams environment includes one or more databases from an earlier release, then ensure that row LCRs do not flow into a database that does not support all of the data types in the row LCRs. See the Oracle Streams documentation for the earlier release for information about supported data types.

See Also:

- ["Unsupported Data Types for Capture Processes"](#) on page B-1
- [Chapter 6, "How Rules Are Used in Oracle Streams"](#)
- ["Data Types Applied"](#) on page 4-13
- *Oracle Database SQL Language Reference* for more information about data types

Types of DML Changes Captured by Capture Processes

When you specify that DML changes made to certain tables should be captured, a [capture process](#) captures the following types of DML changes made to these tables:

- INSERT
- UPDATE
- DELETE
- MERGE
- Piecewise updates to LOBs

A capture process converts each MERGE change into an INSERT or UPDATE change. MERGE is not a valid command type in a row LCR.

See Also:

- ["Unsupported DML Changes for Capture Processes"](#) on page B-3
- [Chapter 4, "Oracle Streams Information Consumption"](#) for information about the types of changes an apply process can apply

Supplemental Logging in an Oracle Streams Environment

Supplemental logging places additional column data into a redo log whenever an operation is performed. A [capture process](#) captures this additional information and places it in LCRs. Supplemental logging is always configured at a [source database](#), regardless of location of the capture process that captures changes to the source database.

Typically, supplemental logging is required in Oracle Streams [replication](#) environments. In these environments, an [apply process](#) needs the additional information in the LCRs to properly apply DML changes and DDL changes that are replicated from a source database to a [destination database](#). However, supplemental logging can also be required in environments where changes are not applied to database objects directly by an apply process. In such environments, an [apply handler](#)

can process the changes without applying them to the database objects, and the supplemental information might be needed by the apply handlers.

See Also:

- *Oracle Streams Replication Administrator's Guide* for detailed information about when supplemental logging is required

Local Capture and Downstream Capture

You can configure a **capture process** to run locally on a **source database** or remotely on a **downstream database**. A single database can have one or more capture processes that capture local changes and other capture processes that capture changes from a remote source database. That is, you can configure a single database to perform both local capture and downstream capture.

Local Capture

Local capture means that a capture process runs on the **source database**. Figure 2-1 on page 2-11 shows a database using local capture.

The Source Database Performs All Change Capture Actions If you configure local capture, then the following actions are performed at the source database:

- The `DBMS_CAPTURE_ADM.BUILD` procedure is run to extract (or build) the data dictionary to the redo log.
- Supplemental logging at the source database places additional information in the redo log. This information might be needed when captured changes are applied by an **apply process**.
- The first time a capture process is started at the database, Oracle Database uses the extracted data dictionary information in the redo log to create a **LogMiner data dictionary**, which is separate from the primary data dictionary for the source database. Additional capture processes can use this existing LogMiner data dictionary, or they can create new LogMiner data dictionaries.
- A capture process scans the redo log for changes using LogMiner.
- The **rules engine** evaluates changes based on the **rules** in one or more of the capture process **rule sets**.
- The capture process enqueues changes that satisfy the rules in its rule sets into a local ANYDATA queue.
- If the captured changes are shared with one or more other databases, then one or more **propagations** propagate these changes from the source database to the other databases.
- If database objects at the source database must be instantiated at a **destination database**, then the objects must be prepared for **instantiation**, and a mechanism such as an Export utility must be used to make a copy of the database objects.

Advantages of Local Capture The following are the advantages of using local capture:

- Configuration and administration of the capture process is simpler than when downstream capture is used. When you use local capture, you do not need to configure redo data copying to a **downstream database**, and you administer the capture process locally at the database where the captured changes originated.
- A **local capture process** can scan changes in the online redo log before the database writes these changes to an archived redo log file. When you use an

archived-log downstream capture process, archived redo log files are copied to the downstream database after the source database has finished writing changes to them, and some time is required to copy the redo log files to the downstream database. However, a real-time downstream capture process can capture changes in the online redo log sent from the source database.

- The amount of data being sent over the network is reduced, because the redo data is not copied to the downstream database. Even if **captured LCRs** are propagated to other databases, the captured LCRs can be a subset of the total changes made to the database, and only the LCRs that satisfy the rules in the rule sets for a **propagation** are propagated.
- Security might be improved because only the source (local) database can access the redo data. For example, if you want to capture changes in the `hr` schema only, then, when you use local capture, only the source database can access the redo data to enqueue changes to the `hr` schema into the capture process **queue**. However, when you use downstream capture, the redo data is copied to the downstream database, and the redo data contains all of the changes made to the database, not just the changes made to the `hr` schema.
- Some types of **custom rule-based transformations** are simpler to configure if the capture process is running at the local source database. For example, if you use local capture, then a custom rule-based transformation can use cached information in a PL/SQL session variable which is populated with data stored at the source database.
- In an Oracle Streams environment where messages are captured and applied in the same database, it might be simpler, and use fewer resources, to configure local queries and computations that require information about captured changes and the local data.

Downstream Capture

Downstream capture means that a capture process runs on a database other than the **source database**. The following types of downstream capture configurations are possible: real-time downstream capture and archived-log downstream capture. The `downstream_real_time_mine` capture process parameter controls whether a downstream capture process performs real-time downstream capture or archived-log downstream capture. A real-time downstream capture process and one or more archived-log downstream capture processes can coexist at a **downstream database**.

Note:

- References to "downstream capture processes" in this document apply to both real-time downstream capture processes and archived-log downstream capture processes. This document distinguishes between the two types of downstream capture processes when necessary.
 - A downstream capture process only can capture changes from a single source database. However, multiple downstream capture processes at a single downstream database can capture changes from a single source database or multiple source databases.
 - To configure downstream capture, the source database must be an Oracle Database 10g Release 1 or later database.
-
-

Real-Time Downstream Capture A real-time downstream capture configuration works in the following way:

- Redo transport services use the log writer process (LGWR) at the source database to send redo data to the downstream database either synchronously or asynchronously. At the same time, the LGWR records redo data in the online redo log at the source database.
- A remote file server process (RFS) at the downstream database receives the redo data over the network and stores the redo data in the standby redo log.
- A log switch at the source database causes a log switch at the downstream database, and the ARCHn process at the downstream database archives the current standby redo log file.
- The real-time downstream capture process captures changes from the standby redo log whenever possible and from the archived standby redo log files whenever necessary. A capture process can capture changes in the archived standby redo log files if it falls behind. When it catches up, it resumes capturing changes from the standby redo log.

Figure 2–2 Real-Time Downstream Capture

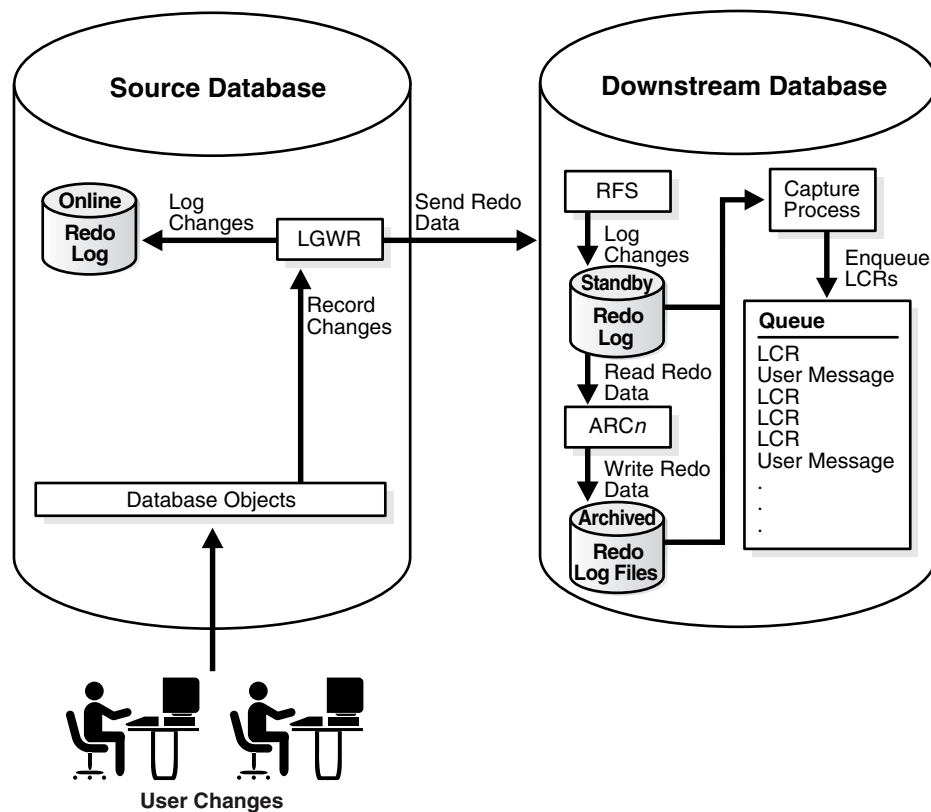

The advantage of real-time downstream capture over archived-log downstream capture is that real-time downstream capture reduces the amount of time required to capture changes made at the source database. The time is reduced because the real-time downstream capture process does not need to wait for the redo log file to be archived before it can capture data from it.

Note: Only one real-time downstream capture process can exist at a downstream database.

Archived-Log Downstream Capture An **archived-log downstream capture** configuration means that archived redo log files from the source database are copied to the downstream database, and the capture process captures changes in these archived redo log files. You can copy the archived redo log files to the downstream database using redo transport services, the `DBMS_FILE_TRANSFER` package, file transfer protocol (FTP), or some other mechanism.

Figure 2-3 Archived-Log Downstream Capture

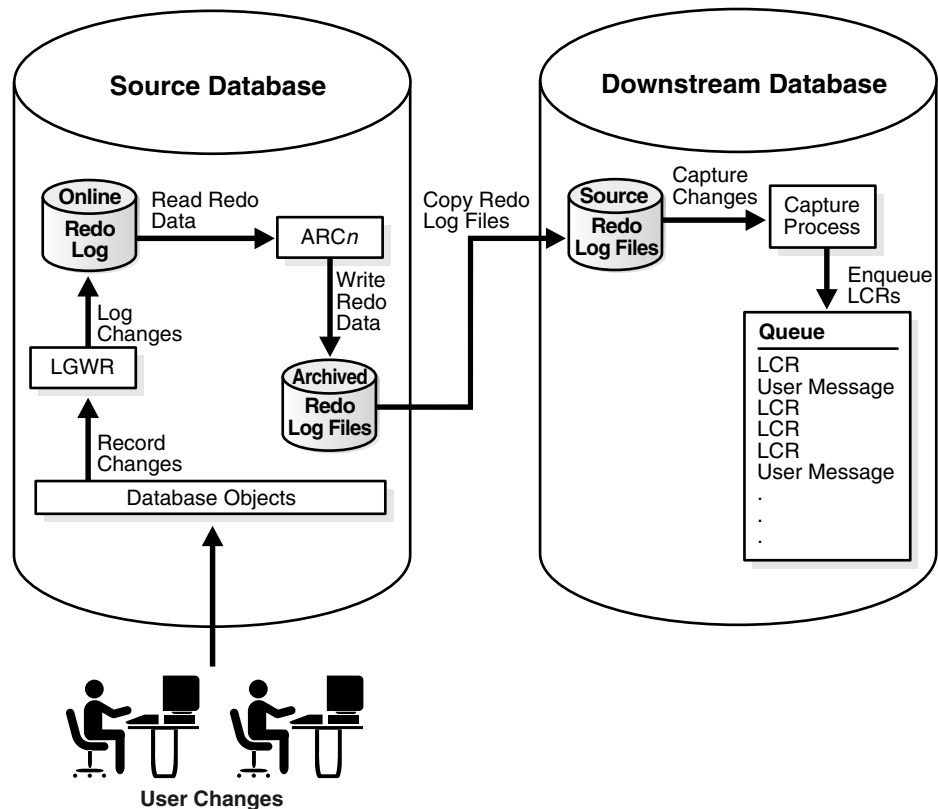

The advantage of archived-log downstream capture over real-time downstream capture is that archived-log downstream capture allows multiple downstream capture processes at a downstream database. You can copy redo log files from multiple source databases to a single downstream database and configure multiple archived-log downstream capture processes to capture changes in these redo log files.

See Also: *Oracle Data Guard Concepts and Administration* for more information about redo transport services

The Downstream Database Performs Most Change Capture Actions If you configure either real-time or archived-log downstream capture, then the following actions are performed at the downstream database:

- The first time a downstream capture process is started at the downstream database, Oracle Database uses data dictionary information in the redo data from the source database to create a LogMiner data dictionary at the downstream database. The `DBMS_CAPTURE_ADM.BUILD` procedure is run at the source database to extract the source data dictionary information to the redo log at the source database. Next, the redo data is copied to the downstream database from the source database. Additional downstream capture processes for the same source database can use this existing LogMiner data dictionary, or they can create new LogMiner data dictionaries. Also, a real-time downstream capture process can share a LogMiner data dictionary with one or more archived-log downstream capture processes.
- A capture process scans the redo data from the source database for changes using LogMiner.
- The **rules engine** evaluates changes based on the **rules** in one or more of the capture process **rule sets**.
- The capture process enqueues changes that satisfy the rules in its rule sets into a local `ANYDATA` queue. The capture process formats the changes as LCRs.
- If the captured LCRs are shared with one or more other databases, then one or more **propagations** propagate these LCRs from the downstream database to the other databases.

In a downstream capture configuration, the following actions are performed at the source database:

- The `DBMS_CAPTURE_ADM.BUILD` procedure is run at the source database to extract the data dictionary to the redo log.
- Supplemental logging at the source database places additional information that might be needed for apply in the redo log.
- If database objects at the source database must be instantiated at other databases in the environment, then the objects must be prepared for **instantiation**, and a mechanism such as an Export utility must be used to make a copy of the database objects.

In addition, the redo data must be copied from the computer system running the source database to the computer system running the downstream database. In a real-time downstream capture configuration, redo transport services use LGWR to send redo data to the downstream database. Typically, in an archived-log downstream capture configuration, redo transport services copy the archived redo log files to the downstream database.

See Also: [Chapter 6, "How Rules Are Used in Oracle Streams"](#) for more information about rule sets for **Oracle Streams clients** and for information about how messages satisfy rule sets

Advantages of Downstream Capture The following are the advantages of using downstream capture:

- Capturing changes uses fewer resources at the source database because the downstream database performs most of the required work.
- If you plan to capture changes originating at multiple source databases, then capture process administration can be simplified by running multiple archived-log downstream capture processes with different source databases at one downstream database. That is, one downstream database can act as the central location for change capture from multiple sources. In such a configuration, one real-time

downstream capture process can run at the downstream database in addition to the archived-log downstream capture processes.

- Copying redo data to one or more downstream databases provides improved protection against data loss. For example, redo log files at the downstream database can be used for recovery of the source database in some situations.
- The ability to configure at one or more downstream databases multiple capture processes that capture changes from a single source database provides more flexibility and can improve scalability.

Optional Database Link From the Downstream Database to the Source Database When you create or alter a downstream capture process, you optionally can specify the use of a database link from the downstream database to the source database. This database link must have the same name as the global name of the source database. Such a database link simplifies the creation and administration of a downstream capture process. You specify that a downstream capture process uses a database link by setting the `use_database_link` parameter to `TRUE` when you run the `CREATE_CAPTURE` or `ALTER_CAPTURE` procedure on the downstream capture process.

When a downstream capture process uses a database link to the source database, the capture process connects to the source database to perform the following administrative actions automatically:

- In certain situations, runs the `DBMS_CAPTURE_ADM.BUILD` procedure at the source database to extract the data dictionary at the source database to the redo log when a capture process is created.
- Prepares source database objects for instantiation.
- Obtains the **first SCN** for the downstream capture process if the first system change number (SCN) is not specified during capture process creation. The first SCN is needed to create a capture process.

If a downstream capture process does not use a database link, then you must perform these actions manually.

Note: During the creation of a downstream capture process, if the `first_scn` parameter is set to `NULL` in the `CREATE_CAPTURE` procedure, then the `use_database_link` parameter must be set to `TRUE`. Otherwise, an error is raised.

See Also: ["Configuring a Real-Time Downstream Capture Process"](#) on page 10-10 for information about when the `DBMS_CAPTURE_ADM.BUILD` procedure is run automatically during capture process creation if the downstream capture process uses a database link

Operational Requirements for Downstream Capture The following are operational requirements for using downstream capture:

- The source database must be running at least Oracle Database 10g and the downstream capture database must be running the same release of Oracle as the source database or later.
- The downstream database must be running Oracle Database 10g Release 2 or later to configure real-time downstream capture. In this case, the source database must be running Oracle Database 10g Release 1 or later.

- The operating system on the source and downstream capture sites must be the same, but the operating system release does not need to be the same. In addition, the downstream sites can use a different directory structure than the source site.
- The hardware architecture on the source and downstream capture sites must be the same. For example, a downstream capture configuration with a source database on a 32-bit Sun system must have a downstream database that is configured on a 32-bit Sun system. Other hardware elements, such as the number of CPUs, memory size, and storage configuration, can be different between the source and downstream sites.

SCN Values Related to a Capture Process

This section describes system change number (SCN) values that are important for a [capture process](#). You can query the DBA_CAPTURE data dictionary view to display these values for one or more capture processes.

- [Captured SCN and Applied SCN](#)
- [First SCN and Start SCN](#)

Captured SCN and Applied SCN

The **captured SCN** is the SCN that corresponds to the most recent change scanned in the redo log by a capture process. The **applied SCN** for a capture process is the SCN of the most recent [message](#) dequeued by the relevant [apply processes](#). All messages lower than this SCN have been dequeued by all apply processes that apply changes captured by the capture process. The applied SCN for a capture process is equivalent to the [low-watermark](#) SCN for an apply process that applies changes captured by the capture process.

First SCN and Start SCN

The following sections describe the first SCN and start SCN for a capture process:

- [First SCN](#)
- [Start SCN](#)
- [Start SCN Must Be Greater Than or Equal to First SCN](#)
- [A Start SCN Setting That Is Prior to Preparation for Instantiation](#)

First SCN The **first SCN** is the lowest SCN in the redo log from which a capture process can capture changes. If you specify a first SCN during capture process creation, then the database must be able to access redo data from the SCN specified and higher.

The DBMS_CAPTURE_ADM.BUILD procedure extracts the [source database](#) data dictionary to the redo log. When you create a capture process, you can specify a first SCN that corresponds to this data dictionary build in the redo log. Specifically, the first SCN for the capture process being created can be set to any value returned by the following query:

```
COLUMN FIRST_CHANGE# HEADING 'First SCN' FORMAT 999999999
COLUMN NAME HEADING 'Log File Name' FORMAT A50

SELECT DISTINCT FIRST_CHANGE#, NAME FROM V$ARCHIVED_LOG
WHERE DICTIONARY_BEGIN = 'YES';
```

The value returned for the `NAME` column is the name of the redo log file that contains the SCN corresponding to the first SCN. This redo log file, and all subsequent redo log files, must be available to the capture process. If this query returns multiple distinct values for `FIRST_CHANGE#`, then the `DBMS_CAPTURE_ADM.BUILD` procedure has been run more than once on the source database. In this case, choose the first SCN value that is most appropriate for the capture process you are creating.

In some cases, the `DBMS_CAPTURE_ADM.BUILD` procedure is run automatically when a capture process is created. When this happens, the first SCN for the capture process corresponds to this data dictionary build.

Start SCN The **start SCN** is the SCN from which a capture process begins to capture changes. You can specify a start SCN that is different than the first SCN during capture process creation, or you can alter a capture process to set its start SCN. The start SCN does not need to be modified for normal operation of a capture process. Typically, you reset the start SCN for a capture process if point-in-time recovery must be performed on one of the **destination databases** that receive changes from the capture process. In these cases, the capture process can be used to capture the changes made at the source database after the point-in-time of the recovery.

Note: An existing capture process must be stopped before setting its start SCN.

Start SCN Must Be Greater Than or Equal to First SCN If you specify a start SCN when you create or alter a capture process, then the start SCN specified must be greater than or equal to the first SCN for the capture process. A capture process always scans any unscanned redo log records that have higher SCN values than the first SCN, even if the redo log records have lower SCN values than the start SCN. So, if you specify a start SCN that is greater than the first SCN, then the capture process might scan redo log records for which it cannot capture changes, because these redo log records have a lower SCN than the start SCN.

Scanning redo log records before the start SCN should be avoided if possible because it can take some time. Therefore, Oracle recommends that the difference between the first SCN and start SCN be as small as possible during capture process creation to keep the initial capture process startup time to a minimum.

Caution: When a capture process is started or restarted, it might need to scan redo log files with a `FIRST_CHANGE#` value that is lower than start SCN. Removing required redo log files before they are scanned by a capture process causes the capture process to abort. You can query the `DBA_CAPTURE` data dictionary view to determine the first SCN, start SCN, and **required checkpoint SCN**. A capture process needs the redo log file that includes the required checkpoint SCN, and all subsequent redo log files.

See Also:

- ["Capture Process Creation"](#) on page 2-29 for more information about the first SCN and start SCN for a capture process

A Start SCN Setting That Is Prior to Preparation for Instantiation If you want to capture changes to a database object and apply these changes using an **apply process**, then only changes that occurred after the database object has been prepared for

instantiation can be applied. Therefore, if you set the start SCN for a capture process lower than the SCN that corresponds to the time when a database object was prepared for instantiation, then any captured changes to this database object prior to the prepare SCN cannot be applied by an apply process.

This limitation can be important during capture process creation. If a database object was never prepared for instantiation prior to the time of capture process creation, then an apply process cannot apply any captured changes to the object from a time before capture process creation time.

In some cases, database objects might have been prepared for instantiation before a new capture process is created. For example, if you want to create a new capture process for a source database whose changes are already being captured by one or more existing capture processes, then some or all of the database objects might have been prepared for instantiation before the new capture process is created. If you want to capture changes to a certain database object with a new capture process from a time before the new capture process was created, then the following conditions must be met for an apply process to apply these captured changes:

- The database object must have been prepared for instantiation before the new capture process is created.
- The start SCN for the new capture process must correspond to a time before the database object was prepared for instantiation.
- The redo logs for the time corresponding to the specified start SCN must be available. Additional redo logs previous to the start SCN might be required as well.

See Also:

- *Oracle Streams Replication Administrator's Guide* for more information about preparing database objects for instantiation
- "[Capture Process Creation](#)" on page 2-29

Oracle Streams Capture Processes and RESTRICTED SESSION

When you enable restricted session during system startup by issuing a `STARTUP RESTRICT` statement, **capture processes** do not start, even if they were running when the database shut down. When restricted session is disabled with an `ALTER SYSTEM` statement, each capture process that was running when the database shut down is started.

When restricted session is enabled in a running database by the SQL statement `ALTER SYSTEM ENABLE RESTRICTED SESSION` clause, it does not affect any running capture processes. These capture processes continue to run and capture changes. If a stopped capture process is started in a restricted session, then the capture process does not actually start until the restricted session is disabled.

Capture Process Components

A **capture process** is an optional Oracle background process whose process name is `CPnn`, where `nn` can include letters and numbers. A capture process captures changes from the redo log by using the infrastructure of LogMiner. Oracle Streams configures LogMiner automatically. The underlying LogMiner process name is `MSnn`, where `nn` can include letters and numbers. You can create, alter, start, stop, and drop a capture process, and you can define capture process **rules** that control which changes a capture process captures.

A capture process consists of the following components:

- One **reader server** that reads the redo log and divides the redo log into regions.
- One or more **preparer servers** that scan the regions defined by the reader server in parallel and perform prefiltering of changes found in the redo log. Prefiltering involves sending partial information about changes, such as schema and object name for a change, to the **rules engine** for evaluation, and receiving the results of the evaluation. You can control the number of preparer servers using the `parallelism` capture process parameter.
- One **builder server** that merges redo records from the preparer servers. These redo records either evaluated to `TRUE` during partial evaluation or partial evaluation was inconclusive for them. The builder server preserves the system change number (SCN) order of these redo records and passes the merged redo records to the capture process.
- The capture process (`CPnn`) performs the following actions for each change when it receives merged redo records from the builder server:
 - Formats the change into an LCR
 - If the partial evaluation performed by a preparer server was inconclusive for the change in the LCR, then sends the LCR to the **rules engine** for full evaluation
 - Receives the results of the full evaluation of the LCR if it was performed
 - Discards the LCR if it satisfies the rules in the **negative rule set** for the capture process or if it does not satisfy the rules in the positive rule set
 - Enqueues the LCR into the **queue** associated with the capture process if the LCR satisfies the **rules** in the **positive rule set** for the capture process

Each reader server, preparer server, and builder server is a process.

See Also:

- ["Capture Process Rule Evaluation"](#) on page 2-36
- ["Capture Process Parameters"](#) on page 2-35

Capture User

Changes are captured in the security domain of the **capture user** for a capture process. The capture user captures all changes that satisfy the capture process **rule sets**. In addition, the capture user runs all **custom rule-based transformations** specified by the rules in these rule sets. The capture user must have the necessary privileges to perform these actions, including `EXECUTE` privilege on the rule sets used by the capture process, `EXECUTE` privilege on all custom rule-based transformation functions specified for rules in the **positive rule set**, and privileges to enqueue **messages** into the capture process **queue**. A capture process can be associated with only one user, but one user can be associated with many capture processes.

See Also:

- ["Configuring an Oracle Streams Administrator"](#) on page 9-1 for information about the required privileges

Capture Process States

The state of a capture process describes what the capture process is doing currently. You can view the state of a capture process by querying the `STATE` column in the `V$STREAMS_CAPTURE` dynamic performance view. The following capture process states are possible:

- `INITIALIZING` - Starting up.
- `WAITING FOR DICTIONARY REDO` - Waiting for redo log files containing the dictionary build related to the **first SCN** to be added to the capture process session. A capture process cannot begin to scan the redo log files until all of the log files containing the dictionary build have been added.
- `DICTIONARY INITIALIZATION` - Processing a dictionary build.
- `MINING (PROCESSED SCN = scn_value)` - Mining a dictionary build at the SCN *scn_value*.
- `LOADING (step X of Y)` - Processing information from a dictionary build and currently at step *X* in a process that involves *Y* steps, where *X* and *Y* are numbers.
- `CAPTURING CHANGES` - Scanning the redo log for changes that satisfy the capture process **rule sets**.
- `WAITING FOR REDO` - Waiting for new redo log files to be added to the capture process session. The capture process has finished processing all of the redo log files added to its session. This state is possible if there is no activity at a **source database**. For a **downstream capture process**, this state is possible if the capture process is waiting for new log files to be added to its session.
- `EVALUATING RULE` - Evaluating a change against a capture process rule set.
- `CREATING LCR` - Converting a change into a logical change record (LCR).
- `ENQUEUEING MESSAGE` - Enqueueing an LCR that satisfies the capture process rule sets into the capture process **queue**.
- `PAUSED FOR FLOW CONTROL` - Unable to enqueue LCRs either because of low memory or because **propagations** and apply processes are consuming **messages** slower than the capture process is creating them. This state indicates flow control that is used to reduce spilling of **captured LCRs** when propagation or apply has fallen behind or is unavailable.
- `SHUTTING DOWN` - Stopping.

See Also:

- ["Displaying Change Capture Information About Each Capture Process"](#) on page 23-3 for a query that displays the state of a capture process

Multiple Capture Processes in a Single Database

If you run multiple **capture processes** in a single database, increase the size of the System Global Area (SGA) for each instance. Use the `SGA_MAX_SIZE` initialization parameter to increase the SGA size. Also, if the size of the **Oracle Streams pool** is not managed automatically in the database, then increase the size of the Oracle Streams pool by 10 MB for each capture process parallelism. For example, if you have two capture processes running in a database, and the parallelism parameter is set to 4 for one of them and 1 for the other, then increase the Oracle Streams pool by 50 MB (4 + 1 = 5 parallelism).

Also, Oracle recommends that each ANYDATA queue used by a **capture process**, **propagation**, or **apply process** store **captured LCRs** from at most one capture process from a particular **source database**. Therefore, use a separate **queue** for each capture process that captures changes originating at a particular source database, and make sure each queue has its own queue table. Also, do not propagate messages from two or more capture processes with the same source database to the same queue.

Note: The size of the Oracle Streams pool is managed automatically if the MEMORY_TARGET, MEMORY_MAX_TARGET, or SGA_TARGET initialization parameter is set to a nonzero value.

See Also:

- ["Configuring the Oracle Streams Pool"](#) on page 9-9
- ["Setting Initialization Parameters Relevant to Oracle Streams"](#) on page 9-4 for more information about the STREAMS_POOL_SIZE initialization parameter

Capture Process Checkpoints

A **checkpoint** is information about the current state of a capture process that is stored persistently in the data dictionary of the database running the capture process. A capture process tries to record a checkpoint at regular intervals called **checkpoint intervals**.

Required Checkpoint SCN

The system change number (SCN) that corresponds to the lowest checkpoint for which a capture process requires redo data is the **required checkpoint SCN**. The redo log file that contains the required checkpoint SCN, and all subsequent redo log files, must be available to the capture process. If a capture process is stopped and restarted, then it starts scanning the redo log from the SCN that corresponds to its required checkpoint SCN. The required checkpoint SCN is important for recovery if a database stops unexpectedly. Also, if the **first SCN** is reset for a capture process, then it must be set to a value that is less than or equal to the required checkpoint SCN for the captured process. You can determine the required checkpoint SCN for a capture process by querying the REQUIRED_CHECKPOINT_SCN column in the DBA_CAPTURE data dictionary view.

See Also: ["Displaying the Redo Log Files that Are Required by Each Capture Process"](#) on page 23-8

Maximum Checkpoint SCN

The SCN that corresponds to the last checkpoint recorded by a capture process is the **maximum checkpoint SCN**. If you create a capture process that captures changes from a **source database**, and other capture processes already exist which capture changes from the same source database, then the maximum checkpoint SCNs of the existing capture processes can help you to decide whether the new capture process should create a new **LogMiner data dictionary** or share one of the existing LogMiner data dictionaries. You can determine the maximum checkpoint SCN for a capture process by querying the MAX_CHECKPOINT_SCN column in the DBA_CAPTURE data dictionary view.

Checkpoint Retention Time

The **checkpoint retention time** is the amount of time, in number of days, that a capture process retains checkpoints before purging them automatically. A capture process periodically computes the age of a checkpoint by subtracting the `NEXT_TIME` of the archived redo log file that corresponds to the checkpoint from `FIRST_TIME` of the archived redo log file containing the required checkpoint SCN for the capture process. If the resulting value is greater than the checkpoint retention time, then the capture process automatically purges the checkpoint by advancing its **first SCN** value. Otherwise, the checkpoint is retained. The `DBA_REGISTERED_ARCHIVED_LOG` view displays the `FIRST_TIME` and `NEXT_TIME` for archived redo log files, and the `REQUIRED_CHECKPOINT_SCN` column in the `DBA_CAPTURE` view displays the required checkpoint SCN for a capture process.

Figure 2–4 shows an example of a checkpoint being purged when the checkpoint retention time is set to 20 days.

Figure 2–4 Checkpoint Retention Time Set to 20 Days

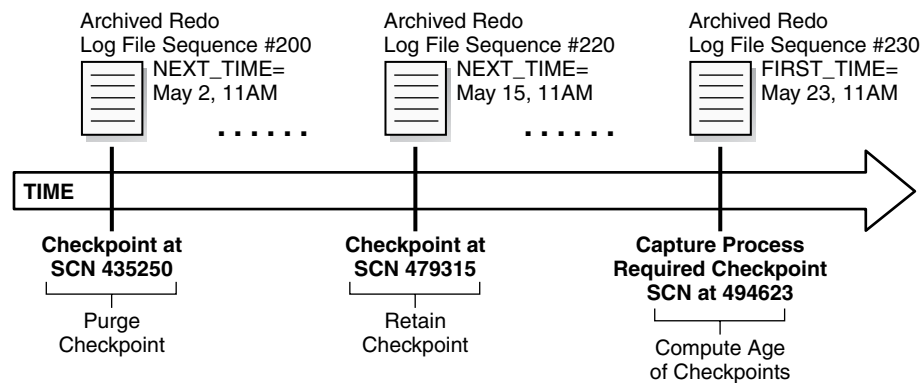

In Figure 2–4, with the checkpoint retention time set to 20 days, the checkpoint at SCN 435250 is purged because it is 21 days old, while the checkpoint at SCN 479315 is retained because it is 8 days old.

Whenever the first SCN is reset for a capture process, the capture process purges information about archived redo log files prior to the new first SCN from its LogMiner data dictionary. After this information is purged, the archived redo log files remain on the hard disk, but the files are not needed by the capture process. The `PURGEABLE` column in the `DBA_REGISTERED_ARCHIVED_LOG` view displays `YES` for the archived redo log files that are no longer needed. These files can be removed from disk or moved to another location without affecting the capture process.

If you create a capture process using the `CREATE_CAPTURE` procedure in the `DBMS_CAPTURE_ADM` package, then you can specify the checkpoint retention time, in days, using the `checkpoint_retention_time` parameter. The default checkpoint retention time is 60 days if the `checkpoint_retention_time` parameter is not specified in the `CREATE_CAPTURE` procedure, or if you use the `DBMS_STREAMS_ADM` package to create the capture process. The `CHECKPOINT_RETENTION_TIME` column in the `DBA_CAPTURE` view displays the current checkpoint retention time for a capture process.

You can change the checkpoint retention time for a capture process by specifying a new time period in the `ALTER_CAPTURE` procedure in the `DBMS_CAPTURE_ADM` package. If you do not want checkpoints for a capture process to be purged automatically, then specify `DBMS_CAPTURE_ADM.INFINITE` for the `checkpoint_retention_time` parameter in `CREATE_CAPTURE` or `ALTER_CAPTURE`.

Note: To specify a checkpoint retention time for a capture process, the compatibility level of the database running the capture process must be 10.2.0 or higher. If the compatibility level is lower than 10.2.0 for a database, then the checkpoint retention time for all capture processes running on the database is infinite.

See Also:

- "The LogMiner Data Dictionary for a Capture Process" on page 2-30
- "A New First SCN Value and Purged LogMiner Data Dictionary Information" on page 2-27
- "Managing the Checkpoint Retention Time for a Capture Process" on page 14-7
- *Oracle Database PL/SQL Packages and Types Reference* for more information about the `CREATE_CAPTURE` and `ALTER_CAPTURE` procedures

A New First SCN Value and Purged LogMiner Data Dictionary Information

If you reset the **first SCN** value for an existing capture process, or if the first SCN is reset automatically when checkpoints are purged, then Oracle automatically purges **LogMiner data dictionary** information prior to the new first SCN setting. If the **start SCN** for a capture process corresponds to redo information that has been purged, then Oracle Database automatically resets the start SCN to the same value as the first SCN. However, if the start SCN is higher than the new first SCN setting, then the start SCN remains unchanged.

Figure 2–5 shows how Oracle automatically purges LogMiner data dictionary information prior to a new first SCN setting, and how the start SCN is not changed if it is higher than the new first SCN setting.

Figure 2–5 Start SCN Higher than Reset First SCN

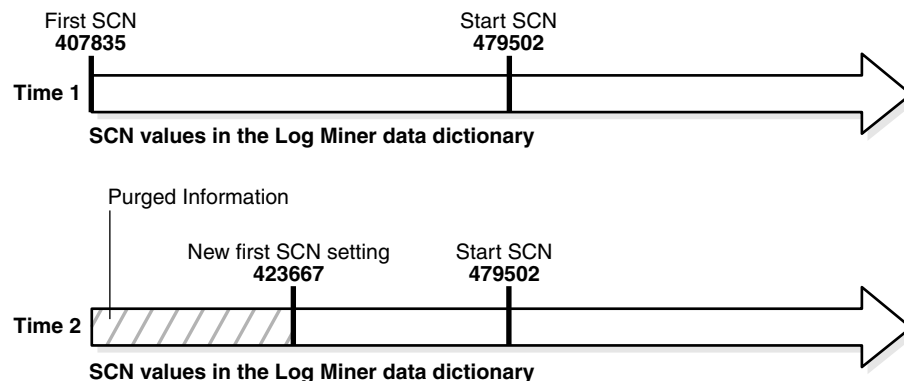

Given this example, if the first SCN is reset again to a value higher than the start SCN value for a capture process, then the start SCN no longer corresponds to existing information in the LogMiner data dictionary. Figure 2–6 shows how Oracle Database resets the start SCN automatically if it is lower than a new first SCN setting.

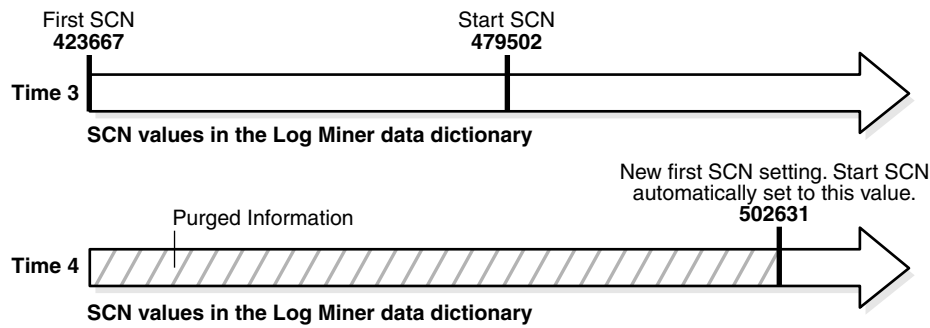
Figure 2-6 Start SCN Lower than Reset First SCN

As you can see, the first SCN and start SCN for a capture process can continually increase over time, and, as the first SCN moves forward, it might no longer correspond to an SCN established by the `DBMS_CAPTURE_ADM.BUILD` procedure.

See Also:

- ["First SCN and Start SCN"](#) on page 2-20
- ["Setting the Start SCN for an Existing Capture Process"](#) on page 14-9
- The `DBMS_CAPTURE_ADM.ALTER_CAPTURE` procedure in the *Oracle Database PL/SQL Packages and Types Reference* for information about altering a capture process

ARCHIVELOG Mode and a Capture Process

The following list describes how different types of capture processes read the redo data:

- A **local capture process** reads from the redo log buffer whenever possible. If it cannot read from the log buffer, then it reads from the online redo logs. If it cannot read from the log buffer or the online redo logs, then it reads from the archived redo log files. Therefore, the **source database** must be running in ARCHIVELOG mode when a local capture process is configured to capture changes.
- A **real-time downstream capture process** reads online redo data from its source database whenever possible and archived redo log files that contain redo data from the source database otherwise. In this case, the redo data from the source database is stored in the standby redo log at the **downstream database**, and the archiver at the downstream database archives the redo data in the standby redo log. Therefore, both the source database and the downstream database must be running in ARCHIVELOG mode when a real-time downstream capture process is configured to capture changes.
- An **archived-log downstream capture process** always reads archived redo log files from its source database. Therefore, the source database must be running in ARCHIVELOG mode when an archived-log downstream capture process is configured to capture changes.

You can query the `REQUIRED_CHECKPOINT_SCN` column in the `DBA_CAPTURE` data dictionary view to determine the **required checkpoint SCN** for a capture process. When the capture process is restarted, it scans the redo log from the required checkpoint SCN forward. Therefore, the redo log file that includes the required checkpoint SCN, and all subsequent redo log files, must be available to the capture process.

You must keep an archived redo log file available until you are certain that no capture process will need that file. The **first SCN** for a capture process can be reset to a higher value, but it cannot be reset to a lower value. Therefore, a capture process will never need the redo log files that contain information prior to its first SCN. Query the DBA_LOGMNR_PURGED_LOG data dictionary view to determine which archived redo log files will never be needed by any capture process.

When a local capture process falls behind, there is a seamless transition from reading an online redo log to reading an archived redo log, and, when a local capture process catches up, there is a seamless transition from reading an archived redo log to reading an online redo log. Similarly, when a real-time downstream capture process falls behind, there is a seamless transition from reading the standby redo log to reading an archived redo log, and, when a real-time downstream capture process catches up, there is a seamless transition from reading an archived redo log to reading the standby redo log.

Note: At a downstream database in a downstream capture configuration, log files from a remote source database should be kept separate from local database log files. In addition, if the downstream database contains log files from multiple source databases, then the log files from each source database should be kept separate from each other.

See Also:

- *Oracle Database Administrator's Guide* for information about running a database in ARCHIVELOG mode
- "[Displaying SCN Values for Each Redo Log File Used by Each Capture Process](#)" on page 23-9 for a query that determines which redo log files are no longer needed

Capture Process Creation

You can create a capture process using a procedure in the DBMS_STREAMS_ADM package or the DBMS_CAPTURE_ADM package. Using a procedure in the DBMS_STREAMS_ADM package to create a capture process is simpler because the procedure automatically uses defaults for some configuration options. In addition, when you use a procedure in the DBMS_STREAMS_ADM package, a **rule set** is created for the capture process, and **rules** can be added to the rule set automatically. The rule set is a **positive rule set** if the `inclusion_rule` parameter is set to TRUE (the default) in the procedure, or it is a **negative rule set** if the `inclusion_rule` parameter is set to FALSE in the procedure.

Alternatively, using the `CREATE_CAPTURE` procedure in the DBMS_CAPTURE_ADM package to create a capture process is more flexible, and you create one or more rule sets and rules for the capture process either before or after it is created. You can use the procedures in the DBMS_STREAMS_ADM package or the DBMS_RULE_ADM package to add rules to a rule set for the capture process. To create a capture process at a **downstream database**, you must use the DBMS_CAPTURE_ADM package.

When you create a capture process using a procedure in the DBMS_STREAMS_ADM package and generate one or more rules in the positive rule set for the capture process, the objects for which changes are captured are prepared for **instantiation** automatically, unless it is a **downstream capture process** and there is no database link from the downstream database to the **source database**.

When you create a capture process using the `CREATE_CAPTURE` procedure in the `DBMS_CAPTURE_ADM` package, you should prepare for instantiation any objects for which you plan to capture changes. Prepare these objects for instantiations as soon as possible after capture process creation. You can prepare objects for instantiation using one of the following procedures in the `DBMS_CAPTURE_ADM` package:

- `PREPARE_TABLE_INSTANTIATION` prepares a single table for instantiation.
- `PREPARE_SCHEMA_INSTANTIATION` prepares for instantiation all of the objects in a schema and all objects added to the schema in the future.
- `PREPARE_GLOBAL_INSTANTIATION` prepares for instantiation all of the objects in a database and all objects added to the database in the future.

These procedures can also enable **supplemental logging** for the key columns or for all columns in the table or tables prepared for instantiation.

Note: After creating a capture process, avoid changing the `DBID` or global name of the source database for the capture process. If you change either the `DBID` or global name of the source database, then the capture process must be dropped and re-created.

See Also:

- ["Configuring a Capture Process"](#) on page 10-1 and *Oracle Database PL/SQL Packages and Types Reference* for more information about the procedures that can be used to create a capture process.
- *Oracle Streams Replication Administrator's Guide* for more information about capture process rules and preparation for instantiation, and for more information about changing the `DBID` or global name of a source database

The LogMiner Data Dictionary for a Capture Process

A capture process requires a data dictionary that is separate from the primary data dictionary for the source database. This separate data dictionary is called a **LogMiner data dictionary**. There can be more than one LogMiner data dictionary for a particular source database. If there are multiple capture processes capturing changes from the source database, then two or more capture processes can share a LogMiner data dictionary, or each capture process can have its own LogMiner data dictionary. If the LogMiner data dictionary that is needed by a capture process does not exist, then the capture process populates it using information in the redo log when the capture process is started for the first time.

The `DBMS_CAPTURE_ADM.BUILD` procedure extracts data dictionary information to the redo log, and this procedure must be run at least once on the source database before any capture process configured to capture changes originating at the source database is started. The extracted data dictionary information in the redo log is consistent with the primary data dictionary at the time when the `DBMS_CAPTURE_ADM.BUILD` procedure is run. This procedure also identifies a valid **first SCN** value that can be used to create a capture process.

You can perform a build of data dictionary information in the redo log multiple times, and a particular build might or might not be used by a capture process to create a LogMiner data dictionary. The amount of information extracted to a redo log when you run the `BUILD` procedure depends on the number of database objects in the

database. Typically, the `BUILD` procedure generates a large amount of redo data that a capture process must scan subsequently. Therefore, you should run the `BUILD` procedure only when necessary.

In most cases, if a build is required when a capture process is created using a procedure in the `DBMS_STREAMS_ADM` or `DBMS_CAPTURE_ADM` package, then the procedure runs the `BUILD` procedure automatically. However, the `BUILD` procedure is not run automatically during capture process creation in the following cases:

- You use `CREATE_CAPTURE` and specify a non-NULL value for the `first_scn` parameter. In this case, the specified first SCN must correspond to a previous build.
- You create a downstream capture process that does not use a database link. In this case, the command at the downstream database cannot communicate with the source database to run the `BUILD` procedure automatically. Therefore, you must run it manually on the source database and specify the first SCN that corresponds to the build during capture process creation.

A capture process requires a LogMiner data dictionary because the information in the primary data dictionary might not apply to the changes being captured from the redo log. These changes might have occurred minutes, hours, or even days before they are captured by a capture process. For example, consider the following scenario:

1. A capture process is configured to capture changes to tables.
2. A database administrator stops the capture process. When the capture process is stopped, it records the SCN of the change it was currently capturing.
3. User applications continue to make changes to the tables while the capture process is stopped.
4. The capture process is restarted three hours after it was stopped.

In this case, to ensure data consistency, the capture process must begin capturing changes in the redo log at the time when it was stopped. The capture process starts capturing changes at the SCN that it recorded when it was stopped.

The redo log contains raw data. It does not contain database object names and column names in tables. Instead, it uses object numbers and internal column numbers for database objects and columns, respectively. Therefore, when a change is captured, a capture process must reference a data dictionary to determine the details of the change.

Because a LogMiner data dictionary might be populated when a capture process is started for the first time, it might take some time to start capturing changes. The amount of time required depends on the number of database objects in the database. You can query the `STATE` column in the `V$STREAMS_CAPTURE` dynamic performance view to monitor the progress while a capture process is processing a data dictionary build.

See Also:

- ["Capture Process Rule Evaluation"](#) on page 2-36
- ["First SCN and Start SCN"](#) on page 2-20
- ["Capture Process States"](#) on page 2-24
- *Oracle Streams Replication Administrator's Guide* for more information about preparing database objects for instantiation

Scenario Illustrating Why a Capture Process Needs a LogMiner Data Dictionary Consider a scenario in which a capture process has been configured to capture changes to table t1, which has columns a and b, and the following changes are made to this table at three different points in time:

Time 1: Insert values a=7 and b=15.

Time 2: Add column c.

Time 3: Drop column b.

If for some reason the capture process is capturing changes from an earlier time, then the primary data dictionary and the relevant version in the LogMiner data dictionary contain different information. Table 2–2 illustrates how the information in the LogMiner data dictionary is used when the current time is different than the change capturing time.

Table 2–2 Information About Table t1 in the Primary and LogMiner Data Dictionaries

Current Time	Change Capturing Time	Primary Data Dictionary	LogMiner Data Dictionary
1	1	Table t1 has columns a and b.	Table t1 has columns a and b at time 1.
2	1	Table t1 has columns a, b, and c at time 2.	Table t1 has columns a and b at time 1.
3	1	Table t1 has columns a and c at time 3.	Table t1 has columns a and b at time 1.

Assume that the capture process captures the change resulting from the insert at time 1 when the actual time is time 3. If the capture process used the primary data dictionary, then it might assume that a value of 7 was inserted into column a and a value of 15 was inserted into column c, because those are the two columns for table t1 at time 3 in the primary data dictionary. However, a value of 15 actually was inserted into column b, not column c.

Because the capture process uses the LogMiner data dictionary, the error is avoided. The LogMiner data dictionary is synchronized with the capture process and continues to record that table t1 has columns a and b at time 1. So, the captured change specifies that a value of 15 was inserted into column b.

Multiple Capture Processes for the Same Source Database If one or more capture processes are capturing changes made to a source database, and you want to create a new capture process that captures changes to the same source database, then the new capture process can either create a new LogMiner data dictionary or share one of the existing LogMiner data dictionaries with one or more other capture processes.

Whether a new LogMiner data dictionary is created for a new capture process depends on the setting for the `first_scn` parameter when you run `CREATE_CAPTURE` to create a capture process.

If multiple LogMiner data dictionaries exist, and you specify `NULL` for the `first_scn` parameter during capture process creation, then the new capture process automatically attempts to share the LogMiner data dictionary of one of the existing capture processes that has taken at least one **checkpoint**. You can view the **maximum checkpoint SCN** for all existing capture processes by querying the `MAX_CHECKPOINT_SCN` column in the `DBA_CAPTURE` data dictionary view. During capture process creation, if the `first_scn` parameter is `NULL` and the `start_scn` parameter is non-`NULL`, then an error is raised if the `start_scn` parameter setting is lower than all of the first SCN values for all existing capture processes.

If multiple LogMiner data dictionaries exist, and you specify a non-NULL value for the `first_scn` parameter during capture process creation, then the new capture process creates a new LogMiner data dictionary the first time it is started. In this case, before you create the new capture process, you must run the `BUILD` procedure in the `DBMS_CAPTURE_ADM` package on the source database. The `BUILD` procedure generates a corresponding valid first SCN value that you can specify when you create the new capture process.

You can find a first SCN generated by the `BUILD` procedure by running the following query:

```
COLUMN FIRST_CHANGE# HEADING 'First SCN' FORMAT 999999999
COLUMN NAME HEADING 'Log File Name' FORMAT A50

SELECT DISTINCT FIRST_CHANGE#, NAME FROM V$ARCHIVED_LOG
       WHERE DICTIONARY_BEGIN = 'YES';
```

This query can return more than one row if the `BUILD` procedure was run more than once.

The most important factor to consider when deciding whether a new capture process should share an existing LogMiner data dictionary or create a new one is the difference between the maximum checkpoint SCN values of the existing capture processes and the **start SCN** of the new capture process. If the new capture process shares a LogMiner data dictionary, then it must scan the redo log from the point of the maximum checkpoint SCN of the shared LogMiner data dictionary onward, even though the new capture process cannot capture changes prior to its first SCN. If the start SCN of the new capture process is much higher than the maximum checkpoint SCN of the existing capture process, then the new capture process must scan a large amount of redo data before it reaches its start SCN.

A capture process creates a new LogMiner data dictionary when the `first_scn` parameter is non-NULL during capture process creation. Follow these guidelines when you decide whether a new capture process should share an existing LogMiner data dictionary or create a new one:

- If one or more maximum checkpoint SCN values is greater than the start SCN you want to specify, and if this start SCN is greater than the first SCN of one or more existing capture processes, then it might be better to share the LogMiner data dictionary of an existing capture process. In this case, you can assume there is a checkpoint SCN that is less than the start SCN and that the difference between this checkpoint SCN and the start SCN is small. The new capture process will begin scanning the redo log from this checkpoint SCN and will catch up to the start SCN quickly.
- If no maximum checkpoint SCN is greater than the start SCN, and if the difference between the maximum checkpoint SCN and the start SCN is small, then it might be better to share the LogMiner data dictionary of an existing capture process. The new capture process will begin scanning the redo log from the maximum checkpoint SCN, but it will catch up to the start SCN quickly.
- If no maximum checkpoint SCN is greater than the start SCN, and if the difference between the highest maximum checkpoint SCN and the start SCN is large, then it might take a long time for the capture process to catch up to the start SCN. In this case, it might be better for the new capture process to create a new LogMiner data dictionary. It will take some time to create the new LogMiner data dictionary when the new capture process is first started, but the capture process can specify the same value for its first SCN and start SCN, and thereby avoid scanning a large amount of redo data unnecessarily.

Figure 2–7 illustrates these guidelines.

Figure 2–7 Deciding Whether to Share a LogMiner Data Dictionary

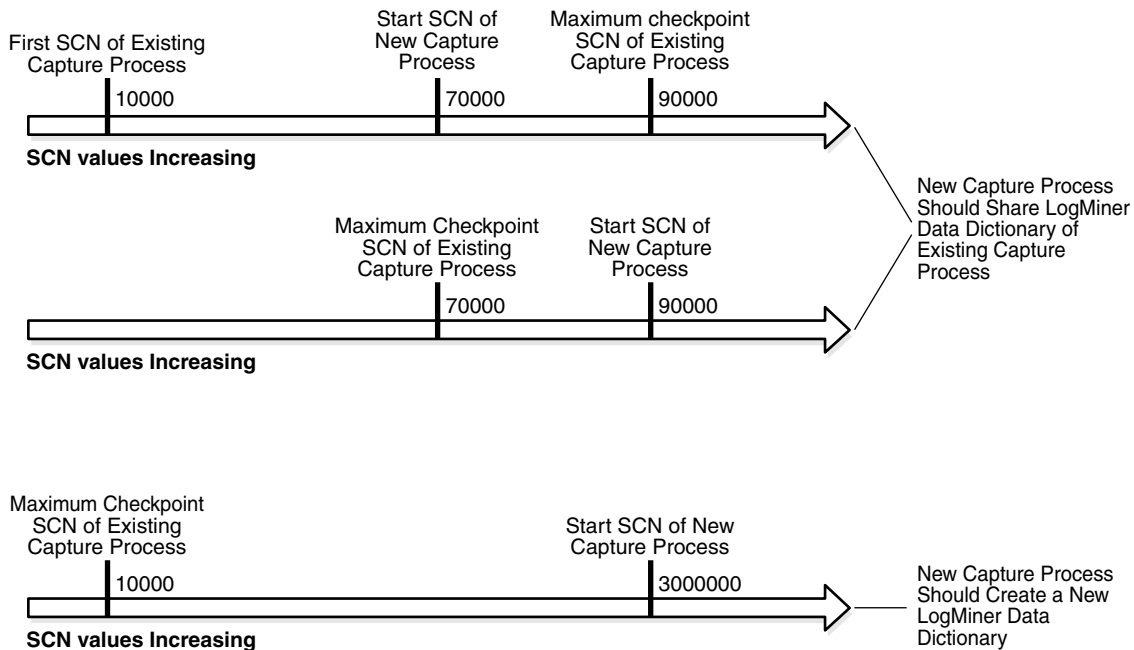

Note:

- If you create a capture process using one of the procedures in the `DBMS_STREAMS_ADM` package, then it is the same as specifying `NULL` for the `first_scn` and `start_scn` parameters in the `CREATE_CAPTURE` procedure.
- You must prepare database objects for **instantiation** if a new capture process will capture changes made to these database objects. This requirement holds even if the new capture process shares a LogMiner data dictionary with one or more other capture processes for which these database objects have been prepared for instantiation.

See Also:

- ["First SCN and Start SCN"](#) on page 2-20
- ["Capture Process Checkpoints"](#) on page 2-25
- *Oracle Database PL/SQL Packages and Types Reference* for more information about setting the `first_scn` and `start_scn` parameters in the `CREATE_CAPTURE` procedure

The Oracle Streams Data Dictionary

Propagations and **apply processes** use an **Oracle Streams data dictionary** to keep track of the database objects from a particular **source database**. An Oracle Streams data dictionary is populated whenever one or more database objects are prepared for **instantiation** at a source database. Specifically, when a database object is prepared for instantiation, it is recorded in the redo log. When a capture process scans the redo log,

it uses this information to populate the local Oracle Streams data dictionary for the source database. In the case of local capture, this Oracle Streams data dictionary is at the source database. In the case of downstream capture, this Oracle Streams data dictionary is at the **downstream database**.

When you prepare a database object for instantiation, you are informing Oracle Streams that information about the database object is needed by **propagations** that propagate changes to the database object and apply processes that apply changes to the database object. Any database that propagates or applies these changes requires an Oracle Streams data dictionary for the source database where the changes originated.

After an object has been prepared for instantiation, the local Oracle Streams data dictionary is updated when a DDL statement on the object is processed by a capture process. In addition, an internal **message** containing information about this DDL statement is captured and placed in the **queue** for the capture process. Propagations can then propagate these internal messages to **destination queues** at databases.

An Oracle Streams data dictionary is multiversed. If a database has multiple propagations and apply processes, then all of them use the same Oracle Streams data dictionary for a particular source database. A database can contain only one Oracle Streams data dictionary for a particular source database, but it can contain multiple Oracle Streams data dictionaries if it propagates or applies changes from multiple source databases.

See Also:

- *Oracle Streams Replication Administrator's Guide* for more information about instantiation
- ["Oracle Streams Data Dictionary for Propagations"](#) on page 3-19
- ["Oracle Streams Data Dictionary for an Apply Process"](#) on page 4-20

Capture Process Parameters

After creation, a capture process is disabled so that you can set the capture process parameters for your environment before starting it for the first time. Capture process parameters control the way a capture process operates. For example, the `parallelism` capture process parameter controls the number of **preparer servers** used by a capture process, and the `time_limit` capture process parameter specifies the amount of time a capture process runs before it is shut down automatically. You set capture process parameters using the `DBMS_CAPTURE_ADM.SET_PARAMETER` procedure.

See Also:

- ["Setting a Capture Process Parameter"](#) on page 14-6
- ["Capture Process Components"](#) on page 2-22 for more information about preparer servers
- *Oracle Database PL/SQL Packages and Types Reference* for detailed information about all of the capture process parameters

Capture Process Rule Evaluation

A capture process evaluates changes it finds in the redo log against its positive and **negative rule sets**. The capture process evaluates a change against the negative rule set first. If one or more **rules** in the negative rule set evaluate to `TRUE` for the change, then the change is discarded, but if no rule in the negative rule set evaluates to `TRUE` for the change, then the change satisfies the negative rule set. When a change satisfies the negative rule set for a capture process, the capture process evaluates the change against its **positive rule set**. If one or more rules in the positive rule set evaluate to `TRUE` for the change, then the change satisfies the positive rule set, but if no rule in the positive rule set evaluates to `TRUE` for the change, then the change is discarded. If a capture process only has one rule set, then it evaluates changes against this one rule set only.

A running capture process completes the following series of actions to capture changes:

1. Finds changes in the redo log.
2. Performs prefiltering of the changes in the redo log. During this step, a capture process evaluates rules in its rule sets at a basic level to place changes found in the redo log into two categories: changes that should be converted into LCRs and changes that should not be converted into LCRs. Prefiltering is done in two phases. In the first phase, information that can be evaluated during prefiltering includes schema name, object name, and command type. If more information is needed to determine whether a change should be converted into an LCR, then information that can be evaluated during the second phase of prefiltering includes **tag** values and column values when appropriate.

Prefiltering is a safe optimization done with incomplete information. This step identifies relevant changes to be processed subsequently, such that:

- A capture process converts a change into an LCR if the change satisfies the capture process rule sets. In this case, proceed to Step 3.
- A capture process does not convert a change into an LCR if the change does not satisfy the capture process rule sets.
- Regarding `MAYBE` evaluations, the rule evaluation proceeds as follows:
 - If a change evaluates to `MAYBE` against both the positive and negative rule set for a capture process, then the capture process might not have enough information to determine whether the change will definitely satisfy both of its rule sets. In this case, further evaluation is necessary. Proceed to Step 3.
 - If the change evaluates to `FALSE` against the negative rule set and `MAYBE` against the positive rule set for the capture process, then the capture process might not have enough information to determine whether the change will definitely satisfy both of its rule sets. In this case, further evaluation is necessary. Proceed to Step 3.
 - If the change evaluates to `MAYBE` against the negative rule set and `TRUE` against the positive rule set for the capture process, then the capture process might not have enough information to determine whether the change will definitely satisfy both of its rule sets. In this case, further evaluation is necessary. Proceed to Step 3.

- If the change evaluates to `TRUE` against the negative rule set and `MAYBE` against the positive rule set for the capture process, then the capture process discards the change.
 - If the change evaluates to `MAYBE` against the negative rule set and `FALSE` against the positive rule set for the capture process, then the capture process discards the change.
3. Converts changes that satisfy, or might satisfy, the capture process rule sets into LCRs based on prefiltering.
 4. Performs LCR filtering. During this step, a capture process evaluates rules regarding information in each LCR to separate the LCRs into two categories: LCRs that should be enqueued and LCRs that should be discarded.
 5. Discards the LCRs that should not be enqueued because they did not satisfy the capture process rule sets.
 6. Enqueues the remaining **captured LCRs** into the **queue** associated with the capture process.

For example, suppose the following rule is defined in the positive rule set for a capture process: Capture changes to the `hr.employees` table where the `department_id` is 50. No other rules are defined for the capture process, and the `parallelism` parameter for the capture process is set to 1.

Given this rule, suppose an `UPDATE` statement on the `hr.employees` table changes 50 rows in the table. The capture process performs the following series of actions for each row change:

1. Finds the next change resulting from the `UPDATE` statement in the redo log.
2. Determines that the change resulted from an `UPDATE` statement to the `hr.employees` table and must be captured. If the change was made to a different table, then the capture process ignores the change.
3. Captures the change and converts it into an LCR.
4. Filters the LCR to determine whether it involves a row where the `department_id` is 50.
5. Either enqueues the LCR into the queue associated with the capture process if it involves a row where the `department_id` is 50, or discards the LCR if it involves a row where the `department_id` is not 50 or is missing.

See Also:

- ["Capture Process Components"](#) on page 2-22
- [Chapter 6, "How Rules Are Used in Oracle Streams"](#) for more information about rule sets for **Oracle Streams clients** and for information about how messages satisfy rule sets

[Figure 2–8](#) illustrates capture process rule evaluation in a flowchart.

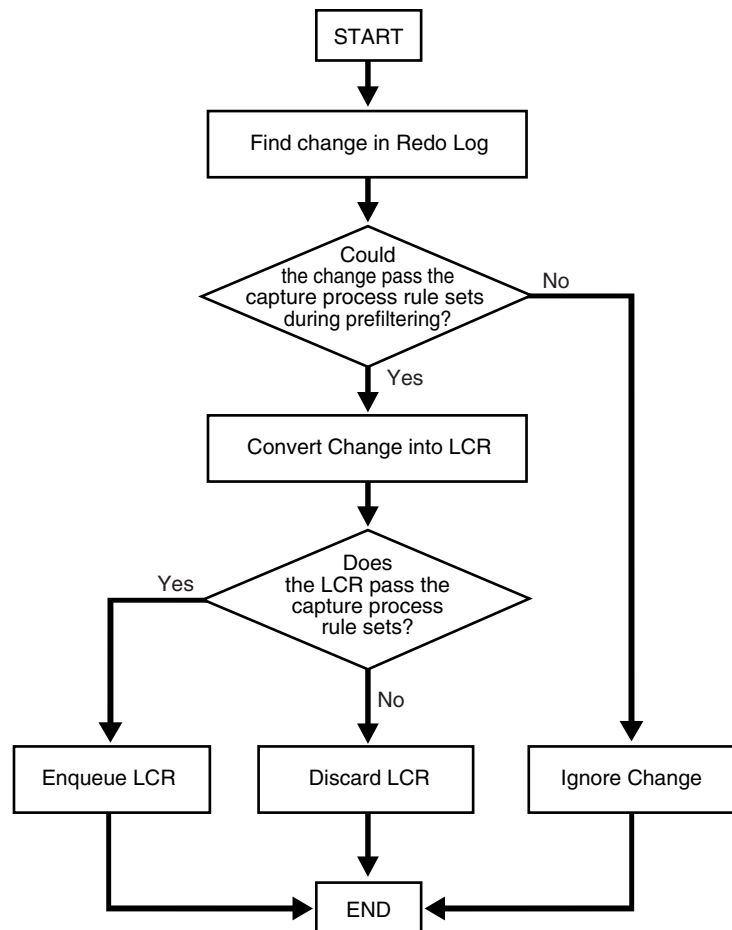
Figure 2–8 Flowchart Showing Capture Process Rule Evaluation

Persistent Capture Process Status Upon Database Restart

A capture process maintains a persistent status when the database running the capture process is shut down and restarted. For example, if a capture process is enabled when the database is shut down, then the capture process automatically starts when the database is restarted. Similarly, if a capture process is disabled or aborted when a database is shut down, then the capture process is not started and retains the disabled or aborted status when the database is restarted.

Implicit Capture with Synchronous Capture

This section explains the concepts related to [synchronous capture](#).

This section discusses the following topics:

- [Introduction to Synchronous Capture](#)
- [Synchronous Capture and Queues](#)
- [Synchronous Capture Rules](#)
- [Data Types Captured by Synchronous Capture](#)
- [Types of DML Changes Captured by Synchronous Capture](#)

- [Capture User for Synchronous Capture](#)
- [Multiple Synchronous Captures in a Single Database](#)

See Also:

- ["Configuring Synchronous Capture"](#) on page 10-23
- ["Managing a Synchronous Capture"](#) on page 14-11
- ["Monitoring a Synchronous Capture"](#) on page 23-15
- *Oracle Database 2 Day + Data Replication and Integration Guide* for an example that configures a replication environment that uses synchronous capture

Introduction to Synchronous Capture

Synchronous capture is an optional **Oracle Streams client** that captures data manipulation language (DML) changes made to tables. Synchronous capture uses an internal mechanism to capture DML changes to specified tables. When synchronous capture is configured to capture changes to tables, the database that contains these tables is called the **source database**.

When a DML change is made to a table, it can result in changes to one or more rows in the table. Synchronous capture captures each row change and converts it into a specific message format called a **row logical change record (row LCR)**. After capturing a row LCR, synchronous capture enqueues a message containing the row LCR into a **queue**. Row LCRs created by synchronous capture always contain values for all the columns in a row, even if some of the columns were not modified by the change.

Figure 2-9 shows a synchronous capture capturing LCRs.

Figure 2-9 Synchronous Capture

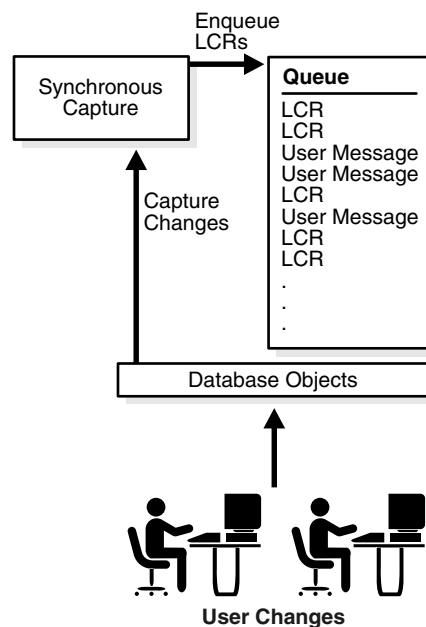

Note: A synchronous capture and a capture process should not capture changes made to the same table.

See Also:

- "Commit-Time Queues" on page 3-8
- "Configuring Synchronous Capture" on page 10-23
- "Managing a Synchronous Capture" on page 14-11

Synchronous Capture and Queues

Synchronous capture is always associated with a single ANYDATA queue, and it enqueues messages into this queue only. The queue used by synchronous capture must be a **commit-time queue**. Commit-time queues ensure that messages are grouped into transactions, and that transactions groups are in commit system change number (CSCN) order. Synchronous capture always enqueues row LCRs into the **persistent queue**. The persistent queue is the portion of a queue that only stores messages on hard disk in a queue table, not in memory. You can create multiple queues and associate a different synchronous capture with each queue.

Although synchronous capture must enqueue messages into a commit-time queue, messages captured by synchronous capture can be propagated to queues that are not commit-time queues. Therefore, any intermediate queues that store messages captured by synchronous capture do not need to be commit-time queue. Also, apply processes that apply messages captured by synchronous capture can use queues that are not commit-time queues.

Note:

- Synchronous capture can be associated only with an ANYDATA queue, not with a **typed queue**.
 - Synchronous capture should not enqueue messages that is used by a capture process.
-
-

Synchronous Capture Rules

Synchronous capture either captures or discards changes based on **rules** that you define. Each rule specifies the database objects and types of changes for which the rule evaluates to TRUE. You can place these rules in a **positive rule set**. If a rule evaluates to TRUE for a change, and the rule is in the positive rule set for synchronous capture, then synchronous capture captures the change. Synchronous capture does not use **negative rule sets**.

You can specify synchronous capture rules at the table level. A table rule captures or discards row changes resulting from DML changes to a particular table. Subset rules are table rules that include a subset of the row changes to a particular table. Synchronous capture does not use schema or global rules.

All synchronous capture rules must be created with one of the following procedures in the DBMS_STREAMS_ADM package:

- ADD_TABLE_RULES
- ADD_SUBSET_RULES

Synchronous capture does not capture changes based on the following types of rules:

- Rules added to the synchronous capture rules set by any procedure other than `ADD_TABLE_RULES` or `ADD_SUBSET_RULES` in the `DBMS_STREAMS_ADM` package.
- Rules created by the `DBMS_RULE_ADM` package.

If these types of rules are in a synchronous capture rule set, then synchronous capture ignores these rules.

A synchronous capture can use a rule set created by the `CREATE_RULE_SET` procedure in the `DBMS_RULE_ADM` package, but you must add rules to the rule set with the `ADD_TABLE_RULES` or `ADD_SUBSET_RULES` procedure.

If the specified synchronous capture does not exist when you run the `ADD_TABLE_RULES` or `ADD_SUBSET_RULES` procedure, then the procedure creates it automatically. You can also use the `CREATE_SYNC_CAPTURE` procedure in the `DBMS_CAPTURE_ADM` package to create a synchronous capture.

Note:

- Synchronous capture does not capture certain types of changes and changes to certain data types in table columns. Also, synchronous capture never captures changes in the `SYS`, `SYSTEM`, or `CTXSYS` schemas.
 - When a rule is in the rule set for a synchronous capture, do not change the following rule conditions: `:dml.get_object_name` and `:dml.get_object_owner`. Changing these conditions can cause the synchronous capture not to capture changes to the database object. You can change other conditions in synchronous capture rules.
-
-

See Also:

- [Chapter 5, "Rules"](#)
- [Chapter 6, "How Rules Are Used in Oracle Streams"](#)
- ["Configuring Synchronous Capture"](#) on page 10-23

Data Types Captured by Synchronous Capture

When capturing the row changes resulting from DML changes made to tables, synchronous capture can capture changes made to columns of the following data types:

- `VARCHAR2`
- `NVARCHAR2`
- `NUMBER`
- `FLOAT`
- `DATE`
- `BINARY_FLOAT`
- `BINARY_DOUBLE`
- `TIMESTAMP`

- `TIMESTAMP WITH TIME ZONE`
- `TIMESTAMP WITH LOCAL TIME ZONE`
- `INTERVAL YEAR TO MONTH`
- `INTERVAL DAY TO SECOND`
- `RAW`
- `CHAR`
- `NCHAR`
- `UROWID`

See Also:

- ["Unsupported Data Types for Synchronous Captures"](#) on page B-7
- ["Data Types Applied"](#) on page 4-13 for information about the data types that can be applied by an apply process
- *Oracle Database SQL Language Reference* for more information about data types

Types of DML Changes Captured by Synchronous Capture

When you specify that DML changes made to specific tables should be captured, synchronous capture captures the following types of DML changes made to these tables:

- `INSERT`
- `UPDATE`
- `DELETE`
- `MERGE`

Synchronous capture converts each `MERGE` change into an `INSERT` or `UPDATE` change. `MERGE` is not a valid command type in a row LCR.

See Also:

- ["Unsupported Changes for Synchronous Captures"](#) on page B-8
- [Chapter 4, "Oracle Streams Information Consumption"](#) for information about the types of changes an apply process can apply

Capture User for Synchronous Capture

Changes are captured in the security domain of the **capture user** for a synchronous capture. The capture user captures all changes that satisfy the synchronous capture **rule set**. In addition, the capture user runs all **custom rule-based transformations** specified by the rules in these rule sets. The capture user must have the necessary privileges to perform these actions, including `EXECUTE` privilege on the rule set used by synchronous capture, `EXECUTE` privilege on all custom rule-based transformation functions specified for rules in the rule set, and privileges to enqueue **messages** into the synchronous capture **queue**. A synchronous capture can be associated with only one user, but one user can be associated with many synchronous captures.

See Also: ["Configuring an Oracle Streams Administrator"](#) on page 9-1 for information about the required privileges

Multiple Synchronous Captures in a Single Database

Oracle recommends that each ANYDATA queue used by a [synchronous capture](#), [propagation](#), or [apply process](#) have messages from at most one synchronous capture from a particular [source database](#). Therefore, a separate [queue](#) should be used for each synchronous capture that captures changes originating at a particular source database, and each queue should have its own queue table. Also, messages from two or more synchronous captures in the same source database should not be propagated to the same [destination queue](#).

Explicit Capture by Applications

When applications enqueue messages manually, it is called [explicit capture](#). After enqueue, these messages can be propagated by Oracle Streams [propagations](#) within the same database or to a different database. These messages can also be consumed by applications, [apply processes](#), and [messaging clients](#). You can use either the DBMS_STREAMS_MESSAGING package or the DBMS_AQADM package to enqueue messages.

The following sections describe conceptual information about enqueueing messages:

- [Types of Messages That Can Be Enqueued Explicitly](#)
- [Enqueue Features](#)

See Also:

- *Oracle Streams Advanced Queuing User's Guide* contains the primary documentation about enqueueing messages
- [Chapter 13, "Configuring Oracle Streams Messaging Environments"](#) for an example that enqueues messages manually

Types of Messages That Can Be Enqueued Explicitly

Applications can create and enqueue different types of messages for various purposes in an Oracle Streams environment. These messages can be messages of a user-defined type called [user messages](#), or they can be [LCRs](#).

This section contains these topics:

- [User Messages](#)
- [Logical Change Records \(LCRs\)](#)

User Messages

An application can construct a message of a user-defined type and enqueue it. The queue can be a queue of the same type as the message, or it can be an [ANYDATA queue](#). Typically, these [user messages](#) are consumed by applications or [apply processes](#).

User messages enqueued into a [buffered queue](#) are called [buffered user messages](#). Buffered user messages can be dequeued by an application only. An application processes the messages after it dequeues them.

User messages enqueued into a [persistent queue](#) are called [persistent user messages](#). Persistent user messages can be dequeued by:

- **Messaging clients:** A messaging client passes the messages to the application that invoked the messaging client for processing.
- **Applications:** An application processes the messages after it dequeues them.
- **Apply processes:** An apply process passes the messages to a **message handler** for processing. The queue must be an ANYDATA queue for an apply process to dequeue messages from it.

Logical Change Records (LCRs)

An application can construct and enqueue LCRs into an ANYDATA queue. Row LCRs describe the results of DML changes, and DDL LCRs describe DDL changes. Typically, LCRs are consumed by apply processes, but they can also be consumed by messaging clients and applications. Heterogeneous replication environment can use explicit enqueue of LCRs to replicate database changes from a non-Oracle database to an Oracle database.

LCRs enqueued explicitly into a **buffered queue** are called **buffered LCRs**. Buffered LCRs can be dequeued only by applications. An application processes the buffered LCRs after it dequeues them.

LCRs enqueued explicitly into a **persistent queue** are called **persistent LCRs**. Persistent LCRs can be dequeued by:

- **Messaging clients:** A messaging client passes the messages to the application that invoked the messaging client for processing.
- **Applications:** An application processes the messages after it dequeues them.
- **Apply processes:** An apply process can apply the LCRs directly or pass them to an **apply handler** for processing.

See Also:

- ["Logical Change Records \(LCRs\)"](#) on page 2-3
- *Oracle Streams Replication Administrator's Guide* for more information about heterogeneous information sharing with Oracle Streams

Enqueue Features

The enqueue features available with Oracle Streams Advanced Queuing include the following:

- Enqueue into a buffered queue or a persistent queue
- Ordering of messages by priority enqueue time, or commit time
- Array enqueue of messages
- Correlation identifiers
- Message grouping
- Sender identification
- Time specification and scheduling

See Also:

- *Oracle Streams Advanced Queuing User's Guide* for information about these features and for information about other features available with Oracle Streams Advanced Queuing

Oracle Streams Staging and Propagation

The following topics contain conceptual information about staging **messages** in **queues** and propagating messages from one queue to another:

- [Introduction to Message Staging and Propagation](#)
- [Queues](#)
- [Message Propagation Between Queues](#)
- [Combined Capture and Apply Optimization](#)

See Also:

- [Chapter 15, "Managing Staging and Propagation"](#)
- ["Monitoring Queues and Messaging"](#) on page 24-1
- ["Monitoring Oracle Streams Propagations and Propagation Jobs"](#) on page 24-13
- ["Troubleshooting Propagation Problems"](#) on page 20-11

Introduction to Message Staging and Propagation

Oracle Streams uses **queues** to stage **messages**. Staged messages can be consumed or propagated, or both. Staged messages can be consumed by an **apply process**, a **messaging client**, or a user application. A running apply process implicitly dequeues messages, but messaging clients and user applications explicitly dequeue messages. Even after a message is consumed, it can remain in the queue if you also have configured an Oracle Streams **propagation** to propagate, or send, the message to one or more other queues or if message retention is specified for the queue. Message retention applies to messages captured by a **synchronous capture** or enqueued explicitly, but it does not apply to messages captured by a **capture process**.

Queues

A queue is an abstract storage unit used by a messaging system to store messages. This section includes the following topics:

- [ANYDATA Queues and Typed Queues](#)
- [Persistent Queues and Buffered Queues](#)
- [Secure Queues](#)
- [Commit-Time Queues](#)

See Also:

- [Managing Queues](#)
- ["Queue Restrictions"](#) on page B-11

ANYDATA Queues and Typed Queues

A queue of ANYDATA type can stage messages of almost any type and is called an **ANYDATA queue**. A **typed queue** can stage messages of a specific type. **Oracle Streams clients** always use ANYDATA queues.

In an Oracle Streams replication environment, logical change records (LCRs) must be staged in ANYDATA queues. In an Oracle Streams messaging environment, both ANYDATA queues and **typed queues** can stage messages. Publishing applications can enqueue messages into a single queue, and subscribing applications can dequeue these messages.

Two types of messages can be encapsulated into an ANYDATA object and staged in an ANYDATA queue: **LCRs** and **user messages**. An LCR is an object that contains information about a change to a database object. A user message is a message of a user-defined type created by users or applications. Both types of messages can be used for information sharing within a single database or between databases.

ANYDATA queues can stage **user messages** whose payloads are of ANYDATA type. An ANYDATA payload can be a wrapper for payloads of different data types.

By using ANYDATA wrappers for **message** payloads, publishing applications can enqueue messages of different types into a single queue, and subscribing applications can dequeue these messages, either explicitly using a **messaging client** or an application, or implicitly using an **apply process**. If the subscribing application is remote, then the messages can be propagated to the remote site, and the subscribing application can dequeue the messages from a local queue in the remote database. Alternatively, a remote subscribing application can dequeue messages directly from the source queue using a variety of standard protocols, such as PL/SQL and OCI.

You can wrap almost any type of payload in an ANYDATA payload. To do this, you use the `Convert`*data_type* static functions of the ANYDATA type, where *data_type* is the type of object to wrap. These functions take the object as input and return an ANYDATA object.

Oracle Streams includes the features of Oracle Streams Advanced Queuing (AQ), which supports all the standard features of message queuing systems, including multiconsumer queues, publish and subscribe, content-based routing, internet propagation, transformations, and gateways to other messaging subsystems.

See Also:

- [Chapter 13, "Configuring Oracle Streams Messaging Environments"](#)
- ["Wrapping User Message Payloads in an ANYDATA Wrapper and Enqueuing Them"](#) on page 13-2
- ["Queue Restrictions"](#) on page B-11
- *Oracle Streams Advanced Queuing User's Guide* for more information relating to ANYDATA queues, such as wrapping payloads in an ANYDATA wrapper, programmatic environments for enqueueing messages into and dequeueing messages from an ANYDATA queue, propagation, and user-defined types
- *Oracle Database PL/SQL Packages and Types Reference* for more information about the ANYDATA type

Persistent Queues and Buffered Queues

Oracle Streams supports the following **message** modes:

- **Persistent messaging:** Messages are always stored on disk in a database table called a **queue table**. This type of storage is sometimes called **persistent queue** storage.
- **Buffered messaging:** Messages are stored in memory but can spill to a queue table under certain conditions. This type of storage is sometimes called **buffered queue** storage. The memory includes **Oracle Streams pool** memory that is associated with a queue that contains messages that were captured by a **capture process** or enqueued by applications.

Buffered queues enable Oracle to optimize messages by buffering them in the System Global Area (SGA) instead of always storing them in a queue table. Buffered messaging provides better performance, but it does not support some messaging features, such as message retention. Message retention lets you specify the amount of time a message is retained in the queue table after being dequeued.

If the size of the Oracle Streams pool is not managed automatically, then you should increase the size of the Oracle Streams pool by 10 MB for each buffered queue in a database. Buffered queues improve performance, but some of the information in a buffered queue can be lost if the instance containing the buffered queue shuts down normally or abnormally. Oracle Streams automatically recovers from these cases, assuming full database recovery is performed on the instance.

Messages in a buffered queue can spill from memory into the queue table if they have been staged in the buffered queue for a period of time without being dequeued, or if there is not enough space in memory to hold all of the messages. Messages that spill from memory are stored in the appropriate AQ\$_queue_table_name_p table, where *queue_table_name* is the name of the queue table for the queue. Also, for each spilled message, information is stored in the AQ\$_queue_table_name_d table about any **propagations** and **apply processes** that are eligible for processing the message.

LCRs that were captured by a capture process are always stored in a buffered queue, but LCRs that were captured by a synchronous capture are always stored in a persistent queue. Other types of messages might or might not be stored in a buffered queue. When an application enqueues a message, the enqueue operation specifies whether the enqueued message is stored in the buffered queue or in the persistent queue. The *delivery_mode* attribute in the *enqueue_options* parameter of the `DBMS_AQ.ENQUEUE` procedure determines whether a message is stored in the

buffered queue or the persistent queue. Specifically, if the `delivery_mode` attribute is the default `PERSISTENT`, then the message is enqueued into the persistent queue. If it is set to `BUFFERED`, then the message is enqueued as the buffered queue. When a transaction is moved to the error queue, all messages in the transaction always are stored in a queue table, not in a buffered queue.

Note: Although buffered and persistent messages can be stored in the same queue, it is sometimes more convenient to think of a queue having a buffered portion and a persistent portion, referred to here as "buffered queue" and "persistent queue." Also, both `ANYDATA` queues and typed queues can include both a buffered queue and a persistent queue.

See Also:

- ["Creating an ANYDATA Queue"](#) on page 11-1
- ["Configuring the Oracle Streams Pool"](#) on page 9-9
- *Oracle Streams Advanced Queuing User's Guide* for detailed conceptual information about buffered messaging and for information about using buffered messaging

Queues and Oracle Streams Clients

Oracle Streams clients always use `ANYDATA` queues. The following sections discuss how queues interact with **Oracle Streams clients**:

- [Queues and Capture Processes](#)
- [Queues and Synchronous Capture](#)
- [Queues and Propagations](#)
- [Queues and Apply Processes](#)
- [Queues and Messaging Clients](#)

See Also:

- ["Persistent Queues and Buffered Queues"](#) on page 3-3
- *Oracle Streams Advanced Queuing User's Guide* for detailed conceptual information about buffered messaging and for information about using buffered messaging

Queues and Capture Processes A capture processes can only enqueue LCRs into a **buffered queue**. LCRs enqueued into a buffered queue by a **capture process** can be dequeued only by an **apply process**. Captured LCRs cannot be dequeued by applications or users.

Queues and Synchronous Capture A synchronous capture can only enqueue LCRs into a **persistent queue**. LCRs captured by synchronous capture can be dequeued by apply processes, messaging clients, applications, and users.

Queues and Propagations A **propagation** propagates any messages in its **source queue** that satisfy its **rule sets**. These messages can be stored in a buffered queue or in a persistent queue. A propagation can propagate both types of messages if the messages satisfy the rule sets used by the propagation.

Queues and Apply Processes A single apply process can either dequeue messages from a buffered queue or a persistent queue, but not both. Apply processes can dequeue and process **captured LCRs** in a buffered queue. To dequeue captured LCRs, the **apply process** must be configured with the `apply_captured` parameter set to TRUE. Apply processes cannot dequeue **buffered LCRs** or **buffered user messages**. To dequeue **persistent LCRs** or **persistent user messages**, the apply process must be configured with the `apply_captured` parameter set to FALSE.

Queues and Messaging Clients A **messaging clients** can only dequeue messages from a persistent queue. In addition, the `DBMS_STREAMS_MESSAGING` package cannot be used to enqueue messages into or dequeue messages from a buffered queue.

Note: The `DBMS_AQ` and `DBMS_AQADM` packages support buffered messaging.

See Also: *Oracle Streams Advanced Queuing User's Guide* for more information about using the `DBMS_AQ` and `DBMS_AQADM` packages

Secure Queues

Secure queues are **queues** for which Oracle Streams Advanced Queuing (AQ) agents must be associated explicitly with one or more database users who can perform queue operations, such as enqueue and dequeue. The owner of a secure queue can perform all queue operations on the queue, but other users cannot perform queue operations on a secure queue, unless they are configured as **secure queue users**. In Oracle Streams, secure queues can be used to ensure that only the appropriate users and **Oracle Streams clients** enqueue **messages** and dequeue messages.

Secure Queues and the SET_UP_QUEUE Procedure

All ANYDATA queues created using the `SET_UP_QUEUE` procedure in the `DBMS_STREAMS_ADM` package are secure queues. When you use the `SET_UP_QUEUE` procedure to create a queue, any user specified by the `queue_user` parameter is configured as a secure queue user of the queue automatically, if possible. The queue user is also granted `ENQUEUE` and `DEQUEUE` privileges on the queue. To enqueue messages and dequeue messages, a queue user must also have `EXECUTE` privilege on the `DBMS_STREAMS_MESSAGING` package or the `DBMS_AQ` package. The `SET_UP_QUEUE` procedure does not grant either of these privileges. Also, a message cannot be enqueued unless a subscriber who can dequeue the message is configured.

To configure a queue user as a secure queue user, the `SET_UP_QUEUE` procedure creates an Oracle Streams AQ agent with the same name as the user name, if one does not already exist. The user must use this agent to perform queue operations on the queue. If an agent with this name already exists and is associated with the queue user only, then the existing agent is used. `SET_UP_QUEUE` then runs the `ENABLE_DB_ACCESS` procedure in the `DBMS_AQADM` package, specifying the agent and the user.

If you use the `SET_UP_QUEUE` procedure in the `DBMS_STREAMS_ADM` package to create a secure queue, and you want a user who is not the queue owner and who was not specified by the `queue_user` parameter to perform operations on the queue, then you can configure the user as a secure queue user of the queue manually. Alternatively, you can run the `SET_UP_QUEUE` procedure again and specify a different `queue_user` for the queue. In this case, `SET_UP_QUEUE` skips queue creation, but it configures the user specified by `queue_user` as a secure queue user of the queue.

If you create an ANYDATA queue using the DBMS_AQADM package, then you use the `secure` parameter when you run the `CREATE_QUEUE_TABLE` procedure to specify whether the queue is secure or not. The queue is secure if you specify `TRUE` for the `secure` parameter when you run this procedure. When you use the DBMS_AQADM package to create a secure queue, and you want to allow users to perform queue operations on the secure queue, you must configure these secure queue users manually.

Secure Queues and Oracle Streams Clients

When you create a **capture process** or an **apply process**, an Oracle Streams AQ agent of the secure queue associated with the Oracle Streams process is configured automatically, and the user who runs the Oracle Streams process is specified as a secure queue user for this queue automatically. Therefore, a capture process is configured to enqueue into its secure queue automatically, and an apply process is configured to dequeue from its secure queue automatically. In either case, the Oracle Streams AQ agent has the same name as the Oracle Streams client.

For a capture process, the user specified as the `capture_user` is the user who runs the capture process. For an apply process, the user specified as the `apply_user` is the user who runs the apply process. If no `capture_user` or `apply_user` is specified, then the user who invokes the procedure that creates the Oracle Streams process is the user who runs the Oracle Streams process.

When you create a **synchronous capture**, an Oracle Streams AQ agent of the secure queue with the same name as the synchronous capture is associated with the user specified as the `capture_user`. If no `capture_user` is specified, then the user who invokes the procedure that creates the synchronous capture is the `capture_user`. The `capture_user` is specified as a secure queue user for this queue automatically. Therefore, the synchronous capture can enqueue into its secure queue automatically.

If you change the `capture_user` for a capture process or synchronous capture or the `apply_user` for an apply process, then the specified `capture_user` or `apply_user` is configured as a secure queue user of the queue used by the Oracle Streams client. However, the old **capture user** or **apply user** remains configured as a secure queue user of the queue. To remove the old user, run the `DISABLE_DB_ACCESS` procedure in the DBMS_AQADM package, specifying the old user and the relevant Oracle Streams AQ agent. You might also want to drop the agent if it is no longer needed. You can view the Oracle Streams AQ agents and their associated users by querying the `DBA_AQ_AGENT_PRIVS` data dictionary view.

When you create a **messaging client**, an Oracle Streams AQ agent of the secure queue with the same name as the messaging client is associated with the user who runs the procedure that creates the messaging client. This messaging client user is specified as a secure queue user for this queue automatically. Therefore, this user can use the messaging client to dequeue messages from the queue.

A capture process, a synchronous capture, an apply process, or a messaging client can be associated with only one user. However, one user can be associated with multiple Oracle Streams clients, including multiple capture processes, synchronous captures, apply processes, and messaging clients. For example, an apply process cannot have both `hr` and `oe` as apply users, but `hr` can be the apply user for multiple apply processes.

If you drop a capture process, synchronous capture, apply process, or messaging client, then the users who were configured as secure queue users for these Oracle Streams clients remain secure queue users of the queue. To remove these users as secure queue users, run the `DISABLE_DB_ACCESS` procedure in the DBMS_AQADM package for each user. You might also want to drop the agent if it is no longer needed.

Note: No configuration is necessary for **propagations** and secure queues. Therefore, when a propagation is dropped, no additional steps are necessary to remove secure queue users from the propagation's queues.

See Also:

- ["Enabling a User to Perform Operations on a Secure Queue"](#) on page 15-1
- ["Disabling a User from Performing Operations on a Secure Queue"](#) on page 15-3
- *Oracle Database PL/SQL Packages and Types Reference* for more information about Oracle Streams AQ agents and using the DBMS_AQADM package

Transactional and Nontransactional Queues

A **transactional queue** is a **queue** in which **messages** can be grouped into a set that are applied as one transaction. That is, an **apply process** performs a COMMIT after it applies all the messages in a group. A **nontransactional queue** is one in which each message is its own transaction. That is, an apply process performs a COMMIT after each message it applies. In either case, the messages can be **LCRs** or **user messages**.

The SET_UP_QUEUE procedure in the DBMS_STREAMS_ADM package always creates a transactional queue. The difference between transactional and nontransactional queues is important only for messages that were enqueued by an application, a **synchronous capture**, or an apply process. An apply process always applies **captured LCRs** in transactions that preserve the transactions executed at the **source database**.

Table 3–1 shows apply process behavior for each type of message and each type of queue.

Table 3–1 Apply Process Behavior for Transactional and Nontransactional Queues

Message Type	Transactional Queue	Nontransactional Queue
Captured LCRs	Apply process preserves the original transaction.	Apply process preserves the original transaction.
Persistent LCRs or Persistent User Messages	Apply process applies a user-specified group of messages as one transaction.	Apply process applies each message in its own transaction.

When it is important to preserve the transactions executed at the source database, use transactional queues to store the messages. Ensure that LCRs captured by synchronous captures are stored in transactional queues.

See Also:

- ["Managing Queues"](#) on page 15-1
- *Oracle Streams Advanced Queuing User's Guide* for more information about message grouping

Commit-Time Queues

You can control the order in which **messages** in a **persistent queue** are browsed or dequeued. Message ordering in a queue is determined by its **queue table**, and you can specify message ordering for a queue table during queue table creation. Specifically, the `sort_list` parameter in the `DBMS_AQADM.CREATE_QUEUE_TABLE` procedure determines how messages are ordered. Each message in a **commit-time queue** is ordered by an **approximate commit system change number (approximate CSCN)**, which is obtained when the transaction that enqueued each message commits.

Commit-time ordering is specified for a queue table, and queues that use the queue table are called commit-time queues. When `commit_time` is specified for the `sort_list` parameter in the `DBMS_AQADM.CREATE_QUEUE_TABLE` procedure, the resulting queue table uses commit-time ordering.

For Oracle Database 10g Release 2 and later, the default `sort_list` setting for queue tables created by the `SET_UP_QUEUE` procedure in the `DBMS_STREAMS_ADM` package is `commit_time`. For releases prior to Oracle Database 10g Release 2, the default is `enq_time`, which is described in the section that follows. When the `queue_table` parameter in the `SET_UP_QUEUE` procedure specifies an existing queue table, message ordering in the queue created by `SET_UP_QUEUE` is determined by the existing queue table.

Note: A **synchronous capture** always enqueues into a commit-time queue to ensure that transactions are ordered properly.

When to Use Commit-Time Queues

A user or application can share information by enqueueing messages into a **queue** in an Oracle database. The enqueued messages can be shared within a single database or propagated to other databases, and the messages can be **LCRs** or **user messages**. For example, messages can be enqueued when an application-specific message occurs or when a trigger is fired for a database change. Also, in a heterogeneous environment, an application can enqueue at an Oracle database messages that originated at a non-Oracle database.

Other than `commit_time`, the settings for the `sort_list` parameter in the `CREATE_QUEUE_TABLE` procedure are `priority` and `enq_time`. The `priority` setting orders messages by the priority specified during enqueue, highest priority to lowest priority. The `enq_time` setting orders messages by the time when they were enqueued, oldest to newest.

Commit-time queues are useful when an environment must support either of the following requirements for concurrent enqueues of **messages**:

- **Transactional Dependency Ordering During Dequeue**
- **Consistent Browse of Messages in a Queue**

Commit-time queues support these requirements. Neither `priority` nor `enq_time` ordering supports these requirements because both allow transactional dependency violations and nonconsistent browses. Both settings allow transactional dependency violations, because messages are dequeued independent of the original dependencies. Also, both settings allow nonconsistent browses of the messages in a queue, because multiple browses performed without any dequeue operations between them can result in different sets of messages.

See Also:

- ["Introduction to Message Staging and Propagation"](#) on page 3-1
- ["Message Propagation Between Queues"](#) on page 3-11
- *Oracle Streams Replication Administrator's Guide* for more information about **heterogeneous information sharing**

Transactional Dependency Ordering During Dequeue A transactional dependency occurs when one database transaction requires that another database transaction commits before it can commit successfully. Messages that contain information about database transactions can be enqueued. For example, a database trigger can fire to enqueue messages. [Figure 3-1](#) shows how enqueue time ordering does not support transactional dependency ordering during dequeue of such messages.

Figure 3-1 Transactional Dependency Violation During Dequeue

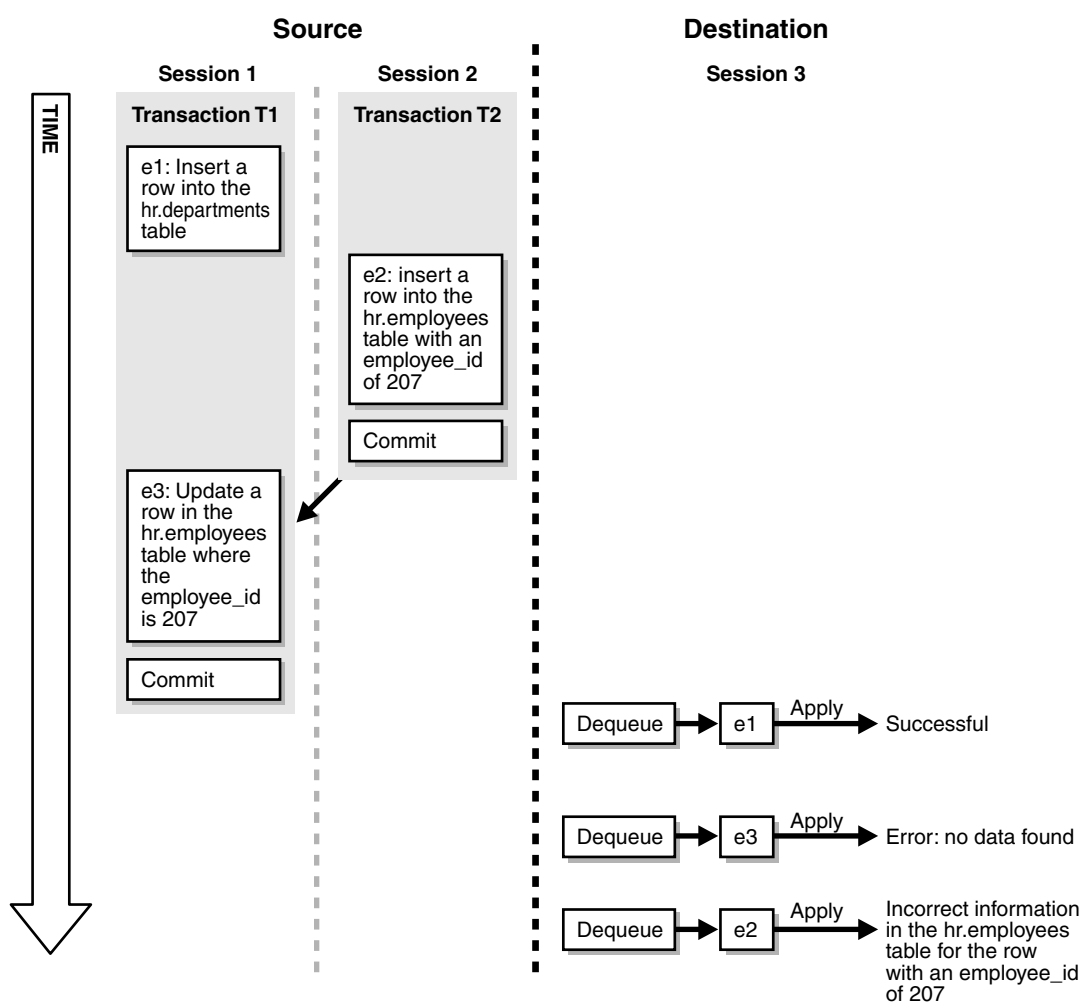

[Figure 3-1](#) shows how transactional dependency ordering can be violated with enqueue time ordering. The transaction that enqueued message e2 was committed before the transaction that enqueued messages e1 and e3 was committed, and the update in message e3 depends on the insert in message e2. So, the correct dequeue order that supports transactional dependencies is e2, e1, e3. However, with enqueue time ordering, e3 can be dequeued before e2. Therefore, when e3 is dequeued, an

error results when an application attempts to apply the change in e3 to the `hr.employees` table. Also, after all three messages are dequeued, a row in the `hr.employees` table contains the wrong information because the change in e3 was not executed.

Consistent Browse of Messages in a Queue Figure 3–2 shows how enqueue time ordering does not support consistent browse of messages in a queue.

Figure 3–2 Inconsistent Browse of Messages in a Queue

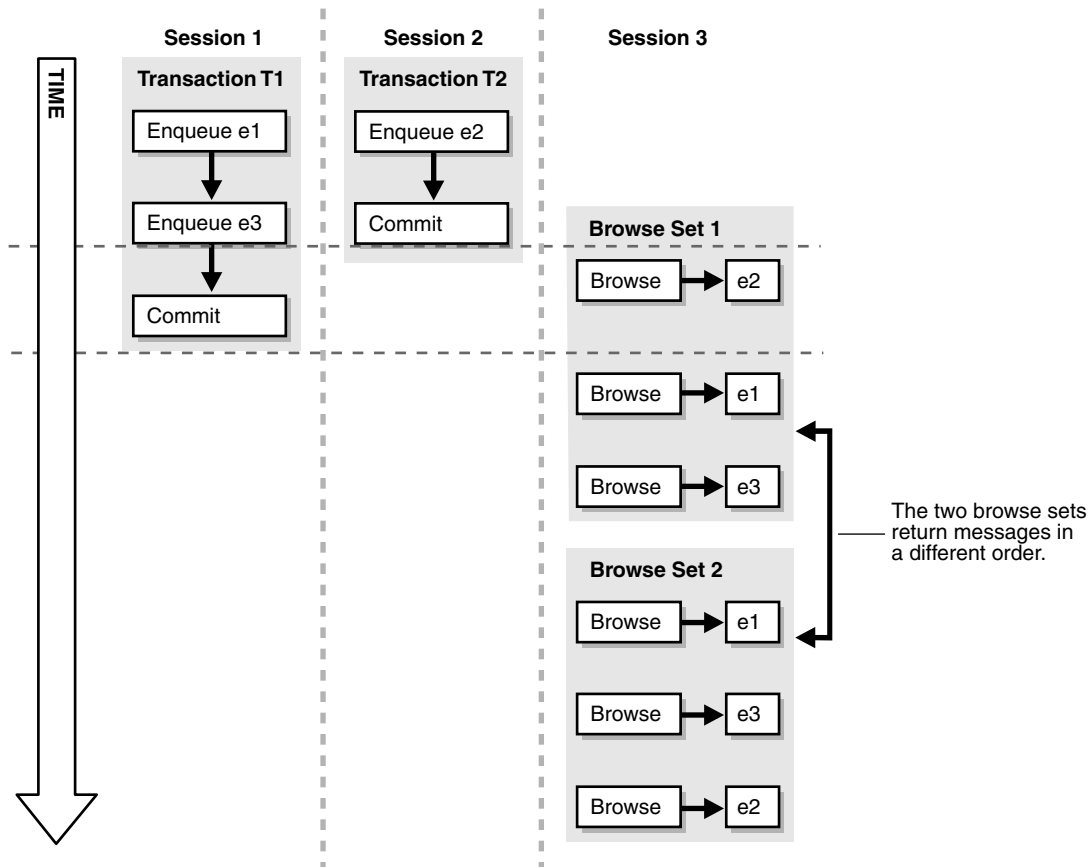

Figure 3–2 shows that a client browsing messages in a queue is not guaranteed a definite order with enqueue time ordering. Sessions 1 and 2 are concurrent sessions that are enqueueing messages. Session 3 shows two sets of client browses that return the three enqueued messages in different orders. If the client requires deterministic ordering of messages, then the client might fail. For example, the client might perform a browse to initiate a program state, and a subsequent dequeue might return messages in a different order than expected.

How Commit-Time Queues Work

The commit system change number (CSCN) for a message that is enqueued into a **queue** is not known until the redo record for the commit of the transaction that includes the message is written to the redo log. The CSCN cannot be recorded when the message is enqueued. Commit-time queues use the current SCN of the database when a transaction is committed as the approximate CSCN for all of the messages in the transaction. The order of messages in a commit-time queue is based on the approximate CSCN of the transaction that enqueued the messages.

In a commit-time queue, messages in a transaction are not visible to dequeue and browse operations until a deterministic order for the messages can be established using the approximate CSCN. When multiple transactions are enqueueing messages concurrently into the same commit-time queue, two or more transactions can commit at nearly the same time, and the commit intervals for these transactions can overlap. In this case, the messages in these transactions are not visible until all of the transactions have committed. At that time, the order of the messages can be determined using the approximate CSCN of each transaction. Dependencies are maintained by using the approximate CSCN for messages rather than the enqueue time. Read consistency for browses is maintained by ensuring that only messages with a fully determined order are visible.

A commit-time queue always maintains transactional dependency ordering for messages that are based on database transactions. However, applications and users can enqueue messages that are not based on database transactions. For these messages, if dependencies exist between transactions, then the application or user must ensure that transactions are committed in the correct order and that the commit intervals of the dependent transactions do not overlap.

The approximate CSCNs of transactions recorded by a commit-time queue might not reflect the actual commit order of these transactions. For example, transaction 1 and transaction 2 can commit at nearly the same time after enqueueing their messages. The approximate CSCN for transaction 1 can be lower than the approximate CSCN for transaction 2, but transaction 1 can take more time to complete the commit than transaction 2. In this case, the actual CSCN for transaction 2 is lower than the actual CSCN for transaction 1.

Note: The `sort_list` parameter in `CREATE_QUEUE_TABLE` can be set to the following:

```
priority, commit_time
```

In this case, ordering is done by priority first and commit time second. Therefore, this setting does not ensure transactional dependency ordering and browse read consistency for messages with different priorities. However, transactional dependency ordering and browse read consistency are ensured for messages with the same priority.

See Also: ["Creating an ANYDATA Queue"](#) on page 11-1 for information about creating a commit-time queue

Message Propagation Between Queues

You can use Oracle Streams to configure **message** propagation between two **queues**. These queues can reside in the same database or in different databases. Oracle Streams uses Oracle Scheduler jobs to propagate messages.

A **propagation** is always between a **source queue** and a **destination queue**. Although propagation is always between two queues, a single queue can participate in many propagations. That is, a single source queue can propagate messages to multiple destination queues, and a single destination queue can receive messages from multiple source queues. Also, a single queue can be a destination queue for some propagations and a source queue for other propagations. However, only one propagation is allowed between a particular source queue and a particular destination queue.

[Figure 3–3](#) shows propagation from a source queue to a destination queue.

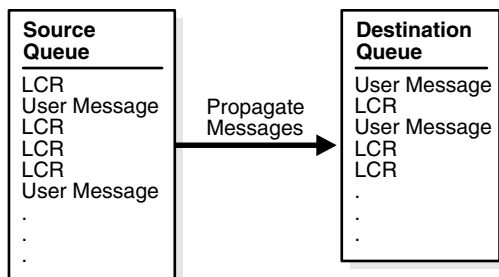
Figure 3–3 Propagation from a Source Queue to a Destination Queue

You can create, alter, and drop a propagation, and you can define propagation **rules** that control which messages are propagated. The user who owns the source queue is the user who propagates messages, and this user must have the necessary privileges to propagate messages. These privileges include the following:

- EXECUTE privilege on the **rule sets** used by the propagation
- EXECUTE privilege on all **custom rule-based transformation** functions used in the rule sets
- Enqueue privilege on the destination queue if the destination queue is in the same database

If the propagation propagates messages to a destination queue in a remote database, then the owner of the source queue must be able to use the database link used by the propagation, and the user to which the database link connects at the remote database must have enqueue privilege on the destination queue.

A propagation can propagate all of the messages in a source queue to a destination queue, or a propagation can propagate only a subset of the messages. A single propagation can propagate messages in both the **buffered queue** portion and **persistent queue** portion of a queue. Also, a single propagation can propagate **LCRs** and **user messages**. You can use **rules** to control which messages in the source queue are propagated to the destination queue and which messages are discarded.

Depending on how you set up your Oracle Streams environment, changes could be sent back to the site where they originated. You must ensure that your environment is configured to avoid cycling a change in an endless loop. You can use Oracle Streams **tags** to avoid such a **change cycling** loop.

The following sections describe propagations in more detail:

- [Propagation Rules](#)
- [Queue-to-Queue Propagations](#)
- [Ensured Message Delivery](#)
- [Directed Networks](#)
- [Binary File Propagation](#)
- [Propagation Jobs](#)
- [Oracle Streams Data Dictionary for Propagations](#)

See Also:

- ["Managing Oracle Streams Propagations and Propagation Jobs"](#) on page 15-4
- *Oracle Streams Advanced Queuing User's Guide* for detailed information about the propagation infrastructure in Oracle Streams AQ
- *Oracle Streams Replication Administrator's Guide* for more information about Oracle Streams tags

Propagation Rules

A **propagation** either propagates or discards **messages** based on **rules** that you define. For **LCRs**, each rule specifies the database objects and types of changes for which the rule evaluates to `TRUE`. For **user messages**, you can create rules to control propagation behavior for specific types of messages. You can place these rules in a **positive rule set** or a **negative rule set** used by the propagation.

If a rule evaluates to `TRUE` for a message, and the rule is in the positive rule set for a propagation, then the propagation propagates the change. If a rule evaluates to `TRUE` for a message, and the rule is in the negative rule set for a propagation, then the propagation discards the change. If a propagation has both a positive and a negative rule set, then the negative rule set is always evaluated first.

You can specify propagation rules for LCRs at the following levels:

- A table rule propagates or discards either row changes resulting from DML changes or DDL changes to a particular table. Subset rules are table rules that include a subset of the row changes to a particular table.
- A schema rule propagates or discards either row changes resulting from DML changes or DDL changes to the database objects in a particular schema.
- A global rule propagates or discards either all row changes resulting from DML changes or all DDL changes in the source **queue**.

A queue subscriber that specifies a condition causes the system to generate a rule. The rule sets for all subscribers to a queue are combined into a single system-generated rule set to make subscription more efficient.

See Also:

- [Chapter 5, "Rules"](#)
- [Chapter 6, "How Rules Are Used in Oracle Streams"](#)
- [Chapter 17, "Managing Rules"](#)

Queue-to-Queue Propagations

A **propagation** can be queue-to-queue or queue-to-database link (queue-to-dblink). A queue-to-queue propagation always has its own exclusive **propagation job** to propagate **messages** from the **source queue** to the **destination queue**. Because each propagation job has its own **propagation schedule**, the propagation schedule of each queue-to-queue propagation can be managed separately. Even when multiple queue-to-queue propagations use the same database link, you can enable, disable, or set the propagation schedule for each queue-to-queue propagation separately. Propagation jobs are described in detail later in this chapter.

A single database link can be used by multiple queue-to-queue propagations. The database link must be created with the service name specified as the global name of the database that contains the destination queue.

In contrast, a queue-to-dblink propagation shares a propagation job with other queue-to-dblink propagations from the same source queue that use the same database link. Therefore, these propagations share the same propagation schedule, and any change to the propagation schedule affects all of the queue-to-dblink propagations from the same source queue that use the database link.

See Also:

- ["Queues and Oracle Real Application Clusters"](#) on page A-3
- ["Propagation Jobs"](#) on page 3-17
- [Chapter 15, "Managing Staging and Propagation"](#)

Ensured Message Delivery

A **captured LCR** is propagated successfully to a destination queue when both of the following actions are completed:

- The **message** is processed by all relevant **apply processes** associated with the destination queue.
- The message is propagated successfully from the destination queue to all of its relevant destination queues.

Any other type of message is propagated successfully to a **destination queue** when the enqueue into the destination queue is committed. Other types of messages include **buffered LCRs**, **buffered user messages**, **persistent LCRs**, and **buffered user messages**.

When a message is successfully propagated between two queues, the destination queue acknowledges successful propagation of the message. If the **source queue** is configured to propagate a message to multiple destination queues, then the message remains in the source queue until each destination queue has sent confirmation of message propagation to the source queue. When each destination queue acknowledges successful propagation of the message, and all local consumers in the source queue database have consumed the message, the source queue can drop the message.

This confirmation system ensures that messages are always propagated from the source queue to the destination queue, but, in some configurations, the source queue can become larger than an optimal size. When a source queue increases, it uses more System Global Area (SGA) memory and might use more disk space.

There are two common reasons for a source queue to become larger:

- If a message cannot be propagated to a specified destination queue for some reason (such as a network problem), then the message remains in the source queue until the destination queue becomes available. This situation could cause the source queue to become large. So, you should monitor your queues regularly to detect problems early.
- Suppose a source queue is propagating messages captured by a **capture process** or **synchronous capture** to multiple destination queues, and one or more **destination databases** acknowledge successful propagation of messages much more slowly than the other queues. In this case, the source queue can grow because the slower destination databases create a backlog of messages that have already been acknowledged by the faster destination databases. In such an environment,

consider creating more than one capture process or synchronous capture to capture changes at the **source database**. Doing so lets you use one source queue for the slower destination databases and another source queue for the faster destination databases.

See Also:

- [Chapter 2, "Oracle Streams Information Capture"](#)
- ["Monitoring Queues and Messaging"](#) on page 24-1

Directed Networks

A **directed network** is one in which propagated **messages** pass through one or more intermediate databases before arriving at a **destination database**. A message might or might not be processed by an **apply process** at an intermediate database. Using Oracle Streams, you can choose which messages are propagated to each destination database, and you can specify the route that messages will traverse on their way to a destination database. [Figure 3-4](#) shows an example of a directed networks environment.

Figure 3-4 Example Directed Networks Environment

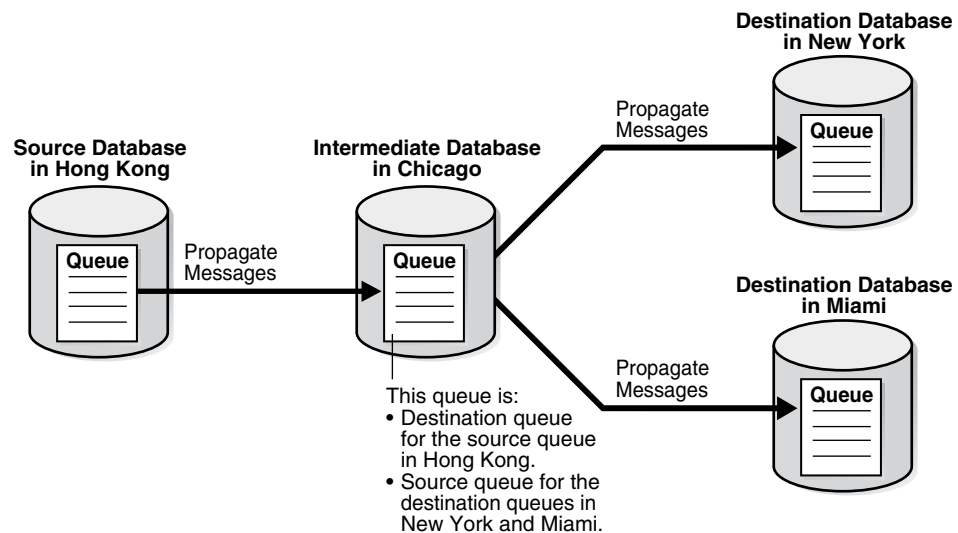

The advantage of using a directed network is that a **source database** does not need to have a physical network connection with a destination database. So, if you want messages to propagate from one database to another, but there is no direct network connection between the computers running these databases, then you can still propagate the messages without reconfiguring your network, as long as one or more intermediate databases connect the source database to the destination database.

If you use directed networks, and an intermediate site goes down for an extended period of time or is removed, then you might need to reconfigure the network and the Oracle Streams environment.

Queue Forwarding and Apply Forwarding

An intermediate database in a directed network can propagate messages using either queue forwarding or apply forwarding. **Queue forwarding** means that the messages being forwarded at an intermediate database are the messages received by the

intermediate database. The source database for a message is the database where the message originated.

Apply forwarding means that the messages being forwarded at an intermediate database are first processed by an apply process. These messages are then recaptured by a **capture process** or a **synchronous capture** at the intermediate database and forwarded. When you use apply forwarding, the intermediate database becomes the new source database for the messages. Either a capture process recaptures the messages from the redo log generated at the intermediate database, or a synchronous capture configured at the intermediate database recaptures the messages.

Consider the following differences between queue forwarding and apply forwarding when you plan your Oracle Streams environment:

- With queue forwarding, a message is propagated through the directed network without being changed, assuming there are no capture or propagation transformations. With apply forwarding, messages are applied and recaptured at intermediate databases and can be changed by **conflict resolution, apply handlers**, or apply transformations.
- With queue forwarding, a destination database must have a separate apply process to apply messages from each source database. With apply forwarding, fewer apply processes might be required at a destination database because recapturing of messages at intermediate databases can result in fewer source databases when changes reach a destination database.
- With queue forwarding, one or more intermediate databases are in place between a source database and a destination database. With apply forwarding, because messages are recaptured at intermediate databases, the source database for a message can be the same as the intermediate database connected directly with the destination database.

A single Oracle Streams environment can use a combination of queue forwarding and apply forwarding.

Advantages of Queue Forwarding Queue forwarding has the following advantages compared with apply forwarding:

- Performance might be improved because a message is captured only once.
- Less time might be required to propagate a message from the database where the message originated to the destination database, because the messages are not applied and recaptured at one or more intermediate databases. In other words, latency might be lower with queue forwarding.
- The origin of a message can be determined easily by running the `GET_SOURCE_DATABASE_NAME` member procedure on the LCR contained in the message. If you use apply forwarding, then determining the origin of a message requires the use of Oracle Streams **tags** and apply handlers.
- Parallel apply might scale better and provide more throughput when separate apply processes are used because there are fewer dependencies, and because there are multiple apply coordinators and apply reader processes to perform the work.
- If one intermediate database goes down, then you can reroute the queues and reset the **start SCN** at the capture site to reconfigure end-to-end capture, propagation, and apply.

If you use apply forwarding, then substantially more work might be required to reconfigure end-to-end capture, propagation, and apply of messages, because the destination database(s) downstream from the unavailable intermediate database

were using the SCN information of this intermediate database. Without this SCN information, the destination databases cannot apply the changes properly.

Advantages of Apply Forwarding Apply forwarding has the following advantages compared with queue forwarding:

- An Oracle Streams environment might be easier to configure because each database can apply changes only from databases directly connected to it, rather than from multiple remote source databases.
- In a large Oracle Streams environment where intermediate databases apply changes, the environment might be easier to monitor and manage because fewer apply processes might be required. An intermediate database that applies changes must have one apply process for each source database from which it receives changes. In an apply forwarding environment, the source databases of an intermediate database are only the databases to which it is directly connected. In a queue forwarding environment, the source databases of an intermediate database are all of the other source databases in the environment, whether they are directly connected to the intermediate database or not.

See Also:

- [Chapter 4, "Oracle Streams Information Consumption"](#)
- *Oracle Streams Replication Administrator's Guide* for an example of an environment that uses queue forwarding and for an example of an environment that uses apply forwarding

Binary File Propagation

You can propagate a binary file between databases by using Oracle Streams. To do so, you put one or more `BFILE` attributes in a **message** payload and then propagate the message to a remote **queue**. Each `BFILE` referenced in the payload is transferred to the remote database after the message is propagated, but before the message propagation is committed. The directory object and filename of each propagated `BFILE` are preserved, but you can map the directory object to different directories on the source and **destination databases**. The message payload can be a `BFILE` wrapped in an `ANYDATA` payload, or the message payload can be one or more `BFILE` attributes of an object wrapped in an `ANYDATA` payload.

The following are not supported in a message payload:

- One or more `BFILE` attributes in a varray
- A user-defined type object with an `ANYDATA` attribute that contains one or more `BFILE` attributes

Propagating a `BFILE` in Oracle Streams has the same restrictions as the procedure `DBMS_FILE_TRANSFER.PUT_FILE`.

See Also: *Oracle Database Administrator's Guide*, and *Oracle Database PL/SQL Packages and Types Reference* for more information about transferring files with the `DBMS_FILE_TRANSFER` package

Propagation Jobs

An Oracle Streams **propagation** is configured internally using Oracle Scheduler. Therefore, a **propagation job** is a job that propagates **messages** from a **source queue** to a **destination queue**. Like other Oracle Scheduler jobs, propagation jobs have an owner, and they use slave processes (`jnnn`) as needed to execute jobs.

The following procedures can create a propagation job when they create a propagation:

- The `ADD_GLOBAL_PROPAGATION_RULES` procedure in the `DBMS_STREAMS_ADM` package
- The `ADD_SCHEMA_PROPAGATION_RULES` procedure in the `DBMS_STREAMS_ADM` package
- The `ADD_TABLE_PROPAGATION_RULES` procedure in the `DBMS_STREAMS_ADM` package
- The `ADD_SUBSET_PROPAGATION_RULE` procedure in the `DBMS_STREAMS_ADM` package
- The `CREATE_PROPAGATION` procedure in the `DBMS_PROPAGATION_ADM` package

When one of these procedures creates a propagation, a new propagation job is created in the following cases:

- If the `queue_to_queue` parameter is set to `TRUE`, then a new propagation job always is created for the propagation. Each queue-to-queue propagation has its own propagation job. However, a slave process can be used by multiple propagation jobs.
- If the `queue_to_queue` parameter is set to `FALSE`, then a propagation job is created when no propagation job exists for the source queue and database link specified. If a propagation job already exists for the specified source queue and database link, then the new propagation uses the existing propagation job and shares this propagation job with all of the other queue-to-dblink propagations that use the same database link.

This section contains the following topics:

- [Propagation Scheduling and Oracle Streams Propagations](#)
- [Propagation Jobs and RESTRICTED SESSION](#)

Note: The source queue owner performs the propagation, but the propagation job is owned by the user who creates it. These two users might or might not be the same.

See Also:

- ["Queue-to-Queue Propagations"](#) on page 3-13
- *Oracle Database Administrator's Guide* for more information about Oracle Scheduler

Propagation Scheduling and Oracle Streams Propagations

A **propagation schedule** specifies how often a propagation job propagates messages from a source queue to a destination queue. Each queue-to-queue propagation has its own propagation job and propagation schedule, but queue-to-dblink propagations that use the same propagation job have the same propagation schedule.

A default propagation schedule is established when a new propagation job is created by a procedure in the `DBMS_STREAMS_ADM` or `DBMS_PROPAGATION_ADM` package.

The default schedule has the following properties:

- The start time is `SYSDATE ()`.
- The duration is `NULL`, which means infinite.
- The next time is `NULL`, which means that propagation restarts as soon as it finishes the current duration.
- The latency is three seconds, which is the wait time after a queue becomes empty to resubmit the propagation job. Therefore, the latency is the maximum wait, in seconds, in the propagation window for a message to be propagated after it is enqueued.

You can alter the schedule for a propagation job using the `ALTER_PROPAGATION_SCHEDULE` procedure in the `DBMS_AQADM` package. Changes made to a propagation job affect all propagations that use the propagation job.

See Also:

- ["Propagation Jobs"](#) on page 3-17
- ["Altering the Schedule of a Propagation Job"](#) on page 15-5

Propagation Jobs and RESTRICTED SESSION

When the restricted session is enabled during system startup by issuing a `STARTUP RESTRICT` statement, propagation jobs with enabled propagation schedules do not propagate messages. When the restricted session is disabled, each propagation schedule that is enabled and ready to run will run when there is an available slave process.

When the restricted session is enabled in a running database by the SQL statement `ALTER SYSTEM ENABLE RESTRICTED SESSION`, any running propagation job continues to run to completion. However, any new propagation job submitted for a propagation schedule is not started. Therefore, propagation for an enabled schedule can eventually come to a halt.

Oracle Streams Data Dictionary for Propagations

When a database object is prepared for **instantiation** at a **source database**, an Oracle Streams data dictionary is populated automatically at the database where changes to the object are captured by a **capture process**. The Oracle Streams data dictionary is a multiversed copy of some of the information in the primary data dictionary at a source database. The Oracle Streams data dictionary maps object numbers, object version information, and internal column numbers from the source database into table names, column names, and column data types. This mapping keeps each **captured LCR** as small as possible, because the message can store numbers rather than names internally.

The mapping information in the Oracle Streams data dictionary at the source database is needed to evaluate **rules** at any database that propagates the captured LCRs from the source database. To make this mapping information available to a **propagation**, Oracle automatically populates a multiversed Oracle Streams data dictionary at each database that has an Oracle Streams propagation. Oracle automatically sends internal messages that contain relevant information from the Oracle Streams data dictionary at the source database to all other databases that receive captured LCRs from the source database.

The Oracle Streams data dictionary information contained in these internal messages in a **queue** might or might not be propagated by a propagation. Which Oracle Streams

data dictionary information to propagate depends on the **rule sets** for the propagation. When a propagation encounters Oracle Streams data dictionary information for a table, the propagation rule sets are evaluated with partial information that includes the source database name, table name, and table owner. If the partial rule evaluation of these rule sets determines that there might be relevant LCRs for the given table from the specified database, then the Oracle Streams data dictionary information for the table is propagated.

When Oracle Streams data dictionary information is propagated to a destination queue, it is incorporated into the Oracle Streams data dictionary at the database that contains the destination queue, in addition to being enqueued into the destination queue. Therefore, a propagation reading the destination queue in a directed networks configuration can forward LCRs immediately without waiting for the Oracle Streams data dictionary to be populated. In this way, the Oracle Streams data dictionary for a source database always reflects the correct state of the relevant database objects for the LCRs relating to these database objects.

See Also:

- ["The Oracle Streams Data Dictionary"](#) on page 2-34
- [Chapter 6, "How Rules Are Used in Oracle Streams"](#)

Combined Capture and Apply Optimization

In Oracle Database 11g Release 1 (11.1) and later, for improved efficiency, a **capture process** can act as a propagation sender to transmit logical change records (LCRs) directly to a propagation receiver under specific conditions. The propagation receiver enqueues the LCRs into the **buffered queue** portion of the **destination queue**, and an **apply process** dequeues the LCRs. This configuration is called combined capture and apply.

The following sections describe combined capture and apply in more detail:

- [Combined Capture and Apply Requirements](#)
- [How to Use Combined Capture and Apply](#)
- [How to Determine Whether Combined Capture and Apply Is Being Used](#)
- [How to Manage the Flow of LCRs From the Capture Process to the Apply Process](#)
- [Combined Capture and Apply and Point-in-Time Recovery](#)

See Also: [Chapter 22, "Monitoring the Oracle Streams Topology and Performance"](#) for information about monitoring the topology and performance of an environment that uses combined capture and apply

Combined Capture and Apply Requirements

Combined capture and apply can be used when the **capture process** and **apply process** reside on the same database or on different databases.

When the capture process and apply process reside on the same database, combined capture and apply is possible only if all of the following conditions are met:

- The database must be an Oracle Database 11g Release 1 (11.1) or later database.
- The capture process and apply process must use the same **queue**.

- The queue must have a single publisher, and it must be the capture process.
- The queue must have a single consumer for the **buffered queue**, and it must be the apply process. The queue can have one or more other apply processes that are consumers for the **persistent queue**.

When the capture process and apply process reside on the different databases, or on different instances in the same database, combined capture and apply is possible only if all of the following conditions are met:

- The database running the capture process and the database running the apply process each must be an Oracle Database 11g Release 1 (11.1) or later database.
- The capture process queue must have a single publisher, and it must be the capture process.
- A **propagation** must be configured between the capture process queue and the apply process queue. There can be no intermediate queues (no directed network).
- The capture process queue must have a single consumer, and it must be the propagation between the capture process queue and the apply process queue.
- The apply process queue must have a single publisher, and it must be the propagation between the capture process queue and the apply process queue.
- The apply process queue must have a single consumer, and it must be the apply process. The queue can have one or more other apply processes that are consumers for the persistent queue.

Note: Combined capture and apply is not possible with **synchronous capture**.

See Also:

- ["Implicit Capture with an Oracle Streams Capture Process"](#) on page 2-9
- ["Persistent Queues and Buffered Queues"](#) on page 3-3
- ["Directed Networks"](#) on page 3-15
- ["Implicit Consumption with an Apply Process"](#) on page 4-5

How to Use Combined Capture and Apply

After you meet the requirements for combined capture and apply, you do not need to perform any other configuration tasks to use it. The **capture process** automatically detects that combined capture and apply is possible when it is started. After it is established a connection with the propagation receiver, it sends captured **LCRs** directly to the propagation receiver.

If combined capture and apply is used, and you change the configuration so that it no longer meets the requirements of combined capture and apply, then the capture process detects this change and restarts. After the capture process restarts, it no longer uses combined capture and apply.

If combined capture and apply is not used, and you change the configuration so that it meets the requirements of combined capture and apply, then combined capture and apply is used automatically when the capture process is restarted. In this case, you must restart the capture process manually. It is not restarted automatically.

See Also: ["Combined Capture and Apply Requirements"](#) on page 3-20

How to Determine Whether Combined Capture and Apply Is Being Used

Check the following dynamic performance views to determine whether combined capture and apply is used:

- For the **capture process**, combined capture and apply is used when the `OPTIMIZATION` column is greater than zero in the `V$STREAMS_CAPTURE` view.
- For the **apply process**, combined capture and apply is used when the `PROXY_SID` column is not `NULL` in the `V$STREAMS_APPLY_READER` view.

See Also:

- ["Determining Which Capture Processes Use Combined Capture and Apply"](#) on page 23-15
- ["Determining Which Apply Processes Use Combined Capture and Apply"](#) on page 25-15
- ["Capture Process States"](#) on page 2-24
- *Oracle Database Reference* for information about data dictionary views

How to Manage the Flow of LCRs From the Capture Process to the Apply Process

The **capture process** uses the **propagation rule sets** to determine which **LCRs** to send to the **apply process**. You can modify the propagation rule sets to control which LCRs are sent. In addition, **rule-based transformations** that are configured for the rules in the positive propagation rule set are run when a rule evaluates to `TRUE`.

To stop the flow of LCRs, either stop or unschedule the propagation. To start the flow of LCRs, either start or schedule the propagation. However, changes to the parameters in the propagation schedule are ignored. In addition, the following views contain no information about the propagation when the propagation is replaced by combined capture and apply:

- `DBA_QUEUE_SCHEDULES`
- `USER_QUEUE_SCHEDULES`

Instead, query the following views for information about the propagation:

- `V$PROPAGATION_SENDER`
- `V$PROPAGATION_RECEIVER`

When combined capture and apply is used, you can manage capture processes and apply processes normally. Specifically, you control capture process and apply process behavior in the following ways:

- Changes must satisfy the capture process rules sets to be captured by the capture process.
- LCRs must satisfy the apply process rule sets to be applied by the apply process.
- Rule-based transformations that are configured for the rules in the positive rule set of a capture process or apply process are run when a rule evaluates to `TRUE`.
- LCRs are sent to apply handlers for an apply process when appropriate.
- Update conflict resolution handlers are invoked when appropriate during apply.

See Also:

- ["Managing Oracle Streams Propagations and Propagation Jobs"](#) on page 15-4 for instructions on starting, stopping, and managing the rules for a propagation
- [Chapter 6, "How Rules Are Used in Oracle Streams"](#)
- [Chapter 7, "Rule-Based Transformations"](#)
- ["Message Processing Options for an Apply Process"](#) on page 4-7 for information about apply handlers
- ["Displaying Information About Propagation Senders"](#) on page 24-17
- ["Displaying Information About Propagation Receivers"](#) on page 24-18
- *Oracle Streams Replication Administrator's Guide* for more information about update conflict handlers

Combined Capture and Apply and Point-in-Time Recovery

When you use combined capture and apply in a single-source replication environment, the Oracle Streams clients handle point-in-time recovery of the destination database automatically. The Oracle Streams client include the [capture process](#), [propagation](#), and [apply process](#) that form the combined capture and apply configuration.

In a single-source replication environment that uses combined capture and apply, complete these general steps to perform point-in-time recovery on the destination database:

1. Stop the capture process and apply process, and disable the propagation.
2. Perform the point-in-time recovery on the destination database.
3. Ensure that the capture process has access to the archived redo log files for the previous point in time.
4. Start the apply process.
5. Enable the propagation.
6. Start the capture process.

When you follow these steps, the capture process determines its start SCN automatically, and no other steps are required.

See Also: *Oracle Streams Replication Administrator's Guide* for more information about performing point-in-time recovery in an Oracle Streams replication environment

Oracle Streams Information Consumption

The following topics contain information about consuming information with Oracle Streams.

- [Overview of Information Consumption with Oracle Streams](#)
- [Implicit Consumption with an Apply Process](#)
- [Explicit Consumption with a Messaging Client](#)
- [Explicit Consumption with Manual Dequeue](#)

See Also:

- [Chapter 16, "Managing Oracle Streams Information Consumption"](#)
- [Chapter 25, "Monitoring Oracle Streams Apply Processes"](#)
- ["Troubleshooting Apply Process Problems" on page 20-14](#)

Overview of Information Consumption with Oracle Streams

Consuming information with Oracle Streams means dequeuing a **message** that contains the information from a **queue** and either processing or discarding the message. The consumed information can describe a database change, or it can be any other type of information. A dequeued message might have originated at the same database where it is dequeued, or it might have originated at a different database.

This section contains these topics:

- [Ways to Consume Information with Oracle Streams](#)
- [Types of Information Consumed with Oracle Streams](#)
- [Summary of Information Consumption Options](#)

Ways to Consume Information with Oracle Streams

The following are ways to consume information with Oracle Streams:

- [Implicit Consumption](#)
- [Explicit Consumption](#)

Implicit Consumption

With **implicit consumption**, an **apply process** automatically dequeues either **captured LCRs**, **persistent LCRs**, or **persistent user messages**. The queue must be an **ANYDATA queue**. If a message contains a **logical change record (LCR)**, then the

apply process can either apply it directly or call a user-specified procedure for processing. If the message does not contain an LCR, then the apply process can invoke a user-specified procedure called a **message handler** to process it.

Note: Captured LCRs must be dequeued by an apply process. However, if an apply process or a user procedure called by an apply process re-enqueues a captured LCR, then the LCR becomes a persistent LCR and can be explicitly dequeued.

Explicit Consumption

With **explicit consumption**, messages are dequeued in one of the following ways:

- A **messaging client** explicitly dequeues **persistent LCRs** or **persistent user messages**. The queue must be an ANYDATA queue. A messaging client dequeues messages when it is invoked by an application, and the application processes the messages after the messaging client dequeues them.
- An application explicitly dequeues **messages** manually and processes them. An application can dequeue the following types of messages: **persistent LCRs**, **persistent user messages**, **buffered LCRs**, and **buffered user messages**. The queue from which the messages are dequeued can be an ANYDATA queue or a **typed queue**.

Types of Information Consumed with Oracle Streams

The following types of information can be consumed with Oracle Streams:

- [Captured LCRs](#)
- [Persistent LCRs](#)
- [Buffered LCRs](#)
- [Persistent User Messages](#)
- [Buffered User Messages](#)

See Also:

- ["Types of Information Captured with Oracle Streams"](#) on page 2-3
- ["Summary of Information Capture Options With Oracle Streams"](#) on page 2-7

Captured LCRs

A **captured LCR** is a **logical change record (LCR)** that was captured implicitly by a **capture process** and enqueued into the **buffered queue** portion of an **ANYDATA queue**.

Only an **apply process** can dequeue captured LCRs. After dequeue, an apply process can apply the captured LCR directly to make a database change, discard the captured LCR, send the captured LCR to an apply handler for processing, or re-enqueue the captured LCR into a **persistent queue**.

See Also:

- ["Implicit Capture with an Oracle Streams Capture Process"](#) on page 2-9
- ["Implicit Consumption with an Apply Process"](#) on page 4-5

Persistent LCRs

A **persistent LCR** is a **logical change record (LCR)** that was enqueued into the **persistent queue** portion of an ANYDATA queue. A persistent LCR can be enqueued in one of the following ways:

- Captured implicitly by a **synchronous capture** and enqueued
- Constructed explicitly by an application and enqueued
- Dequeued by an **apply process** and enqueued by the same apply process using the `SET_ENQUEUE_DESTINATION` procedure in the `DBMS_APPLY_ADM` package

Persistent LCRs can be dequeued by an apply process, a messaging client, or an application.

See Also:

- ["Implicit Capture with Synchronous Capture"](#) on page 2-38
- ["Explicit Capture by Applications"](#) on page 2-43
- ["Implicit Consumption with an Apply Process"](#) on page 4-5
- ["Explicit Consumption with a Messaging Client"](#) on page 4-22
- ["Explicit Consumption with Manual Dequeue"](#) on page 4-23

Buffered LCRs

A **buffered LCR** is a **logical change record (LCR)** that was constructed explicitly by an application and enqueued into the buffered queue portion of an ANYDATA queue. Only an application can dequeue buffered LCRs.

See Also:

- ["Explicit Capture by Applications"](#) on page 2-43
- ["Explicit Consumption with Manual Dequeue"](#) on page 4-23

Persistent User Messages

A **persistent user message** is a non-**LCR message** of a user-defined type that was enqueued into a **persistent queue**. A persistent user message can be enqueued in one of the following ways:

- Created explicitly by an application and enqueued
- Dequeued by an **apply process** and enqueued by the same apply process using the `SET_ENQUEUE_DESTINATION` procedure in the `DBMS_APPLY_ADM` package

Apply processes and messaging clients can only dequeue persistent user messages that are in an **ANYDATA queue**. Applications can dequeue persistent user messages that are in an ANYDATA queue or a **typed queue**.

See Also:

- "Explicit Capture by Applications" on page 2-43
- "Implicit Consumption with an Apply Process" on page 4-5
- "Explicit Consumption with a Messaging Client" on page 4-22
- "Explicit Consumption with Manual Dequeue" on page 4-23

Buffered User Messages

A **buffered user message** is a non-**LCR message** of a user-defined type that was created explicitly by an application and enqueued into a **buffered queue**. A buffered user message can be enqueued into the buffered queue portion of an **ANYDATA queue** or a **typed queue**. Only an application can dequeue buffered user messages.

See Also:

- "Explicit Capture by Applications" on page 2-43
- "Explicit Consumption with Manual Dequeue" on page 4-23

Summary of Information Consumption Options

Table 4–1 summarizes the information consumption options available with Oracle Streams.

Table 4–1 Information Consumption Options with Oracle Streams

Consumption Type	Dequeues Messages	Message Types	Use When
Implicit Consumption with an Apply Process	Continually and automatically when enabled	Captured LCRs Persistent LCRs Persistent user messages	You want to dequeue and process captured LCRs . You want to dequeue persistent LCRs or persistent user messages continually and automatically from the persistent queue portion of an ANYDATA queue . You want to dequeue LCRs that must be applied directly to database objects to make database changes. You want to dequeue messages and process them with an apply handler .
Explicit Consumption with a Messaging Client	When invoked by an application	Persistent LCRs Persistent user messages	You want to use a simple method for dequeuing on demand persistent LCRs or persistent user messages from the persistent queue portion of an ANYDATA queue . You want to send messages to an application for processing after dequeue.
Explicit Consumption with Manual Dequeue	Manually according to application logic	Persistent LCRs Buffered LCRs Persistent user messages Buffered user messages	You want an application to dequeue manually persistent LCRs or buffered LCRs from an ANYDATA queue and process them. You want an application to dequeue manually persistent user messages or buffered user messages from an ANYDATA queue or a typed queue and process them.

Note: A single database can use any combination of the information consumption options summarized in the table.

See Also:

- [Chapter 2, "Oracle Streams Information Capture"](#)
- *Oracle Streams Advanced Queuing User's Guide* for information about enqueueing messages
- *Oracle Streams Replication Administrator's Guide* for more information about managing LCRs

Implicit Consumption with an Apply Process

This section explains the concepts related to Oracle Streams [apply processes](#).

This section contains these topics:

- [Introduction to the Apply Process](#)
- [Apply Process Rules](#)
- [Types of Messages That Can Be Processed with an Apply Process](#)
- [Message Processing Options for an Apply Process](#)
- [The Source of Messages Applied by an Apply Process](#)
- [Data Types Applied](#)
- [Automatic Data Type Conversion During Apply](#)
- [Oracle Streams Apply Processes and RESTRICTED SESSION](#)
- [Apply Process Components](#)
- [Apply User](#)
- [Apply Process Creation](#)
- [Oracle Streams Data Dictionary for an Apply Process](#)
- [Apply Process Parameters](#)
- [Persistent Apply Process Status Upon Database Restart](#)
- [The Error Queue](#)

Introduction to the Apply Process

An **apply process** is an optional Oracle background process that dequeues [messages](#) from a specific [queue](#) and either applies each message directly, discards it, passes it as a parameter to an [apply handler](#), or re-enqueues it. These messages can be logical change records ([LCRs](#)) or [user messages](#).

Note: An apply process can only dequeue messages from an [ANYDATA queue](#), not a [typed queue](#).

Apply Process Rules

An **apply process** applies messages based on **rules** that you define. For **LCRs**, each rule specifies the database objects and types of changes for which the rule evaluates to **TRUE**. For **user messages**, you can create rules to control apply process behavior for specific types of messages. You can place these rules in the **positive rule set** or **negative rule set** for the apply process.

If a rule evaluates to **TRUE** for a message, and the rule is in the positive rule set for an apply process, then the apply process dequeues and processes the message. If a rule evaluates to **TRUE** for a message, and the rule is in the negative rule set for an apply process, then the apply process discards the message. If an apply process has both a positive and a negative rule set, then the negative rule set is always evaluated first.

You can specify apply process rules for LCRs at the following levels:

- A table rule applies or discards either row changes resulting from DML changes or DDL changes to a particular table. A subset rule is a table rule that include a subset of the row changes to a particular table.
- A schema rule applies or discards either row changes resulting from DML changes or DDL changes to the database objects in a particular schema.
- A global rule applies or discards either all row changes resulting from DML changes or all DDL changes in the **queue** associated with an apply process.

See Also:

- [Chapter 5, "Rules"](#)
- [Chapter 6, "How Rules Are Used in Oracle Streams"](#)
- ["Managing Rules"](#) on page 17-1

Types of Messages That Can Be Processed with an Apply Process

Apply processes can dequeue the following types of messages:

- **Captured LCRs:** A **logical change record (LCR)** that was captured implicitly by a **capture process** and enqueued into the **buffered queue** portion of an **ANYDATA queue**. In some situations, an optimization enables capture processes to send LCRs to apply processes more efficiently. This optimization is called combined capture and apply.
- **Persistent LCRs:** An LCR that was captured implicitly by a **synchronous capture**, constructed and enqueued persistently by an application, or enqueued by an apply process. A persistent LCR is enqueued into the **persistent queue** portion of an ANYDATA queue.
- **Persistent user messages:** A non-LCR **message** of a user-defined type that was enqueued explicitly by an application or an apply process. A persistent user message is enqueued into the persistent queue portion of an ANYDATA queue. In addition, a user message can be enqueued into an ANYDATA queue or a typed queue, but an apply process can dequeue only user messages in an ANYDATA queue.

A single apply process cannot dequeue both from the buffered queue and persistent queue portions of a queue. If messages in both the buffered queue and persistent queue must be processed by an apply process, then the **destination database** must have at least two apply processes to process the messages.

See Also:

- "Introduction to Message Staging and Propagation" on page 3-1
- "Overview of Apply Process Creation" on page 12-1
- "Combined Capture and Apply Optimization" on page 3-20

Message Processing Options for an Apply Process

An apply process can either apply **messages** directly or send messages to an **apply handler** for processing. Your options for message processing depend on whether or not the message received by an apply process is a **row logical change record (row LCR)**, a **DDL logical change record (DDL LCR)**, or a **user message**.

Figure 4–1 shows the message processing options for an apply process and which options can be used for different types of messages.

Figure 4–1 Apply Process Message Processing Options

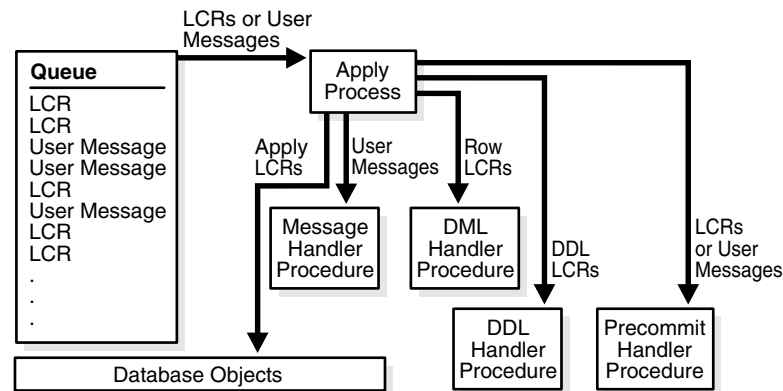

The following sections describe these message processing options:

- [Apply LCRs Directly](#)
- [Process Messages with Apply Handlers](#)
- [Summary of Message Processing Options](#)

Apply LCRs Directly

If you use this option, then an apply process applies LCRs without running a user procedure. The apply process either successfully applies the change in the LCR or, if a **conflict** or an apply error is encountered, tries to resolve the error with a conflict handler or a user-specified procedure called an **error handler**.

If a conflict handler can resolve the conflict, then it either applies the LCR or it discards the change in the LCR. If the error handler can resolve the error, then it should apply the LCR, if appropriate. An error handler can resolve an error by modifying the LCR before applying it. If the conflict handler or error handler cannot resolve the error, then the apply process places the transaction, and all LCRs associated with the transaction, into the error queue.

Note: An apply process cannot apply non-LCR messages directly. Each **user message** dequeued by an apply process must be processed with a message handler.

Process Messages with Apply Handlers

When you use an apply handler, an apply process passes a message as a parameter to a user procedure for processing. The user procedure can process the message in a customized way.

The following sections provide information about specific apply handlers and considerations for using apply handlers:

- [DML Handlers](#)
- [DDL Handlers](#)
- [Message Handlers](#)
- [Precommit Handlers](#)
- [Considerations for Apply Handlers](#)

DML Handlers A user procedure that processes row LCRs is called a **DML handler**. An apply process can have many DML handlers. A DML handler can process row LCRs that were created by a [capture process](#), a [synchronous capture](#), or an application.

For each table associated with an apply process, you can set a separate DML handler to process each of the following types of operations in row LCRs:

- INSERT
- UPDATE
- DELETE
- LOB_UPDATE

For example, the `hr.employees` table can have one DML handler procedure to process INSERT operations and a different DML handler procedure to process UPDATE operations. Alternatively, the `hr.employees` table can use the same DML handler procedure for each type of operation.

The user procedure can perform any customized processing of row LCRs. For example, if you want each insert into a particular table at the [source database](#) to result in inserts into multiple tables at the [destination database](#), then you can create a user procedure that processes INSERT operations on the table to accomplish this.

A DML handler should never commit and never roll back, except to a named savepoint that the user procedure has established. To execute a row LCR inside a DML handler, invoke the EXECUTE member procedure for the row LCR.

To set a DML handler, use the SET_DML_HANDLER procedure in the DBMS_APPLY_ADM package. You can either set a DML handler for a specific apply process, or you can set a DML handler to be a general DML handler that is used by all apply processes in the database. If a DML handler for an operation on a table is set for a specific apply process, and another DML handler is a general handler for the same operation on the same table, then the specific DML handler takes precedence over the general DML handler.

You create an error handler in the same way that you create a DML handler, except that you set the error_handler parameter to TRUE when you run the SET_DML_HANDLER procedure. An error handler is invoked only if an apply error results when an apply process tries to apply a row LCR for the specified operation on the specified table.

Typically, DML handlers are used in Oracle Streams [replication](#) environments to perform custom processing of row LCRs, but DML handlers can be used in

nonreplication environments as well. For example, such handlers can be used to record changes made to database objects without replicating these changes.

Note: When you run the `SET_DML_HANDLER` procedure, you specify the object for which the handler is used. This object does not need to exist at the destination database when you run the procedure.

See Also:

- ["Row LCRs"](#) on page 2-4
- ["Unsupported Data Types for Apply Handlers"](#) on page B-13
- *Oracle Database PL/SQL Packages and Types Reference* for more information about the `EXECUTE` member procedure for LCR types
- *Oracle Streams Replication Administrator's Guide* for more information about DML handlers

DDL Handlers A user procedure that processes DDL LCRs is called a **DDL handler**. An apply process can have only one DDL handler, and this single DDL handler processes all DDL LCRs dequeued by the apply process. A DDL handler can process DDL LCRs that were created by a [capture process](#) or an application.

The user procedure can perform any customized processing of DDL LCRs. For example, if you want to log DDL changes before applying them, then you can create a user procedure that processes DDL operations to accomplish this.

To execute a DDL LCR inside a DDL handler, invoke the `EXECUTE` member procedure for the DDL LCR. To associate a DDL handler with a particular apply process, use the `ddl_handler` parameter in the `CREATE_APPLY` or the `ALTER_APPLY` procedure in the `DBMS_APPLY_ADM` package.

Typically, DDL handlers are used in Oracle Streams [replication](#) environments to perform custom processing of DDL LCRs, but these handlers can be used in nonreplication environments as well. For example, such handlers can be used to record changes made to database objects without replicating these changes.

See Also:

- ["DDL LCRs"](#) on page 2-5
- *Oracle Database PL/SQL Packages and Types Reference* for more information about the `EXECUTE` member procedure for LCR types
- *Oracle Streams Replication Administrator's Guide* for more information about DDL handlers

Message Handlers A [persistent user message](#) is processed by the **message handler** specified for an apply process. A message handler is a user-defined procedure that can process [user messages](#) in a customized way for your environment.

A message handler offers advantages in any environment that has applications that must update one or more remote databases or perform some other remote action. These applications can enqueue user messages into a [queue](#) at the local database, and Oracle Streams can propagate each user message to the appropriate queues at

destination databases. If there are multiple destinations, then Oracle Streams provides the infrastructure for automatic propagation and processing of these messages at these destinations. If there is only one destination, then Oracle Streams still provides a layer between the application at the source database and the application at the destination database, so that, if the application at the remote database becomes unavailable, then the application at the source database can continue to function normally.

For example, a message handler can convert a user message into an electronic mail message. In this case, the user message can contain the attributes you would expect in an electronic mail message, such as `from`, `to`, `subject`, `text_of_message`, and so on. After converting a message into an electronic mail messages, the message handler can send it out through an electronic mail gateway.

You can specify a message handler for an apply process using the `message_handler` parameter in the `CREATE_APPLY` or the `ALTER_APPLY` procedure in the `DBMS_APPLY_ADM` package. An Oracle Streams apply process always assumes that a non-`LCR` message has no dependencies on any other messages in the queue. If parallelism is greater than 1 for an apply process that applies **persistent user messages**, then these messages can be dequeued by a message handler in any order. Therefore, if dependencies exist between these messages in your environment, then Oracle recommends that you set apply process parallelism to 1.

See Also:

- ["Managing the Message Handler for an Apply Process"](#) on page 16-8

Precommit Handlers You can use a **precommit handler** to audit commit directives for **captured LCRs** and transaction boundaries for **persistent LCRs** and **persistent user messages**. A precommit handler is a user-defined PL/SQL procedure that can receive the commit information for a transaction and process the commit information in any customized way. A precommit handler can work with a DML handler or a message handler.

For example, a handler can improve performance by caching data for the length of a transaction. This data can include cursors, temporary LOBs, data from a **message**, and so on. The precommit handler can release or execute the objects cached by the handler when a transaction completes.

A precommit handler executes when the apply process commits a transaction. You can use the `commit_serialization` apply process parameter to control the commit order for an apply process.

The following list describes commit directives and transaction boundaries:

- **Commit Directives for Captured LCRs:** When you are using a **capture process**, and a user commits a transaction, the capture process captures an internal commit directive for the transaction if the transaction contains row LCRs that were captured by the capture process. The capture process also records the transaction identifier in each captured LCR in a transaction.

Once enqueued, these commit directives can be propagated to **destination queues**, along with the LCRs in a transaction. A precommit handler receives each commit SCN for these internal commit directives in the queue of an apply process before they are processed by the apply process.

- **Transaction Boundaries for Persistent LCRs Enqueued by Synchronous Captures:** When you are using a **synchronous capture**, and a user commits a transaction, the persistent LCRs that were enqueued by the synchronous capture

are organized into a message group. The synchronous capture records the transaction identifier in each persistent LCR in a transaction.

After persistent LCRs are enqueued by a synchronous capture, the persistent LCRs in the message group can be propagated to other queues. When an apply process is configured to process these persistent LCRs, it generates a commit SCN for all of the persistent LCRs in a message group. The commit SCN values generated by an individual apply process have no relation to the source transaction, or to the values generated by any other apply process. A precommit handler configured for such an apply process receives the commit SCN supplied by the apply process.

- **Transaction Boundaries for Messages Enqueued by Applications:** An application can enqueue persistent LCRs and persistent user messages, as well as other types of messages. When the user performing these enqueue operations issues a `COMMIT` statement to end the transaction, the enqueued persistent LCRs and persistent user messages are organized into a message group.

When messages that were enqueued by an application are organized into a message group, the messages in the message group can be propagated to other queues. When an apply process is configured to process these messages, it generates a single transaction identifier and commit SCN for all the messages in a message group. Transaction identifiers and commit SCN values generated by an individual apply process have no relation to the source transaction, or to the values generated by any other apply process. A precommit handler configured for such an apply process receives the commit SCN supplied by the apply process.

See Also:

- ["Managing the Precommit Handler for an Apply Process"](#) on page 16-8

Considerations for Apply Handlers The following are considerations for using apply handlers:

- DML handlers, DDL handlers, and message handlers can execute an LCR by calling the LCR's `EXECUTE` member procedure.
- All applied DDL LCRs commit automatically. Therefore, if a DDL handler calls the `EXECUTE` member procedure of a DDL LCR, then a commit is performed automatically.
- If necessary, an apply handler can set an Oracle Streams session [tag](#).
- An apply handler can call a Java stored procedure that is published (or wrapped) in a PL/SQL procedure.
- If an apply process tries to invoke an apply handler that does not exist or is invalid, then the apply process aborts.
- If an apply handler invokes a procedure or function in an Oracle-supplied package, then the user who runs the apply handler must have direct `EXECUTE` privilege on the package. It is not sufficient to grant this privilege through a role.

See Also:

- *Oracle Database PL/SQL Packages and Types Reference* for more information about the `EXECUTE` member procedure for LCR types
- *Oracle Streams Replication Administrator's Guide* for more information about Oracle Streams tags

Summary of Message Processing Options

The table in this section summarizes the message processing options available when you are using one or more of the [apply handlers](#) described in the previous sections. Apply handlers are optional for row LCRs and DDL LCRs because an apply process can apply these messages directly. However, a message handler is required for processing user messages. In addition, an apply process dequeues a message only if the message satisfies the [rule sets](#) for the apply process. In general, a message satisfies the rule sets for an apply process if *no rules* in the [negative rule set](#) evaluate to TRUE for the message, and *at least one rule* in the [positive rule set](#) evaluates to TRUE for the message.

Table 4–2 Summary of Message Processing Options

Message Processing Option	Type of Message	Default Apply Process Behavior	Scope of User Procedure
Apply Message Directly	Row LCR or DDL LCR	Execute DML or DDL	Not applicable
DML Handler or Error Handler	Row LCR	Execute DML	One operation on one table
DDL Handler	DDL LCR	Execute DDL	Entire apply process
Message Handler	User Message	Create error transaction (if no message handler exists)	Entire apply process
Precommit Handler	Commit directive for transactions that include row LCRs or user messages	Commit transaction	Entire apply process

In addition to the message processing options described in this section, you can use the `SET_ENQUEUE_DESTINATION` procedure in the `DBMS_APPLY_ADM` package to instruct an apply process to enqueue messages into the [persistent queue](#) portion of a specified destination queue. Also, you can control message execution using the `SET_EXECUTE` procedure in the `DBMS_APPLY_ADM` package.

See Also:

- [Chapter 6, "How Rules Are Used in Oracle Streams"](#)
- ["Specifying That Apply Processes Enqueue Messages"](#) on page 16-11
- ["Specifying Execute Directives for Apply Processes"](#) on page 16-12

The Source of Messages Applied by an Apply Process

The following list describes the [source database](#) for different types of messages that are processed by an apply process:

- For a [captured LCR](#), the source database is the database where the change encapsulated in the [LCR](#) was generated in the redo log.
- For a [persistent LCR](#) captured by a synchronous capture, the source database is the database where the synchronous capture that captured the row LCR is configured.

- For a persistent LCR constructed and enqueued by an application, the source database is the database where the message was first enqueued.
- For a **user message**, the source database is the database where the message was first enqueued.

A single apply process can apply user messages that originated at multiple databases. However, a single apply process can apply captured LCRs from only one source database. Similarly, a single apply process can apply persistent LCRs captured by a synchronous capture from only one source database. Applying these LCRs requires knowledge of the dependencies, meaningful transaction ordering, and transactional boundaries at the source database.

Captured LCRs from multiple databases can be sent to a single **destination queue**. The same is true for persistent LCRs captured by a synchronous capture. However, if a single queue contains these LCRs from multiple source databases, then there must be multiple apply processes retrieving these LCRs. Each of these apply processes should be configured to receive messages from exactly one source database using **rules**. Oracle recommends that you use a separate `ANYDATA` queue for messages from each source database.

Also, each apply process can apply captured LCRs from only one capture process. If multiple capture processes are running on a source database, and LCRs from more than one of these capture processes are applied at a destination database, then there must be one apply process to apply changes from each capture process. In such an environment, Oracle recommends that each `ANYDATA` queue used by a capture process, propagation, or apply process have captured LCRs from at most one capture process from a particular source database. A queue can contain LCRs from more than one capture process if each capture process is capturing changes that originated at a different source database.

The same restriction applies to persistent LCRs captured by multiple synchronous captures at the same source database. Store these LCRs in separate `ANYDATA` queues, and use a separate apply process to apply the LCRs from each synchronous capture.

Note: Captured LCRs are in the **buffered queue** portion of a queue while persistent LCRs are in the **persistent queue** portion of a **queue**. Therefore, a single apply process cannot apply both captured LCRs and persistent LCRs.

See Also:

- ["Types of Messages That Can Be Processed with an Apply Process"](#) on page 4-6

Data Types Applied

When applying row LCRs resulting from DML changes to tables, an **apply process** applies changes made to columns of the following data types:

- VARCHAR2
- NVARCHAR2
- NUMBER
- FLOAT
- LONG

- DATE
- BINARY_FLOAT
- BINARY_DOUBLE
- TIMESTAMP
- TIMESTAMP WITH TIME ZONE
- TIMESTAMP WITH LOCAL TIME ZONE
- INTERVAL YEAR TO MONTH
- INTERVAL DAY TO SECOND
- RAW
- LONG RAW
- CHAR
- NCHAR
- CLOB with BASICFILE storage
- NCLOB with BASICFILE storage
- BLOB with BASICFILE storage
- UROWID
- XMLType stored as CLOB, object relationally, or as binary XML

Note: Oracle Streams capture processes can only capture changes to XMLType columns that are stored as CLOBs. However, apply processes can apply these captured LCRs to XMLType columns that are stored as CLOBs, object relationally, or as binary XML.

See Also:

- ["Listing Database Objects and Columns That Are Not Compatible With Apply Processes"](#) on page 28-12
- ["Unsupported Data Types for Apply Processes"](#) on page B-13
- [Chapter 6, "How Rules Are Used in Oracle Streams"](#)
- ["Data Types Captured by Capture Processes"](#) on page 2-12
- *Oracle Database SQL Language Reference* for more information about these data types

Automatic Data Type Conversion During Apply

During apply, an [apply process](#) automatically converts certain data types when there is a mismatch between the data type of a column in the row logical change record (row LCR) and the data type of the corresponding column in a table.

[Table 4-3](#) shows which data type combinations are converted automatically during apply.

Table 4–3 Data Type Combinations Converted Automatically During Apply

Data Types	To CHAR	To NCHAR	To VARCHAR2	To NVARCHAR2	To CLOB	To BLOB	To DATE	To TIMESTAMP
From CHAR	Not Applicable	Yes	Yes	Yes	Yes	No	No	No
From NCHAR	Yes	Not Applicable	Yes	Yes	Yes	No	No	No
From VARCHAR2	Yes	Yes	Not Applicable	Yes	Yes	No	No	No
From NVARCHAR2	Yes	Yes	Yes	Not Applicable	Yes	No	No	No
From NUMBER	Yes	Yes	Yes	Yes	No	No	No	No
From LONG	No	No	No	No	Yes	No	No	No
From LONG RAW	No	No	No	No	No	Yes	Yes	No
From RAW	No	No	No	No	No	Yes	Yes	No
From DATE	No	No	No	No	No	No	Not Applicable	Yes
From TIMESTAMP	No	No	No	No	No	No	Yes	Not Applicable

An apply process automatically performs data type conversion for a data type combination when Table 4–3 specifies "Yes" for the combination. An apply process does not perform data type conversion for a data type combination when Table 4–3 specifies "No" for the combination. For example, an apply process automatically converts a CHAR to an NCHAR, but it does not convert a CHAR to a BLOB.

Also, if the corresponding table column is not large enough to hold the converted string from a row LCR column, then the apply process raises an error.

The following sections provide more information about automatic data type conversion during apply:

- [Automatic Trimming of Character Data Types During Apply](#)
- [Automatic Conversion and LOB Data Types](#)

Note: An apply process must be part of Oracle Database 11g Release 1 (11.1.0.7) or later to perform automatic data type conversion. However, an apply process can convert columns in row LCRs that were captured or constructed on an earlier Oracle Database release.

See Also: *Oracle Database SQL Language Reference* for more information about data types

Automatic Trimming of Character Data Types During Apply

The `rtrim_on_implicit_conversion` apply process parameter determines whether the apply process trims data when it converts a CHAR or NCHAR to a VARCHAR2, NVARCHAR2, or CLOB. When this parameter is set to Y, the apply process automatically removes blank padding from the right end of a column during data type

conversion. When this parameter is set to `N`, the apply process preserves blank padding during data type conversion.

Consider the following example:

- A row LCR contains 'abc' for a `CHAR(10)` column.
- The corresponding table column for the row LCR is `NVARCHAR2(10)`.

If the `rtrim_on_implicit_conversion` apply process parameter is set to `Y`, the apply process inserts 'abc' into the table column and trims the padding after these characters. If the `rtrim_on_implicit_conversion` apply process parameter is set to `N`, then the apply process inserts 'abc' into the table column, and the remaining space in the column is filled with blanks.

See Also: *Oracle Database PL/SQL Packages and Types Reference*

Automatic Conversion and LOB Data Types

DML handlers and error handlers can use **LOB assembly** for data that has been converted from `LONG` to `CLOB` or from `LONG RAW` to `BLOB`.

See Also: *Oracle Streams Replication Administrator's Guide*

Oracle Streams Apply Processes and RESTRICTED SESSION

When restricted session is enabled during system startup by issuing a `STARTUP RESTRICT` statement, **apply processes** do not start, even if they were running when the database shut down. When the restricted session is disabled, each apply process that was not stopped is started.

When restricted session is enabled in a running database by the SQL statement `ALTER SYSTEM ENABLE RESTRICTED SESSION`, it does not affect any running apply processes. These apply processes continue to run and apply messages. If a stopped apply process is started in a restricted session, then the apply process does not actually start until the restricted session is disabled.

Apply Process Components

An **apply process** consists of the following components:

- A **reader server** that dequeues **messages**. The reader server is a process that computes dependencies between logical change records (LCRs) and assembles messages into transactions. The reader server then returns the assembled transactions to the coordinator process.
- A **coordinator process** that gets transactions from the reader server and passes them to apply servers. The coordinator process name is `APnn`, where `nn` can include letters and numbers. The coordinator process is an Oracle background process.
- One or more **apply servers** that apply LCRs to database objects as DML or DDL statements or that pass the LCRs to their appropriate **apply handlers**. For non-LCR messages, the apply servers pass the messages to the **message handler**. Apply servers can also enqueue LCR and non-LCR messages into the **persistent queue** portion of a **queue** specified by the `DBMS_APPLY_ADM.SET_ENQUEUE_DESTINATION` procedure. Each apply server is a process. If an apply server encounters an error, then it then tries to resolve the error with a user-specified **conflict** handler or error handler. If an apply server cannot resolve an error, then it

rolls back the transaction and places the entire transaction, including all of its messages, in the error queue.

When an apply server commits a completed transaction, this transaction has been applied. When an apply server places a transaction in the error queue and commits, this transaction also has been applied.

The reader server and the apply server process names are *ASnn*, where *nn* can include letters and numbers. If a transaction being handled by an apply server has a dependency on another transaction that is not known to have been applied, then the apply server contacts the coordinator process and waits for instructions. The coordinator process monitors all of the apply servers to ensure that transactions are applied and committed in the correct order.

The following sections describe the possible states for each apply process component:

- [Reader Server States](#)
- [Coordinator Process States](#)
- [Apply Server States](#)

See Also:

- *Oracle Streams Replication Administrator's Guide* for more information about apply processes and dependencies

Reader Server States

The state of a reader server describes what the reader server is doing currently. You can view the state of the reader server for an apply process by querying the `V$STREAMS_APPLY_READER` dynamic performance view. The following reader server states are possible:

- `INITIALIZING` - Starting up
- `IDLE` - Performing no work
- `DEQUEUE MESSAGES` - Dequeueing messages from the apply process queue
- `SCHEDULE MESSAGES` - Computing dependencies between messages and assembling messages into transactions
- `SPILLING` - Spilling unapplied messages from memory to hard disk
- `PAUSED` - Waiting for a DDL LCR to be applied

See Also:

- ["Displaying Information About the Reader Server for Each Apply Process"](#) on page 25-6 for a query that displays the state of an apply process reader server

Coordinator Process States

The state of a coordinator process describes what the coordinator process is doing currently. You can view the state of a coordinator process by querying the `V$STREAMS_APPLY_COORDINATOR` dynamic performance view. The following coordinator process states are possible:

- `INITIALIZING` - Starting up
- `APPLYING` - Passing transactions to apply servers

- SHUTTING DOWN CLEANLY - Stopping without an error
- ABORTING - Stopping because of an apply error

See Also:

- ["Displaying General Information About Each Coordinator Process"](#) on page 25-9 for a query that displays the state of a coordinator process

Apply Server States

The state of an apply server describes what the apply server is doing currently. You can view the state of each apply server for an apply process by querying the `V$STREAMS_APPLY_SERVER` dynamic performance view. The following apply server states are possible:

- INITIALIZING - Starting up.
- IDLE - Performing no work.
- RECORD LOW-WATERMARK - Performing an administrative action that maintains information about the apply progress, which is used in the `ALL_APPLY_PROGRESS` and `DBA_APPLY_PROGRESS` data dictionary views.
- ADD PARTITION - Performing an administrative action that adds a partition that is used for recording information about in-progress transactions.
- DROP PARTITION - Performing an administrative action that drops a partition that was used to record information about in-progress transactions.
- EXECUTE TRANSACTION - Applying a transaction.
- WAIT COMMIT - Waiting to commit a transaction until all other transactions with a lower commit SCN are applied. This state is possible only if the `COMMIT_SERIALIZATION` apply process parameter is set to a value other than `none` and the `PARALELLISM` apply process parameter is set to a value greater than 1.
- WAIT DEPENDENCY - Waiting to apply an LCR in a transaction until another transaction, on which it has a dependency, is applied. This state is possible only if the `PARALELLISM` apply process parameter is set to a value greater than 1.
- WAIT FOR NEXT CHUNK - Waiting for the next set of LCRs for a large transaction.
- TRANSACTION CLEANUP - Cleaning up an applied transaction, which includes removing LCRs from the apply process queue.

See Also:

- ["Displaying Information About the Apply Servers for Each Apply Process"](#) on page 25-12 for a query that displays the state of each apply process apply server

Apply User

An apply process applies messages in the security domain of its **apply user**. The apply user dequeues all messages that satisfy the apply process **rule sets**. The apply user can apply messages directly to database objects. In addition, the apply user runs all **custom rule-based transformations** specified by the rules in these rule sets. The apply user also runs user-defined **apply handlers**.

The apply user must have the necessary privileges to apply changes, including the following privileges:

- EXECUTE privilege on the rule sets used by the apply process
- EXECUTE privilege on all custom rule-based transformation functions specified for rules in the **positive rule set**
- EXECUTE privilege on any apply handlers
- Privileges to dequeue messages from the apply process queue

An apply process can be associated with only one user, but one user can be associated with many apply processes.

See Also:

- "Configuring an Oracle Streams Administrator" on page 9-1 for information about the required privileges

Apply Process Creation

You can create an **apply process** using the DBMS_STREAMS_ADM package or the DBMS_APPLY_ADM package. Using the DBMS_STREAMS_ADM package to create an apply process is simpler because defaults are used automatically for some configuration options. Alternatively, using the DBMS_APPLY_ADM package to create an apply process is more flexible.

When you create an apply process by running the CREATE_APPLY procedure in the DBMS_APPLY_ADM package, you can specify nondefault values for the apply_captured, apply_database_link, and apply_tag parameters. You can use the procedures in the DBMS_STREAMS_ADM package or the DBMS_RULE_ADM package to add rules to a rule set for the apply process.

If you create more than one apply process in a database, then the apply processes are completely independent of each other. These apply processes do not synchronize with each other, even if they apply **LCRs** from the same **source database**.

Table 4–4 describes the differences between using the DBMS_STREAMS_ADM package and the DBMS_APPLY_ADM package for apply process creation.

Table 4–4 DBMS_STREAMS_ADM and DBMS_APPLY_ADM Apply Process Creation

DBMS_STREAMS_ADM Package	DBMS_APPLY_ADM Package
A rule set is created automatically for the apply process and rules can be added to the rule set automatically. The rule set is a positive rule set if the inclusion_rule parameter is set to TRUE (the default). It is a negative rule set if the inclusion_rule parameter is set to FALSE. You can use the procedures in the DBMS_STREAMS_ADM and DBMS_RULE_ADM package to manage rule sets and rules for the apply process after the apply process is created.	You create one or more rule sets and rules for the apply process either before or after it is created. You can use the procedures in the DBMS_RULE_ADM package to create rule sets and add rules to rule sets either before or after the apply process is created. You can use the procedures in the DBMS_STREAMS_ADM package to create rule sets and add rules to rule sets for the apply process after the apply process is created.
The apply process can apply messages only at the local database.	You specify whether the apply process applies messages at the local database or at a remote database during apply process creation.
Changes applied by the apply process generate tags in the redo log at the destination database with a value of 00 (double zero).	You specify the tag value for changes applied by the apply process during apply process creation. The default value for the tag is 00 (double zero).

See Also:

- ["Overview of Apply Process Creation"](#) on page 12-1
- *Oracle Streams Replication Administrator's Guide* for more information about Oracle Streams tags

Oracle Streams Data Dictionary for an Apply Process

When a database object is prepared for **instantiation** at a **source database**, an Oracle Streams data dictionary is populated automatically at the database where changes to the object are captured by a **capture process**. The Oracle Streams data dictionary is a multiversed copy of some of the information in the primary data dictionary at a source database. The Oracle Streams data dictionary maps object numbers, object version information, and internal column numbers from the source database into table names, column names, and column data types. This mapping keeps each **captured LCR** as small as possible because a captured LCR can often use numbers rather than names internally.

Unless a captured LCR is passed as a parameter to a **custom rule-based transformation** during capture or propagation, the mapping information in the Oracle Streams data dictionary at the source database is needed to interpret the contents of the LCR at any database that applies the captured LCR. To make this mapping information available to an **apply process**, Oracle automatically populates a multiversed Oracle Streams data dictionary at each **destination database** that has an Oracle Streams apply process. Oracle automatically propagates relevant information from the Oracle Streams data dictionary at the source database to all other databases that apply captured LCRs from the source database.

See Also:

- ["The Oracle Streams Data Dictionary"](#) on page 2-34
- ["Oracle Streams Data Dictionary for Propagations"](#) on page 3-19

Apply Process Parameters

After creation, an **apply process** is disabled so that you can set the apply process parameters for your environment before starting the process for the first time. Apply process parameters control the way an apply process operates. For example, the **parallelism apply process** parameter specifies the number of **apply servers** that can concurrently apply transactions, and the `time_limit` apply process parameter specifies the amount of time an apply process runs before it is shut down automatically. After you set the apply process parameters, you can start the apply process.

See Also:

- ["Setting an Apply Process Parameter"](#) on page 16-6
- *Oracle Database PL/SQL Packages and Types Reference* for detailed information about all of the apply process parameters

Multiple Apply Processes in a Single Database

If you run multiple **apply processes** in a single database, consider increasing the size of the System Global Area (SGA). Use the `SGA_MAX_SIZE` initialization parameter to increase the SGA size. Also, if the size of the **Oracle Streams pool** is not managed automatically in the database, then you should increase the size of the Oracle Streams

pool by 1 MB for each apply process parallelism. For example, if you have two apply processes running in a database, and the parallelism parameter is set to 4 for one of them and 1 for the other, then increase the Oracle Streams pool by 5 MB (4 + 1 = 5 parallelism).

Note: The size of the Oracle Streams pool is managed automatically if the `MEMORY_TARGET`, `MEMORY_MAX_TARGET`, or `SGA_TARGET` initialization parameter is set to a nonzero value.

See Also:

- [Configuring the Oracle Streams Pool](#) on page 9-9
- ["Setting Initialization Parameters Relevant to Oracle Streams"](#) on page 9-4 for more information about the `STREAMS_POOL_SIZE` initialization parameter

Persistent Apply Process Status Upon Database Restart

An **apply process** maintains a persistent status when the database running the apply process is shut down and restarted. For example, if an apply process is enabled when the database is shut down, then the apply process automatically starts when the database is restarted. Similarly, if an apply process is disabled or aborted when a database is shut down, then the apply process is not started and retains the disabled or aborted status when the database is restarted.

The Error Queue

The error queue contains all of the current apply errors for a database. If there are multiple **apply processes** in a database, then the error queue contains the apply errors for each apply process. To view information about apply errors, query the `DBA_APPLY_ERROR` data dictionary view or use Enterprise Manager.

The error queue stores information about transactions that could not be applied successfully by the apply processes running in a database. A transaction can include many **messages**. When an unhandled error occurs during apply, an apply process automatically moves all of the messages in the transaction that satisfy the apply process **rule sets** to the error queue.

You can correct the condition that caused an error and then reexecute the transaction that caused the error. For example, you might modify a row in a table to correct the condition that caused an error.

When the condition that caused the error has been corrected, you can either reexecute the transaction in the error queue using the `EXECUTE_ERROR` or `EXECUTE_ALL_ERRORS` procedure, or you can delete the transaction from the error queue using the `DELETE_ERROR` or `DELETE_ALL_ERRORS` procedure. These procedures are in the `DBMS_APPLY_ADM` package.

When you reexecute a transaction in the error queue, you can specify that the transaction be executed either by the user who originally placed the error in the error queue or by the user who is reexecuting the transaction. Also, the current Oracle Streams **tag** for the apply process is used when you reexecute a transaction in the error queue.

A reexecuted transaction uses any relevant **apply handlers** and **conflict resolution handlers**. If, to resolve the error, a row LCR in an error queue must be modified before it is executed, then you can configure a **DML handler** to process the row LCR that

caused the error in the error queue. In this case, the DML handler can modify the row LCR in some way to avoid a repetition of the same error. The row LCR is passed to the DML handler when you reexecute the error containing the row LCR.

The error queue contains information about errors encountered at the local **destination database** only. It does not contain information about errors for apply processes running in other databases in an Oracle Streams environment.

The error queue uses the **exception queues** in the database. When you create an ANYDATA queue using the `SET_UP_QUEUE` procedure in the `DBMS_STREAMS_ADM` package, the procedure creates a **queue table** for the queue if one does not already exist. When a queue table is created, an exception queue is created automatically for the queue table. Multiple queues can use a single queue table, and each queue table has one exception queue. Therefore, a single exception queue can store errors for multiple queues and multiple apply processes.

An exception queue only contains the apply errors for its queue table, but the Oracle Streams error queue contains information about all of the apply errors in each exception queue in a database. You should use the procedures in the `DBMS_APPLY_ADM` package to manage Oracle Streams apply errors. You should not dequeue apply errors from an exception queue directly.

Note: If a **messaging client** encounters an error when it is dequeuing messages, then the messaging client moves these messages to the exception queue associated with the its queue table. However, information about messaging client errors is not stored in the error queue. Only information about apply process errors is stored in the error queue.

See Also:

- ["Managing Apply Errors"](#) on page 16-19
- ["Checking for Apply Errors"](#) on page 25-16
- ["Displaying Detailed Information About Apply Errors"](#) on page 25-17
- ["Managing an Error Handler"](#) on page 16-13
- [Chapter 6, "How Rules Are Used in Oracle Streams"](#)
- *Oracle Database PL/SQL Packages and Types Reference* for more information about the `DBMS_APPLY_ADM` package
- *Oracle Database Reference* for more information about the `DBA_APPLY_ERROR` data dictionary view

Explicit Consumption with a Messaging Client

A **messaging client** dequeues messages from its **persistent queue** when it is invoked by an application or a user. You use **rules** to specify which messages in the **queue** are dequeued by a messaging client. These messages can be **persistent LCRs** or **persistent user messages**.

You can create a messaging client by specifying `dequeue` for the `streams_type` parameter when you run one of the following procedures in the `DBMS_STREAMS_ADM` package:

- `ADD_MESSAGE_RULE`
- `ADD_TABLE_RULES`
- `ADD_SUBSET_RULES`
- `ADD_SCHEMA_RULES`
- `ADD_GLOBAL_RULES`

When you create a messaging client, you specify the name of the messaging client and the `ANYDATA` queue from which the messaging client dequeues messages. These procedures can also add rules to the **positive rule set** or **negative rule set** of a messaging client. You specify the message type for each rule, and a single messaging client can dequeue messages of different types.

The user who creates a messaging client is granted the privileges to dequeue from the queue using the messaging client. This user is the **messaging client user**. The messaging client user can dequeue messages that satisfy the messaging client **rule sets**. A messaging client can be associated with only one user, but one user can be associated with many messaging clients.

Figure 4–2 shows a messaging client dequeuing messages.

Figure 4–2 Messaging Client

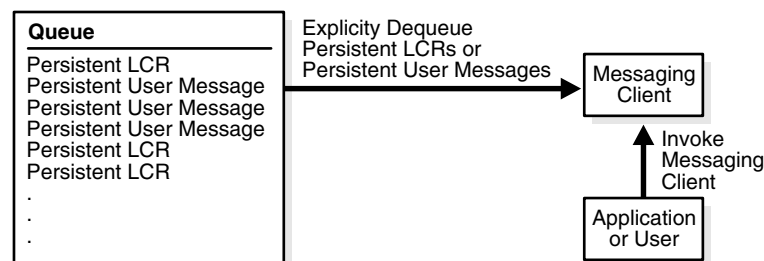

See Also:

- [Chapter 6, "How Rules Are Used in Oracle Streams"](#)
- ["Configuring a Messaging Client and Message Notification"](#) on page 13-5
- ["Messaging Client Restrictions"](#) on page B-15
- *Oracle Streams Advanced Queuing User's Guide* for information about the `DBMS_AQ` package

Explicit Consumption with Manual Dequeue

With **explicit consumption** with manual dequeue, an application explicitly dequeues **buffered LCRs**, **persistent LCRs**, **buffered user messages**, or **persistent user messages** manually and processes them. The queue from which the messages are dequeued can be an **ANYDATA queue** or a **typed queue**. You can use either the `DBMS_STREAMS_MESSAGING` package or the `DBMS_AQ` package to dequeue messages.

The dequeue features available with Oracle Streams Advanced Queuing include the following:

- Dequeue from a buffered queue or a persistent queue
- Concurrent dequeues

- Dequeue methods
- Dequeue modes
- Dequeue an array of messages
- Message states
- Navigation of messages in dequeuing
- Waiting for messages
- Retries with delays
- Optional transaction protection
- Exception queues

See Also:

- *Oracle Streams Advanced Queuing User's Guide* for information about these features and for information about other features available with Oracle Streams Advanced Queuing
- [Chapter 13, "Configuring Oracle Streams Messaging Environments"](#)
- ["Restrictions for Buffered Messaging"](#) on page B-11

The following topics contain information about rules.

- [The Components of a Rule](#)
- [Rule Set Evaluation](#)
- [Database Objects and Privileges Related to Rules](#)

See Also:

- [Chapter 6, "How Rules Are Used in Oracle Streams"](#)
- [Chapter 17, "Managing Rules"](#)
- [Chapter 33, "Rule-Based Application Example"](#)

The Components of a Rule

A **rule** is a database object that enables a client to perform an action when an event occurs and a condition is satisfied. A rule consists of the following components:

- [Rule Condition](#)
- [Rule Evaluation Context](#) (optional)
- [Rule Action Context](#) (optional)

Each rule is specified as a condition that is similar to the condition in the `WHERE` clause of a SQL query. You can group related rules together into **rule sets**. A single rule can be in one rule set, multiple rule sets, or no rule sets.

Rule sets are evaluated by a **rules engine**, which is a built-in part of Oracle. Both user-created applications and Oracle features, such as Oracle Streams, can be clients of the rules engine.

Note: A rule must be in a rule set for it to be evaluated.

Rule Condition

A **rule condition** combines one or more **expressions** and conditions and returns a Boolean value, which is a value of `TRUE`, `FALSE`, or `NULL` (unknown). An **expression** is a combination of one or more values and operators that evaluate to a value. A value can be data in a table, data in variables, or data returned by a SQL function or a PL/SQL function. For example, the following expression includes only a single value:

```
salary
```

The following expression includes two values (`salary` and `.1`) and an operator (`*`):

```
salary * .1
```

The following condition consists of two expressions (`salary` and `3800`) and a condition (`=`):

```
salary = 3800
```

This logical condition evaluates to `TRUE` for a given row when the `salary` column is `3800`. Here, the value is data in the `salary` column of a table.

A single rule condition can include more than one condition combined with the `AND`, `OR`, and `NOT` logical conditions to form a compound condition. A logical condition combines the results of two component conditions to produce a single result based on them or to invert the result of a single condition. For example, consider the following compound condition:

```
salary = 3800 OR job_title = 'Programmer'
```

This rule condition contains two conditions joined by the `OR` logical condition. If either condition evaluates to `TRUE`, then the rule condition evaluates to `TRUE`. If the logical condition were `AND` instead of `OR`, then both conditions must evaluate to `TRUE` for the entire rule condition to evaluate to `TRUE`.

Variables in Rule Conditions

Rule conditions can contain variables. When you use variables in rule conditions, precede each variable with a colon (`:`). The following is an example of a variable used in a rule condition:

```
:x = 55
```

Variables let you refer to data that is not stored in a table. A variable can also improve performance by replacing a commonly occurring expression. Performance can improve because, instead of evaluating the same expression multiple times, the variable is evaluated once.

A rule condition can also contain an evaluation of a call to a subprogram. Such a condition is evaluated in the same way as other conditions. That is, it evaluates to a value of `TRUE`, `FALSE`, or `NULL` (unknown). The following is an example of a condition that contains a call to a simple function named `is_manager` that determines whether an employee is a manager:

```
is_manager(employee_id) = 'Y'
```

Here, the value of `employee_id` is determined by data in a table where `employee_id` is a column.

You can use user-defined types for variables. Therefore, variables can have attributes. When a variable has attributes, each attribute contains partial data for the variable. In rule conditions, you specify attributes using dot notation. For example, the following condition evaluates to `TRUE` if the value of attribute `z` in variable `y` is `9`:

```
:y.z = 9
```

Note: A rule cannot have a `NULL` (or empty) rule condition.

See Also:

- *Oracle Database SQL Language Reference* for more information about conditions, expressions, and operators
- *Oracle Database Object-Relational Developer's Guide* for more information about user-defined types

Simple Rule Conditions

A simple rule condition is a condition that has one of the following forms:

- *simple_rule_expression condition constant*
- *constant condition simple_rule_expression*
- *constant condition constant*

Simple Rule Expressions In a simple rule condition, a *simple_rule_expression* is one of the following:

- Table column.
- Variable.
- Variable attribute.
- Method result where the method either takes no arguments or constant arguments and the method result can be returned by the variable method function, so that the expression is one of the data types supported for simple rules. Such methods include LCR member subprograms that meet these requirements, such as `GET_TAG`, `GET_VALUE`, `GET_COMPATIBLE`, `GET_EXTRA_ATTRIBUTE`, and so on.

For table columns, variables, variable attributes, and method results, the following data types can be used in simple rule conditions:

- VARCHAR2
- NVARCHAR2
- NUMBER
- DATE
- BINARY_FLOAT
- BINARY_DOUBLE
- TIMESTAMP
- TIMESTAMP WITH TIME ZONE
- TIMESTAMP WITH LOCAL TIME ZONE
- RAW
- CHAR

Use of other data types in expressions results in nonsimple rule conditions.

Conditions In a simple rule condition, a *condition* is one of the following:

- <=
- <
- =
- >

- `>=`
- `!=`
- `IS NULL`
- `IS NOT NULL`

Use of other conditions results in nonsimple rule conditions.

Constants A *constant* is a fixed value. A constant can be:

- A number, such as 12 or 5.4
- A character, such as x or \$
- A character string, such as "this is a string"

Examples of Simple Rule Conditions The following conditions are simple rule conditions, assuming the data types used in expressions are supported in simple rule conditions:

- `tab1.col = 5`
- `tab2.col != 5`
- `:v1 > 'aaa'`
- `:v2.a1 < 10.01`
- `:v3.m() = 10`
- `:v4 IS NOT NULL`
- `1 = 1`
- `'abc' > 'AB'`
- `:date_var < to_date('04-01-2004, 14:20:17', 'mm-dd-yyyy, hh24:mi:ss')`
- `:adt_var.ts_attribute >= to_timestamp('04-01-2004, 14:20:17 PST', 'mm-dd-yyyy, hh24:mi:ss TZR')`
- `:my_var.my_to_upper('abc') = 'ABC'`

Rules with simple rule conditions are called simple rules. You can combine two or more simple conditions with the logical conditions AND and OR for a rule, and the rule remains simple. For example, rules with the following conditions are simple rules:

- `tab1.col = 5 AND :v1 > 'aaa'`
- `tab1.col = 5 OR :v1 > 'aaa'`

However, using the NOT logical condition in a rule condition causes the rule to be nonsimple.

Benefits of Simple Rules Simple rules are important for the following reasons:

- Simple rules are indexed by the **rules engine** internally.
- Simple rules can be evaluated without executing SQL.
- Simple rules can be evaluated with partial data.

When a client uses the `DBMS_RULE.EVALUATE` procedure to evaluate an event, the client can specify that only simple rules should be evaluated by specifying `TRUE` for the `simple_rules_only` parameter.

See Also:

- *Oracle Database SQL Language Reference* for more information about conditions and logical conditions
- *Oracle Database PL/SQL Packages and Types Reference* for more information about LCR types and their member subprograms

Rule Evaluation Context

An **evaluation context** is a database object that defines external data that can be referenced in **rule conditions**. The external data can exist as variables, table data, or both. The following analogy might be helpful: If the rule condition were the `WHERE` clause in a SQL query, then the external data in the evaluation context would be the tables and bind variables referenced in the `FROM` clause of the query. That is, the **expressions** in the rule condition should reference the tables, table aliases, and variables in the evaluation context to make a valid `WHERE` clause.

A rule evaluation context provides the necessary information for interpreting and evaluating the rule conditions that reference external data. For example, if a rule refers to a variable, then the information in the rule evaluation context must contain the variable type. Or, if a rule refers to a table alias, then the information in the evaluation context must define the table alias.

The objects referenced by a rule are determined by the rule evaluation context associated with it. The rule owner must have the necessary privileges to access these objects, such as `SELECT` privilege on tables, `EXECUTE` privilege on types, and so on. The rule condition is resolved in the schema that owns the evaluation context.

For example, consider a rule evaluation context named `hr_evaluation_context` that contains the following information:

- Table alias `dep` corresponds to the `hr.departments` table.
- Variables `loc_id1` and `loc_id2` are both of type `NUMBER`.

The `hr_evaluation_context` rule evaluation context provides the necessary information for evaluating the following rule condition:

```
dep.location_id IN (:loc_id1, :loc_id2)
```

In this case, the rule condition evaluates to `TRUE` for a row in the `hr.departments` table if that row has a value in the `location_id` column that corresponds to either of the values passed in by the `loc_id1` or `loc_id2` variables. The rule cannot be interpreted or evaluated properly without the information in the `hr_evaluation_context` rule evaluation context. Also, notice that dot notation is used to specify the column `location_id` in the `dep` table alias.

Note: Views are not supported as base tables in evaluation contexts.

Explicit and Implicit Variables

The value of a variable referenced in a rule condition can be explicitly specified when the rule is evaluated, or the value of a variable can be implicitly available given the event.

Explicit variables are supplied by the caller at evaluation time. These values are specified by the `variable_values` parameter when the `DBMS_RULE.EVALUATE` procedure is run.

Implicit variables are not given a value supplied by the caller at evaluation time. The value of an implicit variable is obtained by calling the variable value function. You define this function when you specify the `variable_types` list during the creation of an evaluation context using the `CREATE_EVALUATION_CONTEXT` procedure in the `DBMS_RULE_ADM` package. If the value for an implicit variable is specified during evaluation, then the specified value overrides the value returned by the variable value function.

Specifically, the `variable_types` list is of type `SYS.RE$VARIABLE_TYPE_LIST`, which is a list of variables of type `SYS.RE$VARIABLE_TYPE`. Within each instance of `SYS.RE$VARIABLE_TYPE` in the list, the function used to determine the value of an implicit variable is specified as the `variable_value_function` attribute.

Whether variables are explicit or implicit is the choice of the designer of the application using the **rules engine**. The following are reasons for using an implicit variable:

- The caller of the `DBMS_RULE.EVALUATE` procedure does not need to know anything about the variable, which can reduce the complexity of the application using the rules engine. For example, a variable can call a function that returns a value based on the data being evaluated.
- The caller might not have `EXECUTE` privileges on the variable value function.
- The caller of the `DBMS_RULE.EVALUATE` procedure does not know the variable value based on the event, which can improve security if the variable value contains confidential information.
- The variable will be used infrequently, and the variable's value always can be derived if necessary. Making such variables implicit means that the caller of the `DBMS_RULE.EVALUATE` procedure does not need to specify many uncommon variables.

For example, in the following rule condition, the values of variable `x` and variable `y` could be specified explicitly, but the value of the variable `max` could be returned by running the `max` function:

```
:x = 4 AND :y < :max
```

Alternatively, variable `x` and `y` could be implicit variables, and variable `max` could be an explicit variable. So, there is no syntactic difference between explicit and implicit variables in the rule condition. You can determine whether a variable is explicit or implicit by querying the `DBA_EVALUATION_CONTEXT_VARS` data dictionary view. For explicit variables, the `VARIABLE_VALUE_FUNCTION` field is `NULL`. For implicit variables, this field contains the name of the function called by the implicit variable.

See Also:

- *Oracle Database PL/SQL Packages and Types Reference* for more information about the `DBMS_RULE` and `DBMS_RULE_ADM` packages, and for more information about the Oracle-supplied rule types
- *Oracle Database Reference* for more information about the `DBA_EVALUATION_CONTEXT_VARS` data dictionary view

Evaluation Context Association with Rule Sets and Rules

To be evaluated, each rule must be associated with an evaluation context or must be part of a **rule set** that is associated with an evaluation context. A single evaluation

context can be associated with multiple rules or rule sets. The following list describes which evaluation context is used when a rule is evaluated:

- If an evaluation context is associated with a rule, then it is used for the rule whenever the rule is evaluated, and any evaluation context associated with the rule set being evaluated is ignored.
- If a rule does not have an evaluation context, but an evaluation context was specified for the rule when it was added to a rule set using the `ADD_RULE` procedure in the `DBMS_RULE_ADM` package, then the evaluation context specified in the `ADD_RULE` procedure is used for the rule when the rule set is evaluated.
- If no rule evaluation context is associated with a rule and none was specified by the `ADD_RULE` procedure, then the evaluation context of the rule set is used for the rule when the rule set is evaluated.

Note: If a rule does not have an evaluation context, and you try to add it to a rule set that does not have an evaluation context, then an error is raised, unless you specify an evaluation context when you run the `ADD_RULE` procedure.

Evaluation Function

You have the option of creating an evaluation function to be run with a rule evaluation context. You can use an evaluation function for the following reasons:

- You want to bypass the rules engine and instead evaluate events using the evaluation function.
- You want to filter events so that some events are evaluated by the evaluation function and other events are evaluated by the rules engine.

You associate a function with a rule evaluation context by specifying the function name for the `evaluation_function` parameter when you create the rule evaluation context with the `CREATE_EVALUATION_CONTEXT` procedure in the `DBMS_RULE_ADM` package. The rules engine invokes the evaluation function during the evaluation of any rule set that uses the evaluation context.

The `DBMS_RULE.EVALUATE` procedure is overloaded. The function must have each parameter in one of the `DBMS_RULE.EVALUATE` procedures, and the type of each parameter must be same as the type of the corresponding parameter in the `DBMS_RULE.EVALUATE` procedure, but the names of the parameters can be different.

An evaluation function has the following return values:

- `DBMS_RULE_ADM.EVALUATION_SUCCESS`: The user specified evaluation function completed the rule set evaluation successfully. The rules engine returns the results of the evaluation obtained by the evaluation function to the rules engine client using the `DBMS_RULE.EVALUATE` procedure.
- `DBMS_RULE_ADM.EVALUATION_CONTINUE`: The rules engine evaluates the rule set as if there were no evaluation function. The evaluation function is not used, and any results returned by the evaluation function are ignored.
- `DBMS_RULE_ADM.EVALUATION_FAILURE`: The user-specified evaluation function failed. Rule set evaluation stops, and an error is raised.

If you always want to bypass the rules engine, then the evaluation function should return either `EVALUATION_SUCCESS` or `EVALUATION_FAILURE`. However, if you want to filter events so that some events are evaluated by the evaluation function and other events are evaluated by the rules engine, then the evaluation function can return

all three return values, and it returns `EVALUATION_CONTINUE` when the rules engine should be used for evaluation.

If you specify an evaluation function for an evaluation context, then the evaluation function is run during evaluation when the evaluation context is used by a rule set or rule.

See Also: *Oracle Database PL/SQL Packages and Types Reference* for more information about the evaluation function specified in the `DBMS_RULE_ADM.CREATE_EVALUATION_CONTEXT` procedure and for more information about the overloaded `DBMS_RULE.EVALUATE` procedure

Rule Action Context

An **action context** contains optional information associated with a rule that is interpreted by the client of the **rules engine** when the rule is evaluated for an event. The client of the rules engine can be a user-created application or an internal feature of Oracle, such as Oracle Streams. Each rule has only one action context. The information in an action context is of type `SYS.RE$NV_LIST`, which is a type that contains an array of name-value pairs.

The rule action context information provides a context for the action taken by a client of the rules engine when a rule evaluates to `TRUE` or `MAYBE`. The rules engine does not interpret the action context. Instead, it returns the action context, and a client of the rules engine can interpret the action context information.

For example, suppose an event is defined as the addition of a new employee to a company. If the employee information is stored in the `hr.employees` table, then the event occurs whenever a row is inserted into this table. The company wants to specify that a number of actions are taken when a new employee is added, but the actions depend on which department the employee joins. One of these actions is that the employee is registered for a course relating to the department.

In this scenario, the company can create a rule for each department with an appropriate action context. Here, an action context returned when a rule evaluates to `TRUE` specifies the number of a course that an employee should take. Here are parts of the **rule condition**s and the action contexts for three departments:

Rule Name	Part of the Rule Condition	Action Context Name-Value Pair
<code>rule_dep_10</code>	<code>department_id = 10</code>	<code>course_number, 1057</code>
<code>rule_dep_20</code>	<code>department_id = 20</code>	<code>course_number, 1215</code>
<code>rule_dep_30</code>	<code>department_id = 30</code>	<code>NULL</code>

These action contexts return the following instructions to the client application:

- The action context for the `rule_dep_10` rule instructs the client application to enroll the new employee in course number 1057.
- The action context for the `rule_dep_20` rule instructs the client application to enroll the new employee in course number 1215.
- The `NULL` action context for the `rule_dep_30` rule instructs the client application not to enroll the new employee in any course.

Each action context can contain zero or more name-value pairs. If an action context contains more than one name-value pair, then each name in the list must be unique. In this example, the client application to which the rules engine returns the action context

registers the new employee in the course with the returned course number. The client application does not register the employee for a course if a NULL action context is returned or if the action context does not contain a course number.

If multiple clients use the same rule, or if you want an action context to return more than one name-value pair, then you can list more than one name-value pair in an action context. For example, suppose the company also adds a new employee to a department electronic mailing list. In this case, the action context for the `rule_dep_10` rule might contain two name-value pairs:

Name	Value
course_number	1057
dist_list	admin_list

The following are considerations for names in name-value pairs:

- If different applications use the same action context, then use different names or prefixes of names to avoid naming conflicts.
- Do not use \$ and # in names because they can cause conflicts with Oracle-supplied action context names.

You add a name-value pair to an action context using the `ADD_PAIR` member procedure of the `RE$NV_LIST` type. You remove a name-value pair from an action context using the `REMOVE_PAIR` member procedure of the `RE$NV_LIST` type. If you want to modify an existing name-value pair in an action context, then you should first remove it using the `REMOVE_PAIR` member procedure and then add an appropriate name-value pair using the `ADD_PAIR` member procedure.

An action context cannot contain information of the following data types:

- CLOB
- NCLOB
- BLOB
- LONG
- LONG RAW

In addition, an action context cannot contain object types with attributes of these data types, or object types that use type evolution or type inheritance.

Note: Oracle Streams uses action contexts for **custom rule-based transformations** and, when **subset rules** are specified, for internal transformations that might be required on LCRs containing UPDATE operations. Oracle Streams also uses action contexts to specify a **destination queue** into which an **apply process** enqueues **messages** that satisfy the rule. In addition, Oracle Streams uses action contexts to specify whether or not a message that satisfies an apply process rule is executed by the apply process.

See Also:

- ["Oracle Streams and Action Contexts"](#) on page 6-40
- ["Creating a Rule with an Action Context"](#) on page 17-6 and ["Altering a Rule"](#) on page 17-6 for examples that add and modify name-value pairs
- *Oracle Database PL/SQL Packages and Types Reference* for more information about the `RE$NV_LIST` type

Rule Set Evaluation

The **rules engine** evaluates **rule sets** against an event. An event is an occurrence that is defined by the client of the rules engine. The client initiates evaluation of an event by calling the `DBMS_RULE.EVALUATE` procedure. This procedure enables the client to send some information about the event to the rules engine for evaluation against a rule set. The event itself can have more information than the information that the client sends to the rules engine.

The following information is specified by the client when it calls the `DBMS_RULE.EVALUATE` procedure:

- The name of the rule set that contains the rules to use to evaluate the event.
- The **evaluation context** to use for evaluation. Only rules that use the specified evaluation context are evaluated.
- Table values and variable values. The table values contain rowids that refer to the data in table rows, and the variable values contain the data for explicit variables. Values specified for implicit variables override the values that might be obtained using a variable value function. If a specified variable has attributes, then the client can send a value for the entire variable, or the client can send values for any number of the attributes of the variable. However, clients cannot specify attribute values if the value of the entire variable is specified.
- An optional **event context**. An event context is a varray of type `SYS.RE$NV_LIST` that contains name-value pairs that contain information about the event. This optional information is not used directly or interpreted by the rules engine. Instead, it is passed to client callbacks, such as an evaluation function, a variable value function (for implicit variables), and a variable method function.

The client can also send other information about how to evaluate an event against the rule set using the `DBMS_RULE.EVALUATE` procedure. For example, the caller can specify if evaluation must stop as soon as the first `TRUE` rule or the first `MAYBE` rule (if there are no `TRUE` rules) is found.

If the client wants all of the rules that evaluate to `TRUE` or `MAYBE` returned to it, then the client can specify whether evaluation results should be sent back in a complete list of the rules that evaluated to `TRUE` or `MAYBE`, or evaluation results should be sent back iteratively. When evaluation results are sent iteratively to the client, the client can retrieve each rule that evaluated to `TRUE` or `MAYBE` one by one using the `GET_NEXT_HIT` function in the `DBMS_RULE` package.

The rules engine uses the rules in the specified rule set for evaluation and returns the results to the client. The rules engine returns rules using two `OUT` parameters in the `EVALUATE` procedure. This procedure is overloaded and the two `OUT` parameters are different in each version of the procedure:

- One version of the procedure returns all of the rules that evaluate to TRUE in one list or all of the rules that evaluate to MAYBE in one list, and the two OUT parameters for this version of the procedure are `true_rules` and `maybe_rules`. That is, the `true_rules` parameter returns rules in one list that evaluate to TRUE, and the `maybe_rules` parameter returns rules in one list that might evaluate to TRUE given more information.
- The other version of the procedure returns all of the rules that evaluate to TRUE or MAYBE iteratively at the request of the client, and the two OUT parameters for this version of the procedure are `true_rules_iterator` and `maybe_rules_iterator`. That is, the `true_rules_iterator` parameter returns rules that evaluate to TRUE one by one, and the `maybe_rules_iterator` parameter returns rules one by one that might evaluate to TRUE given more information.

Rule Set Evaluation Process

Figure 5–1 shows the **rule set** evaluation process:

1. A client-defined event occurs.
2. The client initiates evaluation of a rule set by sending information about an event to the **rules engine** using the `DBMS_RULE.EVALUATE` procedure.
3. The rules engine evaluates the rule set for the event using the relevant **evaluation context**. The client specifies both the rule set and the evaluation context in the call to the `DBMS_RULE.EVALUATE` procedure. Only rules that are in the specified rule set, and use the specified evaluation context, are used for evaluation.
4. The rules engine obtains the results of the evaluation. Each rule evaluates to either TRUE, FALSE, or NULL (unknown).
5. The rules engine returns rules that evaluated to TRUE to the client, either in a complete list or one by one. Each returned rule is returned with its entire **action context**, which can contain information or can be NULL.
6. The client performs actions based on the results returned by the rules engine. The rules engine does not perform actions based on rule evaluations.

Figure 5–1 Rule Set Evaluation

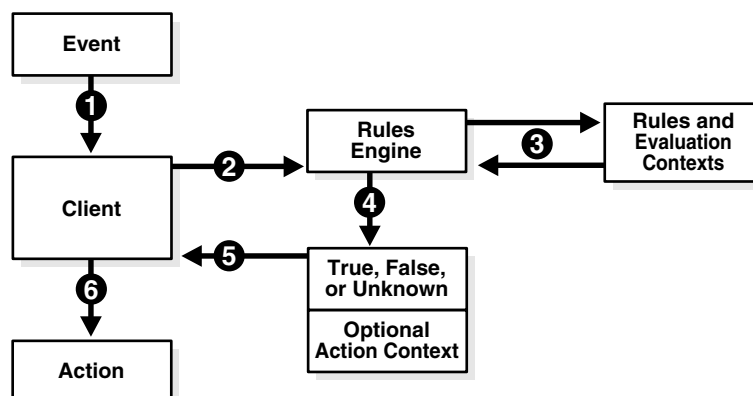

See Also:

- *Oracle Database PL/SQL Packages and Types Reference* for more information about the `DBMS_RULE.EVALUATE` procedure
- ["Rule Conditions with Undefined Variables that Evaluate to NULL"](#) on page 6-48 for information about [Oracle Streams clients](#) and `maybe_rules`

Partial Evaluation

Partial evaluation occurs when the `DBMS_RULE.EVALUATE` procedure is run without data for all the tables and variables in the specified **evaluation context**. During partial evaluation, some rules can reference columns, variables, or attributes that are unavailable, while some other rules can reference only available data.

For example, consider a scenario where only the following data is available during evaluation:

- Column `tab1.col = 7`
- Attribute `v1.a1 = 'ABC'`

The following rules are used for evaluation:

- Rule R1 has the following condition:
`(tab1.col = 5)`
- Rule R2 has the following condition:
`(:v1.a2 > 'aaa')`
- Rule R3 has the following condition:
`(:v1.a1 = 'ABC') OR (:v2 = 5)`
- Rule R4 has the following condition:
`(:v1.a1 = UPPER('abc'))`

Given this scenario, R1 and R4 reference available data, R2 references unavailable data, and R3 references available data and unavailable data.

Partial evaluation always evaluates only simple conditions within a rule. If the **rule condition** has parts which are not simple, then the rule might or might not be evaluated completely, depending on the extent to which data is available. If a rule is not completely evaluated, then it can be returned as a `MAYBE` rule.

Given the rules in this scenario, R1 and the first part of R3 are evaluated, but R2 and R4 are not evaluated. The following results are returned to the client:

- R1 evaluates to `FALSE`, and so is not returned.
- R2 is returned as `MAYBE` because information about attribute `v1.a2` is not available.
- R3 is returned as `TRUE` because R3 is a simple rule and the value of `v1.a1` matches the first part of the rule condition.
- R4 is returned as `MAYBE` because the rule condition is not simple. The client must supply the value of variable `v1` for this rule to evaluate to `TRUE` or `FALSE`.

See Also: ["Simple Rule Conditions"](#) on page 5-3

Database Objects and Privileges Related to Rules

You can create the following types of database objects directly using the `DBMS_RULE_ADM` package:

- Evaluation contexts
- Rules
- Rule sets

You can create rules and **rule sets** indirectly using the `DBMS_STREAMS_ADM` package. You control the privileges for these database objects using the following procedures in the `DBMS_RULE_ADM` package:

- `GRANT_OBJECT_PRIVILEGE`
- `GRANT_SYSTEM_PRIVILEGE`
- `REVOKE_OBJECT_PRIVILEGE`
- `REVOKE_SYSTEM_PRIVILEGE`

To allow a user to create rule sets, rules, and **evaluation contexts** in the user's own schema, grant the user the following system privileges:

- `CREATE_RULE_SET_OBJ`
- `CREATE_RULE_OBJ`
- `CREATE_EVALUATION_CONTEXT_OBJ`

These privileges, and the privileges discussed in the following sections, can be granted to the user directly or through a role.

This section contains these topics:

- [Privileges for Creating Database Objects Related to Rules](#)
- [Privileges for Altering Database Objects Related to Rules](#)
- [Privileges for Dropping Database Objects Related to Rules](#)
- [Privileges for Placing Rules in a Rule Set](#)
- [Privileges for Evaluating a Rule Set](#)
- [Privileges for Using an Evaluation Context](#)

Note: When you grant a privilege on "ANY" object (for example, `ALTER_ANY_RULE`), and the initialization parameter `O7_DICTIONARY_ACCESSIBILITY` is set to `FALSE`, you give the user access to that type of object in all schemas except the `SYS` schema. By default, the initialization parameter `O7_DICTIONARY_ACCESSIBILITY` is set to `FALSE`.

If you want to grant access to an object in the `SYS` schema, then you can grant object privileges explicitly on the object. Alternatively, you can set the `O7_DICTIONARY_ACCESSIBILITY` initialization parameter to `TRUE`. Then privileges granted on "ANY" object will allow access to any schema, including `SYS`.

See Also:

- ["The Components of a Rule"](#) on page 5-1 for more information about these database objects
- *Oracle Database PL/SQL Packages and Types Reference* for more information about the system and object privileges for these database objects
- *Oracle Database Concepts* and *Oracle Database Security Guide* for general information about user privileges
- [Chapter 6, "How Rules Are Used in Oracle Streams"](#) for more information about creating rules and rule sets indirectly using the DBMS_STREAMS_ADM package

Privileges for Creating Database Objects Related to Rules

To create an **evaluation context**, rule, or **rule set** in a schema, a user must meet at least one of the following conditions:

- The schema must be the user's own schema, and the user must be granted the create system privilege for the type of database object being created. For example, to create a rule set in the user's own schema, a user must be granted the CREATE_RULE_SET_OBJ system privilege.
- The user must be granted the create any system privilege for the type of database object being created. For example, to create an evaluation context in any schema, a user must be granted the CREATE_ANY_EVALUATION_CONTEXT system privilege.

Note: When creating a rule with an evaluation context, the rule owner must have privileges on all objects accessed by the evaluation context.

Privileges for Altering Database Objects Related to Rules

To alter an **evaluation context**, rule, or **rule set**, a user must meet at least one of the following conditions:

- The user must own the database object.
- The user must be granted the alter object privilege for the database object if it is in another user's schema. For example, to alter a rule set in another user's schema, a user must be granted the ALTER_ON_RULE_SET object privilege on the rule set.
- The user must be granted the alter any system privilege for the database object. For example, to alter a rule in any schema, a user must be granted the ALTER_ANY_RULE system privilege.

Privileges for Dropping Database Objects Related to Rules

To drop an **evaluation context**, rule, or **rule set**, a user must meet at least one of the following conditions:

- The user must own the database object.
- The user must be granted the drop any system privilege for the database object. For example, to drop a rule set in any schema, a user must be granted the DROP_ANY_RULE_SET system privilege.

Privileges for Placing Rules in a Rule Set

This section describes the privileges required to place a rule in a **rule set**. The user must meet at least one of the following conditions for the rule:

- The user must own the rule.
- The user must be granted the execute object privilege on the rule if the rule is in another user's schema. For example, to place a rule named `depts` in the `hr` schema in a rule set, a user must be granted the `EXECUTE_ON_RULE` privilege for the `hr.depts` rule.
- The user must be granted the execute any system privilege for rules. For example, to place any rule in a rule set, a user must be granted the `EXECUTE_ANY_RULE` system privilege.

The user also must meet at least one of the following conditions for the rule set:

- The user must own the rule set.
- The user must be granted the alter object privilege on the rule set if the rule set is in another user's schema. For example, to place a rule in the `human_resources` rule set in the `hr` schema, a user must be granted the `ALTER_ON_RULE_SET` privilege for the `hr.human_resources` rule set.
- The user must be granted the alter any system privilege for rule sets. For example, to place a rule in any rule set, a user must be granted the `ALTER_ANY_RULE_SET` system privilege.

In addition, the rule owner must have privileges on all objects referenced by the rule. These privileges are important when the rule does not have an **evaluation context** associated with it.

Privileges for Evaluating a Rule Set

To evaluate a **rule set**, a user must meet at least one of the following conditions:

- The user must own the rule set.
- The user must be granted the execute object privilege on the rule set if it is in another user's schema. For example, to evaluate a rule set named `human_resources` in the `hr` schema, a user must be granted the `EXECUTE_ON_RULE_SET` privilege for the `hr.human_resources` rule set.
- The user must be granted the execute any system privilege for rule sets. For example, to evaluate any rule set, a user must be granted the `EXECUTE_ANY_RULE_SET` system privilege.

Granting `EXECUTE` object privilege on a rule set requires that the grantor have the `EXECUTE` privilege specified `WITH GRANT OPTION` on all rules currently in the rule set.

Privileges for Using an Evaluation Context

To use an **evaluation context** in a rule or a **rule set**, the user who owns the rule or rule set must meet at least one of the following conditions for the evaluation context:

- The user must own the evaluation context.
- The user must be granted the `EXECUTE_ON_EVALUATION_CONTEXT` privilege on the evaluation context, if it is in another user's schema.
- The user must be granted the `EXECUTE_ANY_EVALUATION_CONTEXT` system privilege for evaluation contexts.

How Rules Are Used in Oracle Streams

The following topics contain information about how **rules** are used in Oracle Streams:

- [Overview of How Rules Are Used in Oracle Streams](#)
- [Rule Sets and Rule Evaluation of Messages](#)
- [System-Created Rules](#)
- [Evaluation Contexts Used in Oracle Streams](#)
- [Oracle Streams and Event Contexts](#)
- [Oracle Streams and Action Contexts](#)
- [User-Created Rules, Rule Sets, and Evaluation Contexts](#)

See Also:

- [Chapter 5, "Rules"](#) for more information about rules
- [Chapter 17, "Managing Rules"](#)
- [Chapter 26, "Monitoring Rules"](#)
- ["Troubleshooting Problems with Rules and Rule-Based Transformations"](#) on page 20-18

Overview of How Rules Are Used in Oracle Streams

In Oracle Streams, each of the following mechanisms is called an **Oracle Streams client** because each one is a client of a **rules engine** (when the mechanism is associated with one or more **rule sets**):

- Capture process
- Synchronous capture
- Propagation
- Apply process
- Messaging client

Except for **synchronous capture**, each of these clients can be associated with at most two rule sets: a **positive rule set** and a **negative rule set**. A synchronous capture can be associated with at most one positive rule set. A synchronous capture cannot be associated with a negative rule set.

A single rule set can be used by multiple **capture processes**, synchronous captures, **propagations**, **apply processes**, and **messaging clients** within the same database. Also,

a single rule set can be a positive rule set for one Oracle Streams client and a negative rule set for another Oracle Streams client.

Figure 6–1 illustrates how multiple clients of a rules engine can use one rule set.

Figure 6–1 One Rule Set Can Be Used by Multiple Clients of a Rules Engine

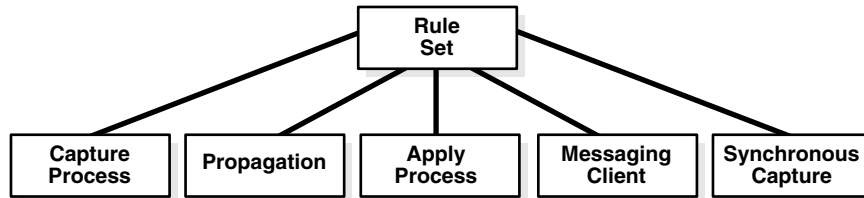

An Oracle Streams client performs a task if a **message** satisfies its rule sets. In general, a message satisfies the rule sets for an Oracle Streams client if *no rules* in the negative rule set evaluate to `TRUE` for the message, and *at least one rule* in the positive rule set evaluates to `TRUE` for the message.

"Rule Sets and Rule Evaluation of Messages" on page 6-3 contains more detailed information about how a message satisfies the rule sets for an Oracle Streams client, including information about Oracle Streams client behavior when one or more rule sets are not specified.

You use rule sets in Oracle Streams in the following ways:

- Specify the changes that a capture process captures from the redo log or discards. That is, if a change found in the redo log satisfies the rule sets for a capture process, then the capture process captures the change. If a change found in the redo log does not satisfy the rule sets for a capture process, then the capture process discards the change.
- Specify the changes that a synchronous capture captures. That is, if DML change satisfies the rule set for a synchronous capture, then the synchronous capture captures the change immediately after the change is committed. If a DML change made to a table does not satisfy the rule set for a synchronous capture, then the synchronous capture does not capture the change.
- Specify the messages that a propagation propagates from one **queue** to another or discards. That is, if a message in a queue satisfies the rule sets for a propagation, then the propagation propagates the message. If a message in a queue does not satisfy the rule sets for a propagation, then the propagation discards the message.
- Specify the messages that an apply process dequeues or discards. That is, if a message in a queue satisfies the rule sets for an apply process, then the message is dequeued and processed by the apply process. If a message in a queue does not satisfy the rule sets for an apply process, then the apply process discards the message.
- Specify the **persistent LCRs** or **persistent user messages** that a **messaging client** dequeues or discards. That is, if a message in a **persistent queue** satisfies the rule sets for a messaging client, then the user or application that is using the messaging client dequeues the message. If a message in a persistent queue does not satisfy the rule sets for a messaging client, then the user or application that is using the messaging client discards the message.

In the case of a propagation, the messages evaluated against the rule sets can be any type of message, including **captured LCRs**, **persistent LCRs**, **buffered LCRs**, **persistent user messages** or **buffered user messages**.

In the case of an apply process, the messages evaluated against the rule sets can be **captured LCRs**, **persistent LCRs**, or **persistent user messages**.

If there are conflicting **rules** in the positive rule set associated with a client, then the client performs the task if either rule evaluates to `TRUE`. For example, if a rule in the positive rule set for a capture process contains one rule that instructs the capture process to capture the results of data manipulation language (DML) changes to the `hr.employees` table, but another rule in the rule set instructs the capture process not to capture the results of DML changes to the `hr.employees` table, then the capture process captures these changes.

Similarly, if there are conflicting rules in the negative rule set associated with a client, then the client discards a message if either rule evaluates to `TRUE` for the message. For example, if a rule in the negative rule set for a capture process contains one rule that instructs the capture process to discard the results of DML changes to the `hr.departments` table, but another rule in the rule set instructs the capture process not to discard the results of DML changes to the `hr.departments` table, then the capture process discards these changes.

See Also:

- [Chapter 2, "Oracle Streams Information Capture"](#)
- ["Message Propagation Between Queues"](#) on page 3-11
- [Chapter 4, "Oracle Streams Information Consumption"](#)
- ["Explicit Consumption with a Messaging Client"](#) on page 4-22

Rule Sets and Rule Evaluation of Messages

Oracle Streams clients perform the following tasks based on **rules**:

- A **capture process** captures changes in the redo log, converts the changes into logical change records (LCRs), and enqueues **messages** containing these LCRs into the capture process **queue**.
- A **synchronous capture** captures the results of DML changes made to tables, converts the changes into row logical change records (row LCRs), and enqueues **messages** containing these row LCRs into the synchronous capture **queue**.
- A **propagation** propagates any type of message from a **source queue** to a **destination queue**.
- An **apply process** dequeues either **captured LCRs**, **persistent LCRs**, or **persistent user messages** from its queue and applies these messages directly or sends the messages to an **apply handler**.
- A **messaging client** dequeues **persistent LCRs** or **persistent user messages** from its queue.

These Oracle Streams clients are all clients of the **rules engine**. An Oracle Streams client performs its task for a message when the message satisfies the **rule sets** used by the Oracle Streams client. An Oracle Streams client can have no rule set, only a **positive rule set**, only a **negative rule set**, or both a positive and a negative rule set.

The following sections explain how rule evaluation works in each of these cases:

- [Oracle Streams Client with No Rule Set](#)
- [Oracle Streams Client with a Positive Rule Set Only](#)
- [Oracle Streams Client with a Negative Rule Set Only](#)

- [Oracle Streams Client with Both a Positive and a Negative Rule Set](#)
- [Oracle Streams Client with One or More Empty Rule Sets](#)
- [Summary of Rule Sets and Oracle Streams Client Behavior](#)

Oracle Streams Client with No Rule Set

An **Oracle Streams client** with no **rule set** performs its task for all of the **messages** it encounters. An empty rule set is not the same as no rule set at all.

A capture process should always have at least one rule set because it must not try to capture changes to unsupported database objects. If a propagation should always propagate all messages in its source queue, or if an apply process should always dequeue all messages in its queue, then removing all rule sets from the propagation or apply process might improve performance. A synchronous capture must have a positive rule set. A synchronous capture cannot be configured without a rule set.

Oracle Streams Client with a Positive Rule Set Only

An **Oracle Streams client** with a **positive rule set**, but no **negative rule set**, performs its task for a **message** if any **rule** in the positive rule set evaluates to `TRUE` for the message. However, if all of the rules in a positive rule set evaluate to `FALSE` for the message, then the Oracle Streams client discards the message.

Oracle Streams Client with a Negative Rule Set Only

An **Oracle Streams client** with a **negative rule set**, but no **positive rule set**, discards a **message** if any **rule** in the negative rule set evaluates to `TRUE` for the message. However, if all of the rules in a negative rule set evaluate to `FALSE` for the message, then the Oracle Streams client performs its task for the message. A synchronous capture cannot have a negative rule set.

Oracle Streams Client with Both a Positive and a Negative Rule Set

If an **Oracle Streams client** has both a positive and a **negative rule set**, then the negative rule set is evaluated first for a **message**. If any **rule** in the negative rule set evaluates to `TRUE` for the message, then the message is discarded, and the message is never evaluated against the **positive rule set**.

However, if all of the rules in the negative rule set evaluate to `FALSE` for the message, then the message is evaluated against the positive rule set. At this point, the behavior is the same as when the Oracle Streams client only has a positive rule set. That is, the Oracle Streams client performs its task for a message if any rule in the positive rule set evaluates to `TRUE` for the message. If all of the rules in a positive rule set evaluate to `FALSE` for the message, then the Oracle Streams client discards the message.

A synchronous capture cannot have a negative rule set.

Oracle Streams Client with One or More Empty Rule Sets

An **Oracle Streams client** can have one or more empty **rule sets**. An Oracle Streams client behaves in the following ways if it has one or more empty rule sets:

- If an Oracle Streams client has no **positive rule set**, and its **negative rule set** is empty, then the Oracle Streams client performs its task for all **messages**.

- If an Oracle Streams client has both a positive and a negative rule set, and the negative rule set is empty but its positive rule set contains **rules**, then the Oracle Streams client performs its task based on the rules in the positive rule set.
- If an Oracle Streams client has a positive rule set that is empty, then the Oracle Streams client discards all messages, regardless of the state of its negative rule set.

Summary of Rule Sets and Oracle Streams Client Behavior

Table 6–1 summarizes the **Oracle Streams client** behavior described in the previous sections.

Table 6–1 Rule Sets and Oracle Streams Client Behavior

Negative Rule Set	Positive Rule Set	Oracle Streams Client Behavior
None	None	Performs its task for all messages
None	Exists with rules	Performs its task for messages that evaluate to TRUE against the positive rule set
Exists with rules	None	Discards messages that evaluate to TRUE against the negative rule set , and performs its task for all other messages
Exists with rules	Exists with rules	Discards messages that evaluate to TRUE against the negative rule set, and performs its task for remaining messages that evaluate to TRUE against the positive rule set. The negative rule set is evaluated first.
Exists but is empty	None	Performs its task for all messages
Exists but is empty	Exists with rules	Performs its task for messages that evaluate to TRUE against the positive rule set
None	Exists but is empty	Discards all messages
Exists but is empty	Exists but is empty	Discards all messages
Exists with rules	Exists but is empty	Discards all messages

System-Created Rules

An **Oracle Streams client** performs its task for a **message** if the message satisfies its **rule sets**. A **system-created rule** is created by the `DBMS_STREAMS_ADM` package and can specify one of the following levels of granularity: table, schema, or global. This section describes each of these levels. You can specify more than one level for a particular task. For example, you can instruct a single **apply process** to perform table-level apply for specific tables in the `oe` schema and schema-level apply for the entire `hr` schema. In addition, a single **rule** pertains to either the results of data manipulation language (DML) changes or data definition language (DDL) changes. So, for example, you must use at least two system-created rules to include all of the changes to a particular table: one rule for the results of DML changes and another rule for DDL changes. The results of a DML change are the row changes that result from the DML change, or the row **LCRs** in a **queue** that encapsulate each row change.

Table 6–2 shows what each level of rule means for each Oracle Streams task. Remember that a **negative rule set** is evaluated before a **positive rule set**.

Table 6–2 *Types of Tasks and Rule Levels*

Task	Table Rule	Schema Rule	Global Rule
Capture with a capture process	<p>If the table rule is in a negative rule set, then discard the changes in the redo log for the specified table.</p> <p>If the table rule is in a positive rule set, then capture all or a subset of the changes in the redo log for the specified table, convert them into logical change records (LCRs), and enqueue them.</p>	<p>If the schema rule is in a negative rule set, then discard the changes in the redo log for the schema itself and for the database objects in the specified schema.</p> <p>If the schema rule is in a positive rule set, then capture the changes in the redo log for the schema itself and for the database objects in the specified schema, convert them into LCRs, and enqueue them.</p>	<p>If the global rule is in a negative rule set, then discard the changes to all of the database objects in the database.</p> <p>If the global rule is in a positive rule set, then capture the changes to all of the database objects in the database, convert them into LCRs, and enqueue them.</p>
Capture with a synchronous capture	<p>If the table rule is in a positive rule set, then capture all or a subset of the changes made to the specified table, convert them into logical change records (LCRs), and enqueue them.</p> <p>A synchronous capture cannot have a negative rule set.</p>	A synchronous capture cannot use schema rules.	A synchronous capture cannot use global rules.
Propagate with a propagation	<p>If the table rule is in a negative rule set, then discard the LCRs relating to the specified table in the source queue.</p> <p>If the table rule is in a positive rule set, then propagate all or a subset of the LCRs relating to the specified table in the source queue to the destination queue.</p>	<p>If the schema rule is in a negative rule set, then discard the LCRs related to the specified schema itself and the LCRs related to database objects in the schema in the source queue.</p> <p>If the schema rule is in a positive rule set, then propagate the LCRs related to the specified schema itself and the LCRs related to database objects in the schema in the source queue to the destination queue.</p>	<p>If the global rule is in a negative rule set, then discard all of the LCRs in the source queue.</p> <p>If the global rule is in a positive rule set, then propagate all of the LCRs in the source queue to the destination queue.</p>
Apply with an apply process	<p>If the table rule is in a negative rule set, then discard the LCRs in the queue relating to the specified table.</p> <p>If the table rule is in a positive rule set, then apply all or a subset of the LCRs in the queue relating to the specified table.</p>	<p>If the schema rule is in a negative rule set, then discard the LCRs in the queue relating to the specified schema itself and the database objects in the schema.</p> <p>If the schema rule is in a positive rule set, then apply the LCRs in the queue relating to the specified schema itself and the database objects in the schema.</p>	<p>If the global rule is in a negative rule set, then discard all of the LCRs in the queue.</p> <p>If the global rule is in a positive rule set, then apply all of the LCRs in the queue.</p>

Table 6–2 (Cont.) Types of Tasks and Rule Levels

Task	Table Rule	Schema Rule	Global Rule
Dequeue with a messaging client	<p>If the table rule is in a negative rule set, then, when the messaging client is invoked, discard the persistent LCRs relating to the specified table in the queue.</p> <p>If the table rule is in a positive rule set, then, when the messaging client is invoked, dequeue all or a subset of the persistent LCRs relating to the specified table in the queue.</p>	<p>If the schema rule is in a negative rule set, then, when the messaging client is invoked, discard the persistent LCRs relating to the specified schema itself and the database objects in the schema in the queue.</p> <p>If the schema rule is in a positive rule set, then, when the messaging client is invoked, dequeue the persistent LCRs relating to the specified schema itself and the database objects in the schema in the queue.</p>	<p>If the global rule is in a negative rule set, then, when the messaging client is invoked, discard all of the persistent LCRs in the queue.</p> <p>If the global rule is in a positive rule set, then, when the messaging client is invoked, dequeue all of the persistent LCRs in the queue.</p>

You can use procedures in the `DBMS_STREAMS_ADM` package to create rules at each of these levels. A system-created rule can include conditions that modify the Oracle Streams client behavior beyond the descriptions in [Table 6–2](#). For example, some rules can specify a particular **source database** for LCRs, and, in this case, the rule evaluates to `TRUE` only if an LCR originated at the specified source database. [Table 6–3](#) lists the types of system-created **rule conditions** that can be specified in the rules created by the `DBMS_STREAMS_ADM` package.

Table 6–3 System-Created Rule Conditions Generated by `DBMS_STREAMS_ADM` Package

Rule Condition Evaluates to TRUE for	Oracle Streams Client	Create Using Procedure
All row changes recorded in the redo log because of DML changes to any of the tables in a particular database	Capture Process	<code>ADD_GLOBAL_RULES</code>
All DDL changes recorded in the redo log to any of the database objects in a particular database	Capture Process	<code>ADD_GLOBAL_RULES</code>
All row changes recorded in the redo log because of DML changes to any of the tables in a particular schema	Capture Process	<code>ADD_SCHEMA_RULES</code>
All DDL changes recorded in the redo log to a particular schema and any of the database objects in the schema	Capture Process	<code>ADD_SCHEMA_RULES</code>
All row changes recorded in the redo log because of DML changes to a particular table	Capture Process	<code>ADD_TABLE_RULES</code>
All DDL changes recorded in the redo log to a particular table	Capture Process	<code>ADD_TABLE_RULES</code>
All row changes recorded in the redo log because of DML changes to a subset of rows in a particular table	Capture Process	<code>ADD_SUBSET_RULES</code>
All row changes made to a particular table resulting from DML statements	Synchronous Capture	<code>ADD_TABLE_RULES</code>
All row changes made to a subset of rows in a particular table resulting from DML statements	Synchronous Capture	<code>ADD_SUBSET_RULES</code>
All row LCRs in the source queue	Propagation	<code>ADD_GLOBAL_PROPAGATION_RULES</code>

Table 6–3 (Cont.) System-Created Rule Conditions Generated by DBMS_STREAMS_ADM Package

Rule Condition Evaluates to TRUE for	Oracle Streams Client	Create Using Procedure
All DDL LCRs in the source queue	Propagation	ADD_GLOBAL_PROPAGATION_RULES
All row LCRs in the source queue relating to the tables in a particular schema	Propagation	ADD_SCHEMA_PROPAGATION_RULES
All DDL LCRs in the source queue relating to a particular schema and any of the database objects in the schema	Propagation	ADD_SCHEMA_PROPAGATION_RULES
All row LCRs in the source queue relating to a particular table	Propagation	ADD_TABLE_PROPAGATION_RULES
All DDL LCRs in the source queue relating to a particular table	Propagation	ADD_TABLE_PROPAGATION_RULES
All row LCRs in the source queue relating to a subset of rows in a particular table	Propagation	ADD_SUBSET_PROPAGATION_RULES
All user messages in the source queue of the specified type that satisfy the user-specified rule condition	Propagation	ADD_MESSAGE_PROPAGATION_RULE
All row LCRs in the queue used by the apply process	Apply Process	ADD_GLOBAL_RULES
All DDL LCRs in the queue used by the apply process	Apply Process	ADD_GLOBAL_RULES
All row LCRs in the queue used by the apply process relating to the tables in a particular schema	Apply Process	ADD_SCHEMA_RULES
All DDL LCRs in the queue used by the apply process relating to a particular schema and any of the database objects in the schema	Apply Process	ADD_SCHEMA_RULES
All row LCRs in the queue used by the apply process relating to a particular table	Apply Process	ADD_TABLE_RULES
All DDL LCRs in the queue used by the apply process relating to a particular table	Apply Process	ADD_TABLE_RULES
All row LCRs in the queue used by the apply process relating to a subset of rows in a particular table	Apply Process	ADD_SUBSET_RULES
All persistent user messages in the queue used by the apply process of the specified type that satisfy the user-specified rule condition	Apply Process	ADD_MESSAGE_RULE
All persistent row LCRs in the queue used by the messaging client	Messaging Client	ADD_GLOBAL_RULES
All persistent DDL LCRs in the queue used by the messaging client	Messaging Client	ADD_GLOBAL_RULES
All persistent row LCRs in the queue used by the messaging client relating to the tables in a particular schema	Messaging Client	ADD_SCHEMA_RULES
All persistent DDL LCRs in the queue used by the messaging client relating to a particular schema and any of the database objects in the schema	Messaging Client	ADD_SCHEMA_RULES

Table 6–3 (Cont.) System-Created Rule Conditions Generated by DBMS_STREAMS_ADM Package

Rule Condition Evaluates to TRUE for	Oracle Streams Client	Create Using Procedure
All persistent row LCRs in the queue for the messaging client relating to a particular table	Messaging Client	ADD_TABLE_RULES
All persistent DDL LCRs in the queue used by the messaging client relating to a particular table	Messaging Client	ADD_TABLE_RULES
All persistent row LCRs in the queue used by the messaging client relating to a subset of rows in a particular table	Messaging Client	ADD_SUBSET_RULES
All persistent messages in the queue used by the messaging client of the specified type that satisfy the user-specified rule condition	Messaging Client	ADD_MESSAGE_RULE

Each procedure listed in Table 6–3 does the following:

- Creates a **capture process, synchronous capture, propagation, apply process, or messaging client** if it does not already exist.
- Creates a rule set for the specified capture process, synchronous capture, propagation, apply process, or messaging client if a rule set does not already exist for it. For a capture process, propagation, apply process, or messaging client, the rule set can be a positive rule set or a negative rule set. You can create each type of rule set by running the procedure at least twice. For a synchronous capture, the rule set must be a positive rule set.
- Creates zero or more rules and adds the rules to the rule set for the specified capture process, synchronous capture, propagation, apply process, or messaging client. Based on your specifications when you run one of these procedures, the procedure adds the rules either to the positive rule set or to the negative rule set.

Except for the ADD_MESSAGE_RULE and ADD_MESSAGE_PROPAGATION_RULE procedures, these procedures create rule sets that use the SYS.STREAMS\$_EVALUATION_CONTEXT **evaluation context**, which is an Oracle-supplied evaluation context for Oracle Streams environments.

Global, schema, table, and subset rules use the SYS.STREAMS\$_EVALUATION_CONTEXT evaluation context. However, when you create a rule using either the ADD_MESSAGE_RULE or the ADD_MESSAGE_PROPAGATION_RULE procedure, the rule uses a system-generated evaluation context that is customized specifically for each message type. Rule sets created by the ADD_MESSAGE_RULE or the ADD_MESSAGE_PROPAGATION_RULE procedure do not have an evaluation context.

Except for ADD_SUBSET_RULES, ADD_SUBSET_PROPAGATION_RULES, ADD_MESSAGE_RULE, and ADD_MESSAGE_PROPAGATION_RULE, these procedures create either zero, one, or two rules. If you want to perform the Oracle Streams task for only the row changes resulting from DML changes or only for only DDL changes, then only one rule is created. If, however, you want to perform the Oracle Streams task for both the results of DML changes and DDL changes, then a rule is created for each. If you create a DML rule for a table now, then you can create a DDL rule for the same table in the future without modifying the DML rule created earlier. The same applies if you create a DDL rule for a table first and a DML rule for the same table in the future.

The ADD_SUBSET_RULES and ADD_SUBSET_PROPAGATION_RULES procedures always create three rules for three different types of DML operations on a table: INSERT, UPDATE, and DELETE. These procedures do not create rules for DDL changes

to a table. You can use the `ADD_TABLE_RULES` or `ADD_TABLE_PROPAGATION_RULES` procedure to create a DDL rule for a table. In addition, you can add subset rules to positive rule sets only, not to negative rule sets.

The `ADD_MESSAGE_RULE` and `ADD_MESSAGE_PROPAGATION_RULE` procedures always create one rule with a user-specified rule condition. These procedures create rules for user messages. They do not create rules for the results of DML changes or DDL changes to a table.

When you create propagation rules for **captured LCRs**, Oracle recommends that you specify a source database for the changes. An apply process uses transaction control messages to assemble captured LCRs into committed transactions. These transaction control messages, such as `COMMIT` and `ROLLBACK`, contain the name of the source database where the message occurred. To avoid unintended cycling of these messages, propagation rules should contain a condition specifying the source database, and you accomplish this by specifying the source database when you create the propagation rules.

The following sections describe system-created rules in more detail:

- [Global Rules](#)
- [Schema Rules](#)
- [Table Rules](#)
- [Subset Rules](#)
- [Message Rules](#)
- [System-Created Rules and Negative Rule Sets](#)
- [System-Created Rules with Added User-Defined Conditions](#)

Note:

- To create rules with more complex rule conditions, such as rules that use the `NOT` or `OR` logical conditions, either use the `and_condition` parameter, which is available with some of the procedures in the `DBMS_STREAMS_ADM` package, or use the `DBMS_RULE_ADM` package.
 - Each example in the sections that follow should be completed by an Oracle Streams administrator that has been granted the appropriate privileges, unless specified otherwise.
 - Some of the examples in this section have additional prerequisites. For example, a queue specified by a procedure parameter must exist.
-
-

See Also:

- ["Managing Rules"](#) on page 17-4
- ["Rule Sets and Rule Evaluation of Messages"](#) on page 6-3 for information about how messages satisfy the rule sets for an Oracle Streams client
- *Oracle Database PL/SQL Packages and Types Reference* for more information about the `DBMS_STREAMS_ADM` package and the `DBMS_RULE_ADM` package
- ["Evaluation Contexts Used in Oracle Streams"](#) on page 6-37
- ["Logical Change Records \(LCRs\)"](#) on page 2-3
- ["Complex Rule Conditions"](#) on page 6-46

Global Rules

When you use a **rule** to specify an Oracle Streams task that is relevant either to an entire database or to an entire **queue**, you are specifying a **global rule**. You can specify a global rule for DML changes, a global rule for DDL changes, or a global rule for each type of change (two rules total).

A single global rule in the **positive rule set** for a **capture process** means that the capture process captures the results of either all DML changes or all DDL changes to the **source database**. A single global rule in the **negative rule set** for a capture process means that the capture process discards the results of either all DML changes or all DDL changes to the source database.

A single global rule in the positive rule set for a **propagation** means that the propagation propagates either all row LCRs or all DDL LCRs in the **source queue** to the **destination queue**. A single global rule in the negative rule set for a propagation means that the propagation discards either all row LCRs or all DDL LCRs in the source queue.

A single global rule in the positive rule set for an **apply process** means that the apply process applies either all row LCRs or all DDL LCRs in its queue for a specified source database. A single global rule in the negative rule set for an apply process means that the apply process discards either all row LCRs or all DDL LCRs in its queue for a specified source database.

If you want to use global rules, but you are concerned about changes to database objects that are not supported by Oracle Streams, then you can create rules using the `DBMS_RULE_ADM` package to discard unsupported changes.

See Also:

- ["Rule Conditions that Instruct Oracle Streams Clients to Discard Unsupported LCRs"](#) on page 6-45

Global Rules Example

Suppose you use the `ADD_GLOBAL_RULES` procedure in the `DBMS_STREAMS_ADM` package to instruct an Oracle Streams capture process to capture all DML changes and DDL changes in a database.

Run the `ADD_GLOBAL_RULES` procedure to create the rules:

```
BEGIN
  DBMS_STREAMS_ADM.ADD_GLOBAL_RULES (
    streams_type      => 'capture',
    streams_name      => 'capture',
    queue_name        => 'streams_queue',
    include_dml       => TRUE,
    include_ddl       => TRUE,
    include_tagged_lcr => FALSE,
    source_database   => NULL,
    inclusion_rule    => TRUE);
END;
/
```

Notice that the `inclusion_rule` parameter is set to `TRUE`. This setting means that the **system-created rules** are added to the positive rule set for the capture process.

`NULL` can be specified for the `source_database` parameter because rules are being created for a **local capture process**. You can also specify the global name of the local database. When creating rules for a **downstream capture process** or apply process using `ADD_GLOBAL_RULES`, specify a source database name.

The `ADD_GLOBAL_RULES` procedure creates two rules: one for row LCRs (which contain the results of DML changes) and one for DDL LCRs.

Here is the **rule condition** used by the row LCR rule:

```
(:dml.is_null_tag() = 'Y' )
```

Notice that the condition in the DML rule begins with the variable `:dml`. The value is determined by a call to the specified member function for the row LCR being evaluated. So, `:dml.is_null_tag()` is a call to the `IS_NULL_TAG` member function for the row LCR being evaluated.

Here is the rule condition used by the DDL LCR rule:

```
(:ddl.is_null_tag() = 'Y' )
```

Notice that the condition in the DDL rule begins with the variable `:ddl`. The value is determined by a call to the specified member function for the DDL LCR being evaluated. So, `:ddl.is_null_tag()` is a call to the `IS_NULL_TAG` member function for the DDL LCR being evaluated.

For a capture process, these conditions indicate that the **tag** must be `NULL` in a redo record for the capture process to capture a change. For a propagation, these conditions indicate that the tag must be `NULL` in an LCR for the propagation to propagate the LCR. For an apply process, these conditions indicate that the tag must be `NULL` in an LCR for the apply process to apply the LCR.

Given the rules created by this example in the positive rule set for the capture process, the capture process captures all supported DML and DDL changes made to the database.

Caution: If you add global rules to the positive rule set for a capture process, then ensure that you add rules to the negative capture process rule set to exclude database objects that are not supported by capture processes. Query the `DBA_STREAMS_UNSUPPORTED` data dictionary view to determine which database objects are not supported by capture processes. If unsupported database objects are not excluded, then capture errors will result.

If you add global rules to the positive rule set for an apply process, then ensure that the apply process does not attempt to apply changes to unsupported columns. To do so, you can add rules to the negative apply process rule set to exclude the table that contains the column, or you can exclude the column with a rule-based transformation or DML handler. Query the `DBA_STREAMS_COLUMNS` data dictionary view to determine which columns are not supported by apply processes. If unsupported columns are not excluded, then apply errors will result.

See Also:

- ["Listing the Database Objects That Are Not Compatible With Capture Processes"](#) on page 28-7
- ["Listing Database Objects and Columns That Are Not Compatible With Apply Processes"](#) on page 28-12
- [Chapter 7, "Rule-Based Transformations"](#)
- ["Process Messages with Apply Handlers"](#) on page 4-8 for information about DML handlers

System-Created Global Rules Avoid Empty Rule Conditions Automatically

You can omit the `is_null_tag` condition in system-created rules by specifying `TRUE` for the `include_tagged_lcr` parameter when you run a procedure in the `DBMS_STREAMS_ADM` package. For example, the following `ADD_GLOBAL_RULES` procedure creates rules without the `is_null_tag` condition:

```
BEGIN DBMS_STREAMS_ADM.ADD_GLOBAL_RULES(
  streams_type      => 'capture',
  streams_name      => 'capture_002',
  queue_name        => 'streams_queue',
  include_dml       => TRUE,
  include_ddl       => TRUE,
  include_tagged_lcr => TRUE,
  source_database   => NULL,
  inclusion_rule    => TRUE);
END;
/
```

When you set the `include_tagged_lcr` parameter to `TRUE` for a global rule, and the `source_database_name` parameter is set to `NULL`, the rule condition used by the row LCR rule is the following:

```
(( :dml.get_source_database_name()>= ' ' OR
:dml.get_source_database_name()<= ' ' ) )
```

Here is the rule condition used by the DDL LCR rule:

```
(( :ddl.get_source_database_name()>=' ' OR  
:ddl.get_source_database_name()<=' ' ) )
```

The system-created global rules contain these conditions to enable all row and DDL LCRs to evaluate to TRUE.

These rule conditions are specified to avoid NULL rule conditions for these rules. NULL rule conditions are not supported. In this case, if you want to capture all DML and DDL changes to a database, and you do not want to use any [rule-based transformation](#) for these changes upon capture, then you can choose to run the capture process without a positive rule set instead of specifying global rules.

Note:

- When you create a capture process using a procedure in the DBMS_STREAMS_ADM package and generate one or more rules for the capture process, the objects for which changes are captured are prepared for [instantiation](#) automatically, unless it is a downstream capture process and there is no database link from the [downstream database](#) to the source database.
 - The capture process does not capture some types of DML and DDL changes, and it does not capture changes made in the SYS, SYSTEM, or CTXSYS schemas.
-

See Also:

- *Oracle Streams Replication Administrator's Guide* for more information about capture process rules and preparation for instantiation
- [Chapter 2, "Oracle Streams Information Capture"](#) for more information about the capture process and for detailed information about which DML and DDL statements are captured by a capture process
- [Chapter 5, "Rules"](#) for more information about variables in conditions
- *Oracle Streams Replication Administrator's Guide* for more information about Oracle Streams tags
- ["Rule Sets and Rule Evaluation of Messages"](#) on page 6-3 for more information about running a capture process with no positive rule set

Schema Rules

When you use a [rule](#) to specify an Oracle Streams task that is relevant to a schema, you are specifying a **schema rule**. You can specify a schema rule for DML changes, a schema rule for DDL changes, or a schema rule for each type of change to the schema (two rules total).

A single schema rule in the [positive rule set](#) for a [capture process](#) means that the capture process captures either the DML changes or the DDL changes to the schema. A single schema rule in the [negative rule set](#) for a capture process means that the capture process discards either the DML changes or the DDL changes to the schema.

A single schema rule in the positive rule set for a **propagation** means that the propagation propagates either the row LCRs or the DDL LCRs in the **source queue** that contain changes to the schema. A single schema rule in the negative rule set for a propagation means that the propagation discards either the row LCRs or the DDL LCRs in the source queue that contain changes to the schema.

A single schema rule in the positive rule set for an **apply process** means that the apply process applies either the row LCRs or the DDL LCRs in its **queue** that contain changes to the schema. A single schema rule in the negative rule set for an apply process means that the apply process discards either the row LCRs or the DDL LCRs in its queue that contain changes to the schema.

If you want to use schema rules, but you are concerned about changes to database objects in a schema that are not supported by Oracle Streams, then you can create rules using the `DBMS_RULE_ADM` package to discard unsupported changes.

See Also:

- ["Rule Conditions that Instruct Oracle Streams Clients to Discard Unsupported LCRs"](#) on page 6-45

Schema Rule Example

Suppose you use the `ADD_SCHEMA_PROPAGATION_RULES` procedure in the `DBMS_STREAMS_ADM` package to instruct an Oracle Streams propagation to propagate row LCRs and DDL LCRs relating to the `hr` schema from a queue at the `dbs1.example.com` database to a queue at the `dbs2.example.com` database.

Run the `ADD_SCHEMA_PROPAGATION_RULES` procedure at `dbs1.example.com` to create the rules:

```
BEGIN
  DBMS_STREAMS_ADM.ADD_SCHEMA_PROPAGATION_RULES (
    schema_name           => 'hr',
    streams_name          => 'dbs1_to_dbs2',
    source_queue_name     => 'streams_queue',
    destination_queue_name => 'streams_queue@dbs2.example.com',
    include_dml           => TRUE,
    include_ddl           => TRUE,
    include_tagged_lcr    => FALSE,
    source_database       => 'dbs1.example.com',
    inclusion_rule        => TRUE);
END;
/
```

Notice that the `inclusion_rule` parameter is set to `TRUE`. This setting means that the **system-created rules** are added to the positive rule set for the propagation.

The `ADD_SCHEMA_PROPAGATION_RULES` procedure creates two rules: one for row LCRs (which contain the results of DML changes) and one for DDL LCRs.

Here is the **rule condition** used by the row LCR rule:

```
((:dml.get_object_owner() = 'HR') and :dml.is_null_tag() = 'Y'
and :dml.get_source_database_name() = 'DBS1.EXAMPLE.COM' )
```

Here is the rule condition used by the DDL LCR rule:

```
((:ddl.get_object_owner() = 'HR' or :ddl.get_base_table_owner() = 'HR')
and :ddl.is_null_tag() = 'Y' and :ddl.get_source_database_name() =
'DBS1.EXAMPLE.COM' )
```

The `GET_BASE_TABLE_OWNER` member function is used in the DDL LCR rule because the `GET_OBJECT_OWNER` function can return `NULL` if a user who does not own an object performs a DDL change on the object.

Given these rules in the positive rule set for the propagation, the following list provides examples of changes propagated by the propagation:

- A row is inserted into the `hr.countries` table.
- The `hr.loc_city_ix` index is altered.
- The `hr.employees` table is truncated.
- A column is added to the `hr.countries` table.
- The `hr.update_job_history` trigger is altered.
- A new table named `candidates` is created in the `hr` schema.
- Twenty rows are inserted into the `hr.candidates` table.

The propagation propagates the LCRs that contain all of the changes previously listed from the source queue to the **destination queue**.

Now, given the same rules, suppose a row is inserted into the `oe.inventories` table. This change is ignored because the `oe` schema was not specified in a schema rule, and the `oe.inventories` table was not specified in a table rule.

Caution: If you add schema rules to the positive rule set for a capture process, then ensure that you add rules to the negative capture process rule set to exclude database objects in the schema that are not supported by capture processes. Query the `DBA_STREAMS_UNSUPPORTED` data dictionary view to determine which database objects are not supported by capture processes. If unsupported database objects are not excluded, then capture errors will result.

If you add schema rules to the positive rule set for an apply process, then ensure that the apply process does not attempt to apply changes to unsupported columns. To do so, you can add rules to the negative apply process rule set to exclude the table that contains the column, or you can exclude the column with a rule-based transformation or DML handler. Query the `DBA_STREAMS_COLUMNS` data dictionary view to determine which columns are not supported by apply processes. If unsupported columns are not excluded, then apply errors will result.

See Also:

- ["Listing the Database Objects That Are Not Compatible With Capture Processes"](#) on page 28-7
- ["Listing Database Objects and Columns That Are Not Compatible With Apply Processes"](#) on page 28-12
- [Chapter 7, "Rule-Based Transformations"](#)
- ["Process Messages with Apply Handlers"](#) on page 4-8 for information about DML handlers

Table Rules

When you use a **rule** to specify an Oracle Streams task that is relevant only for an individual table, you are specifying a **table rule**. You can specify a table rule for DML changes, a table rule for DDL changes, or a table rule for each type of change to a specific table (two rules total).

A single table rule in the **positive rule set** for a **capture process** means that the capture process captures the results of either the DML changes or the DDL changes to the table. A single table rule in the **negative rule set** for a capture process means that the capture process discards the results of either the DML changes or the DDL changes to the table.

A single table rule in the **positive rule set** for a **synchronous capture** means that the synchronous capture captures the results of either the DML changes to the table. A synchronous capture cannot have a **negative rule set**.

A single table rule in the positive rule set for a **propagation** means that the propagation propagates either the row LCRs or the DDL LCRs in the **source queue** that contain changes to the table. A single table rule in the negative rule set for a propagation means that the propagation discards either the row LCRs or the DDL LCRs in the source queue that contain changes to the table.

A single table rule in the positive rule set for an **apply process** means that the apply process applies either the row LCRs or the DDL LCRs in its **queue** that contain changes to the table. A single table rule in the negative rule set for an apply process means that the apply process discards either the row LCRs or the DDL LCRs in its queue that contain changes to the table.

Table Rules Example

Suppose you use the `ADD_TABLE_RULES` procedure in the `DBMS_STREAMS_ADM` package to instruct an Oracle Streams apply process to behave in the following ways:

- [Apply All Row LCRs Related to the hr.locations Table](#)
- [Apply All DDL LCRs Related to the hr.countries Table](#)

Apply All Row LCRs Related to the hr.locations Table The changes in these row LCRs originated at the `db1.example.com` **source database**.

Run the `ADD_TABLE_RULES` procedure to create this rule:

```
BEGIN
  DBMS_STREAMS_ADM.ADD_TABLE_RULES(
    table_name      => 'hr.locations',
    streams_type    => 'apply',
    streams_name    => 'apply',
    queue_name      => 'streams_queue',
    include_dml     => TRUE,
    include_ddl     => FALSE,
    include_tagged_lcr => FALSE,
    source_database => 'db1.example.com',
    inclusion_rule  => TRUE);
END;
/
```

Notice that the `inclusion_rule` parameter is set to `TRUE`. This setting means that the **system-created rule** is added to the positive rule set for the apply process.

The `ADD_TABLE_RULES` procedure creates a rule with a **rule condition** similar to the following:

```
((:dml.get_object_owner() = 'HR' and :dml.get_object_name() = 'LOCATIONS'))
and :dml.is_null_tag() = 'Y' and :dml.get_source_database_name() =
'DBS1.EXAMPLE.COM' )
```

Apply All DDL LCRs Related to the hr.countries Table The changes in these DDL LCRs originated at the `dbssl.example.com` source database.

Run the `ADD_TABLE_RULES` procedure to create this rule:

```
BEGIN
  DBMS_STREAMS_ADM.ADD_TABLE_RULES(
    table_name      => 'hr.countries',
    streams_type    => 'apply',
    streams_name    => 'apply',
    queue_name      => 'streams_queue',
    include_dml     => FALSE,
    include_ddl     => TRUE,
    include_tagged_lcr => FALSE,
    source_database => 'dbssl.example.com',
    inclusion_rule  => TRUE);
END;
/
```

Notice that the `inclusion_rule` parameter is set to `TRUE`. This setting means that the system-created rule is added to the positive rule set for the apply process.

The `ADD_TABLE_RULES` procedure creates a rule with a rule condition similar to the following:

```
((:ddl.get_object_owner() = 'HR' and :ddl.get_object_name() = 'COUNTRIES')
or (:ddl.get_base_table_owner() = 'HR'
and :ddl.get_base_table_name() = 'COUNTRIES')) and :ddl.is_null_tag() = 'Y'
and :ddl.get_source_database_name() = 'DBS1.EXAMPLE.COM' )
```

The `GET_BASE_TABLE_OWNER` and `GET_BASE_TABLE_NAME` member functions are used in the DDL LCR rule because the `GET_OBJECT_OWNER` and `GET_OBJECT_NAME` functions can return `NULL` if a user who does not own an object performs a DDL change on the object.

The generated DDL table rule evaluates to `TRUE` for any DDL change that operates on the table or on an object that is part of the table, such as an index or trigger on the table. The rule evaluates to `FALSE` for any DDL change that either does not refer to the table or refers to the table in a subordinate way. For example, the rule evaluates to `FALSE` for changes that create synonyms or views based on the table. The rule also evaluates to `FALSE` for a change to a PL/SQL subprogram that refers to the table.

Summary of Rules In this example, the following table rules were defined:

- A table rule that evaluates to `TRUE` if a row LCR contains a row change that results from a DML operation on the `hr.locations` table.
- A table rule that evaluates to `TRUE` if a DDL LCR contains a DDL change performed on the `hr.countries` table.

Given these rules, the following list provides examples of changes applied by an apply process:

- A row is inserted into the `hr.locations` table.
- Five rows are deleted from the `hr.locations` table.
- A column is added to the `hr.countries` table.

The apply process dequeues the LCRs containing these changes from its associated queue and applies them to the database objects at the **destination database**.

Given these rules, the following list provides examples of changes that are ignored by the apply process:

- A row is inserted into the `hr.employees` table. This change is not applied because a change to the `hr.employees` table does not satisfy any of the rules.
- A row is updated in the `hr.countries` table. This change is a DML change, not a DDL change. This change is not applied because the rule on the `hr.countries` table is for DDL changes only.
- A column is added to the `hr.locations` table. This change is a DDL change, not a DML change. This change is not applied because the rule on the `hr.locations` table is for DML changes only.

Caution: Do not add table rules to the positive rule set of a capture process for tables that are not supported by capture processes. Query the `DBA_STREAMS_UNSUPPORTED` data dictionary view to determine which tables are not supported by capture processes. If unsupported table are not excluded, then capture errors will result.

If you add table rules to the positive rule set for a synchronous capture or an apply process, then ensure that these Oracle Streams clients do not attempt to process changes to unsupported columns. If a table includes an unsupported column, then you can exclude the column with a rule-based transformation or, in the case of an apply process, with a DML handler. Query the `DBA_STREAMS_COLUMNS` data dictionary view to determine which columns are not supported by synchronous captures and apply processes. If unsupported columns are not excluded, then errors will result.

See Also:

- ["Listing the Database Objects That Are Not Compatible With Capture Processes"](#) on page 28-7
- ["Listing Database Objects and Columns That Are Not Compatible With Synchronous Captures"](#) on page 28-11
- ["Listing Database Objects and Columns That Are Not Compatible With Apply Processes"](#) on page 28-12
- [Chapter 7, "Rule-Based Transformations"](#)
- ["Process Messages with Apply Handlers"](#) on page 4-8 for information about DML handlers

Subset Rules

A **subset rule** is a special type of **table rule** for DML changes that is relevant only to a subset of the rows in a table. You can create subset rules for **capture processes**, **synchronous captures**, **apply processes**, and **messaging clients** using the `ADD_SUBSET_RULES` procedure. You can create subset rules for **propagations** using the `ADD_SUBSET_PROPAGATION_RULES` procedure. These procedures enable you to use a condition similar to a `WHERE` clause in a `SELECT` statement to specify the following:

- That a capture process only captures a subset of the row changes resulting from DML changes to a particular table
- That a synchronous capture only captures a subset of the row changes resulting from DML changes to a particular table
- That a propagation only propagates a subset of the row LCRs relating to a particular table
- That an apply process only applies a subset of the row LCRs relating to a particular table
- That a messaging client only dequeues a subset of the row LCRs relating to a particular table

The `ADD_SUBSET_RULES` procedure and the `ADD_SUBSET_PROPAGATION_RULES` procedure can add subset rules to the **positive rule set** only of an **Oracle Streams client**. You cannot add subset rules to the **negative rule set** for an Oracle Streams client using these procedures.

The following sections describe subset rules in more detail:

- [Subset Rules Example](#)
- [Row Migration and Subset Rules](#)
- [Subset Rules and Supplemental Logging](#)
- [Guidelines for Using Subset Rules](#)

See Also:

- ["Restrictions for Subset Rules"](#) on page B-16

Subset Rules Example

This example instructs an Oracle Streams apply process to apply a subset of row LCRs relating to the `hr.regions` table where the `region_id` is 2. These changes originated at the `dbssl.example.com` **source database**.

Run the `ADD_SUBSET_RULES` procedure to create three rules:

```
BEGIN
  DBMS_STREAMS_ADM.ADD_SUBSET_RULES(
    table_name           => 'hr.regions',
    dml_condition        => 'region_id=2',
    streams_type         => 'apply',
    streams_name         => 'apply',
    queue_name           => 'streams_queue',
    include_tagged_lcr   => FALSE,
    source_database      => 'dbssl.example.com');
END;
/
```

The `ADD_SUBSET_RULES` procedure creates three rules: one for INSERT operations, one for UPDATE operations, and one for DELETE operations.

Here is the **rule condition** used by the insert rule:

```
:dml.get_object_owner()='HR' AND :dml.get_object_name()='REGIONS'
AND :dml.is_null_tag()='Y' AND :dml.get_source_database_name()='DBS1.EXAMPLE.COM'
AND :dml.get_command_type() IN ('UPDATE','INSERT')
AND (:dml.get_value('NEW','REGION_ID') IS NOT NULL)
AND (:dml.get_value('NEW','REGION_ID').AccessNumber()=2)
AND (:dml.get_command_type()='INSERT'
```

```

OR (:dml.get_value('OLD', 'REGION_ID') IS NOT NULL)
AND (((:dml.get_value('OLD', 'REGION_ID').AccessNumber() IS NOT NULL)
AND NOT (:dml.get_value('OLD', 'REGION_ID').AccessNumber()=2))
OR (:dml.get_value('OLD', 'REGION_ID').AccessNumber() IS NULL)
AND NOT EXISTS (SELECT 1 FROM SYS.DUAL
WHERE (:dml.get_value('OLD', 'REGION_ID').AccessNumber()=2))))))

```

Based on this rule condition, row LCRs are evaluated in the following ways:

- For an insert, if the new value in the row LCR for `region_id` is 2, then the insert is applied.
- For an insert, if the new value in the row LCR for `region_id` is not 2 or is NULL, then the insert is filtered out.
- For an update, if the old value in the row LCR for `region_id` is not 2 or is NULL and the new value in the row LCR for `region_id` is 2, then the update is converted into an insert and applied. This automatic conversion is called **row migration**. See ["Row Migration and Subset Rules"](#) on page 6-23 for more information.

Here is the rule condition used by the update rule:

```

:dml.get_object_owner()='HR' AND :dml.get_object_name()='REGIONS'
AND :dml.is_null_tag()='Y' AND :dml.get_source_database_name()='DBS1.EXAMPLE.COM'
AND :dml.get_command_type()='UPDATE'
AND (:dml.get_value('NEW', 'REGION_ID') IS NOT NULL)
AND (:dml.get_value('OLD', 'REGION_ID') IS NOT NULL)
AND (:dml.get_value('OLD', 'REGION_ID').AccessNumber()=2)
AND (:dml.get_value('NEW', 'REGION_ID').AccessNumber()=2)

```

Based on this rule condition, row LCRs are evaluated in the following ways:

- For an update, if both the old value and the new value in the row LCR for `region_id` are 2, then the update is applied as an update.
- For an update, if either the old value or the new value in the row LCR for `region_id` is not 2 or is NULL, then the update does not satisfy the update rule. The LCR can satisfy the insert rule, the delete rule, or neither rule.

Here is the rule condition used by the delete rule:

```

:dml.get_object_owner()='HR' AND :dml.get_object_name()='REGIONS'
AND :dml.is_null_tag()='Y' AND :dml.get_source_database_name()='DBS1.EXAMPLE.COM'
AND :dml.get_command_type() IN ('UPDATE', 'DELETE')
AND (:dml.get_value('OLD', 'REGION_ID') IS NOT NULL)
AND (:dml.get_value('OLD', 'REGION_ID').AccessNumber()=2)
AND (:dml.get_command_type()='DELETE'
OR (:dml.get_value('NEW', 'REGION_ID') IS NOT NULL)
AND (((:dml.get_value('NEW', 'REGION_ID').AccessNumber() IS NOT NULL)
AND NOT (:dml.get_value('NEW', 'REGION_ID').AccessNumber()=2))
OR (:dml.get_value('NEW', 'REGION_ID').AccessNumber() IS NULL)
AND NOT EXISTS (SELECT 1 FROM SYS.DUAL
WHERE (:dml.get_value('NEW', 'REGION_ID').AccessNumber()=2))))))

```

Based on this rule condition, row LCRs are evaluated in the following ways:

- For a delete, if the old value in the row LCR for `region_id` is 2, then the delete is applied.
- For a delete, if the old value in the row LCR for `region_id` is not 2 or is NULL, then the delete is filtered out.

- For an update, if the old value in the row LCR for `region_id` is 2 and the new value in the row LCR for `region_id` is not 2 or is `NULL`, then the update is converted into a delete and applied. This automatic conversion is called row migration. See ["Row Migration and Subset Rules"](#) on page 6-23 for more information.

Given these subset rules, the following list provides examples of changes applied by an apply process:

- A row is updated in the `hr.regions` table where the old `region_id` is 4 and the new value of `region_id` is 2. This update is transformed into an insert.
- A row is updated in the `hr.regions` table where the old `region_id` is 2 and the new value of `region_id` is 1. This update is transformed into a delete.

The apply process dequeues row LCRs containing these changes from its associated **queue** and applies them to the `hr.regions` table at the **destination database**.

Given these subset rules, the following list provides examples of changes that are ignored by the apply process:

- A row is inserted into the `hr.employees` table. This change is not applied because a change to the `hr.employees` table does not satisfy the subset rules.
- A row is updated in the `hr.regions` table where the `region_id` was 1 before the update and remains 1 after the update. This change is not applied because the subset rules for the `hr.regions` table evaluate to `TRUE` only when the new or old (or both) values for `region_id` is 2.

Caution: Do not add subset rules to the positive rule set of a capture process for tables that are not supported by capture processes. Query the `DBA_STREAMS_UNSUPPORTED` data dictionary view to determine which tables are not supported by capture processes. If unsupported table are not excluded, then capture errors will result.

If you add subset rules to the positive rule set for a synchronous capture or an apply process, then ensure that these Oracle Streams clients do not attempt to process changes to unsupported columns. If a table includes an unsupported column, then you can exclude the column with a rule-based transformation or, in the case of an apply process, with a DML handler. Query the `DBA_STREAMS_COLUMNS` data dictionary view to determine which columns are not supported by synchronous captures and apply processes. If unsupported columns are not excluded, then errors will result.

See Also:

- ["Listing the Database Objects That Are Not Compatible With Capture Processes"](#) on page 28-7
- ["Listing Database Objects and Columns That Are Not Compatible With Synchronous Captures"](#) on page 28-11
- ["Listing Database Objects and Columns That Are Not Compatible With Apply Processes"](#) on page 28-12

Row Migration and Subset Rules

When you use subset rules, an update operation can be converted into an insert or delete operation when it is captured, propagated, applied, or dequeued. This automatic conversion is called **row migration** and is performed by an internal transformation specified automatically in the **action context** for a subset rule. The following sections describe row migration during capture, propagation, apply, and dequeue.

This section contains these topics:

- [Row Migration During Capture](#)
- [Row Migration During Propagation](#)
- [Row Migration During Apply](#)
- [Row Migration During Dequeue by a Messaging Client](#)

Caution: Subset rules should reside only in positive rule sets. Do not add subset rules to negative rule sets. Doing so can have unpredictable results, because row migration would not be performed on LCRs that are not discarded by the negative rule set. Also, row migration is not performed on LCRs discarded because they evaluate to `TRUE` against a negative rule set.

Row Migration During Capture When a subset rule is in the rule set for a **capture process** or **synchronous capture**, an update that satisfies the subset rule can be converted into an insert or delete when it is captured.

For example, suppose you use a subset rule to specify that a capture process or a synchronous capture captures changes to the `hr.employees` table where the employee's `department_id` is 50 using the following subset condition: `department_id = 50`. Assume that the table at the source database contains records for employees from all departments. If a DML operation changes an employee's `department_id` from 80 to 50, then the subset rule converts the update operation into an insert operation and captures the change. Therefore, a row LCR that contains an `INSERT` is enqueued into the queue. [Figure 6–2](#) illustrates this example with a subset rule for a capture process.

Figure 6–2 Row Migration During Capture by a Capture Process

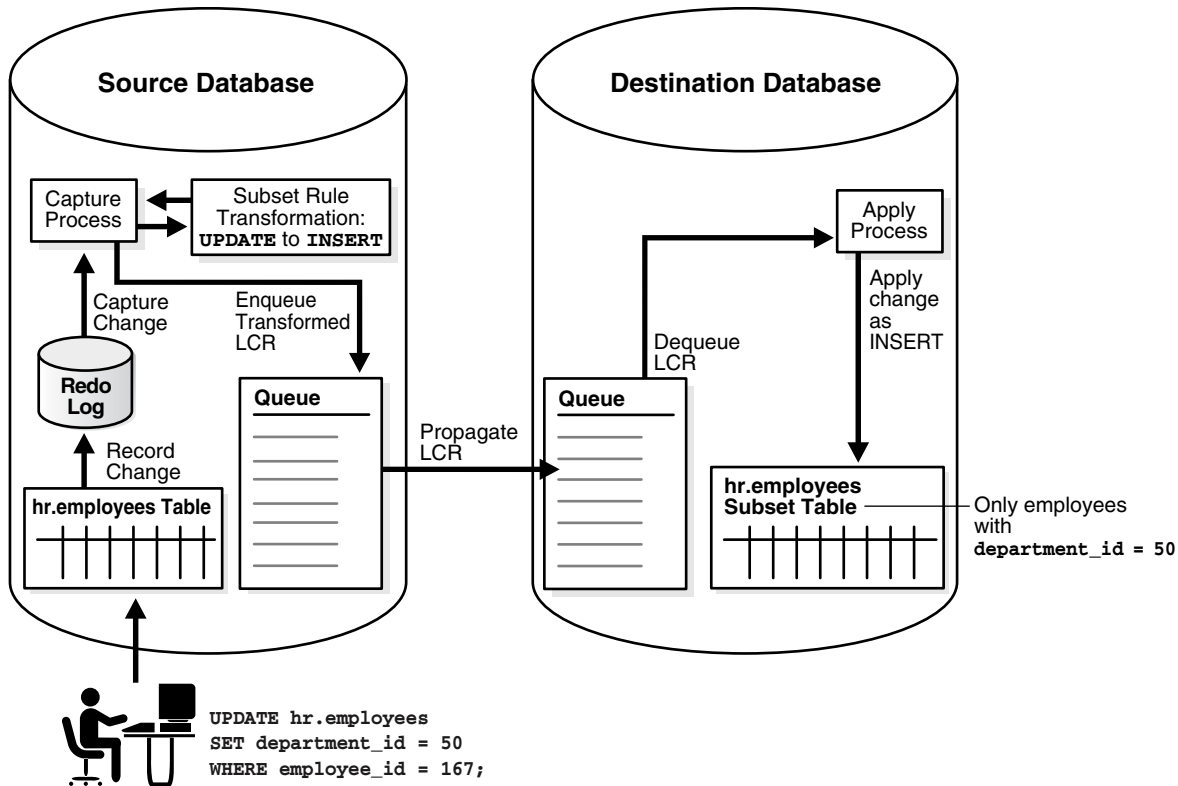

Similarly, if a captured update changes an employee's `department_id` from 50 to 20, then a capture process or synchronous capture with this subset rule converts the update operation into a `DELETE` operation.

Row Migration During Propagation When a subset rule is in the rule set for a propagation, an update operation can be converted into an insert or delete operation for a row LCR is propagated.

For example, suppose you use a subset rule to specify that a propagation propagates changes to the `hr.employees` table where the employee's `department_id` is 50 using the following subset condition: `department_id = 50`. If the **source queue** for the propagation contains a row LCR with an update operation on the `hr.employees` table that changes an employee's `department_id` from 50 to 80, then the propagation with the subset rule converts the update operation into a delete operation and propagates the row LCR to the **destination queue**. Therefore, a row LCR that contains a `DELETE` is enqueued into the destination queue. Figure 6–3 illustrates this example.

Figure 6–3 Row Migration During Propagation

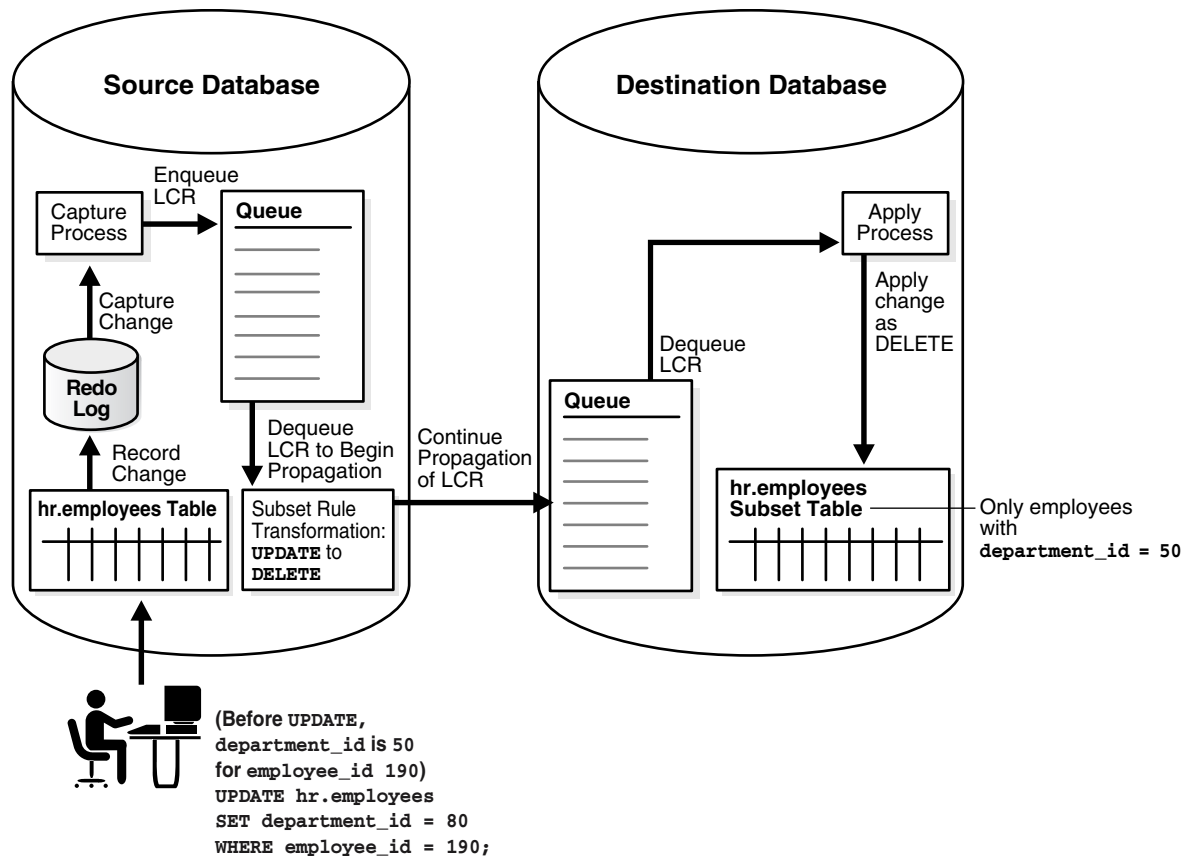

Similarly, if a captured update changes an employee's `department_id` from 80 to 50, then a propagation with this subset rule converts the update operation into an INSERT operation.

Row Migration During Apply When a subset rule is in the rule set for an **apply process**, an update operation can be converted into an insert or delete operation when a row LCR is applied.

For example, suppose you use a subset rule to specify that an apply process applies changes to the `hr.employees` table where the employee's `department_id` is 50 using the following subset condition: `department_id = 50`. Assume that the table at the destination database is a subset table that only contains records for employees whose `department_id` is 50. If a source database captures a change to an employee that changes the employee's `department_id` from 80 to 50, then the apply process with the subset rule at a destination database applies this change by converting the update operation into an insert operation. This conversion is needed because the employee's row does not exist in the destination table. Figure 6–4 illustrates this example.

Figure 6–4 Row Migration During Apply

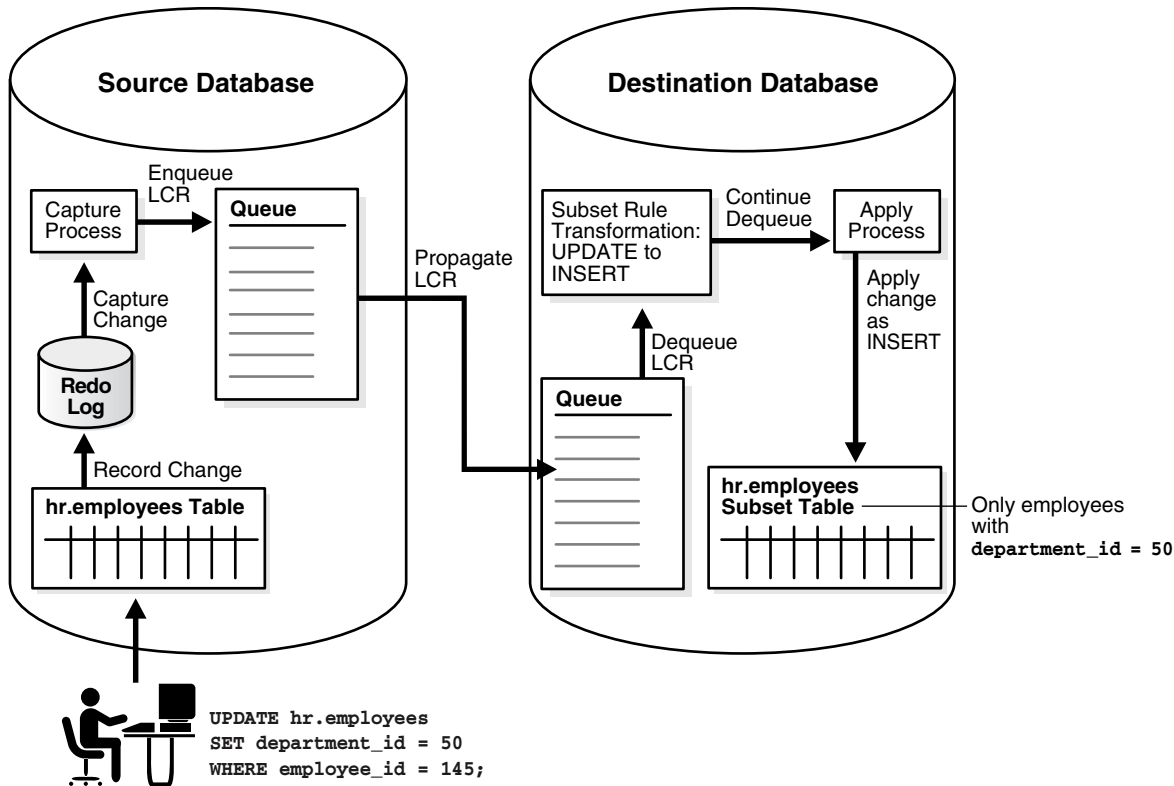

Similarly, if a captured update changes an employee's `department_id` from 50 to 20, then an apply process with this subset rule converts the update operation into a `DELETE` operation.

Row Migration During Dequeue by a Messaging Client When a subset rule is in the rule set for a messaging client, an update operation can be converted into an insert or delete operation when a row LCR is dequeued.

For example, suppose you use a subset rule to specify that a messaging client dequeues changes to the `hr.employees` table when the employee's `department_id` is 50 using the following subset condition: `department_id = 50`. If the queue for a messaging client contains a persistent row LCR with an update operation on the `hr.employees` table that changes an employee's `department_id` from 50 to 90, then when a user or application invokes a messaging client with this subset rule, the messaging client converts the update operation into a delete operation and dequeues the row LCR. Therefore, a row LCR that contains a `DELETE` is dequeued. The messaging client can process this row LCR in any customized way. For example, it can send the row LCR to a custom application. Figure 6–5 illustrates this example.

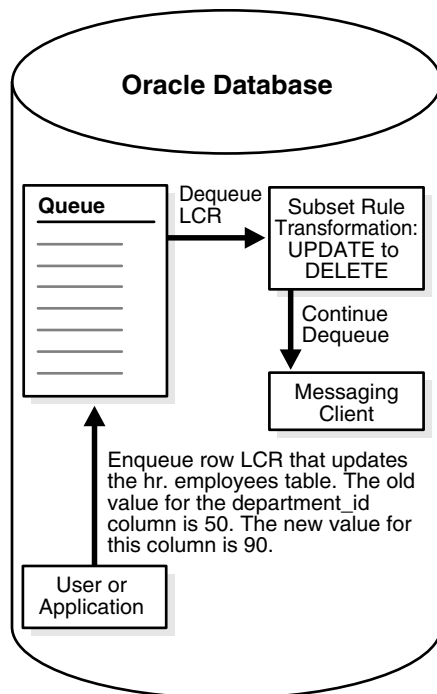
Figure 6–5 Row Migration During Dequeue by a Messaging Client

Similarly, if a persistent row LCR contains an update that changes an employee's `department_id` from 90 to 50, then a messaging client with this subset rule converts the UPDATE operation into an INSERT operation during dequeue.

Subset Rules and Supplemental Logging

Supplemental logging is required when you specify the following types of subset rules:

- Subset rules for a capture process
- Subset rules for a propagation that will propagate LCRs captured by a capture process
- Subset rules for an apply process that will apply LCRs captured by a capture process

In any of these cases, an unconditional **supplemental log group** must be specified at the **source database** for all the columns in the subset condition and all of the columns in the table(s) at the destination database(s) that will apply these changes. In some cases, when a subset rule is specified, an update can be converted to an insert, and, in these cases, supplemental information might be needed for some or all of the columns.

For example, if you specify a subset rule for an apply process that will apply **captured LCRs** at database `db2.example.com` on the `postal_code` column in the `hr.locations` table, and the source database for changes to this table is `db1.example.com`, then specify **supplemental logging** at `db1.example.com` for all of the columns that exist in the `hr.locations` table at `db2.example.com`, as well as the `postal_code` column, even if this column does not exist in the table at the destination database.

Note: Supplemental logging is not required when subset rules are used by a synchronous capture. Also, supplemental logging is not required propagations or apply processes process LCRs captured by synchronous capture.

See Also:

- *Oracle Streams Replication Administrator's Guide* for detailed information about supplemental logging
- ["Supplemental Logging in an Oracle Streams Environment"](#) on page 2-13

Guidelines for Using Subset Rules

The following sections provide guidelines for using subset rules:

- [Use Capture Subset Rules When All Destinations Need Only a Subset of Changes](#)
- [Use Propagation or Apply Subset Rules When Some Destinations Need Subsets](#)
- [Ensure That the Table Where Subset Row LCRs Are Applied Is a Subset Table](#)

Use Capture Subset Rules When All Destinations Need Only a Subset of Changes Subset rules should be used with a capture process or a synchronous capture when all destination databases of the captured changes need only row changes that satisfy the subset condition for the table. In this case, a capture process or a synchronous capture captures a subset of the DML changes to the table, and one or more propagations propagate these changes in the form of row LCRs to one or more destination databases. At each destination database, an apply process applies these row LCRs to a subset table in which all of the rows satisfy the subset condition in the subset rules for the capture process. None of the destination databases need all of the DML changes made to the table. When you use subset rules for a **local capture process** or a synchronous capture, some additional overhead is incurred to perform row migrations at the site running the source database.

Use Propagation or Apply Subset Rules When Some Destinations Need Subsets Subset rules should be used with a propagation or an apply process when some destinations in an environment need only a subset of captured DML changes. The following are examples of such an environment:

- Most of the destination databases for captured DML changes to a table need a different subset of these changes.
- Most of the destination databases need all of the captured DML changes to a table, but some destination databases need only a subset of these changes.

In these types of environments, the capture process or synchronous capture must capture all of the changes to the table, but you can use subset rules with propagations and apply processes to ensure that subset tables at destination databases only apply the correct subset of captured DML changes.

Consider these factors when you decide to use subset rules with a propagation in this type of environment:

- You can reduce network traffic because fewer row LCRs are propagated over the network.

- The site that contains the source queue for the propagation incurs some additional overhead to perform row migrations.

Consider these factors when you decide to use subset rules with an apply process in this type of environment:

- The queue used by the apply process can contain all row LCRs for the subset table. In a **directed networks** environment, propagations can propagate any of the row LCRs for the table to destination queues as appropriate, whether or not the apply process applies these row LCRs.
- The site that is running the apply process incurs some additional overhead to perform row migrations.

Ensure That the Table Where Subset Row LCRs Are Applied Is a Subset Table If an apply process might apply row LCRs that have been transformed by a row migration, then Oracle recommends that the table at the destination database be a subset table where each row matches the condition in the subset rule. If the table is not such a subset table, then apply errors might result.

For example, consider a scenario in which a subset rule for a capture process has the condition `department_id = 50` for DML changes to the `hr.employees` table. If the `hr.employees` table at a destination database of this capture process contains rows for employees in all departments, not just in department 50, then a constraint violation might result during apply:

1. At the source database, a DML change updates the `hr.employees` table and changes the `department_id` for the employee with an `employee_id` of 100 from 90 to 50.
2. A capture process using the subset rule captures the change and converts the update into an insert and enqueues the change into the capture process queue as a row LCR.
3. A propagation propagates the row LCR to the destination database without modifying it.
4. An apply process attempts to apply the row LCR as an insert at the destination database, but an employee with an `employee_id` of 100 already exists in the `hr.employees` table, and an apply error results.

In this case, if the table at the destination database were a subset of the `hr.employees` table and only contained rows of employees whose `department_id` was 50, then the insert would have been applied successfully.

Similarly, if an apply process might apply row LCRs that have been transformed by a row migration to a table, and you allow users or applications to perform DML operations on the table, then Oracle recommends that all DML changes satisfy the subset condition. If you allow local changes to the table, then the apply process cannot ensure that all rows in the table meet the subset condition. For example, suppose the condition is `department_id = 50` for the `hr.employees` table. If a user or an application inserts a row for an employee whose `department_id` is 30, then this row remains in the table and is not removed by the apply process. Similarly, if a user or an application updates a row locally and changes the `department_id` to 30, then this row also remains in the table.

Message Rules

When you use a **rule** to specify an Oracle Streams task that is relevant only for a **user message** of a specific, non-LCR **message** type, you are specifying a **message rule**. You can specify message rules for **propagations**, **apply processes**, and **messaging clients**.

A single message rule in the **positive rule set** for a propagation means that the propagation propagates the user messages of the message type in the **source queue** that satisfy the **rule condition**. A single message rule in the **negative rule set** for a propagation means that the propagation discards the user messages of the message type in the source queue that satisfy the rule condition.

A single message rule in the positive rule set for an apply process means that the apply process dequeues user messages of the message type that satisfy the rule condition. The apply process then sends these user messages to its **message handler**. A single message rule in the negative rule set for an apply process means that the apply process discards user messages of the message type in its **queue** that satisfy the rule condition.

A single message rule in the positive rule set for a messaging client means that a user or an application can use the messaging client to dequeue user messages of the message type that satisfy the rule condition. A single message rule in the negative rule set for a messaging client means that the messaging client discards user messages of the message type in its queue that satisfy the rule condition. Unlike propagations and apply processes, which propagate or apply messages automatically when they are running, a messaging client does not automatically dequeue or discard messages. Instead, a messaging client must be invoked by a user or application to dequeue or discard messages.

Message Rule Example

Suppose you use the `ADD_MESSAGE_RULE` procedure in the `DBMS_STREAMS_ADM` package to instruct an **Oracle Streams client** to behave in the following ways:

- **Dequeue User Messages If region Is EUROPE and priority Is 1**
- **Send User Messages to a Message Handler If region Is AMERICAS and priority Is 2**

The first instruction in the previous list pertains to a messaging client, while the second instruction pertains to an apply process.

The rules created in these examples are for messages of the following type:

```
CREATE TYPE strmadmin.region_pri_msg AS OBJECT(
  region      VARCHAR2(100),
  priority    NUMBER,
  message     VARCHAR2(3000))
/
```

Dequeue User Messages If region Is EUROPE and priority Is 1 Run the `ADD_MESSAGE_RULE` procedure to create a rule for messages of `region_pri_msg` type:

```
BEGIN
  DBMS_STREAMS_ADM.ADD_MESSAGE_RULE (
    message_type => 'strmadmin.region_pri_msg',
    rule_condition => ':msg.region = ''EUROPE'' AND ' ||
                     ':msg.priority = ''1'' ',
    streams_type => 'dequeue',
    streams_name => 'msg_client',
    queue_name => 'streams_queue',
    inclusion_rule => TRUE);
```

```
END;
/
```

Notice that `dequeue` is specified for the `streams_type` parameter. Therefore, this procedure creates a messaging client named `msg_client` if it does not already exist. If this messaging client already exists, then this procedure adds the message rule to its rule set. Also, notice that the `inclusion_rule` parameter is set to `TRUE`. This setting means that the **system-created rule** is added to the positive rule set for the messaging client. The user who runs this procedure is granted the privileges to dequeue from the queue using the messaging client.

The `ADD_MESSAGE_RULE` procedure creates a rule with a rule condition similar to the following:

```
:"VAR$_52".region = 'EUROPE' AND :"$VAR$_52".priority = '1'
```

The variables in the rule condition that begin with `VAR$` are variables that are specified in the system-generated **evaluation context** for the rule.

See Also: ["Evaluation Contexts Used in Oracle Streams"](#) on page 6-37

Send User Messages to a Message Handler If region Is AMERICAS and priority Is 2 Run the `ADD_MESSAGE_RULE` procedure to create a rule for messages of `region_pri_msg` type:

```
BEGIN
  DBMS_STREAMS_ADM.ADD_MESSAGE_RULE (
    message_type => 'strmadmin.region_pri_msg',
    rule_condition => ':msg.region = 'AMERICAS' AND ' ||
                    ':msg.priority = '2' ',
    streams_type => 'apply',
    streams_name => 'apply_msg',
    queue_name => 'streams_queue',
    inclusion_rule => TRUE);
END;
/
```

Notice that `apply` is specified for the `streams_type` parameter. Therefore, this procedure creates an apply process named `apply_msg` if it does not already exist. If this apply process already exists, then this procedure adds the message rule to its rule set. Also, notice that the `inclusion_rule` parameter is set to `TRUE`. This setting means that the system-created rule is added to the positive rule set for the messaging client.

The `ADD_MESSAGE_RULE` procedure creates a rule with a rule condition similar to the following:

```
:"VAR$_56".region = 'AMERICAS' AND :"$VAR$_56".priority = '2'
```

The variables in the rule condition that begin with `VAR$` are variables that are specified in the system-generated evaluation context for the rule.

See Also: ["Evaluation Contexts Used in Oracle Streams"](#) on page 6-37

Summary of Rules In this example, the following message rules were defined:

- A message rule for a messaging client named `msg_client` that evaluates to `TRUE` if a message has `EUROPE` for its region and 1 for its priority. Given this rule, a user or application can use the messaging client to dequeue messages of `region_pri_msg` type that satisfy the rule condition.
- A message rule for an apply process named `apply_msg` that evaluates to `TRUE` if a message has `AMERICAS` for its region and 2 for its priority. Given this rule, the apply process dequeues messages of `region_pri_msg` type that satisfy the rule condition and sends these messages to its message handler or reenqueues the messages into a specified queue.

See Also:

- "Message Handlers" on page 4-9
- "Enqueue Destinations for Messages During Apply" on page 6-42

System-Created Rules and Negative Rule Sets

You add system-created **rules** to a **negative rule set** to specify that you do not want an **Oracle Streams client** to perform its task for changes that satisfy these rules. Specifically, a **system-created rule** in a negative rule set means the following for each type of Oracle Streams client:

- A **capture process** discards changes that satisfy the rule.
- A **propagation** discards **messages** in its **source queue** that satisfy the rule.
- An **apply process** discards messages in its **queue** that satisfy the rule.
- A **messaging client** discards messages in its queue that satisfy the rule.

Note: A **synchronous capture** cannot have a negative rule set.

If an Oracle Streams client does not have a negative rule set, then you can create a negative rule set and add rules to it by running one of the following procedures and setting the `inclusion_rule` parameter to `FALSE`:

- `DBMS_STREAMS_ADM.ADD_TABLE_RULES`
- `DBMS_STREAMS_ADM.ADD_SCHEMA_RULES`
- `DBMS_STREAMS_ADM.ADD_GLOBAL_RULES`
- `DBMS_STREAMS_ADM.ADD_MESSAGE_RULE`
- `DBMS_STREAMS_ADM.ADD_TABLE_PROPAGATION_RULES`
- `DBMS_STREAMS_ADM.ADD_SCHEMA_PROPAGATION_RULES`
- `DBMS_STREAMS_ADM.ADD_GLOBAL_PROPAGATION_RULES`
- `DBMS_STREAMS_ADM.ADD_MESSAGE_PROPAGATION_RULE`

If a negative rule set already exists for the Oracle Streams client when you run one of these procedures, then the procedure adds the system-created rules to the existing negative rule set.

Alternatively, you can create a negative rule set when you create an Oracle Streams client by running one of the following procedures and specifying a non-NULL value for the `negative_rule_set_name` parameter:

- `DBMS_CAPTURE_ADM.CREATE_CAPTURE`
- `DBMS_PROPAGATION_ADM.CREATE_PROPAGATION`
- `DBMS_APPLY_ADM.CREATE_APPLY`

Also, you can specify a negative rule set for an existing Oracle Streams client by altering the client. For example, to specify a negative rule set for an existing capture process, use the `DBMS_CAPTURE_ADM.ALTER_CAPTURE` procedure. After an Oracle Streams client has a negative rule set, you can use the procedures in the `DBMS_STREAM_ADM` package listed previously to add system-created rules to it.

Instead of adding rules to a negative rule set, you can also exclude changes to certain tables or schemas in the following ways:

- Do not add system-created rules for the table or schema to a **positive rule set** for an Oracle Streams client. For example, to capture DML changes to all of the tables in a particular schema except for one table, add a DML **table rule** for each table in the schema, except for the excluded table, to the positive rule set for the capture process. The disadvantages of this approach are that there can be many tables in a schema and each one requires a separate DML rule, and, if a new table is added to the schema, and you want to capture changes to this new table, then a new DML rule must be added for this table to the positive rule set for the capture process.
- Use the `NOT` logical condition in the **rule condition** of a complex rule in the positive rule set for an Oracle Streams client. For example, to capture DML changes to all of the tables in a particular schema except for one table, use the `DBMS_STREAMS_ADM.ADD_SCHEMA_RULES` procedure to add a system-created DML **schema rule** to the positive rule set for the capture process that instructs the capture process to capture changes to the schema, and use the `and_condition` parameter to exclude the table with the `NOT` logical condition. The disadvantages to this approach are that it involves manually specifying parts of rule conditions, which can be error prone, and rule evaluation is not as efficient for complex rules as it is for unmodified system-created rules.

Given the goal of capturing DML changes to all of the tables in a particular schema except for one table, you can add a DML schema rule to the positive rule set for the capture process and a DML table rule for the excluded table to the negative rule set for the capture process.

This approach has the following advantages over the alternatives described previously:

- You add only two rules to achieve the goal.
- If a new table is added to the schema, and you want to capture DML changes to the table, then the capture process captures these changes without requiring modifications to existing rules or additions of new rules.
- You do not need to specify or edit rule conditions manually.
- Rule evaluation is more efficient because you avoid using complex rules.

See Also:

- ["Complex Rule Conditions"](#) on page 6-46
- ["System-Created Rules with Added User-Defined Conditions"](#) on page 6-35

Negative Rule Set Example

Suppose you want to apply row LCRs that contain the results of DML changes to all of the tables in `hr` schema except for the `job_history` table. To do so, you can use the `ADD_SCHEMA_RULES` procedure in the `DBMS_STREAMS_ADM` package to instruct an Oracle Streams apply process to apply row LCRs that contain the results of DML changes to the tables in the `hr` schema. In this case, the procedure creates a schema rule and adds the rule to the positive rule set for the apply process.

You can use the `ADD_TABLE_RULES` procedure in the `DBMS_STREAMS_ADM` package to instruct the Oracle Streams apply process to discard row LCRs that contain the results of DML changes to the tables in the `hr.job_history` table. In this case, the procedure creates a table rule and adds the rule to the negative rule set for the apply process.

The following sections explain how to run these procedures:

- [Apply All DML Changes to the Tables in the hr Schema](#)
- [Discard Row LCRs Containing DML Changes to the hr:job_history Table](#)

Apply All DML Changes to the Tables in the hr Schema These changes originated at the `db1.example.com` [source database](#).

Run the `ADD_SCHEMA_RULES` procedure to create this rule:

```
BEGIN
  DBMS_STREAMS_ADM.ADD_SCHEMA_RULES (
    schema_name      => 'hr',
    streams_type     => 'apply',
    streams_name     => 'apply',
    queue_name       => 'streams_queue',
    include_dml      => TRUE,
    include_ddl      => FALSE,
    include_tagged_lcr => FALSE,
    source_database  => 'db1.example.com',
    inclusion_rule   => TRUE);
END;
/
```

Notice that the `inclusion_rule` parameter is set to `TRUE`. This setting means that the system-created rule is added to the positive rule set for the apply process.

The `ADD_SCHEMA_RULES` procedure creates a rule with a rule condition similar to the following:

```
((:dml.get_object_owner() = 'HR') and :dml.is_null_tag() = 'Y'
and :dml.get_source_database_name() = 'DB1.EXAMPLE.COM' )
```

Discard Row LCRs Containing DML Changes to the hr:job_history Table These changes originated at the `db1.example.com` source database.

Run the `ADD_TABLE_RULES` procedure to create this rule:

```
BEGIN
  DBMS_STREAMS_ADM.ADD_TABLE_RULES (
    table_name       => 'hr.job_history',
    streams_type     => 'apply',
    streams_name     => 'apply',
    queue_name       => 'streams_queue',
    include_dml      => TRUE,
    include_ddl      => FALSE,
    include_tagged_lcr => TRUE,

```



```

source_database => 'dbs1.example.com',
inclusion_rule   => FALSE);
END;
/

```

Notice that the `inclusion_rule` parameter is set to `FALSE`. This setting means that the system-created rule is added to the negative rule set for the apply process.

Also notice that the `include_tagged_lcr` parameter is set to `TRUE`. This setting means that all changes for the table, including tagged LCRs that satisfy all of the other rule conditions, will be discarded. In most cases, specify `TRUE` for the `include_tagged_lcr` parameter if the `inclusion_rule` parameter is set to `FALSE`.

The `ADD_TABLE_RULES` procedure creates a rule with a rule condition similar to the following:

```

(((dml.get_object_owner() = 'HR' and :dml.get_object_name() = 'JOB_HISTORY'))
and :dml.get_source_database_name() = 'DBS1.EXAMPLE.COM' )

```

Summary of Rules In this example, the following rules were defined:

- A schema rule that evaluates to `TRUE` if a DML operation is performed on the tables in the `hr` schema. This rule is in the positive rule set for the apply process.
- A table rule that evaluates to `TRUE` if a DML operation is performed on the `hr.job_history` table. This rule is in the negative rule set for the apply process.

Given these rules, the following list provides examples of changes applied by the apply process:

- A row is inserted into the `hr.departments` table.
- Five rows are updated in the `hr.employees` table.
- A row is deleted from the `hr.countries` table.

The apply process dequeues these changes from its associated queue and applies them to the database objects at the destination database.

Given these rules, the following list provides examples of changes that are ignored by the apply process:

- A row is inserted into the `hr.job_history` table.
- A row is updated in the `hr.job_history` table.
- A row is deleted from the `hr.job_history` table.

These changes are not applied because they satisfy a rule in the negative rule set for the apply process.

See Also: ["Rule Sets and Rule Evaluation of Messages"](#) on page 6-3

System-Created Rules with Added User-Defined Conditions

Some of the procedures that create **rules** in the `DBMS_STREAMS_ADM` package include an `and_condition` parameter. This parameter enables you to add conditions to **system-created rules**. The condition specified by the `and_condition` parameter is appended to the system-created **rule condition** using an `AND` clause in the following way:

```

(system_condition) AND (and_condition)

```

The variable in the specified condition must be `:lcr`. For example, to specify that the **table rules** generated by the `ADD_TABLE_RULES` procedure evaluate to `TRUE` only if the table is `hr.departments`, the **source database** is `dbs1.example.com`, and the Oracle Streams **tag** is the hexadecimal equivalent of `'02'`, run the following procedure:

```
BEGIN
  DBMS_STREAMS_ADM.ADD_TABLE_RULES(
    table_name      => 'hr.departments',
    streams_type    => 'apply',
    streams_name    => 'apply_02',
    queue_name      => 'streams_queue',
    include_dml     => TRUE,
    include_ddl     => TRUE,
    include_tagged_lcr => TRUE,
    source_database => 'dbs1.example.com',
    inclusion_rule  => TRUE,
    and_condition   => ':lcr.get_tag() = HEXTORAW('02')');
END;
/
```

The `ADD_TABLE_RULES` procedure creates a DML rule with the following condition:

```
(((((dml.get_object_owner() = 'HR' and dml.get_object_name() = 'DEPARTMENTS'))
 and dml.get_source_database_name() = 'DBS1.EXAMPLE.COM' ))
 and (:dml.get_tag() = HEXTORAW('02'))))
```

It creates a DDL rule with the following condition:

```
(((((ddl.get_object_owner() = 'HR' and ddl.get_object_name() = 'DEPARTMENTS')
 or (:ddl.get_base_table_owner() = 'HR'
 and :ddl.get_base_table_name() = 'DEPARTMENTS'))
 and :ddl.get_source_database_name() = 'DBS1.EXAMPLE.COM' ))
 and (:ddl.get_tag() = HEXTORAW('02'))))
```

Notice that the `:lcr` in the specified condition is converted to `:dml` or `:ddl`, depending on the rule that is being generated. If you are specifying an LCR member subprogram that is dependent on the LCR type (row or DDL), then ensure that this procedure only generates the appropriate rule. Specifically, if you specify an LCR member subprogram that is valid only for row LCRs, then specify `TRUE` for the `include_dml` parameter and `FALSE` for the `include_ddl` parameter. If you specify an LCR member subprogram that is valid only for DDL LCRs, then specify `FALSE` for the `include_dml` parameter and `TRUE` for the `include_ddl` parameter.

For example, the `GET_OBJECT_TYPE` member function only applies to DDL LCRs. Therefore, if you use this member function in an `and_condition`, then specify `FALSE` for the `include_dml` parameter and `TRUE` for the `include_ddl` parameter.

See Also:

- *Oracle Database PL/SQL Packages and Types Reference* for more information about LCR member subprograms
- *Oracle Streams Replication Administrator's Guide* for more information about Oracle Streams tags

Evaluation Contexts Used in Oracle Streams

The following sections describe the system-created **evaluation contexts** used in Oracle Streams.

- [Evaluation Context for Global, Schema, Table, and Subset Rules](#)
- [Evaluation Contexts for Message Rules](#)

Evaluation Context for Global, Schema, Table, and Subset Rules

When you create global, schema, table, and subset rules, the system-created **rule sets** and rules use a built-in **evaluation context** in the SYS schema named STREAMS\$_EVALUATION_CONTEXT. PUBLIC is granted the EXECUTE privilege on this evaluation context. Global, schema, table, and subset rules can be used by **capture processes**, **synchronous captures**, **propagations**, **apply processes**, and **messaging clients**.

During Oracle installation, the following statement creates the Oracle Streams evaluation context:

```
DECLARE
  vt SYS.RE$VARIABLE_TYPE_LIST;
BEGIN
  vt := SYS.RE$VARIABLE_TYPE_LIST(
    SYS.RE$VARIABLE_TYPE('DML', 'SYS.LCR$_ROW_RECORD',
      'SYS.DBMS_STREAMS_INTERNAL.ROW_VARIABLE_VALUE_FUNCTION',
      'SYS.DBMS_STREAMS_INTERNAL.ROW_FAST_EVALUATION_FUNCTION'),
    SYS.RE$VARIABLE_TYPE('DDL', 'SYS.LCR$_DDL_RECORD',
      'SYS.DBMS_STREAMS_INTERNAL.DDL_VARIABLE_VALUE_FUNCTION',
      'SYS.DBMS_STREAMS_INTERNAL.DDL_FAST_EVALUATION_FUNCTION'));
  SYS.RE$VARIABLE_TYPE(NULL, 'SYS.ANYDATA',
    NULL,
    'SYS.DBMS_STREAMS_INTERNAL.ANYDATA_FAST_EVAL_FUNCTION');
  DBMS_RULE_ADM.CREATE_EVALUATION_CONTEXT(
    evaluation_context_name => 'SYS.STREAMS$_EVALUATION_CONTEXT',
    variable_types          => vt,
    evaluation_function      =>
      'SYS.DBMS_STREAMS_INTERNAL.EVALUATION_CONTEXT_FUNCTION');
END;
/
```

This statement includes references to the following internal functions in the SYS.DBMS_STREAM_INTERNAL package:

- ROW_VARIABLE_VALUE_FUNCTION
- DDL_VARIABLE_VALUE_FUNCTION
- EVALUATION_CONTEXT_FUNCTION
- ROW_FAST_EVALUATION_FUNCTION
- DDL_FAST_EVALUATION_FUNCTION
- ANYDATA_FAST_EVAL_FUNCTION

Caution: Information about these internal functions is provided for reference purposes only. You should never run any of these functions directly.

The `ROW_VARIABLE_VALUE_FUNCTION` converts an `ANYDATA` payload, which encapsulates a `SYS.LCR$_ROW_RECORD` instance, into a `SYS.LCR$_ROW_RECORD` instance prior to evaluating rules on the data.

The `DDL_VARIABLE_VALUE_FUNCTION` converts an `ANYDATA` payload, which encapsulates a `SYS.LCR$_DDL_RECORD` instance, into a `SYS.LCR$_DDL_RECORD` instance prior to evaluating rules on the data.

The `EVALUATION_CONTEXT_FUNCTION` is specified as an `evaluation_function` in the call to the `CREATE_EVALUATION_CONTEXT` procedure. This function supplements normal rule evaluation for **captured LCRs**. A capture process enqueues row LCRs and DDL LCRs into its **queue**, and this function enables it to enqueue other internal **messages** into the queue, such as commits, rollbacks, and data dictionary changes. This information that is enqueued by capture processes is also used during rule evaluation for a propagation or apply process. Synchronous captures do not use the `EVALUATION_CONTEXT_FUNCTION`.

`ROW_FAST_EVALUATION_FUNCTION` improves performance by optimizing access to the following `LCR$_ROW_RECORD` member functions during rule evaluation:

- `GET_OBJECT_OWNER`
- `GET_OBJECT_NAME`
- `IS_NULL_TAG`
- `GET_SOURCE_DATABASE_NAME`
- `GET_COMMAND_TYPE`

`DDL_FAST_EVALUATION_FUNCTION` improves performance by optimizing access to the following `LCR$_DDL_RECORD` member functions during rule evaluation if the condition is `<`, `<=`, `=`, `>=`, or `>` and the other operand is a constant:

- `GET_OBJECT_OWNER`
- `GET_OBJECT_NAME`
- `IS_NULL_TAG`
- `GET_SOURCE_DATABASE_NAME`
- `GET_COMMAND_TYPE`
- `GET_BASE_TABLE_NAME`
- `GET_BASE_TABLE_OWNER`

`ANYDATA_FAST_EVAL_FUNCTION` improves performance by optimizing access to values inside an `ANYDATA` object.

Rules created using the `DBMS_STREAMS_ADM` package use `ROW_FAST_EVALUATION_FUNCTION` or `DDL_FAST_EVALUATION_FUNCTION`, except for subset rules created using the `ADD_SUBSET_RULES` or `ADD_SUBSET_PROPAGATION_RULES` procedure.

See Also:

- *Oracle Database PL/SQL Packages and Types Reference* for more information about LCRs and their member functions

Evaluation Contexts for Message Rules

When you use either the `ADD_MESSAGE_RULE` procedure or the `ADD_MESSAGE_PROPAGATION_RULE` procedure to create a **message rule**, the message rule uses a user-defined **message** type that you specify when you create the rule. Such a

system-created message rule uses a system-created **evaluation context**. The name of the system-created evaluation context is different for each message type used to create message rules. Such an evaluation context has a system-generated name and is created in the schema that owns the rule. Only the user who owns this evaluation context is granted the EXECUTE privilege on it.

The evaluation context for this type of message rule contains a variable that is the same type as the message type. The name of this variable is in the form `VAR$_number`, where *number* is a system-generated number. For example, if you specify `strmadmin.region_pri_msg` as the message type when you create a message rule, then the system-created evaluation context has a variable of this type, and the variable is used in the **rule condition**. Assume that the following statement created the `strmadmin.region_pri_msg` type:

```
CREATE TYPE strmadmin.region_pri_msg AS OBJECT(
  region      VARCHAR2(100),
  priority    NUMBER,
  message     VARCHAR2(3000))
/
```

When you create a message rule using this type, you can specify the following rule condition:

```
:msg.region = 'EUROPE' AND :msg.priority = '1'
```

The system-created message rule replaces `:msg` in the rule condition you specify with the name of the variable. The following is an example of a message rule condition that might result:

```
:VAR$_52.region = 'EUROPE' AND :VAR$_52.priority = '1'
```

In this case, `VAR$_52` is the variable name, the type of the `VAR$_52` variable is `strmadmin.region_pri_msg`, and the evaluation context for the rule contains this variable.

The message rule itself has an evaluation context. A statement similar to the following creates an evaluation context for a message rule:

```
DECLARE
  vt SYS.RE$VARIABLE_TYPE_LIST;
BEGIN
  vt := SYS.RE$VARIABLE_TYPE_LIST(
    SYS.RE$VARIABLE_TYPE('VAR$_52', 'STRMADMIN.REGION_PRI_MSG',
      'SYS.DBMS_STREAMS_INTERNAL.MSG_VARIABLE_VALUE_FUNCTION', NULL));
  DBMS_RULE_ADM.CREATE_EVALUATION_CONTEXT(
    evaluation_context_name => 'STRMADMIN.EVAL_CTX$_99',
    variable_types         => vt,
    evaluation_function     => NULL);
END;
/
```

The name of the evaluation context is in the form `EVAL_CTX$_number`, where *number* is a system-generated number. In this example, the name of the evaluation context is `EVAL_CTX$_99`.

This statement also includes a reference to the `MSG_VARIABLE_VALUE_FUNCTION` internal function in the `SYS.DBMS_STREAM_INTERNAL` package. This function converts an ANYDATA payload, which encapsulates a message instance, into an instance of the same type as the variable prior to evaluating rules on the data. For example, if the variable type is `strmadmin.region_pri_msg`, then the `MSG_`

VARIABLE_VALUE_FUNCTION converts the message payload from an ANYDATA payload to a `strmadmin.region_pri_msg` payload.

If you create rules for different message types, then Oracle creates a different evaluation context for each message type. If you create a new rule with the same message type as an existing rule, then the new rule uses the evaluation context for the existing rule. When you use the `ADD_MESSAGE_RULE` or `ADD_MESSAGE_PROPAGATION_RULE` to create a **rule set** for a **messaging client** or **apply process**, the new rule set does not have an evaluation context.

See Also:

- ["Message Rules"](#) on page 6-30
- ["Evaluation Context for Global, Schema, Table, and Subset Rules"](#) on page 6-37
- ["Displaying the Oracle Streams Rules Used by a Specific Oracle Streams Client"](#) on page 26-4

Oracle Streams and Event Contexts

In Oracle Streams, **capture processes**, **synchronous captures**, and **messaging clients** do not use event contexts, but **propagations** and **apply processes** do. The following types of **messages** can be staged in a **queue**: **captured LCRs**, **buffered LCRs**, **buffered user messages**, **persistent LCRs**, and **persistent user messages**. When a message is staged in a queue, a propagation or apply process can send the message, along with an event context, to the **rules engine** for evaluation. An event context always has the following name-value pair: `AQ$_MESSAGE` as the name and the message as the value.

If you create a custom **evaluation context**, then you can create propagation and apply process **rules** that refer to Oracle Streams events using implicit variables. The variable value function for each implicit variable can check for event contexts with the name `AQ$_MESSAGE`. If an event context with this name is found, then the variable value function returns a value based on a message. You can also pass the event context to an evaluation function and a variable method function.

See Also:

- ["Rule Set Evaluation"](#) on page 5-10 for more information about event contexts
- ["Explicit and Implicit Variables"](#) on page 5-5 for more information about variable value functions
- ["Evaluation Function"](#) on page 5-7

Oracle Streams and Action Contexts

The following sections describe the purposes of **action contexts** in Oracle Streams and the importance of ensuring that only one **rule** in a **rule set** can evaluate to `TRUE` for a particular **rule condition**.

Purposes of Action Contexts in Oracle Streams

In Oracle Streams, an **action context** serves the following purposes:

- [Internal LCR Transformations in Subset Rules](#)
- [Information About Declarative Rule-Based Transformations](#)

- [Custom Rule-Based Transformations](#)
- [Execution Directives for Messages During Apply](#)
- [Enqueue Destinations for Messages During Apply](#)

A different name-value pair can exist in the action context of a **rule** for each of these purposes. If an action context for a rule contains more than one of these name-value pairs, then the actions specified or described by the name-value pairs are performed in the following order:

1. Perform subset transformation.
2. Display information about **declarative rule-based transformation**.
3. Perform **custom rule-based transformation**.
4. Follow execution directive and perform execution if directed to do so (apply only).
5. Enqueue into a **destination queue** (apply only).

Note: The actions specified in the action context for a rule are performed only if the rule is in the **positive rule set** for a **capture process**, **synchronous capture**, **propagation**, **apply process**, or **messaging client**. If a rule is in a **negative rule set**, then these **Oracle Streams clients** ignore the action context of the rule.

Internal LCR Transformations in Subset Rules

When you use **subset rules**, an update operation can be converted into an insert or delete operation when it is captured, propagated, applied, or dequeued. This automatic conversion is called **row migration** and is performed by an internal transformation specified in the action context when the subset rule evaluates to `TRUE`. The name-value pair for a subset transformation has `STREAMS$_ROW_SUBSET` for the name and either `INSERT` or `DELETE` for the value.

See Also:

- ["Subset Rules"](#) on page 6-19
- [Chapter 18, "Managing Rule-Based Transformations"](#) for information about using rule-based transformation with subset rules

Information About Declarative Rule-Based Transformations

A declarative rule-based transformation is an internal modification of a row LCR that results when a rule evaluates to `TRUE`. The name-value pair for a declarative rule-based transformation has `STREAMS$_INTERNAL_TRANSFORM` for the name and the name of a data dictionary view that provides additional information about the transformation for the value.

The name-value pair added for a declarative rule-based transformation is for information purposes only. These name-value pairs are not used by Oracle Streams clients. However, the declarative rule-based transformations described in an action context are performed internally before any custom rule-based transformations specified in the same action context.

See Also:

- ["Declarative Rule-Based Transformations"](#) on page 7-1
- ["Managing Declarative Rule-Based Transformations"](#) on page 18-1

Custom Rule-Based Transformations

A custom rule-based transformation is any modification made by a user-defined function to a [message](#) when a rule evaluates to `TRUE`. The name-value pair for a custom rule-based transformation has `STREAMS$_TRANSFORM_FUNCTION` for the name and the name of the transformation function for the value.

See Also:

- ["Custom Rule-Based Transformations"](#) on page 7-2
- ["Managing Custom Rule-Based Transformations"](#) on page 18-5

Execution Directives for Messages During Apply

The `SET_EXECUTE` procedure in the `DBMS_APPLY_ADM` package specifies whether a message that satisfies the specified rule is executed by an apply process. The name-value pair for an execution directive has `APPLY$_EXECUTE` for the name and `NO` for the value if the apply process should not execute the message. If a message that satisfies a rule should be executed by an apply process, then this name-value pair is not present in the action context of the rule.

See Also: ["Specifying Execute Directives for Apply Processes"](#) on page 16-12

Enqueue Destinations for Messages During Apply

The `SET_ENQUEUE_DESTINATION` procedure in the `DBMS_APPLY_ADM` package sets the [queue](#) where a message that satisfies the specified rule is enqueued automatically by an apply process. The name-value pair for an enqueue destination has `APPLY$_ENQUEUE` for the name and the name of the destination queue for the value.

See Also: ["Specifying That Apply Processes Enqueue Messages"](#) on page 16-11

Ensure That Only One Rule Can Evaluate to TRUE for a Particular Rule Condition

If you use a non-NULL [action context](#) for one or more [rules](#) in a [positive rule set](#), then ensure that only one rule can evaluate to `TRUE` for a particular [rule condition](#). If more than one rule evaluates to `TRUE` for a particular condition, then only one of the rules is returned, which can lead to unpredictable results.

For example, suppose two rules evaluate to `TRUE` if an LCR contains a DML change to the `hr.employees` table. The first rule has a `NULL` action context. The second rule has an action context that specifies a [custom rule-based transformation](#). If there is a DML change to the `hr.employees` table, then both rules evaluate to `TRUE` for the change, but only one rule is returned. In this case, the transformation might or might not occur, depending on which rule is returned.

You might want to ensure that only one rule in a positive rule set can evaluate to `TRUE` for any condition, regardless of whether any of the rules have a non-NULL action context. By following this guideline, you can avoid unpredictable results if, for example, a non-NULL action context is added to a rule in the future.

See Also: [Chapter 7, "Rule-Based Transformations"](#)

Action Context Considerations for Schema and Global Rules

If you use an **action context** for a **custom rule-based transformation**, enqueue destination, or execute directive with a **schema rule** or **global rule**, then the action specified by the action context is carried out on a **message** if the message causes the schema or global rule to evaluate to `TRUE`. For example, if a **schema rule** has an action context that specifies a custom rule-based transformation, then the transformation is performed on LCRs for the tables in the schema.

You might want to use an action context with a schema or global rule but exclude a subset of LCRs from the action performed by the action context. For example, if you want to perform a custom rule-based transformation on all of the tables in the `hr` schema except for the `job_history` table, then ensure that the transformation function returns the original LCR if the table is `job_history`.

If you want to set an enqueue destination or an execute directive for all of the tables in the `hr` schema except for the `job_history` table, then you can use a schema rule and add the following condition to it:

```
:dm1.get_object_name() != 'JOB_HISTORY'
```

In this case, if you want LCRs for the `job_history` table to evaluate to `TRUE`, but you do not want to perform the enqueue or execute directive, then you can add a **table rule** for the table to a **positive rule set**. That is, the schema rule would have the enqueue destination or execute directive, but the table rule would not.

See Also: ["System-Created Rules"](#) on page 6-5 for more information about schema and global rules

User-Created Rules, Rule Sets, and Evaluation Contexts

The `DBMS_STREAMS_ADM` package generates system-created **rules** and **rule sets**, and it can specify an Oracle-supplied **evaluation context** for rules and rule sets or generate system-created evaluation contexts. If you must create rules, rule sets, or evaluation contexts that cannot be created using the `DBMS_STREAMS_ADM` package, then you can use the `DBMS_RULE_ADM` package to create them.

Use the `DBMS_RULE_ADM` package for the following reasons:

- You must create rules with **rule conditions** that cannot be created using the `DBMS_STREAMS_ADM` package, such as rule conditions for specific types of operations, or rule conditions that use the `LIKE` condition.
- You must create custom evaluation contexts for the rules in your Oracle Streams environment.

You can create a rule set using the `DBMS_RULE_ADM` package, and you can associate it with a **capture process**, **synchronous capture**, **propagation**, **apply process**, or **messaging client**. Such a rule set can be a **positive rule set** or **negative rule set** for an **Oracle Streams client**, and a rule set can be a positive rule set for one Oracle Streams client and a negative rule set for another.

This section contains the following topics:

- [User-Created Rules and Rule Sets](#)
- [User-Created Evaluation Contexts](#)

See Also:

- ["Specifying a Rule Set for a Capture Process"](#) on page 14-3
- ["Specifying the Rule Set for a Propagation"](#) on page 15-7
- ["Specifying the Rule Set for an Apply Process"](#) on page 16-3

User-Created Rules and Rule Sets

The following sections describe some of the types of **rules** and **rule sets** that you can create using the `DBMS_RULE_ADM` package:

- [Rule Conditions for Specific Types of Operations](#)
- [Rule Conditions that Instruct Oracle Streams Clients to Discard Unsupported LCRs](#)
- [Complex Rule Conditions](#)
- [Rule Conditions with Undefined Variables that Evaluate to NULL](#)
- [Variables as Function Parameters in Rule Conditions](#)

Note: You can add user-defined conditions to a **system-created rule** by using the `and_condition` parameter that is available in some of the procedures in the `DBMS_STREAMS_ADM` package. Using the `and_condition` parameter is sometimes easier than creating rules with the `DBMS_RULE_ADM` package.

See Also: ["System-Created Rules with Added User-Defined Conditions"](#) on page 6-35 for more information about the `and_condition` parameter

Rule Conditions for Specific Types of Operations

In some cases, you might want to capture, propagate, apply, or dequeue only changes that contain specific types of operations. For example, you might want to apply changes containing only insert operations for a particular table, but not other operations, such as update and delete.

Suppose you want to specify a **rule condition** that evaluates to `TRUE` only for `INSERT` operations on the `hr.employees` table. You can accomplish this by specifying the `INSERT` command type in the rule condition:

```
:dml.get_command_type() = 'INSERT' AND :dml.get_object_owner() = 'HR'  
AND :dml.get_object_name() = 'EMPLOYEES' AND :dml.is_null_tag() = 'Y'
```

Similarly, suppose you want to specify a rule condition that evaluates to `TRUE` for all DML operations on the `hr.departments` table, except `DELETE` operations. You can accomplish this by specifying the following rule condition:

```
:dml.get_object_owner() = 'HR' AND :dml.get_object_name() = 'DEPARTMENTS' AND  
:dml.is_null_tag() = 'Y' AND (:dml.get_command_type() = 'INSERT' OR  
:dml.get_command_type() = 'UPDATE')
```

This rule condition evaluates to `TRUE` for `INSERT` and `UPDATE` operations on the `hr.departments` table, but not for `DELETE` operations. Because the `hr.departments` table does not include any LOB columns, you do not need to specify the LOB command types for DML operations (`LOB ERASE`, `LOB WRITE`, and

LOB TRIM), but these command types should be specified in such a rule condition for a table that contains one or more LOB columns.

The following rule condition accomplishes the same behavior for the `hr.departments` table. That is, the following rule condition evaluates to TRUE for all DML operations on the `hr.departments` table, except DELETE operations:

```
:dml.get_object_owner() = 'HR' AND :dml.get_object_name() = 'DEPARTMENTS' AND
:dml.is_null_tag() = 'Y' AND :dml.get_command_type() != 'DELETE'
```

The example rule conditions described previously in this section are all simple rule conditions. However, when you add custom conditions to system-created rule conditions, the entire condition might not be a simple rule condition, and nonsimple rules might not evaluate efficiently. In general, you should use simple rule conditions whenever possible to improve rule evaluation performance. Rule conditions created using the `DBMS_STREAMS_ADM` package, without custom conditions added, are always simple.

See Also:

- ["Simple Rule Conditions"](#) on page 5-3
- ["Complex Rule Conditions"](#) on page 6-46

Rule Conditions that Instruct Oracle Streams Clients to Discard Unsupported LCRs

You can use the following functions in rule conditions to instruct an **Oracle Streams client** to discard LCRs that encapsulate unsupported changes:

- The `GET_COMPATIBLE` member function for LCRs. This function returns the minimal database compatibility required to support an LCR.
- The `COMPATIBLE_9_2` function, `COMPATIBLE_10_1` function, `COMPATIBLE_10_2` function, and `COMPATIBLE_11_1` function in the `DBMS_STREAMS` package. These functions return constant values that correspond to 9.2.0, 10.1.0, 10.2.0, and 11.1.0 compatibility in a database, respectively. You control the compatibility of an Oracle database using the `COMPATIBLE` initialization parameter.

For example, consider the following rule:

```
BEGIN
  DBMS_RULE_ADM.CREATE_RULE(
    rule_name => 'strmadmin.dml_compat_9_2',
    condition => ':dml.GET_COMPATIBLE() > DBMS_STREAMS.COMPATIBLE_9_2()');
END;
/
```

If this rule is in the **negative rule set** for an Oracle Streams client, such as a **capture process**, a **propagation**, or an **apply process**, then the Oracle Streams client discards any row LCR that is not compatible with Oracle9i Database Release 2 (9.2).

The following is an example that is more appropriate for a **positive rule set**:

```
BEGIN
  DBMS_RULE_ADM.CREATE_RULE(
    rule_name => 'strmadmin.dml_compat_9_2',
    condition => ':dml.GET_COMPATIBLE() <= DBMS_STREAMS.COMPATIBLE_10_1()');
END;
/
```

If this rule is in the positive rule set for an Oracle Streams client, then the Oracle Streams client discards any row LCR that is not compatible with Oracle Database 10g

Release 1 or earlier. That is, the Oracle Streams client processes any row LCR that is compatible with Oracle9i Database Release 2 (9.2) or Oracle Database 10g Release 1 (10.1) and satisfies the other rules in its rule sets, but it discards any row LCR that is not compatible with these releases.

Both of the rules in the previous examples evaluate efficiently. If you use [schema rules](#) or [global rules](#) created by the `DBMS_STREAMS_ADM` package to capture, propagate, apply, or dequeue LCRs, then rules such as these can be used to discard LCRs that are not supported by a particular database.

Note:

- You can determine which database objects in a database are not supported by Oracle Streams by querying the `DBA_STREAMS_UNSUPPORTED` and `DBA_STREAMS_COLUMNS` data dictionary views.
 - Instead of using the `DBMS_RULE_ADM` package to create rules with `GET_COMPATIBLE` conditions, you can use one of the procedures in the `DBMS_STREAMS_ADM` package to create such rules by specifying the `GET_COMPATIBLE` condition in the `AND_CONDITION` parameter.
 - DDL LCRs always return `DBMS_STREAMS.COMPATIBLE_9_2`.
-
-

See Also:

- ["Monitoring Compatibility in an Oracle Streams Environment"](#) on page 28-7
- ["Global Rules Example"](#) on page 6-11, ["Schema Rule Example"](#) on page 6-15, and ["System-Created Rules with Added User-Defined Conditions"](#) on page 6-35
- *Oracle Database Reference* and *Oracle Database Upgrade Guide* for more information about the `COMPATIBLE` initialization parameter

Complex Rule Conditions

Complex rule conditions are rule conditions that do not meet the requirements for simple rule conditions described in ["Simple Rule Conditions"](#) on page 5-3. In an Oracle Streams environment, the `DBMS_STREAMS_ADM` package creates rules with simple rule conditions only, assuming no custom conditions are added to the system-created rules.

[Table 6–3](#) on page 6-7 describes the types of system-created rule conditions that you can create with the `DBMS_STREAMS_ADM` package. If you must create rules with complex conditions, then you can use the `DBMS_RULE_ADM` package.

There is a wide range of complex rule conditions. The following sections contain some examples of complex rule conditions.

Note:

- Complex rule conditions can degrade rule evaluation performance.
- In rule conditions, if you specify the name of a database, then ensure that you include the full database name, including the domain name.

Rule Conditions Using the NOT Logical Condition to Exclude Objects You can use the `NOT` logical condition to exclude certain changes from being captured, propagated, applied, or dequeued in an Oracle Streams environment.

For example, suppose you want to specify rule conditions that evaluate to `TRUE` for all DML and DDL changes to all database objects in the `hr` schema, except for changes to the `hr.regions` table. You can use the `NOT` logical condition to accomplish this with two rules: one for DML changes and one for DDL changes. Here are the rule conditions for these rules:

```
(:dml.get_object_owner() = 'HR' AND NOT :dml.get_object_name() = 'REGIONS')
AND :dml.is_null_tag() = 'Y' ((:ddl.get_object_owner() = 'HR' OR :ddl.get_base_
table_owner() = 'HR') AND NOT :ddl.get_object_name() = 'REGIONS') AND :ddl.is_
null_tag() = 'Y'
```

Notice that object names, such as `HR` and `REGIONS` are specified in all uppercase characters in these examples. For rules to evaluate properly, the case of the characters in object names, such as tables and users, must match the case of the characters in the data dictionary. Therefore, if no case was specified for an object when the object was created, then specify the object name in all uppercase in rule conditions. However, if a particular case was specified through the use of double quotation marks when the objects was created, then specify the object name in the same case in rule conditions. However, the object name cannot be enclosed in double quotes in rule conditions.

For example, if the `REGIONS` table in the `HR` schema was actually created as "Regions", then specify `Regions` in rule conditions that involve this table, as in the following example:

```
:dml.get_object_name() = 'Regions'
```

You can use the Oracle Streams **evaluation context** when you create these rules using the `DBMS_RULE_ADM` package. The following example creates a rule set to hold the complex rules, creates rules with the previous conditions, and adds the rules to the rule set:

```
BEGIN
  -- Create the rule set
  DBMS_RULE_ADM.CREATE_RULE_SET(
    rule_set_name      => 'strmadmin.complex_rules',
    evaluation_context => 'SYS.STREAMS$_EVALUATION_CONTEXT');
  -- Create the complex rules
  DBMS_RULE_ADM.CREATE_RULE(
    rule_name => 'strmadmin.hr_not_regions_dml',
    condition => ' (:dml.get_object_owner() = 'HR' AND NOT ' ||
                  ':dml.get_object_name() = 'REGIONS') AND ' ||
                  ':dml.is_null_tag() = 'Y' ');
  DBMS_RULE_ADM.CREATE_RULE(
    rule_name => 'strmadmin.hr_not_regions_ddl',
    condition => ' ((:ddl.get_object_owner() = 'HR' OR ' ||
                  ':ddl.get_base_table_owner() = 'HR') AND NOT ' ||
```

```

        ' :ddl.get_object_name() = 'REGIONS') AND ' ||
        ' :ddl.is_null_tag() = 'Y' ');
-- Add the rules to the rule set
DBMS_RULE_ADM.ADD_RULE(
    rule_name      => 'strmadmin.hr_not_regions_dml',
    rule_set_name  => 'strmadmin.complex_rules');
DBMS_RULE_ADM.ADD_RULE(
    rule_name      => 'strmadmin.hr_not_regions_ddl',
    rule_set_name  => 'strmadmin.complex_rules');
END;
/

```

In this case, the rules inherit the Oracle Streams evaluation context from the rule set.

Note: In most cases, you can avoid using complex rules with the NOT logical condition by using the DBMS_STREAMS_ADM package to add rules to the negative rule set for an Oracle Streams client

See Also: ["System-Created Rules and Negative Rule Sets"](#) on page 6-32

Rule Conditions Using the LIKE Condition You can use the LIKE condition to create complex rules that evaluate to TRUE when a condition in the rule matches a specified pattern. For example, suppose you want to specify rule conditions that evaluate to TRUE for all DML and DDL changes to all database objects in the hr schema that begin with the pattern JOB. You can use the LIKE condition to accomplish this with two rules: one for DML changes and one for DDL changes. Here are the rule conditions for these rules:

```
(:dml.get_object_owner() = 'HR' AND :dml.get_object_name() LIKE 'JOB%')
AND :dml.is_null_tag() = 'Y'
```

```
((:ddl.get_object_owner() = 'HR' OR :ddl.get_base_table_owner() = 'HR')
AND :ddl.get_object_name() LIKE 'JOB%') AND :ddl.is_null_tag() = 'Y'
```

Rule Conditions with Undefined Variables that Evaluate to NULL

During evaluation, an implicit variable in a rule condition is undefined if the variable value function for the variable returns NULL. An explicit variable without any attributes in a rule condition is undefined if the client does not send the value of the variable to the [rules engine](#) when it runs the DBMS_RULE.EVALUATE procedure.

Regarding variables with attributes, a variable is undefined if the client does not send the value of the variable, or any of its attributes, to the rules engine when it runs the DBMS_RULE.EVALUATE procedure. For example, if variable x has attributes a and b, then the variable is undefined if the client does not send the value of x and does not send the value of a and b. However, if the client sends the value of at least one attribute, then the variable is defined. In this case, if the client sends the value of a, but not b, then the variable is defined.

An undefined variable in a rule condition evaluates to NULL for Oracle Streams clients of the rules engine, which include capture processes, synchronous captures, propagations, apply processes, and messaging clients. In contrast, for non-Oracle Streams clients of the rules engine, an undefined variable in a rule condition can cause the rules engine to return maybe_rules to the client. When a rule set is evaluated, maybe_rules are rules that might evaluate to TRUE given more information.

The number of `maybe_rules` returned to Oracle Streams clients is reduced by treating each undefined variable as `NULL`. Reducing the number of `maybe_rules` can improve performance if the reduction results in more efficient evaluation of a rule set when a message occurs. Rules that would result in `maybe_rules` for non-Oracle Streams clients can result in `TRUE` or `FALSE` rules for Oracle Streams clients, as the following examples illustrate.

Examples of Undefined Variables that Result in TRUE Rules for Oracle Streams Clients Consider the following user-defined rule condition:

```
:m IS NULL
```

If the value of the variable `m` is undefined during evaluation, then a maybe rule results for non-Oracle Streams clients of the rules engine. However, for Oracle Streams clients, this condition evaluates to `TRUE` because the undefined variable `m` is treated as a `NULL`. You should avoid adding rules such as this to rule sets for Oracle Streams clients, because such rules will evaluate to `TRUE` for every message. So, for example, if the positive rule set for a capture process has such a rule, then the capture process might capture messages that you did not intend to capture.

Here is another user-specified rule condition that uses an Oracle Streams `:dml` variable:

```
:dml.get_object_owner() = 'HR' AND :m IS NULL
```

For Oracle Streams clients, if a message consists of a row change to a table in the `hr` schema, and the value of the variable `m` is not known during evaluation, then this condition evaluates to `TRUE` because the undefined variable `m` is treated as a `NULL`.

Examples of Undefined Variables that Result in FALSE Rules for Oracle Streams Clients

Consider the following user-defined rule condition:

```
:m = 5
```

If the value of the variable `m` is undefined during evaluation, then a maybe rule results for non-Oracle Streams clients of the rules engine. However, for Oracle Streams clients, this condition evaluates to `FALSE` because the undefined variable `m` is treated as a `NULL`.

Consider another user-specified rule condition that uses an Oracle Streams `:dml` variable:

```
:dml.get_object_owner() = 'HR' AND :m = 5
```

For Oracle Streams clients, if a message consists of a row change to a table in the `hr` schema, and the value of the variable `m` is not known during evaluation, then this condition evaluates to `FALSE` because the undefined variable `m` is treated as a `NULL`.

See Also: ["Rule Set Evaluation"](#) on page 5-10

Variables as Function Parameters in Rule Conditions

Oracle recommends that you avoid using `:dml` and `:ddl` variables as function parameters for rule conditions. The following example uses the `:dml` variable as a parameter to a function named `my_function`:

```
my_function(:dml) = 'Y'
```

Rule conditions such as these can degrade rule evaluation performance and can result in the capture or propagation of extraneous [Oracle Streams data dictionary](#) information.

See Also: ["The Oracle Streams Data Dictionary"](#) on page 2-34

User-Created Evaluation Contexts

You can use a custom [evaluation context](#) in an Oracle Streams environment. Any user-defined evaluation context involving LCRs must include all the variables in `SYS.STREAMS$_EVALUATION_CONTEXT`. The type of each variable and its variable value function must be the same for each variable as the ones defined in `SYS.STREAMS$_EVALUATION_CONTEXT`. In addition, when creating the evaluation context using `DBMS_RULE_ADM.CREATE_EVALUATION_CONTEXT`, the `SYS.DBMS_STREAMS_INTERNAL.EVALUATION_CONTEXT_FUNCTION` must be specified for the `evaluation_function` parameter. You can alter an existing evaluation context using the `DBMS_RULE_ADM.ALTER_EVALUATION_CONTEXT` procedure.

You can find information about an evaluation context in the following data dictionary views:

- `ALL_EVALUATION_CONTEXT_TABLES`
- `ALL_EVALUATION_CONTEXT_VARS`
- `ALL_EVALUATION_CONTEXTS`

If necessary, you can use the information in these data dictionary views to build a new evaluation context based on the `SYS.STREAMS$_EVALUATION_CONTEXT`.

Note: Avoid using variable names with special characters, such as \$ and #, to ensure that there are no conflicts with Oracle-supplied evaluation context variables.

See Also: *Oracle Database Reference* for more information about these data dictionary views

Rule-Based Transformations

A **rule-based transformation** is any modification to a **message** when a **rule** in a **positive rule set** evaluates to `TRUE`. There are two types of rule-based transformations: declarative and custom.

The following topics contain information about rule-based transformations:

- [Declarative Rule-Based Transformations](#)
- [Custom Rule-Based Transformations](#)
- [Rule-Based Transformations and Oracle Streams Clients](#)
- [Transformation Ordering](#)
- [Considerations for Rule-Based Transformations](#)

See Also:

- [Chapter 18, "Managing Rule-Based Transformations"](#)
- [Chapter 27, "Monitoring Rule-Based Transformations"](#)
- ["Troubleshooting Problems with Rules and Rule-Based Transformations"](#) on page 20-18

Declarative Rule-Based Transformations

Declarative rule-based transformations cover a set of common transformation scenarios for row LCRs.

You specify (or declare) such a transformation using one of the following procedures in the `DBMS_STREAMS_ADM` package:

- `ADD_COLUMN` either adds or removes a declarative transformation that adds a column to a row LCR.
- `DELETE_COLUMN` either adds or removes a declarative transformation that deletes a column from a row LCR.
- `RENAME_COLUMN` either adds or removes a declarative transformation that renames a column in a row LCR.
- `RENAME_SCHEMA` either adds or removes a declarative transformation that renames the schema in a row LCR.
- `RENAME_TABLE` either adds or removes a declarative transformation that renames the table in a row LCR.

When you specify a declarative rule-based transformation, you specify the **rule** that is associated with it. When the specified rule evaluates to `TRUE` for a row LCR, Oracle

Streams performs the declarative transformation internally on the row LCR, without invoking PL/SQL.

Declarative rule-based transformations provide the following advantages:

- Performance is improved because the transformations are run internally without using PL/SQL.
- Complexity is reduced because custom PL/SQL functions are not required.

Note:

- Declarative rule-based transformations can transform row LCRs only. These row LCRs can be [captured LCRs](#) or [persistent LCRs](#). Therefore, a DML rule must be specified when you run one of the procedures to add a declarative transformation. If a DDL rule is specified, then an error is raised.
 - ADD_COLUMN transformations cannot add columns of the following data types: BLOB, CLOB, NCLOB, BFILE, LONG, LONG RAW, ROWID, user-defined types (including object types, REFS, varrays, nested tables), and Oracle-supplied types (including Any types, XML types, spatial types, and media types). The other declarative rule-based transformations that operate on columns support the same data types that are supported by Oracle Streams [capture processes](#).
-
-

See Also:

- ["Managing Declarative Rule-Based Transformations"](#) on page 18-1
- ["Row LCRs"](#) on page 2-4
- ["Data Types Captured by Capture Processes"](#) on page 2-12

Custom Rule-Based Transformations

Custom rule-based transformations require a user-defined PL/SQL function to perform the transformation. The function takes as input an ANYDATA object containing a [message](#) and returns either an ANYDATA object containing the transformed message or an array that contains zero or more ANYDATA encapsulations of a message. A custom rule-based transformation function that returns one message is a one-to-one transformation function. A custom rule-based transformation function that can return more than one message in an array is a one-to-many transformation function. One-to-one transformation functions are supported for any type of [Oracle Streams client](#), but one-to-many transformation functions are supported only for Oracle Streams [capture processes](#) and [synchronous captures](#).

To specify a custom rule-based transformation, use the DBMS_STREAMS_ADM.SET_RULE_TRANSFORM_FUNCTION procedure. You can use a custom rule-based transformation to modify [captured LCRs](#), [persistent LCRs](#), and [persistent user messages](#).

For example, a custom rule-based transformation can be used when the data type of a particular column in a table is different at two different databases. The column might be a NUMBER column in the [source database](#) and a VARCHAR2 column in the [destination database](#). In this case, the transformation takes as input an ANYDATA object containing a row LCR with a NUMBER data type for a column and returns an

ANYDATA object containing a row LCR with a VARCHAR2 data type for the same column.

Other examples of custom transformations on messages include:

- Splitting a column into several columns
- Combining several columns into one column
- Modifying the contents of a column
- Modifying the payload of a user message

Custom rule-based transformations provide the following advantages:

- Flexibility is increased because you can use PL/SQL to perform custom transformations.
- A wider range of messages can be transformed, including DDL LCRs and user messages, as well as row LCRs.

The following considerations apply to custom rule-based transformations:

- When you perform custom rule-based transformations on DDL LCRs, you probably need to modify the DDL text in the DDL LCR to match any other modifications. For example, if the rule-based transformation changes the name of a table in the DDL LCR, then the rule-based transformation should change the table name in the DDL text in the same way.
- If possible, avoid specifying a custom rule-based transformation for a **global rule** or **schema rule** if the transformation pertains to a relatively small number of LCRs that will evaluate to TRUE for the **rule**. For example, a custom rule-based transformation that operates on a single table can be specified for a schema rule, and this schema can contain hundreds of tables. Specifying such a rule-based transformation has performance implications because extra processing is required for the LCRs that will not be transformed.

To avoid specifying such a custom rule-based transformation, either you can use a **DML handler** to perform the transformation, or you can specify the transformation for a **table rule** instead of a global or schema rule. However, replacing a global or schema rule with table rules results in an increase in the total number of rules and additional maintenance when a new table is added.

- When a custom rule-based transformation that uses a one-to-one transformation function receives a **captured LCR** or **persistent LCR**, the transformation can construct a new LCR and return it. Similarly, when a custom rule-based transformation that uses a one-to-many transformation function receives a captured LCR or a persistent LCR, the transformation can construct multiple new LCRs and return them in an array.

For any LCR constructed and returned by a custom rule-based transformation, the `source_database_name`, `transaction_id`, and `scn` parameter values must match the values in the original LCR. Oracle automatically specifies the values in the original LCR for these parameters, even if an attempt is made to construct LCRs with different values.

- A custom rule-based transformation that receives a **user message** can construct a new message and return it. In this case, the returned message can be an LCR constructed by the custom rule-based transformation.
- A custom rule-based transformation cannot convert an LCR into a non-LCR message. This restriction applies to captured LCRs and persistent LCRs.

- A custom rule-based transformation cannot convert a row LCR into a DDL LCR or a DDL LCR into a row LCR. This restriction applies to captured LCRs and persistent LCRs.

See Also:

- ["Required Privileges for Custom Rule-Based Transformations"](#) on page 7-5
- [Chapter 18, "Managing Rule-Based Transformations"](#)
- ["Unsupported Data Types for Rule-Based Transformations"](#) on page B-16
- ["How Rules Are Used in Oracle Streams"](#) on page 6-1
- ["Types of Messages That Can Be Processed with an Apply Process"](#) on page 4-6
- *Oracle Database PL/SQL Packages and Types Reference* for information about the `SET_RULE_TRANSFORM_FUNCTION` procedure
- ["Logical Change Records \(LCRs\)"](#) on page 2-3

Custom Rule-Based Transformations and Action Contexts

You use the `SET_RULE_TRANSFORM_FUNCTION` procedure in the `DBMS_STREAMS_ADM` package to specify a custom rule-based transformation for a **rule**. This procedure modifies the **action context** of a rule to specify the transformation. A rule action context is optional information associated with a rule that is interpreted by the client of the **rules engine** after the rule evaluates to `TRUE` for a **message**. The client of the rules engine can be a user-created application or an internal feature of Oracle, such as Oracle Streams. The information in an action context is an object of type `SYS.RE$NV_LIST`, which consists of a list of name-value pairs.

A custom rule-based transformation in Oracle Streams always consists of the following name-value pair in an action context:

- If the function is a one-to-one transformation function, then the name is `STREAMS$_TRANSFORM_FUNCTION`. If the function is a one-to-many transformation function, then the name is `STREAMS$_ARRAY_TRANS_FUNCTION`.
- The value is an `ANYDATA` instance containing a PL/SQL function name specified as a `VARCHAR2`. This function performs the transformation.

You can display the existing custom rule-based transformations in a database by querying the `DBA_STREAMS_TRANSFORM_FUNCTION` data dictionary view.

When a rule in a **positive rule set** evaluates to `TRUE` for a message in an Oracle Streams environment, and an action context that contains a name-value pair with the name `STREAMS$_TRANSFORM_FUNCTION` or `STREAMS$_ARRAY_TRANS_FUNCTION` is returned, the PL/SQL function is run, taking the message as an input parameter. Other names in an action context beginning with `STREAMS$_` are used internally by Oracle and must not be directly added, modified, or removed. Oracle Streams ignores any name-value pair that does not begin with `STREAMS$_` or `APPLY$_`.

When a rule evaluates to `FALSE` for a message in an Oracle Streams environment, the rule is not returned to the client, and any PL/SQL function appearing in a name-value pair in the action context is not run. Different rules can use the same or different transformations. For example, different transformations can be associated with

different operation types, tables, or schemas for which messages are being captured, propagated, applied, or dequeued.

Required Privileges for Custom Rule-Based Transformations

The user who calls the transformation function must have EXECUTE privilege on the function. The following list describes which user calls the transformation function:

- If a transformation is specified for a **rule** used by a **capture process**, then the **capture user** for the capture process calls the transformation function.
- If a transformation is specified for a rule used by a **synchronous capture**, then the capture user for the synchronous capture calls the transformation function.
- If a transformation is specified for a rule used by a **propagation**, then the owner of the **source queue** for the propagation calls the transformation function.
- If a transformation is specified on a rule used by an **apply process**, then the **apply user** for the apply process calls the transformation function.
- If a transformation is specified on a rule used by a **messaging client**, then the user who invokes the messaging client calls the transformation function.

See Also:

- [Chapter 18, "Managing Rule-Based Transformations"](#)
- [Chapter 2, "Oracle Streams Information Capture"](#)
- [Chapter , "Message Propagation Between Queues"](#)
- [Chapter 4, "Oracle Streams Information Consumption"](#)

Rule-Based Transformations and Oracle Streams Clients

The following sections provide more information about rule-based transformations and **Oracle Streams clients**:

- [Rule-Based Transformations and Capture Processes](#)
- [Rule Based Transformations and Synchronous Captures](#)
- [Rule-Based Transformations and Propagations](#)
- [Rule-Based Transformations and an Apply Process](#)
- [Rule-Based Transformations and a Messaging Client](#)
- [Multiple Rule-Based Transformations](#)

The information in this section applies to both declarative and **custom rule-based transformations**.

See Also:

- [Chapter 18, "Managing Rule-Based Transformations"](#)
- ["Rule Action Context" on page 5-8](#)
- ["Types of Messages That Can Be Processed with an Apply Process" on page 4-6](#)

Rule-Based Transformations and Capture Processes

For a transformation to be performed during capture by a **capture process**, a **rule** that is associated with a rule-based transformation in the **positive rule set** for the capture process must evaluate to **TRUE** for a particular change found in the redo log.

If the transformation is a **declarative rule-based transformation**, then Oracle transforms the **captured LCR** internally when the rule in a positive rule set evaluates to **TRUE** for the message. If the transformation is a **custom rule-based transformation**, then an **action context** containing a name-value pair with the name `STREAMS$_TRANSFORM_FUNCTION` or `STREAMS$_ARRAY_TRANS_FUNCTION` is returned to the capture process when the rule in a positive rule set evaluates to **TRUE** for the captured LCR.

The capture process completes the following steps to perform a rule-based transformation:

1. Formats the change in the redo log into an LCR.
2. Converts the LCR into an `ANYDATA` object.
3. Transforms the LCR. If the transformation is a declarative rule-based transformation, then Oracle transforms the `ANYDATA` object internally based on the specifications of the declarative transformation. If the transformation is a custom rule-based transformation, then the **capture user** for the capture process runs the PL/SQL function in the name-value pair to transform the `ANYDATA` object.
4. Enqueues one or more transformed `ANYDATA` objects into the **queue** associated with the capture process, or discards the LCR if an array that contains zero elements is returned by the transformation function.

All actions are performed by the capture user for the capture process. [Figure 7-1](#) shows a transformation during capture by a capture process.

Figure 7-1 Transformation During Capture by a Capture Process

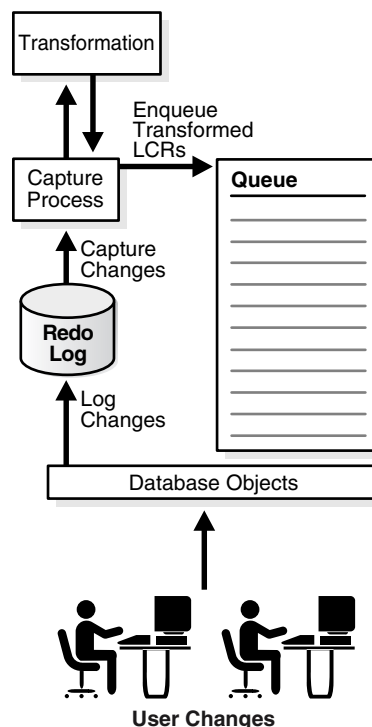

For example, if an LCR is transformed during capture by a capture process, then the transformed LCR is enqueued into the queue used by the capture process. Therefore, if such a captured LCR is propagated from the `db1.example.com` database to the `db2.example.com` and the `db3.example.com` databases, then the queues at `db2.example.com` and `db3.example.com` will contain the transformed LCR after propagation.

The advantages of performing transformations during capture by a capture process are the following:

- Security can be improved if the transformation removes or changes private information, because this private information does not appear in the **source queue** and is not propagated to any **destination queue**.
- Space consumption can be reduced, depending on the type of transformation performed. For example, a transformation that reduces the amount of data results in less data to enqueue, propagate, and apply.
- Transformation overhead is reduced when there are multiple destinations for a transformed LCR, because the transformation is performed only once at the source, not at multiple destinations.
- A capture process transformation can transform a single message into multiple messages.

The possible disadvantages of performing transformations during capture by a capture process are the following:

- The transformation overhead occurs in the **source database** if the capture process is a **local capture process**. However, if the capture process is a **downstream capture process**, then this overhead occurs at the **downstream database**, not at the source database.
- All sites receive the transformed LCR.

Note: A rule-based transformation cannot be used with a capture process to modify or remove a column of a data type that is not supported by Oracle Streams.

See Also:

- ["Data Types Captured by Capture Processes"](#) on page 2-12
- ["Managing Rule-Based Transformations"](#) on page 18-1

Rule-Based Transformation Errors During Capture by a Capture Process

If an error occurs when the transformation is run during capture by a capture process, then the error is returned to the capture process. The behavior of the capture process depends on the type of transformation being performed and the type of error encountered. The following capture process behaviors are possible:

- If the transformation is a declarative rule-based transformation, and the capture process can ignore the error, then the capture process performs the transformation and captures the change. For example, if a capture process tries to perform a `DELETE_COLUMN` declarative rule-based transformation, and the column specified for deletion does not exist in the row LCR, then the capture process captures the change and continues to run.

- If the transformation is a declarative rule-based transformation, and the capture process cannot ignore the error, then the change is not captured, and the capture process becomes disabled. For example, if a capture process tries to perform an `ADD_COLUMN` declarative rule-based transformation, and the column specified for addition already exists in the row LCR, then the change is not captured, and the capture process becomes disabled.
- Whenever an error is encountered in a custom rule-based transformation, the change is not captured, and the capture process becomes disabled.

If the capture process becomes disabled, then you must either change or remove the rule-based transformation to avoid the error before the capture process can be enabled.

Rule Based Transformations and Synchronous Captures

For a transformation to be performed during capture by a **synchronous capture**, a **rule** that is associated with a rule-based transformation in the **positive rule set** for the synchronous capture must evaluate to `TRUE` for a particular DML change made to a table.

If the transformation is a **declarative rule-based transformation**, then Oracle transforms the **persistent LCR** internally when the rule in a positive rule set evaluates to `TRUE` for the message. If the transformation is a **custom rule-based transformation**, then an **action context** containing a name-value pair with the name `STREAMS$_TRANSFORM_FUNCTION` is returned to the capture process when the rule in a positive rule set evaluates to `TRUE` for the persistent LCR.

The synchronous capture completes the following steps to perform a rule-based transformation:

1. Formats the change in the redo log into a row LCR.
2. Converts the row LCR into an `ANYDATA` object.
3. Transforms the LCR. If the transformation is a declarative rule-based transformation, then Oracle transforms the `ANYDATA` object internally based on the specifications of the declarative transformation. If the transformation is a custom rule-based transformation, then the **capture user** for the synchronous capture runs the PL/SQL function in the name-value pair to transform the `ANYDATA` object.
4. Enqueues the transformed `ANYDATA` object into the **queue** associated with the synchronous capture.

All actions are performed by the capture user for the synchronous capture. [Figure 7-2](#) shows a transformation during capture.

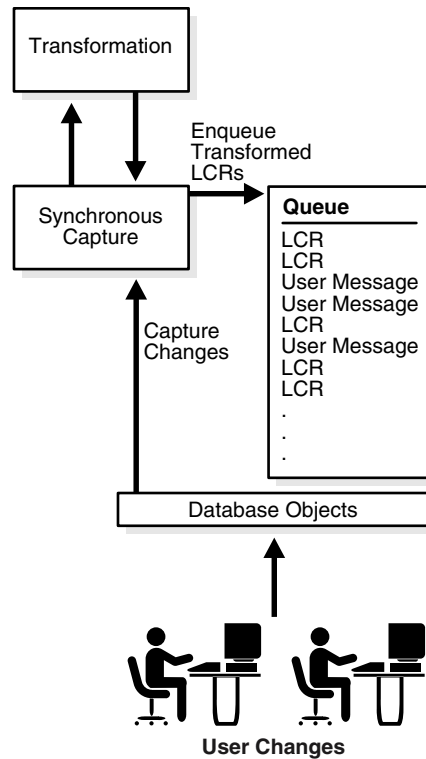
Figure 7-2 Transformation During Capture by a Synchronous Capture

For example, if a row LCR is transformed during capture by a synchronous capture, then the transformed row LCR is enqueued into the queue used by the synchronous capture. Therefore, if such a captured LCR is propagated from the `db1.example.com` database to the `db2.example.com` and the `db3.example.com` databases, then the queues at `db2.example.com` and `db3.example.com` will contain the transformed row LCR after propagation.

The advantages of performing transformations during capture by a synchronous capture are the following:

- Security can be improved if the transformation removes or changes private information, because this private information does not appear in the **source queue** and is not propagated to any **destination queue**.
- Space consumption can be reduced, depending on the type of transformation performed. For example, a transformation that reduces the amount of data results in less data to enqueue, propagate, and apply.
- Transformation overhead is reduced when there are multiple destinations for a transformed row LCR, because the transformation is performed only once at the source, not at multiple destinations.

The possible disadvantages of performing transformations during capture by a synchronous capture are the following:

- The transformation overhead occurs in the **source database**.
- All sites receive the transformed LCR.

Note: A rule-based transformation cannot be used with a synchronous capture to modify or remove a column of a data type that is not supported by Oracle Streams.

See Also: ["Data Types Captured by Synchronous Capture"](#) on page 2-41.

Rule-Based Transformations and Errors During Capture by a Synchronous Capture

If an error occurs when the transformation is run during capture by a synchronous capture, then the error is returned to the synchronous capture. The behavior of the synchronous capture depends on the type of transformation being performed and the type of error encountered. The following synchronous capture behaviors are possible:

- If the transformation is a declarative rule-based transformation, and the synchronous capture can ignore the error, then the synchronous capture performs the transformation and captures the change. For example, if a synchronous capture tries to perform a `DELETE_COLUMN` declarative rule-based transformation, and the column specified for deletion does not exist in the row LCR, then the synchronous capture captures the change.
- If the transformation is a declarative rule-based transformation, and the synchronous capture cannot ignore the error, then the change is not captured, and the DML operation aborts. For example, if a synchronous capture tries to perform an `ADD_COLUMN` declarative rule-based transformation, and the column specified for addition already exists in the row LCR, then the change is not captured, and the DML aborts.
- Whenever an error is encountered in a custom rule-based transformation, the change is not captured, and the DML aborts.

If the DML aborts because of a rule-based transformation, then you must either change or remove the rule-based transformation to perform the DML operation.

Rule-Based Transformations and Propagations

For a transformation to be performed during propagation, a **rule** that is associated with a rule-based transformation in the **positive rule set** for the **propagation** must evaluate to `TRUE` for a **message** in the **source queue** for the propagation. This message can be a **captured LCR**, **buffered LCR**, **buffered user message**, **persistent LCR**, and **persistent user message**.

If the transformation is a **declarative rule-based transformation**, then Oracle transforms the message internally when the rule in a positive rule set evaluates to `TRUE` for the message. If the transformation is a **custom rule-based transformation**, then an **action context** containing a name-value pair with the name `STREAMS$_TRANSFORM_FUNCTION` is returned to the propagation when the rule in a positive rule set evaluates to `TRUE` for the message.

The propagation completes the following steps to perform a rule-based transformation:

1. Starts dequeuing the message from the source queue.
2. Transforms the message. If the transformation is a declarative rule-based transformation, then Oracle transforms the message internally based on the specifications of the declarative transformation. If the transformation is a custom

rule-based transformation, then the source queue owner runs the PL/SQL function in the name-value pair to transform the message.

3. Completes dequeuing the transformed message.
4. Propagates the transformed message to the **destination queue**.

See Also: "Ways to Consume Information with Oracle Streams" on page 4-1

Figure 7-3 shows a transformation during propagation.

Figure 7-3 Transformation During Propagation

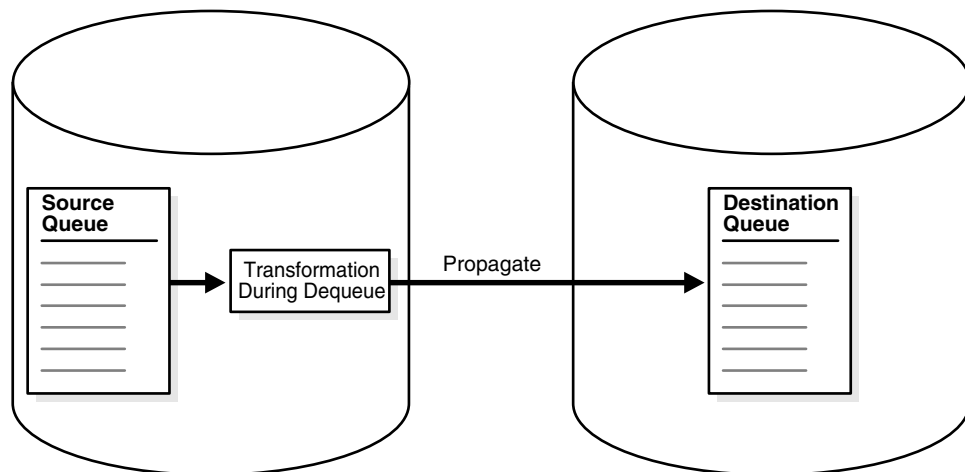

For example, suppose you use a rule-based transformation for a propagation that propagates messages from the `db1.example.com` database to the `db2.example.com` database, but you do not use a rule-based transformation for a propagation that propagates messages from the `db1.example.com` database to the `db3.example.com` database.

In this case, a message in the queue at `db1.example.com` can be transformed before it is propagated to `db2.example.com`, but the same message can remain in its original form when it is propagated to `db3.example.com`. In this case, after propagation, the queue at `db2.example.com` contains the transformed message, and the queue at `db3.example.com` contains the original message.

The advantages of performing transformations during propagation are the following:

- Security can be improved if the transformation removes or changes private information before messages are propagated.
- Some destination queues can receive a transformed message, while other destination queues can receive the original message.
- Different destinations can receive different variations of the same transformed message.

The possible disadvantages of performing transformations during propagation are the following:

- Once a message is transformed, any database to which it is propagated after the first propagation receives the transformed message. For example, if `db2.example.com` propagates the message to `db4.example.com`, then `db4.example.com` receives the transformed message.
- When the first propagation in a **directed network** performs the transformation, and a local **capture process** captured the message, the transformation overhead occurs on the **source database**. However, if the capture process is a **downstream capture process**, then this overhead occurs at the **downstream database**, not at the source database.
- When the first propagation in a **directed network** performs the transformation, and a **synchronous capture** captured the message, the transformation overhead occurs on the **source database**.
- The same transformation can be done multiple times on a message when different propagations send the message to multiple **destination databases**.

Rule-Based Transformation Errors During Propagation

If an error occurs during the transformation, then the message that caused the error is not dequeued or propagated, and the error is returned to the propagation. Before the message can be propagated, you must change or remove the rule-based transformation to avoid the error.

Rule-Based Transformations and an Apply Process

For a transformation to be performed during apply, a **rule** that is associated with a rule-based transformation in the **positive rule set** for the **apply process** must evaluate to TRUE for a **message** in the **queue** for the apply process. This message can be a **captured LCR**, a **persistent LCR**, or a **persistent user message**.

If the transformation is a **declarative rule-based transformation**, then Oracle transforms the message internally when the rule in a positive rule set evaluates to TRUE for the message. If the transformation is a **custom rule-based transformation**, then an **action context** containing a name-value pair with the name `STREAMS$_TRANSFORM_FUNCTION` is returned to the apply process when the rule in a positive rule set evaluates to TRUE for the message.

The apply process completes the following steps to perform a rule-based transformation:

1. Starts to dequeue the message from the queue.
2. Transforms the message. If the transformation is a declarative rule-based transformation, then Oracle transforms the message internally based on the specifications of the declarative transformation. If the transformation is a custom rule-based transformation, then the **apply user** runs the PL/SQL function in the name-value pair to transform the message.
3. Completes dequeuing the transformed message.
4. Applies the transformed message, which can entail changing database objects at the **destination database** or sending the transformed message to an **apply handler**.

All actions are performed by the apply user.

See Also: ["Ways to Consume Information with Oracle Streams"](#)
on page 4-1

Figure 7–4 shows a transformation during apply.

Figure 7–4 Transformation During Apply

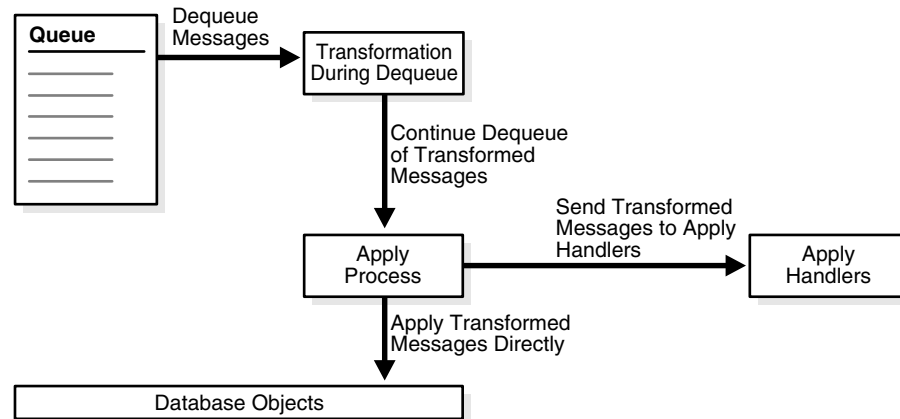

For example, suppose a message is propagated from the `db1.example.com` database to the `db2.example.com` database in its original form. When the apply process dequeues the message at `db2.example.com`, the message is transformed.

The possible advantages of performing transformations during apply are the following:

- Any database to which the message is propagated after the first propagation can receive the message in its original form. For example, if `db2.example.com` propagates the message to `db4.example.com`, then `db4.example.com` can receive the original message.
- The transformation overhead does not occur on the **source database** when the source and destination database are different.

The possible disadvantages of performing transformations during apply are the following:

- Security might be a concern if the messages contain private information, because all databases to which the messages are propagated receive the original messages.
- The same transformation can be done multiple times when multiple destination databases need the same transformation.

Note: Before modifying one or more rules for an apply process, you should stop the apply process.

Rule-Based Transformation Errors During Apply Process Dequeue

If an error occurs when the transformation function is run during apply process dequeue, then the message that caused the error is not dequeued, the transaction containing the message is not applied, the error is returned to the apply process, and the apply process is disabled. Before the apply process can be enabled, you must change or remove the rule-based transformation to avoid the error.

Apply Errors on Transformed Messages

If an apply error occurs for a transaction in which some of the messages have been transformed by a rule-based transformation, then the transformed messages are moved to the error queue with all of the other messages in the transaction. If you use

the `EXECUTE_ERROR` procedure in the `DBMS_APPLY_ADM` package to reexecute a transaction in the error queue that contains transformed messages, then the transformation is not performed on the messages again because the apply process rule set containing the rule is not evaluated again.

Rule-Based Transformations and a Messaging Client

For a transformation to be performed during dequeue by a **messaging client**, a **rule** that is associated with a rule-based transformation in the **positive rule set** for the messaging client must evaluate to `TRUE` for a **message** in the **queue** for the messaging client.

If the transformation is a **declarative rule-based transformation**, then Oracle transforms the message internally when the rule in a positive rule set evaluates to `TRUE` for the message. If the transformation is a **custom rule-based transformation**, then an **action context** containing a name-value pair with the name `STREAMS$_TRANSFORM_FUNCTION` is returned to the messaging client when the rule in a positive rule set evaluates to `TRUE` for the message.

The messaging client completes the following steps to perform a rule-based transformation:

1. Starts to dequeue the message from the queue.
2. Transforms the message. If the transformation is a declarative rule-based transformation, then the message must be a **persistent LCR**, and Oracle transforms the row LCR internally based on the specifications of the declarative transformation. If the transformation is a **custom rule-based transformation**, then the message can be a persistent LCR or a **persistent user message**. The user who invokes the messaging client runs the PL/SQL function in the name-value pair to transform the message during dequeue.
3. Completes dequeuing the transformed message.

All actions are performed by the user who invokes the messaging client.

Figure 7-5 shows a transformation during messaging client dequeue.

Figure 7-5 Transformation During Messaging Client Dequeue

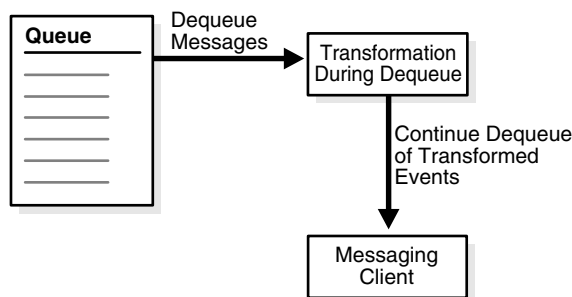

For example, suppose a message is propagated from the `db1.example.com` database to the `db2.example.com` database in its original form. When the messaging client dequeues the message at `db2.example.com`, the message is transformed.

One possible advantage of performing transformations during dequeue in a messaging environment is that any database to which the message is propagated after the first propagation can receive the message in its original form. For example, if

`db2.example.com` propagates the message to `db4.example.com`, then `db4.example.com` can receive the original message.

The possible disadvantages of performing transformations during dequeue in a messaging environment are the following:

- Security might be a concern if the messages contain private information, because all databases to which the messages are propagated receive the original messages.
- The same transformation can be done multiple times when multiple **destination databases** need the same transformation.

Rule-Based Transformation Errors During Messaging Client Dequeue

If an error occurs when the transformation function is run during messaging client dequeue, then the message that caused the error is not dequeued, and the error is returned to the messaging client. Before the message can be dequeued by the messaging client, you must change or remove the rule-based transformation to avoid the error.

Multiple Rule-Based Transformations

You can transform a message during capture, propagation, apply, or dequeue, or during any combination of capture, propagation, apply, and dequeue. For example, if you want to hide sensitive data from all recipients, then you can transform a message during capture. If some recipients require additional custom transformations, then you can transform the previously transformed message during propagation, apply, or dequeue.

Transformation Ordering

In addition to **declarative rule-based transformations** and **custom rule-based transformations**, a **row migration** is an internal transformation that takes place when a **subset rule** evaluates to `TRUE`. If all three types of transformations are specified for a single **rule**, then Oracle performs the transformations in the following order when the rule evaluates to `TRUE`:

1. Row migration
2. Declarative rule-based transformation
3. Custom rule-based transformation

Declarative Rule-Based Transformation Ordering

If more than one **declarative rule-based transformation** is specified for a single **rule**, then Oracle must perform the transformations in a particular order. You can use the default ordering for declarative transformations, or you can specify the order.

This section contains the following topics:

- [Default Declarative Transformation Ordering](#)
- [User-Specified Declarative Transformation Ordering](#)

Default Declarative Transformation Ordering

By default, Oracle performs declarative transformations in the following order when the rule evaluates to `TRUE`:

1. Delete column
2. Rename column
3. Add column
4. Rename table
5. Rename schema

The results of a declarative transformation are used in each subsequent declarative transformation. For example, suppose the following declarative transformations are specified for a single rule:

- Delete column `address`
- Add column `address`

Assuming column `address` exists in a row LCR, both declarative transformations should be performed in this case because column `address` is deleted from the row LCR before column `address` is added back to the row LCR. The following table shows the transformation ordering for this example.

Step Number	Transformation Type	Transformation Details	Transformation Performed?
1	Delete column	Delete column <code>address</code> from row LCR	Yes
2	Rename column	-	-
3	Add column	Add column <code>address</code> to row LCR	Yes
4	Rename table	-	-
5	Rename schema	-	-

Another scenario might rename a table and then rename a schema. For example, suppose the following declarative transformations are specified for a single rule:

- Rename table `john.customers` to `sue.clients`
- Rename schema `sue` to `mary`

Notice that the rename table transformation also renames the schema for the table. In this case, both transformations should be performed and, after both transformations, the table name becomes `mary.clients`. The following table shows the transformation ordering for this example.

Step Number	Transformation Type	Transformation Details	Transformation Performed?
1	Delete column	-	-
2	Rename column	-	-
3	Add column	-	-
4	Rename table	Rename table <code>john.customers</code> to <code>sue.clients</code>	Yes
5	Rename schema	Rename schema <code>sue</code> to <code>mary</code>	Yes

Consider a similar scenario in which the following declarative transformations are specified for a single rule:

- Rename table `john.customers` to `sue.clients`
- Rename schema `john` to `mary`

In this case, the first transformation is performed, but the second one is not. After the first transformation, the table name is `sue.clients`. The second transformation is not performed because the schema of the table is now `sue`, not `john`. The following table shows the transformation ordering for this example.

Step Number	Transformation Type	Transformation Details	Transformation Performed?
1	Delete column	-	-
2	Rename column	-	-
3	Add column	-	-
4	Rename table	Rename table <code>john.customers</code> to <code>sue.clients</code>	Yes
5	Rename schema	Rename schema <code>john</code> to <code>mary</code>	No

The rename schema transformation is not performed, but it does not result in an error. In this case, the row LCR is transformed by the rename table transformation, and a row LCR with the table name `sue.clients` is returned.

User-Specified Declarative Transformation Ordering

If you do not want to use the default declarative rule-based transformation ordering for a particular rule, then you can specify step numbers for each declarative transformation specified for the rule. If you specify a step number for one or more declarative transformations for a particular rule, then the declarative transformations for the rule behave in the following way:

- Declarative transformations are performed in order of increasing step number.
- The default step number for a declarative transformation is 0 (zero). A declarative transformation uses this default if no step number is specified for it explicitly.
- If two or more declarative transformations have the same step number, then these declarative transformations follow the default ordering described in "[Default Declarative Transformation Ordering](#)" on page 7-15.

For example, you can reverse the default ordering for declarative transformations by specifying the following step numbers for transformations associated with a particular rule:

- Delete column with step number 5
- Rename column with step number 4
- Add column with step number 3
- Rename table with step number 2
- Rename schema with step number 1

With this ordering specified, rename schema transformations are performed first, and delete column transformations are performed last.

Considerations for Rule-Based Transformations

The following considerations apply to both **declarative rule-based transformations** and **custom rule-based transformations**:

- For a rule-based transformation to be performed by an **Oracle Streams client**, the **rule** must be in the **positive rule set** for the Oracle Streams client. If the rule is in the **negative rule set** for the Oracle Streams client, then the Oracle Streams client ignores the rule-based transformation.
- Rule-based transformations are different from transformations performed using the `DBMS_TRANSFORM` package. This document does not discuss transformations performed with the `DBMS_TRANSFORM` package.
- If a large percentage of row LCRs will be transformed in your environment, or if you must make expensive transformations on row LCRs, then consider making these modifications within a **DML handler** instead, because DML handlers can execute in parallel when apply parallelism is greater than 1.

See Also: *Oracle Streams Advanced Queuing User's Guide* and *Oracle Database PL/SQL Packages and Types Reference* for more information about the `DBMS_TRANSFORM` package

Oracle Streams High Availability Environments

The following topics contain information about Oracle Streams high availability environments:

- [Overview of Oracle Streams High Availability Environments](#)
- [Protection from Failures](#)
- [Best Practices for Oracle Streams High Availability Environments](#)

Overview of Oracle Streams High Availability Environments

Configuring a high availability solution requires careful planning and analysis of failure scenarios. Database backups and physical standby databases provide physical copies of a source database for failover protection. Oracle Data Guard, in SQL apply mode, implements a logical standby database in a high availability environment. Because Oracle Data Guard is designed for a high availability environment, it handles most failure scenarios. However, some environments might require the flexibility available in Oracle Streams, so that they can take advantage of the extended feature set offered by Oracle Streams.

This chapter discusses some of the scenarios that can benefit from an Oracle Streams-based solution and explains Oracle Streams-specific issues that arise in high availability environments.

See Also:

- *Oracle Data Guard Concepts and Administration* for more information about Oracle Data Guard
- *Oracle Real Application Clusters Administration and Deployment Guide*

Protection from Failures

Oracle Real Application Clusters (Oracle RAC) is the preferred method for protecting from an instance or system failure. After a failure, services are provided by a surviving node in the cluster. However, clustering does not protect from user error, media failure, or disasters. These types of failures require redundant copies of the database. You can make both physical and logical copies of a database.

Physical copies are identical, block for block, with the source database, and are the preferred means of protecting data. There are three types of physical copies: database backup, mirrored or multiplexed database files, and a physical standby database.

Logical copies contain the same information as the source database, but the information can be stored differently within the database. Creating a logical copy of your database offers many advantages. However, you should always create a logical copy in addition to a physical copy, not instead of physical copy.

A logical copy has the following benefits:

- A logical copy can be open while being updated. This ability makes the logical copy useful for near real-time reporting.
- A logical copy can have a different physical layout that is optimized for its own purpose. For example, it can contain additional indexes, and thereby improve the performance of reporting applications that utilize the logical copy.
- A logical copy provides better protection from corruptions. Because data is logically captured and applied, it is very unlikely that a physical corruption can propagate to the logical copy of the database.

There are three types of logical copies of a database:

- Logical standby databases
- Oracle Streams replica databases
- Application-maintained copies

Logical standby databases are best maintained using Oracle Data Guard in SQL apply mode. The rest of this chapter discusses Oracle Streams replica databases and application maintained copies.

See Also:

- ["Oracle Streams and Oracle Real Application Clusters"](#) on page A-1
- *Oracle Database Backup and Recovery User's Guide* for more information about database backups and mirroring or multiplexing database files
- *Oracle Data Guard Concepts and Administration* for more information about physical standby databases and logical standby databases

Oracle Streams Replica Database

Like Oracle Data Guard in SQL apply mode, Oracle Streams can capture database changes, propagate them to destinations, and apply the changes at these destinations. Oracle Streams is optimized for replicating data. Oracle Streams can capture changes at a source database, and the captured changes can be propagated asynchronously to replica databases. This optimization can reduce the latency and can enable the replicas to lag the primary database by no more than a few seconds.

Nevertheless, you might choose to use Oracle Streams to configure and maintain a logical copy of your production database. Although using Oracle Streams might require additional work, it offers increased flexibility that might be required to meet specific business requirements. A logical copy configured and maintained using Oracle Streams is called a replica, not a logical standby, because it provides many capabilities that are beyond the scope of the normal definition of a standby database. Some of the requirements that can best be met using an Oracle Streams replica are listed in the following sections.

See Also: *Oracle Streams Replication Administrator's Guide* for more information about replicating database changes with Oracle Streams

Updates at the Replica Database

The greatest difference between a replica database and a standby database is that a replica database can be updated and a standby database cannot. Applications that must update data can run against the replica, including jobs and reporting applications that log reporting activity. Replica databases also allow local applications to operate autonomously, protecting local applications from WAN failures and reducing latency for database operations.

Heterogeneous Platform Support

The production and the replica do not need to be running on the exact same platform. This provides more flexibility in using computing assets, and facilitates migration between platforms.

Multiple Character Sets

Oracle Streams replicas can use different character sets than the production database. Data is automatically converted from one character set to another before being applied. This ability is extremely important if you have global operations and you must distribute data in multiple countries.

Mining the Online Redo Logs to Minimize Latency

If the replica is used for near real-time reporting, Oracle Streams can lag the production database by no more than a few seconds, providing up-to-date and accurate queries. Changes can be read from the online redo logs as the logs are written, rather than from the redo logs after archiving.

Greater than Ten Copies of Data

Oracle Streams supports unlimited numbers of replicas. Its flexible routing architecture allows for hub-and-spoke configurations that can efficiently propagate data to hundreds of replicas. This ability can be important if you must provide autonomous operation to many local offices in your organization. In contrast, because standby databases configured with Oracle Data Guard use the `LOG_ARCHIVE_DEST_n` initialization parameter to specify destinations, there is a limit of ten copies when you use Oracle Data Guard.

See Also:

- *Oracle Database 2 Day + Data Replication and Integration Guide* for more information about hub-and-spoke replication environments and for instructions that explain how to configure them
- *Oracle Streams Replication Administrator's Guide* for a detailed example of such an environment

Fast Failover

Oracle Streams replicas can be open to read/write operations at all times. If a primary database fails, then Oracle Streams replicas are able to instantly resume processing. A small window of data might be left at the primary database, but this data will be automatically applied when the primary database recovers. This ability can be

important if you value fast recovery time over no lost data. Assuming the primary database can eventually be recovered, the data is only temporarily unavailable.

Single Capture for Multiple Destinations

In a complex environment, changes need only be captured once. These changes can then be sent to multiple destinations. When a capture process is used to capture changes, this ability enables more efficient use of the resources needed to mine the redo logs for changes.

When Not to Use Oracle Streams

As mentioned previously, there are scenarios in which you might choose to use Oracle Streams to meet some of your high availability requirements. One of the rules of high availability is to keep it simple. Oracle Data Guard is designed for high availability and is easier to implement than an Oracle Streams-based high availability solution. If you decide to leverage the flexibility offered by Oracle Streams, then you must be prepared to invest in the expertise and planning required to make an Oracle Streams-based solution robust. This means writing scripts to implement much of the automation and management tools provided with Oracle Data Guard.

Application-Maintained Copies

The best availability can be achieved by designing the maintenance of logical copies of data directly into an application. The application knows what data is valuable and must be immediately moved off-site to guarantee no data loss. It can also synchronously replicate truly critical data, while asynchronously replicating less critical data. Applications maintain copies of data by either synchronously or asynchronously sending data to other applications that manage another logical copy of the data. Synchronous operations are performed using the distributed SQL or remote procedure features of the database. Asynchronous operations are performed using Advanced Queuing. Advanced Queuing is a database message queuing feature that is part of Oracle Streams.

Although the highest levels of availability can be achieved with application-maintained copies of data, great care is required to realize these results. Typically, a great amount of custom development is required. Many of the difficult boundary conditions that have been analyzed and solved with solutions such as Oracle Data Guard and Oracle Streams **replication** must be reanalyzed and solved by the custom application developers. In addition, standard solutions like Oracle Data Guard and Oracle Streams replication undergo stringent testing both by Oracle and its customers. It will take a great deal of effort before a custom-developed solution can exhibit the same degree of maturity. For these reasons, only organizations with substantial patience and expertise should attempt to build a high availability solution with application maintained copies.

See Also: *Oracle Streams Advanced Queuing User's Guide* for more information about developing applications with Advanced Queuing

Best Practices for Oracle Streams High Availability Environments

Implementing Oracle Streams in a high availability environment requires consideration of possible failure and recovery scenarios, and the implementation of procedures to ensure Oracle Streams continues to capture, propagate, and apply

changes after a failure. Some of the issues that must be examined include the following:

- [Configuring Oracle Streams for High Availability](#)
- [Recovering from Failures](#)

Configuring Oracle Streams for High Availability

When configuring a solution using Oracle Streams, it is important to anticipate failures and design availability into the architecture. You must examine every database in the distributed system, and design a recovery plan in case of failure of that database. In some situations, failure of a database affects only services accessing data on that database. In other situations, a failure is multiplied, because it can affect other databases.

This section contains these topics:

- [Directly Connecting Every Database to Every Other Database](#)
- [Creating Hub-and-Spoke Configurations](#)
- [Local or Downstream Capture with Oracle Streams Capture Processes](#)

Directly Connecting Every Database to Every Other Database

A configuration where each database is directly connected to every other database in the distributed system is the most resilient to failures, because a failure of one database will not prevent any other databases from operating or communicating. Assuming all data is replicated, services that were using the failed database can connect to surviving replicas.

See Also:

- *Oracle Streams Replication Administrator's Guide* for a detailed example of such an environment
- ["Queue Forwarding and Apply Forwarding"](#) on page 3-15

Creating Hub-and-Spoke Configurations

Although configurations where each database is directly connected to every other database provide the best high availability characteristics, they can become difficult to manage when the number of databases becomes large. Hub-and-spoke configurations solve this manageability issue by funneling changes from many databases into a hub database, and then to other hub databases, or to other spoke databases. To add a new source or destination, you simply connect it to a hub database, rather than establishing connections to every other database.

A hub, however, becomes a very important node in your distributed environment. Should it fail, all communications flowing through the hub will fail. Due to the asynchronous nature of the **messages** propagating through the hub, it can be very difficult to redirect a stream from one hub to another. A better approach is to make the hub resilient to failures.

The same techniques used to make a single database resilient to failures also apply to distributed hub databases. Oracle recommends Oracle Real Application Clusters (Oracle RAC) to provide protection from instance and node failures. This configuration should be combined with a "no loss" physical standby database, to protect from disasters and data errors. Oracle does not recommend using an Oracle Streams replica as the only means to protect from disasters or data errors.

See Also:

- *Oracle Database 2 Day + Data Replication and Integration Guide* for more information about hub-and-spoke replication environments and for instructions that explain how to configure them
- *Oracle Streams Replication Administrator's Guide* for a detailed example of such an environment
- ["Oracle Streams and Oracle Real Application Clusters"](#) on page A-1

Local or Downstream Capture with Oracle Streams Capture Processes

Oracle Streams capture processes support capturing changes from the redo log on the local **source database** or at a **downstream database** at a different site. The choice of local capture or downstream capture has implications for availability. When a failure occurs at a source database, some changes might not have been captured. With local capture, those changes might not be available until the source database is recovered. In the event of a catastrophic failure, those changes might be lost.

Downstream capture at a remote database reduces the window of potential data loss in the event of a failure. Depending on the configuration, downstream capture enables you to guarantee all changes committed at the source database are safely copied to a remote site, where they can be captured and propagated to other databases and applications. Oracle Streams uses the same mechanism as Oracle Data Guard to copy redo data or log files to remote destinations, and supports the same operational modes, including maximum protection, maximum availability, and maximum performance.

Note: Synchronous capture is always configured at the source database.

See Also: ["Local Capture and Downstream Capture"](#) on page 2-14

Recovering from Failures

The following sections provide best practices for recovering from failures.

This section contains these topics:

- [Automatic Capture Process Restart After a Failover](#)
- [Database Links Reestablishment After a Failover](#)
- [Propagation Job Restart After a Failover](#)
- [Automatic Apply Process Restart After a Failover](#)

Automatic Capture Process Restart After a Failover

After a failure and restart of a single-node database, or a failure and restart of a database on another node in a cold failover cluster, the **capture process** automatically returns to the status it was in at the time of the failure. That is, if it was running at the time of the failure, then the capture process restarts automatically.

See Also:

- ["Capture Processes and Oracle Real Application Clusters"](#) on page A-1
- ["Starting a Capture Process"](#) on page 14-2
- ["Queues and Oracle Real Application Clusters"](#) on page A-3 for information about primary and secondary instance ownership for queues

Database Links Reestablishment After a Failover

It is important to ensure that a **propagation** continues to function after a failure of a **destination database** instance. A **propagation job** will retry (with increasing delay between retries) its database link sixteen times after a failure until the connection is reestablished. If the connection is not reestablished after sixteen tries, then the **propagation schedule** is disabled.

If the database is restarted on the same node, or on a different node in a cold failover cluster, then the connection should be reestablished. In some circumstances, the database link could be waiting on a read or write, and will not detect the failure until a lengthy time out expires. The time out is controlled by the `TCP_KEEPA_LIVE_INTERVAL` TCP/IP parameter. In such circumstances, you should drop and re-create the database link to ensure that communication is reestablished quickly.

In a high availability environment, you can prepare scripts that will drop and re-create all necessary database links. After a failover, you can execute these scripts so that Oracle Streams can resume propagation.

See Also:

- ["Configuring an Oracle Streams Administrator"](#) on page 9-1 for information about creating database links in an Oracle Streams environment
- ["Propagations and Oracle Real Application Clusters"](#) on page A-3 for more information about database links in an Oracle RAC environment

Propagation Job Restart After a Failover

For **messages** to be propagated from a **source queue** to a **destination queue**, a **propagation job** must run on the instance owning the source queue. In a single-node database, or cold failover cluster, propagation resumes when the single database instance is restarted.

See Also: ["Propagations and Oracle Real Application Clusters"](#) on page A-3

Automatic Apply Process Restart After a Failover

After a failure and restart of a single-node database, or a failure and restart of a database on another node in a cold failover cluster, the apply process automatically returns to the status it was in at the time of the failure. That is, if it was running at the time of the failure, then the apply process restarts automatically.

See Also:

- ["Apply Processes and Oracle Real Application Clusters"](#) on page A-4
- ["Starting an Apply Process"](#) on page 16-2
- ["Queues and Oracle Real Application Clusters"](#) on page A-3 for information about primary and secondary instance ownership for queues

Part II

Oracle Streams Configuration

This part describes managing an Oracle Streams environment, including step-by-step instructions for configuring, administering, monitoring and troubleshooting. This part contains the following chapters:

- [Chapter 9, "Preparing for and Configuring an Oracle Streams Environment"](#)
- [Chapter 10, "Configuring Implicit Capture"](#)
- [Chapter 11, "Configuring Queues and Propagations"](#)
- [Chapter 12, "Configuring Implicit Apply"](#)
- [Chapter 13, "Configuring Oracle Streams Messaging Environments"](#)

Preparing for and Configuring an Oracle Streams Environment

The following topics describe preparing a database or a distributed database environment to use Oracle Streams and configuring an Oracle Streams [replication](#) or messaging environment:

- [Configuring an Oracle Streams Administrator](#)
- [Setting Initialization Parameters Relevant to Oracle Streams](#)
- [Configuring the Oracle Streams Pool](#)
- [Configuring Network Connectivity and Database Links](#)
- [Configuring Oracle Streams](#)

Configuring an Oracle Streams Administrator

To manage an Oracle Streams environment, either create a new user with the appropriate privileges or grant these privileges to an existing user. You should not use the SYS or SYSTEM user as an Oracle Streams administrator, and the Oracle Streams administrator should not use the SYSTEM tablespace as its default tablespace.

Complete the following steps to configure an Oracle Streams administrator at each database in the environment that will use Oracle Streams:

1. In SQL*Plus, connect as an administrative user who can create users, grant privileges, and create tablespaces. Remain connected as this administrative user for all subsequent steps.

See *Oracle Database Administrator's Guide* for information about connecting to a database in SQL*Plus.

2. Either create a tablespace for the Oracle Streams administrator or use an existing tablespace. For example, the following statement creates a new tablespace for the Oracle Streams administrator:

```
CREATE TABLESPACE streams_tbs DATAFILE '/usr/oracle/dbs/streams_tbs.dbf'  
  SIZE 25M REUSE AUTOEXTEND ON MAXSIZE UNLIMITED;
```

3. Create a new user to act as the Oracle Streams administrator or use an existing user. For example, to create a new user named `strmadmin` and specify that this user uses the `streams_tbs` tablespace, run the following statement:

```
CREATE USER strmadmin IDENTIFIED BY password  
  DEFAULT TABLESPACE streams_tbs  
  QUOTA UNLIMITED ON streams_tbs;
```

Note: Enter an appropriate password for the administrative user.

See Also: *Oracle Database Security Guide* for guidelines for choosing passwords

4. Grant the Oracle Streams administrator DBA role:

```
GRANT DBA TO strmadmin;
```

Note: The DBA role is required for a user to create or alter capture processes, synchronous captures, and apply processes. When the user does not need to perform these tasks, DBA role can be revoked from the user.

5. Run the `GRANT_ADMIN_PRIVILEGE` procedure in the `DBMS_STREAMS_AUTH` package.

A user must have explicit `EXECUTE` privilege on a package to execute a subprogram in the package inside of a user-created subprogram, and a user must have explicit `SELECT` privilege on a data dictionary view to query the view inside of a user-created subprogram. These privileges cannot be through a role. You can run the `GRANT_ADMIN_PRIVILEGE` procedure to grant such privileges to the Oracle Streams administrator, or you can grant them directly.

Depending on the parameter settings for the `GRANT_ADMIN_PRIVILEGE` procedure, it either grants the privileges needed to be an Oracle Streams administrator directly, or it generates a script that you can edit and then run to grant these privileges.

See Also: *Oracle Database PL/SQL Packages and Types Reference* for more information about this procedure

Use the `GRANT_ADMIN_PRIVILEGE` procedure to grant privileges directly:

```
BEGIN
  DBMS_STREAMS_AUTH.GRANT_ADMIN_PRIVILEGE(
    grantee      => 'strmadmin',
    grant_privileges => TRUE);
END;
/
```

Use the `GRANT_ADMIN_PRIVILEGE` procedure to generate a script:

- a. Use the SQL statement `CREATE DIRECTORY` to create a directory object for the directory into which you want to generate the script. A directory object is similar to an alias for the directory. For example, to create a directory object called `admin_dir` for the `/usr/admin` directory on your computer system, run the following procedure:

```
CREATE DIRECTORY admin_dir AS '/usr/admin';
```

- b. Run the `GRANT_ADMIN_PRIVILEGE` procedure to generate a script named `grant_strms_privs.sql` and place this script in the `/usr/admin` directory on your computer system:

```

BEGIN
  DBMS_STREAMS_AUTH.GRANT_ADMIN_PRIVILEGE (
    grantee          => 'strmadmin',
    grant_privileges => FALSE,
    file_name        => 'grant_strms_privs.sql',
    directory_name   => 'admin_dir');
END;
/

```

Notice that the `grant_privileges` parameter is set to `FALSE` so that the procedure does not grant the privileges directly. Also, notice that the directory object created in Step a is specified for the `directory_name` parameter.

- c. Edit the generated script if necessary and save your changes.
- d. Execute the script in SQL*Plus:

```

SET ECHO ON
SPOOL grant_strms_privs.out
@/usr/admin/grant_strms_privs.sql
SPOOL OFF

```

- e. Check the spool file to ensure that all of the grants executed successfully. If there are errors, then edit the script to correct the errors and rerun it.
6. If necessary, grant the following additional privileges:
 - Grant the privileges for a remote Oracle Streams administrator to perform actions in the local database. Grant these privileges using the `GRANT_REMOTE_ADMIN_ACCESS` procedure in the `DBMS_STREAMS_AUTH` package. Grant this privilege if a remote Oracle Streams administrator will use a database link that connects to the local Oracle Streams administrator to perform administrative actions. Specifically, grant these privileges if either of the following conditions are true:
 - You plan to configure a downstream capture process at a remote downstream database that captures changes originating at the local source database, and the downstream capture process will use a database link to perform administrative actions at the source database.
 - You plan to configure an apply process at the local database and use a remote Oracle Streams administrator to set the instantiation SCN values for replicated database objects at the local database.
 - If no **apply user** is specified for an apply process, then grant the Oracle Streams administrator the necessary privileges to perform DML and DDL changes on the apply objects owned by another user. If an apply user is specified, then the apply user must have these privileges.
 - If no apply user is specified for an apply process, then grant the Oracle Streams administrator `EXECUTE` privilege on any PL/SQL procedure owned by another user that is executed by an Oracle Streams apply process. These procedures can be used in **apply handlers** or **error handlers**. If an apply user is specified, then the apply user must have these privileges.
 - Grant the Oracle Streams administrator `EXECUTE` privilege on any PL/SQL function owned by another user that is specified in a **custom rule-based transformation** for a **rule** used by an Oracle Streams **capture process**, **synchronous capture**, **propagation**, **apply process**, or **messaging client**. For a capture process or synchronous capture, if a **capture user** is specified, then the

capture user must have these privileges. For an apply process, if an apply user is specified, then the apply user must have these privileges.

- Grant the Oracle Streams administrator privileges to alter database objects where appropriate. For example, if the Oracle Streams administrator must create a [supplemental log group](#) for a table in another schema, then the Oracle Streams administrator must have the necessary privileges to alter the table.
- If the Oracle Streams administrator does not own the [queue](#) used by an Oracle Streams capture process, synchronous capture, propagation, apply process, or messaging client, and is not specified as the queue user for the queue when the queue is created, then the Oracle Streams administrator must be configured as a [secure queue](#) user of the queue if you want the Oracle Streams administrator to be able to enqueue [messages](#) into or dequeue messages from the queue. The Oracle Streams administrator might also need `ENQUEUE` or `DEQUEUE` privileges on the queue, or both. See ["Enabling a User to Perform Operations on a Secure Queue"](#) on page 15-1 for instructions.
- Grant the Oracle Streams administrator `EXECUTE` privilege on any object types that the Oracle Streams administrator might need to access.
- If Oracle Database Vault is installed, then the user who performs the following actions must be granted the `BECOME USER` system privilege:
 - Creates a capture process
 - Creates an apply process
 - Alters a capture user
 - Alters an apply user

Granting the `BECOME USER` system privilege to the user who performs these actions is not required if Oracle Database Vault is not installed. You can revoke the `BECOME USER` system privilege from the user after the completing one of these actions, if necessary.

7. Repeat all of the previous steps at each database in the environment that will use Oracle Streams.

See Also: ["Monitoring Oracle Streams Administrators and Other Oracle Streams Users"](#) on page 28-1

Setting Initialization Parameters Relevant to Oracle Streams

Some initialization parameters are important for the operation, reliability, and performance of an Oracle Streams environment. Set these parameters appropriately for your Oracle Streams environment.

[Table 9–1](#) describes the initialization parameters that are relevant to Oracle Streams. This table specifies whether each parameter is modifiable. A modifiable initialization parameter can be modified using the `ALTER SYSTEM` statement while an instance is running. Some of the modifiable parameters can also be modified for a single session using the `ALTER SESSION` statement.

Table 9–1 Initialization Parameters Relevant to Oracle Streams

Parameter	Values	Description
COMPATIBLE	<p>Default: 11.0.0</p> <p>Range: 10.0.0 to default release</p> <p>Modifiable?: No</p>	<p>This parameter specifies the release with which the Oracle server must maintain compatibility. Oracle servers with different compatibility levels can interoperate.</p> <p>To use the new Oracle Streams features introduced in Oracle Database 11g Release 1, this parameter must be set to 11.0.0 or higher.</p>
GLOBAL_NAMES	<p>Default: false</p> <p>Range: true or false</p> <p>Modifiable?: Yes</p>	<p>Specifies whether a database link is required to have the same name as the database to which it connects.</p> <p>To use Oracle Streams to share information between databases, set this parameter to true at each database that is participating in your Oracle Streams environment.</p>
LOG_ARCHIVE_CONFIG	<p>Default: 'SEND, RECEIVE, NODG_CONFIG'</p> <p>Range: Values:</p> <ul style="list-style-type: none"> ▪ SEND ▪ NOSEND ▪ RECEIVE ▪ NORECEIVE ▪ DG_CONFIG ▪ NODG_CONFIG <p>Modifiable?: Yes</p>	<p>Enables or disables the sending of redo logs to remote destinations and the receipt of remote redo logs, and specifies the unique database names (DB_UNIQUE_NAME) for each database in the Data Guard configuration</p> <p>To use downstream capture and copy the redo data to the downstream database using redo transport services, specify the DB_UNIQUE_NAME of the source database and the downstream database using the DG_CONFIG attribute. This parameter must be set at both the source database and the downstream database.</p>
LOG_ARCHIVE_DEST_n	<p>Default: None</p> <p>Range: None</p> <p>Modifiable?: Yes</p>	<p>Defines up to ten log archive destinations, where <i>n</i> is 1, 2, 3, ... 10.</p> <p>To use downstream capture and copy the redo data to the downstream database using redo transport services, at least one log archive destination must be at the site running the downstream capture process.</p>
LOG_ARCHIVE_DEST_STATE_n	<p>Default: enable</p> <p>Range: One of the following:</p> <ul style="list-style-type: none"> ▪ alternate ▪ reset ▪ defer ▪ enable <p>Modifiable?: Yes</p>	<p>Specifies the availability state of the corresponding destination. The parameter suffix (1 through 10) specifies one of the ten corresponding LOG_ARCHIVE_DEST_n destination parameters.</p> <p>To use downstream capture and copy the redo data to the downstream database using redo transport services, ensure that the destination that corresponds to the LOG_ARCHIVE_DEST_n destination for the downstream database is set to enable.</p>

Table 9–1 (Cont.) Initialization Parameters Relevant to Oracle Streams

Parameter	Values	Description
LOG_BUFFER	<p>Default: 512 KB or 128 KB * CPU_COUNT, whichever is greater</p> <p>Range: Operating system-dependent</p> <p>Modifiable?: No</p>	<p>Specifies the amount of memory (in bytes) that Oracle uses when buffering redo entries to a redo log file. Redo log entries contain a record of the changes that have been made to the database block buffers.</p> <p>If a capture process is running on the database, then set this parameter properly so that the capture process reads redo log records from the redo log buffer rather than from the hard disk.</p>
MEMORY_MAX_TARGET	<p>Default: 0</p> <p>Range: 0 to the physical memory size available to Oracle Database</p> <p>Modifiable?: No</p>	<p>Specifies the maximum systemwide usable memory for an Oracle database.</p> <p>If the MEMORY_TARGET parameter is set to a nonzero value, then set this parameter to a large nonzero value if you must specify the maximum memory usage of the Oracle database.</p> <p>See Also: "Configuring the Oracle Streams Pool" on page 9-9</p>
MEMORY_TARGET	<p>Default: 0</p> <p>Range: 152 MB to MEMORY_MAX_TARGET setting</p> <p>Modifiable?: Yes</p>	<p>Specifies the systemwide usable memory for an Oracle database.</p> <p>Oracle recommends enabling the autotuning of the memory usage of an Oracle database by setting MEMORY_TARGET to a large nonzero value (if this parameter is supported on your platform).</p> <p>See Also: "Configuring the Oracle Streams Pool" on page 9-9</p>
OPEN_LINKS	<p>Default: 4</p> <p>Range: 0 to 255</p> <p>Modifiable?: No</p>	<p>Specifies the maximum number of concurrent open connections to remote databases in one session. These connections include database links, as well as external procedures and cartridges, each of which uses a separate process.</p> <p>In an Oracle Streams environment, ensure that this parameter is set to the default value of 4 or higher.</p>
PROCESSES	<p>Default: 100</p> <p>Range: 6 to operating system-dependent</p> <p>Modifiable?: No</p>	<p>Specifies the maximum number of operating system user processes that can simultaneously connect to Oracle.</p> <p>Ensure that the value of this parameter allows for all background processes, such as locks, slave processes. In Oracle Streams, capture processes and apply processes use background processes, and propagation jobs use Oracle Scheduler slave processes.</p>

Table 9–1 (Cont.) Initialization Parameters Relevant to Oracle Streams

Parameter	Values	Description
SESSIONS	<p>Default: Derived from: (1.1 * PROCESSES) + 5</p> <p>Range: 1 to 2³¹</p> <p>Modifiable?: No</p>	<p>Specifies the maximum number of sessions that can be created in the system.</p> <p>To run one or more capture processes or apply processes in a database, you might need to increase the size of this parameter. Each background process in a database requires a session.</p>
SGA_MAX_SIZE	<p>Default: Initial size of SGA at startup</p> <p>Range: 0 to operating system-dependent</p> <p>Modifiable?: No</p>	<p>Specifies the maximum size of System Global Area (SGA) for the lifetime of a database instance.</p> <p>If the SGA_TARGET parameter is set to a nonzero value, then set this parameter to a large nonzero value if you must specify the SGA size.</p> <p>See Also: "Configuring the Oracle Streams Pool" on page 9-9</p>
SGA_TARGET	<p>Default: 0 (SGA autotuning is disabled)</p> <p>Range: 64M to operating system-dependent</p> <p>Modifiable?: Yes</p>	<p>Specifies the total size of all System Global Area (SGA) components.</p> <p>If MEMORY_MAX_TARGET and MEMORY_TARGET are set to 0 (zero), then Oracle recommends enabling the autotuning of SGA memory by setting SGA_TARGET to a large nonzero value.</p> <p>If this parameter is set to a nonzero value, then the size of the Oracle Streams pool is managed by Automatic Shared Memory Management.</p> <p>See Also: "Configuring the Oracle Streams Pool" on page 9-9</p>
SHARED_POOL_SIZE	<p>Default:</p> <p>When SGA_TARGET is set to a nonzero value: If the parameter is not specified, then the default is 0 (internally determined by Oracle Database). If the parameter is specified, then the user-specified value indicates a minimum value for the shared memory pool.</p> <p>When SGA_TARGET is not set (32-bit platforms): 32 MB, rounded up to the nearest granule size. When SGA_TARGET is not set (64-bit platforms): 84 MB, rounded up to the nearest granule size.</p> <p>Range: The granule size to operating system-dependent</p> <p>Modifiable?: Yes</p>	<p>Specifies (in bytes) the size of the shared pool. The shared pool contains shared cursors, stored procedures, control structures, and other structures.</p> <p>If the MEMORY_MAX_TARGET, MEMORY_TARGET, SGA_TARGET, and STREAMS_POOL_SIZE initialization parameters are set to zero, then Oracle Streams transfers an amount equal to 10% of the shared pool from the buffer cache to the Oracle Streams pool.</p> <p>See Also: "Configuring the Oracle Streams Pool" on page 9-9</p>

Table 9–1 (Cont.) Initialization Parameters Relevant to Oracle Streams

Parameter	Values	Description
STREAMS_POOL_SIZE	<p>Default: 0</p> <p>Range: 0 to operating system-dependent limit</p> <p>Modifiable?: Yes</p>	<p>Specifies (in bytes) the size of the Oracle Streams pool. The Oracle Streams pool contains buffered queue messages. In addition, the Oracle Streams pool is used for internal communications during parallel capture and apply.</p> <p>If the MEMORY_TARGET or MEMORY_MAX_TARGET initialization parameter is set to a nonzero value, then the Oracle Streams pool size is set by Automatic Memory Management, and STREAMS_POOL_SIZE specifies the minimum size.</p> <p>If the SGA_TARGET initialization parameter is set to a nonzero value, then the Oracle Streams pool size is set by Automatic Shared Memory Management, and STREAMS_POOL_SIZE specifies the minimum size.</p> <p>This parameter is modifiable. If this parameter is reduced to zero when an instance is running, then Oracle Streams processes and jobs might not run.</p> <p>Ensure that there is enough memory to accommodate the following Oracle Streams requirements:</p> <ul style="list-style-type: none"> ■ 10 MB for each capture process parallelism ■ 10 MB or more for each buffered queue. The buffered queue is where the buffered messages are stored. ■ 1 MB for each apply process parallelism <p>For example, if parallelism is set to 3 for a capture process, then at least 30 MB is required for the capture process. If a database has two buffered queues, then at least 20 MB is required for the buffered queues. If parallelism is set to 5 for an apply process, then at least 5 MB is required for the apply process.</p> <p>You can use the V\$STREAMS_POOL_ADVICE dynamic performance view to determine an appropriate setting for this parameter.</p> <p>See Also: "Configuring the Oracle Streams Pool" on page 9-9</p>

Table 9–1 (Cont.) Initialization Parameters Relevant to Oracle Streams

Parameter	Values	Description
TIMED_STATISTICS	<p>Default:</p> <p>If STATISTICS_LEVEL is set to TYPICAL or ALL, then true</p> <p>If STATISTICS_LEVEL is set to BASIC, then false</p> <p>The default for STATISTICS_LEVEL is TYPICAL.</p> <p>Range: true or false</p> <p>Modifiable?: Yes</p>	<p>Specifies whether or not statistics related to time are collected.</p> <p>To collect elapsed time statistics in the dynamic performance views related to Oracle Streams, set this parameter to true. The views that include elapsed time statistics include: V\$STREAMS_CAPTURE, V\$STREAMS_APPLY_COORDINATOR, V\$STREAMS_APPLY_READER, V\$STREAMS_APPLY_SERVER.</p>
UNDO_RETENTION	<p>Default: 900</p> <p>Range: 0 to $2^{32}-1$ (max value represented by 32 bits)</p> <p>Modifiable?: Yes</p>	<p>Specifies (in seconds) the amount of committed undo information to retain in the database.</p> <p>For a database running one or more capture processes, ensure that this parameter is set to specify an adequate undo retention period.</p> <p>If you are running one or more capture processes and you are unsure about the proper setting, then try setting this parameter to at least 3600. If you encounter "snapshot too old" errors, then increase the setting for this parameter until these errors cease. Ensure that the undo tablespace has enough space to accommodate the UNDO_RETENTION setting.</p>

See Also:

- *Oracle Database 2 Day DBA*
- *Oracle Database Reference* for more information about these initialization parameters
- *Oracle Data Guard Concepts and Administration* for more information about the LOG_ARCHIVE_DEST_n parameter
- *Oracle Database Administrator's Guide* for more information about the UNDO_RETENTION parameter

Configuring the Oracle Streams Pool

The **Oracle Streams pool** is a portion of memory in the System Global Area (SGA) that is used by Oracle Streams. The Oracle Streams pool stores **buffered queue messages** in memory, and it provides memory for **capture processes** and **apply processes**. The Oracle Streams pool always stores LCRs captured by a capture process, and it stores LCRs and messages that are enqueued into a buffered queue by applications.

The Oracle Streams pool is initialized the first time any one of the following actions occur in a database:

- A message is enqueued into a buffered queue. Data Pump export and import operations initialize the Oracle Streams pool because these operations use buffered queues.
- A capture process is started.

- A propagation is created.
- An apply process is started.

The size of the Oracle Streams pool is determined in one of the following ways:

- [Using Automatic Memory Management to Set the Oracle Streams Pool Size](#)
- [Using Automatic Shared Memory Management to Set the Oracle Streams Pool Size](#)
- [Setting the Oracle Streams Pool Size Manually](#)
- [Using the Default Setting for the Oracle Streams Pool Size](#)

Note: If the Oracle Streams pool cannot be initialized, then an ORA-00832 error is returned. If this happens, then first ensure that there is enough space in the SGA for the Oracle Streams pool. If necessary, reset the `SGA_MAX_SIZE` initialization parameter to increase the SGA size. Next, set one or more of the following initialization parameters: `MEMORY_TARGET`, `MEMORY_MAX_TARGET`, `SGA_TARGET`, and `STREAMS_POOL_SIZE`.

See Also:

- ["Setting Initialization Parameters Relevant to Oracle Streams" on page 9-4](#)
- ["Persistent Queues and Buffered Queues" on page 3-3](#)
- [Chapter 2, "Oracle Streams Information Capture"](#)
- [Chapter 4, "Oracle Streams Information Consumption"](#)

Using Automatic Memory Management to Set the Oracle Streams Pool Size

The Automatic Memory Management feature manages the size of the Oracle Streams pool when the `MEMORY_TARGET` or `MEMORY_MAX_TARGET` initialization parameter is set to a nonzero value. When you use Automatic Memory Management, you can still set the following initialization parameters:

- If the `SGA_TARGET` initialization parameter also is set to a nonzero value, then Automatic Memory Management uses this value as a minimum for the system global area (SGA).
- If the `STREAMS_POOL_SIZE` initialization parameter also is set to a nonzero value, then Automatic Memory Management uses this value as a minimum for the Oracle Streams pool.

The current memory allocated to Oracle Streams pool by Automatic Memory Management can be viewed by querying the `V$MEMORY_DYNAMIC_COMPONENTS` view.

Note: Currently, the `MEMORY_TARGET` and `MEMORY_MAX_TARGET` initialization parameters are not supported on some platforms.

See Also:

- *Oracle Database Administrator's Guide*
- *Oracle Database Reference*

Using Automatic Shared Memory Management to Set the Oracle Streams Pool Size

The Automatic Shared Memory Management feature manages the size of the Oracle Streams pool when the following conditions are met:

- The `MEMORY_TARGET` and `MEMORY_MAX_TARGET` initialization parameters are both set to 0 (zero).
- `SGA_TARGET` initialization parameter is set to a nonzero value.

If you are using Automatic Shared Memory Management and the `STREAMS_POOL_SIZE` initialization parameter also is set to a nonzero value, then Automatic Shared Memory Management uses this value as a minimum for the Oracle Streams pool. You can set a minimum size if your environment needs a minimum amount of memory in the Oracle Streams pool to function properly. The current memory allocated to Oracle Streams pool by Automatic Shared Memory Management can be viewed by querying the `V$SGA_DYNAMIC_COMPONENTS` view.

See Also:

- *Oracle Database Administrator's Guide*
- *Oracle Database Reference*

Setting the Oracle Streams Pool Size Manually

The Oracle Streams pool size is the value specified by the `STREAMS_POOL_SIZE` parameter, in bytes, if the following conditions are met.

- The `MEMORY_TARGET`, `MEMORY_MAX_TARGET`, and `SGA_TARGET` initialization parameters are all set to 0 (zero).
- The `STREAMS_POOL_SIZE` initialization parameter is set to a nonzero value.

If you plan to set the Oracle Streams pool size manually, then you can use the `V$STREAMS_POOL_ADVICE` dynamic performance view to determine an appropriate setting for the `STREAMS_POOL_SIZE` initialization parameter.

See Also:

- ["Monitoring the Oracle Streams Pool"](#) on page 28-3

Using the Default Setting for the Oracle Streams Pool Size

The Oracle Streams pool size is set by default if all of the following parameters are set to 0 (zero): `MEMORY_TARGET`, `MEMORY_MAX_TARGET`, `SGA_TARGET`, and `STREAMS_POOL_SIZE`. When the Oracle Streams pool size is set by default, the first use of Oracle Streams in a database transfers an amount of memory equal to 10% of the shared pool from the buffer cache to the Oracle Streams pool. The buffer cache is set by the `DB_CACHE_SIZE` initialization parameter, and the shared pool size is set by the `SHARED_POOL_SIZE` initialization parameter.

For example, consider the following configuration in a database before Oracle Streams is used for the first time:

- `DB_CACHE_SIZE` is set to 100 MB.
- `SHARED_POOL_SIZE` is set to 80 MB.
- `MEMORY_TARGET`, `MEMORY_MAX_TARGET`, `SGA_TARGET`, and `STREAMS_POOL_SIZE` are all set to zero.

Given this configuration, the amount of memory allocated after Oracle Streams is used for the first time is the following:

- The buffer cache has 92 MB.
- The shared pool has 80 MB.
- The Oracle Streams pool has 8 MB.

See Also:

- ["Setting Initialization Parameters Relevant to Oracle Streams"](#) on page 9-4 for more information about the `STREAMS_POOL_SIZE` initialization parameter
- ["Multiple Capture Processes in a Single Database"](#) on page 2-24
- ["Persistent Queues and Buffered Queues"](#) on page 3-3
- ["Multiple Apply Processes in a Single Database"](#) on page 4-20

Configuring Network Connectivity and Database Links

If you plan to use Oracle Streams to share information between databases, then configure network connectivity and database links between these databases:

- For Oracle databases, configure your network and Oracle Net so that the databases can communicate with each other.
- For non-Oracle databases, configure an Oracle Database Gateway for communication between the Oracle database and the non-Oracle database.
- If you plan to propagate **messages** from a **source queue** at a database to a **destination queue** at another database, then create a private database link between the database containing the source queue and the database containing the destination queue. Each database link should use a `CONNECT TO` clause for the user propagating messages between databases.

For example, to create a database link to a database named `dbs2.example.com` connecting as an Oracle Streams administrator named `strmadmin`, run the following statement:

```
CREATE DATABASE LINK dbs2.example.com CONNECT TO strmadmin
  IDENTIFIED BY password
  USING 'dbs2.example.com';
```

See Also:

- *Oracle Database 2 Day DBA*
- *Oracle Database 2 Day + Data Replication and Integration Guide*
- *Oracle Streams Replication Administrator's Guide* for information about the best practices for configuring propagations and network parameters
- *Oracle Database Administrator's Guide*
- *Oracle Database Heterogeneous Connectivity Administrator's Guide* for information about communication between an Oracle database and a non-Oracle database

Configuring Oracle Streams

Oracle Enterprise Manager provides the following configuration options for Oracle Streams:

- The Oracle Streams Global, Schema, Table and Subset Replication Wizard can configure a **replication** environment that replicates changes to the entire source database, certain schemas in the source database, certain tables in the source database, or subsets of tables in the source database. A **capture process** captures changes to the replicated database objects. The wizard can configure a one-way or bi-directional replication environment. This wizard can also configure a **local capture process** or a **downstream capture process**.
- The Oracle Streams Tablespace Replication Wizard can configure a replication environment that replicates changes to one or more self-contained tablespaces. A capture process captures changes to the replicated database objects at each source database. This wizard can configure a one-way or bi-directional replication environment.
- The Messaging option opens the Messaging subpage. Using this subpage, you can configure the **queues**, **queue tables**, and **propagations** in a messaging environment. Users and applications can enqueue **messages**, propagate messages to subscribing queues, notify user applications that messages are ready for consumption, and dequeue messages at the destination.

If these options do not meet your requirements, then you can use SQL*Plus and Oracle-supplied packages to configure an Oracle Streams environment. The `DBMS_STREAMS_ADM` package includes procedures that configure an Oracle Streams replication environment with one procedure call. These configuration procedures might be the easiest way to configure a replication environment that satisfies your requirements.

These procedures and the configuration wizards in Enterprise Manager currently only configure Oracle Streams replication environments that use capture processes. Alternatively, you might choose to use **synchronous captures** instead of capture processes. Synchronous captures might be appropriate if you plan to capture changes to a relatively small number of tables.

See the following documentation for instructions about configuring Oracle Streams and for examples that configure different types of Oracle Streams environments:

- *Oracle Database 2 Day + Data Replication and Integration Guide* for examples that configure Oracle Streams messaging environments and replication environments
- *Oracle Streams Replication Administrator's Guide* for information about Oracle Streams replication and for examples that configure Oracle Streams replication environments
- *Oracle Streams Advanced Queuing User's Guide* for information about configuring an Oracle Streams messaging environment
- *Oracle Database PL/SQL Packages and Types Reference* for more information about the procedures
- [Chapter 32, "Single-Database Capture and Apply Example"](#)

Note: Any source database that generates redo data that will be captured by a capture process must run in ARCHIVELOG mode.

Configuring Implicit Capture

Implicit capture means that database changes are captured automatically and enqueued. Implicit capture can be accomplished with a [capture process](#) or with a [synchronous capture](#). A capture process captures changes in the redo log, while a synchronous capture captures DML changes with an internal mechanism. Both capture processes and synchronous captures reformat the captured changes into logical change records (LCRs) and enqueue the LCRs into an ANYDATA queue.

The following topics describe configuring implicit capture:

- [Configuring a Capture Process](#)
- [Configuring Synchronous Capture](#)

Each task described in this chapter should be completed by an Oracle Streams administrator that has been granted the appropriate privileges, unless specified otherwise.

See Also:

- [Chapter 2, "Oracle Streams Information Capture"](#)
- ["Configuring an Oracle Streams Administrator"](#) on page 9-1

Configuring a Capture Process

You can create a [capture process](#) that captures changes either locally at the [source database](#) or remotely at a [downstream database](#). If a capture process runs on a downstream database, then redo data from the source database is copied to the downstream database, and the capture process captures changes in redo data at the downstream database.

You can use any of the following procedures to create a [local capture process](#):

- `DBMS_STREAMS_ADM.ADD_TABLE_RULES`
- `DBMS_STREAMS_ADM.ADD_SUBSET_RULES`
- `DBMS_STREAMS_ADM.ADD_SCHEMA_RULES`
- `DBMS_STREAMS_ADM.ADD_GLOBAL_RULES`
- `DBMS_CAPTURE_ADM.CREATE_CAPTURE`

Each of the procedures in the `DBMS_STREAMS_ADM` package creates a capture process with the specified name if it does not already exist, creates either a [positive rule set](#) or [negative rule set](#) for the capture process if the capture process does not have such a [rule set](#), and can add [table rules](#), [schema rules](#), or [global rules](#) to the rule set.

The `CREATE_CAPTURE` procedure creates a capture process, but does not create a rule set or rules for the capture process. However, the `CREATE_CAPTURE` procedure enables you to specify an existing rule set to associate with the capture process, either as a positive or a negative rule set, a **first SCN**, and a **start SCN** for the capture process. To create a capture process that performs downstream capture, you must use the `CREATE_CAPTURE` procedure.

The following sections describe configuring a capture process:

- [Preparing to Configure a Capture Process](#)
- [Configuring a Local Capture Process](#)
- [Configuring a Downstream Capture Process](#)
- [After Configuring a Capture Process](#)

Caution: When a capture process is started or restarted, it might need to scan redo log files with a `FIRST_CHANGE#` value that is lower than start SCN. Removing required redo log files before they are scanned by a capture process causes the capture process to abort. You can query the `DBA_CAPTURE` data dictionary view to determine the first SCN, start SCN, and **required checkpoint SCN** for a capture process. A capture process needs the redo log file that includes the required checkpoint SCN, and all subsequent redo log files. See "[Capture Process Creation](#)" on page 2-29 for more information about the first SCN and start SCN for a capture process.

Note:

- You can configure an entire Oracle Streams environment, including capture processes, using procedures in the `DBMS_STREAMS_ADM` package or Oracle Enterprise Manager
 - After creating a capture process, avoid changing the `DBID` or global name of the source database for the capture process. If you change either the `DBID` or global name of the source database, then the capture process must be dropped and re-created.
 - If Oracle Database Vault is installed, then the user who creates the capture process must be granted the `BECOME USER` system privilege. Granting this privilege to the user is not required if Oracle Database Vault is not installed. You can revoke the `BECOME USER` system privilege from the user after the capture process is created, if necessary.
 - To configure downstream capture, the source database must be an Oracle Database 10g Release 1 or later database.
-
-

See Also:

- ["Configuring Oracle Streams"](#) on page 9-13
- ["Capture Process Creation"](#) on page 2-29
- ["First SCN and Start SCN"](#) on page 2-20
- *Oracle Streams Replication Administrator's Guide* for information about changing the DBID or global name of a source database

Preparing to Configure a Capture Process

The following tasks must be completed before you configure a capture process:

- Configure any **source database** that generates redo data that will be captured by a capture process to run in ARCHIVELOG mode. See ["ARCHIVELOG Mode and a Capture Process"](#) on page 2-28 and *Oracle Database Administrator's Guide*. For **downstream capture processes**, the **downstream database** also must run in ARCHIVELOG mode if you plan to configure a **real-time downstream capture process**. The downstream database does not need to run in ARCHIVELOG mode if you plan to run only **archived-log downstream capture process** on it.
- Ensure that the initialization parameters are set properly on any database that will run a capture process. See ["Setting Initialization Parameters Relevant to Oracle Streams"](#) on page 9-4.
- Create an Oracle Streams administrator on each database involved in the Oracle Streams configuration. The examples in this chapter assume that the Oracle Streams administrator is `strmadmin`. To create a capture process, the Oracle Streams administrator must be granted DBA role, but this role can be revoked after the capture process is created if necessary. See ["Configuring an Oracle Streams Administrator"](#) on page 9-1.
- Create an ANYDATA queue to associate with the capture process, if one does not exist. See ["Creating an ANYDATA Queue"](#) on page 11-1 for instructions. The examples in this chapter assume that the **queue** used by the capture process is `strmadmin.streams_queue`. Create the queue on the same database that will run the capture process.
- Specify supplemental logging for some columns at a **source database** for changes to the columns to be applied successfully at a **destination database**. Typically, **supplemental logging** is required in Oracle Streams **replication** environments, but it might be required in any environment that processes **captured LCRs** with an **apply process**.

The procedures listed in ["Configuring a Capture Process"](#) on page 10-1, such as the `ADD_TABLE_RULES` procedure, automatically configure supplemental logging of any primary key, unique key, bitmap index, and foreign key columns in the replicated tables. In addition, you can use the `ALTER DATABASE` statement to specify supplemental logging for all tables in a database, and you can use the `ALTER TABLE` statement to specify supplemental logging for a particular table. See the *Oracle Streams Replication Administrator's Guide* for more information about specifying supplemental logging.

Configuring a Local Capture Process

The following sections describe using the `DBMS_STREAMS_ADM` package and the `DBMS_CAPTURE_ADM` package to create a **local capture process**.

This section contains the following examples:

- [Example of Configuring a Local Capture Process Using DBMS_STREAMS_ADM](#)
- [Example of Configuring a Local Capture Process Using DBMS_CAPTURE_ADM](#)
- [Example of Configuring a Local Capture Process with Non-NULL Start SCN](#)

Example of Configuring a Local Capture Process Using DBMS_STREAMS_ADM

To configure a local capture process using the DBMS_STREAMS_ADM package, complete the following steps:

1. Complete the tasks in "[Preparing to Configure a Capture Process](#)" on page 10-3.
2. Run the ADD_TABLE_RULES procedure in the DBMS_STREAMS_ADM package to create a local capture process:

```
BEGIN
  DBMS_STREAMS_ADM.ADD_TABLE_RULES(
    table_name      => 'hr.employees',
    streams_type    => 'capture',
    streams_name    => 'strm01_capture',
    queue_name      => 'strmadmin.streams_queue',
    include_dml     => TRUE,
    include_ddl     => TRUE,
    include_tagged_lcr => FALSE,
    source_database => NULL,
    inclusion_rule  => TRUE);
END;
/
```

Running this procedure performs the following actions:

- Creates a capture process named `strm01_capture`. The capture process is created only if it does not already exist. If a new capture process is created, then this procedure also sets the **start SCN** to the point in time of creation.
- Associates the capture process with an existing **queue** named `streams_queue`.
- Creates a **positive rule set** and associates it with the capture process, if the capture process does not have a positive rule set, because the `inclusion_rule` parameter is set to `TRUE`. The rule set uses the `SYS.STREAMS$_EVALUATION_CONTEXT` **evaluation context**. The rule set name is system generated.
- Creates two **rules**. One rule evaluates to `TRUE` for DML changes to the `hr.employees` table, and the other rule evaluates to `TRUE` for DDL changes to the `hr.employees` table. The rule names are system generated.
- Adds the two rules to the positive rule set associated with the capture process. The rules are added to the positive rule set because the `inclusion_rule` parameter is set to `TRUE`.
- Specifies that the capture process captures a change in the redo log only if the change has a `NULL` **tag**, because the `include_tagged_lcr` parameter is set to `FALSE`. This behavior is accomplished through the **system-created rules** for the capture process.
- Creates a capture process that captures local changes to the **source database** because the `source_database` parameter is set to `NULL`. For a local capture process, you can also specify the global name of the local database for this parameter.

- Prepares the `hr.employees` table for **instantiation**.
 - Enables **supplemental logging** for any primary key, unique key, bitmap index, and foreign key columns in the table.
3. If necessary, complete the steps described in "After Configuring a Capture Process" on page 10-22.

See Also:

- "Capture Process Creation" on page 2-29
- "System-Created Rules" on page 6-5
- *Oracle Streams Replication Administrator's Guide* for more information about Oracle Streams tags

Example of Configuring a Local Capture Process Using DBMS_CAPTURE_ADM

To configure a local capture process using the `DBMS_CAPTURE_ADM` package, complete the following steps:

1. Complete the tasks in "Preparing to Configure a Capture Process" on page 10-3.
2. Run the `CREATE_CAPTURE` procedure in the `DBMS_CAPTURE_ADM` package to create a local capture process:

```
BEGIN
  DBMS_CAPTURE_ADM.CREATE_CAPTURE(
    queue_name      => 'strmadmin.streams_queue',
    capture_name    => 'strm02_capture',
    rule_set_name   => 'strmadmin.strm01_rule_set',
    start_scn       => NULL,
    source_database => NULL,
    first_scn       => NULL);
END;
/
```

Running this procedure performs the following actions:

- Creates a capture process named `strm02_capture`. A capture process with the same name must not exist.
- Associates the capture process with an existing queue named `streams_queue`.
- Associates the capture process with an existing rule set named `strm01_rule_set`. This rule set is the positive rule set for the capture process.
- Creates a capture process that captures local changes to the source database because the `source_database` parameter is set to `NULL`. For a local capture process, you can also specify the global name of the local database for this parameter.
- Specifies that the Oracle database determines the start SCN and **first SCN** for the capture process because both the `start_scn` parameter and the `first_scn` parameter are set to `NULL`.
- If no other capture processes that capture local changes are running on the local database, then the `BUILD` procedure in the `DBMS_CAPTURE_ADM` package is run automatically. Running this procedure extracts the data dictionary to the redo log, and a **LogMiner data dictionary** is created when the capture process is started for the first time.

See Also:

- ["Capture Process Creation"](#) on page 2-29
 - ["SCN Values Related to a Capture Process"](#) on page 2-20
3. If necessary, complete the steps described in ["After Configuring a Capture Process"](#) on page 10-22.

Example of Configuring a Local Capture Process with Non-NULL Start SCN

This example runs the `CREATE_CAPTURE` procedure in the `DBMS_CAPTURE_ADM` package to create a **local capture process** with a **start SCN** set to 223525. This example assumes that there is at least one local capture process at the database, and that this capture process has taken at least one **checkpoint**. You can always specify a start SCN for a new capture process that is equal to or greater than the current SCN of the **source database**. If you want to specify a start SCN that is lower than the current SCN of the database, then the specified start SCN must be higher than the lowest **first SCN** for an existing local capture process that has been started successfully at least once and has taken at least one checkpoint.

You can determine the first SCN for existing capture processes, and whether these capture processes have taken a checkpoint, by running the following query:

```
SELECT CAPTURE_NAME, FIRST_SCN, MAX_CHECKPOINT_SCN FROM DBA_CAPTURE;
```

Your output looks similar to the following:

CAPTURE_NAME	FIRST_SCN	MAX_CHECKPOINT_SCN
CAPTURE_SIMP	223522	230825

These results show that the `capture_simp` capture process has a first SCN of 223522. Also, this capture process has taken a checkpoint because the `MAX_CHECKPOINT_SCN` value is non-NULL. Therefore, the start SCN for the new capture process can be set to 223522 or higher.

To configure a local capture process with a non-NULL start SCN, complete the following steps:

1. Complete the tasks in ["Preparing to Configure a Capture Process"](#) on page 10-3.
2. Run the following procedure to create the capture process:

```
BEGIN
  DBMS_CAPTURE_ADM.CREATE_CAPTURE(
    queue_name      => 'strmadmin.streams_queue',
    capture_name    => 'strm05_capture',
    rule_set_name   => 'strmadmin.strm01_rule_set',
    start_scn       => 223525,
    source_database => NULL,
    first_scn       => NULL);
END;
/
```

Running this procedure performs the following actions:

- Creates a capture process named `strm05_capture`. A capture process with the same name must not exist.
- Associates the capture process with an existing **queue** named `streams_queue`.

- Associates the capture process with an existing **rule set** named `strm01_rule_set`. This rule set is the **positive rule set** for the capture process.
- Specifies 223525 as the start SCN for the capture process. The new capture process uses the same **LogMiner data dictionary** as one of the existing capture processes. Oracle Streams automatically chooses which LogMiner data dictionary to share with the new capture process. Because the `first_scn` parameter was set to `NULL`, the first SCN for the new capture process is the same as the first SCN of the existing capture process whose LogMiner data dictionary was shared. In this example, the existing capture process is `capture_simp`.
- Creates a capture process that captures local changes to the source database because the `source_database` parameter is set to `NULL`. For a local capture process, you can also specify the global name of the local database for this parameter.

Note: If no local capture process exists when the procedure in this example is run, then the `DBMS_CAPTURE_ADM.BUILD` procedure is run automatically during capture process creation to extract the data dictionary into the redo log. The first time the new capture process is started, it uses this redo data to create a LogMiner data dictionary. In this case, a specified `start_scn` parameter value must be equal to or higher than the current database SCN.

3. If necessary, complete the steps described in "[After Configuring a Capture Process](#)" on page 10-22.

See Also:

- "[Capture Process Creation](#)" on page 2-29
- *Oracle Database PL/SQL Packages and Types Reference* for more information about setting the `first_scn` and `start_scn` parameters in the `CREATE_CAPTURE` procedure

Configuring a Downstream Capture Process

This section describes preparing for a downstream capture process and configuring a real-time or archived-log downstream capture process.

This section contains these topics:

- [Preparing to Transmit Redo Data to a Downstream Database](#)
- [Configuring a Real-Time Downstream Capture Process](#)
- [Configuring an Archived-Log Downstream Capture Process](#)

Preparing to Transmit Redo Data to a Downstream Database

The steps in this section are required to prepare the source database to transmit its redo data to the downstream database, and to prepare the downstream database to accept that redo data. These steps are required whenever you configure downstream capture process.

Complete the following steps to prepare to transmit redo data to a downstream database:

1. Complete the tasks in "[Preparing to Configure a Capture Process](#)" on page 10-3.
2. Configure Oracle Net so that the source database can communicate with the downstream database.

See Also: *Oracle Database Net Services Administrator's Guide*

3. Configure authentication at both databases to support the transfer of redo data.

Redo transport sessions are authenticated using either the Secure Sockets Layer (SSL) protocol or a remote login password file. If the source database has a remote login password file, then copy it to the appropriate directory on the downstream capture database system. The password file must be the same at the source database and the downstream capture database.

See Also: *Oracle Data Guard Concepts and Administration* for detailed information about authentication requirements for redo transport

4. At the source database, set the following initialization parameters to configure redo transport services to transmit redo data from the source database to the downstream database:

- LOG_ARCHIVE_DEST_ *n* - Configure at least one LOG_ARCHIVE_DEST_ *n* initialization parameter to transmit redo data to the downstream database. To do this, set the following attributes of this parameter:
 - SERVICE - Specify the network service name of the downstream database.
 - ASYNC or SYNC - Specify a redo transport mode.

The advantage of specifying ASYNC is that it results in little or no effect on the performance of the source database. If the source database is running Oracle Database 10g Release 1 or later, then ASYNC is recommended to avoid affecting source database performance if the downstream database or network is performing poorly.

The advantage of specifying SYNC is that redo data is sent to the downstream database faster than when ASYNC is specified. Also, specifying SYNC AFFIRM results in behavior that is similar to MAXIMUM AVAILABILITY standby protection mode. Note that specifying an ALTER DATABASE STANDBY DATABASE TO MAXIMIZE AVAILABILITY SQL statement has no effect on an Oracle Streams capture process.

- NOREGISTER - Specify this attribute so that the location of the archived redo log files is not recorded in the downstream database control file.
- VALID_FOR - Specify either (ONLINE_LOGFILE, PRIMARY_ROLE) or (ONLINE_LOGFILE, ALL_ROLES).
- TEMPLATE - If you are configuring an archived-log downstream capture process, then specify a directory and format template for archived redo logs at the downstream database. The TEMPLATE attribute overrides the LOG_ARCHIVE_FORMAT initialization parameter settings at the downstream database. The TEMPLATE attribute is valid only with remote destinations. Ensure that the format uses all of the following variables at each source database: %t, %s, and %r.

Do not specify the TEMPLATE attribute if you are configuring a real-time downstream capture process.

- `DB_UNIQUE_NAME` - The unique name of the downstream database. Use the name specified for the `DB_UNIQUE_NAME` initialization parameter at the downstream database.

The following example is a `LOG_ARCHIVE_DEST_n` setting that specifies a downstream database for a real-time downstream capture process:

```
LOG_ARCHIVE_DEST_2='SERVICE=DBS2.EXAMPLE.COM ASYNC NOREGISTER
VALID_FOR=(ONLINE_LOGFILES,PRIMARY_ROLE)
DB_UNIQUE_NAME=dbs2'
```

The following example is a `LOG_ARCHIVE_DEST_n` setting that specifies a downstream database for an archived-log downstream capture process:

```
LOG_ARCHIVE_DEST_2='SERVICE=DBS2.EXAMPLE.COM ASYNC NOREGISTER
VALID_FOR=(ONLINE_LOGFILES,PRIMARY_ROLE)
TEMPLATE=/usr/oracle/log_for_dbs1/dbs1_arch_%t_%s_%r.log
DB_UNIQUE_NAME=dbs2'
```

Tip: Specify a value for the `TEMPLATE` attribute that keeps log files from a remote source database separate from local database log files. In addition, if the downstream database contains log files from multiple source databases, then the log files from each source database should be kept separate from each other.

- `LOG_ARCHIVE_DEST_STATE_n` - Set this initialization parameter that corresponds with the `LOG_ARCHIVE_DEST_n` parameter for the downstream database to `ENABLE`.

For example, if the `LOG_ARCHIVE_DEST_2` initialization parameter is set for the downstream database, then set the `LOG_ARCHIVE_DEST_STATE_2` parameter in the following way:

```
LOG_ARCHIVE_DEST_STATE_2=ENABLE
```

- `LOG_ARCHIVE_CONFIG` - Set the `DB_CONFIG` attribute in this initialization parameter to include the `DB_UNIQUE_NAME` of the source database and the downstream database.

For example, if the `DB_UNIQUE_NAME` of the source database is `dbs1`, and the `DB_UNIQUE_NAME` of the downstream database is `dbs2`, then specify the following parameter:

```
LOG_ARCHIVE_CONFIG='DG_CONFIG=(dbs1,dbs2)'
```

By default, the `LOG_ARCHIVE_CONFIG` parameter enables a database to both send and receive redo.

See Also: *Oracle Database Reference* and *Oracle Data Guard Concepts and Administration* for more information about these initialization parameters

5. At the downstream database, set the `DB_CONFIG` attribute in the `LOG_ARCHIVE_CONFIG` initialization parameter to include the `DB_UNIQUE_NAME` of the source database and the downstream database.

For example, if the `DB_UNIQUE_NAME` of the source database is `dbs1`, and the `DB_UNIQUE_NAME` of the downstream database is `dbs2`, then specify the following parameter:

```
LOG_ARCHIVE_CONFIG='DG_CONFIG=(dbs1,dbs2)'
```

By default, the `LOG_ARCHIVE_CONFIG` parameter enables a database to both send and receive redo.

6. If you reset any initialization parameters while the instance is running at a database in Step 4 or Step 5, then you might want to reset them in the initialization parameter file as well, so that the new values are retained when the database is restarted.

If you did not reset the initialization parameters while the instance was running, but instead reset them in the initialization parameter file in Step 4 or Step 5, then restart the database. The source database must be open when it sends redo log files to the downstream database, because the global name of the source database is sent to the downstream database only if the source database is open.

7. Complete the steps in one of the following sections:
 - [Configuring a Real-Time Downstream Capture Process](#)
 - [Configuring an Archived-Log Downstream Capture Process](#)

Configuring a Real-Time Downstream Capture Process

To create a capture process that performs downstream capture, you must use the `CREATE_CAPTURE` procedure. The example in this section describes creating a [real-time downstream capture process](#) that uses a database link to the [source database](#). However, a real-time downstream capture process might not use a database link.

This example assumes the following:

- The source database is `dbs1.example.com` and the [downstream database](#) is `dbs2.example.com`.
- The capture process that will be created at `dbs2.example.com` uses the `streams_queue`.
- The capture process will capture DML changes to the `hr.departments` table.

This section contains the following topics:

- [Adding a Standby Redo Log at the Downstream Database](#)
- [Creating a Real-Time Downstream Capture Process](#)

Note: Only one real-time downstream capture process can exist at a downstream database.

See Also: ["Downstream Capture"](#) on page 2-15 for conceptual information about real-time downstream capture

Adding a Standby Redo Log at the Downstream Database Complete the following steps to add a standby redo log at the downstream database:

1. Complete the steps in ["Preparing to Transmit Redo Data to a Downstream Database"](#) on page 10-7.
2. At the downstream database, set the following initialization parameters to configure archiving of the redo data generated locally:

- Set at least one archive log destination in the `LOG_ARCHIVE_DEST_n` initialization parameter to either a directory or to the flash recovery area on the computer system running the downstream database. To do this, set the following attributes of this parameter:
 - `LOCATION` - Specify either a valid path name for a disk directory or `USE_DB_RECOVERY_FILE_DEST`. Each destination that specifies the `LOCATION` attribute must specify either a unique directory path name or `USE_DB_RECOVERY_FILE_DEST`. This is the local destination for archived redo log files generated by the local database.
 - `VALID_FOR` - Specify either `(ONLINE_LOGFILE, PRIMARY_ROLE)` or `(ONLINE_LOGFILE, ALL_ROLES)`.

The following example is a `LOG_ARCHIVE_DEST_n` setting for the locally generated redo data at the real-time downstream capture database:

```
LOG_ARCHIVE_DEST_1='LOCATION=/home/arc_dest/local_r1_dbs2
VALID_FOR=(ONLINE_LOGFILE,PRIMARY_ROLE)'
```

A real-time downstream capture configuration should keep archived standby redo log files separate from archived online redo log files from the downstream database. Specify `ONLINE_LOGFILE` instead of `ALL_LOGFILES` for the redo log type in the `VALID_FOR` attribute to accomplish this.

You can specify other attributes in the `LOG_ARCHIVE_DEST_n` initialization parameter if necessary.

- Set the `LOG_ARCHIVE_DEST_STATE_n` initialization parameter that corresponds with the `LOG_ARCHIVE_DEST_n` parameter previously set in this step to `ENABLE`.

For example, if the `LOG_ARCHIVE_DEST_1` initialization parameter is set, then set the `LOG_ARCHIVE_DEST_STATE_1` parameter in the following way:

```
LOG_ARCHIVE_DEST_STATE_1=ENABLE
```

3. At the downstream database, set the following initialization parameters to configure the downstream database to receive redo data from the source database and write the redo data to the standby redo log at the downstream database:
 - Set at least one archive log destination in the `LOG_ARCHIVE_DEST_n` initialization parameter to either a directory or to the flash recovery area on the computer system running the downstream database. To do this, set the following attributes of this parameter:
 - `LOCATION` - Specify either a valid path name for a disk directory or `USE_DB_RECOVERY_FILE_DEST`. Each destination that specifies the `LOCATION` attribute must specify either a unique directory path name or `USE_DB_RECOVERY_FILE_DEST`. This is the local destination for archived redo log files written from the standby redo logs. Log files from a remote source database should be kept separate from local database log files.
 - `VALID_FOR` - Specify either `(STANDBY_LOGFILE, PRIMARY_ROLE)` or `(STANDBY_LOGFILE, ALL_ROLES)`.

The following example is a `LOG_ARCHIVE_DEST_n` setting for the redo data received from the source database at the real-time downstream capture database:

```
LOG_ARCHIVE_DEST_2='LOCATION=/home/arc_dest/sr1_dbs1
VALID_FOR=(STANDBY_LOGFILE,PRIMARY_ROLE)'
```

You can specify other attributes in the `LOG_ARCHIVE_DEST_n` initialization parameter if necessary.

- Set the `LOG_ARCHIVE_DEST_STATE_n` initialization parameter that corresponds with the `LOG_ARCHIVE_DEST_n` parameter previously set in this step to `ENABLE`.

For example, if the `LOG_ARCHIVE_DEST_2` initialization parameter is set for the downstream database, then set the `LOG_ARCHIVE_DEST_STATE_2` parameter in the following way:

```
LOG_ARCHIVE_DEST_STATE_2=ENABLE
```

See Also: *Oracle Database Reference* and *Oracle Data Guard Concepts and Administration* for more information about these initialization parameters

4. If you reset any initialization parameters while an instance was running at a database in Step 2 or 3, then you might want to reset them in the relevant initialization parameter file as well, so that the new values are retained when the database is restarted.

If you did not reset the initialization parameters while an instance was running, but instead reset them in the initialization parameter file in Step 2 or 3, then restart the database. The source database must be open when it sends redo data to the downstream database, because the global name of the source database is sent to the downstream database only if the source database is open.

5. Create the standby redo log files.

Note: The following steps outline the general procedure for adding standby redo log files to the downstream database. The specific steps and SQL statements used to add standby redo log files depend on your environment. For example, in an Oracle Real Application Clusters (Oracle RAC) environment, the steps are different. See *Oracle Data Guard Concepts and Administration* for detailed instructions about adding standby redo log files to a database.

- a. In SQL*Plus, connect to the source database `dbs1.example.com` as an administrative user.

See *Oracle Database Administrator's Guide* for information about connecting to a database in SQL*Plus.

- b. Determine the log file size used on the source database. The standby log file size must exactly match (or be larger than) the source database log file size. For example, if the source database log file size is 500 MB, then the standby log file size must be 500 MB or larger. You can determine the size of the redo log files at the source database (in bytes) by querying the `V$LOG` view at the source database.

For example, query the `V$LOG` view:

```
SELECT BYTES FROM V$LOG;
```

- c. Determine the number of standby log file groups required on the downstream database. The number of standby log file groups must be at least one more than the number of online log file groups on the source database. For example, if the source database has two online log file groups, then the downstream database must have at least three standby log file groups. You can determine the number of source database online log file groups by querying the V\$LOG view at the source database.

For example, query the V\$LOG view:

```
SELECT COUNT(GROUP#) FROM V$LOG;
```

- d. In SQL*Plus, connect to the downstream database `db2.example.com` as an administrative user.
- e. Use the SQL statement `ALTER DATABASE ADD STANDBY LOGFILE` to add the standby log file groups to the downstream database.

For example, assume that the source database has two online redo log file groups and is using a log file size of 500 MB. In this case, use the following statements to create the appropriate standby log file groups:

```
ALTER DATABASE ADD STANDBY LOGFILE GROUP 3
  ('/oracle/dbs/slog3a.rdo', '/oracle/dbs/slog3b.rdo') SIZE 500M;
```

```
ALTER DATABASE ADD STANDBY LOGFILE GROUP 4
  ('/oracle/dbs/slog4.rdo', '/oracle/dbs/slog4b.rdo') SIZE 500M;
```

```
ALTER DATABASE ADD STANDBY LOGFILE GROUP 5
  ('/oracle/dbs/slog5.rdo', '/oracle/dbs/slog5b.rdo') SIZE 500M;
```

- f. Ensure that the standby log file groups were added successfully by running the following query:

```
SELECT GROUP#, THREAD#, SEQUENCE#, ARCHIVED, STATUS
  FROM V$STANDBY_LOG;
```

Your output should be similar to the following:

GROUP#	THREAD#	SEQUENCE#	ARC	STATUS
3	0	0	YES	UNASSIGNED
4	0	0	YES	UNASSIGNED
5	0	0	YES	UNASSIGNED

Creating a Real-Time Downstream Capture Process This section contains an example that runs the `CREATE_CAPTURE` procedure in the `DBMS_CAPTURE_ADM` package to create a real-time downstream capture process at the `db2.example.com` downstream database that captures changes made to the `db1.example.com` source database. The capture process in this example uses a database link to `db1.example.com` for administrative purposes.

Complete the following steps:

1. In SQL*Plus, connect to the downstream database `db2.example.com` as the Oracle Streams administrator.

See *Oracle Database Administrator's Guide* for information about connecting to a database in SQL*Plus.

2. Create the database link from `db2.example.com` to `db1.example.com`. For example, if the user `stradmin` is the Oracle Streams administrator on both databases, then create the following database link:

```
CREATE DATABASE LINK db1.example.com CONNECT TO stradmin
  IDENTIFIED BY password
  USING 'db1.example.com';
```

This example assumes that an Oracle Streams administrator exists at the source database `db1.example.com`. If no Oracle Streams administrator exists at the source database, then the Oracle Streams administrator at the downstream database should connect to a user who allows remote access by an Oracle Streams administrator. You can enable remote access for a user by specifying the user as the grantee when you run the `GRANT_REMOTE_ADMIN_ACCESS` procedure in the `DBMS_STREAMS_AUTH` package at the source database.

3. Run the `CREATE_CAPTURE` procedure to create the capture process:

```
BEGIN
  DBMS_CAPTURE_ADM.CREATE_CAPTURE(
    queue_name      => 'stradmin.streams_queue',
    capture_name    => 'real_time_capture',
    rule_set_name   => NULL,
    start_scn       => NULL,
    source_database => 'db1.example.com',
    use_database_link => TRUE,
    first_scn       => NULL,
    logfile_assignment => 'implicit');
END;
/
```

Running this procedure performs the following actions:

- Creates a capture process named `real_time_capture` at the downstream database `db2.example.com`. A capture process with the same name must not exist.
- Associates the capture process with an existing **queue** on `db2.example.com` named `streams_queue`.
- Specifies that the source database of the changes that the capture process will capture is `db1.example.com`.
- Specifies that the capture process uses a database link with the same name as the source database global name to perform administrative actions at the source database.
- Specifies that the capture process accepts redo data implicitly from `db1.example.com`. Therefore, the capture process scans the standby redo log at `db2.example.com` for changes that it must capture. If the capture process falls behind, then it scans the archived redo log files written from the standby redo log.

This step does not associate the capture process `real_time_capture` with any **rule set**. A rule set will be created and associated with the capture process in a later step.

If no other capture process at `db2.example.com` is capturing changes from the `db1.example.com` source database, then the `DBMS_CAPTURE_ADM.BUILD` procedure is run automatically at `db1.example.com` using the database link. Running this procedure extracts the data dictionary at `db1.example.com` to the redo log, and a **LogMiner data dictionary** for `db1.example.com` is created at

`dbms2.example.com` when the capture process `real_time_capture` is started for the first time at `dbms2.example.com`.

If multiple capture processes at `dbms2.example.com` are capturing changes from the `dbms1.example.com` source database, then the new capture process `real_time_capture` uses the same LogMiner data dictionary for `dbms1.example.com` as one of the existing archived-log capture process. Oracle Streams automatically chooses which LogMiner data dictionary to share with the new capture process.

Note:

- Only one real-time downstream capture process is allowed at a single downstream database.
 - During the creation of a downstream capture process, if the `first_scn` parameter is set to `NULL` in the `CREATE_CAPTURE` procedure, then the `use_database_link` parameter must be set to `TRUE`. Otherwise, an error is raised.
-
-

See Also: ["SCN Values Related to a Capture Process"](#) on page 2-20

4. Set the `downstream_real_time_mine` capture process parameter to `Y`:

```
BEGIN
  DBMS_CAPTURE_ADM.SET_PARAMETER(
    capture_name => 'real_time_capture',
    parameter    => 'downstream_real_time_mine',
    value        => 'Y');
END;
/
```

5. Create the **positive rule set** for the capture process and add a **rule** to it:

```
BEGIN
  DBMS_STREAMS_ADM.ADD_TABLE_RULES(
    table_name      => 'hr.departments',
    streams_type    => 'capture',
    streams_name    => 'real_time_capture',
    queue_name      => 'strmadmin.streams_queue',
    include_dml     => TRUE,
    include_ddl     => FALSE,
    include_tagged_lcr => FALSE,
    source_database => 'dbms1.example.com',
    inclusion_rule  => TRUE);
END;
/
```

Running this procedure performs the following actions:

- Creates a rule set at `dbms2.example.com` for capture process `real_time_capture`. The rule set has a system-generated name. The rule set is the positive rule set for the capture process because the `inclusion_rule` parameter is set to `TRUE`.
- Creates a rule that captures DML changes to the `hr.departments` table, and adds the rule to the positive rule set for the capture process. The rule has a system-generated name. The rule is added to the positive rule set for the capture process because the `inclusion_rule` parameter is set to `TRUE`.

- Prepares the `hr.departments` table at `db1.example.com` for **instantiation** using the database link created in Step 2.
 - Enables **supplemental logging** for any primary key, unique key, bitmap index, and foreign key columns in the table.
6. Connect to the source database `db1.example.com` as an administrative user with the necessary privileges to switch log files.
 7. Archive the current log file at the source database:

```
ALTER SYSTEM ARCHIVE LOG CURRENT;
```

Archiving the current log file at the source database starts real time mining of the source database redo log.
 8. If necessary, complete the steps described in "[After Configuring a Capture Process](#)" on page 10-22.

Configuring an Archived-Log Downstream Capture Process

This section describes configuring an archived-log downstream capture process that either assigns log files implicitly or explicitly.

This section contains these topics:

- [Configuring an Archived-Log Downstream Capture Process that Assigns Logs Implicitly](#)
- [Configuring an Archived-Log Downstream Capture Process that Assigns Logs Explicitly](#)

Configuring an Archived-Log Downstream Capture Process that Assigns Logs Implicitly To create a capture process that performs downstream capture, you must use the `CREATE_CAPTURE` procedure. The example in this section describes creating an **archived-log downstream capture process** that uses a database link to the **source database** for administrative purposes.

This example assumes the following:

- The source database is `db1.example.com` and the **downstream database** is `db2.example.com`.
- The capture process that will be created at `db2.example.com` uses the `streams_queue` owned by `strmadmin`.
- The capture process will capture DML changes made to the `hr.departments` table at `db1.example.com`.
- The capture process assigns log files implicitly. That is, the downstream capture process automatically scans all redo log files added by redo transport services or manually from the source database to the downstream database.

Complete the following steps:

1. Complete the steps in "[Preparing to Transmit Redo Data to a Downstream Database](#)" on page 10-7.
2. In SQL*Plus, connect to the downstream database `db2.example.com` as the Oracle Streams administrator.

See *Oracle Database Administrator's Guide* for information about connecting to a database in SQL*Plus.

3. Create the database link from `db2.example.com` to `db1.example.com`. For example, if the user `strmadmin` is the Oracle Streams administrator on both databases, then create the following database link:

```
CREATE DATABASE LINK db1.example.com CONNECT TO strmadmin
  IDENTIFIED BY password
  USING 'db1.example.com';
```

This example assumes that an Oracle Streams administrator exists at the source database `db1.example.com`. If no Oracle Streams administrator exists at the source database, then the Oracle Streams administrator at the downstream database should connect to a user who allows remote access by an Oracle Streams administrator. You can enable remote access for a user by specifying the user as the grantee when you run the `GRANT_REMOTE_ADMIN_ACCESS` procedure in the `DBMS_STREAMS_AUTH` package at the source database.

4. Run the `CREATE_CAPTURE` procedure to create the capture process:

```
BEGIN
  DBMS_CAPTURE_ADM.CREATE_CAPTURE(
    queue_name      => 'strmadmin.streams_queue',
    capture_name    => 'strm04_capture',
    rule_set_name   => NULL,
    start_scn       => NULL,
    source_database => 'db1.example.com',
    use_database_link => TRUE,
    first_scn       => NULL,
    logfile_assignment => 'implicit');
END;
/
```

Running this procedure performs the following actions:

- Creates a capture process named `strm04_capture` at the downstream database `db2.example.com`. A capture process with the same name must not exist.
- Associates the capture process with an existing **queue** on `db2.example.com` named `streams_queue`.
- Specifies that the source database of the changes that the capture process will capture is `db1.example.com`.
- Specifies that the capture process accepts new redo log files implicitly from `db1.example.com`. Therefore, the capture process scans any new log files copied from `db1.example.com` to `db2.example.com` for changes that it must capture.

This step does not associate the capture process `strm04_capture` with any **rule set**. A rule set will be created and associated with the capture process in the next step.

If no other capture process at `db2.example.com` is capturing changes from the `db1.example.com` source database, then the `DBMS_CAPTURE_ADM.BUILD` procedure is run automatically at `db1.example.com` using the database link. Running this procedure extracts the data dictionary at `db1.example.com` to the redo log, and a **LogMiner data dictionary** for `db1.example.com` is created at `db2.example.com` when the capture process is started for the first time at `db2.example.com`.

If multiple capture processes at `db2.example.com` are capturing changes from the `db1.example.com` source database, then the new capture process uses the

same LogMiner data dictionary for `db1.example.com` as one of the existing capture process. Oracle Streams automatically chooses which LogMiner data dictionary to share with the new capture process.

Note: During the creation of a downstream capture process, if the `first_scn` parameter is set to `NULL` in the `CREATE_CAPTURE` procedure, then the `use_database_link` parameter must be set to `TRUE`. Otherwise, an error is raised.

See Also:

- ["Capture Process Creation"](#) on page 2-29
- *Oracle Database SQL Language Reference* for more information about the `ALTER DATABASE` statement
- *Oracle Data Guard Concepts and Administration* for more information registering redo log files

5. Create the **positive rule set** for the capture process and add a **rule** to it:

```
BEGIN
  DBMS_STREAMS_ADM.ADD_TABLE_RULES(
    table_name      => 'hr.departments',
    streams_type    => 'capture',
    streams_name    => 'strm04_capture',
    queue_name      => 'strmadmin.streams_queue',
    include_dml     => TRUE,
    include_ddl     => FALSE,
    include_tagged_lcr => FALSE,
    source_database => 'db1.example.com',
    inclusion_rule  => TRUE);
END;
/
```

Running this procedure performs the following actions:

- Creates a rule set at `db2.example.com` for capture process `strm04_capture`. The rule set has a system-generated name. The rule set is a positive rule set for the capture process because the `inclusion_rule` parameter is set to `TRUE`.
 - Creates a rule that captures DML changes to the `hr.departments` table, and adds the rule to the rule set for the capture process. The rule has a system-generated name. The rule is added to the positive rule set for the capture process because the `inclusion_rule` parameter is set to `TRUE`.
6. If necessary, complete the steps described in ["After Configuring a Capture Process"](#) on page 10-22.

Configuring an Archived-Log Downstream Capture Process that Assigns Logs Explicitly To create a capture process that performs downstream capture, you must use the `CREATE_CAPTURE` procedure. This section describes creating an **archived-log downstream capture process** that assigns redo log files explicitly. That is, you must use the `DBMS_FILE_TRANSFER` package, FTP, or some other method to transfer redo log files from the **source database** to the **downstream database**, and then you must register these redo log files with the downstream capture process manually.

In this example, assume the following:

- The source database is `db1.example.com` and the downstream database is `db2.example.com`.
- The capture process that will be created at `db2.example.com` uses the `streams_queue`.
- The capture process will capture DML changes to the `hr.departments` table.
- The capture process does not use a database link to the source database for administrative actions.
- The archived redo log files will not be transferred to the downstream capture database automatically by redo transport services. Instead, each file will be transferred manually.

Complete the following steps:

1. In SQL*Plus, connect to the source database `db1.example.com` as the Oracle Streams administrator.

If you do not use a database link from the downstream database to the source database, then an Oracle Streams administrator must exist at the source database.

See *Oracle Database Administrator's Guide* for information about connecting to a database in SQL*Plus.

2. If there is no capture process at `db2.example.com` that captures changes from `db1.example.com`, then perform a build of the `db1.example.com` data dictionary in the redo log. This step is optional if a capture process at `db2.example.com` is already configured to capture changes from the `db1.example.com` source database.

```
SET SERVEROUTPUT ON
DECLARE
    scn NUMBER;
BEGIN
    DBMS_CAPTURE_ADM.BUILD(
        first_scn => scn);
    DBMS_OUTPUT.PUT_LINE('First SCN Value = ' || scn);
END;
/
First SCN Value = 409391
```

This procedure displays the valid **first SCN** value for the capture process that will be created at `db2.example.com`. Make a note of the SCN value returned because you will use it when you create the capture process at `db2.example.com`.

If you run this procedure to build the data dictionary in the redo log, then when the capture process is first started at `db2.example.com`, it will create a **LogMiner data dictionary** using the data dictionary information in the redo log.

3. Prepare the `hr.departments` table for **instantiation**:

```
BEGIN
    DBMS_CAPTURE_ADM.PREPARE_TABLE_INSTANTIATION(
        table_name          => 'hr.departments',
        supplemental_logging => 'keys');
END;
/
```

Primary key **supplemental logging** is required for the `hr.departments` table because this example creates a capture processes that captures changes to this

table. Specifying keys for the `supplemental_logging` parameter in the `PREPARE_TABLE_INSTANTIATION` procedure enables supplemental logging for any primary key, unique key, bitmap index, and foreign key columns in the table.

4. Determine the current SCN of the source database:

```
SET SERVEROUTPUT ON SIZE 1000000

DECLARE
    iscn NUMBER;          -- Variable to hold instantiation SCN value
BEGIN
    iscn := DBMS_FLASHBACK.GET_SYSTEM_CHANGE_NUMBER();
    DBMS_OUTPUT.PUT_LINE('Current SCN: ' || iscn);
END;
/
```

You can use the returned SCN as the **instantiation SCN** for **destination databases** that will apply changes to the `hr.departments` table that were captured by the capture process being created. In this example, assume the returned SCN is 1001656.

5. Connect to the downstream database `dbs2.example.com` as the Oracle Streams administrator.
6. Run the `CREATE_CAPTURE` procedure to create the capture process and specify the value obtained in Step 2 for the `first_scn` parameter:

```
BEGIN
    DBMS_CAPTURE_ADM.CREATE_CAPTURE(
        queue_name      => 'strmadmin.streams_queue',
        capture_name    => 'strm05_capture',
        rule_set_name   => NULL,
        start_scn       => NULL,
        source_database => 'dbs1.example.com',
        use_database_link => FALSE,
        first_scn       => 409391, -- Use value from Step 2
        logfile_assignment => 'explicit');
END;
/
```

Running this procedure performs the following actions:

- Creates a capture process named `strm05_capture` at the downstream database `dbs2.example.com`. A capture process with the same name must not exist.
- Associates the capture process with an existing **queue** on `dbs2.example.com` named `streams_queue`.
- Specifies that the source database of the changes that the capture process will capture is `dbs1.example.com`.
- Specifies that the first SCN for the capture process is 409391. This value was obtained in Step 2. The first SCN is the lowest SCN for which a capture process can capture changes. Because a first SCN is specified, the capture process creates a new LogMiner data dictionary when it is first started, regardless of whether there are existing LogMiner data dictionaries for the same source database.

- Specifies new redo log files from `db1.example.com` must be assigned to the capture process explicitly. After a redo log file has been transferred to the computer running the downstream database, you assign the log file to the capture process explicitly using the following DDL statement:

```
ALTER DATABASE REGISTER LOGICAL LOGFILE file_name FOR capture_process;
```

Here, *file_name* is the name of the redo log file and *capture_process* is the name of the capture process that will use the redo log file at the downstream database. You must add redo log files manually if the `logfile_assignment` parameter is set to `explicit`.

This step does not associate the capture process `strm05_capture` with any **rule set**. A rule set will be created and associated with the capture process in the next step.

See Also:

- ["Capture Process Creation"](#) on page 2-29
- ["SCN Values Related to a Capture Process"](#) on page 2-20
- *Oracle Database SQL Language Reference* for more information about the `ALTER DATABASE` statement
- *Oracle Data Guard Concepts and Administration* for more information registering redo log files

7. Create the **positive rule set** for the capture process and add a **rule** to it:

```
BEGIN
  DBMS_STREAMS_ADM.ADD_TABLE_RULES(
    table_name      => 'hr.departments',
    streams_type    => 'capture',
    streams_name    => 'strm05_capture',
    queue_name      => 'strmadmin.streams_queue',
    include_dml     => TRUE,
    include_ddl     => FALSE,
    include_tagged_lcr => FALSE,
    source_database => 'db1.example.com',
    inclusion_rule  => TRUE);
END;
/
```

Running this procedure performs the following actions:

- Creates a rule set at `db2.example.com` for capture process `strm05_capture`. The rule set has a system-generated name. The rule set is a positive rule set for the capture process because the `inclusion_rule` parameter is set to `TRUE`.
 - Creates a rule that captures DML changes to the `hr.departments` table, and adds the rule to the rule set for the capture process. The rule has a system-generated name. The rule is added to the positive rule set for the capture process because the `inclusion_rule` parameter is set to `TRUE`.
8. After the redo log file at the source database `db1.example.com` that contains the first SCN for the downstream capture process is archived, transfer the archived redo log file to the computer running the downstream database. The `BUILD` procedure in Step 2 determined the first SCN for the downstream capture process. If the redo log file is not yet archived, you can run the `ALTER SYSTEM SWITCH LOGFILE` statement on the database to archive it.

You can run the following query at `db1.example.com` to identify the archived redo log file that contains the first SCN for the downstream capture process:

```
COLUMN NAME HEADING 'Archived Redo Log|File Name' FORMAT A50
COLUMN FIRST_CHANGE# HEADING 'First SCN' FORMAT 999999999

SELECT NAME, FIRST_CHANGE# FROM V$ARCHIVED_LOG
       WHERE FIRST_CHANGE# IS NOT NULL AND DICTIONARY_BEGIN = 'YES';
```

Transfer the archived redo log file with a `FIRST_CHANGE#` that matches the first SCN returned in Step 2 to the computer running the downstream capture process.

9. Connect to the downstream database `db2.example.com` as an administrative user.
10. Assign the transferred redo log file to the capture process. For example, if the redo log file is `/oracle/logs_from_db1/1_10_486574859.dbf`, then issue the following statement:

```
ALTER DATABASE REGISTER LOGICAL LOGFILE
       '/oracle/logs_from_db1/1_10_486574859.dbf' FOR 'strm05_capture';
```

11. If necessary, complete the steps described in ["After Configuring a Capture Process"](#) on page 10-22.

After Configuring a Capture Process

If you plan to configure propagations and apply processes that process logical change records (LCRs) captured by the new capture process, then perform the configuration in the following order:

1. Create the queues that will be required by propagations and apply processes. See ["Configuring Queues"](#) on page 11-1.
2. Create all of the propagations that will propagate LCRs captured by the new capture process. See ["Creating Oracle Streams Propagations Between ANYDATA Queues"](#) on page 11-3.
3. Create all of the apply processes that will dequeue LCRs captured by the new capture process. See ["Overview of Apply Process Creation"](#) on page 12-1. Configure each apply process to apply **captured LCRs**.
4. Instantiate the tables for which the new capture process captures changes at all destination databases. See the *Oracle Streams Replication Administrator's Guide* for detailed information about instantiation.
5. Start the apply processes that will process LCRs captured by the new capture process. See ["Starting an Apply Process"](#) on page 16-2.
6. Start the new capture process. See ["Starting a Capture Process"](#) on page 14-2.

Note: Other configuration steps might be required for your Oracle Streams environment. For example, some Oracle Streams environments include transformations, apply handlers, and conflict resolution.

Configuring Synchronous Capture

You can use any of the following procedures to create a **synchronous capture**:

- `DBMS_STREAMS_ADM.ADD_TABLE_RULES`
- `DBMS_STREAMS_ADM.ADD_SUBSET_RULES`
- `DBMS_CAPTURE_ADM.CREATE_SYNC_CAPTURE`

Both of the procedures in the `DBMS_STREAMS_ADM` package create a synchronous capture with the specified name if it does not already exist, create a **positive rule set** for the synchronous capture if it does not exist, and can add **table rules** or **subset rules** to the rule set.

The `CREATE_SYNC_CAPTURE` procedure creates a synchronous capture, but does not create a rule set or rules for the synchronous capture. However, the `CREATE_SYNC_CAPTURE` procedure enables you to specify an existing rule set to associate with the synchronous capture, and it enables you to specify a **capture user** other than the default capture user.

The following sections describe configuring a synchronous capture:

- [Preparing to Configure a Synchronous Capture](#)
- [Configuring a Synchronous Capture Using the `DBMS_STREAMS_ADM` Package](#)
- [Configuring a Synchronous Capture Using the `DBMS_CAPTURE_ADM` Package](#)
- [After Configuring a Synchronous Capture](#)

Note:

- To create a synchronous capture, a user must be granted DBA role.
 - If Oracle Database Vault is installed, then the user who creates the synchronous capture must be granted the `BECOME USER` system privilege. Granting this privilege to the user is not required if Oracle Database Vault is not installed. You can revoke the `BECOME USER` system privilege from the user after the synchronous capture is created, if necessary.
-
-

See Also:

- ["Implicit Capture with Synchronous Capture"](#) on page 2-38
- ["Managing a Synchronous Capture"](#) on page 14-11
- ["Monitoring a Synchronous Capture"](#) on page 23-15
- *Oracle Database 2 Day + Data Replication and Integration Guide* for an example that configures a replication environment that uses synchronous capture

Preparing to Configure a Synchronous Capture

The following tasks must be completed before you configure a synchronous capture:

- Ensure that the initialization parameters are set properly on any database that will use synchronous capture. See ["Setting Initialization Parameters Relevant to Oracle Streams"](#) on page 9-4.

- Create an Oracle Streams administrator on each database involved in the Oracle Streams configuration. See ["Configuring an Oracle Streams Administrator"](#) on page 9-1. The examples in this chapter assume that the Oracle Streams administrator is `strmadmin`.
- Create an ANYDATA queue to associate with the synchronous capture, if one does not exist. See ["Creating an ANYDATA Queue"](#) on page 11-1 for instructions. The queue must be a **commit-time queue**. The examples in this chapter assume that the **queue** used by synchronous capture is `strmadmin.streams_queue`. Create the queue in the same database that will run the synchronous capture.
- Create all of the propagations that will propagate LCRs captured by the new synchronous capture. See ["Creating Oracle Streams Propagations Between ANYDATA Queues"](#) on page 11-3.
- Create all of the apply processes that will dequeue LCRs captured by the new synchronous capture. See ["Overview of Apply Process Creation"](#) on page 12-1. Configure each apply process to apply **persistent LCRs** by setting the `apply_captured` parameter to `FALSE` in the `DBMS_APPLY_ADM.CREATE_APPLY` procedure. Do not start the apply process until after the instantiation performed in ["After Configuring a Synchronous Capture"](#) on page 10-27 is complete.

Configuring a Synchronous Capture Using the DBMS_STREAMS_ADM Package

When you run the `ADD_TABLE_RULES` or `ADD_SUBSET_RULES` procedure to create a synchronous capture, set the `streams_type` parameter in these procedures to `sync_capture`. A rule created by the `ADD_TABLE_RULES` procedure instructs the synchronous capture to capture all DML changes to the table. A rule created by the `ADD_SUBSET_RULES` procedure instructs the synchronous capture to capture a subset of the DML changes to the table.

This example assumes the following:

- The source database is `db1.example.com`.
- The synchronous capture that will be created uses the `strmadmin.streams_queue`.
- The synchronous capture that will be created captures the results of DML changes made to the `hr.departments` table.
- The **capture user** for the synchronous capture that will be created is the Oracle Streams administrator `strmadmin`.

Complete the following steps to create a synchronous capture using the `DBMS_STREAMS_ADM` package:

1. Complete the tasks in ["Preparing to Configure a Synchronous Capture"](#) on page 10-23.
2. In SQL*Plus, connect to the `db1.example.com` database as the Oracle Streams administrator.

See *Oracle Database Administrator's Guide* for information about connecting to a database in SQL*Plus.

3. Run the `ADD_TABLE_RULES` or `ADD_SUBSET_RULES` procedure to create a synchronous capture. For example:

```
BEGIN
  DBMS_STREAMS_ADM.ADD_TABLE_RULES(
    table_name => 'hr.departments',
    streams_type => 'sync_capture',
```

```

streams_name => 'sync_capture',
queue_name   => 'strmadmin.streams_queue');
END;
/

```

This procedure performs the following actions:

- Creates a synchronous capture named `sync_capture` at the source database.
 - Enables the synchronous capture. A synchronous capture cannot be disabled.
 - Associates the synchronous capture with the existing `strmadmin.streams_queue` **queue**.
 - Creates a positive rule set for the synchronous capture. The rule set has a system-generated name.
 - Creates a rule that captures DML changes to the `hr.departments` table, and adds the rule to the positive rule set for the synchronous capture. The rule has a system-generated name.
 - Configure the user who runs the procedure as the **capture user** for the synchronous capture.
 - Prepares the specified table for instantiation by running the `DBMS_CAPTURE_ADM.PREPARE_SYNC_INSTANTIATION` function for the table automatically.
4. If necessary, complete the steps described in "[After Configuring a Synchronous Capture](#)" on page 10-27.

Note: When the `ADD_TABLE_RULES` or the `ADD_SUBSET_RULES` procedure adds rules to a synchronous capture rule set, the procedure must obtain an exclusive lock on the specified table. If there are outstanding transactions on the specified table, then the procedure waits until it can obtain a lock.

Configuring a Synchronous Capture Using the `DBMS_CAPTURE_ADM` Package

This section contains an example that runs procedures in the `DBMS_CAPTURE_ADM` package and `DBMS_STREAMS_ADM` package to configure a synchronous capture.

This example assumes the following:

- The source database is `dbs1.example.com`.
- The synchronous capture that will be created uses the `strmadmin.streams_queue`.
- The synchronous capture that will be created uses an existing rule set named `sync01_rule_set` in the `strmadmin` schema. See "[Creating a Rule Set](#)" on page 17-2.
- The synchronous capture that will be created captures the results of a subset of the DML changes made to the `hr.departments` table.
- The **capture user** for the synchronous capture that will be created is `hr`. The `hr` user must have privileges to enqueue into the `streams_queue`.

Complete the following steps to create a synchronous capture using the `DBMS_CAPTURE_ADM` package:

1. Complete the tasks in "[Preparing to Configure a Synchronous Capture](#)" on page 10-23.

2. In SQL*Plus, connect to the `db1.example.com` database as the Oracle Streams administrator.

See *Oracle Database Administrator's Guide* for information about connecting to a database in SQL*Plus.

3. Run the `CREATE_SYNC_CAPTURE` procedure to create a synchronous capture. For example:

```
BEGIN
  DBMS_CAPTURE_ADM.CREATE_SYNC_CAPTURE(
    queue_name    => 'strmadmin.streams_queue',
    capture_name  => 'sync01_capture',
    rule_set_name => 'strmadmin.sync01_rule_set',
    capture_user  => 'hr');
END;
/
```

Running this procedure performs the following actions:

- Creates a synchronous capture named `sync01_capture`. A synchronous capture with the same name must not exist.
 - Enables the synchronous capture. A synchronous capture cannot be disabled.
 - Associates the synchronous capture with an existing **queue** named `streams_queue`.
 - Associates the synchronous capture with an existing **rule set** named `sync01_rule_set` in the `strmadmin` schema.
 - Configures `hr` as the capture user for the synchronous capture.
4. Run the `ADD_TABLE_RULES` or `ADD_SUBSET_RULES` procedure to add a rule to the synchronous capture rule set. For example, run the `ADD_SUBSET_RULES` procedure to instruct the synchronous capture to capture a subset of the DML changes to the `hr.departments` table:

```
BEGIN
  DBMS_STREAMS_ADM.ADD_SUBSET_RULES(
    table_name      => 'hr.departments',
    dml_condition   => 'department_id=1700',
    streams_type    => 'sync_capture',
    streams_name    => 'sync01_capture',
    queue_name      => 'streams_queue',
    include_tagged_lcr => FALSE);
END;
/
```

Running this procedure performs the following actions:

- Adds subset rules to the rule set for the synchronous capture named `sync01_capture` at the source database `db1.example.com`. The subset rules instruct the synchronous capture to capture changes to rows with `department_id` equal to 1700. The synchronous capture does not capture changes to other rows in the table.
- Prepares the `hr.departments` table for instantiation by running the `DBMS_CAPTURE_ADM.PREPARE_SYNC_INSTANTIATION` function for the table automatically.

- Specifies that the synchronous capture captures a change only if the session that makes the change has a NULL **tag**, because the `include_tagged_lcr` parameter is set to `FALSE`. This behavior is accomplished through the **system-created rules** for the synchronous capture.
5. If necessary, complete the steps described in "[After Configuring a Synchronous Capture](#)" on page 10-27.

Note: When the `CREATE_SYNC_CAPTURE` procedure creates a synchronous capture, the procedure must obtain an exclusive lock on each table for which it will capture changes. The rules in the specified rule set for the synchronous capture determine these tables. Similarly, when the `ADD_TABLE_RULES` or the `ADD_SUBSET_RULES` procedure adds rules to a synchronous capture rule set, the procedure must obtain an exclusive lock on the specified table. In these cases, if there are outstanding transactions on a table for which the synchronous capture will capture changes, then the procedure waits until it can obtain a lock.

After Configuring a Synchronous Capture

If you configured propagations and apply processes that process LCRs captured by the new synchronous capture, then complete the following steps:

1. Instantiate the tables for which the new synchronous capture captures changes at all destination databases. See the *Oracle Streams Replication Administrator's Guide* for detailed information about instantiation.
2. Start the apply processes that will process LCRs captured by the synchronous capture. See "[Starting an Apply Process](#)" on page 16-2.

Note: Other configuration steps might be required for your Oracle Streams environment. For example, some Oracle Streams environments include transformations, apply handlers, and conflict resolution.

Configuring Queues and Propagations

The following topics describe configuring [queues](#), [propagations](#), and messaging environments:

- [Configuring Queues](#)
- [Creating Oracle Streams Propagations Between ANYDATA Queues](#)

Each task described in this chapter should be completed by an Oracle Streams administrator that has been granted the appropriate privileges, unless specified otherwise.

See Also:

- [Chapter 3, "Oracle Streams Staging and Propagation"](#)
- ["Configuring an Oracle Streams Administrator"](#) on page 9-1
- ["Monitoring Queues and Messaging"](#) on page 24-1
- ["Monitoring Oracle Streams Propagations and Propagation Jobs"](#) on page 24-13
- ["Troubleshooting Propagation Problems"](#) on page 20-11

Configuring Queues

A [queue](#) stores [message](#)s in an Oracle Streams environment. Messages can be enqueued, propagated from one queue to another, and dequeued.

This section contains instructions for completing the following tasks related to queues:

- [Creating an ANYDATA Queue](#)

Note: You can configure an entire Oracle Streams environment, including queues, using procedures in the `DBMS_STREAMS_ADM` package or Oracle Enterprise Manager

Creating an ANYDATA Queue

An ANYDATA queue stores [messages](#) whose payloads are of ANYDATA type. Therefore, an ANYDATA queue can store a message with a payload of nearly any type, if the payload is wrapped in an ANYDATA wrapper. Each Oracle Streams [capture process](#), [apply process](#), and [messaging client](#) is associated with one ANYDATA queue, and each Oracle Streams [propagation](#) is associated with one ANYDATA [source queue](#) and one ANYDATA [destination queue](#).

The easiest way to create an ANYDATA queue is to use the `SET_UP_QUEUE` procedure in the `DBMS_STREAMS_ADM` package. This procedure enables you to specify the following settings for the ANYDATA queue it creates:

- The **queue table** for the **queue**
- A storage clause for the queue table
- The queue name
- A queue user that will be configured as a **secure queue** user of the queue and granted `ENQUEUE` and `DEQUEUE` privileges on the queue
- A comment for the queue

If the specified queue table does not exist, then it is created. If the specified queue table exists, then the existing queue table is used for the new queue. If you do not specify any queue table when you create the queue, then, by default, `streams_queue_table` is specified.

You can use a single procedure, the `SET_UP_QUEUE` procedure in the `DBMS_STREAMS_ADM` package, to create an ANYDATA queue and the queue table used by the queue. For `SET_UP_QUEUE` to create a new queue table, the specified queue table must not exist.

For example, run the following procedure to create an ANYDATA queue with the `SET_UP_QUEUE` procedure:

```
BEGIN
  DBMS_STREAMS_ADM.SET_UP_QUEUE(
    queue_table => 'strmadmin.streams_queue_table',
    queue_name  => 'strmadmin.streams_queue',
    queue_user  => 'hr');
END;
/
```

Running this procedure performs the following actions:

- Creates a queue table named `streams_queue_table`. The queue table is created only if it does not already exist. Queues based on the queue table store messages of ANYDATA type. Queue table names can be a maximum of 24 bytes.
- Creates a queue named `streams_queue`. The queue is created only if it does not already exist. Queue names can be a maximum of 24 bytes.
- Specifies that the `streams_queue` queue is based on the `strmadmin.streams_queue_table` queue table.
- Configures the `hr` user as a secure queue user of the queue, and grants this user `ENQUEUE` and `DEQUEUE` privileges on the queue.
- Starts the queue.

Default settings are used for the parameters that are not explicitly set in the `SET_UP_QUEUE` procedure.

When the `SET_UP_QUEUE` procedure creates a queue table, the following `DBMS_AQADM.CREATE_QUEUE_TABLE` parameter settings are specified:

- If the database is Oracle Database 10g Release 2 or later, the `sort_list` setting is `commit_time`. If the database is a release prior to Oracle Database 10g Release 2, the `sort_list` setting is `enq_time`.
- The `multiple_consumers` setting is `TRUE`.

- The `message_grouping` setting is transactional.
- The `secure` setting is `TRUE`.

The other parameters in the `CREATE_QUEUE_TABLE` procedure are set to their default values.

You can use the `CREATE_QUEUE_TABLE` procedure in the `DBMS_AQADM` package to create a queue table of `ANYDATA` type with different properties than the default properties specified by the `SET_UP_QUEUE` procedure in the `DBMS_STREAMS_ADM` package. After you create the queue table with the `CREATE_QUEUE_TABLE` procedure, you can create a queue that uses the queue table. To do so, specify the queue table in the `queue_table` parameter of the `SET_UP_QUEUE` procedure.

Similarly, you can use the `CREATE_QUEUE` procedure in the `DBMS_AQADM` package to create a queue instead of `SET_UP_QUEUE`. Use `CREATE_QUEUE` if you require custom settings for the queue. For example, use `CREATE_QUEUE` to specify a custom retry delay or retention time. If you use `CREATE_QUEUE`, then you must start the queue manually.

Note: A message cannot be enqueued unless a subscriber who can dequeue the message is configured.

See Also:

- ["Wrapping User Message Payloads in an ANYDATA Wrapper and Enqueuing Them"](#) on page 13-2 for an example that creates an `ANYDATA` queue using procedures in the `DBMS_AQADM` package
- ["ANYDATA Queues and Typed Queues"](#) on page 3-2
- ["Commit-Time Queues"](#) on page 3-8
- ["Secure Queues"](#) on page 3-5
- *Oracle Database PL/SQL Packages and Types Reference* for more information about the `SET_UP_QUEUE`, `CREATE_QUEUE_TABLE`, and `CREATE_QUEUE` procedures

Creating Oracle Streams Propagations Between ANYDATA Queues

A **propagation** sends **messages** from an Oracle Streams **source queue** to an Oracle Streams **destination queue**. In addition, you can use the features of Oracle Streams Advanced Queuing (AQ) to manage Oracle Streams propagations.

You can use any of the following procedures to create a **propagation** between two `ANYDATA` queues:

- `DBMS_STREAMS_ADM.ADD_SUBSET_PROPAGATION_RULES`
- `DBMS_STREAMS_ADM.ADD_TABLE_PROPAGATION_RULES`
- `DBMS_STREAMS_ADM.ADD_SCHEMA_PROPAGATION_RULES`
- `DBMS_STREAMS_ADM.ADD_GLOBAL_PROPAGATION_RULES`
- `DBMS_PROPAGATION_ADM.CREATE_PROPAGATION`

Each of these procedures in the `DBMS_STREAMS_ADM` package creates a propagation with the specified name if it does not already exist, creates either a **positive rule set** or

negative rule set for the propagation if the propagation does not have such a **rule set**, and can add **table rules**, **schema rules**, or **global rules** to the rule set. The `CREATE_PROPAGATION` procedure creates a propagation, but does not create a rule set or **rules** for the propagation. However, the `CREATE_PROPAGATION` procedure enables you to specify an existing rule set to associate with the propagation, either as a positive or a negative rule set. All propagations are started automatically upon creation.

The following tasks must be completed before you create a propagation:

- Create a **source queue** and a **destination queue** for the propagation, if they do not exist. To complete the task, both queues must be **ANYDATA queues**.

See "Creating an ANYDATA Queue" on page 11-1 for instructions.

- Create a database link between the database containing the source queue and the database containing the destination queue.

See "Configuring an Oracle Streams Administrator" on page 9-1 for information.

This section contains the following topics:

- [Example of Configuring a Propagation Using DBMS_STREAMS_ADM](#)
- [Example of Configuring a Propagation Using DBMS_PROPAGATION_ADM](#)

Note: You can configure an entire Oracle Streams environment, including propagations, using procedures in the `DBMS_STREAMS_ADM` package or Oracle Enterprise Manager

See Also:

- ["Configuring Oracle Streams"](#) on page 9-13 for more information about configuring Oracle Streams
- ["Message Propagation Between Queues"](#) on page 3-11
- ["Monitoring Oracle Streams Propagations and Propagation Jobs"](#) on page 24-13
- *Oracle Streams Advanced Queuing User's Guide* for more information about configuring propagations with the features of Oracle Streams AQ and instructions about configuring propagations between **typed queues**

Example of Configuring a Propagation Using DBMS_STREAMS_ADM

The following example runs the `ADD_TABLE_PROPAGATION_RULES` procedure in the `DBMS_STREAMS_ADM` package to create a propagation:

```
BEGIN
  DBMS_STREAMS_ADM.ADD_TABLE_PROPAGATION_RULES (
    table_name           => 'hr.departments',
    streams_name         => 'strm01_propagation',
    source_queue_name    => 'strmadmin.strm_a_queue',
    destination_queue_name => 'strmadmin.strm_b_queue@dbs2.example.com',
    include_dml          => TRUE,
    include_ddl          => TRUE,
    include_tagged_lcr   => FALSE,
    source_database      => 'dbs1.example.com',
    inclusion_rule       => TRUE,
    queue_to_queue       => TRUE);
END;
```

/

Running this procedure performs the following actions:

- Creates a propagation named `strm01_propagation`. The propagation is created only if it does not already exist.
- Specifies that the propagation propagates LCRs from `strm_a_queue` in the current database to `strm_b_queue` in the `dbms2.example.com` database.
- Specifies that the propagation uses the `dbms2.example.com` database link to propagate the LCRs, because the `destination_queue_name` parameter contains `@dbms2.example.com`.
- Creates a positive rule set and associates it with the propagation because the `inclusion_rule` parameter is set to `TRUE`. The rule set uses the **evaluation context** `SYS.STREAMS$_EVALUATION_CONTEXT`. The rule set name is system generated.
- Creates two rules. One rule evaluates to `TRUE` for row LCRs that contain the results of DML changes to the `hr.departments` table. The other rule evaluates to `TRUE` for DDL LCRs that contain DDL changes to the `hr.departments` table. The rule names are system generated.
- Adds the two rules to the positive rule set associated with the propagation. The rules are added to the positive rule set because the `inclusion_rule` parameter is set to `TRUE`.
- Specifies that the propagation propagates an LCR only if it has a `NULL tag`, because the `include_tagged_lcr` parameter is set to `FALSE`. This behavior is accomplished through the **system-created rules** for the propagation.
- Specifies that the **source database** for the LCRs being propagated is `dbms1.example.com`, which might or might not be the current database. This propagation does not propagate LCRs in the source queue that have a different source database.
- Creates a **propagation job** for the queue-to-queue propagation.

Note: To use queue-to-queue propagation, the compatibility level must be `10.2.0` or higher for each database that contains a queue involved in the propagation.

See Also:

- ["Message Propagation Between Queues"](#) on page 3-11
- ["System-Created Rules"](#) on page 6-5
- ["Queue-to-Queue Propagations"](#) on page 3-13
- *Oracle Streams Replication Administrator's Guide* for more information about Oracle Streams tags

Example of Configuring a Propagation Using DBMS_PROPAGATION_ADM

The following example runs the `CREATE_PROPAGATION` procedure in the `DBMS_PROPAGATION_ADM` package to create a propagation:

```
BEGIN
  DBMS_PROPAGATION_ADM.CREATE_PROPAGATION(
    propagation_name => 'strm02_propagation',
    source_queue     => 'strmadmin.strm03_queue',
    destination_queue => 'strmadmin.strm04_queue',
    destination_dblink => 'dbs2.example.com',
    rule_set_name     => 'strmadmin.strm01_rule_set',
    queue_to_queue    => TRUE);
END;
/
```

Running this procedure performs the following actions:

- Creates a propagation named `strm02_propagation`. A propagation with the same name must not exist.
- Specifies that the propagation propagates **messages** from `strm03_queue` in the current database to `strm04_queue` in the `dbs2.example.com` database. Depending on the rules in the rule sets for the propagation, the propagated messages can be **LCRs** or **user messages**, or both.
- Specifies that the propagation uses the `dbs2.example.com` database link to propagate the messages.
- Associates the propagation with an existing rule set named `strm01_rule_set`. This rule set is the positive rule set for the propagation.
- Creates a **propagation job** for the queue-to-queue propagation.

Note: To use queue-to-queue propagation, the compatibility level must be `10.2.0` or higher for each database that contains a queue involved in the propagation.

See Also:

- ["Ways to Consume Information with Oracle Streams"](#) on page 4-1
- ["Message Propagation Between Queues"](#) on page 3-11
- ["Queue-to-Queue Propagations"](#) on page 3-13

Configuring Implicit Apply

An Oracle Streams **apply process** dequeues logical change records (LCRs) and **user messages** from a specific **queue** and either applies each one directly or passes it as a parameter to a user-defined procedure called an **apply handler**.

The following topics describe configuring implicit apply:

- [Overview of Apply Process Creation](#)
- [Creating an Apply Process Using the DBMS_STREAMS_ADM Package](#)
- [Creating an Apply Process Using the DBMS_APPLY_ADM Package](#)

Each task described in this chapter should be completed by an Oracle Streams administrator that has been granted the appropriate privileges, unless specified otherwise.

See Also:

- [Chapter 4, "Oracle Streams Information Consumption"](#)
- ["Configuring an Oracle Streams Administrator"](#) on page 9-1
- *Oracle Streams Replication Administrator's Guide* for more information about managing **DML handlers**, **DDL handlers**, and Oracle Streams tags for an apply process

Overview of Apply Process Creation

You can use any of the following procedures to create an **apply process**:

- `DBMS_STREAMS_ADM.ADD_TABLE_RULES`
- `DBMS_STREAMS_ADM.ADD_SUBSET_RULES`
- `DBMS_STREAMS_ADM.ADD_SCHEMA_RULES`
- `DBMS_STREAMS_ADM.ADD_GLOBAL_RULES`
- `DBMS_STREAMS_ADM.ADD_MESSAGE_RULE`
- `DBMS_APPLY_ADM.CREATE_APPLY`

Each of the procedures in the `DBMS_STREAMS_ADM` package creates an apply process with the specified name if it does not already exist, creates either a **positive rule set** or **negative rule set** for the apply process if the apply process does not have such a **rule set**, and can add **table rules**, **schema rules**, **global rules**, or a **message rule** to the rule set.

The `CREATE_APPLY` procedure in the `DBMS_APPLY_ADM` package creates an apply process, but does not create a rule set or **rules** for the apply process. However, the

CREATE_APPLY procedure enables you to specify an existing rule set to associate with the apply process, either as a positive or a negative rule set, and a number of other options, such as [apply handlers](#), an [apply user](#), an apply [tag](#), and whether to dequeue messages from a [buffered queue](#) or a [persistent queue](#).

A single apply process must either dequeue messages from a [buffered queue](#) or a [persistent queue](#). Therefore, if a single apply process applies [captured LCRs](#), then it cannot apply [persistent LCRs](#) or [persistent user messages](#). However, a single apply process can apply both persistent LCRs and persistent user messages.

The examples in this chapter create apply processes that apply captured LCRs, persistent LCRs, and persistent user messages. Before you create an apply process, create an ANYDATA queue to associate with the apply process, if one does not exist.

Note:

- You can configure an entire Oracle Streams environment, including apply processes, using procedures in the DBMS_STREAMS_ADM package or Oracle Enterprise Manager
 - Depending on the configuration of the apply process you create, [supplemental logging](#) might be required at the [source database](#) on columns in the tables for which an apply process applies changes.
 - To create an apply process, a user must be granted DBA role.
 - If Oracle Database Vault is installed, then the user who creates the apply process must be granted the BECOME USER system privilege. Granting this privilege to the user is not required if Oracle Database Vault is not installed. You can revoke the BECOME USER system privilege from the user after the apply process is created, if necessary.
-
-

See Also:

- ["Configuring Oracle Streams"](#) on page 9-13 for more information about configuring Oracle Streams with a MAINAIN_ procedure or with Enterprise Manager
- ["Creating an ANYDATA Queue"](#) on page 11-1
- ["Supplemental Logging in an Oracle Streams Environment"](#) on page 2-13 for information about supplemental logging
- *Oracle Streams Replication Administrator's Guide* for more information about specifying supplemental logging

Creating an Apply Process Using the DBMS_STREAMS_ADM Package

This section contains the following examples that create an apply process using the DBMS_STREAMS_ADM package:

- [Creating an Apply Process for Captured LCRs](#)
- [Creating an Apply Process for User Messages](#)

See Also:

- ["Apply Process Creation"](#) on page 4-19
- ["System-Created Rules"](#) on page 6-5
- *Oracle Streams Replication Administrator's Guide* for more information about Oracle Streams tags

Creating an Apply Process for Captured LCRs

The following example runs the `ADD_SCHEMA_RULES` procedure in the `DBMS_STREAMS_ADM` package to create an apply process that applies **captured LCRs**:

```
BEGIN
  DBMS_STREAMS_ADM.ADD_SCHEMA_RULES (
    schema_name      => 'hr',
    streams_type     => 'apply',
    streams_name     => 'strm01_apply',
    queue_name       => 'streams_queue',
    include_dml      => TRUE,
    include_ddl      => FALSE,
    include_tagged_lcr => FALSE,
    source_database  => 'dbs1.example.com',
    inclusion_rule    => TRUE);
END;
/
```

Running this procedure performs the following actions:

- Creates an apply process named `strm01_apply` that applies captured LCRs to the local database. The apply process is created only if it does not already exist.
- Associates the apply process with an existing **queue** named `streams_queue`.
- Creates a **positive rule set** and associates it with the apply process, if the apply process does not have a positive rule set, because the `inclusion_rule` parameter is set to `TRUE`. The rule set uses the `SYS.STREAMS$_EVALUATION_CONTEXT` **evaluation context**. The rule set name is system generated.
- Creates one **rule** that evaluates to `TRUE` for row LCRs that contain the results of DML changes to database objects in the `hr` schema. The rule name is system generated.
- Adds the rule to the positive rule set associated with the apply process because the `inclusion_rule` parameter is set to `TRUE`.
- Sets the `apply_tag` for the apply process to a value that is the hexadecimal equivalent of '00' (double zero). Redo entries generated by the apply process have a **tag** with this value.
- Specifies that the apply process applies a row LCR only if it has a `NULL` tag, because the `include_tagged_lcr` parameter is set to `FALSE`. This behavior is accomplished through the **system-created rule** for the apply process.
- Specifies that the LCRs applied by the apply process originate at the `dbs1.example.com` **source database**. The rules in the apply process rule sets determine which messages are dequeued by the apply process. If the apply process dequeues an LCR with a source database other than `dbs1.example.com`, then an error is raised.

Creating an Apply Process for User Messages

The following example runs the `ADD_MESSAGE_RULE` procedure in the `DBMS_STREAMS_ADM` package to create an apply process that dequeues and processes **user messages** in a **persistent queue**:

```
BEGIN
  DBMS_STREAMS_ADM.ADD_MESSAGE_RULE (
    message_type      => 'oe.order_typ',
    rule_condition    => ':msg.order_status = 1',
    streams_type      => 'apply',
    streams_name      => 'strm02_apply',
    queue_name        => 'strm02_queue',
    inclusion_rule    => TRUE);
END;
/
```

Running this procedure performs the following actions:

- Creates an apply process named `strm02_apply` that dequeues user messages of `oe.order_typ` type and sends them to the **message handler** for the apply process. The apply process is created only if it does not already exist.
- Associates the apply process with an existing queue named `strm02_queue`.
- Creates a positive rule set and associates it with the apply process, if the apply process does not have a positive rule set, because the `inclusion_rule` parameter is set to `TRUE`. The rule set name is system generated, and the rule set does not use an **evaluation context**.
- Creates one rule that evaluates to `TRUE` for user messages that satisfy the **rule condition**. The rule uses a system-created evaluation context for the message type. The rule name and the evaluation context name are system generated.
- Adds the rule to the positive rule set associated with the apply process because the `inclusion_rule` parameter is set to `TRUE`.
- Sets the `apply_tag` for the apply process to a value that is the hexadecimal equivalent of '00' (double zero). Redo entries generated by the apply process, including any redo entries generated by a message handler, have a tag with this value.

Note: You can use the `ALTER_APPLY` procedure in the `DBMS_APPLY_ADM` package to specify a message handler for an apply process.

See Also:

- ["Message Rule Example"](#) on page 6-30
- ["Evaluation Contexts for Message Rules"](#) on page 6-38

Creating an Apply Process Using the DBMS_APPLY_ADM Package

This section contains the following examples that create an apply process using the `DBMS_APPLY_ADM` package:

- [Creating an Apply Process for Captured LCRs with DBMS_APPLY_ADM](#)
- [Creating an Apply Process for Persistent LCRs with DBMS_APPLY_ADM](#)

- [Creating an Apply Process for Persistent User Messages with DBMS_APPLY_ADM](#)

See Also:

- ["Apply Process Creation"](#) on page 4-19
- ["Message Processing Options for an Apply Process"](#) on page 4-7 for more information about apply handlers
- *Oracle Streams Replication Administrator's Guide* for more information about Oracle Streams tags
- *Oracle Streams Replication Administrator's Guide* for information about configuring an apply process to apply messages to a non-Oracle database using the `apply_database_link` parameter

Creating an Apply Process for Captured LCRs with DBMS_APPLY_ADM

The following example runs the `CREATE_APPLY` procedure in the `DBMS_APPLY_ADM` package to create an apply process that applies **captured LCRs**:

```
BEGIN
  DBMS_APPLY_ADM.CREATE_APPLY(
    queue_name          => 'strm03_queue',
    apply_name          => 'strm03_apply',
    rule_set_name       => 'strmadmin.strm03_rule_set',
    message_handler     => NULL,
    ddl_handler         => 'strmadmin.history_ddl',
    apply_user          => 'hr',
    apply_database_link => NULL,
    apply_tag           => HEXTORAW('5'),
    apply_captured      => TRUE,
    precommit_handler  => NULL,
    negative_rule_set_name => NULL,
    source_database     => 'dbs1.example.com');
END;
/
```

Running this procedure performs the following actions:

- Creates an apply process named `strm03_apply`. An apply process with the same name must not exist.
- Associates the apply process with an existing **queue** named `strm03_queue`.
- Associates the apply process with an existing **rule set** named `strm03_rule_set`. This rule set is the **positive rule set** for the apply process.
- Specifies that the apply process does not use a **message handler**.
- Specifies that the **DDL handler** is the `history_ddl` PL/SQL procedure in the `strmadmin` schema. The user who runs the `CREATE_APPLY` procedure must have `EXECUTE` privilege on the `history_ddl` PL/SQL procedure. An example in the *Oracle Streams Replication Administrator's Guide* creates this procedure.
- Specifies that the user who applies the changes is `hr`, and not the user who is running the `CREATE_APPLY` procedure (the Oracle Streams administrator).
- Specifies that the apply process applies changes to the local database because the `apply_database_link` parameter is set to `NULL`.

- Specifies that each redo entry generated by the apply process has a **tag** that is the hexadecimal equivalent of '5'.
- Specifies that the apply process applies captured LCRs, and not **persistent LCRs** or **persistent user messages**. Therefore, if an LCR that was constructed by a user application, not by a **capture process**, is staged in the queue for the apply process, then this apply process does not apply the LCR.
- Specifies that the apply process does not use a **precommit handler**.
- Specifies that the apply process does not use a **negative rule set**.
- Specifies that the LCRs applied by the apply process originate at the `dbms1.example.com` **source database**. The **rules** in the apply process rule sets determine which messages are dequeued by the apply process. If the apply process dequeues an LCR with a source database other than `dbms1.example.com`, then an error is raised.

Creating an Apply Process for Persistent LCRs with DBMS_APPLY_ADM

The following example runs the `CREATE_APPLY` procedure in the `DBMS_APPLY_ADM` package to create an apply process that applies **persistent LCRs**:

```
BEGIN
  DBMS_APPLY_ADM.CREATE_APPLY(
    queue_name          => 'strm04_queue',
    apply_name         => 'strm04_apply',
    rule_set_name      => 'strmadmin.strm04_rule_set',
    message_handler    => NULL,
    ddl_handler        => NULL,
    apply_user         => NULL,
    apply_database_link => NULL,
    apply_tag          => NULL,
    apply_captured     => FALSE,
    precommit_handler  => NULL,
    negative_rule_set_name => NULL);
END;
/
```

Running this procedure performs the following actions:

- Creates an apply process named `strm04_apply`. An apply process with the same name must not exist.
- Associates the apply process with an existing queue named `strm04_queue`.
- Associates the apply process with an existing rule set named `strm04_rule_set`. This rule set is the positive rule set for the apply process.
- Specifies that the apply process does not use a **message handler**.
- Specifies that the apply process does not use a **DDL handler**.
- Specifies that the user who applies the changes is the user who runs the `CREATE_APPLY` procedure, because the `apply_user` parameter is `NULL`.
- Specifies that the apply process applies changes to the local database, because the `apply_database_link` parameter is set to `NULL`.
- Specifies that each redo entry generated by the apply process has a `NULL` tag.
- Specifies that the apply process does not apply captured LCRs. Therefore, the apply process can apply persistent LCRs or **persistent user messages** that are in the **persistent queue** portion of the apply process queue.

- Specifies that the apply process does not use a **precommit handler**.
- Specifies that the apply process does not use a negative rule set.

After creating the apply process, run the `ADD_TABLE_RULES` or `ADD_SUBSET_RULES` procedure to add rules to the apply process rule set. These rules direct the apply process to apply LCRs for the specified tables.

Creating an Apply Process for Persistent User Messages with DBMS_APPLY_ADM

The following example runs the `CREATE_APPLY` procedure in the `DBMS_APPLY_ADM` package to create an apply process that applies **persistent user messages**:

```
BEGIN
  DBMS_APPLY_ADM.CREATE_APPLY (
    queue_name          => 'strm05_queue',
    apply_name         => 'strm05_apply',
    rule_set_name      => 'strmadmin.strm05_rule_set',
    message_handler    => 'strmadmin.mes_handler',
    ddl_handler        => NULL,
    apply_user         => NULL,
    apply_database_link => NULL,
    apply_tag          => NULL,
    apply_captured     => FALSE,
    precommit_handler  => NULL,
    negative_rule_set_name => NULL);
END;
/
```

Running this procedure performs the following actions:

- Creates an apply process named `strm05_apply`. An apply process with the same name must not exist.
- Associates the apply process with an existing queue named `strm05_queue`.
- Associates the apply process with an existing rule set named `strm05_rule_set`. This rule set is the positive rule set for the apply process.
- Specifies that the **message handler** is the `mes_handler` PL/SQL procedure in the `strmadmin` schema. The user who runs the `CREATE_APPLY` procedure must have `EXECUTE` privilege on the `mes_handler` PL/SQL procedure.
- Specifies that the apply process does not use a **DDL handler**.
- Specifies that the user who applies the changes is the user who runs the `CREATE_APPLY` procedure, because the `apply_user` parameter is `NULL`.
- Specifies that the apply process applies changes to the local database, because the `apply_database_link` parameter is set to `NULL`.
- Specifies that each redo entry generated by the apply process has a `NULL` tag.
- Specifies that the apply process does not apply captured LCRs. Therefore, the apply process can apply **persistent LCRs** or persistent user messages that are in the **persistent queue** portion of the apply process queue.
- Specifies that the apply process does not use a **precommit handler**.
- Specifies that the apply process does not use a negative rule set.

Configuring Oracle Streams Messaging Environments

Oracle Streams enables messaging with [queues](#), [propagations](#), and enqueue and dequeue capabilities. The queues can be of [ANYDATA queues](#) or [typed queues](#). ANYDATA queues stage [user messages](#) whose payloads are of ANYDATA type, and an ANYDATA payload can be a wrapper for payloads of different data types. Typed queues can stage messages of a specific type.

The following topics describe configuring Oracle Streams messaging environments:

- [Wrapping User Message Payloads in an ANYDATA Wrapper and Enqueuing Them](#)
- [Dequeuing a Payload that Is Wrapped in an ANYDATA Payload](#)
- [Configuring a Messaging Client and Message Notification](#)

Each task described in this chapter should be completed by an Oracle Streams administrator that has been granted the appropriate privileges, unless specified otherwise. The examples in this chapter assume that you have configured an Oracle Streams administrator at each database.

See Also:

- [Chapter 3, "Oracle Streams Staging and Propagation"](#)
- ["Configuring an Oracle Streams Administrator"](#) on page 9-1
- *Oracle Database 2 Day + Data Replication and Integration Guide* for examples that configure Oracle Streams messaging environments
- *Oracle Streams Advanced Queuing User's Guide* for more information about Oracle Streams Advanced Queuing (AQ) and for information about using typed queues
- *Oracle Database PL/SQL Packages and Types Reference* for more information about the ANYDATA type

Wrapping User Message Payloads in an ANYDATA Wrapper and Enqueuing Them

You can wrap almost any type of payload in an ANYDATA payload. The following sections provide examples of enqueueing **messages** into, and dequeuing messages from, an ANYDATA queue.

The following steps illustrate how to wrap payloads of various types in an ANYDATA payload.

1. In SQL*Plus, connect as an administrative user who can create users, grant privileges, create tablespaces, and alter users at the `dbms1.example.com` database.

See *Oracle Database Administrator's Guide* for information about connecting to a database in SQL*Plus.

2. Grant EXECUTE privilege on the DBMS_AQ package to the `oe` user so that this user can run the ENQUEUE and DEQUEUE procedures in that package:

```
GRANT EXECUTE ON DBMS_AQ TO oe;
```

3. Connect to the `dbms1.example.com` database as the Oracle Streams administrator.

4. Create an ANYDATA queue if one does not already exist.

```
BEGIN
  DBMS_STREAMS_ADM.SET_UP_QUEUE(
    queue_table => 'oe_q_table_any',
    queue_name  => 'oe_q_any',
    queue_user  => 'oe');
END;
/
```

The `oe` user is configured automatically as a **secure queue** user of the `oe_q_any` **queue** and is given ENQUEUE and DEQUEUE privileges on the queue. In addition, an Oracle Streams AQ agent named `oe` is configured and is associated with the `oe` user. However, a message cannot be enqueued unless a subscriber who can dequeue the message is configured.

5. Add a subscriber for `oe_q_any` queue. This subscriber will perform explicit dequeues of messages.

```
DECLARE
  subscriber SYS.AQ$_AGENT;
BEGIN
  subscriber := SYS.AQ$_AGENT('OE', NULL, NULL);
  SYS.DBMS_AQADM.ADD_SUBSCRIBER(
    queue_name => 'strmadmin.oe_q_any',
    subscriber => subscriber);
END;
/
```

6. Connect to the `dbms1.example.com` database as the `oe` user.

7. Create a procedure that takes as an input parameter an object of ANYDATA type and enqueues a message containing the payload into an existing ANYDATA queue.

```
CREATE OR REPLACE PROCEDURE oe.enq_proc (payload ANYDATA)
IS
  enqopt      DBMS_AQ.ENQUEUE_OPTIONS_T;
  mprop       DBMS_AQ.MESSAGE_PROPERTIES_T;
```

```

    enq_msgid RAW(16);
BEGIN
  mprop.SENDER_ID := SYS.AQ$_AGENT('OE', NULL, NULL);
  DBMS_AQ.ENQUEUE(
    queue_name      => 'strmadmin.oe_q_any',
    enqueue_options => enqopt,
    message_properties => mprop,
    payload         => payload,
    msgid          => enq_msgid);
END;
/

```

8. Run the procedure you created in Step 7 by specifying the appropriate `ConvertData_Type` function. The following commands enqueue messages of various types.

VARCHAR2 type:

```

EXEC oe.enq_proc(ANYDATA.ConvertVarchar2('Chemicals - SW'));
COMMIT;

```

NUMBER type:

```

EXEC oe.enq_proc(ANYDATA.ConvertNumber('16'));
COMMIT;

```

User-defined type:

```

BEGIN
  oe.enq_proc(ANYDATA.ConvertObject(oe.cust_address_typ(
    '1646 Brazil Blvd', '361168', 'Chennai', 'Tam', 'IN')));
END;
/
COMMIT;

```

See Also: ["Viewing the Contents of Messages in a Persistent Queue"](#) on page 24-4 for information about viewing the contents of these enqueued messages

Dequeueing a Payload that Is Wrapped in an ANYDATA Payload

The following steps illustrate how to dequeue a payload wrapped in an ANYDATA payload. This example assumes that you have completed the steps in ["Wrapping User Message Payloads in an ANYDATA Wrapper and Enqueuing Them"](#) on page 13-2.

To dequeue **messages**, you must know the consumer of the messages. To find the consumer for the messages in a **queue**, connect as the owner of the queue and query the `AQ$_queue_table_name`, where `queue_table_name` is the name of the queue table. For example, to find the consumers of the messages in the `oe_q_any` queue, run the following query:

```

SELECT MSG_ID, MSG_STATE, CONSUMER_NAME FROM AQ$OE_Q_TABLE_ANY;

```

1. In SQL*Plus, connect to the database as the `oe` user.

See *Oracle Database Administrator's Guide* for information about connecting to a database in SQL*Plus.

2. Create a procedure that takes as an input the consumer of the messages you want to dequeue. The following example procedure dequeues messages of `oe.cust_address_typ` and prints the contents of the messages.

```

CREATE OR REPLACE PROCEDURE oe.get_cust_address (
consumer IN VARCHAR2) AS
  address      OE.CUST_ADDRESS_TYP;
  deq_address  ANYDATA;
  msgid       RAW(16);
  deqopt      DBMS_AQ.DEQUEUE_OPTIONS_T;
  mprop       DBMS_AQ.MESSAGE_PROPERTIES_T;
  new_addresses BOOLEAN := TRUE;
  next_trans  EXCEPTION;
  no_messages EXCEPTION;
  pragma exception_init (next_trans, -25235);
  pragma exception_init (no_messages, -25228);
  num_var     pls_integer;
BEGIN
  deqopt.consumer_name := consumer;
  deqopt.wait := 1;
  WHILE (new_addresses) LOOP
    BEGIN
      DBMS_AQ.DEQUEUE(
        queue_name      => 'strmadmin.oe_q_any',
        dequeue_options => deqopt,
        message_properties => mprop,
        payload         => deq_address,
        msgid           => msgid);
      deqopt.navigation := DBMS_AQ.NEXT;
      DBMS_OUTPUT.PUT_LINE('****');
      IF (deq_address.GetTypeName() = 'OE.CUST_ADDRESS_TYP') THEN
        DBMS_OUTPUT.PUT_LINE('Message TYPE is: ' ||
                             deq_address.GetTypeName());
        num_var := deq_address.GetObject(address);
        DBMS_OUTPUT.PUT_LINE(' **** CUSTOMER ADDRESS **** ');
        DBMS_OUTPUT.PUT_LINE(address.street_address);
        DBMS_OUTPUT.PUT_LINE(address.postal_code);
        DBMS_OUTPUT.PUT_LINE(address.city);
        DBMS_OUTPUT.PUT_LINE(address.state_province);
        DBMS_OUTPUT.PUT_LINE(address.country_id);
      ELSE
        DBMS_OUTPUT.PUT_LINE('Message TYPE is: ' ||
                             deq_address.GetTypeName());
      END IF;
    COMMIT;
  EXCEPTION
    WHEN next_trans THEN
      deqopt.navigation := DBMS_AQ.NEXT_TRANSACTION;
    WHEN no_messages THEN
      new_addresses := FALSE;
      DBMS_OUTPUT.PUT_LINE('No more messages');
    END;
  END LOOP;
END;
/

```

3. Run the procedure you created in Step 1 and specify the consumer of the messages you want to dequeue, as in the following example:

```

SET SERVEROUTPUT ON SIZE 100000
EXEC oe.get_cust_address('OE');

```

Configuring a Messaging Client and Message Notification

This section contains instructions for configuring the following elements in a database:

- An enqueue procedure that enqueues **messages** into an ANYDATA queue at a database. In this example, the enqueue procedure uses a trigger to enqueue a message every time a row is inserted into the `oe.orders` table.
- A **messaging client** that can dequeue **persistent LCRs** and **persistent user messages** based on **rules**. In this example, the messaging client uses a rule so that it dequeues only messages that involve the `oe.orders` table. The messaging client uses the `DEQUEUE` procedure in the `DBMS_STREAMS_MESSAGING` to dequeue one message at a time and display the order number for the order.
- Message notification for the messaging client. In this example, a notification is sent to an e-mail address when a message is enqueued into the **queue** used by the messaging client. The message can be dequeued by the messaging client because the message satisfies the **rule sets** of the messaging client. You can also configure message notifications that alert applications when a message of interest is enqueued. These applications can dequeue and process the message in any customized way. Notification can also be sent to a specified HTTP post.

You can query the `DBA_STREAMS_MESSAGE_CONSUMERS` data dictionary view for information about existing messaging clients and notifications.

Complete the following steps to configure a messaging client and message notification:

1. In SQL*Plus, connect as an administrative user who can grant privileges and execute subprograms in supplied packages.

See *Oracle Database Administrator's Guide* for information about connecting to a database in SQL*Plus.

2. Set the host name used to send the e-mail, the mail port, and the e-mail account that sends e-mail messages for e-mail notifications using the `DBMS_AQELM` package. The following example sets the mail host name to `smtp.example.com`, the mail port to 25, and the e-mail account to `Mary.Smith@example.com`:

```
BEGIN
  DBMS_AQELM.SET_MAILHOST('smtp.example.com') ;
  DBMS_AQELM.SET_MAILPORT(25) ;
  DBMS_AQELM.SET_SENDFROM('Mary.Smith@example.com');
END;
/
```

If you are not sure about the correct mail host, mail port, and send from e-mail address, then ask the system administrator for the computer system that runs the database.

3. Grant the necessary privileges to the users who will create the messaging client, enqueue and dequeue messages, and specify message notifications. In this example, the `oe` user performs all of these tasks.

```
GRANT EXECUTE ON DBMS_AQ TO oe;
GRANT EXECUTE ON DBMS_STREAMS_ADM TO oe;
GRANT EXECUTE ON DBMS_STREAMS_MESSAGING TO oe;

BEGIN
  DBMS_RULE_ADM.GRANT_SYSTEM_PRIVILEGE(
    privilege => DBMS_RULE_ADM.CREATE_RULE_SET_OBJ,
    grantee   => 'oe',
```

```

        grant_option => FALSE);
END;
/

BEGIN
    DBMS_RULE_ADM.GRANT_SYSTEM_PRIVILEGE(
        privilege    => DBMS_RULE_ADM.CREATE_RULE_OBJ,
        grantee      => 'oe',
        grant_option => FALSE);
END;
/

BEGIN
    DBMS_RULE_ADM.GRANT_SYSTEM_PRIVILEGE(
        privilege    => DBMS_RULE_ADM.CREATE_EVALUATION_CONTEXT_OBJ,
        grantee      => 'oe',
        grant_option => FALSE);
END;
/

```

4. Connect to the database as the oe user.
5. Create an ANYDATA queue using SET_UP_QUEUE, as in the following example:

```

BEGIN
    DBMS_STREAMS_ADM.SET_UP_QUEUE(
        queue_table => 'oe.notification_queue_table',
        queue_name  => 'oe.notification_queue');
END;
/

```

6. Create the types for the user messages, as in the following example:

```

CREATE TYPE oe.user_msg AS OBJECT(
    object_name  VARCHAR2(30),
    object_owner VARCHAR2(30),
    message      VARCHAR2(50));
/

```

7. Create a trigger that enqueues a message into the queue whenever an order is inserted into the oe.orders table, as in the following example:

```

CREATE OR REPLACE TRIGGER oe.order_insert AFTER INSERT
ON oe.orders FOR EACH ROW
DECLARE
    msg          oe.user_msg;
    str          VARCHAR2(2000);
BEGIN
    str := 'New Order - ' || :NEW.ORDER_ID || ' Order ID';
    msg := oe.user_msg(
        object_name => 'ORDERS',
        object_owner => 'OE',
        message      => str);
    DBMS_STREAMS_MESSAGING.ENQUEUE (
        queue_name => 'oe.notification_queue',
        payload    => ANYDATA.CONVERTOBJECT(msg));
END;
/

```

8. Create the messaging client that will dequeue messages from the queue and the rule used by the messaging client to determine which messages to dequeue, as in the following example:

```
BEGIN
  DBMS_STREAMS_ADM.ADD_MESSAGE_RULE (
    message_type => 'oe.user_msg',
    rule_condition => ' :msg.OBJECT_OWNER = 'OE' AND ' ||
                    ' :msg.OBJECT_NAME = 'ORDERS' ',
    streams_type => 'dequeue',
    streams_name => 'oe',
    queue_name => 'oe.notification_queue');
END;
/
```

9. Set the message notification to send e-mail upon enqueue of messages that can be dequeued by the messaging client, as in the following example:

```
BEGIN
  DBMS_STREAMS_ADM.SET_MESSAGE_NOTIFICATION (
    streams_name => 'oe',
    notification_action => 'Mary.Smith@example.com',
    notification_type => 'MAIL',
    include_notification => TRUE,
    queue_name => 'oe.notification_queue');
END;
/
```

10. Create a PL/SQL procedure that dequeues messages using the messaging client, as in the following example:

```
CREATE OR REPLACE PROCEDURE oe.deq_notification(consumer IN VARCHAR2) AS
  msg          ANYDATA;
  user_msg     oe.user_msg;
  num_var      PLS_INTEGER;
  more_messages BOOLEAN := TRUE;
  navigation   VARCHAR2(30);
BEGIN
  navigation := 'FIRST MESSAGE';
  WHILE (more_messages) LOOP
    BEGIN
      DBMS_STREAMS_MESSAGING.DEQUEUE(
        queue_name => 'oe.notification_queue',
        streams_name => consumer,
        payload => msg,
        navigation => navigation,
        wait => DBMS_STREAMS_MESSAGING.NO_WAIT);
      IF msg.GETTYPE_NAME() = 'OE.USER_MSG' THEN
        num_var := msg.GETOBJECT(user_msg);
        DBMS_OUTPUT.PUT_LINE(user_msg.object_name);
        DBMS_OUTPUT.PUT_LINE(user_msg.object_owner);
        DBMS_OUTPUT.PUT_LINE(user_msg.message);
      END IF;
      navigation := 'NEXT MESSAGE';
      COMMIT;
    EXCEPTION WHEN SYS.DBMS_STREAMS_MESSAGING.ENDOFCURTRANS THEN
      navigation := 'NEXT TRANSACTION';
    WHEN DBMS_STREAMS_MESSAGING.NOMOREMSGS THEN
      more_messages := FALSE;
      DBMS_OUTPUT.PUT_LINE('No more messages. ');
    WHEN OTHERS THEN
```

```

        RAISE;
    END;
END LOOP;
END;
/

```

11. Insert rows into the oe.orders table, as in the following example:

```

INSERT INTO oe.orders VALUES(2521, 'direct', 144, 0, 922.57, 159, NULL);
INSERT INTO oe.orders VALUES(2522, 'direct', 116, 0, 1608.29, 153, NULL);
COMMIT;
INSERT INTO oe.orders VALUES(2523, 'direct', 116, 0, 227.55, 155, NULL);
COMMIT;

```

Message notification sends a message to the e-mail address specified in Step 9 for each message that was enqueued. Each notification is an AQXmlNotification, which includes the following:

- notification_options, which includes the following:
 - destination - The **destination queue** from which the message was dequeued
 - consumer_name - The name of the messaging client that dequeued the message
- message_set - The set of message properties

The following example shows the AQXmlNotification format sent in an e-mail notification:

```

<?xml version="1.0" encoding="UTF-8"?>
<Envelope xmlns="http://ns.oracle.com/AQ/schemas/envelope">
  <Body>
    <AQXmlNotification xmlns="http://ns.oracle.com/AQ/schemas/access">
      <notification_options>
        <destination>OE.NOTIFICATION_QUEUE</destination>
        <consumer_name>OE</consumer_name>
      </notification_options>
      <message_set>
        <message>
          <message_header>
            <message_id>CB510DDB19454731E034080020AE3E0A</message_id>
            <expiration>-1</expiration>
            <delay>0</delay>
            <priority>1</priority>
            <delivery_count>0</delivery_count>
            <sender_id>
              <agent_name>OE</agent_name>
              <protocol>0</protocol>
            </sender_id>
            <message_state>0</message_state>
          </message_header>
        </message>
      </message_set>
    </AQXmlNotification>
  </Body>
</Envelope>

```

You can dequeue the messages enqueued in this example by running the oe.deq_notification procedure:

```

SET SERVEROUTPUT ON SIZE 100000
EXEC oe.deq_notification('OE');

```

Note: The DBMS_AQ package can also configure notifications. The DBMS_AQ package provides some notification features that are not available in DBMS_STREAMS_ADM package, such as buffered message notifications and notification grouping by time.

See Also:

- ["Viewing the Messaging Clients in a Database"](#) on page 24-2
- ["Viewing Message Notifications"](#) on page 24-3
- [Chapter 6, "How Rules Are Used in Oracle Streams"](#) for more information about rule sets for **Oracle Streams clients** and for information about how messages satisfy rule sets
- *Oracle Database 2 Day + Data Replication and Integration Guide* for an example that uses message notification to dequeue messages of interest automatically
- *Oracle Streams Advanced Queuing User's Guide* and *Oracle XML DB Developer's Guide* for more information about message notifications and XML
- *Oracle Database PL/SQL Packages and Types Reference* for information about the DBMS_AQ package

Part III

Oracle Streams Administration

This part describes managing an Oracle Streams environment, including step-by-step instructions for configuring, administering, monitoring and troubleshooting. This part contains the following chapters:

- [Chapter 14, "Managing Oracle Streams Implicit Capture"](#)
- [Chapter 15, "Managing Staging and Propagation"](#)
- [Chapter 16, "Managing Oracle Streams Information Consumption"](#)
- [Chapter 17, "Managing Rules"](#)
- [Chapter 18, "Managing Rule-Based Transformations"](#)
- [Chapter 19, "Other Oracle Streams Management Tasks"](#)
- [Chapter 20, "Troubleshooting an Oracle Streams Environment"](#)

Managing Oracle Streams Implicit Capture

Both [capture processes](#) and [synchronous captures](#) perform [implicit capture](#). This chapter contains instructions for managing implicit capture.

The following topics describe managing Oracle Streams implicit capture:

- [Managing a Capture Process](#)
- [Managing a Synchronous Capture](#)
- [Managing Extra Attributes in Captured LCRs](#)
- [Switching From a Capture Process to a Synchronous Capture](#)
- [Switching from a Synchronous Capture to a Capture Process](#)

Each task described in this chapter should be completed by an Oracle Streams administrator that has been granted the appropriate privileges, unless specified otherwise.

See Also:

- [Chapter 2, "Oracle Streams Information Capture"](#)
- ["Configuring an Oracle Streams Administrator" on page 9-1](#)
- ["Monitoring Oracle Streams Implicit Capture" on page 23-1](#)
- ["Troubleshooting Capture Process Problems" on page 23-1](#)

Managing a Capture Process

A [capture process](#) captures changes in a redo log, reformats each captured change into a [logical change record \(LCR\)](#), and enqueues the LCR into an ANYDATA queue.

The following topics describe managing a capture process:

- [Starting a Capture Process](#)
- [Stopping a Capture Process](#)
- [Managing the Rule Set for a Capture Process](#)
- [Setting a Capture Process Parameter](#)
- [Setting the Capture User for a Capture Process](#)
- [Managing the Checkpoint Retention Time for a Capture Process](#)
- [Adding an Archived Redo Log File to a Capture Process Explicitly](#)
- [Setting the First SCN for an Existing Capture Process](#)

- [Setting the Start SCN for an Existing Capture Process](#)
- [Specifying Whether Downstream Capture Uses a Database Link](#)
- [Dropping a Capture Process](#)

See Also:

- ["Implicit Capture with an Oracle Streams Capture Process"](#) on page 2-9
- ["Configuring a Capture Process"](#) on page 10-1
- *Oracle Database 2 Day + Data Replication and Integration Guide* and the Enterprise Manager online Help for instructions on managing a capture process with Enterprise Manager

Starting a Capture Process

You run the `START_CAPTURE` procedure in the `DBMS_CAPTURE_ADM` package to start an existing [capture process](#). For example, the following procedure starts a capture process named `strm01_capture`:

```
BEGIN
  DBMS_CAPTURE_ADM.START_CAPTURE (
    capture_name => 'strm01_capture');
END;
/
```

Note: If a new capture process will use a new [LogMiner data dictionary](#), then, when you first start the new capture process, some time might be required to populate the new LogMiner data dictionary. A new LogMiner data dictionary is created if a non-NULL first SCN value was specified when the capture process was created.

See Also: *Oracle Database 2 Day + Data Replication and Integration Guide* for instructions about starting a capture process with Oracle Enterprise Manager

Stopping a Capture Process

You run the `STOP_CAPTURE` procedure in the `DBMS_CAPTURE_ADM` package to stop an existing [capture process](#). For example, the following procedure stops a capture process named `strm01_capture`:

```
BEGIN
  DBMS_CAPTURE_ADM.STOP_CAPTURE (
    capture_name => 'strm01_capture');
END;
/
```

See Also: *Oracle Database 2 Day + Data Replication and Integration Guide* for instructions about stopping a capture process with Oracle Enterprise Manager

Managing the Rule Set for a Capture Process

This section contains instructions for completing the following tasks:

- [Specifying a Rule Set for a Capture Process](#)
- [Adding Rules to a Rule Set for a Capture Process](#)
- [Removing a Rule from a Rule Set for a Capture Process](#)
- [Removing a Rule Set for a Capture Process](#)

See Also:

- [Chapter 5, "Rules"](#)
- [Chapter 6, "How Rules Are Used in Oracle Streams"](#)

Specifying a Rule Set for a Capture Process

You can specify one [positive rule set](#) and one [negative rule set](#) for a [capture process](#). The capture process captures a change if it evaluates to TRUE for at least one [rule](#) in the positive rule set and evaluates to FALSE for all the rules in the negative rule set. The negative rule set is evaluated before the positive rule set.

Specifying a Positive Rule Set for a Capture Process You specify an existing [rule set](#) as the positive rule set for an existing capture process using the `rule_set_name` parameter in the `ALTER_CAPTURE` procedure. This procedure is in the `DBMS_CAPTURE_ADM` package.

For example, the following procedure sets the positive rule set for a capture process named `strm01_capture` to `strm02_rule_set`.

```
BEGIN
  DBMS_CAPTURE_ADM.ALTER_CAPTURE (
    capture_name => 'strm01_capture',
    rule_set_name => 'strmadmin.strm02_rule_set');
END;
/
```

Specifying a Negative Rule Set for a Capture Process You specify an existing rule set as the negative rule set for an existing capture process using the `negative_rule_set_name` parameter in the `ALTER_CAPTURE` procedure. This procedure is in the `DBMS_CAPTURE_ADM` package.

For example, the following procedure sets the negative rule set for a capture process named `strm01_capture` to `strm03_rule_set`.

```
BEGIN
  DBMS_CAPTURE_ADM.ALTER_CAPTURE (
    capture_name      => 'strm01_capture',
    negative_rule_set_name => 'strmadmin.strm03_rule_set');
END;
/
```

Adding Rules to a Rule Set for a Capture Process

To add [rules](#) to a [rule set](#) for an existing [capture process](#), you can run one of the following procedures in the `DBMS_STREAMS_ADM` package and specify the existing capture process:

- `ADD_TABLE_RULES`
- `ADD_SUBSET_RULES`

- ADD_SCHEMA_RULES
- ADD_GLOBAL_RULES

Excluding the ADD_SUBSET_RULES procedure, these procedures can add rules to the **positive rule set** or **negative rule set** for a capture process. The ADD_SUBSET_RULES procedure can add rules only to the positive rule set for a capture process.

See Also: "System-Created Rules" on page 6-5

Adding Rules to the Positive Rule Set for a Capture Process The following example runs the ADD_TABLE_RULES procedure in the DBMS_STREAMS_ADM package to add rules to the positive rule set of a capture process named strm01_capture:

```
BEGIN
  DBMS_STREAMS_ADM.ADD_TABLE_RULES(
    table_name      => 'hr.departments',
    streams_type    => 'capture',
    streams_name    => 'strm01_capture',
    queue_name      => 'strmadmin.streams_queue',
    include_dml     => TRUE,
    include_ddl     => TRUE,
    inclusion_rule  => TRUE);
END;
/
```

Running this procedure performs the following actions:

- Creates two rules. One rule evaluates to TRUE for DML changes to the hr.departments table, and the other rule evaluates to TRUE for DDL changes to the hr.departments table. The rule names are system generated.
- Adds the two rules to the positive rule set associated with the capture process because the inclusion_rule parameter is set to TRUE.
- Prepares the hr.departments table for **instantiation** by running the PREPARE_TABLE_INSTANTIATION procedure in the DBMS_CAPTURE_ADM package.
- Enables **supplemental logging** for any primary key, unique key, bitmap index, and foreign key columns in the hr.departments table. When the PREPARE_TABLE_INSTANTIATION procedure is run, the default value (keys) is specified for the supplemental_logging parameter.

If the capture process is performing downstream capture, then the table is prepared for instantiation and supplemental logging is enabled for key columns only if the **downstream capture process** uses a database link to the **source database**. If a downstream capture process does not use a database link to the source database, then the table must be prepared for instantiation manually and supplemental logging must be enabled manually.

Adding Rules to the Negative Rule Set for a Capture Process The following example runs the ADD_TABLE_RULES procedure in the DBMS_STREAMS_ADM package to add rules to the **negative rule set** of a capture process named strm01_capture:

```
BEGIN
  DBMS_STREAMS_ADM.ADD_TABLE_RULES(
    table_name      => 'hr.job_history',
    streams_type    => 'capture',
    streams_name    => 'strm01_capture',
    queue_name      => 'strmadmin.streams_queue',
    include_dml     => TRUE,
```

```

        include_ddl      => TRUE,
        inclusion_rule   => FALSE);
END;
/

```

Running this procedure performs the following actions:

- Creates two rules. One rule evaluates to `TRUE` for DML changes to the `hr.job_history` table, and the other rule evaluates to `TRUE` for DDL changes to the `hr.job_history` table. The rule names are system generated.
- Adds the two rules to the negative rule set associated with the capture process, because the `inclusion_rule` parameter is set to `FALSE`.

Removing a Rule from a Rule Set for a Capture Process

You remove a rule from the rule set for a [capture process](#) if you no longer want the capture process to capture the changes specified in the rule. For example, assume that the `departments3` rule specifies that DML changes to the `hr.departments` table be captured. If you no longer want a capture process to capture changes to the `hr.departments` table, then remove the `departments3` rule from its rule set.

You specify that you want to remove a [rule](#) from a [rule set](#) for an existing [capture process](#) by running the `REMOVE_RULE` procedure in the `DBMS_STREAMS_ADM` package. For example, the following procedure removes a rule named `departments3` from the [positive rule set](#) of a capture process named `strm01_capture`.

```

BEGIN
    DBMS_STREAMS_ADM.REMOVE_RULE(
        rule_name          => 'departments3',
        streams_type       => 'capture',
        streams_name       => 'strm01_capture',
        drop_unused_rule   => TRUE,
        inclusion_rule     => TRUE);
END;
/

```

In this example, the `drop_unused_rule` parameter in the `REMOVE_RULE` procedure is set to `TRUE`, which is the default setting. Therefore, if the rule being removed is not in any other rule set, then it will be dropped from the database. If the `drop_unused_rule` parameter is set to `FALSE`, then the rule is removed from the rule set, but it is not dropped from the database.

If the `inclusion_rule` parameter is set to `FALSE`, then the `REMOVE_RULE` procedure removes the rule from the [negative rule set](#) for the capture process, not the positive rule set.

If you want to remove all of the rules in a rule set for the capture process, then specify `NULL` for the `rule_name` parameter when you run the `REMOVE_RULE` procedure.

See Also: ["Oracle Streams Client with One or More Empty Rule Sets"](#) on page 6-4

Removing a Rule Set for a Capture Process

You specify that you want to remove a [rule set](#) from an existing [capture process](#) using the `ALTER_CAPTURE` procedure in the `DBMS_CAPTURE_ADM` package. This procedure can remove the [positive rule set](#), [negative rule set](#), or both. Specify `TRUE` for the `remove_rule_set` parameter to remove the positive rule set for the capture process. Specify `TRUE` for the `remove_negative_rule_set` parameter to remove the negative rule set for the capture process.

For example, the following procedure removes both the positive and negative rule set from a capture process named `strm01_capture`.

```
BEGIN
  DBMS_CAPTURE_ADM.ALTER_CAPTURE (
    capture_name      => 'strm01_capture',
    remove_rule_set   => TRUE,
    remove_negative_rule_set => TRUE);
END;
/
```

Note: If a capture process does not have a positive or negative rule set, then the capture process captures all supported changes to all objects in the database, excluding database objects in the `SYS`, `SYSTEM`, and `CTXSYS` schemas.

Setting a Capture Process Parameter

Set a **capture process** parameter using the `SET_PARAMETER` procedure in the `DBMS_CAPTURE_ADM` package. Capture process parameters control the way a capture process operates.

For example, the following procedure sets the `parallelism` parameter for a capture process named `strm01_capture` to 3.

```
BEGIN
  DBMS_CAPTURE_ADM.SET_PARAMETER (
    capture_name => 'strm01_capture',
    parameter    => 'parallelism',
    value        => '3');
END;
/
```

Note:

- Setting the `parallelism` parameter automatically stops and restarts a capture process.
 - The `value` parameter is always entered as a `VARCHAR2` value, even if the parameter value is a number.
 - If the `value` parameter is set to `NULL` or is not specified, then the parameter is set to its default value.
-
-

See Also:

- *Oracle Database 2 Day + Data Replication and Integration Guide* for instructions about setting capture process parameters with Oracle Enterprise Manager
- ["Capture Process Components"](#) on page 2-22
- The `DBMS_CAPTURE_ADM.SET_PARAMETER` procedure in the *Oracle Database PL/SQL Packages and Types Reference* for detailed information about the capture process parameters

Setting the Capture User for a Capture Process

The **capture user** is the user who captures all DML changes and DDL changes that satisfy the **capture process rule sets**. Set the capture user for a capture process using the `capture_user` parameter in the `ALTER_CAPTURE` procedure in the `DBMS_CAPTURE_ADM` package.

To change the capture user, the user who invokes the `ALTER_CAPTURE` procedure must be granted `DBA` role. Only the `SYS` user can set the `capture_user` to `SYS`.

For example, the following procedure sets the capture user for a capture process named `strm01_capture` to `hr`.

```
BEGIN
  DBMS_CAPTURE_ADM.ALTER_CAPTURE (
    capture_name => 'strm01_capture',
    capture_user => 'hr');
END;
/
```

Running this procedure grants the new capture user `enqueue` privilege on the queue used by the capture process and configures the user as a **secure queue** user of the **queue**. In addition, ensure that the capture user has the following privileges:

- `EXECUTE` privilege on the rule sets used by the capture process
- `EXECUTE` privilege on all **custom rule-based transformation** functions used in the rule set

These privileges must be granted directly to the capture user. They cannot be granted through roles.

Note: If Oracle Database Vault is installed, then the user who changes the capture user must be granted the `BECOME USER` system privilege. Granting this privilege to the user is not required if Oracle Database Vault is not installed. You can revoke the `BECOME USER` system privilege from the user after capture user is changed, if necessary.

Managing the Checkpoint Retention Time for a Capture Process

The **checkpoint retention time** is the amount of time that a **capture process** retains **checkpoints** before purging them automatically. Set the checkpoint retention time for a capture process using `checkpoint_retention_time` parameter in the `ALTER_CAPTURE` procedure of the `DBMS_CAPTURE_ADM` package.

See Also: ["Capture Process Checkpoints"](#) on page 2-25

Setting the Checkpoint Retention Time for a Capture Process to a New Value

When you set the checkpoint retention time, you can specify partial days with decimal values. For example, run the following procedure to specify that a capture process named `strm01_capture` should purge checkpoints automatically every ten days and twelve hours:

```
BEGIN
  DBMS_CAPTURE_ADM.ALTER_CAPTURE (
    capture_name           => 'strm01_capture',
    checkpoint_retention_time => 10.5);
END;
```

/

Setting the Checkpoint Retention Time for a Capture Process to Infinite

To specify that a capture process should not purge checkpoints automatically, set the checkpoint retention time to `DBMS_CAPTURE_ADM.INFINITE`. For example, the following procedure sets the checkpoint retention time for a name `strm01_capture` to infinite:

```
BEGIN
  DBMS_CAPTURE_ADM.ALTER_CAPTURE(
    capture_name          => 'strm01_capture',
    checkpoint_retention_time => DBMS_CAPTURE_ADM.INFINITE);
END;
/
```

Adding an Archived Redo Log File to a Capture Process Explicitly

You can add an archived redo log file to a [capture process](#) manually using the following statement:

```
ALTER DATABASE REGISTER LOGICAL LOGFILE
  file_name FOR capture_process;
```

Here, `file_name` is the name of the archived redo log file being added, and `capture_process` is the name of the capture process that will use the redo log file at the [downstream database](#). The `capture_process` is equivalent to the `logminer_session_name` and must be specified. The redo log file must be present at the site running capture process.

For example, to add the `/usr/log_files/1_3_486574859.dbf` archived redo log file to a capture process named `strm03_capture`, issue the following statement:

```
ALTER DATABASE REGISTER LOGICAL LOGFILE '/usr/log_files/1_3_486574859.dbf'
  FOR 'strm03_capture';
```

See Also: *Oracle Database SQL Language Reference* for more information about the `ALTER DATABASE` statement and *Oracle Data Guard Concepts and Administration* for more information registering redo log files

Setting the First SCN for an Existing Capture Process

You can set the [first SCN](#) for an existing [capture process](#).

The specified first SCN must meet the following requirements:

- It must be greater than the current first SCN for the capture process.
- It must be less than or equal to the current [applied SCN](#) for the capture process. However, this requirement does not apply if the current applied SCN for the capture process is zero.
- It must be less than or equal to the [required checkpoint SCN](#) for the capture process.

You can determine the current first SCN, applied SCN, and required checkpoint SCN for each capture process in a database using the following query:

```
SELECT CAPTURE_NAME, FIRST_SCN, APPLIED_SCN, REQUIRED_CHECKPOINT_SCN
  FROM DBA_CAPTURE;
```

When you reset a first SCN for a capture process, information below the new first SCN setting is purged from the **LogMiner data dictionary** for the capture process automatically. Therefore, after the first SCN is reset for a capture process, the **start SCN** for the capture process cannot be set lower than the new first SCN. Also, redo log files that contain information prior to the new first SCN setting will never be needed by the capture process.

For example, the following procedure sets the first SCN for a capture process named `strm01_capture` to 351232 using the `ALTER_CAPTURE` procedure in the `DBMS_CAPTURE_ADM` package:

```
BEGIN
  DBMS_CAPTURE_ADM.ALTER_CAPTURE (
    capture_name => 'strm01_capture',
    first_scn    => 351232);
END;
/
```

Note:

- If the specified first SCN is higher than the current start SCN for the capture process, then the start SCN is set automatically to the new value of the first SCN.
 - If you must capture changes in the redo log from a point in time in the past, then you can create a new capture process and specify a first SCN that corresponds to a previous data dictionary build in the redo log. The `BUILD` procedure in the `DBMS_CAPTURE_ADM` package performs a data dictionary build in the redo log.
 - You can query the `DBA_LOGMNR_PURGED_LOG` data dictionary view to determine which redo log files will never be needed by any capture process.
-
-

See Also:

- ["SCN Values Related to a Capture Process"](#) on page 2-20
- ["The LogMiner Data Dictionary for a Capture Process"](#) on page 2-30
- ["Displaying SCN Values for Each Redo Log File Used by Each Capture Process"](#) on page 23-9 for a query that determines which redo log files are no longer needed

Setting the Start SCN for an Existing Capture Process

You can set the **start SCN** for an existing **capture process**. Typically, you reset the start SCN for a capture process if point-in-time recovery must be performed on one of the **destination databases** that receive changes from the capture process.

The specified start SCN must be greater than or equal to the **first SCN** for the capture process. When you reset a start SCN for a capture process, ensure that the required redo log files are available to the capture process.

You can determine the first SCN for each capture process in a database using the following query:

```
SELECT CAPTURE_NAME, FIRST_SCN FROM DBA_CAPTURE;
```

For example, to set the start SCN for a capture process named `strm01_capture` to 750338, complete the following steps:

1. Stop the capture process. See ["Stopping a Capture Process"](#) on page 14-2 for instructions.
2. Run the `ALTER_CAPTURE` procedure to set the start SCN:

```
BEGIN
  DBMS_CAPTURE_ADM.ALTER_CAPTURE (
    capture_name => 'strm01_capture',
    start_scn    => 750338);
END;
/
```

3. Start the capture process. See ["Starting a Capture Process"](#) on page 14-2 for instructions.

See Also:

- ["SCN Values Related to a Capture Process"](#) on page 2-20
- *Oracle Streams Replication Administrator's Guide* for information about performing database point-in-time recovery on a destination database in an Oracle Streams environment

Specifying Whether Downstream Capture Uses a Database Link

You specify whether an existing [downstream capture process](#) uses a database link to the [source database](#) for administrative purposes using the `ALTER_CAPTURE` procedure in the `DBMS_CAPTURE_ADM` package. Set the `use_database_link` parameter to `TRUE` to specify that the downstream capture process uses a database link, or you set the `use_database_link` parameter to `FALSE` to specify that the downstream capture process does not use a database link.

If you want a capture process that is not using a database link currently to begin using a database link, then specify `TRUE` for the `use_database_link` parameter. In this case, a database link with the same name as the global name as the source database must exist at the [downstream database](#).

If you want a capture process that is using a database link currently to stop using a database link, then specify `FALSE` for the `use_database_link` parameter. In this case, some administration must be performed manually after you alter the capture process. For example, if you add new capture process [rules](#) using the `DBMS_STREAMS_ADM` package, then you must prepare the objects relating to the rules for [instantiation](#) manually at the source database.

If you specify `NULL` for the `use_database_link` parameter, then the current value of this parameter for the capture process is not changed.

The example in ["Configuring an Archived-Log Downstream Capture Process that Assigns Logs Explicitly"](#) on page 10-18 created the capture process `strm05_capture` and specified that this capture process does not use a database link.

To create a database link to the source database `db1.example.com` and specify that this capture process uses the database link, complete the following steps:

1. In SQL*Plus, connect to the downstream database as the Oracle Streams administrator.

See *Oracle Database Administrator's Guide* for information about connecting to a database in SQL*Plus.

2. Create the database link to the source database. Ensure that the database link connects to the Oracle Streams administrator at the source database. For example:

```
CREATE DATABASE LINK dbs1.example.com CONNECT TO strmadmin
  IDENTIFIED BY password
  USING 'dbs1.example.com';
```

3. Alter the capture process to use the database link. For example:

```
BEGIN
  DBMS_CAPTURE_ADM.ALTER_CAPTURE(
    capture_name      => 'strm05_capture',
    use_database_link => TRUE);
END;
/
```

See Also: ["Local Capture and Downstream Capture"](#) on page 2-14

Dropping a Capture Process

You run the `DROP_CAPTURE` procedure in the `DBMS_CAPTURE_ADM` package to drop an existing [capture process](#). For example, the following procedure drops a capture process named `strm02_capture`:

```
BEGIN
  DBMS_CAPTURE_ADM.DROP_CAPTURE(
    capture_name          => 'strm02_capture',
    drop_unused_rule_sets => TRUE);
END;
/
```

Because the `drop_unused_rule_sets` parameter is set to `TRUE`, this procedure also drops any [rule sets](#) used by the `strm02_capture` capture process, unless a rule set is used by another [Oracle Streams client](#). If the `drop_unused_rule_sets` parameter is set to `TRUE`, then both the [positive rule set](#) and [negative rule set](#) for the capture process might be dropped. If this procedure drops a rule set, then it also drops any [rules](#) in the rule set that are not in another rule set.

Note: The status of a capture process must be `DISABLED` or `ABORTED` before it can be dropped. You cannot drop an `ENABLED` capture process.

Managing a Synchronous Capture

A [synchronous capture](#) uses an internal mechanism to capture data manipulation language (DML) changes made to tables. A synchronous capture reformats each captured change into a [logical change record \(LCR\)](#), and enqueues the LCR into an `ANYDATA` queue.

This section contains these topics:

- [Managing the Rule Set for a Synchronous Capture](#)
- [Setting the Capture User for a Synchronous Capture](#)
- [Dropping a Synchronous Capture](#)

See Also:

- ["Implicit Capture with Synchronous Capture"](#) on page 2-38
- ["Configuring Synchronous Capture"](#) on page 10-23
- ["Monitoring a Synchronous Capture"](#) on page 23-15
- *Oracle Database 2 Day + Data Replication and Integration Guide* for an example that configures a replication environment that uses synchronous capture

Managing the Rule Set for a Synchronous Capture

This section contains instructions for completing the following tasks:

- [Specifying a Rule Set for a Synchronous Capture](#)
- [Adding Rules to a Rule Set for a Synchronous Capture](#)
- [Removing a Rule from a Rule Set for a Synchronous Capture](#)

See Also:

- [Chapter 5, "Rules"](#)
- [Chapter 6, "How Rules Are Used in Oracle Streams"](#)

Specifying a Rule Set for a Synchronous Capture

You can specify one **positive rule set** for a **synchronous capture**. The synchronous capture captures a change if it evaluates to TRUE for at least one **rule** in the positive rule set.

You specify an existing **rule set** as the positive rule set for an existing synchronous capture using the `rule_set_name` parameter in the `ALTER_SYNC_CAPTURE` procedure. This procedure is in the `DBMS_CAPTURE_ADM` package.

For example, the following procedure sets the positive rule set for a synchronous capture named `sync_capture` to `sync_rule_set`.

```
BEGIN
  DBMS_CAPTURE_ADM.ALTER_SYNC_CAPTURE (
    capture_name => 'sync_capture',
    rule_set_name => 'strmadmin.sync_rule_set');
END;
/
```

Note: You cannot remove the rule set for a synchronous capture.

Adding Rules to a Rule Set for a Synchronous Capture

To add **rules** to a **rule set** for an existing **synchronous capture**, you can run one of the following procedures in the `DBMS_STREAMS_ADM` package and specify the existing synchronous capture:

- `ADD_TABLE_RULES`
- `ADD_SUBSET_RULES`

See Also: "System-Created Rules" on page 6-5

The following example runs the `ADD_TABLE_RULES` procedure in the `DBMS_STREAMS_ADM` package to add rules to the positive rule set of a synchronous capture named `sync_capture`:

```
BEGIN
  DBMS_STREAMS_ADM.ADD_TABLE_RULES(
    table_name      => 'hr.departments',
    streams_type    => 'sync_capture',
    streams_name    => 'sync_capture',
    queue_name     => 'strmadmin.streams_queue',
    include_dml    => TRUE);
END;
/
```

Running this procedure performs the following actions:

- Creates one rule which evaluates to `TRUE` for DML changes to the `hr.departments` table. The rule name is system generated.
- Adds the rule to the positive rule set associated with the synchronous capture.
- Prepares the `hr.departments` table for **instantiation** by running the `PREPARE_SYNC_INSTANTIATION` function in the `DBMS_CAPTURE_ADM` package.

Note:

- A synchronous capture captures changes to a table only if the `ADD_TABLE_RULES` or `ADD_SUBSET_RULES` procedure was used to add the rule or rules for the table to the synchronous capture rule set. Synchronous capture does not capture changes to a table if a table or subset rule is added to its rule set using the `ADD_RULE` procedure in the `DBMS_RULE_ADM` package. In addition, a synchronous capture ignores all non-table and non-subset rules in its rule set, including global and schema rules.
 - When the `ADD_TABLE_RULES` or the `ADD_SUBSET_RULES` procedure adds rules to a synchronous capture rule set, the procedure must obtain an exclusive lock on the specified table. If there are outstanding transactions on the specified table, then the procedure waits until it can obtain a lock.
-
-

Removing a Rule from a Rule Set for a Synchronous Capture

You remove a rule from the rule set for a **synchronous capture** if you no longer want the synchronous capture to capture the changes specified in the rule. For example, assume that the `departments3` rule specifies that DML changes to the `hr.departments` table be captured. If you no longer want a synchronous capture to capture changes to the `hr.departments` table, then remove the `departments3` rule from its rule set.

You specify that you want to remove a **rule** from a **rule set** for an existing synchronous capture by running the `REMOVE_RULE` procedure in the `DBMS_STREAMS_ADM` package. For example, the following procedure removes a rule named

departments3 from the **positive rule set** of a synchronous capture named sync_capture.

```
BEGIN
  DBMS_STREAMS_ADM.REMOVE_RULE(
    rule_name      => 'departments3',
    streams_type   => 'sync_capture',
    streams_name   => 'sync_capture',
    drop_unused_rule => TRUE);
END;
/
```

In this example, the `drop_unused_rule` parameter in the `REMOVE_RULE` procedure is set to `TRUE`, which is the default setting. Therefore, if the rule being removed is not in any other rule set, then it will be dropped from the database. If the `drop_unused_rule` parameter is set to `FALSE`, then the rule is removed from the rule set, but it is not dropped from the database.

If you want to remove all of the rules in a rule set for the synchronous capture, then specify `NULL` for the `rule_name` parameter when you run the `REMOVE_RULE` procedure.

See Also: ["Oracle Streams Client with One or More Empty Rule Sets"](#) on page 6-4

Setting the Capture User for a Synchronous Capture

The **capture user** is the user who captures all DML changes that satisfy the **synchronous capture rule set**. Set the capture user for a synchronous capture using the `capture_user` parameter in the `ALTER_SYNC_CAPTURE` procedure in the `DBMS_CAPTURE_ADM` package.

To change the capture user, the user who invokes the `ALTER_SYNC_CAPTURE` procedure must be granted `DBA` role. Only the `SYS` user can set the `capture_user` to `SYS`.

For example, the following procedure sets the capture user for a synchronous capture named `sync_capture` to `hr`.

```
BEGIN
  DBMS_CAPTURE_ADM.ALTER_SYNC_CAPTURE(
    capture_name => 'sync_capture',
    capture_user => 'hr');
END;
/
```

Running this procedure grants the new capture user `enqueue` privilege on the queue used by the synchronous capture and configures the user as a **secure queue** user of the **queue**. In addition, ensure that the capture user has the following privileges:

- EXECUTE privilege on the rule set used by the synchronous capture
- EXECUTE privilege on all **custom rule-based transformation** functions used in the rule set

These privileges must be granted directly to the capture user. They cannot be granted through roles.

Note: If Oracle Database Vault is installed, then the user who changes the capture user must be granted the `BECOME USER` system privilege. Granting this privilege to the user is not required if Oracle Database Vault is not installed. You can revoke the `BECOME USER` system privilege from the user after capture user is changed, if necessary.

Dropping a Synchronous Capture

You run the `DROP_CAPTURE` procedure in the `DBMS_CAPTURE_ADM` package to drop an existing **synchronous capture**. For example, the following procedure drops a synchronous capture named `sync_capture`:

```
BEGIN
  DBMS_CAPTURE_ADM.DROP_CAPTURE(
    capture_name          => 'sync_capture',
    drop_unused_rule_sets => TRUE);
END;
/
```

Because the `drop_unused_rule_sets` parameter is set to `TRUE`, this procedure also drops any **rule sets** used by the `sync_capture` synchronous capture, unless a rule set is used by another **Oracle Streams client**. If the `drop_unused_rule_sets` parameter is set to `TRUE`, then the rule set for the synchronous capture might be dropped. If this procedure drops a rule set, then it also drops any **rules** in the rule set that are not in another rule set.

Managing Extra Attributes in Captured LCRs

You can use the `INCLUDE_EXTRA_ATTRIBUTE` procedure in the `DBMS_CAPTURE_ADM` package to instruct a **capture process** or a **synchronous capture** to capture one or more extra attributes. You can also use this procedure to instruct a capture process or synchronous capture to exclude an extra attribute that it is capturing currently.

The extra attributes are the following:

- `row_id` (row LCRs only)
- `serial#`
- `session#`
- `thread#`
- `tx_name`
- `username`

This section contains instructions for completing the following tasks:

- [Including Extra Attributes in Implicitly LCRs](#)
- [Excluding Extra Attributes from Implicitly LCRs](#)

See Also:

- ["Extra Information in LCRs"](#) on page 2-6
- ["Viewing the Extra Attributes Captured by Implicit Capture"](#) on page 23-17
- *Oracle Database PL/SQL Packages and Types Reference* for more information about the `INCLUDE_EXTRA_ATTRIBUTE` procedure

Including Extra Attributes in Implicitly LCRs

To include an extra attribute in the LCRs captured by a capture process or synchronous capture, run the `INCLUDE_EXTRA_ATTRIBUTES` procedure, and set the `include` parameter to `TRUE`. For example, to instruct a capture process or synchronous capture named `strm01_capture` to include the transaction name in each LCR that it captures, run the following procedure:

```
BEGIN
  DBMS_CAPTURE_ADM.INCLUDE_EXTRA_ATTRIBUTE (
    capture_name => 'strm01_capture',
    attribute_name => 'tx_name',
    include      => TRUE);
END;
/
```

Excluding Extra Attributes from Implicitly LCRs

To exclude an extra attribute from the LCRs captured by a capture process or synchronous capture, run the `INCLUDE_EXTRA_ATTRIBUTES` procedure, and set the `include` parameter to `FALSE`. For example, to instruct a capture process or synchronous capture named `strm01_capture` to exclude the transaction name from each LCR that it captures, run the following procedure:

```
BEGIN
  DBMS_CAPTURE_ADM.INCLUDE_EXTRA_ATTRIBUTE (
    capture_name => 'strm01_capture',
    attribute_name => 'tx_name',
    include      => FALSE);
END;
/
```

Switching From a Capture Process to a Synchronous Capture

This section describes how to switch from a [capture process](#) to a [synchronous capture](#). Typically, a synchronous capture is used to capture data manipulation language (DML) changes to a relatively small number of tables. You might decide to make this switch if you are currently capturing changes to a small number of tables with a capture process instead of a synchronous capture.

You should not switch from a capture process to a synchronous capture if any of the following conditions are true:

- Instead of capturing the changes made to a small number of tables, the capture process is capturing changes made to an entire database, one or more schemas, or a large number of tables, and you want to continue to capture these changes.

- The capture process is capturing data definition language (DDL) changes, and you want to continue to capture DDL changes. A synchronous capture cannot capture DDL changes.
- The capture process uses a **negative rule set**, and you want to continue to use a negative rule set. A synchronous capture cannot use negative rule set.
- The capture process is a **downstream capture process**. Downstream capture is not possible with a synchronous capture.

This section uses an example to describe how to switch from a capture process to a synchronous capture. Table 14–1 shows the Oracle Streams components in the sample environment before the switch and after the switch.

Table 14–1 Sample Switch From a Capture Process to a Synchronous Capture

Oracle Streams Component	Before Switch	After Switch
Capture Process	cap_proc	None
Capture Process Rule Set	cap_rules	None
Synchronous Capture	None	sync_cap
Synchronous Capture Rule Set	None	cap_rules
Propagation	cap_proc_prop	sync_cap_prop
Propagation Rule Set	prop_rules	prop_rules
Source Queue	cap_proc_source	sync_cap_source
Destination Queue	cap_proc_dest	sync_cap_dest
Apply Process	apply_cap_proc	apply_sync_cap
Apply Process Rule Set	apply_rules	apply_rules

In Table 14–1, notice that the Oracle Streams environment uses the same **rule sets** before the switch and after the switch. Also, for the example in this section, assume that the **source database** is `db1.example.com` and the **destination database** is `db2.example.com`.

Note: The example in this section assumes that the Oracle Streams environment only involves two databases. If you are using a **directed network** to send changes through multiple databases, then you might need to configure additional **propagations** and **queues** for the new synchronous capture stream of changes, and you might need to drop additional propagations and queues that were used by the capture process stream.

To switch from a capture process to a synchronous capture, complete the following steps:

1. In SQL*Plus, log in to the source database as the Oracle Streams administrator.

This example assumes that the Oracle Streams administrator is `strmadmin` at each database. See "Configuring an Oracle Streams Administrator" on page 9-1 for more information.

2. Stop the capture process.

In this example, run the following procedure:

```

BEGIN
  DBMS_CAPTURE_ADM.STOP_CAPTURE(
    capture_name => 'cap_proc');
END;
/

```

3. In SQL*Plus, log in to the destination database as the Oracle Streams administrator.
4. Create a commit-time queue for the **apply process** that will apply the changes that were captured by the synchronous capture.

In this example, run the following procedure:

```

BEGIN
  DBMS_STREAMS_ADM.SET_UP_QUEUE(
    queue_table => 'strmadmin.sync_cap_dest_qt',
    queue_name => 'strmadmin.sync_cap_dest');
END;
/

```

5. Create an apply process that applies the changes in the queue created in Step 4. Ensure that the `apply_captured` parameter is set to `FALSE`. Also, ensure that the `rule_set_name` parameter specifies the rule set used by the existing apply process.

In this example, run the following procedure:

```

BEGIN
  DBMS_APPLY_ADM.CREATE_APPLY(
    queue_name => 'strmadmin.sync_cap_dest',
    apply_name => 'apply_sync_cap',
    rule_set_name => 'strmadmin.apply_rules',
    apply_captured => FALSE);
END;
/

```

Ensure that the apply process is configured properly for your environment. Specifically, ensure that the new apply process is configured properly regarding the following items:

- Apply user
- Apply handlers
- Apply tag

If appropriate, then ensure that the new apply process is configured in the same way as the existing apply process regarding these items.

See "[Creating an Apply Process Using the DBMS_APPLY_ADM Package](#)" on page 12-4.

6. In SQL*Plus, log in to the source database as the Oracle Streams administrator.
7. Create a **commit-time queue** for the synchronous capture.

In this example, run the following procedure:

```

BEGIN
  DBMS_STREAMS_ADM.SET_UP_QUEUE(
    queue_table => 'strmadmin.sync_cap_source_qt',
    queue_name => 'strmadmin.sync_cap_source');
END;
/

```

See ["Configuring Queues"](#) on page 11-1.

8. Create a propagation that sends changes from the queue created in Step 7 to the queue created in Step 4. Ensure that the `rule_set_name` parameter specifies the rule set used by the existing propagation.

In this example, run the following procedure:

```
BEGIN
  DBMS_PROPAGATION_ADM.CREATE_PROPAGATION(
    propagation_name => 'sync_cap_prop',
    source_queue     => 'strmadmin.sync_cap_source',
    destination_queue => 'strmadmin.sync_cap_dest',
    destination_dblink => 'db2.example.com',
    rule_set_name    => 'strmadmin.prop_rules');
END;
/
```

See ["Creating Oracle Streams Propagations Between ANYDATA Queues"](#) on page 11-3.

9. Create a synchronous capture. Ensure that the `queue_name` parameter specifies the queue created in Step 7. Also, ensure that the `rule_set_name` parameter specifies the rule set used by the existing capture process.

In this example, run the following procedure:

```
BEGIN
  DBMS_CAPTURE_ADM.CREATE_SYNC_CAPTURE(
    queue_name      => 'strmadmin.sync_cap_source',
    capture_name    => 'sync_cap',
    rule_set_name   => 'strmadmin.capture_rules');
END;
/
```

The specified rule set must only contain rules that were created using the `ADD_TABLE_RULES` and `ADD_SUBSET_RULES` procedures in the `DBMS_STREAMS_ADM` package. If the current capture process rule set contains other types of rules, then create a new rule set for the synchronous capture and use the `ADD_TABLE_RULES` and `ADD_SUBSET_RULES` procedures to add rules to the new rule set.

In addition, a synchronous capture cannot have a negative rule set. If the current capture process has a negative rule set, and you want the synchronous capture to behave the same as the capture process, then add rules to the positive synchronous capture rule set that result in the same behavior.

If the existing capture process uses a capture user that is not the Oracle Streams administrator, then ensure that you use the `capture_user` parameter in the `CREATE_SYNC_CAPTURE` procedure to specify the correct capture user for the new synchronous capture.

See ["Configuring Synchronous Capture"](#) on page 10-23.

10. Verify that the tables that are configured for synchronous capture are the same as the ones configured for the existing capture process by running the following query:

```
SELECT * FROM DBA_SYNC_CAPTURE_TABLES ORDER BY TABLE_OWNER, TABLE_NAME;
```

If any table is missing or not enabled, then use the `ADD_TABLE_RULES` or `ADD_SUBSET_RULES` procedure to add the table.

11. Prepare the replicated tables for instantiation. The replicated tables are the tables for which the synchronous capture captures changes.

For example, if the synchronous capture captures changes to the `hr.employees` and `hr.departments` tables, then run the following function:

```
SET SERVEROUTPUT ON
DECLARE
    tables          DBMS_UTILITY.UNCL_ARRAY;
    prepare_scn     NUMBER;
BEGIN
    tables(1) := 'hr.departments';
    tables(2) := 'hr.employees';
    prepare_scn := DBMS_CAPTURE_ADM.PREPARE_SYNC_INSTANTIATION(
        table_names => tables);
    DBMS_OUTPUT.PUT_LINE('Prepare SCN = ' || prepare_scn);
END;
/
```

The returned prepare system change number (SCN) is used in Steps 13, 17, and 18. This example assumes that the prepare SCN is 2700000.

All of the replicated tables must be included in one call to the `PREPARE_SYNC_INSTANTIATION` function.

See *Oracle Streams Replication Administrator's Guide* for more information about preparing database objects for instantiation.

12. In SQL*Plus, log in to the destination database as the Oracle Streams administrator.
13. Set the apply process that applies changes from the capture process to stop applying changes when it reaches the SCN returned in Step 11 plus 1.

For example, if the prepare SCN is 2700000, then run the following procedure to set the `maximum_scn` parameter to 2700001 (2700000 + 1):

```
BEGIN
    DBMS_APPLY_ADM.SET_PARAMETER(
        apply_name => 'apply_cap_proc',
        parameter  => 'maximum_scn',
        value      => '2700001');
END;
/
```

14. In SQL*Plus, log in to the source database as the Oracle Streams administrator.
15. Start the capture process that you stopped in Step 2.

In this example, run the following procedure:

```
BEGIN
    DBMS_CAPTURE_ADM.START_CAPTURE(
        capture_name => 'cap_proc');
END;
/
```

16. In SQL*Plus, log in to the destination database as the Oracle Streams administrator.
17. Wait until the apply process that applies changes that were captured by the capture process has reached the SCN specified in Step 13. When this event occurs,

the apply process is automatically disabled with error ORA-26717 to indicate the SCN limit has reached.

To determine if the apply process has reached this point, query the DBA_APPLY view. In this example, run the following query:

```
SELECT 1 FROM DBA_APPLY
WHERE STATUS      = 'DISABLED' AND
      ERROR_NUMBER = 26717 AND
      APPLY_NAME   = 'APPLY_CAP_PROC';
```

Do not proceed to the next step until this query returns a row.

18. Set the **instantiation SCN** for the replicated tables to the SCN value the SCN returned in Step 11.

In this example, run the following procedures:

```
BEGIN
  DBMS_APPLY_ADM.SET_TABLE_INSTANTIATION_SCN(
    source_object_name => 'hr.employees',
    source_database_name => 'db1.example.com',
    instantiation_scn   => 2700000);
END;
/

BEGIN
  DBMS_APPLY_ADM.SET_TABLE_INSTANTIATION_SCN(
    source_object_name => 'hr.departments',
    source_database_name => 'db1.example.com',
    instantiation_scn   => 2700000);
END;
/
```

See *Oracle Streams Replication Administrator's Guide* for more information about setting the instantiation SCN.

19. Start the apply process that you created in Step 5.

In this example, run the following procedure:

```
BEGIN
  DBMS_APPLY_ADM.START_APPLY(
    apply_name => 'apply_sync_cap');
END;
/
```

20. Drop the apply process that applied changes that were captured by the capture process.

In this example, run the following procedure:

```
BEGIN
  DBMS_APPLY_ADM.DROP_APPLY(
    apply_name => 'apply_cap_proc');
END;
/
```

21. If it is no longer needed, then drop the queue that was used by the apply process that you dropped in Step 20.

In this example, run the following procedure:

```
BEGIN
  DBMS_STREAMS_ADM.REMOVE_QUEUE(
    queue_name => 'strmadmin.cap_proc_dest',
    drop_unused_queue_table => TRUE);
END;
/
```

22. In SQL*Plus, log in to the source database as the Oracle Streams administrator.

23. Stop the capture process.

In this example, run the following procedure:

```
BEGIN
  DBMS_CAPTURE_ADM.STOP_CAPTURE(
    capture_name => 'cap_proc');
END;
/
```

24. Drop the capture process.

In this example, run the following procedure:

```
BEGIN
  DBMS_CAPTURE_ADM.DROP_CAPTURE(
    capture_name => 'cap_proc');
END;
/
```

25. Drop the propagation that sent changes that were captured by the capture process.

In this example, run the following procedure:

```
BEGIN
  DBMS_PROPAGATION_ADM.DROP_PROPAGATION(
    propagation_name => 'cap_proc_prop');
END;
/
```

26. If it is no longer needed, then drop the queue that was used by the capture process and propagation that you dropped in Steps 24 and 25.

In this example, run the following procedure:

```
BEGIN
  DBMS_STREAMS_ADM.REMOVE_QUEUE(
    queue_name => 'strmadmin.cap_proc_source',
    drop_unused_queue_table => TRUE);
END;
/
```

If you have a bi-directional **replication** environment, then you can perform these steps independently to switch from a capture process to synchronous capture in both directions.

See Also:

- [Chapter 2, "Oracle Streams Information Capture"](#)
- [Chapter 6, "How Rules Are Used in Oracle Streams"](#)

Switching from a Synchronous Capture to a Capture Process

This section describes how to switch from a **synchronous capture** to a **capture process**. You might decide to make this switch for one or more of the following reasons:

- You are currently capturing changes to a small number of tables but want to expand your environment to capture changes to a large number of tables, one or more schemas, or an entire database.
- You want to use a **negative rule set** during change capture.
- You want to capture data definition language (DDL) changes to database objects.

This section uses an example to describe how to switch from a synchronous capture to a capture process. Table 14-2 shows the Oracle Streams components in the sample environment before the switch and after the switch.

Table 14-2 Sample Switch From a Synchronous Capture to a Capture Process

Oracle Streams Component	Before Switch	After Switch
Synchronous Capture	sync_proc	None
Synchronous Capture Rule Set	cap_rules	None
Capture Process	None	cap_proc
Capture Process Rule Set	None	cap_rules
Propagation	sync_cap_prop	cap_proc_prop
Propagation Rule Set	prop_rules	prop_rules
Source Queue	sync_cap_source	cap_proc_source
Destination Queue	sync_cap_dest	cap_proc_dest
Apply Process	apply_sync_cap	apply_cap_proc
Apply Process Rule Set	apply_rules	apply_rules

In Table 14-2, notice that the Oracle Streams environment uses the same **rule sets** before the switch and after the switch. Also, for the example in this section, assume that the **source database** is `db1.example.com` and the **destination database** is `db2.example.com`.

Note: The example in this section assumes that the Oracle Streams environment only involves two databases. If you are using a **directed network** to send changes through multiple databases, then you might need to configure additional **propagations** and **queues** for the new capture process stream of changes, and you might need to drop additional propagations and queues that were used by the synchronous capture stream.

To switch from a synchronous capture to a capture process, complete the following steps:

1. Ensure that the source database is running in ARCHIVELOG mode. See "[ARCHIVELOG Mode and a Capture Process](#)" on page 2-28 and *Oracle Database Administrator's Guide* for more information.
2. In SQL*Plus, log in to the destination database as the Oracle Streams administrator.

This example assumes that the Oracle Streams administrator is `strmadmin` at each database. See ["Configuring an Oracle Streams Administrator"](#) on page 9-1 for more information.

3. Create the queue for the **apply process** that will apply the changes that were captured by the capture process.

In this example, run the following procedure:

```
BEGIN
  DBMS_STREAMS_ADM.SET_UP_QUEUE(
    queue_table => 'strmadmin.cap_proc_dest_qt',
    queue_name  => 'strmadmin.cap_proc_dest');
END;
/
```

See ["Configuring Queues"](#) on page 11-1.

4. Create an apply process that applies the changes in the queue created in Step 3. Ensure that the `apply_captured` parameter is set to `TRUE`. Also, ensure that the `rule_set_name` parameter specifies the rule set used by the existing apply process.

In this example, run the following procedure:

```
BEGIN
  DBMS_APPLY_ADM.CREATE_APPLY(
    queue_name      => 'strmadmin.cap_proc_dest',
    apply_name     => 'apply_cap_proc',
    rule_set_name  => 'strmadmin.apply_rules',
    apply_captured => TRUE);
END;
/
```

Ensure that the apply process is configured properly for your environment. Specifically, ensure that the new apply process is configured properly regarding the following items:

- Apply user
- Apply handlers
- Apply tag

If appropriate, then ensure that the new apply process is configured in the same way as the existing apply process regarding these items.

See ["Creating an Apply Process Using the DBMS_APPLY_ADM Package"](#) on page 12-4.

5. Stop the apply process that applies changes captured by the synchronous capture.

In this example, run the following procedure:

```
BEGIN
  DBMS_APPLY_ADM.STOP_APPLY(
    apply_name => 'apply_sync_cap');
END;
/
```

6. In SQL*Plus, log in to the source database as the Oracle Streams administrator.
7. Create the queue for the capture process.

In this example, run the following procedure:

```

BEGIN
  DBMS_STREAMS_ADM.SET_UP_QUEUE(
    queue_table => 'strmadmin.cap_proc_source_qt',
    queue_name  => 'strmadmin.cap_proc_source');
END;
/

```

8. Create a propagation that sends changes from the queue created in Step 7 to the queue created in Step 3. Ensure that the `rule_set_name` parameter specifies the rule set used by the existing propagation.

In this example, run the following procedure:

```

BEGIN
  DBMS_PROPAGATION_ADM.CREATE_PROPAGATION(
    propagation_name => 'cap_proc_prop',
    source_queue     => 'strmadmin.cap_proc_source',
    destination_queue => 'strmadmin.cap_proc_dest',
    destination_dblink => 'db2.example.com',
    rule_set_name     => 'strmadmin.prop_rules');
END;
/

```

See ["Creating Oracle Streams Propagations Between ANYDATA Queues"](#) on page 11-3

9. Create a capture process. Ensure that the parameters are set properly in the `CREATE_CAPTURE` procedure:
 - Set the `queue_name` parameter to the queue created in Step 7.
 - Set the `rule_set_name` parameter to the rule set used by the existing synchronous capture.
 - If the existing synchronous capture uses a capture user that is not the Oracle Streams administrator, then set the `capture_user` parameter to the correct capture user for the new capture process.

In this example, run the following procedure:

```

BEGIN
  DBMS_CAPTURE_ADM.CREATE_CAPTURE(
    queue_name     => 'strmadmin.cap_proc_source',
    capture_name   => 'cap_proc',
    rule_set_name  => 'strmadmin.cap_rules');
END;
/

```

See ["Configuring a Capture Process"](#) on page 10-1.

10. Prepare the replicated tables for instantiation. The replicated tables are the tables for which the capture process captures changes.

For example, if the capture process captures changes to the `hr.employees` and `hr.departments` tables, then run the following procedures:

```

BEGIN
  DBMS_CAPTURE_ADM.PREPARE_TABLE_INSTANTIATION(
    table_name      => 'hr.employees',
    supplemental_logging => 'keys');
END;
/

```

```

BEGIN
  DBMS_CAPTURE_ADM.PREPARE_TABLE_INSTANTIATION(
    table_name      => 'hr.departments',
    supplemental_logging => 'keys');
END;
/

```

See *Oracle Streams Replication Administrator's Guide* for more information about preparing database objects for instantiation.

11. Lock all of the replicated tables in SHARE MODE.

In this example, run the following SQL statement:

```
LOCK TABLE hr.employees, hr.departments IN SHARE MODE;
```

12. Determine the current system change number (SCN) by running the following query:

```
SELECT CURRENT_SCN FROM V$DATABASE;
```

The returned switch SCN is used in Steps 15 and 18. This example assumes that the switch SCN is 2700000.

13. Run a COMMIT statement to release the lock on the replicated tables:

```
COMMIT;
```

14. In SQL*Plus, log in to the destination database as the Oracle Streams administrator.

15. Set the apply process that applies changes from the synchronous capture to stop applying changes when it reaches the SCN returned in Step 12 plus 1.

For example, if the switch SCN is 2700000, then run the following procedure to set the `maximum_scn` parameter to 2700001 (2700000 + 1):

```

BEGIN
  DBMS_APPLY_ADM.SET_PARAMETER(
    apply_name  => 'apply_sync_cap',
    parameter   => 'maximum_scn',
    value       => '2700001');
END;
/

```

16. Start the apply process that applies changes from the synchronous capture.

In this example, run the following procedure:

```

BEGIN
  DBMS_APPLY_ADM.START_APPLY(
    apply_name => 'apply_sync_cap');
END;
/

```

17. Wait until the apply process that applies changes that were captured by the synchronous capture has reached the SCN specified in Step 15. When this event occurs, the apply process is automatically disabled with error ORA-26717 to indicate the SCN limit has reached.

To determine if the apply process has reached this point, query the `DBA_APPLY` view. In this example, run the following query:

```

SELECT 1 FROM DBA_APPLY
WHERE STATUS      = 'DISABLED' AND
      ERROR_NUMBER = 26717 AND
      APPLY_NAME   = 'APPLY_SYNC_CAP';

```

Do not proceed to the next step until this query returns a row.

- 18.** Set the **instantiation SCN** for the replicated tables to the SCN value returned in Step 12.

In this example, run the following procedures:

```

BEGIN
  DBMS_APPLY_ADM.SET_TABLE_INSTANTIATION_SCN(
    source_object_name => 'hr.employees',
    source_database_name => 'db1.example.com',
    instantiation_scn   => 2700000);
END;
/

BEGIN
  DBMS_APPLY_ADM.SET_TABLE_INSTANTIATION_SCN(
    source_object_name => 'hr.departments',
    source_database_name => 'db1.example.com',
    instantiation_scn   => 2700000);
END;
/

```

See *Oracle Streams Replication Administrator's Guide* for more information about setting the instantiation SCN.

- 19.** Start the apply process that you created in Step 4.

In this example, run the following procedure:

```

BEGIN
  DBMS_APPLY_ADM.START_APPLY(
    apply_name => 'apply_cap_proc');
END;
/

```

- 20.** Drop the apply process that applied changes that were captured by the synchronous capture.

In this example, run the following procedure:

```

BEGIN
  DBMS_APPLY_ADM.DROP_APPLY(
    apply_name => 'apply_sync_cap');
END;
/

```

- 21.** If it is no longer needed, then drop the queue that was used by the apply process that you dropped in Step 20.

In this example, run the following procedure:

```

BEGIN
  DBMS_STREAMS_ADM.REMOVE_QUEUE(
    queue_name           => 'strmadmin.sync_cap_dest',
    drop_unused_queue_table => TRUE);
END;
/

```

22. In SQL*Plus, log in to the source database as the Oracle Streams administrator.

23. Start the capture process that you created in Step 9.

In this example, run the following procedure:

```
BEGIN
  DBMS_CAPTURE_ADM.START_CAPTURE(
    capture_name => 'cap_proc');
END;
/
```

24. Drop the synchronous capture.

In this example, run the following procedure:

```
BEGIN
  DBMS_CAPTURE_ADM.DROP_CAPTURE(
    capture_name => 'sync_cap');
END;
/
```

25. Drop the propagation that sent changes that were captured by the synchronous capture.

In this example, run the following procedure:

```
BEGIN
  DBMS_PROPAGATION_ADM.DROP_PROPAGATION(
    propagation_name => 'sync_cap_prop');
END;
/
```

26. If it is no longer needed, then drop the queue that was used by the synchronous capture and propagation that you dropped in Steps 24 and 25.

In this example, run the following procedure:

```
BEGIN
  DBMS_STREAMS_ADM.REMOVE_QUEUE(
    queue_name           => 'strmadmin.sync_cap_source',
    drop_unused_queue_table => TRUE);
END;
/
```

If you have a bi-directional **replication** environment, then you can perform these steps independently to switch from a synchronous capture to a capture process in both directions.

See Also:

- [Chapter 2, "Oracle Streams Information Capture"](#)
- [Chapter 6, "How Rules Are Used in Oracle Streams"](#)

Managing Staging and Propagation

The following topics describe managing **ANYDATA queues** and **propagations**:

- [Managing Queues](#)
- [Managing Oracle Streams Propagations and Propagation Jobs](#)

Each task described in this chapter should be completed by an Oracle Streams administrator that has been granted the appropriate privileges, unless specified otherwise.

See Also:

- [Chapter 3, "Oracle Streams Staging and Propagation"](#)
- ["Configuring an Oracle Streams Administrator"](#) on page 9-1
- ["Monitoring Queues and Messaging"](#) on page 24-1
- ["Monitoring Oracle Streams Propagations and Propagation Jobs"](#) on page 24-13
- ["Troubleshooting Propagation Problems"](#) on page 20-11

Managing Queues

An ANYDATA queue stages **messages** whose payloads are of ANYDATA type. Therefore, an ANYDATA queue can stage a message with a payload of nearly any type, if the payload is wrapped in an ANYDATA wrapper. Each Oracle Streams **capture process**, **apply process**, and **messaging client** is associated with one ANYDATA queue, and each Oracle Streams **propagation** is associated with one ANYDATA **source queue** and one ANYDATA **destination queue**.

This section contains instructions for completing the following tasks related to queues:

- [Enabling a User to Perform Operations on a Secure Queue](#)
- [Disabling a User from Performing Operations on a Secure Queue](#)
- [Removing a Queue](#)

Enabling a User to Perform Operations on a Secure Queue

For a user to perform **queue** operations, such as enqueue and dequeue, on a **secure queue**, the user must be configured as a secure queue user of the queue. If you use the `SET_UP_QUEUE` procedure in the `DBMS_STREAMS_ADM` package to create the secure queue, then the queue owner and the user specified by the `queue_user` parameter are configured as secure users of the queue automatically. If you want to enable other

users to perform operations on the queue, then you can configure these users in one of the following ways:

- Run `SET_UP_QUEUE` and specify a `queue_user`. Queue creation is skipped if the queue already exists, but a new queue user is configured if one is specified.
- Associate the user with an Oracle Streams Advanced Queuing (AQ) agent manually.

The following example illustrates associating a user with an Oracle Streams AQ agent manually. Suppose you want to enable the `oe` user to perform queue operations on the `streams_queue` created in "Creating an ANYDATA Queue" on page 11-1. The following steps configure the `oe` user as a secure queue user of `streams_queue`:

1. In SQL*Plus, connect as an administrative user who can create Oracle Streams AQ agents and alter users.

See *Oracle Database Administrator's Guide* for information about connecting to a database in SQL*Plus.

2. Create an agent:

```
EXEC DBMS_AQADM.CREATE_AQ_AGENT(agent_name => 'streams_queue_agent');
```

3. If the user must be able to dequeue **messages** from queue, then make the agent a subscriber of the secure queue:

```
DECLARE
  subscriber SYS.AQ$_AGENT;
BEGIN
  subscriber := SYS.AQ$_AGENT('streams_queue_agent', NULL, NULL);
  DBMS_AQADM.ADD_SUBSCRIBER(
    queue_name      => 'strmadmin.streams_queue',
    subscriber      => subscriber,
    rule            => NULL,
    transformation  => NULL);
END;
/
```

4. Associate the user with the agent:

```
BEGIN
  DBMS_AQADM.ENABLE_DB_ACCESS(
    agent_name => 'streams_queue_agent',
    db_username => 'oe');
END;
/
```

5. Grant the user EXECUTE privilege on the `DBMS_STREAMS_MESSAGING` package or the `DBMS_AQ` package, if the user is not already granted these privileges:

```
GRANT EXECUTE ON DBMS_STREAMS_MESSAGING TO oe;
```

```
GRANT EXECUTE ON DBMS_AQ TO oe;
```

When these steps are complete, the `oe` user is a secure user of the `streams_queue` queue and can perform operations on the queue. You still must grant the user specific privileges to perform queue operations, such as enqueue and dequeue privileges.

See Also:

- ["Secure Queues"](#) on page 3-5
- *Oracle Database PL/SQL Packages and Types Reference* for more information about Oracle Streams AQ agents and using the DBMS_AQADM package

Disabling a User from Performing Operations on a Secure Queue

You might want to disable a user from performing **queue** operations on a **secure queue** for the following reasons:

- You dropped a **capture process** or a **synchronous capture**, but you did not drop the queue that was used by the capture process or synchronous capture, and you do not want the user who was the **capture user** to be able to perform operations on the remaining secure queue.
- You dropped an **apply process**, but you did not drop the queue that was used by the apply process, and you do not want the user who was the **apply user** to be able to perform operations on the remaining secure queue.
- You used the ALTER_APPLY procedure in the DBMS_APPLY_ADM package to change the apply_user for an apply process, and you do not want the old apply_user to be able to perform operations on the apply process queue.
- You enabled a user to perform operations on a secure queue by completing the steps described in [Enabling a User to Perform Operations on a Secure Queue](#) on page 15-1, but you no longer want this user to be able to perform operations on the secure queue.

To disable a secure queue user, you can revoke ENQUEUE and DEQUEUE privilege on the queue from the user, or you can run the DISABLE_DB_ACCESS procedure in the DBMS_AQADM package. For example, suppose you want to disable the oe user from performing queue operations on the streams_queue created in ["Creating an ANYDATA Queue"](#) on page 11-1.

Caution: If an Oracle Streams AQ agent is used for multiple secure queues, then running DISABLE_DB_ACCESS for the agent prevents the user associated with the agent from performing operations on all of these queues.

1. Run the following procedure to disable the oe user from performing queue operations on the secure queue streams_queue:

```
BEGIN
  DBMS_AQADM.DISABLE_DB_ACCESS (
    agent_name => 'streams_queue_agent',
    db_username => 'oe');
END;
/
```

2. If the agent is no longer needed, you can drop the agent:

```
BEGIN
  DBMS_AQADM.DROP_AQ_AGENT(
    agent_name => 'streams_queue_agent');
END;
/
```

3. Revoke privileges on the queue from the user, if the user no longer needs these privileges.

```
BEGIN
  DBMS_AQADM.REVOKE_QUEUE_PRIVILEGE (
    privilege => 'ALL',
    queue_name => 'strmadmin.streams_queue',
    grantee   => 'oe');
END;
/
```

See Also:

- ["Secure Queues"](#) on page 3-5
- *Oracle Database PL/SQL Packages and Types Reference* for more information about Oracle Streams AQ agents and using the DBMS_AQADM package

Removing a Queue

You use the `REMOVE_QUEUE` procedure in the `DBMS_STREAMS_ADM` package to remove an existing ANYDATA queue. When you run the `REMOVE_QUEUE` procedure, it waits until any existing **messages** in the **queue** are consumed. Next, it stops the queue, which means that no further enqueues into the queue or dequeues from the queue are allowed. When the queue is stopped, it drops the queue.

You can also drop the **queue table** for the queue if it is empty and is not used by another queue. To do so, specify `TRUE`, the default, for the `drop_unused_queue_table` parameter.

In addition, you can drop any **Oracle Streams clients** that use the queue by setting the `cascade` parameter to `TRUE`. By default, the `cascade` parameter is set to `FALSE`.

For example, to remove an ANYDATA queue named `streams_queue` in the `strmadmin` schema and drop its empty queue table, run the following procedure:

```
BEGIN
  DBMS_STREAMS_ADM.REMOVE_QUEUE(
    queue_name           => 'strmadmin.streams_queue',
    cascade              => FALSE,
    drop_unused_queue_table => TRUE);
END;
/
```

In this case, because the `cascade` parameter is set to `FALSE`, this procedure drops the `streams_queue` only if no Oracle Streams clients use the queue. If the `cascade` parameter is set to `FALSE` and any Oracle Streams client uses the queue, then an error is raised.

Managing Oracle Streams Propagations and Propagation Jobs

A **propagation** propagates **messages** from an Oracle Streams **source queue** to an Oracle Streams **destination queue**. This section provides instructions for completing the following tasks:

- [Starting a Propagation](#)
- [Stopping a Propagation](#)
- [Altering the Schedule of a Propagation Job](#)

- [Specifying the Rule Set for a Propagation](#)
- [Adding Rules to the Rule Set for a Propagation](#)
- [Removing a Rule from the Rule Set for a Propagation](#)
- [Removing a Rule Set for a Propagation](#)
- [Dropping a Propagation](#)

In addition, you can use the features of Oracle Streams Advanced Queuing (AQ) to manage Oracle Streams propagations.

See Also:

- ["Message Propagation Between Queues"](#) on page 3-11
- *Oracle Database 2 Day + Data Replication and Integration Guide* and the Oracle Enterprise Manager online Help for instructions on managing propagations with Enterprise Manager
- *Oracle Streams Advanced Queuing User's Guide* for more information about managing propagations with the features of Oracle Streams AQ

Starting a Propagation

You run the `START_PROPAGATION` procedure in the `DBMS_PROPAGATION_ADM` package to start an existing **propagation**. For example, the following procedure starts a propagation named `strm01_propagation`:

```
BEGIN
  DBMS_PROPAGATION_ADM.START_PROPAGATION(
    propagation_name => 'strm01_propagation');
END;
/
```

Stopping a Propagation

You run the `STOP_PROPAGATION` procedure in the `DBMS_PROPAGATION_ADM` package to stop an existing **propagation**. For example, the following procedure stops a propagation named `strm01_propagation`:

```
BEGIN
  DBMS_PROPAGATION_ADM.STOP_PROPAGATION(
    propagation_name => 'strm01_propagation',
    force             => FALSE);
END;
/
```

To clear the statistics for the propagation when it is stopped, set the `force` parameter to `TRUE`. If there is a problem with a propagation, then stopping the propagation with the `force` parameter set to `TRUE` and restarting the propagation might correct the problem. If the `force` parameter is set to `FALSE`, then the statistics for the propagation are not cleared.

Altering the Schedule of a Propagation Job

To alter the schedule of an existing **propagation job**, use the `ALTER_PROPAGATION_SCHEDULE` procedure in the `DBMS_AQADM` package. The following sections contain examples that alter the schedule of a propagation job for a queue-to-queue

propagation and for a queue-to-dblink propagation. These examples set the propagation job to propagate **messages** every 15 minutes (900 seconds), with each propagation lasting 300 seconds, and a 25-second wait before new messages in a completely propagated **queue** are propagated.

This section contains these topics:

- [Altering the Schedule of a Propagation Job for a Queue-to-Queue Propagation](#)
- [Altering the Schedule of a Propagation Job for a Queue-to-Dblink Propagation](#)

See Also:

- *Oracle Streams Advanced Queuing User's Guide* for more information about using the ALTER_PROPAGATION_SCHEDULE procedure
- ["Queue-to-Queue Propagations"](#) on page 3-13
- ["Propagation Jobs"](#) on page 3-17

Altering the Schedule of a Propagation Job for a Queue-to-Queue Propagation

To alter the schedule of a propagation job for a queue-to-queue propagation that propagates messages from the `strmadmin.strm_a_queue` source queue to the `strmadmin.strm_b_queue` **destination queue** using the `db2.example.com` database link, run the following procedure:

```
BEGIN
  DBMS_AQADM.ALTER_PROPAGATION_SCHEDULE(
    queue_name      => 'strmadmin.strm_a_queue',
    destination     => 'db2.example.com',
    duration        => 300,
    next_time       => 'SYSDATE + 900/86400',
    latency         => 25,
    destination_queue => 'strmadmin.strm_b_queue');
END;
/
```

Because each queue-to-queue propagation has its own propagation job, this procedure alters only the schedule of the propagation that propagates messages between the two queues specified. The `destination_queue` parameter must specify the name of the destination queue to alter the **propagation schedule** of a queue-to-queue propagation.

Altering the Schedule of a Propagation Job for a Queue-to-Dblink Propagation

To alter the schedule of a propagation job for a queue-to-dblink propagation that propagates messages from the `strmadmin.streams_queue` source queue using the `db3.example.com` database link, run the following procedure:

```
BEGIN
  DBMS_AQADM.ALTER_PROPAGATION_SCHEDULE(
    queue_name  => 'strmadmin.streams_queue',
    destination => 'db3.example.com',
    duration    => 300,
    next_time   => 'SYSDATE + 900/86400',
    latency     => 25);
END;
/
```

Because the propagation is a queue-to-dblink propagation, the `destination_queue` parameter is not specified. Completing this task affects all queue-to-dblink

propagations that propagate messages from the source queue to all destination queues that use the `db3.example.com` database link.

Specifying the Rule Set for a Propagation

You can specify one **positive rule set** and one **negative rule set** for a **propagation**. The propagation propagates a **message** if it evaluates to `TRUE` for at least one **rule** in the positive rule set and discards a change if it evaluates to `TRUE` for at least one rule in the negative rule set. The negative rule set is evaluated before the positive rule set.

This section contains these topics:

- [Specifying a Positive Rule Set for a Propagation](#)
- [Specifying a Negative Rule Set for a Propagation](#)

See Also:

- [Chapter 5, "Rules"](#)
- [Chapter 6, "How Rules Are Used in Oracle Streams"](#)

Specifying a Positive Rule Set for a Propagation

You specify an existing **rule set** as the **positive rule set** for an existing **propagation** using the `rule_set_name` parameter in the `ALTER_PROPAGATION` procedure. This procedure is in the `DBMS_PROPAGATION_ADM` package.

For example, the following procedure sets the positive rule set for a propagation named `strm01_propagation` to `strm02_rule_set`.

```
BEGIN
  DBMS_PROPAGATION_ADM.ALTER_PROPAGATION(
    propagation_name => 'strm01_propagation',
    rule_set_name     => 'strmadmin.strm02_rule_set');
END;
/
```

Specifying a Negative Rule Set for a Propagation

You specify an existing **rule set** as the **negative rule set** for an existing **propagation** using the `negative_rule_set_name` parameter in the `ALTER_PROPAGATION` procedure. This procedure is in the `DBMS_PROPAGATION_ADM` package.

For example, the following procedure sets the negative rule set for a propagation named `strm01_propagation` to `strm03_rule_set`.

```
BEGIN
  DBMS_PROPAGATION_ADM.ALTER_PROPAGATION(
    propagation_name      => 'strm01_propagation',
    negative_rule_set_name => 'strmadmin.strm03_rule_set');
END;
/
```

Adding Rules to the Rule Set for a Propagation

To add **rules** to the **rule set** of a **propagation**, you can run one of the following procedures:

- `DBMS_STREAMS_ADM.ADD_TABLE_PROPAGATION_RULES`
- `DBMS_STREAMS_ADM.ADD_SUBSET_PROPAGATION_RULES`

- `DBMS_STREAMS_ADM.ADD_SCHEMA_PROPAGATION_RULES`
- `DBMS_STREAMS_ADM.ADD_GLOBAL_PROPAGATION_RULES`

Excluding the `ADD_SUBSET_PROPAGATION_RULES` procedure, these procedures can add rules to the **positive rule set** or **negative rule set** for a propagation. The `ADD_SUBSET_PROPAGATION_RULES` procedure can add rules only to the positive rule set for a propagation.

This section contains these topics:

- [Adding Rules to the Positive Rule Set for a Propagation](#)
- [Adding Rules to the Negative Rule Set for a Propagation](#)

See Also:

- ["Message Propagation Between Queues"](#) on page 3-11
- ["System-Created Rules"](#) on page 6-5

Adding Rules to the Positive Rule Set for a Propagation

The following example runs the `ADD_TABLE_PROPAGATION_RULES` procedure in the `DBMS_STREAMS_ADM` package to add rules to the positive rule set of an existing propagation named `strm01_propagation`:

```
BEGIN
  DBMS_STREAMS_ADM.ADD_TABLE_PROPAGATION_RULES (
    table_name           => 'hr.locations',
    streams_name         => 'strm01_propagation',
    source_queue_name    => 'strmadmin.strm_a_queue',
    destination_queue_name => 'strmadmin.strm_b_queue@dbs2.example.com',
    include_dml          => TRUE,
    include_ddl          => TRUE,
    source_database      => 'dbs1.example.com',
    inclusion_rule       => TRUE);
END;
/
```

Running this procedure performs the following actions:

- Creates two rules. One rule evaluates to `TRUE` for row LCRs that contain the results of DML changes to the `hr.locations` table. The other rule evaluates to `TRUE` for DDL LCRs that contain DDL changes to the `hr.locations` table. The rule names are system generated.
- Specifies that both rules evaluate to `TRUE` only for LCRs whose changes originated at the `dbs1.example.com` **source database**.
- Adds the two rules to the positive rule set associated with the propagation because the `inclusion_rule` parameter is set to `TRUE`.

Adding Rules to the Negative Rule Set for a Propagation

The following example runs the `ADD_TABLE_PROPAGATION_RULES` procedure in the `DBMS_STREAMS_ADM` package to add rules to the negative rule set of an existing propagation named `strm01_propagation`:

```
BEGIN
  DBMS_STREAMS_ADM.ADD_TABLE_PROPAGATION_RULES (
    table_name           => 'hr.departments',
    streams_name         => 'strm01_propagation',
    source_queue_name    => 'strmadmin.strm_a_queue',
```

```

destination_queue_name => 'strmadmin.strm_b_queue@dbs2.example.com',
include_dml             => TRUE,
include_ddl            => TRUE,
source_database        => 'dbs1.example.com',
inclusion_rule          => FALSE);
END;
/

```

Running this procedure performs the following actions:

- Creates two rules. One rule evaluates to `TRUE` for row LCRs that contain the results of DML changes to the `hr.departments` table, and the other rule evaluates to `TRUE` for DDL LCRs that contain DDL changes to the `hr.departments` table. The rule names are system generated.
- Specifies that both rules evaluate to `TRUE` only for LCRs whose changes originated at the `dbs1.example.com` source database.
- Adds the two rules to the negative rule set associated with the propagation because the `inclusion_rule` parameter is set to `FALSE`.

Removing a Rule from the Rule Set for a Propagation

You remove a **rule** from the **rule set** for an existing **propagation** by running the `REMOVE_RULE` procedure in the `DBMS_STREAMS_ADM` package. For example, the following procedure removes a rule named `departments3` from the **positive rule set** of a propagation named `strm01_propagation`.

```

BEGIN
  DBMS_STREAMS_ADM.REMOVE_RULE(
    rule_name          => 'departments3',
    streams_type       => 'propagation',
    streams_name       => 'strm01_propagation',
    drop_unused_rule   => TRUE,
    inclusion_rule     => TRUE);
END;
/

```

In this example, the `drop_unused_rule` parameter in the `REMOVE_RULE` procedure is set to `TRUE`, which is the default setting. Therefore, if the rule being removed is not in any other rule set, then it will be dropped from the database. If the `drop_unused_rule` parameter is set to `FALSE`, then the rule is removed from the rule set, but it is not dropped from the database even if it is not in any other rule set.

If the `inclusion_rule` parameter is set to `FALSE`, then the `REMOVE_RULE` procedure removes the rule from the **negative rule set** for the propagation, not the positive rule set.

To remove all of the rules in the rule set for the propagation, then specify `NULL` for the `rule_name` parameter when you run the `REMOVE_RULE` procedure.

See Also: ["Oracle Streams Client with One or More Empty Rule Sets"](#) on page 6-4

Removing a Rule Set for a Propagation

You specify that you want to remove a **rule set** from a **propagation** using the `ALTER_PROPAGATION` procedure in the `DBMS_PROPAGATION_ADM` package. This procedure can remove the **positive rule set**, **negative rule set**, or both. Specify `TRUE` for the `remove_rule_set` parameter to remove the positive rule set for the propagation. Specify `TRUE` for the `remove_negative_rule_set` parameter to remove the negative rule set for the propagation.

For example, the following procedure removes both the positive and the negative rule set from a propagation named `strm01_propagation`.

```
BEGIN
  DBMS_PROPAGATION_ADM.ALTER_PROPAGATION(
    propagation_name      => 'strm01_propagation',
    remove_rule_set       => TRUE,
    remove_negative_rule_set => TRUE);
END;
/
```

Note: If a propagation does not have a positive or negative rule set, then the propagation propagates all **messages** in the **source queue** to the **destination queue**.

Dropping a Propagation

You run the `DROP_PROPAGATION` procedure in the `DBMS_PROPAGATION_ADM` package to drop an existing **propagation**. For example, the following procedure drops a propagation named `strm01_propagation`:

```
BEGIN
  DBMS_PROPAGATION_ADM.DROP_PROPAGATION(
    propagation_name      => 'strm01_propagation',
    drop_unused_rule_sets => TRUE);
END;
/
```

Because the `drop_unused_rule_sets` parameter is set to `TRUE`, this procedure also drops any **rule sets** used by the propagation `strm01_propagation`, unless a rule set is used by another **Oracle Streams client**. If the `drop_unused_rule_sets` parameter is set to `TRUE`, then both the **positive rule set** and **negative rule set** for the propagation might be dropped. If this procedure drops a rule set, then it also drops any **rules** in the rule set that are not in another rule set.

Note: When you drop a propagation, the **propagation job** used by the propagation is dropped automatically, if no other propagations are using the propagation job.

Managing Oracle Streams Information Consumption

An **apply process** implicitly consumes information in an Oracle Streams environment. An apply process dequeues logical change records (LCRs) and **user messages** from a specific **queue** and either applies each one directly or passes it as a parameter to a user-defined procedure.

The following topics describe managing Oracle Streams apply processes:

- [Starting an Apply Process](#)
- [Stopping an Apply Process](#)
- [Managing the Rule Set for an Apply Process](#)
- [Setting an Apply Process Parameter](#)
- [Setting the Apply User for an Apply Process](#)
- [Managing the Message Handler for an Apply Process](#)
- [Managing the Precommit Handler for an Apply Process](#)
- [Specifying That Apply Processes Enqueue Messages](#)
- [Specifying Execute Directives for Apply Processes](#)
- [Managing an Error Handler](#)
- [Managing Apply Errors](#)
- [Dropping an Apply Process](#)

Each task described in this chapter should be completed by an Oracle Streams administrator that has been granted the appropriate privileges, unless specified otherwise.

See Also:

- [Chapter 4, "Oracle Streams Information Consumption"](#)
- ["Monitoring Oracle Streams Apply Processes"](#) on page 25-1
- ["Troubleshooting Apply Process Problems"](#) on page 20-14
- ["Configuring an Oracle Streams Administrator"](#) on page 9-1
- *Oracle Database 2 Day + Data Replication and Integration Guide* and the Enterprise Manager online Help for instructions on managing an apply process with Enterprise Manager
- *Oracle Streams Replication Administrator's Guide* for more information about managing [DML handlers](#), [DDL handlers](#), and Oracle Streams tags for an apply process

Starting an Apply Process

You run the `START_APPLY` procedure in the `DBMS_APPLY_ADM` package to start an existing [apply process](#). For example, the following procedure starts an apply process named `strm01_apply`:

```
BEGIN
  DBMS_APPLY_ADM.START_APPLY(
    apply_name => 'strm01_apply');
END;
/
```

See Also: *Oracle Database 2 Day + Data Replication and Integration Guide* for instructions about starting an apply process with Oracle Enterprise Manager

Stopping an Apply Process

You run the `STOP_APPLY` procedure in the `DBMS_APPLY_ADM` package to stop an existing [apply process](#). For example, the following procedure stops an apply process named `strm01_apply`:

```
BEGIN
  DBMS_APPLY_ADM.STOP_APPLY(
    apply_name => 'strm01_apply');
END;
/
```

See Also: *Oracle Database 2 Day + Data Replication and Integration Guide* for instructions about stopping an apply process with Oracle Enterprise Manager

Managing the Rule Set for an Apply Process

This section contains instructions for completing the following tasks:

- [Specifying the Rule Set for an Apply Process](#)
- [Adding Rules to the Rule Set for an Apply Process](#)

- [Removing a Rule from the Rule Set for an Apply Process](#)
- [Removing a Rule Set for an Apply Process](#)

See Also:

- [Chapter 5, "Rules"](#)
- [Chapter 6, "How Rules Are Used in Oracle Streams"](#)

Specifying the Rule Set for an Apply Process

You can specify one **positive rule set** and one **negative rule set** for an **apply process**. The apply process applies a **message** if it evaluates to TRUE for at least one **rule** in the positive rule set and discards a message if it evaluates to TRUE for at least one rule in the negative rule set. The negative rule set is evaluated before the positive rule set.

Specifying a Positive Rule Set for an Apply Process

You specify an existing **rule set** as the positive rule set for an existing apply process using the `rule_set_name` parameter in the `ALTER_APPLY` procedure. This procedure is in the `DBMS_APPLY_ADM` package.

For example, the following procedure sets the positive rule set for an apply process named `strm01_apply` to `strm02_rule_set`.

```
BEGIN
  DBMS_APPLY_ADM.ALTER_APPLY(
    apply_name    => 'strm01_apply',
    rule_set_name => 'strmadmin.strm02_rule_set');
END;
/
```

Specifying a Negative Rule Set for an Apply Process

You specify an existing rule set as the negative rule set for an existing apply process using the `negative_rule_set_name` parameter in the `ALTER_APPLY` procedure. This procedure is in the `DBMS_APPLY_ADM` package.

For example, the following procedure sets the negative rule set for an apply process named `strm01_apply` to `strm03_rule_set`.

```
BEGIN
  DBMS_APPLY_ADM.ALTER_APPLY(
    apply_name              => 'strm01_apply',
    negative_rule_set_name => 'strmadmin.strm03_rule_set');
END;
/
```

Adding Rules to the Rule Set for an Apply Process

To add **rules** to the **rule set** for an **apply process**, you can run one of the following procedures:

- `DBMS_STREAMS_ADM.ADD_TABLE_RULES`
- `DBMS_STREAMS_ADM.ADD_SUBSET_RULES`
- `DBMS_STREAMS_ADM.ADD_SCHEMA_RULES`
- `DBMS_STREAMS_ADM.ADD_GLOBAL_RULES`

Excluding the `ADD_SUBSET_RULES` procedure, these procedures can add rules to the **positive rule set** or **negative rule set** for an apply process. The `ADD_SUBSET_RULES` procedure can add rules only to the positive rule set for an apply process.

See Also: "System-Created Rules" on page 6-5

Adding Rules to the Positive Rule Set for an Apply Process

The following example runs the `ADD_TABLE_RULES` procedure in the `DBMS_STREAMS_ADM` package to add rules to the positive rule set of an apply process named `strm01_apply`:

```
BEGIN
  DBMS_STREAMS_ADM.ADD_TABLE_RULES(
    table_name      => 'hr.departments',
    streams_type    => 'apply',
    streams_name    => 'strm01_apply',
    queue_name      => 'streams_queue',
    include_dml     => TRUE,
    include_ddl     => TRUE,
    source_database => 'dbs1.example.com',
    inclusion_rule  => TRUE);
END;
/
```

Running this procedure performs the following actions:

- Creates one rule that evaluates to `TRUE` for row LCRs that contain the results of DML changes to the `hr.departments` table. The rule name is system generated.
- Creates one rule that evaluates to `TRUE` for DDL LCRs that contain DDL changes to the `hr.departments` table. The rule name is system generated.
- Specifies that both rules evaluate to `TRUE` only for LCRs whose changes originated at the `dbs1.example.com` **source database**.
- Adds the rules to the positive rule set associated with the apply process because the `inclusion_rule` parameter is set to `TRUE`.

Adding Rules to the Negative Rule Set for an Apply Process

The following example runs the `ADD_TABLE_RULES` procedure in the `DBMS_STREAMS_ADM` package to add rules to the negative rule set of an apply process named `strm01_apply`:

```
BEGIN
  DBMS_STREAMS_ADM.ADD_TABLE_RULES(
    table_name      => 'hr.regions',
    streams_type    => 'apply',
    streams_name    => 'strm01_apply',
    queue_name      => 'streams_queue',
    include_dml     => TRUE,
    include_ddl     => TRUE,
    source_database => 'dbs1.example.com',
    inclusion_rule  => FALSE);
END;
/
```

Running this procedure performs the following actions:

- Creates one rule that evaluates to TRUE for row LCRs that contain the results of DML changes to the `hr.regions` table. The rule name is system generated.
- Creates one rule that evaluates to TRUE for DDL LCRs that contain DDL changes to the `hr.regions` table. The rule name is system generated.
- Specifies that both rules evaluate to TRUE only for LCRs whose changes originated at the `dbssl.example.com` source database.
- Adds the rules to the negative rule set associated with the apply process because the `inclusion_rule` parameter is set to FALSE.

Removing a Rule from the Rule Set for an Apply Process

You remove a **rule** from a **rule set** for an existing **apply process** by running the `REMOVE_RULE` procedure in the `DBMS_STREAMS_ADM` package. For example, the following procedure removes a rule named `departments3` from the **positive rule set** of an apply process named `strm01_apply`.

```
BEGIN
  DBMS_STREAMS_ADM.REMOVE_RULE(
    rule_name      => 'departments3',
    streams_type   => 'apply',
    streams_name   => 'strm01_apply',
    drop_unused_rule => TRUE,
    inclusion_rule  => TRUE);
END;
/
```

In this example, the `drop_unused_rule` parameter in the `REMOVE_RULE` procedure is set to TRUE, which is the default setting. Therefore, if the rule being removed is not in any other rule set, then it will be dropped from the database. If the `drop_unused_rule` parameter is set to FALSE, then the rule is removed from the rule set, but it is not dropped from the database even if it is not in any other rule set.

If the `inclusion_rule` parameter is set to FALSE, then the `REMOVE_RULE` procedure removes the rule from the **negative rule set** for the apply process, not from the positive rule set.

To remove all of the rules in a rule set for the apply process, then specify NULL for the `rule_name` parameter when you run the `REMOVE_RULE` procedure.

See Also: ["Oracle Streams Client with One or More Empty Rule Sets"](#) on page 6-4

Removing a Rule Set for an Apply Process

You remove a **rule set** from an existing **apply process** using the `ALTER_APPLY` procedure in the `DBMS_APPLY_ADM` package. This procedure can remove the **positive rule set**, **negative rule set**, or both. Specify TRUE for the `remove_rule_set` parameter to remove the positive rule set for the apply process. Specify TRUE for the `remove_negative_rule_set` parameter to remove the negative rule set for the apply process.

For example, the following procedure removes both the positive and negative rule sets from an apply process named `strm01_apply`.

```
BEGIN
  DBMS_APPLY_ADM.ALTER_APPLY(
    apply_name      => 'strm01_apply',
    remove_rule_set  => TRUE,
```

```

        remove_negative_rule_set => TRUE);
END;
/

```

Note: If an apply process that dequeues messages from a **buffered queue** does not have a positive or negative rule set, then the apply process dequeues all **captured LCRs** in its **queue**. Similarly, if an apply process that dequeues messages from a **persistent queue** does not have a positive or negative rule set, the apply process dequeues all **persistent LCRs** and **persistent user messages** in its queue.

Setting an Apply Process Parameter

Set an **apply process** parameter using the `SET_PARAMETER` procedure in the `DBMS_APPLY_ADM` package. Apply process parameters control the way an apply process operates.

For example, the following procedure sets the `commit_serialization` parameter for an apply process named `strm01_apply` to `none`. This setting for the `commit_serialization` parameter enables the apply process to commit transactions in any order.

```

BEGIN
  DBMS_APPLY_ADM.SET_PARAMETER(
    apply_name   => 'strm01_apply',
    parameter    => 'commit_serialization',
    value        => 'none');
END;
/

```

Note:

- The `value` parameter is always entered as a `VARCHAR2` value, even if the parameter value is a number.
 - If the `value` parameter is set to `NULL` or is not specified, then the parameter is set to its default value.
 - If you set the `parallelism` apply process parameter to a value greater than 1, then you must specify a conditional **supplemental log group** at the **source database** for all of the unique key and foreign key columns in the tables for which an apply process applies changes. **supplemental logging** might be required for other columns in these tables as well, depending on your configuration.
-
-

See Also:

- ["Apply Process Parameters"](#) on page 4-20
- *Oracle Database 2 Day + Data Replication and Integration Guide* for instructions about setting an apply process parameter with Oracle Enterprise Manager
- The `DBMS_APPLY_ADM.SET_PARAMETER` procedure in the *Oracle Database PL/SQL Packages and Types Reference* for detailed information about the apply process parameters
- *Oracle Streams Replication Administrator's Guide* for more information about specifying supplemental logging

Setting the Apply User for an Apply Process

The **apply user** is the user who applies all DML changes and DDL changes that satisfy the **apply process rule sets** and who runs user-defined **apply handlers**. Set the apply user for an apply process using the `apply_user` parameter in the `ALTER_APPLY` procedure in the `DBMS_APPLY_ADM` package.

To change the apply user, the user who invokes the `ALTER_APPLY` procedure must be granted DBA role. Only the SYS user can set the `apply_user` to SYS.

For example, the following procedure sets the apply user for an apply process named `strm03_apply` to `hr`.

```
BEGIN
  DBMS_APPLY_ADM.ALTER_APPLY (
    apply_name => 'strm03_apply',
    apply_user => 'hr');
END;
/
```

Running this procedure grants the new apply user `dequeue` privilege on the **queue** used by the apply process and configures the user as a **secure queue** user of the queue. In addition, ensure that the apply user has the following privileges:

- EXECUTE privilege on the rule sets used by the apply process
- EXECUTE privilege on all **custom rule-based transformation** functions used in the rule set
- EXECUTE privilege on all apply handler procedures

These privileges must be granted directly to the apply user. They cannot be granted through roles.

Note: If Oracle Database Vault is installed, then the user who changes the apply user must be granted the `BECOME USER` system privilege. Granting this privilege to the user is not required if Oracle Database Vault is not installed. You can revoke the `BECOME USER` system privilege from the user after apply user is changed, if necessary.

Managing the Message Handler for an Apply Process

A message handler is an **apply handler** that processes **persistent user messages**. The following sections contain instructions for setting and unsetting the message handler for an **apply process**:

- [Setting the Message Handler for an Apply Process](#)
- [Unsetting the Message Handler for an Apply Process](#)

See Also:

- ["Types of Messages That Can Be Processed with an Apply Process"](#) on page 4-6
- ["Message Handlers"](#) on page 4-9
- *Oracle Streams Advanced Queuing User's Guide* for an example that creates a message handler

Setting the Message Handler for an Apply Process

Set the **message handler** for an **apply process** using the `message_handler` parameter in the `ALTER_APPLY` procedure in the `DBMS_APPLY_ADM` package. For example, the following procedure sets the message handler for an apply process named `strm03_apply` to the `mes_handler` procedure in the `oe` schema.

```
BEGIN
  DBMS_APPLY_ADM.ALTER_APPLY(
    apply_name      => 'strm03_apply',
    message_handler => 'oe.mes_handler');
END;
/
```

The user who runs the `ALTER_APPLY` procedure must have `EXECUTE` privilege on the specified message handler. If the message handler is already set for an apply process, then you can run the `ALTER_APPLY` procedure to change the message handler for the apply process.

Unsetting the Message Handler for an Apply Process

You unset the **message handler** for an **apply process** by setting the `remove_message_handler` parameter to `TRUE` in the `ALTER_APPLY` procedure in the `DBMS_APPLY_ADM` package. For example, the following procedure unsets the message handler for an apply process named `strm03_apply`.

```
BEGIN
  DBMS_APPLY_ADM.ALTER_APPLY(
    apply_name      => 'strm03_apply',
    remove_message_handler => TRUE);
END;
/
```

Managing the Precommit Handler for an Apply Process

A precommit handler is an **apply handler** that can receive the commit information for a transaction and process the commit information in any customized way.

The following sections contain instructions for creating, setting, and unsetting the precommit handler for an **apply process**:

- [Creating a Precommit Handler for an Apply Process](#)
- [Setting the Precommit Handler for an Apply Process](#)
- [Unsetting the Precommit Handler for an Apply Process](#)

Creating a Precommit Handler for an Apply Process

A **precommit handler** must have the following signature:

```
PROCEDURE handler_procedure (
    parameter_name IN NUMBER);
```

Here, *handler_procedure* stands for the name of the procedure and *parameter_name* stands for the name of the parameter passed to the procedure. The parameter passed to the procedure is a commit SCN from an internal commit directive in the **queue** used by the **apply process**.

You can use a precommit handler to record information about commits processed by an apply process. The apply process can apply **captured LCRs**, **persistent LCRs**, or **persistent user messages**. For a captured row LCR, a commit directive contains the commit SCN of the transaction from the **source database**. For a persistent LCRs and persistent user messages, the commit SCN is generated by the apply process.

The precommit handler procedure must conform to the following restrictions:

- Any work that commits must be an autonomous transaction.
- Any rollback must be to a named save point created in the procedure.

If a precommit handler raises an exception, then the entire apply transaction is rolled back, and all of the messages in the transaction are moved to the error queue.

For example, a precommit handler can be used for auditing the row LCRs applied by an apply process. Such a precommit handler is used with one or more separate **DML handlers** to record the source database commit SCN for a transaction, and possibly the time when the apply process applies the transaction, in an audit table.

Specifically, this example creates a precommit handler that is used with a DML handler that records information about row LCRs in the following table:

```
CREATE TABLE strmadmin.history_row_lcrs(
    timestamp          DATE,
    source_database_name VARCHAR2(128),
    command_type       VARCHAR2(30),
    object_owner       VARCHAR2(32),
    object_name        VARCHAR2(32),
    tag                RAW(10),
    transaction_id     VARCHAR2(10),
    scn                NUMBER,
    commit_scn         NUMBER,
    old_values         SYS.LCR$_ROW_LIST,
    new_values         SYS.LCR$_ROW_LIST)
    NESTED TABLE old_values STORE AS old_values_ntab
    NESTED TABLE new_values STORE AS new_values_ntab;
```

The DML handler inserts a row in the `strmadmin.history_row_lcrs` table for each row LCR processed by an apply process. The precommit handler created in this example inserts a row into the `strmadmin.history_row_lcrs` table when a transaction commits.

Create the procedure that inserts the commit information into the `history_row_lcrs` table:

```
CREATE OR REPLACE PROCEDURE strmadmin.history_commit(commit_number IN NUMBER)
IS
BEGIN
  -- Insert commit information into the history_row_lcrs table
  INSERT INTO strmadmin.history_row_lcrs (timestamp, commit_scn)
  VALUES (SYSDATE, commit_number);
END;
/
```

See Also:

- ["Precommit Handlers"](#) on page 4-10
- *Oracle Streams Replication Administrator's Guide* for more information about the DML handler referenced in this example

Setting the Precommit Handler for an Apply Process

A precommit handler processes all commit directives dequeued by an [apply process](#). When you set a precommit handler for an apply process, the apply process uses it to process all of the commit directives that it dequeues. An apply process can have only one precommit handler.

Set the precommit handler for an apply process using the `precommit_handler` parameter in the `ALTER_APPLY` procedure in the `DBMS_APPLY_ADM` package. For example, the following procedure sets the precommit handler for an apply process named `strm01_apply` to the `history_commit` procedure in the `strmadmin` schema.

```
BEGIN
  DBMS_APPLY_ADM.ALTER_APPLY(
    apply_name      => 'strm01_apply',
    precommit_handler => 'strmadmin.history_commit');
END;
/
```

You can also specify a precommit handler when you create an apply process using the `CREATE_APPLY` procedure in the `DBMS_APPLY_ADM` package. If the precommit handler is already set for an apply process, then you can run the `ALTER_APPLY` procedure to change the precommit handler for the apply process.

Unsetting the Precommit Handler for an Apply Process

You unset the [precommit handler](#) for an [apply process](#) by setting the `remove_precommit_handler` parameter to `TRUE` in the `ALTER_APPLY` procedure in the `DBMS_APPLY_ADM` package. For example, the following procedure unsets the precommit handler for an apply process named `strm01_apply`.

```
BEGIN
  DBMS_APPLY_ADM.ALTER_APPLY(
    apply_name      => 'strm01_apply',
    remove_precommit_handler => TRUE);
END;
/
```

Specifying That Apply Processes Enqueue Messages

This section contains instructions for setting a destination **queue** into which **apply processes** that use a specified **rule** in a **positive rule set** will enqueue **messages** that satisfy the rule. This section also contains instructions for removing destination queue settings.

See Also: ["Viewing Rules that Specify a Destination Queue on Apply"](#) on page 25-14

Setting the Destination Queue for Messages that Satisfy a Rule

You use the `SET_ENQUEUE_DESTINATION` procedure in the `DBMS_APPLY_ADM` package to set a destination **queue** for **messages** that satisfy a specific **rule**. For example, to set the destination queue for a rule named `employees5` to the queue `hr.change_queue`, run the following procedure:

```
BEGIN
  DBMS_APPLY_ADM.SET_ENQUEUE_DESTINATION(
    rule_name           => 'employees5',
    destination_queue_name => 'hr.change_queue');
END;
/
```

This procedure modifies the **action context** of the rule to specify the queue. Any **apply process** in the local database with the `employees5` rule in its **positive rule set** will enqueue a message into `hr.change_queue` if the message satisfies the `employees5` rule. If you want to change the destination queue for the `employees5` rule, then run the `SET_ENQUEUE_DESTINATION` procedure again and specify a different queue.

The **apply user** of each apply process using the specified rule must have the necessary privileges to enqueue messages into the specified queue. If the queue is a **secure queue**, then the apply user must be a secure queue user of the queue.

A message that has been enqueued using the `SET_ENQUEUE_DESTINATION` procedure is the same as any other message that is enqueued manually. Such messages can be manually dequeued, applied by an apply process created with the `apply_captured` parameter set to `FALSE`, or propagated to another queue.

Note:

- The specified rule must be in the positive rule set for an apply process. If the rule is in the **negative rule set** for an apply process, then the apply process does not enqueue the message into the destination queue.
 - The apply process always enqueues messages into a **persistent queue**. It cannot enqueue messages into a **buffered queue**.
-
-

See Also:

- ["Enabling a User to Perform Operations on a Secure Queue"](#) on page 15-1
- ["Enqueue Destinations for Messages During Apply"](#) on page 6-42 for more information about how the `SET_ENQUEUE_DESTINATION` procedure modifies the action context of the specified rule

Removing the Destination Queue Setting for a Rule

You use the `SET_ENQUEUE_DESTINATION` procedure in the `DBMS_APPLY_ADM` package to remove a destination **queue** for **messages** that satisfy a specified **rule**. Specifically, you set the `destination_queue_name` parameter in this procedure to `NULL` for the rule. When a destination queue specification is removed for a rule, messages that satisfy the rule are no longer enqueued into the queue by an **apply process**.

For example, to remove the destination queue for a rule named `employees5`, run the following procedure:

```
BEGIN
  DBMS_APPLY_ADM.SET_ENQUEUE_DESTINATION(
    rule_name           => 'employees5',
    destination_queue_name => NULL);
END;
/
```

Any apply process in the local database with the `employees5` rule in its **positive rule set** no longer enqueues a message into `hr.change_queue` if the message satisfies the `employees5` rule.

Specifying Execute Directives for Apply Processes

This section contains instructions for setting an **apply process** execute directive for **messages** that satisfy a specified **rule** in the **positive rule set** for the apply process.

See Also: ["Viewing Rules that Specify No Execution on Apply"](#)
on page 25-15

Specifying that Messages that Satisfy a Rule Are Not Executed

You use the `SET_EXECUTE` procedure in the `DBMS_APPLY_ADM` package to specify that **apply processes** do not execute **messages** that satisfy a specified **rule**. Specifically, you set the `execute` parameter in this procedure to `FALSE` for the rule. After setting the execution directive to `FALSE` for a rule, an apply process with the rule in its **positive rule set** does not execute a message that satisfies the rule.

For example, to specify that apply processes do not execute messages that satisfy a rule named `departments8`, run the following procedure:

```
BEGIN
  DBMS_APPLY_ADM.SET_EXECUTE(
    rule_name   => 'departments8',
    execute     => FALSE);
END;
/
```

This procedure modifies the **action context** of the rule to specify the execution directive. Any apply process in the local database with the `departments8` rule in its positive rule set will not execute a message if the message satisfies the `departments8` rule. That is, if the message is an LCR, then an apply process does not apply the change in the LCR to the relevant database object. Also, an apply process does not send a message that satisfies this rule to any **apply handler**.

Note:

- The specified rule must be in the positive rule set for an apply process for the apply process to follow the execution directive. If the rule is in the **negative rule set** for an apply process, then the apply process ignores the execution directive for the rule.
- The `SET_EXECUTE` procedure can be used with the `SET_ENQUEUE_DESTINATION` procedure if you want to enqueue messages that satisfy a particular rule into a destination **queue** without executing these messages. After a message is enqueued using the `SET_ENQUEUE_DESTINATION` procedure, it is the same as any message that is enqueued manually. Therefore, it can be manually dequeued, applied by an apply process, or propagated to another queue.

See Also:

- ["Execution Directives for Messages During Apply"](#) on page 6-42 for more information about how the `SET_EXECUTE` procedure modifies the action context of the specified rule
- ["Specifying That Apply Processes Enqueue Messages"](#) on page 16-11

Specifying that Messages that Satisfy a Rule Are Executed

You use the `SET_EXECUTE` procedure in the `DBMS_APPLY_ADM` package to specify that **apply processes** execute **message**s that satisfy a specified **rule**. Specifically, you set the `execute` parameter in this procedure to `TRUE` for the rule. By default, each apply process executes messages that satisfy a rule in the **positive rule set** for the apply process, assuming that the message does not satisfy a rule in the **negative rule set** for the apply process. Therefore, you must set the `execute` parameter to `TRUE` for a rule only if this parameter was set to `FALSE` for the rule in the past.

For example, to specify that apply processes executes messages that satisfy a rule named `departments8`, run the following procedure:

```
BEGIN
  DBMS_APPLY_ADM.SET_EXECUTE (
    rule_name   => 'departments8',
    execute     => TRUE);
END;
/
```

Any apply process in the local database with the `departments8` rule in its positive rule set will execute a message if the message satisfies the `departments8` rule. That is, if the message is an LCR, then an apply process applies the change in the LCR to the relevant database object. Also, an apply process sends a message that satisfies this rule to an **apply handler** if it is configured to do so.

Managing an Error Handler

An **error handler** handles errors resulting from a row LCR dequeued by any **apply process** that contains a specific operation on a specific table.

The following sections contain instructions for creating, setting, and unsetting an error handler:

- [Creating an Error Handler](#)
- [Setting an Error Handler](#)
- [Unsetting an Error Handler](#)

See Also:

- ["Types of Messages That Can Be Processed with an Apply Process"](#) on page 4-6
- ["Message Processing Options for an Apply Process"](#) on page 4-7

Creating an Error Handler

You create an **error handler** by running the `SET_DML_HANDLER` procedure in the `DBMS_APPLY_ADM` package and setting the `error_handler` parameter to `TRUE`.

An error handler must have the following signature:

```
PROCEDURE user_procedure (
    message           IN ANYDATA,
    error_stack_depth IN NUMBER,
    error_numbers     IN DBMS_UTILITY.NUMBER_ARRAY,
    error_messages    IN emsg_array);
```

Here, `user_procedure` stands for the name of the procedure. Each parameter is required and must have the specified data type. However, you can change the names of the parameters. The `emsg_array` parameter must be a user-defined array that is a PL/SQL table of type `VARCHAR2` with at least 76 characters.

Note: Some conditions on the user procedure specified in `SET_DML_HANDLER` must be met for error handlers. See *Oracle Streams Replication Administrator's Guide* for information about these conditions.

Running an error handler results in one of the following outcomes:

- The error handler successfully resolves the error, applies the row LCR if appropriate, and returns control back to the **apply process**.
- The error handler fails to resolve the error, and the error is raised. The raised error causes the transaction to be rolled back and placed in the error queue.

If you want to retry the DML operation, then have the error handler procedure run the `EXECUTE` member procedure for the LCR.

The following example creates an error handler named `regions_pk_error` that resolves primary key violations for the `hr.regions` table. At a **destination database**, assume users insert rows into the `hr.regions` table and an apply process applies changes to the `hr.regions` table that originated from a **capture process** at a remote **source database**. In this environment, there is a possibility of errors resulting from users at the destination database inserting a row with the same primary key value as an insert row LCR applied from the source database.

This example creates a table in the `strmadmin` schema called `errorlog` to record the following information about each primary key violation error on the `hr.regions` table:

- The time stamp when the error occurred
- The name of the apply process that raised the error
- The user who caused the error (sender), which is the capture process name for **captured LCRs**, the **synchronous capture** name for **persistent LCRs** captured by the synchronous capture, or the name of the Oracle Streams Advanced Queuing (AQ) agent for **persistent LCRs** and **persistent user messages** enqueued by an application
- The name of the object on which the DML operation was run, because errors for other objects might be logged in the future
- The type of command used in the DML operation
- The name of the constraint violated
- The error message
- The LCR that caused the error

This error handler resolves only errors that are caused by a primary key violation on the `hr.regions` table. To resolve this type of error, the error handler modifies the `region_id` value in the row LCR using a sequence and then executes the row LCR to apply it. If other types of errors occur, then you can use the row LCR you stored in the `errorlog` table to resolve the error manually.

For example, the following error is resolved by the error handler:

1. At the destination database, a user inserts a row into the `hr.regions` table with a `region_id` value of 6 and a `region_name` value of 'LILLIPUT'.
2. At the source database, a user inserts a row into the `hr.regions` table with a `region_id` value of 6 and a `region_name` value of 'BROBDINGNAG'.
3. A capture process at the source database captures the change described in Step 2.
4. A **propagation** propagates the LCR containing the change from a queue at the source database to the queue used by the apply process at the destination database.
5. When the apply process tries to apply the LCR, an error results because of a primary key violation.
6. The apply process invokes the error handler to handle the error.
7. The error handler logs the error in the `strmadmin.errorlog` table.
8. The error handler modifies the `region_id` value in the LCR using a sequence and executes the LCR to apply it.

Complete the following steps to create the `regions_pk_error` error handler:

1. In SQL*Plus, connect to the database as the `hr` user.
See *Oracle Database Administrator's Guide* for information about connecting to a database in SQL*Plus.
2. Create the sequence used by the error handler to assign new primary key values:

```
CREATE SEQUENCE hr.reg_exception_s START WITH 9000;
```

This example assumes that users at the destination database will never insert a row into the `hr.regions` table with a `region_id` greater than 8999.

3. Grant the Oracle Streams administrator `ALL` privilege on the sequence:

```
GRANT ALL ON reg_exception_s TO strmadmin;
```

4. Connect to the database as the Oracle Streams administrator.

5. Create the errorlog table:

```
CREATE TABLE strmadmin.errorlog(
  logdate      DATE,
  apply_name   VARCHAR2(30),
  sender       VARCHAR2(100),
  object_name  VARCHAR2(32),
  command_type VARCHAR2(30),
  errnum       NUMBER,
  errmsg       VARCHAR2(2000),
  text         VARCHAR2(2000),
  lcr          SYS.LCR$_ROW_RECORD);
```

6. Create a package that includes the regions_pk_error procedure:

```
CREATE OR REPLACE PACKAGE errors_pkg
AS
  TYPE emsg_array IS TABLE OF VARCHAR2(2000) INDEX BY BINARY_INTEGER;
  PROCEDURE regions_pk_error(
    message          IN ANYDATA,
    error_stack_depth IN NUMBER,
    error_numbers    IN DBMS_UTILITY.NUMBER_ARRAY,
    error_messages   IN EMSG_ARRAY);
END errors_pkg ;
/
```

7. Create the package body:

```
CREATE OR REPLACE PACKAGE BODY errors_pkg AS
  PROCEDURE regions_pk_error (
    message          IN ANYDATA,
    error_stack_depth IN NUMBER,
    error_numbers    IN DBMS_UTILITY.NUMBER_ARRAY,
    error_messages   IN EMSG_ARRAY )
  IS
    reg_id      NUMBER;
    ad          ANYDATA;
    lcr         SYS.LCR$_ROW_RECORD;
    ret         PLS_INTEGER;
    vc         VARCHAR2(30);
    apply_name  VARCHAR2(30);
    errlog_rec  errorlog%ROWTYPE ;
    ov2        SYS.LCR$_ROW_LIST;
  BEGIN
    -- Access the error number from the top of the stack.
    -- In case of check constraint violation,
    -- get the name of the constraint violated.
    IF error_numbers(1) IN ( 1 , 2290 ) THEN
      ad := DBMS_STREAMS.GET_INFORMATION('CONSTRAINT_NAME');
      ret := ad.GetVarchar2(errlog_rec.text);
    ELSE
      errlog_rec.text := NULL ;
    END IF ;
    -- Get the name of the sender and the name of the apply process.
    ad := DBMS_STREAMS.GET_INFORMATION('SENDER');
    ret := ad.GETVARCHAR2(errlog_rec.sender);
    apply_name := DBMS_STREAMS.GET_STREAMS_NAME();
```

```

-- Try to access the LCR.
ret := message.GETOBJECT(lcr);
errlog_rec.object_name := lcr.GET_OBJECT_NAME() ;
errlog_rec.command_type := lcr.GET_COMMAND_TYPE() ;
errlog_rec.errnum := error_numbers(1) ;
errlog_rec.errmsg := error_messages(1) ;
INSERT INTO strmadmin.errorlog VALUES (SYSDATE, apply_name,
    errlog_rec.sender, errlog_rec.object_name, errlog_rec.command_type,
    errlog_rec.errnum, errlog_rec.errmsg, errlog_rec.text, lcr);
-- Add the logic to change the contents of LCR with correct values.
-- In this example, get a new region_id number
-- from the hr.reg_exception_s sequence.
ov2 := lcr.GET_VALUES('new', 'n');
FOR i IN 1 .. ov2.count
LOOP
    IF ov2(i).column_name = 'REGION_ID' THEN
        SELECT hr.reg_exception_s.NEXTVAL INTO reg_id FROM DUAL;
        ov2(i).data := ANYDATA.ConvertNumber(reg_id) ;
    END IF ;
END LOOP ;
-- Set the NEW values in the LCR.
lcr.SET_VALUES(value_type => 'NEW', value_list => ov2);
-- Execute the modified LCR to apply it.
lcr.EXECUTE(TRUE);
END regions_pk_error;
END errors_pkg;
/

```

Note:

- For subsequent changes to the modified row to be applied successfully, you should converge the rows at the two databases as quickly as possible. That is, you should make the `region_id` for the row match at the source and destination database. If you do not want these manual changes to be recaptured at a database, then use the `SET_TAG` procedure in the `DBMS_STREAMS` package to set the **tag** for the session in which you make the change to a value that is not captured.
 - This example error handler illustrates the use of the `GET_VALUES` member function and `SET_VALUES` member procedure for the LCR. If you are modifying only one value in the LCR, then the `GET_VALUE` member function and `SET_VALUE` member procedure might be more convenient and more efficient.
-
-

See Also: *Oracle Streams Replication Administrator's Guide* for more information about setting tag values generated by the current session and for information about specific error messages to handle in an error handler

Setting an Error Handler

An **error handler** handles errors resulting from a row LCR dequeued by any **apply process** that contains a specific operation on a specific table. You can specify multiple error handlers on the same table, to handle errors resulting from different operations

on the table. You can either set an error handler for a specific apply process, or you can set an error handler as a general error handler that is used by all apply processes that apply the specified operation to the specified table.

Set an error handler using the `SET_DML_HANDLER` procedure in the `DBMS_APPLY_ADM` package. When you run this procedure to set an error handler, set the `error_handler` parameter to `TRUE`.

For example, the following procedure sets the error handler for `INSERT` operations on the `hr.regions` table. Therefore, when any apply process dequeues a row LCR containing an `INSERT` operation on the local `hr.regions` table, and the row LCR results in an error, the apply process sends the row LCR to the `strmadmin.errors_pkg.regions_pk_error` PL/SQL procedure for processing. If the error handler cannot resolve the error, then the row LCR and all of the other row LCRs in the same transaction are moved to the error queue.

In this example, the `apply_name` parameter is set to `NULL`. Therefore, the error handler is a general error handler that is used by all of the apply processes in the database.

Run the following procedure to set the error handler:

```
BEGIN
  DBMS_APPLY_ADM.SET_DML_HANDLER (
    object_name      => 'hr.regions',
    object_type      => 'TABLE',
    operation_name   => 'INSERT',
    error_handler    => TRUE,
    user_procedure   => 'strmadmin.errors_pkg.regions_pk_error',
    apply_database_link => NULL,
    apply_name       => NULL);
END;
/
```

If the error handler is already set, then you can run the `SET_DML_HANDLER` procedure to change the error handler.

Unsetting an Error Handler

You unset an **error handler** using the `SET_DML_HANDLER` procedure in the `DBMS_APPLY_ADM` package. When you run that procedure, set the `user_procedure` parameter to `NULL` for a specific operation on a specific table.

For example, the following procedure unsets the error handler for `INSERT` operations on the `hr.regions` table:

```
BEGIN
  DBMS_APPLY_ADM.SET_DML_HANDLER (
    object_name      => 'hr.regions',
    object_type      => 'TABLE',
    operation_name   => 'INSERT',
    user_procedure   => NULL,
    apply_name       => NULL);
END;
/
```

Note: The `error_handler` parameter does not need to be specified.

Managing Apply Errors

The following sections contain instructions for retrying and deleting apply errors:

- [Retrying Apply Error Transactions](#)
- [Deleting Apply Error Transactions](#)

See Also:

- ["The Error Queue"](#) on page 4-21
- ["Checking for Apply Errors"](#) on page 25-16
- ["Displaying Detailed Information About Apply Errors"](#) on page 25-17
- *Oracle Database 2 Day + Data Replication and Integration Guide* for instructions on managing apply errors in Oracle Enterprise Manager
- *Oracle Streams Replication Administrator's Guide* for information about the possible causes of apply errors

Retrying Apply Error Transactions

You can retry a specific error transaction or you can retry all error transactions for an [apply process](#). You might need to make DML or DDL changes to database objects to correct the conditions that caused one or more apply errors before you retry error transactions. You can also have one or more [capture processes](#) or [synchronous captures](#) configured to capture changes to the same database objects, but you might not want the changes captured. In this case, you can set the session [tag](#) to a value that will not be captured for the session that makes the changes.

See Also: *Oracle Streams Replication Administrator's Guide* for more information about setting tag values generated by the current session

Retrying a Specific Apply Error Transaction

When you retry an error transaction, you can execute it immediately or send the error transaction to a user procedure for modifications before executing it. The following sections provide instructions for each method:

- [Retrying a Specific Apply Error Transaction Without a User Procedure](#)
- [Retrying a Specific Apply Error Transaction with a User Procedure](#)

See Also: *Oracle Database PL/SQL Packages and Types Reference* for more information about the EXECUTE_ERROR procedure

Retrying a Specific Apply Error Transaction Without a User Procedure After you correct the conditions that caused an apply error, you can retry the transaction by running the EXECUTE_ERROR procedure in the DBMS_APPLY_ADM package without specifying a user procedure. In this case, the transaction is executed without any custom processing.

For example, to retry a transaction with the transaction identifier 5.4.312, run the following procedure:

```

BEGIN
  DBMS_APPLY_ADM.EXECUTE_ERROR(
    local_transaction_id => '5.4.312',
    execute_as_user      => FALSE,
    user_procedure       => NULL);
END;
/

```

If `execute_as_user` is `TRUE`, then the apply process executes the transaction in the security context of the current user. If `execute_as_user` is `FALSE`, then the apply process executes the transaction in the security context of the original receiver of the transaction. The original receiver is the user who was processing the transaction when the error was raised.

In either case, the user who executes the transaction must have privileges to perform DML and DDL changes on the apply objects and to run any **apply handlers**. This user must also have dequeue privileges on the queue used by the apply process.

Retrying a Specific Apply Error Transaction with a User Procedure You can retry an error transaction by running the `EXECUTE_ERROR` procedure in the `DBMS_APPLY_ADM` package, and specify a user procedure to modify one or more **messages** in the transaction before the transaction is executed. The modifications should enable successful execution of the transaction. The messages in the transaction can be LCRs or **user messages**.

For example, consider a case in which an apply error resulted because of a **conflict**. Examination of the error transaction reveals that the old value for the `salary` column in a row LCR contained the wrong value. Specifically, the current value of the salary of the employee with `employee_id` of 197 in the `hr.employees` table did not match the old value of the salary for this employee in the row LCR. Assume that the current value for this employee is 3250 in the `hr.employees` table.

Given this scenario, the following user procedure modifies the salary in the row LCR that caused the error:

```

CREATE OR REPLACE PROCEDURE strmadmin.modify_emp_salary(
  in_any          IN      ANYDATA,
  error_record    IN      DBA_APPLY_ERROR%ROWTYPE,
  error_message_number IN  NUMBER,
  messaging_default_processing IN OUT BOOLEAN,
  out_any         OUT     ANYDATA)
AS
  row_lcr          SYS.LCR$_ROW_RECORD;
  row_lcr_changed  BOOLEAN := FALSE;
  res              NUMBER;
  ob_owner         VARCHAR2(32);
  ob_name          VARCHAR2(32);
  cmd_type         VARCHAR2(30);
  employee_id      NUMBER;
BEGIN
  IF in_any.getTypeName() = 'SYS.LCR$_ROW_RECORD' THEN
    -- Access the LCR
    res := in_any.GETOBJECT(row_lcr);
    -- Determine the owner of the database object for the LCR
    ob_owner := row_lcr.GET_OBJECT_OWNER;
    -- Determine the name of the database object for the LCR
    ob_name := row_lcr.GET_OBJECT_NAME;
    -- Determine the type of DML change
    cmd_type := row_lcr.GET_COMMAND_TYPE;
    IF (ob_owner = 'HR' AND ob_name = 'EMPLOYEES' AND cmd_type = 'UPDATE') THEN

```

```

-- Determine the employee_id of the row change
IF row_lcr.GET_VALUE('old', 'employee_id') IS NOT NULL THEN
  employee_id := row_lcr.GET_VALUE('old', 'employee_id').ACCESSNUMBER();
  IF (employee_id = 197) THEN
    -- error_record.message_number should equal error_message_number
    row_lcr.SET_VALUE(
      value_type => 'OLD',
      column_name => 'salary',
      column_value => ANYDATA.ConvertNumber(3250));
    row_lcr_changed := TRUE;
  END IF;
END IF;
END IF;
END IF;
-- Specify that the apply process continues to process the current message
messaging_default_processing := TRUE;
-- assign out_any appropriately
IF row_lcr_changed THEN
  out_any := ANYDATA.ConvertObject(row_lcr);
ELSE
  out_any := in_any;
END IF;
END;
/

```

To retry a transaction with the transaction identifier 5.6.924 and process the transaction with the `modify_emp_salary` procedure in the `strmadmin` schema before execution, run the following procedure:

```

BEGIN
  DBMS_APPLY_ADM.EXECUTE_ERROR(
    local_transaction_id => '5.6.924',
    execute_as_user      => FALSE,
    user_procedure       => 'strmadmin.modify_emp_salary');
END;
/

```

Note: The user who runs the procedure must have `SELECT` privilege on `DBA_APPLY_ERROR` data dictionary view.

See Also: ["Displaying Detailed Information About Apply Errors"](#) on page 25-17

Retrying All Error Transactions for an Apply Process

After you correct the conditions that caused all of the apply errors for an apply process, you can retry all of the error transactions by running the `EXECUTE_ALL_ERRORS` procedure in the `DBMS_APPLY_ADM` package. For example, to retry all of the error transactions for an apply process named `strm01_apply`, you can run the following procedure:

```

BEGIN
  DBMS_APPLY_ADM.EXECUTE_ALL_ERRORS(
    apply_name          => 'strm01_apply',
    execute_as_user     => FALSE);
END;
/

```

Note: If you specify `NULL` for the `apply_name` parameter, and you have multiple apply processes, then all of the apply errors are retried for all of the apply processes.

Deleting Apply Error Transactions

You can delete a specific error transaction or you can delete all error transactions for an **apply process**.

Deleting a Specific Apply Error Transaction

If an error transaction should not be applied, then you can delete the transaction from the error queue using the `DELETE_ERROR` procedure in the `DBMS_APPLY_ADM` package. For example, to delete a transaction with the transaction identifier `5.4.312`, run the following procedure:

```
EXEC DBMS_APPLY_ADM.DELETE_ERROR(local_transaction_id => '5.4.312');
```

Deleting All Error Transactions for an Apply Process

If none of the error transactions should be applied, then you can delete all of the error transactions by running the `DELETE_ALL_ERRORS` procedure in the `DBMS_APPLY_ADM` package. For example, to delete all of the error transactions for an apply process named `strm01_apply`, you can run the following procedure:

```
EXEC DBMS_APPLY_ADM.DELETE_ALL_ERRORS(apply_name => 'strm01_apply');
```

Note: If you specify `NULL` for the `apply_name` parameter, and you have multiple apply processes, then all of the apply errors are deleted for all of the apply processes.

Dropping an Apply Process

You run the `DROP_APPLY` procedure in the `DBMS_APPLY_ADM` package to drop an existing **apply process**. For example, the following procedure drops an apply process named `strm02_apply`:

```
BEGIN
  DBMS_APPLY_ADM.DROP_APPLY(
    apply_name          => 'strm02_apply',
    drop_unused_rule_sets => TRUE);
END;
/
```

Because the `drop_unused_rule_sets` parameter is set to `TRUE`, this procedure also drops any **rule sets** used by the `strm02_apply` apply process, unless a rule set is used by another **Oracle Streams client**. If the `drop_unused_rule_sets` parameter is set to `TRUE`, then both the positive and **negative rule set** for the apply process might be dropped. If this procedure drops a rule set, then it also drops any **rules** in the rule set that are not in another rule set.

An error is raised if you try to drop an apply process and there are errors in the error queue for the specified apply process. Therefore, if there are errors in the error queue for an apply process, delete the errors before dropping the apply process.

See Also:

- ["Managing Apply Errors"](#) on page 16-19

Managing Rules

An Oracle Streams environment uses **rules** to control the behavior of **Oracle Streams clients** (**capture processes**, **propagations**, **apply processes**, and **messaging clients**). In addition, you can create custom applications that are clients of the **rules engine**. This chapter contains instructions for managing **rule sets**, rules, and privileges related to rules.

The following topics describe managing rules:

- [Managing Rule Sets](#)
- [Managing Rules](#)
- [Managing Privileges on Evaluation Contexts, Rule Sets, and Rules](#)

Each task described in this chapter should be completed by an Oracle Streams administrator that has been granted the appropriate privileges, unless specified otherwise.

Caution: Modifying the rules and rule sets used by an **Oracle Streams client** changes the behavior of the Oracle Streams client.

Note: This chapter does not contain examples for creating **evaluation contexts**, nor does it contain examples for evaluating events using the `DBMS_RULE.EVALUATE` procedure. See [Chapter 33, "Rule-Based Application Example"](#) for these examples.

See Also:

- [Chapter 5, "Rules"](#)
- [Chapter 6, "How Rules Are Used in Oracle Streams"](#)
- [Chapter 7, "Rule-Based Transformations"](#)
- ["Configuring an Oracle Streams Administrator"](#) on page 9-1
- ["Troubleshooting Problems with Rules and Rule-Based Transformations"](#) on page 20-18

Managing Rule Sets

You can modify a **rule set** without stopping Oracle Streams **capture processes**, **propagations**, and **apply processes** that use the rule set. Oracle Streams will detect the change immediately after it is committed. If you need precise control over which **messages** use the new version of a rule set, then complete the following steps:

1. Stop the relevant capture processes, propagations, and apply processes.
2. Modify the rule set.
3. Restart the **Oracle Streams clients** you stopped in Step 1.

This section provides instructions for completing the following tasks:

- [Creating a Rule Set](#)
- [Adding a Rule to a Rule Set](#)
- [Removing a Rule from a Rule Set](#)
- [Dropping a Rule Set](#)

See Also:

- ["Stopping a Capture Process"](#) on page 14-2
- ["Stopping a Propagation"](#) on page 15-5
- ["Stopping an Apply Process"](#) on page 16-2

Creating a Rule Set

The following example runs the `CREATE_RULE_SET` procedure in the `DBMS_RULE_ADM` package to create a **rule set**:

```
BEGIN
  DBMS_RULE_ADM.CREATE_RULE_SET(
    rule_set_name      => 'strmadmin.hr_capture_rules',
    evaluation_context => 'SYS.STREAMS$_EVALUATION_CONTEXT');
END;
/
```

Running this procedure performs the following actions:

- Creates a rule set named `hr_capture_rules` in the `strmadmin` schema. A rule set with the same name and owner must not exist.
- Associates the rule set with the `SYS.STREAMS$_EVALUATION_CONTEXT` **evaluation context**, which is the Oracle-supplied evaluation context for Oracle Streams.

You can also use the following procedures in the `DBMS_STREAMS_ADM` package to create a rule set automatically, if one does not exist for an Oracle Streams **capture process**, **propagation**, **apply process**, or **messaging client**:

- `ADD_MESSAGE_PROPAGATION_RULE`
- `ADD_MESSAGE_RULE`
- `ADD_TABLE_PROPAGATION_RULES`
- `ADD_TABLE_RULES`
- `ADD_SUBSET_PROPAGATION_RULES`
- `ADD_SUBSET_RULES`

- ADD_SCHEMA_PROPAGATION_RULES
- ADD_SCHEMA_RULES
- ADD_GLOBAL_PROPAGATION_RULES
- ADD_GLOBAL_RULES

Except for ADD_SUBSET_PROPAGATION_RULES and ADD_SUBSET_RULES, these procedures can create either a **positive rule set** or a **negative rule set** for an **Oracle Streams client**. ADD_SUBSET_PROPAGATION_RULES and ADD_SUBSET_RULES can only create a positive rule set for an Oracle Streams client.

See Also:

- ["Example of Configuring a Local Capture Process Using DBMS_STREAMS_ADM"](#) on page 10-4
- ["Example of Configuring a Propagation Using DBMS_STREAMS_ADM"](#) on page 11-4
- ["Creating an Apply Process for Captured LCRs"](#) on page 12-3

Adding a Rule to a Rule Set

When you add **rules** to a **rule set**, the behavior of the **Oracle Streams clients** that use the rule set changes. Ensure that you understand how rules to a rule set will affect Oracle Streams clients before proceeding.

The following example runs the ADD_RULE procedure in the DBMS_RULE_ADM package to add the hr_dml rule to the hr_capture_rules rule set:

```
BEGIN
  DBMS_RULE_ADM.ADD_RULE(
    rule_name          => 'strmadmin.hr_dml',
    rule_set_name      => 'strmadmin.hr_capture_rules',
    evaluation_context => NULL);
END;
/
```

In this example, no **evaluation context** is specified when running the ADD_RULE procedure. Therefore, if the rule does not have its own evaluation context, it will inherit the evaluation context of the hr_capture_rules rule set. If you want a rule to use an evaluation context other than the one specified for the rule set, then you can set the evaluation_context parameter to this evaluation context when you run the ADD_RULE procedure.

Removing a Rule from a Rule Set

When you remove a **rule** from a **rule set**, the behavior of the **Oracle Streams clients** that use the rule set changes. Ensure that you understand how removing a rule from a rule set will affect Oracle Streams clients before proceeding.

The following example runs the REMOVE_RULE procedure in the DBMS_RULE_ADM package to remove the hr_dml rule from the hr_capture_rules rule set:

```
BEGIN
  DBMS_RULE_ADM.REMOVE_RULE(
    rule_name          => 'strmadmin.hr_dml',
    rule_set_name      => 'strmadmin.hr_capture_rules');
END;
/
```

After running the `REMOVE_RULE` procedure, the rule still exists in the database and, if it was in any other rule sets, it remains in those rule sets.

See Also: ["Dropping a Rule"](#) on page 17-11

Dropping a Rule Set

The following example runs the `DROP_RULE_SET` procedure in the `DBMS_RULE_ADM` package to drop the `hr_capture_rules` **rule set** from the database:

```
BEGIN
  DBMS_RULE_ADM.DROP_RULE_SET(
    rule_set_name => 'strmadmin.hr_capture_rules',
    delete_rules  => FALSE);
END;
/
```

In this example, the `delete_rules` parameter in the `DROP_RULE_SET` procedure is set to `FALSE`, which is the default setting. Therefore, if the rule set contains any **rules**, then these rules are not dropped. If the `delete_rules` parameter is set to `TRUE`, then any rules in the rule set that are not in another rule set are dropped from the database automatically. Rules in the rule set that are in one or more other rule sets are not dropped.

Managing Rules

You can modify a **rule** without stopping Oracle Streams **capture processes**, **propagations**, and **apply processes** that use the rule. Oracle Streams will detect the change immediately after it is committed. If you need precise control over which **messages** use the new version of a rule, then complete the following steps:

1. Stop the relevant capture processes, propagations, and apply processes.
2. Modify the rule.
3. Restart the **Oracle Streams clients** you stopped in Step 1.

This section provides instructions for completing the following tasks:

- [Creating a Rule](#)
- [Altering a Rule](#)
- [Modifying System-Created Rules](#)
- [Dropping a Rule](#)

See Also:

- ["Stopping a Capture Process"](#) on page 14-2
- ["Stopping a Propagation"](#) on page 15-5
- ["Stopping an Apply Process"](#) on page 16-2

Creating a Rule

The following examples use the `CREATE_RULE` procedure in the `DBMS_RULE_ADM` package to create a **rule** without an **action context** and a rule with an action context.

Creating a Rule Without an Action Context

To create a rule without an **action context**, run the `CREATE_RULE` procedure and specify the rule name using the `rule_name` parameter and the **rule condition** using the `condition` parameter, as in the following example:

```
BEGIN
  DBMS_RULE_ADM.CREATE_RULE(
    rule_name => 'strmadmin.hr_dml',
    condition => ':dml.get_object_owner() = ''HR'' ');
END;
/
```

Running this procedure performs the following actions:

- Creates a rule named `hr_dml` in the `strmadmin` schema. A rule with the same name and owner must not exist.
- Creates a condition that evaluates to `TRUE` for any DML change to a table in the `hr` schema.

In this example, no **evaluation context** is specified for the rule. Therefore, the rule will either inherit the evaluation context of any **rule set** to which it is added, or it will be assigned an evaluation context explicitly when the `DBMS_RULE_ADM.ADD_RULE` procedure is run to add it to a rule set. At this point, the rule cannot be evaluated because it is not part of any rule set.

You can also use the following procedures in the `DBMS_STREAMS_ADM` package to create rules and add them to a rule set automatically:

- `ADD_MESSAGE_PROPAGATION_RULE`
- `ADD_MESSAGE_RULE`
- `ADD_TABLE_PROPAGATION_RULES`
- `ADD_TABLE_RULES`
- `ADD_SUBSET_PROPAGATION_RULES`
- `ADD_SUBSET_RULES`
- `ADD_SCHEMA_PROPAGATION_RULES`
- `ADD_SCHEMA_RULES`
- `ADD_GLOBAL_PROPAGATION_RULES`
- `ADD_GLOBAL_RULES`

Except for `ADD_SUBSET_PROPAGATION_RULES` and `ADD_SUBSET_RULES`, these procedures can add rules to either the **positive rule set** or the **negative rule set** for an **Oracle Streams client**. `ADD_SUBSET_PROPAGATION_RULES` and `ADD_SUBSET_RULES` can add rules only to the positive rule set for an Oracle Streams client.

See Also:

- ["Example of Configuring a Local Capture Process Using `DBMS_STREAMS_ADM`"](#) on page 10-4
- ["Example of Configuring a Propagation Using `DBMS_STREAMS_ADM`"](#) on page 11-4
- ["Creating an Apply Process for Captured LCRs"](#) on page 12-3

Creating a Rule with an Action Context

To create a rule with an **action context**, run the `CREATE_RULE` procedure and specify the rule name using the `rule_name` parameter, the rule condition using the `condition` parameter, and the rule action context using the `action_context` parameter. You add a name-value pair to an action context using the `ADD_PAIR` member procedure of the `RE$NV_LIST` type

The following example creates a rule with a non-NULL action context:

```
DECLARE
  ac SYS.RE$NV_LIST;
BEGIN
  ac := SYS.RE$NV_LIST(NULL);
  ac.ADD_PAIR('course_number', ANYDATA.CONVERTNUMBER(1057));
  DBMS_RULE_ADM.CREATE_RULE(
    rule_name      => 'strmadmin.rule_dep_10',
    condition      => ' :dml.get_object_owner()='HR' AND ' ||
      ' :dml.get_object_name()='EMPLOYEES' AND ' ||
      ' (:dml.get_value('NEW', 'DEPARTMENT_ID').AccessNumber()=10) AND ' ||
      ' :dml.get_command_type() = 'INSERT' ',
    action_context => ac);
END;
/
```

Running this procedure performs the following actions:

- Creates a rule named `rule_dep_10` in the `strmadmin` schema. A rule with the same name and owner must not exist.
- Creates a condition that evaluates to `TRUE` for any insert into the `hr.employees` table where the `department_id` is 10.
- Creates an action context with one name-value pair that has `course_number` for the name and 1057 for the value.

See Also: ["Rule Action Context"](#) on page 5-8 for a scenario that uses such a name-value pair in an action context

Altering a Rule

You can use the `ALTER_RULE` procedure in the `DBMS_RULE_ADM` package to alter an existing **rule**. Specifically, you can use this procedure to do the following:

- Change a **rule condition**
- Change a rule **evaluation context**
- Remove a rule evaluation context
- Modify a name-value pair in a rule **action context**
- Add a name-value pair to a rule action context
- Remove a name-value pair from a rule action context
- Change the comment for a rule
- Remove the comment for a rule

The following sections contains examples for some of these alterations.

Changing a Rule Condition

You use the `condition` parameter in the `ALTER_RULE` procedure to change the condition of an existing rule. For example, suppose you want to change the condition of the rule created in ["Creating a Rule"](#) on page 17-4. The condition in the existing `hr_dml` rule evaluates to `TRUE` for any DML change to any object in the `hr` schema. If you want to exclude changes to the `employees` table in this schema, then you can alter the rule so that it evaluates to `FALSE` for DML changes to the `hr.employees` table, but continues to evaluate to `TRUE` for DML changes to any other table in this schema. The following procedure alters the rule in this way:

```
BEGIN
  DBMS_RULE_ADM.ALTER_RULE(
    rule_name          => 'strmadmin.hr_dml',
    condition          => ':dml.get_object_owner() = ''HR'' AND NOT ' ||
                          ':dml.get_object_name() = ''EMPLOYEES'' ',
    evaluation_context => NULL);
END;
/
```

Note:

- Changing the condition of a rule affects all **rule sets** that contain the rule.
 - If you want to alter a rule but retain the rule action context, then specify `NULL` for `action_context` parameter in the `ALTER_RULE` procedure. `NULL` is the default value for the `action_context` parameter.
 - When a rule is in the rule set for a synchronous capture, do not change the following rule conditions: `:dml.get_object_name` and `:dml.get_object_owner`. Changing these conditions can cause the synchronous capture not to capture changes to the database object. You can change other conditions in synchronous capture rules.
-
-

Modifying a Name-Value Pair in a Rule Action Context

To modify a name-value pair in a rule action context, you first remove the name-value pair from the rule action context and then add a different name-value pair to the rule action context.

This example modifies a name-value pair for rule `rule_dep_10` by first removing the name-value pair with the name `course_name` from the rule action context and then adding a different name-value pair back to the rule action context with the same name (`course_name`) but a different value. This name-value pair being modified was added to the rule in the example in ["Creating a Rule with an Action Context"](#) on page 17-6.

If an action context contains name-value pairs in addition to the name-value pair that you are modifying, then be cautious when you modify the action context so that you do not change or remove any of the other name-value pairs.

Complete the following steps to modify a name-value pair in an action context:

1. You can view the name-value pairs in the action context of a rule by performing the following query:

```
COLUMN ACTION_CONTEXT_NAME HEADING 'Action Context Name' FORMAT A25
COLUMN AC_VALUE_NUMBER HEADING 'Action Context Number Value' FORMAT 9999
```

```

SELECT
    AC.NVN_NAME ACTION_CONTEXT_NAME,
    AC.NVN_VALUE.ACCESSNUMBER() AC_VALUE_NUMBER
FROM DBA_RULES R, TABLE(R.RULE_ACTION_CONTEXT.ACTX_LIST) AC
WHERE RULE_NAME = 'RULE_DEP_10';

```

This query displays output similar to the following:

Action Context Name	Action Context Number Value
course_number	1057

2. Modify the name-value pair. Ensure that no other users are modifying the action context at the same time. This step first removes the name-value pair containing the name `course_number` from the action context for the `rule_dep_10` rule using the `REMOVE_PAIR` member procedure of the `RE$NV_LIST` type. Next, this step adds a name-value pair containing the new name-value pair to the rule action context using the `ADD_PAIR` member procedure of this type. In this case, the name is `course_number` and the value is 1108 for the added name-value pair.

To preserve any existing name-value pairs in the rule action context, this example selects the rule action context into a variable before altering it:

```

DECLARE
    action_ctx      SYS.RE$NV_LIST;
    ac_name         VARCHAR2(30) := 'course_number';
BEGIN
    SELECT RULE_ACTION_CONTEXT
    INTO action_ctx
    FROM DBA_RULES R
    WHERE RULE_OWNER='STRMADMIN' AND RULE_NAME='RULE_DEP_10';
    action_ctx.REMOVE_PAIR(ac_name);
    action_ctx.ADD_PAIR(ac_name,
        ANYDATA.CONVERTNUMBER(1108));
    DBMS_RULE_ADM.ALTER_RULE(
        rule_name      => 'strmadmin.rule_dep_10',
        action_context => action_ctx);
END;
/

```

To ensure that the name-value pair was altered properly, you can rerun the query in Step 1. The query should display output similar to the following:

Action Context Name	Action Context Number Value
course_number	1108

Adding a Name-Value Pair to a Rule Action Context

You can preserve the existing name-value pairs in the action context by selecting the action context into a variable before adding a new pair using the `ADD_PAIR` member procedure of the `RE$NV_LIST` type. Ensure that no other users are modifying the action context at the same time. The following example preserves the existing name-value pairs in the action context of the `rule_dep_10` rule and adds a new name-value pair with `dist_list` for the name and `admin_list` for the value:

```

DECLARE
    action_ctx      SYS.RE$NV_LIST;
    ac_name         VARCHAR2(30) := 'dist_list';

```

```

BEGIN
  action_ctx := SYS.RE$NV_LIST(SYS.RE$NV_ARRAY());
  SELECT RULE_ACTION_CONTEXT
    INTO action_ctx
    FROM DBA_RULES R
    WHERE RULE_OWNER='STRMADMIN' AND RULE_NAME='RULE_DEP_10';
  action_ctx.ADD_PAIR(ac_name,
    ANYDATA.CONVERTVARCHAR2('admin_list'));
  DBMS_RULE_ADM.ALTER_RULE(
    rule_name      => 'strmadmin.rule_dep_10',
    action_context => action_ctx);
END;
/

```

To ensure that the name-value pair was added successfully, you can run the following query:

```

COLUMN ACTION_CONTEXT_NAME HEADING 'Action Context Name' FORMAT A25
COLUMN AC_VALUE_NUMBER HEADING 'Action Context|Number Value' FORMAT 9999
COLUMN AC_VALUE_VARCHAR2 HEADING 'Action Context|Text Value' FORMAT A25

SELECT
  AC.NVN_NAME ACTION_CONTEXT_NAME,
  AC.NVN_VALUE.ACCESSNUMBER() AC_VALUE_NUMBER,
  AC.NVN_VALUE.ACCESSVARCHAR2() AC_VALUE_VARCHAR2
  FROM DBA_RULES R, TABLE(R.RULE_ACTION_CONTEXT.ACTX_LIST) AC
  WHERE RULE_NAME = 'RULE_DEP_10';

```

This query should display output similar to the following:

```

                Action Context Action Context
Action Context Name      Number Value Text Value
-----
course_number                1088
dist_list                    admin_list

```

See Also: ["Rule Action Context"](#) on page 5-8 for a scenario that uses similar name-value pairs in an action context

Removing a Name-Value Pair from a Rule Action Context

You remove a name-value pair in the action context of a rule using the `REMOVE_PAIR` member procedure of the `RE$NV_LIST` type. Ensure that no other users are modifying the action context at the same time.

Removing a name-value pair means altering the action context of a rule. If an action context contains name-value pairs in addition to the name-value pair being removed, then be cautious when you modify the action context so that you do not change or remove any other name-value pairs.

This example assumes that the `rule_dep_10` rule has the following name-value pairs:

Name	Value
course_number	1088
dist_list	admin_list

See Also: You added these name-value pairs to the `rule_dep_10` rule if you completed the examples in the following sections:

- ["Creating a Rule with an Action Context"](#) on page 17-6
- ["Modifying a Name-Value Pair in a Rule Action Context"](#) on page 17-7
- ["Adding a Name-Value Pair to a Rule Action Context"](#) on page 17-8

This example preserves existing name-value pairs in the action context of the `rule_dep_10` rule that should not be removed by selecting the existing action context into a variable and then removing the name-value pair with `dist_list` for the name.

```

DECLARE
  action_ctx      SYS.RE$NV_LIST;
  ac_name         VARCHAR2(30) := 'dist_list';
BEGIN
  SELECT RULE_ACTION_CONTEXT
  INTO action_ctx
  FROM DBA_RULES R
  WHERE RULE_OWNER='STRMADMIN' AND RULE_NAME='RULE_DEP_10';
  action_ctx.REMOVE_PAIR(ac_name);
  DBMS_RULE_ADM.ALTER_RULE(
    rule_name      => 'strmadmin.rule_dep_10',
    action_context => action_ctx);
END;
/

```

To ensure that the name-value pair was removed successfully without removing any other name-value pairs in the action context, you can run the following query:

```

COLUMN ACTION_CONTEXT_NAME HEADING 'Action Context Name' FORMAT A25
COLUMN AC_VALUE_NUMBER HEADING 'Action Context|Number Value' FORMAT 9999
COLUMN AC_VALUE_VARCHAR2 HEADING 'Action Context|Text Value' FORMAT A25

SELECT
  AC.NVN_NAME ACTION_CONTEXT_NAME,
  AC.NVN_VALUE.ACCESSNUMBER() AC_VALUE_NUMBER,
  AC.NVN_VALUE.ACCESSVARCHAR2() AC_VALUE_VARCHAR2
FROM DBA_RULES R, TABLE(R.RULE_ACTION_CONTEXT.ACTX_LIST) AC
WHERE RULE_NAME = 'RULE_DEP_10';

```

This query should display output similar to the following:

Action Context Name	Action Context Number Value	Action Context Text Value
course_number	1108	

Modifying System-Created Rules

System-created **rules** are rules created by running a procedure in the `DBMS_STREAMS_ADM` package. If you cannot create a rule with the exact **rule condition** you need using the `DBMS_STREAMS_ADM` package, then you can create a new rule with a condition based on a **system-created rule** by following these general steps:

1. Copy the rule condition of the system-created rule. You can view the rule condition of a system-created rule by querying the `DBA_STREAMS_RULES` data dictionary view.

2. Modify the condition.
3. Create a new rule with the modified condition.
4. Add the new rule to a **rule set** for an Oracle Streams **capture process**, **propagation**, **apply process**, or **messaging client**.
5. Remove the original rule if it is no longer needed using the `REMOVE_RULE` procedure in the `DBMS_STREAMS_ADM` package.

See Also:

- [Chapter 7, "Rule-Based Transformations"](#)
- [Chapter 21, "Monitoring an Oracle Streams Environment"](#) for more information about the data dictionary views related to Oracle Streams

Dropping a Rule

The following example runs the `DROP_RULE` procedure in the `DBMS_RULE_ADM` package to drop the `hr_dml` **rule** from the database:

```
BEGIN
  DBMS_RULE_ADM.DROP_RULE(
    rule_name => 'strmadmin.hr_dml',
    force      => FALSE);
END;
/
```

In this example, the `force` parameter in the `DROP_RULE` procedure is set to `FALSE`, which is the default setting. Therefore, the rule cannot be dropped if it is in one or more **rule sets**. If the `force` parameter is set to `TRUE`, then the rule is dropped from the database and automatically removed from any rule sets that contain it.

Managing Privileges on Evaluation Contexts, Rule Sets, and Rules

This section provides instructions for completing the following tasks:

- [Granting System Privileges on Evaluation Contexts, Rule Sets, and Rules](#)
- [Granting Object Privileges on an Evaluation Context, Rule Set, or Rule](#)
- [Revoking System Privileges on Evaluation Contexts, Rule Sets, and Rules](#)
- [Revoking Object Privileges on an Evaluation Context, Rule Set, or Rule](#)

See Also:

- ["Database Objects and Privileges Related to Rules"](#) on page 5-13
- The `GRANT_SYSTEM_PRIVILEGE` and `GRANT_OBJECT_PRIVILEGE` procedures in the `DBMS_RULE_ADM` package in *Oracle Database PL/SQL Packages and Types Reference*

Granting System Privileges on Evaluation Contexts, Rule Sets, and Rules

You can use the `GRANT_SYSTEM_PRIVILEGE` procedure in the `DBMS_RULE_ADM` package to grant system privileges on **evaluation contexts**, **rule sets**, and **rules** to users and roles. These privileges enable a user to create, alter, execute, or drop these objects in the user's own schema or, if the "ANY" version of the privilege is granted, in any schema.

For example, to grant the `hr` user the privilege to create an evaluation context in the user's own schema, enter the following while connected as a user who can grant privileges and alter users:

```
BEGIN
  DBMS_RULE_ADM.GRANT_SYSTEM_PRIVILEGE(
    privilege    => SYS.DBMS_RULE_ADM.CREATE_EVALUATION_CONTEXT_OBJ,
    grantee     => 'hr',
    grant_option => FALSE);
END;
/
```

In this example, the `grant_option` parameter in the `GRANT_SYSTEM_PRIVILEGE` procedure is set to `FALSE`, which is the default setting. Therefore, the `hr` user cannot grant the `CREATE_EVALUATION_CONTEXT_OBJ` system privilege to other users or roles. If the `grant_option` parameter were set to `TRUE`, then the `hr` user could grant this system privilege to other users or roles.

Granting Object Privileges on an Evaluation Context, Rule Set, or Rule

You can use the `GRANT_OBJECT_PRIVILEGE` procedure in the `DBMS_RULE_ADM` package to grant object privileges on a specific **evaluation context**, **rule set**, or **rule**. These privileges enable a user to alter or execute the specified object.

For example, to grant the `hr` user the privilege to both alter and execute a rule set named `hr_capture_rules` in the `strmadmin` schema, enter the following:

```
BEGIN
  DBMS_RULE_ADM.GRANT_OBJECT_PRIVILEGE(
    privilege    => SYS.DBMS_RULE_ADM.ALL_ON_RULE_SET,
    object_name  => 'strmadmin.hr_capture_rules',
    grantee     => 'hr',
    grant_option => FALSE);
END;
/
```

In this example, the `grant_option` parameter in the `GRANT_OBJECT_PRIVILEGE` procedure is set to `FALSE`, which is the default setting. Therefore, the `hr` user cannot grant the `ALL_ON_RULE_SET` object privilege for the specified rule set to other users or roles. If the `grant_option` parameter were set to `TRUE`, then the `hr` user could grant this object privilege to other users or roles.

Revoking System Privileges on Evaluation Contexts, Rule Sets, and Rules

You can use the `REVOKE_SYSTEM_PRIVILEGE` procedure in the `DBMS_RULE_ADM` package to revoke system privileges on **evaluation contexts**, **rule sets**, and **rules**.

For example, to revoke from the `hr` user the privilege to create an evaluation context in the user's own schema, enter the following while connected as a user who can grant privileges and alter users:

```
BEGIN
  DBMS_RULE_ADM.REVOKE_SYSTEM_PRIVILEGE(
    privilege    => SYS.DBMS_RULE_ADM.CREATE_EVALUATION_CONTEXT_OBJ,
    revokee     => 'hr');
END;
/
```

Revoking Object Privileges on an Evaluation Context, Rule Set, or Rule

You can use the `REVOKE_OBJECT_PRIVILEGE` procedure in the `DBMS_RULE_ADM` package to revoke object privileges on a specific **evaluation context**, **rule set**, or **rule**.

For example, to revoke from the `hr` user the privilege to both alter and execute a rule set named `hr_capture_rules` in the `strmadmin` schema, enter the following:

```
BEGIN
  DBMS_RULE_ADM.REVOKE_OBJECT_PRIVILEGE(
    privilege => SYS.DBMS_RULE_ADM.ALL_ON_RULE_SET,
    object_name => 'strmadmin.hr_capture_rules',
    revokee => 'hr');
END;
/
```

Managing Rule-Based Transformations

In Oracle Streams, a rule-based transformation is any modification to a **message** that results when a **rule** in a **positive rule set** evaluates to `TRUE`. There are two types of rule-based transformations: declarative and custom.

The following sections describe managing rule-based transformations:

- [Managing Declarative Rule-Based Transformations](#)
- [Managing Custom Rule-Based Transformations](#)

Note: A transformation specified for a rule is performed only if the rule is in a positive rule set. If the rule is in the **negative rule set** for a **capture process**, **propagation**, **apply process**, or **messaging client**, then these **Oracle Streams clients** ignore the rule-based transformation.

See Also:

- [Chapter 7, "Rule-Based Transformations"](#)

Managing Declarative Rule-Based Transformations

You can use the following procedures in the `DBMS_STREAMS_ADM` package to manage **declarative rule-based transformations**: `ADD_COLUMN`, `DELETE_COLUMN`, `RENAME_COLUMN`, `RENAME_SCHEMA`, and `RENAME_TABLE`.

This section provides instructions for completing the following tasks:

- [Adding Declarative Rule-Based Transformations](#)
- [Overwriting an Existing Declarative Rule-Based Transformation](#)
- [Removing Declarative Rule-Based Transformations](#)

Adding Declarative Rule-Based Transformations

The following sections contain examples that add **declarative rule-based transformations** to **rules**.

Adding a Declarative Rule-Based Transformation that Renames a Table

Use the `RENAME_TABLE` procedure in the `DBMS_STREAMS_ADM` package to add a declarative rule-based transformation that renames a table in a row LCR. For example, the following procedure adds a declarative rule-based transformation to the `jobs12` rule in the `strmadmin` schema:

```

BEGIN
  DBMS_STREAMS_ADM.RENAME_TABLE(
    rule_name      => 'strmadmin.jobs12',
    from_table_name => 'hr.jobs',
    to_table_name  => 'hr.assignments',
    step_number    => 0,
    operation      => 'ADD');
END;
/

```

The declarative rule-based transformation added by this procedure renames the table `hr.jobs` to `hr.assignments` in a row LCR when the rule `jobs12` evaluates to `TRUE` for the row LCR. If more than one declarative rule-based transformation is specified for the `jobs12` rule, then this transformation follows default transformation ordering because the `step_number` parameter is set to 0 (zero). In addition, the `operation` parameter is set to `ADD` to indicate that the transformation is being added to the rule, not removed from it.

The `RENAME_TABLE` procedure can also add a transformation that renames the schema in addition to the table. For example, in the previous example, to specify that the schema should be renamed to `oe`, specify `oe.assignments` for the `to_table_name` parameter.

Adding a Declarative Rule-Based Transformation that Adds a Column

Use the `ADD_COLUMN` procedure in the `DBMS_STREAMS_ADM` package to add a declarative rule-based transformation that adds a column to a row in a row LCR. For example, the following procedure adds a declarative rule-based transformation to the `employees35` rule in the `strmadmin` schema:

```

BEGIN
  DBMS_STREAMS_ADM.ADD_COLUMN(
    rule_name      => 'employees35',
    table_name     => 'hr.employees',
    column_name    => 'birth_date',
    column_value   => ANYDATA.ConvertDate(NULL),
    value_type     => 'NEW',
    step_number    => 0,
    operation      => 'ADD');
END;
/

```

The declarative rule-based transformation added by this procedure adds a `birth_date` column of data type `DATE` to an `hr.employees` table row in a row LCR when the rule `employees35` evaluates to `TRUE` for the row LCR.

Notice that the `ANYDATA.ConvertDate` function specifies the column type and the column value. In this example, the added column value is `NULL`, but a valid date can also be specified. Use the appropriate `AnyData` function for the column being added. For example, if the data type of the column being added is `NUMBER`, then use the `ANYDATA.ConvertNumber` function.

The `value_type` parameter is set to `NEW` to indicate that the column is added to the new values in a row LCR. You can also specify `OLD` to add the column to the old values.

If more than one declarative rule-based transformation is specified for the `employees35` rule, then the transformation follows default transformation ordering because the `step_number` parameter is set to 0 (zero). In addition, the `operation`

parameter is set to ADD to indicate that the transformation is being added, not removed.

Note: The ADD_COLUMN procedure is overloaded. A column_function parameter can specify that the current system date or time stamp is the value for the added column. The column_value and column_function parameters are mutually exclusive.

See Also: *Oracle Database PL/SQL Packages and Types Reference* for more information about AnyData type functions

Overwriting an Existing Declarative Rule-Based Transformation

When the operation parameter is set to ADD in a procedure that adds a **declarative rule-based transformation**, an existing declarative rule-based transformation is overwritten if the parameters in the following list match the existing transformation parameters:

- ADD_COLUMN procedure: rule_name, table_name, column_name, and step_number parameters
- DELETE_COLUMN procedure: rule_name, table_name, column_name, and step_number parameters
- RENAME_COLUMN procedure: rule_name, table_name, from_column_name, and step_number parameters
- RENAME_SCHEMA procedure: rule_name, from_schema_name, and step_number parameters
- RENAME_TABLE procedure: rule_name, from_table_name, and step_number parameters

For example, suppose an existing declarative rule-based transformation was created by running the following procedure:

```
BEGIN
  DBMS_STREAMS_ADM.RENAME_COLUMN (
    rule_name      => 'departments33',
    table_name     => 'hr.departments',
    from_column_name => 'manager_id',
    to_column_name  => 'lead_id',
    value_type     => 'NEW',
    step_number    => 0,
    operation      => 'ADD');
END;
/
```

Running the following procedure overwrites this existing declarative rule-based transformation:

```
BEGIN
  DBMS_STREAMS_ADM.RENAME_COLUMN (
    rule_name      => 'departments33',
    table_name     => 'hr.departments',
    from_column_name => 'manager_id',
    to_column_name  => 'lead_id',
    value_type     => '*',
    step_number    => 0,
    operation      => 'ADD');
END;
```

```
END;
/
```

In this case, the `value_type` parameter in the declarative rule-based transformation was changed from `NEW` to `*`. That is, in the original transformation, only new values were renamed in row LCRs, but, in the new transformation, both old and new values are renamed in row LCRs.

Removing Declarative Rule-Based Transformations

To remove a **declarative rule-based transformation** from a **rule**, use the same procedure used to add the transformation, but specify `REMOVE` for the `operation` parameter. For example, to remove the transformation added in ["Adding a Declarative Rule-Based Transformation that Renames a Table"](#) on page 18-1, run the following procedure:

```
BEGIN
  DBMS_STREAMS_ADM.RENAME_TABLE(
    rule_name      => 'strmadmin.jobs12',
    from_table_name => 'hr.jobs',
    to_table_name  => 'hr.assignments',
    step_number    => 0,
    operation      => 'REMOVE');
END;
/
```

When the `operation` parameter is set to `REMOVE` in any of the declarative transformation procedures listed in ["Managing Declarative Rule-Based Transformations"](#) on page 18-1, the other parameters in the procedure are optional, excluding the `rule_name` parameter. If these optional parameters are set to `NULL`, then they become wildcards.

The `RENAME_TABLE` procedure in the previous example behaves in the following way when one or more of the optional parameters are set to `NULL`:

from_table_name Parameter	to_table_name Parameter	step_number Parameter	Result
NULL	NULL	NULL	Remove all rename table transformations for the specified rule
non-NULL	NULL	NULL	Remove all rename table transformations with the specified <code>from_table_name</code> for the specified rule
NULL	non-NULL	NULL	Remove all rename table transformations with the specified <code>to_table_name</code> for the specified rule
NULL	NULL	non-NULL	Remove all rename table transformations with the specified <code>step_number</code> for the specified rule
non-NULL	non-NULL	NULL	Remove all rename table transformations with the specified <code>from_table_name</code> and <code>to_table_name</code> for the specified rule

from_table_name Parameter	to_table_name Parameter	step_number Parameter	Result
NULL	non-NULL	non-NULL	Remove all rename table transformations with the specified <code>to_table_name</code> and <code>step_number</code> for the specified rule
non-NULL	NULL	non-NULL	Remove all rename table transformations with the specified <code>from_table_name</code> and <code>step_number</code> for the specified rule

The other declarative transformation procedures work in a similar way when optional parameters are set to NULL and the operation parameter is set to REMOVE.

Managing Custom Rule-Based Transformations

Use the `SET_RULE_TRANSFORM_FUNCTION` procedure in the `DBMS_STREAMS_ADM` package to set or unset a **custom rule-based transformation** for a **rule**. This procedure modifies the rule **action context** to specify the custom rule-based transformation.

This section provides instructions for completing the following tasks:

- [Creating a Custom Rule-Based Transformation](#)
- [Altering a Custom Rule-Based Transformation](#)
- [Unsetting a Custom Rule-Based Transformation](#)

Caution: Do not modify LONG, LONG RAW, or LOB column data in an LCR with a custom rule-based transformation.

Note:

- There is no automatic locking mechanism for a rule action context. Therefore, ensure that an action context is not updated by two or more sessions at the same time.
 - When you perform custom rule-based transformations on DDL LCRs, you probably need to modify the DDL text in the DDL LCR to match any other modification. For example, if the transformation changes the name of a table in the DDL LCR, then the transformation should change the table name in the DDL text in the same way.
-

Creating a Custom Rule-Based Transformation

A **custom rule-based transformation** function always operates on one **message**, but it can return one message or many messages. A custom rule-based transformation function that returns one message is a one-to-one transformation function. A one-to-one transformation function must have the following signature:

```
FUNCTION user_function (
    parameter_name IN ANYDATA)
RETURN ANYDATA;
```

Here, *user_function* stands for the name of the function and *parameter_name* stands for the name of the parameter passed to the function. The parameter passed to the function is an ANYDATA encapsulation of a message, and the function must return an ANYDATA encapsulation of a message.

A custom rule-based transformation function that can return more than one message is a one-to-many transformation function. A one-to-many transformation function must have the following signature:

```
FUNCTION user_function (
    parameter_name IN ANYDATA)
RETURN STREAMS$_ANYDATA_ARRAY;
```

Here, *user_function* stands for the name of the function and *parameter_name* stands for the name of the parameter passed to the function. The parameter passed to the function is an ANYDATA encapsulation of a message, and the function must return an array that contains zero or more ANYDATA encapsulations of a message. If the array contains zero ANYDATA encapsulations of a message, then the original message is discarded. One-to-many transformation functions are supported only for Oracle Streams **capture processes** and **synchronous captures**.

The STREAMS\$_ANYDATA_ARRAY type is an Oracle-supplied type that has the following definition:

```
CREATE OR REPLACE TYPE SYS.STREAMS$_ANYDATA_ARRAY
AS VARRAY(2147483647) of SYS.ANYDATA
/
```

The following steps outline the general procedure for creating a custom rule-based transformation that uses a one-to-one function:

1. In SQL*Plus, connect to the database as an administrative user or as the user who will own the PL/SQL function.

See *Oracle Database Administrator's Guide* for information about connecting to a database in SQL*Plus.

2. Create a PL/SQL function that performs the transformation.

Caution: Ensure that the transformation function is deterministic. A deterministic function always returns the same value for any given set of input argument values, now and in the future. Also, ensure that the transformation function does not raise any exceptions. Exceptions can cause a capture process, **propagation**, or **apply process** to become disabled, and you will need to correct the transformation function before the capture process, propagation, or apply process can proceed. Exceptions raised by a custom rule-based transformation for a **synchronous capture** aborts the DML statement that caused the exception. Exceptions raised by a custom rule-based transformation for a **messaging client** can prevent the messaging client from dequeuing messages.

The following example creates a function called `executive_to_management` in the `hr` schema that changes the value in the `department_name` column of the `departments` table from `Executive` to `Management`. Such a transformation might be necessary if one branch in a company uses a different name for this department.

```

CREATE OR REPLACE FUNCTION hr.executive_to_management(in_any IN ANYDATA)
RETURN ANYDATA
IS
  lcr SYS.LCR$_ROW_RECORD;
  rc NUMBER;
  ob_owner VARCHAR2(30);
  ob_name VARCHAR2(30);
  dep_value_anydata ANYDATA;
  dep_value_varchar2 VARCHAR2(30);
BEGIN
  -- Get the type of object
  -- Check if the object type is SYS.LCR$_ROW_RECORD
  IF in_any.GETTYPENAME='SYS.LCR$_ROW_RECORD' THEN
    -- Put the row LCR into lcr
    rc := in_any.GETOBJECT(lcr);
    -- Get the object owner and name
    ob_owner := lcr.GET_OBJECT_OWNER();
    ob_name := lcr.GET_OBJECT_NAME();
    -- Check for the hr.departments table
    IF ob_owner = 'HR' AND ob_name = 'DEPARTMENTS' THEN
      -- Get the old value of the department_name column in the LCR
      dep_value_anydata := lcr.GET_VALUE('old', 'DEPARTMENT_NAME');
      IF dep_value_anydata IS NOT NULL THEN
        -- Put the column value into dep_value_varchar2
        rc := dep_value_anydata.GETVARCHAR2(dep_value_varchar2);
        -- Change a value of Executive in the column to Management
        IF (dep_value_varchar2 = 'Executive') THEN
          lcr.SET_VALUE('OLD', 'DEPARTMENT_NAME',
            ANYDATA.CONVERTVARCHAR2('Management'));
        END IF;
      END IF;
      -- Get the new value of the department_name column in the LCR
      dep_value_anydata := lcr.GET_VALUE('new', 'DEPARTMENT_NAME', 'n');
      IF dep_value_anydata IS NOT NULL THEN
        -- Put the column value into dep_value_varchar2
        rc := dep_value_anydata.GETVARCHAR2(dep_value_varchar2);
        -- Change a value of Executive in the column to Management
        IF (dep_value_varchar2 = 'Executive') THEN
          lcr.SET_VALUE('new', 'DEPARTMENT_NAME',
            ANYDATA.CONVERTVARCHAR2('Management'));
        END IF;
      END IF;
    END IF;
  END IF;
  RETURN ANYDATA.CONVERTOBJECT(lcr);
END IF;
RETURN in_any;
END;
/

```

3. Grant the Oracle Streams administrator EXECUTE privilege on the hr.executive_to_management function.

```
GRANT EXECUTE ON hr.executive_to_management TO strmadmin;
```

4. Connect to the database as the Oracle Streams administrator.
5. Create **subset rules** for DML operations on the hr.departments table. The subset rules will use the transformation created in Step 2.

Subset rules are not required to use custom rule-based transformations. This example uses subset rules to illustrate an **action context** with more than one

name-value pair. This example creates subset rules for an apply process on a database named `dbssl.example.com`. These rules evaluate to `TRUE` when an LCR contains a DML change to a row with a `location_id` of 1700 in the `hr.departments` table. This example assumes that an ANYDATA queue named `streams_queue` already exists in the database.

To create these rules, run the following `ADD_SUBSET_RULES` procedure:

```
BEGIN
  DBMS_STREAMS_ADM.ADD_SUBSET_RULES (
    table_name           => 'hr.departments',
    dml_condition        => 'location_id=1700',
    streams_type         => 'apply',
    streams_name         => 'strm01_apply',
    queue_name           => 'streams_queue',
    include_tagged_lcr   => FALSE,
    source_database      => 'dbssl.example.com');
END;
/
```

Note:

- To create the rule and the **rule set**, the Oracle Streams administrator must have `CREATE_RULE_SET_OBJ` (or `CREATE_ANYRULE_SET_OBJ`) and `CREATE_RULE_OBJ` (or `CREATE_ANY_RULE_OBJ`) system privileges. You grant these privileges using the `GRANT_SYSTEM_PRIVILEGE` procedure in the `DBMS_RULE_ADM` package.
 - This example creates the rule using the `DBMS_STREAMS_ADM` package. Alternatively, you can create a rule, add it to a rule set, and specify a custom rule-based transformation using the `DBMS_RULE_ADM` package. *Oracle Streams Replication Administrator's Guide* contains an example of this procedure.
 - The `ADD_SUBSET_RULES` procedure adds the subset rules to the **positive rule set** for the apply process.
-
-

6. Determine the names of the system-created **rules** by running the following query:

```
SELECT RULE_NAME, SUBSETTING_OPERATION FROM DBA_STREAMS_RULES
WHERE OBJECT_NAME='DEPARTMENTS' AND DML_CONDITION='location_id=1700';
```

This query displays output similar to the following:

RULE_NAME	SUBSET
DEPARTMENTS5	INSERT
DEPARTMENTS6	UPDATE
DEPARTMENTS7	DELETE

Note: You can also obtain this information using the `OUT` parameters when you run `ADD_SUBSET_RULES`.

Because these are subset rules, two of them contain a non-NULL action context that performs an internal transformation:

- The rule with a subsetting condition of INSERT contains an internal transformation that converts updates into inserts if the update changes the value of the `location_id` column to 1700 from some other value. The internal transformation does not affect inserts.
- The rule with a subsetting condition of DELETE contains an internal transformation that converts updates into deletes if the update changes the value of the `location_id` column from 1700 to a different value. The internal transformation does not affect deletes.

In this example, you can confirm that the rules DEPARTMENTS5 and DEPARTMENTS7 have a non-NULL action context, and that the rule DEPARTMENTS6 has a NULL action context, by running the following query:

```
COLUMN RULE_NAME HEADING 'Rule Name' FORMAT A13
COLUMN ACTION_CONTEXT_NAME HEADING 'Action Context Name' FORMAT A27
COLUMN ACTION_CONTEXT_VALUE HEADING 'Action Context Value' FORMAT A30

SELECT
    RULE_NAME,
    AC.NVN_NAME ACTION_CONTEXT_NAME,
    AC.NVN_VALUE.ACCESSVARCHAR2() ACTION_CONTEXT_VALUE
FROM DBA_RULES R, TABLE(R.RULE_ACTION_CONTEXT.ACTX_LIST) AC
WHERE RULE_NAME IN ('DEPARTMENTS5', 'DEPARTMENTS6', 'DEPARTMENTS7');
```

This query displays output similar to the following:

Rule Name	Action Context Name	Action Context Value
DEPARTMENTS5	STREAMS\$_ROW_SUBSET	INSERT
DEPARTMENTS7	STREAMS\$_ROW_SUBSET	DELETE

The DEPARTMENTS6 rule does not appear in the output because its action context is NULL.

7. Set the custom rule-based transformation for each subset rule by running the `SET_RULE_TRANSFORM_FUNCTION` procedure. This step runs this procedure for each rule and specifies `hr.executive_to_management` as the transformation function. Ensure that no other users are modifying the action context at the same time.

```
BEGIN
    DBMS_STREAMS_ADM.SET_RULE_TRANSFORM_FUNCTION(
        rule_name          => 'departments5',
        transform_function => 'hr.executive_to_management');
    DBMS_STREAMS_ADM.SET_RULE_TRANSFORM_FUNCTION(
        rule_name          => 'departments6',
        transform_function => 'hr.executive_to_management');
    DBMS_STREAMS_ADM.SET_RULE_TRANSFORM_FUNCTION(
        rule_name          => 'departments7',
        transform_function => 'hr.executive_to_management');
END;
/
```

Specifically, this procedure adds a name-value pair to each rule action context that specifies the name `STREAMS$_TRANSFORM_FUNCTION` and a value that is an ANYDATA instance containing the name of the PL/SQL function that performs the

transformation. In this case, the transformation function is `hr.executive_to_management`.

Note: The `SET_RULE_TRANSFORM_FUNCTION` does not verify that the specified transformation function exists. If the function does not exist, then an error is raised when an Oracle Streams process or job tries to invoke the transformation function.

Now, if you run the query that displays the name-value pairs in the action context for these rules, each rule, including the `DEPARTMENTS6` rule, shows the name-value pair for the custom rule-based transformation:

```
SELECT
  RULE_NAME,
  AC.NVN_NAME ACTION_CONTEXT_NAME,
  AC.NVN_VALUE.ACCESSVARCHAR2() ACTION_CONTEXT_VALUE
FROM DBA_RULES R, TABLE(R.RULE_ACTION_CONTEXT.ACTX_LIST) AC
WHERE RULE_NAME IN ('DEPARTMENTS5', 'DEPARTMENTS6', 'DEPARTMENTS7');
```

This query displays output similar to the following:

Rule Name	Action Context Name	Action Context Value
DEPARTMENTS51	STREAMS\$_ROW_SUBSET	INSERT
DEPARTMENTS51	STREAMS\$_TRANSFORM_FUNCTION	"HR"."EXECUTIVE_TO_MANAGEMENT"
DEPARTMENTS52	STREAMS\$_TRANSFORM_FUNCTION	"HR"."EXECUTIVE_TO_MANAGEMENT"
DEPARTMENTS53	STREAMS\$_ROW_SUBSET	DELETE
DEPARTMENTS53	STREAMS\$_TRANSFORM_FUNCTION	"HR"."EXECUTIVE_TO_MANAGEMENT"

You can also view transformation functions using the `DBA_STREAMS_TRANSFORM_FUNCTION` data dictionary view.

See Also: *Oracle Database PL/SQL Packages and Types Reference* for more information about the `SET_RULE_TRANSFORM_FUNCTION` and the rule types used in this example

Altering a Custom Rule-Based Transformation

To alter a **custom rule-based transformation**, you can either edit the transformation function or run the `SET_RULE_TRANSFORM_FUNCTION` procedure to specify a different transformation function. This example runs the `SET_RULE_TRANSFORM_FUNCTION` procedure to specify a different transformation function. The `SET_RULE_TRANSFORM_FUNCTION` procedure modifies the **action context** of a specified **rule** to run a different transformation function. If you edit the transformation function itself, then you do not need to run this procedure.

This example alters a custom rule-based transformation for rule `DEPARTMENTS5` by changing the transformation function from `hr.execute_to_management` to `hr.executive_to_lead`. The `hr.execute_to_management` rule-based transformation was added to the `DEPARTMENTS5` rule in the example in ["Creating a Custom Rule-Based Transformation"](#) on page 18-5.

In Oracle Streams, **subset rules** use name-value pairs in an action context to perform internal transformations that convert `UPDATE` operations into `INSERT` and `DELETE` operations in some situations. Such a conversion is called a **row migration**. The `SET_RULE_TRANSFORM_FUNCTION` procedure preserves the name-value pairs that perform row migrations.

See Also: ["Row Migration and Subset Rules"](#) on page 6-23 for more information about row migration

Complete the following steps to alter a custom rule-based transformation:

1. You can view all of the name-value pairs in the action context of a rule by performing the following query:

```
COLUMN ACTION_CONTEXT_NAME HEADING 'Action Context Name' FORMAT A30
COLUMN ACTION_CONTEXT_VALUE HEADING 'Action Context Value' FORMAT A30

SELECT
    AC.NVN_NAME ACTION_CONTEXT_NAME,
    AC.NVN_VALUE.ACCESSVARCHAR2() ACTION_CONTEXT_VALUE
FROM DBA_RULES R, TABLE(R.RULE_ACTION_CONTEXT.ACTX_LIST) AC
WHERE RULE_NAME = 'DEPARTMENTS5';
```

This query displays output similar to the following:

Action Context Name	Action Context Value
STREAMS\$_ROW_SUBSET	INSERT
STREAMS\$_TRANSFORM_FUNCTION	"HR"."EXECUTIVE_TO_MANAGEMENT"

2. Run the `SET_RULE_TRANSFORM_FUNCTION` procedure to set the transformation function to `executive_to_lead` for the `DEPARTMENTS5` rule. In this example, it is assumed that the new transformation function is `hr.executive_to_lead` and that the `strmadmin` user has `EXECUTE` privilege on it.

```
BEGIN
    DBMS_STREAMS_ADM.SET_RULE_TRANSFORM_FUNCTION(
        rule_name          => 'departments5',
        transform_function => 'hr.executive_to_lead');
END;
/
```

To ensure that the transformation function was altered properly, you can rerun the query in Step 1. You should alter the action context for the `DEPARTMENTS6` and `DEPARTMENTS7` rules in a similar way to keep the three subset rules consistent.

Note:

- The `SET_RULE_TRANSFORM_FUNCTION` does not verify that the specified transformation function exists. If the function does not exist, then an error is raised when an Oracle Streams process or job tries to invoke the transformation function.
 - If a custom rule-based transformation function is modified at the same time that an [Oracle Streams client](#) tries to access it, then an error might be raised.
-
-

Unsetting a Custom Rule-Based Transformation

To unset a [custom rule-based transformation](#) from a [rule](#), run the `SET_RULE_TRANSFORM_FUNCTION` procedure and specify `NULL` for the transformation function. Specifying `NULL` unsets the name-value pair that specifies the custom rule-based transformation in the rule [action context](#). This example unsets a custom rule-based transformation for rule `DEPARTMENTS5`. This transformation was added to the

DEPARTMENTS5 rule in the example in ["Creating a Custom Rule-Based Transformation"](#) on page 18-5.

In Oracle Streams, **subset rules** use name-value pairs in an action context to perform internal transformations that convert UPDATE operations into INSERT and DELETE operations in some situations. Such a conversion is called a **row migration**. The SET_RULE_TRANSFORM_FUNCTION procedure preserves the name-value pairs that perform row migrations.

See Also: ["Row Migration and Subset Rules"](#) on page 6-23 for more information about row migration

Run the following procedure to unset the custom rule-based transformation for rule DEPARTMENTS5:

```
BEGIN
  DBMS_STREAMS_ADM.SET_RULE_TRANSFORM_FUNCTION (
    rule_name          => 'departments5',
    transform_function => NULL);
END;
/
```

To ensure that the transformation function was unset, you can run the query in Step 1 on page 18-11. You should alter the action context for the DEPARTMENTS6 and DEPARTMENTS7 rules in a similar way to keep the three subset rules consistent.

See Also: ["Row Migration and Subset Rules"](#) on page 6-23 for more information about row migration

Other Oracle Streams Management Tasks

This chapter provides instructions for performing full database export/import in an Oracle Streams environment. This chapter also provides instructions for removing an Oracle Streams configuration.

The following topics describe Oracle Streams management tasks:

- [Performing Full Database Export/Import in an Oracle Streams Environment](#)
- [Removing an Oracle Streams Configuration](#)

Each task described in this chapter should be completed by an Oracle Streams administrator that has been granted the appropriate privileges, unless specified otherwise.

See Also: ["Configuring an Oracle Streams Administrator"](#) on page 9-1

Performing Full Database Export/Import in an Oracle Streams Environment

This section describes how to perform a full database export/import on a database that is running one or more Oracle Streams [capture processes](#), [propagations](#), or [apply processes](#). These instructions pertain to a full database export/import where the import database and export database are running on different computers, and the import database replaces the export database. The global name of the import database and the global name of the export database must match. These instructions assume that both databases already exist.

Note: If you want to add a database to an existing Oracle Streams environment, then do not use the instructions in this section. Instead, see *Oracle Streams Replication Administrator's Guide*.

See Also:

- *Oracle Streams Replication Administrator's Guide* for more information about export/import parameters that are relevant to Oracle Streams
- *Oracle Database Utilities* for more information about performing a full database export/import

Complete the following steps to perform a full database export/import on a database that is using Oracle Streams:

1. If the export database contains any **destination queues** for **propagations** from other databases, then stop each propagation that propagates **messages** to the export database. You can stop a propagation using the `STOP_PROPAGATION` procedure in the `DBMS_PROPAGATION_ADM` package.
2. Make the necessary changes to your network configuration so that the database links used by the **propagation jobs** you disabled in Step 1 point to the computer running the import database.

To complete this step, you might need to re-create the database links used by these propagation jobs or modify your Oracle networking files at the databases that contain the **source queues**.

3. Notify all users to stop making data manipulation language (DML) and data definition language (DDL) changes to the export database, and wait until these changes have stopped.
4. Make a note of the current export database system change number (SCN). You can determine the current SCN using the `GET_SYSTEM_CHANGE_NUMBER` function in the `DBMS_FLASHBACK` package. For example:

```
SET SERVEROUTPUT ON SIZE 1000000
DECLARE
    current_scn NUMBER;
BEGIN
    current_scn:= DBMS_FLASHBACK.GET_SYSTEM_CHANGE_NUMBER;
    DBMS_OUTPUT.PUT_LINE('Current SCN: ' || current_scn);
END;
/
```

In this example, assume that current SCN returned is 7000000.

After completing this step, do not stop any **capture process** running on the export database. Step 7d instructs you to use the `V$STREAMS_CAPTURE` dynamic performance view to ensure that no DML or DDL changes were made to the database after Step 3. The information about a capture process in this view is reset if the capture process is stopped and restarted.

For the check in Step 7d to be valid, this information should not be reset for any capture process. To prevent a capture process from stopping automatically, you might need to set the `message_limit` and `time_limit` capture process parameters to `infinite` if these parameters are set to another value for any capture process.

5. If any **downstream capture processes** are capturing changes that originated at the export database, then ensure that the log file containing the SCN determined in Step 4 has been transferred to the **downstream database** and added to the capture process session. See "Displaying the Registered Redo Log Files for Each Capture Process" on page 23-7 for queries that can determine this information.
6. If the export database is not running any apply processes, and is not propagating messages, then start the full database export now. Ensure that the `FULL` export parameter is set to `y` so that the required Oracle Streams metadata is exported.

If the export database is running one or more apply processes or is propagating messages, then do not start the export and proceed to the next step.

7. If the export database is the **source database** for changes captured by any capture processes, then complete the following steps for each capture process:

- a. Wait until the capture process has scanned past the redo record that corresponds to the SCN determined in Step 4. You can view the SCN of the redo record last scanned by a capture process by querying the `CAPTURE_MESSAGE_NUMBER` column in the `V$STREAMS_CAPTURE` dynamic performance view. Ensure that the value of `CAPTURE_MESSAGE_NUMBER` is greater than or equal to the SCN determined in Step 4 before you continue.
- b. In SQL*Plus, connect to the database as the Oracle Streams administrator.
See *Oracle Database Administrator's Guide* for information about connecting to a database in SQL*Plus.
- c. Monitor the Oracle Streams environment until the apply process at the **destination database** has applied all of the changes from the capture database. For example, if the name of the capture process is `capture`, the name of the apply process is `apply`, the global name of the destination database is `dest.example.com`, and the SCN value returned in Step 4 is `7000000`, then run the following query at the capture database:

```
SELECT cap.ENQUEUE_MESSAGE_NUMBER
FROM V$STREAMS_CAPTURE cap
WHERE cap.CAPTURE_NAME = 'CAPTURE' AND
      cap.ENQUEUE_MESSAGE_NUMBER IN (
      SELECT DEQUEUED_MESSAGE_NUMBER
      FROM V$STREAMS_APPLY_READER@dest.example.com reader,
           V$STREAMS_APPLY_COORDINATOR@dest.example.com coord
      WHERE reader.APPLY_NAME = 'APPLY' AND
            reader.DEQUEUED_MESSAGE_NUMBER = reader.OLDEST_SCN_NUM AND
            coord.APPLY_NAME = 'APPLY' AND
            coord.LWM_MESSAGE_NUMBER = coord.HWM_MESSAGE_NUMBER AND
            coord.APPLY# = reader.APPLY#) AND
      cap.CAPTURE_MESSAGE_NUMBER >= 7000000;
```

When this query returns a row, all of the changes from the capture database have been applied at the destination database, and you can move on to the next step.

If this query returns no results for an inordinately long time, then ensure that the **Oracle Streams clients** in the environment are enabled by querying the `STATUS` column in the `DBA_CAPTURE` view at the source database and the `DBA_APPLY` view at the destination database. You can check the status of the propagation by running the query in "[Displaying the Schedule for a Propagation Job](#)" on page 24-15.

If an Oracle Streams client is disabled, then try restarting it. If an Oracle Streams client will not restart, then troubleshoot the environment using the information in [Chapter 20, "Troubleshooting an Oracle Streams Environment"](#).

The query in this step assumes that a database link accessible to the Oracle Streams administrator exists between the capture database and the destination database. If such a database link does not exist, then you can perform two separate queries at the capture database and destination database.

- d. Verify that the enqueue message number of each capture process is less than or equal to the SCN determined in Step 4. You can view the enqueue message number for each capture process by querying the `ENQUEUE_MESSAGE_NUMBER` column in the `V$STREAMS_CAPTURE` dynamic performance view.

If the enqueue message number of each capture process is less than or equal to the SCN determined in Step 4, then proceed to Step 9.

However, if the enqueue message number of any capture process is higher than the SCN determined in Step 4, then one or more DML or DDL changes were made after the SCN determined in Step 4, and these changes were captured and enqueued by a capture process. In this case, perform all of the steps in this section again, starting with Step 1 on page 19-2.

Note: For this verification to be valid, each capture process must have been running uninterrupted since Step 4.

8. If any downstream capture processes captured changes that originated at the export database, then drop these downstream capture processes. You will re-create them in Step 14a.
9. If the export database has any propagations that are propagating messages, then stop these propagations using the `STOP_PROPAGATION` procedure in the `DBMS_PROPAGATION` package.
10. If the export database is running one or more apply processes, or is propagating messages, then start the full database export now. Ensure that the `FULL` export parameter is set to `y` so that the required Oracle Streams metadata is exported. If you already started the export in Step 6, then proceed to Step 11.
11. When the export is complete, transfer the export dump file to the computer running the import database.
12. Perform the full database import. Ensure that the `STREAMS_CONFIGURATION` and `FULL` import parameters are both set to `y` so that the required Oracle Streams metadata is imported. The default setting is `y` for the `STREAMS_CONFIGURATION` import parameter. Also, ensure that no DML or DDL changes are made to the import database during the import.
13. If any downstream capture processes are capturing changes that originated at the database, then make the necessary changes so that log files are transferred from the import database to the downstream database. See "[Preparing to Transmit Redo Data to a Downstream Database](#)" on page 10-7 for instructions.
14. Re-create downstream capture processes:
 - a. Re-create any downstream capture processes that you dropped in Step 8, if necessary. These dropped downstream capture processes were capturing changes that originated at the export database. Configure the re-created downstream capture processes to capture changes that originate at the import database.
 - b. Re-create in the import database any downstream capture processes that were running in the export database, if necessary. If the export database had any downstream capture processes, then those downstream capture processes were not exported.

See Also: "[Configuring a Capture Process](#)" on page 10-1 for information about creating a downstream capture process

15. If any local or downstream capture processes will capture changes that originate at the database, then, at the import database, prepare the database objects whose changes will be captured for **instantiation**. See *Oracle Streams Replication Administrator's Guide* for information about preparing database objects for instantiation.

16. Let users access the import database, and shut down the export database.
17. Enable any propagation jobs you disabled in Steps 1 and 9.
18. If you reset the value of a `message_limit` or `time_limit` capture process parameter in Step 4, then, at the import database, reset these parameters to their original settings.

Removing an Oracle Streams Configuration

You run the `REMOVE_STREAMS_CONFIGURATION` procedure in the `DBMS_STREAMS_ADM` package to remove an Oracle Streams configuration at the local database.

Caution: Running this procedure is dangerous. You should run this procedure only if you are sure you want to remove the entire Oracle Streams configuration at a database.

To remove the Oracle Streams configuration at the local database, run the following procedure:

```
EXEC DBMS_STREAMS_ADM.REMOVE_STREAMS_CONFIGURATION();
```

After running this procedure, drop the Oracle Streams administrator at the database, if possible.

See Also: *Oracle Database PL/SQL Packages and Types Reference* for detailed information about the actions performed by the `REMOVE_STREAMS_CONFIGURATION` procedure

Troubleshooting an Oracle Streams Environment

The following topics describe identifying and resolving common problems in an Oracle Streams environment:

- [Viewing Oracle Streams Alerts](#)
- [Troubleshooting Capture Process Problems](#)
- [Troubleshooting Synchronous Capture Problems](#)
- [Troubleshooting Propagation Problems](#)
- [Troubleshooting Apply Process Problems](#)
- [Troubleshooting Problems with Rules and Rule-Based Transformations](#)
- [Checking the Trace Files and Alert Log for Problems](#)

See Also:

- *Oracle Streams Replication Administrator's Guide* for more information about troubleshooting Oracle Streams [replication](#) environments

Viewing Oracle Streams Alerts

An **alert** is a warning about a potential problem or an indication that a critical threshold has been crossed. There are two types of alerts:

- **Stateless:** Alerts that indicate single events that are not necessarily tied to the system state. For example, an alert that indicates that a capture aborted with a specific error is a stateless alert.
- **Stateful:** Alerts that are associated with a specific system state. Stateful alerts are usually based on a numeric value, with thresholds defined at warning and critical levels. For example, an alert on the current Oracle Streams pool memory usage percentage, with the warning level at 85% and the critical level at 95%, is a stateful alert.

An Oracle Database 11g Release 1 or later database generates a stateless Oracle Streams alert under the following conditions:

- A capture process aborts.
- A propagation aborts after 16 consecutive errors.

- An apply process aborts.
- An apply process with an empty error queue encounters an apply error.

An Oracle Database 11g Release 1 or later database generates a stateful Oracle Streams alert under the following condition:

- Oracle Streams pool memory usage exceeds the percentage specified by the `STREAMS_POOL_USED_PCT` metric. You can manage this metric in Oracle Enterprise Manager or with the `SET_THRESHOLD` procedure in the `DBMS_SERVER_ALERT` package.

You can view alerts in Enterprise Manager, or you can query the following data dictionary views:

- The `DBA_OUTSTANDING_ALERTS` view records current stateful alerts. The `DBA_ALERT_HISTORY` view records stateless alerts and stateful alerts that have been cleared. For example, if the memory usage in the Oracle Streams pool exceeds the specified threshold, then a stateful alert is recorded in the `DBA_OUTSTANDING_ALERTS` view.
- The `DBA_ALERT_HISTORY` data dictionary view shows alerts that have been cleared from the `DBA_OUTSTANDING_ALERTS` view. For example, if the memory usage in the Oracle Streams pool falls below the specified threshold, then the alert recorded in the `DBA_OUTSTANDING_ALERTS` view is cleared and moved to the `DBA_ALERT_HISTORY` view.

For example, to list the current stateful Oracle Streams alerts, run the following query on the `DBA_OUTSTANDING_ALERTS` view:

```
COLUMN REASON HEADING 'Reason for Alert' FORMAT A35
COLUMN SUGGESTED_ACTION HEADING 'Suggested Response' FORMAT A35

SELECT REASON, SUGGESTED_ACTION
       FROM DBA_OUTSTANDING_ALERTS
       WHERE MODULE_ID LIKE '%STREAMS%';
```

To list the Oracle Streams stateless alerts and cleared Oracle Streams stateful alerts, run the following query on the `DBA_ALERT_HISTORY` view:

```
COLUMN REASON HEADING 'Reason for Alert' FORMAT A35
COLUMN SUGGESTED_ACTION HEADING 'Suggested Response' FORMAT A35

SELECT REASON, SUGGESTED_ACTION
       FROM DBA_ALERT_HISTORY
       WHERE MODULE_ID LIKE '%STREAMS%';
```

The following is example output from a query on the `DBA_ALERT_HISTORY` view:

Reason for Alert	Suggested Response
----- STREAMS apply process "APPLY_EMP_DE P" aborted with ORA-26714	----- Obtain the exact error message in d ba_apply, take the appropriate acti on for this error, and restart the apply process using dbms_apply_adm. start_apply. If the error is an OR A-26714, consider setting the 'DISA BLE_ON_ERROR' apply parameter to 'N ' to avoid aborting on future user errors.

STREAMS error queue for apply proce Look at the contents of the error q
 ss "APPLY_EMP_DEP" contains new tra ueue as well as dba_apply_error to
 nsaction with ORA-26786 determine the cause of the error.
 Once the errors are resolved, reexe
 cute them using dbms_apply_adm.exec
 ute_error or dbms_apply_adm.execute
 _all_errors.

Note: Oracle Streams alerts are informational only. They do not need to be managed. If you monitor your Oracle Streams environment regularly and address problems as they arise, then you might not need to monitor Oracle Streams alerts.

See Also:

- *Oracle Database 2 Day + Data Replication and Integration Guide* for more information about Oracle Streams alerts
- *Oracle Database 2 Day DBA* for information about managing alerts and metric thresholds
- *Oracle Database Administrator's Guide* for information about alerts and for information about subscribing to the ALERT_QUEUE to receive notifications when new alerts are generated
- *Oracle Database PL/SQL Packages and Types Reference* for more information about the DBMS_SERVER_ALERT package
- ["Setting Initialization Parameters Relevant to Oracle Streams"](#) on page 9-4
- ["Configuring the Oracle Streams Pool"](#) on page 9-9 for information about the Oracle Streams pool, Automatic Memory Management, and Automatic Shared Memory Management

Troubleshooting Capture Process Problems

If a **capture process** is not capturing changes as expected, or if you are having other problems with a capture process, then use the following checklist to identify and resolve capture problems:

- [Is Capture Process Creation or Data Dictionary Build Taking a Long Time?](#)
- [Is the Capture Process Enabled?](#)
- [Is the Capture Process Current?](#)
- [Are Required Redo Log Files Missing?](#)
- [Is a Downstream Capture Process Waiting for Redo Data?](#)
- [Are You Trying to Configure Downstream Capture Incorrectly?](#)
- [Are You Trying to Configure Downstream Capture Without Proper Authentication?](#)
- [Are More Actions Required for Downstream Capture Without a Database Link?](#)

See Also:

- ["Implicit Capture with an Oracle Streams Capture Process"](#) on page 2-9
- ["Configuring a Capture Process"](#) on page 10-1
- ["Managing a Capture Process"](#) on page 14-1
- ["Monitoring a Capture Process"](#) on page 23-1

Is Capture Process Creation or Data Dictionary Build Taking a Long Time?

If capture process creation or a data dictionary build is taking an inordinately long time, then it might be because one or more in-flight transactions have not yet committed. An in-flight transaction is one that is active during capture process creation or a data dictionary build.

To determine whether there are in-flight transactions, check the alert log for the following messages:

```
wait for inflight txns at this scn
Done with waiting for inflight txns at this scn
```

If you see only the first message in the alert log, then the capture process creation or data dictionary build is waiting for the in-flight transactions and will complete after all of the in-flight transactions have committed.

See Also:

- ["Configuring a Capture Process"](#) on page 10-1
- ["Capture Process Creation"](#) on page 2-29
- ["Checking the Trace Files and Alert Log for Problems"](#) on page 20-26

Is the Capture Process Enabled?

A [capture process](#) captures changes only when it is enabled.

You can check whether a capture process is enabled, disabled, or aborted by querying the `DBA_CAPTURE` data dictionary view. For example, to check whether a capture process named `capture` is enabled, run the following query:

```
SELECT STATUS FROM DBA_CAPTURE WHERE CAPTURE_NAME = 'CAPTURE';
```

If the capture process is disabled, then your output looks similar to the following:

```
STATUS
-----
DISABLED
```

If the capture process is disabled, then try restarting it. If the capture process is aborted, then you might need to correct an error before you can restart it successfully.

To determine why the capture process aborted, query the `DBA_CAPTURE` data dictionary view or check the trace file for the capture process. The following query shows when the capture process aborted and the error that caused it to abort:

```
COLUMN CAPTURE_NAME HEADING 'Capture|Process|Name' FORMAT A10
COLUMN STATUS_CHANGE_TIME HEADING 'Abort Time'
COLUMN ERROR_NUMBER HEADING 'Error Number' FORMAT 99999999
COLUMN ERROR_MESSAGE HEADING 'Error Message' FORMAT A40
```

```
SELECT CAPTURE_NAME, STATUS_CHANGE_TIME, ERROR_NUMBER, ERROR_MESSAGE
FROM DBA_CAPTURE WHERE STATUS='ABORTED' ;
```

See Also:

- ["Starting a Capture Process"](#) on page 14-2
- ["Checking the Trace Files and Alert Log for Problems"](#) on page 20-26
- ["Capture Processes and Oracle Real Application Clusters"](#) on page A-1 for information about restarting a capture process in an Oracle Real Application Clusters (Oracle RAC) environment

Is the Capture Process Current?

If a **capture process** has not captured recent changes, then the cause might be that the capture process has fallen behind. To check, you can query the `V$STREAMS_CAPTURE` dynamic performance view. If capture process latency is high, then you might be able to improve performance by adjusting the setting of the `parallelism` capture process parameter.

See Also:

- ["Determining Redo Log Scanning Latency for Each Capture Process"](#) on page 23-12
- ["Determining Message Enqueuing Latency for Each Capture Process"](#) on page 23-13
- ["Capture Process Components"](#) on page 2-22
- ["Setting a Capture Process Parameter"](#) on page 14-6

Are Required Redo Log Files Missing?

When a **capture process** is started or restarted, it might need to scan redo log files that were generated before the log file that contains the **start SCN**. You can query the `DBA_CAPTURE` data dictionary view to determine the **first SCN** and start SCN for a capture process. Removing required redo log files before they are scanned by a capture process causes the capture process to abort and results in the following error in a capture process trace file:

```
ORA-01291: missing logfile
```

If you see this error, then try restoring any missing redo log file and restarting the capture process. You can check the `V$LOGMNR_LOGS` dynamic performance view to determine the missing SCN range, and add the relevant redo log files. A capture process needs the redo log file that includes the **required checkpoint SCN** and all subsequent redo log files. You can query the `REQUIRED_CHECKPOINT_SCN` column in the `DBA_CAPTURE` data dictionary view to determine the required checkpoint SCN for a capture process.

If you are using the flash recovery area feature of Recovery Manager (RMAN) on a **source database** in an Oracle Streams environment, then RMAN might delete archived redo log files that are required by a capture process. RMAN might delete these files when the disk space used by the recovery-related files is nearing the specified disk quota for the flash recovery area. To prevent this problem in the future, complete one or more of the following actions:

- Increase the disk quota for the flash recovery area. Increasing the disk quota makes it less likely that RMAN will delete a required archived redo log file, but it will not always prevent the problem.
- Configure the source database to store archived redo log files in a location other than the flash recovery area. A **local capture process** will be able to use the log files in the other location if the required log files are missing in the flash recovery area. In this case, a database administrator must manage the log files manually in the other location.

RMAN always ensures that archived redo log files are backed up before it deletes them. If RMAN deletes an archived redo log file that is required by a capture process, then RMAN records this action in the alert log.

See Also:

- "ARCHIVELOG Mode and a Capture Process" on page 2-28
- "First SCN and Start SCN" on page 2-20
- "Displaying the Registered Redo Log Files for Each Capture Process" on page 23-7
- *Oracle Database Backup and Recovery User's Guide* for more information about the flash recovery area feature

Is a Downstream Capture Process Waiting for Redo Data?

If a **downstream capture process** is not capturing changes, then it might be waiting for redo data to scan. Redo log files can be registered implicitly or explicitly for a downstream capture process. Redo log files registered implicitly typically are registered in one of the following ways:

- For a **real-time downstream capture process**, redo transport services use the log writer process (LGWR) to transfer the redo data from the **source database** to the standby redo log at the **downstream database**. Next, the archiver at the downstream database registers the redo log files with the downstream capture process when it archives them.
- For an **archived-log downstream capture process**, redo transport services transfer the archived redo log files from the source database to the downstream database and register the archived redo log files with the downstream capture process.

If redo log files are registered explicitly for a downstream capture process, then you must manually transfer the redo log files to the downstream database and register them with the downstream capture process.

Regardless of whether the redo log files are registered implicitly or explicitly, the downstream capture process can capture changes made to the source database only if the appropriate redo log files are registered with the downstream capture process. You can query the `V$STREAMS_CAPTURE` dynamic performance view to determine whether a downstream capture process is waiting for a redo log file. For example, run the following query for a downstream capture process named `strm05_capture`:

```
SELECT STATE FROM V$STREAMS_CAPTURE WHERE CAPTURE_NAME='STRM05_CAPTURE';
```

If the capture process state is either `WAITING FOR DICTIONARY REDO` or `WAITING FOR REDO`, then verify that the redo log files have been registered with the downstream capture process by querying the `DBA_REGISTERED_ARCHIVED_LOG` and `DBA_CAPTURE` data dictionary views. For example, the following query lists the redo log files currently registered with the `strm05_capture` downstream capture process:

```

COLUMN SOURCE_DATABASE HEADING 'Source|Database' FORMAT A15
COLUMN SEQUENCE# HEADING 'Sequence|Number' FORMAT 9999999
COLUMN NAME HEADING 'Archived Redo Log|File Name' FORMAT A30
COLUMN DICTIONARY_BEGIN HEADING 'Dictionary|Build|Begin' FORMAT A10
COLUMN DICTIONARY_END HEADING 'Dictionary|Build|End' FORMAT A10

SELECT r.SOURCE_DATABASE,
       r.SEQUENCE#,
       r.NAME,
       r.DICTIONARY_BEGIN,
       r.DICTIONARY_END
FROM DBA_REGISTERED_ARCHIVED_LOG r, DBA_CAPTURE c
WHERE c.CAPTURE_NAME = 'STRM05_CAPTURE' AND
      r.CONSUMER_NAME = c.CAPTURE_NAME;

```

If this query does not return any rows, then no redo log files are registered with the capture process currently. If you configured redo transport services to transfer redo data from the source database to the downstream database for this capture process, then ensure that the redo transport services are configured correctly. If the redo transport services are configured correctly, then run the `ALTER SYSTEM ARCHIVE LOG CURRENT` statement at the source database to archive a log file. If you did not configure redo transport services to transfer redo data, then ensure that the method you are using for log file transfer and registration is working properly. You can register log files explicitly using an `ALTER DATABASE REGISTER LOGICAL LOGFILE` statement.

If the downstream capture process is waiting for redo, then it also is possible that there is a problem with the network connection between the source database and the downstream database. There also might be a problem with the log file transfer method. Check your network connection and log file transfer method to ensure that they are working properly.

If you configured a real-time downstream capture process, and no redo log files are registered with the capture process, then try switching the log file at the source database. You might need to switch the log file more than once if there is little or no activity at the source database.

Also, if you plan to use a downstream capture process to capture changes to historical data, then consider the following additional issues:

- Both the source database that generates the redo log files and the database that runs a downstream capture process must be Oracle Database 10g or later databases.
- The start of a data dictionary build must be present in the oldest redo log file added, and the capture process must be configured with a **first SCN** that matches the start of the data dictionary build.
- The database objects for which the capture process will capture changes must be prepared for **instantiation** at the source database, not at the downstream database. In addition, you cannot specify a time in the past when you prepare objects for instantiation. Objects are always prepared for instantiation at the current database SCN, and only changes to a database object that occurred after the object was prepared for instantiation can be captured by a capture process.

See Also:

- ["Local Capture and Downstream Capture"](#) on page 2-14
- [Capture Process States](#) on page 2-24
- ["Configuring an Archived-Log Downstream Capture Process that Assigns Logs Implicitly"](#) on page 10-16
- ["Configuring an Archived-Log Downstream Capture Process that Assigns Logs Explicitly"](#) on page 10-18

Are You Trying to Configure Downstream Capture Incorrectly?

To create a [downstream capture process](#), you must use one of the following procedures:

- `DBMS_CAPTURE_ADM.CREATE_CAPTURE`
- `DBMS_STREAMS_ADM.MAINTAIN_GLOBAL`
- `DBMS_STREAMS_ADM.MAINTAIN_SCHEMAS`
- `DBMS_STREAMS_ADM.MAINTAIN_SIMPLE_TTS`
- `DBMS_STREAMS_ADM.MAINTAIN_TABLES`
- `DBMS_STREAMS_ADM.MAINTAIN_TTS`
- `PRE_INSTANTIATION_SETUP` and `POST_INSTANTIATION_SETUP` in the `DBMS_STREAMS_ADM` package

The procedures in the `DBMS_STREAMS_ADM` package can configure a downstream capture process as well as the other Oracle Streams components in an Oracle Streams replication environment.

If you try to create a downstream capture process without using one of these procedures, then Oracle returns the following error:

```
ORA-26678: Streams capture process must be created first
```

To correct the problem, use one of these procedures to create the downstream capture process.

If you are trying to create a [local capture process](#) using a procedure in the `DBMS_STREAMS_ADM` package, and you encounter this error, then make sure the database name specified in the `source_database` parameter of the procedure you are running matches the global name of the local database.

See Also: ["Configuring a Capture Process"](#) on page 10-1

Are You Trying to Configure Downstream Capture Without Proper Authentication?

If authentication is not configured properly between the source database and the downstream capture database, redo data transfer fails with one of the following errors:

```
ORA-16191: Primary log shipping client not logged on standby
```

```
ORA-1017: Invalid username/password; login denied
```

Redo transport sessions are authenticated using either the Secure Sockets Layer (SSL) protocol or a remote login password file. The password file must be the same at the source database and the downstream capture database.

To correct the problem, perform one of the following actions:

- If the source database has a remote login password file, then copy it to the appropriate directory on the downstream capture database system.
- Turn off the case sensitivity option by setting the initialization parameter `SEC_CASE_SENSITIVE_LOGON` to `FALSE`. Next, create the password file on the source and downstream capture database systems using `ORAPWD`. Make sure the password is the same on both systems, and set the `ignorecase` argument to `Y`.

See Also: *Oracle Data Guard Concepts and Administration* for detailed information about authentication requirements for redo transport

Are More Actions Required for Downstream Capture Without a Database Link?

When downstream capture is configured with a database link, the database link can be used to perform operations at the **source database** and obtain information from the source database automatically. When downstream capture is configured without a database link, these actions must be performed manually, and the information must be obtained manually. If you do not complete these actions manually, then errors result when you try to create the downstream **capture process**.

Specifically, the following actions must be performed manually when you configure downstream capture without a database link:

- In certain situations, you must run the `DBMS_CAPTURE_ADM.BUILD` procedure at the source database to extract the data dictionary at the source database to the redo log before a capture process is created.
- You must prepare the source database objects for **instantiation**.
- You must obtain the **first SCN** for the **downstream capture process** and specify the first SCN using the `first_scn` parameter when you create the capture process with the `CREATE_CAPTURE` procedure in the `DBMS_CAPTURE_ADM` package.

See Also: ["Configuring an Archived-Log Downstream Capture Process"](#) on page 10-16

Troubleshooting Synchronous Capture Problems

If a **synchronous capture** is not capturing changes as expected, then use this section to identify and resolve synchronous capture problems.

See Also:

- ["Implicit Capture with Synchronous Capture"](#) on page 2-38
- ["Configuring Synchronous Capture"](#) on page 10-23
- ["Managing a Synchronous Capture"](#) on page 14-11
- ["Monitoring a Synchronous Capture"](#) on page 23-15

Is a Synchronous Capture Failing to Capture Changes to Tables?

If a **synchronous capture** is not capturing changes to tables as you expected, then the **rules** in the synchronous capture **rule set** might not be configured properly. To avoid problems, always use the `ADD_TABLE_RULES` or `ADD_SUBSET_RULES` procedure in the `DBMS_STREAMS_ADM` package to add rules to a synchronous capture rules set.

The following are common reasons why a synchronous capture is not capturing changes as expected:

- Global rules or schema rules are being used to try to control the behavior of the synchronous capture. A synchronous capture ignores **global rules** and **schema rules** in its rule set. A synchronous capture only captures changes that satisfy **table rules** and **subset rules**.
- The the DBMS_RULE_ADM package was used to configure the rules for a synchronous capture. A synchronous capture does not behave correctly when
 - The DBMS_RULE_ADM package is used to create rules that are added to a synchronous capture rule set.
 - The DBMS_RULE_ADM package is used to add rules to a synchronous capture rule set.

If a synchronous capture is not capturing changes to tables as expected, then complete the following steps to identify and correct problems:

1. Query the DBA_SYNC_CAPTURE_TABLES data dictionary view to determine the tables for which a synchronous capture is capturing changes. The synchronous capture captures changes to a table only if the ENABLED column is set to YES for the table.
2. If the DBA_SYNC_CAPTURE_TABLES view does not list tables for which a synchronous capture should capture changes, then use the ADD_TABLE_RULES or ADD_SUBSET_RULES procedure in the DBMS_STREAMS_ADM package to add rules for the tables.

If the DBA_SYNC_CAPTURE_TABLES view shows ENABLED for a table, and a synchronous capture still does not capture changes to the table, then there might be a problem with the rule condition in the rule for the table. In this case, check the rule condition and correct any errors, or drop the rule and re-create it using the ADD_TABLE_RULES or ADD_SUBSET_RULES procedure.

Note: Oracle recommends that you use the REMOVE_RULE procedure in the DBMS_STREAMS_ADM package if you want to remove a rule from a synchronous capture rule set or drop a rule used by synchronous capture. However, you can also use the REMOVE_RULE or DROP_RULE procedure in the DBMS_RULE_ADM package to perform these actions.

See Also:

- ["Displaying the Tables For Which Synchronous Capture Captures Changes"](#) on page 23-16
- ["Adding Rules to a Rule Set for a Synchronous Capture"](#) on page 14-12
- ["Displaying the Condition for Each Rule in a Rule Set"](#) on page 26-10
- ["Removing a Rule from a Rule Set for a Synchronous Capture"](#) on page 14-13

Troubleshooting Propagation Problems

If a **propagation** is not propagating changes as expected, then use the following checklist to identify and resolve propagation problems:

- [Does the Propagation Use the Correct Source and Destination Queue?](#)
- [Is the Propagation Enabled?](#)
- [Is Security Configured Properly for the ANYDATA Queue?](#)

See Also:

- ["Message Propagation Between Queues"](#) on page 3-11
- ["Creating Oracle Streams Propagations Between ANYDATA Queues"](#) on page 11-3
- ["Managing Oracle Streams Propagations and Propagation Jobs"](#) on page 15-4
- ["Monitoring Oracle Streams Propagations and Propagation Jobs"](#) on page 24-13

Does the Propagation Use the Correct Source and Destination Queue?

If messages are not appearing in the **destination queue** for a **propagation** as expected, then the propagation might not be configured to propagate messages from the correct **source queue** to the correct destination queue.

For example, to check the source queue and destination queue for a propagation named `db1_to_db2`, run the following query:

```
COLUMN SOURCE_QUEUE HEADING 'Source Queue' FORMAT A35
COLUMN DESTINATION_QUEUE HEADING 'Destination Queue' FORMAT A35

SELECT
  p.SOURCE_QUEUE_OWNER||'.'||
  p.SOURCE_QUEUE_NAME||'@'||
  g.GLOBAL_NAME SOURCE_QUEUE,
  p.DESTINATION_QUEUE_OWNER||'.'||
  p.DESTINATION_QUEUE_NAME||'@'||
  p.DESTINATION_DBLINK DESTINATION_QUEUE
FROM DBA_PROPAGATION p, GLOBAL_NAME g
WHERE p.PROPGATION_NAME = 'DB1_TO_DB2';
```

Your output looks similar to the following:

Source Queue	Destination Queue

STRMADMIN.QUEUE1@DBS1.EXAMPLE.COM	STRMADMIN.QUEUE2@DBS2.EXAMPLE.COM

If the propagation is not using the correct queues, then create a new propagation. You might need to remove the existing propagation if it is not appropriate for your environment.

See Also:

- ["Creating Oracle Streams Propagations Between ANYDATA Queues"](#) on page 11-3
- ["Dropping a Propagation"](#) on page 15-10

Is the Propagation Enabled?

For a **propagation job** to propagate messages, the propagation must be enabled. If messages are not being propagated by a **propagation** as expected, then the propagation might not be enabled.

You can find the following information about a propagation:

- The database link used to propagate messages from the **source queue** to the **destination queue**
- Whether the propagation is `ENABLED`, `DISABLED`, or `ABORTED`
- The date of the last error, if there are any propagation errors
- If there are any propagation errors, then the error number of the last error
- The error message of the last error, if there are any propagation errors

For example, to check whether a propagation named `streams_propagation` is enabled, run the following query:

```
COLUMN DESTINATION_DBLINK HEADING 'Database|Link'      FORMAT A15
COLUMN STATUS              HEADING 'Status'            FORMAT A8
COLUMN ERROR_DATE          HEADING 'Error|Date'        FORMAT A15
COLUMN ERROR_MESSAGE       HEADING 'Error Message'     FORMAT A35

SELECT DESTINATION_DBLINK,
       STATUS,
       ERROR_DATE,
       ERROR_MESSAGE
FROM DBA_PROPAGATION
WHERE PROPAGATION_NAME = 'STREAMS_PROPAGATION';
```

If the propagation is disabled currently, then your output looks similar to the following:

Database Link	Status	Error Date	Error Message
D2.EXAMPLE.COM	DISABLED	27-APR-05	ORA-25307: Enqueue rate too high, f low control enabled

If there is a problem, then try the following actions to correct it:

- If a propagation is disabled, then you can enable it using the `START_PROPAGATION` procedure in the `DBMS_PROPAGATION_ADM` package, if you have not done so already.
- If the propagation is disabled or aborted, and the `Error Date` and `Error Message` fields are populated, then diagnose and correct the problem based on the error message.
- If the propagation is disabled or aborted, then check the trace file for the **propagation job** process. The query in "[Displaying the Schedule for a Propagation Job](#)" on page 24-15 displays the propagation job process.
- If the propagation job is enabled, but is not propagating messages, then try stopping and restarting the propagation.

See Also:

- ["Starting a Propagation"](#) on page 15-5
- ["Checking the Trace Files and Alert Log for Problems"](#) on page 20-26
- ["Stopping a Propagation"](#) on page 15-5
- *Oracle Database Error Messages* for more information about a specific error message

Is Security Configured Properly for the ANYDATA Queue?

ANYDATA queues are **secure queues**, and security must be configured properly for users to be able to perform operations on them. If you use the `SET_UP_QUEUE` procedure in the `DBMS_STREAMS_ADM` package to configure a secure ANYDATA queue, then an error is raised if the agent that `SET_UP_QUEUE` tries to create already exists and is associated with a user other than the user specified by `queue_user` in this procedure. In this case, rename or remove the existing agent using the `ALTER_AQ_AGENT` or `DROP_AQ_AGENT` procedure, respectively, in the `DBMS_AQADM` package. Next, retry `SET_UP_QUEUE`.

In addition, you might encounter one of the following errors if security is not configured properly for an ANYDATA queue:

- [ORA-24093 AQ Agent not granted privileges of database user](#)
- [ORA-25224 Sender name must be specified for enqueue into secure queues](#)

See Also: ["Secure Queues"](#) on page 3-5

ORA-24093 AQ Agent not granted privileges of database user

Secure queue access must be granted to an Oracle Streams Advanced Queuing (AQ) agent explicitly for both enqueue and dequeue operations. You grant the agent these privileges using the `ENABLE_DB_ACCESS` procedure in the `DBMS_AQADM` package.

For example, to grant an agent named `explicit_dq` privileges of the database user `oe`, run the following procedure:

```
BEGIN
  DBMS_AQADM.ENABLE_DB_ACCESS(
    agent_name => 'explicit_dq',
    db_username => 'oe');
END;
/
```

To check the privileges of the agents in a database, run the following query:

```
SELECT AGENT_NAME "Agent", DB_USERNAME "User" FROM DBA_AQ_AGENT_PRIVS;
```

Your output looks similar to the following:

Agent	User
EXPLICIT_ENQ	OE
APPLY_OE	OE
EXPLICIT_DQ	OE

See Also: ["Enabling a User to Perform Operations on a Secure Queue"](#) on page 15-1 for a detailed example that grants privileges to an agent

ORA-25224 Sender name must be specified for enqueue into secure queues

To enqueue into a secure queue, the `SENDER_ID` must be set to an Oracle Streams Advanced Queuing (AQ) agent with secure queue privileges for the queue in the message properties.

See Also: ["Wrapping User Message Payloads in an ANYDATA Wrapper and Enqueuing Them"](#) on page 13-2 for an example that sets the `SENDER_ID` for enqueue

Troubleshooting Apply Process Problems

If an **apply process** is not applying changes as expected, then use the following checklist to identify and resolve apply problems:

- [Is the Apply Process Enabled?](#)
- [Is the Apply Process Current?](#)
- [Does the Apply Process Apply Captured LCRs?](#)
- [Is the Apply Process Queue Receiving the Messages to be Applied?](#)
- [Is a Custom Apply Handler Specified?](#)
- [Is the AQ_TM_PROCESSES Initialization Parameter Set to Zero?](#)
- [Does the Apply User Have the Required Privileges?](#)
- [Are There Any Apply Errors in the Error Queue?](#)

See Also:

- ["Implicit Consumption with an Apply Process"](#) on page 4-5
- [Chapter 12, "Configuring Implicit Apply"](#)
- [Chapter 16, "Managing Oracle Streams Information Consumption"](#)
- [Chapter 25, "Monitoring Oracle Streams Apply Processes"](#)
- *Oracle Streams Replication Administrator's Guide* for more information about troubleshooting apply errors

Is the Apply Process Enabled?

An **apply process** applies changes only when it is enabled.

You can check whether an apply process is enabled, disabled, or aborted by querying the `DBA_APPLY` data dictionary view. For example, to check whether an apply process named `apply` is enabled, run the following query:

```
SELECT STATUS FROM DBA_APPLY WHERE APPLY_NAME = 'APPLY';
```

If the apply process is disabled, then your output looks similar to the following:

```
STATUS
-----
DISABLED
```

If the apply process is disabled, then try restarting it. If the apply process is aborted, then you might need to correct an error before you can restart it successfully. If the apply process did not shut down cleanly, then it might not restart. In this case, it returns the following error:

```
ORA-26666 cannot alter STREAMS process
```

If this happens then, then run the `STOP_APPLY` procedure in the `DBMS_APPLY_ADM` package with the `force` parameter set to `TRUE`. Next, restart the apply process.

To determine why an apply process aborted, query the `DBA_APPLY` data dictionary view or check the trace files for the apply process. The following query shows when the apply process aborted and the error that caused it to abort:

```
COLUMN APPLY_NAME HEADING 'APPLY|Process|Name' FORMAT A10
COLUMN STATUS_CHANGE_TIME HEADING 'Abort Time'
COLUMN ERROR_NUMBER HEADING 'Error Number' FORMAT 99999999
COLUMN ERROR_MESSAGE HEADING 'Error Message' FORMAT A40

SELECT APPLY_NAME, STATUS_CHANGE_TIME, ERROR_NUMBER, ERROR_MESSAGE
       FROM DBA_APPLY WHERE STATUS='ABORTED';
```

See Also:

- ["Starting an Apply Process"](#) on page 16-2
- ["Displaying Detailed Information About Apply Errors"](#) on page 25-17
- ["Checking the Trace Files and Alert Log for Problems"](#) on page 20-26
- ["Apply Processes and Oracle Real Application Clusters"](#) on page A-4 for information about restarting an apply process in an Oracle Real Application Clusters (Oracle RAC) environment

Is the Apply Process Current?

If an **apply process** has not applied recent changes, then the problem might be that the apply process has fallen behind. You can check apply process latency by querying the `V$STREAMS_APPLY_COORDINATOR` dynamic performance view. If apply process latency is high, then you might be able to improve performance by adjusting the setting of the `parallelism` apply process parameter.

See Also:

- ["Determining the Capture to Apply Latency for a Message for Each Apply Process"](#) on page 25-11
- ["Apply Process Parameters"](#) on page 4-20
- ["Setting an Apply Process Parameter"](#) on page 16-6

Does the Apply Process Apply Captured LCRs?

An **apply process** can apply either **captured LCRs** from its **buffered queue**, or it can apply messages from its **persistent queue**, but not both types of messages. Messages in a persistent queue can be **persistent LCRs** and **persistent user messages**. An apply process might not be applying messages of a one type because it was configured to apply the other type of messages.

You can check the type of messages applied by an apply process by querying the DBA_APPLY data dictionary view. For example, to check whether an apply process named apply applies **captured LCRs** or not, run the following query:

```
COLUMN APPLY_CAPTURED HEADING 'Type of Messages Applied' FORMAT A25

SELECT DECODE(APPLY_CAPTURED,
              'YES', 'Captured',
              'NO',  'Messages from Persistent Queue') APPLY_CAPTURED
FROM DBA_APPLY
WHERE APPLY_NAME = 'APPLY';
```

If the apply process applies captured LCRs, then your output looks similar to the following:

```
Type of Messages Applied
-----
Captured
```

If an apply process is not applying the expected type of messages, then you might need to create a new apply process to apply the messages.

See Also:

- ["Ways to Consume Information with Oracle Streams"](#) on page 4-1
- ["Configuring a Capture Process"](#) on page 10-1

Is the Apply Process Queue Receiving the Messages to be Applied?

An **apply process** must receive messages in its **queue** before it can apply these messages. Therefore, if an apply process is applying messages captured by a **capture process** or a **synchronous capture**, then the capture process or synchronous capture that captures these messages must be configured properly. If it is a capture process, then it must also be enabled. Similarly, if messages are propagated from one or more databases before reaching the apply process, then each **propagation** must be enabled and must be configured properly. If a capture process, a synchronous capture, or a propagation on which the apply process depends is not enabled or is not configured properly, then the messages might never reach the apply process queue.

The **rule sets** used by all **Oracle Streams clients**, including capture processes, synchronous captures, and propagations, determine the behavior of these Oracle Streams clients. Therefore, ensure that the rule sets for any capture processes, synchronous capture, or propagations on which an apply process depends contain the correct **rules**. If the **rules** for these Oracle Streams clients are not configured properly, then the apply process queue might never receive the appropriate messages. Also, a message traveling through a stream is the composition of all of the transformations done along the path. For example, if a capture process uses **subset rules** and performs **row migration** during capture of a message, and a propagation uses a **rule-based transformation** on the message to change the table name, then, when the message reaches an apply process, the apply process rules must account for these transformations.

In an environment where a capture process or synchronous capture captures changes that are propagated and applied at multiple databases, you can use the following guidelines to determine whether a problem is caused by a capture process, a synchronous capture, or a propagation on which an apply process depends or by the apply process itself:

- If no other **destination databases** of a capture process or synchronous capture are applying the changes, then the problem is most likely caused by the capture process or synchronous capture, or by a propagation near the capture process. In this case, first ensure that the capture process or synchronous capture is configured properly, and then ensure that the propagations nearest the capture process or synchronous capture are enabled and configured properly. In the case of a capture process, also ensure that the capture process is enabled.
- If other destination databases of a capture process or synchronous capture are applying the changes, then the problem is most likely caused by the apply process itself or a propagation near the apply process. In this case, first ensure that the apply process is enabled and configured properly, and then ensure that the propagations nearest the apply process are enabled and configured properly.

See Also:

- ["Troubleshooting Capture Process Problems"](#) on page 20-3
- ["Troubleshooting Propagation Problems"](#) on page 20-11
- ["Troubleshooting Problems with Rules and Rule-Based Transformations"](#) on page 20-18

Is a Custom Apply Handler Specified?

You can use **apply handlers** to handle messages dequeued by an **apply process** in a customized way. These handlers include **DML handlers**, **DDL handlers**, **precommit handlers**, and **message handlers**. If an apply process is not behaving as expected, then check the handler procedures used by the apply process, and correct any flaws. You might need to modify a handler procedure or remove it to correct an apply problem.

You can find the names of these procedures by querying the `DBA_APPLY_DML_HANDLERS` and `DBA_APPLY` data dictionary views.

See Also:

- ["Message Processing Options for an Apply Process"](#) on page 4-7
- [Chapter 16, "Managing Oracle Streams Information Consumption"](#)
- ["Displaying Information About Apply Handlers"](#) on page 25-4

Is the AQ_TM_PROCESSES Initialization Parameter Set to Zero?

The `AQ_TM_PROCESSES` initialization parameter controls time monitoring on **queue** messages and controls processing of messages with delay and expiration properties specified. In Oracle Database 10g or later, the database automatically controls these activities when the `AQ_TM_PROCESSES` initialization parameter is not set.

If an **apply process** is not applying messages, but there are messages that satisfy the apply process **rule sets** in the apply process queue, then ensure that the `AQ_TM_PROCESSES` initialization parameter is not set to zero at the **destination database**. If this parameter is set to zero, then unset this parameter or set it to a nonzero value and monitor the apply process to see if it begins to apply messages.

To determine whether there are messages in a **buffered queue**, you can query the `V$BUFFERED_QUEUES` and `V$BUFFERED_SUBSCRIBERS` dynamic performance views. To determine whether there are messages in a **persistent queue**, you can query the **queue table** for the queue.

See Also:

- ["Viewing the Contents of Messages in a Persistent Queue"](#) on page 24-4
- ["Monitoring Buffered Queues"](#) on page 24-5
- *Oracle Streams Advanced Queuing User's Guide* for information about the AQ_TM_PROCESSES initialization parameter

Does the Apply User Have the Required Privileges?

If the apply user does not have explicit EXECUTE privilege on an apply handler procedure or custom rule-based transformation function, then an ORA-26808 error might result when the apply user tries to run the procedure or function. Typically, this error is causes the apply process to abort without adding errors to the DBA_APPLY_ERROR view. However, the trace file for the apply coordinator reports the error. Specifically, an error similar to the following appears in the trace file:

```
ORA-26808: Apply process AP01 died unexpectedly
```

Typically, error messages surround this message, and one or more of these messages contain the name of the procedure or function. To correct the problem, grant the required EXECUTE privilege to the apply user.

See Also:

- ["Apply User"](#) on page 4-18
- [Chapter 16, "Managing Oracle Streams Information Consumption"](#)
- ["Does an Apply Process Trace File Contain Messages About Apply Problems?"](#) on page 20-27

Are There Any Apply Errors in the Error Queue?

When an [apply process](#) cannot apply a message, it moves the message and all of the other messages in the same transaction into the error queue. You should check for apply errors periodically to see if there are any transactions that could not be applied.

You can check for apply errors by querying the DBA_APPLY_ERROR data dictionary view. Also, you can reexecute a particular transaction from the error queue or all of the transactions in the error queue.

See Also:

- ["Checking for Apply Errors"](#) on page 25-16
- ["Managing Apply Errors"](#) on page 16-19
- ["The Error Queue"](#) on page 4-21

Troubleshooting Problems with Rules and Rule-Based Transformations

When a [capture process](#), [synchronous capture](#), [propagation](#), [apply process](#), or [messaging client](#) is not behaving as expected, the problem might be that [rule sets](#), [rules](#), or [rule-based transformations](#) for the [Oracle Streams client](#) are not configured properly. Use the following sections to identify and resolve problems with rule sets, rules, and rule-based transformations:

- [Are Rules Configured Properly for the Oracle Streams Client?](#)
- [Are Declarative Rule-Based Transformations Configured Properly?](#)
- [Are the Custom Rule-Based Transformations Configured Properly?](#)
- [Are Incorrectly Transformed LCRs in the Error Queue?](#)

See Also:

- [Chapter 5, "Rules"](#)
- [Chapter 6, "How Rules Are Used in Oracle Streams"](#)
- [Chapter 17, "Managing Rules"](#)
- [Chapter 26, "Monitoring Rules"](#)

Are Rules Configured Properly for the Oracle Streams Client?

If a **capture process**, **synchronous capture**, **propagation**, **apply process**, or **messaging client** is behaving in an unexpected way, then the problem might be that the **rules** in one or more of the **rule sets** for the **Oracle Streams client** are not configured properly. For example, if you expect a capture process to capture changes made to a particular table, but the capture process is not capturing these changes, then the cause might be that the rules in the rule sets used by the capture process do not instruct the capture process to capture changes to the table.

You can check the rules for a particular Oracle Streams client by querying the `DBA_STREAMS_RULES` data dictionary view. If you use both **positive rule sets** and **negative rule sets** in your Oracle Streams environment, then it is important to know whether a rule returned by this view is in the positive or negative rule set for a particular Oracle Streams client.

An Oracle Streams client performs an action, such as capture, propagation, apply, or dequeue, for messages that satisfy its rule sets. In general, a message satisfies the rule sets for an Oracle Streams client if *no rules* in the negative rule set evaluate to `TRUE` for the message, and *at least one rule* in the positive rule set evaluates to `TRUE` for the message.

"[Rule Sets and Rule Evaluation of Messages](#)" on page 6-3 contains more detailed information about how a message satisfies the rule sets for an Oracle Streams client, including information about Oracle Streams client behavior when one or more rule sets are not specified.

See Also:

- ["Rule Sets and Rule Evaluation of Messages" on page 6-3](#)

This section includes the following subsections:

- [Checking Schema and Global Rules](#)
- [Checking Table Rules](#)
- [Checking Subset Rules](#)
- [Checking for Message Rules](#)
- [Resolving Problems with Rules](#)

Checking Schema and Global Rules

Schema and [global rules](#) in the positive rule set for an Oracle Streams client instruct the Oracle Streams client to perform its task for all of the messages relating to a particular schema or database, respectively. Schema and global rules in the negative rule set for an Oracle Streams client instruct the Oracle Streams client to discard all of the messages relating to a particular schema or database, respectively. If an Oracle Streams client is not behaving as expected, then it might be because schema or global rules are not configured properly for the Oracle Streams client.

For example, suppose a database is running an apply process named `strm01_apply`, and you want this apply process to apply LCRs containing changes to the `hr` schema. If the apply process uses a negative rule set, then ensure that there are no [schema rules](#) that evaluate to `TRUE` for this schema in the negative rule set. Such rules cause the apply process to discard LCRs containing changes to the schema. "[Displaying the Rules in the Negative Rule Set for an Oracle Streams Client](#)" on page 26-5 contains an example of a query that shows such rules.

If the query returns any such rules, then the rules returned might be causing the apply process to discard changes to the schema. If this query returns no rows, then ensure that there are schema rules in the positive rule set for the apply process that evaluate to `TRUE` for the schema. "[Displaying the Rules in the Positive Rule Set for an Oracle Streams Client](#)" on page 26-4 contains an example of a query that shows such rules.

Checking Table Rules

Table rules in the positive rule set for an Oracle Streams client instruct the Oracle Streams client to perform its task for the messages relating to one or more particular tables. Table rules in the negative rule set for an Oracle Streams client instruct the Oracle Streams client to discard the messages relating to one or more particular tables.

If an Oracle Streams client is not behaving as expected for a particular table, then it might be for one of the following reasons:

- One or more global rules in the rule sets for the Oracle Streams client instruct the Oracle Streams client to behave in a particular way for messages relating to the table because the table is in a specific database. That is, a global rule in the negative rule set for the Oracle Streams client might instruct the Oracle Streams client to discard all messages from the [source database](#) that contains the table, or a global rule in the positive rule set for the Oracle Streams client might instruct the Oracle Streams client to perform its task for all messages from the source database that contains the table.
- One or more schema rules in the rule sets for the Oracle Streams client instruct the Oracle Streams client to behave in a particular way for messages relating to the table because the table is in a specific schema. That is, a schema rule in the negative rule set for the Oracle Streams client might instruct the Oracle Streams client to discard all messages relating to database objects in the schema, or a schema rule in the positive rule set for the Oracle Streams client might instruct the Oracle Streams client to perform its task for all messages relating to database objects in the schema.
- One or more [table rules](#) in the rule sets for the Oracle Streams client instruct the Oracle Streams client to behave in a particular way for messages relating to the table.

See Also: "[Checking Schema and Global Rules](#)" on page 20-20

If you are sure that no global or schema rules are causing the unexpected behavior, then you can check for table rules in the rule sets for an Oracle Streams client. For example, if you expect a capture process to capture changes to a particular table, but the capture process is not capturing these changes, then the cause might be that the rules in the positive and negative rule sets for the capture process do not instruct it to capture changes to the table.

Suppose a database is running a capture process named `strm01_capture`, and you want this capture process to capture changes to the `hr.departments` table. If the capture process uses a negative rule set, then ensure that there are no table rules that evaluate to `TRUE` for this table in the negative rule set. Such rules cause the capture process to discard changes to the table. ["Displaying the Rules in the Negative Rule Set for an Oracle Streams Client"](#) on page 26-5 contains an example of a query that shows rules in a negative rule set.

If that query returns any such rules, then the rules returned might be causing the capture process to discard changes to the table. If that query returns no rules, then ensure that there are one or more table rules in the positive rule set for the capture process that evaluate to `TRUE` for the table. ["Displaying the Rules in the Positive Rule Set for an Oracle Streams Client"](#) on page 26-4 contains an example of a query that shows rules in a positive rule set.

You can also determine which rules have a particular pattern in their rule condition. ["Listing Each Rule that Contains a Specified Pattern in Its Condition"](#) on page 26-10. For example, you can find all of the rules with the string "departments" in their rule condition, and you can ensure that these rules are in the correct rule sets.

See Also: ["Table Rules Example"](#) on page 6-17 for more information about specifying table rules

Checking Subset Rules

A **subset rule** can be in the rule set used by a capture process, synchronous capture, propagation, apply process, or messaging client. A subset rule evaluates to `TRUE` only if a DML operation contains a change to a particular subset of rows in the table. For example, to check for table rules that evaluate to `TRUE` for an apply process named `strm01_apply` when there are changes to the `hr.departments` table, run the following query:

```
COLUMN RULE_NAME HEADING 'Rule Name' FORMAT A20
COLUMN RULE_TYPE HEADING 'Rule Type' FORMAT A20
COLUMN DML_CONDITION HEADING 'Subset Condition' FORMAT A30

SELECT RULE_NAME, RULE_TYPE, DML_CONDITION
FROM DBA_STREAMS_RULES
WHERE STREAMS_NAME = 'STRM01_APPLY' AND
      STREAMS_TYPE = 'APPLY' AND
      SCHEMA_NAME = 'HR' AND
      OBJECT_NAME = 'DEPARTMENTS';
```

Rule Name	Rule Type	Subset Condition
DEPARTMENTS5	DML	location_id=1700
DEPARTMENTS6	DML	location_id=1700
DEPARTMENTS7	DML	location_id=1700

Notice that this query returns any subset condition for the table in the `DML_CONDITION` column, which is labeled "Subset Condition" in the output. In this example, subset rules are specified for the `hr.departments` table. These subset rules

evaluate to `TRUE` only if an LCR contains a change that involves a row where the `location_id` is 1700. So, if you expected the apply process to apply all changes to the table, then these subset rules cause the apply process to discard changes that involve rows where the `location_id` is not 1700.

Note: Subset rules must reside only in positive rule sets.

See Also:

- ["Table Rules Example"](#) on page 6-17 for more information about specifying subset rules
- ["Row Migration and Subset Rules"](#) on page 6-23

Checking for Message Rules

A message rule can be in the rule set used by a propagation, apply process, or messaging client. Message rules pertain only to **user messages** of a specific message type, not to **captured LCRs**. A message rule evaluates to `TRUE` if a user message in a **queue** is of the type specified in the message rule and satisfies the **rule condition** of the message rule.

If you expect a propagation, apply process, or messaging client to perform its task for some user messages, but the Oracle Streams client is not performing its task for these messages, then the cause might be that the rules in the positive and negative rule sets for the Oracle Streams client do not instruct it to perform its task for these messages. Similarly, if you expect a propagation, apply process, or messaging client to discard some user messages, but the Oracle Streams client is not discarding these messages, then the cause might be that the rules in the positive and negative rule sets for the Oracle Streams client do not instruct it to discard these messages.

For example, suppose you want a messaging client named `oe` to dequeue messages of type `oe.user_msg` that satisfy the following condition:

```
: "VAR$_2".OBJECT_OWNER = 'OE' AND : "VAR$_2".OBJECT_NAME = 'ORDERS'
```

If the messaging client uses a negative rule set, then ensure that there are no message rules that evaluate to `TRUE` for this message type in the negative rule set. Such rules cause the messaging client to discard these messages. For example, to determine whether there are any such rules in the negative rule set for the messaging client, run the following query:

```
COLUMN RULE_NAME HEADING 'Rule Name' FORMAT A30
COLUMN RULE_CONDITION HEADING 'Rule Condition' FORMAT A30

SELECT RULE_NAME, RULE_CONDITION
FROM DBA_STREAMS_RULES
WHERE STREAMS_NAME = 'OE' AND
MESSAGE_TYPE_OWNER = 'OE' AND
MESSAGE_TYPE_NAME = 'USER_MSG' AND
RULE_SET_TYPE = 'NEGATIVE';
```

If this query returns any rules, then the rules returned might be causing the messaging client to discard messages. Examine the rule condition of the returned rules to determine whether these rules are causing the messaging client to discard the messages that it should be dequeuing. If this query returns no rules, then ensure that there are message rules in the positive rule set for the messaging client that evaluate to `TRUE` for this message type and condition.

For example, to determine whether any message rules evaluate to TRUE for this message type in the positive rule set for the messaging client, run the following query:

```

COLUMN RULE_NAME HEADING 'Rule Name' FORMAT A35
COLUMN RULE_CONDITION HEADING 'Rule Condition' FORMAT A35

SELECT RULE_NAME, RULE_CONDITION
FROM DBA_STREAMS_RULES
WHERE STREAMS_NAME      = 'OE' AND
      MESSAGE_TYPE_OWNER = 'OE' AND
      MESSAGE_TYPE_NAME  = 'USER_MSG' AND
      RULE_SET_TYPE      = 'POSITIVE';

```

If you have message rules that evaluate to TRUE for this message type in the positive rule set for the messaging client, then these rules are returned. In this case, your output looks similar to the following:

Rule Name	Rule Condition
RULE\$_3	: "VAR\$_2".OBJECT_OWNER = 'OE' AND : "VAR\$_2".OBJECT_NAME = 'ORDERS'

Examine the rule condition for the rules returned to determine whether they instruct the messaging client to dequeue the proper messages. Based on these results, the messaging client named oe should dequeue messages of oe.user_msg type that satisfy condition shown in the output. In other words, no rule in the negative messaging client rule set discards these messages, and a rule exists in the positive messaging client rule set that evaluates to TRUE when the messaging client finds a message in its queue of the oe.user_msg type that satisfies the rule condition.

See Also:

- ["Message Rule Example"](#) on page 6-30 for more information about specifying message rules
- ["Configuring a Messaging Client and Message Notification"](#) on page 13-5 for an example that creates the rule discussed in this section

Resolving Problems with Rules

If you determine that an Oracle Streams capture process, synchronous capture, propagation, apply process, or messaging client is not behaving as expected because one or more rules must be added to the rule set for the Oracle Streams client, then you can use one of the following procedures in the DBMS_STREAMS_ADM package to add appropriate rules:

- ADD_GLOBAL_PROPAGATION_RULES
- ADD_GLOBAL_RULES
- ADD_SCHEMA_PROPAGATION_RULES
- ADD_SCHEMA_RULES
- ADD_SUBSET_PROPAGATION_RULES
- ADD_SUBSET_RULES
- ADD_TABLE_PROPAGATION_RULES
- ADD_TABLE_RULES

- `ADD_MESSAGE_PROPAGATION_RULE`
- `ADD_MESSAGE_RULE`

You can use the `DBMS_RULE_ADM` package to add customized rules, if necessary.

It is also possible that the Oracle Streams capture process, synchronous capture, propagation, apply process, or messaging client is not behaving as expected because one or more rules should be altered or removed from a rule set.

If you have the correct rules, and the relevant messages are still filtered out by an Oracle Streams capture process, propagation, or apply process, then check your trace files and alert log for a warning about a missing "multi-version data dictionary", which is an **Oracle Streams data dictionary**. The following information might be included in such warning messages:

- `gdbnm`: Global name of the source database of the missing object
- `scn`: SCN for the transaction that has been missed

If you find such messages, and you are using custom capture process rules or reusing existing capture process rules for a new **destination database**, then ensure that you run the appropriate procedure to prepare for **instantiation**:

- `PREPARE_TABLE_INSTANTIATION`
- `PREPARE_SCHEMA_INSTANTIATION`
- `PREPARE_GLOBAL_INSTANTIATION`

Also, ensure that propagation is working from the source database to the destination database. Oracle Streams data dictionary information is propagated to the destination database and loaded into the dictionary at the destination database.

See Also:

- "Altering a Rule" on page 17-6
- "Removing a Rule from a Rule Set" on page 17-3
- *Oracle Streams Replication Administrator's Guide* for more information about preparing database objects for instantiation
- "The Oracle Streams Data Dictionary" on page 2-34 for more information about the Oracle Streams data dictionary

Are Declarative Rule-Based Transformations Configured Properly?

A **declarative rule-based transformation** is a rule-based transformation that covers one of a common set of transformation scenarios for row LCRs. Declarative rule-based transformations are run internally without using PL/SQL. If an Oracle Streams **capture process**, **synchronous capture**, **propagation**, **apply process**, or **messaging client** is not behaving as expected, then check the declarative rule-based transformations specified for the **rules** used by the Oracle Streams client and correct any mistakes.

The most common problems with declarative rule-based transformations are:

- The declarative rule-based transformation is specified for a table or involves columns in a table, but the schema either was not specified or was incorrectly specified when the transformation was created. If the schema is not correct in a declarative rule-based transformation, then the transformation will not be run on the appropriate LCRs. You should specify the owning schema for a table when you create a declarative rule-based transformation. If the schema is not specified

when a declarative rule-based transformation is created, then the user who creates the transformation is specified for the schema by default.

If the schema is not correct for a declarative rule-based transformation, then, to correct the problem, remove the transformation and re-create it, specifying the correct schema for each table.

- If more than one declarative rule-based transformation is specified for a particular rule, then ensure that the ordering is correct for execution of these transformations. Incorrect ordering of declarative rule-based transformations can result in errors or inconsistent data.

If the ordering is not correct for the declarative rule-based transformation specified on a single rule, then, to correct the problem, remove the transformations and re-create them with the correct ordering.

See Also:

- ["Displaying Declarative Rule-Based Transformations"](#) on page 27-2
- ["Transformation Ordering"](#) on page 7-15

Are the Custom Rule-Based Transformations Configured Properly?

A **custom rule-based transformation** is any modification by a user-defined function to a message when a **rule** evaluates to TRUE. A custom rule-based transformation is specified in the **action context** of a rule, and these action contexts contain a name-value pair with `STREAMS$_TRANSFORM_FUNCTION` for the name and a user-created function name for the value. This user-created function performs the transformation. If the user-created function contains any flaws, then unexpected behavior can result.

If an Oracle Streams **capture process**, **synchronous capture**, **propagation**, **apply process**, or **messaging client** is not behaving as expected, then check the custom rule-based transformation functions specified for the rules used by the **Oracle Streams client** and correct any flaws. You can find the names of these functions by querying the `DBA_STREAMS_TRANSFORM_FUNCTION` data dictionary view. You might need to modify a transformation function or remove a custom rule-based transformation to correct the problem. Also, ensure that the name of the function is spelled correctly when you specify the transformation for a rule.

An error caused by a custom rule-based transformation might cause a capture process, synchronous capture, propagation, apply process, or messaging client to abort. In this case, you might need to correct the transformation before the Oracle Streams client can be restarted or invoked.

Rule evaluation is done before a custom rule-based transformation. For example, if you have a transformation that changes the name of a table from `emps` to `employees`, then ensure that each rule using the transformation specifies the table name `emps`, rather than `employees`, in its **rule condition**.

See Also:

- ["Rule-Based Transformations"](#) on page 7-1
- ["Managing Custom Rule-Based Transformations"](#) on page 18-5
- ["Displaying Custom Rule-Based Transformations"](#) on page 27-5

Are Incorrectly Transformed LCRs in the Error Queue?

In some cases, incorrectly transformed LCRs might have been moved to the error queue by an **apply process**. When this occurs, you should examine the transaction in the error queue to analyze the feasibility of reexecuting the transaction successfully. If an abnormality is found in the transaction, then you might be able to configure a **DML handler** to correct the problem. The DML handler will run when you reexecute the error transaction. When a DML handler is used to correct a problem in an error transaction, the apply process that uses the DML handler should be stopped to prevent the DML handler from acting on LCRs that are not involved with the error transaction. After successful reexecution, if the DML handler is no longer needed, then remove it. Also, correct the **rule-based transformation** to avoid future errors.

See Also:

- ["The Error Queue"](#) on page 4-21
- ["Checking for Apply Errors"](#) on page 25-16
- ["Displaying Detailed Information About Apply Errors"](#) on page 25-17

Checking the Trace Files and Alert Log for Problems

Messages about each **capture process**, **propagation**, and **apply process** are recorded in trace files for the database in which the process or **propagation job** is running. A **local capture process** runs on a **source database**, a **downstream capture process** runs on a **downstream database**, a propagation job runs on the database containing the **source queue** in the propagation, and an apply process runs on a **destination database**. These trace file messages can help you to identify and resolve problems in an Oracle Streams environment.

All trace files for background processes are written to the Automatic Diagnostic Repository. The names of trace files are operating system specific, but each file usually includes the name of the process writing the file.

For example, on some operating systems, the trace file name for a process is *sid_xxxx_iiii.trc*, where:

- *sid* is the system identifier for the database
- *xxxx* is the name of the process
- *iiii* is the operating system process number

Also, you can set the `write_alert_log` parameter to `y` for both a capture process and an apply process. When this parameter is set to `y`, which is the default setting, the alert log for the database contains messages about why the capture process or apply process stopped.

You can control the information in the trace files by setting the `trace_level` capture process or apply process parameter using the `SET_PARAMETER` procedure in the `DBMS_CAPTURE_ADM` and `DBMS_APPLY_ADM` packages.

Use the following checklist to check the trace files related to Oracle Streams:

- [Does a Capture Process Trace File Contain Messages About Capture Problems?](#)
- [Do the Trace Files Related to Propagation Jobs Contain Messages About Problems?](#)
- [Does an Apply Process Trace File Contain Messages About Apply Problems?](#)

See Also:

- *Oracle Database Administrator's Guide* for more information about trace files and the alert log, and for more information about their names and locations
- *Oracle Database PL/SQL Packages and Types Reference* for more information about setting the `trace_level` capture process parameter and the `trace_level` apply process parameter
- Your operating system specific Oracle documentation for more information about the names and locations of trace files

Does a Capture Process Trace File Contain Messages About Capture Problems?

A capture process is an Oracle background process named `CPnn`, where `nn` can include letters and numbers. For example, on some operating systems, if the system identifier for a database running a capture process is `hqdb` and the capture process number is `01`, then the trace file for the capture process starts with `hqdb_CP01`.

See Also: ["Displaying Change Capture Information About Each Capture Process"](#) on page 23-3 for a query that displays the capture process number of a capture process

Do the Trace Files Related to Propagation Jobs Contain Messages About Problems?

Each propagation uses a propagation job that depends on one or more slave processes named `jnnn`, where `nnn` is the slave process number. For example, on some operating systems, if a slave process is `001`, then the trace file for the slave process includes `j001` in its name. You can check the process name by querying the `PROCESS_NAME` column in the `DBA_QUEUE_SCHEDULES` data dictionary view.

See Also: ["Is the Propagation Enabled?"](#) on page 20-12 for a query that displays the job slave used by a propagation job

Does an Apply Process Trace File Contain Messages About Apply Problems?

An **apply process** is an Oracle background process named `APnn`, where `nn` can include letters and numbers. For example, on some operating systems, if the system identifier for a database running an apply process is `hqdb` and the apply process number is `01`, then the trace file for the apply process starts with `hqdb_AP01`.

An apply process also uses other processes. Information about an apply process might be recorded in the trace file for one or more of these processes. The process name of the reader server and apply servers is `ASnn`, where `nn` can include letters and numbers. So, on some operating systems, if the system identifier for a database running an apply process is `hqdb` and the process number is `01`, then the trace file that contains information about a process used by an apply process starts with `hqdb_AS01`.

See Also:

- ["Displaying General Information About Each Coordinator Process"](#) on page 25-9 for a query that displays the apply process number of an apply process
- ["Displaying Information About the Reader Server for Each Apply Process"](#) on page 25-6 for a query that displays the process used by the **reader server** of an apply process
- ["Displaying Information About the Apply Servers for Each Apply Process"](#) on page 25-9 for a query that displays the processes used by the **apply servers** of an apply process

Part IV

Monitoring Oracle Streams

This part describes monitoring an Oracle Streams environment. This part contains the following chapters:

- [Chapter 21, "Monitoring an Oracle Streams Environment"](#)
- [Chapter 22, "Monitoring the Oracle Streams Topology and Performance"](#)
- [Chapter 23, "Monitoring Oracle Streams Implicit Capture"](#)
- [Chapter 24, "Monitoring Oracle Streams Queues and Propagations"](#)
- [Chapter 25, "Monitoring Oracle Streams Apply Processes"](#)
- [Chapter 26, "Monitoring Rules"](#)
- [Chapter 27, "Monitoring Rule-Based Transformations"](#)
- [Chapter 28, "Monitoring Other Oracle Streams Components"](#)

Monitoring an Oracle Streams Environment

This chapter lists the static data dictionary views and dynamic performance views related to Oracle Streams. You can use these views to monitor your Oracle Streams environment.

The following sections contain data dictionary views for monitoring an Oracle Streams environment:

- [Summary of Oracle Streams Static Data Dictionary Views](#)
- [Summary of Oracle Streams Dynamic Performance Views](#)

Note: The Oracle Streams tool in the Oracle Enterprise Manager Console is also an excellent way to monitor an Oracle Streams environment. See *Oracle Database 2 Day + Data Replication and Integration Guide* and the online Help for the Oracle Streams tool for more information.

See Also:

- *Oracle Database Reference* for information about the data dictionary views described in this chapter
- *Oracle Streams Replication Administrator's Guide* for information about monitoring an Oracle Streams **replication** environment

Summary of Oracle Streams Static Data Dictionary Views

[Table 21–1](#) lists the Oracle Streams static data dictionary views.

Table 21–1 Oracle Streams Static Data Dictionary Views

ALL_ Views	DBA_ Views	USER_ Views
ALL_APPLY	DBA_APPLY	N/A
ALL_APPLY_CONFLICT_COLUMNS	DBA_APPLY_CONFLICT_COLUMNS	N/A
ALL_APPLY_DML_HANDLERS	DBA_APPLY_DML_HANDLERS	N/A
ALL_APPLY_ENQUEUE	DBA_APPLY_ENQUEUE	N/A
ALL_APPLY_ERROR	DBA_APPLY_ERROR	N/A
ALL_APPLY_EXECUTE	DBA_APPLY_EXECUTE	N/A
N/A	DBA_APPLY_INSTANTIATED_GLOBAL	N/A
N/A	DBA_APPLY_INSTANTIATED_OBJECTS	N/A
N/A	DBA_APPLY_INSTANTIATED_SCHEMAS	N/A

Table 21–1 (Cont.) Oracle Streams Static Data Dictionary Views

ALL_ Views	DBA_ Views	USER_ Views
ALL_APPLY_KEY_COLUMNS	DBA_APPLY_KEY_COLUMNS	N/A
N/A	DBA_APPLY_OBJECT_DEPENDENCIES	N/A
ALL_APPLY_PARAMETERS	DBA_APPLY_PARAMETERS	N/A
ALL_APPLY_PROGRESS	DBA_APPLY_PROGRESS	N/A
N/A	DBA_APPLY_SPILL_TXN	N/A
ALL_APPLY_TABLE_COLUMNS	DBA_APPLY_TABLE_COLUMNS	N/A
N/A	DBA_APPLY_VALUE_DEPENDENCIES	N/A
ALL_CAPTURE	DBA_CAPTURE	N/A
ALL_CAPTURE_EXTRA_ATTRIBUTES	DBA_CAPTURE_EXTRA_ATTRIBUTES	N/A
ALL_CAPTURE_PARAMETERS	DBA_CAPTURE_PARAMETERS	N/A
ALL_CAPTURE_PREPARED_DATABASE	DBA_CAPTURE_PREPARED_DATABASE	N/A
ALL_CAPTURE_PREPARED_SCHEMAS	DBA_CAPTURE_PREPARED_SCHEMAS	N/A
ALL_CAPTURE_PREPARED_TABLES	DBA_CAPTURE_PREPARED_TABLES	N/A
N/A	DBA_COMPARISON	USER_COMPARISON
N/A	DBA_COMPARISON_COLUMNS	USER_COMPARISON_COLUMNS
N/A	DBA_COMPARISON_ROW_DIF	USER_COMPARISON_ROW_DIF
N/A	DBA_COMPARISON_SCAN	USER_COMPARISON_SCAN
N/A	DBA_COMPARISON_SCAN_VALUES	USER_COMPARISON_SCAN_VALUES
ALL_EVALUATION_CONTEXT_TABLES	DBA_EVALUATION_CONTEXT_TABLES	USER_EVALUATION_CONTEXT_TABLES
ALL_EVALUATION_CONTEXT_VARS	DBA_EVALUATION_CONTEXT_VARS	USER_EVALUATION_CONTEXT_VARS
ALL_EVALUATION_CONTEXTS	DBA_EVALUATION_CONTEXTS	USER_EVALUATION_CONTEXTS
ALL_FILE_GROUP_EXPORT_INFO	DBA_FILE_GROUP_EXPORT_INFO	USER_FILE_GROUP_EXPORT_INFO
ALL_FILE_GROUP_FILES	DBA_FILE_GROUP_FILES	USER_FILE_GROUP_FILES
ALL_FILE_GROUP_TABLES	DBA_FILE_GROUP_TABLES	USER_FILE_GROUP_TABLES
ALL_FILE_GROUP_TABLESPACES	DBA_FILE_GROUP_TABLESPACES	USER_FILE_GROUP_TABLESPACES
ALL_FILE_GROUP_VERSIONS	DBA_FILE_GROUP_VERSIONS	USER_FILE_GROUP_VERSIONS
ALL_FILE_GROUPS	DBA_FILE_GROUPS	USER_FILE_GROUPS
N/A	DBA_HIST_STREAMS_APPLY_SUM	N/A
N/A	DBA_HIST_STREAMS_CAPTURE	N/A
N/A	DBA_HIST_STREAMS_POOL_ADVICE	N/A
ALL_PROPAGATION	DBA_PROPAGATION	N/A
N/A	DBA_REGISTERED_ARCHIVED_LOG	N/A
ALL_RULE_SET_RULES	DBA_RULE_SET_RULES	USER_RULE_SET_RULES
ALL_RULE_SETS	DBA_RULE_SETS	USER_RULE_SETS
ALL_RULES	DBA_RULES	USER_RULES
N/A	DBA_STREAMS_ADD_COLUMN	N/A
N/A	DBA_STREAMS_ADMINISTRATOR	N/A
ALL_STREAMS_COLUMNS	DBA_STREAMS_COLUMNS	N/A
N/A	DBA_STREAMS_DELETE_COLUMN	N/A
ALL_STREAMS_GLOBAL_RULES	DBA_STREAMS_GLOBAL_RULES	N/A
ALL_STREAMS_MESSAGE_CONSUMERS	DBA_STREAMS_MESSAGE_CONSUMERS	N/A
ALL_STREAMS_MESSAGE_RULES	DBA_STREAMS_MESSAGE_RULES	N/A

Table 21–1 (Cont.) Oracle Streams Static Data Dictionary Views

ALL_ Views	DBA_ Views	USER_ Views
ALL_STREAMS_NEWLY_SUPPORTED	DBA_STREAMS_NEWLY_SUPPORTED	N/A
N/A	DBA_STREAMS_RENAME_COLUMN	N/A
N/A	DBA_STREAMS_RENAME_SCHEMA	N/A
N/A	DBA_STREAMS_RENAME_TABLE	N/A
ALL_STREAMS_RULES	DBA_STREAMS_RULES	N/A
ALL_STREAMS_SCHEMA_RULES	DBA_STREAMS_SCHEMA_RULES	N/A
N/A	DBA_STREAMS_TP_COMPONENT	N/A
N/A	DBA_STREAMS_TP_COMPONENT_LINK	N/A
N/A	DBA_STREAMS_TP_COMPONENT_STAT	N/A
N/A	DBA_STREAMS_TP_DATABASE	N/A
N/A	DBA_STREAMS_TP_PATH_BOTTLENECK	N/A
N/A	DBA_STREAMS_TP_PATH_STAT	N/A
ALL_STREAMS_TABLE_RULES	DBA_STREAMS_TABLE_RULES	N/A
ALL_STREAMS_TRANSFORM_FUNCTION	DBA_STREAMS_TRANSFORM_FUNCTION	N/A
N/A	DBA_STREAMS_TRANSFORMATIONS	N/A
ALL_STREAMS_UNSUPPORTED	DBA_STREAMS_UNSUPPORTED	N/A
ALL_SYNC_CAPTURE	DBA_SYNC_CAPTURE	N/A
ALL_SYNC_CAPTURE_PREPARED_TABS	DBA_SYNC_CAPTURE_PREPARED_TABS	N/A
N/A	DBA_SYNC_CAPTURE_TABLES	N/A

Summary of Oracle Streams Dynamic Performance Views

The Oracle Streams dynamic performance views are:

- V\$BUFFERED_PUBLISHERS
- V\$BUFFERED_QUEUES
- V\$BUFFERED_SUBSCRIBERS
- V\$PROPAGATION_RECEIVER
- V\$PROPAGATION_SENDER
- V\$RULE
- V\$RULE_SET
- V\$RULE_SET_AGGREGATE_STATS
- V\$STREAMS_APPLY_COORDINATOR
- V\$STREAMS_APPLY_READER
- V\$STREAMS_APPLY_SERVER
- V\$STREAMS_CAPTURE
- V\$STREAMS_POOL_ADVICE
- V\$STREAMS_TRANSACTION

Note:

- When monitoring an Oracle Real Application Clusters (Oracle RAC) database, use the GV\$ versions of the dynamic performance views.
 - To collect elapsed time statistics in these dynamic performance views, set the `TIMED_STATISTICS` initialization parameter to `TRUE`.
-
-

Monitoring the Oracle Streams Topology and Performance

The Oracle Streams Performance Advisor consists of the `DBMS_STREAMS_ADVISOR_ADM` PL/SQL package and a collection of data dictionary views. The Oracle Streams Performance Advisor enables you to monitor the topology and performance of an Oracle Streams environment. The Oracle Streams topology includes information about the components in an Oracle Streams environment, the links between the components, and the way information flows from capture to consumption. The Oracle Streams Performance Advisor also provides information about how Oracle Streams components are performing.

The following topics contain information about the Oracle Streams Performance Advisor:

- [About the Oracle Streams Topology](#)
- [About the Oracle Streams Performance Advisor](#)
- [About Stream Paths in an Oracle Streams Topology](#)
- [About the Information Gathered With the Oracle Streams Performance Advisor](#)
- [Gathering Information About the Oracle Streams Topology and Performance](#)
- [Viewing the Oracle Streams Topology and Analyzing Oracle Streams Performance](#)
- [Using the UTL_SPADV Package](#)

About the Oracle Streams Topology

Oracle Streams enables you to send **messages** between multiple databases. An Oracle Streams environment can send the following types of messages:

- Logical change records (LCRs) that contain database changes
- User messages that contain custom information based on user-defined types

The **Oracle Streams topology** is a representation of the databases in an Oracle Streams environment, the Oracle Streams components configured in these databases, and the flow of messages between these components.

The messages in the environment flow in separate stream paths. A **stream path** begins when a **capture process**, a **synchronous capture**, or an application generates messages and enqueues them. The messages can flow through one or more **propagations** and **queues** in its stream path. The stream path ends when the messages are dequeued by an **apply process**, a **messaging client**, or an application.

Currently, the Oracle Streams topology only gathers information about a stream path if the stream path ends with an apply process. The Oracle Streams topology does not track stream paths that end when a messaging client or an application dequeues messages.

See Also:

- ["Implicit Capture with an Oracle Streams Capture Process"](#) on page 2-9
- ["Message Propagation Between Queues"](#) on page 3-11
- ["Implicit Consumption with an Apply Process"](#) on page 4-5
- ["Queues"](#) on page 3-1
- ["Types of Information Captured with Oracle Streams"](#) on page 2-3

About the Oracle Streams Performance Advisor

The Oracle Streams Performance Advisor consists of the DBMS_STREAMS_ADVISOR_ADM PL/SQL package and a collection of data dictionary views. You can use the ANALYZE_CURRENT_PERFORMANCE procedure in the DBMS_STREAMS_ADVISOR_ADM package to gather information about the Oracle Streams topology and about the performance of the Oracle Streams components in the topology.

This section contains the following topics:

- [Oracle Streams Performance Advisor Data Dictionary Views](#)
- [Oracle Streams Components and Statistics](#)

Oracle Streams Performance Advisor Data Dictionary Views

After information is gathered by the Oracle Streams Performance Advisor, you can view it by querying the following data dictionary views:

- DBA_STREAMS_TP_COMPONENT contains information about each Oracle Streams component at each database.
- DBA_STREAMS_TP_COMPONENT_LINK contains information about how messages flow between Oracle Streams components.
- DBA_STREAMS_TP_COMPONENT_STAT contains temporary performance statistics and session statistics about each Oracle Streams component.
- DBA_STREAMS_TP_DATABASE contains information about each database that contains Oracle Streams components.
- DBA_STREAMS_TP_PATH_BOTTLENECK contains temporary information about Oracle Streams components that might be slowing down the flow of messages in a stream path.
- DBA_STREAMS_TP_PATH_STAT contains temporary performance statistics about each stream path that exists in the Oracle Streams topology.

The topology information is stored permanently in the following data dictionary views: DBA_STREAMS_TP_DATABASE, DBA_STREAMS_TP_COMPONENT, and DBA_STREAMS_TP_COMPONENT_LINK.

The following views contain temporary information: DBA_STREAMS_TP_COMPONENT_STAT, DBA_STREAMS_TP_PATH_BOTTLENECK, and DBA_STREAMS_TP_PATH_STAT. Some of the data in these views is retained only for the user session that

runs the `ANALYZE_CURRENT_PERFORMANCE` procedure. When this user session ends, this temporary information is purged.

See Also: ["Viewing the Oracle Streams Topology and Analyzing Oracle Streams Performance"](#) on page 22-10

Oracle Streams Components and Statistics

The `DBMS_STREAMS_ADVISOR_ADM` package gathers information about the following Oracle Streams components:

- A `QUEUE` stores messages. The package gathers the following component-level statistics for queues:
 - `ENQUEUE RATE`
 - `SPILL RATE`
 - `CURRENT QUEUE SIZE`
- A `CAPTURE` is a capture process. A capture process captures database changes in the redo log and enqueues the changes as logical change records (LCRs). Each capture process has the following subcomponents:
 - `LOGMINER BUILDER` is a builder server.
 - `LOGMINER PREPARER` is a preparer server.
 - `LOGMINER READER` is a reader server.
 - `CAPTURE SESSION` is the capture process session.

The package gathers the following component-level statistics for each capture process (`CAPTURE`):

- `CAPTURE RATE`
- `ENQUEUE RATE`
- `LATENCY`

The package also gathers session-level statistics for capture process subcomponents.

- A `PROPAGATION SENDER` sends messages from a **source queue** to a **destination queue**. The package gathers the following component-level statistics for propagation senders:
 - `SEND RATE`
 - `BANDWIDTH`
 - `LATENCY`

The package also gathers session-level statistics for propagation senders.

- A `PROPAGATION RECEIVER` enqueues messages sent by propagation senders into a destination queue. The package gathers session-level statistics for propagation receivers.
- An `APPLY` is an apply process. An apply process either applies messages directly or sends messages to **apply handlers**. Each apply process has the following subcomponents:
 - `APPLY READER` is a reader server.
 - `APPLY COORDINATOR` is a coordinator process.

- APPLY SERVER is an apply server.

The package gathers the following component-level statistics for each apply process (APPLY):

- MESSAGE APPLY RATE
- TRANSACTION APPLY RATE
- LATENCY

The package also gathers session-level statistics for apply process subcomponents.

When the package gathers session-level statistics for a component or subcomponent, the session-level statistics include the following:

- IDLE percentage
- FLOW CONTROL percentage
- EVENT percentage for wait events

Note: Currently, the DBMS_STREAMS_ADVISOR_ADM package does not gather information about [synchronous captures](#) or [messaging clients](#).

See Also:

- ["Viewing Component-Level Statistics"](#) on page 22-20 for detailed information about component-level statistics
- ["Viewing Session-Level Statistics"](#) on page 22-27 for detailed information about session-level statistics

About Stream Paths in an Oracle Streams Topology

In the Oracle Streams topology, a stream path is a flow of messages from a source to a destination. A stream path begins when a [capture process](#), [synchronous capture](#), or application enqueues [messages](#) into a [queue](#). A stream path ends when an [apply process](#) dequeues the messages. The stream path might flow through multiple queues and [propagations](#) before it reaches the apply process. Therefore, a single stream path can consist of multiple source/destination pairs before it reaches the apply process.

The Oracle Streams topology assigns a number to each stream path so that you can monitor each one easily. The Oracle Streams topology also assigns a number to each link between two components in a stream path. The number specifies the **position** of the link in the overall stream path. [Table 22-1](#) shows the position of each link in a sample stream path.

Table 22-1 Position of Each Link in a Sample Stream Path

Start Component	End Component	Position
Capture process	Queue	1
Queue	Propagation sender	2
Propagation sender	Propagation receiver	3
Propagation receiver	Queue	4
Queue	Apply process	5

When the Oracle Streams Performance Advisor gathers information about an Oracle Streams environment, it tracks stream paths by starting with each apply process and working backward to its source. When a capture process is the source, the Oracle Streams Performance Advisor tracks the path from the apply process back to the capture process. When a synchronous capture or an application that enqueues messages is the source, the Oracle Streams Performance Advisor tracks the path from the apply process back to the queue into which the messages are enqueued.

The following sections describe sample replication environments and the stream paths in each one:

- [Stream Paths in a Combined Capture and Apply Replication Environment](#)
- [Stream Paths in a Replication Environment That Does Not Use Combined Capture and Apply](#)

See Also: *Oracle Streams Replication Administrator's Guide* for information about best practices for Oracle Streams replication environments

Stream Paths in a Combined Capture and Apply Replication Environment

Consider an Oracle Streams **replication** environment with two databases. Each database captures changes made to the replicated database objects with a capture process and sends the changes to the other database, where they are applied by an apply process.

This type of Oracle Streams replication environment can use combined capture and apply. In a combined capture and apply path, the capture process acts as the propagation sender to improve efficiency.

[Figure 22-1](#) shows an Oracle Streams replication environment that uses combined capture and apply in two separate stream paths.

Figure 22–1 Oracle Streams Topology with Two Separate Stream Paths

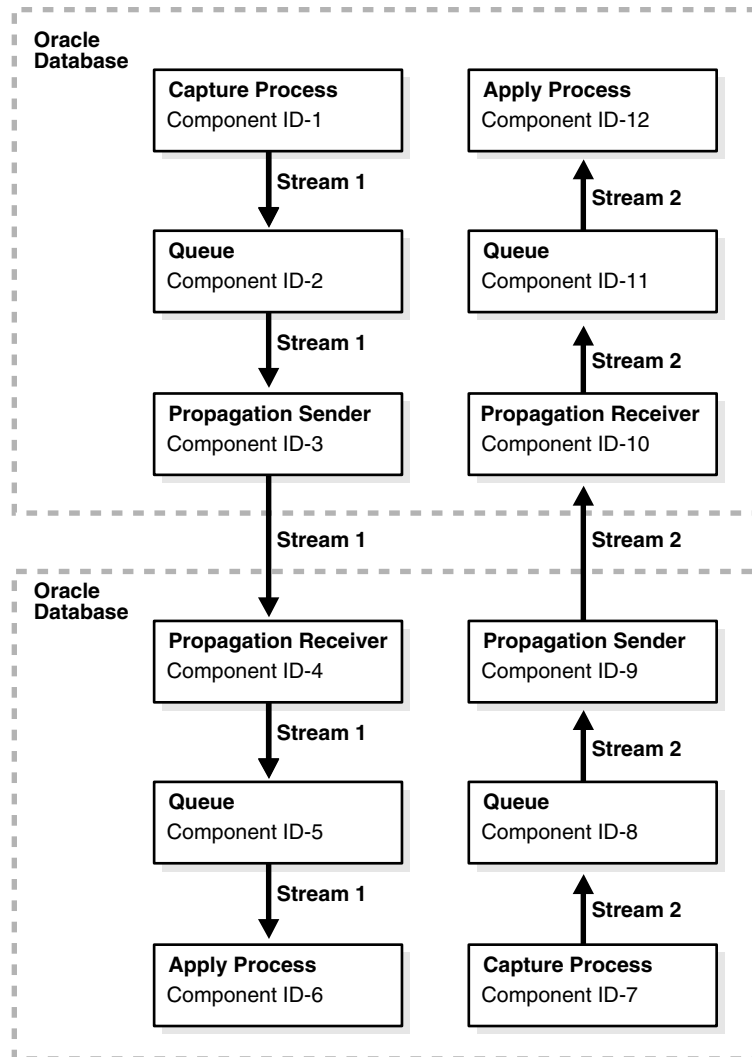

Notice that the Oracle Streams Performance Advisor assigns a component ID to each Oracle Streams component and a path ID to each path. The Oracle Streams topology in [Figure 22–1](#) shows the following information:

- There are twelve Oracle Streams components in the Oracle Streams environment.
- There are two stream paths in the Oracle Streams environment.
- Stream path 1 starts with component 1 and ends with component 6.
- Stream path 2 starts with component 7 and ends with component 12.

See Also: ["Combined Capture and Apply Optimization"](#) on page 3-20

Stream Paths in a Replication Environment That Does Not Use Combined Capture and Apply

When there are multiple apply processes that apply changes generated by a single source, a stream path splits into multiple stream paths. This type of configuration cannot use the combined capture and apply optimization.

Figure 22–2 shows this type of Oracle Streams environment.

Figure 22–2 Oracle Streams Topology with Multiple Apply Processes for a Single Source

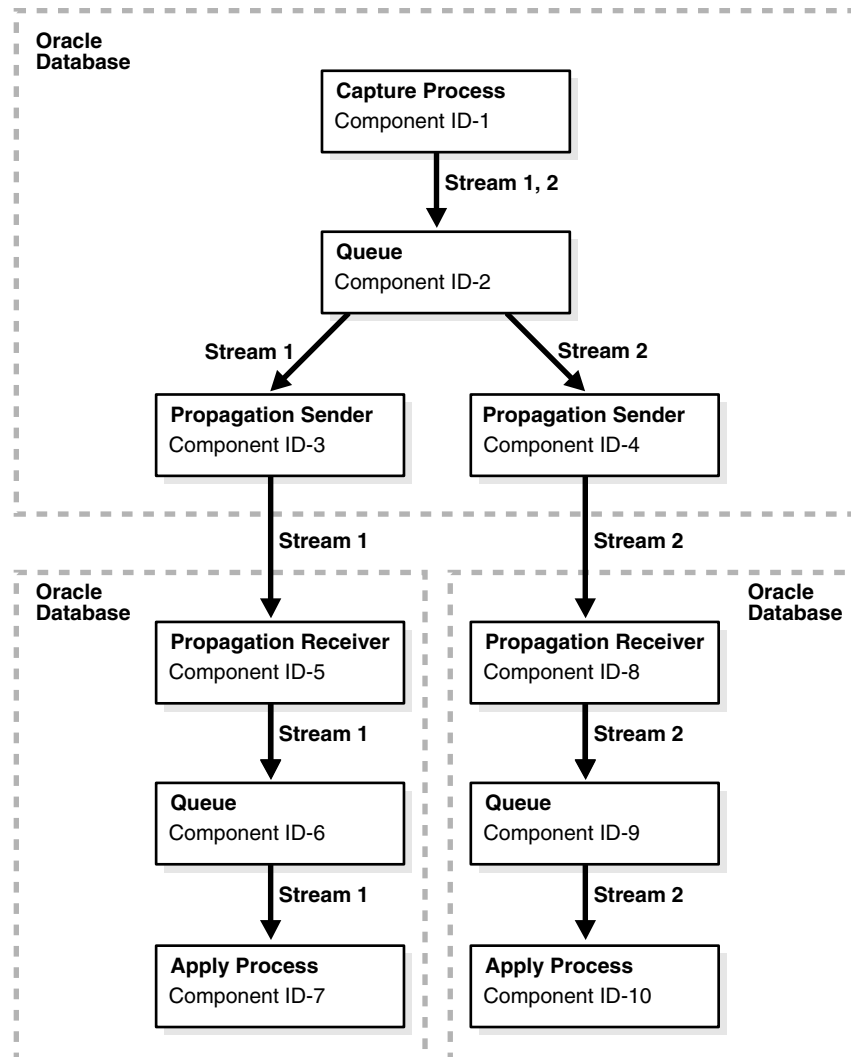

The Oracle Streams topology in Figure 22–2 shows the following information:

- There are ten Oracle Streams components in the Oracle Streams environment.
- There are two stream paths in the Oracle Streams environment.
- Stream path 1 starts with component 1 and ends with component 7.
- Stream path 2 starts with component 1 and ends with component 10.
- The messages flowing between component 1 and component 2 are in both path 1 and path2.

See Also: "[Message Propagation Between Queues](#)" on page 3-11

About the Information Gathered With the Oracle Streams Performance Advisor

The `ANALYZE_CURRENT_PERFORMANCE` procedure in the `DBMS_STREAMS_ADVISOR_ADM` package gathers information about the Oracle Streams topology and the performance of Oracle Streams components. The procedure stores the information in a collection of data dictionary views. To use the Oracle Streams Performance Advisor effectively, it is important to understand how the procedure gathers information and calculates statistics.

The procedure takes snapshots of the Oracle Streams environment to gather information and calculate statistics. For some statistics, the information in a single snapshot is sufficient. For example, only one snapshot is needed to determine the current number of messages in a queue. However, to calculate other statistics, the procedure must compare two snapshots. These statistics include the rate, bandwidth, event, and flow control statistics. The first time the procedure is run in a user session, it takes two snapshots to calculate these statistics. In each subsequent run in the same user session, the procedure takes one snapshot and compares it with the snapshot taken during the previous run.

Table 22–2 illustrates how the procedure gathers information in each advisor run in a single user session.

Table 22–2 *How the Oracle Streams Performance Advisor Gathers Information in a Session*

Advisor Run	Information Gathered
1	<ol style="list-style-type: none"> 1. Take snapshot of statistics. 2. Wait at least five seconds. 3. Take another snapshot of statistics. 4. Compare data from the first snapshot with data from the second snapshot to calculate performance statistics.
2	<ol style="list-style-type: none"> 1. Take snapshot of statistics. 2. Compare data from the last snapshot in advisor run 1 with the snapshot taken in advisor run 2 to calculate performance statistics.
3	<ol style="list-style-type: none"> 1. Take snapshot of statistics. 2. Compare data from the snapshot in advisor run 2 with the snapshot taken in advisor run 3 to calculate performance statistics.

For the best results in an advisor run, meet the following criteria:

- Ensure that as many Oracle Streams components as possible are enabled during the time period between the two snapshots used in the advisor run. Specifically, capture processes, propagations, and apply processes should be enabled, queues should be started, and database links should be active.
- If data is replicated in the Oracle Streams environment, then ensure that the replicated database objects are experiencing an average, or near average, number of changes during the time period between the two snapshots used in the advisor run. The Oracle Streams Performance Advisor gathers more accurate statistics if it is run when the Oracle Streams replication environment is experiencing typical replication activity.
- If messages are sent by applications in the Oracle Streams environment, then ensure that the applications are sending an average, or near average, number of messages during the time period between the two snapshots used in the advisor

run. The Oracle Streams Performance Advisor gathers more accurate statistics if it is run when the Oracle Streams messaging environment is sending a typical number of messages.

Gathering Information About the Oracle Streams Topology and Performance

To gather information about the Oracle Streams topology and Oracle Streams performance, complete the following steps:

1. Identify the database that you will use to gather the information. An administrative user at this database must meet the following requirements:
 - The user must have access to a database link to each database that contains Oracle Streams components.
 - The user must have been granted privileges using the `DBMS_STREAMS_AUTH.GRANT_ADMIN_PRIVILEGE` procedure, and each database link must connect to a user at the remote database that has been granted privileges using the `DBMS_STREAMS_AUTH.GRANT_ADMIN_PRIVILEGE` procedure.

If you configure an Oracle Streams administrator at each database with Oracle Streams components, then the Oracle Streams administrator has the necessary privileges. See ["Configuring an Oracle Streams Administrator"](#) on page 9-1 for instructions.

If no database in your environment meets these requirements, then choose a database, configure the necessary database links, and grant the necessary privileges to the users before proceeding.

2. In SQL*Plus, connect to the database you identified in Step 1 as a user that meets the requirements listed in Step 1.

For example, connect to the `hub.example.com` database as the Oracle Streams administrator.

See *Oracle Database Administrator's Guide* for information about connecting to a database in SQL*Plus.

3. Run the `ANALYZE_CURRENT_PERFORMANCE` procedure in the `DBMS_STREAMS_ADVISOR_ADM` package:

```
exec DBMS_STREAMS_ADVISOR_ADM.ANALYZE_CURRENT_PERFORMANCE;
```

4. Optionally, rerun the `ANALYZE_CURRENT_PERFORMANCE` procedure one or more times in same session that ran the procedure in Step 3:

```
exec DBMS_STREAMS_ADVISOR_ADM.ANALYZE_CURRENT_PERFORMANCE;
```

5. Run the following query to identify the advisor run ID for the information gathered in Step 4:

```
SELECT DISTINCT ADVISOR_RUN_ID FROM DBA_STREAMS_TP_COMPONENT_STAT
ORDER BY ADVISOR_RUN_ID;
```

Your output is similar to the following:

```
ADVISOR_RUN_ID
-----
1
2
```

The Oracle Streams Performance Advisor assigns an advisor run ID to the statistics for each run. Use the last value in the output for the advisor run ID in the queries in ["Viewing Performance Statistics for Oracle Streams Components"](#) on page 22-17. In this example, use 2 for the advisor run ID in the queries.

Remember that the Oracle Streams Performance Advisor purges some of the performance statistics that it gathered when a user session ends. Therefore, run the performance statistics queries in the same session that ran the `ANALYZE_CURRENT_PERFORMANCE` procedure.

Complete these steps whenever you want to monitor the current performance of your Oracle Streams environment.

You should also run the `ANALYZE_CURRENT_PERFORMANCE` procedure when new Oracle Streams components are added to any database in the Oracle Streams environment. Running the procedure updates the Oracle Streams topology with information about any new components.

See Also:

- *Oracle Database PL/SQL Packages and Types Reference* for information about the `DBMS_STREAMS_ADVISOR_ADM` package
- ["About the Oracle Streams Topology"](#) on page 22-1

Viewing the Oracle Streams Topology and Analyzing Oracle Streams Performance

This section contains several queries that you can use to view your Oracle Streams topology and monitor the performance of your Oracle Streams components. The queries specify the views described in ["About the Oracle Streams Topology"](#) on page 22-1.

The queries in this section can be run in any Oracle Stream environment. However, the output shown for these queries is based on the sample Oracle Streams replication environment shown in [Figure 22-3](#).

Figure 22-3 Sample Oracle Streams Replication Environment

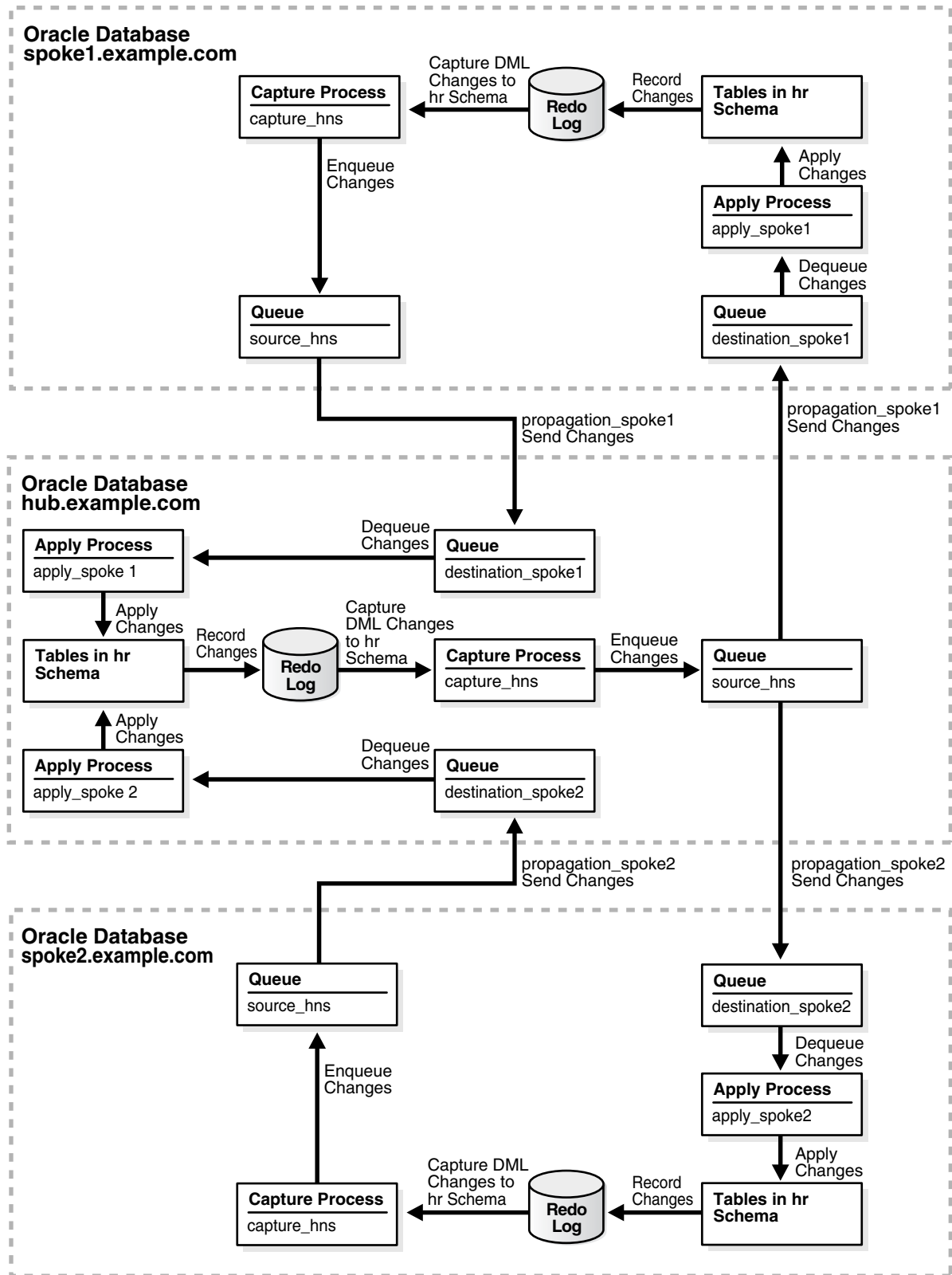

The *Oracle Database 2 Day + Data Replication and Integration Guide* contains instructions for configuring the Oracle Streams replication environment shown in Figure 22-3. This environment contains both of the following types of stream paths:

- A combined capture and apply stream path flows from the `spoke1.example.com` database to the `hub.example.com` database and from the `spoke2.example.com` database to the `hub.example.com` database. This type of stream path is described in "[Stream Paths in a Combined Capture and Apply Replication Environment](#)" on page 22-5.
- Two stream paths that do not use combined capture and apply flow from the `hub.example.com` database to the `spoke1.example.com` and `spoke2.example.com` databases. This type of stream path is described in "[Stream Paths in a Replication Environment That Does Not Use Combined Capture and Apply](#)" on page 22-6.

The output of the queries in this section illustrate the differences between these two types of stream paths.

This section contains the following topics:

- [Viewing the Oracle Streams Topology](#)
- [Viewing Performance Statistics for Oracle Streams Components](#)

Viewing the Oracle Streams Topology

To view the Oracle Streams topology, you must first gather information about the Oracle Streams environment using the `DBMS_STREAMS_ADVISOR_ADM` package. See "[Gathering Information About the Oracle Streams Topology and Performance](#)" on page 22-9.

The following sections explain how to view different types of information in an Oracle Streams topology:

- [Viewing the Databases in the Oracle Streams Environment](#)
- [Viewing the Oracle Streams Components at Each Database](#)
- [Viewing Each Stream Path in an Oracle Streams Topology](#)

Viewing the Databases in the Oracle Streams Environment

You can view the following information about the databases in an Oracle Streams environment:

- The global name of each database
- The last time the Oracle Streams Performance Advisor was run at each database
- The version number of each database
- The compatibility level of each database
- Whether each database has access to the Oracle Diagnostics Pack and Oracle Tuning Pack

To display this information, run the following query:

```
COLUMN GLOBAL_NAME HEADING 'Global Name' FORMAT A15
COLUMN LAST_QUERIED HEADING 'Last|Queried'
COLUMN VERSION HEADING 'Version' FORMAT A15
COLUMN COMPATIBILITY HEADING 'Compatibility' FORMAT A15
COLUMN MANAGEMENT_PACK_ACCESS HEADING 'Management Pack' FORMAT A20

SELECT GLOBAL_NAME, LAST_QUERIED, VERSION, COMPATIBILITY, MANAGEMENT_PACK_ACCESS
FROM DBA_STREAMS_TP_DATABASE;
```

The following output shows the databases in the Oracle Streams replication environment described in "[Viewing the Oracle Streams Topology and Analyzing Oracle Streams Performance](#)" on page 22-10:

Global Name	Last		Compatibility	Management Pack
	Queried	Version		
HUB.EXAMPLE.COM	08-APR-08	11.1.0.7.0	11.1.0	DIAGNOSTIC+TUNING
SPOKE1.EXAMPLE.COM	08-APR-08	11.1.0.7.0	11.1.0	DIAGNOSTIC+TUNING
SPOKE2.EXAMPLE.COM	08-APR-08	11.1.0.7.0	11.1.0	DIAGNOSTIC+TUNING

This output shows the following information about the databases in the Oracle Streams environment:

- The `Global Name` column shows that the global names of the databases are `hub.example.com`, `spoke1.example.com`, and `spoke2.example.com`.
- The `Last Queried` column shows that the Oracle Streams Performance Advisor was last run on April 8, 2008 at each database.
- The `Version` column shows that version of each database is 11.1.0.7.0.
- The `Compatibility` column shows that the compatibility level of each database is 11.1.0.
- The `Management Pack` column shows that each database has access to the Oracle Diagnostics Pack and Oracle Tuning Pack.

See Also: *Oracle Database Upgrade Guide* for information about database compatibility

Viewing the Oracle Streams Components at Each Database

You can view the following information about the components in an Oracle Streams environment:

- The component ID for each Oracle Streams component. The Oracle Streams topology assigns an ID number to each component and uses the number to track information about the component and about the stream path that flows through the component.
- The name of the Oracle Streams component. For [capture processes](#) and [apply processes](#), the query lists the name of each process. For [queues](#), the query lists the name of each queue. For [propagations](#), two Oracle Streams components are tracked in the Oracle Streams topology:
 - The name of a propagation sender is the [source queue](#) of the propagation and the [destination queue](#) and database to which the propagation sends messages. For example, a propagation sender with the `strmadmin.source_hns` source queue that sends messages to the `strmadmin.destination_spoke1` destination queue at the `spoke1.example.com` database is shown in the following way:

```
"STRMADMIN" . "SOURCE_HNS" => "STRMADMIN" . "DESTINATION_SPOKE1"
@SPOKE1.EXAMPLE.COM
```
 - The name of a propagation receiver is the source queue and database from which the messages are sent and the destination queue for the propagation. For example, a propagation receiver that gets messages from the `strmadmin.source_hns` source queue at the `hub.example.com` database

and enqueues them into the `strmadmin.destination_spoke1` destination queue is shown in the following way:

```
"STRMADMIN"."SOURCE_HNS"@HUB.EXAMPLE.COM=>"STRMADMIN".
"DESTINATION_SPOKE1"
```

- The type of the Oracle Streams component. The following types are possible:
 - CAPTURE for capture processes
 - QUEUE for queues
 - PROPAGATION SENDER for propagation senders
 - PROPAGATION RECEIVER for propagation receivers
 - APPLY for apply processes
- The database that contains the component

To display this information, run the following query:

```
COLUMN COMPONENT_ID HEADING 'ID' FORMAT 999
COLUMN COMPONENT_NAME HEADING 'Name' FORMAT A43
COLUMN COMPONENT_TYPE HEADING 'Type' FORMAT A20
COLUMN COMPONENT_DB HEADING 'Database' FORMAT A10

SELECT COMPONENT_ID, COMPONENT_NAME, COMPONENT_TYPE, COMPONENT_DB
FROM DBA_STREAMS_TP_COMPONENT
ORDER BY COMPONENT_ID;
```

The following output shows the components in the Oracle Streams replication environment described in ["Viewing the Oracle Streams Topology and Analyzing Oracle Streams Performance"](#) on page 22-10:

ID	Name	Type	Database
1	"STRMADMIN"."DESTINATION_SPOKE1"	QUEUE	HUB.EXAMPL E.COM
2	"STRMADMIN"."DESTINATION_SPOKE2"	QUEUE	HUB.EXAMPL E.COM
3	"STRMADMIN"."SOURCE_HNS"	QUEUE	HUB.EXAMPL E.COM
4	"STRMADMIN"."SOURCE_HNS"=>"STRMADMIN"."DEST INATION_SPOKE1"@SPOKE1.EXAMPLE.COM	PROPAGATION SENDER	HUB.EXAMPL E.COM
5	"STRMADMIN"."SOURCE_HNS"=>"STRMADMIN"."DEST INATION_SPOKE2"@SPOKE2.EXAMPLE.COM	PROPAGATION SENDER	HUB.EXAMPL E.COM
6	"STRMADMIN"."SOURCE_HNS"@SPOKE1.EXAMPLE.COM =>"STRMADMIN"."DESTINATION_SPOKE1"	PROPAGATION RECEIVER	HUB.EXAMPL E.COM
7	"STRMADMIN"."SOURCE_HNS"@SPOKE2.EXAMPLE.COM =>"STRMADMIN"."DESTINATION_SPOKE2"	PROPAGATION RECEIVER	HUB.EXAMPL E.COM
8	APPLY_SPOKE1	APPLY	HUB.EXAMPL E.COM
9	APPLY_SPOKE2	APPLY	HUB.EXAMPL E.COM
10	CAPTURE_HNS	CAPTURE	HUB.EXAMPL E.COM
11	"STRMADMIN"."DESTINATION_SPOKE1"	QUEUE	SPOKE1.EXA MPLE.COM
12	"STRMADMIN"."SOURCE_HNS"	QUEUE	SPOKE1.EXA MPLE.COM
13	"STRMADMIN"."SOURCE_HNS"=>"STRMADMIN"."DEST INATION_SPOKE1"@HUB.EXAMPLE.COM	PROPAGATION SENDER	SPOKE1.EXA MPLE.COM

14	"STRMADMIN" . "SOURCE_HNS"@HUB.EXAMPLE.COM=>"	PROPAGATION RECEIVER	SPOKE1 . EXA MPLE.COM
15	STRMADMIN" . "DESTINATION_SPOKE1 "	APPLY	SPOKE1 . EXA MPLE.COM
16	CAPTURE_HNS	CAPTURE	SPOKE1 . EXA MPLE.COM
17	"STRMADMIN" . "DESTINATION_SPOKE2 "	QUEUE	SPOKE2 . EXA MPLE.COM
18	"STRMADMIN" . "SOURCE_HNS "	QUEUE	SPOKE2 . EXA MPLE.COM
19	"STRMADMIN" . "SOURCE_HNS" =>"STRMADMIN" . "DESTINATION_SPOKE2"@HUB.EXAMPLE.COM	PROPAGATION SENDER	SPOKE2 . EXA MPLE.COM
20	"STRMADMIN" . "SOURCE_HNS"@HUB.EXAMPLE.COM=>"	PROPAGATION RECEIVER	SPOKE2 . EXA MPLE.COM
21	STRMADMIN" . "DESTINATION_SPOKE2 "	APPLY	SPOKE2 . EXA MPLE.COM
22	CAPTURE_HNS	CAPTURE	SPOKE2 . EXA MPLE.COM

See Also:

- ["About the Oracle Streams Topology"](#) on page 22-1
- ["Viewing Component-Level Statistics"](#) on page 22-20 for a query that shows performance statistics for each Oracle Streams component
- *Oracle Streams Replication Administrator's Guide* for information about the n-way replication environment shown in the output

Viewing Each Stream Path in an Oracle Streams Topology

You can view the following information about the stream paths in an Oracle Streams topology:

- The path ID. The Oracle Streams topology assigns an ID number to each stream path it identifies. The path ID is associated with each link in the path. For example, a single path ID can be associated with the following component links:
 - Capture process to queue
 - Queue to propagation sender
 - Propagation sender to propagation receiver
 - Propagation receiver to queue
 - Queue to apply process
- The source component ID. A source component is a component from which messages flow to another component.
- The name of the source component. See ["Viewing the Oracle Streams Components at Each Database"](#) on page 22-13 for information about how components are named in the query output.
- The destination component ID. A destination component receives messages from another component.
- The name of the destination component.

- The position in the stream path shows the location of a particular link in a path. For example, a position might be the first link in a path, the second link in a path, and so on.

To display this information, run the following query:

```

COLUMN PATH_ID HEADING 'Path|ID' FORMAT 9999
COLUMN SOURCE_COMPONENT_ID HEADING 'Source|Component|ID' FORMAT 9999
COLUMN SOURCE_COMPONENT_NAME HEADING 'Source|Component|Name' FORMAT A20
COLUMN DESTINATION_COMPONENT_ID HEADING 'Dest|Component|ID' FORMAT 9999
COLUMN DESTINATION_COMPONENT_NAME HEADING 'Dest|Component|Name' FORMAT A15
COLUMN POSITION HEADING 'Position' FORMAT 9999

SELECT PATH_ID,
       SOURCE_COMPONENT_ID,
       SOURCE_COMPONENT_NAME,
       DESTINATION_COMPONENT_ID,
       DESTINATION_COMPONENT_NAME,
       POSITION
FROM DBA_STREAMS_TP_COMPONENT_LINK
ORDER BY PATH_ID, POSITION;

```

The following output shows the paths in the Oracle Streams topology for the components listed in ["Viewing the Oracle Streams Components at Each Database"](#) on page 22-13:

Path ID	Source Component ID	Source Component Name	Dest Component ID	Dest Component Name	Position
1	16	CAPTURE_HNS	12	"STRMADMIN"."SOURCE_HNS"	1
1	12	"STRMADMIN"."SOURCE_HNS"	13	"STRMADMIN"."SOURCE_HNS"=>"STRMADMIN"."DESTINATION_SPOKE1"@HUB.EXAMPLE.COM	2
1	13	"STRMADMIN"."SOURCE_HNS"=>"STRMADMIN"."DESTINATION_SPOKE1"@HUB.EXAMPLE.COM	6	"STRMADMIN"."SOURCE_HNS"@SPOKE1.EXAMPLE.COM=>"STRMADMIN"."DESTINATION_SPOKE1"	3
1	6	"STRMADMIN"."SOURCE_HNS"@SPOKE1.EXAMPLE.COM=>"STRMADMIN"."DESTINATION_SPOKE1"	1	"STRMADMIN"."DESTINATION_SPOKE1"	4
1	1	"STRMADMIN"."DESTINATION_SPOKE1"	8	APPLY_SPOKE1	5
2	22	CAPTURE_HNS	18	"STRMADMIN"."SOURCE_HNS"	1
2	18	"STRMADMIN"."SOURCE_HNS"	19	"STRMADMIN"."SOURCE_HNS"=>"STRMADMIN"."DESTINATION_SPOKE2"@HUB.EXAMPLE.COM	2
2	19	"STRMADMIN"."SOURCE_HNS"=>"STRMADMIN"."DESTINATION_SPOKE2"@HUB.EXAMPLE.COM	7	"STRMADMIN"."SOURCE_HNS"@SPOKE2.EXAMPLE.COM=>"STRMADMIN"."DESTINATION_SPOKE2"	3

2	7	"STRMADMIN"."SOURCE_HNS"@SPOKE2.EXAMPLE.COM=>"STRMADMIN"."DESTINATION_SPOKE2"	2	"STRMADMIN"."DESTINATION_SPOKE2"	4
2	2	"STRMADMIN"."DESTINATION_SPOKE2"	9	APPLY_SPOKE2	5
3	10	CAPTURE_HNS	3	"STRMADMIN"."SOURCE_HNS"	1
3	3	"STRMADMIN"."SOURCE_HNS"	4	"STRMADMIN"."SOURCE_HNS"=>"STRMADMIN"."DESTINATION_SPOKE1"@SPOKE1.EXAMPLE.COM	2
3	4	"STRMADMIN"."SOURCE_HNS"=>"STRMADMIN"."DESTINATION_SPOKE1"@SPOKE1.EXAMPLE.COM	14	"STRMADMIN"."SOURCE_HNS"@HUB.NET=>"STRMADMIN"."DESTINATION_SPOKE1"	3
3	14	"STRMADMIN"."SOURCE_HNS"@HUB.EXAMPLE.COM=>"STRMADMIN"."DESTINATION_SPOKE1"	11	"STRMADMIN"."DESTINATION_SPOKE1"	4
3	11	"STRMADMIN"."DESTINATION_SPOKE1"	15	APPLY_SPOKE1	5
4	10	CAPTURE_HNS	3	"STRMADMIN"."SOURCE_HNS"	1
4	3	"STRMADMIN"."SOURCE_HNS"	5	"STRMADMIN"."SOURCE_HNS"=>"STRMADMIN"."DESTINATION_SPOKE2"@SPOKE2.EXAMPLE.COM	2
4	5	"STRMADMIN"."SOURCE_HNS"=>"STRMADMIN"."DESTINATION_SPOKE2"@SPOKE2.EXAMPLE.COM	20	"STRMADMIN"."SOURCE_HNS"@HUB.NET=>"STRMADMIN"."DESTINATION_SPOKE2"	3
4	20	"STRMADMIN"."SOURCE_HNS"@HUB.EXAMPLE.COM=>"STRMADMIN"."DESTINATION_SPOKE2"	17	"STRMADMIN"."DESTINATION_SPOKE2"	4
4	17	"STRMADMIN"."DESTINATION_SPOKE2"	21	APPLY_SPOKE2	5

See Also:

- ["About Stream Paths in an Oracle Streams Topology"](#) on page 22-4
- ["Viewing Statistics for the Stream Paths in an Oracle Streams Environment"](#) on page 22-32

Viewing Performance Statistics for Oracle Streams Components

The DBMS_STREAMS_ADVISOR_ADM package and the Oracle Streams topology views comprise the Oracle Streams Performance Advisor. The Oracle Streams topology views enable you to display and analyze performance statistics for the Oracle Streams components in your environment.

To view performance statistics for Oracle Streams components, you must first gather information about the Oracle Streams environment using the `DBMS_STREAMS_ADV` package. See ["Gathering Information About the Oracle Streams Topology and Performance"](#) on page 22-9.

The following sections explain how to view performance statistics for Oracle Streams components:

- [Checking for Bottleneck Components in the Oracle Streams Topology](#)
- [Viewing Component-Level Statistics](#)
- [Viewing Session-Level Statistics](#)
- [Viewing Statistics for the Stream Paths in an Oracle Streams Environment](#)

Note: The performance of Oracle Streams components depends on several factors, including the computer equipment used in the environment and the speed of the network.

Checking for Bottleneck Components in the Oracle Streams Topology

A bottleneck component is the busiest component or the component with the least amount of idle time. You can view the following information about the bottleneck components in an Oracle Streams environment:

- The path ID of the path that includes the component.
- The component ID for each Oracle Streams component. The Oracle Streams topology assigns an ID number to each component and uses the number to track information about the component and about the stream path that flows through the component.
- The name of the Oracle Streams component. See ["Viewing the Oracle Streams Components at Each Database"](#) on page 22-13 for information about how components are named in the query output.
- The type of the Oracle Streams component. The following types are possible:
 - CAPTURE for **capture processes**
 - QUEUE for **queues**
 - PROPAGATION SENDER for **propagation senders**
 - PROPAGATION RECEIVER for propagation receivers
 - APPLY for **apply processes**
- The database that contains the component

Run the following query to check for bottleneck components in your Oracle Streams environment:

```
COLUMN PATH_ID HEADING 'Path ID' FORMAT 999
COLUMN COMPONENT_ID HEADING 'Component ID' FORMAT 999
COLUMN COMPONENT_NAME HEADING 'Name' FORMAT A20
COLUMN COMPONENT_TYPE HEADING 'Type' FORMAT A20
COLUMN COMPONENT_DB HEADING 'Database' FORMAT A15
```

```
SELECT PATH_ID,
       COMPONENT_ID,
       COMPONENT_NAME,
```

```

COMPONENT_TYPE,
COMPONENT_DB
FROM DBA_STREAMS_TP_PATH_BOTTLENECK
WHERE BOTTLENECK_IDENTIFIED='YES' AND
      ADVISOR_RUN_ID=2
ORDER BY PATH_ID, COMPONENT_ID;

```

This example uses 2 for the `ADVISOR_RUN_ID` in the `WHERE` clause. Substitute the advisor run ID for the advisor run you want to query. See ["Gathering Information About the Oracle Streams Topology and Performance"](#) on page 22-9 for information about determining the `ADVISOR_RUN_ID`.

The following output shows the bottleneck components for the components listed in ["Viewing the Oracle Streams Components at Each Database"](#) on page 22-13:

Path ID	Component ID	Name	Type	Database
1	6	"STRMADMIN"."SOURCE_HNS"@SPOKE1.EXAMPLE.COM=>"STRMADMIN"."DESTINATION_SPOKE1"	PROPAGATION RECEIVER	HUB.EXAMPLE.COM
3	10	CAPTURE_HNS	CAPTURE	HUB.EXAMPLE.COM
4	10	CAPTURE_HNS	CAPTURE	HUB.EXAMPLE.COM

If this query returns no results, then the Oracle Streams Performance Advisor did not identify any bottleneck components in your environment. However, if this query returns one or more bottleneck components, then check the status of these components. If they are disabled, then you can enable them. If the components are enabled, then you can examine the components to see if they can be modified to perform better.

In some cases, the Oracle Streams Performance Advisor cannot determine whether a component is a bottleneck component. To view these components, set `BOTTLENECK_IDENTIFIED` to 'NO' when you query the `DBA_STREAMS_TP_PATH_BOTTLENECK` view. The output for the `ADVISOR_RUN_REASON` column shows why the Oracle Streams Performance Advisor could not determine whether the component is a bottleneck component. The following reasons can be specified in the `ADVISOR_RUN_REASON` column output:

- `PRE-11.1 DATABASE EXISTS` means that the component is in a stream path that includes a database prior to Oracle Database 11g Release 1. Bottleneck analysis is not performed on these components.
- `DIAGNOSTIC PACK REQUIRED` means that the component is in a stream path that includes a database that does not have the Oracle Diagnostics Pack. Bottleneck analysis is not performed on these components.
- `NO BOTTLENECK IDENTIFIED` means that either no bottleneck was identified in a stream path or that there might be more than one bottleneck component in the stream path.

See Also:

- [Chapter 20, "Troubleshooting an Oracle Streams Environment"](#)
- *Oracle Streams Replication Administrator's Guide* for more information about troubleshooting Oracle Streams replication environments

Viewing Component-Level Statistics

You can view statistics for the Oracle Streams components in the Oracle Streams topology. The query in this section displays the following information for each component:

- The ID of the path to which the component belongs
- The name of the Oracle Streams component
- The type of the Oracle Streams component. The following types are possible:
 - CAPTURE for **capture processes**
 - QUEUE for **queues**
 - PROPAGATION SENDER for **propagation senders**
 - PROPAGATION RECEIVER for propagation receivers
 - APPLY for **apply processes**
- The statistic that was gathered for the component
- The value and unit of the statistic. For example, a LATENCY statistic shows a number for the value and SECONDS for the unit. A TRANSACTION APPLY RATE statistic shows a number for the value and TRANSACTIONS PER SECOND for the unit.

The ANALYZE_CURRENT_PERFORMANCE procedure in the DBMS_STREAMS_ADVISOR_ADM package gathers the statistics returned by the query in this section. Therefore, the statistics returned by the query were the current statistics when the procedure was run. The statistics are not updated automatically.

Table 22–3 describes each of the statistics that can be returned by the query in this section:

Table 22–3 Component-Level Statistics for Oracle Streams Components

Component Type	Statistic	Unit	Description
CAPTURE	CAPTURE RATE	MESSAGES PER SECOND	The average number of database changes in the redo log scanned by the capture process each second. A capture process captures and enqueues the scanned changes that satisfy its rule sets .
CAPTURE	ENQUEUE RATE	MESSAGES PER SECOND	The average number of logical change records (LCRs) enqueued by the capture process each second.
CAPTURE	LATENCY	SECONDS	The amount of time between when the last redo entry became available for the capture process and the time when the last redo entry scanned by the capture process was recorded in the redo log. The purpose of the statistic is to show the amount of time between when a change is recorded in the redo log is and when the redo record is scanned by the capture process. The capture process might or might not enqueue a scanned change. A capture process only enqueues a change if the change satisfies its rule sets.
PROPAGATION SENDER	SEND RATE	MESSAGES PER SECOND	The average number of messages sent each second by the propagation sender.

Table 22–3 (Cont.) Component-Level Statistics for Oracle Streams Components

Component Type	Statistic	Unit	Description
PROPAGATION SENDER	BANDWIDTH	BYTES PER SECOND	The average number of bytes sent each second by the propagation sender.
PROPAGATION SENDER	LATENCY	SECONDS	<p>The amount of time between when a message was created at the source database and when the message was sent to the destination queue by the propagation sender.</p> <p>The value shown is for a single message that was sent from the source queue to the destination queue by the propagation sender. This message was the last message sent by the propagation sender when the <code>ANALYZE_CURRENT_PERFORMANCE</code> procedure was run.</p> <p>Depending on the type of message sent by the propagation, message creation time is one of the following:</p> <ul style="list-style-type: none"> ■ For captured LCRs, the time when the redo entry for the database change was recorded ■ For persistent LCRs, the time when the LCR was constructed ■ For persistent user messages, the time when the message was enqueued
APPLY	MESSAGE APPLY RATE	MESSAGES PER SECOND	<p>The average number of messages applied by the apply process each second.</p> <p>A captured LCR or persistent LCR can be applied in one of the following ways:</p> <ul style="list-style-type: none"> ■ The apply process makes the change encapsulated in the LCR to a database object. ■ The apply process passes the LCR to an apply handler. ■ The apply process sends the LCR to the error queue. <p>A persistent user message can be applied in one of the following ways:</p> <ul style="list-style-type: none"> ■ The apply process sends the message to a message handler. ■ The apply process sends the message to the error queue.

Table 22–3 (Cont.) Component-Level Statistics for Oracle Streams Components

Component Type	Statistic	Unit	Description
APPLY	TRANSACTION APPLY RATE	TRANSACTIONS PER SECOND	<p>The average number of transactions applied by the apply process each second. Transactions typically include multiple messages.</p> <p>A transaction that includes captured LCRs or persistent LCRs can be applied in one of the following ways:</p> <ul style="list-style-type: none"> ■ The apply process makes all of the changes in the transaction and commits the transaction. ■ The apply process passes all of the LCRs in the transaction to an apply handler. ■ The apply process sends the transaction and all of the LCRs in the transaction to the error queue. <p>A transaction that includes persistent user messages can be applied in one of the following ways:</p> <ul style="list-style-type: none"> ■ The apply process passes all of the messages in the transaction to a message handler. ■ The apply process sends all of the messages in the transaction to the error queue.
APPLY	LATENCY	SECONDS	<p>The amount of time between when the message was created at a source database and when the message was applied by the apply process at the destination database.</p> <p>The value shown is for a single message that was applied by the apply process. This message was the last message applied by the apply process when the <code>ANALYZE_CURRENT_PERFORMANCE</code> procedure was run.</p> <p>Depending on the type of message applied, message creation time is one of the following:</p> <ul style="list-style-type: none"> ■ For captured LCRs, the time when the redo entry for the database change was recorded ■ For persistent LCRs, the time when the LCR was constructed ■ For user messages, the time when the message was enqueued
QUEUE	ENQUEUE RATE	MESSAGES PER SECOND	The average number of messages enqueued into the queue each second.
QUEUE	SPILL RATE	MESSAGES PER SECOND	The average number of messages that spilled from the buffered queue to the queue table each second.
QUEUE	CURRENT QUEUE SIZE	NUMBER OF MESSAGES	The number of messages in the queue when the <code>ANALYZE_CURRENT_PERFORMANCE</code> procedure was run.
CAPTURE, PROPAGATION SENDER, PROPAGATION RECEIVER, and APPLY	EVENT (Top wait event)	PERCENT	<p>The percentage of time that the Oracle Streams component spent waiting because of a wait event.</p> <p>The Oracle Streams Performance Advisor only gathers information about the top three events for each component.</p> <p>For example, a capture process might wait for a redo log file to become available.</p>

The following are general considerations for these performance statistics:

- Regarding rate, bandwidth, and event statistics, the time period is calculated as the time difference between the two snapshots used by the `ANALYZE_CURRENT_PERFORMANCE` procedure in the same user session. See ["About the Information Gathered With the Oracle Streams Performance Advisor"](#) on page 22-8 for information about the snapshots. When a user session ends, the rate, bandwidth, and event statistics are purged.
- When a latency statistic is -1 seconds, the `ANALYZE_CURRENT_PERFORMANCE` procedure could not gather statistics for the component when it was run. In most cases, this result indicates that the component was disabled when the procedure was run. For example, if the `LATENCY` statistic for an apply process is -1, then the apply process was probably disabled when the `ANALYZE_CURRENT_PERFORMANCE` procedure was run.

To display performance statistics for the components in an Oracle Streams topology, run the following query:

```

COLUMN PATH_ID HEADING 'Path|ID' FORMAT 999
COLUMN COMPONENT_ID HEADING 'Component|ID' FORMAT 999
COLUMN COMPONENT_NAME HEADING 'Name' FORMAT A20
COLUMN COMPONENT_TYPE HEADING 'Type' FORMAT A12
COLUMN STATISTIC_NAME HEADING 'Statistic' FORMAT A15
COLUMN STATISTIC_VALUE HEADING 'Value' FORMAT 9999999999.99
COLUMN STATISTIC_UNIT HEADING 'Unit' FORMAT A15

SELECT DISTINCT
    cp.PATH_ID,
    cs.COMPONENT_ID,
    cs.COMPONENT_NAME,
    cs.COMPONENT_TYPE,
    cs.STATISTIC_NAME,
    cs.STATISTIC_VALUE,
    cs.STATISTIC_UNIT
FROM DBA_STREAMS_TP_COMPONENT_STAT cs,
     (SELECT PATH_ID, SOURCE_COMPONENT_ID AS COMPONENT_ID
      FROM DBA_STREAMS_TP_COMPONENT_LINK
      UNION
      SELECT PATH_ID, DESTINATION_COMPONENT_ID AS COMPONENT_ID
      FROM DBA_STREAMS_TP_COMPONENT_LINK) cp
WHERE cs.ADVISOR_RUN_ID = 2 AND
      cs.SESSION_ID IS NULL AND
      cs.SESSION_SERIAL# IS NULL AND
      cs.COMPONENT_ID = cp.COMPONENT_ID
ORDER BY PATH_ID, COMPONENT_ID, COMPONENT_NAME, COMPONENT_TYPE, STATISTIC_NAME;
```

This example uses 2 for the `ADVISOR_RUN_ID` in the `WHERE` clause. Substitute the advisor run ID for the advisor run you want to query. See ["Gathering Information About the Oracle Streams Topology and Performance"](#) on page 22-9 for information about determining the `ADVISOR_RUN_ID`.

The following output shows a partial list of the performance statistics for the components listed in ["Viewing the Oracle Streams Components at Each Database"](#) on page 22-13. Specifically, the following output shows performance statistics for the components in stream path 1 and stream path 3:

Path	Component	ID	Name	Type	Statistic	Value	Unit
1	1	"STRMADMIN". "DESTINATION_SPOKE1"	QUEUE	CURRENT QUEUE SIZE	.00	NUMBER OF MESSAGES	
1	1	"STRMADMIN". "DESTINATION_SPOKE1"	QUEUE	ENQUEUE RATE	2573.21	MESSAGES PER SECOND	
1	1	"STRMADMIN". "DESTINATION_SPOKE1"	QUEUE	SPILL RATE	.00	MESSAGES PER SECOND	
1	6	"STRMADMIN". "SOURCE_HNS"@SPOKE1.EXAMPLE.COM=>"STRMADMIN". "DESTINATION_SPOKE1"	PROPAGATION RECEIVER	EVENT: CPU + Wait for CPU	32.55	PERCENT	
1	6	"STRMADMIN". "SOURCE_HNS"@SPOKE1.EXAMPLE.COM=>"STRMADMIN". "DESTINATION_SPOKE1"	PROPAGATION RECEIVER	EVENT: SQL*Net more data from client	23.62	PERCENT	
1	6	"STRMADMIN". "SOURCE_HNS"@SPOKE1.EXAMPLE.COM=>"STRMADMIN". "DESTINATION_SPOKE1"	PROPAGATION RECEIVER	EVENT: latch: row cache objects	2.10	PERCENT	
1	8	APPLY_SPOKE1	APPLY	EVENT: CPU + Wait for CPU	23.10	PERCENT	
1	8	APPLY_SPOKE1	APPLY	EVENT: latch: row cache objects	1.31	PERCENT	
1	8	APPLY_SPOKE1	APPLY	EVENT: latch: shared pool	1.57	PERCENT	
1	8	APPLY_SPOKE1	APPLY	LATENCY	2.13	SECONDS	
1	8	APPLY_SPOKE1	APPLY	MESSAGE APPLY RATE	10004.00	MESSAGES PER SECOND	
1	8	APPLY_SPOKE1	APPLY	TRANSACTION APPLY RATE	100.00	TRANSACTIONS PER SECOND	
1	12	"STRMADMIN". "SOURCE_HNS"	QUEUE	CURRENT QUEUE SIZE	.00	NUMBER OF MESSAGES	
1	12	"STRMADMIN". "SOURCE_HNS"	QUEUE	ENQUEUE RATE	9932.00	MESSAGES PER SECOND	
1	12	"STRMADMIN". "SOURCE_HNS"	QUEUE	SPILL RATE	.00	MESSAGES PER SECOND	
1	13	"STRMADMIN". "SOURCE_HNS"=>"STRMADMIN". "DESTINATION_SPOKE1"@HUB.EXAMPLE.COM	PROPAGATION SENDER	BANDWIDTH	32992.96	BYTES PER SECOND	
1	13	"STRMADMIN". "SOURCE_HNS"=>"STRMADMIN". "DESTINATION_SPOKE1"@HUB.EXAMPLE.COM	PROPAGATION SENDER	EVENT: CPU + Wait for CPU	35.96	PERCENT	
1	13	"STRMADMIN". "SOURCE_HNS"=>"STRMADMIN". "DESTINATION_SPOKE1"@HUB.EXAMPLE.COM	PROPAGATION SENDER	EVENT: SQL*Net message to dblink	.26	PERCENT	
1	13	"STRMADMIN". "SOURCE_HNS"=>"STRMADMIN". "DESTINATION_SPOKE1"@HUB.EXAMPLE.COM	PROPAGATION SENDER	EVENT: latch: row cache objects	.26	PERCENT	
1	13	"STRMADMIN". "SOURCE_HNS"=>"STRMADMIN". "DESTINATION_SPOKE1"@HUB.EXAMPLE.COM	PROPAGATION SENDER	LATENCY	4.00	SECONDS	

1	13	"STRMADMIN"."SOURCE_HNS"=>"STRMADMIN".D	PROPAGATION SENDER	SEND RATE	2568.00	MESSAGES PER SECOND
1	16	CAPTURE_HNS	CAPTURE	CAPTURE RATE	10464.00	MESSAGES PER SECOND
1	16	CAPTURE_HNS	CAPTURE	ENQUEUE RATE	10002.00	MESSAGES PER SECOND
1	16	CAPTURE_HNS	CAPTURE	EVENT: CPU + Wait for CPU	11.02	PERCENT
1	16	CAPTURE_HNS	CAPTURE	EVENT: CPU + Wait for CPU	35.96	PERCENT
1	16	CAPTURE_HNS	CAPTURE	EVENT: SQL*Net message from db link	5.51	PERCENT
1	16	CAPTURE_HNS	CAPTURE	LATENCY	2.65	SECONDS
.						
.						
.						
3	3	"STRMADMIN"."SOURCE_HNS"	QUEUE	CURRENT QUEUE SIZE	42580.00	NUMBER OF MESSAGES
3	3	"STRMADMIN"."SOURCE_HNS"	QUEUE	ENQUEUE RATE	2624.17	MESSAGES PER SECOND
3	3	"STRMADMIN"."SOURCE_HNS"	QUEUE	SPILL RATE	15.48	MESSAGES PER SECOND
3	4	"STRMADMIN"."SOURCE_HNS"=>"STRMADMIN".D	PROPAGATION SENDER	EVENT: CPU + Wait for CPU	17.65	PERCENT
3	4	"STRMADMIN"."SOURCE_HNS"=>"STRMADMIN".D	PROPAGATION SENDER	EVENT: latch free	.45	PERCENT
3	4	"STRMADMIN"."SOURCE_HNS"=>"STRMADMIN".D	PROPAGATION SENDER	EVENT: latch: row cache objects	4.90	PERCENT
3	4	"STRMADMIN"."SOURCE_HNS"=>"STRMADMIN".D	PROPAGATION SENDER	BANDWIDTH	30265.44	BYTES PER SECOND
3	4	"STRMADMIN"."SOURCE_HNS"=>"STRMADMIN".D	PROPAGATION SENDER	LATENCY	3.60	SECONDS
3	4	"STRMADMIN"."SOURCE_HNS"=>"STRMADMIN".D	PROPAGATION SENDER	SEND RATE	2572.00	MESSAGES PER SECOND
3	10	CAPTURE_HNS	CAPTURE	CAPTURE RATE	2595.29	MESSAGES PER SECOND
3	10	CAPTURE_HNS	CAPTURE	ENQUEUE RATE	2573.21	MESSAGES PER SECOND
3	10	CAPTURE_HNS	CAPTURE	EVENT: ARCH wait for archivelog lock	52.23	PERCENT
3	10	CAPTURE_HNS	CAPTURE	EVENT: CPU + Wait for CPU	7.35	PERCENT
3	10	CAPTURE_HNS	CAPTURE	EVENT: control file sequential	.52	PERCENT

3	10	CAPTURE_HNS	CAPTURE	read	LATENCY	3.65 SECONDS
3	11	"STRMADMIN"."DESTINATION_SPOKE1"	QUEUE	CURRENT QUEUE SIZE	CURRENT QUEUE SIZE	40779.00 NUMBER OF MESSAGES
3	11	"STRMADMIN"."DESTINATION_SPOKE1"	QUEUE	ENQUEUE RATE	ENQUEUE RATE	2573.21 MESSAGES PER SECOND
3	11	"STRMADMIN"."DESTINATION_SPOKE1"	QUEUE	SPILL RATE	SPILL RATE	.00 MESSAGES PER SECOND
3	14	"STRMADMIN"."SOURCE_HNS"@HUB.EXAMPLE.COM	PROPAGATION RECEIVER	EVENT: CPU + Wait for CPU	EVENT: CPU + Wait for CPU	6.92 PERCENT
3	14	"STRMADMIN"."SOURCE_HNS"@HUB.EXAMPLE.COM	PROPAGATION RECEIVER	EVENT: latch: row cache objects	EVENT: latch: row cache objects	2.23 PERCENT
3	14	"STRMADMIN"."SOURCE_HNS"@HUB.EXAMPLE.COM	PROPAGATION RECEIVER	EVENT: library cache: mutex X	EVENT: library cache: mutex X	3.79 PERCENT
3	15	APPLY_SPOKE1	APPLY	EVENT: latch: row cache objects	EVENT: latch: row cache objects	4.20 PERCENT
3	15	APPLY_SPOKE1	APPLY	EVENT: latch: shared pool	EVENT: latch: shared pool	.26 PERCENT
3	15	APPLY_SPOKE1	APPLY	EVENT: latch: shared pool	EVENT: latch: shared pool	.52 PERCENT
3	15	APPLY_SPOKE1	APPLY	LATENCY	LATENCY	3.64 SECONDS
3	15	APPLY_SPOKE1	APPLY	MESSAGE APPLY RATE	MESSAGE APPLY RATE	2580.05 MESSAGES PER SECOND
3	15	APPLY_SPOKE1	APPLY	TRANSACTION APPLY RATE	TRANSACTION APPLY RATE	25.68 TRANSACTIONS PER SECOND
.						
.						
.						

Note: This output is for illustrative purposes only. Actual performance characteristics vary depending on individual configurations and conditions.

You can analyze this output along with the output for the queries in ["Viewing the Oracle Streams Components at Each Database"](#) on page 22-13 and ["Viewing Each Stream Path in an Oracle Streams Topology"](#) on page 22-15.

For example, performance is better for components that are part of a combined capture and apply stream path than it is for components that are not. Compare the statistics for the `apply_spoke1` apply process at `hub.example.com` (component ID 8) with the statistics for the `apply_spoke1` apply process at `spoke1.example.com` (component ID 15).

The `apply_spoke1` apply process at `hub.example.com` is part of a combined capture and apply stream path. The `apply_spoke1` apply process at `spoke1.example.com` is not part of a combined capture and apply stream path.

The following statistics illustrate the performance differences between these apply processes:

- The LATENCY statistic for the apply_spoke1 apply process at hub.example.com (component ID 8) is 2.13 seconds. The LATENCY statistic for the apply_spoke1 apply process at spoke1.example.com (component ID 15) is 3.64 seconds.
- The MESSAGE APPLY RATE statistic for the apply_spoke1 apply process at hub.example.com is 10004.00 messages per second. The MESSAGE APPLY RATE statistic for the apply_spoke1 apply process at spoke1.example.com is 2580.05 messages per second.
- The TRANSACTION APPLY RATE statistic for the apply_spoke1 apply process at hub.example.com is 100.00 transactions per second. The TRANSACTION APPLY RATE statistic for the apply_spoke1 apply process at spoke1.example.com is 25.68 transactions per second.

See Also:

- ["About the Oracle Streams Topology"](#) on page 22-1
- ["Gathering Information About the Oracle Streams Topology and Performance"](#) on page 22-9 for information about running the ANALYZE_CURRENT_PERFORMANCE procedure to gather statistics
- ["Message Processing Options for an Apply Process"](#) on page 4-7 for information about apply handlers
- ["The Error Queue"](#) on page 4-21

Viewing Session-Level Statistics

You can view session-level statistics for the Oracle Streams components. The query in this section displays the following information for each session-level statistic:

- The name of the Oracle Streams component
- The type of the Oracle Streams component. The following types are possible:
 - CAPTURE for [capture processes](#)
 - PROPAGATION SENDER for [propagation senders](#)
 - PROPAGATION RECEIVER for propagation receivers
 - APPLY for [apply processes](#)
- The type of the subcomponent. Only capture processes and apply processes have subcomponents.

The following capture process subcomponent types are possible:

- LOGMINER READER for a builder server of a capture process
- LOGMINER PREPARER for a preparer server of a capture process
- LOGMINER BUILDER for a reader server of a capture process
- CAPTURE SESSION for a capture process session

The following apply process subcomponent types are possible:

- PROPAGATION SENDER+RECEIVER for sending LCRs from a capture process directly to an apply process in a combined capture and apply configuration
- APPLY READER for a reader server of an apply process
- APPLY COORDINATOR for a coordinator process of an apply process

- APPLY SERVER for a reader server of an apply process
- The statistic that was gathered for the component
- The value and unit of the statistic. Session-level statistics show PERCENT for the unit. The value is the percentage of time spent either IDLE, paused for FLOW CONTROL, or waiting for an EVENT.

The ANALYZE_CURRENT_PERFORMANCE procedure in the DBMS_STREAMS_ADVISOR_ADM package gathers the statistics returned by the query in this section. Therefore, the statistics returned by the query were the current statistics when the procedure was run. The statistics are not updated automatically.

Table 22–4 describes each of the statistics that can be returned by the query in this section:

Table 22–4 Session-Level Statistics for Oracle Streams Components

Statistic	Unit	Description
IDLE	PERCENT	The percentage of time that the session spent idle. When a session is idle, it is not performing any work.
FLOW CONTROL	PERCENT	The percentage of time that the session was paused for flow control. See "Capture Process States" on page 2-24 for information about flow control.
EVENT (Top wait event)	PERCENT	The percentage of time that the session spent waiting because of a wait event. The Oracle Streams Performance Advisor only gathers information about the top three events for each session. For example, an apply server might wait for a dependent transaction to be applied before applying its transaction.

Regarding flow control and event statistics, the time period is calculated as the time difference between the two snapshots used by the ANALYZE_CURRENT_PERFORMANCE procedure in the same user session. See ["About the Information Gathered With the Oracle Streams Performance Advisor"](#) on page 22-8 for information about the snapshots. When a user session ends, the flow control and event statistics are purged.

To display session-level performance statistics for the components in an Oracle Streams topology, run the following query:

```

COLUMN PATH_ID HEADING 'Path|ID' FORMAT 999
COLUMN COMPONENT_ID HEADING 'Component|ID' FORMAT 999
COLUMN COMPONENT_NAME HEADING 'Component|Name' FORMAT A20
COLUMN COMPONENT_TYPE HEADING 'Component|Type' FORMAT A10
COLUMN SUB_COMPONENT_TYPE HEADING 'Subcomponent|Type' FORMAT A17
COLUMN STATISTIC_NAME HEADING 'Statistic' FORMAT A15
COLUMN STATISTIC_VALUE HEADING 'Value' FORMAT 999.99
COLUMN STATISTIC_UNIT HEADING 'Unit' FORMAT A7

SELECT DISTINCT
    cp.PATH_ID,
    cs.COMPONENT_ID,
    cs.COMPONENT_NAME,
    cs.COMPONENT_TYPE,
    cs.SUB_COMPONENT_TYPE,
    cs.STATISTIC_NAME,
    cs.STATISTIC_VALUE,
    cs.STATISTIC_UNIT
FROM DBA_STREAMS_TP_COMPONENT_STAT cs,
     (SELECT PATH_ID, SOURCE_COMPONENT_ID AS COMPONENT_ID

```

```

FROM DBA_STREAMS_TP_COMPONENT_LINK
UNION
SELECT PATH_ID, DESTINATION_COMPONENT_ID AS COMPONENT_ID
FROM DBA_STREAMS_TP_COMPONENT_LINK) cp
WHERE cs.ADVISOR_RUN_ID=2 AND
      cs.SESSION_ID IS NOT NULL AND
      cs.SESSION_SERIAL# IS NOT NULL AND
      cs.COMPONENT_ID = cp.COMPONENT_ID
ORDER BY PATH_ID, COMPONENT_ID, COMPONENT_NAME, COMPONENT_TYPE, STATISTIC_NAME;

```

This example uses 2 for the ADVISOR_RUN_ID in the WHERE clause. Substitute the advisor run ID for the advisor run you want to query. See ["Gathering Information About the Oracle Streams Topology and Performance"](#) on page 22-9 for information about determining the ADVISOR_RUN_ID.

The following output shows a partial list of the session-level performance statistics for the components listed in ["Viewing the Oracle Streams Components at Each Database"](#) on page 22-13. Specifically, the following output shows session-level performance statistics for the components in stream path 1 and stream path 3:

Path ID	Component ID	Component Name	Component Type	Subcomponent Type	Statistic	Value	Unit
1	6	"STRMADMIN". "SOURCE_HNS"@SPOKE1.EXAMPLE.COM=>"STRMADMIN". "DESTINATION_SPOKE1"	PROPAGATION RECEIVER		EVENT: CPU + Wait for CPU	32.55	PERCENT
1	6	"STRMADMIN". "SOURCE_HNS"@SPOKE1.EXAMPLE.COM=>"STRMADMIN". "DESTINATION_SPOKE1"	PROPAGATION RECEIVER		EVENT: SQL*Net more data from client	23.62	PERCENT
1	6	"STRMADMIN". "SOURCE_HNS"@SPOKE1.EXAMPLE.COM=>"STRMADMIN". "DESTINATION_SPOKE1"	PROPAGATION RECEIVER		EVENT: latch: row cache objects	2.10	PERCENT
1	6	"STRMADMIN". "SOURCE_HNS"@SPOKE1.EXAMPLE.COM=>"STRMADMIN". "DESTINATION_SPOKE1"	PROPAGATION RECEIVER		FLOW CONTROL	.89	PERCENT
1	6	"STRMADMIN". "SOURCE_HNS"@SPOKE1.EXAMPLE.COM=>"STRMADMIN". "DESTINATION_SPOKE1"	PROPAGATION RECEIVER		IDLE	36.61	PERCENT
1	8	APPLY_SPOKE1	APPLY	APPLY READER	EVENT: CPU + Wait for CPU	.26	PERCENT
1	8	APPLY_SPOKE1	APPLY	APPLY SERVER	EVENT: CPU + Wait for CPU	23.10	PERCENT
1	8	APPLY_SPOKE1	APPLY	APPLY SERVER	EVENT: latch: row cache objects	1.31	PERCENT
1	8	APPLY_SPOKE1	APPLY	APPLY READER	EVENT: latch: shared pool	.26	PERCENT
1	8	APPLY_SPOKE1	APPLY	APPLY SERVER	EVENT: latch: shared pool	1.57	PERCENT
1	8	APPLY_SPOKE1	APPLY	APPLY COORDINATOR	FLOW CONTROL	.00	PERCENT
1	8	APPLY_SPOKE1	APPLY	APPLY READER	FLOW CONTROL	10.76	PERCENT
1	8	APPLY_SPOKE1	APPLY	APPLY SERVER	FLOW CONTROL	.00	PERCENT
1	8	APPLY_SPOKE1	APPLY	APPLY COORDINATOR	IDLE	6.21	PERCENT
1	8	APPLY_SPOKE1	APPLY	APPLY READER	IDLE	9.24	PERCENT
1	8	APPLY_SPOKE1	APPLY	APPLY SERVER	IDLE	8.53	PERCENT

1	13	"STRMADMIN". "SOURCE_	PROPAGATIO		EVENT: CPU + Wa	21.65 PERCENT
		HNS"=>"STRMADMIN". "D	N SENDER		it for CPU	
		ESTINATION_SPOKE1"@H				
		UB.EXAMPLE.COM				
1	13	"STRMADMIN". "SOURCE_	PROPAGATIO		EVENT: SQL*Net	.26 PERCENT
		HNS"=>"STRMADMIN". "D	N SENDER		message to dbli	
		ESTINATION_SPOKE1"@H			nk	
		UB.EXAMPLE.COM				
1	13	"STRMADMIN". "SOURCE_	PROPAGATIO		EVENT: latch: r	.26 PERCENT
		HNS"=>"STRMADMIN". "D	N SENDER		ow cache object	
		ESTINATION_SPOKE1"@H			s	
		UB.EXAMPLE.COM				
1	13	"STRMADMIN". "SOURCE_	PROPAGATIO		EVENT: latch: s	.26 PERCENT
		HNS"=>"STRMADMIN". "D	N SENDER		hared pool	
		ESTINATION_SPOKE1"@H				
		UB.EXAMPLE.COM				
1	13	"STRMADMIN". "SOURCE_	PROPAGATIO		FLOW CONTROL	7.37 PERCENT
		HNS"=>"STRMADMIN". "D	N SENDER			
		ESTINATION_SPOKE1"@H				
		UB.EXAMPLE.COM				
1	13	"STRMADMIN". "SOURCE_	PROPAGATIO		IDLE	67.41 PERCENT
		HNS"=>"STRMADMIN". "D	N SENDER			
		ESTINATION_SPOKE1"@H				
		UB.EXAMPLE.COM				
1	16	CAPTURE_HNS	CAPTURE	LOGMINER READER	EVENT: ARCH wai	.26 PERCENT
					t on c/f tx acq	
					uire 2	
1	16	CAPTURE_HNS	CAPTURE	CAPTURE SESSION	EVENT: CPU + Wa	35.96 PERCENT
					it for CPU	
1	16	CAPTURE_HNS	CAPTURE	LOGMINER BUILDER	EVENT: CPU + Wa	.26 PERCENT
					it for CPU	
1	16	CAPTURE_HNS	CAPTURE	LOGMINER PREPARER	EVENT: CPU + Wa	11.02 PERCENT
					it for CPU	
1	16	CAPTURE_HNS	CAPTURE	LOGMINER READER	EVENT: CPU + Wa	.26 PERCENT
					it for CPU	
1	16	CAPTURE_HNS	CAPTURE	CAPTURE SESSION	EVENT: SQL*Net	5.51 PERCENT
					message from db	
					link	
1	16	CAPTURE_HNS	CAPTURE	CAPTURE SESSION	EVENT: SQL*Net	.26 PERCENT
					message to dbli	
					nk	
1	16	CAPTURE_HNS	CAPTURE	CAPTURE SESSION	EVENT: latch: r	.26 PERCENT
					ow cache object	
					s	
1	16	CAPTURE_HNS	CAPTURE	LOGMINER BUILDER	EVENT: latch: r	1.84 PERCENT
					ow cache object	
					s	
1	16	CAPTURE_HNS	CAPTURE	LOGMINER PREPARER	EVENT: latch: r	.79 PERCENT
					ow cache object	
					s	
1	16	CAPTURE_HNS	CAPTURE	CAPTURE SESSION	EVENT: latch: s	.26 PERCENT
					hared pool	
1	16	CAPTURE_HNS	CAPTURE	LOGMINER READER	EVENT: latch: s	.79 PERCENT
					hared pool	
1	16	CAPTURE_HNS	CAPTURE	CAPTURE SESSION	FLOW CONTROL	16.27 PERCENT
1	16	CAPTURE_HNS	CAPTURE	LOGMINER BUILDER	FLOW CONTROL	.00 PERCENT
1	16	CAPTURE_HNS	CAPTURE	LOGMINER PREPARER	FLOW CONTROL	.00 PERCENT
1	16	CAPTURE_HNS	CAPTURE	LOGMINER READER	FLOW CONTROL	.00 PERCENT
1	16	CAPTURE_HNS	CAPTURE	CAPTURE SESSION	IDLE	41.47 PERCENT
1	16	CAPTURE_HNS	CAPTURE	LOGMINER BUILDER	IDLE	97.90 PERCENT

1	16	CAPTURE_HNS	CAPTURE	LOGMINER PREPARER	IDLE	88.19 PERCENT
1	16	CAPTURE_HNS	CAPTURE	LOGMINER READER	IDLE	98.69 PERCENT
.						
.						
.						
3	4	"STRMADMIN"."SOURCE_ HNS"=>"STRMADMIN"."D ESTINATION_SPOKE1"@SPOKE1.EXAMPLE.COM	PROPAGATIO N SENDER		FLOW CONTROL	6.50 PERCENT
3	4	"STRMADMIN"."SOURCE_ HNS"=>"STRMADMIN"."D ESTINATION_SPOKE1"@SPOKE1.EXAMPLE.COM	PROPAGATIO N SENDER		IDLE	70.50 PERCENT
3	10	CAPTURE_HNS	CAPTURE	CAPTURE SESSION	EVENT: ARCH wait for archivelog lock	52.23 PERCENT
3	10	CAPTURE_HNS	CAPTURE	CAPTURE SESSION	EVENT: CPU + Wait for CPU	7.35 PERCENT
3	10	CAPTURE_HNS	CAPTURE	CAPTURE SESSION	EVENT: control file sequential read	.52 PERCENT
3	10	CAPTURE_HNS	CAPTURE	CAPTURE SESSION	FLOW CONTROL	4.24 PERCENT
3	10	CAPTURE_HNS	CAPTURE	CAPTURE SESSION	IDLE	2.23 PERCENT
3	14	"STRMADMIN"."SOURCE_ HNS"@HUB.EXAMPLE.COM =>"STRMADMIN"."DESTINATION_SPOKE1"	PROPAGATIO N RECEIVER		EVENT: CPU + Wait for CPU	6.92 PERCENT
3	14	"STRMADMIN"."SOURCE_ HNS"@HUB.EXAMPLE.COM =>"STRMADMIN"."DESTINATION_SPOKE1"	PROPAGATIO N RECEIVER		EVENT: latch: row cache objects	2.23 PERCENT
3	14	"STRMADMIN"."SOURCE_ HNS"@HUB.EXAMPLE.COM =>"STRMADMIN"."DESTINATION_SPOKE1"	PROPAGATIO N RECEIVER		EVENT: library cache: mutex X	3.79 PERCENT
3	14	"STRMADMIN"."SOURCE_ HNS"@HUB.EXAMPLE.COM =>"STRMADMIN"."DESTINATION_SPOKE1"	PROPAGATIO N RECEIVER		FLOW CONTROL	.67 PERCENT
3	14	"STRMADMIN"."SOURCE_ HNS"@HUB.EXAMPLE.COM =>"STRMADMIN"."DESTINATION_SPOKE1"	PROPAGATIO N RECEIVER		IDLE	85.04 PERCENT
3	15	APPLY_SPOKE1	APPLY	APPLY COORDINATOR	EVENT: latch: row cache objects	4.20 PERCENT
3	15	APPLY_SPOKE1	APPLY	APPLY COORDINATOR	EVENT: latch: shared pool	.52 PERCENT
3	15	APPLY_SPOKE1	APPLY	APPLY READER	EVENT: latch: shared pool	.26 PERCENT
3	15	APPLY_SPOKE1	APPLY	APPLY COORDINATOR	FLOW CONTROL	.00 PERCENT
3	15	APPLY_SPOKE1	APPLY	APPLY READER	FLOW CONTROL	1.56 PERCENT
3	15	APPLY_SPOKE1	APPLY	APPLY SERVER	FLOW CONTROL	.00 PERCENT
3	15	APPLY_SPOKE1	APPLY	APPLY COORDINATOR	IDLE	87.28 PERCENT
3	15	APPLY_SPOKE1	APPLY	APPLY READER	IDLE	96.88 PERCENT
3	15	APPLY_SPOKE1	APPLY	APPLY SERVER	IDLE	91.29 PERCENT

Note:

- This output is for illustrative purposes only. Actual performance characteristics vary depending on individual configurations and conditions.
- You can view the session ID and serial number for each session by adding the `SESSION_ID` and `SESSION_SERIAL#` columns to the query on the `DBA_STREAMS_TP_COMPONENT_STAT` view.

See Also:

- ["Capture Process Components"](#) on page 2-22 for more information about capture process subcomponents
- ["Apply Process Components"](#) on page 4-16 for more information about apply process subcomponents
- ["Combined Capture and Apply Optimization"](#) on page 3-20

Viewing Statistics for the Stream Paths in an Oracle Streams Environment

The query in this section shows the following information for each stream path in the Oracle Streams topology:

- Whether optimization mode for Oracle Streams is used for the path. When the `OPTIMIZATION_MODE` statistic is greater than 0 (zero) for a path, the path uses the combined capture and apply optimization. When the `OPTIMIZATION_MODE` statistic is 0 (zero) for a path, the path does not use the combined capture and apply optimization.
- The `MESSAGE RATE` value is the average number of messages sent each second from the start of the path to the end of the path.
- The `TRANSACTION RATE` value is the average number of transactions sent each second from the start of the path to the end of the path.

The time period for these statistics is calculated as the time difference between the two snapshots used by the `ANALYZE_CURRENT_PERFORMANCE` procedure in the same user session. See ["About the Information Gathered With the Oracle Streams Performance Advisor"](#) on page 22-8 for information about the snapshots. When a user session ends, these statistics are purged.

To display this information, run the following query:

```
COLUMN PATH_ID HEADING 'Path ID' FORMAT 999
COLUMN STATISTIC_NAME HEADING 'Statistic' FORMAT A25
COLUMN STATISTIC_VALUE HEADING 'Value' FORMAT 99999999.99
COLUMN STATISTIC_UNIT HEADING 'Unit' FORMAT A25

SELECT PATH_ID,
       STATISTIC_NAME,
       STATISTIC_VALUE,
       STATISTIC_UNIT
FROM DBA_STREAMS_TP_PATH_STAT
WHERE ADVISOR_RUN_ID=2
ORDER BY PATH_ID, STATISTIC_NAME;
```

This example uses 2 for the `ADVISOR_RUN_ID` in the `WHERE` clause. Substitute the advisor run ID for the advisor run you want to query. See ["Gathering Information"](#)

["About the Oracle Streams Topology and Performance"](#) on page 22-9 for information about determining the ADVISOR_RUN_ID.

The following output shows the path statistics for the stream paths listed in ["Viewing Each Stream Path in an Oracle Streams Topology"](#) on page 22-15:

Path ID	Statistic	Value	Unit
1	OPTIMIZATION_MODE	1.00	NUMBER
1	MESSAGE RATE	10004.00	MESSAGES PER SECOND
1	TRANSACTION RATE	100.00	TRANSACTIONS PER SECOND
2	OPTIMIZATION_MODE	1.00	NUMBER
2	MESSAGE RATE	10028.25	MESSAGES PER SECOND
2	TRANSACTION RATE	100.37	TRANSACTIONS PER SECOND
3	OPTIMIZATION_MODE	.00	NUMBER
3	MESSAGE RATE	2623.20	MESSAGES PER SECOND
3	TRANSACTION RATE	26.10	TRANSACTIONS PER SECOND
4	OPTIMIZATION_MODE	.00	NUMBER
4	MESSAGE RATE	2580.05	MESSAGES PER SECOND
4	TRANSACTION RATE	25.68	TRANSACTIONS PER SECOND

Note: This output is for illustrative purposes only. Actual performance characteristics vary depending on individual configurations and conditions.

Stream paths 1 and 2 use combined capture and apply, while stream paths 3 and 4 do not. Notice that performance is better for the stream paths that use combined capture and apply.

See Also: ["About Stream Paths in an Oracle Streams Topology"](#) on page 22-4

Using the UTL_SPADV Package

The UTL_SPADV package provides subprograms to collect and analyze statistics for the Oracle Streams components in a distributed database environment. The package uses the Oracle Streams Performance Advisor to gather statistics.

The package includes the following procedures:

- The COLLECT_STATS procedure uses the Oracle Streams Performance Advisor to gather statistics about the Oracle Streams components and subcomponents in a distributed database environment.
- The SHOW_STATS procedure generates output that includes the statistics gathered by the COLLECT_STATS procedure. The output is formatted so that it can be imported into a spreadsheet easily and analyzed.

These procedures collect the same statistics as the Oracle Streams Performance Advisor. These statistics are described in [Table 22-3, "Component-Level Statistics for Oracle Streams Components"](#) on page 22-20 and [Table 22-4, "Session-Level Statistics for Oracle Streams Components"](#) on page 22-28.

To collect and show statistics using the UTL_SPADV package, complete the following steps:

1. Identify the database that you will use to gather the information. An administrative user at this database must meet the following requirements:
 - The user must have access to a database link to each database that contains Oracle Streams components.
 - The user must have been granted privileges using the `DBMS_STREAMS_AUTH.GRANT_ADMIN_PRIVILEGE` procedure, and each database link must connect to a user at the remote database that has been granted privileges using the `DBMS_STREAMS_AUTH.GRANT_ADMIN_PRIVILEGE` procedure.

If you configure an Oracle Streams administrator at each database with Oracle Streams components, then the Oracle Streams administrator has the necessary privileges. See ["Configuring an Oracle Streams Administrator"](#) on page 9-1 for instructions.

If no database in your environment meets these requirements, then choose a database, configure the necessary database links, and grant the necessary privileges to the users before proceeding.

2. In SQL*Plus, connect to the database you identified in Step 1 as a user that meets the requirements listed in Step 1.

For example, connect to the `hub.example.com` database as the Oracle Streams administrator.

See *Oracle Database Administrator's Guide* for information about connecting to a database in SQL*Plus.

3. Run the `utlspadv.sql` script in the `rdbms/admin` directory to load the UTL_SPADV package. For example:

```
@utlspadv.sql
```

4. Run the `COLLECT_STATS` procedure:

```
exec UTL_SPADV.COLLECT_STATS
```

5. Run the `SHOW_STATS` procedure:

```
SET SERVEROUTPUT ON SIZE 50000
exec UTL_SPADV.SHOW_STATS
```

Your output is similar to the following:

LEGEND

```
<statistics>= <capture> [ <queue> <psender> <preceiver> <queue> ] <apply> <bottleneck>
<capture>    = '|<C>' <name> <msgs captured/sec> <msgs enqueued/sec> <latency>
              'LMR' <idl%> <flwctrl%> <topevt%> <topevt>
              'LMP' (<parallelism>) <idl%> <flwctrl%> <topevt%> <topevt>
              'LMB' <idl%> <flwctrl%> <topevt%> <topevt>
              'CAP' <idl%> <flwctrl%> <topevt%> <topevt>
              'CAP+PS' <msgs sent/sec> <bytes sent/sec> <latency> <idl%> <flwctrl%> <topevt%>
<topevt%>
<apply>      = '|<A>' <name> <msgs applied/sec> <txns applied/sec> <latency>
              'PS+PR' <idl%> <flwctrl%> <topevt%> <topevt>
              'APR' <idl%> <flwctrl%> <topevt%> <topevt>
              'APC' <idl%> <flwctrl%> <topevt%> <topevt>
              'APS' (<parallelism>) <idl%> <flwctrl%> <topevt%> <topevt>
<queue>     = '|<Q>' <name> <msgs enqueued/sec> <msgs spilled/sec> <msgs in queue>
<psender>   = '|<PS>' <name> <msgs sent/sec> <bytes sent/sec> <latency> <idl%> <flwctrl%>
<topevt%> <topevt>
<preceiver> = '|<PR>' <name> <idl%> <flwctrl%> <topevt%> <topevt>
<bottleneck>= '|<B>' <name> <sub_name> <sessionid> <serial#> <topevt%> <topevt>
```

OUTPUT

```

PATH 1 RUN_ID 3 RUN_TIME 2008-MAR-20 10:52:22 CCA Y
|<C> CAPTURE_HNS=>HUB.EXAMPLE.COM 10267 10040 3 LMR 95% 0% 3.3% "" LMP (1) 86.7% 0% 11.7% ""
LMB 86.7% 0% 11.7% "" CAP+PS 10040 1.46E+06 3 16.7% 71.7% 11.7% ""
|<PR> SPOKE1.EXAMPLE.COM=> 98.5% 0% 0.6% "" |<Q> "STRMADMIN"."DESTINATION_SPOKE1" 25 0 0
|<A> APPLY_SPOKE1 10042 100 4 APR 93.3% 0% 6.7% "" APC 98.1% 0% 1.8% ""
APS (1) 953 272 76.7% "CPU + Wait for CPU" |<B> "NO BOTTLENECK IDENTIFIED"

PATH 1 RUN_ID 4 RUN_TIME 2008-MAR-20 10:53:32 CCA Y
|<C> CAPTURE_HNS=>HUB.EXAMPLE.COM 10464 10002 3 LMR 95% 0% 1.7% "" LMP (1) 83.3% 0% 16.7% ""
LMB 85% 0% 15% "" CAP+PS 10002 1.41E+06 2 62.9% 0% 35.7% "CPU + Wait for CPU"
|<PR> SPOKE1.EXAMPLE.COM=> 0% 83.3% 13.3% "" |<Q> "STRMADMIN"."DESTINATION_SPOKE1" 127 0 0
|<A> APPLY_SPOKE1 10004 100 3 APR 42.9% 57.1% 0% "" APC 90% 0% 10% ""
APS (1) 11.7% 0% 75% "CPU + Wait for CPU" |<B> APPLY_SPOKE1 APS 953 272 65.% "CPU + Wait for CPU"
.
.
.

```

Note: This output is for illustrative purposes only. Actual performance characteristics vary depending on individual configurations and conditions.

The following table describes the abbreviations used in the legend:

Abbreviation	Description
A	Apply process
APC	Coordinator process used by an apply process
APR	Reader server used by an apply process
APS	Apply server used by an apply process
B	Bottleneck
C or CAP	Capture process
CAP+PS	Capture process session and propagation sender in a combined capture and apply configuration
CCA	Combined capture and apply (Y indicates that it is used for the path; N indicates that it is not used for the path.)
flwctrl	Flow control
idl	Idle
LMB	Builder server used by a capture process (LogMiner builder)
LMP	Preparer server used by a capture process (LogMiner preparer)
LMR	Reader server used by a capture process (LogMiner reader)
msgs	Messages
preceiver or PR	Propagation receiver
psender or PS	Propagation sender
PS+PR	Propagation sender and propagation receiver in a combined capture and apply configuration
Q	Queue
serial#	Session serial number

Abbreviation	Description
sec	Second
sid	Session identifier
sub_name	Subcomponent name
topevt	Top event

Use the legend and the abbreviations to determine the statistics in the output. For example, the following output is for `capture_hns` capture process in path 1, run ID 4:

```
|<C> CAPTURE_HNS=>HUB.EXAMPLE.COM 10464 10002 3 LMR 95% 0% 1.7% "" LMP (1) 83.3% 0% 16.7% ""
LMB 85% 0% 15% "" CAP+PS 10002 1.41E+06 2 62.9% 0% 35.7% "CPU + Wait for CPU"
```

This output shows the following statistics:

- The capture process captured an average of 10464 database changes each second.
- The capture process enqueued an average of 10002 messages each second.
- The capture process latency was 3 seconds.
- The reader server (LMR) used by the capture process spent 95% of its time idle.
- The reader server used by the capture process spent 0% of its time in flow control mode.
- The reader server used by the capture process spent 1.7% of its time on the top wait event.
- The preparer server (LMP) parallelism was 1.
- The preparer server used by the capture process spent 83.3% of its time idle.
- The preparer server used by the capture process spent 0% of its time in flow control mode.
- The preparer server used by the capture process spent 16.7% of its time on the top wait event.
- The builder server (LMB) used by the capture process spent 85% of its time idle.
- The builder server used by the capture process spent 0% of its time in flow control mode.
- The builder server used by the capture process spent 15% of its time on the top wait event.
- The capture process session and propagation sender in a combined capture and apply configuration sent 10002 messages each second to the propagation receiver.
- The capture process session and propagation sender in a combined capture and apply configuration sent 1,410,000 bytes each second to the propagation receiver.
- The latency of the capture process session and propagation sender in a combined capture and apply configuration was 2 seconds.
- The capture process session and propagation sender in a combined capture and apply configuration spent 62.9% of its time idle.

- The capture process session and propagation sender in a combined capture and apply configuration spent 0% of its time in flow control mode.
- The capture process session and propagation sender in a combined capture and apply configuration spent 39.7% of its time on the top wait event. This wait event was CPU + Wait for CPU.

See Also: *Oracle Database PL/SQL Packages and Types Reference* for more information about the UTL_SPADV package

Monitoring Oracle Streams Implicit Capture

Both [capture processes](#) and [synchronous captures](#) perform [implicit capture](#).

The following topics describe monitoring Oracle Streams implicit capture:

- [Monitoring a Capture Process](#)
- [Monitoring a Synchronous Capture](#)
- [Viewing the Extra Attributes Captured by Implicit Capture](#)

Note: The Oracle Streams tool in the Oracle Enterprise Manager Console is also an excellent way to monitor an Oracle Streams environment. See *Oracle Database 2 Day + Data Replication and Integration Guide* and the online Help for the Oracle Streams tool for more information.

See Also:

- [Chapter 2, "Oracle Streams Information Capture"](#)
- [Chapter 14, "Managing Oracle Streams Implicit Capture"](#)
- ["Troubleshooting Capture Process Problems"](#) on page 20-3
- *Oracle Database Reference* for information about the data dictionary views described in this chapter
- *Oracle Streams Replication Administrator's Guide* for information about monitoring an Oracle Streams [replication](#) environment

Monitoring a Capture Process

This section provides sample queries that you can use to monitor Oracle Streams [capture processes](#).

This section contains these topics:

- [Displaying the Queue, Rule Sets, and Status of Each Capture Process](#)
- [Displaying Change Capture Information About Each Capture Process](#)
- [Displaying State Change and Message Creation Time for Each Capture Process](#)
- [Displaying Elapsed Time Performing Capture Operations for Each Capture Process](#)
- [Displaying Information About Each Downstream Capture Process](#)

- [Displaying the Registered Redo Log Files for Each Capture Process](#)
- [Displaying the Redo Log Files that Are Required by Each Capture Process](#)
- [Displaying SCN Values for Each Redo Log File Used by Each Capture Process](#)
- [Displaying the Last Archived Redo Entry Available to Each Capture Process](#)
- [Listing the Parameter Settings for Each Capture Process](#)
- [Determining the Applied SCN for All Capture Processes in a Database](#)
- [Determining Redo Log Scanning Latency for Each Capture Process](#)
- [Determining Message Enqueuing Latency for Each Capture Process](#)
- [Displaying Information About Rule Evaluations for Each Capture Process](#)
- [Determining Which Capture Processes Use Combined Capture and Apply](#)

Displaying the Queue, Rule Sets, and Status of Each Capture Process

You can display the following information about each **capture process** in a database by running the query in this section:

- The capture process name
- The name of the **queue** used by the capture process
- The name of the **positive rule set** used by the capture process
- The name of the **negative rule set** used by the capture process
- The status of the capture process, which can be ENABLED, DISABLED, or ABORTED

To display this general information about each capture process in a database, run the following query:

```
COLUMN CAPTURE_NAME HEADING 'Capture|Process|Name' FORMAT A15
COLUMN QUEUE_NAME HEADING 'Capture|Process|Queue' FORMAT A15
COLUMN RULE_SET_NAME HEADING 'Positive|Rule Set' FORMAT A15
COLUMN NEGATIVE_RULE_SET_NAME HEADING 'Negative|Rule Set' FORMAT A15
COLUMN STATUS HEADING 'Capture|Process|Status' FORMAT A15

SELECT CAPTURE_NAME, QUEUE_NAME, RULE_SET_NAME, NEGATIVE_RULE_SET_NAME, STATUS
       FROM DBA_CAPTURE;
```

Your output looks similar to the following:

Capture Process Name	Capture Process Queue	Positive Rule Set	Negative Rule Set	Capture Process Status
STRM01_CAPTURE	STREAMS_QUEUE	RULESET\$_25	RULESET\$_36	ENABLED

If the status of a capture process is ABORTED, then you can query the `ERROR_NUMBER` and `ERROR_MESSAGE` columns in the `DBA_CAPTURE` data dictionary view to determine the error.

See Also: ["Is the Capture Process Enabled?"](#) on page 20-4 for an example query that shows the error number and error message if a capture process is aborted

Displaying Change Capture Information About Each Capture Process

The query in this section displays the following information about each **capture process** in a database:

- The name of the capture process.
- The process number *CPnn*, where *nn* can include letters and numbers
- The session identifier.
- The serial number of the session.
- The current state of the capture process:
 - INITIALIZING
 - WAITING FOR DICTIONARY REDO
 - DICTIONARY INITIALIZATION
 - MINING
 - LOADING
 - CAPTURING CHANGES
 - WAITING FOR REDO
 - EVALUATING RULE
 - CREATING LCR
 - ENQUEUEING MESSAGE
 - PAUSED FOR FLOW CONTROL
 - SHUTTING DOWN
- The total number of redo entries passed by LogMiner to the capture process for detailed **rule** evaluation. A capture process converts a redo entry into a **message** and performs detailed rule evaluation on the message when capture process prefiltering cannot discard the change.
- The total number LCRs enqueued since the capture process was last started.

To display this information for each capture process in a database, run the following query:

```

COLUMN CAPTURE_NAME HEADING 'Capture|Name' FORMAT A7
COLUMN PROCESS_NAME HEADING 'Capture|Process|Number' FORMAT A7
COLUMN SID HEADING 'Session|ID' FORMAT 9999
COLUMN SERIAL# HEADING 'Session|Serial|Number' FORMAT 9999
COLUMN STATE HEADING 'State' FORMAT A20
COLUMN TOTAL_MESSAGES_CAPTURED HEADING 'Redo|Entries|Evaluated|In Detail' FORMAT
9999999
COLUMN TOTAL_MESSAGES_ENQUEUED HEADING 'Total|LCRs|Enqueued' FORMAT 9999999999

SELECT c.CAPTURE_NAME,
       SUBSTR(s.PROGRAM, INSTR(s.PROGRAM, '(')+1,4) PROCESS_NAME,
       c.SID,
       c.SERIAL#,
       c.STATE,
       c.TOTAL_MESSAGES_CAPTURED,
       c.TOTAL_MESSAGES_ENQUEUED
FROM V$STREAMS_CAPTURE c, V$SESSION s
WHERE c.SID = s.SID AND
      c.SERIAL# = s.SERIAL#;

```

Your output looks similar to the following:

Capture Name	Capture Process Number	Session ID	Session Serial Number	State	Redo	Total
					Entries Evaluated In Detail	LCRs Enqueued
CAPTURE _HNS	CP01	954	3	CAPTURING CHANGES	3719085	3389713

The number of redo entries scanned can be higher than the number of DML and DDL redo entries captured by a capture process. Only DML and DDL redo entries that satisfy the **rule sets** of a capture process are captured and enqueued into the capture process **queue**. Also, the total LCRs enqueued includes LCRs that contain transaction control statements. These row LCRs contain directives such as `COMMIT` and `ROLLBACK`. Therefore, the total LCRs enqueued is a number higher than the number of row changes and DDL changes enqueued by a capture process.

See Also:

- ["Row LCRs"](#) on page 2-4 for more information about transaction control statements
- ["Capture Process States"](#) on page 2-24

Displaying State Change and Message Creation Time for Each Capture Process

The query in this section displays the following information for each **capture process** in a database:

- The name of the capture process
- The current state of the capture process:
 - INITIALIZING
 - WAITING FOR DICTIONARY REDO
 - DICTIONARY INITIALIZATION
 - MINING
 - LOADING
 - CAPTURING CHANGES
 - WAITING FOR REDO
 - EVALUATING RULE
 - CREATING LCR
 - ENQUEUEING MESSAGE
 - PAUSED FOR FLOW CONTROL
 - SHUTTING DOWN
- The date and time when the capture process state last changed
- The date and time when the capture process last created an LCR

To display this information for each capture process in a database, run the following query:

```

COLUMN CAPTURE_NAME HEADING 'Capture|Name' FORMAT A15
COLUMN STATE HEADING 'State' FORMAT A27
COLUMN STATE_CHANGED HEADING 'State|Change Time'
COLUMN CREATE_MESSAGE HEADING 'Last Message|Create Time'

SELECT CAPTURE_NAME,
       STATE,
       TO_CHAR(STATE_CHANGED_TIME, 'HH24:MI:SS MM/DD/YY') STATE_CHANGED,
       TO_CHAR(CAPTURE_MESSAGE_CREATE_TIME, 'HH24:MI:SS MM/DD/YY') CREATE_MESSAGE
FROM V$STREAMS_CAPTURE;

```

Your output looks similar to the following:

Capture Name	State	State Change Time	Last Message Create Time
CAPTURE_SIMP	CAPTURING CHANGES	13:24:42 11/08/04	13:24:41 11/08/04

See Also: ["Capture Process States"](#) on page 2-24

Displaying Elapsed Time Performing Capture Operations for Each Capture Process

The query in this section displays the following information for each [capture process](#) in a database:

- The name of the capture process
- The elapsed capture time, which is the amount of time (in seconds) spent scanning for changes in the redo log since the capture process was last started
- The elapsed [rule](#) evaluation time, which is the amount of time (in seconds) spent evaluating rules since the capture process was last started
- The elapsed enqueue time, which is the amount of time (in seconds) spent enqueueing [messages](#) since the capture process was last started
- The elapsed LCR creation time, which is the amount of time (in seconds) spent creating logical change records (LCRs) since the capture process was last started
- The elapsed pause time, which is the amount of time (in seconds) spent paused for flow control since the capture process was last started

Note: All times for this query are displayed in seconds. The V\$STREAMS_CAPTURE view displays elapsed time in centiseconds by default. A centisecond is one-hundredth of a second. The query in this section divides each elapsed time by one hundred to display the elapsed time in seconds.

To display this information for each capture process in a database, run the following query:

```

COLUMN CAPTURE_NAME HEADING 'Capture|Name' FORMAT A15
COLUMN ELAPSED_CAPTURE_TIME HEADING 'Elapsed|Capture|Time' FORMAT 99999999.99
COLUMN ELAPSED_RULE_TIME HEADING 'Elapsed|Rule|Evaluation|Time' FORMAT 99999999.99
COLUMN ELAPSED_ENQUEUE_TIME HEADING 'Elapsed|Enqueue|Time' FORMAT 99999999.99
COLUMN ELAPSED_LCR_TIME HEADING 'Elapsed|LCR|Creation|Time' FORMAT 99999999.99
COLUMN ELAPSED_PAUSE_TIME HEADING 'Elapsed|Pause|Time' FORMAT 99999999.99

```

```

SELECT CAPTURE_NAME,
       (ELAPSED_CAPTURE_TIME/100) ELAPSED_CAPTURE_TIME,
       (ELAPSED_RULE_TIME/100) ELAPSED_RULE_TIME,
       (ELAPSED_ENQUEUE_TIME/100) ELAPSED_ENQUEUE_TIME,
       (ELAPSED_LCR_TIME/100) ELAPSED_LCR_TIME,
       (ELAPSED_PAUSE_TIME/100) ELAPSED_PAUSE_TIME
FROM V$STREAMS_CAPTURE;

```

Your output looks similar to the following:

Capture Name	Elapsed Capture Time	Elapsed Rule Evaluation Time	Elapsed Enqueue Time	Elapsed LCR Creation Time	Elapsed Pause Time
STM1\$CAP	1213.92	.04	33.84	185.25	600.60

Displaying Information About Each Downstream Capture Process

A downstream capture is a **capture process** that runs on a database other than the **source database**. You can display the following information about each **downstream capture process** in a database by running the query in this section:

- The capture process name
- The **source database** of the changes captured by the capture process
- The name of the **queue** used by the capture process
- The status of the capture process, which can be `ENABLED`, `DISABLED`, or `ABORTED`
- Whether the downstream capture process uses a database link to the source database for administrative actions

To display this information about each downstream capture process in a database, run the following query:

```

COLUMN CAPTURE_NAME HEADING 'Capture|Process|Name' FORMAT A15
COLUMN SOURCE_DATABASE HEADING 'Source|Database' FORMAT A15
COLUMN QUEUE_NAME HEADING 'Capture|Process|Queue' FORMAT A15
COLUMN STATUS HEADING 'Capture|Process|Status' FORMAT A15
COLUMN USE_DATABASE_LINK HEADING 'Uses|Database|Link?' FORMAT A8

SELECT CAPTURE_NAME,
       SOURCE_DATABASE,
       QUEUE_NAME,
       STATUS,
       USE_DATABASE_LINK
FROM DBA_CAPTURE
WHERE CAPTURE_TYPE = 'DOWNSTREAM';

```

Your output looks similar to the following:

Capture Process Name	Source Database	Capture Process Queue	Capture Process Status	Uses Database Link?
STRM03_CAPTURE	DBS1.EXAMPLE.COM	STRM03_QUEUE	ENABLED	YES

In this case, the source database for the capture process is `dbs1.example.com`, but the local database running the capture process is not `dbs1.example.com`. Also, the capture process returned by this query uses a database link to the source database to

perform administrative actions. The database link name is the same as the global name of the source database, which is `db1.example.com` in this case.

If the status of a capture process is `ABORTED`, then you can query the `ERROR_NUMBER` and `ERROR_MESSAGE` columns in the `DBA_CAPTURE` data dictionary view to determine the error.

Note: At the source database for an Oracle Streams downstream capture process, you can query the `V$ARCHIVE_DEST_STATUS` view to display information about the downstream database. The following columns in the view relate to the downstream database:

- The `TYPE` column shows `DOWNSTREAM` if redo log information is being shipped to a downstream capture database.
 - The `DESTINATION` column shows the name of the downstream capture database.
-

See Also:

- ["Local Capture and Downstream Capture"](#) on page 2-14
- ["Configuring an Archived-Log Downstream Capture Process that Assigns Logs Implicitly"](#) on page 10-16
- ["Is the Capture Process Enabled?"](#) on page 20-4 for an example query that shows the error number and error message if a capture process is aborted

Displaying the Registered Redo Log Files for Each Capture Process

You can display information about the archived redo log files that are registered for each [capture process](#) in a database by running the query in this section. This query displays information about these files for both [local capture processes](#) and [downstream capture processes](#).

The query displays the following information for each registered archived redo log file:

- The name of a capture process that uses the file
- The [source database](#) of the file
- The sequence number of the file
- The name and location of the file at the local site
- Whether the file contains the beginning of a data dictionary build
- Whether the file contains the end of a data dictionary build

To display this information about each registered archive redo log file in a database, run the following query:

```
COLUMN CONSUMER_NAME HEADING 'Capture|Process|Name' FORMAT A15
COLUMN SOURCE_DATABASE HEADING 'Source|Database' FORMAT A10
COLUMN SEQUENCE# HEADING 'Sequence|Number' FORMAT 99999
COLUMN NAME HEADING 'Archived Redo Log|File Name' FORMAT A20
COLUMN DICTIONARY_BEGIN HEADING 'Dictionary|Build|Begin' FORMAT A10
COLUMN DICTIONARY_END HEADING 'Dictionary|Build|End' FORMAT A10
```

```

SELECT r.CONSUMER_NAME,
       r.SOURCE_DATABASE,
       r.SEQUENCE#,
       r.NAME,
       r.DICTIONARY_BEGIN,
       r.DICTIONARY_END
FROM DBA_REGISTERED_ARCHIVED_LOG r, DBA_CAPTURE c
WHERE r.CONSUMER_NAME = c.CAPTURE_NAME;

```

Your output looks similar to the following:

Capture Process Name	Source Database	Sequence Number	Archived Redo Log File Name	Dictionary Build Begin	Dictionary Build End
STRM02_CAPTURE	DBS2.EXAMP LE.COM	15	/orc/dbs/log/arch2_1_15_478347508.arc	NO	NO
STRM02_CAPTURE	DBS2.EXAMP LE.COM	16	/orc/dbs/log/arch2_1_16_478347508.arc	NO	NO
STRM03_CAPTURE	DBS1.EXAMP LE.COM	45	/remote_logs/arch1_1_45_478347335.arc	YES	YES
STRM03_CAPTURE	DBS1.EXAMP LE.COM	46	/remote_logs/arch1_1_46_478347335.arc	NO	NO
STRM03_CAPTURE	DBS1.EXAMP LE.COM	47	/remote_logs/arch1_1_47_478347335.arc	NO	NO

Assume that this query was run at the `dbs2.example.com` database, and that `strm02_capture` is a **local capture process**, and `strm03_capture` is a **downstream capture process**. The **source database** for the `strm03_capture` downstream capture process is `dbs1.example.com`. This query shows that there are two registered archived redo log files for `strm02_capture` and three registered archived redo log files for `strm03_capture`. This query shows the name and location of each of these files in the local file system.

See Also:

- ["The LogMiner Data Dictionary for a Capture Process"](#) on page 2-30 for more information about data dictionary builds
- ["Local Capture and Downstream Capture"](#) on page 2-14
- ["Configuring an Archived-Log Downstream Capture Process that Assigns Logs Implicitly"](#) on page 10-16
- ["ARCHIVELOG Mode and a Capture Process"](#) on page 2-28

Displaying the Redo Log Files that Are Required by Each Capture Process

A **capture process** needs the redo log file that includes the **required checkpoint SCN**, and all subsequent redo log files. You can query the `REQUIRED_CHECKPOINT_SCN` column in the `DBA_CAPTURE` data dictionary view to determine the required checkpoint SCN for a capture process. Redo log files prior to the redo log file that contains the required checkpoint SCN are no longer needed by the capture process. These redo log files can be stored offline if they are no longer needed for any other purpose. If you reset the **start SCN** for a capture process to a lower value in the future, then these redo log files might be needed.

The query displays the following information for each required archived redo log file:

- The name of a capture process that uses the file
- The **source database** of the file

- The sequence number of the file
- The name and location of the required redo log file at the local site

To display this information about each required archive redo log file in a database, run the following query:

```

COLUMN CONSUMER_NAME HEADING 'Capture|Process|Name' FORMAT A15
COLUMN SOURCE_DATABASE HEADING 'Source|Database' FORMAT A10
COLUMN SEQUENCE# HEADING 'Sequence|Number' FORMAT 99999
COLUMN NAME HEADING 'Required|Archived Redo Log|File Name' FORMAT A40

SELECT r.CONSUMER_NAME,
       r.SOURCE_DATABASE,
       r.SEQUENCE#,
       r.NAME
FROM DBA_REGISTERED_ARCHIVED_LOG r, DBA_CAPTURE c
WHERE r.CONSUMER_NAME = c.CAPTURE_NAME AND
      r.NEXT_SCN      >= c.REQUIRED_CHECKPOINT_SCN;

```

Your output looks similar to the following:

Capture Process Name	Source Database	Sequence Number	Required Archived Redo Log File Name
STRM02_CAPTURE	DBS2.EXAMP LE.COM	16	/orc/dbs/log/arch2_1_16_478347508.arc
STRM03_CAPTURE	DBS1.EXAMP LE.COM	47	/remote_logs/arch1_1_47_478347335.arc

See Also: ["Required Checkpoint SCN"](#) on page 2-25

Displaying SCN Values for Each Redo Log File Used by Each Capture Process

You can display information about the SCN values for archived redo log files that are registered for each [capture process](#) in a database by running the query in this section. This query displays information the SCN values for these files for both [local capture processes](#) and [downstream capture processes](#). This query also identifies redo log files that are no longer needed by any capture process at the local database.

The query displays the following information for each registered archived redo log file:

- The capture process name of a capture process that uses the file
- The name and location of the file at the local site
- The lowest SCN value for the information contained in the redo log file
- The lowest SCN value for the next redo log file in the sequence
- Whether the redo log file is purgeable

To display this information about each registered archive redo log file in a database, run the following query:

```

COLUMN CONSUMER_NAME HEADING 'Capture|Process|Name' FORMAT A15
COLUMN NAME HEADING 'Archived Redo Log|File Name' FORMAT A25
COLUMN FIRST_SCN HEADING 'First SCN' FORMAT 99999999999
COLUMN NEXT_SCN HEADING 'Next SCN' FORMAT 99999999999
COLUMN PURGEABLE HEADING 'Purgeable?' FORMAT A10

```

```

SELECT r.CONSUMER_NAME,
       r.NAME,
       r.FIRST_SCN,
       r.NEXT_SCN,
       r.PURGEABLE
FROM DBA_REGISTERED_ARCHIVED_LOG r, DBA_CAPTURE c
WHERE r.CONSUMER_NAME = c.CAPTURE_NAME;

```

Your output looks similar to the following:

Capture Process Name	Archived Redo Log File Name	First SCN	Next SCN	Purgeable?
CAPTURE_SIMP	/private1/ARCHIVE_LOGS/1_3_502628294.dbf	509686	549100	YES
CAPTURE_SIMP	/private1/ARCHIVE_LOGS/1_4_502628294.dbf	549100	587296	YES
CAPTURE_SIMP	/private1/ARCHIVE_LOGS/1_5_502628294.dbf	587296	623107	NO

The redo log files with YES for Purgeable? for all capture processes will never be needed by any capture process at the local database. These redo log files can be removed without affecting any existing capture process at the local database. The redo log files with NO for Purgeable? for one or more capture processes must be retained.

See Also: ["ARCHIVELOG Mode and a Capture Process"](#) on page 2-28

Displaying the Last Archived Redo Entry Available to Each Capture Process

For a **local capture process**, the last archived redo entry available is the last entry from the online redo log flushed to an archived log file. For a **downstream capture process**, the last archived redo entry available is the redo entry with the most recent SCN in the last archived log file added to the LogMiner session used by the capture process.

You can display the following information about the last redo entry that was made available to each capture process by running the query in this section:

- The name of the capture process
- The identification number of the LogMiner session used by the capture process
- The SCN of the last redo entry available for the capture process
- The time when the last redo entry became available for the capture process

The information displayed by this query is valid only for an enabled capture process.

Run the following query to display this information for each capture process:

```

COLUMN CAPTURE_NAME HEADING 'Capture|Name' FORMAT A20
COLUMN LOGMINER_ID HEADING 'LogMiner ID' FORMAT 9999
COLUMN AVAILABLE_MESSAGE_NUMBER HEADING 'Last Redo SCN' FORMAT 9999999999
COLUMN AVAILABLE_MESSAGE_CREATE_TIME HEADING 'Time of|Last Redo SCN'

SELECT CAPTURE_NAME,
       LOGMINER_ID,
       AVAILABLE_MESSAGE_NUMBER,

```



```

        TO_CHAR(AVAILABLE_MESSAGE_CREATE_TIME, 'HH24:MI:SS MM/DD/YY')
        AVAILABLE_MESSAGE_CREATE_TIME
FROM V$STREAMS_CAPTURE;

```

Your output looks similar to the following:

Capture Name	LogMiner ID	Last Redo SCN	Time of Last Redo	SCN
----- STREAMS_CAPTURE	1	322953	11:33:20	10/16/03

Listing the Parameter Settings for Each Capture Process

The following query displays the current setting for each [capture process](#) parameter for each capture process in a database:

```

COLUMN CAPTURE_NAME HEADING 'Capture|Process|Name' FORMAT A25
COLUMN PARAMETER HEADING 'Parameter' FORMAT A26
COLUMN VALUE HEADING 'Value' FORMAT A10
COLUMN SET_BY_USER HEADING 'Set by User?' FORMAT A15

SELECT CAPTURE_NAME,
       PARAMETER,
       VALUE,
       SET_BY_USER
FROM DBA_CAPTURE_PARAMETERS;

```

Your output looks similar to the following:

Capture Process Name	Parameter	Value	Set by User?
----- CAPTURE_HNS	DISABLE_ON_LIMIT	N	NO
CAPTURE_HNS	DOWNSTREAM_REAL_TIME_MINE	Y	YES
CAPTURE_HNS	MAXIMUM_SCN	INFINITE	NO
CAPTURE_HNS	MESSAGE_LIMIT	INFINITE	NO
CAPTURE_HNS	MESSAGE_TRACKING_FREQUENCY	2000000	NO
CAPTURE_HNS	PARALLELISM	1	NO
CAPTURE_HNS	STARTUP_SECONDS	0	NO
CAPTURE_HNS	TIME_LIMIT	INFINITE	NO
CAPTURE_HNS	TRACE_LEVEL	0	NO
CAPTURE_HNS	WRITE_ALERT_LOG	Y	NO

Note: If the Set by User? column is NO for a parameter, then the parameter is set to its default value. If the Set by User? column is YES for a parameter, then the parameter might or might not be set to its default value.

See Also:

- ["Capture Process Components"](#) on page 2-22
- ["Setting a Capture Process Parameter"](#) on page 14-6

Determining the Applied SCN for All Capture Processes in a Database

The applied system change number (SCN) for a **capture process** is the SCN of the most recent **message** dequeued by the relevant **apply processes**. All changes below this **applied SCN** have been dequeued by all apply processes that apply changes captured by the capture process.

To display the applied SCN for all of the capture processes in a database, run the following query:

```
COLUMN CAPTURE_NAME HEADING 'Capture Process Name' FORMAT A30
COLUMN APPLIED_SCN HEADING 'Applied SCN' FORMAT 9999999999

SELECT CAPTURE_NAME, APPLIED_SCN FROM DBA_CAPTURE;
```

Your output looks similar to the following:

```
Capture Process Name          Applied SCN
-----
CAPTURE_EMP                    177154
```

Determining Redo Log Scanning Latency for Each Capture Process

You can find the following information about each **capture process** by running the query in this section:

- The redo log scanning latency, which specifies the number of seconds between the creation time of the most recent redo log entry scanned by a capture process and the current time. This number might be relatively large immediately after you start a capture process.
- The seconds since last recorded status, which is the number of seconds since a capture process last recorded its status.
- The current capture process time, which is the latest time when the capture process recorded its status.
- The **message** creation time, which is the time when the data manipulation language (DML) or data definition language (DDL) change generated the redo data for the most recently **captured LCR**.

The information displayed by this query is valid only for an enabled capture process.

Run the following query to determine the redo scanning latency for each capture process:

```
COLUMN CAPTURE_NAME HEADING 'Capture|Process|Name' FORMAT A10
COLUMN LATENCY_SECONDS HEADING 'Latency|in|Seconds' FORMAT 999999
COLUMN LAST_STATUS HEADING 'Seconds Since|Last Status' FORMAT 999999
COLUMN CAPTURE_TIME HEADING 'Current|Process|Time'
COLUMN CREATE_TIME HEADING 'Message|Creation Time' FORMAT 999999

SELECT CAPTURE_NAME,
       ((SYSDATE - CAPTURE_MESSAGE_CREATE_TIME)*86400) LATENCY_SECONDS,
       ((SYSDATE - CAPTURE_TIME)*86400) LAST_STATUS,
       TO_CHAR(CAPTURE_TIME, 'HH24:MI:SS MM/DD/YY') CAPTURE_TIME,
       TO_CHAR(CAPTURE_MESSAGE_CREATE_TIME, 'HH24:MI:SS MM/DD/YY') CREATE_TIME
FROM V$STREAMS_CAPTURE;
```

Your output looks similar to the following:

Capture Process Name	Latency in Seconds	Current Process Last Status Time	Message Creation Time
CAPTURE	4	4 12:04:13 03/01/02	12:04:13 03/01/02

The "Latency in Seconds" returned by this query is the difference between the current time (SYSDATE) and the "Message Creation Time." The "Seconds Since Last Status" returned by this query is the difference between the current time (SYSDATE) and the "Current Process Time."

Determining Message Enqueuing Latency for Each Capture Process

You can find the following information about each [capture process](#) by running the query in this section:

- The [message](#) enqueuing latency, which specifies the number of seconds between when an entry was recorded in the redo log and when the message was enqueued by the capture process
- The message creation time, which is the time when the data manipulation language (DML) or data definition language (DDL) change generated the redo data for the most recently enqueued message
- The enqueue time, which is when the capture process enqueued the message into its [queue](#)
- The message number of the enqueued message

The information displayed by this query is valid only for an enabled capture process.

Run the following query to determine the message capturing latency for each capture process:

```

COLUMN CAPTURE_NAME HEADING 'Capture|Process|Name' FORMAT A10
COLUMN LATENCY_SECONDS HEADING 'Latency|in|Seconds' FORMAT 999999
COLUMN CREATE_TIME HEADING 'Message Creation|Time' FORMAT A20
COLUMN ENQUEUE_TIME HEADING 'Enqueue Time' FORMAT A20
COLUMN ENQUEUE_MESSAGE_NUMBER HEADING 'Message|Number' FORMAT 9999999999

SELECT CAPTURE_NAME,
       (ENQUEUE_TIME-ENQUEUE_MESSAGE_CREATE_TIME)*86400 LATENCY_SECONDS,
       TO_CHAR(ENQUEUE_MESSAGE_CREATE_TIME, 'HH24:MI:SS MM/DD/YY') CREATE_TIME,
       TO_CHAR(ENQUEUE_TIME, 'HH24:MI:SS MM/DD/YY') ENQUEUE_TIME,
       ENQUEUE_MESSAGE_NUMBER
FROM V$STREAMS_CAPTURE;

```

Your output looks similar to the following:

Capture Process Name	Latency in Seconds	Message Creation Time	Enqueue Time	Message Number
CAPTURE	0	10:56:51 03/01/02	10:56:51 03/01/02	253962

The "Latency in Seconds" returned by this query is the difference between the "Enqueue Time" and the "Message Creation Time."

Displaying Information About Rule Evaluations for Each Capture Process

You can display the following information about **rule** evaluation for each **capture process** by running the query in this section:

- The name of the capture process.
- The number of changes discarded during prefiltering since the capture process was last started. The capture process determined that these changes definitely did not satisfy the capture process **rule sets** during prefiltering.
- The number of changes kept during prefiltering since the capture process was last started. The capture process determined that these changes definitely satisfied the capture process rule sets during prefiltering. Such changes are converted into LCRs and enqueued into the capture process **queue**.
- The total number of prefilter evaluations since the capture process was last started.
- The number of undecided changes after prefiltering since the capture process was last started. These changes might or might not satisfy the capture process rule sets. Some of these changes might be filtered out after prefiltering without requiring full evaluation. Other changes require full evaluation to determine whether they satisfy the capture process rule sets.
- The number of full evaluations since the capture process was last started. Full evaluations can be expensive. Therefore, capture process performance is best when this number is relatively low.

The information displayed by this query is valid only for an enabled capture process.

Run the following query to display this information for each capture process:

```
COLUMN CAPTURE_NAME HEADING 'Capture|Name' FORMAT A15
COLUMN TOTAL_PREFILTER_DISCARDED HEADING 'Prefilter|Changes|Discarded'
      FORMAT 9999999999
COLUMN TOTAL_PREFILTER_KEPT HEADING 'Prefilter|Changes|Kept' FORMAT 9999999999
COLUMN TOTAL_PREFILTER_EVALUATIONS HEADING 'Prefilter|Evaluations'
      FORMAT 9999999999
COLUMN UNDECIDED HEADING 'Undecided|After|Prefilter' FORMAT 9999999999
COLUMN TOTAL_FULL_EVALUATIONS HEADING 'Full|Evaluations' FORMAT 9999999999

SELECT CAPTURE_NAME,
       TOTAL_PREFILTER_DISCARDED,
       TOTAL_PREFILTER_KEPT,
       TOTAL_PREFILTER_EVALUATIONS,
       (TOTAL_PREFILTER_EVALUATIONS -
        (TOTAL_PREFILTER_KEPT + TOTAL_PREFILTER_DISCARDED)) UNDECIDED,
       TOTAL_FULL_EVALUATIONS
FROM V$STREAMS_CAPTURE;
```

Your output looks similar to the following:

Capture Name	Prefilter Changes Discarded	Prefilter Changes Kept	Prefilter Evaluations	Undecided After Prefilter Evaluations	Full Evaluations
CAPTURE_HNS	927409	3271491	4198900	0	9

The total number of prefilter evaluations equals the sum of the prefilter changes discarded, the prefilter changes kept, and the undecided changes.

See Also: ["Capture Process Rule Evaluation"](#) on page 2-36

Determining Which Capture Processes Use Combined Capture and Apply

A combined capture and apply environment is efficient because the [capture process](#) acts as the propagation sender, and the [buffered queue](#) is optimized to make replication of changes more efficient.

When a capture process uses combined capture and apply, the OPTIMIZATION column the V\$STREAMS_CAPTURE data dictionary view is greater than zero. When a capture process does not use combined capture and apply, the OPTIMIZATION column is 0 (zero).

To determine whether a capture process uses combined capture and apply, run the following query:

```
COLUMN CAPTURE_NAME HEADING 'Capture Name' FORMAT A30
COLUMN OPTIMIZATION HEADING 'Optimized?' FORMAT A10

SELECT CAPTURE_NAME,
       DECODE(OPTIMIZATION,
              0, 'No',
              'Yes') OPTIMIZATION
FROM V$STREAMS_CAPTURE;
```

Your output looks similar to the following:

Capture Name	Optimized?
-----	-----
CAPTURE_HNS	Yes

This output indicates that the `capture_hns` capture process uses combined capture and apply.

See Also: ["Combined Capture and Apply Optimization"](#) on page 3-20

Monitoring a Synchronous Capture

This section provides sample queries that you can use to monitor Oracle Streams [synchronous captures](#).

This section contains these topics:

- [Displaying the Queue and Rule Set of Each Synchronous Capture](#)
- [Displaying the Tables For Which Synchronous Capture Captures Changes](#)

See Also:

- ["Implicit Capture with Synchronous Capture"](#) on page 2-38
- ["Configuring Synchronous Capture"](#) on page 10-23
- ["Managing a Synchronous Capture"](#) on page 14-11
- *Oracle Database 2 Day + Data Replication and Integration Guide* for an example that configures a replication environment that uses synchronous capture

Displaying the Queue and Rule Set of Each Synchronous Capture

You can display the following information about each **synchronous capture** in a database by running the query in this section:

- The synchronous capture name
- The name of the **queue** used by the synchronous capture
- The name of the **positive rule set** used by the synchronous capture
- The **capture user** for the synchronous capture

To display this general information about each synchronous capture in a database, run the following query:

```
COLUMN CAPTURE_NAME HEADING 'Synchronous|Capture Name' FORMAT A20
COLUMN QUEUE_NAME HEADING 'Synchronous|Capture Queue' FORMAT A20
COLUMN RULE_SET_NAME HEADING 'Positive Rule Set' FORMAT A20
COLUMN CAPTURE_USER HEADING 'Capture User' FORMAT A15

SELECT CAPTURE_NAME, QUEUE_NAME, RULE_SET_NAME, CAPTURE_USER
       FROM DBA_SYNC_CAPTURE;
```

Your output looks similar to the following:

Synchronous Capture Name	Synchronous Capture Queue	Positive Rule Set	Capture User
SYNC01_CAPTURE	STRM01_QUEUE	RULESET\$ _21	STRMADMIN
SYNC02_CAPTURE	STRM02_QUEUE	SYNC02_RULE_SET	HR

Displaying the Tables For Which Synchronous Capture Captures Changes

The `DBA_SYNC_CAPTURE_TABLES` view displays the tables whose DML changes are captured by any synchronous capture in the local database. The `DBA_STREAMS_TABLE_RULES` view has information about each synchronous capture name and the rules used by each synchronous capture. You can display the following information by running the query in this section:

- The name of each synchronous capture
- The name of each **rule** used by the synchronous capture
- If the rule is a **subset rule**, then the type of subsetting operation covered by the rule
- The owner of each table specified in each rule
- The name of each table specified in each rule
- Whether synchronous capture is enabled or disabled for the table. If the synchronous capture is enabled for a table, then it captures DML changes made to the table. If synchronous capture is not enabled for a table, then it does not capture DML changes made to the table.

To display this information, run the following query:

```
COLUMN STREAMS_NAME HEADING 'Synchronous|Capture Name' FORMAT A15
COLUMN RULE_NAME HEADING 'Rule Name' FORMAT A15
COLUMN SUBSETTING_OPERATION HEADING 'Subsetting|Operation' FORMAT A10
COLUMN TABLE_OWNER HEADING 'Table|Owner' FORMAT A10
COLUMN TABLE_NAME HEADING 'Table Name' FORMAT A15
COLUMN ENABLED HEADING 'Enabled?' FORMAT A8
```

```

SELECT r.STREAMS_NAME,
       r.RULE_NAME,
       r.SUBSETTING_OPERATION,
       t.TABLE_OWNER,
       t.TABLE_NAME,
       t.ENABLED
FROM DBA_STREAMS_TABLE_RULES r,
     DBA_SYNC_CAPTURE_TABLES t
WHERE r.STREAMS_TYPE = 'SYNC_CAPTURE' AND
      r.TABLE_OWNER = t.TABLE_OWNER AND
      r.TABLE_NAME = t.TABLE_NAME;

```

Your output looks similar to the following:

Synchronous Capture Name	Rule Name	Subsetting Table Operation	Owner	Table Name	Enabled?
SYNC01_CAPTURE	EMPLOYEES20		HR	EMPLOYEES	YES
SYNC02_CAPTURE	DEPARTMENTS24	DELETE	HR	DEPARTMENTS	YES
SYNC02_CAPTURE	DEPARTMENTS23	UPDATE	HR	DEPARTMENTS	YES
SYNC02_CAPTURE	DEPARTMENTS22	INSERT	HR	DEPARTMENTS	YES

This output indicates that synchronous capture `sync01_capture` captures DML changes made to the `hr.employees` table. This output also indicates that synchronous capture `sync02_capture` captures a subset of the changes to the `hr.departments` table.

If the `ENABLED` column shows `NO` for a table, then synchronous capture does not capture changes to the table. The `ENABLED` column shows `NO` when a table rule is added to a synchronous capture rule set by a procedure other than `ADD_TABLE_RULES` or `ADD_SUBSET_RULES` in the `DBMS_STREAMS_ADM` package. For example, if the `ADD_RULE` procedure in the `DBMS_RULE_ADM` package adds a table rule to a synchronous capture rule set, then the table appears when you query the `DBA_SYNC_CAPTURE_TABLES` view, but synchronous capture does not capture DML changes to the table. No results appear in the `DBA_SYNC_CAPTURE_TABLES` view for schema and global rules.

Viewing the Extra Attributes Captured by Implicit Capture

You can use the `INCLUDE_EXTRA_ATTRIBUTE` procedure in the `DBMS_CAPTURE_ADM` package to instruct a **capture process** or **synchronous capture** to capture one or more extra attributes and include the extra attributes in LCRs. The following query displays the extra attributes included in the LCRs captured by each capture process and synchronous capture in the local database:

```

COLUMN CAPTURE_NAME HEADING 'Capture Process or|Synchronous Capture' FORMAT A20
COLUMN ATTRIBUTE_NAME HEADING 'Attribute Name' FORMAT A15
COLUMN INCLUDE HEADING 'Include Attribute in LCRs?' FORMAT A30

SELECT CAPTURE_NAME, ATTRIBUTE_NAME, INCLUDE
FROM DBA_CAPTURE_EXTRA_ATTRIBUTES
ORDER BY CAPTURE_NAME;

```

Your output looks similar to the following:

Capture Process or Synchronous Capture	Attribute Name	Include Attribute in LCRs?
SYNC_CAPTURE	ROW_ID	NO
SYNC_CAPTURE	SERIAL#	NO
SYNC_CAPTURE	SESSION#	NO
SYNC_CAPTURE	THREAD#	NO
SYNC_CAPTURE	TX_NAME	YES
SYNC_CAPTURE	USERNAME	NO

Based on this output, the capture process or synchronous capture named `sync_capture` includes the transaction name (`tx_name`) in the LCRs that it captures, but this capture process or synchronous capture does not include any other extra attributes in the LCRs that it captures. To determine whether name returned by the `CAPTURE_NAME` column is a capture process or a synchronous capture, query the `DBA_CAPTURE` and `DBA_SYNC_CAPTURE` views.

See Also:

- ["Extra Information in LCRs"](#) on page 2-6
- ["Managing Extra Attributes in Captured LCRs"](#) on page 14-15
- *Oracle Database PL/SQL Packages and Types Reference* for more information about the `INCLUDE_EXTRA_ATTRIBUTE` procedure

Monitoring Oracle Streams Queues and Propagations

The following topics describe monitoring Oracle Streams **queues** and **propagations**:

- [Monitoring Queues and Messaging](#)
- [Monitoring Buffered Queues](#)
- [Monitoring Oracle Streams Propagations and Propagation Jobs](#)

Note: The Oracle Streams tool in the Oracle Enterprise Manager Console is also an excellent way to monitor an Oracle Streams environment. See *Oracle Database 2 Day + Data Replication and Integration Guide* and the online Help for the Oracle Streams tool for more information.

See Also:

- [Chapter 3, "Oracle Streams Staging and Propagation"](#)
- [Chapter 15, "Managing Staging and Propagation"](#)
- *Oracle Database Reference* for information about the data dictionary views described in this chapter
- *Oracle Streams Replication Administrator's Guide* for information about monitoring an Oracle Streams **replication** environment

Monitoring Queues and Messaging

The following topics describe displaying information about **queues** and messaging:

- [Displaying the ANYDATA Queues in a Database](#)
- [Viewing the Messaging Clients in a Database](#)
- [Viewing Message Notifications](#)
- [Determining the Consumer of Each Message in a Persistent Queue](#)
- [Viewing the Contents of Messages in a Persistent Queue](#)

See Also:

- [Chapter 3, "Oracle Streams Staging and Propagation"](#)
- [Chapter 15, "Managing Staging and Propagation"](#)

Displaying the ANYDATA Queues in a Database

To display all of the ANYDATA queues in a database, run the following query:

```
COLUMN OWNER HEADING 'Owner' FORMAT A10
COLUMN NAME HEADING 'Queue Name' FORMAT A28
COLUMN QUEUE_TABLE HEADING 'Queue Table' FORMAT A22
COLUMN USER_COMMENT HEADING 'Comment' FORMAT A15

SELECT q.OWNER, q.NAME, t.QUEUE_TABLE, q.USER_COMMENT
       FROM DBA_QUEUES q, DBA_QUEUE_TABLES t
       WHERE t.OBJECT_TYPE = 'SYS.ANYDATA' AND
             q.QUEUE_TABLE = t.QUEUE_TABLE AND
             q.OWNER       = t.OWNER;
```

Your output looks similar to the following:

Owner	Queue Name	Queue Table	Comment
SYS	AQ\$_SCHEDULER\$JOBQTAB_E	SCHEDULER\$JOBQTAB	exception queue
SYS	SCHEDULER\$JOBQ	SCHEDULER\$JOBQTAB	Scheduler job queue
SYS	AQ\$_DIR\$EVENT_TABLE_E	DIR\$EVENT_TABLE	exception queue
SYS	DIR\$EVENT_QUEUE	DIR\$EVENT_TABLE	
SYS	AQ\$_DIR\$CLUSTER_DIR_TABLE_E	DIR\$CLUSTER_DIR_TABLE	exception queue
SYS	DIR\$CLUSTER_DIR_QUEUE	DIR\$CLUSTER_DIR_TABLE	
STRMADMIN	AQ\$_STREAMS_QUEUE_TABLE_E	STREAMS_QUEUE_TABLE	exception queue
STRMADMIN	STREAMS_QUEUE	STREAMS_QUEUE_TABLE	

An **exception queue** is created automatically when you create an ANYDATA queue.

See Also: ["Managing Queues"](#) on page 15-1

Viewing the Messaging Clients in a Database

You can view the **messaging clients** in a database by querying the DBA_STREAMS_MESSAGE_CONSUMERS data dictionary view. The query in this section displays the following information about each messaging client:

- The name of the messaging client
- The **queue** used by the messaging client
- The **positive rule set** used by the messaging client
- The **negative rule set** used by the messaging client

Run the following query to view this information about messaging clients:

```
COLUMN STREAMS_NAME HEADING 'Messaging|Client' FORMAT A25
COLUMN QUEUE_OWNER HEADING 'Queue|Owner' FORMAT A10
COLUMN QUEUE_NAME HEADING 'Queue Name' FORMAT A18
COLUMN RULE_SET_NAME HEADING 'Positive|Rule Set' FORMAT A11
COLUMN NEGATIVE_RULE_SET_NAME HEADING 'Negative|Rule Set' FORMAT A11

SELECT STREAMS_NAME,
       QUEUE_OWNER,
       QUEUE_NAME,
       RULE_SET_NAME,
       NEGATIVE_RULE_SET_NAME
       FROM DBA_STREAMS_MESSAGE_CONSUMERS;
```

Your output looks similar to the following:

Messaging Client	Queue Owner	Queue Name	Positive Rule Set	Negative Rule Set
SCHEDULER_PICKUP	SYS	SCHEDULER\$_JOBQ	RULESET\$_8	
SCHEDULER_COORDINATOR	SYS	SCHEDULER\$_JOBQ	RULESET\$_4	
HR	STRMADMIN	STREAMS_QUEUE	RULESET\$_15	

See Also: [Chapter 3, "Oracle Streams Staging and Propagation"](#) for more information about messaging clients

Viewing Message Notifications

You can configure a **message** notification to send a notification when a message that can be dequeued by a **messaging client** is enqueued into a **queue**. The notification can be sent to an e-mail address, to an HTTP URL, or to a PL/SQL procedure. Run the following query to view the message notifications configured in a database:

```

COLUMN STREAMS_NAME HEADING 'Messaging|Client' FORMAT A10
COLUMN QUEUE_OWNER HEADING 'Queue|Owner' FORMAT A5
COLUMN QUEUE_NAME HEADING 'Queue Name' FORMAT A20
COLUMN NOTIFICATION_TYPE HEADING 'Notification|Type' FORMAT A15
COLUMN NOTIFICATION_ACTION HEADING 'Notification|Action' FORMAT A25

SELECT STREAMS_NAME,
       QUEUE_OWNER,
       QUEUE_NAME,
       NOTIFICATION_TYPE,
       NOTIFICATION_ACTION
FROM DBA_STREAMS_MESSAGE_CONSUMERS
WHERE NOTIFICATION_TYPE IS NOT NULL;

```

Your output looks similar to the following:

Messaging Client	Queue Owner	Queue Name	Notification Type	Notification Action
OE	OE	NOTIFICATION_QUEUE	MAIL	mary.smith@example.com

See Also: ["Configuring a Messaging Client and Message Notification"](#) on page 13-5

Determining the Consumer of Each Message in a Persistent Queue

To determine the consumer for each **message** in a **persistent queue**, query `AQ$queue_table_name` in the queue owner's schema, where `queue_table_name` is the name of the **queue table**. For example, to find the consumers of the messages in the `oe_q_table_any` queue table, run the following query:

```

COLUMN MSG_ID HEADING 'Message ID' FORMAT 9999
COLUMN MSG_STATE HEADING 'Message State' FORMAT A13
COLUMN CONSUMER_NAME HEADING 'Consumer' FORMAT A30

SELECT MSG_ID, MSG_STATE, CONSUMER_NAME FROM AQ$OE_Q_TABLE_ANY;

```

Your output looks similar to the following:

Message ID	Message State	Consumer
B79AC412AE6E08CAE034080020AE3E0A	PROCESSED	OE

```
B79AC412AE6F08CAE034080020AE3E0A PROCESSED    OE
B79AC412AE7008CAE034080020AE3E0A PROCESSED    OE
```

Note: This query lists only messages in a persistent queue, not **captured LCRs** or other messages in a **buffered queue**.

See Also: *Oracle Streams Advanced Queuing User's Guide* for an example that enqueues messages into an ANYDATA queue

Viewing the Contents of Messages in a Persistent Queue

In an ANYDATA queue, to view the contents of a payload that is encapsulated within an ANYDATA payload, you query the **queue table** using the *Accessdata_type* static functions of the ANYDATA type, where *data_type* is the type of payload to view.

See Also: "Wrapping User Message Payloads in an ANYDATA Wrapper and Enqueuing Them" on page 13-2 for an example that enqueues the **messages** shown in the queries in this section into an ANYDATA queue

For example, to view the contents of payload of type NUMBER in a **queue** with a queue table named *oe_queue_table*, run the following query as the queue owner:

```
SELECT qt.user_data.AccessNumber() "Numbers in Queue"
FROM strmadmin.oe_q_table_any qt;
```

Your output looks similar to the following:

```
Numbers in Queue
-----
                16
```

Similarly, to view the contents of a payload of type VARCHAR2 in a queue with a queue table named *oe_q_table_any*, run the following query:

```
SELECT qt.user_data.AccessVarchar2() "Varchar2s in Queue"
FROM strmadmin.oe_q_table_any qt;
```

Your output looks similar to the following:

```
Varchar2s in Queue
-----
Chemicals - SW
```

To view the contents of a user-defined data type, you query the queue table using a custom function that you create. For example, to view the contents of a payload of *oe.cust_address_typ*, create a function similar to the following:

```
CREATE OR REPLACE FUNCTION oe.view_cust_address_typ(
in_any IN ANYDATA)
RETURN oe.cust_address_typ
IS
    address    oe.cust_address_typ;
    num_var    NUMBER;
BEGIN
    IF (in_any.GetTypeName() = 'OE.CUST_ADDRESS_TYP') THEN
        num_var := in_any.GetObject(address);
        RETURN address;
    END IF;
```

```

ELSE RETURN NULL;
END IF;
END;
/

GRANT EXECUTE ON oe.view_cust_address_typ TO strmadmin;

GRANT EXECUTE ON oe.cust_address_typ TO strmadmin;

```

Query the queue table using the function, as in the following example:

```

SELECT oe.view_cust_address_typ(qt.user_data) "Customer Addresses"
FROM strmadmin.oe_q_table_any qt
WHERE qt.user_data.GetTypeName() = 'OE.CUST_ADDRESS_TYP';

```

Your output looks similar to the following:

```

Customer Addresses(STREET_ADDRESS, POSTAL_CODE, CITY, STATE_PROVINCE, COUNTRY_ID
-----
CUST_ADDRESS_TYP('1646 Brazil Blvd', '361168', 'Chennai', 'Tam', 'IN')

```

Monitoring Buffered Queues

A **buffered queue** includes the following storage areas:

- System Global Area (SGA) memory associated with a **queue**
- Part of the **queue table** for a queue that stores **messages** that have spilled from memory

Buffered queues are stored in the **Oracle Streams pool**, and the Oracle Streams pool is a portion of memory in the SGA that is used by Oracle Streams. In an Oracle Streams environment, LCRs captured by a **capture process** always are stored in the buffered queue of an ANYDATA queue. Users and application can also enqueue messages into buffered queues, and these buffered queues be part of ANYDATA queues or part of **typed queues**.

Buffered queues enable Oracle databases to optimize messages by storing them in the SGA instead of always storing them in a queue table. Captured LCRs always are stored in buffered queues, but other types of messages can be stored in buffered queues or persistently in queue tables. Messages in a buffered queue can spill from memory if they have been staged in the buffered queue for a period of time without being dequeued, or if there is not enough space in memory to hold all of the messages. Messages that spill from memory are stored in the appropriate queue table.

The following sections describe queries that monitor buffered queues:

- [Determining the Number of Messages in Each Buffered Queue](#)
- [Viewing the Capture Processes for the LCRs in Each Buffered Queue](#)
- [Displaying Information About Propagations that Send Buffered Messages](#)
- [Displaying the Number of Messages and Bytes Sent By Propagations](#)
- [Displaying Performance Statistics for Propagations that Send Buffered Messages](#)
- [Viewing the Propagations Dequeuing Messages from Each Buffered Queue](#)
- [Displaying Performance Statistics for Propagations That Receive Buffered Messages](#)
- [Viewing the Apply Processes Dequeuing Messages from Each Buffered Queue](#)

Determining the Number of Messages in Each Buffered Queue

The V\$BUFFERED_QUEUES dynamic performance view contains information about the number of **messages** in a **buffered queue**. The messages can be **captured LCRs**, **buffered LCRs**, or **buffered user messages**.

You can determine the following information about each buffered queue in a database by running the query in this section:

- The **queue** owner
- The queue name
- The number of messages currently in memory
- The number of messages that have spilled from memory into the **queue table**
- The total number of messages in the buffered queue, which includes the messages in memory and the messages spilled to the queue table

To display this information, run the following query:

```
COLUMN QUEUE_SCHEMA HEADING 'Queue Owner' FORMAT A15
COLUMN QUEUE_NAME HEADING 'Queue Name' FORMAT A15
COLUMN MEM_MSG HEADING 'Messages|in Memory' FORMAT 99999999
COLUMN SPILL_MSGS HEADING 'Messages|Spilled' FORMAT 99999999
COLUMN NUM_MSGS HEADING 'Total Messages|in Buffered Queue' FORMAT 99999999

SELECT QUEUE_SCHEMA,
       QUEUE_NAME,
       (NUM_MSGS - SPILL_MSGS) MEM_MSG,
       SPILL_MSGS,
       NUM_MSGS
FROM V$BUFFERED_QUEUES;
```

Your output looks similar to the following:

Queue Owner	Queue Name	Messages in Memory	Messages Spilled	Total Messages in Buffered Queue
STRMADMIN	STREAMS_QUEUE	534	21	555

Viewing the Capture Processes for the LCRs in Each Buffered Queue

A **capture process** is a **queue** publisher that enqueues **captured LCRs** into a **buffered queue**. These LCRs can be propagated to other queues subsequently. By querying the V\$BUFFERED_PUBLISHERS dynamic performance view, you can display each capture process that captured the LCRs in the buffered queue. These LCRs might have been captured at the local database, or they might have been captured at a remote database and propagated to the queue specified in the query.

The query in this section assumes that the buffered queues in the local database only store captured LCRs, not **buffered LCRs** or **buffered user messages**. The query displays the following information about each capture process:

- The name of a capture process that captured the LCRs in the buffered queue
- If the capture process is running on a remote database, and the captured LCRs have been propagated to the local queue, then the name of the queue and database from which the captured LCRs were last propagated
- The name of the local queue staging the captured LCRs

- The total number of LCRs captured by a capture process that have been staged in the buffered queue since the database instance was last started
- The message number of the LCR last enqueued into the buffered queue from the sender

To display this information, run the following query:

```
COLUMN SENDER_NAME HEADING 'Capture|Process' FORMAT A13
COLUMN SENDER_ADDRESS HEADING 'Sender Queue' FORMAT A27
COLUMN QUEUE_NAME HEADING 'Queue Name' FORMAT A15
COLUMN CNUM_MSGS HEADING 'Number|of LCRs|Enqueued' FORMAT 99999999
COLUMN LAST_ENQUEUED_MSG HEADING 'Last|Enqueued|LCR' FORMAT 99999999
```

```
SELECT SENDER_NAME,
       SENDER_ADDRESS,
       QUEUE_NAME,
       CNUM_MSGS,
       LAST_ENQUEUED_MSG
FROM V$BUFFERED_PUBLISHERS;
```

Your output looks similar to the following:

Capture Process	Sender Queue	Queue Name	Number of LCRs Enqueued	Last Enqueued LCR
CAPTURE_HR	"STRMADMIN"."STREAMS_QUEUE" @MULT3.EXAMPLE.COM	STREAMS_QUEUE	382	844
CAPTURE_HR	"STRMADMIN"."STREAMS_QUEUE" @MULT2.EXAMPLE.COM	STREAMS_QUEUE	387	840
CAPTURE_HR		STREAMS_QUEUE	75	833

This output shows following:

- 382 LCRs from the `capture_hr` capture process running on a remote database were propagated from a queue named `streams_queue` on database `mult3.example.com` to the local queue named `streams_queue`. The message number of the last enqueued LCR from this sender was 844.
- 387 LCRs from the `capture_hr` capture process running on a remote database were propagated from a queue named `streams_queue` on database `mult2.example.com` to the local queue named `streams_queue`. The message number of the last enqueued LCR from this sender was 840.
- 75 LCRs from the local `capture_hr` capture process were enqueued into the local queue named `streams_queue`. The capture process is local because the `Sender Queue` column is NULL. The message number of the last enqueued LCR from this capture process was 833.

Displaying Information About Propagations that Send Buffered Messages

The query in this section displays the following information about each [propagation](#) that sends buffered [messages](#) from a [buffered queue](#) in the local database:

- The name of the propagation
- The [queue](#) owner
- The queue name

- The name of the database link used by the propagation
- The status of the **propagation schedule**

To display this information, run the following query:

```
COLUMN PROPAGATION_NAME HEADING 'Propagation' FORMAT A15
COLUMN QUEUE_SCHEMA HEADING 'Queue|Owner' FORMAT A10
COLUMN QUEUE_NAME HEADING 'Queue|Name' FORMAT A15
COLUMN DBLINK HEADING 'Database|Link' FORMAT A10
COLUMN SCHEDULE_STATUS HEADING 'Schedule Status' FORMAT A20

SELECT p.PROPAGATION_NAME,
       s.QUEUE_SCHEMA,
       s.QUEUE_NAME,
       s.DBLINK,
       s.SCHEDULE_STATUS
FROM DBA_PROPAGATION p, V$PROPAGATION_SENDER s
WHERE p.SOURCE_QUEUE_OWNER      = s.QUEUE_SCHEMA AND
      p.SOURCE_QUEUE_NAME       = s.QUEUE_NAME AND
      p.DESTINATION_QUEUE_OWNER = s.DST_QUEUE_SCHEMA AND
      p.DESTINATION_QUEUE_NAME  = s.DST_QUEUE_NAME;
```

Your output looks similar to the following:

Propagation	Queue Owner	Queue Name	Database Link	Schedule Status
MULT1_TO_MULT3	STRMADMIN	STREAMS_QUEUE	MULT3.EXAM PLE.COM	SCHEDULE ENABLED
MULT1_TO_MULT2	STRMADMIN	STREAMS_QUEUE	MULT2.EXAM PLE.COM	SCHEDULE ENABLED

When the `SCHEDULE_STATUS` column in the `V$PROPAGATION_SENDER` view shows `SCHEDULE OPTIMIZED` for a propagation, it means that the propagation is part of a combined capture and apply configuration.

See Also: ["Combined Capture and Apply Optimization"](#) on page 3-20

Displaying the Number of Messages and Bytes Sent By Propagations

The query in this section displays the number of **messages** and the number of bytes sent by each **propagation** that sends buffered messages from a **buffered queue** in the local database:

- The name of the propagation
- The **queue** name
- The name of the database link used by the propagation
- The total number of messages sent since the database instance was last started
- The total number of bytes sent since the database instance was last started

To display this information, run the following query:

```
COLUMN PROPAGATION_NAME HEADING 'Propagation' FORMAT A15
COLUMN QUEUE_NAME HEADING 'Queue|Name' FORMAT A15
COLUMN DBLINK HEADING 'Database|Link' FORMAT A20
COLUMN TOTAL_MSGS HEADING 'Total|Messages' FORMAT 99999999
COLUMN TOTAL_BYTES HEADING 'Total|Bytes' FORMAT 999999999999
```



```

SELECT p.PROPAGATION_NAME,
       s.QUEUE_NAME,
       s.DBLINK,
       s.TOTAL_MSGS,
       s.TOTAL_BYTES
FROM DBA_PROPAGATION p, V$PROPAGATION_SENDER s
WHERE p.SOURCE_QUEUE_OWNER      = s.QUEUE_SCHEMA AND
      p.SOURCE_QUEUE_NAME       = s.QUEUE_NAME AND
      p.DESTINATION_QUEUE_OWNER = s.DST_QUEUE_SCHEMA AND
      p.DESTINATION_QUEUE_NAME  = s.DST_QUEUE_NAME;

```

Your output looks similar to the following:

Propagation	Queue Name	Database Link	Total Messages	Total Bytes
MULT1_TO_MULT3	STREAMS_QUEUE	MULT3.EXAMPLE.COM	79	71467
MULT1_TO_MULT2	STREAMS_QUEUE	MULT2.EXAMPLE.COM	79	71467

Displaying Performance Statistics for Propagations that Send Buffered Messages

The query in this section displays the amount of time that a **propagation** sending buffered **messages** spends performing various tasks. Each propagation sends messages from the **source queue** to the **destination queue**. Specifically, the query displays the following information:

- The name of the propagation
- The **queue** name
- The name of the database link used by the propagation
- The amount of time spent dequeuing messages from the queue since the database instance was last started, in seconds
- The amount of time spent pickling messages since the database instance was last started, in seconds. Pickling involves changing a message in memory into a series of bytes that can be sent over a network.
- The amount of time spent propagating messages since the database instance was last started, in seconds

To display this information, run the following query:

```

COLUMN PROPAGATION_NAME HEADING 'Propagation' FORMAT A15
COLUMN QUEUE_NAME HEADING 'Queue|Name' FORMAT A13
COLUMN DBLINK HEADING 'Database|Link' FORMAT A9
COLUMN ELAPSED_DEQUEUE_TIME HEADING 'Dequeue|Time' FORMAT 99999999.99
COLUMN ELAPSED_PICKLE_TIME HEADING 'Pickle|Time' FORMAT 99999999.99
COLUMN ELAPSED_PROPAGATION_TIME HEADING 'Propagation|Time' FORMAT 99999999.99

SELECT p.PROPAGATION_NAME,
       s.QUEUE_NAME,
       s.DBLINK,
       (s.ELAPSED_DEQUEUE_TIME / 100) ELAPSED_DEQUEUE_TIME,
       (s.ELAPSED_PICKLE_TIME / 100) ELAPSED_PICKLE_TIME,
       (s.ELAPSED_PROPAGATION_TIME / 100) ELAPSED_PROPAGATION_TIME
FROM DBA_PROPAGATION p, V$PROPAGATION_SENDER s
WHERE p.SOURCE_QUEUE_OWNER      = s.QUEUE_SCHEMA AND
      p.SOURCE_QUEUE_NAME       = s.QUEUE_NAME AND
      p.DESTINATION_QUEUE_OWNER = s.DST_QUEUE_SCHEMA AND
      p.DESTINATION_QUEUE_NAME  = s.DST_QUEUE_NAME;

```

Your output looks similar to the following:

Propagation	Queue Name	Database Link	Dequeue Time	Pickle Time	Propagation Time
MULT1_TO_MULT2	STREAMS_QUEUE	MULT2.EXA MPLE.COM	30.65	45.10	10.91
MULT1_TO_MULT3	STREAMS_QUEUE	MULT3.EXA MPLE.COM	25.36	37.07	8.35

Viewing the Propagations Dequeuing Messages from Each Buffered Queue

Propagations are **queue** subscribers that can dequeue **messages**. By querying the `V$BUFFERED_SUBSCRIBERS` dynamic performance view, you can display all the **propagations** that can dequeue buffered messages.

You can also use the `V$BUFFERED_SUBSCRIBERS` dynamic performance view to determine the performance of a propagation. For example, if a propagation has a high number of spilled messages, then that propagation might not be dequeuing messages fast enough from the **buffered queue**. Spilling messages to a **queue table** has a negative impact on the performance of your Oracle Streams environment.

Apply processes also are queue subscribers. This query joins with the `DEA_PROPAGATION` and `V$BUFFERED_QUEUES` views to limit the output to propagations only and to show the propagation name of each propagation.

The query in this section displays the following information about each propagation that can dequeue messages from queues:

- The name of the propagation.
- The **destination database**, which is the database that contains the **destination queue** for the propagation.
- The sequence number for the message most recently enqueued into the queue. The sequence number for message shows the order of the message in the queue.
- The sequence number for the message in the queue most recently browsed by the propagation.
- The sequence number for the message most recently dequeued from the queue by the propagation.
- The current number of messages in the queue waiting to be dequeued by the propagation.
- The cumulative number of messages spilled from memory to the queue table for the propagation since the database last started.

To display this information, run the following query:

```
COLUMN PROPAGATION_NAME HEADING 'Propagation' FORMAT A15
COLUMN SUBSCRIBER_ADDRESS HEADING 'Destination|Database' FORMAT A11
COLUMN CURRENT_ENQ_SEQ HEADING 'Current|Enqueued|Sequence' FORMAT 99999999
COLUMN LAST_BROWSED_SEQ HEADING 'Last|Browsed|Sequence' FORMAT 99999999
COLUMN LAST_DEQUEUED_SEQ HEADING 'Last|Dequeued|Sequence' FORMAT 99999999
COLUMN NUM_MSGS HEADING 'Number of|Messages|in Queue|(Current)' FORMAT 99999999
COLUMN TOTAL_SPILLED_MSG HEADING 'Number of|Spilled|Messages|(Cumulative)'
      FORMAT 99999999

SELECT p.PROPAGATION_NAME,
       s.SUBSCRIBER_ADDRESS,
```

```

s.CURRENT_ENQ_SEQ,
s.LAST_BROWSED_SEQ,
s.LAST_DEQUEUED_SEQ,
s.NUM_MSGS,
s.TOTAL_SPILED_MSG
FROM DBA_PROPAGATION p, V$BUFFERED_SUBSCRIBERS s, V$BUFFERED_QUEUES q
WHERE q.QUEUE_ID = s.QUEUE_ID AND
p.SOURCE_QUEUE_OWNER = q.QUEUE_SCHEMA AND
p.SOURCE_QUEUE_NAME = q.QUEUE_NAME AND
s.SUBSCRIBER_ADDRESS LIKE '%' || p.DESTINATION_DBLINK;

```

Your output looks similar to the following:

Propagation	Destination Database	Current Enqueued Sequence	Last Browsed Sequence	Last Dequeued Sequence	Number of Messages in Queue (Current)	Number of Spilled Messages (Cumulative)
MULT1_TO_MULT2	MULT2.EXAMP LE.COM	157	144	129	24	0
MULT1_TO_MULT3	MULT3.EXAMP LE.COM	98	88	81	53	0

Note: If there are multiple propagations using the same database link but propagating messages to different queues at the destination database, then the statistics returned by this query are approximate rather than accurate.

Displaying Performance Statistics for Propagations That Receive Buffered Messages

The query in this section displays the amount of time that each **propagation** receiving buffered **messages** spends performing various tasks. Each propagation receives the messages and enqueues them into the **destination queue** for the propagation. Specifically, the query displays the following information:

- The name of the **source queue** from which messages are propagated.
- The name of the **source database**.
- The amount of time spent unpickling messages since the database instance was last started, in seconds. Unpickling involves changing a series of bytes that can be sent over a network back into a buffered message in memory.
- The amount of time spent evaluating **rules** for propagated messages since the database instance was last started, in seconds.
- The amount of time spent enqueueing messages into the destination queue for the propagation since the database instance was last started, in seconds.

To display this information, run the following query:

```

COLUMN SRC_QUEUE_NAME HEADING 'Source|Queue|Name' FORMAT A20
COLUMN SRC_DBNAME HEADING 'Source|Database' FORMAT A20
COLUMN ELAPSED_UNPICKLE_TIME HEADING 'Unpickle|Time' FORMAT 99999999.99
COLUMN ELAPSED_RULE_TIME HEADING 'Rule|Evaluation|Time' FORMAT 99999999.99
COLUMN ELAPSED_ENQUEUE_TIME HEADING 'Enqueue|Time' FORMAT 99999999.99

SELECT SRC_QUEUE_NAME,
       SRC_DBNAME,
       (ELAPSED_UNPICKLE_TIME / 100) ELAPSED_UNPICKLE_TIME,

```

```

        (ELAPSED_RULE_TIME / 100) ELAPSED_RULE_TIME,
        (ELAPSED_ENQUEUE_TIME / 100) ELAPSED_ENQUEUE_TIME
FROM V$PROPAGATION_RECEIVER;

```

Your output looks similar to the following:

Source Queue Name	Source Database	Unpickle Time	Rule Evaluation Time	Enqueue Time
STREAMS_QUEUE	MULT2.EXAMPLE.COM	45.65	5.44	45.85
STREAMS_QUEUE	MULT3.EXAMPLE.COM	53.35	8.01	50.41

Viewing the Apply Processes Dequeuing Messages from Each Buffered Queue

Apply processes are **queue** subscribers that can dequeue **messages**. By querying the V\$BUFFERED_SUBSCRIBERS dynamic performance view, you can display all the apply processes that can dequeue messages.

You can also use the V\$BUFFERED_SUBSCRIBERS dynamic performance view to determine the performance of an apply process. For example, if an apply process has a high number of spilled messages, then that apply process might not be dequeuing messages fast enough from the **buffered queue**. Spilling messages to a **queue table** has a negative impact on the performance of your Oracle Streams environment.

This query joins with the V\$BUFFERED_QUEUES views to show the name of the queue. In addition, **propagations** also are queue subscribers, and this query limits the output to subscribers where the SUBSCRIBER_ADDRESS is NULL to return only apply processes.

The query in this section displays the following information about the apply processes that can dequeue messages from queues:

- The name of the apply process.
- The queue owner.
- The queue name.
- The sequence number for the message most recently dequeued by the apply process. The sequence number for message shows the order of the message in the queue.
- The current number of messages in the queue waiting to be dequeued by the apply process.
- The cumulative number of messages spilled from memory to the queue table for the apply process since the database last started.

To display this information, run the following query:

```

COLUMN SUBSCRIBER_NAME HEADING 'Apply Process' FORMAT A16
COLUMN QUEUE_SCHEMA HEADING 'Queue|Owner' FORMAT A10
COLUMN QUEUE_NAME HEADING 'Queue|Name' FORMAT A15
COLUMN LAST_DEQUEUED_SEQ HEADING 'Last|Dequeued|Sequence' FORMAT 99999999
COLUMN NUM_MSGS HEADING 'Number of|Messages|in Queue|(Current)' FORMAT 99999999
COLUMN TOTAL_SPILLED_MSG HEADING 'Number of|Spilled|Messages|(Cumulative)'
      FORMAT 99999999

SELECT s.SUBSCRIBER_NAME,
       q.QUEUE_SCHEMA,
       q.QUEUE_NAME,

```

```

s.LAST_DEQUEUED_SEQ,
s.NUM_MSGS,
s.TOTAL_SPILLED_MSG
FROM V$BUFFERED_QUEUES q, V$BUFFERED_SUBSCRIBERS s, DBA_APPLY a
WHERE q.QUEUE_ID = s.QUEUE_ID AND
s.SUBSCRIBER_ADDRESS IS NULL AND
s.SUBSCRIBER_NAME = a.APPLY_NAME;

```

Your output looks similar to the following:

Apply Process	Queue Owner	Queue Name	Last Dequeued Sequence	Number of Messages in Queue (Current)	Number of Spilled Messages (Cumulative)
APPLY_FROM_MULT3	STRMADMIN	STREAMS_QUEUE	49	148	0
APPLY_FROM_MULT2	STRMADMIN	STREAMS_QUEUE	85	241	1

Monitoring Oracle Streams Propagations and Propagation Jobs

The following topics describe monitoring **propagations** and **propagation jobs**:

- [Displaying the Queues and Database Link for Each Propagation](#)
- [Determining the Source Queue and Destination Queue for Each Propagation](#)
- [Determining the Rule Sets for Each Propagation](#)
- [Displaying the Schedule for a Propagation Job](#)
- [Determining the Total Number of Messages and Bytes Propagated](#)
- [Displaying Information About Propagation Senders](#)
- [Displaying Information About Propagation Receivers](#)

See Also:

- [Chapter 3, "Oracle Streams Staging and Propagation"](#)
- ["Managing Oracle Streams Propagations and Propagation Jobs" on page 15-4](#)
- ["Troubleshooting Propagation Problems" on page 20-11](#)

Displaying the Queues and Database Link for Each Propagation

You can display information about each **propagation** by querying the DBA_PROPAGATION data dictionary view. This view contains information about each propagation with a **source queue** is at the local database.

The query in this section displays the following information about each propagation:

- The propagation name
- The source **queue** name
- The database link used by the propagation
- The **destination queue** name
- The status of the propagation, either ENABLED, DISABLED, or ABORTED
- Whether the propagation is a queue-to-queue propagation

To display this information about each propagation in a database, run the following query:

```

COLUMN PROPAGATION_NAME          HEADING 'Propagation|Name'   FORMAT A19
COLUMN SOURCE_QUEUE_NAME         HEADING 'Source|Queue|Name'   FORMAT A17
COLUMN DESTINATION_DBLINK        HEADING 'Database|Link'       FORMAT A9
COLUMN DESTINATION_QUEUE_NAME    HEADING 'Dest|Queue|Name'     FORMAT A15
COLUMN STATUS                    HEADING 'Status'              FORMAT A8
COLUMN QUEUE_TO_QUEUE           HEADING 'Queue-|to-|Queue?'    FORMAT A6

SELECT PROPAGATION_NAME,
       SOURCE_QUEUE_NAME,
       DESTINATION_DBLINK,
       DESTINATION_QUEUE_NAME,
       STATUS,
       QUEUE_TO_QUEUE
FROM DBA_PROPAGATION;

```

Your output looks similar to the following:

Propagation Name	Source Queue Name	Database Link	Dest Queue Name	Status	Queue- to- Queue?
STREAMS_PROPAGATION	STREAMS_CAPTURE_Q	INST2.EXA	STREAMS_APPLY_Q	ENABLED	FALSE
		MPLE.COM			

Determining the Source Queue and Destination Queue for Each Propagation

You can determine the **source queue** and **destination queue** for each **propagation** by querying the DBA_PROPAGATION data dictionary view.

The query in this section displays the following information about each propagation:

- The propagation name
- The source **queue** owner
- The source queue name
- The database that contains the source queue
- The destination queue owner
- The destination queue name
- The database that contains the destination queue

To display this information about each propagation in a database, run the following query:

```

COLUMN PROPAGATION_NAME HEADING 'Propagation|Name' FORMAT A20
COLUMN SOURCE_QUEUE_OWNER HEADING 'Source|Queue|Owner' FORMAT A10
COLUMN 'Source Queue' HEADING 'Source|Queue' FORMAT A15
COLUMN DESTINATION_QUEUE_OWNER HEADING 'Dest|Queue|Owner' FORMAT A10
COLUMN 'Destination Queue' HEADING 'Destination|Queue' FORMAT A15

SELECT p.PROPAGATION_NAME,
       p.SOURCE_QUEUE_OWNER,
       p.SOURCE_QUEUE_NAME || '@' ||
       g.GLOBAL_NAME "Source Queue",
       p.DESTINATION_QUEUE_OWNER,
       p.DESTINATION_QUEUE_NAME || '@' ||

```

```
p.DESTINATION_DBLINK "Destination Queue"
FROM DBA_PROPAGATION p, GLOBAL_NAME g;
```

Your output looks similar to the following:

Propagation Name	Source Queue Owner	Source Queue	Dest Queue Owner	Destination Queue
STREAMS_PROPAGATION	STRMADMIN	STREAMS_CAPTURE_Q@INST1.EXAMPL E.COM	STRMADMIN	STREAMS_APPLY_Q@INST2.EXAMPLE .COM

Determining the Rule Sets for Each Propagation

The query in this section displays the following information for each **propagation**:

- The propagation name
- The owner of the **positive rule set** for the propagation
- The name of the positive rule set used by the propagation
- The owner of the **negative rule set** used by the propagation
- The name of the negative rule set used by the propagation

To display this general information about each propagation in a database, run the following query:

```
COLUMN PROPAGATION_NAME HEADING 'Propagation|Name' FORMAT A20
COLUMN RULE_SET_OWNER HEADING 'Positive|Rule Set|Owner' FORMAT A10
COLUMN RULE_SET_NAME HEADING 'Positive Rule|Set Name' FORMAT A15
COLUMN NEGATIVE_RULE_SET_OWNER HEADING 'Negative|Rule Set|Owner' FORMAT A10
COLUMN NEGATIVE_RULE_SET_NAME HEADING 'Negative Rule|Set Name' FORMAT A15

SELECT PROPAGATION_NAME,
       RULE_SET_OWNER,
       RULE_SET_NAME,
       NEGATIVE_RULE_SET_OWNER,
       NEGATIVE_RULE_SET_NAME
FROM DBA_PROPAGATION;
```

Your output looks similar to the following:

Propagation Name	Positive Rule Set Owner	Positive Rule Set Name	Negative Rule Set Owner	Negative Rule Set Name
STRM01_PROPAGATION	STRMADMIN	RULESET\$22	STRMADMIN	RULESET\$31

Displaying the Schedule for a Propagation Job

The query in this section displays the following information about the **propagation schedule** for a **propagation job** used by a **propagation** named `db1_to_db2`:

- The date and time when the propagation schedule started (or will start).
- The duration of the propagation job, which is the amount of time the job propagates **messages** before restarting.
- The next time the propagation will start.

- The latency of the propagation job, which is the maximum wait time to propagate a new message during the duration, when all other messages in the **queue** to the relevant destination have been propagated.
- Whether or not the propagation job is enabled.
- The name of the process that most recently executed the schedule.
- The number of consecutive times schedule execution has failed, if any. After 16 consecutive failures, a propagation job becomes disabled automatically.

Run this query at the database that contains the **source queue**:

```

COLUMN START_DATE HEADING 'Start Date'
COLUMN PROPAGATION_WINDOW HEADING 'Duration|in Seconds' FORMAT 99999
COLUMN NEXT_TIME HEADING 'Next|Time' FORMAT A8
COLUMN LATENCY HEADING 'Latency|in Seconds' FORMAT 99999
COLUMN SCHEDULE_DISABLED HEADING 'Status' FORMAT A8
COLUMN PROCESS_NAME HEADING 'Process' FORMAT A8
COLUMN FAILURES HEADING 'Number of|Failures' FORMAT 99

SELECT DISTINCT TO_CHAR(s.START_DATE, 'HH24:MI:SS MM/DD/YY') START_DATE,
                s.PROPAGATION_WINDOW,
                s.NEXT_TIME,
                s.LATENCY,
                DECODE(s.SCHEDULE_DISABLED,
                    'Y', 'Disabled',
                    'N', 'Enabled') SCHEDULE_DISABLED,
                s.PROCESS_NAME,
                s.FAILURES
FROM DBA_QUEUE_SCHEDULES s, DBA_PROPAGATION p
WHERE p.PROPAGATION_NAME = 'DBS1_TO_DBS2'
      AND s.DESTINATION LIKE '%' || p.DESTINATION_DBLINK
      AND s.SCHEMA = p.SOURCE_QUEUE_OWNER
      AND s.QNAME = p.SOURCE_QUEUE_NAME;

```

Your output looks similar to the following:

Start Date	Duration	Next	Latency	Status	Process	Number of
	in Seconds	Time	in Seconds			Failures
15:23:40 03/02/02			5	Enabled	J002	0

This propagation job uses the default schedule for an Oracle Streams propagation job. That is, the duration and next time are both `NULL`, and the latency is five seconds. When the duration is `NULL`, the job propagates changes without restarting automatically. When the next time is `NULL`, the propagation job is running currently.

See Also:

- ["Propagation Scheduling and Oracle Streams Propagations"](#) on page 3-18 for more information about the default propagation schedule for an Oracle Streams propagation job
- ["Is the Propagation Enabled?"](#) on page 20-12 if the propagation job is disabled
- *Oracle Streams Advanced Queuing User's Guide* and *Oracle Database Reference* for more information about the `DBA_QUEUE_SCHEDULES` data dictionary view

Determining the Total Number of Messages and Bytes Propagated

A **propagation** can be queue-to-queue or queue-to-database link (queue-to-dblink). A queue-to-queue propagation always has its own exclusive **propagation job** to propagate **messages** from the **source queue** to the **destination queue**. Because each propagation job has its own **propagation schedule**, the propagation schedule of each queue-to-queue propagation can be managed separately. All queue-to-dblink propagations that share the same database link have a single propagation schedule.

The query in this section displays the following information for each propagation:

- The name of the propagation
- The total time spent by the system executing the propagation schedule
- The total number of **messages** propagated by the propagation schedule
- The total number of bytes propagated by the propagation schedule

Run the following query to display this information for each propagation with a source queue at the local database:

```
COLUMN PROPAGATION_NAME HEADING 'Propagation|Name' FORMAT A20
COLUMN TOTAL_TIME HEADING 'Total Time|Executing|in Seconds' FORMAT 999999
COLUMN TOTAL_NUMBER HEADING 'Total Messages|Propagated' FORMAT 999999999
COLUMN TOTAL_BYTES HEADING 'Total Bytes|Propagated' FORMAT 9999999999999

SELECT p.PROPAGATION_NAME, s.TOTAL_TIME, s.TOTAL_NUMBER, s.TOTAL_BYTES
FROM DBA_QUEUE_SCHEDULES s, DBA_PROPAGATION p
WHERE s.DESTINATION LIKE '%' || p.DESTINATION_DBLINK
AND s.SCHEMA = p.SOURCE_QUEUE_OWNER
AND s.QNAME = p.SOURCE_QUEUE_NAME;
```

Your output looks similar to the following:

Propagation Name	Total Time		Total Bytes Propagated
	Executing in Seconds	Total Messages Propagated	
MULT3_TO_MULT1	351	872	875252
MULT3_TO_MULT2	596	872	875252

See Also: *Oracle Streams Advanced Queuing User's Guide* and *Oracle Database Reference* for more information about the DBA_QUEUE_SCHEDULES data dictionary view

Displaying Information About Propagation Senders

A propagation sender sends **messages** from a **source queue** to a **destination queue**.

The query in this section displays the following information about each propagation sender in a database:

- The name of the propagation
- The session identifier of the propagation sender
- The session serial number of the propagation sender
- The operating system process identification number of the propagation sender
- The state of the propagation sender

In a combined capture and apply configuration, the **capture process** acts as the propagation sender and transmits messages directly to the propagation receiver. When a propagation is part of a combined capture and apply configuration, this query shows the capture process session ID, session serial number, operating system process ID, and state.

When a propagation is not part of a combined capture and apply configuration, this query shows the propagation job session ID, session serial number, operating system process ID, and state.

To view this information, run the following query:

```
COLUMN PROPAGATION_NAME HEADING 'Propagation|Name' FORMAT A11
COLUMN SESSION_ID HEADING 'Session ID' FORMAT 9999
COLUMN SERIAL# HEADING 'Session|Serial Number' FORMAT 9999
COLUMN SPID HEADING 'Operating System|Process ID' FORMAT A24
COLUMN STATE HEADING 'State' FORMAT A16

SELECT p.PROPAGATION_NAME,
       s.SESSION_ID,
       s.SERIAL#,
       s.SPID,
       s.STATE
FROM DBA_PROPAGATION p, V$PROPAGATION_SENDER s
WHERE p.SOURCE_QUEUE_OWNER      = s.QUEUE_SCHEMA AND
      p.SOURCE_QUEUE_NAME       = s.QUEUE_NAME AND
      p.DESTINATION_QUEUE_OWNER = s.DST_QUEUE_SCHEMA AND
      p.DESTINATION_QUEUE_NAME  = s.DST_QUEUE_NAME;
```

Your output looks similar to the following:

Propagation Name	Session ID	Session Serial Number	Operating System Process ID	State
PROPAGATION_SPOKE1	951	1	22594	Capturing change records

This output shows that the propagation sender is part of a combined capture and apply configuration because the capture process state is shown. Also, when column `SCHEDULE_STATUS` in the `V$PROPAGATION_SENDER` view shows `SCHEDULE OPTIMIZED`, it means that the propagation is part of a combined capture and apply configuration.

See Also: ["Combined Capture and Apply Optimization"](#) on page 3-20

Displaying Information About Propagation Receivers

A propagation receiver enqueues messages sent by propagation senders into a **destination queue**. The query in this section displays the following information about each propagation receiver in a database:

- The name of the propagation
- The session ID of the propagation receiver
- The session serial number propagation receiver
- The operating system process identification number of the propagation receiver
- The state of the propagation receiver

To view this information, run the following query:

```

COLUMN PROPAGATION_NAME HEADING 'Propagation|Name' FORMAT A11
COLUMN SESSION_ID HEADING 'Session ID' FORMAT 99999999
COLUMN SERIAL# HEADING 'Session|Serial Number' FORMAT 99999999
COLUMN SPID HEADING 'Operating System|Process ID' FORMAT 99999999999
COLUMN STATE HEADING 'State' FORMAT A16

SELECT p.PROPAGATION_NAME,
       s.SESSION_ID,
       s.SERIAL#,
       s.SPID,
       s.STATE
FROM DBA_PROPAGATION p, V$PROPAGATION_RECEIVER s
WHERE p.SOURCE_QUEUE_OWNER      = s.SRC_QUEUE_SCHEMA AND
      p.SOURCE_QUEUE_NAME       = s.SRC_QUEUE_NAME AND
      p.DESTINATION_QUEUE_OWNER = s.DST_QUEUE_SCHEMA AND
      p.DESTINATION_QUEUE_NAME  = s.DST_QUEUE_NAME;

```

Your output looks similar to the following:

Propagation Name	Session ID	Serial Number	Operating System Process ID	State
PROPAGATION _SPOKE1	940	1	22636	Waiting for mess age from client
PROPAGATION _SPOKE2	928	4	29154	Waiting for mess age from client

Monitoring Oracle Streams Apply Processes

The following topics describe monitoring Oracle Streams **apply processes**:

- [Determining the Queue, Rule Sets, and Status for Each Apply Process](#)
- [Displaying General Information About Each Apply Process](#)
- [Listing the Parameter Settings for Each Apply Process](#)
- [Displaying Information About Apply Handlers](#)
- [Displaying Information About the Reader Server for Each Apply Process](#)
- [Monitoring Transactions and Messages Spilled by Each Apply Process](#)
- [Determining Capture to Dequeue Latency for a Message](#)
- [Displaying General Information About Each Coordinator Process](#)
- [Displaying Information About Transactions Received and Applied](#)
- [Determining the Capture to Apply Latency for a Message for Each Apply Process](#)
- [Displaying Information About the Apply Servers for Each Apply Process](#)
- [Displaying Effective Apply Parallelism for an Apply Process](#)
- [Viewing Rules that Specify a Destination Queue on Apply](#)
- [Viewing Rules that Specify No Execution on Apply](#)
- [Determining Which Apply Processes Use Combined Capture and Apply](#)
- [Checking for Apply Errors](#)
- [Displaying Detailed Information About Apply Errors](#)

Note: The Oracle Streams tool in Oracle Enterprise Manager is also an excellent way to monitor an Oracle Streams environment. See *Oracle Database 2 Day + Data Replication and Integration Guide* and the online Help for the Oracle Streams tool for more information.

See Also:

- [Chapter 4, "Oracle Streams Information Consumption"](#)
- [Chapter 16, "Managing Oracle Streams Information Consumption"](#)
- ["Troubleshooting Apply Process Problems"](#) on page 20-14
- *Oracle Database Reference* for information about the data dictionary views described in this chapter
- *Oracle Streams Replication Administrator's Guide* for information about monitoring an Oracle Streams [replication](#) environment

Determining the Queue, Rule Sets, and Status for Each Apply Process

You can determine the following information for each [apply process](#) in a database by running the query in this section:

- The apply process name
- The name of the [queue](#) used by the apply process
- The name of the [positive rule set](#) used by the apply process
- The name of the [negative rule set](#) used by the apply process
- The status of the apply process, either ENABLED, DISABLED, or ABORTED

To display this general information about each apply process in a database, run the following query:

```
COLUMN APPLY_NAME HEADING 'Apply|Process|Name' FORMAT A15
COLUMN QUEUE_NAME HEADING 'Apply|Process|Queue' FORMAT A15
COLUMN RULE_SET_NAME HEADING 'Positive|Rule Set' FORMAT A15
COLUMN NEGATIVE_RULE_SET_NAME HEADING 'Negative|Rule Set' FORMAT A15
COLUMN STATUS HEADING 'Apply|Process|Status' FORMAT A15

SELECT APPLY_NAME,
       QUEUE_NAME,
       RULE_SET_NAME,
       NEGATIVE_RULE_SET_NAME,
       STATUS
FROM DBA_APPLY;
```

Your output looks similar to the following:

Apply Process Name	Apply Process Queue	Positive Rule Set	Negative Rule Set	Apply Process Status
STRM01_APPLY	STREAMS_QUEUE	RULESET\$_36		ENABLED
APPLY_EMP	STREAMS_QUEUE	RULESET\$_16		DISABLED
APPLY	STREAMS_QUEUE	RULESET\$_21	RULESET\$_23	ENABLED

If the status of an apply process is ABORTED, then you can query the `ERROR_NUMBER` and `ERROR_MESSAGE` columns in the `DBA_APPLY` data dictionary view to determine the error. These columns are populated when an apply process aborts or when an apply process is disabled after reaching a limit. These columns are cleared when an apply process is restarted.

Note: The `ERROR_NUMBER` and `ERROR_MESSAGE` columns in the `DBA_APPLY` data dictionary view are not related to the information in the `DBA_APPLY_ERROR` data dictionary view.

See Also: ["Checking for Apply Errors"](#) on page 25-16 to check for apply errors if the apply process status is `ABORTED`

Displaying General Information About Each Apply Process

You can display the following general information about each **apply process** in a database by running the query in this section:

- The apply process name.
- The type of **messages** applied by the apply process. An apply process either can apply either **captured LCRs**, or an apply process can apply **persistent LCRs** and **persistent user messages**.
- The **apply user**.

To display this general information about each apply process in a database, run the following query:

```
COLUMN APPLY_NAME HEADING 'Apply Process Name' FORMAT A20
COLUMN APPLY_CAPTURED HEADING 'Applies Captured LCRs?' FORMAT A30
COLUMN APPLY_USER HEADING 'Apply User' FORMAT A20

SELECT APPLY_NAME, APPLY_CAPTURED, APPLY_USER
       FROM DBA_APPLY;
```

Your output looks similar to the following:

Apply Process Name	Applies Captured LCRs?	Apply User
STRM01_APPLY	YES	STRMADMIN
SYNC_APPLY	NO	STRMADMIN

Listing the Parameter Settings for Each Apply Process

The following query displays the current setting for each **apply process** parameter for each apply process in a database:

```
COLUMN APPLY_NAME HEADING 'Apply Process|Name' FORMAT A15
COLUMN PARAMETER HEADING 'Parameter' FORMAT A25
COLUMN VALUE HEADING 'Value' FORMAT A20
COLUMN SET_BY_USER HEADING 'Set by User?' FORMAT A15

SELECT APPLY_NAME,
       PARAMETER,
       VALUE,
       SET_BY_USER
       FROM DBA_APPLY_PARAMETERS;
```

Your output looks similar to the following:

Apply Process Name	Parameter	Value	Set by User?
APPLY_HR	ALLOW_DUPLICATE_ROWS	N	NO
APPLY_HR	COMMIT_SERIALIZATION	FULL	NO
APPLY_HR	DISABLE_ON_ERROR	Y	NO
APPLY_HR	DISABLE_ON_LIMIT	N	NO
APPLY_HR	MAXIMUM_SCN	INFINITE	NO
APPLY_HR	PARALLELISM	1	NO
APPLY_HR	STARTUP_SECONDS	0	NO
APPLY_HR	TIME_LIMIT	INFINITE	NO
APPLY_HR	TRACE_LEVEL	0	NO
APPLY_HR	TRANSACTION_LIMIT	INFINITE	NO
APPLY_HR	TXN_LCR_SPILL_THRESHOLD	5000	YES
APPLY_HR	WRITE_ALERT_LOG	Y	NO

Note: If the Set by User? column is NO for a parameter, then the parameter is set to its default value. If the Set by User? column is YES for a parameter, then the parameter might or might not be set to its default value.

See Also:

- ["Apply Process Parameters"](#) on page 4-20
- ["Setting an Apply Process Parameter"](#) on page 16-6

Displaying Information About Apply Handlers

This section contains instructions for displaying information about **apply process message handlers** and **error handlers**.

This section contains these topics:

- [Displaying All of the Error Handlers for Local Apply Processes](#)
- [Displaying All of the Error Handlers for Local Apply Processes](#)
- [Displaying All of the Error Handlers for Local Apply Processes](#)

See Also:

- ["Types of Messages That Can Be Processed with an Apply Process"](#) on page 4-6
- ["Troubleshooting Apply Process Problems"](#) on page 20-14
- *Oracle Streams Replication Administrator's Guide* for information about monitoring **DML handlers** and **DDL handlers**

Displaying All of the Error Handlers for Local Apply Processes

When you specify a local **error handler** using the SET_DML_HANDLER procedure in the DBMS_APPLY_ADM package at a **destination database**, you can specify either that the handler runs for a specific apply process or that the handler is a general handler that runs for all apply processes in the database that apply changes locally when an error is raised by an apply process. A specific error handler takes precedence over a

generic error handler. An error handler is run for a specified operation on a specific table.

To display the error handler for each apply process that applies changes locally in a database, run the following query:

```
COLUMN OBJECT_OWNER HEADING 'Table|Owner' FORMAT A5
COLUMN OBJECT_NAME HEADING 'Table Name' FORMAT A10
COLUMN OPERATION_NAME HEADING 'Operation' FORMAT A10
COLUMN USER_PROCEDURE HEADING 'Handler Procedure' FORMAT A30
COLUMN APPLY_NAME HEADING 'Apply Process|Name' FORMAT A15

SELECT OBJECT_OWNER,
       OBJECT_NAME,
       OPERATION_NAME,
       USER_PROCEDURE,
       APPLY_NAME
FROM DBA_APPLY_DML_HANDLERS
WHERE ERROR_HANDLER = 'Y'
ORDER BY OBJECT_OWNER, OBJECT_NAME;
```

Your output looks similar to the following:

Table Owner	Table Name	Operation	Handler Procedure	Apply Process Name
HR	REGIONS	INSERT	"STRMADMIN"."ERRORS_PKG". REGIONS_PK_ERROR"	

Apply Process Name is NULL for the strmadmin.errors_pkg.regions_pk_error error handler. Therefore, this handler is a general handler that runs for all of the local apply processes.

See Also: ["Managing an Error Handler"](#) on page 16-13

Displaying the Message Handler for Each Apply Process

To display each **message handler** in a database, run the following query:

```
COLUMN APPLY_NAME HEADING 'Apply Process Name' FORMAT A20
COLUMN MESSAGE_HANDLER HEADING 'Message Handler' FORMAT A20

SELECT APPLY_NAME, MESSAGE_HANDLER FROM DBA_APPLY
WHERE MESSAGE_HANDLER IS NOT NULL;
```

Your output looks similar to the following:

Apply Process Name	Message Handler
STRM03_APPLY	"OE"."MES_HANDLER"

See Also: ["Managing the Message Handler for an Apply Process"](#) on page 16-8

Displaying the Precommit Handler for Each Apply Process

You can display the following information about each **precommit handler** used by an **apply process** in a database by running the query in this section:

- The apply process name.
- The owner and name of the precommit handler
- The type of **messages** applied by the apply process. An apply process either can apply either **captured LCRs**, or an apply process can apply **persistent LCRs** and **persistent user messages**.

To display each this information for each precommit handler in the database, run the following query:

```
COLUMN APPLY_NAME HEADING 'Apply Process Name' FORMAT A15
COLUMN PRECOMMIT_HANDLER HEADING 'Precommit Handler' FORMAT A30
COLUMN APPLY_CAPTURED HEADING 'Applies Captured|Messages?' FORMAT A20

SELECT APPLY_NAME, PRECOMMIT_HANDLER, APPLY_CAPTURED
FROM DBA_APPLY
WHERE PRECOMMIT_HANDLER IS NOT NULL;
```

Your output looks similar to the following:

Apply Process Name	Precommit Handler	Applies Captured Messages?
STRM01_APPLY	"STRMADMIN"."HISTORY_COMMIT"	YES

See Also: ["Managing the Precommit Handler for an Apply Process"](#) on page 16-8

Displaying Information About the Reader Server for Each Apply Process

The **reader server** for an **apply process** dequeues **messages** from the **queue**. The reader server is a process that computes dependencies between LCRs and assembles messages into transactions. The reader server then returns the assembled transactions to the coordinator, which assigns them to idle **apply servers**.

The query in this section displays the following information about the reader server for each apply process:

- The name of the apply process
- The type of **messages** dequeued by the reader server. An apply process either can dequeue either **captured LCRs**, or an apply process can dequeue **persistent LCRs** and **persistent user messages**.
- The name of the process used by the reader server. The process name is in the form *ASnn*, where *nn* can be letters and numbers.
- The current state of the reader server, either **INITIALIZING**, **IDLE**, **DEQUEUE MESSAGES**, **SCHEDULE MESSAGES**, **SPILLING**, or **PAUSED**
- The total number of messages dequeued by the reader server since the last time the apply process was started

The information displayed by this query is valid only for an enabled apply process.

Run the following query to display this information for each apply process:

```
COLUMN APPLY_NAME HEADING 'Apply Process|Name' FORMAT A15
COLUMN APPLY_CAPTURED HEADING 'Dequeues Captured|Messages?' FORMAT A17
COLUMN PROCESS_NAME HEADING 'Process|Name' FORMAT A7
COLUMN STATE HEADING 'State' FORMAT A17
COLUMN TOTAL_MESSAGES_DEQUEUED HEADING 'Total Messages|Dequeued' FORMAT 99999999
```

```

SELECT r.APPLY_NAME,
       ap.APPLY_CAPTURED,
       SUBSTR(s.PROGRAM, INSTR(s.PROGRAM, '(')+1,4) PROCESS_NAME,
       r.STATE,
       r.TOTAL_MESSAGES_DEQUEUED
FROM V$STREAMS_APPLY_READER r, V$SESSION s, DBA_APPLY ap
WHERE r.SID = s.SID AND
       r.SERIAL# = s.SERIAL# AND
       r.APPLY_NAME = ap.APPLY_NAME;

```

Your output looks similar to the following:

Apply Process Name	Dequeues Captured Messages?	Process Name	State	Total Messages Dequeued
APPLY_SPOKE	YES	AS01	DEQUEUE MESSAGES	54

See Also: ["Reader Server States"](#) on page 4-17

Monitoring Transactions and Messages Spilled by Each Apply Process

If the `txn_lcr_spill_threshold` [apply process](#) parameter is set to a value other than `infinite`, then an apply process can spill [messages](#) from memory to hard disk when the number of messages in a transaction exceeds the specified number.

The first query in this section displays the following information about each transaction currently being applied for which the apply process has spilled messages:

- The name of the apply process
- The transaction ID of the transaction with spilled messages
- The system change number (SCN) of the first message in the transaction
- The number of messages currently spilled in the transaction

To display this information for each apply process in a database, run the following query:

```

COLUMN APPLY_NAME HEADING 'Apply Name' FORMAT A20
COLUMN 'Transaction ID' HEADING 'Transaction ID' FORMAT A15
COLUMN FIRST_SCN HEADING 'First SCN' FORMAT 99999999
COLUMN MESSAGE_COUNT HEADING 'Message Count' FORMAT 99999999

SELECT APPLY_NAME,
       XIDUSN || '.' ||
       XIDSLT || '.' ||
       XIDSQN "Transaction ID",
       FIRST_SCN,
       MESSAGE_COUNT
FROM DBA_APPLY_SPILL_TXN;

```

Your output looks similar to the following:

Apply Name	Transaction ID	First SCN	Message Count
APPLY_HR	1.42.2277	2246944	100

The next query in this section displays the following information about the messages spilled by the apply processes in the local database:

- The name of the apply process
- The total number of messages spilled by the apply process since it last started
- The amount of time the apply process spent spilling messages, in seconds

To display this information for each apply process in a database, run the following query:

```
COLUMN APPLY_NAME HEADING 'Apply Name' FORMAT A15
COLUMN TOTAL_MESSAGES_SPILLED HEADING 'Total|Spilled Messages' FORMAT 99999999
COLUMN ELAPSED_SPILL_TIME HEADING 'Elapsed Time|Spilling Messages' FORMAT
99999999.99

SELECT APPLY_NAME,
       TOTAL_MESSAGES_SPILLED,
       (ELAPSED_SPILL_TIME/100) ELAPSED_SPILL_TIME
FROM V$STREAMS_APPLY_READER;
```

Your output looks similar to the following:

Apply Name	Total Spilled Messages	Elapsed Time Spilling Messages
APPLY_HR	100	2.67

Note: The elapsed time spilling messages is displayed in seconds. The V\$STREAMS_APPLY_READER view displays elapsed time in centiseconds by default. A centisecond is one-hundredth of a second. The query in this section divides each elapsed time by one hundred to display the elapsed time in seconds.

Determining Capture to Dequeue Latency for a Message

The query in this section displays the following information about the last **message** dequeued by each **apply process**:

- The name of the apply process.
- The latency. For **captured LCRs**, the latency is the amount of time between when the message was created at a **source database** and when the message was dequeued by the apply process. For any other type of message, the latency is the amount of time between when the message enqueued at the local database and when the message was dequeued by the apply process.
- The message creation time. For captured LCRs, the message creation time is the time when the data manipulation language (DML) or data definition language (DDL) change generated the redo data at the source database for the message. For messages enqueued by an application or apply process, the message creation time is the last time the message was enqueued. A message can be enqueued one or more additional times by **propagations** before it reaches an apply process.
- The time when the message was dequeued by the apply process.
- The message number of the message that was last dequeued by the apply process.

The information displayed by this query is valid only for an enabled apply process.

Run the following query to display this information for each apply process:

```

COLUMN APPLY_NAME HEADING 'Apply Process|Name' FORMAT A17
COLUMN LATENCY HEADING 'Latency|in|Seconds' FORMAT 999999
COLUMN CREATION HEADING 'Message Creation' FORMAT A17
COLUMN LAST_DEQUEUE HEADING 'Last Dequeue Time' FORMAT A20
COLUMN DEQUEUED_MESSAGE_NUMBER HEADING 'Dequeued|Message Number' FORMAT 999999999
    
```

```

SELECT APPLY_NAME,
       (DEQUEUE_TIME-DEQUEUED_MESSAGE_CREATE_TIME)*86400 LATENCY,
       TO_CHAR(DEQUEUED_MESSAGE_CREATE_TIME, 'HH24:MI:SS MM/DD/YY') CREATION,
       TO_CHAR(DEQUEUE_TIME, 'HH24:MI:SS MM/DD/YY') LAST_DEQUEUE,
       DEQUEUED_MESSAGE_NUMBER
FROM V$STREAMS_APPLY_READER;
    
```

Your output looks similar to the following:

Apply Process Name	Latency in Seconds	Message Creation	Last Dequeue Time	Dequeued Message Number
APPLY\$_STM1_14	1	15:22:15 06/13/05	15:22:16 06/13/05	502129

Displaying General Information About Each Coordinator Process

A **coordinator process** gets transactions from the **reader server** and passes these transactions to **apply servers**. The **coordinator process** name is *APnn*, where *nn* is a coordinator process number.

The query in this section displays the following information about the coordinator process for each **apply process**:

- The apply process name
- The number of the coordinator in the process name *APnn*, where *nn* can include letters and numbers
- The session identifier of the coordinator's session
- The serial number of the coordinator's session
- The current state of the coordinator, either `INITIALIZING`, `APPLYING`, `SHUTTING DOWN CLEANLY`, or `ABORTING`

The information displayed by this query is valid only for an enabled apply process.

Run the following query to display this information for each apply process:

```

COLUMN APPLY_NAME HEADING 'Apply Process|Name' FORMAT A17
COLUMN PROCESS_NAME HEADING 'Coordinator|Process|Name' FORMAT A11
COLUMN SID HEADING 'Session|ID' FORMAT 9999
COLUMN SERIAL# HEADING 'Session|Serial|Number' FORMAT 9999
COLUMN STATE HEADING 'State' FORMAT A21
    
```

```

SELECT c.APPLY_NAME,
       SUBSTR(s.PROGRAM, INSTR(s.PROGRAM, '(')+1,4) PROCESS_NAME,
       c.SID,
       c.SERIAL#,
       c.STATE
FROM V$STREAMS_APPLY_COORDINATOR c, V$SESSION s
WHERE c.SID = s.SID AND
      c.SERIAL# = s.SERIAL#;
    
```

Your output looks similar to the following:

Apply Process Name	Coordinator Process Name	Session ID	Session Serial Number	State
APPLY_SPOKE	AP01	944	5	IDLE

See Also: ["Coordinator Process States"](#) on page 4-17

Displaying Information About Transactions Received and Applied

The query in this section displays the following information about the transactions received, applied, and being applied by each **apply process**:

- The apply process name
- The total number of transactions received by the **coordinator process** since the apply process was last started
- The total number of transactions successfully applied by the apply process since the apply process was last started
- The number of transactions applied by the apply process that resulted in an apply error since the apply process was last started
- The total number of transactions currently being applied by the apply process
- The total number of complete transactions that the coordinator process has received but has not yet assigned to any apply servers
- The total number of transactions received by the coordinator process but ignored because the apply process had already applied the transactions since the apply process was last started

The information displayed by this query is valid only for an enabled apply process.

For example, to display this information for an apply process named `apply`, run the following query:

```

COLUMN APPLY_NAME HEADING 'Apply Process Name' FORMAT A20
COLUMN TOTAL_RECEIVED HEADING 'Total|Trans|Received' FORMAT 99999999
COLUMN TOTAL_APPLIED HEADING 'Total|Trans|Applied' FORMAT 99999999
COLUMN TOTAL_ERRORS HEADING 'Total|Apply|Errors' FORMAT 9999
COLUMN BEING_APPLIED HEADING 'Total|Trans Being|Applied' FORMAT 99999999
COLUMN UNASSIGNED_COMPLETE_TXNS HEADING 'Total|Unassigned|Trans' FORMAT 99999999
COLUMN TOTAL_IGNORED HEADING 'Total|Trans|Ignored' FORMAT 99999999

SELECT APPLY_NAME,
       TOTAL_RECEIVED,
       TOTAL_APPLIED,
       TOTAL_ERRORS,
       (TOTAL_ASSIGNED - (TOTAL_ROLLBACKS + TOTAL_APPLIED)) BEING_APPLIED,
       UNASSIGNED_COMPLETE_TXNS,
       TOTAL_IGNORED
FROM V$STREAMS_APPLY_COORDINATOR;
    
```

Your output looks similar to the following:

Apply Process Name	Total Trans Received	Total Trans Applied	Total Apply Errors	Total Trans Being Applied	Total Unassigned Trans	Total Trans Ignored
APPLY_FROM_MULT1	81	73	2	6	4	0

APPLY_FROM_MULT2	114	96	0	14	7	4
------------------	-----	----	---	----	---	---

Determining the Capture to Apply Latency for a Message for Each Apply Process

This section contains two different queries that show the capture to apply latency for a particular **message**. That is, these queries show the amount of time between when the message was created at a **source database** and when the message was applied by an **apply process**. One query uses the V\$STREAMS_APPLY_COORDINATOR dynamic performance view. The other uses the DBA_APPLY_PROGRESS static data dictionary view.

The two queries differ in the following ways:

- You can use the query on the V\$STREAMS_APPLY_COORDINATOR view to determine capture to apply latency for **captured LCRs** or **persistent LCRs**. However, the query on the DBA_APPLY_PROGRESS view only returns results for captured LCRs.
- The apply process must be enabled when you run the query on the V\$STREAMS_APPLY_COORDINATOR view, while the apply process can be enabled or disabled when you run the query on the DBA_APPLY_PROGRESS view. Therefore, if the apply process is currently disabled and change capture is performed by a capture process, then run the query on the DBA_APPLY_PROGRESS view to determine the capture to apply latency.
- The query on the V\$STREAMS_APPLY_COORDINATOR view can show the latency for a more recent transaction than the query on the DBA_APPLY_PROGRESS view.

Both queries display the following information about a message applied by each apply process:

- The apply process name
- The capture to apply latency for the message
- The message creation time

For captured LCRs, the message creation time is the time when the data manipulation language (DML) or data definition language (DDL) change generated the redo data at the source database for the message.

For persistent LCRs, the message creation time is the time when the LCR was constructed.

- The time when the message was applied by the apply process
- The message number of the message

Note: These queries do not pertain to **persistent user messages**.

Example V\$STREAMS_APPLY_COORDINATOR Query for Latency

Run the following query to display the capture to apply latency using the V\$STREAMS_APPLY_COORDINATOR view for a captured LCR or a persistent LCR for each apply process:

```
COLUMN APPLY_NAME HEADING 'Apply Process|Name' FORMAT A17
COLUMN 'Latency in Seconds' FORMAT 999999
COLUMN 'Message Creation' FORMAT A17
```

```

COLUMN 'Apply Time' FORMAT A17
COLUMN HWM_MESSAGE_NUMBER HEADING 'Applied|Message|Number' FORMAT 9999999999

SELECT APPLY_NAME,
       (HWM_TIME-HWM_MESSAGE_CREATE_TIME)*86400 "Latency in Seconds",
       TO_CHAR(HWM_MESSAGE_CREATE_TIME, 'HH24:MI:SS MM/DD/YY')
       "Message Creation",
       TO_CHAR(HWM_TIME, 'HH24:MI:SS MM/DD/YY') "Apply Time",
       HWM_MESSAGE_NUMBER
FROM V$STREAMS_APPLY_COORDINATOR;

```

Your output looks similar to the following:

Apply Process Name	Latency in Seconds	Message Creation	Apply Time	Applied Message Number
APPLY\$_STM1_14	4	14:05:13 06/13/05	14:05:17 06/13/05	498215

Example DBA_APPLY_PROGRESS Query for Latency

Run the following query to display the capture to apply latency using the DBA_APPLY_PROGRESS view for a captured LCR for each apply process:

```

COLUMN APPLY_NAME HEADING 'Apply Process|Name' FORMAT A17
COLUMN 'Latency in Seconds' FORMAT 999999
COLUMN 'Message Creation' FORMAT A17
COLUMN 'Apply Time' FORMAT A17
COLUMN APPLIED_MESSAGE_NUMBER HEADING 'Applied|Message|Number' FORMAT 9999999999

SELECT APPLY_NAME,
       (APPLY_TIME-APPLIED_MESSAGE_CREATE_TIME)*86400 "Latency in Seconds",
       TO_CHAR(APPLIED_MESSAGE_CREATE_TIME, 'HH24:MI:SS MM/DD/YY')
       "Message Creation",
       TO_CHAR(APPLY_TIME, 'HH24:MI:SS MM/DD/YY') "Apply Time",
       APPLIED_MESSAGE_NUMBER
FROM DBA_APPLY_PROGRESS;

```

Your output looks similar to the following:

Apply Process Name	Latency in Seconds	Message Creation	Apply Time	Applied Message Number
APPLY\$_STM1_14	33	14:05:13 06/13/05	14:05:46 06/13/05	498215

Displaying Information About the Apply Servers for Each Apply Process

An **apply process** can use one or more **apply servers** that apply LCRs to database objects as DML statements or DDL statements or pass the LCRs to their appropriate handlers. For non-LCR **messages**, the apply servers pass the messages to the **message handler**. Each apply server is a process.

The query in this section displays the following information about the apply servers for each apply process:

- The name of the apply process.
- The names of the reader server processes, in order. Each process name is in the form ASnn, where nn can be letters and numbers.

- The current state of each apply server:
 - IDLE
 - RECORD LOW-WATERMARK
 - ADD PARTITION
 - DROP PARTITION
 - EXECUTE TRANSACTION
 - WAIT COMMIT
 - WAIT DEPENDENCY
 - WAIT FOR NEXT CHUNK
 - TRANSACTION CLEANUP
- The total number of transactions assigned to each apply server since the last time the apply process was started. A transaction can contain more than one message.
- The total number of messages applied by each apply server since the last time the apply process was started.

The information displayed by this query is valid only for an enabled apply process.

Run the following query to display information about the apply servers for each apply process:

```

COLUMN APPLY_NAME HEADING 'Apply Process Name' FORMAT A22
COLUMN PROCESS_NAME HEADING 'Process Name' FORMAT A12
COLUMN STATE HEADING 'State' FORMAT A17
COLUMN TOTAL_ASSIGNED HEADING 'Total|Transactions|Assigned' FORMAT 99999999
COLUMN TOTAL_MESSAGES_APPLIED HEADING 'Total|Messages|Applied' FORMAT 99999999

SELECT r.APPLY_NAME,
       SUBSTR(s.PROGRAM, INSTR(S.PROGRAM, '(')+1,4) PROCESS_NAME,
       r.STATE,
       r.TOTAL_ASSIGNED,
       r.TOTAL_MESSAGES_APPLIED
FROM V$STREAMS_APPLY_SERVER R, V$SESSION S
WHERE r.SID = s.SID AND
      r.SERIAL# = s.SERIAL#
ORDER BY r.APPLY_NAME, r.SERVER_ID;
    
```

Your output looks similar to the following:

Apply Process Name	Process Name	State	Total Transactions Assigned	Total Messages Applied
APPLY_SPOKE	AS00	IDLE	2	216
APPLY_SPOKE	AS03	IDLE	1	28
APPLY_SPOKE	AS04	IDLE	1	20

See Also: ["Apply Server States"](#) on page 4-18

Displaying Effective Apply Parallelism for an Apply Process

In some environments, an **apply process** might not use all of the **apply servers** available to it. For example, apply process parallelism can be set to five, but only three apply servers are ever used by the apply process. In this case, the effective apply parallelism is three.

The following query displays the effective apply parallelism for an apply process named `apply`:

```
SELECT COUNT(SERVER_ID) "Effective Parallelism"
   FROM V$STREAMS_APPLY_SERVER
   WHERE APPLY_NAME = 'APPLY' AND
         TOTAL_MESSAGES_APPLIED > 0;
```

Your output looks similar to the following:

```
Effective Parallelism
-----
                      2
```

This query returned two for the effective parallelism. If parallelism is set to three for the apply process named `apply`, then one apply server has not been used since the last time the apply process was started.

You can display the total number of **messages** applied by each apply server by running the following query:

```
COLUMN SERVER_ID HEADING 'Apply Server ID' FORMAT 99
COLUMN TOTAL_MESSAGES_APPLIED HEADING 'Total Messages Applied' FORMAT 999999

SELECT SERVER_ID, TOTAL_MESSAGES_APPLIED
   FROM V$STREAMS_APPLY_SERVER
   WHERE APPLY_NAME = 'APPLY'
   ORDER BY SERVER_ID;
```

Your output looks similar to the following:

```
Apply Server ID Total Messages Applied
-----
                1                2141
                2                 276
                3                 0
```

In this case, apply server 3 has not been used by the apply process since it was last started. If the `parallelism` setting for an apply process is higher than the effective parallelism for the apply process, then consider lowering the `parallelism` setting.

Viewing Rules that Specify a Destination Queue on Apply

You can specify a **destination queue** for a **rule** using the `SET_ENQUEUE_DESTINATION` procedure in the `DBMS_APPLY_ADM` package. If an **apply process** has such a rule in its **positive rule set**, and a **message** satisfies the rule, then the apply process enqueues the message into the destination queue.

To view destination queue settings for rules, run the following query:

```
COLUMN RULE_OWNER HEADING 'Rule Owner' FORMAT A15
COLUMN RULE_NAME HEADING 'Rule Name' FORMAT A15
COLUMN DESTINATION_QUEUE_NAME HEADING 'Destination Queue' FORMAT A30
```

```
SELECT RULE_OWNER, RULE_NAME, DESTINATION_QUEUE_NAME
FROM DBA_APPLY_ENQUEUE;
```

Your output looks similar to the following:

Rule Owner	Rule Name	Destination Queue
STRMADMIN	DEPARTMENTS17	"STRMADMIN"."STREAMS_QUEUE"

See Also:

- ["Specifying That Apply Processes Enqueue Messages"](#) on page 16-11
- ["Enqueue Destinations for Messages During Apply"](#) on page 6-42

Viewing Rules that Specify No Execution on Apply

You can specify an execution directive for a **rule** using the SET_EXECUTE procedure in the DBMS_APPLY_ADM package. An execution directive controls whether a **message** that satisfies the specified rule is executed by an **apply process**. If an apply process has a rule in its **positive rule set** with NO for its execution directive, and a message satisfies the rule, then the apply process does not execute the message and does not send the message to any **apply handler**.

To view each rule with NO for its execution directive, run the following query:

```
COLUMN RULE_OWNER HEADING 'Rule Owner' FORMAT A20
COLUMN RULE_NAME HEADING 'Rule Name' FORMAT A20

SELECT RULE_OWNER, RULE_NAME
FROM DBA_APPLY_EXECUTE
WHERE EXECUTE_EVENT = 'NO';
```

Your output looks similar to the following:

Rule Owner	Rule Name
STRMADMIN	DEPARTMENTS18

See Also:

- ["Specifying Execute Directives for Apply Processes"](#) on page 16-12
- ["Execution Directives for Messages During Apply"](#) on page 6-42

Determining Which Apply Processes Use Combined Capture and Apply

A combined capture and apply environment is efficient because the **capture process** acts as the propagation sender that sends logical change records (LCRs) directly to the propagation receiver.

When an apply process uses combined capture and apply, the following columns in the V\$STREAMS_APPLY_READER data dictionary view are populated:

- PROXY_SID shows the session ID of the propagation receiver
- PROXY_SERIAL shows the serial number of the propagation receiver
- PROXY_SPID shows the process identification number of the propagation receiver
- CAPTURE_BYTES_RECEIVED shows the number of bytes received by the apply process from the capture process since the apply process last started

When an apply process does not use combined capture and apply, the PROXY_SID and PROXY_SERIAL columns are 0 (zero), and the PROXY_SPID and CAPTURE_BYTES_RECEIVED columns are not populated.

To determine whether an apply process uses combined capture and apply, run the following query:

```
COLUMN APPLY_NAME HEADING 'Apply Process Name' FORMAT A20
COLUMN PROXY_SID HEADING 'Propagation|Receiver|Session ID' FORMAT 99999999
COLUMN PROXY_SERIAL HEADING 'Propagation|ReceiverSerial|Number' FORMAT 99999999
COLUMN PROXY_SPID HEADING 'Propagation|Receiver|Process ID' FORMAT 9999999999
COLUMN CAPTURE_BYTES_RECEIVED HEADING 'Number of|Bytes Received' FORMAT 9999999999

SELECT APPLY_NAME,
       PROXY_SID,
       PROXY_SERIAL,
       PROXY_SPID,
       CAPTURE_BYTES_RECEIVED
FROM V$STREAMS_APPLY_READER;
```

Your output looks similar to the following:

Apply Process Name	Propagation Receiver Session ID	Propagation ReceiverSerial Number	Propagation Receiver Process ID	Number of Bytes Received
APPLY_SPOKE1	940	1 22636		4358614
APPLY_SPOKE2	928	4 29154		4310581

This output indicates that the apply_spoke1 apply process uses combined capture and apply. Since it last started, this apply process has received 4358614 bytes from the capture process. The apply_spoke2 apply process also uses combined capture and apply. Since it last started, this apply process has received 4310581 bytes from the capture process.

See Also: ["Combined Capture and Apply Optimization"](#) on page 3-20

Checking for Apply Errors

To check for apply errors, run the following query:

```
COLUMN APPLY_NAME HEADING 'Apply|Process|Name' FORMAT A10
COLUMN SOURCE_DATABASE HEADING 'Source|Database' FORMAT A10
COLUMN LOCAL_TRANSACTION_ID HEADING 'Local|Transaction|ID' FORMAT A11
COLUMN ERROR_NUMBER HEADING 'Error Number' FORMAT 99999999
COLUMN ERROR_MESSAGE HEADING 'Error Message' FORMAT A20
COLUMN MESSAGE_COUNT HEADING 'Messages in|Error|Transaction' FORMAT 99999999

SELECT APPLY_NAME,
       SOURCE_DATABASE,
       LOCAL_TRANSACTION_ID,
       ERROR_NUMBER,
```

```

ERROR_MESSAGE,
MESSAGE_COUNT
FROM DBA_APPLY_ERROR;

```

If there are any apply errors, then your output looks similar to the following:

Apply Process Name	Source Database	Local Transaction ID	Error Number	Error Message	Messages in Error Transaction
APPLY_FROM_MULT3	MULT3.EXAM_PLE.COM	1.62.948	1403	ORA-01403: no data found	1
APPLY_FROM_MULT2	MULT2.EXAM_PLE.COM	1.54.948	1403	ORA-01403: no data found	1

If there are apply errors, then you can either try to reexecute the transactions that encountered the errors, or you can delete the transactions. If you want to reexecute a transaction that encountered an error, then first correct the condition that caused the transaction to raise an error.

If you want to delete a transaction that encountered an error, then you might need to resynchronize data manually if you are sharing data between multiple databases. Remember to set an appropriate session **tag**, if necessary, when you resynchronize data manually.

See Also:

- ["Troubleshooting Apply Process Problems"](#) on page 20-14
- ["The Error Queue"](#) on page 4-21
- ["Managing Apply Errors"](#) on page 16-19
- *Oracle Streams Replication Administrator's Guide* for information about the possible causes of apply errors
- *Oracle Streams Replication Administrator's Guide* for more information about setting tag values generated by the current session

Displaying Detailed Information About Apply Errors

This section contains SQL scripts that you can use to display detailed information about the error transactions in the error queue in a database. These scripts are designed to display information about LCRs, but you can extend them to display information about any non-LCR **messages** used in your environment as well.

To use these scripts, complete the following steps:

1. [Grant Explicit SELECT Privilege on the DBA_APPLY_ERROR View](#)
2. [Create a Procedure that Prints the Value in an ANYDATA Object](#)
3. [Create a Procedure that Prints a Specified LCR](#)
4. [Create a Procedure that Prints All the LCRs in the Error Queue](#)
5. [Create a Procedure that Prints All the Error LCRs for a Transaction](#)

Note: These scripts display only the first 253 characters for VARCHAR2 values in LCRs.

Step 1 Grant Explicit SELECT Privilege on the DBA_APPLY_ERROR View

The user who creates and runs the `print_errors` and `print_transaction` procedures described in the following sections must be granted explicit SELECT privilege on the `DBA_APPLY_ERROR` data dictionary view. This privilege cannot be granted through a role. Running the `GRANT_ADMIN_PRIVILEGE` procedure in the `DBMS_STREAMS_AUTH` package on a user grants this privilege to the user.

To grant this privilege to a user directly, complete the following steps:

1. In SQL*Plus, connect as an administrative user who can grant privileges.
See *Oracle Database Administrator's Guide* for information about connecting to a database in SQL*Plus.
2. Grant SELECT privilege on the `DBA_APPLY_ERROR` data dictionary view to the appropriate user. For example, to grant this privilege to the `strmadmin` user, run the following statement:

```
GRANT SELECT ON DBA_APPLY_ERROR TO strmadmin;
```

3. Grant EXECUTE privilege on the `DBMS_APPLY_ADM` package. For example, to grant this privilege to the `strmadmin` user, run the following statement:

```
GRANT EXECUTE ON DBMS_APPLY_ADM TO strmadmin;
```

4. Connect to the database as the user to whom you granted the privilege in Step 2 and 3.

Step 2 Create a Procedure that Prints the Value in an ANYDATA Object

The following procedure prints the value in a specified ANYDATA object for some selected data types. Optionally, you can add more data types to this procedure.

```
CREATE OR REPLACE PROCEDURE print_any(data IN ANYDATA) IS
  tn VARCHAR2(61);
  str VARCHAR2(4000);
  chr VARCHAR2(1000);
  num NUMBER;
  dat DATE;
  rw RAW(4000);
  res NUMBER;
BEGIN
  IF data IS NULL THEN
    DBMS_OUTPUT.PUT_LINE('NULL value');
    RETURN;
  END IF;
  tn := data.GETTYPENAME();
  IF tn = 'SYS.VARCHAR2' THEN
    res := data.GETVARCHAR2(str);
    DBMS_OUTPUT.PUT_LINE(SUBSTR(str,0,253));
  ELSIF tn = 'SYS.CHAR' then
    res := data.GETCHAR(chr);
    DBMS_OUTPUT.PUT_LINE(SUBSTR(chr,0,253));
  ELSIF tn = 'SYS.VARCHAR' THEN
    res := data.GETVARCHAR(chr);
    DBMS_OUTPUT.PUT_LINE(chr);
  ELSIF tn = 'SYS.NUMBER' THEN
    res := data.GETNUMBER(num);
    DBMS_OUTPUT.PUT_LINE(num);
  ELSIF tn = 'SYS.DATE' THEN
    res := data.GETDATE(dat);
    DBMS_OUTPUT.PUT_LINE(dat);
```

```

ELSIF tn = 'SYS.RAW' THEN
  -- res := data.GETRAW(rw);
  -- DBMS_OUTPUT.PUT_LINE(SUBSTR(DBMS_LOB.SUBSTR(rw),0,253));
  DBMS_OUTPUT.PUT_LINE('BLOB Value');
ELSIF tn = 'SYS.BLOB' THEN
  DBMS_OUTPUT.PUT_LINE('BLOB Found');
ELSE
  DBMS_OUTPUT.PUT_LINE('typename is ' || tn);
END IF;
END print_any;
/

```

Step 3 Create a Procedure that Prints a Specified LCR

The following procedure prints a specified LCR. It calls the `print_any` procedure created in ["Create a Procedure that Prints the Value in an ANYDATA Object"](#) on page 25-18.

```

CREATE OR REPLACE PROCEDURE print_lcr(lcr IN ANYDATA) IS
  typenm    VARCHAR2(61);
  ddlcr     SYS.LCR$_DDL_RECORD;
  proclcr   SYS.LCR$_PROCEDURE_RECORD;
  rowlcr    SYS.LCR$_ROW_RECORD;
  res       NUMBER;
  newlist   SYS.LCR$_ROW_LIST;
  oldlist   SYS.LCR$_ROW_LIST;
  ddl_text  CLOB;
  ext_attr  ANYDATA;
BEGIN
  typenm := lcr.GETTYPENAME();
  DBMS_OUTPUT.PUT_LINE('type name: ' || typenm);
  IF (typenm = 'SYS.LCR$_DDL_RECORD') THEN
    res := lcr.GETOBJECT(ddlcr);
    DBMS_OUTPUT.PUT_LINE('source database: ' ||
                        ddlcr.GET_SOURCE_DATABASE_NAME);
    DBMS_OUTPUT.PUT_LINE('owner: ' || ddlcr.GET_OBJECT_OWNER);
    DBMS_OUTPUT.PUT_LINE('object: ' || ddlcr.GET_OBJECT_NAME);
    DBMS_OUTPUT.PUT_LINE('is tag null: ' || ddlcr.IS_NULL_TAG);
    DBMS_LOB.CREATETEMPORARY(ddl_text, TRUE);
    ddlcr.GET_DDL_TEXT(ddl_text);
    DBMS_OUTPUT.PUT_LINE('ddl: ' || ddl_text);
    -- Print extra attributes in DDL LCR
    ext_attr := ddlcr.GET_EXTRA_ATTRIBUTE('serial#');
    IF (ext_attr IS NOT NULL) THEN
      DBMS_OUTPUT.PUT_LINE('serial#: ' || ext_attr.ACCESSNUMBER());
    END IF;
    ext_attr := ddlcr.GET_EXTRA_ATTRIBUTE('session#');
    IF (ext_attr IS NOT NULL) THEN
      DBMS_OUTPUT.PUT_LINE('session#: ' || ext_attr.ACCESSNUMBER());
    END IF;
    ext_attr := ddlcr.GET_EXTRA_ATTRIBUTE('thread#');
    IF (ext_attr IS NOT NULL) THEN
      DBMS_OUTPUT.PUT_LINE('thread#: ' || ext_attr.ACCESSNUMBER());
    END IF;
    ext_attr := ddlcr.GET_EXTRA_ATTRIBUTE('tx_name');
    IF (ext_attr IS NOT NULL) THEN
      DBMS_OUTPUT.PUT_LINE('transaction name: ' || ext_attr.ACCESSVARCHAR2());
    END IF;
    ext_attr := ddlcr.GET_EXTRA_ATTRIBUTE('username');
    IF (ext_attr IS NOT NULL) THEN
      DBMS_OUTPUT.PUT_LINE('username: ' || ext_attr.ACCESSVARCHAR2());
    END IF;
  END IF;
END print_lcr;

```

```

        END IF;
        DBMS_LOB.FREETEMPORARY(ddl_text);
    ELSIF (typenm = 'SYS.LCR$_ROW_RECORD') THEN
        res := lcr.GETOBJECT(rowlcr);
        DBMS_OUTPUT.PUT_LINE('source database: ' ||
            rowlcr.GET_SOURCE_DATABASE_NAME);
        DBMS_OUTPUT.PUT_LINE('owner: ' || rowlcr.GET_OBJECT_OWNER);
        DBMS_OUTPUT.PUT_LINE('object: ' || rowlcr.GET_OBJECT_NAME);
        DBMS_OUTPUT.PUT_LINE('is tag null: ' || rowlcr.IS_NULL_TAG);
        DBMS_OUTPUT.PUT_LINE('command_type: ' || rowlcr.GET_COMMAND_TYPE);
        oldlist := rowlcr.GET_VALUES('old');
        FOR i IN 1..oldlist.COUNT LOOP
            IF oldlist(i) IS NOT NULL THEN
                DBMS_OUTPUT.PUT_LINE('old(' || i || '): ' || oldlist(i).column_name);
                print_any(oldlist(i).data);
            END IF;
        END LOOP;
        newlist := rowlcr.GET_VALUES('new', 'n');
        FOR i IN 1..newlist.count LOOP
            IF newlist(i) IS NOT NULL THEN
                DBMS_OUTPUT.PUT_LINE('new(' || i || '): ' || newlist(i).column_name);
                print_any(newlist(i).data);
            END IF;
        END LOOP;
        -- Print extra attributes in row LCR
        ext_attr := rowlcr.GET_EXTRA_ATTRIBUTE('row_id');
        IF (ext_attr IS NOT NULL) THEN
            DBMS_OUTPUT.PUT_LINE('row_id: ' || ext_attr.ACCESSUROWID());
        END IF;
        ext_attr := rowlcr.GET_EXTRA_ATTRIBUTE('serial#');
        IF (ext_attr IS NOT NULL) THEN
            DBMS_OUTPUT.PUT_LINE('serial#: ' || ext_attr.ACCESSNUMBER());
        END IF;
        ext_attr := rowlcr.GET_EXTRA_ATTRIBUTE('session#');
        IF (ext_attr IS NOT NULL) THEN
            DBMS_OUTPUT.PUT_LINE('session#: ' || ext_attr.ACCESSNUMBER());
        END IF;
        ext_attr := rowlcr.GET_EXTRA_ATTRIBUTE('thread#');
        IF (ext_attr IS NOT NULL) THEN
            DBMS_OUTPUT.PUT_LINE('thread#: ' || ext_attr.ACCESSNUMBER());
        END IF;
        ext_attr := rowlcr.GET_EXTRA_ATTRIBUTE('tx_name');
        IF (ext_attr IS NOT NULL) THEN
            DBMS_OUTPUT.PUT_LINE('transaction name: ' || ext_attr.ACCESSVARCHAR2());
        END IF;
        ext_attr := rowlcr.GET_EXTRA_ATTRIBUTE('username');
        IF (ext_attr IS NOT NULL) THEN
            DBMS_OUTPUT.PUT_LINE('username: ' || ext_attr.ACCESSVARCHAR2());
        END IF;
    ELSE
        DBMS_OUTPUT.PUT_LINE('Non-LCR Message with type ' || typenm);
    END IF;
END print_lcr;
/

```

Step 4 Create a Procedure that Prints All the LCRs in the Error Queue

The following procedure prints all of the LCRs in all of the error queues. It calls the `print_lcr` procedure created in ["Create a Procedure that Prints a Specified LCR"](#) on page 25-19.

```

CREATE OR REPLACE PROCEDURE print_errors IS
  CURSOR c IS
    SELECT LOCAL_TRANSACTION_ID,
           SOURCE_DATABASE,
           MESSAGE_NUMBER,
           MESSAGE_COUNT,
           ERROR_NUMBER,
           ERROR_MESSAGE
    FROM DBA_APPLY_ERROR
    ORDER BY SOURCE_DATABASE, SOURCE_COMMIT_SCN;
  i      NUMBER;
  txnid  VARCHAR2(30);
  source VARCHAR2(128);
  msgno  NUMBER;
  msgcnt NUMBER;
  errnum NUMBER := 0;
  errno  NUMBER;
  errmsg VARCHAR2(2000);
  lcr    ANYDATA;
  r      NUMBER;
BEGIN
  FOR r IN c LOOP
    errnum := errnum + 1;
    msgcnt := r.MESSAGE_COUNT;
    txnid  := r.LOCAL_TRANSACTION_ID;
    source := r.SOURCE_DATABASE;
    msgno  := r.MESSAGE_NUMBER;
    errno  := r.ERROR_NUMBER;
    errmsg := r.ERROR_MESSAGE;
    DBMS_OUTPUT.PUT_LINE('*****');
    DBMS_OUTPUT.PUT_LINE('----- ERROR #' || errnum);
    DBMS_OUTPUT.PUT_LINE('----- Local Transaction ID: ' || txnid);
    DBMS_OUTPUT.PUT_LINE('----- Source Database: ' || source);
    DBMS_OUTPUT.PUT_LINE('-----Error in Message: ' || msgno);
    DBMS_OUTPUT.PUT_LINE('-----Error Number: ' || errno);
    DBMS_OUTPUT.PUT_LINE('-----Message Text: ' || errmsg);
    FOR i IN 1..msgcnt LOOP
      DBMS_OUTPUT.PUT_LINE('--message: ' || i);
      lcr := DBMS_APPLY_ADM.GET_ERROR_MESSAGE(i, txnid);
      print_lcr(lcr);
    END LOOP;
  END LOOP;
END print_errors;
/

```

To run this procedure after you create it, enter the following:

```

SET SERVEROUTPUT ON SIZE 1000000

EXEC print_errors

```

Step 5 Create a Procedure that Prints All the Error LCRs for a Transaction

The following procedure prints all the LCRs in the error queue for a particular transaction. It calls the `print_lcr` procedure created in ["Create a Procedure that Prints a Specified LCR"](#) on page 25-19.

```

CREATE OR REPLACE PROCEDURE print_transaction(ltxnid IN VARCHAR2) IS
  i      NUMBER;
  txnid  VARCHAR2(30);
  source VARCHAR2(128);

```

```

msgno NUMBER;
msgcnt NUMBER;
errno NUMBER;
errmsg VARCHAR2(2000);
lcr ANYDATA;
BEGIN
  SELECT LOCAL_TRANSACTION_ID,
         SOURCE_DATABASE,
         MESSAGE_NUMBER,
         MESSAGE_COUNT,
         ERROR_NUMBER,
         ERROR_MESSAGE
         INTO txnid, source, msgno, msgcnt, errno, errmsg
         FROM DBA_APPLY_ERROR
         WHERE LOCAL_TRANSACTION_ID = ltxnid;
  DBMS_OUTPUT.PUT_LINE('----- Local Transaction ID: ' || txnid);
  DBMS_OUTPUT.PUT_LINE('----- Source Database: ' || source);
  DBMS_OUTPUT.PUT_LINE('-----Error in Message: ' || msgno);
  DBMS_OUTPUT.PUT_LINE('-----Error Number: ' || errno);
  DBMS_OUTPUT.PUT_LINE('-----Message Text: ' || errmsg);
  FOR i IN 1..msgcnt LOOP
    DBMS_OUTPUT.PUT_LINE('--message: ' || i);
    lcr := DBMS_APPLY_ADM.GET_ERROR_MESSAGE(i, txnid); -- gets the LCR
    print_lcr(lcr);
  END LOOP;
END print_transaction;
/

```

To run this procedure after you create it, pass to it the local transaction identifier of a error transaction. For example, if the local transaction identifier is 1.17.2485, then enter the following:

```

SET SERVEROUTPUT ON SIZE 1000000

EXEC print_transaction('1.17.2485')

```

Monitoring Rules

The following topics describe monitoring **rules**, **rule sets**, and **evaluation contexts**:

- [Displaying All Rules Used by All Oracle Streams Clients](#)
- [Displaying the Oracle Streams Rules Used by a Specific Oracle Streams Client](#)
- [Displaying the Current Condition for a Rule](#)
- [Displaying Modified Rule Conditions for Oracle Streams Rules](#)
- [Displaying the Evaluation Context for Each Rule Set](#)
- [Displaying Information About the Tables Used by an Evaluation Context](#)
- [Displaying Information About the Variables Used in an Evaluation Context](#)
- [Displaying All of the Rules in a Rule Set](#)
- [Displaying the Condition for Each Rule in a Rule Set](#)
- [Listing Each Rule that Contains a Specified Pattern in Its Condition](#)
- [Displaying Aggregate Statistics for All Rule Set Evaluations](#)
- [Displaying Information About Evaluations for Each Rule Set](#)
- [Determining the Resources Used by Evaluation of Each Rule Set](#)
- [Displaying Evaluation Statistics for a Rule](#)

Note: The Oracle Streams tool in the Oracle Enterprise Manager Console is also an excellent way to monitor an Oracle Streams environment. See the online Help for the Oracle Streams tool for more information.

See Also:

- [Chapter 5, "Rules"](#)
- [Chapter 6, "How Rules Are Used in Oracle Streams"](#)
- [Chapter 17, "Managing Rules"](#)
- ["Troubleshooting Problems with Rules and Rule-Based Transformations"](#) on page 20-18
- ["Modifying a Name-Value Pair in a Rule Action Context"](#) on page 17-7 for information about viewing a rule **action context**
- *Oracle Database Reference* for information about the data dictionary views described in this chapter
- *Oracle Streams Replication Administrator's Guide* for information about monitoring an Oracle Streams **replication** environment

Displaying All Rules Used by All Oracle Streams Clients

Oracle Streams **rules** are created using the `DBMS_STREAMS_ADM` package or the Oracle Streams tool in the Oracle Enterprise Manager Console. Oracle Streams rules in the **rule sets** for an **Oracle Streams client** determine the behavior of the Oracle Streams client. Oracle Streams clients include **capture processes**, **propagations**, **apply processes**, and **messaging clients**. The rule sets for an Oracle Streams client can also contain rules created using the `DBMS_RULE_ADM` package, and these rules also determine the behavior of the Oracle Streams client.

For example, if a rule in the **positive rule set** for a capture process evaluates to `TRUE` for DML changes to the `hr.employees` table, then the capture process captures DML changes to this table. However, if a rule in the **negative rule set** for a capture process evaluates to `TRUE` for DML changes to the `hr.employees` table, then the capture process discards DML changes to this table.

You query the following data dictionary views to display all rules in the rule sets for Oracle Streams clients, including Oracle Streams rules and rules created using the `DBMS_RULE_ADM` package:

- `ALL_STREAMS_RULES`
- `DBA_STREAMS_RULES`

In addition, these two views display the current **rule condition** for each rule and whether the rule condition has been modified.

The query in this section displays the following information about all of the rules used by Oracle Streams clients in a database:

- The name of each Oracle Streams client that uses the rule
- The type of each Oracle Streams client that uses the rule, either `CAPTURE` for a capture process, `SYNCHRONOUS CAPTURE` for a synchronous capture, `PROPAGATION` for a propagation, `APPLY` for an apply process, or `DEQUEUE` for a messaging client
- The name of the rule
- The type of rule set that contains the rule for the Oracle Streams client, either `POSITIVE` or `NEGATIVE`
- For Oracle Streams rules, the Oracle Streams rule level, either `GLOBAL`, `SCHEMA`, or `TABLE`

- For Oracle Streams rules, the name of the schema for **schema rules** and **table rules**
- For Oracle Streams rules, the name of the table for table rules
- For Oracle Streams rules, the rule type, either DML or DDL

Run the following query to display this information:

```

COLUMN STREAMS_NAME HEADING 'Oracle|Streams|Name' FORMAT A14
COLUMN STREAMS_TYPE HEADING 'Oracle|Streams|Type' FORMAT A11
COLUMN RULE_NAME HEADING 'Rule|Name' FORMAT A12
COLUMN RULE_SET_TYPE HEADING 'Rule Set|Type' FORMAT A8
COLUMN STREAMS_RULE_TYPE HEADING 'Oracle|Streams|Rule|Level' FORMAT A7
COLUMN SCHEMA_NAME HEADING 'Schema|Name' FORMAT A6
COLUMN OBJECT_NAME HEADING 'Object|Name' FORMAT A11
COLUMN RULE_TYPE HEADING 'Rule|Type' FORMAT A4

SELECT STREAMS_NAME,
       STREAMS_TYPE,
       RULE_NAME,
       RULE_SET_TYPE,
       STREAMS_RULE_TYPE,
       SCHEMA_NAME,
       OBJECT_NAME,
       RULE_TYPE
FROM DBA_STREAMS_RULES;
    
```

Your output looks similar to the following:

Oracle Streams Name	Oracle Streams Type	Rule Name	Rule Set Type	Oracle Streams Rule Level	Schema Name	Object Name	Rule Type
STRM01_CAPTURE	CAPTURE	JOBS4	POSITIVE	TABLE	HR	JOBS	DML
STRM01_CAPTURE	CAPTURE	JOBS5	POSITIVE	TABLE	HR	JOBS	DDL
DBS1_TO_DBS2	PROPAGATION	HR18	POSITIVE	SCHEMA	HR		DDL
DBS1_TO_DBS2	PROPAGATION	HR17	POSITIVE	SCHEMA	HR		DML
APPLY	APPLY	HR20	POSITIVE	SCHEMA	HR		DML
APPLY	APPLY	JOB_HISTORY2	NEGATIVE	TABLE	HR	JOB_HISTORY	DML
OE	DEQUEUE	RULE\$_28	POSITIVE				

This output provides the following information about the rules used by Oracle Streams clients in the database:

- The DML rule `jobs4` and the DDL rule `jobs5` are both table rules for the `hr.jobs` table in the positive rule set for the capture process `strm01_capture`.
- The DML rule `hr17` and the DDL rule `hr18` are both **schema rules** for the `hr` schema in the positive rule set for the propagation `db1_to_db2`.
- The DML rule `hr20` is a schema rule for the `hr` schema in the positive rule set for the apply process `apply`.
- The DML rule `job_history2` is a table rule for the `hr` schema in the negative rule set for the apply process `apply`.
- The rule `rule$_28` is a messaging rule in the positive rule set for the messaging client `oe`.

The `ALL_STREAMS_RULES` and `DBA_STREAMS_RULES` views also contain information about the rule sets used by an Oracle Streams client, the current and original rule condition for Oracle Streams rules, whether the rule condition has been changed, the

subsetting operation and DML condition for each Oracle Streams **subset rule**, the **source database** specified for each Oracle Streams rule, and information about the **message** type and message variable for Oracle Streams messaging rules.

The following data dictionary views also display Oracle Streams rules:

- ALL_STREAMS_GLOBAL_RULES
- DBA_STREAMS_GLOBAL_RULES
- ALL_STREAMS_MESSAGE_RULES
- DBA_STREAMS_MESSAGE_RULES
- ALL_STREAMS_SCHEMA_RULES
- DBA_STREAMS_SCHEMA_RULES
- ALL_STREAMS_TABLE_RULES
- DBA_STREAMS_TABLE_RULES

These views display Oracle Streams rules only. They do not display any manual modifications to these rules made by the DBMS_RULE_ADM package, and they do not display rules created using the DBMS_RULE_ADM package. These views can display the original rule condition for each rule only. They do not display the current rule condition for a rule if the rule condition was modified after the rule was created.

Displaying the Oracle Streams Rules Used by a Specific Oracle Streams Client

To determine which **rules** are in a **rule set** used by a particular **Oracle Streams client**, you can query the DBA_STREAMS_RULES data dictionary view. For example, suppose a database is running an **apply process** named strm01_apply. The following sections describe how to determine the rules in the **positive rule set** and **negative rule set** for this apply process.

The following sections describe how to determine which rules are in a rule set used by a particular Oracle Streams client:

- [Displaying the Rules in the Positive Rule Set for an Oracle Streams Client](#)
- [Displaying the Rules in the Negative Rule Set for an Oracle Streams Client](#)

See Also:

- ["System-Created Rules"](#) on page 6-5

Displaying the Rules in the Positive Rule Set for an Oracle Streams Client

The following query displays all of the **rules** in the **positive rule set** for an **apply process** named strm01_apply:

```
COLUMN RULE_OWNER HEADING 'Rule Owner' FORMAT A10
COLUMN RULE_NAME HEADING 'Rule|Name' FORMAT A12
COLUMN STREAMS_RULE_TYPE HEADING 'Oracle Streams|Rule|Level' FORMAT A7
COLUMN SCHEMA_NAME HEADING 'Schema|Name' FORMAT A6
COLUMN OBJECT_NAME HEADING 'Object|Name' FORMAT A11
COLUMN RULE_TYPE HEADING 'Rule|Type' FORMAT A4
COLUMN SOURCE_DATABASE HEADING 'Source' FORMAT A10
COLUMN INCLUDE_TAGGED_LCR HEADING 'Apply|Tagged|LCRs?' FORMAT A9
```

```

SELECT RULE_OWNER,
       RULE_NAME,
       STREAMS_RULE_TYPE,
       SCHEMA_NAME,
       OBJECT_NAME,
       RULE_TYPE,
       SOURCE_DATABASE,
       INCLUDE_TAGGED_LCR
FROM DBA_STREAMS_RULES
WHERE STREAMS_NAME = 'STRM01_APPLY' AND
      RULE_SET_TYPE = 'POSITIVE';
    
```

If this query returns any rows, then the apply process applies LCRs containing changes that evaluate to TRUE for the rules.

Your output looks similar to the following:

Rule Owner	Rule Name	Oracle Streams Rule Level	Schema Name	Object Name	Rule Type	Source	Apply Tagged LCRs?
STRMADMIN	HR20	SCHEMA	HR		DML	DBS1.EXAM PLE.COM	NO
STRMADMIN	HR21	SCHEMA	HR		DDL	DBS1.EXAM PLE.COM	NO

Assuming the **rule conditions** for the Oracle Streams rules returned by this query have not been modified, these results show that the apply process applies LCRs containing DML changes and DDL changes to the hr schema and that the LCRs originated at the dbs1.example.com database. The rules in the positive rule set that instruct the apply process to apply these LCRs are owned by the strmadmin user and are named hr20 and hr21. Also, the apply process applies an LCR that satisfies one of these rules only if the **tag** in the LCR is NULL.

If the rule condition for an Oracle Streams rule has been modified, then you must check the current rule condition to determine the effect of the rule on an **Oracle Streams client**. Oracle Streams rules whose rule condition has been modified have NO for the SAME_RULE_CONDITION column.

See Also:

- ["Displaying Modified Rule Conditions for Oracle Streams Rules"](#) on page 26-7

Displaying the Rules in the Negative Rule Set for an Oracle Streams Client

The following query displays all of the **rules** in the **negative rule set** for an **apply process** named strm01_apply:

```

COLUMN RULE_OWNER HEADING 'Rule Owner' FORMAT A10
COLUMN RULE_NAME HEADING 'Rule|Name' FORMAT A15
COLUMN STREAMS_RULE_TYPE HEADING 'Oracle Streams|Rule|Level' FORMAT A7
COLUMN SCHEMA_NAME HEADING 'Schema|Name' FORMAT A6
COLUMN OBJECT_NAME HEADING 'Object|Name' FORMAT A11
COLUMN RULE_TYPE HEADING 'Rule|Type' FORMAT A4
COLUMN SOURCE_DATABASE HEADING 'Source' FORMAT A10
COLUMN INCLUDE_TAGGED_LCR HEADING 'Apply|Tagged|LCRs?' FORMAT A9
    
```

```

SELECT RULE_OWNER,
       RULE_NAME,
       STREAMS_RULE_TYPE,
       SCHEMA_NAME,
       OBJECT_NAME,
       RULE_TYPE,
       SOURCE_DATABASE,
       INCLUDE_TAGGED_LCR
FROM DBA_STREAMS_RULES
WHERE STREAMS_NAME = 'APPLY' AND
      RULE_SET_TYPE = 'NEGATIVE';

```

If this query returns any rows, then the apply process discards LCRs containing changes that evaluate to TRUE for the rules.

Your output looks similar to the following:

Rule		Oracle Streams			Apply		
Rule Owner	Rule Name	Rule Level	Schema Name	Object Name	Rule Type Source	Tagged LCRs?	
STRMADMIN	JOB_HISTORY22	TABLE	HR	JOB_HISTORY	DML DBS1.EXAMP LE.COM	YES	
STRMADMIN	JOB_HISTORY23	TABLE	HR	JOB_HISTORY	DDL DBS1.EXAMP LE.COM	YES	

Assuming the **rule conditions** for the Oracle Streams rules returned by this query have not been modified, these results show that the apply process discards LCRs containing DML changes and DDL changes to the `hr.job_history` table and that the LCRs originated at the `db1.example.com` database. The rules in the negative rule set that instruct the apply process to discard these LCRs are owned by the `strmadmin` user and are named `job_history22` and `job_history23`. Also, the apply process discards an LCR that satisfies one of these rules regardless of the value of the **tag** in the LCR.

If the rule condition for an Oracle Streams rule has been modified, then you must check the current rule condition to determine the effect of the rule on an **Oracle Streams client**. Oracle Streams rules whose rule condition has been modified have NO for the `SAME_RULE_CONDITION` column.

See Also:

- ["Displaying Modified Rule Conditions for Oracle Streams Rules"](#) on page 26-7

Displaying the Current Condition for a Rule

If you know the name of a **rule**, then you can display its **rule condition**. For example, consider the rule returned by the query in ["Displaying the Oracle Streams Rules Used by a Specific Oracle Streams Client"](#) on page 26-4. The name of the rule is `hr1`, and you can display its condition by running the following query:

```

SET LONG 8000
SET PAGES 8000
SELECT RULE_CONDITION "Current Rule Condition"
FROM DBA_STREAMS_RULES
WHERE RULE_NAME = 'HR1' AND
      RULE_OWNER = 'STRMADMIN';

```

Your output looks similar to the following:

Current Rule Condition

```
-----
(:dml.get_object_owner() = 'HR' and :dml.is_null_tag() = 'Y' and
:dml.get_source_database_name() = 'DBS1.EXAMPLE.COM' )
```

See Also:

- ["Rule Condition"](#) on page 5-1
- ["System-Created Rules"](#) on page 6-5

Displaying Modified Rule Conditions for Oracle Streams Rules

It is possible to modify the **rule condition** of an Oracle Streams **rule**. These modifications can change the behavior of the **Oracle Streams clients** using the Oracle Streams rule. In addition, some modifications can degrade rule evaluation performance.

The following query displays the rule name, the original rule condition, and the current rule condition for each Oracle Streams rule whose condition has been modified:

```
COLUMN RULE_NAME HEADING 'Rule Name' FORMAT A12
COLUMN ORIGINAL_RULE_CONDITION HEADING 'Original Rule Condition' FORMAT A33
COLUMN RULE_CONDITION HEADING 'Current Rule Condition' FORMAT A33

SET LONG 8000
SET PAGES 8000
SELECT RULE_NAME, ORIGINAL_RULE_CONDITION, RULE_CONDITION
FROM DBA_STREAMS_RULES
WHERE SAME_RULE_CONDITION = 'NO';
```

Your output looks similar to the following:

Rule Name	Original Rule Condition	Current Rule Condition
HR20	((:dml.get_object_owner() = 'HR') and :dml.is_null_tag() = 'Y')	((:dml.get_object_owner() = 'HR') and :dml.is_null_tag() = 'Y' and :dml.get_object_name() != 'JOB_HISTORY')

In this example, the output shows that the condition of the hr20 rule has been modified. Originally, this **schema rule** evaluated to TRUE for all changes to the hr schema. The current modified condition for this rule evaluates to TRUE for all changes to the hr schema, except for DML changes to the hr.job_history table.

Note: The query in this section applies only to Oracle Streams rules. It does not apply to rules created using the DBMS_RULE_ADM package because these rules always show NULL for the ORIGINAL_RULE_CONDITION column and NULL for the SAME_RULE_CONDITION column.

See Also:

- ["Rule Condition"](#) on page 5-1
- ["System-Created Rules"](#) on page 6-5

Displaying the Evaluation Context for Each Rule Set

The following query displays the default **evaluation context** for each **rule set** in a database:

```
COLUMN RULE_SET_OWNER HEADING 'Rule Set|Owner' FORMAT A10
COLUMN RULE_SET_NAME HEADING 'Rule Set Name' FORMAT A20
COLUMN RULE_SET_EVAL_CONTEXT_OWNER HEADING 'Eval Context|Owner' FORMAT A12
COLUMN RULE_SET_EVAL_CONTEXT_NAME HEADING 'Eval Context Name' FORMAT A30

SELECT RULE_SET_OWNER,
       RULE_SET_NAME,
       RULE_SET_EVAL_CONTEXT_OWNER,
       RULE_SET_EVAL_CONTEXT_NAME
FROM DBA_RULE_SETS;
```

Your output looks similar to the following:

Rule Set		Eval Context	
Owner	Rule Set Name	Owner	Eval Context Name
STRMADMIN	RULESET\$_2	SYS	STREAMS\$_EVALUATION_CONTEXT
STRMADMIN	STRM02_QUEUE_R	STRMADMIN	AQ\$_STRM02_QUEUE_TABLE_V
STRMADMIN	APPLY_OE_RS	STRMADMIN	OE_EVAL_CONTEXT
STRMADMIN	OE_QUEUE_R	STRMADMIN	AQ\$_OE_QUEUE_TABLE_V
STRMADMIN	AQ\$_1_RE	STRMADMIN	AQ\$_OE_QUEUE_TABLE_V
SUPPORT	RS	SUPPORT	EVALCTX
OE	NOTIFICATION_QUEUE_R	OE	AQ\$_NOTIFICATION_QUEUE_TABLE_V

See Also:

- ["Rule Evaluation Context"](#) on page 5-5
- ["Evaluation Contexts Used in Oracle Streams"](#) on page 6-37

Displaying Information About the Tables Used by an Evaluation Context

The following query displays information about the tables used by an **evaluation context** named `evalctx`, which is owned by the `support` user:

```
COLUMN TABLE_ALIAS HEADING 'Table Alias' FORMAT A20
COLUMN TABLE_NAME HEADING 'Table Name' FORMAT A40

SELECT TABLE_ALIAS,
       TABLE_NAME
FROM DBA_EVALUATION_CONTEXT_TABLES
WHERE EVALUATION_CONTEXT_OWNER = 'SUPPORT' AND
      EVALUATION_CONTEXT_NAME = 'EVALCTX';
```

Your output looks similar to the following:

Table Alias	Table Name
PROB	problems

See Also: ["Rule Evaluation Context"](#) on page 5-5

Displaying Information About the Variables Used in an Evaluation Context

The following query displays information about the variables used by an **evaluation context** named `evalctx`, which is owned by the `support` user:

```
COLUMN VARIABLE_NAME HEADING 'Variable Name' FORMAT A15
COLUMN VARIABLE_TYPE HEADING 'Variable Type' FORMAT A15
COLUMN VARIABLE_VALUE_FUNCTION HEADING 'Variable Value|Function' FORMAT A20
COLUMN VARIABLE_METHOD_FUNCTION HEADING 'Variable Method|Function' FORMAT A20

SELECT VARIABLE_NAME,
       VARIABLE_TYPE,
       VARIABLE_VALUE_FUNCTION,
       VARIABLE_METHOD_FUNCTION
FROM DBA_EVALUATION_CONTEXT_VARS
WHERE EVALUATION_CONTEXT_OWNER = 'SUPPORT' AND
      EVALUATION_CONTEXT_NAME = 'EVALCTX';
```

Your output looks similar to the following:

Variable Name	Variable Type	Variable Value Function	Variable Method Function
-----	-----	-----	-----
CURRENT_TIME	DATE	timefunc	

See Also: ["Rule Evaluation Context"](#) on page 5-5

Displaying All of the Rules in a Rule Set

The query in this section displays the following information about all of the **rules** in a **rule set**:

- The owner of the rule.
- The name of the rule.
- The **evaluation context** for the rule, if any. If a rule does not have an evaluation context, and no evaluation context is specified in the `ADD_RULE` procedure when the rule is added to a rule set, then it inherits the evaluation context of the rule set.
- The evaluation context owner, if the rule has an evaluation context.

For example, to display this information for each rule in a rule set named `oe_queue_r` that is owned by the user `strmadmin`, run the following query:

```
COLUMN RULE_OWNER HEADING 'Rule Owner' FORMAT A10
COLUMN RULE_NAME HEADING 'Rule Name' FORMAT A20
COLUMN RULE_EVALUATION_CONTEXT_NAME HEADING 'Eval Context Name' FORMAT A27
COLUMN RULE_EVALUATION_CONTEXT_OWNER HEADING 'Eval Context|Owner' FORMAT A11

SELECT R.RULE_OWNER,
       R.RULE_NAME,
       R.RULE_EVALUATION_CONTEXT_NAME,
       R.RULE_EVALUATION_CONTEXT_OWNER
FROM DBA_RULES R, DBA_RULE_SET_RULES RS
WHERE RS.RULE_SET_OWNER = 'STRMADMIN' AND
      RS.RULE_SET_NAME = 'OE_QUEUE_R' AND
      RS.RULE_NAME = R.RULE_NAME AND
      RS.RULE_OWNER = R.RULE_OWNER;
```

Your output looks similar to the following:

Rule Owner	Rule Name	Eval Context Name	Eval Context Owner
STRMADMIN	HR1	STREAMS\$_EVALUATION_CONTEXT	SYS
STRMADMIN	APPLY_LCRS	STREAMS\$_EVALUATION_CONTEXT	SYS
STRMADMIN	OE_QUEUE\$3		
STRMADMIN	APPLY_ACTION		

Displaying the Condition for Each Rule in a Rule Set

The following query displays the condition for each **rule** in a **rule set** named hr_queue_r that is owned by the user strmadmin:

```

SET LONGCHUNKSIZE 4000
SET LONG 4000
COLUMN RULE_OWNER HEADING 'Rule Owner' FORMAT A15
COLUMN RULE_NAME HEADING 'Rule Name' FORMAT A15
COLUMN RULE_CONDITION HEADING 'Rule Condition' FORMAT A45

SELECT R.RULE_OWNER,
       R.RULE_NAME,
       R.RULE_CONDITION
FROM DBA_RULES R, DBA_RULE_SET_RULES RS
WHERE RS.RULE_SET_OWNER = 'STRMADMIN' AND
      RS.RULE_SET_NAME = 'HR_QUEUE_R' AND
      RS.RULE_NAME = R.RULE_NAME AND
      RS.RULE_OWNER = R.RULE_OWNER;

```

Your output looks similar to the following:

Rule Owner	Rule Name	Rule Condition
STRMADMIN	APPLY_ACTION	hr.get_hr_action(tab.user_data) = 'APPLY'
STRMADMIN	APPLY_LCRS	:dml.get_object_owner() = 'HR' AND (:dml.get_object_name() = 'DEPARTMENTS' OR :dml.get_object_name() = 'EMPLOYEES')
STRMADMIN	HR_QUEUE\$3	hr.get_hr_action(tab.user_data) != 'APPLY'

See Also:

- ["Rule Condition"](#) on page 5-1
- ["System-Created Rules"](#) on page 6-5

Listing Each Rule that Contains a Specified Pattern in Its Condition

To list each **rule** in a database that contains a specified pattern in its condition, you can query the DBMS_RULES data dictionary view and use the DBMS_LOB.INSTR function to search for the pattern in the **rule conditions**. For example, the following query lists each rule that contains the pattern 'HR' in its condition:

```

COLUMN RULE_OWNER HEADING 'Rule Owner' FORMAT A30
COLUMN RULE_NAME HEADING 'Rule Name' FORMAT A30

SELECT RULE_OWNER, RULE_NAME FROM DBA_RULES
WHERE DBMS_LOB.INSTR(RULE_CONDITION, 'HR', 1, 1) > 0;

```

Your output looks similar to the following:

Rule Owner	Rule Name
STRMADMIN	DEPARTMENTS4
STRMADMIN	DEPARTMENTS5
STRMADMIN	DEPARTMENTS6

Displaying Aggregate Statistics for All Rule Set Evaluations

You can query the `V$RULE_SET_AGGREGATE_STATS` dynamic performance view to display statistics for all **rule set** evaluations since the database instance last started.

The query in this section contains the following information about rule set evaluations:

- The number of rule set evaluations.
- The number of rule set evaluations that were instructed to stop on the first hit.
- The number of rule set evaluations that were instructed to evaluate only simple **rules**.
- The number of times a rule set was evaluated without issuing any SQL. Generally, issuing SQL to evaluate rules is more expensive than evaluating rules without issuing SQL.
- The number of centiseconds of CPU time used for rule set evaluation.
- The number of centiseconds spent on rule set evaluation.
- The number of SQL executions issued to evaluate a rule in a rule set.
- The number of **rule conditions** processed during rule set evaluation.
- The number of TRUE rules returned to the **rules engine** clients.
- The number of MAYBE rules returned to the rules engine clients.
- The number of times the following types of functions were called during rule set evaluation: variable value function, variable method function, and evaluation function.

Run the following query to display this information:

```
COLUMN NAME HEADING 'Name of Statistic' FORMAT A55
COLUMN VALUE HEADING 'Value' FORMAT 999999999
```

```
SELECT NAME, VALUE FROM V$RULE_SET_AGGREGATE_STATS;
```

Your output looks similar to the following:

Name of Statistic	Value
rule set evaluations (all)	5584
rule set evaluations (first_hit)	5584
rule set evaluations (simple_rules_only)	3675
rule set evaluations (SQL free)	5584
rule set evaluation time (CPU)	179
rule set evaluation time (elapsed)	1053
rule set SQL executions	0
rule set conditions processed	11551
rule set true rules	10
rule set maybe rules	328
rule set user function calls (variable value function)	182

```
rule set user function calls (variable method function)    12794
rule set user function calls (evaluation function)        3857
```

Note: A centisecond is one-hundredth of a second. So, for example, this output shows 1.79 seconds of CPU time and 10.53 seconds of elapsed time.

Displaying Information About Evaluations for Each Rule Set

You can query the V\$RULE_SET dynamic performance view to display information about evaluations for each **rule set** since the database instance last started. The query in this section contains the following information about each rule set in a database:

- The owner of the rule set.
- The name of the rule set.
- The total number of evaluations of the rule set since the database instance last started.
- The total number of times SQL was executed to evaluate **rules** since the database instance last started. Generally, issuing SQL to evaluate rules is more expensive than evaluating rules without issuing SQL.
- The total number of evaluations on the rule set that did not issue SQL to evaluate rules since the database instance last started.
- The total number of TRUE rules returned to the **rules engine** clients using the rule set since the database instance last started.
- The total number of MAYBE rules returned to the rules engine clients using the rule set since the database instance last started.

Run the following query to display this information for each rule set in the database:

```
COLUMN OWNER HEADING 'Rule Set|Owner' FORMAT A9
COLUMN NAME HEADING 'Rule Set|Name' FORMAT A11
COLUMN EVALUATIONS HEADING 'Total|Evaluations' FORMAT 9999999999
COLUMN SQL_EXECUTIONS HEADING 'SQL|Executions' FORMAT 9999999999
COLUMN SQL_FREE_EVALUATIONS HEADING 'SQL Free|Evaluations' FORMAT 9999999999
COLUMN TRUE_RULES HEADING 'True|Rules' FORMAT 9999999999
COLUMN MAYBE_RULES HEADING 'Maybe|Rules' FORMAT 9999999999

SELECT OWNER,
       NAME,
       EVALUATIONS,
       SQL_EXECUTIONS,
       SQL_FREE_EVALUATIONS,
       TRUE_RULES,
       MAYBE_RULES
FROM V$RULE_SET;
```

Your output looks similar to the following:

Rule Set Owner	Rule Set Name	Total Evaluations	SQL Executions	SQL Free Evaluations	True Rules	Maybe Rules
STRMADMIN	RULESET\$_18	403	0	403	0	200
STRMADMIN	RULESET\$_9	3454	0	3454	5	64

Note: Querying the V\$RULE_SET view can have a negative impact on performance if a database has a large library cache.

Determining the Resources Used by Evaluation of Each Rule Set

You can query the V\$RULE_SET dynamic performance view to determine the resources used by evaluation of a **rule set** since the database instance last started. If a rule set was evaluated more than one time since the database instance last started, then some statistics are cumulative, including statistics for the amount of CPU time, evaluation time, and shared memory bytes used.

The query in this section contains the following information about each rule set in a database:

- The owner of the rule set
- The name of the rule set
- The total number of seconds of CPU time used to evaluate the rule set since the database instance last started
- The total number of seconds used to evaluate the rule set since the database instance last started
- The total number of shared memory bytes used to evaluate the rule set since the database instance last started

Run the following query to display this information for each rule set in the database:

```

COLUMN OWNER HEADING 'Rule Set|Owner' FORMAT A15
COLUMN NAME HEADING 'Rule Set Name' FORMAT A15
COLUMN CPU_SECONDS HEADING 'Seconds|of CPU|Time' FORMAT 999999.999
COLUMN ELAPSED_SECONDS HEADING 'Seconds of|Evaluation|Time' FORMAT 999999.999
COLUMN SHARABLE_MEM HEADING 'Bytes|of Shared|Memory' FORMAT 999999999

SELECT OWNER,
       NAME,
       (CPU_TIME/100) CPU_SECONDS,
       (ELAPSED_TIME/100) ELAPSED_SECONDS,
       SHARABLE_MEM
FROM V$RULE_SET;
```

Your output looks similar to the following:

Rule Set Owner	Rule Set Name	Seconds of CPU Time	Seconds of Evaluation Time	Bytes of Shared Memory
STRMADMIN	RULESET\$_18	.840	8.550	444497
STRMADMIN	RULESET\$_9	.700	1.750	444496

Note: Querying the V\$RULE_SET view can have a negative impact on performance if a database has a large library cache.

Displaying Evaluation Statistics for a Rule

You can query the V\$RULE dynamic performance view to display evaluation statistics for a particular **rule** since the database instance last started. The query in this section contains the following information about each **rule set** in a database:

- The total number of times the rule evaluated to TRUE since the database instance last started.
- The total number of times the rule evaluated to MAYBE since the database instance last started.
- The total number of evaluations on the rule that issued SQL since the database instance last started. Generally, issuing SQL to evaluate a rule is more expensive than evaluating the rule without issuing SQL.

For example, run the following query to display this information for the `locations25` rule in the `strmadmin` schema:

```
COLUMN TRUE_HITS HEADING 'True Evaluations' FORMAT 9999999999
COLUMN MAYBE_HITS HEADING 'Maybe Evaluations' FORMAT 9999999999
COLUMN SQL_EVALUATIONS HEADING 'SQL Evaluations' FORMAT 9999999999

SELECT TRUE_HITS, MAYBE_HITS, SQL_EVALUATIONS
       FROM V$RULE
       WHERE RULE_OWNER = 'STRMADMIN' AND
             RULE_NAME = 'LOCATIONS25';
```

Your output looks similar to the following:

```
True Evaluations Maybe Evaluations SQL Evaluations
-----
                1518                154                0
```

Monitoring Rule-Based Transformations

A rule-based transformation is any modification to a **message** that results when a **rule** in a **positive rule set** evaluates to TRUE. This chapter provides sample queries that you can use to monitor rule-based transformations.

The following topics describe monitoring rule-based transformations:

- [Displaying Information About All Rule-Based Transformations](#)
- [Displaying Declarative Rule-Based Transformations](#)
- [Displaying Custom Rule-Based Transformations](#)

Note: The Oracle Streams tool in the Oracle Enterprise Manager Console is also an excellent way to monitor an Oracle Streams environment. See the online Help for the Oracle Streams tool for more information.

See Also:

- [Chapter 7, "Rule-Based Transformations"](#)
- [Chapter 18, "Managing Rule-Based Transformations"](#)
- *Oracle Database Reference* for information about the data dictionary views described in this chapter
- *Oracle Streams Replication Administrator's Guide* for information about monitoring an Oracle Streams **replication** environment

Displaying Information About All Rule-Based Transformations

The query in this section displays the following information about each **rule-based transformation** in a database:

- The owner of the **rule** for which a rule-based transformation is specified
- The name of the rule for which a rule-based transformation is specified
- The type of rule-based transformation:
 - SUBSET RULE is displayed for **subset rules**, which use internal rule-based transformations.
 - DECLARATIVE TRANSFORMATION is displayed for **declarative rule-based transformations**.

- CUSTOM TRANSFORMATION is displayed for **custom rule-based transformations**.

Run the following query to display this information for the rule-based transformations in a database:

```
COLUMN RULE_OWNER HEADING 'Rule Owner' FORMAT A20
COLUMN RULE_NAME HEADING 'Rule Name' FORMAT A20
COLUMN TRANSFORM_TYPE HEADING 'Transformation Type' FORMAT A30

SELECT RULE_OWNER,
       RULE_NAME,
       TRANSFORM_TYPE
FROM DBA_STREAMS_TRANSFORMATIONS;
```

Your output looks similar to the following:

Rule Owner	Rule Name	Transformation Type
STRMADMIN	EMPLOYEES23	DECLARATIVE TRANSFORMATION
STRMADMIN	JOBS26	DECLARATIVE TRANSFORMATION
STRMADMIN	DEPARTMENTS33	SUBSET RULE
STRMADMIN	DEPARTMENTS32	SUBSET RULE
STRMADMIN	DEPARTMENTS34	SUBSET RULE
STRMADMIN	DEPARTMENTS32	CUSTOM TRANSFORMATION
STRMADMIN	DEPARTMENTS33	CUSTOM TRANSFORMATION
STRMADMIN	DEPARTMENTS34	CUSTOM TRANSFORMATION

Displaying Declarative Rule-Based Transformations

A **declarative rule-based transformation** is a rule-based transformation that covers one of a common set of transformation scenarios for row LCRs. Declarative rule-based transformations are run internally without using PL/SQL.

The query in this section displays the following information about each declarative rule-based transformation in a database:

- The owner of the **rule** for which a declarative rule-based transformation is specified.
- The name of the rule for which a declarative rule-based transformation is specified.
- The type of declarative rule-based transformation specified. The following types are possible: ADD COLUMN, DELETE COLUMN, RENAME COLUMN, RENAME SCHEMA, and RENAME TABLE.
- The precedence of the declarative rule-based transformation. The precedence is the execution order of a transformation in relation to other transformations with the same step number specified for the same rule. For transformations with the same step number, the transformation with the lowest precedence is executed first.
- The step number of the declarative rule-based transformation. If more than one declarative rule-based transformation is specified for the same rule, then the transformation with the lowest step number is executed first. You can specify the step number for a declarative rule-based transformation when you create the transformation.

Run the following query to display this information for the declarative rule-based transformations in a database:

```

COLUMN RULE_OWNER HEADING 'Rule Owner' FORMAT A15
COLUMN RULE_NAME HEADING 'Rule Name' FORMAT A15
COLUMN DECLARATIVE_TYPE HEADING 'Declarative|Type' FORMAT A15
COLUMN PRECEDENCE HEADING 'Precedence' FORMAT 99999
COLUMN STEP_NUMBER HEADING 'Step Number' FORMAT 99999

SELECT RULE_OWNER,
       RULE_NAME,
       DECLARATIVE_TYPE,
       PRECEDENCE,
       STEP_NUMBER
FROM DBA_STREAMS_TRANSFORMATIONS
WHERE TRANSFORM_TYPE = 'DECLARATIVE TRANSFORMATION';

```

Your output looks similar to the following:

Rule Owner	Rule Name	Declarative Type	Precedence	Step Number
STRMADMIN	JOBS26	RENAME TABLE	4	0
STRMADMIN	EMPLOYEES23	ADD COLUMN	3	0

Based on this output, the ADD COLUMN transformation executes before the RENAME TABLE transformation because the step number is the same (zero) for both transformations and the ADD COLUMN transformation has the lower precedence.

When you determine which types of declarative rule-based transformations are in a database, you can display more detailed information about each transformation. The following data dictionary views contain detailed information about the various types of declarative rule-based transformations:

- The DBA_STREAMS_ADD_COLUMN view contains information about ADD COLUMN declarative transformations.
- The DBA_STREAMS_DELETE_COLUMN view contains information about DELETE COLUMN declarative transformations.
- The DBA_STREAMS_RENAME_COLUMN view contains information about RENAME COLUMN declarative transformations.
- The DBA_STREAMS_RENAME_SCHEMA view contains information about RENAME SCHEMA declarative transformations.
- The DBA_STREAMS_RENAME_TABLE view contains information about RENAME TABLE declarative transformations.

For example, the previous query listed an ADD COLUMN transformation and a RENAME TABLE transformation. The following sections contain queries that display detailed information about these transformations:

- [Displaying Information About ADD COLUMN Transformations](#)
- [Displaying Information About RENAME TABLE Transformations](#)

Note: Precedence and step number pertain only to declarative rule-based transformations. They do not pertain to **subset rule** transformations or **custom rule-based transformations**.

See Also:

- ["Declarative Rule-Based Transformations"](#) on page 7-1
- ["Managing Declarative Rule-Based Transformations"](#) on page 18-1

Displaying Information About ADD COLUMN Transformations

The following query displays detailed information about the ADD COLUMN **declarative rule-based transformations** in a database:

```

COLUMN RULE_OWNER HEADING 'Rule|Owner' FORMAT A9
COLUMN RULE_NAME HEADING 'Rule|Name' FORMAT A12
COLUMN SCHEMA_NAME HEADING 'Schema|Name' FORMAT A6
COLUMN TABLE_NAME HEADING 'Table|Name' FORMAT A9
COLUMN COLUMN_NAME HEADING 'Column|Name' FORMAT A10
COLUMN COLUMN_TYPE HEADING 'Column|Type' FORMAT A8

SELECT RULE_OWNER,
       RULE_NAME,
       SCHEMA_NAME,
       TABLE_NAME,
       COLUMN_NAME,
       ANYDATA.AccessDate(COLUMN_VALUE) "Value",
       COLUMN_TYPE
FROM DBA_STREAMS_ADD_COLUMN;
    
```

Your output looks similar to the following:

Rule Owner	Rule Name	Schema Name	Table Name	Column Name	Value	Column Type
STRMADMIN	EMPLOYEES23	HR	EMPLOYEES	BIRTH_DATE		SYS.DATE

This output show the following information about the ADD COLUMN declarative rule-based transformation:

- It is specified on the `employees23` **rule** in the `strmadmin` schema.
- It adds a column to row LCRs that involve the `employees` table in the `hr` schema.
- The column name of the added column is `birth_date`.
- The value of the added column is NULL. Notice that the `COLUMN_VALUE` column in the `DBA_STREAMS_ADD_COLUMN` view is type `ANYDATA`. In this example, because the column type is `DATE`, the `ANYDATA.AccessDate` member function is used to display the value. Use the appropriate member function to display values of other types.
- The type of the added column is `DATE`.

Displaying Information About RENAME TABLE Transformations

The following query displays detailed information about the RENAME TABLE **declarative rule-based transformations** in a database:

```

COLUMN RULE_OWNER HEADING 'Rule|Owner' FORMAT A10
COLUMN RULE_NAME HEADING 'Rule|Name' FORMAT A10
COLUMN FROM_SCHEMA_NAME HEADING 'From|Schema|Name' FORMAT A10
COLUMN TO_SCHEMA_NAME HEADING 'To|Schema|Name' FORMAT A10
COLUMN FROM_TABLE_NAME HEADING 'From|Table|Name' FORMAT A15
COLUMN TO_TABLE_NAME HEADING 'To|Table|Name' FORMAT A15
    
```

```
SELECT RULE_OWNER,
       RULE_NAME,
       FROM_SCHEMA_NAME,
       TO_SCHEMA_NAME,
       FROM_TABLE_NAME,
       TO_TABLE_NAME
FROM DBA_STREAMS_RENAME_TABLE;
```

Your output looks similar to the following:

Rule Owner	Rule Name	From Schema Name	To Schema Name	From Table Name	To Table Name
STRMADMIN	JOBS26	HR	HR	JOBS	ASSIGNMENTS

This output show the following information about the RENAME TABLE declarative rule-based transformation:

- It is specified on the `jobs26` rule in the `strmadmin` schema.
- It renames the `hr.jobs` table in row LCRs to the `hr.assignments` table.

Displaying Custom Rule-Based Transformations

A **custom rule-based transformation** is a rule-based transformation that requires a user-defined PL/SQL function. The query in this section displays the following information about each custom rule-based transformation specified in a database:

- The owner of the rule on which the custom rule-based transformation is set
- The name of the rule on which the custom rule-based transformation is set
- The owner and name of the transformation function
- Whether the custom rule-based transformation is one-to-one or one-to-many

Run the following query to display this information:

```
COLUMN RULE_OWNER HEADING 'Rule Owner' FORMAT A20
COLUMN RULE_NAME HEADING 'Rule Name' FORMAT A15
COLUMN TRANSFORM_FUNCTION_NAME HEADING 'Transformation Function' FORMAT A30
COLUMN CUSTOM_TYPE HEADING 'Type' FORMAT A11
```

```
SELECT RULE_OWNER, RULE_NAME, TRANSFORM_FUNCTION_NAME, CUSTOM_TYPE
FROM DBA_STREAMS_TRANSFORM_FUNCTION;
```

Your output looks similar to the following:

Rule Owner	Rule Name	Transformation Function	Type
STRMADMIN	DEPARTMENTS31	"HR"."EXECUTIVE_TO_MANAGEMENT"	ONE TO ONE
STRMADMIN	DEPARTMENTS32	"HR"."EXECUTIVE_TO_MANAGEMENT"	ONE TO ONE
STRMADMIN	DEPARTMENTS33	"HR"."EXECUTIVE_TO_MANAGEMENT"	ONE TO ONE

Note: The transformation function name must be of type VARCHAR2. If it is not, then the value of TRANSFORM_FUNCTION_NAME is NULL. The VALUE_TYPE column in the DBA_STREAMS_TRANSFORM_FUNCTION view displays the type of the transform function name.

See Also:

- ["Custom Rule-Based Transformations"](#) on page 7-2
- ["Managing Custom Rule-Based Transformations"](#) on page 18-5

Monitoring Other Oracle Streams Components

This chapter provides sample queries that you can use to monitor various Oracle Streams components.

The following topics describe monitoring various Oracle Streams components:

- [Monitoring Oracle Streams Administrators and Other Oracle Streams Users](#)
- [Monitoring the Oracle Streams Pool](#)
- [Monitoring Compatibility in an Oracle Streams Environment](#)
- [Monitoring Oracle Streams Performance Using AWR and Statspack](#)

Note: The Oracle Streams tool in the Oracle Enterprise Manager Console is also an excellent way to monitor an Oracle Streams environment. See the online Help for the Oracle Streams tool for more information.

See Also:

- *Oracle Database Reference* for information about the data dictionary views described in this chapter
- *Oracle Streams Replication Administrator's Guide* for information about monitoring an Oracle Streams **replication** environment

Monitoring Oracle Streams Administrators and Other Oracle Streams Users

The following sections contain queries that you can run to list Oracle Streams administrators and other users who allow access to remote Oracle Streams administrators:

- [Listing Local Oracle Streams Administrators](#)
- [Listing Users Who Allow Access to Remote Oracle Streams Administrators](#)

See Also: *Oracle Database PL/SQL Packages and Types Reference* for more information about configuring Oracle Streams administrators and other Oracle Streams users using the `DBMS_STREAMS_AUTH` package

Listing Local Oracle Streams Administrators

You can grant privileges to a local Oracle Streams administrator by running the `GRANT_ADMIN_PRIVILEGE` procedure in the `DBMS_STREAMS_AUTH` package. The `DBA_STREAMS_ADMINISTRATOR` data dictionary view contains only the local Oracle Streams administrators created with the `grant_privileges` parameter set to `TRUE` when the `GRANT_ADMIN_PRIVILEGE` procedure was run for the user. If you created an Oracle Streams administrator using generated scripts and set the `grant_privileges` parameter to `FALSE` when the `GRANT_ADMIN_PRIVILEGE` procedure was run for the user, then the `DBA_STREAMS_ADMINISTRATOR` data dictionary view does not list the user as an Oracle Streams administrator.

To list the local Oracle Streams administrators created with the `grant_privileges` parameter set to `TRUE` when running the `GRANT_ADMIN_PRIVILEGE` procedure, run the following query:

```
COLUMN USERNAME HEADING 'Local Oracle Streams Administrator' FORMAT A30

SELECT USERNAME FROM DBA_STREAMS_ADMINISTRATOR
       WHERE LOCAL_PRIVILEGES = 'YES';
```

Your output looks similar to the following:

```
Local Oracle Streams Administrator
-----
STRMADMIN
```

The `GRANT_ADMIN_PRIVILEGE` might not have been run on a user who is an Oracle Streams administrator. Such administrators are not returned by the query in this section. Also, you can change the privileges for the users listed after the `GRANT_ADMIN_PRIVILEGE` procedure has been run for them. The `DBA_STREAMS_ADMINISTRATOR` view does not track these changes unless they are performed by the `DBMS_STREAMS_AUTH` package. For example, you can revoke the privileges granted by the `GRANT_ADMIN_PRIVILEGE` procedure for a particular user using the `REVOKE` SQL statement, but this user would be listed when you query the `DBA_STREAMS_ADMINISTRATOR` view.

Oracle recommends using the `REVOKE_ADMIN_PRIVILEGE` procedure in the `DBMS_STREAMS_AUTH` package to revoke privileges from a user listed by the query in this section. When you revoke privileges from a user using this procedure, the user is removed from the `DBA_STREAMS_ADMINISTRATOR` view.

See Also: ["Configuring an Oracle Streams Administrator"](#) on page 9-1

Listing Users Who Allow Access to Remote Oracle Streams Administrators

You can configure a user to allow access to remote Oracle Streams administrators by running the `GRANT_REMOTE_ADMIN_ACCESS` procedure in the `DBMS_STREAMS_AUTH` package. Such a user allows the remote Oracle Streams administrator to perform administrative actions in the local database using a database link.

Typically, you configure such a user at a local [source database](#) if a [downstream capture process](#) captures changes originating at the local source database. The Oracle Streams administrator at a downstream capture database administers the source database using this connection.

To list the users who allow to remote Oracle Streams administrators, run the following query:

```

COLUMN USERNAME HEADING 'Users Who Allow Remote Access' FORMAT A30
SELECT USERNAME FROM DBA_STREAMS_ADMINISTRATOR
WHERE ACCESS_FROM_REMOTE = 'YES';

```

Your output looks similar to the following:

```

Users Who Allow Remote Access
-----
STRMREMOTE

```

Monitoring the Oracle Streams Pool

The **Oracle Streams pool** is a portion of memory in the System Global Area (SGA) that is used by Oracle Streams. The Oracle Streams pool stores enqueued **messages** in memory, and it provides memory for **capture processes** and **apply processes**. The Oracle Streams pool always stores LCRs captured by a capture process, and it can store other types of messages that are enqueued manually into a **buffered queue**.

The Oracle Streams pool size is managed automatically when the `MEMORY_TARGET`, `MEMORY_MAX_TARGET`, or `SGA_TARGET` initialization parameter is set to a nonzero value. If these parameters are all set to 0 (zero), then you can specify the size of the Oracle Streams pool in bytes using the `STREAMS_POOL_SIZE` initialization parameter. In this case, the `V$STREAMS_POOL_ADVICE` dynamic performance view provides information about an appropriate setting for the `STREAMS_POOL_SIZE` initialization parameter.

This section contains example queries that show when you should increase, retain, or decrease the size of the Oracle Streams pool. Each query shows the following information about the Oracle Streams pool:

- `STREAMS_POOL_SIZE_FOR_ESTIMATE` shows the size, in megabytes, of the Oracle Streams pool for the estimate. The size ranges from values smaller than the current Oracle Streams pool size to values larger than the current Oracle Streams pool size, and there is a separate row for each increment. There always is an entry that shows the current Oracle Streams pool size, and there always are 20 increments. The range and the size of the increments depend on the current size of the Oracle Streams pool.
- `STREAMS_POOL_SIZE_FACTOR` shows the size factor of an estimate as it relates to the current size of the Oracle Streams pool. For example, a size factor of .2 means that the estimate is for 20% of the current size of the Oracle Streams pool, while a size factor of 1.6 means that the estimate is for 160% of the current size of the Oracle Streams pool. The row with a size factor of 1.0 shows the current size of the Oracle Streams pool.
- `ESTD_SPILL_COUNT` shows the estimated number messages that will spill from memory to the **queue table** for each `STREAMS_POOL_SIZE_FOR_ESTIMATE` and `STREAMS_POOL_SIZE_FACTOR` returned by the query.
- `ESTD_SPILL_TIME` shows the estimated elapsed time, in seconds, spent spilling messages from memory to the queue table for each `STREAMS_POOL_SIZE_FOR_ESTIMATE` and `STREAMS_POOL_SIZE_FACTOR` returned by the query.
- `ESTD_UNSPILL_COUNT` shows the estimated number messages that will unspill from the queue table back into memory for each `STREAMS_POOL_SIZE_FOR_ESTIMATE` and `STREAMS_POOL_SIZE_FACTOR` returned by the query.

- `ESTD_UNSPILL_TIME` shows the estimated elapsed time, in seconds, spent unspilling messages from the queue table back into memory for each `STREAMS_POOL_SIZE_FOR_ESTIMATE` and `STREAMS_POOL_SIZE_FACTOR` returned by the query.

If any capture processes, [propagations](#), or apply processes are disabled when you query the `V$STREAMS_POOL_ADVICE` view, and you plan to enable them in the future, then ensure that you consider the memory resources required by these [Oracle Streams clients](#) before you decrease the size of the Oracle Streams pool.

Tips:

- In general, the best size for the Oracle Streams pool is the smallest size for which spilled and unspilled messages and times are close to zero.
 - For the most accurate results, you should run a query on the `V$STREAMS_POOL_ADVICE` view when there is a typical amount of dequeue activity by propagations and apply processes in a database. If dequeue activity is far lower than typical, or far higher than typical, then the query results might not be a good guide for adjusting the size of the Oracle Streams pool.
-
-

See Also:

- [Configuring the Oracle Streams Pool](#) on page 9-9
- ["Setting Initialization Parameters Relevant to Oracle Streams"](#) on page 9-4 for more information about the `STREAMS_POOL_SIZE` initialization parameter

Query Result that Advises Increasing the Oracle Streams Pool Size

Consider the following results returned by the `V$STREAMS_POOL_ADVICE` view:

```

COLUMN STREAMS_POOL_SIZE_FOR_ESTIMATE HEADING 'Oracle Streams Pool Size|for
Estimate(MB) '
      FORMAT 999999999999999
COLUMN STREAMS_POOL_SIZE_FACTOR HEADING 'Oracle Streams Pool|Size|Factor' FORMAT
99.9
COLUMN ESTD_SPILL_COUNT HEADING 'Estimated|Spill|Count' FORMAT 99999999
COLUMN ESTD_SPILL_TIME HEADING 'Estimated|Spill|Time' FORMAT 99999999.99
COLUMN ESTD_UNSPILL_COUNT HEADING 'Estimated|Unspill|Count' FORMAT 99999999
COLUMN ESTD_UNSPILL_TIME HEADING 'Estimated|Unspill|Time' FORMAT 99999999.99

SELECT STREAMS_POOL_SIZE_FOR_ESTIMATE,
       STREAMS_POOL_SIZE_FACTOR,
       ESTD_SPILL_COUNT,
       ESTD_SPILL_TIME,
       ESTD_UNSPILL_COUNT,
       ESTD_UNSPILL_TIME
FROM V$STREAMS_POOL_ADVICE;
```

Oracle Streams Pool Size for Estimate(MB)	Oracle Streams Pool Size Factor	Oracle Streams Pool Estimated Size	Estimated Spill Count	Estimated Spill Time	Estimated Unspill Count
24	.1	158	62.00	0	.00
48	.2	145	59.00	0	.00
72	.3	137	53.00	0	.00
96	.4	122	50.00	0	.00
120	.5	114	48.00	0	.00
144	.6	103	45.00	0	.00
168	.7	95	39.00	0	.00
192	.8	87	32.00	0	.00
216	.9	74	26.00	0	.00
240	1.0	61	21.00	0	.00
264	1.1	56	17.00	0	.00
288	1.2	43	15.00	0	.00
312	1.3	36	11.00	0	.00
336	1.4	22	8.00	0	.00
360	1.5	9	2.00	0	.00
384	1.6	0	.00	0	.00
408	1.7	0	.00	0	.00
432	1.8	0	.00	0	.00
456	1.9	0	.00	0	.00
480	2.0	0	.00	0	.00

Based on these results, 384 megabytes, or 160% of the size of the current **Oracle Streams pool**, is the optimal size for the Oracle Streams pool. That is, this size is the smallest size for which the estimated number of spilled and unspilled **messages** is zero.

Note: After you adjust the size of the Oracle Streams pool, it might take some time for the new size to result in new output for the V\$STREAMS_POOL_ADVICE view.

Query Result that Advises Retaining the Current Oracle Streams Pool Size

Consider the following results returned by the V\$STREAMS_POOL_ADVICE view:

```

COLUMN STREAMS_POOL_SIZE_FOR_ESTIMATE HEADING 'Oracle Streams Pool|Size for
Estimate'
  FORMAT 999999999999999
COLUMN STREAMS_POOL_SIZE_FACTOR HEADING 'Oracle Streams Pool|Size|Factor' FORMAT
99.9
COLUMN ESTD_SPILL_COUNT HEADING 'Estimated|Spill|Count' FORMAT 99999999
COLUMN ESTD_SPILL_TIME HEADING 'Estimated|Spill|Time' FORMAT 99999999.99
COLUMN ESTD_UNSPILL_COUNT HEADING 'Estimated|Unspill|Count' FORMAT 99999999
COLUMN ESTD_UNSPILL_TIME HEADING 'Estimated|Unspill|Time' FORMAT 99999999.99

SELECT STREAMS_POOL_SIZE_FOR_ESTIMATE,
       STREAMS_POOL_SIZE_FACTOR,
       ESTD_SPILL_COUNT,
       ESTD_SPILL_TIME,
       ESTD_UNSPILL_COUNT,
       ESTD_UNSPILL_TIME
FROM V$STREAMS_POOL_ADVICE;

```

Oracle Streams Pool Size for Estimate(MB)	Oracle Streams Pool Size Factor	Estimated Spill Count	Estimated Spill Time	Estimated Unspill Count
24	.1	89	52.00	0
48	.2	78	48.00	0
72	.3	71	43.00	0
96	.4	66	37.00	0
120	.5	59	32.00	0
144	.6	52	26.00	0
168	.7	39	20.00	0
192	.8	27	12.00	0
216	.9	15	5.00	0
240	1.0	0	.00	0
264	1.1	0	.00	0
288	1.2	0	.00	0
312	1.3	0	.00	0
336	1.4	0	.00	0
360	1.5	0	.00	0
384	1.6	0	.00	0
408	1.7	0	.00	0
432	1.8	0	.00	0
456	1.9	0	.00	0
480	2.0	0	.00	0

Based on these results, the current size of the **Oracle Streams pool** is the optimal size. That is, this size is the smallest size for which the estimated number of spilled and unspilled **messages** is zero.

Query Result that Advises Decreasing the Oracle Streams Pool Size

Consider the following results returned by the V\$STREAMS_POOL_ADVICE view:

```

COLUMN STREAMS_POOL_SIZE_FOR_ESTIMATE HEADING 'Oracle Streams Pool|Size for
Estimate'
  FORMAT 999999999999999
COLUMN STREAMS_POOL_SIZE_FACTOR HEADING 'Oracle Streams Pool|Size|Factor' FORMAT
99.9
COLUMN ESTD_SPILL_COUNT HEADING 'Estimated|Spill|Count' FORMAT 99999999
COLUMN ESTD_SPILL_TIME HEADING 'Estimated|Spill|Time' FORMAT 99999999.99
COLUMN ESTD_UNSPILL_COUNT HEADING 'Estimated|Unspill|Count' FORMAT 99999999
COLUMN ESTD_UNSPILL_TIME HEADING 'Estimated|Unspill|Time' FORMAT 99999999.99

SELECT STREAMS_POOL_SIZE_FOR_ESTIMATE,
       STREAMS_POOL_SIZE_FACTOR,
       ESTD_SPILL_COUNT,
       ESTD_SPILL_TIME,
       ESTD_UNSPILL_COUNT,
       ESTD_UNSPILL_TIME
FROM V$STREAMS_POOL_ADVICE;

```

Oracle Streams Pool Size for Estimate(MB)	Oracle Streams Pool Size Factor	Estimated Spill Count	Estimated Spill Time	Estimated Unspill Count
24	.1	158	62.00	0
48	.2	145	59.00	0
72	.3	137	53.00	0
96	.4	122	50.00	0
120	.5	114	48.00	0

144	.6	103	45.00	0	.00
168	.7	0	.00	0	.00
192	.8	0	.00	0	.00
216	.9	0	.00	0	.00
240	1.0	0	.00	0	.00
264	1.1	0	.00	0	.00
288	1.2	0	.00	0	.00
312	1.3	0	.00	0	.00
336	1.4	0	.00	0	.00
360	1.5	0	.00	0	.00
384	1.6	0	.00	0	.00
408	1.7	0	.00	0	.00
432	1.8	0	.00	0	.00
456	1.9	0	.00	0	.00
480	2.0	0	.00	0	.00

Based on these results, 168 megabytes, or 70% of the size of the current **Oracle Streams pool**, is the optimal size for the Oracle Streams pool. That is, this size is the smallest size for which the estimated number of spilled and unspilled messages is zero.

Note: After you adjust the size of the Oracle Streams pool, it might take some time for the new size to result in new output for the V\$STREAMS_POOL_ADVICE view.

Monitoring Compatibility in an Oracle Streams Environment

Some database objects and data types are not compatible with Oracle Streams **capture processes**, **synchronous captures**, and **apply processes**. If one of these **Oracle Streams clients** tries to process an unsupported database object or data type, errors result.

The queries in the following sections show Oracle Streams compatibility for database objects and columns in the local database:

- [Monitoring Compatibility for Capture Processes](#)
- [Listing Database Objects and Columns That Are Not Compatible With Synchronous Captures](#)
- [Monitoring Compatibility for Apply Processes](#)

Monitoring Compatibility for Capture Processes

This section contains these topics:

- [Listing the Database Objects That Are Not Compatible With Capture Processes](#)
- [Listing the Database Objects That Have Become Compatible With Capture Processes Recently](#)

Listing the Database Objects That Are Not Compatible With Capture Processes

A database object is not compatible with **capture processes** if capture processes cannot capture changes to it. The query in this section displays the following information about database objects that are not compatible with capture processes:

- The object owner
- The object name
- The reason why the object is not compatible with capture processes

- Whether capture processes automatically filter out changes to the database object (AUTO_FILTERED column)

If capture processes automatically filter out changes to a database object, then the **rule sets** used by the capture processes do not need to filter them out explicitly. For example, capture processes automatically filter out changes to domain indexes. However, if changes to incompatible database objects are not filtered out automatically, then the rule sets used by the capture process must filter them out to avoid errors.

For example, suppose the rule sets for a capture process instruct the capture process to capture all of the changes made to a specific schema. Also suppose that the query in this section shows that one object in this schema is not compatible with capture processes, and that changes to the object are not filtered out automatically. In this case, you can add a **rule** to the **negative rule set** for the capture process to filter out changes to the incompatible database object.

Run the following query to list the database objects in the local database that are not compatible with capture processes:

```
COLUMN OWNER HEADING 'Object|Owner' FORMAT A8
COLUMN TABLE_NAME HEADING 'Object Name' FORMAT A30
COLUMN REASON HEADING 'Reason' FORMAT A30
COLUMN AUTO_FILTERED HEADING 'Auto|Filtered?' FORMAT A9

SELECT OWNER, TABLE_NAME, REASON, AUTO_FILTERED FROM DBA_STREAMS_UNSUPPORTED;
```

Your output looks similar to the following:

Object Owner	Object Name	Reason	Auto Filtered?
IX	AQ\$_ORDERS_QUEUE_TABLE_G	column with user-defined type	NO
IX	AQ\$_ORDERS_QUEUE_TABLE_H	unsupported column exists	NO
IX	AQ\$_ORDERS_QUEUE_TABLE_I	unsupported column exists	NO
IX	AQ\$_ORDERS_QUEUE_TABLE_S	AQ queue table	NO
IX	AQ\$_ORDERS_QUEUE_TABLE_T	AQ queue table	NO
IX	AQ\$_STREAMS_QUEUE_TABLE_C	AQ queue table	NO
IX	AQ\$_STREAMS_QUEUE_TABLE_G	column with user-defined type	NO
IX	AQ\$_STREAMS_QUEUE_TABLE_H	unsupported column exists	NO
IX	AQ\$_STREAMS_QUEUE_TABLE_I	unsupported column exists	NO
IX	AQ\$_STREAMS_QUEUE_TABLE_S	AQ queue table	NO
IX	AQ\$_STREAMS_QUEUE_TABLE_T	AQ queue table	NO
IX	ORDERS_QUEUE_TABLE	column with user-defined type	NO
IX	STREAMS_QUEUE_TABLE	column with user-defined type	NO
OE	ACTION_TABLE	column with user-defined type	NO
OE	CATEGORIES_TAB	column with user-defined type	NO
OE	CUSTOMERS	column with user-defined type	NO
OE	LINEITEM_TABLE	column with user-defined type	NO
OE	PRODUCT_REF_LIST_NESTEDTAB	column with user-defined type	NO
OE	SUBCATEGORY_REF_LIST_NESTEDTAB	column with user-defined type	NO
PM	ONLINE_MEDIA	column with user-defined type	NO
PM	PRINT_MEDIA	column with user-defined type	NO
PM	TEXTDOCS_NESTEDTAB	column with user-defined type	NO
SH	DIMENSION_EXCEPTIONS	unsupported column exists	NO
SH	DR\$SUP_TEXT_IDX\$I	domain index	YES
SH	DR\$SUP_TEXT_IDX\$K	unsupported column exists	YES
SH	DR\$SUP_TEXT_IDX\$N	domain index	YES
SH	DR\$SUP_TEXT_IDX\$R	domain index	YES
SH	SALES_TRANSACTIONS_EXT	external table	NO

Notice that the `Auto Filtered?` column is `YES` for the `sh.drsup_text_idxi` domain index. A capture process automatically filters out data manipulation language (DML) changes to this database object, even if the rules sets for a capture process instruct the capture process to capture changes to it. By default, a capture process also filters out data definition language (DDL) changes to these database objects. However, if you want to capture these DDL changes, then use the `DBMS_CAPTURE_ADM.SET_PARAMETER` procedure to set the `set_autofiltered_table_ddl` capture process parameter to `N` and configure the capture process rule sets to capture these DDL changes.

Because the `Auto Filtered?` column is `NO` for other database objects listed in the example output, capture processes do not filter out changes to these database objects automatically. If a capture process attempts to process changes to these unsupported database objects, then the capture process raises an error. However, you can avoid these errors by configuring rules sets that instruct the capture process not to capture changes to these unsupported objects.

Note:

- The results of the query in this section depend on the compatibility level of the database. More database objects are incompatible with capture processes at lower compatibility levels. The `COMPATIBLE` initialization parameter controls the compatibility level of the database.
 - For capture processes, you cannot use **rule-based transformations** to exclude a column of an unsupported data type. The entire database object must be excluded to avoid capture errors.
 - The `DBA_STREAMS_UNSUPPORTED` view only pertains to capture processes in Oracle Database 11g Release 1 (11.1) and later databases. This view does not pertain to **synchronous captures** and **apply processes**.
-
-

See Also:

- [Chapter 6, "How Rules Are Used in Oracle Streams"](#)
- *Oracle Database Reference* and *Oracle Database Upgrade Guide* for more information about the `COMPATIBLE` initialization parameter
- *Oracle Database PL/SQL Packages and Types Reference* for more information about the `DBMS_CAPTURE_ADM.SET_PARAMETER` procedure

Listing the Database Objects That Have Become Compatible With Capture Processes Recently

The query in this section displays the following information about database objects that have become compatible with **capture processes** in a recent release of Oracle Database:

- The object owner
- The object name

- The reason why the object was not compatible with capture processes in previous releases of Oracle Database
- The Oracle Database release in which the object became compatible with capture processes

Run the following query to display this information for the local database:

```
COLUMN OWNER HEADING 'Owner' FORMAT A10
COLUMN TABLE_NAME HEADING 'Object Name' FORMAT A20
COLUMN REASON HEADING 'Reason' FORMAT A30
COLUMN COMPATIBLE HEADING 'Compatible' FORMAT A10

SELECT OWNER, TABLE_NAME, REASON, COMPATIBLE FROM DBA_STREAMS_NEWLY_SUPPORTED;
```

The following is a sample of the output from this query:

Owner	Object Name	Reason	Compatible
HR	COUNTRIES	IOT	10.1
OE	WAREHOUSES	table with XMLType column	11.1
SH	CAL_MONTH_SALES_MV	materialized view	10.1
SH	FWEEK_PSCAT_SALES_MV	materialized view	10.1

The `Compatible` column shows the minimum database compatibility for capture processes to support the database object. If the local database compatibility is equal to or higher than the value in the `Compatible` column for a database object, then capture processes can capture changes to the database object successfully. You control the compatibility of a database using the `COMPATIBLE` initialization parameter.

If your Oracle Streams environment includes databases that are running different versions of the Oracle Database, then you can configure [rules](#) that use the `GET_COMPATIBLE` member function for LCRs to filter out LCRs that are not compatible with particular databases. These rules can be added to the [rule sets](#) of capture processes, [synchronous captures](#), [propagations](#), and [apply processes](#) to filter out incompatible LCRs wherever necessary in a stream.

Note: The `DBA_STREAMS_NEWLY_SUPPORTED` view only pertains to capture processes in Oracle Database 11g Release 1 (11.1) and later databases. This view does not pertain to synchronous captures and apply processes.

See Also:

- *Oracle Database Reference* and *Oracle Database Upgrade Guide* for more information about the `COMPATIBLE` initialization parameter
- ["Listing the Database Objects That Are Not Compatible With Capture Processes"](#) on page 28-7
- ["Rule Conditions that Instruct Oracle Streams Clients to Discard Unsupported LCRs"](#) on page 6-45 for information about creating rules that use the `GET_COMPATIBLE` member function for LCRs

Listing Database Objects and Columns That Are Not Compatible With Synchronous Captures

A database object or a column in a table is not compatible with **synchronous captures** if synchronous captures cannot capture changes to it. For example, synchronous captures cannot capture changes to object tables. Synchronous captures can capture changes to relational tables, but they cannot capture changes to columns of some data types.

The query in this section displays the following information about database objects and columns that are not compatible with synchronous captures:

- The object owner
- The object name
- The column name
- The reason why the column is not compatible with synchronous captures

To list the columns that are not compatible with synchronous captures in the local database, run the following query:

```
COLUMN OWNER HEADING 'Object|Owner' FORMAT A8
COLUMN TABLE_NAME HEADING 'Object Name' FORMAT A20
COLUMN COLUMN_NAME HEADING 'Column Name' FORMAT A20
COLUMN SYNC_CAPTURE_REASON HEADING 'Synchronous|Capture Reason' FORMAT A25

SELECT OWNER,
       TABLE_NAME,
       COLUMN_NAME,
       SYNC_CAPTURE_REASON
FROM DBA_STREAMS_COLUMNS
WHERE SYNC_CAPTURE_VERSION IS NULL;
```

When a query on the `DBA_STREAMS_COLUMNS` view returns `NULL` for `SYNC_CAPTURE_VERSION`, it means that synchronous captures do not support the column. The `WHERE` clause in the query ensures that the query only returns columns that are not supported by synchronous captures.

The following is a sample of the output from this query:

Object Owner	Object Name	Column Name	Synchronous Capture Reason
OE	CATEGORIES_TAB	CATEGORY_ID	object table
PM	ONLINE_MEDIA	PRODUCT_TEXT	(N)CLOB column
IX	ORDERS_QUEUE_TABLE	EXCEPTION_QSCHEMA	AQ queue table
IX	ORDERS_QUEUE_TABLE	EXCEPTION_QUEUE	AQ queue table
OE	WAREHOUSES	WH_GEO_LOCATION	ADT column
OE	ACTION_TABLE	DATE_ACTIONED	object table
OE	LINEITEM_TABLE	DESCRIPTION	object table
PM	ONLINE_MEDIA	PRODUCT_THUMBNAI	ADT column
PM	PRINT_MEDIA	AD_FLTEXTN	table with nested table c olumn
.			
.			
.			

To avoid synchronous capture errors, configure the synchronous capture **rule set** to ensure that the synchronous capture does not try to capture changes to an

unsupported database object, such as an object table. To avoid synchronous capture errors while capturing changes to relational tables, you have the following options:

- Configure the synchronous capture rule set to ensure that the synchronous capture does not try to capture changes to a table that contains one or more unsupported columns.
- Configure **rule-based transformations** to exclude columns that are not supported by synchronous captures.

Note: Synchronous capture is available in Oracle Database 11g Release 1 (11.1) and later databases. It is not available in previous releases of Oracle Database.

See Also:

- ["Data Types Captured by Synchronous Capture"](#) on page 2-41
- [Chapter 7, "Rule-Based Transformations"](#)
- [Chapter 6, "How Rules Are Used in Oracle Streams"](#)

Monitoring Compatibility for Apply Processes

This section contains these topics:

- [Listing Database Objects and Columns That Are Not Compatible With Apply Processes](#)
- [Listing Columns That Have Become Compatible With Apply Processes Recently](#)

Listing Database Objects and Columns That Are Not Compatible With Apply Processes

A database object or a column in a table is not compatible with **apply processes** if apply processes cannot apply changes to it. For example, apply processes cannot apply changes to object tables. Apply processes can apply changes to relational tables, but they cannot apply changes to columns of some data types.

The query in this section displays the following information about database objects and columns that are not compatible with apply processes:

- The object owner
- The object name
- The column name
- The reason why the column is not compatible with apply processes

To list the columns that are not compatible with apply processes in the local database, run the following query:

```
COLUMN OWNER HEADING 'Object|Owner' FORMAT A8
COLUMN TABLE_NAME HEADING 'Object Name' FORMAT A20
COLUMN COLUMN_NAME HEADING 'Column Name' FORMAT A20
COLUMN APPLY_REASON HEADING 'Apply Process Reason' FORMAT A25

SELECT OWNER,
       TABLE_NAME,
       COLUMN_NAME,
       APPLY_REASON
```

```
FROM DBA_STREAMS_COLUMNS
WHERE APPLY_VERSION IS NULL;
```

When a query on the `DBA_STREAMS_COLUMNS` view returns `NULL` for `APPLY_VERSION`, it means that apply processes do not support the column. The `WHERE` clause in the query ensures that the query only returns columns that are not supported by apply processes.

The following is a sample of the output from this query:

Object Owner	Object Name	Column Name	Apply Process Reason
OE	CATEGORIES_TAB	CATEGORY_ID	object table
IX	ORDERS_QUEUE_TABLE	EXCEPTION_QSCHEMA	AQ queue table
IX	ORDERS_QUEUE_TABLE	EXCEPTION_QUEUE	AQ queue table
OE	WAREHOUSES	WH_GEO_LOCATION	ADT column
OE	ACTION_TABLE	DATE_ACTIONED	object table
OE	LINEITEM_TABLE	DESCRIPTION	object table
PM	ONLINE_MEDIA	PRODUCT_THUMBNAIL	ADT column
.	.	.	.

To avoid apply errors, configure the apply process **rule sets** to ensure that the apply process does not try to apply changes to an unsupported database object, such as an object table. To avoid apply errors while applying changes to relational tables, you have the following options:

- Configure the apply process rule sets to ensure that the apply process does not try to apply changes to a table that contains one or more unsupported columns.
- Configure **rule-based transformations** to exclude columns that are not supported by apply processes.
- Configure **DML handlers** to exclude columns that are not supported by apply processes.

See Also:

- ["Data Types Applied"](#) on page 4-13
- [Chapter 7, "Rule-Based Transformations"](#)
- ["Process Messages with Apply Handlers"](#) on page 4-8 for information about DML handlers
- [Chapter 6, "How Rules Are Used in Oracle Streams"](#)

Listing Columns That Have Become Compatible With Apply Processes Recently

The query in this section displays the following information about database objects and columns that have become compatible with **apply processes** in a recent release of Oracle Database:

- The object owner
- The object name
- The column name

- The reason why the object was not compatible with apply processes in previous releases of Oracle Database
- The Oracle Database release in which the object became compatible with apply processes

Run the following query to display this information for the local database:

```
COLUMN OWNER HEADING 'Object|Owner' FORMAT A8
COLUMN TABLE_NAME HEADING 'Object Name' FORMAT A15
COLUMN COLUMN_NAME HEADING 'Column Name' FORMAT A15
COLUMN APPLY_VERSION HEADING 'Apply|Process|Version' FORMAT 99.9
COLUMN APPLY_REASON HEADING 'Apply|Process Reason' FORMAT A25

SELECT OWNER,
       TABLE_NAME,
       COLUMN_NAME,
       APPLY_VERSION,
       APPLY_REASON
FROM DBA_STREAMS_COLUMNS
WHERE APPLY_VERSION > 10;
```

When a query on the `DBA_STREAMS_COLUMNS` view returns a non-NULL value for `APPLY_VERSION`, it means that apply processes support the column. The `WHERE` clause in the query ensures that the query only returns columns that are supported by apply processes. This query returns the columns that have become supported by apply processes in Oracle Database 10g Release 1 and later.

The following is a sample of the output from this query:

Object Owner	Object Name	Column Name	Apply	
			Process Version	Apply Process Reason
SH	CAL_MONTH_SALES_MV	CALENDAR_MONTH_DESC	10.1	materialized view
PM	PRINT_MEDIA	AD_FLTEXTN	10.1	NCLOB column
HR	COUNTRIES	COUNTRY_ID	10.1	IOT
SH	FWEEK_PSCAT_SAL_ES_MV	WEEK_ENDING_DAY	10.1	materialized view
SH	FWEEK_PSCAT_SAL_ES_MV	DOLLARS	10.1	materialized view
HR	COUNTRIES	COUNTRY_NAME	10.1	IOT
HR	COUNTRIES	REGION_ID	10.1	IOT
SH	CAL_MONTH_SALES_MV	DOLLARS	10.1	materialized view
SH	FWEEK_PSCAT_SAL_ES_MV	PROD_SUBCATEGOR Y	10.1	materialized view
SH	FWEEK_PSCAT_SAL_ES_MV	CHANNEL_ID	10.1	materialized view
SH	FWEEK_PSCAT_SAL_ES_MV	PROMO_ID	10.1	materialized view
OE	WAREHOUSES	WAREHOUSE_SPEC	11.1	XMLType column

The `Apply Process Version` column shows the minimum database compatibility for apply processes to support the column. If the local database compatibility is equal to or higher than the value in the `Apply Process Version` column for a column, then apply processes can apply changes to the column successfully. You control the compatibility of a database using the `COMPATIBLE` initialization parameter.

If your Oracle Streams environment includes databases that are running different versions of the Oracle Database, then you can configure **rules** that use the `GET_COMPATIBLE` member function for LCRs to filter out LCRs that are not compatible with particular databases. These rules can be added to the **rule sets** of **capture processes**, **synchronous captures**, **propagations**, and apply processes to filter out incompatible LCRs wherever necessary in a stream.

Note: When this query returns NULL for Apply Process Reason, it means that the column has always been supported by apply processes since the first Oracle Database release that included Oracle Streams.

See Also:

- *Oracle Database Reference* and *Oracle Database Upgrade Guide* for more information about the `COMPATIBLE` initialization parameter
- ["Listing Database Objects and Columns That Are Not Compatible With Apply Processes"](#) on page 28-12
- ["Rule Conditions that Instruct Oracle Streams Clients to Discard Unsupported LCRs"](#) on page 6-45 for information about creating rules that use the `GET_COMPATIBLE` member function for LCRs

Monitoring Oracle Streams Performance Using AWR and Statspack

You can use Automatic Workload Repository (AWR) to monitor performance statistics related to Oracle Streams. If AWR is not available on your database, then you can use the Statspack package to monitor performance statistics related to Oracle Streams. The most current instructions and information about installing and using the Statspack package are contained in the `spdoc.txt` file installed with your database. Refer to that file for Statspack information. On UNIX systems, the file is located in the `ORACLE_HOME/rdbms/admin` directory. On Windows systems, the file is located in the `ORACLE_HOME\rdbms\admin` directory.

See Also:

- *Oracle Database Performance Tuning Guide* for more information about AWR
- [Chapter 22, "Monitoring the Oracle Streams Topology and Performance"](#) for information about monitoring performance using the Oracle Streams Performance Advisor

Part V

Oracle Streams Information Provisioning

This part describes information provisioning with Oracle Streams. This part contains the following chapters:

- [Chapter 29, "Information Provisioning Concepts"](#)
- [Chapter 30, "Using Information Provisioning"](#)
- [Chapter 31, "Monitoring File Group and Tablespace Repositories"](#)

Information Provisioning Concepts

Information provisioning makes information available when and where it is needed. Information provisioning is part of Oracle grid computing, which pools large numbers of servers, storage areas, and networks into a flexible, on-demand computing resource for enterprise computing needs. Information provisioning uses many of the features that also are used for information integration.

The following topics contain information about information provisioning:

- [Overview of Information Provisioning](#)
- [Bulk Provisioning of Large Amounts of Information](#)
- [Incremental Information Provisioning with Oracle Streams](#)
- [On-Demand Information Access](#)

See Also:

- [Chapter 30, "Using Information Provisioning"](#)
- *Oracle Database Concepts* for more information about information integration

Overview of Information Provisioning

Oracle grid computing enables resource provisioning with features such as Oracle Real Application Clusters (Oracle RAC), Oracle Scheduler, and Database Resource Manager. Oracle RAC enables you to provision hardware resources by running a single Oracle database server on a cluster of physical servers. Oracle Scheduler enables you to provision database workload over time for more efficient use of resources. Database Resource Manager provisions resources to database users, applications, or services within an Oracle database.

In addition to resource provisioning, Oracle grid computing also enables information provisioning. Information provisioning delivers information when and where it is needed, regardless of where the information currently resides on the grid. In a grid environment with distributed systems, the grid must move or copy information efficiently to make it available where it is needed.

Information provisioning can take the following forms:

- **Bulk Provisioning of Large Amounts of Information:** Data Pump export/import, transportable tablespaces, the `DBMS_STREAMS_TABLESPACE_ADM` package, and the `DBMS_FILE_TRANSFER` package all are ways to provide large amounts of information. Data Pump export/import enables you to move or copy information at the database, tablespace, schema, or table level. Transportable tablespaces enables you to move or copy tablespaces from one database to another efficiently.

The procedures in the `DBMS_STREAMS_TABLESPACE_ADM` package enable you to clone, detach, and attach tablespaces. In addition, some procedures in this package enable you to store tablespaces in a **tablespace repository** that provides versioning of tablespaces. When tablespaces are needed, they can be pulled from the tablespace repository and plugged into a database. The procedures in the `DBMS_FILE_TRANSFER` package enable you to copy a binary file within a database or between databases.

- **Incremental Information Provisioning with Oracle Streams:** Some data must be shared as it is created or changed, rather than occasionally shared in bulk. Oracle Streams can stream data between databases, nodes, or blade farms in a grid and can keep two or more copies synchronized as updates are made.
- **On-Demand Information Access:** You can make information available without moving or copying it to a new location. Oracle Distributed SQL allows grid users to access and integrate data stored in multiple Oracle databases and, through gateways, non-Oracle databases.

These information provisioning capabilities can be used individually or in combination to provide a full information provisioning solution in your environment. The remaining sections in this chapter discuss the ways to provision information in more detail.

See Also:

- *Oracle Real Application Clusters Administration and Deployment Guide* for more information about Oracle RAC
- *Oracle Database Administrator's Guide* for information about Oracle Scheduler and Database Resource Manager

Bulk Provisioning of Large Amounts of Information

Oracle provides several ways to move or copy large amounts of information from database to database efficiently. Data Pump can export and import at the database, tablespace, schema, or table level. There are several ways to move or copy a tablespace set from one Oracle database to another. Transportable tablespaces can move or copy a subset of an Oracle database and "plug" it in to another Oracle database. Transportable tablespace from backup with RMAN enables you to move or copy a tablespace set while the tablespaces remain online. The procedures in the `DBMS_STREAMS_TABLESPACE_ADM` package combine several steps that are required to move or copy a tablespace set into one procedure call.

Each method for moving or copying a tablespace set requires that the tablespace set is self-contained. A self-contained tablespace has no references from the tablespace pointing outside of the tablespace. For example, if an index in the tablespace is for a table in a different tablespace, then the tablespace is not self-contained. A self-contained tablespace set has no references from inside the set of tablespaces pointing outside of the set of tablespaces. For example, if a partitioned table is partially contained in the set of tablespaces, then the set of tablespaces is not self-contained. To determine whether a set of tablespaces is self-contained, use the `TRANSPORT_SET_CHECK` procedure in the Oracle supplied package `DBMS_TTS`.

The following sections describe the options for moving or copying large amounts of information and when to use each option:

- [Data Pump Export/Import](#)
- [Transportable Tablespace from Backup with RMAN](#)

- [DBMS_STREAMS_TABLESPACE_ADM Procedures](#)
- [Options for Bulk Information Provisioning](#)

Data Pump Export/Import

Data Pump export/import can move or copy data efficiently between databases. Data Pump can export/import a full database, tablespaces, schemas, or tables to provision large or small amounts of data for a particular requirement. Data Pump exports and imports can be performed using command line clients (`expdp` and `impdp`) or the `DBMS_DATAPUMP` package.

A transportable tablespaces export/import is specified using the `TRANSPORT_TABLESPACES` parameter. Transportable tablespaces enables you to unplug a set of tablespaces from a database, move or copy them to another location, and then plug them into another database. The transport is quick because the process transfers metadata and files. It does not unload and load the data. In transportable tablespaces mode, only the metadata for the tables (and their dependent objects) within a specified set of tablespaces are unloaded at the source and loaded at the target. This allows the tablespace data files to be copied to the target Oracle database and incorporated efficiently.

The tablespaces being transported can be either dictionary managed or locally managed. Moving or copying tablespaces using transportable tablespaces is faster than performing either an export/import or unload/load of the same data. To use transportable tablespaces, you must have the `EXP_FULL_DATABASE` and `IMP_FULL_DATABASE` role. The tablespaces being transported must be read-only during export, and the export cannot have a degree of parallelism greater than 1.

See Also:

- *Oracle Database Utilities* for more information about Data Pump
- *Oracle Database Administrator's Guide* for more information about using Data Pump with the `TRANSPORT_TABLESPACES` option

Transportable Tablespace from Backup with RMAN

The Recovery Manager (RMAN) `TRANSPORT TABLESPACE` command copies tablespaces without requiring that the tablespaces be in read-only mode during the transport process. Appropriate database backups must be available to perform RMAN transportable tablespace from backup.

See Also:

- *Oracle Database Backup and Recovery Reference*
- *Oracle Database Backup and Recovery User's Guide*

DBMS_STREAMS_TABLESPACE_ADM Procedures

The following procedures in the `DBMS_STREAMS_TABLESPACE_ADM` package can be used to move or copy tablespaces:

- `ATTACH_TABLESPACES`: Uses Data Pump to import a self-contained tablespace set previously exported using the `DBMS_STREAMS_TABLESPACE_ADM` package, Data Pump export, or the RMAN `TRANSPORT TABLESPACE` command.

- **CLONE_TABLESPACES:** Uses Data Pump export to clone a set of self-contained tablespaces. The tablespace set can be attached to a database after it is cloned. The tablespace set remains in the database from which it was cloned.
- **DETACH_TABLESPACES:** Uses Data Pump export to detach a set of self-contained tablespaces. The tablespace set can be attached to a database after it is detached. The tablespace set is dropped from the database from which it was detached.
- **PULL_TABLESPACES:** Uses Data Pump export/import to copy a set of self-contained tablespaces from a remote database and attach the tablespace set to the current database.

In addition, the `DBMS_STREAMS_TABLESPACE_ADM` package also contains the following procedures: `ATTACH_SIMPLE_TABLESPACE`, `CLONE_SIMPLE_TABLESPACE`, `DETACH_SIMPLE_TABLESPACE`, and `PULL_SIMPLE_TABLESPACE`. These procedures operate on a single tablespace that uses only one data file instead of a tablespace set.

File Group Repository

In the context of a file group, a **file** is a reference to a file stored on hard disk. A file is composed of a file name, a directory object, and a file type. The directory object references the directory in which the file is stored on hard disk. A **version** is a collection of related files, and a **file group** is a collection of versions.

A **file group repository** is a collection of all of the file groups in a database. A file group repository can contain multiple file groups and multiple versions of a particular file group.

For example, a file group named `reports` can store versions of sales reports. The reports can be generated on a regular schedule, and each version can contain the report files. The file group repository can version the file group under names such as `sales_reports_v1`, `sales_reports_v2`, and so on.

File group repositories can contain all types of files. You can create and manage file group repositories using the `DBMS_FILE_GROUP` package.

See Also:

- ["Using a File Group Repository"](#) on page 30-14
- *Oracle Database PL/SQL Packages and Types Reference* for more information about the `DBMS_FILE_GROUP` package

Tablespace Repository

A **tablespace repository** is a collection of tablespace sets in a file group repository. Tablespace repositories are built on file group repositories, but tablespace repositories only contain the files required to move or copy tablespaces between databases. A file group repository can store versioned sets of files, including, but not restricted to, tablespace sets.

Different tablespace sets can be stored in a tablespace repository, and different versions of a particular tablespace set can also be stored. A version of a tablespace set in a tablespace repository consists of the following files:

- The Data Pump export dump file for the tablespace set
- The Data Pump log file for the export
- The data files that make up the tablespace set

All of the files in a version can reside in a single directory, or they can reside in different directories. The following procedures can move or copy tablespaces with or without using a tablespace repository:

- ATTACH_TABLESPACES
- CLONE_TABLESPACES
- DETACH_TABLESPACES

If one of these procedures is run without using a tablespace repository, then a tablespace set is moved or copied, but it is not placed in or copied from a tablespace repository. If the CLONE_TABLESPACES or DETACH_TABLESPACES procedure is run using a tablespace repository, then the procedure places a tablespace set in the repository as a version of the tablespace set. If the ATTACH_TABLESPACES procedure is run using a tablespace repository, then the procedure copies a particular version of a tablespace set from the repository and attaches it to a database.

When to Use a Tablespace Repository A tablespace repository is useful when you must store different versions of one or more tablespace sets. For example, a tablespace repository can be used to accomplish the following goals:

- You want to run quarterly reports on a tablespace set. You can clone the tablespace set quarterly for storage in a versioned tablespace repository, and a specific version of the tablespace set can be requested from the repository and attached to another database to run the reports.
- You want applications to be able to attach required tablespace sets on demand in a grid environment. You can store multiple versions of several different tablespace sets in the tablespace repository. Each tablespace set can be used for a different purpose by the application. When the application needs a particular version of a particular tablespace set, the application can scan the tablespace repository and attach the correct tablespace set to a database.

Differences Between the Tablespace Repository Procedures The procedures that include the `file_group_name` parameter in the DBMS_STREAMS_TABLESPACE_ADM package behave differently with regard to the tablespace set, the data files in the tablespace set, and the export dump file. [Table 29-1](#) describes these differences.

Table 29–1 Tablespace Repository Procedures

Procedure	Tablespace Set	Data Files	Export Dump File
ATTACH_TABLESPACES	The tablespace set is added to the local database.	<p>If the <code>datafiles_directory_</code> object parameter is non-NULL, then the data files are copied from their current location(s) for the version in the tablespace repository to the directory object specified in the <code>datafiles_directory_object</code> parameter. The attached tablespace set uses the data files that were copied.</p> <p>If the <code>datafiles_directory_</code> object parameter is NULL, then the data files are not moved or copied. The data files remain in the directory object(s) for the version in the tablespace repository, and the attached tablespace set uses these data files.</p>	<p>If the <code>datafiles_directory_object</code> parameter is non-NULL, then the export dump file is copied from its directory object for the version in the tablespace repository to the directory object specified in the <code>datafiles_directory_object</code> parameter.</p> <p>If the <code>datafiles_directory_object</code> parameter is NULL, then the export dump file is not moved or copied.</p>
CLONE_TABLESPACES	The tablespace set is retained in the local database.	The data files are copied from their current location(s) to the directory object specified in the <code>tablespace_directory_object</code> parameter or in the default directory for the version or file group . This parameter specifies where the version of the tablespace set is stored in the tablespace repository. The current location of the data files can be determined by querying the <code>DBA_DATA_FILES</code> data dictionary view. A directory object must exist, and must be accessible to the user who runs the procedure, for each data file location.	The export dump file is placed in the directory object specified in the <code>tablespace_directory_object</code> parameter or in the default directory for the version or file group.
DETACH_TABLESPACES	The tablespace set is dropped from the local database.	The data files are not moved or copied. The data files remain in their current location(s). A directory object must exist, and must be accessible to the user who runs the procedure, for each data file location. These data files are included in the version of the tablespace set stored in the tablespace repository.	The export dump file is placed in the directory object specified in the <code>export_directory_object</code> parameter or in the default directory for the version or file group.

Remote Access to a Tablespace Repository A tablespace repository can reside in the database that uses the tablespaces, or it can reside in a remote database. If it resides in a remote database, then a database link must be specified in the `repository_db_link` parameter when you run one of the procedures, and the database link must be accessible to the user who runs the procedure.

Only One Tablespace Version Can Be Online in a Database A version of a tablespace set in a tablespace repository can be either online or offline in a database. A tablespace set version is online in a database when it is attached to the database using the `ATTACH_TABLESPACES` procedure. Only a single version of a tablespace set can be online in a database at a particular time. However, the same version or different versions of a tablespace set can be online in different databases at the same time. In this case, it might be necessary to ensure that only one database can make changes to the tablespace set.

Tablespace Repository Procedures Use the DBMS_FILE_GROUP Package Automatically

Although tablespace repositories are built on file group repositories, it is not necessary to use the DBMS_FILE_GROUP package to create a file group repository before using one of the procedures in the DBMS_STREAMS_TABLESPACE_ADM package. If you run the CLONE_TABLESPACES or DETACH_TABLESPACES procedure and specify a file group that does not exist, then the procedure creates the file group automatically.

A Tablespace Repository Provides Versioning but Not Source Control A tablespace repository provides versioning of tablespace sets, but it does not provide source control. If two or more versions of a tablespace set are changed at the same time and placed in a tablespace repository, then these changes are not merged.

Read-Only Tablespaces Requirement During Export

The procedures in the DBMS_STREAMS_TABLESPACE_ADM package that perform a Data Pump export make any read/write tablespace being exported read-only. After the export is complete, if a procedure in the DBMS_STREAMS_TABLESPACE_ADM package made a tablespace read-only, then the procedure makes the tablespace read/write.

Automatic Platform Conversion for Tablespaces

When one of the procedures in the DBMS_STREAMS_TABLESPACE_ADM package moves or copies tablespaces to a database that is running on a different platform, the procedure can convert the data files to the appropriate platform if the conversion is supported. The V\$TRANSPORTABLE_PLATFORM dynamic performance view lists all platforms that support cross-platform transportable tablespaces.

When a tablespace repository is used, the platform conversion is automatic if it is supported. When a tablespace repository is not used, you must specify the platform to which or from which the tablespace is being converted.

See Also:

- [Chapter 30, "Using Information Provisioning"](#) for information about using the procedures in the DBMS_STREAMS_TABLESPACE_ADM package, including usage scenarios
- *Oracle Database PL/SQL Packages and Types Reference* for reference information about the DBMS_STREAMS_TABLESPACE_ADM package and the DBMS_FILE_GROUP package

Options for Bulk Information Provisioning

[Table 29–2](#) describes when to use each option for bulk information provisioning.

Table 29–2 Options for Moving or Copying Tablespaces

Option	Use this Option Under these Conditions
Data Pump export/import	<ul style="list-style-type: none"> ■ You want to move or copy data at the database, tablespace, schema, or table level. ■ You want to perform each step required to complete the Data Pump export/import.
Data Pump export/import with the <code>TRANSPORT_TABLESPACES</code> option	<ul style="list-style-type: none"> ■ The tablespaces being moved or copied can be read-only during the operation. ■ You want to perform each step required to complete the Data Pump export/import.
Transportable tablespace from backup with the <code>RMAN TRANSPORT TABLESPACE</code> command	The tablespaces being moved or copied must remain online (writeable) during the operation.
<code>DBMS_STREAMS_TABLESPACE_ADM</code> procedures without a tablespace repository	<ul style="list-style-type: none"> ■ The tablespaces being moved or copied can be read-only during the operation. ■ You want to combine multiple steps in the Data Pump export/import into one procedure call. ■ You do not want to use a tablespace repository for the tablespaces being moved or copied.
<code>DBMS_STREAMS_TABLESPACE_ADM</code> procedures with a tablespace repository	<ul style="list-style-type: none"> ■ The tablespaces being moved or copied can be read-only during the operation. ■ You want to combine multiple steps in the Data Pump export/import into one procedure call. ■ You want to use a tablespace repository for the tablespaces being moved or copied. ■ You want platform conversion to be automatic.

Incremental Information Provisioning with Oracle Streams

Oracle Streams can share and maintain database objects in different databases at each of the following levels:

- Database
- Schema
- Table
- Table subset

Oracle Streams can keep shared database objects synchronized at two or more databases. Specifically, an Oracle Streams **capture process** or **synchronous capture** captures changes to a shared database object in a **source database**, one or more **propagations** propagate the changes to another database, and an Oracle Streams **apply process** applies the changes to the shared database object. If database objects are not identical at different databases, then Oracle Streams can transform them at any point in the process. That is, a change can be transformed during capture, propagation, or apply. In addition, Oracle Streams provides custom processing of changes during apply with apply handlers. Database objects can be shared between Oracle databases, or they can be shared between Oracle and non-Oracle databases through the use of Oracle Database Gateway. In addition to data **replication**, Oracle Streams provides messaging, event management and notification, and data warehouse loading.

A combination of Oracle Streams and bulk provisioning enables you to copy and maintain a large amount of data by running a single procedure. The following

procedures in the `DBMS_STREAMS_ADM` package use Data Pump to copy data between databases and configure Oracle Streams to maintain the copied data incrementally:

- `MAINTAIN_GLOBAL` configures an Oracle Streams environment that replicates changes at the database level between two databases.
- `MAINTAIN_SCHEMAS` configures an Oracle Streams environment that replicates changes to specified schemas between two databases.
- `MAINTAIN_SIMPLE_TTS` clones a simple tablespace from a **source database** to a **destination database** and uses Oracle Streams to maintain this tablespace at both databases.
- `MAINTAIN_TABLES` configures an Oracle Streams environment that replicates changes to specified tables between two databases.
- `MAINTAIN_TTS` uses transportable tablespaces with Data Pump to clone a set of tablespaces from a source database to a destination database and uses Oracle Streams to maintain these tablespaces at both databases.

In addition, the `PRE_INSTANTIATION_SETUP` and `POST_INSTANTIATION_SETUP` procedures configure an Oracle Streams environment that replicates changes either at the database level or to specified tablespaces between two databases. These procedures must be used together, and **instantiation** actions must be performed manually, to complete the Oracle Streams replication configuration.

Using these procedures, you can export data from one database, ship it to another database, reformat the data if the second database is on a different platform, import the data into the second database, and start syncing the data with the changes happening in the first database. If the second database is on a grid, then you have just migrated your application to a grid with one command.

These procedures can configure **Oracle Streams clients** to maintain changes originating at the source database in a single-source replication environment, or they can configure Oracle Streams clients to maintain changes originating at both databases in a bidirectional replication environment. By maintaining changes to the data, it can be kept synchronized at both databases. These procedures can either perform these actions directly, or they can generate one or more scripts that performs these actions.

See Also:

- [Chapter 1, "Introduction to Oracle Streams"](#)
- *Oracle Database PL/SQL Packages and Types Reference* for reference information about the `DBMS_STREAMS_ADM` package
- *Oracle Streams Replication Administrator's Guide* for information about using the `DBMS_STREAMS_ADM` package

On-Demand Information Access

Users and applications can access information without moving or copying it to a new location. Distributed SQL allows grid users to access and integrate data stored in multiple Oracle and, through Oracle Database Gateway, non-Oracle databases. Transparent remote data access with distributed SQL allows grid users to run their applications against any other database without making any code change to the applications. While integrating data and managing transactions across multiple data stores, the Oracle database optimizes the execution plans to access data in the most efficient manner.

See Also:

- *Oracle Database Administrator's Guide* for information about distributed SQL
- *Oracle Database Heterogeneous Connectivity Administrator's Guide* for more information about Oracle Database Gateway

Using Information Provisioning

This chapter describes how to use information provisioning. This chapter includes an example that creates a **tablespace repository**, examples that transfer tablespaces between databases, and an example that uses a **file group repository** to store different versions of files.

The following topics describe using information provisioning:

- [Using a Tablespace Repository](#)
- [Using a File Group Repository](#)

See Also: [Chapter 29, "Information Provisioning Concepts"](#)

Using a Tablespace Repository

The following procedures in the `DBMS_STREAMS_TABLESPACE_ADM` package can create a **tablespace repository**, add versioned tablespace sets to a tablespace repository, and copy versioned tablespace sets from a tablespace repository:

- `ATTACH_TABLESPACES`: This procedure copies a **version** of a tablespace set from a tablespace repository and attaches the tablespaces to a database.
- `CLONE_TABLESPACES`: This procedure adds a new version of a tablespace set to a tablespace repository by copying the tablespace set from a database. The tablespaces in the tablespace set remain part of the database from which they were copied.
- `DETACH_TABLESPACES`: This procedure adds a new version of a tablespace set to a tablespace repository by moving the tablespace set from a database to the repository. The tablespaces in the tablespace set are dropped from the database from which they were copied.

This section illustrates how to use a tablespace repository with an example scenario. In the scenario, the goal is to run quarterly reports on the sales tablespaces (`sales_tbs1` and `sales_tbs2`). Sales are recorded in these tablespaces in the `inst1.example.com` database. The example clones the tablespaces quarterly and stores a new version of the tablespaces in the tablespace repository. The tablespace repository also resides in the `inst1.example.com` database. When a specific version of the tablespace set is required to run reports at a reporting database, it is copied from the tablespace repository and attached to the reporting database.

In this example scenario, the following databases are the reporting databases:

- The reporting database `inst2.example.com` shares a file system with the `inst1.example.com` database. Also, the reports that are run on `inst2.example.com` might make changes to the tablespace. Therefore, the tablespaces are made read/write at `inst2.example.com`, and, when the reports are complete, a new version of the tablespace files is stored in a separate directory from the original version of the tablespace files.
- The reporting system `inst3.example.com` does not share a file system with the `inst1.example.com` database. The reports that are run on `inst3.example.com` do not make any changes to the tablespace. Therefore, the tablespaces remain read-only at `inst3.example.com`, and, when the reports are complete, the original version of the tablespace files remains in a single directory.

The following sections describe how to create and populate the tablespace repository and how to use the tablespace repository to run reports at the other databases:

- [Creating and Populating a Tablespace Repository](#)
- [Using a Tablespace Repository for Remote Reporting with a Shared File System](#)
- [Using a Tablespace Repository for Remote Reporting Without a Shared File System](#)

These examples must be run by an administrative user with the necessary privileges to run the procedures listed previously.

See Also: *Oracle Database PL/SQL Packages and Types Reference* for more information about these procedures and the privileges required to run them

Creating and Populating a Tablespace Repository

This example creates a tablespaces repository and adds a new **version** of a tablespace set to the repository after each quarter. The tablespace set consists of the sales tablespaces for a business: `sales_tbs1` and `sales_tbs2`.

[Figure 30–1](#) provides an overview of the **tablespace repository** created in this example:

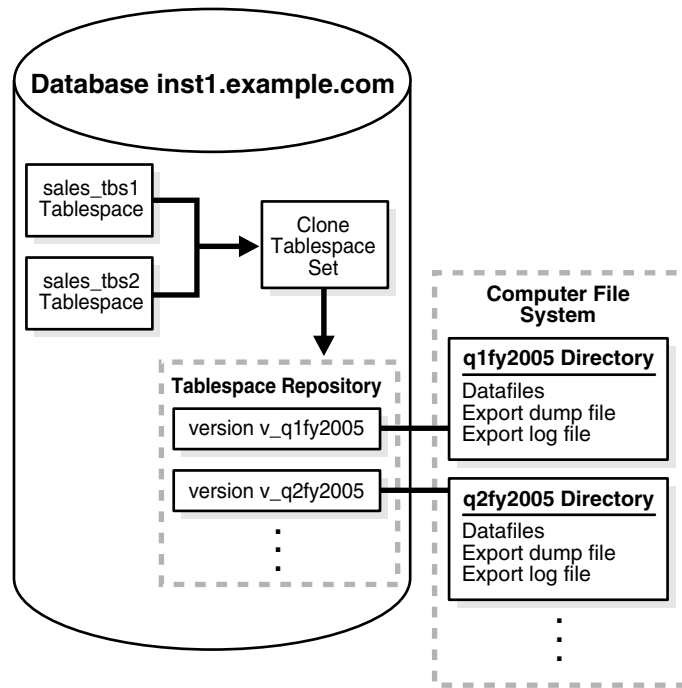
Figure 30-1 Example Tablespace Repository

The following table shows the tablespace set versions created in this example, their directory objects, and the corresponding file system directory for each directory object.

Version	Directory Object	Corresponding File System Directory
v_q1fy2005	q1fy2005	/home/sales/q1fy2005
v_q2fy2005	q2fy2005	/home/sales/q2fy2005

This example makes the following assumptions:

- The `inst1.example.com` database exists.
- The `sales_tbs1` and `sales_tbs2` tablespaces exist in the `inst1.example.com` database.

The following steps create and populate a tablespace repository:

1. Connect as an administrative user to the database where the sales tablespaces are modified with new sales data. In this example, connect to the `inst1.example.com` database.

The administrative user must have the necessary privileges to run the procedures in the `DBMS_STREAMS_TABLESPACE_ADM` package and must have the necessary privileges to create directory objects.

See *Oracle Database Administrator's Guide* for information about connecting to a database in SQL*Plus.

2. Create a directory object for the first quarter in fiscal year 2005 on `inst1.example.com`:

```
CREATE OR REPLACE DIRECTORY q1fy2005 AS '/home/sales/q1fy2005';
```

The specified file system directory must exist when you create the directory object.

3. Create a directory object that corresponds to the directory that contains the data files for the tablespaces in the `inst1.example.com` database. For example, if the data files for the tablespaces are in the `/orc/inst1/dbs` directory, then create a directory object that corresponds to this directory:

```
CREATE OR REPLACE DIRECTORY dbfiles_inst1 AS '/orc/inst1/dbs';
```

4. Clone the tablespace set and add the first version of the tablespace set to the tablespace repository:

```
DECLARE
  tbs_set DBMS_STREAMS_TABLESPACE_ADM.TABLESPACE_SET;
BEGIN
  tbs_set(1) := 'sales_tbs1';
  tbs_set(2) := 'sales_tbs2';
  DBMS_STREAMS_TABLESPACE_ADM.CLONE_TABLESPACES(
    tablespace_names      => tbs_set,
    tablespace_directory_object => 'q1fy2005',
    file_group_name       => 'strmadmin.sales',
    version_name          => 'v_q1fy2005');
END;
/
```

The `sales` **file group** is created automatically if it does not exist.

5. When the second quarter in fiscal year 2005 is complete, create a directory object for the second quarter in fiscal year 2005:

```
CREATE OR REPLACE DIRECTORY q2fy2005 AS '/home/sales/q2fy2005';
```

The specified file system directory must exist when you create the directory object.

6. Clone the tablespace set and add the next version of the tablespace set to the tablespace repository at the `inst1.example.com` database:

```
DECLARE
  tbs_set DBMS_STREAMS_TABLESPACE_ADM.TABLESPACE_SET;
BEGIN
  tbs_set(1) := 'sales_tbs1';
  tbs_set(2) := 'sales_tbs2';
  DBMS_STREAMS_TABLESPACE_ADM.CLONE_TABLESPACES(
    tablespace_names      => tbs_set,
    tablespace_directory_object => 'q2fy2005',
    file_group_name       => 'strmadmin.sales',
    version_name          => 'v_q2fy2005');
END;
/
```

Steps 5 and 6 can be repeated whenever a quarter ends to store a version of the tablespace set for each quarter. Each time, create a new directory object to store the tablespace files for the quarter, and specify a unique version name for the quarter.

Using a Tablespace Repository for Remote Reporting with a Shared File System

This example runs reports at `inst2.example.com` on specific versions of the sales tablespaces stored in a **tablespace repository** at `inst1.example.com`. These two databases share a file system, and the reports that are run on `inst2.example.com` might make changes to the tablespace. Therefore, the tablespaces are made read/write at `inst2.example.com`. When the reports are complete, a new **version** of the tablespace files is stored in a separate directory from the original version of the tablespace files.

Figure 30–2 provides an overview of how tablespaces in a tablespace repository are attached to a different database in this example:

Figure 30–2 Attaching Tablespaces with a Shared File System

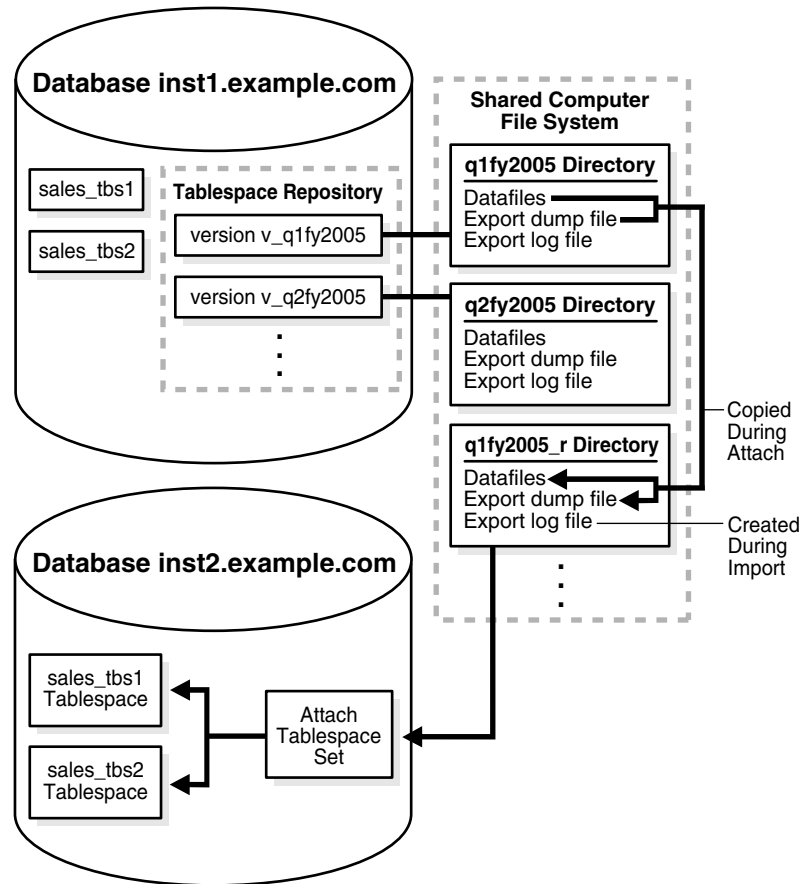
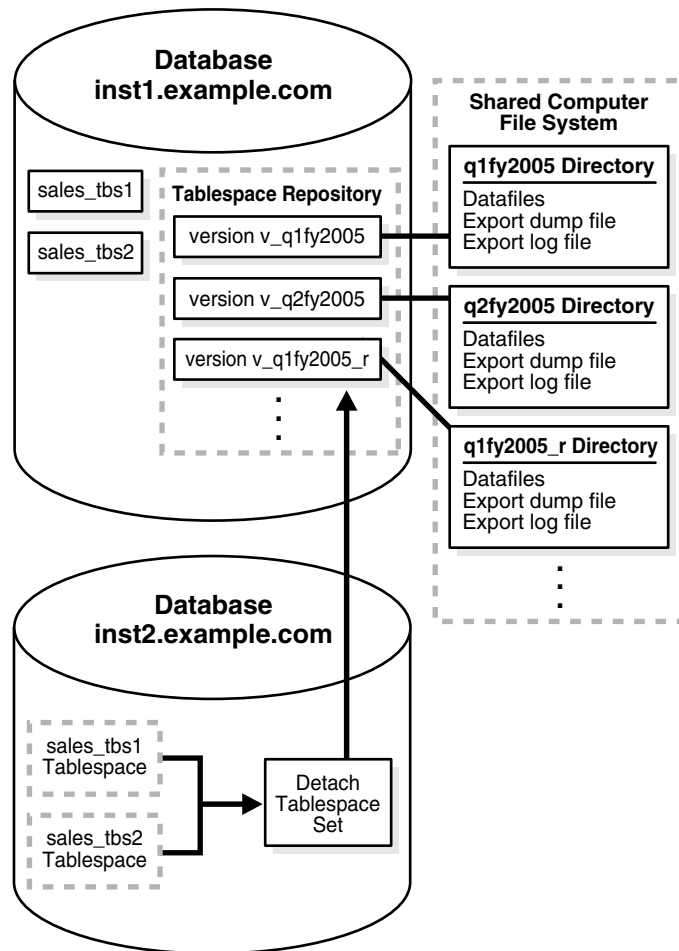

Figure 30–3 provides an overview of how tablespaces are detached and placed in a tablespace repository in this example:

Figure 30-3 Detaching Tablespaces with a Shared File System

The following table shows the tablespace set versions in the tablespace repository when this example is complete. It shows the directory object for each version and the corresponding file system directory for each directory object. The versions that are new are created in this example. The versions that existed prior to this example were created in ["Creating and Populating a Tablespace Repository"](#) on page 30-2.

Version	Directory Object	Corresponding File System Directory	New?
v_q1fy2005	q1fy2005	/home/sales/q1fy2005	No
v_q1fy2005_r	q1fy2005_r	/home/sales/q1fy2005_r	Yes
v_q2fy2005	q2fy2005	/home/sales/q2fy2005	No
v_q2fy2005_r	q2fy2005_r	/home/sales/q2fy2005_r	Yes

This example makes the following assumptions:

- The `inst1.example.com` and `inst2.example.com` databases exist.
- The `inst1.example.com` and `inst2.example.com` databases can access a shared file system.
- Networking is configured between the databases so that these databases can communicate with each other.

- A tablespace repository that contains a version of the sales tablespaces (`sales_tbs1` and `sales_tbs2`) for various quarters exists in the `inst1.example.com` database. This tablespace repository was created and populated in the example "[Creating and Populating a Tablespace Repository](#)" on page 30-2.

Complete the following steps:

1. In SQL*Plus, connect to `inst1.example.com` as an administrative user.

The administrative user must have the necessary privileges to create directory objects.

See *Oracle Database Administrator's Guide* for information about connecting to a database in SQL*Plus.

2. Create a directory object that will store the tablespace files for the first quarter in fiscal year 2005 on `inst1.example.com` after the `inst2.example.com` database has completed reporting on this quarter:

```
CREATE OR REPLACE DIRECTORY q1fy2005_r AS '/home/sales/q1fy2005_r';
```

The specified file system directory must exist when you create the directory objects.

3. Connect to the `inst2.example.com` database as an administrative user.

The administrative user must have the necessary privileges to run the procedures in the `DBMS_STREAMS_TABLESPACE_ADM` package, create directory objects, and create database links.

4. Create two directory objects for the first quarter in fiscal year 2005 on `inst2.example.com`. These directory objects must have the same names and correspond to the same directories on the shared file system as the directory objects used by the tablespace repository in the `inst1.example.com` database for the first quarter:

```
CREATE OR REPLACE DIRECTORY q1fy2005 AS '/home/sales/q1fy2005';
```

```
CREATE OR REPLACE DIRECTORY q1fy2005_r AS '/home/sales/q1fy2005_r';
```

5. Create a database link from `inst2.example.com` to the `inst1.example.com` database. For example:

```
CREATE DATABASE LINK inst1.example.com CONNECT TO strmadmin
  IDENTIFIED BY password
  USING 'inst1.example.com';
```

6. Attach the tablespace set to the `inst2.example.com` database from the `strmadmin.sales` **file group** in the `inst1.example.com` database:

```
DECLARE
  tbs_set DBMS_STREAMS_TABLESPACE_ADM.TABLESPACE_SET;
BEGIN
  DBMS_STREAMS_TABLESPACE_ADM.ATTACH_TABLESPACES (
    file_group_name      => 'strmadmin.sales',
    version_name         => 'v_q1fy2005',
    datafiles_directory_object => 'q1fy2005_r',
    repository_db_link   => 'inst1.example.com',
    tablespace_names     => tbs_set);
END;
/
```

Notice that `q1fy2005_r` is specified for the `datafiles_directory_object` parameter. Therefore, the data files for the tablespaces and the export dump file are copied from the `/home/sales/q1fy2005` location to the `/home/sales/q1fy2005_r` location by the procedure. The attached tablespaces in the `inst2.example.com` database use the data files in the `/home/sales/q1fy2005_r` location. The Data Pump import log file also is placed in this directory.

The attached tablespaces use the data files in the `/home/sales/q1fy2005_r` location. However, the `v_q1fy2005` version of the tablespaces in the tablespace repository consists of the files in the original `/home/sales/q1fy2005` location.

7. Make the tablespaces read/write at `inst2.example.com`:

```
ALTER TABLESPACE sales_tbs1 READ WRITE;
```

```
ALTER TABLESPACE sales_tbs2 READ WRITE;
```

8. Run the reports on the data in the sales tablespaces at the `inst2.example.com` database. The reports make changes to the tablespaces.
9. Detach the version of the tablespace set for the first quarter of 2005 from the `inst2.example.com` database:

```
DECLARE
  tbs_set DBMS_STREAMS_TABLESPACE_ADM.TABLESPACE_SET;
BEGIN
  tbs_set(1) := 'sales_tbs1';
  tbs_set(2) := 'sales_tbs2';
  DBMS_STREAMS_TABLESPACE_ADM.DETACH_TABLESPACES (
    tablespace_names      => tbs_set,
    export_directory_object => 'q1fy2005_r',
    file_group_name       => 'strmadmin.sales',
    version_name          => 'v_q1fy2005_r',
    repository_db_link    => 'inst1.example.com');
END;
/
```

Only one version of a tablespace set can be attached to a database at a time. Therefore, the version of the sales tablespaces for the first quarter of 2005 must be detached from `inst2.example.com` before the version of this tablespace set for the second quarter of 2005 can be attached.

Also, notice that the specified `export_directory_object` is `q1fy2005_r`, and that the `version_name` is `v_q1fy2005_r`. After the detach operation, there are two versions of the tablespace files for the first quarter of 2005 stored in the tablespace repository on `inst1.example.com`: one version of the tablespace prior to reporting and one version after reporting. These two versions have different version names and are stored in different directory objects.

10. Connect to the `inst1.example.com` database as an administrative user.
11. Create a directory object that will store the tablespace files for the second quarter in fiscal year 2005 on `inst1.example.com` after the `inst2.example.com` database has completed reporting on this quarter:

```
CREATE OR REPLACE DIRECTORY q2fy2005_r AS '/home/sales/q2fy2005_r';
```

The specified file system directory must exist when you create the directory object.

12. Connect to the `inst2.example.com` database as an administrative user.

13. Create two directory objects for the second quarter in fiscal year 2005 at `inst2.example.com`. These directory objects must have the same names and correspond to the same directories on the shared file system as the directory objects used by the tablespace repository in the `inst1.example.com` database for the second quarter:

```
CREATE OR REPLACE DIRECTORY q2fy2005 AS '/home/sales/q2fy2005';

CREATE OR REPLACE DIRECTORY q2fy2005_r AS '/home/sales/q2fy2005_r';
```

14. Attach the tablespace set for the second quarter of 2005 to the `inst2.example.com` database from the sales file group in the `inst1.example.com` database:

```
DECLARE
  tbs_set DBMS_STREAMS_TABLESPACE_ADM.TABLESPACE_SET;
BEGIN
  DBMS_STREAMS_TABLESPACE_ADM.ATTACH_TABLESPACES(
    file_group_name          => 'strmadmin.sales',
    version_name             => 'v_q2fy2005',
    datafiles_directory_object => 'q2fy2005_r',
    repository_db_link       => 'inst1.example.com',
    tablespace_names         => tbs_set);
END;
/
```

15. Make the tablespaces read/write at `inst2.example.com`:

```
ALTER TABLESPACE sales_tbs1 READ WRITE;

ALTER TABLESPACE sales_tbs2 READ WRITE;
```

16. Run the reports on the data in the sales tablespaces at the `inst2.example.com` database. The reports make changes to the tablespace.

17. Detach the version of the tablespace set for the second quarter of 2005 from `inst2.example.com`:

```
DECLARE
  tbs_set DBMS_STREAMS_TABLESPACE_ADM.TABLESPACE_SET;
BEGIN
  tbs_set(1) := 'sales_tbs1';
  tbs_set(2) := 'sales_tbs2';
  DBMS_STREAMS_TABLESPACE_ADM.DETACH_TABLESPACES(
    tablespace_names          => tbs_set,
    export_directory_object   => 'q2fy2005_r',
    file_group_name           => 'strmadmin.sales',
    version_name               => 'v_q2fy2005_r',
    repository_db_link        => 'inst1.example.com');
END;
/
```

Steps 11-17 can be repeated whenever a quarter ends to run reports on each quarter.

Using a Tablespace Repository for Remote Reporting Without a Shared File System

This example runs reports at `inst3.example.com` on specific versions of the sales tablespaces stored in a **tablespace repository** at `inst1.example.com`. These two databases do not share a file system, and the reports that are run on `inst3.example.com` do not make any changes to the tablespace. Therefore, the tablespaces remain read-only at `inst3.example.com`, and, when the reports are

complete, there is no need for a new **version** of the tablespace files in the tablespace repository on `inst1.example.com`.

Figure 30-4 provides an overview of how tablespaces in a tablespace repository are attached to a different database in this example:

Figure 30-4 Attaching Tablespaces Without a Shared File System

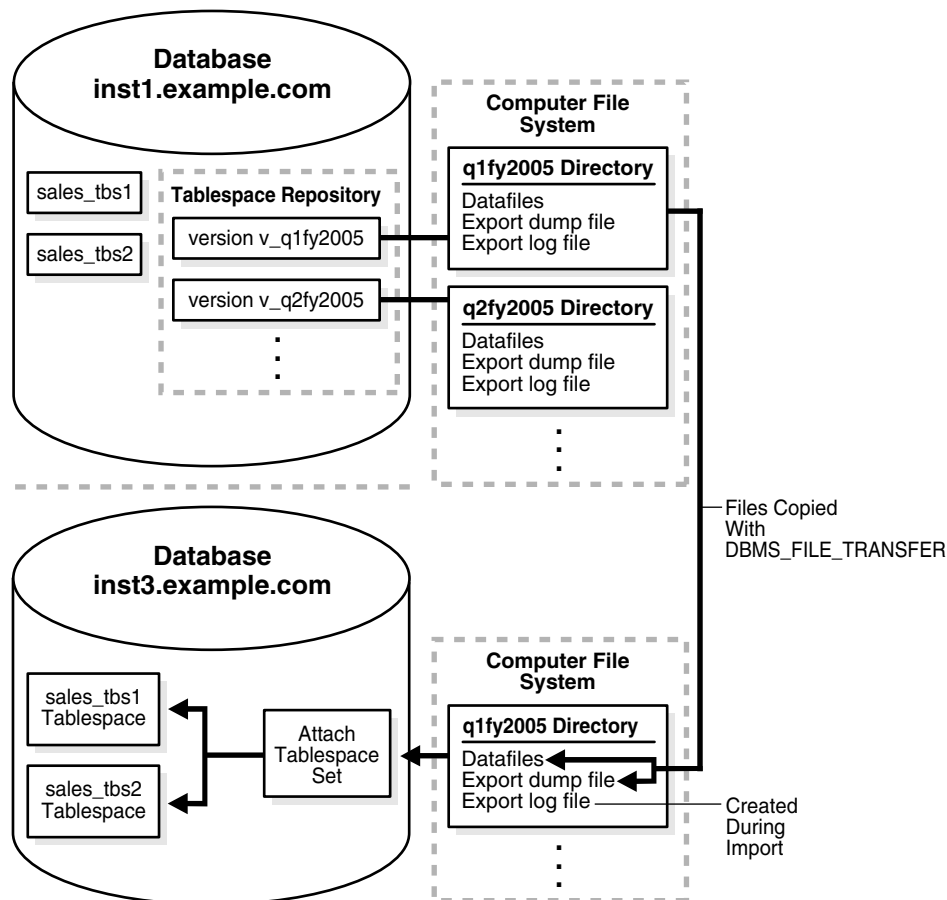

The following table shows the directory objects used in this example. It shows the existing directory objects that are associated with tablespace repository versions on the `inst1.example.com` database, and it shows the new directory objects created on the `inst3.example.com` database in this example. The directory objects that existed prior to this example were created in "Creating and Populating a Tablespace Repository" on page 30-2.

Directory Object	Database	Version	Corresponding File System Directory	New?
q1fy2005	inst1.examp le.com	v_q1fy2005	/home/sales/q1fy2005	No
q2fy2005	inst1.examp le.com	v_q2fy2005	/home/sales/q2fy2005	No

Directory Object	Database	Version	Corresponding File System Directory	New?
q1fy2005	inst3.example.com	Not associated with a tablespace repository version	/usr/sales_data/fy2005q1	Yes
q2fy2005	inst3.example.com	Not associated with a tablespace repository version	/usr/sales_data/fy2005q2	Yes

This example makes the following assumptions:

- The `inst1.example.com` and `inst3.example.com` databases exist.
- The `inst1.example.com` and `inst3.example.com` databases do not share a file system.
- Networking is configured between the databases so that they can communicate with each other.
- The sales tablespaces (`sales_tbs1` and `sales_tbs2`) exist in the `inst1.example.com` database.

Complete the following steps:

1. In SQL*Plus, connect to the `inst3.example.com` database as an administrative user.

The administrative user must have the necessary privileges to run the procedures in the `DBMS_STREAMS_TABLESPACE_ADM` package, create directory objects, and create database links.

See *Oracle Database Administrator's Guide* for information about connecting to a database in SQL*Plus.

2. Create a database link from `inst3.example.com` to the `inst1.example.com` database. For example:

```
CREATE DATABASE LINK inst1.example.com CONNECT TO strmadmin
  IDENTIFIED BY password
  USING 'inst1.example.com';
```

3. Create a directory object for the first quarter in fiscal year 2005 on `inst3.example.com`. Although `inst3.example.com` is a remote database that does not share a file system with `inst1.example.com`, the directory object must have the same name as the directory object used by the tablespace repository in the `inst1.example.com` database for the first quarter. However, the directory paths of the directory objects on `inst1.example.com` and `inst3.example.com` do not need to match.

```
CREATE OR REPLACE DIRECTORY q1fy2005 AS '/usr/sales_data/fy2005q1';
```

The specified file system directory must exist when you create the directory object.

4. Connect to the `inst1.example.com` database as an administrative user.

The administrative user must have the necessary privileges to run the procedures in the `DBMS_FILE_TRANSFER` package and create database links. This example uses the `DBMS_FILE_TRANSFER` package to copy the tablespace files from `inst1.example.com` to `inst3.example.com`. If some other method is used to transfer the files, then the privileges to run the procedures in the `DBMS_FILE_TRANSFER` package are not required.

5. Create a database link from `inst1.example.com` to the `inst3.example.com` database. For example:

```
CREATE DATABASE LINK inst3.example.com CONNECT TO strmadmin
  IDENTIFIED BY password
  USING 'inst3.example.com';
```

This database link will be used to transfer files to the `inst3.example.com` database in Step 6.

6. Copy the data file for each tablespace and the export dump file for the first quarter to the `inst3.example.com` database:

```
BEGIN
  DBMS_FILE_TRANSFER.PUT_FILE(
    source_directory_object => 'q1fy2005',
    source_file_name        => 'sales_tbs1.dbf',
    destination_directory_object => 'q1fy2005',
    destination_file_name    => 'sales_tbs1.dbf',
    destination_database     => 'inst3.example.com');
  DBMS_FILE_TRANSFER.PUT_FILE(
    source_directory_object => 'q1fy2005',
    source_file_name        => 'sales_tbs2.dbf',
    destination_directory_object => 'q1fy2005',
    destination_file_name    => 'sales_tbs2.dbf',
    destination_database     => 'inst3.example.com');
  DBMS_FILE_TRANSFER.PUT_FILE(
    source_directory_object => 'q1fy2005',
    source_file_name        => 'expdat16.dmp',
    destination_directory_object => 'q1fy2005',
    destination_file_name    => 'expdat16.dmp',
    destination_database     => 'inst3.example.com');
END;
/
```

Before you run the `PUT_FILE` procedure for the export dump file, you can query the `DBA_FILE_GROUP_FILES` data dictionary view to determine the name and directory object of the export dump file. For example, run the following query to list this information for the export dump file in the `v_q1fy2005` version:

```
COLUMN FILE_NAME HEADING 'Export Dump|File Name' FORMAT A35
COLUMN FILE_DIRECTORY HEADING 'Directory Object' FORMAT A35

SELECT FILE_NAME, FILE_DIRECTORY FROM DBA_FILE_GROUP_FILES
  where FILE_GROUP_NAME = 'SALES' AND
         VERSION_NAME   = 'V_Q1FY2005';
```

7. Connect to the `inst3.example.com` database as an administrative user.
8. Attach the tablespace set for the first quarter of 2005 to the `inst3.example.com` database from the sales file group in the `inst1.example.com` database:

```
DECLARE
  tbs_set DBMS_STREAMS_TABLESPACE_ADM.TABLESPACE_SET;
BEGIN
  DBMS_STREAMS_TABLESPACE_ADM.ATTACH_TABLESPACES(
    file_group_name        => 'strmadmin.sales',
    version_name           => 'v_q1fy2005',
    datafiles_directory_object => 'q1fy2005',
    repository_db_link     => 'inst1.example.com',
    tablespace_names       => tbs_set);
END;
```

/

The tablespaces are read-only when they are attached. Because the reports on `inst3.example.com` do not change the tablespaces, the tablespaces can remain read-only.

9. Run the reports on the data in the sales tablespaces at the `inst3.example.com` database.
10. Drop the tablespaces and their contents at `inst3.example.com`:

```
DROP TABLESPACE sales_tbs1 INCLUDING CONTENTS;
```

```
DROP TABLESPACE sales_tbs2 INCLUDING CONTENTS;
```

The tablespaces are dropped from the `inst3.example.com` database, but the tablespace files remain in the directory object.

11. Create a directory object for the second quarter in fiscal year 2005 on `inst3.example.com`. The directory object must have the same name as the directory object used by the tablespace repository in the `inst1.example.com` database for the second quarter. However, the directory paths of the directory objects on `inst1.example.com` and `inst3.example.com` do not need to match.

```
CREATE OR REPLACE DIRECTORY q2fy2005 AS '/usr/sales_data/fy2005q2';
```

The specified file system directory must exist when you create the directory object.

12. Connect to the `inst1.example.com` database as an administrative user.
13. Copy the data file and the export dump file for the second quarter to the `inst3.example.com` database:

```
BEGIN
  DBMS_FILE_TRANSFER.PUT_FILE(
    source_directory_object => 'q2fy2005',
    source_file_name        => 'sales_tbs1.dbf',
    destination_directory_object => 'q2fy2005',
    destination_file_name    => 'sales_tbs1.dbf',
    destination_database     => 'inst3.example.com');
  DBMS_FILE_TRANSFER.PUT_FILE(
    source_directory_object => 'q2fy2005',
    source_file_name        => 'sales_tbs2.dbf',
    destination_directory_object => 'q2fy2005',
    destination_file_name    => 'sales_tbs2.dbf',
    destination_database     => 'inst3.example.com');
  DBMS_FILE_TRANSFER.PUT_FILE(
    source_directory_object => 'q2fy2005',
    source_file_name        => 'expdat18.dmp',
    destination_directory_object => 'q2fy2005',
    destination_file_name    => 'expdat18.dmp',
    destination_database     => 'inst3.example.com');
END;
```

/

Before you run the `PUT_FILE` procedure for the export dump file, you can query the `DBA_FILE_GROUP_FILES` data dictionary view to determine the name and directory object of the export dump file. For example, run the following query to list this information for the export dump file in the `v_q2fy2005` version:

```

COLUMN FILE_NAME HEADING 'Export Dump|File Name' FORMAT A35
COLUMN FILE_DIRECTORY HEADING 'Directory Object' FORMAT A35

SELECT FILE_NAME, FILE_DIRECTORY FROM DBA_FILE_GROUP_FILES
       where FILE_GROUP_NAME = 'SALES' AND
              VERSION_NAME   = 'V_Q2FY2005';

```

14. Connect to the `inst3.example.com` database as an administrative user.
15. Attach the tablespace set for the second quarter of 2005 to the `inst3.example.com` database from the sales **file group** in the `inst1.example.com` database:

```

DECLARE
  tbs_set DBMS_STREAMS_TABLESPACE_ADM.TABLESPACE_SET;
BEGIN
  DBMS_STREAMS_TABLESPACE_ADM.ATTACH_TABLESPACES(
    file_group_name      => 'strmadmin.sales',
    version_name         => 'v_q2fy2005',
    datafiles_directory_object => 'q2fy2005',
    repository_db_link   => 'inst1.example.com',
    tablespace_names     => tbs_set);
END;
/

```

The tablespaces are read-only when they are attached. Because the reports on `inst3.example.com` do not change the tablespace, the tablespaces can remain read-only.

16. Run the reports on the data in the sales tablespaces at the `inst3.example.com` database.
17. Drop the tablespaces and their contents:

```

DROP TABLESPACE sales_tbs1 INCLUDING CONTENTS;

DROP TABLESPACE sales_tbs2 INCLUDING CONTENTS;

```

The tablespaces are dropped from the `inst3.example.com` database, but the tablespace files remain in the directory object.

Steps 11-17 can be repeated whenever a quarter ends to run reports on each quarter.

Using a File Group Repository

The `DBMS_FILE_GROUP` package can create a **file group repository**, add versioned **file groups** to the repository, and copy versioned file groups from the repository. This section illustrates how to use a file group repository with a scenario that stores reports in the repository.

In this scenario, a business sells books and music over the internet. The business runs weekly reports on the sales data in the `inst1.example.com` database and stores these reports in two HTML files on a computer file system. The `book_sales.htm` file contains the report for book sales, and the `music_sales.htm` file contains the report for music sales. The business wants to store these weekly reports in a file group repository at the `inst2.example.com` remote database. Every week, the two reports are generated on the `inst1.example.com` database, transferred to the computer system running the `inst2.example.com` database, and added to the repository as a file group **version**. The file group repository stores all of the file group versions that contain the reports for each week.

Figure 30-5 provides an overview of the file group repository created in this example:

Figure 30-5 Example File Group Repository

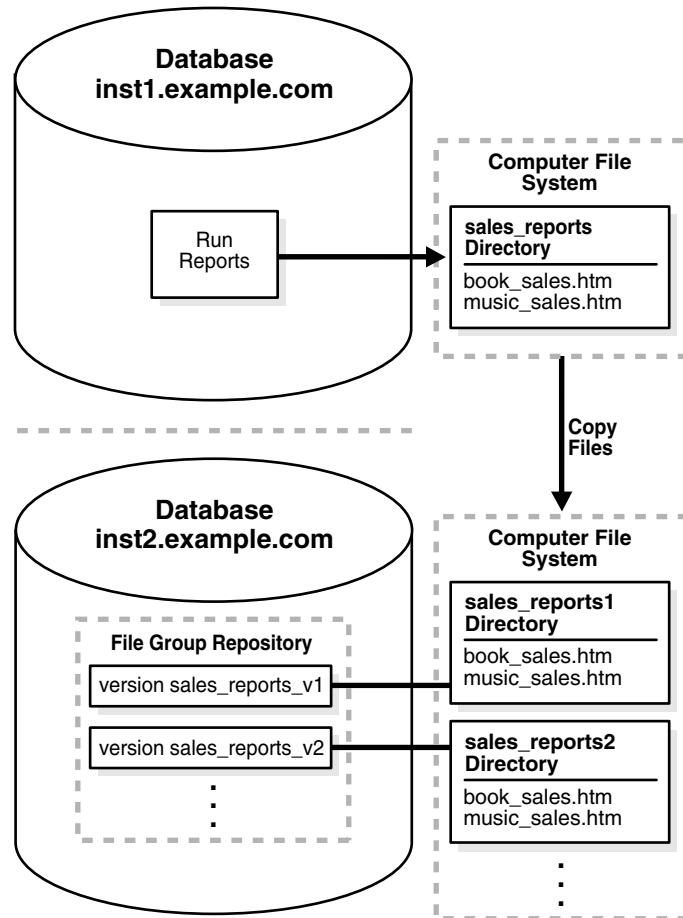

The benefits of the file group repository are that it stores metadata about each file group version in the data dictionary and provides a standard interface for managing the file group versions. For example, when the business must view a specific sales report, it can query the data dictionary in the `inst2.example.com` database to determine the location of the report on the computer file system.

The following table shows the directory objects created in this example. It shows the directory object created on the `inst1.example.com` database to store new reports, and it shows the directory objects that are associated with file group repository versions on the `inst2.example.com` database.

Directory Object	Database	Version	Corresponding File System Directory
<code>sales_reports</code>	<code>inst1.example.com</code>	Not associated with a file group repository version	<code>/home/sales_reports</code>
<code>sales_reports1</code>	<code>inst2.example.com</code>	<code>sales_reports_v1</code>	<code>/home/sales_reports/fg1</code>
<code>sales_reports2</code>	<code>inst2.example.com</code>	<code>sales_reports_v1</code>	<code>/home/sales_reports/fg2</code>

This example makes the following assumptions:

- The `inst1.example.com` and `inst2.example.com` databases exist.
- The `inst1.example.com` and `inst2.example.com` databases do not share a file system.
- Networking is configured between the databases so that they can communicate with each other.
- The `inst1.example.com` database runs reports on the books and music sales data in the database and stores the reports as HTML files on the computer file system.

The following steps configure and populate a file group repository at a remote database:

1. Connect as an administrative user to the remote database that will contain the file group repository. In this example, connect to the `inst2.example.com` database.

The administrative user must have the necessary privileges to create directory objects and run the procedures in the `DBMS_FILE_GROUP` package.

See *Oracle Database Administrator's Guide* for information about connecting to a database in SQL*Plus.

2. Create a directory object to hold the first version of the file group:

```
CREATE OR REPLACE DIRECTORY sales_reports1 AS '/home/sales_reports/fg1';
```

The specified file system directory must exist when you create the directory object.

3. Connect as an administrative user to the database that runs the reports. In this example, connect to the `inst1.example.com` database.

The administrative user must have the necessary privileges to create directory objects.

4. Create a directory object to hold the latest reports:

```
CREATE OR REPLACE DIRECTORY sales_reports AS '/home/sales_reports';
```

The specified file system directory must exist when you create the directory object.

5. Create a database link to the `inst2.example.com` database:

```
CREATE DATABASE LINK inst2.example.com CONNECT TO strmadmin  
  IDENTIFIED BY password  
  USING 'inst2.example.com';
```

6. Run the reports on the `inst1.example.com` database. Running the reports should place the `book_sales.htm` and `music_sales.htm` files in the directory specified in Step 4.

7. Transfer the report files from the computer system running the `inst1.example.com` database to the computer system running the `inst2.example.com` database using file transfer protocol (FTP) or some other method. Ensure that the files are copied to the directory that corresponds to the directory object created in Step 2.

8. Connect as an administrative user to the remote database that will contain the file group repository. In this example, connect to the `inst2.example.com` database.

9. Create the file group repository that will contain the reports:

```
BEGIN  
  DBMS_FILE_GROUP.CREATE_FILE_GROUP(  
    file_group_name => 'strmadmin.reports');
```

```
END;
/
```

The `reports` file group repository is created with the following default properties:

- The minimum number of versions in the repository is 2. When the file group is purged, the number of versions cannot drop below 2.
- The maximum number of versions is infinite. A file group version is not purged because of the number of versions in the file group in the repository.
- The retention days is infinite. A file group version is not purged because of the amount of time it has been in the repository.

10. Create the first version of the file group:

```
BEGIN
  DBMS_FILE_GROUP.CREATE_VERSION(
    file_group_name => 'strmadmin.reports',
    version_name    => 'sales_reports_v1',
    comments        => 'Sales reports for week of 06-FEB-2005');
END;
/
```

11. Add the report files to the file group version:

```
BEGIN
  DBMS_FILE_GROUP.ADD_FILE(
    file_group_name => 'strmadmin.reports',
    file_name       => 'book_sales.htm',
    file_type       => 'HTML',
    file_directory  => 'sales_reports1',
    version_name    => 'sales_reports_v1');
  DBMS_FILE_GROUP.ADD_FILE(
    file_group_name => 'strmadmin.reports',
    file_name       => 'music_sales.htm',
    file_type       => 'HTML',
    file_directory  => 'sales_reports1',
    version_name    => 'sales_reports_v1');
END;
/
```

12. Create a directory object on `inst2.example.com` to hold the next version of the file group:

```
CREATE OR REPLACE DIRECTORY sales_reports2 AS '/home/sales_reports/fg2';
```

The specified file system directory must exist when you create the directory object.

- 13.** At the end of the next week, run the reports on the `inst1.example.com` database. Running the reports should place new `book_sales.htm` and `music_sales.htm` files in the directory specified in Step 4. If necessary, remove the old files from this directory before running the reports.
- 14.** Transfer the report files from the computer system running the `inst1.example.com` database to the computer system running the `inst2.example.com` database using file transfer protocol (FTP) or some other method. Ensure that the files are copied to the directory that corresponds to the directory object created in Step 12.
- 15.** In SQL*Plus, connect to the `inst2.example.com` database as an administrative user.

16. Create the next version of the file group:

```
BEGIN
  DBMS_FILE_GROUP.CREATE_VERSION(
    file_group_name => 'strmadmin.reports',
    version_name    => 'sales_reports_v2',
    comments       => 'Sales reports for week of 13-FEB-2005');
END;
/
```

17. Add the report files to the file group version:

```
BEGIN
  DBMS_FILE_GROUP.ADD_FILE(
    file_group_name => 'strmadmin.reports',
    file_name       => 'book_sales.htm',
    file_type       => 'HTML',
    file_directory  => 'sales_reports2',
    version_name    => 'sales_reports_v2');
  DBMS_FILE_GROUP.ADD_FILE(
    file_group_name => 'strmadmin.reports',
    file_name       => 'music_sales.htm',
    file_type       => 'HTML',
    file_directory  => 'sales_reports2',
    version_name    => 'sales_reports_v2');
END;
/
```

The file group repository now contains two versions of the file group that contains the sales report files. Repeat steps 12-17 to add new versions of the file group to the repository.

See Also:

- ["File Group Repository"](#) on page 29-4
- *Oracle Database PL/SQL Packages and Types Reference* for more information about the DBMS_FILE_GROUP package

Monitoring File Group and Tablespace Repositories

A **file group repository** can contain multiple **file groups** and multiple versions of a particular file group. A **tablespace repository** is a collection of tablespace sets in a file group repository. Tablespace repositories are built on file group repositories, but tablespace repositories only contain the files required to move or copy tablespaces between databases. This chapter provides sample queries that you can use to monitor file group repositories and tablespace repositories.

The following topics describe monitoring file group and tablespace repositories:

- [Monitoring a File Group Repository](#)
- [Monitoring a Tablespace Repository](#)

Note: The Oracle Streams tool in the Oracle Enterprise Manager Console is also an excellent way to monitor an Oracle Streams environment. See the online Help for the Oracle Streams tool for more information.

See Also:

- [Chapter 29, "Information Provisioning Concepts"](#)
- [Chapter 30, "Using Information Provisioning"](#)
- *Oracle Database Reference* for information about the data dictionary views described in this chapter
- *Oracle Streams Replication Administrator's Guide* for information about monitoring an Oracle Streams **replication** environment

Monitoring a File Group Repository

The queries in the following sections provide examples for monitoring a **file group repository**:

- [Displaying General Information About the File Groups in a Database](#)
- [Displaying Information About File Group Versions](#)
- [Displaying Information About File Group Files](#)

See Also:

- ["File Group Repository"](#) on page 29-4
- ["Using a File Group Repository"](#) on page 30-14

Displaying General Information About the File Groups in a Database

The query in this section displays the following information for each **file group** in the local database:

- The file group owner
- The file group name
- Whether the files in a **version** of the file group are kept on disk if the version is purged
- The minimum number of versions of the file group allowed
- The maximum number of versions of the file group allowed
- The number of days to retain a file group version after it is created

Run the following query to display this information for the local database:

```
COLUMN FILE_GROUP_OWNER HEADING 'File Group|Owner' FORMAT A10
COLUMN FILE_GROUP_NAME HEADING 'File Group|Name' FORMAT A10
COLUMN KEEP_FILES HEADING 'Keep|Files?' FORMAT A10
COLUMN MIN_VERSIONS HEADING 'Minimum|Number|of Versions' FORMAT 9999
COLUMN MAX_VERSIONS HEADING 'Maximum|Number|of Versions' FORMAT 9999999999
COLUMN RETENTION_DAYS HEADING 'Days to|Retain|a Version' FORMAT 9999999999.99

SELECT FILE_GROUP_OWNER,
       FILE_GROUP_NAME,
       KEEP_FILES,
       MIN_VERSIONS,
       MAX_VERSIONS,
       RETENTION_DAYS
FROM DBA_FILE_GROUPS;
```

Your output looks similar to the following:

File Group Owner	File Group Name	Keep Files?	Minimum Number of Versions	Maximum Number of Versions	Days to Retain a Version
STRMADMIN	REPORTS	Y	2	4294967295	4294967295.00

This output shows that the database has one file group with the following characteristics:

- The file group owner is `strmadmin`.
- The file group name is `reports`.
- The files in a version are kept on disk if a version is purged because the "Keep Files?" is "Y" for the file group.
- The minimum number of versions allowed is 2. If the file group automatically purges versions, then it will not purge a version if the purge would cause the total number of versions to drop below 2.

- The file group allows an infinite number of versions. The number 4294967295 means an infinite number of versions.
- The file group retains a version of an infinite number of days. The number 4294967295 means an infinite number of days.

Displaying Information About File Group Versions

The query in this section displays the following information for each **file group version** in the local database:

- The owner of the file group that contains the version
- The name of the file group that contains the version
- The version name
- The version number
- The name of the user who created the version
- Comments for the version

Run the following query to display this information for the local database:

```
COLUMN FILE_GROUP_OWNER HEADING 'File Group|Owner' FORMAT A10
COLUMN FILE_GROUP_NAME HEADING 'File Group|Name' FORMAT A10
COLUMN VERSION_NAME HEADING 'Version Name' FORMAT A20
COLUMN VERSION HEADING 'Version|Number' FORMAT 99999999
COLUMN CREATOR HEADING 'Creator' FORMAT A10
COLUMN COMMENTS HEADING 'Comments' FORMAT A14
```

```
SELECT FILE_GROUP_OWNER,
       FILE_GROUP_NAME,
       VERSION_NAME,
       VERSION,
       CREATOR,
       COMMENTS
FROM DBA_FILE_GROUP_VERSIONS;
```

Your output looks similar to the following:

File Group Owner	File Group Name	Version Name	Version Number	Creator	Comments
STRMADMIN	REPORTS	SALES_REPORTS_V1	1	STRMADMIN	Sales reports for week of 06 -FEB-2005
STRMADMIN	REPORTS	SALES_REPORTS_V2	2	STRMADMIN	Sales reports for week of 13 -FEB-2005

Displaying Information About File Group Files

The query in this section displays the following information about each file in a **file group version** in the local database:

- The owner of the file group that contains the file
- The name of the file group that contains the file
- The name of the version in the file group that contains the file

- The file name
- The directory object that contains the file

```

COLUMN FILE_GROUP_OWNER HEADING 'File Group|Owner' FORMAT A10
COLUMN FILE_GROUP_NAME HEADING 'File Group|Name' FORMAT A10
COLUMN VERSION_NAME HEADING 'Version Name' FORMAT A20
COLUMN FILE_NAME HEADING 'File Name' FORMAT A15
COLUMN FILE_DIRECTORY HEADING 'File Directory|Object' FORMAT A15

SELECT FILE_GROUP_OWNER,
       FILE_GROUP_NAME,
       VERSION_NAME,
       FILE_NAME,
       FILE_DIRECTORY
FROM DBA_FILE_GROUP_FILES;

```

Your output looks similar to the following:

File Group Owner	File Group Name	Version Name	File Name	File Directory Object
STRMADMIN	REPORTS	SALES_REPORTS_V1	book_sales.htm	SALES_REPORTS1
STRMADMIN	REPORTS	SALES_REPORTS_V1	music_sales.htm	SALES_REPORTS1
STRMADMIN	REPORTS	SALES_REPORTS_V2	book_sales.htm	SALES_REPORTS2
STRMADMIN	REPORTS	SALES_REPORTS_V2	music_sales.htm	SALES_REPORTS2

Query the DBA_DIRECTORIES data dictionary view to determine the corresponding file system directory for a directory object.

Monitoring a Tablespace Repository

The queries in the following sections provide examples for monitoring a **tablespace repository**:

- [Displaying Information About the Tablespaces in a Tablespace Repository](#)
- [Displaying Information About the Tables in a Tablespace Repository](#)
- [Displaying Export Information About Versions in a Tablespace Repository](#)

See Also:

- ["Tablespace Repository" on page 29-4](#)
- ["Using a Tablespace Repository" on page 30-1](#)

Displaying Information About the Tablespaces in a Tablespace Repository

The query in this section displays the following information about each tablespace in the **tablespace repository** in the local database:

- The owner of the **file group** that contains the tablespace in the tablespace repository
- The name of the file group that contains the tablespace in the tablespace repository
- The name of the **version** that contains the tablespace
- The tablespace name

```

COLUMN FILE_GROUP_OWNER HEADING 'File Group|Owner' FORMAT A15
COLUMN FILE_GROUP_NAME HEADING 'File Group|Name' FORMAT A15
COLUMN VERSION_NAME HEADING 'Version Name' FORMAT A15

```



```

COLUMN VERSION HEADING 'Version|Number' FORMAT 99999999
COLUMN TABLESPACE_NAME HEADING 'Tablespace Name' FORMAT A15

SELECT FILE_GROUP_OWNER,
       FILE_GROUP_NAME,
       VERSION_NAME,
       VERSION,
       TABLESPACE_NAME
FROM DBA_FILE_GROUP_TABLESPACES;

```

Your output looks similar to the following:

File Group Owner	File Group Name	Version Version Name	Version Number	Tablespace Name
STRMADMIN	SALES	V_Q1FY2005	1	SALES_TBS1
STRMADMIN	SALES	V_Q1FY2005	1	SALES_TBS2
STRMADMIN	SALES	V_Q2FY2005	3	SALES_TBS1
STRMADMIN	SALES	V_Q2FY2005	3	SALES_TBS2
STRMADMIN	SALES	V_Q1FY2005_R	4	SALES_TBS1
STRMADMIN	SALES	V_Q1FY2005_R	4	SALES_TBS2
STRMADMIN	SALES	V_Q2FY2005_R	5	SALES_TBS1
STRMADMIN	SALES	V_Q2FY2005_R	5	SALES_TBS2

Displaying Information About the Tables in a Tablespace Repository

The query in this section displays the following information about each table in the [tablespace repository](#) in the local database:

- The owner of the **file group** that contains the table in the tablespace repository
- The name of the file group that contains the table in the tablespace repository
- The name of the **version** that contains the table
- The table owner
- The table name
- The tablespace that contains the table

```

COLUMN FILE_GROUP_OWNER HEADING 'File Group|Owner' FORMAT A10
COLUMN FILE_GROUP_NAME HEADING 'File Group|Name' FORMAT A10
COLUMN VERSION_NAME HEADING 'Version Name' FORMAT A15
COLUMN OWNER HEADING 'Table|Owner' FORMAT A10
COLUMN TABLE_NAME HEADING 'Table Name' FORMAT A15
COLUMN TABLESPACE_NAME HEADING 'Tablespace Name' FORMAT A15

SELECT FILE_GROUP_OWNER,
       FILE_GROUP_NAME,
       VERSION_NAME,
       OWNER,
       TABLE_NAME,
       TABLESPACE_NAME
FROM DBA_FILE_GROUP_TABLES;

```

Your output looks similar to the following:

File Group Owner	File Group Name	Version Name	Table Owner	Table Name	Tablespace Name
STRMADMIN	SALES	V_Q1FY2005	SL	ORDERS	SALES_TBS1
STRMADMIN	SALES	V_Q1FY2005	SL	ORDER_ITEMS	SALES_TBS1

STRMADMIN	SALES	V_Q1FY2005	SL	CUSTOMERS	SALES_TBS2
STRMADMIN	SALES	V_Q2FY2005	SL	ORDERS	SALES_TBS1
STRMADMIN	SALES	V_Q2FY2005	SL	ORDER_ITEMS	SALES_TBS1
STRMADMIN	SALES	V_Q2FY2005	SL	CUSTOMERS	SALES_TBS2
STRMADMIN	SALES	V_Q1FY2005_R	SL	ORDERS	SALES_TBS1
STRMADMIN	SALES	V_Q1FY2005_R	SL	ORDER_ITEMS	SALES_TBS1
STRMADMIN	SALES	V_Q1FY2005_R	SL	CUSTOMERS	SALES_TBS2
STRMADMIN	SALES	V_Q2FY2005_R	SL	ORDERS	SALES_TBS1
STRMADMIN	SALES	V_Q2FY2005_R	SL	ORDER_ITEMS	SALES_TBS1
STRMADMIN	SALES	V_Q2FY2005_R	SL	CUSTOMERS	SALES_TBS2

Displaying Export Information About Versions in a Tablespace Repository

To display export information about the versions in the **tablespace repository** in the local database, query the `DBA_FILE_GROUP_EXPORT_INFO` data dictionary view. This view only displays information for versions that contain a valid Data Pump export dump file. The query in this section displays the following export information about each **version** in the local database:

- The name of the **file group** that contains the version
- The name of the version
- The export version of the export dump file. The export version corresponds to the version of Data Pump that performed the export.
- The platform on which the export was performed
- The date and time of the export
- The global name of the exporting database

```

COLUMN FILE_GROUP_NAME HEADING 'File Group|Name' FORMAT A10
COLUMN VERSION_NAME HEADING 'Version Name' FORMAT A13
COLUMN EXPORT_VERSION HEADING 'Export|Version' FORMAT A7
COLUMN PLATFORM_NAME HEADING 'Export Platform' FORMAT A17
COLUMN EXPORT_TIME HEADING 'Export Time' FORMAT A17
COLUMN SOURCE_GLOBAL_NAME HEADING 'Export|Database' FORMAT A10

SELECT FILE_GROUP_NAME,
       VERSION_NAME,
       EXPORT_VERSION,
       PLATFORM_NAME,
       TO_CHAR(EXPORT_TIME, 'HH24:MI:SS MM/DD/YY') EXPORT_TIME,
       SOURCE_GLOBAL_NAME
FROM DBA_FILE_GROUP_EXPORT_INFO;

```

Your output looks similar to the following:

File Group Name	Version Name	Export Version	Export Platform	Export Time	Export Database
SALES	V_Q1FY2005	10.2.0	Linux IA (32-bit)	12:23:52 03/08/05	INST1.EXAM PLE.COM
SALES	V_Q2FY2005	10.2.0	Linux IA (32-bit)	12:27:37 03/08/05	INST1.EXAM PLE.COM
SALES	V_Q1FY2005_R	10.2.0	Linux IA (32-bit)	12:39:50 03/08/05	INST2.EXAM PLE.COM
SALES	V_Q2FY2005_R	10.2.0	Linux IA (32-bit)	12:46:04 03/08/05	INST2.EXAM PLE.COM

Part VI

Sample Environments and Applications

This part includes the following detailed examples:

- [Chapter 32, "Single-Database Capture and Apply Example"](#)
- [Chapter 33, "Rule-Based Application Example"](#)

Single-Database Capture and Apply Example

This chapter illustrates an example of a single database that captures changes to a table with a **capture process**, reenqueues the captured changes into a **queue**, and then uses a **DML handler** during apply to insert a subset of the changes into a different table.

The following topics describe configuring an example single-database capture and apply example:

- [Overview of the Single-Database Capture and Apply Example](#)
- [Prerequisites](#)

Note: The extended example is not included in the PDF version of this chapter, but it is included in the HTML version of the chapter.

Overview of the Single-Database Capture and Apply Example

The example in this chapter illustrates using Oracle Streams to capture and apply data manipulation language (DML) changes at a single database named `cpap.example.com`. Specifically, this example captures DML changes to the `employees` table in the `hr` schema, placing row logical change records (LCRs) into a **queue** named `streams_queue`. Next, an **apply process** dequeues these row LCRs from the same queue, reenqueues them into this queue, and sends them to a **DML handler**.

When the row LCRs are captured, they reside in the **buffered queue** and cannot be dequeued explicitly. After the row LCRs are reenqueued during apply, they are available for explicit dequeue by an application. This example does not create the application that dequeues these row LCRs.

This example illustrates a DML handler that inserts records of deleted employees into an `emp_del` table in the `hr` schema. This example assumes that the `emp_del` table is used to retain the records of all deleted employees. The DML handler is used to determine whether each row LCR contains a `DELETE` statement. When the DML handler finds a row LCR containing a `DELETE` statement, it converts the `DELETE` into an `INSERT` on the `emp_del` table and then inserts the row.

[Figure 32–1](#) provides an overview of the environment.

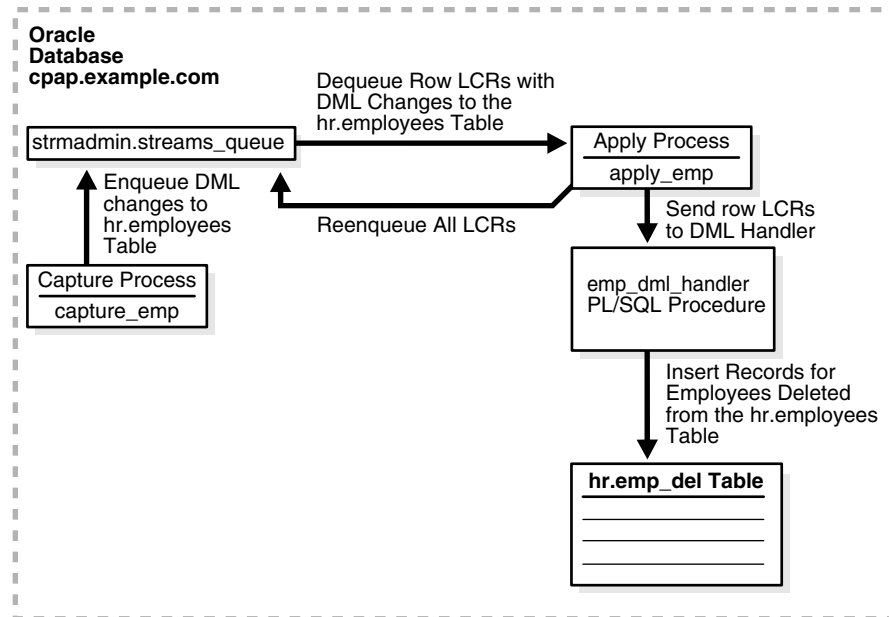
Figure 32-1 Single Database Capture and Apply Example**See Also:**

- [Chapter 2, "Oracle Streams Information Capture"](#)
- ["Process Messages with Apply Handlers"](#) on page 4-8 for more information about DML handlers

Prerequisites

The following prerequisites must be completed before you begin the example in this chapter.

- Set the following initialization parameters to the values indicated for all databases in the environment:
 - Set the COMPATIBLE initialization parameter to 10.1.0 or higher.
 - STREAMS_POOL_SIZE: Optionally set this parameter to an appropriate value for each database in the environment. This parameter specifies the size of the **Oracle Streams pool**. The Oracle Streams pool stores **messages** in a **buffered queue** and is used for internal communications during parallel capture and apply. When the MEMORY_TARGET, MEMORY_MAX_TARGET, or SGA_TARGET initialization parameter is set to a nonzero value, the Oracle Streams pool size is managed automatically.

See Also: ["Setting Initialization Parameters Relevant to Oracle Streams"](#) on page 9-4 for information about other initialization parameters that are important in an Oracle Streams environment

- Set the database to run in ARCHIVELOG mode. Any database producing changes that will be captured must run in ARCHIVELOG mode.

See Also: *Oracle Database Administrator's Guide* for information about running a database in ARCHIVELOG mode

- Create an Oracle Streams administrator at the database. This example assumes that the user name of the Oracle Streams administrator is `strmadmin`.

This example executes a subprogram in an Oracle Streams packages within a stored procedure. Specifically, the `emp_dq` procedure created in Step 8 on page -HIDDEN runs the `DEQUEUE` procedure in the `DBMS_STREAMS_MESSAGING` package. Therefore, the Oracle Streams administrator must be granted `EXECUTE` privilege explicitly on the package. In this case, `EXECUTE` privilege cannot be granted through a role. The `DBMS_STREAMS_AUTH.GRANT_ADMIN_PRIVILEGE` procedure grants `EXECUTE` on all Oracle Streams packages, as well as other privileges relevant to Oracle Streams. You can either grant the `EXECUTE` privilege on the package directly, or use the `GRANT_ADMIN_PRIVILEGE` procedure to grant it.

See Also: ["Configuring an Oracle Streams Administrator"](#) on page 9-1

Rule-Based Application Example

This chapter illustrates a rule-based application that uses the Oracle [rules engine](#).

The examples in this chapter are independent of Oracle Streams. That is, no Oracle Streams [capture processes](#), [propagations](#), [apply processes](#), or [messaging clients](#) are clients of the rules engine in these examples, and no [queues](#) are used.

The following topics describe configuring examples of rules-based applications:

- [Overview of the Rule-Based Application](#)

Note: The extended example is not included in the PDF version of this chapter, but it is included in the HTML version of the chapter.

See Also:

- [Chapter 5, "Rules"](#)
- [Chapter 17, "Managing Rules"](#)
- [Chapter 26, "Monitoring Rules"](#)

Overview of the Rule-Based Application

Each example in this chapter creates a rule-based application that handles customer problems. The application uses [rules](#) to determine actions that must be completed based on the problem priority when a new problem is reported. For example, the application assigns each problem to a particular company center based on the problem priority.

The application enforces these rules using the [rules engine](#). An [evaluation context](#) named `evalctx` is created to define the information surrounding a support problem. Rules are created based on the requirements described previously, and they are added to a [rule set](#) named `rs`.

The task of assigning problems is done by a user-defined procedure named `problem_dispatch`, which calls the rules engine to evaluate rules in the rule set `rs` and then takes appropriate action based on the rules that evaluate to `TRUE`.

Part VII

Appendixes

This part includes the following appendixes:

- [Appendix A, "How Oracle Streams Works With Other Database Components"](#)
- [Appendix B, "Oracle Streams Restrictions"](#)
- [Appendix C, "XML Schema for LCRs"](#)
- [Appendix D, "Online Database Upgrade with Oracle Streams"](#)
- [Appendix E, "Online Database Maintenance with Oracle Streams"](#)

How Oracle Streams Works With Other Database Components

This appendix describes how Oracle Streams works with other Oracle Database components.

This appendix includes these topics:

- [Oracle Streams and Oracle Real Application Clusters](#)
- [Oracle Streams and Transparent Data Encryption](#)
- [Oracle Streams and Flashback Data Archive](#)
- [Oracle Streams and Recovery Manager \(RMAN\)](#)

Oracle Streams and Oracle Real Application Clusters

The following topics describe how Oracle Streams works with Oracle Real Application Clusters (Oracle RAC):

- [Capture Processes and Oracle Real Application Clusters](#)
- [Synchronous Capture and Oracle Real Application Clusters](#)
- [Combined Capture and Apply and Oracle Real Application Clusters](#)
- [Queues and Oracle Real Application Clusters](#)
- [Propagations and Oracle Real Application Clusters](#)
- [Apply Processes and Oracle Real Application Clusters](#)

See Also: *Oracle Streams Replication Administrator's Guide* for information about best practices for Oracle Streams in an Oracle RAC environment

Capture Processes and Oracle Real Application Clusters

A [capture process](#) can capture changes in an Oracle Real Application Clusters (Oracle RAC) environment. If you use one or more capture processes and Oracle RAC in the same environment, then all archived logs that contain changes to be captured by a capture process must be available for all instances in the Oracle RAC environment. In an Oracle RAC environment, a capture process reads changes made by all instances. Any processes used by a single capture process run on a single instance in an Oracle RAC environment.

Each capture process is started and stopped on the owner instance for its ANYDATA queue, even if the start or stop procedure is run on a different instance. Also, a capture

process follows its **queue** to a different instance if the current owner instance becomes unavailable. The queue itself follows the rules for primary instance and secondary instance ownership.

If the owner instance for a **queue table** containing a queue used by a capture process becomes unavailable, then queue ownership is transferred automatically to another instance in the cluster. In addition, if the capture process was enabled when the owner instance became unavailable, then the capture process is restarted automatically on the new owner instance. If the capture process was disabled when the owner instance became unavailable, then the capture process remains disabled on the new owner instance.

LogMiner supports the `LOG_ARCHIVE_DEST_n` initialization parameter, and Oracle Streams capture processes use LogMiner to capture changes from the redo log. If an archived log file is inaccessible from one destination, then a **local capture process** can read it from another accessible destination. On an Oracle RAC database, this ability also enables you to use cross instance archival (CIA) such that each instance archives its files to all other instances. This solution cannot detect or resolve gaps caused by missing archived log files. Hence, it can be used only to complement an existing solution to have the archived files shared between all instances.

In a **downstream capture process** environment, the source database can be a single instance database or a multi-instance Oracle RAC database. The downstream database can be a single instance database or a multi-instance Oracle RAC database, regardless of whether the source database is single instance or multi-instance.

See Also:

- ["Implicit Capture with an Oracle Streams Capture Process"](#) on page 2-9
- *Oracle Database Reference* for more information about the `DBA_QUEUE_TABLES` data dictionary view
- *Oracle Real Application Clusters Administration and Deployment Guide* for more information about configuring archived logs to be shared between instances

Synchronous Capture and Oracle Real Application Clusters

A **synchronous capture** can capture changes in an Oracle Real Application Clusters (Oracle RAC) environment. In an Oracle RAC environment, synchronous capture reads changes made by all instances.

For the best performance with synchronous capture in an Oracle RAC environment, changes to independent sets of tables should be captured by separate synchronous captures. For example, if different applications use different sets of database objects in the database, then configure a separate synchronous capture to capture changes to the database objects for each application. In this case, each synchronous capture should use a different queue and queue table.

See Also: ["Implicit Capture with Synchronous Capture"](#) on page 2-38

Combined Capture and Apply and Oracle Real Application Clusters

Combined capture and apply can be used in an Oracle Real Application Clusters (Oracle RAC) environment. In an Oracle RAC environment, the capture process and apply process can be on the same instance, on different instances in a single Oracle RAC database, or on different databases. When the capture process and apply process

are on different instances in the same database or on different databases, you must configure a propagation between the capture process queue and the apply process queue for combined capture and apply to be used.

See Also: ["Combined Capture and Apply Optimization"](#) on page 3-20

Queues and Oracle Real Application Clusters

You can configure a **queue** to stage **LCRs** and **user messages** in an Oracle Real Application Clusters (Oracle RAC) environment. In an Oracle RAC environment, only the owner instance can have a buffer for a queue, but different instances can have buffers for different queues. A **buffered queue** is System Global Area (SGA) memory associated with a queue.

Oracle Streams processes and jobs support primary instance and secondary instance specifications for **queue tables**. If you use these specifications, then the secondary instance assumes ownership of a queue table when the primary instance becomes unavailable, and ownership is transferred back to the primary instance when it becomes available again.

You can set primary and secondary instance specifications using the `ALTER_QUEUE_TABLE` procedure in the `DBMS_AQADM` package. The `DBA_QUEUE_TABLES` data dictionary view contains information about the owner instance for a queue table. A queue table can contain multiple queues. In this case, each queue in a queue table has the same owner instance as the queue table.

See Also:

- ["Queues"](#) on page 3-1
- *Oracle Database Reference* for more information about the `DBA_QUEUE_TABLES` data dictionary view
- *Oracle Streams Advanced Queuing User's Guide* for more information about queues and Oracle RAC
- *Oracle Database PL/SQL Packages and Types Reference* for more information about the `ALTER_QUEUE_TABLE` procedure

Propagations and Oracle Real Application Clusters

A **propagation** can propagate messages from one **queue** to another in an Oracle Real Application Clusters (Oracle RAC) environment. A **propagation job** running on an instance propagates logical change records (LCRs) from any queue owned by that instance to **destination queues**.

Any propagation to an Oracle RAC database is made over database links. The database links must be configured to connect to the destination instance that owns the queue that will receive the messages.

If the owner instance for a queue table containing a **destination queue** for a propagation becomes unavailable, then queue ownership is transferred automatically to another instance in the cluster. If both the primary and secondary instance for a queue table containing a destination queue become unavailable, then queue ownership is transferred automatically to another instance in the cluster. In this case, if the primary or secondary instance becomes available again, then ownership is transferred back to one of them accordingly.

A queue-to-queue propagation to a buffered destination queue uses a service to provide transparent failover in an Oracle RAC environment. That is, a propagation job

for a queue-to-queue propagation automatically connects to the instance that owns the destination queue. The service used by a queue-to-queue propagation always runs on the owner instance of the destination queue. This service is created only for buffered queues in an Oracle RAC database. If you plan to use buffered messaging with an Oracle RAC database, then messages can be enqueued into a buffered queue on any instance. If messages are enqueued on an instance that does not own the queue, then the messages are sent to the correct instance, but it is more efficient to enqueue messages on the instance that owns the queue. The service can be used to connect to the owner instance of the queue before enqueueing messages into a buffered queue.

Because the queue service always runs on the owner instance of the queue, transparent failover can occur when Oracle RAC instances fail. When multiple queue-to-queue propagations use a single database link, the connect description for each queue-to-queue propagation changes automatically to propagate messages to the correct destination queue.

In contrast, queue-to-dblink propagations do not use services. Queue-to-dblink propagations require you to repoint your database links if the owner instance in an Oracle RAC database that contains the destination queue for the propagation fails. To make the propagation job connect to the correct instance on the **destination database**, manually reconfigure the database link from the **source database** to connect to the instance that owns the destination queue. You do not need to modify a propagation that uses a re-created database link.

The `NAME` column in the `DBA_SERVICES` data dictionary view contains the service name for a queue. The `NETWORK_NAME` column in the `DBA_QUEUES` data dictionary view contains the network name for a queue. Do not manage the services for queue-to-queue propagations in any way. Oracle manages them automatically. For queue-to-dblink propagations, use the network name as the service name in the connect string of the database link to connect to the correct instance.

Note: If a queue contains or will contain **captured LCRs** in an Oracle RAC environment, then queue-to-queue propagations should be used to propagate messages to an Oracle RAC destination database. If a queue-to-dblink propagation propagates captured LCRs to an Oracle RAC destination database, then this propagation must use an instance-specific database link that refers to the owner instance of the destination queue. If such a propagation connects to any other instance, then the propagation raises an error.

See Also: ["Message Propagation Between Queues"](#) on page 3-11

Apply Processes and Oracle Real Application Clusters

You can configure an Oracle Streams **apply process** to apply changes in an Oracle Real Application Clusters (Oracle RAC) environment. Each apply process is started and stopped on the owner instance for its `ANYDATA` queue, even if the start or stop procedure is run on a different instance. An apply **coordinator process**, its corresponding apply **reader server**, and all of its **apply servers** run on a single instance.

If the owner instance for a **queue table** containing a **queue** used by an apply process becomes unavailable, then queue ownership is transferred automatically to another instance in the cluster. Also, an apply process will follow its queue to a different instance if the current owner instance becomes unavailable. The queue itself follows the rules for primary instance and secondary instance ownership. In addition, if the

apply process was enabled when the owner instance became unavailable, then the apply process is restarted automatically on the new owner instance. If the apply process was disabled when the owner instance became unavailable, then the apply process remains disabled on the new owner instance.

See Also:

- ["Implicit Consumption with an Apply Process"](#) on page 4-5
- *Oracle Database Reference* for more information about the `DBA_QUEUE_TABLES` data dictionary view

Oracle Streams and Transparent Data Encryption

The following topics describe how Oracle Streams works with Transparent Data Encryption:

- [Capture Processes and Transparent Data Encryption](#)
- [Synchronous Capture and Transparent Data Encryption](#)
- [Explicit Capture and Transparent Data Encryption](#)
- [Queues and Transparent Data Encryption](#)
- [Propagations and Transparent Data Encryption](#)
- [Apply Processes and Transparent Data Encryption](#)
- [Messaging Clients and Transparent Data Encryption](#)
- [Manual Dequeue and Transparent Data Encryption](#)

See Also: *Oracle Database Advanced Security Administrator's Guide* for information about transparent data encryption

Capture Processes and Transparent Data Encryption

A local **capture process** can capture changes to columns that have been encrypted using transparent data encryption. A downstream capture process can capture changes to columns that have been encrypted only if the downstream database shares a wallet with the **source database**. A wallet can be shared through a network file system (NFS), or it can be copied from one computer system to another manually. When a wallet is shared with a downstream database, ensure that the `ENCRYPTION_WALLET_LOCATION` parameter in the `sqlnet.ora` file at the downstream database specifies the wallet location.

If you copy a wallet to a downstream database, then ensure that you copy the wallet from the source database to the downstream database whenever the wallet at the source database changes. Do not perform any operations on the wallet at the downstream database, such as changing the encryption key for a replicated table.

Encrypted columns in row logical change records (row LCRs) captured by a local or downstream capture process are decrypted when the row LCRs are staged in a **buffered queue**. If row LCRs spill to disk in a database with transparent data encryption enabled, then Oracle Streams transparently encrypts any encrypted columns while the row LCRs are stored on disk.

Note: A capture process only supports encrypted columns if the redo logs used by the capture process were generated by a database with a compatibility level of 11.0.0 or higher. The compatibility level is controlled by the `COMPATIBLE` initialization parameter.

See Also:

- ["Implicit Capture with an Oracle Streams Capture Process"](#) on page 2-9
- ["Persistent Queues and Buffered Queues"](#) on page 3-3

Synchronous Capture and Transparent Data Encryption

A **synchronous capture** can capture changes to columns that have been encrypted using transparent data encryption. Encrypted columns in row logical change records (row LCRs) captured by a synchronous capture remain encrypted when the row LCRs are staged in a **persistent queue**.

See Also: ["Implicit Capture with Synchronous Capture"](#) on page 2-38

Explicit Capture and Transparent Data Encryption

You can use explicit capture to construct and enqueue row logical change records (row LCRs) for columns that are encrypted in database tables. However, you cannot specify that columns are encrypted when you construct the row LCRs. Therefore, when explicitly captured row LCRs are staged in a queue, all of the columns in the row LCRs are decrypted.

See Also: ["Explicit Capture by Applications"](#) on page 2-43

Queues and Transparent Data Encryption

A **persistent queue** can store row logical change records (row LCRs) captured by a **synchronous capture**, and these row LCRs can contain changes to columns that were encrypted using transparent data encryption. The row LCRs remain encrypted while they are stored in the persistent queue. Explicitly captured row LCRs cannot contain encrypted columns.

A **buffered queue** can store row LCRs that contain changes captured by a **capture process**, and these row LCRs can contain changes to columns that were encrypted using transparent data encryption. When row LCRs with encrypted columns are stored in buffered queues, the columns are decrypted. When row LCRs spill to disk, Oracle Streams transparently encrypts any encrypted columns while the row LCRs are stored on disk.

Note: For Oracle Streams to encrypt columns transparently, the encryption master key must be stored in the wallet on the local database, and the wallet must be open. The following statements set the master key and open the wallet:

```
ALTER SYSTEM SET ENCRYPTION KEY IDENTIFIED BY key-password;
```

```
ALTER SYSTEM SET WALLET OPEN IDENTIFIED BY key-password;
```

See Also:

- ["Queues"](#) on page 3-1
- ["Ways to Capture Information with Oracle Streams"](#) on page 2-1

Propagations and Transparent Data Encryption

A **propagation** can propagate row logical change records (row LCRs) that contain changes to columns that were encrypted using transparent data encryption. When a propagation propagates row LCRs with encrypted columns, the encrypted columns are decrypted while the row LCRs are transferred over the network. You can use the features of Oracle Advanced Security to encrypt data transfers over the network if necessary.

See Also:

- *Oracle Database Advanced Security Administrator's Guide* for information about configuring network data encryption
- ["Message Propagation Between Queues"](#) on page 3-11

Apply Processes and Transparent Data Encryption

An **apply process** can dequeue and process implicitly captured row logical change records (row LCRs) that contain columns encrypted using transparent data encryption. When row LCRs with encrypted columns are dequeued by an apply process, the encrypted columns are decrypted. These row LCRs with decrypted columns can be sent to an apply handler for custom processing, or they can be applied directly. When row LCRs are applied, and the modified table contains encrypted columns, any changes to encrypted columns are encrypted when they are applied.

When row LCRs contain encrypted columns, but the corresponding columns at the **destination database** are not encrypted, then the `preserve_encryption` apply process parameter controls apply process behavior:

- If the `preserve_encryption` parameter is set to `Y`, then the apply process raises an error when row LCRs contain encrypted columns, but the corresponding columns at the destination database are not encrypted. When an error is raised, the row LCR is not applied, and all of the row LCRs in the transaction are moved to the error queue.
- If the `preserve_encryption` parameter is set to `N`, then the apply process applies the row changes when row LCRs contain encrypted columns, but the corresponding columns at the destination database are not encrypted.

When an apply process moves implicitly captured row LCRs with encrypted columns to the error queue, the encrypted columns are encrypted when the row LCRs are in the error queue. Row LCRs are implicitly captured using **capture processes** and **synchronous captures**.

See Also: ["Implicit Consumption with an Apply Process"](#) on page 4-5

Messaging Clients and Transparent Data Encryption

A **messaging client** can dequeue implicitly captured row LCRs that contain columns encrypted using transparent data encryption. When row LCRs with encrypted columns are dequeued by a messaging client, the encrypted columns are decrypted.

See Also: ["Explicit Consumption with a Messaging Client"](#) on page 4-22

Manual Dequeue and Transparent Data Encryption

A user or application can dequeue implicitly captured row LCRs that contain columns encrypted using transparent data encryption. When row LCRs with encrypted columns are dequeued, the encrypted columns are decrypted.

See Also: ["Explicit Consumption with Manual Dequeue"](#) on page 4-23

Oracle Streams and Flashback Data Archive

Oracle Streams supports tables in a flashback data archive. Capture processes can capture data manipulation language (DML) and data definition language (DDL) changes made to these tables. Synchronous captures can capture DML changes made to these tables. Apply processes can apply changes encapsulated in logical change records (LCRs) to these tables.

Oracle Streams capture processes and apply processes also support the following DDL statements:

- CREATE FLASHBACK ARCHIVE
- ALTER FLASHBACK ARCHIVE
- DROP FLASHBACK ARCHIVE
- CREATE TABLE with a FLASHBACK ARCHIVE clause
- ALTER TABLE with a FLASHBACK ARCHIVE clause

Note: Oracle Streams does not capture or apply changes made to internal tables used by a flashback data archive.

See Also:

- *Oracle Database Advanced Application Developer's Guide* for information about flashback data archive
- [Chapter, "Implicit Capture with an Oracle Streams Capture Process"](#) on page 2-9
- [Chapter, "Implicit Capture with Synchronous Capture"](#) on page 2-38
- [Chapter, "Implicit Consumption with an Apply Process"](#) on page 4-5

Oracle Streams and Recovery Manager (RMAN)

The following topics describe how Oracle Streams works with Recovery Manager (RMAN):

- [RMAN and Instantiation](#)
- [RMAN and Archived Redo Log Files Required by a Capture Process](#)
- [The Recovery Catalog and Oracle Streams](#)

See Also: *Oracle Database Backup and Recovery User's Guide*

RMAN and Instantiation

You can use RMAN to instantiate database objects during the configuration of an Oracle Streams replication environment. The RMAN `DUPLICATE` and `CONVERT DATABASE` commands can instantiate an entire database, and the RMAN `TRANSPORT TABLESPACE` command can instantiate a tablespace or set of tablespaces.

See Also: *Oracle Streams Replication Administrator's Guide* for information about using RMAN for instantiation

RMAN and Archived Redo Log Files Required by a Capture Process

Some Recovery Manager (RMAN) deletion policies and commands delete archived redo log files. If one of these RMAN policies or commands is used on a database that generates redo log files for one or more capture processes, then ensure that the RMAN commands do not delete archived redo log files that are required by a capture process.

The following sections describe the behavior of RMAN deletion policies and commands for local capture processes and downstream capture processes

- [RMAN and Local Capture Processes](#)
- [RMAN and Downstream Capture Processes](#)

See Also:

- ["ARCHIVELOG Mode and a Capture Process"](#) on page 2-28
- ["Are Required Redo Log Files Missing?"](#) on page 20-5 for information about determining whether a capture process is missing required archived redo log files and for information correcting this problem. This section also contains information about flash recovery area and local capture processes.
- ["Checking the Trace Files and Alert Log for Problems"](#) on page 20-26
- *Oracle Database Backup and Recovery User's Guide* and *Oracle Database Backup and Recovery Reference* for more information about RMAN

RMAN and Local Capture Processes

When a **local capture process** is configured, RMAN does not delete archived redo log files that are required by the local capture process unless there is space pressure in the flash recovery area. Specifically, RMAN does not delete archived redo log files that contain changes with system change number (SCN) values that are equal to or greater than the **required checkpoint SCN** for the local capture process. This is the default RMAN behavior for all RMAN deletion policies and `DELETE` commands, including `DELETE ARCHIVELOG` and `DELETE OBSOLETE`.

When there is not enough space in the flash recovery area to write a new log file, RMAN automatically deletes one or more archived redo log files. Oracle Database writes warnings to the alert log when RMAN automatically deletes an archived redo log file that is required by a local capture process.

When backups of the archived redo log files are taken on the local capture process database, Oracle recommends the following RMAN deletion policy:

```
CONFIGURE ARCHIVELOG DELETION POLICY TO BACKED UP integer TIMES
TO DEVICE TYPE deviceSpecifier;
```

This deletion policy requires that a log file be backed up *integer* times before it is considered for deletion.

When no backups of the archived redo log files are taken on the local capture process database, no specific deletion policy is recommended. By default, RMAN does not delete archived redo log files that are required by a local capture process.

RMAN and Downstream Capture Processes

When a **downstream capture process** captures database changes made at a **source database**, ensure that no RMAN deletion policy or command deletes an archived redo log file until after it is transferred from the source database to the downstream capture process database.

The following are considerations for specific RMAN deletion policies and commands that delete archived redo log files:

- The RMAN command CONFIGURE ARCHIVELOG DELETION POLICY sets a deletion policy that determines when archived redo log files in the flash recovery area are eligible for deletion. The deletion policy also applies to all RMAN DELETE commands, including DELETE ARCHIVELOG and DELETE OBSOLETE.

The following settings determine the behavior at the source database:

- A deletion policy set TO SHIPPED TO STANDBY does not delete a log file until after it is transferred to a downstream capture process database that requires the file. These log files might or might not have been processed by the downstream capture process. Automatic deletion occurs when there is not enough space in the flash recovery area to write a new log file.
- A deletion policy set TO APPLIED ON STANDBY currently *does not* check whether a log file has been transferred to a downstream capture process that requires the file. Automatic deletion occurs when there is not enough space in the flash recovery area to write a new log file.
- A deletion policy set to BACKED UP *integer* TIMES TO DEVICE TYPE requires that a log file be backed up *integer* times before it is considered for deletion. A log file can be deleted even if the log file has not been processed by a downstream capture process that requires it.
- A deletion policy set TO NONE means that a log file can be deleted when there is space pressure on the flash recovery area, even if the log file has not been processed by a downstream capture process that requires it.
- The RMAN command DELETE ARCHIVELOG deletes archived redo log files that meet all of the following conditions:
 - The log files satisfy the condition specified in the DELETE ARCHIVELOG command.
 - The log files can be deleted according to the CONFIGURE ARCHIVELOG DELETION POLICY. For example, if the policy is set TO SHIPPED TO STANDBY, then this command does not delete a log file until after it is transferred to any downstream capture process database that requires it.

This behavior applies when the database is mounted or open.

If archived redo log files are not deleted because they contain changes required by a downstream capture process, then RMAN displays a warning message about skipping the delete operation for these files.

- The RMAN command `DELETE OBSOLETE` permanently purges the archived redo log files that meet all of the following conditions:
 - The log files are obsolete according to the retention policy.
 - The log files can be deleted according to the `CONFIGURE ARCHIVELOG DELETION POLICY`. For example, if the policy is set `TO SHIPPED TO STANDBY`, then this command does not delete a log file until after it is transferred to any downstream capture process database that requires it.

This behavior applies when the database is mounted or open.

- The RMAN command `BACKUP ARCHIVELOG ALL DELETE INPUT` copies the archived redo log files and deletes the original files after completing the backup. This command does not delete the log file until after it is transferred to a downstream capture process database when the following conditions are met:
 - The database is mounted or open.
 - The log file is required by a downstream capture process.
 - The deletion policy is set `TO SHIPPED TO STANDBY`.

If archived redo log files are not deleted because they contain changes required by a downstream capture process, then RMAN displays a warning message about skipping the delete operation for these files.

Oracle recommends one of the following RMAN deletion policies at the source database for a downstream capture process:

- When backups of the archived redo log files are taken on the source database, set the deletion policy to the following:

```
CONFIGURE ARCHIVELOG DELETION POLICY TO SHIPPED TO STANDBY
  BACKED UP integer TIMES TO DEVICE TYPE deviceSpecifier;
```

- When no backups of the archived redo log files are taken on the source database, set the deletion policy to the following:

```
CONFIGURE ARCHIVELOG DELETION POLICY TO SHIPPED TO STANDBY;
```

Note: At a downstream capture process database, archived redo log files transferred from a source database are not managed by RMAN.

The Recovery Catalog and Oracle Streams

Oracle Streams supports replicating a recovery catalog in a one-way replication environment. Bi-directional replication of a recovery catalog is not supported.

See Also:

- *Oracle Database 2 Day + Data Replication and Integration Guide* for information about one-way and bi-directional replication
- *Oracle Database Backup and Recovery User's Guide* for information about the recovery catalog

Oracle Streams Restrictions

This appendix describes Oracle Streams restrictions.

This appendix includes these topics:

- [Capture Process Restrictions](#)
- [Synchronous Capture Restrictions](#)
- [Queue Restrictions](#)
- [Propagation Restrictions](#)
- [Apply Process Restrictions](#)
- [Messaging Client Restrictions](#)
- [Rule Restrictions](#)
- [Rule-Based Transformation Restrictions](#)

Capture Process Restrictions

This section describes restrictions for capture processes.

This section contains these topics:

- [Unsupported Data Types for Capture Processes](#)
- [Unsupported Changes for Capture Processes](#)
- [Supplemental Logging Data Type Restrictions](#)
- [Apply Process Interoperability with Oracle Streams Capture Processes](#)
- [Capture Processes Do Not Support Oracle Label Security](#)
- [Capture Process Interoperability with Oracle Streams Apply Processes](#)

Unsupported Data Types for Capture Processes

A capture process does not capture the results of DML changes to columns of the following data types:

- SecureFile CLOB, NCLOB, and BLOB
- BFILE
- ROWID
- User-defined types (including object types, REFS, varrays, and nested tables)

- `XMLType` stored object relationally or as binary XML
- The following Oracle-supplied types: Any types, URI types, spatial types, and media types

A capture process raises an error if it tries to create a row LCR for a DML change to a column of an unsupported data type. When a capture process raises an error, it writes the LCR that caused the error into its trace file, raises an ORA-26744 error, and becomes disabled. In this case, modify the **rules** used by the capture process to avoid the error, and restart the capture process.

Note: You can add rules to a **negative rule set** for a capture process that instruct the capture process to discard changes to tables with columns of unsupported data types. However, if these rules are not simple rules, then a capture process might create a row LCR for the change and continue to process it. In this case, a change that includes an unsupported data type can cause the capture process to raise an error, even if the change does not satisfy the **rule sets** used by the capture process. The `DBMS_STREAMS_ADM` package creates only simple rules.

See Also:

- ["Data Types Captured by Capture Processes"](#) on page 2-12
- ["Listing the Database Objects That Are Not Compatible With Capture Processes"](#) on page 28-7
- ["Simple Rule Conditions"](#) on page 5-3 for information about simple rules
- ["System-Created Rules and Negative Rule Sets"](#) on page 6-32
- ["Capture Process Rule Evaluation"](#) on page 2-36
- *Oracle Database SQL Language Reference* for more information about data types

Unsupported Changes for Capture Processes

This section describes changes that are not supported by capture processes.

This section contains these topics:

- [Unsupported Schemas for Capture Processes](#)
- [Unsupported DML Changes for Capture Processes](#)
- [Unsupported DDL Changes for Capture Processes](#)
- [Changes Ignored by a Capture Process](#)
- [NOLOGGING and UNRECOVERABLE Keywords for SQL Operations](#)
- [UNRECOVERABLE Clause for Direct Path Loads](#)

Unsupported Schemas for Capture Processes

A capture process never captures changes made to the following schemas:

- CTXSYS
- DBSNMP
- DMSYS
- DVSYS
- EXFSYS
- LBACSYS
- MDDATA
- MDSYS
- OLAPSYS
- ORDPLUGINS
- ORDSYS
- OUTLN
- SI_INFORMTN_SCHEMA
- SYS
- SYSMAN
- SYSTEM
- WMSYS
- XDB

Unsupported DML Changes for Capture Processes

A capture process captures the results of DML changes that satisfy its **rule sets**, *except for* the following types of DML changes:

- A capture process cannot capture changes made to an index-organized table if the index-organized table contains any columns of the following data types:
 - ROWID
 - User-defined types (including object types, REFS, varrays, and nested tables)
 - XMLType stored object relationally or as binary XML (XMLType stored as CLOB is supported.)
 - The following Oracle-supplied types: Any types, URI types, spatial types, and media types

If an index-organized table contains a column of one of these data types, then a capture process raises an error when a user makes a change to the index-organized table and the change satisfies the capture process **rule sets**.

If an index-organized table does not contain a column of one of these data types, then a capture process can capture changes to it.

- A capture process cannot capture DML changes made to temporary tables, object tables, or tables stored with segment compression enabled. A capture process raises an error if it attempts to capture such changes.

Also, if you share a sequence at multiple databases, then sequence values used for individual rows at these databases might vary. Also, changes to actual sequence values are not captured. For example, if a user references a `NEXTVAL` or sets the sequence, then a capture process does not capture changes resulting from these operations.

See Also:

- ["Types of DML Changes Captured by Capture Processes"](#) on page 2-13
- [Chapter 6, "How Rules Are Used in Oracle Streams"](#) for more information about rule sets for **Oracle Streams clients** and for information about how messages satisfy rule sets
- *Oracle Streams Replication Administrator's Guide* for information about applying DML changes with an **apply process** and for information about strategies to avoid having the same sequence-generated value for two different rows at different databases

Unsupported DDL Changes for Capture Processes

A capture process captures the DDL changes that satisfy its **rule sets**, *except for* the following types of DDL changes:

- ALTER DATABASE
- CREATE CONTROLFILE
- CREATE DATABASE
- CREATE PFILE
- CREATE SPFILE

A capture process can capture DDL statements, but not the results of DDL statements, unless the DDL statement is a `CREATE TABLE AS SELECT` statement. For example, when a capture process captures an `ANALYZE` statement, it does not capture the statistics generated by the `ANALYZE` statement. However, when a capture process captures a `CREATE TABLE AS SELECT` statement, it captures the statement itself and all of the rows selected (as `INSERT` row LCRs).

Some types of DDL changes that are captured by a capture process cannot be applied by an **apply process**. If an apply process receives a DDL LCR that specifies an operation that cannot be applied, then the apply process ignores the DDL LCR and records information about it in the trace file for the apply process.

When a capture process captures a DDL change that specifies time stamps or system change number (SCN) values in its syntax, configure a DDL handler for any apply processes that will dequeue the change. The DDL handler must process time stamp or SCN values properly. For example, a capture process captures `FLASHBACK TABLE` statements when its rule sets instruct it to capture DDL changes to the specified table. `FLASHBACK TABLE` statements include time stamps or SCN values in its syntax.

See Also:

- *Oracle Streams Replication Administrator's Guide* for information about applying DDL changes with an apply process
- [Chapter 6, "How Rules Are Used in Oracle Streams"](#) for more information about rule sets for **Oracle Streams clients** and for information about how messages satisfy rule sets

Changes Ignored by a Capture Process

A capture process ignores the following types of changes:

- The session control statements ALTER SESSION and SET ROLE.
- The system control statement ALTER SYSTEM.
- CALL, EXPLAIN PLAN, and LOCK TABLE statements.
- GRANT statements on views.
- Changes made to a table or schema by online redefinition using the DBMS_REDEFINITION package. Online table redefinition is supported on a table for which a capture process captures changes, but the logical structure of the table before online redefinition must be the same as the logical structure after online redefinition.
- Invocations of PL/SQL procedures, which means that a call to a PL/SQL procedure is not captured. However, if a call to a PL/SQL procedure causes changes to database objects, then these changes can be captured by a capture process if the changes satisfy the capture process **rule sets**.

Note: If an Oracle-supplied package related to XML makes changes to database objects, then these changes are not captured by capture processes. See *Oracle Database PL/SQL Packages and Types Reference* for information about packages related to XML.

NOLOGGING and UNRECOVERABLE Keywords for SQL Operations

If you use the NOLOGGING or UNRECOVERABLE keyword for a SQL operation, then the changes resulting from the SQL operation cannot be captured by a **capture process**. Therefore, do not use these keywords if you want to capture the changes that result from a SQL operation.

If the object for which you are specifying the logging attributes resides in a database or tablespace in FORCE LOGGING mode, then Oracle Database ignores any NOLOGGING or UNRECOVERABLE setting until the database or tablespace is taken out of FORCE LOGGING mode. You can determine the current logging mode for a database by querying the FORCE_LOGGING column in the V\$DATABASE dynamic performance view. You can determine the current logging mode for a tablespace by querying the FORCE_LOGGING column in the DBA_TABLESPACES static data dictionary view.

Note: The UNRECOVERABLE keyword is deprecated and has been replaced with the NOLOGGING keyword in the *logging_clause*. Although UNRECOVERABLE is supported for backward compatibility, Oracle strongly recommends that you use the NOLOGGING keyword, when appropriate.

See Also: *Oracle Database SQL Language Reference* for more information about the `NOLOGGING` and `UNRECOVERABLE` keywords, `FORCE LOGGING` mode, and the `logging_clause`

UNRECOVERABLE Clause for Direct Path Loads

If you use the `UNRECOVERABLE` clause in the `SQL*Loader` control file for a direct path load, then a **capture process** cannot capture the changes resulting from the direct path load. Therefore, if the changes resulting from a direct path load should be captured by a capture process, then do not use the `UNRECOVERABLE` clause.

If you perform a direct path load without logging changes at a **source database**, but you do not perform a similar direct path load at the **destination databases** of the source database, then apply errors can result at these destination databases when changes are made to the loaded objects at the source database. In this case, a capture process at the source database can capture changes to these objects, and one or more **propagations** can propagate the changes to the destination databases. When an apply process tries to apply these changes, errors result unless both the changed object and the changed rows in the object exist on the destination database.

Therefore, if you use the `UNRECOVERABLE` clause for a direct path load and a capture process is configured to capture changes to the loaded objects, then ensure that any destination databases contain the loaded objects and the loaded data to avoid apply errors. One way to ensure that these objects exist at the destination databases is to perform a direct path load at each of these destination databases that is similar to the direct path load performed at the source database.

If you load objects into a database or tablespace that is in `FORCE LOGGING` mode, then Oracle Database ignores any `UNRECOVERABLE` clause during a direct path load, and the loaded changes are logged. You can determine the current logging mode for a database by querying the `FORCE_LOGGING` column in the `V$DATABASE` dynamic performance view. You can determine the current logging mode for a tablespace by querying the `FORCE_LOGGING` column in the `DBA_TABLESPACES` static data dictionary view.

See Also: *Oracle Database Utilities* for information about direct path loads and `SQL*Loader`

Supplemental Logging Data Type Restrictions

`LOB`, `LONG`, `LONG RAW`, user-defined type, and Oracle-supplied type columns cannot be part of a supplemental log group.

See Also: *Oracle Streams Replication Administrator's Guide*

Capture Processes Do Not Support Oracle Label Security

Capture processes do not support database objects that use Oracle Label Security (OLS).

See Also: *Oracle Label Security Administrator's Guide*

Capture Process Interoperability with Oracle Streams Apply Processes

A capture process must be Oracle9i Database release 9.2.0.6 or later for the changes it captures to be processed by an Oracle Database 11g Release 1 (11.1) apply process. The data type restrictions for the release of the capture process are enforced at the capture process database.

See Also: The Oracle Streams documentation for an earlier Oracle Database release for information about capture process data type restrictions for that release.

Synchronous Capture Restrictions

This section describes restrictions for synchronous captures.

This section contains these topics:

- [Synchronous Captures Only Use Table Rules](#)
- [Unsupported Data Types for Synchronous Captures](#)
- [Unsupported Changes for Synchronous Captures](#)
- [Synchronous Capture Rules and the DBMS_STREAMS_ADM Package](#)
- [Synchronous Captures Do Not Support Oracle Label Security](#)

Synchronous Captures Only Use Table Rules

Synchronous captures only use table rules that were created by a procedure in the DBMS_STREAMS_ADM package. Synchronous captures ignore schema rules, global rules, and rules created by a procedure in the DBMS_RULE_ADM package.

See Also: "[Synchronous Capture Rules](#)" on page 2-40

Unsupported Data Types for Synchronous Captures

Synchronous capture does not capture the results of DML changes to columns of the following data types:

- LONG
- LONG RAW
- CLOB
- NCLOB
- BLOB
- BFILE
- ROWID
- User-defined types (including object types, REFs, varrays, and nested tables)
- Oracle-supplied types (including Any types, XML types, spatial types, and media types)

Synchronous capture raises an error if it tries to create a row LCR for a DML change to a table containing a column of an unsupported data type. Synchronous capture returns an ORA-25341 error to the user, and the DML change is not made. In this case, modify the [rules](#) used by synchronous capture to avoid the error.

Note:

- The rules in the [positive rule set](#) determine the types of changes captured by synchronous capture. To avoid errors, ensure that these rules do not instruct synchronous capture to capture changes to tables with unsupported data types.
 - It might be possible to configure a synchronous capture to capture changes to tables with unsupported columns. To do so, specify `DELETE_COLUMN` [declarative rule-based transformations](#) on the relevant synchronous capture rules to remove the unsupported columns.
-

See Also:

- ["Data Types Captured by Synchronous Capture"](#) on page 2-41
- ["Listing Database Objects and Columns That Are Not Compatible With Synchronous Captures"](#) on page 28-11
- [Chapter 6, "How Rules Are Used in Oracle Streams"](#) for more information about rule sets for Oracle Streams clients and for information about how messages satisfy rule sets
- ["Declarative Rule-Based Transformations"](#) on page 7-1
- *Oracle Database SQL Language Reference* for more information about data types

Unsupported Changes for Synchronous Captures

This section describes changes that are not supported by synchronous captures.

This section contains these topics:

- [Unsupported Schemas for Synchronous Captures](#)
- [Unsupported DML Changes for Synchronous Captures](#)
- [Changes Ignored by Synchronous Capture](#)

Unsupported Schemas for Synchronous Captures

A synchronous capture never captures changes made to the following schemas:

- CTXSYS
- DBSNMP
- DMSYS
- DVSYS
- EXFSYS
- LBACSYS
- MDDATA
- MDSYS
- OLAPSYS
- ORDPLUGINS

- ORDSYS
- OUTLN
- SI_INFORMTN_SCHEMA
- SYS
- SYSMAN
- SYSTEM
- WMSYS
- XDB

Unsupported DML Changes for Synchronous Captures

A synchronous capture captures the results of DML changes that satisfy its **rule set**, *except for* the following types of DML changes:

- Synchronous capture cannot capture changes made to an index-organized table if the index-organized table contains any columns of the following data types:
 - LONG
 - LONG RAW
 - CLOB
 - NCLOB
 - BLOB
 - BFILE
 - ROWID
 - User-defined types (including object types, REFS, varrays, and nested tables)
 - Oracle-supplied types (including Any types, XML types, spatial types, and media types)

If an index-organized table contains a column of one of these data types, then synchronous capture raises an error when a user makes a change to the index-organized table and the change satisfies the synchronous capture **rule set**.

If an index-organized table does not contain a column of one of these data types, then a synchronous capture can capture changes to it.

- Synchronous capture cannot capture DML changes made to temporary tables or object tables. Synchronous capture raises an error if it attempts to capture such changes.

Also, if you share a sequence at multiple databases, then sequence values used for individual rows at these databases might vary. Also, changes to actual sequence values are not captured by synchronous capture. For example, if a user references a NEXTVAL or sets the sequence, then synchronous capture does not capture changes resulting from these operations.

See Also:

- ["Types of DML Changes Captured by Synchronous Capture"](#) on page 2-42
- [Chapter 6, "How Rules Are Used in Oracle Streams"](#) for more information about rule sets for **Oracle Streams clients** and for information about how messages satisfy rule sets
- *Oracle Streams Replication Administrator's Guide* for information about applying DML changes with an **apply process** and for information about strategies to avoid having the same sequence-generated value for two different rows at different databases

Changes Ignored by Synchronous Capture

The following types of changes are ignored by synchronous capture:

- DDL changes.
- The session control statements ALTER SESSION and SET ROLE.
- The system control statement ALTER SYSTEM.
- Synchronous capture ignores CALL, EXPLAIN PLAN, or LOCK TABLE statements.
- Changes made by direct path loads.
- Changes made to a table or schema by online redefinition using the DBMS_REDEFINITION package. Online table redefinition is supported on a table for which synchronous capture captures changes, but the logical structure of the table before online redefinition must be the same as the logical structure after online redefinition.
- Invocations of PL/SQL procedures, which means that a call to a PL/SQL procedure is not captured. However, if a call to a PL/SQL procedure causes changes to database objects, then these changes can be captured by synchronous capture if the changes satisfy the synchronous capture rule set.

Note: If an Oracle-supplied package related to XML makes changes to database objects, then these changes are not captured by synchronous captures. See *Oracle Database PL/SQL Packages and Types Reference* for information about packages related to XML.

Synchronous Capture Rules and the DBMS_STREAMS_ADM Package

Although you can create a rule set for a synchronous capture using the DBMS_RULE_ADM package, only rules created using the DBMS_STREAMS_ADM package determine the behavior of a **synchronous capture**. A synchronous capture ignores rules created by the DBMS_RULE_ADM package.

Synchronous Captures Do Not Support Oracle Label Security

Synchronous captures do not support database objects that use Oracle Label Security (OLS).

See Also: *Oracle Label Security Administrator's Guide*

Queue Restrictions

This section describes restrictions for queues.

This section contains these topics:

- [Explicit Enqueue Restrictions for ANYDATA Queues](#)
- [Restrictions for Buffered Messaging](#)
- [Triggers and Queue Tables](#)

See Also: ["Queues"](#) on page 3-1

Explicit Enqueue Restrictions for ANYDATA Queues

You cannot explicitly enqueue ANYDATA payloads that contain payloads of the following types into an ANYDATA queue:

- CLOB
- NCLOB
- BLOB
- Object types with LOB attributes
- Object types that use type evolution or type inheritance

Note: Payloads of ROWID data type cannot be wrapped in an ANYDATA wrapper. This restriction does not apply to payloads of UROWID data type.

See Also:

- ["ANYDATA Queues and Typed Queues"](#) on page 3-2
- ["Wrapping User Message Payloads in an ANYDATA Wrapper and Enqueuing Them"](#) on page 13-2
- *Oracle Streams Advanced Queuing User's Guide* for more information relating to ANYDATA queues, such as wrapping payloads in an ANYDATA wrapper, programmatic environments for enqueueing messages into and dequeuing messages from an ANYDATA queue, propagation, and user-defined types
- *Oracle Database PL/SQL Packages and Types Reference* for more information about the ANYDATA type

Restrictions for Buffered Messaging

To use buffered messaging, the compatibility level of the Oracle database must be 10.2.0 or higher.

The DBMS_STREAMS_MESSAGING package cannot be used to enqueue messages into or dequeue messages from a buffered queue. However, the DBMS_AQ package supports enqueue and dequeue of buffered messages.

See Also:

- ["Persistent Queues and Buffered Queues"](#) on page 3-3
- *Oracle Streams Advanced Queuing User's Guide* for information about the DBMS_AQ package

Triggers and Queue Tables

Using triggers on queue tables is not recommended because it can have a negative impact on performance. Also, triggers are not supported on index-organized queue tables.

Propagation Restrictions

This section describes restrictions for propagations.

This section contains these topics:

- [Connection Qualifiers and Propagations](#)
- [Character Set Restrictions for Propagations](#)
- [Compatibility Requirements for Queue-To-Queue Propagations](#)

See Also: ["Message Propagation Between Queues"](#) on page 3-11

Connection Qualifiers and Propagations

Connection qualifiers cannot be specified in the database links that are used by Oracle Streams propagations.

Character Set Restrictions for Propagations

Propagations can propagate ANYDATA messages that encapsulate payloads of object types, varrays, or nested tables between databases only if the databases use the same character set.

Propagations can propagate logical change records (LCRs) between databases of the same character set or different character sets.

Compatibility Requirements for Queue-To-Queue Propagations

To use queue-to-queue propagation, the compatibility level must be 10.2.0 or higher for each database that contains a queue involved in the propagation.

See Also: ["Queue-to-Queue Propagations"](#) on page 3-13

Apply Process Restrictions

This section describes restrictions for apply processes.

This section contains these topics:

- [Unsupported Data Types for Apply Processes](#)
- [Unsupported Data Types for Apply Handlers](#)
- [Types of DDL Changes Ignored by an Apply Process](#)
- [Database Structures in an Oracle Streams Environment](#)

- [Current Schema User Must Exist at Destination Database](#)
- [Apply Processes Do Not Support Oracle Label Security](#)
- [Apply Process Interoperability with Oracle Streams Capture Processes](#)

Unsupported Data Types for Apply Processes

An apply process does not apply row LCRs containing the results of DML changes in columns of the following data types:

- SecureFile CLOB, NCLOB, and BLOB
- BFILE
- ROWID
- User-defined types (including object types, REFs, varrays, and nested tables)
- The following Oracle-supplied types: ANY types, URI types, spatial types, and media types

An apply process raises an error if it attempts to apply a row LCR that contains information about a column of an unsupported data type. In addition, an apply process cannot apply DML changes to temporary tables or object tables. An apply process raises an error if it attempts to apply such changes. When an apply process raises an error for an LCR, it moves the transaction that includes the LCR into the error queue.

These data type restrictions pertain to both ordinary (heap-organized) tables and index-organized tables.

See Also: ["Data Types Applied"](#) on page 4-13

Unsupported Data Types for Apply Handlers

Do not modify LONG, LONG RAW, or nonassembled LOB column data in an LCR with DML handlers or error handlers. DML handlers and error handlers can modify LOB columns in row LCRs that have been constructed by [LOB assembly](#).

See Also: ["Process Messages with Apply Handlers"](#) on page 4-8

Types of DDL Changes Ignored by an Apply Process

The following types of DDL changes are not supported by an apply process. These types of DDL changes are not applied:

- ALTER MATERIALIZED VIEW
- ALTER MATERIALIZED VIEW LOG
- CREATE DATABASE LINK
- CREATE SCHEMA AUTHORIZATION
- CREATE MATERIALIZED VIEW
- CREATE MATERIALIZED VIEW LOG
- DROP DATABASE LINK
- DROP MATERIALIZED VIEW
- DROP MATERIALIZED VIEW LOG

- FLASHBACK DATABASE
- RENAME

If an apply process receives a DDL LCR that specifies an operation that cannot be applied, then the apply process ignores the DDL LCR and records the following message in the apply process trace file, followed by the DDL text that was ignored:

Apply process ignored the following DDL:

An apply process applies all other types of DDL changes if the DDL LCRs containing the changes should be applied according to the apply process rule sets.

Note:

- An apply process applies `ALTER object_type object_name RENAME` changes, such as `ALTER TABLE jobs RENAME`. Therefore, if you want DDL changes that rename objects to be applied, then use `ALTER object_type object_name RENAME` statements instead of `RENAME` statements. After changing the name of a database object, new rules that specify the new database object name might be needed to replicate changes to the database object.
 - The name "materialized view" is synonymous with the name "snapshot". Snapshot equivalents of the statements on materialized views are ignored by an apply process.
-
-

See Also: [Chapter 6, "How Rules Are Used in Oracle Streams"](#) for more information about how rules are used in Oracle Streams

Database Structures in an Oracle Streams Environment

For captured DDL changes to be applied properly at a destination database, either the destination database must have the same database structures as the source database, or the nonidentical database structural information must not be specified in the DDL statement. Database structures include data files, tablespaces, rollback segments, and other physical and logical structures that support database objects.

For example, for captured DDL changes to tables to be applied properly at a destination database, the following conditions must be met:

- The same storage parameters must be specified in the `CREATE TABLE` statement at the source database and destination database.
- If a DDL statement refers to specific tablespaces or rollback segments, then the tablespaces or rollback segments must have the same names and compatible specifications at the source database and destination database.

However, if the tablespaces and rollback segments are not specified in the DDL statement, then the default tablespaces and rollback segments are used. In this case, the tablespaces and rollback segments can differ at the source database and destination database.

- The same partitioning specifications must be used at the source database and destination database.

Current Schema User Must Exist at Destination Database

For a DDL LCR to be applied at a destination database successfully, the user specified as the `current_schema` in the DDL LCR must exist at the destination database. The current schema is the schema that is used if no schema is specified for an object in the DDL text.

See Also:

- *Oracle Database Concepts* for more information about database structures
- *Oracle Database PL/SQL Packages and Types Reference* for more information about the `current_schema` attribute in DDL LCRs

Apply Processes Do Not Support Oracle Label Security

Apply processes do not support database objects that use Oracle Label Security (OLS).

See Also: *Oracle Label Security Administrator's Guide*

Apply Process Interoperability with Oracle Streams Capture Processes

An apply process must be Oracle9i Database release 9.2.0.6 or later to process changes captured by an Oracle Database 11g Release 1 (11.1) capture process. The data type restrictions for the release of the apply process are enforced at the apply process database.

See Also: The Oracle Streams documentation for an earlier Oracle Database release for information about apply process data type restrictions for that release.

Messaging Client Restrictions

This section describes restrictions for messaging clients.

This section contains these topics:

- [Messaging Clients and Buffered Messages](#)

See Also: ["Explicit Consumption with a Messaging Client"](#) on page 4-22

Messaging Clients and Buffered Messages

Messaging clients cannot dequeue buffered messages. However, the `DBMS_AQ` package supports enqueue and dequeue of buffered messages.

See Also: *Oracle Streams Advanced Queuing User's Guide* for information about the `DBMS_AQ` package

Rule Restrictions

This section describes restrictions for rules.

This section contains these topics:

- [Restrictions for Subset Rules](#)

Restrictions for Subset Rules

The following restrictions apply to subset rules:

- A table with the table name referenced in the subset rule must exist in the same database as the subset rule, and this table must be in the same schema referenced for the table in the subset rule.
- If the subset rule is in the positive rule set for a capture process or a synchronous capture, then the table must contain the columns specified in the subset condition, and the data type of each of these columns must match the data type of the corresponding column at the source database.
- If the subset rule is in the positive rule set for a propagation or apply process, then the table must contain the columns specified in the subset condition, and the data type of each column must match the data type of the corresponding column in row LCRs that evaluate to TRUE for the subset rule.
- Creating subset rules for tables that have one or more LOB, LONG, LONG RAW, or user-defined type columns is not supported.

See Also: ["Subset Rules"](#) on page 6-19

Rule-Based Transformation Restrictions

This section describes restrictions for rule-based transformations.

This section contains these topics:

- [Unsupported Data Types for Rule-Based Transformations](#)

Unsupported Data Types for Rule-Based Transformations

Do not modify LONG, LONG RAW, or nonassembled LOB column data in a [custom rule-based transformation](#) function.

See Also: ["Custom Rule-Based Transformations"](#) on page 7-2

XML Schema for LCRs

The XML schema described in this appendix defines the format of a **logical change record (LCR)**. The Oracle XML DB must be installed to use the XML schema for LCRs.

The namespace for this schema is the following:

```
http://xmlns.oracle.com/streams/schemas/lcr
```

The schema is the following:

```
http://xmlns.oracle.com/streams/schemas/lcr/streams_lcr.xsd
```

Definition of the XML Schema for LCRs

The following is the XML schema definition for LCRs:

```
'<schema xmlns="http://www.w3.org/2001/XMLSchema"
  targetNamespace="http://xmlns.oracle.com/streams/schemas/lcr"
  xmlns:lcr="http://xmlns.oracle.com/streams/schemas/lcr"
  xmlns:xdb="http://xmlns.oracle.com/xdb"
  version="1.0"
  elementFormDefault="qualified">

  <simpleType name = "short_name">
    <restriction base = "string">
      <maxLength value="30"/>
    </restriction>
  </simpleType>

  <simpleType name = "long_name">
    <restriction base = "string">
      <maxLength value="4000"/>
    </restriction>
  </simpleType>

  <simpleType name = "db_name">
    <restriction base = "string">
      <maxLength value="128"/>
    </restriction>
  </simpleType>

  <!-- Default session parameter is used if format is not specified -->
  <complexType name="datetime_format">
    <sequence>
      <element name = "value" type = "string" nillable="true"/>
      <element name = "format" type = "string" minOccurs="0" nillable="true"/>
    </sequence>
  </complexType>
</schema>
```

```

    </sequence>
</complexType>

<complexType name="anydata">
  <choice>
    <element name="varchar2" type = "string" xdb:SQLType="CLOB"
      nillable="true"/>

    <!-- Represent char as varchar2. xdb:CHAR blank pads upto 2000 bytes! -->
    <element name="char" type = "string" xdb:SQLType="CLOB"
      nillable="true"/>
    <element name="nchar" type = "string" xdb:SQLType="NCLOB"
      nillable="true"/>

    <element name="nvarchar2" type = "string" xdb:SQLType="NCLOB"
      nillable="true"/>
    <element name="number" type = "double" xdb:SQLType="NUMBER"
      nillable="true"/>
    <element name="raw" type = "hexBinary" xdb:SQLType="BLOB"
      nillable="true"/>
    <element name="date" type = "lcr:datetime_format"/>
    <element name="timestamp" type = "lcr:datetime_format"/>
    <element name="timestamp_tz" type = "lcr:datetime_format"/>
    <element name="timestamp_ltz" type = "lcr:datetime_format"/>

    <!-- Interval YM should be as per format allowed by SQL -->
    <element name="interval_ym" type = "string" nillable="true"/>

    <!-- Interval DS should be as per format allowed by SQL -->
    <element name="interval_ds" type = "string" nillable="true"/>

    <element name="urowid" type = "string" xdb:SQLType="VARCHAR2"
      nillable="true"/>
  </choice>
</complexType>

<complexType name="column_value">
  <sequence>
    <element name = "column_name" type = "lcr:long_name" nillable="false"/>
    <element name = "data" type = "lcr:anydata" nillable="false"/>
    <element name = "lob_information" type = "string" minOccurs="0"
      nillable="true"/>
    <element name = "lob_offset" type = "nonNegativeInteger" minOccurs="0"
      nillable="true"/>
    <element name = "lob_operation_size" type = "nonNegativeInteger"
      minOccurs="0" nillable="true"/>
    <element name = "long_information" type = "string" minOccurs="0"
      nillable="true"/>
  </sequence>
</complexType>

<complexType name="extra_attribute">
  <sequence>
    <element name = "attribute_name" type = "lcr:short_name"/>
    <element name = "attribute_value" type = "lcr:anydata"/>
  </sequence>
</complexType>

<element name = "ROW_LCR" xdb:defaultTable="">
  <complexType>

```

```

<sequence>
  <element name = "source_database_name" type = "lcr:db_name"
    nillable="false"/>
  <element name = "command_type" type = "string" nillable="false"/>
  <element name = "object_owner" type = "lcr:short_name"
    nillable="false"/>
  <element name = "object_name" type = "lcr:short_name"
    nillable="false"/>
  <element name = "tag" type = "hexBinary" xdb:SQLType="RAW"
    minOccurs="0" nillable="true"/>
  <element name = "transaction_id" type = "string" minOccurs="0"
    nillable="true"/>
  <element name = "scn" type = "double" xdb:SQLType="NUMBER"
    minOccurs="0" nillable="true"/>
  <element name = "old_values" minOccurs = "0">
    <complexType>
      <sequence>
        <element name = "old_value" type="lcr:column_value"
          maxOccurs = "unbounded"/>
      </sequence>
    </complexType>
  </element>
  <element name = "new_values" minOccurs = "0">
    <complexType>
      <sequence>
        <element name = "new_value" type="lcr:column_value"
          maxOccurs = "unbounded"/>
      </sequence>
    </complexType>
  </element>
  <element name = "extra_attribute_values" minOccurs = "0">
    <complexType>
      <sequence>
        <element name = "extra_attribute_value"
          type="lcr:extra_attribute"
          maxOccurs = "unbounded"/>
      </sequence>
    </complexType>
  </element>
</sequence>
</complexType>
</element>
<element name = "DDL_LCR" xdb:defaultTable="">
  <complexType>
    <sequence>
      <element name = "source_database_name" type = "lcr:db_name"
        nillable="false"/>
      <element name = "command_type" type = "string" nillable="false"/>
      <element name = "current_schema" type = "lcr:short_name"
        nillable="false"/>
      <element name = "ddl_text" type = "string" xdb:SQLType="CLOB"
        nillable="false"/>
      <element name = "object_type" type = "string"
        minOccurs = "0" nillable="true"/>
      <element name = "object_owner" type = "lcr:short_name"
        minOccurs = "0" nillable="true"/>
      <element name = "object_name" type = "lcr:short_name"
        minOccurs = "0" nillable="true"/>
      <element name = "logon_user" type = "lcr:short_name"
    </sequence>
  </complexType>
</element>

```

```

                minOccurs = "0" nillable="true"/>
<element name = "base_table_owner" type = "lcr:short_name"
                minOccurs = "0" nillable="true"/>
<element name = "base_table_name" type = "lcr:short_name"
                minOccurs = "0" nillable="true"/>
<element name = "tag" type = "hexBinary" xdb:SQLType="RAW"
                minOccurs = "0" nillable="true"/>
<element name = "transaction_id" type = "string"
                minOccurs = "0" nillable="true"/>
<element name = "scn" type = "double" xdb:SQLType="NUMBER"
                minOccurs = "0" nillable="true"/>
<element name = "extra_attribute_values" minOccurs = "0">
  <complexType>
    <sequence>
      <element name = "extra_attribute_value"
                type="lcr:extra_attribute"
                maxOccurs = "unbounded"/>
    </sequence>
  </complexType>
</element>
</sequence>
</complexType>
</element>
</schema>;

```

Online Database Upgrade with Oracle Streams

This appendix describes how to perform a database upgrade of an Oracle database with Oracle Streams. The database upgrade operation described in this appendix uses the features of Oracle Streams to achieve little or no database down time. To use Oracle Streams for a database upgrade, the database must be Oracle9i Database Release 2 (9.2) or later.

The following topics describe performing an online database upgrade with Oracle Streams:

- [Overview of Using Oracle Streams in the Database Upgrade Process](#)
- [Preparing for a Database Upgrade Using Oracle Streams](#)
- [Performing a Database Upgrade Using Oracle Streams](#)

See Also: [Appendix E, "Online Database Maintenance with Oracle Streams"](#) for information about performing other database maintenance operations with Oracle Streams

Overview of Using Oracle Streams in the Database Upgrade Process

An Oracle database upgrade is the process of transforming an existing, prior release of an Oracle database into the current release. A database upgrade typically requires substantial database down time, but you can perform a database upgrade with little or no down time by using the features of Oracle Streams. To do so, you use Oracle Streams to configure a single-source **replication** environment with the following databases:

- **Source Database:** The original database that is being upgraded.
- **Capture Database:** The database where a **capture process** captures changes made to the source database during the upgrade.
- **Destination Database:** The copy of the source database where an **apply process** applies changes made to the source database during the upgrade process.

Specifically, you can use the following general steps to perform a database upgrade while the database is online:

1. Create an empty **destination database**.
2. Configure an Oracle Streams single-source replication environment where the original database is the source database and a copy of the database is the destination database for the changes made at the source.

3. Perform the database upgrade on the destination database. During this time the original source database is available online.
4. Use Oracle Streams to apply the changes made at the source database to the destination database.
5. When the destination database has caught up with the changes made at the source database, take the source database offline and make the destination database available for applications and users.

Figure D-1 provides an overview of this process.

Figure D-1 Online Database Upgrade with Oracle Streams

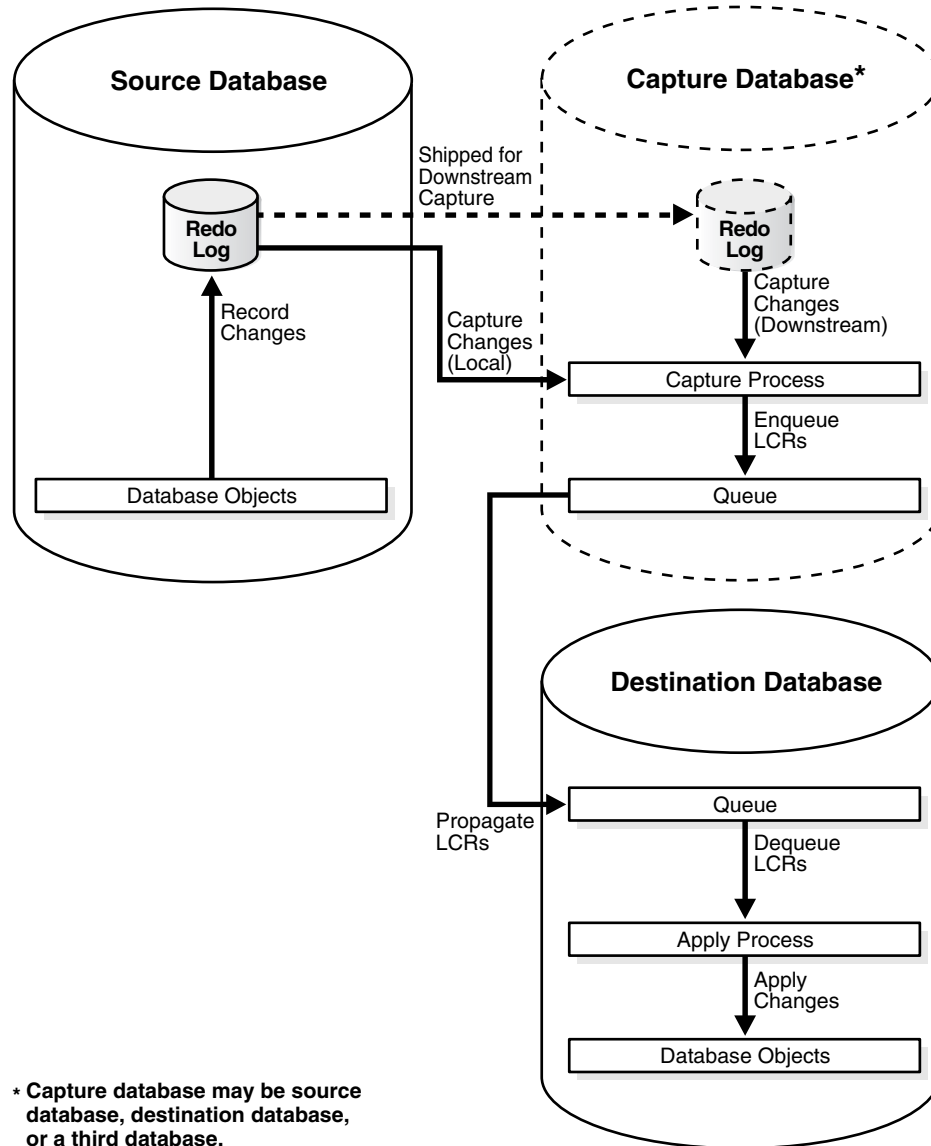

The Capture Database During the Upgrade Process

During the upgrade process, the capture database is the database where the **capture process** is created. Downstream capture was introduced in Oracle Database 10g Release 1 (10.1). If you are upgrading a database from Oracle Database 10g Release 1 or later to Oracle Database 11g Release 1 (11.1), then you have the following options:

- A **local capture process** can be created at the source database during the upgrade process.
- A **downstream capture process** can be created at the **destination database**. If the destination database is the capture database, then a **propagation** from the capture database to the destination database is not needed.
- A third database can be the capture database. In this case, the third database can be Oracle Database 10g Release 1, Oracle Database 10g Release 2, or Oracle Database 11g Release 1.

However, if you are upgrading a database from Oracle9i Database Release 2 (9.2) to Oracle Database 11g Release 1, then downstream capture is not supported, and a local capture process must be created at the source database.

A downstream capture process reduces the resources required at the source database during the upgrade process, but a local capture process is easier to configure. [Table D–1](#) describes which database can be the capture database during the upgrade process.

Table D–1 Supported Capture Database During Upgrade

Existing Database Release	Capture Database Can Be Source Database?	Capture Database Can Be Destination Database?	Capture Database Can Be Third Database?
9.2	Yes	No	No
10.1 or 10.2	Yes	Yes	Yes

Note: If you are upgrading from Oracle Database 10g, then, before you begin the upgrade, decide which database will be the capture database.

See Also: "[Local Capture and Downstream Capture](#)" on page 2-14

Assumptions for the Database Being Upgraded

The instructions in this appendix assume that all of the following statements are true for the database being upgraded:

- The database is not part of an existing Oracle Streams environment.
- The database is not part of an existing logical standby environment.
- The database is not part of an existing Advanced Replication environment.
- No tables at the database are master tables for materialized views in other databases.
- Any user-created **queues** are read-only during the upgrade process.

Considerations for Job Queue Processes and PL/SQL Package Subprograms

If possible, ensure that no job queue processes are created, modified, or deleted during the upgrade process, and that no Oracle-supplied PL/SQL package subprograms are invoked during the upgrade process that modify both user data and dictionary metadata at the same time. The following packages contain subprograms that modify both user data and dictionary metadata at the same time: `DBMS_RLS`, `DBMS_STATS`, and `DBMS_JOB`.

It might be possible to perform such actions on the database if you ensure that the same actions are performed on the source database and **destination database** in Steps 13 and 14 in "[Task 5: Finishing the Upgrade and Removing Oracle Streams](#)" on page D-18. For example, if a PL/SQL procedure gathers statistics on the source database during the upgrade process, then the same PL/SQL procedure should be invoked at the destination database in Step 14.

Preparing for a Database Upgrade Using Oracle Streams

The following sections describe tasks to complete before starting the database upgrade with Oracle Streams:

- [Preparing to Upgrade a Database with User-defined Types](#)
- [Deciding Which Utility to Use for Instantiation](#)

Preparing to Upgrade a Database with User-defined Types

User-defined types include object types, `REF` values, varrays, and nested tables. Currently, Oracle Streams **capture processes** and **apply processes** do not support user-defined types. This section discusses using Oracle Streams to perform a database upgrade on a database that has user-defined types.

One option is to make tables that contain user-defined types read-only during the database upgrade. In this case, these tables are instantiated at the **destination database**, and no changes are made to these tables during the entire operation. After the upgrade is complete, make the tables that contain user-defined types read/write at the destination database.

If tables that contain user-defined types must remain open during the upgrade, then the following general steps can be used to retain changes to these tables during the upgrade:

1. Before you begin the upgrade process described in "[Performing a Database Upgrade Using Oracle Streams](#)" on page D-6, create one or more logging tables to store row changes to tables at the source database that include user-defined types. Each column in the logging table must use a data type that is supported by Oracle Streams in the source database release.
2. Before you begin the upgrade process described in "[Performing a Database Upgrade Using Oracle Streams](#)" on page D-6, create a DML trigger at the source database that fires on the tables that contain the user-defined data types. The trigger converts each row change into relational equivalents and logs the modified row in a logging table created in Step 1.
3. When the instructions in "[Performing a Database Upgrade Using Oracle Streams](#)" on page D-6 say to configure a capture process and **propagation**, configure the capture process and propagation to capture changes to the logging table and propagate these changes to the destination database. Changes to tables that contain user-defined types should not be captured or propagated.

4. When the instructions in "[Performing a Database Upgrade Using Oracle Streams](#)" on page D-6 say to configure a an apply process on the destination database, configure the apply process to use a **DML handler** that processes the changes to the logging tables. The DML handler reconstructs the user-defined types from the relational equivalents and applies the modified changes to the tables that contain user-defined types.

See Also:

- *Oracle Database PL/SQL Language Reference* for more information about creating triggers
- *Oracle Streams Replication Administrator's Guide* for more information about creating DML handlers

Deciding Which Utility to Use for Instantiation

Before you begin the database upgrade, decide whether you want to use the Export/Import utilities (Data Pump or original) or the Recovery Manager (RMAN) utility to instantiate the **destination database** during the operation. The destination database will replace the existing database that is being upgraded.

Consider the following factors when you make this decision:

- If you use original Export/Import or Data Pump Export/Import, then you can make the destination database an Oracle Database 11g Release 1 (11.1) database at the beginning of the operation. Therefore, you do not need to upgrade the destination database after the **instantiation**.

If you use Export/Import for instantiation, and Data Pump is supported, then Oracle recommends using Data Pump. Data Pump can perform the instantiation faster than original Export/Import.

- If you use the RMAN `DUPLICATE` command, then the instantiation might be faster than with Export/Import, especially if the database is large, but the database release must be the same for RMAN instantiation. Therefore, if the database is an Oracle9i Database Release 2 (9.2) database, then the destination database is an Oracle9i Database Release 2 database when it is instantiated. If the database is an Oracle Database 10g Release 1 (10.1) database, then the destination database is an Oracle Database 10g Release 1 database when it is instantiated. If the database is an Oracle Database 10g Release 2 (10.2) database, then the destination database is an Oracle Database 10g Release 2 database when it is instantiated. After the instantiation, you must upgrade the destination database.

Also, Oracle recommends that you do not use RMAN for instantiation in an environment where distributed transactions are possible. Doing so might cause in-doubt transactions that must be corrected manually.

[Table D-2](#) describes whether each instantiation method is supported based on the release being upgraded, whether the platform at the source and destination databases are different, and whether the character set at the source and destination databases are different. Each instantiation method is supported when the platform and character set are the same at the source and destination databases.

Table D-2 Instantiation Methods for Database Upgrade with Oracle Streams

Instantiation Method	Supported When Upgrading From	Different Platforms Supported?	Different Character Sets Supported?
Original Export/Import	9.2, 10.1, or 10.2	Yes	Yes
Data Pump Export/Import	10.1 or 10.2	Yes	Yes
RMAN DUPLICATE	9.2, 10.1, or 10.2	No	No

Performing a Database Upgrade Using Oracle Streams

This section contains instructions for performing a database upgrade using Oracle Streams. To use Oracle Streams for a database upgrade, the database must be Oracle9i Database Release 2 (9.2) or later.

Complete the following tasks to upgrade a database using Oracle Streams:

- [Task 1: Beginning the Upgrade](#)
- [Task 2: Setting Up Oracle Streams Prior to Instantiation](#)
- [Task 3: Instantiating the Database](#)
- [Task 4: Setting Up Oracle Streams After Instantiation](#)
- [Task 5: Finishing the Upgrade and Removing Oracle Streams](#)

Task 1: Beginning the Upgrade

Complete the following steps to begin the upgrade using Oracle Streams:

1. Create an empty database. Ensure that the **destination database** has a different global name than the source database. This example assumes that the global name of the source database is `orcl.example.com` and the global name of the destination database during the upgrade is `updb.example.com`. The global name of the destination database is changed when the destination database replaces the source database at the end of the upgrade process.

The release of the empty database you create depends on the **instantiation** method you decided to use in "[Deciding Which Utility to Use for Instantiation](#)" on page D-5:

- If you decided to use export/import for instantiation, then create an empty Oracle Database 11g Release 1 database. This database will be the destination database during the upgrade process.

See the Oracle Database installation guide for your operating system if you must install Oracle Database, and see the *Oracle Database Administrator's Guide* for information about creating a database.

- If you decided to use RMAN for instantiation, then create an empty Oracle database that is the same release as the database you are upgrading.

Specifically, if you are upgrading an Oracle9i Database Release 2 (9.2) database, then create an Oracle9i Release 2 database. Alternatively, if you are upgrading an Oracle Database 10g database, then create an Oracle Database 10g database.

This database will be the destination database during the upgrade process. Both the source database that is being upgraded and the destination database must be the same release of Oracle when you start the upgrade process.

See the Oracle installation guide for your operating system if you must install Oracle, and see *Database Administrator's Guide* for the release for information about creating a database.

2. Ensure that the source database is running in ARCHIVELOG mode. See the Oracle *Administrator's Guide* for the source database release for information about running a database in ARCHIVELOG mode.
3. Ensure that the initialization parameters are set properly at each database to support an Oracle Streams environment. For the source database, see the Oracle Streams documentation for the source database release. For the destination database, see "[Setting Initialization Parameters Relevant to Oracle Streams](#)" on page 9-4. If the capture database is a third database, then see the Oracle Streams documentation for the capture database release.
4. At the source database, make read-only any database objects that were not supported by Oracle Streams in the release you are upgrading:
 - If you are upgrading an Oracle9i Database Release 2 (9.2) database, then make tables with columns of the following data types read-only: NCLOB, LONG, LONG RAW, BFILE, ROWID, and UROWID, and user-defined types (including object types, REFS, varrays, and nested tables). In addition, make the following types of tables read-only: temporary tables, index-organized tables, and object tables. See *Oracle9i Oracle Streams* for complete information about unsupported database objects.
 - If you are upgrading an Oracle Database 10g database, then query the DBA_STREAMS_UNSUPPORTED data dictionary view to list the database objects that are not supported by Oracle Streams. Make each of the listed database objects read-only.

"[Preparing to Upgrade a Database with User-defined Types](#)" on page D-4 discusses a method for retaining changes to tables that contain user-defined types during the upgrade. If you are using this method, then tables that contain user-defined types can remain open during the upgrade.

5. At the source database, configure an Oracle Streams administrator:
 - If you are upgrading an Oracle9i Database Release 2 (9.2) database, then see *Oracle9i Oracle Streams* for instructions.
 - If you are upgrading an Oracle Database 10g database, then see the *Oracle Streams Concepts and Administration* book for that release for instructions.

These instructions assume that the name of the Oracle Streams administrator at the source database is `strmadmin`. This Oracle Streams administrator will be copied automatically to the destination database during instantiation.

6. In SQL*Plus, connect to the source database `orcl.example.com` as an administrative user.

See *Oracle Database Administrator's Guide* for information about connecting to a database in SQL*Plus.

7. Specify **database supplemental logging** of primary keys, unique keys, and foreign keys for all updates. For example:

```
ALTER DATABASE ADD SUPPLEMENTAL LOG DATA
(PRIMARY KEY, UNIQUE, FOREIGN KEY) COLUMNS;
```

Task 2: Setting Up Oracle Streams Prior to Instantiation

The specific instructions for setting up Oracle Streams prior to **instantiation** depend on which database is the capture database. Follow the instructions in the appropriate section:

- [The Source Database Is the Capture Database](#)
- [The Destination Database Is the Capture Database](#)
- [A Third Database Is the Capture Database](#)

See Also: ["Overview of Using Oracle Streams in the Database Upgrade Process"](#) on page D-1 for information about the capture database

The Source Database Is the Capture Database

Complete the following steps to set up Oracle Streams prior to instantiation when the source database is the capture database:

1. Configure your network and Oracle Net so that the source database can communicate with the **destination database**. See *Oracle Database Net Services Administrator's Guide* for instructions.
2. In SQL*Plus, connect to the source database `orcl.example.com` as the Oracle Streams administrator.

See *Oracle Database Administrator's Guide* for information about connecting to a database in SQL*Plus.

3. Create an ANYDATA queue that will stage changes made to the source database during the upgrade process. For example:

```
BEGIN
  DBMS_STREAMS_ADM.SET_UP_QUEUE(
    queue_table => 'strmadmin.capture_queue_table',
    queue_name  => 'strmadmin.capture_queue');
END;
/
```

4. While still as the Oracle Streams administrator to the source database, configure a **capture process** that will capture all supported changes made to the source database and stage these changes in the **queue** created in Step 3. Do not start the capture process. For example:

```
BEGIN
  DBMS_STREAMS_ADM.ADD_GLOBAL_RULES(
    streams_type      => 'capture',
    streams_name      => 'capture_upgrade',
    queue_name        => 'strmadmin.capture_queue',
    include_dml       => TRUE,
    include_ddl       => TRUE,
    include_tagged_lcr => FALSE,
    source_database   => 'orcl.example.com',
    inclusion_rule    => TRUE);
END;
/
```

["Preparing to Upgrade a Database with User-defined Types"](#) on page D-4 discusses a method for retaining changes to tables that contain user-defined types during the maintenance operation. If you are using this method, then ensure that the capture process does not attempt to capture changes to tables with

user-defined types. See the Oracle Streams documentation for the source database for information about excluding database objects from an Oracle Streams configuration with [rules](#).

5. Proceed to "[Task 3: Instantiating the Database](#)" on page D-11.

The Destination Database Is the Capture Database

The database being upgraded must be an Oracle Database 10g database to use this option. Complete the following steps to set up Oracle Streams prior to instantiation when the [destination database](#) is the capture database:

1. Configure your network and Oracle Net so that the source database and destination database can communicate with each other. See *Oracle Database Net Services Administrator's Guide* for instructions.
2. Follow the instructions in the appropriate section based on the method you are using for instantiation:

- [Export/Import](#)
- [RMAN](#)

Export/Import

Complete the following steps if you are using export/import for instantiation:

- a. In SQL*Plus, connect to the destination database `updb.example.com` as the Oracle Streams administrator.

See *Oracle Database Administrator's Guide* for information about connecting to a database in SQL*Plus.

- b. Create an ANYDATA queue that will stage changes made to the source database during the upgrade process. For example:

```
BEGIN
  DBMS_STREAMS_ADM.SET_UP_QUEUE(
    queue_table => 'strmadmin.destination_queue_table',
    queue_name  => 'strmadmin.destination_queue');
END;
/
```

- c. While still as the Oracle Streams administrator to the destination database, configure a downstream [capture process](#) that will capture all supported changes made to the source database and stage these changes in the [queue](#) created in Step b. Ensure that the capture process uses a database link to the source database. The capture process can be a [real-time downstream capture process](#) or an [archived-log downstream capture process](#). See "[Configuring a Capture Process](#)" on page 10-1. Do not start the capture process.

"[Preparing to Upgrade a Database with User-defined Types](#)" on page D-4 discusses a method for retaining changes to tables that contain user-defined types during the maintenance operation. If you are using this method, then ensure that the capture process does not attempt to capture changes to tables with user-defined types. See the Oracle Streams documentation for the source database for information about excluding database objects from an Oracle Streams configuration with [rules](#).

RMAN

Complete the following steps if you are using RMAN for instantiation:

- a. In SQL*Plus, connect to the source database `orcl.example.com` as the Oracle Streams administrator.

See *Oracle Database Administrator's Guide* for information about connecting to a database in SQL*Plus.

- b. Perform a build of the data dictionary in the redo log:

```
SET SERVEROUTPUT ON
DECLARE
  scn NUMBER;
BEGIN
  DBMS_CAPTURE_ADM.BUILD(
    first_scn => scn);
  DBMS_OUTPUT.PUT_LINE('First SCN Value = ' || scn);
END;
/
First SCN Value = 1122610
```

This procedure displays the valid **first SCN** value for the capture process that will be created at the destination database. Make a note of the SCN value returned because you will use it when you create the capture process at the destination database.

- c. While still as the Oracle Streams administrator to the source database, prepare the source database for instantiation:

```
exec DBMS_CAPTURE_ADM.PREPARE_GLOBAL_INSTANTIATION();
```

3. Proceed to "[Task 3: Instantiating the Database](#)" on page D-11.

A Third Database Is the Capture Database

To use this option, meet the following requirements:

- The database being upgraded must be an Oracle Database 10g database.
- The third database must be an Oracle Database 10g or later database.

This example assumes that the global name of the third database is `thrd.example.com`. Complete the following steps to set up Oracle Streams prior to instantiation when a third database is the capture database:

1. Configure your network and Oracle Net so that the source database, **destination database**, and third database can communicate with each other. See *Oracle Database Net Services Administrator's Guide* for instructions.
2. In SQL*Plus, connect to the third database `thrd.example.com` as an administrative user, and create an Oracle Streams administrator:
 - If the third database is an Oracle Database 10g database, then see the *Oracle Streams Concepts and Administration* book for that release for instructions.
 - If the third database is an Oracle Database 11g Release 1 database, then see "[Configuring an Oracle Streams Administrator](#)" on page 9-1 for instructions.

These instructions assume that the name of the Oracle Streams administrator at the third database is `strmadmin`.

See *Oracle Database Administrator's Guide* for information about connecting to a database in SQL*Plus.

3. While still connected to the third database as the Oracle Streams administrator, create an ANYDATA queue that will stage changes made to the source database during the upgrade process. For example:

```
BEGIN
  DBMS_STREAMS_ADM.SET_UP_QUEUE(
    queue_table => 'strmadmin.capture_queue_table',
    queue_name  => 'strmadmin.capture_queue');
END;
/
```

4. Configure a downstream **capture process** that will capture all supported changes made to the source database and stage these changes in the **queue** created in Step 3. Ensure that the capture process uses a database link to the source database. Do not start the capture process.

See the following documentation for instructions:

- If the capture database is an Oracle Database 10g database, then see the *Oracle Streams Concepts and Administration* book for that release for instructions.
- If the capture database is an Oracle Database 11g Release 1 database, then see "Configuring a Capture Process" on page 10-1 for instructions. The capture process can be a **real-time downstream capture process** or an **archived-log downstream capture process**.

"Preparing to Upgrade a Database with User-defined Types" on page D-4 discusses a method for retaining changes to tables that contain user-defined types during the maintenance operation. If you are using this method, then ensure that the capture process does not attempt to capture changes to tables with user-defined types. See the Oracle Streams documentation for the source database for information about excluding database objects from an Oracle Streams configuration with **rules**.

5. Proceed to "Task 3: Instantiating the Database" on page D-11.

Task 3: Instantiating the Database

"Deciding Which Utility to Use for Instantiation" on page D-5 discusses different options for instantiating an entire database. Complete the steps in the appropriate section based on the **instantiation** option you are using:

- [Instantiating the Database Using Export/Import](#)
- [Instantiating the Database Using RMAN](#)

Instantiating the Database Using Export/Import

Complete the following steps to instantiate the **destination database** using export/import:

1. Instantiate the destination database using Export/Import. See *Oracle Streams Replication Administrator's Guide* for more information about performing instantiations, and see *Oracle Database Utilities* for information about performing an export/import using the Export and Import utilities.

If you use Oracle Data Pump or original Export/Import to instantiate the destination database, then ensure that the following parameters are set to the appropriate values:

- Set the `STREAMS_CONFIGURATION` import parameter to `n`.
- If you use original Export/Import, then set the `CONSISTENT` export parameter to `y`. This parameter does not apply to Data Pump exports.
- If you use original Export/Import, then set the `STREAMS_INSTANTIATION` import parameter to `y`. This parameter does not apply to Data Pump imports.

If you are upgrading an Oracle9i Database Release 2 (9.2) database, then you must use original Export/Import.

2. At the destination database, disable any imported jobs that modify data that will be replicated from the source database. Query the `DBA_JOBS` data dictionary view to list the jobs.
3. Proceed to "[Task 4: Setting Up Oracle Streams After Instantiation](#)" on page D-14.

Instantiating the Database Using RMAN

Complete the following steps to instantiate the **destination database** using the RMAN `DUPLICATE` command:

Note: These steps provide a general outline for using RMAN to duplicate a database. If you are upgrading an Oracle9i Release 2 database, then see the *Oracle9i Recovery Manager User's Guide* for detailed information about using RMAN in that release. If you are upgrading an Oracle Database 10g database, then see the *Oracle Database Backup and Recovery Advanced User's Guide* for that release.

1. Create a backup of the source database if one does not exist. RMAN requires a valid backup for duplication. In this example, create a backup of `orcl.example.com` if one does not exist.
2. In SQL*Plus, connect to the source database `orcl.example.com` as an administrative user.

See *Oracle Database Administrator's Guide* for information about connecting to a database in SQL*Plus.

3. Determine the until SCN for the RMAN `DUPLICATE` command. For example:

```
SET SERVEROUTPUT ON SIZE 1000000
DECLARE
    until_scn NUMBER;
BEGIN
    until_scn:= DBMS_FLASHBACK.GET_SYSTEM_CHANGE_NUMBER;
    DBMS_OUTPUT.PUT_LINE('Until SCN: ' || until_scn);
END;
/
```

Make a note of the until SCN value. This example assumes that the until SCN value is 439882. You will set the `UNTIL SCN` option to this value when you use RMAN to duplicate the database in Step 7.

4. While still connected as an administrative user in SQL*Plus to the source database, archive the current online redo log. For example:

```
ALTER SYSTEM ARCHIVE LOG CURRENT;
```

5. Prepare your environment for database duplication, which includes preparing the destination database as an auxiliary instance for duplication. See the

documentation for the release from which you are upgrading for instructions. Specifically, see the "Duplicating a Database with Recovery Manager" chapter in the *Oracle9i Recovery Manager User's Guide* or *Oracle Database Backup and Recovery Advanced User's Guide* (10g) for instructions.

6. Start the RMAN client, and connect to the database `orcl.example.com` as TARGET and to the `updb.example.com` database as AUXILIARY. Connect to each database as an administrative user.

See *Oracle Database Backup and Recovery Reference* for more information about the RMAN CONNECT command.

7. Use the RMAN DUPLICATE command with the OPEN RESTRICTED option to instantiate the source database at the destination database. The OPEN RESTRICTED option is required. This option enables a restricted session in the duplicate database by issuing the following SQL statement: ALTER SYSTEM ENABLE RESTRICTED SESSION. RMAN issues this statement immediately before the duplicate database is opened.

You can use the UNTIL SCN clause to specify an SCN for the duplication. Use the until SCN determined in Step 3 for this clause. Archived redo logs must be available for the until SCN specified and for higher SCN values. Therefore, Step 4 archived the redo log containing the until SCN.

Ensure that you use TO *database_name* in the DUPLICATE command to specify the name of the duplicate database. In this example, the duplicate database is `updb.example.com`. Therefore, the DUPLICATE command for this example includes TO `updb.example.com`.

The following example is an RMAN DUPLICATE command:

```
RMAN> RUN
{
  SET UNTIL SCN 439882;
  ALLOCATE AUXILIARY CHANNEL updb DEVICE TYPE sbt;
  DUPLICATE TARGET DATABASE TO updb
  NOFILENAMECHECK
  OPEN RESTRICTED;
}
```

8. In SQL*Plus, connect to the destination database as an administrative user.
9. Use the ALTER SYSTEM statement to disable the RESTRICTED SESSION:

```
ALTER SYSTEM DISABLE RESTRICTED SESSION;
```
10. While still connected as an administrative user in SQL*Plus to the destination database, rename the database global name. After the RMAN DUPLICATE command, the destination database has the same global name as the source database, but the destination database must have its original name until the end of the upgrade. For example:

```
ALTER DATABASE RENAME GLOBAL_NAME TO updb.example.com;
```

11. At the destination database, disable any jobs that modify data that will be replicated from the source database. Query the DBA_JOBS data dictionary view to list the jobs.
12. Upgrade the destination database to Oracle Database 11g Release 1. See the *Oracle Database Upgrade Guide* for instructions.

13. If you have not done so already, configure your network and Oracle Net so that the source database and destination database can communicate with each other. See *Oracle Database Net Services Administrator's Guide* for instructions.

14. Connect to the destination database as the Oracle Streams administrator in SQL*Plus. In this example, the destination database is `updb.example.com`.

15. Create a database link to the source database. For example:

```
CREATE DATABASE LINK orcl.example.com CONNECT TO strmadmin
  IDENTIFIED BY password
  USING 'orcl.example.com';
```

16. While still connected as the Oracle Streams administrator in SQL*Plus to the destination database, set the **instantiation SCN** for the entire database and all of the database objects. The `RMAN DUPLICATE` command duplicates the database up to one less than the SCN value specified in the `UNTIL SCN` clause. Therefore, you should subtract one from the until SCN value that you specified when you ran the `DUPLICATE` command in Step 7. In this example, the until SCN was set to 439882. Therefore, the instantiation SCN should be set to $439882 - 1$, or 439881.

```
BEGIN
  DBMS_APPLY_ADM.SET_GLOBAL_INSTANTIATION_SCN(
    source_database_name => 'orcl.example.com',
    instantiation_scn     => 439881,
    recursive             => TRUE);
END;
/
```

17. Proceed to "[Task 4: Setting Up Oracle Streams After Instantiation](#)" on page D-14.

Task 4: Setting Up Oracle Streams After Instantiation

The specific instructions for setting up Oracle Streams after **instantiation** depend on which database is the capture database. Follow the instructions in the appropriate section:

- [The Source Database Is the Capture Database](#)
- [The Destination Database Is the Capture Database](#)
- [A Third Database Is the Capture Database](#)

See Also: "[Overview of Using Oracle Streams in the Database Upgrade Process](#)" on page D-1 for information about the capture database

The Source Database Is the Capture Database

Complete the following steps to set up Oracle Streams after instantiation when the source database is the capture database:

1. In SQL*Plus, connect to the **destination database** as the Oracle Streams administrator. In this example, the destination database is `updb.example.com`.
See *Oracle Database Administrator's Guide* for information about connecting to a database in SQL*Plus.
2. Remove the Oracle Streams components that were cloned from the source database during instantiation:

- If export/import was used for instantiation, then remove the ANYDATA queue that was cloned from the source database.
- If RMAN was used for instantiation, then remove the ANYDATA queue and the capture process that were cloned from the source database.

To remove the **queue** that was cloned from the source database, run the `REMOVE_QUEUE` procedure in the `DBMS_STREAMS_ADM` package. For example:

```
BEGIN
  DBMS_STREAMS_ADM.REMOVE_QUEUE(
    queue_name          => 'strmadmin.capture_queue',
    cascade             => FALSE,
    drop_unused_queue_table => TRUE);
END;
/
```

To remove the capture process that was cloned from the source database, run the `DROP_CAPTURE` procedure in the `DBMS_CAPTURE_ADM` package. For example:

```
BEGIN
  DBMS_CAPTURE_ADM.DROP_CAPTURE(
    capture_name       => 'capture_upgrade',
    drop_unused_rule_sets => TRUE);
END;
/
```

3. Create an ANYDATA queue. This queue will stage changes propagated from the source database. For example:

```
BEGIN
  DBMS_STREAMS_ADM.SET_UP_QUEUE(
    queue_table => 'strmadmin.destination_queue_table',
    queue_name  => 'strmadmin.destination_queue');
END;
/
```

4. Connect to the source database as the Oracle Streams administrator. In this example, the source database is `orcl.example.com`.

5. Create a database link to the destination database. For example:

```
CREATE DATABASE LINK updb.example.com CONNECT TO strmadmin
  IDENTIFIED BY password
  USING 'updb.example.com';
```

6. Create a **propagation** that propagates all changes from the **source queue** to the destination database created in Step 3. For example:

```
BEGIN
  DBMS_STREAMS_ADM.ADD_GLOBAL_PROPAGATION_RULES(
    streams_name          => 'to_updb',
    source_queue_name     => 'strmadmin.capture_queue',
    destination_queue_name => 'strmadmin.destination_queue@updb.example.com',
    include_dml           => TRUE,
    include_ddl           => TRUE,
    include_tagged_lcr    => TRUE,
    source_database       => 'orcl.example.com');
END;
/
```

7. Connect to the destination database as the Oracle Streams administrator.

8. Create an **apply process** that applies all changes in the queue created in Step 3. For example:

```
BEGIN
  DBMS_STREAMS_ADM.ADD_GLOBAL_RULES(
    streams_type      => 'apply',
    streams_name      => 'apply_upgrade',
    queue_name        => 'strmadmin.destination_queue',
    include_dml       => TRUE,
    include_ddl       => TRUE,
    include_tagged_lcr => TRUE,
    source_database   => 'orcl.example.com');
END;
/
```

9. Proceed to "[Task 5: Finishing the Upgrade and Removing Oracle Streams](#)" on page D-18.

The Destination Database Is the Capture Database

Complete the following steps to set up Oracle Streams after instantiation when the **destination database** is the capture database:

1. Complete the following steps if you used RMAN for instantiation. If you used export/import for instantiation, then proceed to Step 2.
 - a. In SQL*Plus, connect to the destination database as the Oracle Streams administrator. In this example, the destination database is `updb.example.com`.

See *Oracle Database Administrator's Guide* for information about connecting to a database in SQL*Plus.
 - b. Create an ANYDATA queue that will stage changes made to the source database during the upgrade process. For example:

```
BEGIN
  DBMS_STREAMS_ADM.SET_UP_QUEUE(
    queue_table => 'strmadmin.destination_queue_table',
    queue_name  => 'strmadmin.destination_queue');
END;
/
```

- c. While still as the Oracle Streams administrator to the destination database, configure a **downstream capture process** that will capture all supported changes made to the source database and stage these changes in the **queue** created in Step b.

Ensure that you set the `first_scn` parameter in the `CREATE_CAPTURE` procedure to the value obtained for the data dictionary build in Step 2b on page D-10 in "[The Destination Database Is the Capture Database](#)". In this example, the `first_scn` parameter should be set to 1122610.

The capture process can be a **real-time downstream capture process** or an **archived-log downstream capture process**. See "[Configuring a Capture Process](#)" on page 10-1. Do not start the capture process.

"[Preparing to Upgrade a Database with User-defined Types](#)" on page D-4 discusses a method for retaining changes to tables that contain user-defined types during the maintenance operation. If you are using this method, then ensure that the capture process does not attempt to capture changes to tables with user-defined types. See the Oracle Streams documentation for the source

database for information about excluding database objects from an Oracle Streams configuration with **rules**.

2. While still as the Oracle Streams administrator to the destination database, create an **apply process** that applies all changes in the queue used by the downstream capture process. For example:

```
BEGIN
  DBMS_STREAMS_ADM.ADD_GLOBAL_RULES(
    streams_type      => 'apply',
    streams_name      => 'apply_upgrade',
    queue_name        => 'strmadmin.destination_queue',
    include_dml       => TRUE,
    include_ddl       => TRUE,
    include_tagged_lcr => TRUE,
    source_database   => 'orcl.example.com');
END;
/
```

3. Proceed to "[Task 5: Finishing the Upgrade and Removing Oracle Streams](#)" on page D-18.

A Third Database Is the Capture Database

This example assumes that the global name of the third database is `thrd.example.com`. Complete the following steps to set up Oracle Streams after instantiation when a third database is the capture database:

1. In SQL*Plus, connect to the **destination database** as the Oracle Streams administrator. In this example, the destination database is `updb.example.com`.

See *Oracle Database Administrator's Guide* for information about connecting to a database in SQL*Plus.

2. Create an ANYDATA queue. This **queue** will stage changes propagated from the capture database. For example:

```
BEGIN
  DBMS_STREAMS_ADM.SET_UP_QUEUE(
    queue_table => 'strmadmin.destination_queue_table',
    queue_name  => 'strmadmin.destination_queue');
END;
/
```

3. Connect to the capture database as the Oracle Streams administrator. In this example, the capture database is `thrd.example.com`.
4. Create a database link to the destination database. For example:

```
CREATE DATABASE LINK updb.example.com CONNECT TO strmadmin
  IDENTIFIED BY password
  USING 'updb.example.com';
```

5. While connected as the Oracle Streams administrator in SQL*Plus to the capture database, create a **propagation** that propagates all changes from the **source queue** at the capture database to the **destination queue** created in Step 2. For example:

```
BEGIN
  DBMS_STREAMS_ADM.ADD_GLOBAL_PROPAGATION_RULES(
    streams_name      => 'to_updb',
    source_queue_name => 'strmadmin.capture_queue',
    destination_queue_name => 'strmadmin.destination_queue@updb.example.com',
    include_dml       => TRUE,
```

```

        include_ddl           => TRUE,
        include_tagged_lcr    => TRUE,
        source_database       => 'orcl.example.com');
END;
/

```

6. Connect to the destination database as the Oracle Streams administrator. In this example, the destination database is `updb.example.com`.
7. Create an **apply process** that applies all changes in the queue created in Step 2. For example:

```

BEGIN
  DBMS_STREAMS_ADM.ADD_GLOBAL_RULES(
    streams_type           => 'apply',
    streams_name           => 'apply_upgrade',
    queue_name             => 'strmadmin.destination_queue',
    include_dml            => TRUE,
    include_ddl            => TRUE,
    include_tagged_lcr     => TRUE,
    source_database       => 'orcl.example.com');
END;
/

```

8. Complete the steps in "[Task 5: Finishing the Upgrade and Removing Oracle Streams](#)" on page D-18.

Task 5: Finishing the Upgrade and Removing Oracle Streams

Complete the following steps to finish the upgrade operation using Oracle Streams and remove Oracle Streams components:

1. Connect to the **destination database** as the Oracle Streams administrator. In this example, the destination database is `updb.example.com`.

See *Oracle Database Administrator's Guide* for information about connecting to a database in SQL*Plus.

2. Start the apply process. For example:

```

BEGIN
  DBMS_APPLY_ADM.START_APPLY(
    apply_name => 'apply_upgrade');
END;
/

```

3. Connect to the capture database as the Oracle Streams administrator. In this example, the capture database is `thrd.example.com`.
4. Start the capture process. For example:

```

BEGIN
  DBMS_CAPTURE_ADM.START_CAPTURE(
    capture_name => 'capture_upgrade');
END;
/

```

This step begins the process of replicating changes that were made to the source database during instantiation of the destination database.

5. While still connected as the Oracle Streams administrator in SQL*Plus to the capture database, monitor the Oracle Streams environment until the apply process

at the destination database has applied most of the changes from the source database.

To determine whether the apply process at the destination database has applied most of the changes from the source database, complete the following steps:

- a. Query the enqueue message number of the capture process and the high-watermark message number of the apply process to see if they are nearly equal.

For example, if the name of the capture process is `capture_upgrade`, and the name of the apply process is `apply_upgrade`, then run the following query at the source database:

```
COLUMN ENQUEUE_MESSAGE_NUMBER HEADING 'Captured SCN' FORMAT 99999999999
COLUMN HWM_MESSAGE_NUMBER HEADING 'Applied SCN' FORMAT 99999999999

SELECT c.ENQUEUE_MESSAGE_NUMBER, a.HWM_MESSAGE_NUMBER
       FROM V$STREAMS_CAPTURE c, V$STREAMS_APPLY_COORDINATOR@updb.example.com a
       WHERE CAPTURE_NAME = 'CAPTURE_UPGRADE'
             AND APPLY_NAME = 'APPLY_UPGRADE';
```

When the two values returned by this query are nearly equal, most of the changes from the source database have been applied at the destination database, and you can proceed to the next step. At this point in the process, the values returned by this query might never be equal because the source database still allows changes.

If this query returns no results, then ensure that the **Oracle Streams clients** in the environment are enabled by querying the `STATUS` column in the `DBA_CAPTURE` view at the capture database and the `DBA_APPLY` view at the destination database. If a **propagation** is used, you can check the status of the propagation by running the query in "[Displaying the Schedule for a Propagation Job](#)" on page 24-15.

If an Oracle Streams client is disabled, then try restarting it. If an Oracle Streams client will not restart, then troubleshoot the environment using the information in [Chapter 20, "Troubleshooting an Oracle Streams Environment"](#).

- b. Query the state of the apply process apply servers at the destination database to determine whether they have finished applying changes.

For example, if the name of the apply process is `apply_upgrade`, then run the following query at the source database:

```
COLUMN STATE HEADING 'Apply Server State' FORMAT A20

SELECT STATE
       FROM V$STREAMS_APPLY_SERVER@updb.example.com
       WHERE APPLY_NAME = 'APPLY_UPGRADE';
```

When the state for all apply servers is `IDLE`, you can proceed to the next step.

6. Connect to the destination database as the Oracle Streams administrator. In this example, the destination database is `updb.example.com`.
7. Ensure that there are no apply errors by running the following query:

```
SELECT COUNT(*) FROM DBA_APPLY_ERROR;
```

If this query returns zero, then proceed to the next step. If this query shows errors in the error queue, then resolve these errors before continuing. See "[Managing Apply Errors](#)" on page 16-19 for instructions.

8. Disconnect all applications and users from the source database.
9. Connect as an administrative user to the source database. In this example, the source database is `orcl.example.com`.
10. Restrict access to the database. For example:

```
ALTER SYSTEM ENABLE RESTRICTED SESSION;
```
11. Connect as an administrative user in SQL*Plus to the capture database, and repeat the query you ran in Step 5. When the two values returned by the query are equal, all of the changes from the source database have been applied at the destination database, and you can proceed to the next step.
12. Connect as the Oracle Streams administrator in SQL*Plus to the destination database, and repeat the query you ran in Step 7. If this query returns zero, then move on to the next step. If this query shows errors in the error queue, then resolve these errors before continuing. See ["Managing Apply Errors"](#) on page 16-19 for instructions.
13. If you performed any actions that created, modified, or deleted job queue processes at the source database during the upgrade process, then perform the same actions at the destination database. See ["Considerations for Job Queue Processes and PL/SQL Package Subprograms"](#) on page D-4 for more information.
14. If you invoked any Oracle-supplied PL/SQL package subprograms at the source database during the upgrade process that modified both user data and dictionary metadata at the same time, then invoke the same subprograms at the destination database. See ["Considerations for Job Queue Processes and PL/SQL Package Subprograms"](#) on page D-4 for more information.
15. Shut down the source database. This database should not be opened again.
16. Connect to the destination database as an administrative user.
17. Change the global name of the database to match the source database. For example:

```
ALTER DATABASE RENAME GLOBAL_NAME TO orcl.example.com;
```
18. At the destination database, enable any jobs that you disabled earlier.
19. Make the destination database available for applications and users. Redirect any applications and users that were connecting to the source database to the destination database. If necessary, reconfigure your network and Oracle Net so that systems that communicated with the source database now communicate with the destination database. See *Oracle Database Net Services Administrator's Guide* for instructions.
20. At the destination database, remove the Oracle Streams components that are no longer needed. Connect as an administrative user to the destination database, and run the following procedure:

Note: Running this procedure is dangerous. It removes the local Oracle Streams configuration. Ensure that you are ready to remove the Oracle Streams configuration at the destination database before running this procedure.

```
EXEC DBMS_STREAMS_ADM.REMOVE_STREAMS_CONFIGURATION();
```

If you no longer need **database supplemental logging** at the destination database, then run the following statement to drop it:

```
ALTER DATABASE DROP SUPPLEMENTAL LOG DATA
(PRIMARY KEY, UNIQUE, FOREIGN KEY) COLUMNS;
```

If you no longer need the Oracle Streams administrator at the destination database, then run the following statement:

```
DROP USER strmadmin CASCADE;
```

21. If the capture database was a third database, then, at the third database, remove the Oracle Streams components that are no longer needed. Connect as an administrative user to the third database, and run the following procedure:

Note: Running this procedure is dangerous. It removes the local Oracle Streams configuration. Ensure that you are ready to remove the Oracle Streams configuration at the third database before running this procedure.

```
EXEC DBMS_STREAMS_ADM.REMOVE_STREAMS_CONFIGURATION();
```

If you no longer need database **supplemental logging** at the third database, then run the following statement to drop it:

```
ALTER DATABASE DROP SUPPLEMENTAL LOG DATA
(PRIMARY KEY, UNIQUE, FOREIGN KEY) COLUMNS;
```

If you no longer need the Oracle Streams administrator at the destination database, then run the following statement:

```
DROP USER strmadmin CASCADE;
```

The database upgrade is complete.

Online Database Maintenance with Oracle Streams

This appendix describes how to perform some maintenance operations with Oracle Streams on an Oracle Database 11g Release 1 (11.1) database. These maintenance operations include migrating an Oracle database to a different platform or character set, upgrading user-created applications, and applying Oracle Database patches or patch sets. The maintenance operations described in this appendix use the features of Oracle Streams to achieve little or no database down time.

The following topics describe performing online database maintenance with Oracle Streams:

- [Overview of Using Oracle Streams for Database Maintenance Operations](#)
- [Preparing for a Database Maintenance Operation](#)
- [Performing a Database Maintenance Operation Using Oracle Streams](#)

See Also: [Appendix D, "Online Database Upgrade with Oracle Streams"](#) for instructions on performing an upgrade of a prior release of Oracle Database with Oracle Streams

Overview of Using Oracle Streams for Database Maintenance Operations

The following maintenance operations typically require substantial database down time:

- Migrating a database to a different platform
- Migrating a database to a different character set
- Modifying database schema objects to support upgrades to user-created applications
- Applying an Oracle Database software patch or patch set

You can achieve these maintenance operations with little or no down time by using the features of Oracle Streams. To do so, you use Oracle Streams to configure a single-source **replication** environment with the following databases:

- **Source Database:** The original database that is being maintained.
- **Capture Database:** The database where a **capture process** captures changes made to the source database during the maintenance operation.
- **Destination Database:** The copy of the source database where an **apply process** applies changes made to the source database during the maintenance operation.

Specifically, you can use the following general steps to perform the maintenance operation while the database is online:

1. Create an empty **destination database**.
2. Configure an Oracle Streams single-source replication environment where the original database is the source database and a copy of the database is the destination database. The `PRE_INSTANTIATION_SETUP` and `POST_INSTANTIATION_SETUP` procedures in the `DBMS_STREAMS_ADM` package configure the Oracle Streams replication environment.
3. Perform the maintenance operation on the destination database. During this time the original source database is available online, and changes to the original source database are being captured by a capture process.
4. Use Oracle Streams to apply the changes made to the source database at the destination database.
5. When the destination database has caught up with the changes made at the source database, take the source database offline and make the destination database available for applications and users.

Figure E-1 provides an overview of this process.

Figure E-1 Online Database Maintenance with Oracle Streams

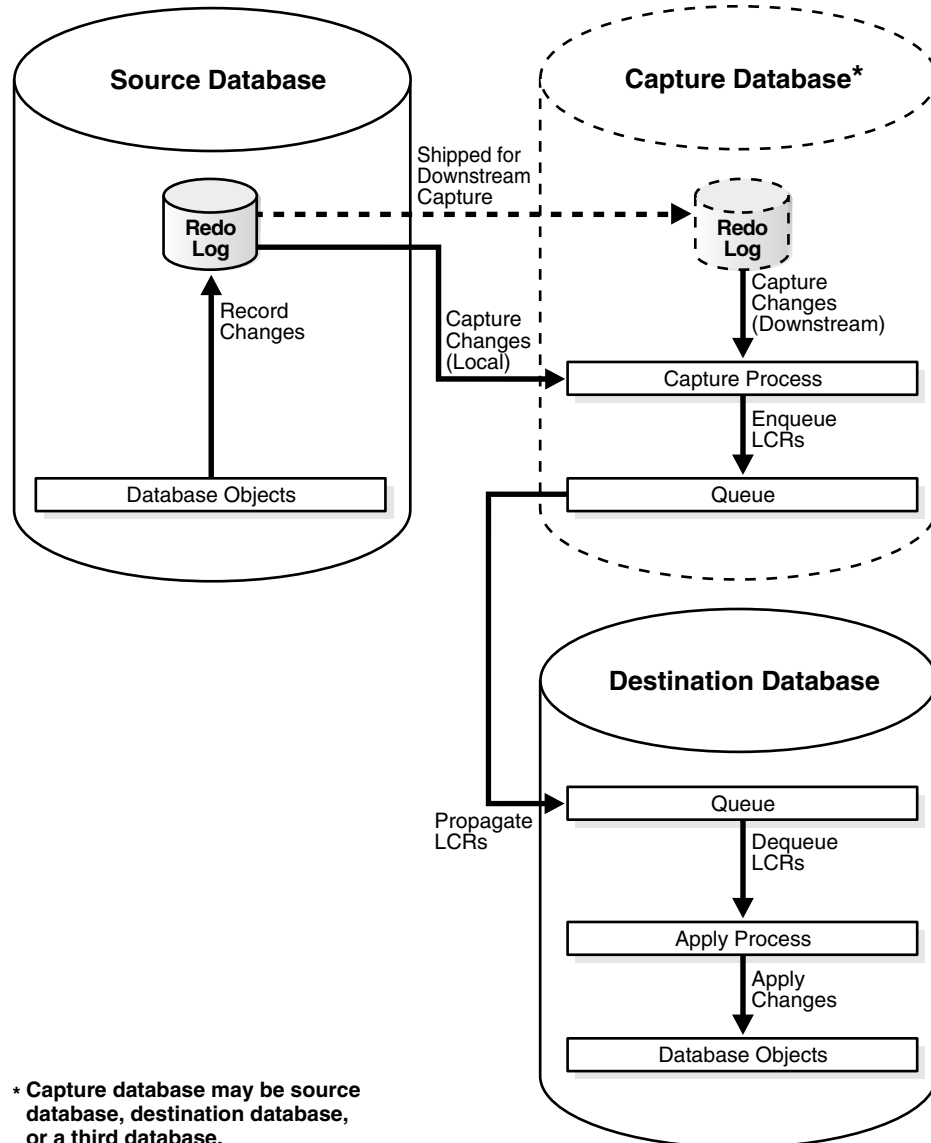

The Capture Database During the Maintenance Operation

During the maintenance operation, the capture database is the database where the **capture process** is created. A **local capture process** can be created at the source database during the maintenance operation, or a **downstream capture process** can be created at the **destination database** or at a third database. If the destination database is the capture database, then a **propagation** from the capture database to the destination database is not needed. A downstream capture process reduces the resources required at the source database during the maintenance operation.

Note:

- Before you begin the database maintenance operation with Oracle Streams, decide which database will be the capture database.
 - If the RMAN DUPLICATE or CONVERT DATABASE command is used for database **instantiation**, then the destination database cannot be the capture database.
-

See Also:

- ["Local Capture and Downstream Capture"](#) on page 2-14
- ["Deciding Which Utility to Use for Instantiation"](#) on page E-11

Assumptions for the Database Being Maintained

The instructions in this appendix assume that all of the following statements are true for the database being maintained:

- The database is not part of an existing Oracle Streams environment.
- The database is not part of an existing logical standby environment.
- The database is not part of an existing Advanced Replication environment.
- No tables at the database are master tables for materialized views in other databases.
- Any user-created **queues** are read-only during the maintenance operation.

Considerations for Job Slaves and PL/SQL Package Subprograms

If possible, ensure that no job slaves are created, modified, or deleted during the maintenance operation, and that no Oracle-supplied PL/SQL package subprograms are invoked during the maintenance operation that modify both user data and data dictionary metadata at the same time. The following packages contain subprograms that modify both user data and data dictionary metadata at the same time: DBMS_RLS, DBMS_STATS, and DBMS_JOB.

It might be possible to perform such actions on the database if you ensure that the same actions are performed on the source database and **destination database** in Steps 19 and 20 in ["Performing a Database Maintenance Operation Using Oracle Streams"](#) on page E-12. For example, if a PL/SQL procedure gathers statistics on the source database during the maintenance operation, then the same PL/SQL procedure should be invoked at the destination database in Step 20.

Unsupported Database Objects Are Excluded

The PRE_INSTANTIATION_SETUP and POST_INSTANTIATION_SETUP procedures in the DBMS_STREAMS_ADM package include the following parameters:

- `exclude_schemas`
- `exclude_flags`

These parameters specify which database objects to exclude from the Oracle Streams configuration. The examples in this appendix set these parameters to the following values:

```
exclude_schemas => '*',
exclude_flags    => DBMS_STREAMS_ADM.EXCLUDE_FLAGS_UNSUPPORTED +
                   DBMS_STREAMS_ADM.EXCLUDE_FLAGS_DML +
                   DBMS_STREAMS_ADM.EXCLUDE_FLAGS_DDL);
```

These values exclude any database objects that are not supported by Oracle Streams. The asterisk (*) specified for `exclude_schemas` indicates that some database objects in every schema in the database might be excluded from the **replication** environment. The value specified for the `exclude_flags` parameter indicates that DML and DDL changes for all unsupported database objects are excluded from the replication environment. Rules are placed in the **negative rule sets** for the **capture processes** to exclude these database objects.

To list unsupported database objects, query the `DBA_STREAMS_UNSUPPORTED` data dictionary view at the source database. If you use these parameter settings, then changes to the database objects listed in this view are not maintained by Oracle Streams during the maintenance operation. Therefore, Step 6 on page E-13 in "[Task 1: Beginning the Maintenance Operation](#)" instructs you to make these database objects read-only during the database maintenance operation.

Note: "[Preparing for Maintenance of a Database with User-defined Types](#)" on page E-8 discusses a method for retaining changes to tables that contain user-defined types during the maintenance operation. If you are using this method, then tables that contain user-defined types can remain open during the maintenance operation.

See Also: *Oracle Database PL/SQL Packages and Types Reference* for more information about the `exclude_schemas` and `exclude_flags` parameters

Preparing for a Database Maintenance Operation

The following sections describe tasks to complete before starting the database maintenance operation with Oracle Streams:

- [Preparing for Downstream Capture](#)
- [Preparing for Maintenance of a Database with User-defined Types](#)
- [Preparing for Upgrades to User-Created Applications](#)
- [Deciding Whether to Configure Oracle Streams Directly or Generate a Script](#)
- [Deciding Which Utility to Use for Instantiation](#)

Preparing for Downstream Capture

If you decided that the **destination database** or a third database will be the capture database, then you must prepare for downstream capture by configuring log file copying from the source database to the capture database. If you decided that the source database will be the capture database, then log file copying is not required.

Complete the following steps to prepare the source database to copy its redo log files to the capture database, and to prepare the capture database to accept these redo log files:

1. Configure Oracle Net so that the source database can communicate with the capture database.

See Also: *Oracle Database Net Services Administrator's Guide*

2. Configure authentication at both databases to support the transfer of redo data.

Redo transport sessions are authenticated using either the Secure Sockets Layer (SSL) protocol or a remote login password file. If the source database has a remote login password file, then copy it to the appropriate directory on the downstream capture database system. The password file must be the same at the source database and the downstream capture database.

See Also: *Oracle Data Guard Concepts and Administration* for detailed information about authentication requirements for redo transport

3. At the source database, set the following initialization parameters to configure redo transport services to transmit redo data from the source database to the downstream database:

- LOG_ARCHIVE_DEST_ *n* - Configure at least one LOG_ARCHIVE_DEST_ *n* initialization parameter to transmit redo data to the downstream database. To do this, set the following attributes of this parameter:

- SERVICE - Specify the network service name of the downstream database.
- ASYNC or SYNC - Specify a redo transport mode.

The advantage of specifying ASYNC is that it results in little or no effect on the performance of the source database. If the source database is running Oracle Database 10g Release 1 or later, then ASYNC is recommended to avoid affecting source database performance if the downstream database or network is performing poorly.

The advantage of specifying SYNC is that redo data is sent to the downstream database faster than when ASYNC is specified. Also, specifying SYNC AFFIRM results in behavior that is similar to MAXIMUM AVAILABILITY standby protection mode. Note that specifying an ALTER DATABASE STANDBY DATABASE TO MAXIMIZE AVAILABILITY SQL statement has no effect on an Oracle Streams capture process.

- NOREGISTER - Specify this attribute so that the location of the archived redo log files is not recorded in the downstream database control file.
- VALID_FOR - Specify either (ONLINE_LOGFILE, PRIMARY_ROLE) or (ONLINE_LOGFILE, ALL_ROLES).
- TEMPLATE - Specify a directory and format template for archived redo logs at the downstream database. The TEMPLATE attribute overrides the LOG_ARCHIVE_FORMAT initialization parameter settings at the downstream database. The TEMPLATE attribute is valid only with remote destinations. Ensure that the format uses all of the following variables at each source database: %t, %s, and %r.
- DB_UNIQUE_NAME - The unique name of the downstream database. Use the name specified for the DB_UNIQUE_NAME initialization parameter at the downstream database.

The following example is a LOG_ARCHIVE_DEST_ *n* setting that specifies a capture database (DBS2 . EXAMPLE . COM):

```
LOG_ARCHIVE_DEST_2='SERVICE=DBS2.EXAMPLE.COM ASYNC NOREGISTER
VALID_FOR=(ONLINE_LOGFILES,PRIMARY_ROLE)
TEMPLATE=/usr/oracle/log_for_dbs1/dbs1_arch_%t_%s_%r.log
DB_UNIQUE_NAME=dbs2'
```

Tip: Specify a value for the `TEMPLATE` attribute that keeps log files from a remote source database separate from local database log files. In addition, if the downstream database contains log files from multiple source databases, then the log files from each source database should be kept separate from each other.

- `LOG_ARCHIVE_DEST_STATE_n` - Set this initialization parameter that corresponds with the `LOG_ARCHIVE_DEST_n` parameter for the downstream database to `ENABLE`.

For example, if the `LOG_ARCHIVE_DEST_2` initialization parameter is set for the downstream database, then set the `LOG_ARCHIVE_DEST_STATE_2` parameter in the following way:

```
LOG_ARCHIVE_DEST_STATE_2=ENABLE
```

- `LOG_ARCHIVE_CONFIG` - Set the `DB_CONFIG` attribute in this initialization parameter to include the `DB_UNIQUE_NAME` of the source database and the downstream database.

For example, if the `DB_UNIQUE_NAME` of the source database is `dbs1`, and the `DB_UNIQUE_NAME` of the downstream database is `dbs2`, then specify the following parameter:

```
LOG_ARCHIVE_CONFIG='DG_CONFIG=(dbs1,dbs2)'
```

By default, the `LOG_ARCHIVE_CONFIG` parameter enables a database to both send and receive redo.

See Also: *Oracle Database Reference* and *Oracle Data Guard Concepts and Administration* for more information about these initialization parameters

4. At the downstream database, set the `DB_CONFIG` attribute in the `LOG_ARCHIVE_CONFIG` initialization parameter to include the `DB_UNIQUE_NAME` of the source database and the downstream database.

For example, if the `DB_UNIQUE_NAME` of the source database is `dbs1`, and the `DB_UNIQUE_NAME` of the downstream database is `dbs2`, then specify the following parameter:

```
LOG_ARCHIVE_CONFIG='DG_CONFIG=(dbs1,dbs2)'
```

By default, the `LOG_ARCHIVE_CONFIG` parameter enables a database to both send and receive redo.

5. If you reset any initialization parameters while the instance is running at a database in Step 3 or Step 4, then you might want to reset them in the initialization parameter file as well, so that the new values are retained when the database is restarted.

If you did not reset the initialization parameters while the instance was running, but instead reset them in the initialization parameter file in Step 3 or Step 4, then restart the database. The source database must be open when it sends redo log

files to the capture database because the global name of the source database is sent to the capture database only if the source database is open.

See Also: ["Overview of Using Oracle Streams for Database Maintenance Operations"](#) on page E-1 for more information about the capture database

Preparing for Maintenance of a Database with User-defined Types

User-defined types include object types, REF values, varrays, and nested tables. Currently, Oracle Streams **capture processes** and **apply processes** do not support user-defined types. This section discusses using Oracle Streams to perform a maintenance operation on a database that has user-defined types.

One option is to make tables that contain user-defined types read-only during the database maintenance operation. In this case, these tables are instantiated at the **destination database**, and no changes are made to these tables during the entire operation. After the maintenance operation is complete, make the tables that contain user-defined types read/write at the destination database.

However, if tables that contain user-defined types must remain open during the maintenance operation, then the following general steps can be used to retain changes to these types during the database maintenance operation:

1. At the source database, create one or more logging tables to store row changes to tables that include user-defined types. Each column in the logging table must use a data type that is supported by Oracle Streams.
2. At the source database, create a DML trigger that fires on the tables that contain the user-defined data types. The trigger converts each row change into relational equivalents and logs the modified row in a logging table created in Step 1.
3. Ensure that the capture process and **propagation** are configured to capture and, if necessary, propagate changes made to the logging table to the destination database. Changes to tables that contain user-defined types should not be captured or propagated. Therefore, ensure that the `PRE_INSTANTIATION_SETUP` and `POST_INSTANTIATION_SETUP` procedures include the logging tables and exclude the tables that contain user-defined types.
4. At the destination, configure the apply process to use a **DML handler** that processes the changes to the logging tables. The DML handler reconstructs the user-defined types from the relational equivalents and applies the modified changes to the tables that contain user-defined types.

See Also:

- *Oracle Database PL/SQL Language Reference* for more information about creating triggers
- *Oracle Streams Replication Administrator's Guide* for more information about creating DML handlers

Preparing for Upgrades to User-Created Applications

This section is relevant only if the maintenance operation entails upgrading user-created applications. During an upgrade of user-created applications, schema objects can be modified, and there might be logical dependencies that cannot be detected by the database alone. The following sections describe handling these issues during an application upgrade:

- [Handling Modifications to Schema Objects](#)
- [Handling Logical Dependencies](#)

Handling Modifications to Schema Objects

If you are upgrading user-created applications, then, typically, schema objects in the database change to support the upgraded applications. In Oracle Streams, row LCRs contain information about row changes that result from DML statements. A [declarative rule-based transformation](#) or [DML handler](#) can modify row LCRs captured from the source database redo log so that the row LCRs can be applied to the altered tables at the [destination database](#).

A [rule-based transformation](#) is any modification to a [message](#) that results when a [rule](#) in a [positive rule set](#) evaluates to TRUE. Declarative rule-based transformation cover one of a common set of transformation scenarios for row LCRs. Declarative rule-based transformations are run internally without using PL/SQL. You specify such a transformation using a procedure in the `DBMS_STREAMS_ADM` package. A declarative rule-based transformation can modify row LCRs during capture, propagation, or apply.

A [DML handler](#) is a user procedure that processes row LCRs resulting from DML statements at a source database. An Oracle Streams [apply process](#) at a destination database can pass row LCRs to a DML handler, and the DML handler can modify the row LCRs.

The process for upgrading user-created applications using Oracle Streams can involve modifying and creating the schema objects at the destination database after [instantiation](#). You can use one or more declarative rule-based transformations and DML handlers at the destination database to process changes from the source database so that they apply to the modified schema objects correctly. Declarative rule-based transformations and DML handlers can be used during application upgrade to account for differences between the source database and destination database.

In general, declarative rule-based transformations are easier to use than DML handlers. Therefore, when modifications to row LCRs are required, try to configure a declarative rule-based transformation first. If a declarative rule-based transformation is not sufficient, then use a DML handler. If row LCRs for tables that contain one or more LOB columns must be modified, then you should use a DML handler and [LOB assembly](#).

Before you begin the database maintenance operation, you should complete the following tasks to prepare your declarative rule-based transformations or DML handlers:

- Learn about declarative rule-based transformations. See "[Declarative Rule-Based Transformations](#)" on page 7-1.
- Learn about DML handlers. See "[Message Processing Options for an Apply Process](#)" on page 4-7.
- Determine the declarative rule-based transformations and DML handlers you will need at your destination database. Your determination depends on the modifications to the schema objects required by your upgraded applications.
- Create the PL/SQL procedures that you will use for any DML handlers during the database maintenance operation. See the *Oracle Streams Replication Administrator's Guide* for information about creating the PL/SQL procedures.

- If row LCRs for tables that contain one or more LOB columns must be modified, then learn about using LOB assembly. See *Oracle Streams Replication Administrator's Guide*.

Note: Custom rule-based transformation can also be used to modify row LCRs during application upgrade. However, these modifications can be accomplished using DML handlers, and DML handlers are more efficient than **custom rule-based transformations**.

Handling Logical Dependencies

In some cases, an **apply process** requires additional information to detect dependencies in row LCRs that are being applied in parallel. During application upgrades, an apply process might require additional information to detect dependencies in the following situations:

- The application, rather than the database, enforces logical dependencies.
- Schema objects have been modified to support the application upgrade, and a **DML handler** will modify row LCRs to account for differences between the source database and destination database.

A **virtual dependency definition** is a description of a dependency that is used by an apply process to detect dependencies between transactions at a destination database. A virtual dependency definition is not described as a constraint in the destination database data dictionary. Instead, it is specified using procedures in the DBMS_APPLY_ADM package. Virtual dependency definitions enable an apply process to detect dependencies that it would not be able to detect by using only the constraint information in the data dictionary. After dependencies are detected, an apply process schedules LCRs and transactions in the correct order for apply.

If virtual dependency definitions are required for your application upgrade, then learn about virtual dependency definitions and plan to configure them during the application upgrade.

See Also: *Oracle Streams Replication Administrator's Guide* for more information about virtual dependency definitions

Deciding Whether to Configure Oracle Streams Directly or Generate a Script

The PRE_INSTANTIATION_SETUP and POST_INSTANTIATION_SETUP procedures in the DBMS_STREAMS_ADM package configure the Oracle Streams **replication** environment during the maintenance operation. These procedures can configure the Oracle Streams replication environment directly, or they can generate a script that configures the environment. Using a procedure to configure replication directly is simpler than running a script, and the environment is configured immediately. However, you might choose to generate a script for the following reasons:

- You want to review the actions performed by the procedure before configuring the environment.
- You want to modify the script to customize the configuration.

To configure Oracle Streams directly when you run one of these procedures, set the `perform_actions` parameter to `TRUE`. The examples in this appendix assume that the procedures will configure Oracle Streams directly.

To generate a configuration script when you run one of these procedures, complete the following steps when you are instructed to run a procedure in this appendix:

1. In SQL*Plus, connect as the Oracle Streams administrator to database where you will run the procedure.
See *Oracle Database Administrator's Guide* for information about connecting to a database in SQL*Plus.
2. Create a directory object to store the script that will be generated by the procedure. For example:

```
CREATE DIRECTORY scripts_dir AS '/usr/scripts';
```
3. Run the procedure. Ensure that the following parameters are set to generate a script:
 - Set the `perform_actions` parameter to `FALSE`.
 - Set the `script_name` parameter to the name of the script you want to generate.
 - Set the `script_directory_object` parameter to the directory object into which you want to place the script.
4. Review or modify the script, if necessary.
5. In SQL*Plus, connect as the Oracle Streams administrator to database where you will run the procedure.
6. Run the generated script. For example:

```
@/usr/scripts/pre_instantiation.sql;
```

Deciding Which Utility to Use for Instantiation

Before you begin the database maintenance operation, decide whether you want to use Export/Import utilities (Data Pump or original) or the Recovery Manager (RMAN) utility to instantiate the **destination database** during the operation. Consider the following factors when you make this decision:

- If you are migrating the database to a different platform, then you can use either Export/Import or the RMAN `CONVERT DATABASE` command. The RMAN `DUPLICATE` command does not support migrating a database to a different platform.
- If you are migrating the database to a different character set, then you must use Export/Import. The RMAN `DUPLICATE` and `CONVERT DATABASE` commands do not support migrating a database to a different character set.
- If RMAN is supported for the operation, then using RMAN for the **instantiation** might be faster than using Export/Import, especially if the database is large.
- Oracle recommends that you do not use RMAN for instantiation in an environment where distributed transactions are possible. Doing so might cause in-doubt transactions that must be corrected manually.
- If the RMAN `DUPLICATE` or `CONVERT DATABASE` command is used for database instantiation, then the destination database cannot be the capture database.

Table E-1 describes when each instantiation method is supported based on whether the platform at the source and destination databases are the same or different, and whether the character set at the source and destination databases are the same or different.

Table E–1 Instantiation Methods for Database Maintenance with Oracle Streams

Instantiation Method	Same Platform Supported?	Different Platforms Supported?	Same Character Set Supported?	Different Character Sets Supported?
Data Pump Export/Import	Yes	Yes	Yes	Yes
RMAN DUPLICATE	Yes	No	Yes	No
RMAN CONVERT DATABASE	No	Maybe	Yes	No

Only some platform combinations are supported by the RMAN CONVERT DATABASE command. You can use the DBMS_TDB package to determine whether a platform combination is supported.

See Also:

- *Oracle Streams Replication Administrator's Guide* for more information about Oracle Streams instantiations
- *Oracle Database Backup and Recovery User's Guide* for instructions on using the RMAN DUPLICATE and CONVERT DATABASE commands
- *Oracle Database Backup and Recovery Reference* for more information about the RMAN DUPLICATE and CONVERT DATABASE commands
- *Oracle Database PL/SQL Packages and Types Reference* for more information about the DBMS_TDB package

Performing a Database Maintenance Operation Using Oracle Streams

This section describes performing one of the following database maintenance operations on an Oracle Database 11g Release 1 database:

- Migrating the database to a different platform
- Migrating the database to a different character set
- Modifying database schema objects to support upgrades to user-created applications
- Applying an Oracle Database software patch or patch set

You can use Oracle Streams to achieve little or no downtime during these operations. During the operation, the source database is the existing database on which you are performing database maintenance. The capture database is the database on which the Oracle Streams **capture process** runs. The **destination database** is the database that will replace the source database at the end of the operation.

Complete the following tasks to perform a database maintenance operation using Oracle Streams:

- [Task 1: Beginning the Maintenance Operation](#)
- [Task 2: Setting Up Oracle Streams Prior to Instantiation](#)
- [Task 3: Instantiating the Database](#)
- [Task 4: Setting Up Oracle Streams After Instantiation](#)
- [Task 5: Finishing the Maintenance Operation and Removing Oracle Streams](#)

Task 1: Beginning the Maintenance Operation

Complete the following steps to begin the maintenance operation using Oracle Streams:

1. Create an empty Oracle Database 11g Release 1 database. This database will be the **destination database** during the maintenance operation. If you are migrating the database to a different platform, then create the database on a computer system that uses the new platform. If you are migrating the database to a different character set, then create a database that uses the new character set.

See the Oracle installation guide for your operating system if you must install Oracle, and see the *Oracle Database Administrator's Guide* for information about creating a database.

Ensure that the destination database has a different global name than the source database. This example assumes that the global name of the source database is `orcl.example.com` and the global name of the destination database during the database maintenance operation is `stms.example.com`. The global name of the destination database is changed when the destination database replaces the source database at the end of the maintenance operation.

2. Ensure that the source database is running in ARCHIVELOG mode. See *Oracle Database Administrator's Guide* for information about running a database in ARCHIVELOG mode.
3. Ensure that the initialization parameters are set properly at both databases to support an Oracle Streams environment. See "[Setting Initialization Parameters Relevant to Oracle Streams](#)" on page 9-4.
4. Configure an Oracle Streams administrator at each database, including the source database, destination database, and capture database (if the capture database is a third database). See "[Configuring an Oracle Streams Administrator](#)" on page 9-1 for instructions. This example assumes that the name of the Oracle Streams administrator is `stradmin` at each database.
5. If you are upgrading user-created applications, then supplementally log any columns at the source database that will be involved in a **rule-based transformation, DML handler, or value dependency**. These columns must be unconditionally logged at the source database. See *Oracle Streams Replication Administrator's Guide* for information about specifying unconditional **supplemental log groups** for these columns.
6. At the source database, make read-only any database objects that are not supported by Oracle Streams. To list unsupported database objects, query the `DBA_STREAMS_UNSUPPORTED` data dictionary view.

"[Preparing for Maintenance of a Database with User-defined Types](#)" on page E-8 discusses a method for retaining changes to tables that contain user-defined types during the maintenance operation. If you are using this method, then tables that contain user-defined types can remain open during the maintenance operation.

Task 2: Setting Up Oracle Streams Prior to Instantiation

The specific instructions for setting up Oracle Streams prior to **instantiation** depend on which database is the capture database. The `PRE_INSTANTIATION_SETUP` procedure always configures the capture process on the database where it is run. Therefore, this procedure must be run at the capture database.

When you run this procedure, you can specify that the procedure performs the configuration directly, or that the procedure generates a script that contains the

configuration actions. See ["Deciding Whether to Configure Oracle Streams Directly or Generate a Script"](#) on page E-10. The examples in this section specify that the procedure performs the configuration directly.

Follow the instructions in the appropriate section:

- [The Source Database Is the Capture Database](#)
- [The Destination Database Is the Capture Database](#)
- [A Third Database Is the Capture Database](#)

Note: When the `PRE_INSTANTIATION_SETUP` procedure is running with the `perform_actions` parameter set to `TRUE`, metadata about its configuration actions is recorded in the following data dictionary views: `DBA_RECOVERABLE_SCRIPT`, `DBA_RECOVERABLE_SCRIPT_PARAMS`, `DBA_RECOVERABLE_SCRIPT_BLOCKS`, and `DBA_RECOVERABLE_SCRIPT_ERRORS`. If the procedure stops because it encounters an error, then you can use the `RECOVER_OPERATION` procedure in the `DBMS_STREAMS_ADM` package to complete the configuration after you correct the conditions that caused the error. These views are not populated if a script is used to configure the [replication](#) environment.

See Also:

- ["Overview of Using Oracle Streams for Database Maintenance Operations"](#) on page E-1 for information about the capture database
- *Oracle Database PL/SQL Packages and Types Reference* for more information about the `RECOVER_OPERATION` procedure

The Source Database Is the Capture Database

Complete the following steps to set up Oracle Streams prior to instantiation when the source database is the capture database:

1. Configure your network and Oracle Net so that the source database can communicate with the [destination database](#). See *Oracle Database Net Services Administrator's Guide* for instructions.
2. In SQL*Plus, connect to the source database as the Oracle Streams administrator. In this example, the source database is `orcl.example.com`.

See *Oracle Database Administrator's Guide* for information about connecting to a database in SQL*Plus.

3. Create a database link to the destination database. For example:

```
CREATE DATABASE LINK stms.example.com CONNECT TO strmadmin
  IDENTIFIED BY password
  USING 'stms.example.com';
```

4. While connected as the Oracle Streams administrator in SQL*Plus to the source database, run the `PRE_INSTANTIATION_SETUP` procedure:

```

DECLARE
  empty_tbs  DBMS_STREAMS_TABLESPACE_ADM.TABLESPACE_SET;
BEGIN
  DBMS_STREAMS_ADM.PRE_INSTANTIATION_SETUP(
    maintain_mode          => 'GLOBAL',
    tablespace_names      => empty_tbs,
    source_database        => 'orcl.example.com',
    destination_database  => 'stms.example.com',
    perform_actions       => TRUE,
    script_name           => NULL,
    script_directory_object => NULL,
    capture_name          => 'capture_maint',
    capture_queue_table   => 'strmadmin.capture_q_table',
    capture_queue_name    => 'strmadmin.capture_q',
    propagation_name     => 'prop_maint',
    apply_name            => 'apply_maint',
    apply_queue_table     => 'strmadmin.apply_q',
    apply_queue_name      => 'strmadmin.apply_q_table',
    bi_directional        => FALSE,
    include_ddl           => TRUE,
    start_processes       => FALSE,
    exclude_schemas     => '*',
    exclude_flags         => DBMS_STREAMS_ADM.EXCLUDE_FLAGS_UNSUPPORTED +
      DBMS_STREAMS_ADM.EXCLUDE_FLAGS_DML +
      DBMS_STREAMS_ADM.EXCLUDE_FLAGS_DDL);

END;
/

```

5. Proceed to ["Task 3: Instantiating the Database"](#) on page E-17.

The Destination Database Is the Capture Database

Complete the following steps to set up Oracle Streams prior to instantiation when the **destination database** is the capture database:

1. Configure your network and Oracle Net so that the source database and destination database can communicate with each other. See *Oracle Database Net Services Administrator's Guide* for instructions.
2. Ensure that log file shipping from the source database to the destination database is configured. See ["Preparing for Downstream Capture"](#) on page E-5 for instructions.
3. In SQL*Plus, connect to the destination database as the Oracle Streams administrator. In this example, the destination database is `stms.example.com`. See *Oracle Database Administrator's Guide* for information about connecting to a database in SQL*Plus.
4. Create a database link to the source database. For example:

```

CREATE DATABASE LINK orcl.example.com CONNECT TO strmadmin
  IDENTIFIED BY password
  USING 'orcl.example.com';

```

5. While connected as the Oracle Streams administrator in SQL*Plus to the destination database, run the `PRE_INSTANTIATION_SETUP` procedure:

```

DECLARE
    empty_tbs    DBMS_STREAMS_TABLESPACE_ADM.TABLESPACE_SET;
BEGIN
    DBMS_STREAMS_ADM.PRE_INSTANTIATION_SETUP(
        maintain_mode      => 'GLOBAL',
        tablespace_names   => empty_tbs,
        source_database    => 'orcl.example.com',
        destination_database => 'stms.example.com',
        perform_actions    => TRUE,
        script_name        => NULL,
        script_directory_object => NULL,
        capture_name       => 'capture_maint',
        capture_queue_table => 'strmadmin.streams_q_table',
        capture_queue_name => 'strmadmin.streams_q',
        apply_name         => 'apply_maint',
        apply_queue_table  => 'strmadmin.streams_q',
        apply_queue_name   => 'strmadmin.streams_q_table',
        bi_directional    => FALSE,
        include_ddl        => TRUE,
        start_processes    => FALSE,
        exclude_schemas  => '*',
        exclude_flags     => DBMS_STREAMS_ADM.EXCLUDE_FLAGS_UNSUPPORTED +
                            DBMS_STREAMS_ADM.EXCLUDE_FLAGS_DML +
                            DBMS_STREAMS_ADM.EXCLUDE_FLAGS_DDL);

END;
/
    
```

Notice that the `propagation_name` parameter is omitted because a **propagation** is not necessary when the destination database is the capture database and the downstream **capture process** and **apply process** use the same **queue** at the destination database.

Also, notice that the capture process and apply process will share a queue named `streams_q` at the destination database.

6. Proceed to ["Task 3: Instantiating the Database"](#) on page E-17.

A Third Database Is the Capture Database

This example assumes that the global name of the third database is `thrd.example.com`. Complete the following steps to set up Oracle Streams prior to instantiation when a third database is the capture database:

1. Configure your network and Oracle Net so that the source database, **destination database**, and third database can communicate with each other. See *Oracle Database Net Services Administrator's Guide* for instructions.
2. Ensure that log file shipping from the source database to the third database is configured. See ["Preparing for Downstream Capture"](#) on page E-5 for instructions.
3. In SQL*Plus, connect to the third database as the Oracle Streams administrator. In this example, the third database is `thrd.example.com`.

See *Oracle Database Administrator's Guide* for information about connecting to a database in SQL*Plus.

4. Create a database link to the source database. For example:

```

CREATE DATABASE LINK orcl.example.com CONNECT TO strmadmin
    IDENTIFIED BY password
    USING 'orcl.example.com';
    
```

5. While still connected as the Oracle Streams administrator in SQL*Plus to the third database, create a database link to the destination database. For example:

```
CREATE DATABASE LINK stms.example.com CONNECT TO strmadmin
  IDENTIFIED BY password
  USING 'stms.example.com';
```

6. Run the PRE_INSTANTIATION_SETUP procedure:

```
DECLARE
  empty_tbs DBMS_STREAMS_TABLESPACE_ADM.TABLESPACE_SET;
BEGIN
  DBMS_STREAMS_ADM.PRE_INSTANTIATION_SETUP (
    maintain_mode          => 'GLOBAL',
    tablespace_names       => empty_tbs,
    source_database        => 'orcl.example.com',
    destination_database   => 'stms.example.com',
    perform_actions        => TRUE,
    script_name            => NULL,
    script_directory_object => NULL,
    capture_name           => 'capture_maint',
    capture_queue_table    => 'strmadmin.capture_q_table',
    capture_queue_name     => 'strmadmin.capture_q',
    propagation_name      => 'prop_maint',
    apply_name             => 'apply_maint',
    apply_queue_table      => 'strmadmin.apply_q',
    apply_queue_name       => 'strmadmin.apply_q_table',
    bi_directional         => FALSE,
    include_ddl            => TRUE,
    start_processes        => FALSE,
    exclude_schemas      => '*',
    exclude_flags          => DBMS_STREAMS_ADM.EXCLUDE_FLAGS_UNSUPPORTED +
      DBMS_STREAMS_ADM.EXCLUDE_FLAGS_DML +
      DBMS_STREAMS_ADM.EXCLUDE_FLAGS_DDL);
END;
```

7. Proceed to "Task 3: Instantiating the Database" on page E-17.

Task 3: Instantiating the Database

"Deciding Which Utility to Use for Instantiation" on page E-11 discusses different options for instantiating an entire database. Complete the steps in the appropriate section based on the **instantiation** option you are using:

- [Instantiating the Database Using Export/Import](#)
- [Instantiating the Database Using the RMAN DUPLICATE Command](#)
- [Instantiating the Database Using the RMAN CONVERT DATABASE Command](#)

See Also: *Oracle Streams Replication Administrator's Guide* for more information about performing instantiations

Instantiating the Database Using Export/Import

If you use Oracle Data Pump Export/Import to instantiate the **destination database**, then ensure that you set the STREAMS_CONFIGURATION import parameter to n.

Complete the following steps to instantiate an entire database with Data Pump:

1. In SQL*Plus, connect to the source database as the Oracle Streams administrator.
See *Oracle Database Administrator's Guide* for information about connecting to a database in SQL*Plus.

2. Create a directory object to hold the export dump file and export log file:

```
CREATE DIRECTORY dpump_dir AS '/usr/dpump_dir';
```

3. While connected to the source database as the Oracle Streams administrator, determine the current system change number (SCN) of the source database:

```
SET SERVEROUTPUT ON SIZE 1000000
DECLARE
    current_scn NUMBER;
BEGIN
    current_scn:= DBMS_FLASHBACK.GET_SYSTEM_CHANGE_NUMBER;
    DBMS_OUTPUT.PUT_LINE('Current SCN: ' || current_scn);
END;
/
```

The returned SCN value is specified for the `FLASHBACK_SCN` Data Pump export parameter in Step 4. Specifying the `FLASHBACK_SCN` export parameter, or a similar export parameter, ensures that the export is consistent to a single SCN. In this example, assume that the query returned 876606.

After you perform this query, ensure that no DDL changes are made to the objects being exported until after the export is complete.

4. On a command line, use Data Pump to export the source database.

Perform the export by connecting as an administrative user who is granted `EXP_FULL_DATABASE` role. This user also must have `READ` and `WRITE` privilege on the directory object created in Step 2. This example connects as the Oracle Streams administrator `stradmin`.

The following example is a Data Pump export command:

```
expdp stradmin FULL DIRECTORY=DPUMP_DIR DUMPFILE=orc1.dmp FLASHBACK_SCN=876606
```

See Also: *Oracle Database Utilities* for information about performing a Data Pump export

5. In SQL*Plus, connect to the destination database as the Oracle Streams administrator.
6. Create a directory object to hold the import dump file and import log file:

```
CREATE DIRECTORY dpump_dir AS '/usr/dpump_dir';
```
7. Transfer the Data Pump export dump file `orc1.dmp` to the destination database. You can use the `DBMS_FILE_TRANSFER` package, binary FTP, or some other method to transfer the file to the destination database. After the file transfer, the export dump file should reside in the directory that corresponds to the directory object created in Step 6.
8. On a command line at the destination database, use Data Pump to import the export dump file `orc1.dmp`. Ensure that no changes are made to the database tables until the import is complete. Performing the import automatically sets the **instantiation SCN** for the destination database and all of its objects.

Perform the import by connecting as an administrative user who is granted `IMP_FULL_DATABASE` role. This user also must have `READ` and `WRITE` privilege on the directory object created in Step 6. This example connects as the Oracle Streams administrator `stradmin`.

The following example is an import command:

```
impdp stradmin FULL DIRECTORY=DPUMP_DIR DUMPFILE=orcl.dmp STREAMS_
CONFIGURATION=n
```

See Also: *Oracle Database Utilities* for information about performing a Data Pump import

Instantiating the Database Using the RMAN DUPLICATE Command

If you use the `RMAN DUPLICATE` command for instantiation on the same platform, then complete the following steps:

1. Create a backup of the source database if one does not exist. RMAN requires a valid backup for duplication. In this example, create a backup of `orcl.example.com` if one does not exist.

Note: A backup of the source database is not necessary if you use the `FROM ACTIVE DATABASE` option when you run the `RMAN DUPLICATE` command. For large databases, the `FROM ACTIVE DATABASE` option requires significant network resources. This example does not use this option.

2. In SQL*Plus, connect as an administrative user to the source database. In this example, the source database is `orcl.example.com`.

See *Oracle Database Administrator's Guide* for information about connecting to a database in SQL*Plus.

3. Determine the until SCN for the `RMAN DUPLICATE` command. For example:

```
SET SERVEROUTPUT ON SIZE 1000000
DECLARE
    until_scn NUMBER;
BEGIN
    until_scn:= DBMS_FLASHBACK.GET_SYSTEM_CHANGE_NUMBER;
    DBMS_OUTPUT.PUT_LINE('Until SCN: ' || until_scn);
END;
/
```

Make a note of the until SCN value. This example assumes that the until SCN value is 748044. You will set the `UNTIL SCN` option to this value when you use RMAN to duplicate the database in Step 7 and as the **instantiation SCN** in "[Task 4: Setting Up Oracle Streams After Instantiation](#)" on page E-24.

4. Archive the current online redo log. For example:

```
ALTER SYSTEM ARCHIVE LOG CURRENT;
```

5. Prepare your environment for database duplication, which includes preparing the **destination database** as an auxiliary instance for duplication. See the *Oracle Database Backup and Recovery User's Guide* for instructions.

6. Start the RMAN client, and connect to the database `orcl.example.com` as TARGET and to the `stms.example.com` database as AUXILIARY. Connect to each database as an administrative user.

See *Oracle Database Backup and Recovery Reference* for more information about the RMAN CONNECT command.

7. Use the RMAN DUPLICATE command with the OPEN RESTRICTED option to instantiate the source database at the destination database. The OPEN RESTRICTED option is required. This option enables a restricted session in the duplicate database by issuing the following SQL statement: ALTER SYSTEM ENABLE RESTRICTED SESSION. RMAN issues this statement immediately before the duplicate database is opened.

You can use the UNTIL SCN clause to specify an SCN for the duplication. Use the until SCN determined in Step 3 for this clause. Archived redo logs must be available for the until SCN specified and for higher SCN values. Therefore, Step 4 archived the redo log containing the until SCN.

Ensure that you use `TO database_name` in the DUPLICATE command to specify the name of the duplicate database. In this example, the duplicate database is `stms.example.com`. Therefore, the DUPLICATE command for this example includes `TO stms.example.com`.

The following example is an RMAN DUPLICATE command:

```
RMAN> RUN
  {
    SET UNTIL SCN 748044;
    ALLOCATE AUXILIARY CHANNEL mgdb DEVICE TYPE sbt;
    DUPLICATE TARGET DATABASE TO mgdb
    NOFILENAMECHECK
    OPEN RESTRICTED;
  }
```

8. In SQL*Plus, connect to the destination database as a system administrator. In this example, the destination database is `stms.example.com`.
9. Rename the global name. After an RMAN database instantiation, the destination database has the same global name as the source database, but the destination database must have its original name until the end of the maintenance operation. Rename the global name of the destination database back to its original name with the following statement:

```
ALTER DATABASE RENAME GLOBAL_NAME TO stms.example.com;
```

10. In SQL*Plus, connect to the destination database as the Oracle Streams administrator.
11. Create a database link to the source database. For example:

```
CREATE DATABASE LINK orcl.example.com CONNECT TO strmadmin
  IDENTIFIED BY password
  USING 'orcl.example.com';
```

This database link is required because the `POST_INSTANTIATION_SETUP` procedure runs the `SET_GLOBAL_INSTANTIATION_SCN` procedure in the `DBMS_APPLY_ADM` package at the destination database, and the `SET_GLOBAL_INSTANTIATION_SCN` procedure requires the database link.

12. If the source database and the capture database are the same database, then while still connected as the Oracle Streams administrator in SQL*Plus to the destination

database, drop the database link from the source database to the destination database that was cloned from the source database:

```
DROP DATABASE LINK stms.example.com;
```

See Also: *Oracle Database Backup and Recovery Reference* for more information about the RMAN DUPLICATE command

Instantiating the Database Using the RMAN CONVERT DATABASE Command

If you use the RMAN CONVERT DATABASE command for instantiation to migrate the database to a different platform, then complete the following steps:

1. Create a backup of the source database if one does not exist. RMAN requires a valid backup. In this example, create a backup of `orcl.example.com` if one does not exist.
2. In SQL*Plus, connect to the source database as an administrative user.

See *Oracle Database Administrator's Guide* for information about connecting to a database in SQL*Plus.

3. Archive the current online redo log. For example:

```
ALTER SYSTEM ARCHIVE LOG CURRENT;
```

4. Prepare your environment for database conversion, which includes opening the source database in read-only mode. Complete the following steps:
 - a. If the source database is open, then shut it down and start it in read-only mode.
 - b. Run the CHECK_DB and CHECK_EXTERNAL functions in the DBMS_TDB package. Check the results to ensure that the conversion is supported by the RMAN CONVERT DATABASE command.

See Also: *Oracle Database Backup and Recovery User's Guide* for more information about these steps

5. Determine the current SCN of the source database:

```
SET SERVEROUTPUT ON SIZE 1000000
DECLARE
    current_scn NUMBER;
BEGIN
    current_scn:= DBMS_FLASHBACK.GET_SYSTEM_CHANGE_NUMBER;
    DBMS_OUTPUT.PUT_LINE('Current SCN: ' || current_scn);
END;
/
```

Make a note of the SCN value returned. You will use this number for the **instantiation SCN** in "Task 4: Setting Up Oracle Streams After Instantiation" on page E-24. For this example, assume that the returned value is 748044.

6. Start the RMAN client, and connect to the database `orcl.example.com` as TARGET as an administrative user.

See *Oracle Database Backup and Recovery Reference* for more information about the RMAN CONNECT command.

7. Run the CONVERT DATABASE command.

Ensure that you use `NEW DATABASE database_name` in the `CONVERT DATABASE` command to specify the name of the **destination database**. In this example, the destination database name is `stms`. Therefore, the `CONVERT DATABASE` command for this example includes `NEW DATABASE stms`.

The following example is an `RMAN CONVERT DATABASE` command for a destination database that is running on the Linux IA (64-bit) platform:

```
CONVERT DATABASE NEW DATABASE 'stms'
      TRANSPORT SCRIPT '/tmp/convertldb/transportscript.sql'
      TO PLATFORM 'Linux IA (64-bit)'
      DB_FILE_NAME_CONVERT = ('/home/oracle/dbs', '/tmp/convertldb');
```

8. Transfer the data files, PFILE, and SQL script produced by the `RMAN CONVERT DATABASE` command to the computer system that is running the destination database.
9. On the computer system that is running the destination database, modify the SQL script so that the destination database always opens with restricted session enabled.

An example script follows with the necessary modifications in bold font:

```
-- The following commands will create a new control file and use it
-- to open the database.
-- Data used by Recovery Manager will be lost.
-- The contents of online logs will be lost and all backups will
-- be invalidated. Use this only if online logs are damaged.

-- After mounting the created controlfile, the following SQL
-- statement will place the database in the appropriate
-- protection mode:
-- ALTER DATABASE SET STANDBY DATABASE TO MAXIMIZE PERFORMANCE

STARTUP NOMOUNT PFILE='init_00gd2lak_1_0.ora'
CREATE CONTROLFILE REUSE SET DATABASE "STMS" RESETLOGS NOARCHIVELOG
      MAXLOGFILES 32
      MAXLOGMEMBERS 2
      MAXDATAFILES 32
      MAXINSTANCES 1
      MAXLOGHISTORY 226
LOGFILE
      GROUP 1 '/tmp/convertldb/archlog1' SIZE 25M,
      GROUP 2 '/tmp/convertldb/archlog2' SIZE 25M
DATAFILE
      '/tmp/convertldb/systemdf',
      '/tmp/convertldb/sysauxdf',
      '/tmp/convertldb/datafile1',
      '/tmp/convertldb/datafile2',
      '/tmp/convertldb/datafile3'
CHARACTER SET WE8DEC
;

-- NOTE: This ALTER SYSTEM statement is added to enable restricted session.

ALTER SYSTEM ENABLE RESTRICTED SESSION;

-- Database can now be opened zeroing the online logs.
ALTER DATABASE OPEN RESETLOGS;

-- No tempfile entries found to add.
```



```

--

set echo off
prompt ~~~~~
prompt * Your database has been created successfully!
prompt * There are many things to think about for the new database. Here
prompt * is a checklist to help you stay on track:
prompt * 1. You may want to redefine the location of the directory objects.
prompt * 2. You may want to change the internal database identifier (DBID)
prompt * or the global database name for this database. Use the
prompt * NEWDBID Utility (nid).
prompt ~~~~~

SHUTDOWN IMMEDIATE
-- NOTE: This startup has the UPGRADE parameter.
-- The startup already has restricted session enabled, so no change is needed.
STARTUP UPGRADE PFILE='init_00gd2lak_1_0.ora'
@@ ?/rdbms/admin/utlirp.sql
SHUTDOWN IMMEDIATE
-- NOTE: The startup below is generated without the RESTRICT clause.
-- Add the RESTRICT clause.
STARTUP RESTRICT PFILE='init_00gd2lak_1_0.ora'
-- The following step will recompile all PL/SQL modules.
-- It may take severnal hours to complete.
@@ ?/rdbms/admin/utlirp.sql
set feedback 6;

```

Other changes to the script might be necessary. For example, the data file locations and PFILE location might need to be changed to point to the correct locations on the destination database computer system.

10. In SQL*Plus, connect to the destination database as a system administrator.
11. Rename the global name. After an RMAN database instantiation, the destination database has the same global name as the source database, but the destination database must have its original name until the end of the maintenance operation. Rename the global name of the destination database back to its original name with the following statement:

```
ALTER DATABASE RENAME GLOBAL_NAME TO stms.example.com;
```

12. Connect to the destination database as the Oracle Streams administrator using the new global name.
13. Create a database link to the source database. For example:

```
CREATE DATABASE LINK orcl.example.com CONNECT TO strmadmin
IDENTIFIED BY password
USING 'orcl.example.com';
```

This database link is required because the `POST_INSTANTIATION_SETUP` procedure runs the `SET_GLOBAL_INSTANTIATION_SCN` procedure in the `DBMS_APPLY_ADM` package at the destination database, and the `SET_GLOBAL_INSTANTIATION_SCN` procedure requires the database link.

14. If the source database and the capture database are the same database, then while still connected as the Oracle Streams administrator in SQL*Plus to the destination database, drop the database link from the source database to the destination database that was cloned from the source database:

```
DROP DATABASE LINK stms.example.com;
```

Task 4: Setting Up Oracle Streams After Instantiation

To set up Oracle Streams after **instantiation**, run the `POST_INSTANTIATION_SETUP` procedure. The `POST_INSTANTIATION_SETUP` procedure must be run at the database where the `PRE_INSTANTIATION_SETUP` procedure was run in "[Task 2: Setting Up Oracle Streams Prior to Instantiation](#)" on page E-13.

When you run the `POST_INSTANTIATION_SETUP` procedure, you can specify that the procedure performs the configuration directly, or that the procedure generates a script that contains the configuration actions. See "[Deciding Whether to Configure Oracle Streams Directly or Generate a Script](#)" on page E-10. The examples in this section specify that the procedure performs the configuration directly.

The parameter values specified in the `PRE_INSTANTIATION_SETUP` and `POST_INSTANTIATION_SETUP` procedures must match, except for the values of the following parameters: `perform_actions`, `script_name`, `script_directory_object`, and `start_processes`. In this example, all of the parameter values match in the two procedures.

It is important to set the `instantiation_scn` parameter in the `POST_INSTANTIATION_SETUP` procedure correctly. Follow these instructions when you set this parameter:

- If RMAN was used for instantiation, then set the `instantiation_scn` parameter to the value determined during instantiation. This value was determined when you completed the instantiation in "[Instantiating the Database Using the RMAN DUPLICATE Command](#)" on page E-19 or "[Instantiating the Database Using the RMAN CONVERT DATABASE Command](#)" on page E-21.

The source database and third database examples in this section set the `instantiation_scn` parameter to 748044 for the following reasons:

- If the RMAN `DUPLICATE` command was used for instantiation, then the command duplicates the database up to one less than the SCN value specified in the `UNTIL SCN` clause. Therefore, you should subtract one from the until SCN value that you specified when you ran the `DUPLICATE` command in Step 7 on page E-20 in "[Instantiating the Database Using the RMAN DUPLICATE Command](#)". In this example, the until SCN was set to 748045. Therefore, the `instantiation_scn` parameter should be set to $748045 - 1$, or 748044.
- If the RMAN `CONVERT DATABASE` command was used for instantiation, then the `instantiation_scn` parameter should be set to the SCN value determined immediately before running the `CONVERT DATABASE` command. This value was determined in Step 5 on page E-21 in "[Instantiating the Database Using the RMAN CONVERT DATABASE Command](#)".
- If Export/Import was used for instantiation, then the **instantiation SCN** was set during import, and the `instantiation_scn` parameter must be set to `NULL`. The **destination database** example in this section sets the `instantiation_scn` to `NULL` because RMAN cannot be used for database instantiation when the destination database is the capture database.

The specific instructions for setting up Oracle Streams after instantiation depend on which database is the capture database. Follow the instructions in the appropriate section:

- [The Source Database Is the Capture Database](#)
- [The Destination Database Is the Capture Database](#)
- [A Third Database Is the Capture Database](#)

Note: When the `POST_INSTANTIATION_SETUP` procedure is running with the `perform_actions` parameter set to `TRUE`, metadata about its configuration actions is recorded in the following data dictionary views: `DBA_RECOVERABLE_SCRIPT`, `DBA_RECOVERABLE_SCRIPT_PARAMS`, `DBA_RECOVERABLE_SCRIPT_BLOCKS`, and `DBA_RECOVERABLE_SCRIPT_ERRORS`. If the procedure stops because it encounters an error, then you can use the `RECOVER_OPERATION` procedure in the `DBMS_STREAMS_ADM` package to complete the configuration after you correct the conditions that caused the error. These views are not populated if a script is used to configure the [replication](#) environment.

See Also:

- ["Overview of Using Oracle Streams for Database Maintenance Operations"](#) on page E-1 for information about the capture database
- *Oracle Database PL/SQL Packages and Types Reference* for more information about the `RECOVER_OPERATION` procedure

The Source Database Is the Capture Database

Complete the following steps to set up Oracle Streams after instantiation when the source database is the capture database:

1. In SQL*Plus, connect to the source database as the Oracle Streams administrator. In this example, the source database is `orcl.example.com`.

See *Oracle Database Administrator's Guide* for information about connecting to a database in SQL*Plus.

2. Run the `POST_INSTANTIATION_SETUP` procedure:

```

DECLARE
  empty_tbs  DBMS_STREAMS_TABLESPACE_ADM.TABLESPACE_SET;
BEGIN
  DBMS_STREAMS_ADM.POST_INSTANTIATION_SETUP (
    maintain_mode          => 'GLOBAL',
    tablespace_names      => empty_tbs,
    source_database       => 'orcl.example.com',
    destination_database  => 'stms.example.com',
    perform_actions       => TRUE,
    script_name           => NULL,
    script_directory_object => NULL,
    capture_name          => 'capture_maint',
    capture_queue_table   => 'strmadmin.capture_q_table',
    capture_queue_name    => 'strmadmin.capture_q',
    propagation_name     => 'prop_maint',
    apply_name            => 'apply_maint',
    apply_queue_table     => 'strmadmin.apply_q',
    apply_queue_name      => 'strmadmin.apply_q_table',
    bi_directional        => FALSE,
    include_ddl           => TRUE,
    start_processes       => FALSE,
    instantiation_scn     => 748044, -- NULL if Export/Import instantiation
    exclude_schemas     => '*',
  );

```

```

        exclude_flags          => DBMS_STREAMS_ADM.EXCLUDE_FLAGS_UNSUPPORTED +
                                DBMS_STREAMS_ADM.EXCLUDE_FLAGS_DML +
                                DBMS_STREAMS_ADM.EXCLUDE_FLAGS_DDL);

    END;
    /
    
```

3. Proceed to "[Task 5: Finishing the Maintenance Operation and Removing Oracle Streams](#)" on page E-27.

The Destination Database Is the Capture Database

Complete the following steps to set up Oracle Streams after instantiation when the **destination database** is the capture database:

1. In SQL*Plus, connect to the destination database as the Oracle Streams administrator. In this example, the destination database is `stms.example.com`.

See *Oracle Database Administrator's Guide* for information about connecting to a database in SQL*Plus.

2. Run the `POST_INSTANTIATION_SETUP` procedure:

```

DECLARE
    empty_tbs  DBMS_STREAMS_TABLESPACE_ADM.TABLESPACE_SET;
BEGIN
    DBMS_STREAMS_ADM.POST_INSTANTIATION_SETUP(
        maintain_mode          => 'GLOBAL',
        tablespace_names       => empty_tbs,
        source_database        => 'orcl.example.com',
        destination_database   => 'stms.example.com',
        perform_actions        => TRUE,
        script_name            => NULL,
        script_directory_object => NULL,
        capture_name           => 'capture_maint',
        capture_queue_table    => 'strmadmin.streams_q_table',
        capture_queue_name     => 'strmadmin.streams_q',
        apply_name             => 'apply_maint',
        apply_queue_table      => 'strmadmin.streams_q',
        apply_queue_name       => 'strmadmin.streams_q_table',
        bi_directional         => FALSE,
        include_ddl            => TRUE,
        start_processes        => FALSE,
        instantiation_scn      => NULL,
        exclude_schemas       => '*',
        exclude_flags          => DBMS_STREAMS_ADM.EXCLUDE_FLAGS_UNSUPPORTED +
                                DBMS_STREAMS_ADM.EXCLUDE_FLAGS_DML +
                                DBMS_STREAMS_ADM.EXCLUDE_FLAGS_DDL);

    END;
    /
    
```

Notice that the `propagation_name` parameter is omitted because a **propagation** is not necessary when the destination database is the capture database.

3. Proceed to "[Task 5: Finishing the Maintenance Operation and Removing Oracle Streams](#)" on page E-27.

A Third Database Is the Capture Database

This example assumes that the global name of the third database is `thrd.example.com`. Complete the following steps to set up Oracle Streams after instantiation when a third database is the capture database:

1. In SQL*Plus, connect to the third database as the Oracle Streams administrator. In this example, the third database is `thrd.example.com`.

See *Oracle Database Administrator's Guide* for information about connecting to a database in SQL*Plus.

2. Run the `POST_INSTANTIATION_SETUP` procedure:

```

DECLARE
    empty_tbs    DBMS_STREAMS_TABLESPACE_ADM.TABLESPACE_SET;
BEGIN
    DBMS_STREAMS_ADM.POST_INSTANTIATION_SETUP(
        maintain_mode          => 'GLOBAL',
        tablespace_names       => empty_tbs,
        source_database        => 'orcl.example.com',
        destination_database   => 'stms.example.com',
        perform_actions        => TRUE,
        script_name            => NULL,
        script_directory_object => NULL,
        capture_name           => 'capture_maint',
        capture_queue_table    => 'strmadmin.capture_q_table',
        capture_queue_name     => 'strmadmin.capture_q',
        propagation_name      => 'prop_maint',
        apply_name             => 'apply_maint',
        apply_queue_table      => 'strmadmin.apply_q',
        apply_queue_name       => 'strmadmin.apply_q_table',
        bi_directional         => FALSE,
        include_ddl            => TRUE,
        start_processes        => FALSE,
        instantiation_scn      => 748044, -- NULL if Export/Import instantiation
        exclude_schemas      => '*',
        exclude_flags          => DBMS_STREAMS_ADM.EXCLUDE_FLAGS_UNSUPPORTED +
                                DBMS_STREAMS_ADM.EXCLUDE_FLAGS_DML +
                                DBMS_STREAMS_ADM.EXCLUDE_FLAGS_DDL);

END;
/

```

3. Proceed to "[Task 5: Finishing the Maintenance Operation and Removing Oracle Streams](#)" on page E-27.

Task 5: Finishing the Maintenance Operation and Removing Oracle Streams

Complete the following steps to finish a maintenance operation using Oracle Streams and remove Oracle Streams components:

1. At the **destination database**, disable any imported jobs that modify data that will be replicated from the source database. Query the `DBA_JOBS` data dictionary view to list the jobs.
2. If you are applying a patch or patch set, then apply the patch or patch set to the destination database now. Follow the instructions included with the patch or patch set.
3. If you are upgrading user-created applications, then, at the destination database, you might need to complete the following steps:
 - a. Modify the schema objects in the database to support the upgraded user-created applications.
 - b. Configure one or more **declarative rule-based transformations** and **DML handlers** that modify row LCRs from the source database so that the apply process applies these row LCRs to the modified schema objects correctly. For

example, if a column name was changed to support the upgraded user-created applications, then a declarative rule-based transformation should rename the column in a row LCR that involves the column.

See "Handling Modifications to Schema Objects" on page E-9.

- c. Configure one or more **virtual dependency definitions** if row LCRs might contain logical dependencies that cannot be detected by the apply process alone.

See "Handling Logical Dependencies" on page E-10.

4. In SQL*Plus, connect to the destination database as an administrative user.

See *Oracle Database Administrator's Guide* for information about connecting to a database in SQL*Plus.

5. Use the ALTER SYSTEM statement to disable the RESTRICTED SESSION:

```
ALTER SYSTEM DISABLE RESTRICTED SESSION;
```

6. Connect to the destination database as the Oracle Streams administrator.

7. Start the **apply process**. For example:

```
BEGIN
  DBMS_APPLY_ADM.START_APPLY(
    apply_name => 'apply_maint');
END;
/
```

8. Connect to the capture database as the Oracle Streams administrator.

9. Start the capture process. For example:

```
BEGIN
  DBMS_CAPTURE_ADM.START_CAPTURE(
    capture_name => 'capture_maint');
END;
/
```

This step begins the process of replicating changes that were made to the source database during **instantiation** of the destination database.

10. Monitor the Oracle Streams environment until the apply process at the destination database has applied most of the changes from the source database.

To determine whether the apply process at the destination database has applied most of the changes from the source database, complete the following steps:

- a. Query the enqueue message number of the capture process and the high-watermark message number of the apply process to see if they are nearly equal.

For example, if the name of the capture process is `capture_maint`, and the name of the apply process is `apply_maint`, then run the following query at the capture database:

```
COLUMN ENQUEUE_MESSAGE_NUMBER HEADING 'Captured SCN' FORMAT 9999999999
COLUMN HWM_MESSAGE_NUMBER HEADING 'Applied SCN' FORMAT 9999999999

SELECT c.ENQUEUE_MESSAGE_NUMBER, a.HWM_MESSAGE_NUMBER
FROM V$STREAMS_CAPTURE c, V$STREAMS_APPLY_COORDINATOR@stms.example.com a
WHERE CAPTURE_NAME = 'CAPTURE_MAINT'
AND APPLY_NAME = 'APPLY_MAINT';
```

When the two values returned by this query are nearly equal, most of the changes from the source database have been applied at the destination database, and you can proceed to the next step. At this point in the process, the values returned by this query might never be equal because the source database still allows changes.

If this query returns no results, then ensure that the **Oracle Streams clients** in the environment are enabled by querying the `STATUS` column in the `DBA_CAPTURE` view at the capture database and the `DBA_APPLY` view at the destination database. If a **propagation** is used, you can check the status of the propagation by running the query in "[Displaying the Schedule for a Propagation Job](#)" on page 24-15.

If an Oracle Streams client is disabled, then try restarting it. If an Oracle Streams client will not restart, then troubleshoot the environment using the information in [Chapter 20, "Troubleshooting an Oracle Streams Environment"](#).

- b. Query the state of the apply process apply servers at the destination database to determine whether they have finished applying changes.

For example, if the name of the apply process is `apply_maint`, then run the following query at the source database:

```
COLUMN STATE HEADING 'Apply Server State' FORMAT A20

SELECT STATE
FROM V$STREAMS_APPLY_SERVER@stms.example.com
WHERE APPLY_NAME = 'APPLY_MAINT';
```

When the state for all apply servers is `IDLE`, you can proceed to the next step.

11. Connect to the destination database as the Oracle Streams administrator.
12. Ensure that there are no apply errors by running the following query:

```
SELECT COUNT(*) FROM DBA_APPLY_ERROR;
```

If this query returns zero, then move on to the next step. If this query shows errors in the error queue, then resolve these errors before continuing. See "[Managing Apply Errors](#)" on page 16-19 for instructions.

13. Disconnect all applications and users from the source database.
14. Connect to the source database as an administrative user.
15. Restrict access to the database. For example:

```
ALTER SYSTEM ENABLE RESTRICTED SESSION;
```
16. While connected as an administrative user in SQL*Plus to the source database, repeat the query you ran in Step 10. When the two values returned by the query are equal, all of the changes from the source database have been applied at the destination database, and you can move on to the next step.
17. Connect to the destination database as the Oracle Streams administrator.
18. Repeat the query you ran in Step 12. If this query returns zero, then move on to the next step. If this query shows errors in the error queue, then resolve these errors before continuing. See "[Managing Apply Errors](#)" on page 16-19 for instructions.
19. If you performed any actions that created, modified, or deleted job slaves at the source database during the maintenance operation, then perform the same actions

at the destination database. See "[Considerations for Job Slaves and PL/SQL Package Subprograms](#)" on page E-4 for more information.

20. If you invoked any Oracle-supplied PL/SQL package subprograms at the source database during the maintenance operation that modified both user data and dictionary metadata at the same time, then invoke the same subprograms at the destination database. See "[Considerations for Job Slaves and PL/SQL Package Subprograms](#)" on page E-4 for more information.
21. Remove the Oracle Streams components that are no longer needed from both databases, including the ANYDATA queues, **supplemental logging** specifications, the capture process, the propagation if one exists, and the apply process. Connect as the Oracle Streams administrator in SQL*Plus to the capture database, and run the CLEANUP_INSTANTIATION_SETUP procedure to remove the Oracle Streams components both databases.

If the capture database is the source database or a third database, then run the following procedure:

```
DECLARE
    empty_tbs    DBMS_STREAMS_TABLESPACE_ADM.TABLESPACE_SET;
BEGIN
    DBMS_STREAMS_ADM.CLEANUP_INSTANTIATION_SETUP (
        maintain_mode          => 'GLOBAL',
        tablespace_names       => empty_tbs,
        source_database        => 'orcl.example.com',
        destination_database   => 'stms.example.com',
        perform_actions        => TRUE,
        script_name            => NULL,
        script_directory_object => NULL,
        capture_name           => 'capture_maint',
        capture_queue_table    => 'strmadmin.capture_q_table',
        capture_queue_name     => 'strmadmin.capture_q',
        propagation_name      => 'prop_maint',
        apply_name             => 'apply_maint',
        apply_queue_table      => 'strmadmin.apply_q',
        apply_queue_name       => 'strmadmin.apply_q_table',
        bi_directional         => FALSE,
        change_global_name     => TRUE);
END;
/
```

If the capture database is the destination database, then run the following procedure:

```
DECLARE
    empty_tbs    DBMS_STREAMS_TABLESPACE_ADM.TABLESPACE_SET;
BEGIN
    DBMS_STREAMS_ADM.CLEANUP_INSTANTIATION_SETUP (
        maintain_mode          => 'GLOBAL',
        tablespace_names       => empty_tbs,
        source_database        => 'orcl.example.com',
        destination_database   => 'stms.example.com',
        perform_actions        => TRUE,
        script_name            => NULL,
        script_directory_object => NULL,
        capture_name           => 'capture_maint',
        capture_queue_table    => 'strmadmin.streams_q_table',
        capture_queue_name     => 'strmadmin.streams_q',
        apply_name             => 'apply_maint',
        apply_queue_table      => 'strmadmin.streams_q',
        bi_directional         => FALSE,
        change_global_name     => TRUE);
END;
/
```



```
    apply_queue_name      => 'strmadmin.streams_q_table',
    bi_directional        => FALSE,
    change_global_name    => TRUE);
END;
/
```

Notice that the `propagation_name` parameter is omitted because a propagation is not necessary when the destination database is the capture database.

Both sample procedures in this step rename the global name of the destination database to `orc1.example.com` because the `change_global_name` parameter is set to `TRUE`.

- 22.** Shut down the source database. This database should not be opened again.
- 23.** At the destination database, enable any jobs that you disabled earlier.
- 24.** Make the destination database available for applications and users. Redirect any applications and users that were connecting to the source database to the destination database. If necessary, reconfigure your network and Oracle Net so that systems that communicated with the source database now communicate with the destination database. See *Oracle Database Net Services Administrator's Guide* for instructions.
- 25.** If you no longer need the Oracle Streams administrator at the destination database, then connect as an administrative user in SQL*Plus to the destination database, and run the following statement:

```
DROP USER strmadmin CASCADE;
```

The maintenance operation is complete.

Glossary

action context

Optional information associated with a [rule](#) that is interpreted by the client of the [rules engine](#) when the rule is evaluated for a [message](#).

ANYDATA queue

A [queue](#) of type ANYDATA. These queues can stage [messages](#) of different types wrapped in an ANYDATA wrapper.

See Also: [typed queue](#)

applied SCN

A system change number (SCN) relating to a [capture process](#) that corresponds to the most recent [message](#) dequeued by an [apply process](#) that applies changes captured by the capture process.

apply forwarding

A [directed network](#) in which [messages](#) being forwarded at an intermediate database are first processed by an [apply process](#). These messages are then recaptured by a [capture process](#) at the intermediate database and forwarded.

See Also: [queue forwarding](#)

apply handler

A user-defined procedure used by an [apply process](#) for customized processing of [messages](#). Apply handlers include [message handlers](#), [DML handlers](#), [DDL handlers](#), [precommit handlers](#), and [error handlers](#).

apply process

An optional Oracle background process that dequeues [messages](#) from a specific [queue](#) and either applies each message directly, discards it, passes it as a parameter to an [apply handler](#), or re-enqueues it. An apply process is an [Oracle Streams client](#).

See Also: [logical change record \(LCR\)](#)

apply servers

A component of an [apply process](#) that includes one or more processes that apply LCRs to database objects as DML or DDL statements or pass the LCRs to their appropriate [apply handlers](#). For [user messages](#), the apply servers pass the [messages](#) to the [message handler](#). Apply servers can also enqueue [logical change record \(LCR\)](#) and non-LCR messages specified by the `DBMS_APPLY_ADM.SET_ENQUEUE_DESTINATION` procedure. If an apply server encounters an error, then it tries to resolve the error with a user-specified [error handler](#). If an apply server cannot resolve

an error, then it places the entire transaction, including all of its LCRs, in the error queue.

See Also: [logical change record \(LCR\)](#)

apply user

The user in whose security domain an [apply process](#) dequeues [messages](#) that satisfy its [rule sets](#), applies messages directly to database objects, runs custom [rule-based transformations](#) configured for apply process [rules](#), and runs [apply handlers](#) configured for the apply process.

approximate commit system change number (approximate CSCN)

An SCN value based on the current SCN of the database when a transaction that has enqueued [messages](#) into a [commit-time queue](#) is committed.

archived-log downstream capture process

A [downstream capture process](#) that captures changes in archived redo log files copied from the [source database](#) to the [downstream database](#).

barrier transaction

A DDL transaction or a transaction that includes a [row logical change record \(row LCR\)](#) for which an [apply process](#) cannot identify the table rows or the database object by using the [destination database](#) data dictionary and [virtual dependency definitions](#).

builder server

A component of a [capture process](#) that is a process that merges redo records from the [preparer server](#). These redo records either evaluated to TRUE during partial evaluation or partial evaluation was inconclusive for them. The builder server preserves the system change number (SCN) order of these redo records and passes the merged redo records to the capture process.

buffered LCR

A [logical change record \(LCR\)](#) that is constructed explicitly by an application and enqueued into the [buffered queue](#) portion of an [ANYDATA queue](#).

buffered queue

The portion of a [queue](#) that uses the [Oracle Streams pool](#) to store [messages](#) in memory and a queue table to store messages that have spilled from memory.

buffered user message

A non-[LCR message](#) of a user-defined type that is created explicitly by an application and enqueued into a [buffered queue](#). A buffered user message can be enqueued into the buffered queue portion of an [ANYDATA queue](#) or a [typed queue](#).

capture process

An optional Oracle background process that scans the database redo log to capture DML and DDL changes made to database objects. A capture process is an [Oracle Streams client](#).

capture user

Either the user in whose security domain a [capture process](#) captures changes that satisfy its [rule sets](#) and runs custom [rule-based transformations](#) configured for capture process [rules](#), or the user in whose security domain a [synchronous capture](#)

captures changes that satisfy its **rule set** and runs custom **rule-based transformations** configured for synchronous capture **rules**.

captured LCR

A **logical change record (LCR)** that was captured implicitly by a **capture process** and enqueued into the **buffered queue** portion of an **ANYDATA queue**.

See Also: **user message**

captured SCN

The system change number (SCN) that corresponds to the most recent change scanned in the redo log by a **capture process**.

change cycling

Sending a change back to the database where it originated. Typically, change cycling should be avoided in an information sharing environment by using **tags** and by using the LCR member function `GET_SOURCE_DATABASE_NAME` in **rule conditions**.

See Also: **logical change record (LCR)**

checkpoint

Information about the current state of a **capture process** that is stored persistently in the data dictionary of the database running the capture process.

checkpoint interval

A regular interval at which a **capture process** attempts to record a **checkpoint**.

checkpoint retention time

The amount of time that a **capture process** retains **checkpoints** before purging them automatically.

column list

A list of columns for which an update conflict handler is called when an update **conflict** occurs for one or more of the columns in the list.

See Also: **conflict resolution**

commit-time queue

A **queue** in which **messages** are ordered by their **approximate commit system change number (approximate CSCN)** values.

conditional log group

A **supplemental log group** that logs the before images of all specified columns only if at least one of the columns in the supplemental log group is modified.

See Also: **unconditional log group**

conflict

A mismatch between the old values in an LCR and the expected data in a table. Conflicts are detected by an **apply process** when it attempts to apply an LCR. Conflicts typically result when two different databases that are sharing data in a table modify the same row in the table at nearly the same time.

See Also: **logical change record (LCR)**

conflict resolution

Handling a [conflict](#) to avoid an apply error. Either prebuilt update conflict handlers or custom conflict handlers can resolve conflicts.

consumption

The process of dequeuing an [message](#) from a [queue](#).

coordinator process

A component of an [apply process](#) that is an Oracle background process that gets transactions from the [reader server](#) and passes them to [apply servers](#).

custom apply

An [apply process](#) passes an LCR as a parameter to a user procedure for processing. The user procedure can process the LCR in a customized way.

See Also: [logical change record \(LCR\)](#)

custom rule-based transformation

A [rule-based transformation](#) that requires a user-defined PL/SQL function to perform the transformation.

See Also: [declarative rule-based transformation](#)

database supplemental logging

The type of [supplemental logging](#) that can apply to the primary key, foreign key, and unique key columns in an entire database.

DDL handler

An [apply handler](#) that processes DDL LCRs.

See Also: [DDL logical change record \(DDL LCR\)](#)

DDL logical change record (DDL LCR)

A [logical change record \(LCR\)](#) that describes a data definition language (DDL) change.

declarative rule-based transformation

A [rule-based transformation](#) that covers one of a common set of transformation scenarios for row LCRs. Declarative rule-based transformations are run internally without using PL/SQL.

See Also: [row logical change record \(row LCR\)](#) and [custom rule-based transformation](#)

dequeue

To retrieve a [message](#) from a [queue](#).

destination database

A database where [messages](#) are consumed. Messages can be consumed when they are dequeued implicitly from a [queue](#) by a [propagation](#) or [apply process](#), or messages can be consumed when they are dequeued explicitly by an application, a [messaging client](#), or a user.

See Also: [consumption](#)

destination queue

The **queue** that receives the **messages** propagated by a **propagation** from a **source queue**.

direct apply

An **apply process** applies an LCR without running a user procedure.

See Also: **logical change record (LCR)**

directed network

A network in which propagated **messages** pass through one or more intermediate databases before arriving at a **destination database**.

DML handler

An **apply handler** that processes row LCRs.

See Also: **row logical change record (row LCR)**

downstream capture process

A **capture process** that runs on a database other than its **source database**.

downstream database

The database on which a **downstream capture process** runs.

enqueue

To place a **message** in a **queue**.

error handler

An **apply handler** that tries to resolve apply errors. An error handler is invoked only when a **row logical change record (row LCR)** raises an **apply process** error. Such an error might result from a **conflict** if no conflict handler is specified or if the update conflict handler cannot resolve the conflict.

evaluation context

A database object that defines external data that can be referenced in **rule conditions**. The external data can exist as variables, table data, or both.

exception queue

Messages are transferred to an exception **queue** if they cannot be retrieved and processed for some reason.

explicit capture

The **messages** are enqueued into a **queue** by an application or a user.

explicit consumption

The **messages** in a queue are dequeued either by a **messaging client** when it is invoked by a user or application or by an application or user directly.

expression

A combination of one or more values and operators that evaluate to a value.

file

In the context of a [file group](#), a reference to a file stored on hard disk. A file is composed of a file name, a directory object, and a file type. The directory object references the directory in which the file is stored on hard disk.

file group

A collection of [versions](#).

file group repository

A collection of all of the [file groups](#) in a database.

first SCN

The lowest system change number (SCN) in the redo log from which a [capture process](#) can capture changes.

global rule

A [rule](#) that is relevant either to an entire database or an entire [queue](#).

heterogeneous information sharing

Sharing information between Oracle and non-Oracle databases.

high-watermark

The system change number (SCN) beyond which no [messages](#) have been applied by an [apply process](#).

See Also: [low-watermark](#)

ignore SCN

The system change number (SCN) specified for a table below which changes cannot be applied by an [apply process](#).

implicit capture

The [messages](#) are captured automatically by a [capture process](#) or by [synchronous capture](#) and enqueued into a [queue](#).

implicit consumption

The [messages](#) in a queue are dequeued automatically by an [apply process](#).

instantiation

The process of preparing database objects for instantiation at a [source database](#), optionally copying the database objects from a source database to a [destination database](#), and setting the [instantiation SCN](#) for each instantiated database object.

instantiation SCN

The system change number (SCN) for a table which specifies that only changes that were committed after the SCN at the [source database](#) are applied by an [apply process](#).

LCR

See [logical change record \(LCR\)](#).

LOB assembly

An option for DML handlers and error handlers that assembles multiple row LCRs resulting from a change to a single row with LOB columns into a single row LCR. LOB

assembly simplifies processing of row LCRs with LOB columns in DML handlers and error handlers.

local capture process

A [capture process](#) that runs on its [source database](#).

logical change record (LCR)

A [message](#) with a specific format that describes a database change.

See Also: [row logical change record \(row LCR\)](#) and [DDL logical change record \(DDL LCR\)](#)

LogMiner data dictionary

A separate data dictionary used by a [capture process](#) to determine the details of a change that it is capturing. The LogMiner data dictionary is necessary because the primary data dictionary of the [source database](#) might not be synchronized with the redo data being scanned by a capture process.

low-watermark

The system change number (SCN) up to which all [messages](#) have been applied by an [apply process](#).

See Also: [high-watermark](#)

maximum checkpoint SCN

The system change number (SCN) that corresponds to the last [checkpoint interval](#) recorded by a [capture process](#).

message

A unit of shared information in an Oracle Streams environment.

message handler

An [apply handler](#) that processes [persistent user messages](#).

See Also: [logical change record \(LCR\)](#)

message rule

A [rule](#) that is relevant only for a [user message](#) of a specific message type.

messaging client

An optional [Oracle Streams client](#) that dequeues [persistent LCRs](#) or [persistent user messages](#) when it is invoked by an application or a user.

negative rule set

A [rule set](#) for an [Oracle Streams client](#) that results in the Oracle Streams client discarding a [message](#) when a [rule](#) in the rule set evaluates to TRUE for the message. The negative rule set for an Oracle Streams client always is evaluated before the [positive rule set](#).

nonpersistent queue

Nonpersistent [queues](#) store messages in memory. They are generally used to provide an asynchronous mechanism to send notifications to all users that are currently connected. Nonpersistent queues were deprecated in Oracle Database 10g Release 2. Oracle recommends that you use buffered messaging instead.

nontransactional queue

A **queue** in which each **message** is its own transaction.

See Also: **transactional queue**

object dependency

A **virtual dependency definition** that defines a parent-child relationship between two objects at a **destination database**.

oldest SCN

For a running **apply process**, the earliest system change number (SCN) of the transactions currently being dequeued and applied. For a stopped apply process, the oldest SCN is the earliest SCN of the transactions that were being applied when the apply process was stopped.

Oracle Streams client

A mechanism that performs work in an Oracle Streams environment and is a client of the **rules engine** (when the mechanism is associated with one or more **rule sets**). The following are Oracle Streams clients: **capture process**, **propagation**, **apply process**, and **messaging client**.

Oracle Streams data dictionary

A separate data dictionary used by **propagations** and **apply processes** to keep track of the database objects from a particular **source database**.

Oracle Streams pool

A portion of memory in the System Global Area (SGA) that is used by Oracle Streams. The Oracle Streams pool stores **buffered queue messages** in memory, and it provides memory for **capture processes** and **apply processes**.

Oracle Streams topology

A representation of the databases in an Oracle Streams environment, the Oracle Streams components configured in these databases, and the flow of messages between these components.

persistent LCR

A **logical change record (LCR)** that is enqueued into the **persistent queue** portion of an **ANYDATA queue**. A persistent LCR can be enqueued in one of the following ways:

- Captured implicitly by a **synchronous capture** and enqueued
- Constructed explicitly by an application and enqueued
- Dequeued by an **apply process** and enqueued by the same apply process using the `SET_ENQUEUE_DESTINATION` procedure in the `DBMS_APPLY_ADM` package

persistent queue

The portion of a **queue** that only stores messages on hard disk in a queue table, not in memory.

persistent user message

A non-**LCR message** of a user-defined type that is enqueued into a **persistent queue**. A persistent user message can be enqueued in one of the following ways:

- Created explicitly by an application and enqueued
- Dequeued by an **apply process** and enqueued by the same apply process using the `SET_ENQUEUE_DESTINATION` procedure in the `DBMS_APPLY_ADM` package

A persistent user message can be enqueued into the persistent queue portion of an **ANYDATA queue** or a **typed queue**.

positive rule set

A **rule set** for an **Oracle Streams client** that results in the Oracle Streams client performing its task for a **message** when a **rule** in the rule set evaluates to TRUE for the message. The **negative rule set** for an Oracle Streams client always is evaluated before the positive rule set.

precommit handler

An **apply handler** that can receive the commit information for a transaction and process the commit information in any customized way.

prepared table

A table that has been prepared for **instantiation**.

preparer server

A component of a **capture process** that scans a region defined by the **reader server** and performs prefiltering of changes found in the redo log. A reader server is a process, and multiple reader servers can run in parallel. Prefiltering entails sending partial information about changes, such as schema and object name for a change, to the **rules engine** for evaluation, and receiving the results of the evaluation.

propagation

An optional **Oracle Streams client** that uses an Oracle Scheduler job to send **messages** from a **source queue** to a **destination queue**.

propagation job

An Oracle Scheduler job used by a **propagation** to propagate **messages**.

propagation schedule

A schedule that specifies how often a **propagation job** propagates **messages**.

queue

The abstract storage unit used by a messaging system to store messages.

queue forwarding

A **directed network** in which the **messages** being forwarded at an intermediate database are the messages received by the intermediate database, so that the **source database** for a message is the database where the message originated.

See Also: **apply forwarding**

queue table

A database table where **queues** are stored. Each queue table contains a default exception queue.

reader server

1. A component of a **capture process** that is a process that reads the redo log and divides the redo log into regions.

2. A component of an **apply process** that dequeues **messages**. The reader server is a process that computes dependencies between LCRs and assembles messages into transactions. The reader server then returns the assembled transactions to the **coordinator process**, which assigns them to idle **apply servers**.

See Also: [logical change record \(LCR\)](#)

real-time downstream capture process

A **downstream capture process** that can capture changes made at the **source database** before the changes are archived in an archived redo log file.

required checkpoint SCN

The system change number (SCN) that corresponds to the lowest **checkpoint interval** for which a **capture process** requires redo data.

replication

The process of sharing database objects and data at multiple databases.

resolution column

The column used to identify a prebuilt update conflict handler.

See Also: [conflict resolution](#)

row logical change record (row LCR)

A **logical change record (LCR)** that describes a change to the data in a single row or a change to a single LONG, LONG RAW, or LOB column in a row that results from a data manipulation language (DML) statement or a piecewise update to a LOB. One DML statement can result in multiple row LCRs.

row migration

An automatic conversion performed by an internal **rule-based transformation** when a **subset rule** evaluates to TRUE in which an UPDATE operation might be converted into an INSERT or DELETE operation.

rule

A database object that enables a client to perform an action when an event occurs and a condition is satisfied.

rule condition

A component of a **rule** which combines one or more **expressions** and conditions and returns a Boolean value, which is a value of TRUE, FALSE, or NULL (unknown).

rule set

A group of **rules**.

rule-based transformation

Any modification to a **message** when a **rule** in a **positive rule set** evaluates to TRUE.

rules engine

A built-in part of Oracle that evaluates **rule sets**.

schema rule

A **rule** that is relevant only to a particular schema.

secure queue

A **queue** for which Oracle Streams Advanced Queuing (AQ) agents must be associated explicitly with one or more database users who can perform queue operations, such as enqueue and dequeue.

source database

The database where changes captured by a **capture process** are generated in a redo log, or the database where a **synchronous capture** that generated **LCRs** is configured.

source queue

The **queue** from which a **propagation** propagates **messages** to a **destination queue**.

start SCN

The system change number (SCN) from which a **capture process** begins to capture changes.

subset rule

A **rule** that is relevant only to a subset of the rows in a particular table.

supplemental log group

A group of columns in a table that is supplementally logged.

See Also: [supplemental logging](#)

supplemental logging

Additional column data placed in a redo log whenever an operation is performed. A **capture process** captures this additional information and places it in LCRs, and the additional information might be needed for an **apply process** to apply LCRs properly at a **destination database**.

See Also: [logical change record \(LCR\)](#)

synchronous capture

An optional **Oracle Streams client** that uses an internal mechanism to capture DML changes made to tables immediately after the changes are made.

system-created rule

A **rule** with a system-generated name that was created using the DBMS_STREAMS_ADM package.

table rule

A **rule** that is relevant only to a particular table.

table supplemental logging

The type of **supplemental logging** that applies to columns in a particular table.

tablespace repository

A collection of the tablespace sets in a **file group**.

tag

Data of RAW data type that appears in each redo entry and LCR. Tags can be used to modify the behavior of **Oracle Streams clients** and to track LCRs. Tags can also be used to prevent **change cycling**.

See Also: [logical change record \(LCR\)](#)

topology

See [Oracle Streams topology](#).

transactional queue

A [queue](#) in which [messages](#) can be grouped into a set that are applied as one transaction.

See Also: [nontransactional queue](#)

typed queue

A [queue](#) that can stage [messages](#) of one specific type only.

See Also: [ANYDATA queue](#)

unconditional log group

A [supplemental log group](#) that logs the before images of specified columns when the table is changed, regardless of whether the change affected any of the specified columns.

See Also: [conditional log group](#)

user message

A non-LCR [message](#) of a user-defined type. A user message can be a [buffered user message](#) or a [persistent user message](#).

See Also: [logical change record \(LCR\)](#)

value dependency

A [virtual dependency definition](#) that defines a table constraint, such as a unique key, or a relationship between the columns of two or more tables.

version

A collection of related [files](#).

virtual dependency definition

A description of a dependency that is used by an [apply process](#) to detect dependencies between transactions being applied at a [destination database](#).

A

- action contexts, 5-8
 - name-value pairs
 - adding, 17-8, 18-9, 18-11
 - altering, 17-7
 - removing, 17-9, 18-11
 - querying, 18-8
 - system-created rules, 6-40
- ADD_COLUMN procedure, 18-2
- ADD_GLOBAL_RULES procedure, 6-11
- ADD_MESSAGE_RULE procedure, 13-7
- ADD_PAIR member procedure, 17-7, 17-8, 18-9, 18-11
- ADD_RULE procedure, 5-6, 17-3
- ADD_SCHEMA_PROPAGATION_RULES procedure, 6-14
- ADD_SUBSCRIBER procedure, 15-1
- ADD_SUBSET_PROPAGATION_RULES procedure
 - row migration, 6-23
- ADD_SUBSET_RULES procedure, 6-9, 6-19
 - row migration, 6-23
- ADD_TABLE_RULES procedure, 6-17
- alert log
 - Oracle Streams entries, 20-26
- alerts, 20-1
- ALTER_APPLY procedure
 - removing a rule set, 16-5
 - setting an apply user, 16-7
 - setting the message handler, 16-8
 - setting the precommit handler, 16-10
 - specifying a rule set, 16-3
 - unsetting the message handler, 16-8
 - unsetting the precommit handler, 16-10
- ALTER_CAPTURE procedure
 - removing a rule set, 14-5
 - setting a capture user, 14-7
 - setting the first SCN, 14-8, 14-9
 - specifying a rule set, 14-3, 14-12
 - specifying database link use, 14-10
- ALTER_PROPAGATION procedure
 - removing the rule set, 15-10
 - specifying the rule set, 15-7
- ALTER_PROPAGATION_SCHEDULE procedure, 15-5
- ALTER_RULE procedure, 17-6
- ALTER_SYNC_CAPTURE procedure
 - setting a capture user, 14-14
- ANALYZE_CURRENT_PERFORMANCE procedure, 22-9
- ANALYZE_CURRENT_STATISTICS procedure, 22-2
- ANYDATA data type
 - queues, 3-2, 13-2
 - creating, 11-1
 - dequeuing, 13-3
 - enqueueing, 13-2
 - monitoring, 24-1
 - removing, 15-4
 - wrapper for messages, 3-2, 13-2
- applications
 - upgrading
 - using Streams, E-12
- applied SCN, 2-20, 23-12
- apply forwarding, 3-15
- apply handlers, 4-8
- apply process, 4-1
 - apply forwarding, 3-15
 - apply handlers, 4-8
 - Java stored procedures, 4-11
 - apply servers, 4-16
 - states, 4-18
 - apply user, 4-5
 - privileges, 20-18
 - secure queues, 3-6
 - setting, 16-7
- combined capture and apply, 3-20
 - query to determine, 25-15
- coordinator process, 4-16
 - states, 4-17
- creating, 4-19, 12-1
- data type conversion, 4-14
- data types, B-13
- data types applied, 4-13
 - automatic conversion, 4-14
- DDL changes
 - current schema, B-15
 - data structures, B-14
 - ignored, B-13
- DDL handlers, 4-7, 4-9
- dependencies, 4-16
- DML handlers, 4-7, 4-8

- dropping, 16-22
- enqueueing messages, 16-11
 - monitoring, 25-14
- error handlers
 - creating, 16-14
 - monitoring, 25-4
 - setting, 16-17
- error queue, 4-21
 - monitoring, 25-16, 25-17
- index-organized tables, B-13
- interoperation with capture processes, B-6, B-15
- logical change records (LCRs), 4-8
- managing, 16-1
- message handlers, 4-7, 4-9
 - monitoring, 25-5
 - setting, 16-8
 - unsetting, 16-8
- messages
 - captured LCRs, 4-6
 - persistent LCRs, 4-6
 - user messages, 4-6
- monitoring, 25-1
 - apply handlers, 25-4
 - compatible columns, 28-12
 - latency, 25-8, 25-11
 - transactions, 25-10
- non-LCR messages, 4-9
- options, 4-7
- Oracle Label Security (OLS), B-15
- Oracle Real Application Clusters, A-4
- parallelism, 25-14
- parameters, 4-20
 - preserve_encryption, A-7
 - setting, 16-6
 - txn_lcr_spill_threshold, 25-7
- persistent status, 4-21
- precommit handlers, 4-10
 - creating, 16-9
 - monitoring, 25-5
 - setting, 16-10
 - unsetting, 16-10
- reader server, 4-16
 - states, 4-17
- RESTRICTED SESSION, 4-16
- row subsetting, 6-9
- rule sets
 - removing, 16-5
 - specifying, 16-3
- rules, 4-6, 6-1
 - adding, 16-3
 - removing, 16-5
- specifying execution, 16-12
 - monitoring, 25-15
- spilled messages, 25-7
- starting, 16-2
- stopping, 16-2
- trace files, 20-27
- transformations
 - rule-based, 7-12
- transparent data encryption, A-7

- troubleshooting, 20-14
 - checking apply handlers, 20-17
 - checking message type, 20-15
 - checking status, 20-14
 - error queue, 20-18
- approximate CSCN, 3-10
- AQ_TM_PROCESSES initialization parameter
 - Streams apply process, 20-17
- ARCHIVELOG mode
 - capture process, 2-28, 10-3, 32-2
 - Recovery Manager, A-9
- ATTACH_TABLESPACES procedure, 30-1

B

- buffered messaging, 3-4
- buffered queues, 3-3
 - monitoring, 24-5
 - apply processes, 24-12
 - capture processes, 24-6
 - propagations, 24-7, 24-8, 24-9, 24-10, 24-11
 - transparent data encryption, A-6
- BUILD procedure, 2-20, 2-30
 - troubleshooting, 20-4

C

- capture
 - explicit, 2-43
- capture process, 2-1, 2-9, 2-38
 - applied SCN, 2-20, 23-12
 - architecture, 2-22
 - ARCHIVELOG mode, 2-28, 10-3, 32-2
 - automatically filtered changes, 28-7
 - builder server, 2-22
 - capture user, 2-23
 - secure queues, 3-6
 - setting, 14-7
 - captured LCRs, 4-1
 - captured SCN, 2-20
 - changes captured
 - DDL changes, B-4
 - DML changes, 2-13
 - NOLOGGING keyword, B-5
 - UNRECOVERABLE clause for
 - SQL*Loader, B-6
 - UNRECOVERABLE SQL keyword, B-5
 - checkpoints, 2-25
 - managing retention time, 14-7
 - maximum checkpoint SCN, 2-25
 - required checkpoint SCN, 2-25, 2-28
 - retention time, 2-26
 - combined capture and apply, 3-20
 - query to determine, 23-15
 - compressed tables, B-3
 - configuring, 10-1
 - creating, 2-29, 10-1
 - data types captured, 2-12
 - DBID, 2-30, 10-2
 - downstream capture, 2-14

- advantages, 2-18
- creating, 10-1
- database link, 2-19, 14-10
- monitoring, 23-6
- monitoring remote access, 28-2
- dropping, 14-11
- first SCN, 2-20
 - setting, 14-8, 14-9
- global name, 2-30, 10-2
- index-organized tables, B-3
- interoperation with apply processes, B-6, B-15
- latency
 - capture to apply, 25-11
 - redo log scanning, 23-12
- local capture, 2-14
 - advantages, 2-14
- LogMiner, 2-24
 - data dictionary, 2-30
 - multiple sessions, 2-24
- managing, 14-1
- maximum checkpoint SCN, 2-25, 2-32
- monitoring, 23-1
 - applied SCN, 23-12
 - compatible tables, 28-7
 - downstream capture, 23-6
 - elapsed time, 23-5
 - last redo entry, 23-10
 - latency, 23-12, 23-13, 25-11
 - message creation time, 23-4
 - old log files, 23-9
 - registered log files, 23-7, 23-9
 - required log files, 23-8
 - rule evaluations, 23-14
 - state change time, 23-4
- online redefinition, B-5
- Oracle Label Security (OLS), B-6
- Oracle Real Application Clusters, A-1
- parameters, 2-35
 - parallelism, 2-35
 - set_autofiltered_table_ddl, 28-9
 - setting, 14-6
 - time_limit, 2-35
- PAUSED FOR FLOW CONTROL state, 2-24
- persistent status, 2-38
- preparer servers, 2-22
- preparing for, 10-3
- reader server, 2-22
- Recovery Manager, A-9
 - flash recovery area, 20-5
- redo logs, 2-10
 - adding manually, 14-8
 - missing files, 20-5
- redo transport services, 2-14
- required checkpoint SCN, 2-25
- RESTRICTED SESSION, 2-22
- rule evaluation, 2-36
- rule sets
 - removing, 14-5
 - specifying, 14-3
 - rules, 2-11, 6-1
 - adding, 14-3
 - removing, 14-5
- SGA_MAX_SIZE initialization parameter, 2-24
- start SCN, 2-20, 2-21
- starting, 14-2
- states, 2-24
- stopping, 14-2
- supplemental logging, 2-13
 - specifying, 10-3
- switching to, 14-23
- SYS schema, 2-12
- SYSTEM schema, 2-12
- trace files, 20-27
- transformations
 - rule-based, 7-6
- transparent data encryption, A-5
- troubleshooting, 20-3
 - checking progress, 20-5
 - checking status, 20-4
 - creation, 20-4
- capture user
 - capture process, 2-23
 - synchronous capture, 2-42
- captured LCRs, 4-2
- captured SCN, 2-20
- character sets
 - migrating
 - using Streams, E-12
- checkpoints, 2-25
 - retention time, 2-26
 - managing, 14-7
- CLONE_TABLESPACES procedure, 30-1
- combined capture and apply, 3-20
 - apply process
 - query to determine, 25-15
 - capture process
 - query to determine, 23-15
 - propagation
 - query to determine, 24-17, 24-18
 - stream paths, 22-5
 - topology, 22-5
- COMPATIBLE initialization parameter, 9-5, 32-2
- COMPATIBLE_10_1 function, 6-45
- COMPATIBLE_10_2 function, 6-45
- COMPATIBLE_11_1 function, 6-45
- COMPATIBLE_9_2 function, 6-45
- compressed tables
 - capture process, B-3
- conditions
 - rules, 5-1
- configuring
 - Oracle Streams, 9-13
- CREATE_APPLY procedure, 4-19, 12-1
- CREATE_CAPTURE procedure, 2-29, 10-1, 10-5
- CREATE_PROPAGATION procedure, 11-3
- CREATE_RULE procedure, 17-4
- CREATE_RULE_SET procedure, 17-2
- CREATE_SYNC_CAPTURE procedure, 10-25

D

data types

- applied, 4-13
 - automatic conversion, 4-14

database links

- Oracle Streams, 9-12

database maintenance

- using Streams, E-1
 - assumptions, E-4
 - capture database, E-3
 - instantiation, E-11
 - job slaves, E-4
 - logical dependencies, E-10
 - PL/SQL package subprograms, E-4
 - user-created applications, E-8
 - user-defined types, E-8

DBA_APPLY view, 20-14, 20-15, 25-2, 25-3, 25-5, 25-6, 25-12

DBA_APPLY_DML_HANDLERS view, 25-4

DBA_APPLY_ENQUEUE view, 25-14

DBA_APPLY_ERROR view, 25-16, 25-17, 25-20, 25-21

DBA_APPLY_EXECUTE view, 25-15

DBA_APPLY_PARAMETERS view, 25-3

DBA_APPLY_PROGRESS view, 25-11

DBA_APPLY_SPILL_TXN view, 25-7

DBA_CAPTURE view, 20-4, 23-2, 23-6, 23-7, 23-8, 23-9, 23-12

DBA_CAPTURE_EXTRA_ATTRIBUTES view, 23-17

DBA_CAPTURE_PARAMETERS view, 23-11

DBA_EVALUATION_CONTEXT_TABLES view, 26-8

DBA_EVALUATION_CONTEXT_VARS view, 26-9

DBA_FILE_GROUP_EXPORT_INFO view, 31-6

DBA_FILE_GROUP_FILES view, 31-3

DBA_FILE_GROUP_TABLES view, 31-5

DBA_FILE_GROUP_TABLESPACES view, 31-4

DBA_FILE_GROUP_VERSOINS view, 31-3

DBA_FILE_GROUPS view, 31-2

DBA_LOGMNR_PURGED_LOG view, 2-21, 2-28

DBA_PROPAGATION view, 20-11, 20-12, 24-7, 24-8, 24-9, 24-10, 24-13, 24-14, 24-15, 24-17

DBA_QUEUE_SCHEDULES view, 24-15, 24-17

DBA_QUEUE_TABLES view, 24-2

DBA_QUEUES view, 24-2

DBA_REGISTERED_ARCHIVED_LOG view, 23-7, 23-8, 23-9

DBA_RULE_SET_RULES view, 26-9, 26-10

DBA_RULE_SETS view, 26-8

DBA_RULES view, 26-9, 26-10

DBA_STREAMS_ADD_COLUMN view, 27-4

DBA_STREAMS_COLUMNS view, 28-11, 28-12

DBA_STREAMS_NEWLY_SUPPORTED view, 28-9

DBA_STREAMS_RENAME_TABLE view, 27-4

DBA_STREAMS_RULES view, 20-19, 26-6

DBA_STREAMS_TABLE_RULES view, 23-16

DBA_STREAMS_TP_COMPONENT view, 22-2, 22-13

DBA_STREAMS_TP_COMPONENT_LINK view, 22-2, 22-15

DBA_STREAMS_TP_COMPONENT_STAT view, 22-2, 22-20

DBA_STREAMS_TP_DATABASE view, 22-2, 22-12

DBA_STREAMS_TP_PATH_BOTTLENECK view, 22-2, 22-18

DBA_STREAMS_TP_PATH_STAT view, 22-2, 22-32

DBA_STREAMS_TRANSFORM_FUNCTION view, 27-5

DBA_STREAMS_TRANSFORMATIONS view, 27-1, 27-2

DBA_STREAMS_UNSUPPORTED view, 28-7

DBA_SYNC_CAPTURE view, 23-16

DBA_SYNC_CAPTURE_TABLES view, 23-16

DBID (database identifier)

- capture process, 2-30, 10-2

DBMS_APPLY_ADM package, 1-14, 12-1, 16-1

DBMS_CAPTURE_ADM package, 1-15, 10-1, 14-1

DBMS_COMPARISON package, 1-15

DBMS_PROPAGATION_ADM package, 1-15, 11-1, 15-1

- starting a propagation, 15-5

- stopping a propagation, 15-5

DBMS_RULE package, 1-15, 5-10, 33-1

DBMS_RULE_ADM package, 1-15, 17-1, 17-2, 33-1

DBMS_STREAMS package, 1-15

DBMS_STREAMS_ADM package, 1-15, 6-5, 10-1, 11-1, 12-1, 14-1, 15-1, 16-1

- creating a capture process, 2-29, 10-1

- creating a propagation, 11-3

- creating an apply process, 4-19, 12-1

DBMS_STREAMS_ADVISOR_ADM package, 1-16, 22-2

- gathering information, 22-9

DBMS_STREAMS_AUTH package, 1-16

DBMS_STREAMS_MESSAGING package, 1-16

DBMS_STREAMS_TABLESPACE_ADM package, 1-16, 30-1

- information provisioning, 29-3

- platform conversion, 29-7

DDL handlers, 4-7, 4-9

DELETE_ALL_ERRORS procedure, 16-22

DELETE_ERROR procedure, 4-21, 16-22

dependencies

- apply process, 4-16

- queues, 3-8

dequeue high-watermark, 3-10

DEQUEUE procedure, 13-4, 13-7

destination queue, 3-1

DETACH_TABLESPACES procedure, 30-1

direct path load

- capture processes, B-6

directed networks, 3-15

- apply forwarding, 3-15

- queue forwarding, 3-15

DISABLE_DB_ACCESS procedure, 15-3

DML handlers, 4-7, 4-8

documentation

- Oracle Streams, 1-18

DROP_APPLY procedure, 16-22

DROP_CAPTURE procedure, 14-11, 14-15

DROP_PROPAGATION procedure, 15-10
DROP_RULE procedure, 17-11
DROP_RULE_SET procedure, 17-4

E

ENABLE_DB_ACCESS procedure, 15-1
ENQUEUE procedure, 13-2, 13-6
error handlers
 creating, 16-14
 monitoring, 25-4
 setting, 16-17
 unsetting, 16-18
error queue, 4-21
 apply process, 20-18
 deleting errors, 16-22
 executing errors, 16-19
 monitoring, 25-16, 25-17
 transparent data encryption, A-7
EVALUATE procedure, 5-10
evaluation contexts, 5-5
 association with rule sets, 5-6
 association with rules, 5-6
 evaluation function, 5-7
 object privileges
 granting, 17-12
 revoking, 17-13
 system privileges
 granting, 17-11
 revoking, 17-12
 user-created, 6-43, 6-50
 variables, 5-5
event contexts
 system-created rules, 6-40
EXECUTE member procedure, 16-16
EXECUTE_ALL_ERRORS procedure, 16-21
EXECUTE_ERROR procedure, 4-21, 16-19
explicit capture, 1-2, 2-43
 features, 2-44
 message types, 2-43
 transparent data encryption, A-6
explicit consumption
 dequeue, 4-23
Export
 database maintenance, E-11
 database upgrade, D-5
 Oracle Streams, 19-1

F

file group repositories, 29-4
 monitoring, 31-1
 using, 30-14
first SCN, 2-20
flash recovery area
 capture processes
 archived redo log files, 20-5
flashback data archive
 Oracle Streams, A-8
flow control, 2-24

G

GET_COMMA, 25-19
GET_COMMAND_TYPE member function, 16-16, 16-20
GET_COMPATIBLE member function, 6-45
GET_DDL_TEXT member function, 25-19
GET_ERROR_MESSAGE function, 25-20, 25-21
GET_INFORMATION function, 16-16
GET_NEXT_HIT function, 5-10
GET_OBJECT_NAME member function, 16-16, 16-20, 18-6, 25-19
GET_OBJECT_OWNER member function, 16-20, 18-6, 25-19
GET_SOURCE_DATABASE_NAME member function, 25-19
GET_STREAMS_NAME function, 16-16
GET_VALUE member function, 16-20
 LCRs, 18-6
GET_VALUES member function, 16-16, 25-19
global name
 capture process, 2-30, 10-2
GLOBAL_NAME view, 20-11, 23-6
GLOBAL_NAMES initialization parameter, 9-5
GRANT_ADMIN_PRIVILEGE procedure, 9-1
GRANT_OBJECT_PRIVILEGE procedure, 5-13
GRANT_REMOTE_ADMIN_ACCESS
 procedure, 10-14, 10-17
GRANT_SYSTEM_PRIVILEGE procedure, 5-13
grids
 information provisioning, 29-1

H

high availability
 Streams, 8-1
 advantages, 8-2
 apply, 8-7
 best practices, 8-4
 capture, 8-6
 database links, 8-7
 propagation, 8-7

I

implicit capture, 1-2
 managing, 14-1
 switching mechanisms, 14-16, 14-23
Import
 database maintenance, E-11
 database upgrade, D-5
 Oracle Streams, 19-1
INCLUDE_EXTRA_ATTRIBUTE procedure, 2-6, 14-15
index-organized tables
 apply process, B-13
 capture process, B-3
 synchronous capture, 2-42
in-flight transactions, 20-4
information provisioning, 29-1
 bulk provisioning, 29-2

- Data Pump, 29-3
- DBMS_STREAMS_TABLESPACE_ADM
 - package, 29-3
- file group repositories, 29-4
- incremental provisioning, 29-8
- on-demand information access, 29-9
- RMAN
 - transportable tablespace from backup, 29-3
- tablespace repositories, 29-4
- using, 30-1
- initialization parameters
 - AQ_TM_PROCESSES
 - Streams apply process, 20-17
 - COMPATIBLE, 9-5
 - GLOBAL_NAMES, 9-5
 - LOG_ARCHIVE_CONFIG, 9-5
 - LOG_ARCHIVE_DEST_1, 9-5
 - LOG_ARCHIVE_DEST_STATE_1, 9-5
 - LOG_BUFFER, 9-6
 - MEMORY_MAX_TARGET, 9-6
 - MEMORY_TARGET, 9-6
 - OPEN_LINKS, 9-6
 - Oracle Streams, 9-4
 - PROCESSES, 9-6
 - SESSIONS, 9-7
 - SGA_MAX_SIZE, 9-7
 - SGA_TARGET, 9-7
 - SHARED_POOL_SIZE, 9-7
 - STREAMS_POOL_SIZE, 9-8, 9-9
 - TIMED_STATISTICS, 9-9
 - UNDO_RETENTION, 9-9
- instantiation
 - example
 - RMAN CONVERT DATABASE, E-21
 - RMAN DUPLICATE, D-12, E-19
 - export/import, D-5, E-11
 - in Streams, 2-8
 - RMAN CONVERT DATABASE, E-11
 - RMAN DUPLICATE, D-5, E-11
- interoperability
 - compatibility, 28-7
 - Oracle Streams, B-6, B-15
 - Streams, 28-9
- IS_NULL_TAG member function, 25-19

L

- LCRs. *See* logical change records
- LOG_ARCHIVE_CONFIG initialization
 - parameter, 9-5
- LOG_ARCHIVE_DEST_1 initialization
 - parameter, 9-5
- LOG_ARCHIVE_DEST_STATE_1 initialization
 - parameter, 9-5
- LOG_BUFFER initialization parameter, 9-6
- logical change records (LCRs), 2-3, 16-16
 - apply process, 4-8
 - DDL LCRs, 2-5
 - current_schema, B-15
 - rules, 6-18, 6-35
 - extra attributes, 2-6
 - managing, 14-15
 - monitoring, 23-17
 - getting information about, 18-6, 25-19
 - compatibility, 6-45
 - row LCRs, 2-4
 - rules, 6-12
 - XML schema, C-1
- LogMiner
 - capture process, 2-24
 - multiple sessions, 2-24

M

- MAINTAIN_GLOBAL procedure, 29-9
- MAINTAIN_SCHEMAS procedure, 29-9
- MAINTAIN_SIMPLE_TTS procedure, 29-9
- MAINTAIN_TABLES procedure, 29-9
- MAINTAIN_TTS procedure, 29-9
- maximum checkpoint SCN, 2-32
- MEMORY_MAX_TARGET initialization
 - parameter, 9-6, 9-10
- MEMORY_TARGET initialization parameter, 9-6, 9-10
- message handlers, 4-7, 4-9
 - monitoring, 25-5
- messages
 - captured, 4-2
 - captured LCRs, 4-1
 - dequeue, 4-1
 - enqueue, 2-43
 - persistent LCRs, 4-1, 4-3
 - persistent user messages, 4-3
 - propagation, 3-11
 - user messages, 4-1, 4-3
- messaging, 3-2, 13-1
 - ANYDATA queues, 13-2
 - buffered messaging, 3-4
 - configuring, 9-13
 - dequeue, 4-23, 13-5
 - transparent data encryption, A-8
 - enqueue, 2-43, 13-5
 - notifications
 - managing, 13-5
- messaging client, 4-22
 - managing, 13-5
 - messaging client user
 - secure queues, 3-6
 - transformations
 - rule-based, 7-14
- messaging clients
 - transparent data encryption, A-7, A-8
- migrating
 - to different character set
 - using Streams, E-12
 - to different operating system
 - using Streams, E-12
- monitoring
 - ANYDATA data type queues, 24-1
 - message consumers, 24-3

- viewing event contents, 24-4
- apply process, 25-1
 - apply handlers, 25-4
 - compatible columns, 28-12
 - error handlers, 25-4
 - error queue, 25-16, 25-17
 - message handlers, 25-5
- capture process, 23-1
 - applied SCN, 23-12
 - compatible tables, 28-7
 - elapsed time, 23-5
 - latency, 23-12, 23-13, 25-11
 - message creation time, 23-4
 - rule evaluations, 23-14
 - state change time, 23-4
- compatibility, 28-7
- file group repositories, 31-1
- Oracle Streams, 21-1
 - performance, 22-2, 28-15
 - propagation jobs, 24-13
 - propagations, 24-1, 24-13
 - queues, 24-1
 - rule-based transformations, 27-1
 - rules, 26-1
 - synchronous capture, 23-15
 - compatible columns, 28-11
 - latency, 25-11
 - tablespace repositories, 31-1
- multi-version data dictionary
 - missing, 20-23

N

- NOLOGGING mode
 - capture process, B-5

O

- online redefinition
 - capture process, B-5
 - synchronous capture, B-10
- OPEN_LINKS initialization parameter, 9-6
- operating systems
 - migrating
 - using Streams, E-12
- ORA-01291 error, 20-5
- ORA-06550 error, 20-18
- ORA-24093 error, 20-13
- ORA-25224 error, 20-14
- ORA-26666 error, 20-14
- ORA-26678 error, 20-8
- Oracle Data Pump
 - information provisioning, 29-3
- Oracle Enterprise Manager
 - Streams tool, 1-16
- Oracle Label Security (OLS)
 - apply processes, B-15
 - capture processes, B-6
 - synchronous captures, B-10

- Oracle Real Application Clusters
 - interoperation with Oracle Streams, A-1, A-2, A-3, A-4
 - queues, A-3
- Oracle Scheduler
 - propagation jobs, 3-17
- Oracle Streams
 - administrator
 - configuring, 9-1
 - monitoring, 28-2
 - alert log, 20-26
 - alerts, 20-1
 - ANYDATA queues, 13-2
 - apply process, 4-1
 - capture process, 2-1, 2-9, 2-38
 - compatibility, 6-45, 28-7
 - configuring, 9-13
 - data dictionary, 3-19, 4-20, 21-1
 - database links, 9-12
 - database maintenance, E-1
 - directed networks, 3-15
 - documentation roadmap, 1-18
 - Export utility, 19-1
 - flashback data archive, A-8
 - high availability, 8-1
 - Import utility, 19-1
 - information provisioning, 29-8
 - initialization parameters, 9-4, 32-2
 - instantiation, 2-8
 - interoperability, 28-9, B-6, B-15
 - interoperation with Oracle Real Application Clusters, A-1
 - interoperation with Transparent Data Encryption, A-5
 - logical change records (LCRs), 2-3
 - XML schema, C-1
 - LogMiner data dictionary, 2-30
 - messaging, 3-2, 13-1
 - messaging clients, 4-22
 - monitoring, 21-1
 - network connectivity, 9-12
 - overview, 1-1
 - packages, 1-14
 - preparing for, 9-1
 - propagation, 3-1
 - Oracle Real Application Clusters, A-3
 - queues
 - Oracle Real Application Clusters, A-3
 - rules, 6-1
 - action context, 6-40
 - evaluation context, 6-9, 6-37
 - event context, 6-40
 - subset rules, 6-9, 6-19
 - system-created, 6-5
 - sample environments
 - single database, 32-1
 - staging, 3-1
 - Oracle Real Application Clusters, A-3
 - Streams data dictionary, 2-34

- Streams pool, 9-9
 - monitoring, 28-3
- Streams tool, 1-16
- supplemental logging, 2-13
- synchronous capture, 2-38
- tags, 1-4
- topology, 22-1
- trace files, 20-26
- transformations
 - rule-based, 7-1
- transparent data encryption, A-6
- troubleshooting, 20-1
- upgrading online, D-1
- user messages, 3-1
- Oracle Streams Performance Advisor, 22-2
 - gathering information, 22-9
 - Streams components, 22-3
 - viewing statistics, 22-17
 - bottleneck components, 22-18
 - component-level, 22-20
 - latency, 22-20
 - rates, 22-20
 - session-level, 22-27
 - stream paths, 22-32

P

- patches
 - applying
 - using Streams, E-12
- performance
 - Oracle Streams Performance Advisor, 22-2
 - gathering information, 22-9
 - Streams components, 22-3
 - viewing statistics, 22-17
- persistent LCRs, 4-3
- persistent user messages, 4-3
- POST_INSTANTIATION_SETUP procedure, 29-9
- PRE_INSTANTIATION_SETUP procedure, 29-9
- precommit handlers, 4-10
 - creating, 16-9
 - monitoring, 25-5
 - setting, 16-10
 - unsettling, 16-10
- prepare SCN, 2-21
- privileges
 - Oracle Streams administrator, 9-1
 - monitoring, 28-2
 - rules, 5-13
- PROCESSES initialization parameter, 9-6
- propagation
 - combined capture and apply, 3-20
 - query to determine, 24-17, 24-18
 - propagation receivers, 24-18
 - propagation senders, 24-17
- propagation jobs, 3-17
 - altering, 15-5
 - managing, 11-3, 15-4
 - monitoring, 24-13
 - Oracle Scheduler, 3-17

- RESTRICTED SESSION, 3-19
- scheduling, 3-18
- trace files, 20-27
- troubleshooting, 20-11
- propagations, 3-1, 3-11
 - binary files, 3-17
 - buffered queues, 3-3
 - creating, 11-1, 11-3
 - destination queue, 3-1
 - directed networks, 3-15
 - dropping, 15-10
 - ensured delivery, 3-14
 - managing, 11-3, 15-4
 - monitoring, 24-1, 24-13
 - queue-to-queue, 3-13, 24-13
 - Oracle Real Application Clusters, A-3
 - propagation job, 3-17
 - schedule, 15-6
 - rule sets
 - removing, 15-10
 - specifying, 15-7
 - rules, 3-13, 6-1
 - adding, 15-7
 - removing, 15-9
 - source queue, 3-1
 - starting, 15-5
 - stopping, 15-5
 - transformations
 - rule-based, 7-10
 - transparent data encryption, A-7
 - troubleshooting, 20-11
 - checking queues, 20-11
 - checking status, 20-12
 - security, 20-13

Q

- queue forwarding, 3-15
- queues
 - ANYDATA, 3-2, 13-2
 - creating, 11-1
 - removing, 15-4
 - browsing, 3-10
 - buffered, 3-3
 - commit-time, 3-8
 - creating, 11-1
 - dependencies, 3-8
 - dequeue high-watermark, 3-10
 - monitoring, 24-1
 - nontransactional, 3-7
 - Oracle Real Application Clusters, A-3
 - queue tables, 3-3
 - triggers, 3-4
 - secure, 3-5
 - disabling user access, 15-3
 - enabling user access, 15-1
 - users, 3-6
 - synchronous capture, 2-40
 - transactional, 3-7
 - typed, 3-2

queue-to-queue propagations, 3-13, 24-13
schedule, 15-6

R

RE\$NV_LIST type, 5-10

ADD_PAIR member procedure, 17-7, 17-8, 18-9, 18-11

REMOVE_PAIR member procedure, 17-7, 17-9, 18-11

Recovery Manager

capture processes

archived redo log files, A-9

flash recovery area, 20-5

CONVERT DATABASE command

Streams instantiation, E-11, E-21

DUPLICATE command

Streams instantiation, D-5, D-12, E-11, E-19

information provisioning, 29-3

redo logs

capture process, 2-10

reenqueue

captured LCRs, 32-1

REMOVE_PAIR member procedure, 17-7, 17-9, 18-11

REMOVE_QUEUE procedure, 15-4

REMOVE_RULE procedure, 14-5, 15-9, 16-5, 17-3

RENAME_COLUMN procedure, 18-3

RENAME_TABLE procedure, 18-1, 18-4

replication

configuring, 9-13

required checkpoint SCN, 2-28

RESTRICTED SESSION system privilege

apply processes, 4-16

capture processes, 2-22

propagation jobs, 3-19

REVOKE_OBJECT_PRIVILEGE procedure, 5-13

REVOKE_SYSTEM_PRIVILEGE procedure, 5-13

RMAN. *See* Recovery Manager

row migration, 6-23

rule sets, 5-1

adding rules to, 17-3

creating, 17-2

dropping, 17-4

evaluation, 5-10

partial, 5-12

negative, 6-3

object privileges

granting, 17-12

revoking, 17-13

positive, 6-3

removing rules from, 17-3

system privileges

granting, 17-11

revoking, 17-12

rule-based transformations, 7-1

custom, 7-2

action contexts, 7-4

altering, 18-10

creating, 18-5

managing, 18-5

monitoring, 27-5

privileges, 7-5

removing, 18-11

declarative, 7-1

adding, 18-1

managing, 18-1

monitoring, 27-2

removing, 18-4

step number, 7-15

troubleshooting, 20-24

managing, 18-1

monitoring, 27-1

ordering, 7-15

rules, 5-1

action contexts, 5-8

adding name-value pairs, 17-7, 17-8, 18-9, 18-11

altering, 17-7

removing name-value pairs, 17-9, 18-11

transformations, 7-4

ADD_RULE procedure, 5-6

altering, 17-6

apply process, 4-6, 6-1

capture process, 2-11, 6-1

components, 5-1

creating, 17-4

DBMS_RULE package, 5-10

DBMS_RULE_ADM package, 17-1

dropping, 17-11

EVALUATE procedure, 5-10

evaluation, 5-10

capture process, 2-36

iterators, 5-10

partial, 5-12

evaluation contexts, 5-5

evaluation function, 5-7

user-created, 6-50

variables, 5-5

event context, 5-10

example applications, 33-1

explicit variables, 5-5

implicit variables, 5-5

iterative results, 5-10

managing, 17-2

MAYBE rules, 5-10

monitoring, 26-1

object privileges

granting, 17-12

revoking, 17-13

partial evaluation, 5-12

privileges, 5-13

managing, 17-11

propagations, 3-13, 6-1

rule conditions, 5-1, 6-17, 6-19

complex, 6-46

explicit variables, 5-5

finding patterns in, 26-10

implicit variables, 5-5

Streams compatibility, 6-45

- types of operations, 6-44
- undefined variables, 6-48
- using NOT, 6-47
- variables, 6-12
- rule_hits, 5-10
- simple rules, 5-3
- subset, 6-19
 - querying for action context of, 18-8
 - querying for names of, 18-8
- synchronous capture, 2-40
- system privileges
 - granting, 17-11
 - revoking, 17-12
- system-created, 6-1, 6-5
 - action context, 6-40
 - and_condition parameter, 6-35
 - DDL rules, 6-18, 6-35
 - DML rules, 6-12
 - evaluation context, 6-9, 6-37
 - event context, 6-40
 - global, 6-11
 - modifying, 17-10
 - row migration, 6-23
 - schema, 6-14
 - STREAMS\$EVALUATION_CONTEXT, 6-9, 6-37
 - subset, 6-9, 6-19
 - table, 6-17
- troubleshooting, 20-18
- TRUE rules, 5-10
- user-created, 6-43
- variables, 5-5

S

- secure queues, 3-5
 - disabling user access, 15-3
 - enabling user access, 15-1
 - propagation, 20-13
 - Streams clients
 - users, 3-6
- SESSIONS initialization parameter, 9-7
- SET_DML_HANDLER procedure, 4-8
 - setting an error handler, 16-17
 - unsetting an error handler, 16-18
- SET_ENQUEUE_DESTINATION procedure, 16-11
- SET_EXECUTE procedure, 16-12
- SET_MESSAGE_NOTIFICATION procedure, 13-7
- SET_PARAMETER procedure
 - apply process, 16-6
 - capture process, 14-6
- SET_RULE_TRANSFORM_FUNCTION
 - procedure, 18-5
- SET_UP_QUEUE procedure, 11-1
- SET_VALUE member procedure, 16-20, 18-6
- SET_VALUES member procedure, 16-16
- SGA_MAX_SIZE initialization parameter, 2-24, 9-7
- SGA_TARGET initialization parameter, 9-7, 9-11
- SHARED_POOL_SIZE initialization parameter, 9-7
- source queue, 3-1
- SQL*Loader
 - capture processes, B-6
- staging, 3-1
 - approximate CSCN, 3-10
 - buffered queues, 3-3
 - monitoring, 24-5
 - management, 15-1
 - messages, 4-1
 - secure queues, 3-5
 - disabling user access, 15-3
 - enabling user access, 15-1
- start SCN, 2-20
- START_APPLY procedure, 16-2
- START_CAPTURE procedure, 14-2
- START_PROPAGATION procedure, 15-5
- Statspack
 - Oracle Streams, 28-15
- STOP_APPLY procedure, 16-2
- STOP_CAPTURE procedure, 14-2
- STOP_PROPAGATION procedure, 15-5
- stream paths, 22-4
 - combined capture and apply, 22-5
- Streams data dictionary, 2-34, 3-19, 4-20
- streams paths
 - statistics, 22-32
- Streams pool, 9-9
 - MEMORY_MAX_TARGET initialization parameter, 9-10
 - MEMORY_TARGET initialization parameter, 9-10
 - monitoring, 28-3
 - SGA_TARGET initialization parameter, 9-11
- Streams. *See* Oracle Streams
- Streams tool, 1-16
- Streams topology
 - DBMS_STREAMS_ADVISOR_ADM package
 - gathering information, 22-9
- STREAMS\$EVALUATION_CONTEXT, 6-9, 6-37
- STREAMS\$TRANSFORM_FUNCTION, 7-4
- STREAMS_POOL_SIZE initialization parameter, 9-8, 9-9
- supplemental logging
 - capture process, 2-13
 - specifying, 10-3
- synchronous capture, 2-38
 - capture user, 2-42
 - setting, 14-14
 - changes captured
 - DML changes, 2-42
 - data types captured, 2-41
 - dropping, 14-15
 - index-organized tables, 2-42
 - latency
 - capture to apply, 25-11
 - managing, 14-11
 - monitoring, 23-15
 - compatible columns, 28-11
 - online redefinition, B-10
 - Oracle Label Security (OLS), B-10
 - Oracle Real Application Clusters, A-2

- preparing for, 10-23
- queues, 2-40
- rule sets
 - specifying, 14-12
- rules, 2-40
 - adding, 14-12
 - modifying, 2-41, 17-7
- switching to, 14-16
- SYS schema, 2-41
- SYSTEM schema, 2-41
- transformations
 - rule-based, 7-8
- transparent data encryption, A-6
- SYS.AnyData. *See* ANYDATA data type
- system change numbers (SCN)
 - applied SCN for a capture process, 2-20, 23-12
 - captured SCN for a capture process, 2-20
 - first SCN for a capture process, 2-20
 - maximum checkpoint SCN for a capture process, 2-25
 - required checkpoint SCN for a capture process, 2-25
 - start SCN for a capture process, 2-20

T

- tables
 - compressed
 - capture process, B-3
 - index-organized
 - capture process, B-3
- tablespace repositories, 29-4
 - creating, 30-2
 - monitoring, 31-1, 31-4
 - using, 30-1
 - with shared file system, 30-4
 - without shared file system, 30-9
- tags, 1-4
- TIMED_STATISTICS initialization parameter, 9-9
- topology
 - component IDs, 22-4
 - DBMS_STREAMS_ADVISOR_ADM package
 - gathering information, 22-9
 - gathering information, 22-9
 - Oracle Streams, 22-1
 - stream paths, 22-4
 - combined capture and apply, 22-5
 - statistics, 22-32
 - viewing, 22-15
 - viewing, 22-12
- trace files
 - Oracle Streams, 20-26
- transformations
 - custom rule-based, 7-2
 - action context, 7-4
 - altering, 18-10
 - creating, 18-5
 - monitoring, 27-5
 - removing, 18-11
 - STREAMS\$_TRANSFORM_FUNCTION, 7-4

- troubleshooting, 20-25
- declarative rule-based, 7-1
 - monitoring, 27-2
 - troubleshooting, 20-24
- Oracle Streams, 7-1
- rule-based, 7-1
 - apply process, 7-12
 - capture process, 7-6
 - errors during apply, 7-13
 - errors during capture, 7-7
 - errors during dequeue, 7-15
 - errors during propagation, 7-12
 - managing, 18-1
 - messaging client, 7-14
 - monitoring, 27-1
 - multiple, 7-15
 - propagations, 7-10
 - synchronous capture, 7-8
- Transparent Data Encryption
 - interoperation with Oracle Streams, A-5
- transparent data encryption
 - apply processes, A-7
 - buffered queues, A-6
 - capture processes, A-5
 - dequeue, A-8
 - error queue, A-7
 - explicit capture, A-6
 - messaging clients, A-7, A-8
 - propagations, A-7
 - synchronous capture, A-6
- triggers
 - queue tables, 3-4
- troubleshooting
 - alerts, 20-1
 - apply process, 20-14
 - checking apply handlers, 20-17
 - checking message type, 20-15
 - checking status, 20-14
 - error queue, 20-18
 - capture process, 20-3
 - checking progress, 20-5
 - checking status, 20-4
 - creation, 20-4
 - custom rule-based transformations, 20-25
 - missing multi-version data dictionary, 20-23
 - Oracle Streams, 20-1
 - propagation jobs, 20-11
 - propagations, 20-11
 - checking queues, 20-11
 - checking status, 20-12
 - security, 20-13
 - rules, 20-18

U

- UNDO_RETENTION initialization parameter, 9-9
- UNRECOVERABLE clause
 - SQL*Loader
 - capture process, B-6

UNRECOVERABLE SQL keyword
capture process, B-5
upgrading
online using Streams, D-1
assumptions, D-3
capture database, D-3
instantiation, D-5
job queue processes, D-4
PL/SQL package subprograms, D-4
user-defined types, D-4
user messages, 3-1, 4-3
UTL_SPADV package, 1-16

V

V\$ARCHIVE_DEST view, 23-7
V\$ARCHIVED_LOG view, 2-20
V\$BUFFERED_PUBLISHERS view, 24-6
V\$BUFFERED_QUEUES view, 24-6, 24-10, 24-12
V\$BUFFERED_SUBSCRIBERS view, 24-10, 24-12
V\$PROPAGATION_RECEIVER view, 24-11, 24-18
V\$PROPAGATION_SENDER view, 24-7, 24-8, 24-9,
24-17
V\$RULE view, 26-14
V\$RULE_SET view, 26-12, 26-13
V\$RULE_SET_AGGREGATE_STATS view, 26-11
V\$SESSION view, 23-3, 25-6, 25-8, 25-9, 25-12
V\$STREAMS_APPLY_COORDINATOR view, 4-17,
25-9, 25-10, 25-11
V\$STREAMS_APPLY_READER view, 4-17, 25-6,
25-7, 25-8, 25-15
V\$STREAMS_APPLY_SERVER view, 4-18, 25-12,
25-14
V\$STREAMS_CAPTURE view, 2-24, 20-5, 23-3, 23-4,
23-5, 23-10, 23-12, 23-13, 23-14, 23-15
V\$STREAMS_POOL_ADVICE view, 9-11, 28-3

W

wallets
Oracle Streams, A-6

X

XML Schema
for LCRs, C-1