

PeopleSoft®

EnterpriseOne
Global Solutions Austria 8.9
PeopleBook

September 2003

EnterpriseOne
Global Solutions Austria 8.9 PeopleBook
SKU REL9EAU0309

Copyright© 2003 PeopleSoft, Inc. All rights reserved.

All material contained in this documentation is proprietary and confidential to PeopleSoft, Inc. ("PeopleSoft"), protected by copyright laws and subject to the nondisclosure provisions of the applicable PeopleSoft agreement. No part of this documentation may be reproduced, stored in a retrieval system, or transmitted in any form or by any means, including, but not limited to, electronic, graphic, mechanical, photocopying, recording, or otherwise without the prior written permission of PeopleSoft.

This documentation is subject to change without notice, and PeopleSoft does not warrant that the material contained in this documentation is free of errors. Any errors found in this document should be reported to PeopleSoft in writing.

The copyrighted software that accompanies this document is licensed for use only in strict accordance with the applicable license agreement which should be read carefully as it governs the terms of use of the software and this document, including the disclosure thereof.

PeopleSoft, PeopleTools, PS/nVision, PeopleCode, PeopleBooks, PeopleTalk, and Vantive are registered trademarks, and Pure Internet Architecture, Intelligent Context Manager, and The Real-Time Enterprise are trademarks of PeopleSoft, Inc. All other company and product names may be trademarks of their respective owners. The information contained herein is subject to change without notice.

Open Source Disclosure

This product includes software developed by the Apache Software Foundation (<http://www.apache.org/>). Copyright (c) 1999-2000 The Apache Software Foundation. All rights reserved. THIS SOFTWARE IS PROVIDED "AS IS" AND ANY EXPRESSED OR IMPLIED WARRANTIES, INCLUDING, BUT NOT LIMITED TO, THE IMPLIED WARRANTIES OF MERCHANTABILITY AND FITNESS FOR A PARTICULAR PURPOSE ARE DISCLAIMED. IN NO EVENT SHALL THE APACHE SOFTWARE FOUNDATION OR ITS CONTRIBUTORS BE LIABLE FOR ANY DIRECT, INDIRECT, INCIDENTAL, SPECIAL, EXEMPLARY, OR CONSEQUENTIAL DAMAGES (INCLUDING, BUT NOT LIMITED TO, PROCUREMENT OF SUBSTITUTE GOODS OR SERVICES; LOSS OF USE, DATA, OR PROFITS; OR BUSINESS INTERRUPTION) HOWEVER CAUSED AND ON ANY THEORY OF LIABILITY, WHETHER IN CONTRACT, STRICT LIABILITY, OR TORT (INCLUDING NEGLIGENCE OR OTHERWISE) ARISING IN ANY WAY OUT OF THE USE OF THIS SOFTWARE, EVEN IF ADVISED OF THE POSSIBILITY OF SUCH DAMAGE.

PeopleSoft takes no responsibility for its use or distribution of any open source or shareware software or documentation and disclaims any and all liability or damages resulting from use of said software or documentation.

Table of Contents

System Setup	1
Setting Up Your System for Localization	1
Setting Up User Display Preferences	1
Setting Up User Defined Codes - Austria	3
User Defined Codes for International Payment Instructions (IPI)	4
Setting Up User Defined Codes for Intrastat Reporting	5
Setting Up an Alternate Chart of Accounts	13
Setting Up Commodity Code Information	15
Entering Cross-References for Items and Suppliers	16
Validating Tax ID Numbers	17
Additional Information	19
Data Integrity and the Chart of Accounts	19
Multiple Ledger Types	20
Translation Considerations for Multilingual Environments	21
Translation Routines	23
J.D. Edwards Multicurrency Solution Summary	23
International Bank Account Numbers	26
Automatic Debits	28
Working with Automatic Debits for Austria	30
Processing Options for Austrian Bank Diskette Format and Statement (R03B575AD)	31
Creating and Processing a Batch of Automatic Debits	31
Processing Options for Process Auto Debits (P03B571)	33
Processing Options for Create Automatic Debit Batch (R03B571)	34
Approving and Posting Automatic Debit Batches	43
Formatting a Batch of Automatic Debits	44
Transferring Automatic Debit Batches to the Bank	45
User Defined Codes for Transferring Automatic Debit Batches	46
Processing Options for Copy Bank File to Diskette (P0457D)	48
Purging a Batch of Automatic Debits	51
Printing Invoices With an Attached International Payment Instruction (IPI)	53
Processing Options for Invoice Print with International Payment Instruction (R03B5053)	54
Automatic Payment Processing	62
Setting Up Bank Account Information	63
Working with Payment Instruments	72
Working with Austrian Payment Formats	73
Setting Up Payment Instruments	77
Creating Payment Control Groups	85

Next Numbers for Create Payment Control Groups	88
Processing Options for Create Payment Groups (R04570)	88
Data Sequence for Create Payment Control Groups	103
Working with Payment Groups.....	104
Printing the Payment Analysis Report	106
Reviewing Payment Groups	106
Reviewing Payments with a Write Status	107
Reviewing Payments with an Update Status	110
Revising Unprocessed Payments.....	111
Working with Automatic Payments.....	115
Writing Payments.....	115
Record Reservation for Payments.....	117
Payment ID Using Next Numbers.....	117
Resetting Payment Processing	121
Removing Processed Payments	122
Copying Payments to Tape	123
Updating the Accounts Payable Ledger	129
Processing Options for Work with Payment Groups (P04571)	131
General Ledger Accounting	140
Reviewing Account Ledgers by Object Account.....	140
Reviewing Account Ledgers by Category Code	143
Processing Options for Account Inquiry by Category Code (P09202)	145
Reviewing Alternate Account Information	147
Additional Reporting for Austria	150
Working with European Union Reporting	150
Intrastat Requirements	150
Intrastat Reporting and the Euro	152
Updating Intrastat Information	152
Revising Intrastat Information.....	161
Purging Records from the Intrastat Table	163
Printing the Intrastat Report - Austria	165
Using the IDEP/IRIS Interface for Intrastat Reporting	166
Working with the EC Sales List	180
Working with the Text File Processor.....	190
Copying Text in the Text File Processor.....	191
Importing Text Using the Text File Processor	195
Resetting a Text Batch in the Text File Processor	196
Purging a Text Batch in the Text File Processor	196

System Setup

Before you use J.D. Edwards software, you must set up and define certain information that the system uses during processing. You use this information to customize the system for your business needs.

Setting Up Your System for Localization

You must complete the system setup tasks that are included in the base guides, as well as country-specific tasks.

Setting Up User Display Preferences

Some of J.D. Edwards localized software uses country-server technology to isolate country-specific features from the base software. For example, if during normal transaction processing, you record additional information about a supplier or validate a tax identification number to meet country-specific requirements, you enter the additional information using a localized program; and the tax validation is performed by a localized program instead of by the base software. The country server indicates that this localized program should be included in the process.

To take full advantage of J.D. Edwards localized solutions for your business, you must set up your user display preferences to specify the country in which you are working. The country server uses this information to determine which localized programs should be run for the specified country.

You use localization country codes to specify the country in which you are working. J.D. Edwards supplies localization country codes in user defined code table 00/LC. This table stores both two-digit and three-digit localization country codes. In addition, the Description 02 field contains the localization tier for each country. The localization tier determines the level of support that J.D. Edwards provides for that country.

You can also set up user display preferences to use other features in J.D. Edwards software. For example, you can specify how the system displays dates (such as DDMMYY, the typical European format) or specify a language to override the base language.

See Also

- ❑ *International Product Handbook* for more information about J.D. Edwards localization tier classifications and policies

► To set up user display preferences

From the System Administration Tools menu (GH9011), choose User Profiles.

1. On Work With User / Role Profiles, click Find to locate a user profile.
You can complete fields on the QBE line to limit your search.
2. Choose a record and click Select.

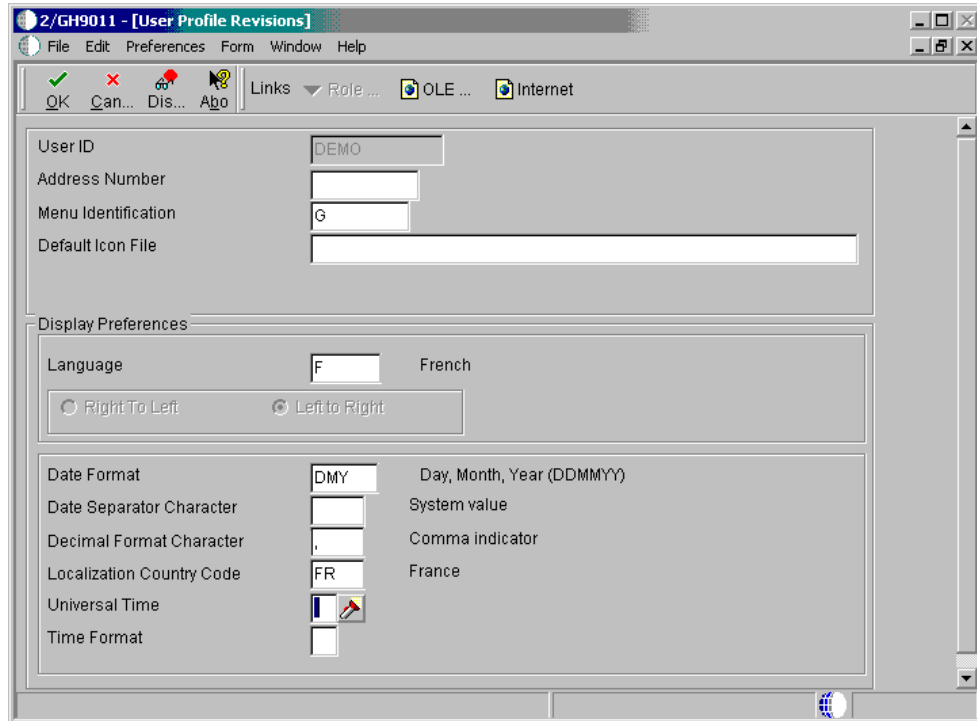

3. On User Profile Revisions, complete the following field:
 - Localization Country Code
4. Complete the following optional fields:
 - Language
 - Date Format
 - Date Separator Character
 - Decimal Format Character
5. Click OK.

See Also

- *User Profiles* in the *System Administration Guide*

Processing Options for User Profiles (P0092)

A/B Validation

Enter a '1' to enable editing on address book number against the F0101.

Setting Up User Defined Codes - Austria

From the System Administration Tools menu (GH9011), choose User Defined Codes.

Many fields throughout the J.D. Edwards software accept only user defined codes. You can customize your system by setting up user defined codes that meet the specific needs of your business environment.

Caution

User defined codes are central to J.D. Edwards systems. You should be thoroughly familiar with user defined codes before you change them.

See Also

- ❑ *Customizing User Defined Codes* in the *Foundation Guide* for more information about user defined codes

Bank Type Code (00/BT) - Austria

You assign bank type codes (00/BT) to set up multiple bank accounts for suppliers. When you assign codes to bank types, you can use any code except those that are hard-coded in the system, such as types V, C, D, P, G, M, and B.

You must set up a bank type code for the system to determine banking information.

Note

You must also set up user defined code list 01/W0.

See Also

- ❑ *Setting Up Multiple Bank Accounts for Suppliers* in the *Accounts Payable Guide*

Payment Instrument (00/PY) – Austria

Set up user defined codes to identify each payment instrument that you use. You can associate payment instruments with documents so that you can process similar documents together. For example, you might set up payment instruments for automatic debits and automatic receipts.

In addition, you can associate a payment instrument with a bank account and with a print program to generate a check or a bank file.

See Also

- ❑ *Working with Austrian Payment Formats* in the *Global Solutions Austria Guide*

Produce Bank File (04/PP) - Austria

For each of the print or tape programs that you use to write payments, set up a user defined code. The following print and tape program is available for Austria:

- P04572A, Produce EFT Diskette – Austria

Type Code (01/W0) – Austria

You must set up a type code so that the system can determine contact information for the bank.

Note

You must also set up user defined code list 00/BT.

User Defined Codes for International Payment Instructions (IPI)

Most of the values for the UDCs for International Payment Instructions are hard-coded. However, you must set up values for the IPI - Languages and Countries (00/IL) UDC table.

IPI – Languages and Countries (00/IL)

International Payment Instructions (IPIs) must be printed in English, but they can also contain a second language. You specify the secondary language by setting up a value in the IPI - Languages and Countries UDC table (00/IL). Some countries require that you print IPI forms with a secondary language; for some countries, the use of a secondary language is optional. The European Committee for Banking Standards publishes the requirements for IPIs.

When you set up the IPI – Languages and Countries UDC, you complete the Special Handling field with a value from the Language (01/LP) UDC table. The system uses the value in the Special Handling field to determine the secondary language that prints on the IPI form. If you do not want the system to print a secondary language on the IPI form, set the Special Handling code for a country to E (English). Generally, you use the language of the country where your customer's bank is located.

You can set up only one language per country. For example, for banks in Belgium, you must specify a secondary language; but you can choose to use French, German, or Dutch. In the 00/IL UDC, you can set up only one of those languages for Belgium; you cannot set up a value for each language. The graphic below shows the secondary language preference for Belgium to be French.

The following table shows examples of the languages that you can set up for countries:

Codes	Description 01	Description 02	Special Handling
AT	Austria	O - German	G
BE	Belgium	R – French, Dutch, or German	F
CH	Switzerland	O – German, French, or Italian	F

Codes	Description 01	Description 02	Special Handling
DE	Germany	R – German	G
DK	Denmark	Unspecified – Danish	DN
ES	Spain	R – Spanish	S
FI	Finland	R – Finnish and Swedish	FN
FR	France	R – French	F
GB	United Kingdom	NA	E

IPI – Address Line Sequencing (00/IA)

The IPI - Address Line Sequencing UDC table (00/IA) determines the combination of the values for the Postal Code, City, and Country that the system includes as the second address line of the ordering customer's address on the International Payment Instruction (IPI).

These values are hard-coded and consistent with the requirements for IPIs. The European Committee for Banking Standards publishes the requirements for IPIs.

IPI – Charges Paid By (00/IC)

The IPI – Charges Paid By UDC table (00/IC) contains values that specify the entity who is responsible for paying the bank charges that are associated with the International Payment Instruction (IPI). These values are hard-coded and consistent with the requirements for IPIs. The European Committee for Banking Standards publishes the requirements for IPIs.

IPI – Form Types (00/IF)

The IPI – Form Types UDC table (00/IF) contains hard-coded values that represent the types of pre-formatted International Payment Instruction (IPI) forms that are available to use. The values in this UDC are consistent with the requirements for IPIs. The European Committee for Banking Standards publishes the requirements for IPIs.

IPI – Details of Payment (00/IP)

The IPI – Details of Payment UDC table (00/IP) determines the data that appears in the Details of Payment section on the International Payment Instruction (IPI). These values are hard-coded and are consistent with the requirements for International Payment Instructions (IPI). The European Committee for Banking Standards publishes the requirements for IPIs.

Setting Up User Defined Codes for Intrastat Reporting

Many fields throughout J.D. Edwards systems accept user defined codes as valid values. You must set up several user defined codes to provide valid information for Intrastat reporting.

Caution

User defined codes are central to J.D. Edwards systems. You should be thoroughly familiar with user defined codes before you change them.

See Also

- *User Defined Codes* in the *Foundation Guide* for more information about setting up and using user defined codes

Country Codes (00/CN)

You must specify a country code in the Address Book records for your branch/plants, customers, and suppliers.

The following table shows examples of country codes:

Codes	Description 01	Special Handling
AE	United Arab Emirates (UAE)	784
AF	Afghanistan	004
AG	Antigua and Barbuda	028
AR	Argentina	032
AT	Austria	040
AU	Australia	036

To find the country code for your branch/plants, the system searches for records based on the address number in the Inventory Constants table (F41001). If no address number is specified, the system uses the address number that is specified in the Business Unit Master table (F0006).

Transaction eligibility for Intrastat reporting is based on the country of the customer or supplier, the country of origin of the goods, and the country of the declarant.

Caution

Do not use blank as your default country code. You must use a nonblank country code on your address book records for the country code to be included on Intrastat reports.

State and Province Codes (00/S)

For countries that require regional information, such as Germany, use the State field on the Address Book record to specify the region. Set up state and province codes to identify the region of origin for shipments or the region of destination for purchases.

The system searches for Address Book records based on the address number in the Inventory Constants table (F41001). If no address number is specified, the system uses the address number specified in the Business Unit Master table (F0006).

The following table shows examples of state and province codes:

Codes	Description
*	All states
AB	Alberta
AI	Arctic Islands
AK	Alaska
AL	Alabama
AM	Amazonas
AR	Arkansas

European Community Members (74/EC)

Only transactions between European Union (EU) members are included in the Intrastat Revision table (F0018T). Verify that a one-to-one relationship exists between the country codes that you set up in UDC 00/CN and the country codes for all EU countries on user defined code table 74/EC. When you run the Intrastat update programs, the system cross-references the country codes that you specify for customers, suppliers, and branch/plants in user defined code table 00/CN to the codes in 74/EC.

The following table shows examples of EU country codes:

Codes	Description 01
AT	Austria
BE	Belgium
BL	Belgium and Luxembourg
DE	Germany
DK	Denmark
ES	Spain
FI	Finland
FR	France
GB	Great Britain

Nature of Transaction Codes

Use Nature of Transaction codes to identify the type of import and export rules to which an item is subject. The import and export rules depend on the way that a product is moved; whether it is for sales, purchases, leases; or other reasons.

You can set up nature of transaction codes specifically for EU reporting on user defined codes table 74/NT, or you can use the user defined codes tables from the Inventory systems

(specifically, 41/P1–P5 and 41/S1–S5). You can also create your own user defined codes table to store nature of transaction codes.

When you update the Intrastat Revision table (F0018T), you use a processing option to specify the user defined codes table that you want the system to use to find the applicable information.

See Also

- *Updating Intrastat Information in the Global Solutions Spain Guide*

Nature of Transaction – EU (74/NT)

Use Nature of Transaction (74/NT) to set up nature of transaction codes specifically for EU reporting.

Set up user defined codes table 74/NT as follows:

- Use the Codes field to enter a concatenated value to identify the nature of transaction. Concatenate the following values in sequence without any separators, such as commas or spaces:
 Company Number, Order Document Type, Line Type
- Enter the nature of transaction code in the Description 02 field.
- Enter the nature of VAT regime (statistical procedure) in the Special Handling field, if required.

The following table shows examples of nature of transaction codes:

Codes	Description 01	Description 02
00100XIS	Export to Customer	16
00100COC	Credit to Customer	16
00100SOS	Stock Inv Item	10
00100X2S	Transfer from Branch	10
00200SOS	Stock Inv Item	11
00200X1S	Export to Customer	16
00200X2S	Transfer from Branch	11

When you update the Intrastat Revision table (F0018T), you use a processing option to specify the user defined codes table that you want the system to use to find the applicable information.

Sales Reporting Codes 01 through 05 (41/S1 through 41/S5)

Use Sales Reporting Codes 01 through 05 (41/S1 through 41/S5) to set up nature of transaction codes specifically for sales order transactions. Using these UDC tables to indicate the nature of transaction for the item is an alternative to using UDC 74/NT to indicate the nature of transaction.

You can designate any one of the five sales reporting codes to specify the nature of transaction for individual items. You must indicate the reporting code that you are using for nature of transaction in the processing options for the Intrastat – Tax Update - Sales program

(R001811). The reporting code that you specify in these processing options should correspond to the reporting code that you use to identify the nature of transaction for the item in the Item Master program (P4101). Enter 1 for table 41/S1, 2 for table 41/S2, and so on.

The following table shows examples of sales reporting codes:

Codes	Description 01
APP	Apparel Section
AVA	Aviation
COM	Commuter Bike Section
MNT	Mountain Bike Section
SAF	Safety Equipment Section
TRG	Touring Bike Section

When you update the Intrastat Revision table (F0018T), you use a processing option to specify the UDC that you want the system to use to find the applicable information.

Purchasing Reporting Codes 01 through 05 (41/P1 through 41/P5)

Use Purchasing Reporting Codes 01 through 05 (41/P1 through 41/P5) to set up nature of transaction codes specifically for purchase order transactions. Using these UDC tables to indicate the nature of transaction for the item is an alternative to using UDC 74/NT to indicate the nature of transaction.

You can designate any one of the five purchasing reporting codes to specify the nature of transaction for individual items. You must indicate the reporting code that you are using for nature of transaction in the processing options for the Intrastats Tax Update - Purchasing program (R001812). The reporting code that you specify in these processing options should correspond to the reporting code that you use to identify the nature of transaction for the item in the Item Master program (P4101). Enter 1 for table 41/P1, 2 for table 41/P2, and so on.

The following table shows examples for purchase reporting codes:

Codes	Description 01
	Blank – Commodity Class 41/P1
A	Aluminum
B	Brass
C	Copper
DRG	Drugs-Pharmaceutical
ELC	Electrical

When you update the Intrastat Revision table (F0018T), you use a processing option to specify the UDC you want the system to use to find the applicable information.

Intrastat Regime Code (00/NV)

Use the Intrastat Regime UDC to set up the Nature of VAT Regime codes. The Nature of VAT Regime code is similar to the nature of transaction code (NAT) and is applicable only to certain countries. Nature of VAT Regime is commonly used in France.

Caution

If the reporting requirements for your country do not include Nature of VAT Regime, you must add a blank code to UDC 00/NV to prevent errors in the Intrastat Revision table (F0018T).

The following table shows examples of Intrastat regime codes:

Codes	Description 01
10	Permanent export
11	Permanent export after rework
21	Temporary export
22	Temporary export after rework

Shipping Commodity Class (41/E)

Use Shipping Commodity Class codes (41/E) to further identify the products that your company imports or exports.

To comply with Intrastat guidelines, commodity codes must have a corresponding commodity value.

For B73.3.1 and later releases, use the Intrastat Commodity Code form to set up commodity values and supplemental units of measure for commodity codes.

The following table shows examples of shipping commodity classes:

Codes	Description 01
	Blank – Shipping Comm Class 41/E
CSE	Consumer Electronics
FPD	Food Products
LST	Livestock

Condition of Transport (00/TC)

You set up Condition of Transport codes (user defined code 00/TC) to indicate how goods are transported.

You must set up values in UDC 00/TC that correspond to the first three characters of the values that you set up in the Description 02 field in the Freight Handling Code UDC table (42/FR). For example, if you set up a value in UDC 42/FR for Carriage, Insurance, and Freight and use CIF as the value in the Description 02 field, you must set up a code of CIF in UDC 00/TC.

You can set up default conditions of transport using the Supplier Master program (P04012). Enter the condition of transport in the Freight Handling Code field. When you enter purchase orders, this information appears in the purchase order header fields.

The following table shows examples of condition of transport codes:

Codes	Description 01
CIF	Carriage, Insurance, Freight
DDP	Delivered Duty Paid
DDU	Delivered Duty Unpaid
EXW	Ex Works
FOB	Free on Board

Mode of Transport (00/TM)

You set up codes for the modes of transport on user defined codes table 00/TM (Mode of Transport). The first eight code values are predefined for EU trade reporting.

The following table shows examples of mode of transport codes:

Codes	Description 01
1	Transport by sea
2	Transport by rail
3	Transport by road
GRD	Ground Service
LTL	Less than Truckload
NDA	Next Day Air

The fifth position of the Description 02 field of the Freight Handling Code UDC (42/FR) is used to indicate the mode of transport; it corresponds to the values in UDC 00/TM. To assign a default mode of transport to a supplier, complete the Freight Handling Code field on the Supplier Master Revision form of the Supplier Master program (P04012). Setting up a supplier in this way causes freight handling and mode of transport information to appear by default in purchase order header fields.

Freight Handling Code (42/FR)

You use freight handling codes to identify various freight information. To comply with EU requirements, modify your freight handling codes to include the codes that you set up for the Condition of Transport, Condition of Transport extension, and Mode of Transport tables. For this action, enter the codes for the conditions of transport, conditions of transport extension, and the modes of transport in the second description field for the table.

Note

You must set up one freight handling code line in UDC 42/FR for each separate combination of Condition of Transport, Condition of Transport extension, and Mode of Transport tables.

The Description 02 field allows up to 15 characters. When you modify freight handling codes, use the first three characters in the field to specify the conditions of transport. Use the 4th character to indicate the COTX extension (the code for the place indicated in the contract of transport). The COTX extension is required only in certain countries. Enter the code for mode of transport as the fifth character of the second description.

Note

You should define the codes that indicate the various conditions and modes of transport on their respective user defined code tables, in addition to indicating the conditions and modes of transport on the freight handling codes. If the conditions and modes of transport are not defined in their respective tables, you receive an error when you try to modify the condition or mode of transport in the Intrastat Revision table (F0018T).

For IDEP, the Incoterms field accepts only the following valid values:

- C - Main transportation expenses paid (CFR, CIF, CPT, CIP)
- D - Arrival (DAF, DES, DEQ, DDU, DDP)
- E - Depart (EXW)
- F - Main transportation not paid (FCA, FAS, FOB)

For IDEP, set up UDC 42/FR with these codes, rather than the standard transport conditions, in the first three positions of Description 02.

The following table shows examples of freight handling codes:

Codes	Description 01	Description 02	Special Handling
A	Free Alongside Ship	FAS	
BRR	Bypass Routing and Rating		9
C	Freight Collect		1
D	Delivered, Duty Paid	DDP	
F	Freight On Board – Our Dock	FOB	
FP	Freight Pre-pay and Add		

Arrivals or Dispatchings (74/TD)

If you use the SEMDEC interface for Intrastat submissions, set up a user defined code for each document type that is used in Intrastat transactions to indicate whether the document type corresponds to the arrival (purchase) or dispatch (sale) of goods.

To set up user defined code list 74/TD, enter the same codes in the Codes field that you use for document types on user defined code list 00/DT. The Description 01 field must contain either "Arrival" or "Dispatch." The system uses user defined code list 74/TD, in conjunction with user defined code list 00/DT, to determine whether the transaction represents the arrival or dispatch of goods for Intrastat reporting purposes. You need to include only those document types that are used in sales or purchasing on user defined code list 74/TD.

Note

If you do not set up user defined code list 74/TD, the system assumes that all sales are dispatches and that all purchases are arrivals.

Intrastat Declaration Type (74/IT)

Set up user defined code 74/IT to specify whether your IDEP declaration is fiscal, statistical, or complete.

The following table shows examples of Intrastat declaration type codes:

Codes	Description 01	Special Handling
1	Fiscal	F
2	Statistical	S
3	Complete	C

You specify the character that the system uses to populate the Intrastat declaration in the special handling code for each value. The code specified in the special handling code is written to the text field in the Text Processor Detail Table (F007111) when you process the IDEP/IRIS Interface (R001813). This special handling code is also used to determine the VAT registration number for sales transactions. For statistical declarations, the system uses the Ship To - Address Number. For fiscal or complete declarations, the system uses the Sold To - Address Number.

The default value is 3 (complete).

Triangulation Tax Rates (00/VT)

If you use the VAT EC Sales List (R0018S), you must list the tax rates that are used for trade triangulation transactions. Transactions that use any of the tax rates that are listed on this UDC are flagged as trade triangulation transactions on the EC Sales List - A/R.

Setting Up an Alternate Chart of Accounts

You can set up an alternate chart of accounts if your corporate reporting requirements are different from the local reporting requirements of the country in which you are doing business. For example, if you set up the local chart of accounts by object and subsidiary, but you need to provide fiscal reports that reflect a different chart of accounts, you can set up and maintain an alternate chart of accounts in Category Codes 21, 22, and 23.

In the Account Master table (F0901), you can define the local chart of accounts by object and subsidiary, or in Category Codes 21, 22, and 23. The location that you choose might depend on the use of your corporate chart of accounts, especially if your company is multinational.

Whether you define the local chart of accounts by object and subsidiary, or in Category Codes 21, 22, and 23, the accounts that you set up in the category codes are referred to in J.D. Edwards software as alternate descriptions of your accounts.

The software identifies individual accounts in your chart of accounts based on a system-assigned number that is unique for each account. This number is called the Account Short ID.

The Account Short ID is the key that the system uses to distinguish between accounts when you access, change, and delete the account information in any of J.D. Edwards tables. The system stores the short identification number in data item AID.

If you are using the Business Units program (P0006) to create a chart of accounts based on a model, the system copies any alternate chart of accounts that is associated with the model, in addition to copying the standard chart of accounts.

► **To set up an alternate chart of accounts**

From the Organization and Account Setup menu (G09411), choose Revise and Review Accounts.

1. On Work With Accounts, complete the following optional field and click Find:

- Company

You can customize the detail area by creating an alternate format to display the alternate chart of accounts (Category Codes 21, 22, or 23) next to the main chart of accounts (Object Account).

2. Click Add to access Revise Single Account.

The screenshot shows the PeopleSoft interface for the 'Revise Single Account' form. The form is titled 'Revise Single Account' and is part of the 'Active Foundation' workspace. The 'Account Number' field is populated with '70.1110.FRANCE' and the description is 'First Bank of Paris'. The 'Business Unit/Object/Subsidiary' field is populated with '70', '1110', and 'FRANCE'. The 'Description' field is populated with 'First Bank of Paris'. The 'Account Level of Detail' field is set to '7'. The 'Posting Edit' field is empty. The 'Budget Pattern Code' field is empty. The 'Model Account/Consolidations' field is empty. The 'Currency Code' field is empty. The 'Account ID' field is populated with '00019641'. The form is divided into sections for 'Revise Single Account', 'Category Codes 1-10', 'Category Codes 11-20', and 'Category Codes 21-23'.

3. On the Revise Single Account tab, complete the following fields:

- Business Unit/Object/Subsidiary
- Description
- Account Level of Detail

- Posting Edit
 - Budget Pattern Code
 - Currency Code
 - Account ID
4. Click the Category Codes 21–23 tab.
 5. On the Category Codes 21–23 tab, complete the following fields and click OK:
 - Category Code 21
 - Category Code 22
 - Category Code 23

Note

In China, use only Category Code 21.

See Also

- *Data Integrity and the Chart of Accounts* in the *Global Solutions Spain Guide* for more information about maintaining an alternate chart of accounts

Setting Up Commodity Code Information

European Union requirements state that you must identify the products that are exported from or introduced to your country. You use commodity codes to comply with that requirement.

Commodity codes must have a corresponding commodity value. For release B73.3.1 and later releases, you set up this information on the Intrastat Commodity Code form.

Commodity code information is stored in the Intrastat Commodity Code Additional Information table (F744102).

Before You Begin

- Set up shipping commodity class codes on UDC 41/E. See *Setting Up User Defined Codes for Intrastat Reporting* in the *Global Solutions Spain Guide*.

► To set up commodity code information

From the Set Up menu (G74STAT4), choose Commodity Codes.

1. On Work With Intrastat Commodity Code, click Add.
2. On Intrastat Commodity Code, complete the following fields:
 - Shipping Commodity Class

- Commodity Code
 - Description
3. Complete the following optional fields if they pertain to the commodity code:
 - Supplementary UOM
 - Volume Conversion Factor

Enter the density of the product in the Volume Conversion Factor field only if the product is typically measured in liquid volume but needs to be reported in kilograms. The system multiplies the volume of the product by the density that you enter to calculate the mass of the product.

The Include on VAT or Statistics field is for future use for the United Kingdom.
 4. Click OK.

Entering Cross-References for Items and Suppliers

An important element of including purchases on Intrastat reports is tracking the country of origin of goods. In some countries, Intrastat reports must contain the country of origin and the original country of origin for each item.

For example, a German company might place a purchase order with a French supplier for goods manufactured in France. These goods are stored in a warehouse in Belgium, so the actual delivery comes from Belgium. The country of origin is Belgium, but the original country of origin is France.

Depending on your business and your suppliers, you might need to set up a more advanced relationship among the supplier, the item, and the country of origin. You can cross-reference the following information in the Intrastat Item/Supplier Cross Reference program (P744101):

- Supplier
- Item
- Country of origin
- Original country of origin

The Supplier and Item Cross Reference program stores information in the Intrastat Supplier/Item Cross Reference Table (F744101). The Intrastats – Update - Purchasing program (R001812) retrieves the cross-referenced information if you specify in the processing options to use table F744101.

Note

The system retrieves the country of origin from the address book record of the supplier. The supplier's country of origin can be overridden when you update the Order Address Information table (F4006) for an individual order. If necessary, you can override the country of origin in the Country of Origin field (ORIG) in table F744101 and by specifying in the processing options of the Intrastats – Update - Purchasing program (R001812) to use table F744101.

The system uses the Country of Origin field (ORIG) to determine transaction eligibility for Intrastat reporting. The Original Country of Origin field (ORGO) is for information only.

Note also that in the United Kingdom, country of origin is called country of consignment and original country of origin is called country of origin.

► To enter a cross reference for items and suppliers

From the Set Up menu (G74STAT4), choose Supplier and Item Cross Reference.

1. On Work With Intrastat Cross Reference, click Add.
2. On Intrastat Cross Reference, complete the following fields, and then click OK:

- Item Number

You can enter *ALL in the Item Number field to indicate that all items for the supplier come from the specified country of origin and original country of origin.

- Address Number

You can enter *ALL in the Address Number field to indicate that the item always comes from the specified country of origin and original country of origin, regardless of supplier.

When the system searches for a specific record in the Intrastat Supplier/Item Cross Reference Table (F744101), it first searches for a record that matches the Item Number and Address Number. If no record is found, the system searches for a record that matches the Address Number with an Item Number of *ALL. If no record is found, the system then searches for a record that matches the Item Number with an Address Number of *ALL.

- Country of Origin
- Original Country of Origin

See Also

- *Updating Intrastat Information* in the *Global Solutions Spain Guide* for information about building the Intrastat Revision table (F0018T)

Validating Tax ID Numbers

A tax ID is the identification number that you use when you report information to the various tax authorities. For every transaction that can occur with a company, a customer, or a supplier, you must enter an associated tax identification number. Tax IDs are also called VAT codes, VAT registration numbers, or fiscal codes.

To export goods free of value-added tax (VAT), you must have the tax ID or VAT registration number of your customers in other EU countries, and you must send your own tax ID or VAT registration numbers to your suppliers. The length and format of these numbers vary by country.

When you create an address book record for each company, customer, or supplier, enter the tax ID number in the Tax ID field on the Address Book Revision form. To ensure that the tax

ID that you enter is checked for authenticity, enter a country code from UDC table 00/CN in the Country field on the Mailing tab on the Address Book Revision form. When a country code is on the Mailing tab, the system validates tax IDs for that country.

The system only validates the tax ID if the country code that you have specified is set up and activated for validation in UDC table 70/TI.

Activating Tax ID Validation

You activate tax ID validation routines for specific countries by setting up country codes in UDC table 70/TI.

The following table shows examples of country codes:

Codes	Description 01	Description 02	Special Handling
	Default Country	US	1
AU	Austria	AU	1
AUS	Austria	AU	1
BE	Belgium	BE	1
BEL	Belgium	BE	1
DE	Germany	DE	1
DEU	Germany	DE	1

To turn on tax ID validation for a specific country code, enter 1 in the Special Handling field for that country code. To turn off tax ID validation for a specific country code, remove the 1 from the Special Handling field.

To activate tax ID validation for a country code that is not listed in UDC table 70/TI or to change the meaning of an existing country code, complete the fields as follows:

1. Enter the country code in the Codes field.
2. Enter the standard two-digit ISO code for that country in the Description 02 field.

The two-digit ISO code is required in the Description 02 field to cross-reference the new country code with the country code that is hard-coded in the J.D. Edwards system.

For example, if you use DE for Denmark, enter DN (the two-digit ISO code for Denmark) in the Description 02 field for the DE country code. The system then validates tax IDs that are entered with the country code DE according to Danish, not German, specifications.

3. Enter 1 in the Special Handling field.

To activate tax ID validation for the default (blank) country code, complete the fields as described above, but leave the Codes field blank.

For example, if you use a blank country code to mean Denmark, enter DN (the two-2-digit ISO code for Denmark) in the Description 02 field for the blank country code.

Example: Tax ID or VAT Registration Number for Austria

Country
ID
□
AU 440 6704

See Also

- *Working with Address Book Records in the Address Book Guide*

Additional Information

This section provides additional information about setup issues, technical considerations, and system use.

Data Integrity and the Chart of Accounts

In addition to the corporate chart of accounts that you set up in the Account Master table (F0901), you can define an alternate chart of accounts using category codes 21, 22, and 23.

Account Defined Only in the Account Master Table

You might create an account in the Account Master table (F0901) without defining a corresponding alternate account. If you do, when transactions are entered for the account in the F0901 table, any reporting measures that are based on the alternate chart of accounts are incomplete.

J.D. Edwards recommends that you establish an internal procedure to audit the integrity of the data entered. For example, you can run a Financial Enterprise Report Writer (Financial ERW) report that provides the following information to verify that the alternate accounts correspond to the accounts in table F0901:

Ledger Type (AA Actual Amounts)	DR	CR
Total Alternate Accounts (A)	DR	CR
Total Other or Corporate Accounts (B)	DR	CR
General Total (A + B)	DR	CR

Run the report on a daily or weekly basis, depending on the volume of your transactions.

Account Defined Only in the Alternate Chart of Accounts

You might create an alternate account using category codes 21, 22, and 23 without defining a corresponding account in the Account Master table (F0901).

In this case, no actual transactions can be entered for the account. In J.D. Edwards software, you cannot enter accounts with an alternate account number.

Security on the Alternate Chart of Accounts

You can secure both your local chart of accounts (defined by object and subsidiary) and your alternate chart of accounts (defined in category codes 21, 22, and 23) by using the processing options on any of the account master programs (P0901). If you secure your accounts in this way, you cannot change account numbers in the category code that you secured. For example, if you secure category code 21, you cannot change the value of category code 21 on any account.

Caution

You should secure your chart of accounts after the account structure is well defined. J.D. Edwards recommends that you then restrict access to the processing options so that the security is not compromised.

If you use the Change Account Information program (R09813) and want to maintain the integrity of your alternate chart of accounts, you should exclude the category code that contains your alternate account from the global update. To exclude a category code, verify that the processing option for that category code does not contain a 1. The processing options for category codes are located on the Account Info tab.

Account Deleted from the Category Code Tables

From the category code tables (UDCs 09/21 through 09/23), you might delete an alternate account that has active transactions and balances. When you take this action, the system does not display an error message to indicate that active transaction information is attached to the account.

Caution

J.D. Edwards recommends that you establish an internal procedure to restrict the access to user defined codes tables to a few individuals who are responsible for system setup. These individuals should understand how category codes and accounts are related.

See Also

- *Setting Up an Alternate Chart of Accounts in the Global Solutions International Guide*

Multiple Ledger Types

International businesses can use multiple ledgers to fulfill the reporting requirements of both the corporate entity and the local legal authorities.

During the first few days of January, your company reports the yearly results for the previous year. However, in France, for example, the law specifies that the company has until March to report fiscal activity to the authorities. From January 1 until the time that the French company reports fiscal activity, the year is closed from the standpoint of the company; but it is not yet

closed from a local legal standpoint. The time difference means that the French company must make adjustments for three months to report transactions in the correct year. These adjustments do not have to appear in the corporate ledger. These adjustments are typically recorded in an alternate ledger type.

Currency Ledgers

A company might impose a fixed yearly exchange rate by management choice. In some countries, such as France, ignoring gains and losses in foreign currency is illegal. You can use the actual amounts (AA) ledger for foreign transactions that do not have any currency gains and losses, and use an alternate ledger type to record the currency gains and losses. In either case, the additional ledger is required to enter transactions that adjust either the local or the company's accounting system.

Depreciation Ledgers

Three ledger types are common when fixed assets depreciation is involved. In this case, you use one ledger to record the depreciation that is calculated with the corporate depreciation method in the corporate ledger. You use an alternate ledger to record the depreciation that is calculated using the depreciation method that is required by the local authorities. The difference between the two depreciation methods is recorded in a third ledger. For local legal reports, you sum the three ledger types to show the actual activity in the depreciation account.

User Defined Ledgers

To accommodate the need for multiple ledgers, J.D. Edwards software provides UDC 09/LT in which you can define all of the ledgers that you use as the ledger types on which you must report.

The AA ledger is the company's standard ledger. The alternate ledgers contain the adjusting transactions that justify the differences between the company books and the local legal books. You can specify ledger types in the processing options for the reports. An inquiry or a report on the account shows the sum of the two ledger types, and displays the actual activity in that account.

Translation Considerations for Multilingual Environments

J.D. Edwards software can display menus, forms, and reports in different languages. All software is shipped with the base language of English. You can install other languages as needed. For example, if you have multiple languages installed in one environment to allow different users to display different languages, each user can work in his or her preferred language by setting up his or her user preferences accordingly.

In addition to the standard menus, forms, and reports, you might want to translate other parts of the software. For example, you might want to translate the names of the accounts that you set up for your company or translate the values in some UDCs.

You might want to translate the following common software elements if you use the software in a multinational environment:

Business Unit Descriptions	<p>You can translate the descriptions of the business units that you set up for your system.</p> <p>The system stores translation information for business units in the Business Unit Alternate Description Master table (F0006D).</p> <p>Print the Business Unit Translation Report (R00067) to review the description translations in the base language, and one or all of the additional languages that your business uses.</p>
Account Descriptions	<p>You can translate the descriptions of your accounts into languages other than the base language.</p> <p>After you translate your chart of accounts, you can print the Account Translation report. You can set a processing option to show account descriptions in both the base language, and one or all of the additional languages that your business uses.</p>
Automatic Accounting Instruction (AAI) Descriptions	<p>You can translate the descriptions of the automatic accounting instructions (AAIs) that you set up for your system.</p>
UDC Descriptions	<p>You can translate the descriptions of the UDCs that you set up for your system.</p>
Delinquency Notice Text	<p>Specify a language preference for each customer when you create customer master records. The language preference field on the Address Book - Additional Information form determines the language in which the delinquency notice and the text on the notice should appear when you use final mode. (In proof mode, the statements print in the language preference that is assigned to the client in the Address Book.)</p> <p>J.D. Edwards base software includes the delinquency notice translated into German, French, and Italian. You should translate any text that you add to the bottom of the notice. To do this translation, follow the instructions for setting up text for delinquency notices, and verify that you have completed the Language field on the Letter Text Identification form.</p>

The translations that you set up for your system also work with the language that is specified in the user profile for each person who uses the system. For example, when a French-speaking user accesses the chart of accounts, the system displays the account descriptions in French, rather than in the base language.

See Also

- ❑ *Setting Up User Display Preferences* in the *Global Solutions China Guide* for information about setting up language preferences for users
- ❑ *Translating User Defined Codes into Alternate Languages* in the *Foundation Guide* for information about translating user defined codes

- ❑ *Translating Business Units* in the *General Accounting Guide* for information about translating business units
- ❑ *Translating Accounts* in the *General Accounting Guide* for information about translating accounts
- ❑ *Setting Up Letter Text for Delinquency Notices and Statements* in the *Accounts Receivable Guide*

Translation Routines

J.D. Edwards provides several translation routines to convert amounts to words. These translation routines are generally used by payment formats, draft formats, and check-writing programs that produce numerical output in both numeric and textual form. You specify the translation routine that you want to use in the processing options for these programs.

J.D. Edwards provides the following translation routines:

- X00500 - English
- X00500BR - Brazilian Portuguese
- X00500CH - Chinese
- X00500D - German (mark)
- X00500ED - German (euro)
- X00500FR - French (franc)
- X00500EF - French (euro)
- X00500I - Italian (lira)
- X00500EI - Italian (euro)
- X00500S1 - Spanish (female)
- X00500S2 - Spanish (male)
- X00500S3 - Spanish (female, no decimal)
- X00500S4 - Spanish (male, no decimal)
- X00500S5 - Spanish (euro)
- X00500U - United Kingdom
- X00500U1 - United Kingdom (words in boxes)

In some cases, the translation routine that you use depends on the currency that you are using. For example, if you are converting euro amounts to words, you should use a translation routine that has been set up to handle euro currencies. In Spanish, the gender of the currency determines the translation routine that you choose.

J.D. Edwards Multicurrency Solution Summary

Companies that do business internationally often have additional accounting needs. These needs arise from doing business in different currencies, and following different reporting and accounting requirements for each country in which they do business. To process and report on transactions in multiple currencies, a company that operates internationally can:

- Convert foreign currencies into the local currency

- Convert different local currencies into one currency for reporting and comparisons
- Adhere to regulations that are defined in the countries where the company operates
- Reevaluate currencies due to changes in exchange rates

J.D. Edwards software performs the following multicurrency functions throughout most base applications:

- Converts from one currency to another
- Restates multiple currencies to consolidate into one currency
- Reevaluates currencies due to changes in exchange rates

J.D. Edwards software stores each currency in a different ledger, as illustrated in the following table:

AA ledger	Domestic transactions are posted to the AA ledger.
CA ledger	Foreign transactions are posted to the CA ledger.
XA ledger	Alternate currency transactions, if used, are posted to the XA ledger.

You can designate a specific currency for the following:

- Company
- Account
- Address book record

Data Entry in Foreign or Domestic Currency

You can enter all transactions in the original currency of the documents that you receive or send. You do not need to convert currencies before you enter transactions. For foreign entries, the system automatically converts foreign amounts to domestic amounts.

Setting Up Daily Transaction Rates

You can set up the Currency Exchange Rates table (F0015) to use the following multicurrency features:

Default exchange rates	When you enter a transaction, the system supplies the exchange rate from table F0015.
Exchange rates for individual contracts	You can specify exchange rates for individual customers and suppliers.
Spot rates	You can enter an exchange rate when you enter a transaction. The value that you enter overrides the exchange rate from table F0015.

Intercompany Settlements

You can enter transactions that cross company and currency boundaries. The system automatically generates the multicurrency intercompany settlements.

Gain and Loss Recognition

Features of gain and loss recognition include:

Realized gains and losses Entries that represent realized gains and losses for exchange rates are automatically created at the time of cash receipt or entry.

Unrealized gains and losses You can print a report to analyze open receivables and payables to book unrealized gains and losses at the end of the month. Optionally, you can set up your system to create these entries automatically.

Detailed Currency Restatement

Detailed currency restatement enables you to do the following:

- Maintain a dual set of accounting books:
 - One in the domestic (local) currency
 - One in an alternate, stable currency
- Restate amounts at the transaction level for a specified range of accounts

Balance Currency Restatement

Use the Balance Currency Restatement feature to consolidate balances into a common currency. You can specify the ledger type in which the system creates the newly restated balances. In addition, you can set up an exchange table and conversion specifications according to standard restatement practices.

As If Currency Repost

Use the As If Currency Repost feature to restate all transactions to a new ledger type by using one exchange rate instead of the individual rates that were associated with each transaction over the course of time. The As If Currency Repost feature eliminates the exchange rate fluctuation for financial analysis.

See Also

- ❑ *Multicurrency Overview* in the *Multicurrency Guide* for more information about multiple currencies

International Bank Account Numbers

The International Organization for Standardization (ISO) and the European Committee for Banking Standards (ECBS) developed the International Bank Account Number (IBAN) to assist companies with account identification. ISO standard 12616:1997 defines the IBAN.

The IBAN is used internationally to uniquely identify the account of a customer at a participating financial institution. The IBAN allows for validation checks through the use of international 2-character country codes as established by ISO 3166. Additional validation is performed through the use of an algorithm/check-digit process. The account-administering bank is responsible for calculating the IBAN and providing it to its customers.

The IBAN format differs, depending on whether it is transmitted electronically or printed on paper. The variance is only in its presentation; the IBAN number remains the same whether in electronic or print format. The IBAN consists of the following:

- Country code** A two-letter country code as specified in ISO 3166. The country code used in the IBAN is the code of the county in which the bank or branch that is servicing the IBAN resides.
- Check digits** Two digits that are assigned according to an algorithm.
- Basic Bank Account Number (BBAN)** An alphanumeric string of characters of up to 30 characters that includes 0-9 and A-Z in upper-case letters only. The electronic format cannot contain separators or county-specific characters.

The length of the BBAN is determined by the country of origin, and includes an explicit identification code of the bank or branch servicing the account at a fixed position within the BBAN.

When transmitted electronically, the IBAN is one string of characters. When printed, the IBAN is preceded by the text string “IBAN” and is split into groups of four characters that are separated by a space. The last group might contain fewer than four characters.

The following table shows examples of IBANs:

	Belgium	France
Account Number	510-0075470-61	20041 01005 0500013M026 06
Electronic IBAN format	BE62510007547061	FR1420041010050500013M02606
Print IBAN format	IBAN BE62 5100 0754 7061	IBAN FR14 2004 1010 0505 0001 3M02 606

The ECBS specifies that the IBAN appear on the International Payment Instruction (IPI) form in the print format but without the term IBAN. For example, the IBAN for the Belgian account number in the above table would appear on an IPI as BE62 5100 0754 7061.

You can link the IBAN number with a bank address in the Address Book application. When you link the IBAN with a bank address, the Auto Payment process can identify the correct country for suppliers and customers who have bank accounts in multiple countries. You enter the IBAN in the Bank Accounts by Address (P0030A) and the G/L Bank Accounts (P0030G) programs in the electronic format. J.D. Edwards stores the IBAN in the electronic format in the Bank Transit Master table (F0030)

See Also

- ❑ *Setting Up Multiple Bank Accounts for Suppliers* in the *Accounts Payable Guide*
- ❑ *Setting Up Bank Account Information* in the *Accounts Payable Guide* or *Accounts Receivable Guide*

Automatic Debits

You can automatically debit (withdraw funds from) a customer's bank account by updating a table that you send to your bank that collects payment from your customer via electronic funds transfer (EFT).

The automatic debit process records the receipt at the time the table is updated. You run a program to format the table according to your bank's specifications, and then send it to the bank by copying it to a medium (such as a tape, diskette, or CD) or sending it electronically. Your bank collects payment from your customer and then notifies you that the transaction is complete.

Automatic debits work well in situations in which you invoice predefined amounts every month. You can also use automatic debits with invoice amounts that vary with each billing period.

The following graphic illustrates the information flow when you are using automatic debits:

Automatic Debits Information Flow

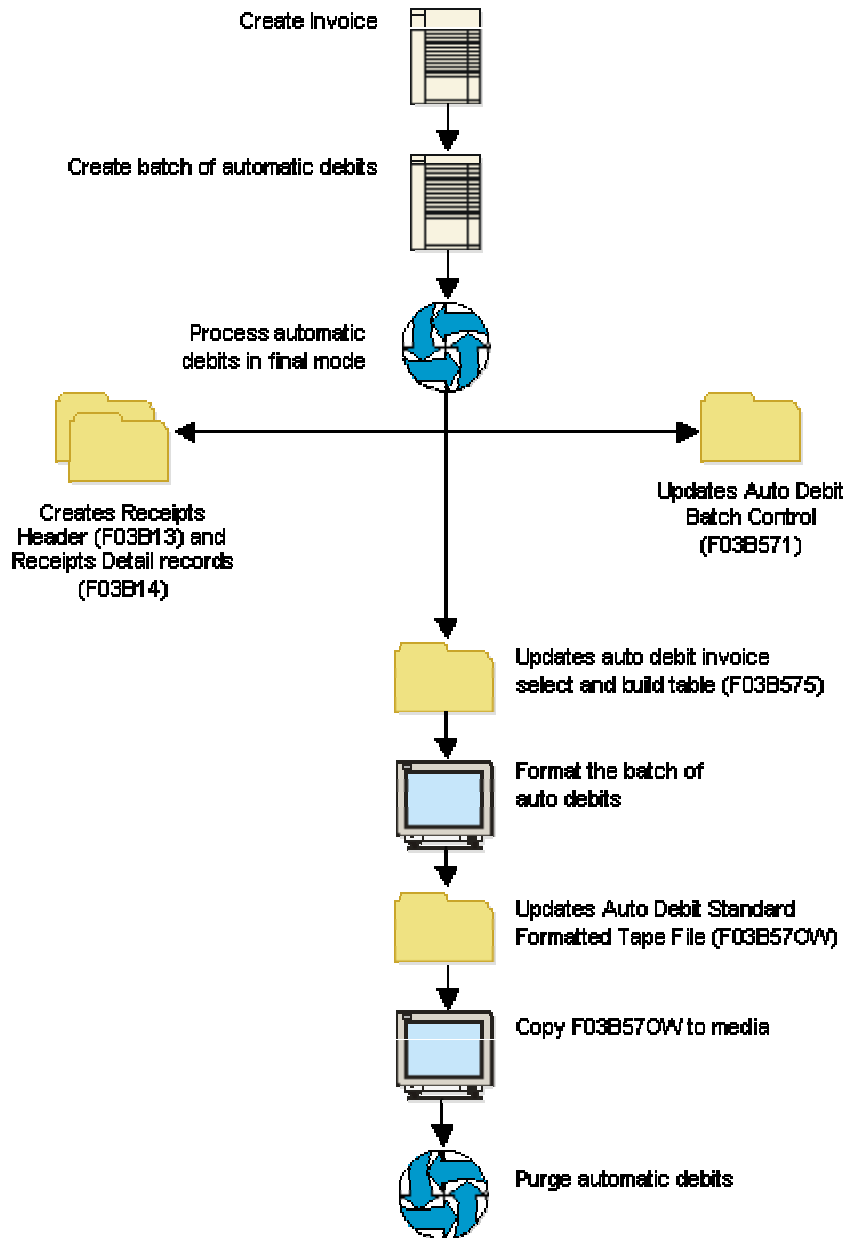

When you use the automatic debit process, you:

- Identify those customers who have agreed to the automatic debit process
- Select the customer invoices to be paid
- Build and update worktables that are sent to the bank
- Update customer invoices as paid
- Format automatic debit information to meet country-specific bank requirements

- Copy automatic debit information to a medium to send to your bank, or transfer automatic debit information electronically
- Purge automatic debit batches

The automatic debit process updates the following tables:

- Auto Debit Batch Control (F03B571)
- Auto Debit Invoice Select and Build (F03B575)
- Auto Debit Standard Formatted Tape File (F03B57OW)

See Also

- *Processing Automatic Debits in a Foreign Currency* in the *Multicurrency Guide* for currency considerations when processing automatic debits

Working with Automatic Debits for Austria

When you process automatic debits in Austria, specify the following program numbers for Austrian formats:

R03B575AD Austrian Bank Diskette Format and Statement

R03B575AD1 Austrian Format Diskette Cover Page Auto Debit

The programs generate a bank table that adheres to the banking standards for automatic debits in Austria.

Note

The Austrian Bank Diskette Format and Statement program calls the Austrian Format Diskette Cover Page Auto Debit program automatically.

You can specify the program numbers of one of these bank formats in the Bank File processing options of the Create Automatic Debit Batch program (R03B571) when you create and process automatic debits. Alternatively, you can specify the program number of the bank format in the Process Auto Debits program (P03B571) on the Revise Auto Debits Control form, and then format the bank file.

See Also

- *Formatting a Batch of Automatic Debits* in the *Accounts Receivable Guide* for detailed instructions for formatting automatic debits

Processing Options for Austrian Bank Diskette Format and Statement (R03B575AD)

Statement Print

1. Enter a '1' if a Customer Statement is to be printed for the Automatic Debits. If left blank, Customer Statements will only be printed where the number of invoice details exceeds the maximum number that can be included onto the format.

Statement Print

Creating and Processing a Batch of Automatic Debits

To create a batch of automatic debits, you use processing options and data selection to specify which invoices you want to include in the batch. You can create the batch in either proof or final mode.

Proof Mode

When you run the Create Automatic Debit Batch program (R03B571) in proof mode, the system:

- Validates the selection of invoices that are to be automatically debited to customers.
- Generates a record in the Auto Debit Batch Control table (F03B571) to identify the automatic debit batch. This record appears on the Work with Auto Debit Batches form.
- Generates records in the Auto Debit Invoice Select and Build table (F03B575) that includes all of the invoices that match your data selection criteria.
- Creates two reports:
 - R03B571 (Create Automatic Debit Batch) creates an exception report of any errors that occur in the selection of invoices for the automatic debit batch. If the system does not detect an error, it prints the message *Records Processed - No Exceptions*.
 - R03B575 (Process Automatic Debits) creates the invoices that constitute the automatic debit batch.
- Updates the Status field in the Auto Debit Batch Control table (F03B571) to 1 (Proof Mode).

You can create an unlimited number of automatic debit batches. The system stores the automatic debit information in the appropriate tables until you delete or purge them.

Final Mode

When you run the Create Automatic Debit Batch program (R03B571) in final mode, the system does everything it does for proof mode. In addition, it:

- Runs version ZJDE0001 of Process Automatic Debits program (R03B575).
- Creates a record in the Batch Control Records table (F0011) with a batch type RB.
- Creates records in the Receipts Header (F03B13) and Receipts Detail (F03B14) tables that you must post to the Account Ledger table (F0911). The system creates one receipt for each customer regardless of the number of invoices it pays.
- Assigns a payment number using the Next Numbers feature for automatic debits.
- Changes the invoice pay status to P (paid).
- Updates the Status field in the Auto Debit Batch Control table (F03B571) to 2 (Final Mode).

When you create the automatic debit batch in final mode, you can also set processing options to automatically format the batch to meet country-specific bank requirements. To do this, specify the bank file format program in the Bank File processing option. Alternatively, you can manually format a batch of automatic debits after you process the batch by entering the program number on the Revise Auto Debit Controls form.

See Also

- ❑ *Formatting a Batch of Automatic Debits* in the *Accounts Receivable Guide* for information about running this process manually as opposed to running the program automatically (based on a processing option) when you process automatic debits in final mode

Related Information for Processing Automatic Debit Batches

Deleting an automatic debit batch	<p>If at any time during the automatic debit process you discover an error in a batch, you can delete the batch and create a new batch in the Automatic Debit worktable. For example, you would need to create a new batch in the worktable if you make a change to customer, invoice, or bank account information. These changes do not automatically update existing batches of automatic debit information in the worktable.</p> <p>When you delete an automatic debit batch, the system deletes or voids any receipt records and journal entries that were created for the batch and reopens the invoices associated with the batch. The invoices are then eligible to be included in a new automatic debit batch.</p>
Data selection	<p>You must specify data selection values to ensure that the Automatic Debiting program selects the invoices that you want for the automatic debit batch. At a minimum, you must specify a payment instrument to identify the invoices that are eligible for payment by the automatic debit process.</p>

► To create a batch of automatic debits in proof mode

From the Automatic Debiting menu (G03B131), choose Process Auto Debits.

1. On Work With Auto Debit Batches, click Add.
2. On Work With Batch Versions - Available Versions, click Add or Copy to create a new version of the Create Automatic Debit Batch program.
3. Verify that the data selection is set up correctly.
4. Verify that the processing options are set for proof mode.
5. Run the version.

► **To process a batch of automatic debits in final mode**

Complete the following steps if the automatic debit batch was created previously in proof mode; otherwise, follow the steps to create the automatic batch in proof mode, but change the processing option to Final Mode.

Note

The system runs the version of the Create Automatic Debit Batch program (R03B571) that was used to create the batch in proof mode.

From the Automatic Debiting menu (G03B131), choose Process Auto Debits.

1. On Work With Auto Debit Batches, to locate a batch of automatic debits, complete any of the following fields:
 - Bank Account
 - User
2. To display batches by mode, click one of the following options:
 - All Batches
 - Proof Mode
 - Final Mode
3. Click Find to display the batches that meet your criteria.
4. Choose the batch that you want to process.
5. From the Row menu, choose Final Mode.

After you process automatic debits, you can review the resulting receipt batches on Auto Debits Journal Review. Then, post the entries to the general ledger.

Processing Options for Process Auto Debits (P03B571)

Version Tab

This processing option specifies the version of the Copy Bank File to Diskette program (P0457D) to use.

1. Copy Bank File to Diskette Version (P0457D)

Blank = ZJDE0001

Use this processing option to specify the version of the Copy Bank File to Diskette program (P0457D) that the system uses to copy a bank file. If you leave this option blank, the system uses version ZJDE0001.

Processing Options for Create Automatic Debit Batch (R03B571)

Processing Tab

These processing options specify information to select invoices for automatic debit processing.

1. Process Mode

Blank = Proof mode

1 = Final mode

Use this processing option to specify whether the system runs the program in proof or final mode. In proof mode, the system generates a report, but does not update any tables. In final mode, the system generates a report and updates the Receipts Header and Receipts Detail tables (F03B13 and F03B14) based on the information that you provide. Valid values are:

Blank

Proof mode

1

Final mode

2. Process Through Date

Blank = System date

Use this processing option to specify the date through which the system selects invoices to pay. The system uses this processing option in conjunction with the Date Type for Comparison processing option to determine the invoices to select and pay. For example, if you specify a Process Through Date of 6/30/02 and a Date Type of I (invoice date), the system selects all open invoices with an invoice date on or before 6/30/02.

If you leave this processing option blank, the system uses today's date as the process through date.

3. Date Type for Comparison

Blank = Net due date

D = Discount due date

I = Invoice date

G = G/L date

S = Statement date

Use this processing option to specify the type of date for the system to use to select invoices. The system uses this processing option in conjunction with the Process Through Date processing option to determine the invoices to select and pay. For example, if you specify a Process Through Date of 6/30/02 and a Date Type of I (invoice date), the system selects all open invoices with an invoice date on or before 6/30/02. Valid values are:

Blank

Net due date

D

Discount due date

I

Invoice date

G

G/L date

S

Statement date

4. Currency Mode

Blank = Use the domestic currency of the invoice

1 = Use the transaction currency of the invoice

Use this processing option to specify whether the system processes auto debits using the foreign (transaction) currency of the invoice or the domestic (base) currency of the invoice. Valid values are:

Blank

Domestic currency of the invoice

1

Foreign currency of the invoice

Bank Account Tab

This processing option specifies the bank account to which you want receipts deposited.

1. G/L Bank Account

Blank = Retrieve the bank account from the AAI

Use this processing option to specify the G/L bank account for the system to use to credit the receipt deposits. Enter the bank account in the standard format (bu.obj.sub). If you leave this processing option blank, the system uses the bank account that corresponds to the AAI item RB for the company entered on the invoice.

Discounts Tab

These processing options specify whether and how to process discounts.

1. Process Discounts

Blank = Use the discount cutoff date

1 = Process all discounts

Use this processing option to specify whether to take all available discounts or to use the value in the Discount Cutoff Date processing option to determine which discounts to take. Valid values are:

Blank

Use the date in the Discount Cutoff Date processing option to determine which discounts to take. The system takes only those discounts on invoices that have a discount due date on or before the cut-off date specified.

1

Take all available discounts. If you choose this option, the system might take discounts that are not earned.

2. Discount Cutoff Date

Use this processing option to specify the date that the system uses to determine which discounts to take. The system takes all discounts on invoices with a discount due date on or before the date specified. The Process Discounts processing option must be blank for the system to use a cutoff date.

3. Discount Reason Code

Use this processing option to specify the default discount reason code for the system to use when discounts are taken. The discount reason code that you enter must exist in UDC 00/DE. You must also set up a corresponding AAI item (RKDxxx, where xxx is the reason code) for each discount reason code that you specify.

G/L Defaults Tab

These processing options specify information for the journal entry that the system generates.

1. G/L Date

Blank = System date

Use this processing option to specify the G/L date for the system to use to post receipt records. If you leave this processing option blank, the system uses today's date.

2. Journal Entry Creation Method

Blank = Summarize journal entries

1 = Detail journal entries

Use this processing option to specify whether the post program creates one summarized journal entry for the batch of receipts entered, or one journal entry for each receipt. The system assigns the value that you enter in this processing option to the A/R Post field (ISTR) in the Receipts Header table (F03B13). The post program uses this value to create the journal entry records. Valid values are:

Blank

Summarized journal entries. The system creates one journal entry with the document type RK for each batch of receipts that you post. The system assigns the receipt batch number as the document number of the journal entry. To use this method, you must also ensure that:

- o The offset method in the A/R Constants is equal to B (batch mode)
- o The batch does not contain any foreign transactions

Otherwise, the system creates journal entries in detail.

1

Detail journal entries. The system creates one journal entry with the document type RC for each receipt in the batch. The system uses Next Numbers for journal entry documents (system 09) to assign the document number to the receipt journal entry.

To provide an audit trail, the system updates the following fields in the Receipts Detail table (F03B14) with the journal entry information:

- o JE document type (RZDCTG)
- o JE document number (RZDOCG)
- o JE document company (RZKCOG)

Amount Limits Tab

These processing options provide amount limits for processing automatic debit batches.

1. Minimum Payment Amount

Use this processing option to specify the minimum amount for the system to use to process the batch of automatic debits. The system processes only batches of invoices with a total open amount that is greater than the amount specified. For example, if you specify a minimum amount of 100, and the batch has three invoices that total more than 100, the system processes the batch.

2. Maximum Payment Amount

Use this processing option to specify the maximum amount for the system to use to process the batch of automatic debits. The system processes only batches of invoices with a total open amount that is less than the amount specified. For example, if you specify a maximum amount of 10,000, and the batch has thirty invoices that total less than 10,000, the system processes the batch.

Bank File Tab

These processing options specify the information necessary to format the automatic debit batches.

1. Bank Format Program

Use this processing option to specify the program to use to format the bank file. Valid program numbers are:

- o R03B575AD - Austrian format
 - o R03B575BD - Belgian format
 - o R03B575DD - German format
 - o R03B575DH - Dutch format
 - o R03B575FD - French format
 - o R03B575GB - United Kingdom format
 - o R03B575SD - Swiss format
-

BACS Tab

These processing options specify BACS processing information.

1. BACS Processing

Blank = Do not perform BACS processing

1 = Perform BACS processing

Use this processing option to specify whether to process the auto debits using BACS processing. Valid values are:

Blank

Do not process auto debits using BACS processing.

1

Process auto debits using BACS processing.

2. BACS Processing Date

Use this processing option to specify the BACS processing date. The system updates the bank file with the date specified. If you leave this processing option blank, the system uses today's date.

3. Number of BACS Days

Use this processing option to specify the number of days to add to the date entered in the BACS Processing Date processing option to determine the expiration date that the system writes to the bank file.

4. Workday Calendar Name

Use this processing option to specify the name of the calendar to use to adjust the BACS expiration date to a working day. The system calculates the BACS expiration date by adding the value in the Number Of BACS Days processing option to the date specified in the BACS Processing Date processing option.

Approving and Posting Automatic Debit Batches

Choose one of the following navigations:

From the Automatic Debiting menu (G03B131), choose Auto Debits Journal Review

From the Automatic Debiting menu (G03B131), choose Post Auto Debits to G/L.

After you process automatic debits in final mode, you must post them to the general ledger. You can review the processed automatic debit batches using the Auto Debits Journal Review program (P0011) before you post the batches. Depending on the setting of your accounts receivable constants, you might have to approve batches before you post them.

Because automatic debit batches are receipt batches (batch type RB), you follow the same steps to post them that you use to post receipts. When you post automatic debit batches, the system creates the appropriate entries to your bank, A/R trade and, if applicable, discount taken account.

See Also

- ❑ *Approving and Posting Receipts* in the *Accounts Receivable Guide* for information about the accounts and tables that the system updates

Formatting a Batch of Automatic Debits

You create records in the Auto Debit Standard Formatted Tape File worktable (F03B57OW) to meet country-specific requirements of the bank. To do this, specify the bank-file format program on the Revise Auto Debit Controls form. The following bank file format programs are currently available:

- R03B575AD - Austrian format
- R03B575BD - Belgian format
- R03B575DD - German format
- R03B575DH - Dutch format
- R03B575FD - French format
- R03B575GB - United Kingdom format
- R03B575SD - Swiss format

Note

The Austrian, German, and Swiss format programs each call an additional bank cover sheet program (R03B575AD1, R03B575DD1, and R03B575SD1, respectively) automatically.

If a program is not available for your country-specific requirements, you must create a custom program for your bank's specifications.

You can format automatic debit information for the bank in one of the following ways:

- Enter the format program number (such as R03B575DD) into the processing option of the Process Auto Debits program (R03B571) prior to running it in final mode
- Enter the program number on the Revise Auto Debit Controls form, and then run that program manually by choosing Format Bank File from the Row menu of the Work with Auto Debit Batches form.

When you complete this process, the system changes the value of the Status field of the Auto Debit Batch Control table (F03B571) from 3 (Bank File Formatted).

If you are using a custom program, ensure that it updates the Status field in the Auto Debit Batch Control table. J.D. Edwards recommends that you use one of the supplied programs as a template if you are creating a custom program for this purpose.

► To format a batch of automatic debits

From the Automatic Debiting menu (G03B131), choose Process Auto Debits.

1. On Work With Auto Debit Batches, locate a batch of automatic debits.
2. Choose the batch that you want to work with and click Select.

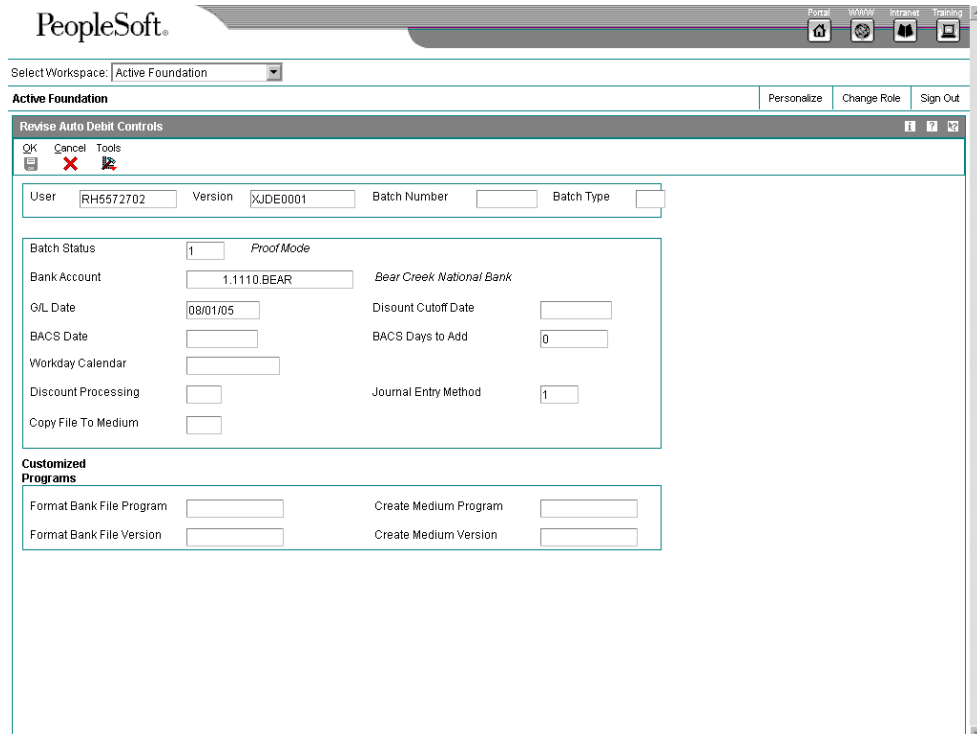

3. On Revise Auto Debit Controls, verify that the selections are correct for the following fields:
 - Format Bank File Program
 - Format Bank File Version
 - Create Medium Program
 - Create Medium Version

You can change the values in these fields, if necessary.
4. Click OK.
5. On Work With Auto Debit Batches, choose Format Bank File from the Row menu.

Transferring Automatic Debit Batches to the Bank

After you format the automatic debit batch and have records in the Auto Debit Standard Formatted Tape File table (F03B57OW), you must copy the records to a medium to send to your bank, or transfer them to the bank electronically.

The Copy Bank File to Diskette program (P0457D) generates a text file from the records in the F03B57OW table so that they are in a format that your bank can readily use. The system creates the text file in the UCS2 (Unicode) format by default. You can specify a different format by setting up and using a different encoding code page in the Unicode Flat File Encoding Configuration program (P93081).

In addition to the ability to generate the text file in different formats, you can also specify replacement characters to use for letters that are not recognized by the bank. For example, you can specify to use 0 (zero) in place of Z. You can also specify to replace special characters that might not be used, such as !, @, %, \$, with a special character that is used, for example /. You use UDC tables (04/RC and 04/SC) in conjunction with processing options to facilitate the character replacement feature.

When you run the Copy Bank File to Diskette program, you must specify a path to which the text file is copied. You can specify a path to your hard drive, to a different PC, to a diskette, or to a CD. It is your responsibility to deliver the file according to your bank's requirements; therefore, you might need to create a custom program. After the records are copied, the program changes the Status field in the Auto Debit Batch Control table (F03B571) to 4 (Copy to Medium) to indicate that the batches are ready for purging.

Note

The Copy Bank File to Diskette program is not available on the J.D. Edwards web client.

See Also

- ❑ *Flat File Encoding* in the *System Administration Guide*
- ❑ *User Defined Codes* in the *Foundation Guide* for information about adding, changing, and deleting user defined codes.

User Defined Codes for Transferring Automatic Debit Batches

The system references two UDC tables when you run the Copy Bank File to Diskette program (P0457D). The purpose of the UDC tables is to enable you to use replacement characters for the text file that the system creates when you use the copy feature. If the bank's program does not recognize a specific character or set of characters, you have two methods available for specifying replacement characters:

- Replacement Character (04/RC)
This UDC table allows you to set up a one-to-one replacement map. You define the value and specify the replacement character for the system to use. You can specify an unlimited number of codes, one for each character that you want to replace.
- Special Character (04/SC)
This UDC table allows you to set up a string of values that the system replaces with the value specified in the corresponding processing option of program P0457.

Depending on the requirements of your bank, you can use one or both methods of replacing characters.

Replaced Character (04/RC)

If the text file that you transfer contains letters or special characters that are not recognized by your bank, you can set up replacement characters in UDC 04/RC.

Unlike most UDC codes, the system does not use the code that you specify in this UDC; it uses the first character from the Description 1 field and replaces it with the first character in the Description 2 field. For example, you could replace the letter Z with the number 0. If you

leave the Description 2 field blank, or accidentally enter the value in the second space of the field, the system replaces the character specified in the Description 1 field with blank.

The system uses this table only if the appropriate processing option is turned on in program P0457D.

Special Character (04/SC)

If the text file that you transfer contains letters or special characters that are not recognized by your bank, you can add them to UDC 04/SC, and replace them with the value specified in the processing option for program P0457D (Copy Bank File to Diskette).

Unlike most UDC codes, the system does not use the code that you specify in this UDC; it uses the characters that you define in the Description 1 field. You can specify up to 30 characters in the Description 1 field, and if you need more, you can add another code and specify additional characters in the Description 1 field for that code. The system replaces all values in the Description 1 field for all codes with the value specified in the processing option.

For example, if you specify !@#\$% in the Description 1 field and specify / in the value of the corresponding processing option, the system replaces every instance of !, @, #, \$, and % in the text file with /.

Note

To replace characters with blank, leave the processing option for Replacement Character (UDC 04/SC) blank. If you do not want to use replacement characters, do not set up any codes in UDC 04/SC.

► To review formatted automatic debit records

Before you copy the records to transfer to your bank, you might want to review them.

From the Automatic Debiting menu (G03B131), choose Process Auto Debits.

1. On Work With Auto Debit Batches, enter 3 in the Status field of the QBE row to limit your search to batches that have been formatted, and then click Find.
2. Choose the formatted batch that you want to review and choose Browse Bank File from the Row menu.

The On Browse Auto Debit Bank File form appears with the records that are in the formatted batch displayed.

Note

You cannot add or remove records from the batch using this form.

If you need to add records, you can either delete the automatic debit batch and rerun the process to include the records, or else process the additional records in a separate batch.

If you need to remove records, you must delete the automatic debit batch and rerun the process using data selection to exclude the records.

► **To copy formatted automatic debit batches**

From the Automatic Debiting menu (G03B131), choose Process Auto Debits.

1. On Work With Auto Debit Batches, enter 3 in the Status field of the QBE row to limit your search to batches that have been formatted, and then click Find.
2. Choose the batch that you want to copy, and then choose Copy to Diskette from the Row menu.
3. On Write Bank Diskette, verify that the path is correct and click one of the following options:
 - **Append Records**
If you click this option, the system adds the records in the batch to the existing file for the path specified.
 - **Generate New File**
If you click this option, the system deletes the records in the existing file and replaces them with the records in the batch.

When the records are successfully copied, the system changes the batch status to 4 (Copy to Medium).

Processing Options for Copy Bank File to Diskette (P0457D)

Defaults Tab

These processing options specify default information for the system to use when it generates the text file.

1. Record Length

Use this processing option to specify the record length of the output file. The maximum length is 1000 characters. If you leave this processing option blank, the system creates the output table with the original record length.

2. Insert Carriage Return

Use this processing option to specify whether the system inserts a hard return at the end of each record. If you leave this processing option blank, the system formats the file into a long string instead of multiple separate records.

3. Default File Path/Name

Use this processing option to specify the default path and the default name for the output file. The path and file name should conform to the file structure and naming standard of the operating system of the computer where the file is stored.

For example:

If you store the output file on your local machine C drive, you would specify the directory path: C:\FolderName\FileName.txt. If you store the output file to a folder on a networked machine, you might specify the network path: \\MachineName\FolderName\FileName.

If you leave this processing option blank, the system uses the following for the path and name: A:\DTALSV.

Note: You should store the files only on a Windows client.

Data Tab

These processing options specify whether to use replacement characters and whether to capitalize all alpha characters.

1. Replace pre-defined characters (UDC 04/RC) in One-To-One mode

Use this processing option to specify whether the system replaces special characters. If you specify to replace special characters, the system reads the Replaced Character UDC (04/RC) and replaces single characters according to the values in the UDC. The system then reads the Special Characters UDC (04/SC) and replaces special characters according to the values in that UDC. Valid values are:

Blank

Do not replace special characters

1

Replace special characters

Note: For programs P0457 and P03B571, the system replaces only the first character in the Description 01 field of UDC 04/RC with the first character in the Description 02 field. It does not replace more than one character, even if the UDC is mapped in a one-to-many mode. Other programs that use UDC 04/RC replace more than one character if the UDC is mapped in a one-to-many mode.

2. Capitalize all alpha characters

Use this processing option to specify whether the system capitalizes all alphabetic characters in the record. If you leave this processing option blank, the system does not capitalize characters.

3. Replacement Character (UDC 04/SC)

Use this processing option to specify whether the system replaces characters in fields and tables that match characters defined in UDC 04/SC with a specified character or with a blank. To replace the characters with a specified character, enter the character in the processing option. To replace the special characters with a blank, leave the processing option blank.

Note: The system always replaces the character defined in UDC 04/SC with either the character that you specify or a blank. If you do not want to replace any characters, UDC 04/SC must be blank.

Purging a Batch of Automatic Debits

After you successfully process a batch of automatic debits, you can purge the processed records. When you choose to purge auto debit batches, the system purges records from the following tables:

- Auto Debit Invoice Select and Build (F03B575)
- Auto Debit Standard Formatted Tape File (F03B57OW)

The system also prompts you to additionally purge the record in the Auto Debit Batch Control table (F03B571). If you do not choose to purge the Auto Debit Batch Control table (F03B571), the system updates the status of the batch records to 5 (Purged) but does not remove them from the table. You can still purge these records at a later date by choosing the option.

You should purge automatic debit batches only when the status of the auto debit batch is 4 (Copy to Medium). If you purge batches at any other status, the system displays a Purge Confirmation window.

Caution

After you purge automatic debit information, you cannot recover the information, and no audit trail exists.

► To purge a batch of automatic debits

From the Automatic Debiting menu (G03B131), choose Process Auto Debits.

1. On Work With Auto Debit Batches, to locate a batch of automatic debits, complete any of the following fields:

- Bank Account
 - User
2. To display batches by mode, click one of the following options:
 - All Batches
 - Proof Mode
 - Final Mode
 3. Click Find to display the batches that meet your criteria.
 4. Choose the batch.
 5. From the Row menu, choose Purge.
 6. If the system displays the Purge Confirmation window, click Yes.
The system displays the Purge Confirmation window if the status of the batch is not 4.
 7. On Purge Historical Information, click OK to purge only the Auto Debit Invoice Select and Build (F03B575) and Auto Debit Standard Formatted Tape File (F03B57OW) tables, or enter 1 in the field provided to additionally purge the Auto Debit Batch Control table (F03B571).
 8. Click OK.

Printing Invoices With an Attached International Payment Instruction (IPI)

From the Statement Reminder Processing menu (G03B22), choose Invoice Print with International Payment Instruction.

You use International Payment Instructions (IPI) for cross-border invoice settlements. When you originate invoicing from the Accounts Receivable system, you can choose to print your invoices with an attached IPI form. To print invoices with attached IPI forms, you must use preformatted invoices that contain the IPI form. J.D. Edwards software processes and formats data from J.D. Edwards tables, and prints the information in the appropriate places on the IPI form.

IPIs must be printed in English, but they can also contain a second language. Some countries require that you print IPI forms with a secondary language; for some countries, the use of a secondary language is optional. The European Committee for Banking Standards publishes the requirements for IPIs. You specify the secondary language by choosing a value in the IPI - Languages and Countries UDC table (00/IL).

The IPI form contains the four sections described below:

- **Ordering Customer**

The Ordering Customer section contains the name, address, and account number of your customer. The system uses the name, address, and account number (CBNK) that are associated with the invoice to which the IPI is attached. Your customer sends the IPI to the bank for processing, and the bank credits your account with the specified amount.
- **Beneficiary**

The Beneficiary section contains your company name, and the bank name and account number that you specify in processing options.
- **Amount to be paid**

The Amount to be paid section contains the amount and currency of the transaction, as well as a code to indicate who is responsible for paying the bank fees that are associated with the transaction. You specify the code for the bank fees in a processing option; the system uses the amount and currency from the transaction.
- **Signature**

The J.D. Edwards system does not print the signature.

Data Selection

When you set your data selection for the Invoice Print with International Payment Instruction program (R03B5053), you should filter out credit memos and other non-positive invoices. You can filter out these invoices by specifying that the Amount Open (AAP) is greater than zero. You should also designate in the Payment Instrument UDC table (00/PY) the code to use for invoices with attached IPIs, and then choose that payment type in your data selection.

Note

The Invoice Print with International Payment Instruction program does not write error messages to the Work Center; however, you can view error messages in the UBE log if you

use UBE logging. If the Invoice Print with International Payment Instruction program encounters errors, it prints a blank invoice.

Before You Begin

- ❑ Set up the IPI – Languages and Countries UDC (00/IL). See *IPI – Languages and Countries (00/IL)* in the *Global Solutions Spain Guide* for information about setting up this UDC table.

Processing Options for Invoice Print with International Payment Instruction (R03B5053)

Defaults Tab

1. Invoice Print Date

Blank = Current date

Use this processing option to specify the date that will appear on the invoices. If you leave this processing option blank, the system uses the current date.

2. Customer Bank Account Type

Blank = D

Use this processing option to specify the type of bank account of the ordering customer. The system uses this account type code to retrieve the bank account number of the ordering customer. The code you enter must exist in the Bank Type Code UDC (00/BT) table. If you leave this processing option blank, the system uses bank type D.

3. Customer Address Format

Blank = 00

Use this processing option to specify the IPI - Address Line Sequencing code. This code determines the combination of the values for the Postal Code, City, and Country that the system includes as the second address line of the ordering customer's address on the International Payment Instruction. The code that you enter must exist in the IPI - Address Line Sequencing (00/IA) UDC table. If you leave this processing option blank, the system uses 00 (Postal Code City).

4. Beneficiary Bank Account

Blank = Use RBxxx AAI

Use this processing option to specify the beneficiary's G/L bank account number on the International Payment Instruction. The system uses this account number to locate the corresponding bank account information from the Bank Transit Master table (F0030), including the IBAN and SWIFT bank identification code. If you leave this processing option blank, the system uses the account associated with the RB AAI.

5. Beneficiary Bank Account Format

Blank = Use the International Bank Account Number (IBAN)

1 = Use the National Bank Account Number

Use this processing option to define the beneficiary's bank account format on the International Payment Instruction (IPI). Typically, you use the International Bank Account Number format, (IBAN) from the Bank Transit Master table (F0030). In some cases you can use a national account number (CBNK) from the Bank Transit Master table instead of the IBAN. Valid values are:

Blank

Use the IBAN as the bank account format.

1

Use the CBANK as the bank account format.

6. Beneficiary Bank Name

Blank = Use SWIFT Bank Identification Code (BIC)

1 = Use Bank Name

Use this processing option to define the beneficiary's bank name on the International Payment Instruction (IPI). The IPI allows you to present the bank name in one of two formats. You can either use the SWIFT Bank Identification Code (BIC), stored as SWFT in the Bank Transit Master table (F0030), or you can use the name of the bank. Valid values are:

Blank

Use the BIC code.

1

Use the bank name.

7. Details of Payment

Blank = 00

Use this processing option to specify the data that appears in the Details of Payment section on the International Payment Instrument (IPI). You choose a hard-coded value from the IPI - Details of Payment UDC table (00/IP). If you leave this processing option blank, the system uses 00. Valid values are:

00

Unstructured - DOC. The system writes the value from the DOC field in the Customer Ledger (F03B11) table to the Details of Payment section of the IPI.

01

Unstructured - DOC, DCT, & CO. The system concatenates the values in the DOC, DCT, and CO fields in the Customer Ledger table and writes the concatenated string to the Details of Payment section of the IPI.

02

Unstructured - DOC & AN8. The system concatenates the values in the DOC and AN8 fields in the Customer Ledger table and writes the concatenated string to the Details of Payment section of the IPI.

8. Charges Paid By

Blank = 0

Use this processing option to specify the entity responsible for paying the bank charges associated with the International Payment Instrument (IPI). The value that you enter must exist in the IPI - Charges Paid By UDC table (00/IC). If you leave this processing option blank, the system uses 0 (Ordering Customer). Valid values are:

0

Ordering Customer

1

Beneficiary

2

Shared/Both

9. IPI Form Type

Blank = 03

Use this processing option to specify the type of preformatted International Payment Instrument form to use. The value that you enter must exist in the IPI - Form Types UDC table (00/IF). If you leave this processing option blank, the system uses 03 (Black - Unstructured). Valid values are:

00

Blind Colour - Structured

01

Blind Colour - Unstructured

02

Black - Structured

03

Black - Unstructured

04

Drop Out - Structured

05

Drop Out - Unstructured

Print Tab

1. Tax Amounts

Blank = Do not print tax amounts.

1 = Print tax amounts.

Use this processing option to specify whether tax amounts appear on the invoices. Valid values are:

Blank

Tax amounts do not appear on invoices.

1

Tax amounts appear on invoices.

2. Attachments

Blank = Do not print attachments on the invoice.

1 = Print attachments on the invoice.

Use this processing option to specify whether generic text that is associated with the invoice appears on the invoice. Valid values are:

Blank

Do not include generic text attachment.

1

Include generic text attachment.

3. Customer Bank Account Number

Blank = Do not print the customer's bank account number.

1 = Print the customer's bank account number.

Use this processing option to specify whether the customer's bank account number appears on the International Payment Instrument portion of the invoice. Valid values are:

Blank

Do not include the customer's bank account number.

1

Include the customer's bank account number.

4. Customer Name and Address

Blank = Do not print the customer's name and address.

1 = Print the customer's name and address.

Use this processing option to specify whether the name and address of the customer appears on the International Payment Instrument portion of the invoice. Valid values are:

Blank

Do not include the customer's name and address.

1

Include the customer's name and address.

5. Details of Payment

Blank = Do not print the details of payment.

1 = Print the details of payment.

Use this processing option to specify whether the system completes the payment details section on the International Payment Instrument portion of the invoice. Valid values are:

Blank

Do not complete the payment details section.

1

Complete the payment details section. The system prints in the payment details section the data that you specified in the Details of Payment processing option on the Defaults tab.

6. Charges To Be Paid By

Blank = Do not print the charges to be paid by information.

1 = Print the charges to be paid by information.

Use this processing option to specify whether the system completes the charges to be paid section on the International Payment Instrument portion of the invoice. Valid values are:

Blank

Do not complete the charges to be paid section.

1

Complete the charges to be paid section.

7. IPI Currency and Currency Amounts

Blank = Do not print the currency and related amount on the IPI.

1 = Print the currency and related amount on the IPI.

Use this processing option to specify whether the currency and amount appear on the International Payment Instrument portion of the invoice. Valid values are:

Blank

Do not print the currency and amount.

1

Print the currency and amount.

Process Tab

1. Maximum IPI Amount

Blank = 999999,99

Use this processing option to specify the maximum amount allowed for an International Payment Instrument (IPI). If the IPI is greater than this amount, the system will not generate an IPI. If you leave this field blank, the system uses 999,999.99 as the maximum IPI amount.

Automatic Payment Processing

Use automatic payment processing to pay vouchers during your usual payment cycle.

The following graphic illustrates the automatic payment process:

Automatic Payment Process



Step 1.
Set up auto withholding.



Step 2.
Run Cash Requirements report.



Step 3.
Decide what to pay. Use Speed Status Change to put all other Payments on hold.



Step 4.
Create payment groups.



Step 5.
Review the Payment Group Edit report and the Payment analysis report (optional).

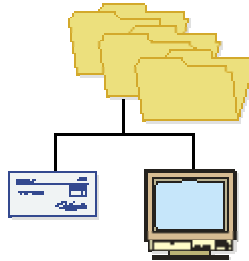

Step 6.
Work with payment groups.

Step 7.
Write payment / copy to tape.



Step 8.
Update payment.



Step 9.
Review payment register.



Step 10.
Post payments.

Setting Up Bank Account Information

You must set up bank account information if you process Accounts Payable payments or use specific Accounts Receivable applications, such as draft processing and auto debit processing. Depending on the type of information that you process, you must set up bank account information for your company's bank accounts, as well as for your suppliers or customers.

The system provides the following programs for setting up bank account information:

- **Bank Account Information (P0030G)** – You use this program to set up your company's bank accounts. If you process Accounts Payable payments or Accounts Receivable automatic debits, you must set up your company's bank accounts.
- **Bank Account Cross Reference (P0030A)** – You use this program to set up bank account information for your suppliers and customers. If you process Accounts Payable payments using electronic funds transfer, you must set up bank account information for the supplier. If you process automatic receipts, Accounts Receivable drafts, or automatic debits, you must set up bank account information for the customer.
- **Bank Account Addresses (P0030A)** – You use this program if you want to associate a bank transit number with a bank address book record.

Although all the programs update and store bank account information in the Bank Transit Master table (F0030), the system differentiates each bank account record using a record type. The record type not only identifies whether the bank account is for a supplier or customer; it is also used to differentiate customers who process drafts and automatic debits from suppliers who process automatic payments.

The following table describes the available record types and how they are used:

Record Type	Description
B	The system assigns this value to records created using the Bank Account Addresses program (P0030A). You use this program to associate bank transit numbers with the bank account address number.
C	The system assigns this value when you set up bank account information and specify the option for Customer using the Bank Account Cross Reference program (P0030A).
D	The system assigns this value when you set up bank account information and turn on the A/R Drafts, Auto Debit option using the Bank Account Cross Reference program (P0030A). You must turn on this option for customers who process drafts or auto debits.
G	The system assigns this value when you set up G/L bank account information for your company using the Bank Account Information program (P0030G).
H	The system assigns this value when you set up Dutch bank accounts using the Dutch Payments Bank Information program (P74030H).

Record Type	Description
M	The system assigns this value when you set up bank account information by business unit using the Business Unit Information program (P0030B).
P	The system assigns this value when you set up bank account information and turn on the Auto Receipts Payor option using the Bank Account Cross Reference program (P0030A).
V	The system assigns this value when you set up bank account information and turn on the Supplier option using the Bank Account Cross Reference program (P0030A).
X, Y	These codes are predefined for you to use if your supplier has multiple bank accounts. You do not need to use these specific codes (X or Y); you can set up and use any value in the UDC for bank type codes (00/BT) that are not listed above.

Note

Although the same program is used for the Bank Account Cross Reference and Bank Account Addresses applications, the system displays a different form for each application, as follows:

- If you choose Bank Account Cross Reference, the system displays the Work With Bank Accounts By Address form (W0030AD).
- If you choose Bank Account Addresses, the system displays the Work With Bank Transit Addresses form (W0030AE).

You can also access this form by choosing Bank Transit from the Form menu on Work With Bank Accounts by Address.

See Also

- *Setting Up Multiple Bank Accounts for Suppliers* in the *Accounts Payable Guide* for detailed setup instructions

► To set up G/L bank account information

Use one of the following navigations:

From the Automatic Payment Setup menu (G04411), choose Bank Account Information.

From the Accounts Receivable Setup menu (G03B41), choose Bank Account Information.

From the Automatic Debiting menu (G03B131), choose G/L Bank Accounts

1. On Work With G/L Bank Accounts, click Find to display all bank account records.
2. To add a new bank account record, click Add.

PeopleSoft

Select Workspace: Active Foundation

Active Foundation Personalize Change Role Sign Out

Set Up G/L Bank Account

OK Cancel Form Tools

G/L Bank Account 1.1110.BEAR

Description Bear Creek National

Payment Information

Next Payment Number Next Autodebit Number

Default Print Options

Number of Alignment Forms

Detail Lines Per Stub 10

3. On Set Up G/L Bank Account, complete the following fields:
 - G/L Bank Account
 - Description
4. Complete the following optional field for Accounts Payable payment processing:
 - Next Payment Number
5. Complete the following optional field for the Accounts Receivable system:
 - Next Autodebit Number
6. To set up default print options for Accounts Payable payments, complete the following fields:
 - Number of Alignment Forms
 - Detail Lines Per Stub
7. Click OK, and then click Cancel.
8. On Work With G/L Bank Accounts, to enter additional bank account information, locate and choose your bank account, and then choose Bank Info from the Row menu.

PeopleSoft

Select Workspace: Active Foundation

Active Foundation Personalize Change Role Sign Out

Revise Bank Information

OK Cancel Form Tools

G/L Bank Account: 1.1110.BEAR
Description: Bear Creek National

Bank Address Number: 3333
Bank Transit Number: 578955422
Bank Account Number: 45-879512
IBAN:
Control Digit:
Checking or Savings Account: *Checking account*
SWIFT Code:
Bank Country Code:

Float Days
Receivables:
Payables:

Override Supplier Pre-Note Code

9. On Revise Bank Information, complete the following fields:

- Bank Address Number
This is the bank's address book number.
- Bank Transit Number
You can leave this field blank.
- Bank Account Number
- Control Digit
- Checking or Savings Account
- SWIFT Code

10. To avoid the use of the pre-note code that is assigned to the supplier, verify that the following option is turned on:

- Override Supplier Pre-Note Code

Note

Some payment instruments are hard-coded to produce a paper check if insufficient information is provided, regardless of whether this option is turned on.

11. Complete the following options if you use float days:

- Receivables
This field is used only in Accounts Receivable draft processing.
 - Payables
12. Click OK.
 13. On Work With G/L Bank Accounts, if you use A/P drafts or BACS, choose BACS Info from the Row menu.
 14. On Revise BACS Information, complete the following fields and click OK:
 - Bank User Number
 - Reference/Roll Number
 - Bank Reference Name
 15. On Work With G/L Bank Accounts, to enter account information for CTX bank tapes used in A/P payment processing, choose X12 Info from the Form menu.
 16. On Work With Bank Account X12 Information, click Add.
 17. On Set Up Bank Account X12 Information, complete the following fields and click OK:
 - Authorization Info Qualifier
 - Authorization Information
 - Security Info Qualifier
 - Security Information
 - Interchange Sender ID
 - Interchange Receiver ID
 - Application Sender's Code
 - Application Receiver's Code

► **To delete or revise G/L bank account information**

Use one of the following navigations:

From the Automatic Payment Setup menu (G04411), choose Bank Account Information.

From the Accounts Receivable Setup menu (G03B41), choose Bank Account Information.

From the Automatic Debiting menu (G03B131), choose G/L Bank Accounts

1. On Work With G/L Bank Accounts, click Find to display all bank account records.
2. To delete a bank account record, choose the bank account record and click Delete.

3. On Confirm Delete, click OK.
4. To revise payment information or default print options, choose the bank account record and choose Revise from the Row menu.
5. On Set Up G/L Bank Account, revise any of the fields on the form and click OK.
6. To revise additional bank information, such as the bank transit or account numbers, on Work With G/L Bank Accounts, choose the bank account record and choose Bank Info from the Row menu.
7. On Revise Bank Information, revise any of the fields on the form and click OK.
8. To revise BACS information, on Work With G/L Bank Accounts, choose the bank account record and choose BACS Info from the Row menu.
9. On Revise BACS Information, revise any of the fields on the form and click OK.
10. To revise CTX information, on Work With G/L Bank Accounts, choose X12 Info from the Form menu.
11. On Work With Bank Account X12 Information, click Find, choose the bank account, and click Select.
12. On Set Up Bank Account X12 Information, revise any of the fields on the form and click OK.

► **To set up supplier and customer bank account information**

Use one of the following navigations:

From the Automatic Payment Setup menu (G04411), choose Bank Account Cross Reference.

From the Accounts Receivable Setup menu (G03B41), choose Bank Account Cross-Reference.

From the Automatic Debiting menu (G03B131), choose Customer Bank Account.

1. On Work With Bank Accounts by Address, click Find to display all bank account information, or complete the following field to limit the display and click Find:
 - Address Number

Note

The system displays records for suppliers and customers only. The system does not display records for record types B, G, or M.

2. To add a new bank account record, click Add.

PeopleSoft

Select Workspace: Active Foundation

Active Foundation Personalize Change Role Sign Out

Set Up Bank Accounts By Address

OK Cancel Form Tools

Address Number 3333 Continental Incorporated

Record Type

Supplier Customer A/R Drafts, Auto Debit Auto Receipts Payor

Bank Information

Bank Transit Number 96051785

Bank Account Number 2173579

Control Digit

IBAN

Description First Interstate Bank

Checking or Savings Account

SWIFT Code

Reference/Roll Number

Bank Address Number

Bank Country Code

3. On Set Up Bank Accounts By Address, complete the following field:
 - Address Number
4. To specify the record type, choose one of the following options:
 - Supplier
 - Customer
 - A/R Drafts, Auto Debit
 - Auto Receipts Payor
5. Complete the following fields:
 - Bank Transit Number
You can leave this field blank.
 - Bank Account Number
 - Control Digit
 - IBAN
 - Description
 - Checking or Savings Account

- SWIFT Code
The system displays this field only when you choose the option for Supplier.
- Reference/Roll Number
The system displays this field only when you choose the option for Supplier.

Note

Some of the fields are required for specific bank formats in specific countries. Your bank might not require all of this information.

- Bank Address Number
- Bank Country Code

6. Click OK.

► To delete or revise supplier or customer bank account information

Use one of the following navigations:

From the Automatic Payment Setup menu (G04411), choose Bank Account Cross Reference.

From the Accounts Receivable Setup menu (G03B41), choose Bank Account Cross-Reference.

From the Automatic Debiting menu (G03B131), choose Customer Bank Account.

1. On Work With Bank Accounts By Address, complete the following field and click Find:
 - Address Number

Note

The system displays all bank account records for suppliers and customers only. The system does not display bank account records for record types B, G, or M.

2. To delete a bank account record, choose the record and choose Delete from the toolbar.
3. On Confirm Delete, click OK.
4. To revise bank account information, choose the bank account that you want to revise and choose Revise from the Row menu.

The system displays either the Set Up Bank Accounts By Address or the Set Up Multiple Vendor Bank Accounts form depending on the record type of the bank account that you choose.
5. Revise any of the fields on the form and click OK.

► **To set up bank transit numbers by bank address**

You can associate a bank transit number with a bank's address book number.

From the Accounts Receivable Setup menu (G03B41), choose Bank Account Addresses.

Note

You can also access this form by choosing Bank Transit from the Form menu in the Bank Account Cross Reference program.

1. On Work With Bank Transit Addresses, click Add.

The screenshot shows the 'Set Up Bank Transit Address' form in the PeopleSoft system. The form is titled 'Set Up Bank Transit Address' and is part of the 'Active Foundation' workspace. It contains several input fields: 'Bank Transit' with the value '852200451', 'Address Number' with the value '3333', and an 'Address' section with three lines of text: 'CSC Corporation', '43 Billmore Plaza', and 'Scottsdale, AZ 85257'. There are also several empty input fields below the address section. The form has a standard PeopleSoft header with the logo and navigation links like 'Portal', 'WWW', 'Intranet', and 'Training'. Below the header, there are links for 'Personalize', 'Change Role', and 'Sign Out'.

2. On Set Up Bank Transit Address, complete the following fields and click OK:

- Bank Transit
- Address Number

The system creates a record in the Bank Transit Master table (F0030) with the record type B.

Note

You can revise the address book number that is associated with the bank transit number by locating the bank transit record and choosing Revise from the Row menu. If you need to revise the bank transit number, choose the record and delete it, and then add it again.

Working with Payment Instruments

You can specify various output formats for automatic payments by assigning the programs that generate the formats to user-defined payment instruments. Payment formats can be printed or electronic; and can include checks, magnetic tapes, and drafts. You must set up a payment instrument for each payment format that you use.

The programs that you assign to your payment instruments determine the formats for payments and any additional output that the system generates when you process payment groups. The additional output components can include one or more of the following:

- **Payment registers**
A printed list of payments.
- **Attachments**
A printed report that contains the detail information which does not fit on a payment stub.
- **Debit statements**
A printed list of debit balances. This printed list is debit balances that indicates that you have overpaid a supplier. It shows net amounts that are either a credit or that zero out on a voucher.

To assign formats to payment instruments, you specify a format generation program for each component of a payment instrument. For example, you could assign the Auto Payment Detail program (P04573), which is for standard attachments, to the attachments component of your payment instrument for drafts. Then, when you generate drafts, the system accesses this program to produce the appropriate type of attachment.

You can also define the specific uses for a payment instrument by assigning a specific bank account to the instrument. For example, you can set up two types of payment instruments for drafts with each type of instrument drawn on a different bank account.

Payment Instrument Codes

You set up payment instrument codes in UDC 00/PY, and then use the Set Up Payment Instrument Defaults form to associate payment instruments with each payment instrument code.

Note

You can use any digit or letter as a payment instrument code except for the letters B, C, D, G, and M. These letters are hard-coded for use in the Bank Type Code field and might cause problems if you use them for payment instruments.

You designate a payment instrument code using the Supplier Master Information program (P04012). When you create payment groups, the system creates a different payment control group for each payment instrument.

If you assign a bank account to a payment instrument, the system uses the payment instrument default, or the combination of the payment instrument and the bank account, to produce payments in a specific default format.

Working with Austrian Payment Formats

Specify the following write programs to generate payment formats for Austria:

R04572A Create A/P Bank Diskette - Austrian EFT

R04572A3 Create A/P Bank Diskette - Austrian V3 PAYMUL

V3 Payment Format for Austria

Austrian banks use the V3 payment format to implement the U.N. EDIFACT standard. J.D. Edwards provides the V3 payment format so that the banks can use this Austrian-specific version of the EDIFACT PAYMUL (MULTiple PAYments) message.

The V3 version of the PAYMUL format allows the following domestic payment options:

Transfers to a Beneficiary Account Held by a Domestic Bank

The transfer amounts can be denominated in either Austrian Shillings (ATS) or the European Monetary Union's euro (EUR). When you transfer a payment that is in a currency other than the transfer currency of the account, the amount of the payment is automatically converted into the account currency.

For example, if the payment is denominated in EUR and the recipient's account is denominated in ATS, the transfer is converted to ATS automatically.

Instructions for PostBar

The beneficiary is paid in cash by the postal service via mail carrier.

Note

J.D. Edwards software does not support PostBar payment.

Priority Payments

Priority payments are credited to the beneficiary account as soon as possible and prioritized by the assigned bank via the multibank standard (MBS).

Note

J.D. Edwards software does not support priority payments.

Note

In Austria, the PAYMUL might also direct the postal service to delivery payments directly to customers, a practice known as *payment with allonge*. To take advantage of *allonge*, an additional document must be automatically created and used to collect a signature at the time

that the payment is delivered to the customer. J.D. Edwards software does not support payment with allonge.

Before You Begin

- ❑ Enter a bank type code in the processing options for Create A/P Bank Diskette-Austrian V3 PAYMUL (R04572A3).
- ❑ Enter an address book type code in the processing options for Create A/P Bank Diskette-Austrian V3 PAYMUL (R04572A3).
- ❑ Set up a unique bank type code in user defined code table 00/BT, which the program uses to determine banking information.
- ❑ Set up address book type codes in user defined code table 01/W0, which the program uses to determine contact information.

Processing Options for Create A/P Bank Diskette - Austrian EFT (R04572A)

Transfer

1. Enter the tape payment detail (10 pos.) description. For example, you may want to enter EXP REIMB for expense reimbursements. This description may be used by the bank and printed on the supplier's bank account statement.

Tape Payment Detail

Tape

1. Enter the following default values:

Device Name

Tape Density

Label Name

Block Size

New Volume

New Owner ID

File Name

Processing Options for Create A/P Bank Diskette - Austrian V3 PAYMUL (R04572A3)

Process Tab

Use these processing options to specify the information that the system writes to the A/P Bank Diskette.

1. Tape Payment Detail

Use this processing option to specify the tape payment detail description (10 characters). This description may be used by the bank and printed on the supplier's bank account statement. For example, you may want to enter EXP REIMB for expense reimbursements.

2. Address Book Type Code

Use this processing option to specify the one-character Address Book Type Code you want to use to process the payment. For example, enter A to use the Attention Name.

Print Tab

Use this processing option to specify whether the system prints the report.

1. Print Report (Y/N)

Default of blank will not print a report.

Use this processing option to specify whether to print a report of the payments that are included on the bank tape. Valid values are:

Blank

Do not print a report.

Y

Print a report.

Bank Tape Tab

Use these processing options to specify the default values for the bank tape.

Device Name

Use this processing option to specify the name of the tape drive.

Tape Density

Use this processing option to specify the density of the tape to be created, for example, 1600 or 6250.

Label Name

Use this processing option to specify the label name to be used when copying data to tape.

Block Size

Use this processing option to specify the block length to be used when copying data to tape.

New Volume

Use this processing option to specify new volume name to be used when copying data to tape.

New Owner ID

Use this processing option to specify the new owner ID to be used when copying data to tape.

File Name

Use this processing option to specify the filename for the bank tape.

Setting Up Payment Instruments

Payment instruments can be checks, tapes, drafts, BACS (Bank Automated Clearing System), and so on. You must define the payment instruments that your business uses. Clients outside the U.S. must set up payment instruments that are country specific for their automatic payments. You control the format of each payment instrument by choosing programs and versions of the programs that produce each component of a payment. These components include the following:

- Payment. This is the printed copy or tape table for the payment.
- Payment register. This is the printed list of payments.
- Attachment. This is a printed report that contains the detail information that does not fit on a payment stub.
- Debit statement. This is a printed list of debit balances that indicates that you have overpaid a supplier. It shows net amounts that are either a credit or that zero out a voucher.

The Payment Instrument Defaults program (P0417) includes all of the default programs associated with each component. The default program information is stored in the A/P Payments - Default Print and Update table (F0417).

You assign a program number to each component of a payment instrument. For example, you might assign program P04573 (for print standard attachments) to the attachments component of a payment instrument. The system accesses this program and produces the appropriate type of attachment.

You are not limited to using the preassigned programs for each payment instrument. For example, if the default of blank for your company is to print a check that is in a Canadian format, you can change the payment print program from the Auto Payments Write/Reset program (P04572) to the Print Automatic Payments - Check - Canada report (R04572C).

You are able to narrow your selections for each component even further by selecting a version of each program that will write the components. The advantage of this is that you can use different processing options or data selection in the versions, based on your needs.

A debit statement is another type of payment instrument and is used to notify suppliers when you have overpaid them. By assigning a program to the debit statement component, you can print a separate debit statement form with a payment. A debit statement is automatically generated if debit memos and open vouchers for a supplier net to zero. The system assigns a debit statement number as the payment number for the payment record, clears the open amounts of all records, and changes the pay status to paid.

You can limit the use of a payment instrument by assigning it a specific bank account. For example, you can set up two types of payment instruments for drafts with each type drawn on a different bank account.

See Also

- ❑ *Working with Payment Groups* in the *Accounts Payable Guide* for more information about the payment process

Before You Begin

- ❑ Determine what payment instruments you use.
- ❑ Set up additional codes in UDC 00/PY for payment instruments, if necessary.

► To assign programs to a payment instrument

From the Automatic Payment Setup menu (G04411), choose Payment Instrument Defaults.

1. On Work With Payment Instrument Defaults, click Find to display payment instruments.
2. Choose the payment instrument and click Select.

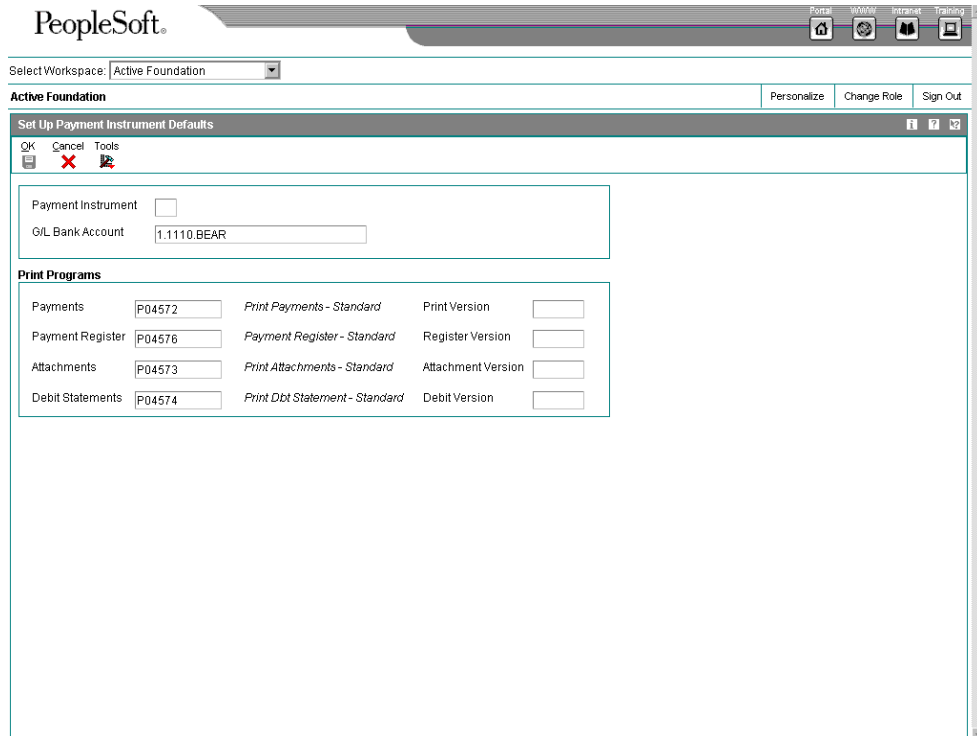

3. On Set Up Payment Instrument Defaults, enter a program number in the following fields:
 - Payments
 - Payment Register
 - Attachments
 - Debit Statements
4. Enter a version number in any of the following optional fields for the corresponding print program:
 - Print Version
 - Register Version
 - Attachment Version
 - Debit Version
5. Click OK.

► **To revise processing options for payment instrument formats**

Some of the programs associated with a payment instrument have processing options that further define the format of each component of a payment instrument. Review and, if necessary, revise these processing options before using each program.

The payment instrument formats use the Rxxxx convention (where xxxx equals the program number), whereas the program format used in the payment instrument defaults is Pxxxx. For example, to access the format for P04572, the standard print payment format, you enter R04572 in the Batch Application field, and click Find.

From the System Administration Tools menu (GH9011), choose Batch Versions.

1. On Work With Batch Versions - Available Versions, enter the program number in the following field and click Find:
 - Batch Application
2. Choose the version.
3. From the Row menu, choose Processing Options.
4. Revise the processing options, as necessary.

► **To assign a payment instrument to a supplier**

When you print payments, the system uses the payment instrument assigned to the voucher. Typically, you set up the most commonly used payment instrument as the default, so you do not have to define a payment instrument for each supplier. The system uses the payment instrument assigned to the supplier, unless you override it when you enter a voucher.

From the Supplier & Voucher Entry menu (G0411), choose Supplier Master Information.

1. On Work With Supplier Master, locate and choose the supplier.
2. Click Select.
3. On Supplier Master Revision, click the Vouchers tab and complete the following field:
 - Payment Instrument
4. You can also select the following optional box:
 - Pre-Note Code
5. Click OK.

To assign or change a payment instrument associated with vouchers entered previously, use Speed Status Change.

Processing Options for Payment Instruments

The following subsections include processing options for the payment instrument formats.

Processing Options for Print Automatic Payments – Standard Format (R04572)

Translation

1. Enter the program name to translate payment amounts from numbers to words. (See User Defined Codes system '98', record type 'CT' for program names.) If left blank, the translation program associated with the payment currency will be used.

Translation Program

Address

1. Enter an override address format to use for the payee and/or company addresses. If left blank, the country format will be used.

Address Format (FUTURE)

Payment

1. Enter a '1' if you would like to print the company name and address on the payment. If left blank, no company information will print.

Company Name

2. Enter a '1' if you would like the payee name and number printed on the stub. If left blank, no payee information will print on the stub.

Payee Name

3. Enter a '1' if you would like the purchase order number to print on the stub instead of the supplier invoice number.

Purchase Order

4. Choose one of the following to print on the stub: ' ' - Remark, '1' - Supplier Name (Useful if paying alternate payee for several vendors), '2' - Supplier Invoice Number.

Alternate Stub Information

Print

1. Enter the Forms Type for the Payments Spool File. If left blank, the default is 'APCHECKS'.

Form Type (FUTURE)

Processing Options for Print Automatic Payments – Draft Format (R04572N)

Address

1. Enter an override address format.
address number's country format will be used.

If left blank, the

Address Format (FUTURE)

Payment

1. Choose one of the following to print on the stub: ' ' - Remark, '1' - Supplier Name (useful if paying alternate payee for several vendors), '2' - Supplier Invoice Number

Print Information

Print

1. Enter the Forms Type for the Payments Spool File. If left blank, the default is 'APCHECKS'

Form Type (FUTURE)

Processing Options for Create A/P Bank Tape – CTX Format (R04572T2)

EFT

1. Enter the File ID modifier (1 pos.). This is used to distinguish between multiple files created on the same date. Default is '1'.

File ID Modifier

2. Enter the tape payment detail (10 pos.) description. For example, you may want to enter EXP REIMB for expense reimbursements. This description may be used by th bank and printed on the supplier's bank account statement.

Tape Payment Detail Description

EFT(more)

1. Enter the Immediate Origin (10 positions). (Header Record 1, positions 14-23). If you provide only 9 characters/digits, we will right justify your information and place a blank in the first position of this field. If this option is blank, the Tax ID for the bank account's company will be used. NOTE: If this field is blank and no Tax ID is available, the tape will be rejected by the Clearing House.

Immediate Origin

2. Enter the Company ID Number.(10 positions).(Record 5, 41-50 and Record 8, 45-54). The ID Number MAY be preceeded by one of the following ID Code Designators (ICDs) or

a value of your own.

'1' = IRS Employer ID No. (EIN)

'3' = Data Universal No. System(DUNS)

'9' = User Assigned Number

If this option is blank, the Tax ID for the bank account's company will be used. NOTE: If this field is blank and no Tax ID is available OR less than 10 characters, the tape will be rejected by the Clearing House

Identification Code Designator

3. Enter a value (20 character alpha) to be placed in the Discretionary Data field on the Company/Batch Header Record (Record 5, position 21-40) If left blank, the Discretionary Data field will be left blank

Discretionary Data

PRINT

1. Enter the payment print program to use if the pre-note status is set to 'P', requiring a payment print.

Print Program

TAPE

1. Enter the following defaults values:

Device Name

Tape Density

Label Name

Block Size

New Volume Name

TAPE (more)

New Owner ID

File Name

Processing Options for Print Automatic Payments – Subcontract Processing (R04572J)

Translation

1. Enter the program name to translate payment amount from numbers to words. (See User Defined Codes system code '98', record type 'CT' for program names.) If left blank, the translation program associated with the payment currency code will be used.

Translation Program

Address

2. Enter an override address format to use for the payee and/or company addresses. If left blank, the country format will be used.

Address

Payment

3. Enter a '1' if you would like to print the company name and address on the payment. If left blank, no company information will print.

Company Name

Print

4. Enter the Forms Type for the Payments Spool File. If left blank, the default is ' SUBCHECKS'

Form Type

See Also

- Localization guides for country-specific payment formats

Creating Payment Control Groups

From the Automatic Payment Processing menu (G0413), choose Create Payment Control Groups.

After you have processed your vouchers, you can prepare to write your payments. Before you write payments, you must create payment groups to organize vouchers that can be paid together. For example, you can organize vouchers by bank account and payment instrument in separate groups. Then the vouchers can be paid with the proper check stock. You use the payment groups when you review and write payments.

Create Payment Control Groups is a batch process that you run once for each payment cycle. The program typically creates more than one payment group. Each payment group contains information that determines how the group will be processed, including:

- Bank account
- Payment instrument

Each payment group also contains control information that determines which program to use for:

- Payments
- Registers
- Attachments
- Debit statements

If you need to include additional vouchers in a payment group, you can undo the group, approve those vouchers for payment, and rerun the program. The system displays payment groups after you write them until you undo them or update them to the Accounts Payable ledger.

When you create payment groups, the system:

4. Selects vouchers with a pay status of A (approved) and a due date that is less than or equal to the specified pay through date.
5. Creates payment groups for all selected vouchers by grouping vouchers with the following common information:
 - Vouchers summarized or unsummarized
 - Bank account
 - Payment instrument
 - Business unit (optional)
 - Company (optional)

Note

To group vouchers for a supplier where the vouchers have different G/L bank accounts, use version XJDE0008, or a copy of it, to create the payment group. Be sure to enter the G/L Bank Account override on the Printing tab of the processing options. This version of P04570 does not include G/L Bank Account as a mandatory sequence, so will use the override G/L bank account processing option to determine the G/L bank account for the checks. If you do not enter a value in the processing option, this version will give unpredictable results.

After the system creates payment groups, each group also has the following information in common:

- Version ID
 - User
 - Creation date
 - Output queue
6. Assigns each payment group a "next status" of WRT (write).
 7. Changes the pay status of selected vouchers from A to # (payment in-process).
 8. Creates the following worktables to use in writing payments:
 - A/P Payment Processing - Header table (F04571). Contains a single header record for each payment group with information about that group of payments.
 - A/P Payment Processing - Summary table (F04572). Contains a record for each payment within a group. These records are the actual payments that will be written and updated through the Work with Payment Groups program. This information is the basis for the Accounts Payable - Matching Document table (F0413).
 - A/P Payment Processing - Detail table (F04573). Contains a record for each voucher pay item within a payment. This is the information that will be printed on the payment stub and used to update the Accounts Payable ledger. This information is the basis for the Accounts Payable Matching Document Detail table (F0414).
 9. Prints a Create Payment Control Groups report that shows the vouchers that are selected for payment. It also shows pay items that were bypassed for payment and prints an error message next to each blank payment total. Examples of error messages include:
 - Hold payment code active
 - Supplier master information missing
 - Amount under payment limit

The following graphic shows the process for creating payment groups:

Creating Payment Groups



Accounts Payable
Ledger (F0411)



Before you create
Payment groups

Voucher	Pay Status	Pay Inst	Due Date (MM/DD)
PV101	A		6/01
PR102	H		7/15
PD103	A	T	6/01
PV104	H		6/05
PV105	A	T	6/15



Create payment groups

Pay Status = Approved
Due on or before
June 15



Create two
payment groups

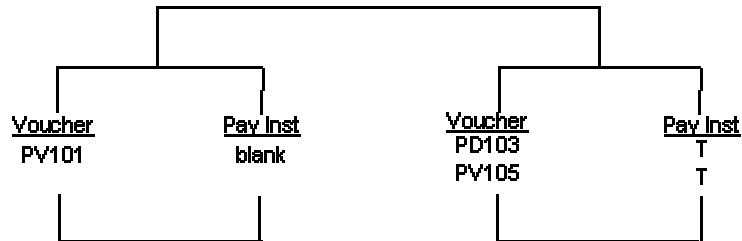

See Also

- *Multicurrency Payments* in the *Multicurrency Guide* for more information about how to create payment groups based on currency code

Before You Begin

- ❑ Verify that you set up suppliers with the correct payment instrument.
- ❑ Make changes to vouchers, if necessary. In general, you cannot change vouchers in a payment group until you complete the automatic payment process or remove the voucher from the group.
- ❑ Approve vouchers for payment.
- ❑ Calculate withholding, or set the processing options for this program to automatically calculate withholding.

Next Numbers for Create Payment Control Groups

When the Create Payment Groups program (R04570) is run, the payment group is assigned a number that is used to identify the payment group in the three workfiles that are used in the payment process (F04571, F04572, and F04573). This number prevents payments in one payment group from being combined with payments in different payment groups.

The Accounts Payable system uses the Next Numbers table (F0002) to assign these payment group numbers. The F0002 table is locked during the time a number is being assigned to one payment group, and is released immediately after the payment group has been assigned its identifying number.

The F0002 table will increment until it reaches its maximum (a number greater than 99 million), then will reset the next number for payment control groups to 1.

Note

The next number for Create Payment Control Groups is the number assigned to a payment control group, not to the payments within a group. There can be many payments in a single payment control group. Only one number from the Next Numbers table (F0020) is assigned to each payment control group.

Processing Options for Create Payment Groups (R04570)

Dates Tab

These processing options allow you to customize payment and discount dates of payment groups. If you leave the Pay Through Date processing blank and the Displacement Days processing option is zero, the system date is used for the Pay Through Date.

1. Pay Through Date

Use this processing option to specify a due date through which you want to create a group of vouchers for payment. For example, if you want to create a payment group consisting of vouchers with due dates through March 15, 2005, enter 03/15/05. The system creates a payment group consisting of vouchers with due dates on or before March 15, 2005. Enter the date in this processing option, or leave the processing option blank to select vouchers by Displacement Days.

Note: If you leave the Pay Through Date field blank and the Displacement Days processing option as zero, the system date is used for the Pay Through Date.

2. Displacement Days

Use this processing option to specify the number of days from today's date through which you want to create a group of vouchers for payment. For example, if today's date is March 10, and you specify three displacement days, the system includes vouchers with due dates through March 13 in the payment group.

Enter the number of days in this processing option, or leave as zero to use the system date as the Pay Through Date.

3. Discount Cutoff Date

Use this processing option to enter the final date that you are allowed to take a discount. Pay items with a due date prior to the date you enter are not eligible for discounts, so the system sets the discount amounts of these pay items to zero. If this processing option is blank, the program takes all discounts currently available for the selected pay items.

Amounts Tab

These processing options specify payment ranges, currency, and payment range exceptions.

The minimum and maximum amounts here refer to payment amounts, not voucher amounts. Use data selection to control the maximum and minimum amounts of the vouchers to be selected.

1. Payment Amount Range

Maximum

Use this processing option to enter a numeric value indicating a payment amount range for a group of vouchers. For example, you can select vouchers between 500 and 1000.

NOTE: Do not enter symbols indicating a specific currency. Rather, specify the currency in the Currency Code processing option.

- o Maximum - Enter the maximum amount allowed for vouchers in the selection range.

Minimum

Use this processing option to enter a non-zero numeric value indicating a payment amount range for a group of vouchers. For example, you can select vouchers between 500 and 1000.

NOTE: Do not enter symbols indicating a specific currency. Rather, specify the currency in the Currency Code processing option.

- o Minimum - Enter the minimum amount allowed for vouchers in the selection range.

To prevent the system from generating a debit statement (negative or zero payment totals) enter the lowest currency unit. For example, .01 for USD or CAD.

2. Currency Code for Range Amounts

Use this processing option to enter a code that specifies the currency for the values you entered in the Payment Amount Range processing option fields. If necessary, the system converts these amounts to the payment currency of each payment control group. For example, if you enter ranges of 100 to 5000 in USD, the system converts those USD amounts to EUR for an EUR payment group, to GBP for a GBP payment group, and so on. The conversion allows for the correct minimum and maximum comparisons for all payment groups created each time you run this program.

3. Payment Instruments for Range Exceptions

Minimum Payment Instrument

Use this processing option to assign payment instruments to vouchers that are not included in the amount range you specify in the Payment Amount Range processing option.

- o Minimum Payment Instrument - A payment instrument that you want to assign to vouchers that have an amount less than the minimum amount range you specify in the Payment Amount Range processing option.

NOTE: You set up payment instruments on user defined code table 00/PY. You must also set up payment instruments defaults. On the Automatic Payment Setup menu (G04411), choose Payment Instrument Defaults (P0417).

Maximum Payment Instrument

Use this processing option to assign payment instruments to vouchers that are not included in the amount range you specify in the Payment Amount Range processing option.

- o Maximum Payment Instrument - A payment instrument that you want to assign to vouchers that have an amount more than the maximum amount range you specify in the Payment Amount Range processing option.

NOTE: You set up payment instruments on user defined code table 00/PY. You must also set up payment instruments defaults. On the Automatic Payment Setup menu (G04411), choose Payment Instrument Defaults (P0417).

Printing Tab

These processing options allow you to customize various printing options for payment groups.

1. Sequence ID

Use this processing option to determine the order that the program processes and prints the A/P payments by entering a sequence ID.

Sequence IDs are user defined. To set up and define sequence IDs, choose Payment

Sequence from the Automatic Payment Setup menu (G04411).

NOTE: You cannot leave this processing option blank.

2. Print Attachments

Use this processing option to specify whether to print attachments with the payment. For example, you might want to print an attachment when the payment detail information will not fit on the pay stub. Only 99 pay stubs can print per payment, and each pay stub can print 10 detail lines.

Valid values are:

Blank

Do not print attachments.

1

Print attachments.

Note: If you leave this option blank and you have more than 99 pay stubs, two or more payments will print. However, if you enter 1, a single payment will print with one pay stub referring to the attachment. The attachment will print all pay items.

Before using this processing option, you must assign an attachments program to your payment instrument. From the Automatic Payment Setup menu (G04411), choose Payment Instrument Defaults, and then choose the payment instrument and click Select. On Set Up Payment Instrument Defaults, you can enter a program number in the Attachments field to specify the attachment program you want the payment instrument to use. The default attachment program is R04573.

3. G/L Bank Account

Use this processing option to specify a bank account that you want the system to use instead of the bank account that is assigned to the voucher pay item when the voucher is entered.

To specify a G/L bank account, enter its short account ID. The short account ID is an eight-digit alphanumeric field that does not allow any special characters. Therefore, if you identify a short account ID in the General Accounting Constants by attaching a special character to it, you do not include the special character in this field.

If the short account ID does not use eight digits, whatever digits are unused must be filled with zeros. For example, if the short account ID for the bank account you want to use is 108, enter the number as 00000108. If you use the visual assist to choose the bank account, the system enters the number into the field correctly.

If the intercompany settlements constant is set to N, and you specify a G/L override bank account in this field, the system compares each voucher's company to the company of the override G/L bank account. If the voucher company is not the same as the company of the override G/L bank account, the system does not include that voucher in the payment group.

Before you can enter a G/L bank account in this field, you must set up the account on your system. To set up G/L bank accounts, choose Bank Account Information from the Automatic Payment Setup menu (G04411).

If you use multicurrency, consider the following guidelines when using this processing option:

- o If the bank account is a monetary account, it must have the same currency as either the domestic or foreign currency of the voucher.

- o If the bank account is a non-monetary account, its company currency must be the same as the domestic currency of the voucher.

4. Payment Currency

Use this processing option to specify the currency method that the program uses for payment.

Valid values are:

Blank

You pay in the currency of the G/L bank account. For monetary accounts, this is the currency assigned to the G/L bank account in the Account Master table (F0901). For nonmonetary accounts, this is the currency assigned to the company in which the business unit of the G/L bank account resides. For example, the currency associated with the G/L bank account 1.1110.BEAR is U.S. dollars (USD) because business unit 1 belongs to company 00001 whose currency is USD. If you enter vouchers in the euro (EUR) for company 00001, you can either pay the vouchers from the monetary bank account in EUR, or you can pay them from a bank account that belongs to a company whose base currency is USD.

1

You pay the domestic amount of the voucher in the domestic currency. For example, if you entered the voucher in FRF for company 00001, whose base currency is USD, the voucher is paid in USD.

2

You pay the foreign amount of the voucher in the foreign currency. For example, if you entered the voucher in EUR for company 00001, whose base currency is USD, the vouchers are paid in EUR. Vouchers that do not have a foreign currency are paid in the domestic currency.

3

You pay the current domestic amount of a foreign voucher in the domestic currency. For example, if you entered the voucher in EUR for company 00001, whose base currency is USD, the foreign amount is converted to the current domestic amount based on today's effective exchange rate, and the voucher is paid in USD.

4

You pay the voucher in an alternate currency that is neither the domestic amount nor

foreign currency of the voucher. For example, if you entered the voucher in EUR for company 00001, whose base currency is USD, but you want to pay the voucher in Canadian dollars (CAD), the voucher is paid in the alternate currency. Designate the payment currency in processing option 5.

Exchange Rate Notes: When you make payments in the current domestic currency, the Create Payment Groups program calculates the domestic amounts being paid using the exchange rate effective that day. This may be different from the exchange rate effective when you actually make the payment.

Later in the automatic payment process, the system calculates a gain or loss if the exchange rate of the voucher is different from the exchange rate of the payment.

5. Alternate Currency Code

Use this processing option to enter the code for the alternate currency amount. You enter a value in this processing option only if you specified 4 in the Payment Currency processing option.

6. Prepayment Selection

Use this processing option to indicate whether you want to include negative prepayment items in the payment group.

Valid values are:

Blank Do not include negative prepayment items.

1 Include negative prepayment items.

Process By Tab

These processing options specify the categories by which the system groups payments.

1. Company

Use this processing option to specify whether to create separate payments based on company.

Valid values are:

Blank No

1 Yes

2. Due Date

Use this processing option to specify whether to create separate payments based on due date.

Valid values are:

Blank No

1 Yes

3. Payee

Use this processing option to specify whether to create payments based on payee, regardless of the supplier.

Valid values are:

Blank No

1 Yes

For example, the following table illustrates one possible voucher, supplier, and payee combination:

Voucher 1, Supplier 1001, Payee 1001

Voucher 2, Supplier 1001, Payee 1002

Voucher 3, Supplier 1001, Payee 1002

Voucher 4, Supplier 1002, Payee 1002

Voucher 5, Supplier 1003, Payee 1001

If you leave the Payee processing option blank, the system generates four payments, based on the payee, then supplier:

o Payee 1001: Supplier 1001, Voucher 1

o Payee 1001: Supplier 1003, Voucher 5

o Payee 1002: Supplier 1001, Vouchers 2 and 3

o Payee 1002: Supplier 1002, Voucher 4

If you set the Payee processing option to 1, you have two payments based only on the payee:

o Payee 1001: Supplier 1001, Voucher 1, and Supplier 1003, Voucher 5

o Payee 1002: Supplier 1001, Vouchers 2 and 3, and Supplier 1002, Voucher 4

4. Business Unit

Use this processing option to specify whether to create separate payment control groups by business unit.

Valid values are:

Blank No

1 Yes

Summarize Tab

These processing options allow you to customize the information that appears on the payment stub.

1. Summarized Pay Item

Use this processing option to specify whether to summarize pay items within a document on the pay stub or attachment. When you set the processing option to summarize pay items, the Due Date processing option on the Process By tab must have a value of 1. Valid values are:

Blank

Do not summarize pay items.

1

Summarize pay items.

2. Summary Description

Use this processing option to specify the information that appears in the Description field on the pay stub.

Valid values are:

Blank The generic description Invoice Summary appears on the pay stub.

1 The remark from the first pay item appears on the pay stub.

Report Tab

These processing options specify the information that will appear on the report. To produce separate payments by job, the Statement Number field (CTL) must be included in the sort sequence.

1. Print Mailing Address

Use this processing option to specify whether the mailing address for each payee appears on the report.

Valid values are:

Blank No

1 Yes

2. Print Contract Number

Use this processing option to specify whether the the contract number appears on the report.

Valid values are:

Blank No

1 Yes

NOTE: To produce separate payments by job, the Statement Number field (CTL) must be included in the sort sequence. See DEMO version XJDE0007 for an example of the sort sequence, or copy DEMO version XJDE0007 and use it as a basis for your report.

3. Print Job Number

Use this processing option to specify whether the job number appears on the report.

Valid values are:

Blank No

1 Yes

NOTE: To produce separate payments by job, the Statement Number field (CTL) must be included in the sort sequence. See DEMO version XJDE0007 for an example of the sort sequence, or copy DEMO version XJDE0007 and use it as a basis for your report.

Bank Tape Tab

These processing options specify the bank information that prints on the report.

1. Print Bank Tape Information

Use this processing option to specify whether bank tape information appears on the edit report.

Valid values are:

Blank No

1 Yes

2. Payee Bank Account Error

Use this processing option to specify whether the program issues an error when bank account information does not exist for the payee.

Valid values are:

Blank Do not issue an error.

1 Issue an error.

3. Bank Account X12 Information Error

Use this processing option to specify whether the program issues an error when X12 information does not exist for the G/L bank account.

Valid values are:

Blank Do not issue an error.

1 Issue an error.

If this processing option is populated, the system will generate a message whenever a payee does not have bank account information stored in Bank Information table (F0030). This will happen whether a bank tape is being processed or not. The system cannot distinguish between pay instruments when using this processing option.

Withholding Tab

These processing options specify whether to submit the Calculate Withholding program before you create payment control groups.

1. Calculate Withholding

Use this processing option to specify whether to submit the Calculate Withholding program prior to creating payment control groups.

Blank No

1 Yes

2. Program Version

Use this processing option to specify the version number of the Calculate Withholding program. You must specify a version number if you enter 1 in the Calculate Withholding processing option.

Blank Version number ZJDE0001 (default)

Or, enter the specific program version number

Data Sequence for Create Payment Control Groups

The data sequence for this program is set to create separate payments by payee. Any changes to this sequencing results in payments by voucher instead of payments by payee. Selecting the Multiple Payments option on the Supplier Master Revision form does not override the payee sequencing.

The sequence for Create Payment Control Groups must be as follows:

- G/L Bank Account
- Payment Instrument
- Check Routing Code

This sequence must be used to produce payments that are grouped properly.

Working with Payment Groups

After you create payment groups, you can work with them to review and change payments. You generally review payments twice:

- After you create payment groups but before you write payments. This allows you to identify payments and vouchers that you want to change or remove from the payment cycle. You can:
 - Change information at the payment and voucher levels
 - Remove payment groups, payments, and vouchers from the payment cycle
 - Change control information for payment groups
- After you write payments but before you update the A/P ledger. This allows you to identify payments that you want to void or remove from the payment cycle. You can:
 - Void the payments that were written and rewrite them
 - Remove payment groups, payments, and vouchers from the payment cycle

When you work with payment groups, you work with pay items that are at one of the following statuses:

Write	The pay item is ready to be written.
Update	The payment has been written and is ready to be updated in the Accounts Payable Ledger table (F0411).

When pay items in a payment group are at a status of *write* or *update*, you might need to perform one of the following actions:

Undo	Undo means to remove a pay item from the payment group. You can undo pay items, regardless of whether they are at a status of write or update. In either case, the pay item will have an open amount other than 0, and will have a status of approved.
Reset	Reset means to return a pay item to the previous step in the payment process. If the status of the pay item is update and you reset it, the pay item returns to a pay status of write.

The following graphic shows the process for working with payment groups:

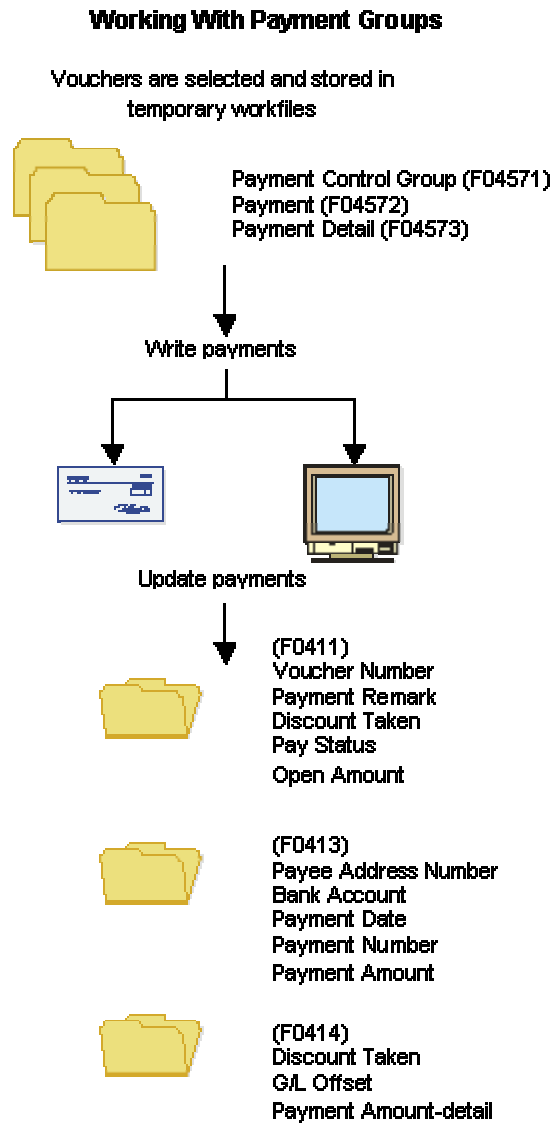

After you process payment groups

Voucher	Pay Status	Pay Inst	Due Date (MM/DD)
PV101	P		6/01
PR102	H		7/15
PD103	P	T	6/01
PV104	H		6/05
PV105	P	T	6/15

Printing the Payment Analysis Report

From the Automatic Payment Processing menu (G0413), choose Payment Analysis Report.

You can print the Payment Analysis report at any time in the automatic payment process to ensure that payments are correct. This report shows whether payments are ready to be written or ready to be updated to the A/P ledger. It shows all payments in all payment groups.

Processing Options for Payment Analysis Report (R04578)

Print

1. Enter a '1' if you would like to see the detail voucher information displayed. If left blank, only payment information will print.

Detail Voucher Information

2. Enter a '1' if processing payment control groups by Business Unit and would like to display the Business Unit on the report. If left blank, the Business Unit will not appear.

Business Unit

Reviewing Payment Groups

When you review payment groups, you can display groups based on a next status of write, update, or both. For example, you might want to review all payment groups that are ready to be written (next status of WRT). Optionally, you can review payments assigned to a specific bank account or payments that meet a number of additional search criteria.

This program displays information from the A/P Payment Processing - Header table (F04571).

► To review a payment group

From the Automatic Payment Processing menu (G0413), choose Work with Payment Groups.

1. On Work With Payment Groups, click one or both of the following options:
 - Write Status
 - Update Status
2. To further limit your search, complete the following field:

- Bank Account
3. Click Find.
For additional search criteria, you can preset a value in a processing option. For example, if you want to review only those vouchers for business unit 100, you can preset that value in a processing option. This is particularly useful if you routinely review vouchers that meet certain search criteria.
 4. To view the detailed information for a single payment group, select the payment group on Work With Payment Groups.
 5. Choose Detail from the Row menu.

The screenshot shows the PeopleSoft interface for the 'Payment Group Detail' form. At the top, the PeopleSoft logo is visible on the left, and navigation icons for Portal, Work, Intranet, and Training are on the right. Below the logo, there is a 'Select Workspace' dropdown menu set to 'Active Foundation'. The main header area includes 'Active Foundation' on the left and 'Personalize', 'Change Role', and 'Sign Out' on the right. The form itself is titled 'Payment Group Detail' and has a 'Cancel' button and a 'Tools' icon. The form is divided into several sections:

- Bank Account:** Includes fields for 'Bank Account' (1.1110 BEAR), 'Bank Name' (Bear Creek National Bank), 'Version' (TR0002), 'Payment Instrument' (with a checkbox for 'Default (A/R & A/P)'), 'Originator' (DEMO), 'Payment Group Control Number' (9), and 'Currency' (USD).
- Write Status:** Includes fields for 'Payment Amount' (13,123.00), 'Discount Taken' (77.00), and 'Number of Payments' (2).
- Update Status:** Includes empty fields for 'Payment Amount', 'Discount Taken', and 'Number of Payments'.

 The form is displayed within a browser window with standard navigation and toolbar icons.

The Payment Group Detail form shows the same detailed information for the single payment group that appears on Work With Payment Groups.

Reviewing Payments with a Write Status

Before you write payments, you can do the following:

- Review payment and voucher information (write status)
- Review payment summary information (write status)

The payment group programs display information from the following temporary worktables:

- A/P Payment Processing - Header table (F04571)
- A/P Payment Processing - Summary table (F04572)

► **To review payment and voucher information (write status)**

You can review the payment and voucher information for a specific payment group before you write a payment. For example, you might want to verify that the correct bank account was assigned to a payment group or that a specific voucher is included in a payment.

From the Automatic Payment Processing menu (G0413), choose Work with Payment Groups.

1. On Work With Payment Groups, click the following option and click Find:
 - Write Status
2. Choose a payment group and click Select.

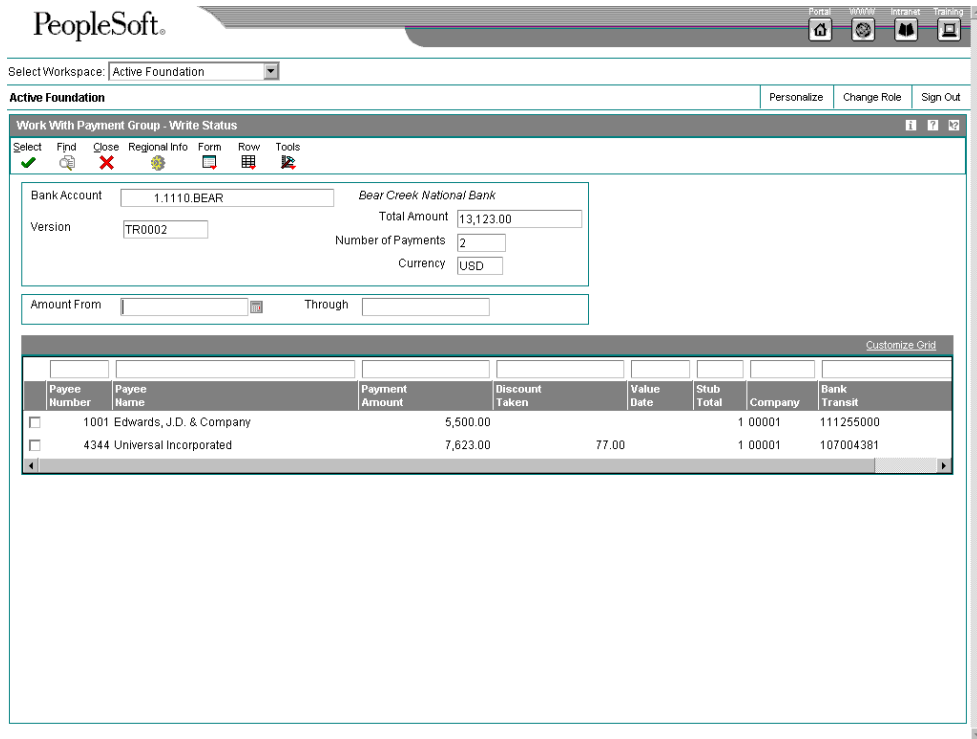

3. On Work With Payment Group - Write Status, choose a payee and click Select.

PeopleSoft

Select Workspace: Active Foundation

Active Foundation Personalize Change Role Sign Out

Work With Payment Detail

Select Find Close Regional Info Row Tools

Payee 4344 Universal Incorporated
 Bank Account 1.1110.BEAR Bear Creek National Bank
 Payment Amount 7,623.00 Currency USD

Document Number	Doc Type	Doc Co	Pay Item	Payment Amount	Discount Taken	Invoice Number
<input type="checkbox"/>	1571 PV	00001	001	2,673.00		27.00 C375
<input type="checkbox"/>	1572 PV	00001	001	4,950.00		50.00 C741

- On Work With Payment Detail, choose a voucher and click Select to review voucher information associated with a payment.

PeopleSoft

Select Workspace: Active Foundation

Active Foundation Personalize Change Role Sign Out

Payment Detail

Cancel Tools

Document No/Typ/Co 1571 PV 00001
 Pay Item 001
 Supplier Number 4344 Universal Incorporated
 Remark Advertising Expense
 Invoice Number C375
 Invoice Date 05/10/05 Due Date 05/20/05
 Company 00001 Financia/Distribution Company

Payment Amount 2,673.00 Currency USD
 Discount Taken 27.00

The Payment Detail form shows the voucher information associated with a payment.

► **To review payment summary information (write status)**

When you review payments within a payment group, you can review the summary information for each payment before you actually write the payment.

From the Automatic Payment Processing menu (G0413), choose Work with Payment Groups.

1. On Work With Payment Groups, click the following option and click Find:
 - Write Status
2. Choose a payment group and click Select.
3. On Work With Payment Group - Write Status, choose the payee that you want to review.
4. From the Row menu, choose Detail.

The screenshot shows the PeopleSoft interface for the 'Payment Header Detail - Write Status' form. The form is titled 'Payment Header Detail - Write Status' and is located within the 'Active Foundation' workspace. The form contains the following fields:

Payee Number	4344	Universal Incorporated	Currency	USD	
Payment Amount	7,623.00	Discount Taken	77.00	Stub Total	1
Bank Transit	107004381				
Value Date					
Company	00001	Financia#Distribution Company			

Reviewing Payments with an Update Status

Before you update the payments that you have written, you can review them. To do so, complete either of the following tasks:

- Review payment information (update status)
- Review payment summary information (update status)

You can reset a payment group that is at update status and rewrite your payments, if necessary. When you reset written payments in an update status (UPD), you return them to a status of write (WRT). The payment group programs display information from the following worktables:

- A/P Payment Processing - Header table (F04571)
- A/P Payment Processing - Summary table (F04572)

► **To review payment information (update status)**

You can review payment information for a specific payment group before you update the payment.

From the Automatic Payment Processing menu (G0413), choose Work with Payment Groups.

1. On Work With Payment Groups, click the following option and click Find:
 - Update Status
2. Choose a payment group and click Select.

► **To review payment summary information (update status)**

When you review payments within a payment group, you can review the summary information associated with a specific payment.

From the Automatic Payment Processing menu (G0413), choose Work with Payment Groups.

1. On Work With Payment Groups, click the following option and click Find:
 - Update Status
2. Choose a payment group and click Select.
3. On Work With Payment Group - Update Status, choose the payee that you want to review.
4. From the Row menu, choose Detail.

See Also

- ❑ *Resetting Payment Processing* in the *Accounts Payable Guide* for information about changing values in payment processing

Revising Unprocessed Payments

You can make limited changes to payments, vouchers, and payment groups before you write them, including the following:

- Excluding debit memos (credit vouchers)
- Splitting payments

- Revising the value date of payments
- Removing voucher pay items
- Removing unprocessed payments
- Removing an entire payment group
- Revising control information for a payment group

See Also

- *Setting Up Payment Instruments* in the *Accounts Payable Guide* for information about how to set up payment instruments

► To exclude a debit memo (credit voucher)

You can exclude a debit memo on any of the following forms:

- Work With Payment Groups (the steps in this procedure use this form)
- Work With Payment Group - Write Status
- Work With Payment Detail
- Work With Payment Group - Update Status

Debit memos occur when you have overpaid a supplier or have been issued credit from a supplier. You can exclude these debit memos from payment processing.

From the Automatic Payment Processing menu (G0413), choose Work with Payment Groups.

1. On Work With Payment Groups, choose a payment group, payment, or voucher.
2. From the Row menu, choose Undo.
3. On Undo Confirmation, click Yes.
4. On Reset Payments, click OK.

Related Tasks

Excluding all debit memos	To exclude all debit memos, set the processing option for Minimum Amount in Create Payment Control Groups to the smallest currency unit (for example, .01).
Reviewing debit memos	When you process debit memos for review purposes only, you can run the Payment Analysis Report or review them on Work With Payment Groups before you undo them.

► To split a payment

When you want to pay part of a voucher now and part later, you can split the payment. When you decrease the gross amount of a voucher, the system creates a new voucher pay item for

the remaining balance. The new pay item is created using the default pay status, which is typically A (approved) for payment. The new pay item is not part of a payment group.

From the Automatic Payment Processing menu (G0413), choose Work with Payment Groups.

1. On Work With Payment Groups, choose a payment group and click Select.
2. On Work With Payment Group - Write Status or on Work With Payment Group - Update Status, depending on what options you selected on Work With Payment Groups, choose a record and choose Pay Items from the Row menu.
3. On Work With Payment Detail, choose a voucher.
4. From the Row menu, choose Split.

PeopleSoft

Select Workspace: Active Foundation

Active Foundation Personalize Change Role Sign Out

Split Payment

OK Cancel Tools

Document No/Ty/Co 1580 PV 00001

Pay Item 001

Invoice Number 17984

Payment Amount 5,500.00

Enter Amounts to be Paid

Gross Amount 2500

Discount Taken 50

5. On Split Payment, complete the following fields and click OK:
 - Gross Amount
 - Discount Taken

► To revise the value date of a payment

Typically, payment value dates apply to draft processing and indicate the date that a payment reaches a bank.

From the Automatic Payment Processing menu (G0413), choose Work with Payment Groups.

1. On Work With Payment Groups, follow the steps for reviewing payments for a payment group with a next status of Write.
2. On Work With Payment Group - Write Status, choose ValueDate from the Form menu.

PeopleSoft

Select Workspace: Active Foundation

Active Foundation Personalize Change Role Sign Out

Revise Payment Value Date

Bank Account: 1.1110.BEAR Bear Creek National Bank

Version: TR0002

Total Amount: 13,123.00

Number of Payments: 2

Currency: USD

Global Value Date: []

Payee Number	Payee Name	Payment Amount	Value Date
<input checked="" type="checkbox"/> 1001	Edwards, J.D. & Company	5,500.00	[]
<input type="checkbox"/> 4344	Universal Incorporated	7,623.00	[]

3. On Revise Payment Value Date, complete the following field to revise the value date of all payments in the group:
 - Global Value Date
4. Click Load Date to update the value date for each payment.
5. To revise the value date of an individual payment, complete the following field:
 - Value Date
6. Click OK.

► To remove a voucher pay item

When you do not want to pay a voucher, remove it from the payment group. The system resets the pay status of the voucher from payment in-process to approved.

From the Automatic Payment Processing menu (G0413), choose Work with Payment Groups.

1. On Work With Payment Groups, follow the steps for reviewing vouchers.
2. On Work With Payment Detail, choose a voucher.
3. From the Row menu, choose Undo.

4. On Undo Confirmation, click Yes.
5. On Reset Payments, click OK.

► To remove an unprocessed payment

If you do not want to make a payment, you can remove it from the payment group. The system removes the voucher pay items from the payment group and resets their pay status from payment in-process to approved.

From the Automatic Payment Processing menu (G0413), choose Work with Payment Groups.

1. On Work With Payment Groups, follow the steps for reviewing payments for a payment group with a next status of Write.
2. On Work With Payment Group - Write Status, choose a payment.
3. From the Row menu, choose Undo.
4. On Undo Confirmation, accept or reject undoing the selected payment.

► To remove an entire payment group

From the Automatic Payment Processing menu (G0413), choose Work with Payment Groups.

1. On Work With Payment Groups, choose a payment group.
2. From the Row menu, choose Undo.
3. On Undo Confirmation, click Yes.

See Also

- ❑ *Reviewing Payments with a Write Status* in the *Accounts Payable Guide* for more information about how to review payments that are in a Write status
- ❑ *Reviewing Vouchers* in the *Accounts Payable Guide* for information about how to review vouchers

Working with Automatic Payments

After you create payment groups, you must write payments. When you create payment groups, the system creates temporary payment records. You then use these records to print payments or copy them to a bank tape, depending on your setup.

Writing Payments

When you write payments, you can print the payments or copy them to a bank tape. You can perform either of the following actions:

- Write all payments in a payment group

- Write selected payments in a payment group

When you write payments, the system:

- Creates a matching document with a document type of PK (automatic payment). This payment closes the voucher.
- Creates a matching document with a document type of PT (electronic funds transfer).
- Assigns payment numbers.
- Changes the "next status" of the payment group from WRT (write) to UPD (update).
- Prints payments using control information for payment groups.
- Prints attachments if needed

Note

Create Payment Control Groups (R04570) controls the printing of attachments. The J.D. Edwards standard payment processing is designed to print *ten* lines of detail on a payment stub.

If there are more than ten lines of detail to print, and the R04570 processing option to print attachments is set, the payment stub will print "See Attachment" and all detail will print on the attachment.

If the R04570 processing option for attachments is not set to print attachments and there are more than ten lines of detail for a single payment, the J.D. Edwards Auto Payments Write/Reset program (P04572) will print ten lines of detail on a stub, void the payment, print ten lines of detail on the next stub, void the payment, and so on until all lines of detail have been printed. The payment form following the last line of detail will print with the full payment amount. The P04572 will print up to 99 lines of detail on a single payment. If there are more than 99 lines of detail, the system will print multiple payments.

When you issue a payment, you issue it to the alternate payee. You choose whether the alternate payee is the supplier or the factor/special payee in the voucher entry processing options by specifying a version of the Voucher Entry Master Business Function. On the Defaults tab for the Voucher Entry MBF enter a "1" in the Alternate Payee option to populate the alternate payee with the factor/special payee. Leaving this option blank will populate the alternate payee with the supplier number. You can override the alternate payee default when you enter the voucher.

The system does not update the Accounts Payable Ledger table (F0411), the Accounts Payable Matching Document table (F0413), or the A/P Matching Document Detail table (F0414) until the update process. The payments remain in the temporary workfiles: A/P Payment Processing - Header table (F04571), A/P Payment Processing - Summary table (F04572), and A/P Payment Processing - Detail table (F04573).

Note

When you write a payment whose amount, in words, exceeds the number of characters provided in the print program, the system prints checks with digits for the payment amount instead of words.

Record Reservation for Payments

Record reservation for payments is a process in which the system determines, prior to writing payments, how many payment numbers to reserve for a payment cycle. The system adds that number to the next payment number in the Bank Transit Master table (F0030). The F0030 table has a record for each bank account in the system. Payment numbers are reserved by bank account.

The purpose of using the record reservation process is to prevent more than one payment from having the same payment number. This is especially useful when more than one user is making payments from one bank account at the same time.

To use record reservation, the F0030 table must be added to UDC 00/RR.with the Special Handling Code set to 1.

After the user defined code is set up, when you write payments, the system determines the number of payments to be used and increases the value in the Next Check Number field in the F0030 table by that number. Thus, if the next payment number in the F0030 table for the bank account being used in the payment cycle is 258, and the record reservation process determines that 30 payment numbers are going to be used, the system updates the next payment number to 288. When another person writes payments from the same bank account, the next payment number will begin at 288. Payment numbers between 258 and 287 will be used only by the payment cycle that reserved those numbers.

If two users access the write payments process at the same time, the system activates the record reservation process for the first user and sends an error message to the second user. When the first user completes the record reservation process, the second user will be able to access a payment number record and reserve the number of payments needed for that payment cycle.

Payment ID Using Next Numbers

When a write payment program is run (R04572 or one of its variations, such as R04572A, R04572C, and so on), each payment is assigned a number that identifies it throughout the payment process and after the process finishes. This number is the Payment ID (PKID), and is a key to both the Accounts Payable - Matching Document (F0413) and Accounts Payable Matching Document Detail (F0414) tables. The Payment ID prevents pay items in one payment from being mixed with pay items that are paid on a different payment.

The Accounts Payable system uses the Next Numbers - Automatic table (F0002) or the Next Numbers by Company/Fiscal Year – Automatic table (F00021) to assign Payment ID numbers. The table is locked while a number is being assigned to the pay items associated with one payment, and is unlocked immediately after the pay items have been assigned their identifying numbers.

Before You Begin

- Review payments and make any changes necessary.
- Verify control information for payment groups.

► To write all payments in a payment group

From the Automatic Payment Processing menu (G0413), choose Work with Payment Groups.

1. On Work with Payment Groups, follow the steps for reviewing payment groups.

2. Choose one or more payment groups.

If some payments in a group have already been written, the payment group appears as two lines on the Work With Payment Groups form, with the appropriate totals for each line. One line is at a WRT (write) status and the other line is at a UPD (update) status.

3. From the Row menu, choose Controls.

The screenshot shows the 'Revise Payment Group Controls' dialog box in the PeopleSoft interface. The dialog is titled 'Revise Payment Group Controls' and has a 'Personalize' button, a 'Change Role' button, and a 'Sign Out' button. The 'Active Foundation' workspace is selected. The dialog contains the following fields and options:

- Bank Account: 1.1110.BEAR (Bear Creek National Bank)
- Version: TR0002
- Originator: DEMO
- Payment Instrument: Default (AR & APF)
- Payment Group Control Number: g
- Currency: USD
- Sequence ID: DEMO (Demo sequence)
- Payment: P04572 (Print Payments - Standard) Print Version:
- Register: P04576 (Payment Register - Standard) Register Version:
- Attachment: P04573 (Print Attachments - Standard) Attachment Version:
- Debit Statement: P04574 (Print Dbt Statement - Stand...) Debit Version:

4. On Revise Payment Group Controls, verify that the following fields show the correct programs and versions and click OK:

- Payment
- Print Version
- Register
- Register Version
- Attachment
- Attachment Version
- Debit Statement
- Debit Version

5. On Work with Payment Groups, choose Write from the Row menu.

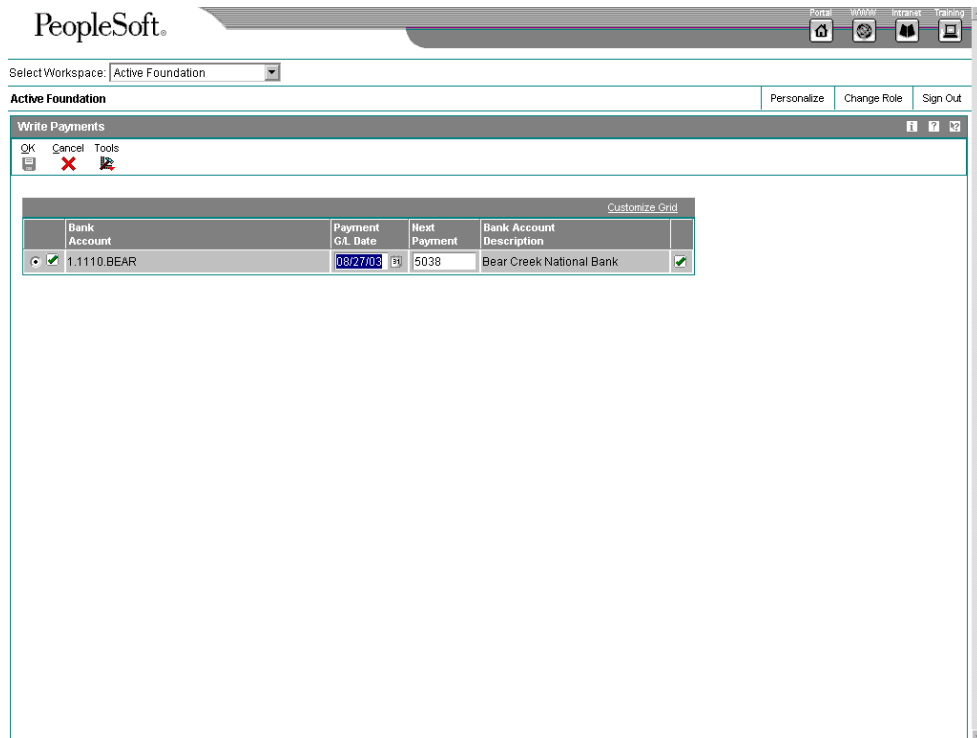

The Write Payments form displays one line for each bank account.

6. On Write Payments, verify the following fields and click OK:
 - Payment G/L Date
 - Next Payment

► To revise control information for a payment group

You can change the programs for printing payments, payment register, attachments, and debit statements by changing the control information for the payment group. You can also change the sequence ID, which determines the order in which the group's payments print.

The system uses payment instrument defaults to create the control information when you create payment groups. You can change this information before you write payments. Any change that you make affects the entire payment group.

From the Automatic Payment Processing menu (G0413), choose Work with Payment Groups.

1. On Work With Payment Groups, follow the steps for reviewing payment groups.
2. Choose a payment group.
3. From the Row menu, choose Controls.
4. On Revise Payment Group Controls, change the following field (optional):
 - Sequence ID

5. Change any of the following print program fields:

- Payment
- Print Version
- Register
- Register Version
- Attachment
- Attachment Version
- Debit Statement
- Debit Version

6. Click OK.

► **To write selected payments in a payment group**

From the Automatic Payment Processing menu (G0413), choose Work with Payment Groups.

1. On Work with Payment Groups, follow the steps for reviewing payment groups.
2. On Work With Payment Group - Write Status, complete the following fields to limit your search and click Find:
 - Amount From
 - Through
3. Choose one or more payments.
4. From the Row menu, choose Write.
5. On Write Payments, verify the following fields and click OK:
 - Payment G/L Date
 - Next Payment

See Also

- *Reviewing Payment Groups* in the *Accounts Payable Guide* for information about how to review payment groups after creating them

Resetting Payment Processing

After you write payments but before you update them, you might need to rewrite them. For example, you might need to rewrite payments because of an error, such as a paper jam, wrong payment number, or wrong payment date.

Before you can rewrite payments, you must reset them. Written payments have a next status of UPD (update). When you reset payments, you are returning them to a next status of WRT (write), so you can correct the problem and rewrite them.

If you need to undo or reset a payment, you can identify the tape affected on the Copy Bank Tape File to Tape program that you access from the Automatic Payment Processing menu (G0413). This program shows information, including the file ID and the member ID.

If you reset payments that were written to a bank tape, you must delete the bank tape record before you can rewrite the payments.

When you reset payments, you can either void payments or rewrite them with the same payment number:

- If you enter a new beginning payment number, the system voids any payments selected for reset that have a payment number less than the new beginning number, if that number was previously assigned.
- If you accept the next payment number (the default), the system voids payments by writing zero records.

The system processes voided payments when you update the A/P ledger. You see these records when you post payments to the general ledger.

You can set a processing option for Work with Payment Groups to process voided payments that are stored in the Account Ledger table (F0911).

► To reset payment processing

When you reset payment processing, the pay items return to open vouchers.

From the Automatic Payment Processing menu (G0413), choose Work with Payment Groups.

1. On Work with Payment Groups, follow the steps for reviewing payment groups.
2. To reset the payments for an entire payment group, choose that group (next status must be UPD) on Work With Payment Groups.
3. To reset single payments, choose the payment on Work With Payment Group-Update Status.
4. To limit your search when resetting single payments, complete the following fields:
 - Beginning Payment
 - Ending Payment
5. Click Find.
6. Choose the payments to reset.
7. From the Row menu, choose Reset.

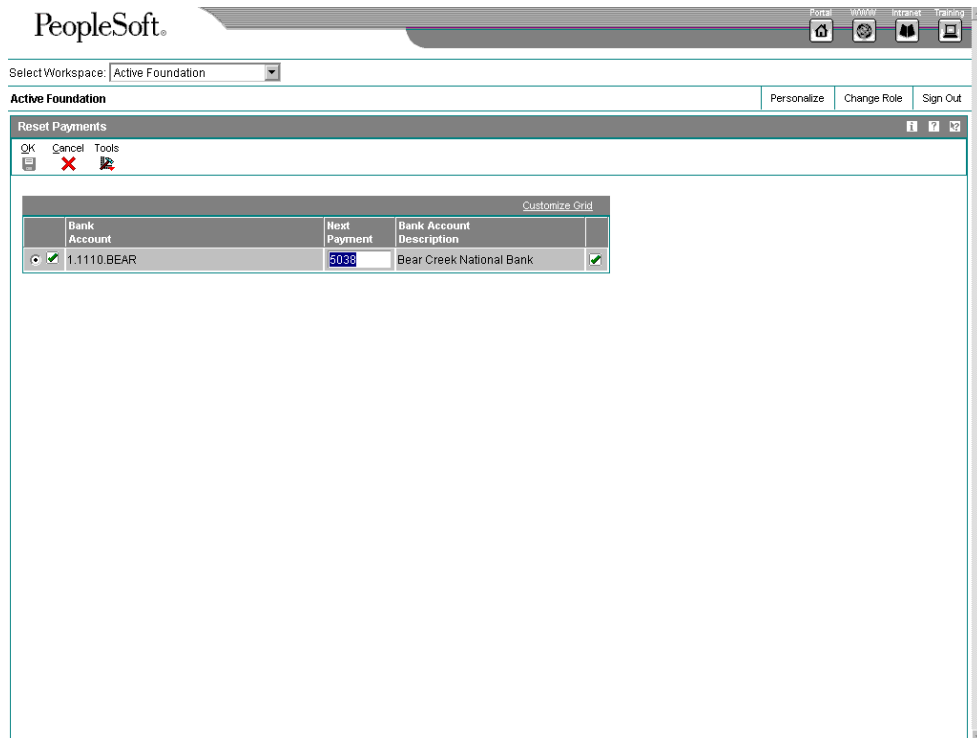

8. On Reset Payments, change the following field, if necessary, and click OK:
 - Next Payment

► **To reset payment processing for a bank tape**

From the Automatic Payment Processing menu (G0413), choose Copy Bank Tape File to Tape.

1. On Copy Bank Tape to Tape, click Find.
2. Choose the payment record you want to remove from the bank tape table and click Delete.
3. On Confirm Delete, click OK.

See Also

- *Reviewing Payment Groups in the Accounts Payable Guide* for information about how to verify the information in payment groups

Removing Processed Payments

After you write payments but before you update them, you might need to remove one or all of them from the current payment cycle. To do so, you undo the payment. The system then:

- Voids the payment
- Removes the voucher pay items from the payment group

- Resets the pay status of the voucher from payment in-process to approved

You can then change vouchers and process them for payment at another time.

If you need to undo a payment, you can identify the tape affected on the Copy Bank Tape to Tape form that you access from the Automatic Payment Processing menu (G0413). This form shows information, including the file ID and the member ID.

If you undo one or all payments that were written to a bank tape, you must delete the bank tape record before you process them for payment.

► To remove processed payments

From the Automatic Payment Processing menu (G0413), choose Work with Payment Groups.

1. On Work with Payment Groups, follow the steps for reviewing payment groups.
2. Perform one of the following actions:
 - Choose a payment group with a next status of UPD
 - On Work With Payment Group - Update Status, choose a payment
3. From the Row menu, choose Undo.
4. On Undo Confirmation, click Yes.
5. On Reset Payments, complete the following optional field and click OK:

- Next Payment

If you do not reset the next payment number, the system creates void payments.

If you are resetting payments that were written to a bank tape, complete the following step to remove the payment record from the bank tape table.

6. On Copy Bank Tape to Tape, choose the payment record and click Delete.
7. On Confirm Delete, click OK.

See Also

- *Reviewing Payment Groups* in the *Accounts Payable Guide* for information about how to verify the data contained in payment groups

Copying Payments to Tape

When you write payments, the payment instrument can be an electronic format. In this case, writing payments creates bank tape tables rather than printed payments. You must copy these tables to tape or diskette if you want to send the information to a financial institution.

Copying payments to tape consists of the following tasks:

- Reviewing and changing the status and detail for a tape table
- Copying a tape table to tape or diskette

Typically, your MIS department presets the detail for a tape table. You should not change this information unless instructed to do so. You can, however, change many format specifications prior to copying the table to tape.

You can recopy a bank table to tape as long as you have not deleted the table. This might be necessary if, for example, your financial institution loses the original tape.

When you create a new bank tape table, you do not overwrite an existing table. The A/P Payment Tape table (F04572OW) is a multimember table, which means that each version (payment group) is a separate table. The system does not automatically delete records in the table. Instead, you must delete the record using the Copy Bank Tape to Tape form. Do not do this until you verify that your bank has received the bank tape.

► **To review and change the status and detail for a tape table**

From the Automatic Payment Processing menu (G0413), choose Copy Bank Tape File to Tape.

1. On Copy Bank Tape to Tape, to locate a tape table, click Find, or limit your search by completing any of the fields in the QBE row, and then click Find.
2. Choose the table that you want to work with and click Select.

The screenshot shows the 'Update Tape Information' form in the PeopleSoft application. The form is titled 'Update Tape Information' and has a toolbar with 'OK', 'Cancel', and 'Tools' buttons. Below the toolbar, there are two rows of input fields. The first row contains 'File ID' with the value 'F04572T' and 'Member ID' with the value 'OW00000000'. The second row contains 'File Name' with the value 'TAP01' and 'Device Name' with the value 'TAP01'. Below these are four more rows of input fields: 'Record Length' with '94', 'Tape Density' with '1600', 'New Volume' with '000001', and 'New Owner ID' which is empty. The final row contains 'Block Size' with '940' and 'Label Name' which is empty.

3. On Update Tape Information, change any of the information in the following fields as needed:
 - File Name
 - Record Length
 - New Volume
 - Block Size

- Device Name
 - Tape Density
 - New Owner ID
 - Label Name
4. Click OK.

Processing Options for Copy Bank Tape File to Tape (P0457)

BACS

1. Enter a '1' to display the BACS format

Display BACS Format

PROGRAM

1. Enter the name of an alternate program to be used. If left blank, program J0457T will be used. NOTE: This processing option is ignored if BACS processing is turned on.

Alternate Processing Program (FUTURE)

Version

1. Copy Bank File to Diskette Version (P0457D)

Blank = ZJDE0001

► To copy a tape table to tape or diskette

From the Automatic Payment Processing menu (G0413), choose Copy Bank Tape File to Tape.

1. On Copy Bank Tape to Tape, to locate a tape table, click Find, or limit your search by completing any of the fields in the QBE row, and then click Find.
2. Choose the table that you want to work with, and then choose Diskette from the Row menu.
3. On Write Bank Diskette, enter the path and/or file name you want to generate.
4. Depending on how you want to use the tape table, select one of the following options:

- Generate New File
 - Append Records
5. Click OK, and then click OK again when the “File created Successfully” message appears.

Processing Options for Copy Bank File to Diskette (P0457D)

Defaults Tab

These processing options specify default information for the system to use when it generates the text file.

1. Record Length

Use this processing option to specify the record length of the output file. The maximum length is 1000 characters. If you leave this processing option blank, the system creates the output table with the original record length.

2. Insert Carriage Return

Use this processing option to specify whether the system inserts a hard return at the end of each record. If you leave this processing option blank, the system formats the file into a long string instead of multiple separate records.

3. Default File Path/Name

Use this processing option to specify the default path and the default name for the output file. The path and file name should conform to the file structure and naming standard of the operating system of the computer where the file is stored.

For example:

If you store the output file on your local machine C drive, you would specify the directory path: C:\FolderName\File Name.txt. If you store the output file to a folder on a networked machine, you might specify the network path: \\MachineName\FolderName\File Name.

If you leave this processing option blank, the system uses the following for the path and name: A:\DTALSV.

Note: You should store the files only on a Windows client.

Data Tab

These processing options specify whether to use replacement characters and whether to capitalize all alpha characters.

1. Replace pre-defined characters (UDC 04/RC) in One-To-One mode

Use this processing option to specify whether the system replaces special characters. If you specify to replace special characters, the system reads the Replaced Character UDC (04/RC) and replaces single characters according to the values in the UDC. The system then reads the Special Characters UDC (04/SC) and replaces special characters according to the values in that UDC. Valid values are:

Blank

Do not replace special characters

1

Replace special characters

Note: For programs P0457 and P03B571, the system replaces only the first character in the Description 01 field of UDC 04/RC with the first character in the Description 02 field. It does not replace more than one character, even if the UDC is mapped in a one-to-many mode. Other programs that use UDC 04/RC replace more than one character if the UDC is mapped in a one-to-many mode.

2. Capitalize all alpha characters

Use this processing option to specify whether the system capitalizes all alphabetic characters in the record. If you leave this processing option blank, the system does not capitalize characters.

3. Replacement Character (UDC 04/SC)

Use this processing option to specify whether the system replaces characters in fields and tables that match characters defined in UDC 04/SC with a specified character or with a blank. To replace the characters with a specified character, enter the character in the processing option. To replace the special characters with a blank, leave the processing option blank.

Note: The system always replaces the character defined in UDC 04/SC with either the character that you specify or a blank. If you do not want to replace any characters, UDC 04/SC must be blank.

Additional Tape Copy Options

Three additional options for copying a tape table are available, which might be relevant to specific users.

- You can use IBM system commands to view the tape table. You must specify the table and member IDs, for example, table ID F04572T and member ID AP00000390.
- Information in tape tables is stored in a standard format. Instead of copying a tape table to tape or diskette, you can upload a tape table to a financial institution using a modem.

- Bank Automated Clearing System (BACS) clients can approve a bank tape before copying it to tape or diskette. On the Copy Bank Tape to Tape form, choose Approve from the row menu. This menu selection is controlled by a BACS processing option for the Copy Bank Tape File to Tape program (P0457).

Updating the Accounts Payable Ledger

After you write payments, you must update the Accounts Payable ledger. Updating the accounts payable ledger creates transaction records of your payments and your payment register. You can update payments only if the next status of the payment group is UPD (update).

When you update the Accounts payable ledger, the system:

- Processes void payments.
- Changes the pay status of vouchers from payment in-process (#) to paid (P) and sets the open amount to zero.
- Prints a payment register.
- Copies payment information to the Accounts Payable Matching Document table (F0413) and the Accounts Payable Matching Document Detail table (F0414) from the following workfiles:
 - A/P Payment Processing - Header table (F04571)
 - A/P Payment Processing - Summary table (F04572)
 - A/P Payment Processing - Detail table (F04573)
- Removes the records in the worktables that were created when you grouped vouchers for payment. Note that bank tape records remain in the table until they are deleted.

The following graphic illustrates what happens when the system updates the accounts payable ledger:

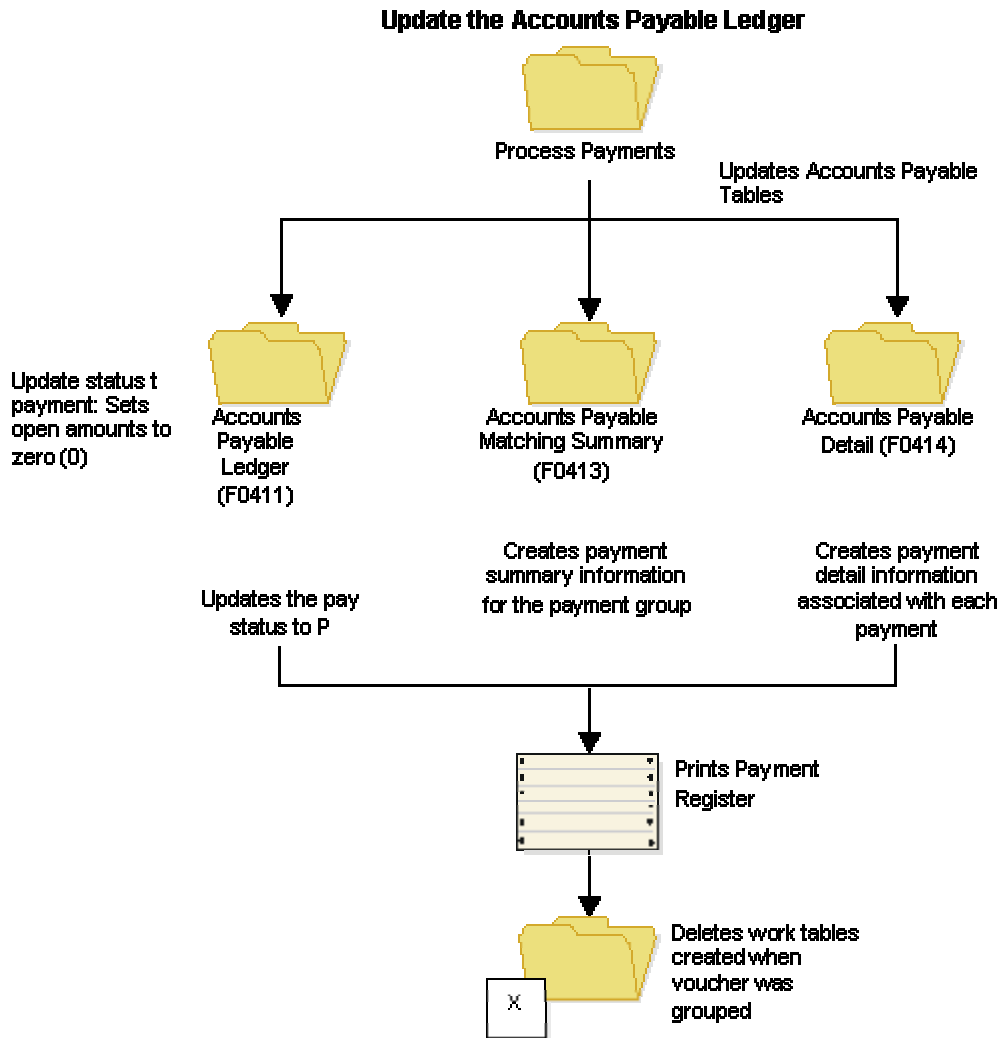

After you update the accounts payable ledger tables, you can post payments to the General Ledger. Alternatively, a processing option for Work With Payment Groups allows you to automatically submit payments for posting to the General Ledger after you update the accounts payable ledger. During the posting process, the system creates the journal entries that debit the A/P trade account and credit the payables bank account.

Before You Begin

- ❑ Verify that all payments printed correctly. After you update the A/P ledger, you cannot reset payment processing. You must void the payments and begin the payment process again.
- ❑ Review processed payments. See *Reviewing Payment Groups* in the *Global Solutions Japan Guide*.

► To update the Accounts Payable ledger

From the *Automatic Payment Processing* menu (G0413), choose *Work with Payment Groups*.

1. On Work With Payment Groups, follow the steps for reviewing payment groups.
2. Choose one or more payment groups with a next status of Update.
3. From the Row menu, choose Update.
4. On Report Output Destination, select the Report Destination and click OK.

Processing Options for Work with Payment Groups (P04571)

Print Tab

These processing options specify how the system prints payment groups.

1. Default Print Program Version

Use this processing option to specify the version the system uses for the print program. Enter a version number, or leave this processing option blank to use default version ZJDE0001.

2. Payment Control Group Output

Use this processing option to specify the output configuration for Payment Control Groups (PCG). You can send a spool file to a printer by PCG, by bank account, or you can send multiple PCGs to a printer simultaneously in one spool file.

Valid values are:

Blank Separate files by PCG.

- 1 Separate files by bank account.
 - 2 Send multiple PCGs in one spool file.
-

Save Spool File (FUTURE)

Use this processing option to specify whether you want to save a copy of a spool file after it has printed. This option is not yet functional in OneWorld software.

Valid values are:

Blank Do not save spool file.

1 Save spool file.

Hold Spool File (FUTURE)

Use this processing option to specify whether you want to hold a spool file, which requires that you release it manually before it prints. This option is not yet functional in OneWorld software.

Valid values are:

Blank Do not hold spool file.

1 Hold spool file.

Update Tab

These processing options specify the register program version, how you want the system to post void payments to the general ledger, and whether you want the system to submit the A/P payment post after the payments are updated.

1. Default Register Program Version

Use this processing option to specify the version number of the register program. You can enter a specific version number, or leave this processing option blank to use default version ZJDE0001.

2. Post Void Payments

Use this processing option to specify whether you want the system to post void payments to the general ledger. Void payments include alignment checks and reset payments. Void payments also include checks that are printed as Void so that the stub can be used for additional information continued from the previous stub.

Valid values are:

Blank Do not post void payments to the general ledger.

1 Post void payments to the general ledger.

3. Submit Post Program

Use this processing option to specify whether you want the system to automatically submit the A/P payment post after the payments are updated.

Valid values are:

Blank Do not automatically submit the A/P post.

1 Automatically submit the A/P post.

Display Tab

These processing options specify the way the system displays payment groups.

1. Display Business Units

Display Business Units

Use this processing option to specify whether you want to display the Business Unit assigned to the Payment Control Groups. If you enter 1, the Business Unit field appears on the Work With Payment Groups form. You can perform a search on a specific business unit by completing the Business Unit field in the Specify Preloaded Values processing option.

NOTE: This field is valid if the Create Payment Control Groups program (R04570) was set to process payment groups by business unit.

Valid values are:

Blank Do not display Business Units.

1 Display Business Units.

Write Status

Use this processing option to specify the initial selection of criteria for the Payment Control Group's Next Status. You can change the selection criteria on the Work With Payment Groups form.

Valid values are:

Blank Do not display payment control groups at Write Status.

1 Display payment control groups at Write Status.

Update Status

Use this processing option to specify the initial selection of criteria for the Payment Control Group's Next Status. You can change the selection criteria on the Work With Payment Groups form.

Valid values are:

Blank Do not display payment control groups at Update Status.

1 Display payment control groups at Update Status.

3. G/L Bank Account

Use this processing option to specify a preloaded value for the G/L Bank Account selection criteria. You can change the selection criteria on the Work With Payment Groups form. Enter a specific G/L bank account number, or leave this processing option blank to display all G/L bank accounts (default).

Originator

Use this processing option to specify a preloaded value for the Transaction Originator (data item TORG) that ran the Create Payment Control Groups program (R04570). If you specify a preloaded value for this field, you limit the initial inquiry to the PCGs that the Originator created. You can change the selection criteria on the Additional Selection Criteria form. Enter a specific User ID (TORG), or leave this processing option blank to search on all transaction originators (default).

Payment Control Group Version

Use this processing option to specify a version number that created the Payment Control Groups (R04570). If you specify a preloaded value for this field, you limit the initial inquiry to the PCGs with this version number. You can change the selection criteria on the Additional Selection Criteria form.

You can enter a specific version number, or leave this processing option blank to search

on all versions (default).

Payment Instrument

Use this processing option to specify the business unit that was originally assigned to the PCG by Create Payment Control Groups (R04570). If you specify a preloaded value for this field, you limit the initial inquiry to the PCGs with this business unit. You can change the selection criteria on the Additional Selection Criteria form. You can enter a specific business unit (data item MCU), or leave this processing option blank to search on all business units (default).

NOTE: This field is valid if the Create Payment Control Groups program (R04570) was set to process payment groups by business unit. Additionally, this field is valid only if you enter 1 in the Display Business Units processing option.

Currency Code

Use this processing option to specify the payment instrument that was originally assigned to the PCG by Create Payment Control Groups (R04570). If you specify a preloaded value for this field, you limit the initial inquiry to the PCGs with this payment instrument. You can change the selection criteria on the Additional Selection Criteria form. You can enter a specific payment instrument (data item PYIN), or leave this processing option blank to search on all payment instruments.

Currency Code

Use this processing option to specify the payment currency that was originally assigned to the PCG by Create Payment Control Groups (R04570). If you specify a preloaded value for this field, you limit the initial inquiry to the PCGs with this currency code. You can change the selection criteria on the Additional Selection Criteria form. You can enter a specific payment currency code (data item CRCD), or leave this processing option blank to search on all payment currencies (default).

Display Alternate Currency Amounts

Use this processing option to specify whether you want the system to display the payment control group (PCG) amounts in the alternate currency. This conversion is for display purposes only, affecting the amounts on the Work With Payment Groups form. For writing foreign payments, complete the processing options on the Currency tab.

Valid values are:

Blank Do not display PCG amounts in the alternate currency.

1 Display PCG amounts in the alternate currency.

Alternate Currency Effective Date

Use this processing option to specify the effective date for the alternate currency's exchange rate. Enter the effective date for the currency's exchange rate, or leave this processing option blank to use the system date (default).

Currency Tab

These processing options specify the effective date and exchange rate to use when your business transactions involve foreign currencies.

Effective Date

Use this processing option to specify the date to use to retrieve the exchange rate when you write foreign or alternate currency payments. If you leave this processing option blank, the system uses the payment G/L date.

If you create a payment group using the domestic amount of a voucher instead of the foreign amount, the system calculates a currency gain or loss based on the pay date exchange rate. The payment is not a foreign currency payment because it is made in the domestic currency.

Note: If you enter an effective date for which there is no corresponding exchange rate in the Currency Exchange Rates table (F0015), the system uses the exchange rate on the voucher and, therefore, does not create a gain or loss.

Use Voucher's Rate

Use this processing option to specify the voucher's exchange rate when you are writing foreign payments.

Blank Use the exchange rate for the specified effective date.

1 Use the voucher's exchange rate.

Process Tab

This processing option specifies how the system processes payment control groups.

1. Interactive Process

Use this processing option to specify how you want the system to process payment control groups.

NOTE: This processing option does not override the Object Configuration Manager (OCM) mapping for server batch jobs, but only affects batch jobs run locally.

Valid values are:

Blank Submit the print and update jobs for batch processing.

- 1 Process payments interactively.

BACS Tab

This processing option specifies whether the system allows the entry of Bank Automated Clearing System (BACS) processing dates. BACS is an electronic funds transfer method used in the United Kingdom.

1. BACS Processing

Use this processing option to indicate to the system whether you want to allow the entry of Bank Automated Clearing System (BACS) processing dates.

Valid values are:

Blank Do not allow the entry of BACS processing dates.

- 1 Allow the entry of BACS processing dates.
-

General Ledger Accounting

You can review your chart of accounts by object and subsidiary. You can also review your alternate chart of accounts by category code.

Reviewing Account Ledgers by Object Account

Use the Account Inquiry by Object Account program (P09201) to review detailed transactions for an object account across all business units.

You can use all of the criteria that are available in the Account Ledger Inquiry program (P09200) to limit your search for transactions to review.

After you move the cursor to the row heading in the left column on the form, the system displays a paper clip icon to indicate when the transaction (for example, the journal entry) has additional text or another attachment.

Using the Second Ledger processing option, you can review amounts for two ledger types at the same time, such as actual and budget ledgers.

The system displays both posted and unposted transactions from the Account Ledger table (F0911).

► To review account ledgers by object account

From the Accounting Reports & Inquiries menu (G0912), choose Account Inquiry by Object Account.

PeopleSoft®

Select Workspace: Active Foundation

Active Foundation Personalize Change Role Sign Out

Work With Account Ledger by Object Account

Close Form Row Report Tools

Object/Sub

Ledger Type 1: AA General Ledger From Company

Ledger Type 2: CA Thru Company

Subledger/Type

Posted Unposted All

Display Company Subtotals

From Date: 06/01/05

Thru Date: 06/30/05

Currency Code

No records fetched. Customize Grid

Account Number	Account Description	Do Ty	Doc Number	Doc Co	G.L. Date	Explanation	LT 1 Amount	LT 1 Debit
----------------	---------------------	-------	------------	--------	-----------	-------------	-------------	------------

1. On Work With Account Ledger by Object Account, complete the following field:
 - Object/Sub
2. To review a ledger other than AA (actual amounts), replace the value in the following field:
 - Ledger Type 1
3. If you set a second ledger type in the processing option, you can replace the value in the following field:
 - Ledger Type 2
4. To display a range of companies, complete the following fields:
 - From Company
 - Thru Company
5. To display a range of transaction dates, complete the following fields:
 - From Date
 - Thru Date
6. To display one subledger, complete the following fields:
 - Subledger/Type
7. Turn on one of the following options, if necessary:
 - Posted
 - Unposted
 - All
8. To further limit your search for transactions, use the fields in the QBE row.
For example, you might want to search for a specific document type, document number, batch number, or G/L posted code.
9. Click Find.
10. To print the account ledger, from the Report menu, click Print Ledger.

Processing Options for Account Inquiry by Object Account (P09201)

Defaults

Any values entered in the following options will be loaded upon entry into the program:

Object/Subsidiary Account Number

From Date

Through Date

Ledger Type

Subledger - G/L

Subledger Type

Currency Code

Second Ledger

Enter a 1 to display a second ledger type to view two ledger types at one time. Leave blank to display one ledger type only.

Display Second Ledger Type

Enter a default value for the second ledger type if the second ledger type is activated above.

Ledger Type

Exits

For document type PK or PN: enter a 1 to exit to Journal Entries when going to the source document. Leave blank to go to Manual Payments.

Exit for PK or PN

As-If Currency

Enter the currency code for as-if currency display. This option allows for amounts to display in a currency other than the currency they are stored in. This as-if currency option is activated by the form exit As-If Currency. Amounts will be translated and displayed in this as-if currency. If left blank, amounts will display in their database currency. Only the amounts associated with Ledger Type 1 will be converted to the as-if currency.

As-If Currency

Enter the as of date for processing the current exchange rate for the as-if currency. If left blank the thru date will be used.

Exchange Rate Date

Reviewing Account Ledgers by Category Code

Use the Account Inquiry by Category Code program (P09202) to review detailed transactions for any of the category codes that are set up for an alternate (statutory) chart of accounts. You specify the category code (21, 22, or 23) in the Category Code processing option for this program.

You can use all of the criteria that are available in the Account Ledger Inquiry program (P09200) to limit your search for transactions to review.

After you move the cursor to the row heading in the left column on the form, the system displays a paper clip icon to indicate that the transaction (for example, the journal entry) has additional text or another attachment.

Using the Second Ledger processing option, you can review amounts for two ledger types, such as actual and budget ledgers, at the same time.

The system displays both posted and unposted transactions from the Account Ledger table (F0911).

► To review account ledgers by category code

From the Accounting Reports & Inquiries menu (G0912), choose Account Inquiry by Category Code.

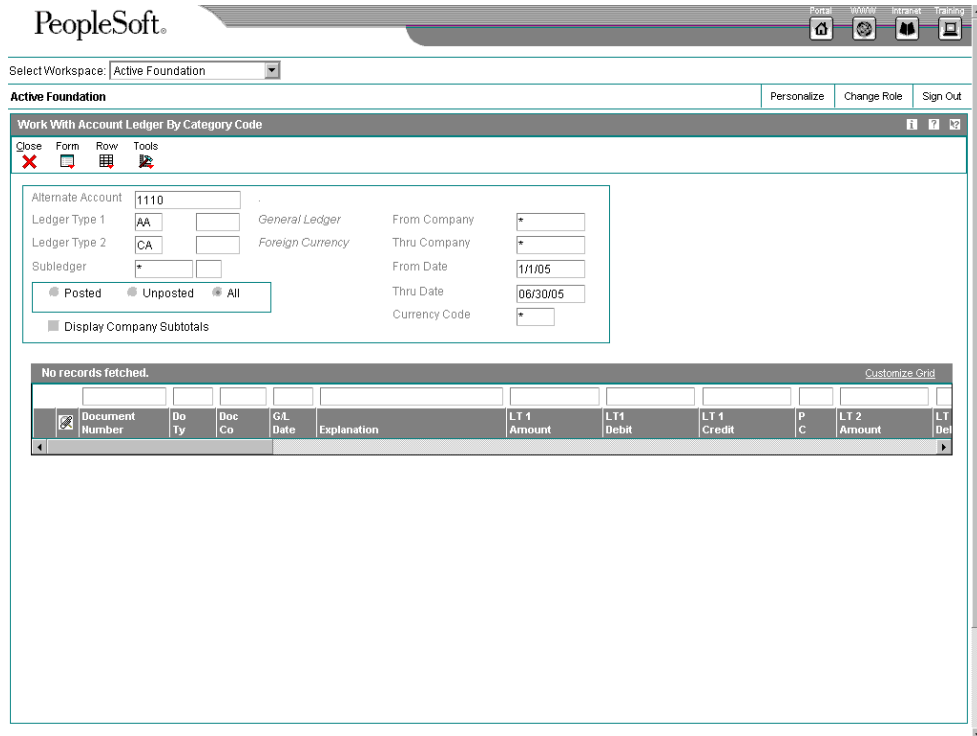

1. On Work With Account Ledger By Category Code, complete the following field:
 - Alternate Account
2. To review a ledger other than AA (actual amounts), replace the value in the following field:
 - Ledger Type 1
3. If you set a second ledger type in the processing option, you can replace the value in the following field:
 - Ledger Type 2
4. To display a range of companies, complete the following fields:
 - From Company
 - Thru Company
5. To display a range of transaction dates, complete the following fields:
 - From Date
 - Thru Date
6. To display one subledger, complete the following fields:
 - Subledger

- Sub Type
7. Turn on one of the following options:
 - Posted
 - Unposted
 - All
 8. To display company subtotals, turn on the following option:
 - Display Company Subtotals
 9. To further limit your search for transactions, use the fields in the QBE row.
For example, you might want to search for a specific document type, document number, batch number, or G/L posted code.
 10. Click Find.
 11. To print the account ledger for an account, choose the account and then from the Row menu, choose Print Ledger.

Processing Options for Account Inquiry by Category Code (P09202)

Category Code

Enter the account category code (21-23) to inquire on. The default value of blank will use category code 21.

Category Code (21-23)

Defaults

Any values entered in the following options will be loaded upon entry into the program:

Alternate Account

From Date

Through Date

Ledger Type

Subledger - G/L

Subledger Type

Currency Code

Second Ledger

Enter a 1 to display a second ledger type to view two ledger types at one time. Leave blank to display one ledger type only.

Display Second Ledger Type

Enter a default value for the second ledger type if the second ledger type is activated above.

Ledger Type

Exits

For document type PK or PN: enter a 1 to exit to Journal Entries when going to the source document. Leave blank to go to Manual Payments.

Exit for PK or PN

As-If Currency

Enter the currency code for as-if currency display. This option allows for amounts to display in a currency other than the currency they are stored in. This as-if currency option is activated by the form exit As-If Currency. Amounts will be translated and displayed in this as-if currency. If left blank, amounts will display in their database currency. Only the amounts associated with Ledger Type 1 will be converted to the as-if currency.

As-If Currency

Enter the as of date for processing the current exchange rate for the as-if currency. If left blank the thru date will be used.

Exchange Rate Date

Reviewing Alternate Account Information

You can review alternate accounts and account ledgers for one category code at a time. You specify the category code in the processing options.

You can also review alternate accounts by company or organization structure, and you can review their balances online by company or organization structure. By doing this review, you can see several companies that together are one legal entity.

► To review alternate account information

You can review selected alternate accounts and the associated detailed information. You can also review account ledgers.

From the Accounting Reports & Inquiries menu (G0912), choose Statutory Account Inquiry.

1. On Statutory Account Inquiry, complete the following optional fields:

- Company
- Business Unit

PeopleSoft

Select Workspace: Active Foundation

Active Foundation Personalize Change Role Sign Out

Statutory Account Inquiry

Select Find Close Row Tools

Company: 00070 Ledger Type: AA
Business Unit: * Digit To Use For Subtotal:
From Account: 44440 Level Of Rollup:
Thru Account: Period/Cumulative
Thru Date: 06/30/05 Period Currency Code: *

Records 1 - 10 Customize Grid

Alternate Account	Alternate Account Description	Debit Amount	Credit Amount	Balance
<input checked="" type="radio"/> 44440	Suppliers		54,102.25-	54,102.25-
<input type="radio"/> 45450	Estimated taxes			
<input type="radio"/> 45451	V.A.T. payable			
<input type="radio"/> 45459	Other social obligations			
<input type="radio"/> 48489	Sundry amounts payable			
<input type="radio"/> 49	Deferrals and accruals			
<input type="radio"/> 49492	Accrued charges		1,876.33-	1,876.33-
<input type="radio"/> 5200	Other Sales			
<input type="radio"/> 52520	Cost	10,200.00		10,200.00
<input type="radio"/> 55550	Current account		85,000.00-	85,000.00-

2. To limit your search, complete the following fields:

- From Account
- Thru Account

3. To display amounts for a specific period, complete one of the following fields:
 - Thru Date
 - Period

If the Period option is selected, the system shows the through period in the Thru Period field. If the Period option is cleared, the system shows the through date in the Thru Date field.
4. To specify how many leading digits in the alternate account number to use for subtotaling, complete the following field:
 - Digit To Use For Subtotal
5. To specify the digit of the category code to use for rollup, complete the following field:
 - Level Of Rollup
6. To toggle between year-to-date and period totals, click the following option:
 - Period/Cumulative
7. Click Find.

The processing time depends on the number of accounts that you are viewing.
8. To review account ledger information for the category code that you specified in the processing options, choose an account and choose Ledger Inquiry from the Row menu.

The screenshot displays the 'Work With Account Ledger By Category Code' window in PeopleSoft. The search criteria are as follows:

- Alternate Account: 4444
- Ledger Type 1: AA (General Ledger)
- Ledger Type 2: CA (Foreign Currency)
- Subledger: AA
- From Date: 06/01/05
- Thru Date: 06/30/05
- Options: Posted, Unposted, All
- Display Company Subtotals

The table below shows the ledger entries:

Document Number	Do Ty	Doc Co	G/L Date	Explanation	LT 1 Amount	LT 1 Debit	LT 1 Credit	P C	LT 2 Amount	LT Det
3152 AE		00070	06/20/05	Offset By Document PV 3152	950.00-		950.00-	P		
3154 AE		00070	06/20/05	Offset By Document PV 3154	1,600.00-		1,600.00-	P		
3158 AE		00070	06/12/05	Offset By Document PV 3158	3,065.60-		3,065.60-	P	3,990.00-	
3165 AE		00070	06/30/05	Offset By Document PV 3165	1,536.65-		1,536.65-	P	2,000.00-	
3800 JE		00070	06/30/05	Account Balances Company 70	31,300.00	31,300.00		P		
				Column Total	24,147.75	31,300.00	7,152.25-		5,990.00-	
				Ledger Total	24,147.75	24,147.75			5,990.00-	
				Posted Total	24,147.75	31,300.00	7,152.25-		5,990.00-	
				Unposted Total						

9. On Work With Account Ledger By Category Code, follow the steps for reviewing account ledgers by category code.
10. To display all of the accounts with the category code that you specified in the processing options, go back to Statutory Account Inquiry (if necessary) by clicking Close, and then choose Accounts from the Row menu.

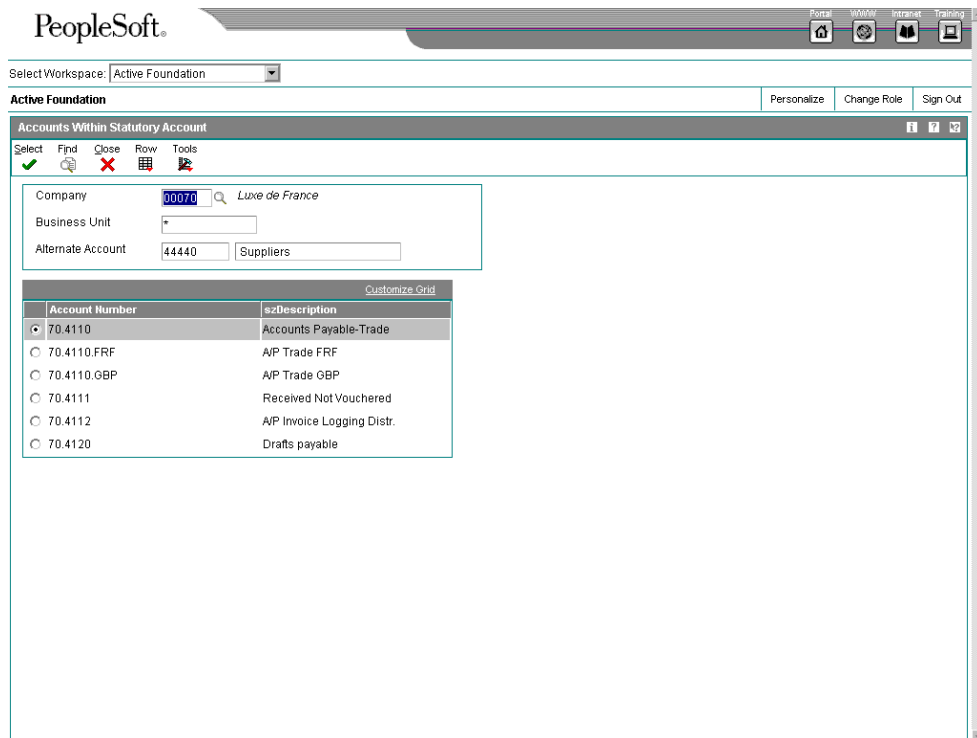

11. On Accounts Within Statutory Account, choose an account to review.
12. From the Row menu, choose one of the following to review the detail:
 - Account Ledger
 - Account Balance
 - TB by Object

See Also

See the following topics in the *General Accounting Guide*:

- ❑ *Reviewing Account Ledgers by Category Code* for more information about how to review ledgers by category code
- ❑ *Printing a Debit/Credit T/B by Category Code Report* for more information about how to print a Debit/Credit Trial Balance report using category codes
- ❑ *Printing a G/L by Category Code Report* for more information about how to print a General Ledger report using category codes

Additional Reporting for Austria

J.D. Edwards provides a country-specific solution for European Union reporting.

Working with European Union Reporting

Countries that are members of the European Union (EU) observe the Single European Act of 1987. The Single European Act is an agreement that opens markets to an area without internal boundaries, where free movement of goods, persons, services, and capital is assured in accordance with the provisions of the Treaty of Rome.

Because of the Single European Act, businesses in EU countries must adhere to EU requirements. For example, to help monitor the trade among members of the EU, businesses that exceed the limit of intraunion trade must submit the following reports to the customs authorities:

- Intrastat Report
- EC Sales List

Detailed statistical information regarding merchandise trade between members of the EU is used for market research and sector analysis. To maintain the statistics on trade between EU members, the statistical office of the EU and the statistical departments of member countries developed the Intrastat system.

In compliance with the Intrastat system, information on intraunion trade is collected directly from businesses. If you do business in a country that belongs to the EU, and you use J.D. Edwards Sales Order Management and Procurement systems, you can set up your system to extract all of the necessary information to meet EU Intrastat reporting requirements.

Intrastat Requirements

Customs formalities and controls at the internal borders between member states of the EU disappeared in 1993 with the creation of the single European market. With the elimination of custom formalities, the traditional systems for collecting statistics on trade between EU member states also disappeared.

Detailed statistical information regarding merchandise trade between members of the EU is important for market research and sector analysis. To maintain the statistics on trade between EU members, the statistical office of the EU and the statistical departments of member countries developed the Intrastat system.

In compliance with the Intrastat system, information on intraunion trade is collected directly from businesses. Periodically, businesses are required to send a statistical declaration or, in some member states, a combined statistical and fiscal declaration that gives detailed information regarding their intraunion trade operations of the previous period. The frequency with which you are required to submit these declarations depends on national requirements.

The major features of the Intrastat system are common in all member states, but the system can take national specifications into account. If you do business in a country that belongs to the EU and you use J.D. Edwards Sales Order Management and Procurement systems, you can extract all of the information that is necessary to meet Intrastat reporting requirements.

Note

The information that is tracked by the Intrastat system is based strictly on the actual physical movement of goods between member countries of the EU. Intrastat information does not apply to the movement of monetary amounts or the placement of orders between member countries.

The following graphic illustrates the J.D. Edwards Intrastat reporting process:

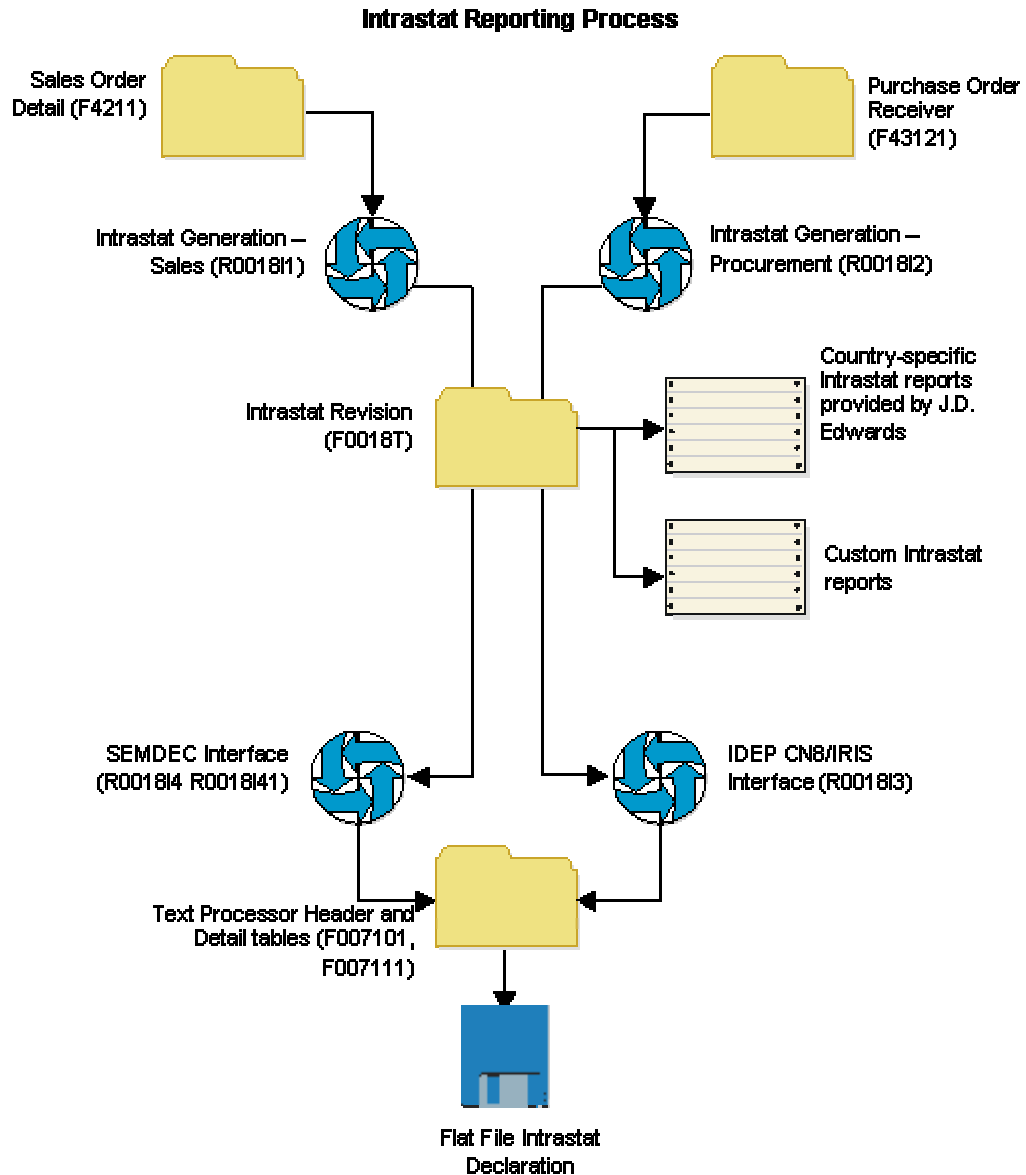

Intrastat Reporting and the Euro

With the introduction of the euro, the Statistical Office of the European Communities (Eurostat) and the national Statistical Offices of the Economic and Monetary Union (EMU) member nations have changed their Intrastat reporting requirements. Each EMU member nation, however, continues to determine its own Intrastat requirements.

Regardless of whether your company has converted its base currency to the euro, you can handle the Intrastat reporting requirements for the country in which you do business. The following examples describe situations that might apply to your company:

- Your company has not converted its base currency to the euro, but the Statistical Office of the EMU member nation in which you do business requires that you submit Intrastat reports in the euro.
- Your company has converted its base currency to the euro, but the Statistical Office of the EMU member nation in which you do business requires that you submit reports in an alternate currency.

For Intrastat reporting, the "as if" currency processing options in the Intrastat generation programs (R0018I1 and R0018I2) provide a simplified approach to reviewing and printing amounts in a currency that is different from your base currency.

Considerations for Creating Intrastat Reports

Before you create Intrastat reports, determine the following:

- The base currency of each of your companies
- The currency in which you must submit Intrastat reports for each of your companies

If your business has multiple companies with multiple currencies, you should approach your Intrastat reporting carefully. You should always be aware of each company's base currency, and whether Intrastat reports must be in the euro or an alternate. This information helps to ensure that you convert currencies for Intrastat reporting only if necessary.

Based on the Intrastat reporting requirements for your companies and the countries in which you do business, you can use the processing options and data selection to create different versions of Intrastats - Tax Update – Sales (R0018I1) and Intrastats – Tax Update – Purchasing (R0018I2).

See Also

- *Updating Intrastat Information* in the *Global Solutions Spain Guide* for information about euro considerations when updating the Intrastat Revision table (F0018T)

Updating Intrastat Information

Use one or both of the following navigations:

From the Periodic Processing menu (G74STAT2), choose Intrastat Workfile Generation – Sales.

From the Periodic Processing menu (G74STAT2), choose Intrastat Workfile Generation – Purchase.

J.D. Edwards Intrastat reporting is based on the Intrastat Revision table (F0018T). This workfile is populated with information from the Sales Order Management, Procurement, and

other systems. You run Intrastat reports based on your company's sales and procurement transactions for the reporting period. When you do this action, the update process writes all of the required information from the tables in the Sales Order and Procurement systems to the F0018T table.

Use the following programs to update the F0018T table:

Intrastat Workfile Generation - Sales Updates the F0018T table with sales information based on the following tables:

- Sales Order Header File (F4201)
- Sales Order Detail File (F4211)

Intrastat Workfile Generation - Purchase Updates the F0018T table with purchase information based on the following tables:

- Purchase Order Header (F4301)
- Purchase Order Detail File (F4311)
- Purchase Order Receiver File (F43121)

In addition, the update programs collect information from the following tables:

- Intrastat Supplier/Item Cross Reference Table (F744101)
- Inventory Constants (F41001)
- Business Unit Master (F0006)
- Company Constants (F0010)
- Currency Codes (F0013)
- Currency Restatement Rates File (F1113)
- Item Master (F4101)
- Item Branch File (F4102)
- Address Book Master (F0101)
- Address by Date (F0116)
- Order Address Information (F4006)
- Item Units of Measure Conversion Factors (F41002)
- Unit of Measure standard conversion (F41003)
- User Defined Codes (F0005)

When you run the update programs, you use processing options and data selections to select transactions that are based on a number of different criteria in the sales and procurement tables. Depending on the structure of your company and country-specific reporting requirements, you can specify that the system write records at cost, cost plus markup, or at the taxable purchase price. If you want to report the quantity actually shipped rather than the quantity ordered, you can use data selection to select order lines from the sales and procurement tables that are based on the order activity rule which corresponds to the shipped status. The system verifies that the transactions meet your selection criteria and qualify for Intrastat reporting before writing the required information from the sales and procurement tables, and any other applicable information from the additional tables, to the Intrastat Revision table.

To ensure that table F0018T contains the most current information, you should periodically update the information in table F0018T. The update program for sales accesses the detail for your sales transactions in table F4211. If you automatically purge the sales details to the Sales Order History File table (F42119) when you run the Sales Update program (R42800), run the Intrastat generation program for sales after you confirm shipments and before you update sales information. You should update table F0018T at least once per reporting period, after all sales order and purchase order transactions are entered and finalized.

Note

If you change sales order or purchase order information after you generate table F0018T, your changes are not reflected in the F0018T table unless you regenerate the table or manually edit the table using the Intrastat Revision program (P0018T). See *Revising Intrastat Information* in the *Global Solutions Spain Guide* for information about manually editing the Intrastat Revision table.

Transaction Eligibility

Sales Order transactions are *not* eligible for Intrastat reporting if either the Sold To country or the Ship To country is the same as the Declarant country, or if any of these countries (Sold To, Ship To, or Declarant) is not in the European Union.

Procurement transactions are *not* eligible for Intrastat reporting if either the Supplier country or the Ship From country is the same as the Declarant country, or if any of these countries (Supplier, Ship From, or Declarant) is not in the European Union.

The system retrieves the Ship To country from the Order Address Information table (F4006), if a record exists. Otherwise, the system retrieves the Ship To country from the Sales Order Detail File table (F4211).

The system retrieves the Ship From country by searching the following tables in sequence:

10. Country (CTR) in the Address by Date table (F0116), using the supplier's address book record
11. Country (CTR) in the Order Address Information table (F4006)
12. Country of Origin (ORIG) in the Intrastat Supplier/Item Cross Reference table (F744101)

In table F744101, the Country of Origin (ORIG) is used to determine transaction eligibility for Intrastat reporting. The Original Country of Origin (ORGO) is for information only. The Original Country of Origin field is populated by the Country of Origin (ORIG) field in the Item Branch File table (F4102) when you generate table F0018T.

Note

You must include codes for all European Union countries as valid values on UDC 74/EC (European Community Members).

Caution

Changes to transaction eligibility that occur *after* you generate table F0018T are *not* recognized when you regenerate table F0018T using the processing option to refresh it. J.D.

Edwards recommends that you generate table F0018T only after you have completed all relevant changes to shipping and receiving information for the reporting period. If you must override addresses and change the transaction eligibility after generating table F0018T, you should clear and completely regenerate table F0018T.

Triangulation

The Intrastats – Tax Update - Sales program (R001811) includes processing options for triangulation. However, the program has no logic to identify triangulation. Rather, the processing options allow you to indicate how to process interbranch records. If you use the processing options, the header branch/plant from table F4211 is written to table F0018T as the declaring company. Using the processing options also affects the document type and the taxable amount. Three separate taxable amounts can be written to the TAXA field in the Intrastat Revision table:

- The amount extended price (AEXP)
- The amount original cost (ECST)
- The amount total extended cost (TCST)

The amounts are retrieved for the header or detail branch/plant, depending on the processing option fields that you choose.

If you do not use the triangulation processing options, the detail branch/plant from table F4211 is always written to table F0018T as the declaring company; and the document type is always the type that is entered on the sales order.

For the Intrastats - Tax Update - Purchase program, you can specify the actual Ship From in table F4006. For example, suppose that the purchase order specifies the branch/plant (declarant) as Italy, and the supplier as Switzerland. However, when the goods are received, the customs note indicates that the goods were shipped from France. You should specify the actual Ship From in the Order Address table as France to ensure that the transaction is included in the Intrastat Revision table correctly.

Multicurrency Environments

In multicurrency environments, the system creates records in table F0018T based on the base currency of the Sales branch/plant or the Purchasing branch/plant for each transaction.

You might need to restate the domestic amounts of foreign transactions at an official exchange rate or a monthly average exchange rate. To do this restatement, use the processing options on the Currency tab to indicate the exchange rate type and the date for the exchange rate. The system recalculates the domestic amount based on the rate and date that are indicated in the processing options. The exchange rate is taken from table F1113.

“As If” Currency Processing

To use "as if" currency processing for the Intrastats – Tax Update - Sales and Intrastats – Tax Update - Purchasing programs, you must set processing options. These programs, unlike other programs that use "as if" currency processing, write amounts to a table. Other programs display or print "as if" currency amounts, but do not write amounts to a table.

If you use "as if" currency processing, you lose the direct audit trail for the amount fields between table F0018T and the original tables in the Sales Order Management and Procurement systems.

Performance Considerations

Depending on your data selection and the number of transactions stored in the Sales Order and Procurement systems, the time that is required to run the Intrastat Generation programs varies. To minimize the impact that these programs have on system performance, do the following:

- Specify your data selection as carefully as possible so that only the necessary records are written to table F0018T.
- Update table F0018T as part of your nightly operations.

Before You Begin

- ❑ Set up the user defined code tables that are used in Intrastat reporting. See *Setting Up User Defined Codes for Intrastat Reporting* in the *Global Solutions Spain Guide*.
- ❑ Set up commodity codes. See *Setting Up Commodity Code Information* in the *Global Solutions Spain Guide*.
- ❑ For Sales, set up country codes for the selling business unit (header business unit), shipping business unit (detail business unit), and customer in the Address Book. See *Creating and Revising Address Book Records* in the *Address Book Guide*.
- ❑ For Procurement, set up country codes for the branch/plant and supplier in the Address Book, or enter countries of origin in the Intrastat Item/Supplier Cross Reference program (P744101). See *Entering Cross-References for Items and Suppliers* in the *Global Solutions Spain Guide*.

Processing Options for Intrastat Workfile Generation – Sales (R001811)

Transaction

1. To use the Reporting Code method, enter the Sales Reporting Code (1-5) which contains the Nature of Transaction.

-Or-

To use the User Defined Code method, enter the UDC table which contains the Nature of Transaction. If no values are entered in this option, table 74/NT will be used.

System Code

User Defined Codes

2. Enter '1' to refresh transactions that already exist in the Intrastat Work File (F0018T). If left blank, only new transactions will be written.

Defaults

1. Enter a value to update all records written during this execution for VAT Regime.

-Or-

Enter a User Defined Code table which contains the value to be used. If no values are entered in this option, the table 74/NT will be used.

System Code

User Defined Codes

2. Enter a value to indicate if the Statistical Value Calculation is required.

Blank = Not Required

1 = Required

3. Enter the constant value per Kg to be used for Statistical Value Calculation. (Statistical Amount = Constant * Net Mass in KG + Taxable Amount.

3. To use the percentage method, enter the percentage to be used. (for example, 105 = 105% of actual value). If no values are entered in these options, the statistical value will be equal to the actual value.

Currency

1. Enter the currency code for as-if currency reporting. This option allows for amounts to print in a currency other than the currency they are stored in. Amounts will be translated and print in this as-if currency. If left blank, amounts will print in their database currency.

2. Enter the As-Of date for processing the current rate for the as-if currency. If left blank, the system date will be used.

3. To restate domestic amounts of foreign transactions at an official or monthly average exchange rate enter the rate type and date here.

Rate Type

Date - Effective

Process

TRIANGULATION RECORDS:

For the following situations, specify the records to be created by entering the value to be used followed by the document type for the record. The possible values are:

' ' = Record not created

'1' = Price

'2' = Cost

'3' = Transfer Cost

Leave the document blank to use the original document type.

Examples:

"3SI" = Transfer Cost, Document Type SI

"2 " = Cost, Original Document Type

1. Header Branch and Customer in the same country, Detail Branch in a different country:

Export from Header to Customer

Export from Detail to Customer

Export from Detail to Header

Import from Header to Detail

2. Header Branch and Detail Branch in the same country, Customer in a different country:

Export from Header to Customer

Export from Detail to Customer

3. Header Branch, Detail Branch and Customer in different countries:

Export from Header to Customer

Export from Detail to Customer

Export from Detail to Header

Import to Header from Detail

Processing Options for Intrastat Workfile Generation – Procurement (R0018I2)

Process

1. Enter the Purchasing Report Code (1-5) which contains the Nature of Transaction;

- Or -

Enter the User Defined Code table which contains the Nature of the Transaction. If no values are entered in this option, table 74/NT will be used.

System Code

User Defined Codes

2. Enter '1' to refresh transactions that already exist in the Intrastat Work File (F0018T). If left blank, only new transactions will be written.

3. Enter a '1' to use the Intrastat Supplier/Item Cross-Reference Table (F744101) for Country of Origin.

4. Enter a '1' to use the Intrastat Supplier/Item Cross-Reference Table (F744101) for Original Country of Origin.

Defaults

1. Enter a value to indicate if the Statistical Value Calculation is required.

Blank = Not Required

1 = Required

2. Enter a percent to use for calculating Statistical Value. (For example, 105 = 105% or actual value)

- Or -

Enter the constant value per KG to be used. (Statistical Amount = Constant * Net mass in Kg + Taxable Amount)

If no values are entered, the statistical value will be equal to the actual value.

3. Enter a value to Statistical Procedure to update all records with.

- Or -

Enter the User Defined Code table which contains the value to be used. If no values are entered in this option, the table 74/NT will be used.

System Code

User Defined Codes

Currency

1. Enter the currency code for as-if currency reporting. This option allows for amounts to print in a currency other than the currency stored in. Amounts will be converted and printed in this as-if currency.

2. Enter the As-Of date for processing the exchange rate for the As-If currency. If left blank, the system date will be used.

3. To restate domestic amounts of foreign transactions at an official or monthly average exchange rate enter the rate type and date here.

Exchange Rate Type

Revising Intrastat Information

You can revise existing data in the Intrastat Revision table (F0018T). You might need to do this revision to correct missing or inaccurate information, to add a specific transaction, to update the process indicator, or to enter information in fields that are required by the authorities but are not populated by the J.D. Edwards system. You can also use the Intrastat Revision program (P0018T) to update sales order or purchase order information that has changed since you generated table F0018T.

Before You Begin

- ❑ Run the Intrastats – Tax Update - Sales (R0018I1) and Intrastats – Tax Update - Purchasing (R0018I2) programs to build the Intrastat Revision table (F0018T). See *Updating Intrastat Information* in the *Global Solutions Spain Guide*.

► To revise Intrastat information

From the *Periodic Processing* menu (G74STAT2), choose *Intrastat Workfile Revision*.

1. On *Work with Intrastat Tax File - 1993 EEC*, locate and choose a record, and then click *Select*.

PeopleSoft

Select Workspace: Active Foundation

Active Foundation Personalize Change Role Sign Out

Intrastat Tax File Revision

OK Cancel Tools

OrderType/Co 12346 AF 1 Order Suffix 000
Line Number 5
Purchase Receiver 20

Detail Amounts Codes User Reserved

Company 1
Branch/Plant 1
Ship To/From 3002
Sold To
Document Company 1 J.D. Edwards & Company
Document Number 500
Document Type AF
Line Type S Stock Inventory Item
G/L Date 5/1/05
Invoice Date 05/01/05
Actual Ship 05/01/05
Receipt Date 05/05/05

2. On Intrastat Tax File Revision, revise the information in any of the following fields on the Detail tab:
 - Company
 - Branch/Plant
 - Ship To/From
 - Document Company
 - Document Number
 - Document Type
 - Line Type
 - G/L Date
 - Invoice Date
 - Actual Ship
 - Receipt Date
3. Click the Amounts tab and revise the information in any of the following fields:
 - Net Mass in KG
 - Base Currency
 - Taxable Amount
 - Statistical Value Amount
 - Transaction Currency
 - Foreign Taxable Amount
 - Foreign Statistical Value
 - Supplementary Units
4. Click the Codes tab, revise the information in any of the following fields, and then click OK:
 - Country of Origin
 - Original Country of Origin
 - Region of Origin or Destination
 - Mode of Transport

- Conditions of Transport
- Nature of Transaction
- Port of Entry or Exit
- Nature of VAT Regime
- Nature Code
- Process Indicator
- Commodity Code

Purging Records from the Intrastat Table

From the Periodic Processing menu (G74STAT2), choose Intrastat Workfile Purge.

The Intrastat Revision table (F0018T) is a temporary workfile that stores information that is used to generate monthly or quarterly Intrastat declarations. After the declarations have been accepted by the tax authority, the data in this file continues to accumulate. You do not need to store this data.

You can purge records from table F0018T. You can use data selection to purge all of the records in the file or purge only selected records. You can specify selection criteria based on the invoice date, general ledger date, procurement date, or shipment date. For example, you might purge records with shipment dates between 3/1/1999 and 5/1/1999.

You can run Intrastat Workfile Purge (R0018TP) in proof mode or final mode. Run the program in proof mode to review which records will be deleted. No records are deleted until you run the report in final mode.

Processing Options for Intrastat Workfile Purge (R0018TP)

Defaults Tab

Use these processing options to specify whether to run the program in proof or final mode, and to specify the dates to use to select transactions.

1. Proof or Final Mode

Use this processing option to specify the mode in which you want to run this report. Final mode deletes all selected records from the Intrastat Revision table (F0018T).

Valid values are:

Blank

Run the report in proof mode.

1

Run the report in final mode.

2. From Date (Required)

Use this processing option to specify the beginning date of the records you want to purge. This date is used with the date specified for comparison. The system purges records whose comparison date is greater than or equal to the From Date and less than or equal to the Thru Date.

3. Thru Date (Required)

Use this processing option to specify the last date of the records you want to purge. This date is used with the date specified for comparison. The system purges records whose comparison date is greater than or equal to the From Date and less than or equal to the Thru Date.

4. Compare Date (Required)

Blank = Invoice date

1 = G/L date

2 = Receipt date

3 = Ship date

Use this processing option to specify which date to use for comparison.

Valid values are:

Blank

Invoice date

1

G/L date

2

Receipt date

3

Ship date

Printing the Intrastat Report - Austria

From the Statistical Reports menu (G74STAT3), choose Austria Paper Report.

You print Intrastat reports based on the information in the Intrastat Revision table (F0018T). Although the information that is required to appear on the Intrastat report is common for most European Union (EU) members, report formats vary from country to country. J.D. Edwards provides an Intrastat report that meets the requirements for Austria.

Processing Options for Austria Paper Report (R00181A)

Branch ID

1. Enter the Branch ID to print on the report.

Tax Region Cod

2. Enter the region code of the tax office to which your company is attached.

Report Period

3. Enter the reporting period to print on the report heading.

Period:

Year:

Summary Mode

4. Enter a '1' to print summary only. A default of blank will print all details.

Currency Code

5. Currency Code of the Report.

Using the IDEP/IRIS Interface for Intrastat Reporting

From the Statistical Reports menu (G74STAT3), choose IDEP CN8 / IRIS Interface.

IDEP/IRIS is an abbreviation for Intrastat Data Entry Package/Interactive Registration of the International Trade Statistics. Use IDEP CN8/IRIS Interface (R001813) to generate an electronic Intrastat declaration in any of the following formats, which are used in the specified countries:

IDEP/CN8 France, Italy, Spain, Austria, Belgium, Sweden, Denmark, Finland, Portugal, Greece, Ireland, and Luxembourg

CBS-IRIS Holland

CBS-IRIS Germany

Intrastat declarations are based on the information in the Intrastat Revision table (F0018T). Although the information that is required to appear on the Intrastat report is common for most EU members, reporting requirements vary by country.

Note

Neither the IDEP/CN8 format nor the CBS-IRIS format requires a specific file layout.

IDEP/CN8 - France, Italy, Spain, Austria, Belgium, Sweden, Denmark, Finland, Portugal, Greece, Ireland, and Luxembourg

IDEP/CN8 includes an option to import the data that is necessary for the statistical declaration from an external administrative and financial system. IDEP/CN8 does not require a fixed record layout for the import file. You need to define the format of the data to be imported in IDEP/CN8. IDEP/CN8 can automatically perform the required conversions and validations of the data, and produce the declaration.

In IDEP/CN8, you can import the following information:

- Detail lines
- Good codes for the provider of statistical information
- VAT registration numbers of trading partners
- Exchange rates

Although you can import all of the information above, the J.D. Edwards Interface with IDEP/CN8 provides the ability to import only the detail lines and the VAT registration numbers or the trading partners. For sales transactions, the VAT registration number of the customer is based on the declaration type. For statistical declarations, the system uses the value in the Ship To - Address Number field. For fiscal or complete declarations, the system uses the Sold To - Address Number. Because the default declaration type is complete, the VAT registration number uses the Sold To - Address Number by default. For procurement transactions, the system uses the VAT registration number of the supplier.

Note

For B73.3.2 and OneWorld Xe, the Sold To address number is stored in user-reserved field URAB of the Intrastat Revision table (F0018T).

Before importing this information from an external system, such as from J.D. Edwards to IDEP/CN8, you need to specify the format of the file to be imported. After you specify the

format, you need to indicate the structure of the file to be imported (field sequence, field number, field size, and so forth) into IDEP/CN8.

The following table illustrates the structure that you must set up for an IDEP/CN8 file:

Field	Position[Length]
Declarant Reference Number	1-14[14]
Partner VAT number	16-35[20]
Original Country of Origin	37-39[3]
Country of Origin	41-43[3]
Nature of Transaction A	45-45[1]
Nature of Transaction B	47-47[1]
Statistical Procedure	49-53[5]
Mode of Transport	55-55[1]
Port of Entry	57-60[4]
Region of Origin	62-63[2]
Terms of Delivery	65-67[3]
Related Location 1 Identity	69-69[1]
Commodity Code	71-78[8]
Goods Description	80-219[140]
Supplementary Unit	221-233[13]
Net Mass	235-248[12,2]
Invoice Value	250-262[13]
Foreign Invoice Value	264-276[13]
Statistical Value	278-289[10,2]
Foreign Statistical Value	291-302[10,2]
Currency Code	304-306[3]
Declaration Type	307-307[1]

Note

The comma in the Net Mass, Statistical Value, and Foreign Statistical Value field lengths listed above denotes that a decimal point can be used before the last two characters in those field lengths.

CBS-IRIS - Holland

The Dutch version of CBS-IRIS requires no fixed record layout for the import file. However, you must map the data coming from an import file in CBS-IRIS.

Note

The data to be imported must be in flat file format. Also, you must indicate the first position and the number of positions of each field to be imported from the flat file. The number of positions to import should not exceed the number of positions that is defined in CBS-IRIS for the field. The fields cannot overlap. You should end each field with a carriage return and a line feed.

In CBS-IRIS, the file containing the data to be imported should be a “blank-separated txt-file” (this type of file can be compared with a Microsoft Excel file that is saved as a text file with blanks as separation characters).

In CBS-IRIS, you can leave the fields blank, as long as the positions defined are correct (in other words, each blank stands for one position in the record).

The following table illustrates the structure that you must set up for an CBS-IRIS - Holland file:

Field	Position[Length]
Declarant Reference Number	1-10[10]
Del VAT Number	12-23[12]
Partner VAT Number	25-42[18]
Original Country of Origin	44-46[3]
Country of Origin	48-50[3]
Nature of Transaction A	52-52[1]
Statistical Procedure/Nature of VAT Regime	554-55[2]
Mode of Transport	57-57[1]
Port of Entry	59-60[2]
Commodity Code	62-69[8]
Tariff Code	71-72[2]
Currency Code	74-74[1]
Supplementary Unit	76-85[10]
Net Mass	87-96[10]
Invoice Value	98-107[10]
Statistical Value	109-118[10]
Commodity Flow	120-120[1]
Reporting Period	122-127[6]

CBS-IRIS - Germany

The German version of CBS-IRIS requires no fixed record layout for the import file. However, you must map the data coming from an import file. For each field imported in the flat file format, you need to set up the beginning position and the length of the field. The following table illustrates the structure that you must set up for a CBS-IRIS - Germany file:

Field	Position[Length]
Declarant VAT Number	1-16[16]
Original Country of Origin	18-20[3]

Country of Origin	22-24[3]
Nature of Transaction	26-27[2]
Statistical Procedure/Nature of VAT Regime	29-33[5]
Mode of Transport	35-35[1]
Port of Entry	37-40[4]
Region of Origin	42-44[3]
Commodity Code	46-53[8]
Currency Code	55-55[1]
Supplementary Unit	57-65[9]
Net Mass	67-75[9]
Invoice Value	77-85[9]
Statistical Value	87-95[9]
Commodity Flow	97-97[1]
Reporting Period	99-104[6]

Grouping Transactions

To group transactions for sales, purchases, and adjustment declarations, set up versions of the IDEP/IRIS Interface program (R001813) that have data selection for sales orders, purchase orders, adjustments for sales orders, and adjustments for purchase orders based on document type.

Electronic Format

Use the IDEP/IRIS Interface program (R001813) to create a flat file in the IDEP/IRIS message format, which you can then submit to the proper tax authorities in an electronic format.

The IDEP/IRIS Interface program generates one record for each declaring company.

When you run the IDEP/IRIS Interface program, the system creates a batch for review by the Text File Processor program (P007101). The batch is stored in the following tables:

- F007101 - Text Processor Header
- F007111 - Text Processor Detail Table

You must run the Text File Processor program to convert the batch to a flat file that you can submit to the different countries' customs authorities, statistical offices, or both.

The Text File Processor program assigns the batch number and interchange from the seventh field of next numbers for system 00. The Text File Processor assigns the message number from the fifth field of next numbers for system 74.

See Also

- *Setting Up System Next Numbers in the General Accounting Guide*

Before You Begin

- Run the Intrastats – Tax Update - Sales (R001811) and Intrastats – Tax Update - Purchasing (R001812) programs to build the Intrastat Revision table (F0018T). See *Updating Intrastat Information in the Global Solutions Spain Guide*.

Processing Options for IDEP CN8/IRIS Interface (R0018I3)

Defaults Tab

1. Tax ID

Blank = Tax ID

1 = Additional Tax ID

Use this processing option to specify which tax ID to use for the company and the customer. You can retrieve the tax ID from either the Additional Tax ID field (ABTX2) or the Tax ID field (ABTAX) in the Address Book Master table (F0101).

Valid values are:

Blank

Tax ID (ABTAX)

1

Additional Tax ID (ABTX2)

2. Country Code

Blank = ISO Code

1 = GEONOM Code

Use this processing option to specify which format to use for the country code.

Valid values are:

Blank

Two-character ISO code. You must enter a two-character ISO code that is defined in UDC 00/CN.

1

Three-digit GEONOM code. You must enter a three-digit GEONOM code that is defined in the special handling code field of UDC 00/CN.

3. Declaration Type (UDC 74/IT)

1 = Fiscal

2 = Statistical

3 = Complete

Use this processing option to specify the Intrastat declaration type (required for IDEP).

Valid values are:

1

Fiscal

2

Statistical

3

Complete

The codes that correspond to these declaration types are maintained in the Intrastat Declaration Type UDC (74/IT).

For IDEP, the code specified in the special handling code for the UDC is written to the text field in the Text Processor Detail table (F007111). This special handling code is also used to determine the VAT registration number for sales transactions. For statistical declarations, the system uses the Ship To - Address Number. For fiscal or complete declarations, the system uses the Sold To - Address Number.

Process Tab

1. Interface Type

Blank = IDEP

1 = IRIS Holland

2 = IRIS Germany

Use this processing option to specify the interface type for which the data should be formatted.

Valid values are:

Blank

IDEP

1

Dutch version of IRIS

2

German version of IRIS

2. Commodity Flow

Use this processing option to specify the direction of the movement of goods.

Valid values for Holland are:

6

Arrivals

7

Dispatches

For valid values for Germany, consult your CBS-IRIS documentation.

Note: This option is required only for the IRIS interface.

3. Level of Detail

Blank = No summary

1 = Summary

Use this processing option to specify whether the program should be run in detail or summary mode. In detail mode, the system reports on all transactions. In summary mode, the system summarizes the transactions according to the version you set up.

Valid values are:

Blank

Detail mode

1

Summary mode

Note: The level of summarization is determined by the version sequencing. If any sequenced field value changes, a level break occurs and a summarized record is written to the text file.

4. Proof or Final Mode

Blank = run IDEP/IRIS Interface in Proof mode

1 = run IDEP/IRIS Interface in Final mode

Use this processing option to specify the mode in which you want to process the IDEP/IRIS Interface. Final mode updates the Text Processor Header table (F007101) and the Text Processor Detail table (F007111).

Valid values are:

Blank

Run the IDEP/IRIS Interface in proof mode.

1

Run the IDEP/IRIS Interface in final mode.

Currency Tab

1. As-if Processing

Blank = Base Currency

1 = As-if Currency

Use this processing option to specify whether the invoice amount and statistical amount are reported to IRIS in the domestic currency or in the as-if currency.

Valid values are:

Blank

Domestic currency

1

As-if currency

Note: The as-if values can be used only if the Intrastat Revision table (F0018T) has been generated using as-if processing. If you generate the Intrastat Revision table using as-if currency, both the domestic and the as-if amounts are stored in the F0018T table.

2. Number of digits to truncate from monetary amounts

Use this processing option to determine how many digits are truncated from monetary amounts. For example, if the value entered is 3, the monetary amount 123456 is truncated to 123.

Valid values are 0 - 9.

Rounding Tab

1. Round Rules

Blank = No rounding

1 = Round to nearest whole amount

2 = Round down to whole amount

3 = Round up to whole amount

4 = Round to the nearest half

5 = Round to the nearest tenth

6 = Round to the nearest hundred

7 = Round to the nearest thousand

Taxable Amount

Use this processing option to specify the method to round both domestic and foreign taxable amounts.

Valid values are:

Blank

No rounding: $14.66=14.66$

1

Round to the nearest whole amount: $14.66=15$ (no decimals)

2

Round down to the nearest whole amount: $14.66=14$ (no decimals)

3

Round up to the nearest whole amount: $14.66=15$ (no decimals)

4

Round to the nearest half: $14.66=14.5$ (one decimal place)

5

Round to the nearest tenth: $14.66=14.7$ (one decimal place)

6

Divide by one hundred and then round: $1674=17$

7

Divide by one thousand and then round: $1674=2$

Statistical Amount

Use this processing option to specify the method to round both domestic and foreign statistical amounts.

Valid values are:

Blank

No rounding: $14.66=14.66$

1

Round to the nearest whole amount: $14.66=15$ (no decimals)

2

Round down to the nearest whole amount: $14.66=14$ (no decimals)

3

Round up to the nearest whole amount: $14.66=15$ (no decimals)

4

Round to the nearest half: $14.66=14.5$ (one decimal place)

5

Round to the nearest tenth: $14.66=14.7$ (one decimal place)

6

Divide by one hundred and then round: $1674=17$

7

Divide by one thousand and then round: $1674=2$

Supplementary UOM

Use this processing option to specify the method to round the supplementary unit of measure.

Valid values are:

Blank

No rounding: $14.66=14.66$

1

Round to the nearest whole amount: $14.66=15$ (no decimals)

2

Round down to the nearest whole amount: $14.66=14$ (no decimals)

3

Round up to the nearest whole amount: $14.66=15$ (no decimals)

4

Round to the nearest half: $14.66=14.5$ (one decimal place)

5

Round to the nearest tenth: $14.66=14.7$ (one decimal place)

6

Divide by one hundred and then round: $1674=17$

7

Divide by one thousand and then round: $1674=2$

Net Mass UOM

Use this processing option to specify the method to round the net mass unit of measure.

Valid values are:

Blank

No rounding: $14.66=14.66$

1

Round to the nearest whole amount: $14.66=15$ (no decimals)

2

Round down to the nearest whole amount: $14.66=14$ (no decimals)

3

Round up to the nearest whole amount: $14.66=15$ (no decimals)

4

Round to the nearest half: $14.66=14.5$ (one decimal place)

5

Round to the nearest tenth: $14.66=14.7$ (one decimal place)

6

Divide by one hundred and then round: $1674=17$

7

Divide by one thousand and then round: $1674=2$

Print Tab

1. Reporting Period

Year (Required)

Use this processing option to specify the reporting year.

Period (Required)

Use this processing option to specify the reporting period.

Working with the EC Sales List

If they perform the following functions, businesses in the EU that exceed the local limit of intra-union trade must submit the EC Sales List to their customs authorities on a quarterly basis:

- Supply goods to an entity that is registered for VAT in another EU-member country
- Send goods for processing to an entity that is registered for VAT in another EU-member country
- Return processed goods to an entity that is registered for VAT in another EU-member country
- Transfer goods from one EU-member country to another EU-member country in the course of business

Note

If a sales or purchase transaction is arranged between EU members, but the goods are not shipped, the transaction must still be reported to the government.

You can use either of two EC Sales List programs (R0018L or R0018S) to generate the EC Sales List. Refer to the following table to determine which EC Sales List program you should use:

R0018L**R0018S**

Retrieves trade information from the Supply Chain system.

Retrieves trade information from the Financials system.

Bases results on information in the Intrastat Revision table (F0018T).

Bases results on information in the Taxes table (F0018).

Reports trade triangulation in summary and detail mode. You can report triangulation for interbranch transactions, direct ship transactions, or both.

Uses tax rates from the Triangulation Tax Rates UDC (00/VT) to identify trade triangulation.

Can exclude nonstock items. Use data selection on the Intrastat generation programs (R0018I1 and R0018I2) to exclude nonstock items.

Cannot distinguish between stock and nonstock items; use this report only if your business does not provide services.

Does not net trade amounts based on credit memos, discounts, and write-offs.

Nets trade amounts based on credit memos, discounts, and write-offs.

Trade Triangulation

Trade triangulation occurs when one EU member makes a sale or purchase with another EU member, but the goods represented by the transaction are physically shipped from a third EU member. Statistical reports that are submitted to EU authorities must identify trade triangulation transactions. Both the R0018L and R0018S programs identify trade triangulation transactions.

Printing the EC Sales List (R0018L)

From the Statistical Reports menu (G74STAT3), choose EC Sales List.

You can print the EC Sales List (R0018L) in summary or detail mode. Detail mode provides information for auditing.

If you print in summary mode, the EC Sales List provides the following information about customers:

- VAT number
- Country of destination
- Total amount in reporting currency
- Triangulation

If you print in detail mode, the EC Sales List provides the following information about customers in addition to the information above:

- Company order number
- Order type
- Country of sale
- Country of shipment

Triangulation

Triangulation can be reported in summary and detail mode in two ways:

- Interbranch
- Direct ship

Interbranch Identifies as trade triangulation a transaction between two EU member countries in which the goods are shipped from a branch/plant of the supplier who is located in a third EU member country

Direct Ship Identifies as trade triangulation a transaction between two EU member countries in which the goods are shipped directly from a third company that is located in a third EU member country

Data Selection

You must run the EC Sales List separately for each VAT-registered company in your organization.

If you have interbranch shipments from branch/plants that are located in countries other than the country of your headquarters organization, you must submit the EC Sales List for each country within which you operate.

For example, if a German company has three branch/plants in Germany, one branch/plant in France, and one branch/plant in Denmark, that company must run the EC Sales List three times:

- For the three branch/plants in Germany
- For the branch/plant in France
- For the branch/plant in Denmark

To run the EC Sales List for the branch/plants in each country, set up data selection with Document Company (KCO) equal to the company number of the headquarters company, and Company (CO) equal to the companies that are associated with each branch/plant.

Note

The companies that are associated with the branch/plants must be set up with the country code that corresponds to the location of the branch/plant.

In the example above, you would run the EC Sales list with the following data selection:

For branch/plants in Germany:

- Document Company (KCO) = German company
- Company (CO) = company for German branch/plant 1
- Company (CO) = company for German branch/plant 2
- Company (CO) = company for German branch/plant 3

For the branch/plant in France:

- Document Company (KCO) = German company

- Company (CO) = company for French branch/plant

For the branch/plant in Denmark:

- Document Company (KCO) = German company
- Company (CO) = company for Danish branch/plant

Before You Begin

- Enter VAT registration numbers for each customer. See *Validating Tax ID Numbers* in the *Global Solutions Spain Guide*.
- Enter country codes for each customer. See *Setting Up User Defined Codes for Intrastat Reporting* in the *Global Solutions Spain Guide*.
- Run the Intrastats – Tax Update – Sales (R0018I1) and Intrastats – Tax Update - Purchasing (R0018I2) programs to build the Intrastat Revisions table (F0018T). See *Updating Intrastat Information* in the *Global Solutions Spain Guide*.

Processing Options for VAT EC Sales List (R0018L)

Process Tab

Use these processing options to specify whether to print the report in summary or detail mode, and to specify the triangulation method to use.

1. Reporting Level

Blank = Summary

1 = Detail

Use this processing option to specify whether to run the program in summary or detail mode. If you run the program in detail mode, the report displays information that can be used for auditing.

Valid values are:

Blank

Summary

1

Detail

2. Triangulation

Blank = No Triangulation

1 = Direct Ship and Interbranch

2 = Direct Ship

3 = Interbranch

Use this processing option to specify which triangulation method to use. Trade triangulation occurs when one EU member makes a sale or purchase with another EU member but the goods are physically shipped from a third EU member. If the goods are not shipped from an EU member then the transaction is not required to be reported to the government. This terminology is used specifically in the EU for Intrastat.

Valid values are:

Blank

No triangulation

1

Direct Ship and Interbranch

2

Direct Ship

3

Interbranch

Print Tab

Use these processing options to specify the reporting period for the report.

1. Reporting Period

From month

Use this processing option to specify the beginning month of the period for which you are submitting the VAT EC Sales List.

From year

Use this processing option to specify the beginning year of the period for which you are submitting the VAT EC Sales List.

To month

Use this processing option to specify the ending month of the period for which you are submitting the VAT EC Sales List.

To year

Use this processing option to specify the ending year of the period for which you are submitting the VAT EC Sales List.

Currency Tab

Use this processing option to specify the currency code for "as -if" currency processing.

1. As-if Processing

Blank = Base Currency

1 = As-if Currency

Use this processing option to specify whether the invoice amount is reported in the domestic currency or in the as-if currency.

Valid values are:

Blank

Domestic currency

1

As-if currency

Note: The as-if values can be used only if the Intrastat Revision table (F0018T) has been generated using as-if processing. If you generate the Intrastat Revision table using as-if currency, both the domestic and the as-if amounts are stored in the F0018T table.

Printing the EC Sales List - A/R (R0018S)

From the Statistical Reports menu (G74STAT3), choose EC Sales List – A/R.

You can print the EC Sales List - A/R (R0018S) in summary or detail mode. If you print in summary mode, the EC Sales List - A/R provides the following information about customers:

- Country of destination
- Customer VAT registration number
- Total value of supplies
- Triangulation (yes or no)
- Customer name and address (optional)

If you print in detail mode, the EC Sales List - A/R also includes the document number.

The EC Sales List - A/R includes the following information in the report header:

- Reporting company VAT registration number
- Reporting company currency code
- Company name and address

The report header can also include the approval code of the EC authority to whom the report will be submitted.

Information on the report is sequenced by company, address book number, tax ID, and document number. Line numbering and page numbering restart for each reporting company.

Before You Begin

- Enter VAT registration numbers for each customer. See *Validating Tax ID Numbers* in the *Global Solutions Spain Guide*.
- Enter country codes for each customer. See *Setting Up User Defined Codes for Intrastat Reporting* in the *Global Solutions Spain Guide*.
- Set up tax rules for both Accounts Receivable and Accounts Payable with the following options selected:

- Tax on Gross Including Discount
- Discount on Gross Including Tax

See *Setting Up Tax Rules* in the *Tax Reference Guide*.

- ❑ Set the processing options in the General Ledger Post Report program (R09801) to automatically update the Taxes table (F0018).
- ❑ Set up the user defined code for Triangulation Tax Rates (00/VT). See *Setting Up User Defined Codes for Intrastat Reporting* in the *Global Solutions Spain Guide*.

Processing Options for EC Sales List – A/R (R0018S)

Select Tab

Use these processing options to specify the branch ID and the date range for the report.

1. Branch ID

Use this processing option to specify the branch ID for the reporting company. The branch ID is displayed in the report heading; it is not used for data selection.

2. To and From Dates

From month (1-12):

Use this processing option to specify the first calendar month of the reporting period. This information is used for data selection.

From year (4 digits):

Use this processing option to specify the first four-digit calendar year of the reporting period (for example, 2001). This information is used for data selection.

To month (1-12):

Use this processing option to specify the last calendar month of the reporting period. This information is used for data selection.

To year (4 digits):

Use this processing option to specify the last four-digit calendar year of the reporting period (for example, 2001). This information is used for data selection.

Process Tab

Use this processing option to specify whether to print the report in detail or summary mode.

1. Report Mode

Blank = Print in detail mode

1 = Print in summary mode

Use this processing option to specify whether to run the report in summary mode or detail mode. If you choose detail mode, the document number of each transaction is displayed on the report. Valid values are:

Blank

Detail mode

1

Summary mode

Display Tab

Use this processing option to specify whether to display the name and address on the report.

1. Name and Address

Blank = Do not print name and address

1 = Print name and address

Use this processing option to include the name and address of each customer on the report.

Valid values are:

Blank

Do not print name and address.

1

Print name and address.

As-If-Currency Tab

Use these processing options to specify the “as – if” currency and the date to use to select the exchange rate.

1. As-If-Currency Code

Use this processing option to specify the currency code for as-if-currency reporting. This option lets you print amounts in a currency other than the currency in which they are stored. Amounts are converted and are displayed in the currency you specify. If you leave this processing option blank, amounts are displayed in the reporting company's base currency.

2. Exchange Rate Date

Use this processing option to enter the as-of date for determining the exchange rate for the as-if-currency conversion. If you leave this processing option blank, the system uses the current date.

Approval Code Tab

Use this processing option to specify the approval code for the reporting authority.

Reporting Authority Approval Code

Use this processing option to enter the Reporting Authority Approval Code. This code is displayed in the report heading. This code is required in Germany.

Working with the Text File Processor

The Text File Processor is a tool that is used to convert J.D. Edwards data to text files in the formats that are required by external entities, such as banks or government agencies.

To use the Text File Processor to create a text file, you must run one of the programs that has been set up to populate the Text Processor Header table (F007101) and Text Process Detail Table (F007111). For example, the following programs populate the text processor tables:

- IDEP/IRIS Interface (R0018I3)
- SEMDEC Interface - VAT EC Sales List (R0018I4)
- Draft Remittance File Format AEB 19 - Spain (R74S6729)
- Draft Remittance File Format AEB 32 - Spain (R74S6722)
- Draft Remittance File Format AEB 58 - Spain (R74S6728)

When you run any of these programs or any other programs that populate the text processor tables, the system creates a text batch in the text processor tables with the information that is generated by the program. For example, all of the information that is required for the IDEP/IRIS Intrastat declaration is stored as one text batch.

Text batches are stored in the following tables:

- Text Processor Header (F007101)

- Text Processor Detail Table (F007111)

The F007101 table stores information about the extract of information for an external system, such as information about the processes that populated the table and information about the creation of the text file. The F007111 table stores the text for the text file.

When you export or import text in the Text File Processor, the system uses the seventh field from Next Numbers System 00.

You use the Copy Text function in the Text File Processor to copy the information from the text batch to a flat file that can be copied to disk or other media, and then submitted to the appropriate entity. When you use the Copy Text function, you can specify the location and filename for the flat file that is created.

Copying Text in the Text File Processor

Use the Copy Text function to copy text from the Text Processor Detail Table (F007111) to a text file that can be submitted to an external agency or system. When you copy the text, specify the filename and location for the text file.

The system updates the Text Processor Header table (F007101) with the date when the text was copied. The system also updates table F007101 to indicate that the batch has been processed.

Note

If the text file is too large for the device that you selected, the system displays an error message. You should copy the text file to a larger device. You can then use a compression utility to reduce the size of the text file, if necessary.

Before You Begin

- Create a text batch by running a program that uses the Text File Processor.

► To copy text in the Text File Processor

From the Text File Processor menu (G0071), choose Text File Processor.

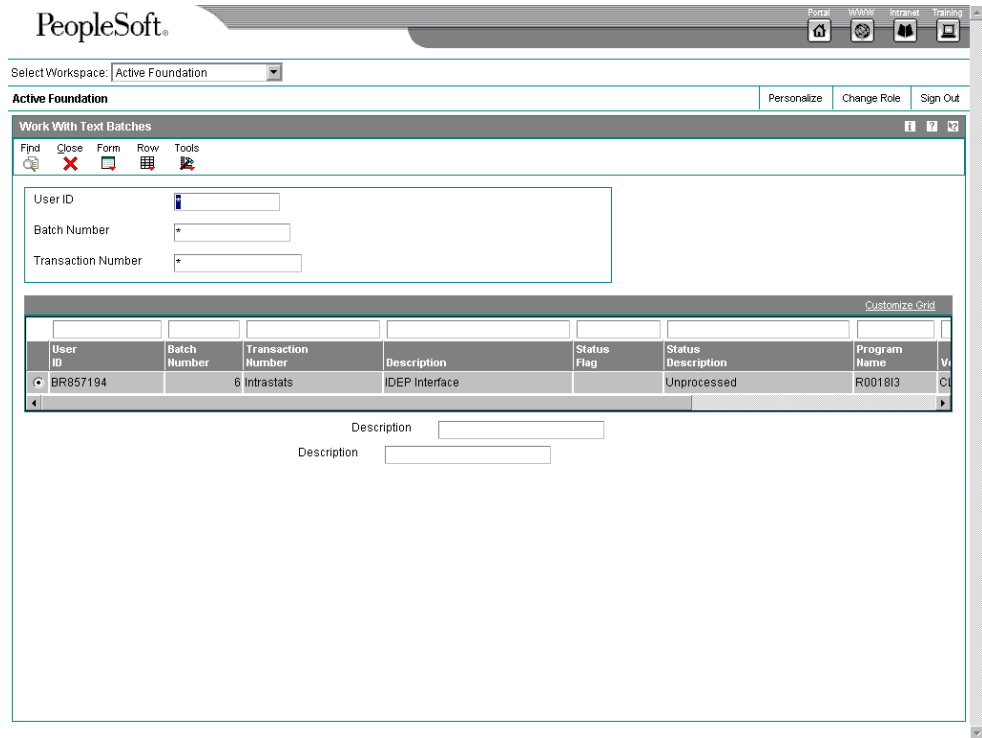

1. On Work With Text Batches, complete any of the following fields and click Find:
 - User ID
 - Batch Number
 - Transaction Number
2. In the detail area, select the batch that you want to process.
3. Choose Process Batch from the Row menu, and then choose Copy Text.

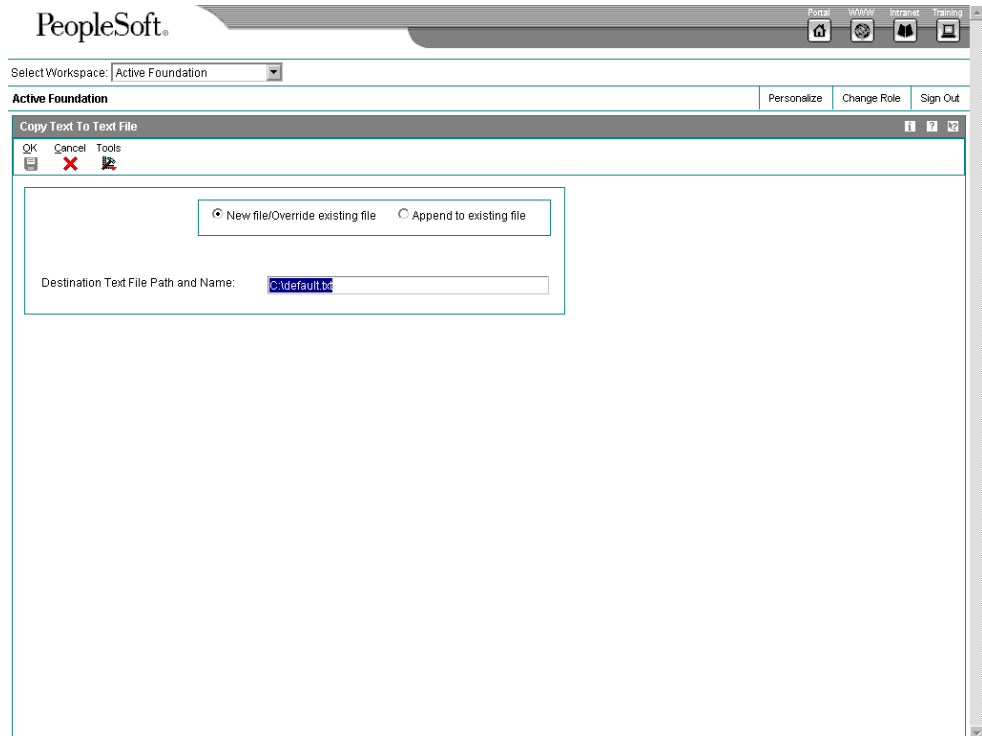

4. On Copy To Text File, click either of the following options:
 - New file/Override existing file
 - Append to existing file
5. Complete the following field and click OK:
 - Destination Text File Path and Name:The system displays the Work With Text Batches form.

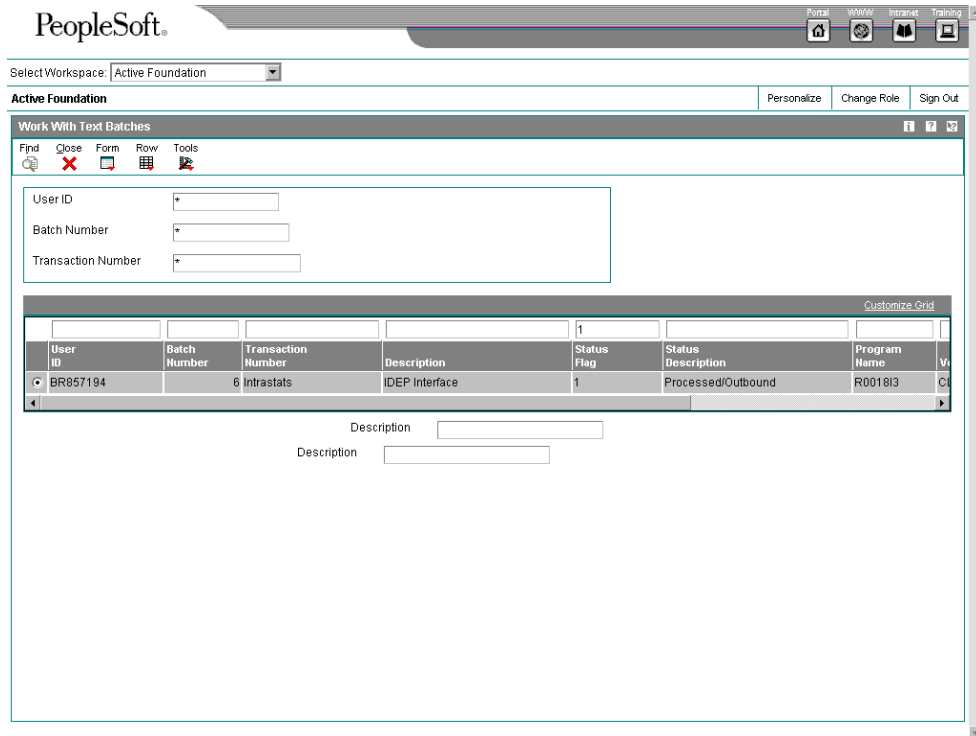

A value of 1 (Processed/Outbound) in the Status Flag field indicates that the batch has been processed successfully.

Processing Options for Text File Processor (P007101)

Process Tab

Use this processing option to specify the location of the Microsoft Word template to use during creation of the text file.

Path Microsoft Word Template

Use this processing option to override the location of the Microsoft Word template to be used during creation of the text file. The ActiveX copy text creates a Microsoft Word document based on the normal.dot template, which is normally located in c:\Program Files\Microsoft Office\Templates\normal.dot. If your Microsoft Office objects have been installed in a different path, you need to enter the correct path for the location of the normal.dot template.

Importing Text Using the Text File Processor

You can import information from an external text file to the J.D. Edwards system. When you import a text file, the system creates a batch in the Text File Header table (F007101) and the Text File Detail table (F007111). To move the information from the Text File Header and Detail tables into other tables in the J.D. Edwards system, you must run a batch program that has been designed to retrieve data from tables F007101 and F007111.

► To import text using the Text File Processor

From the Text File Processor menu (G0071), choose Text File Processor.

1. On Work With Text Batches, choose Import Text from the Form menu.

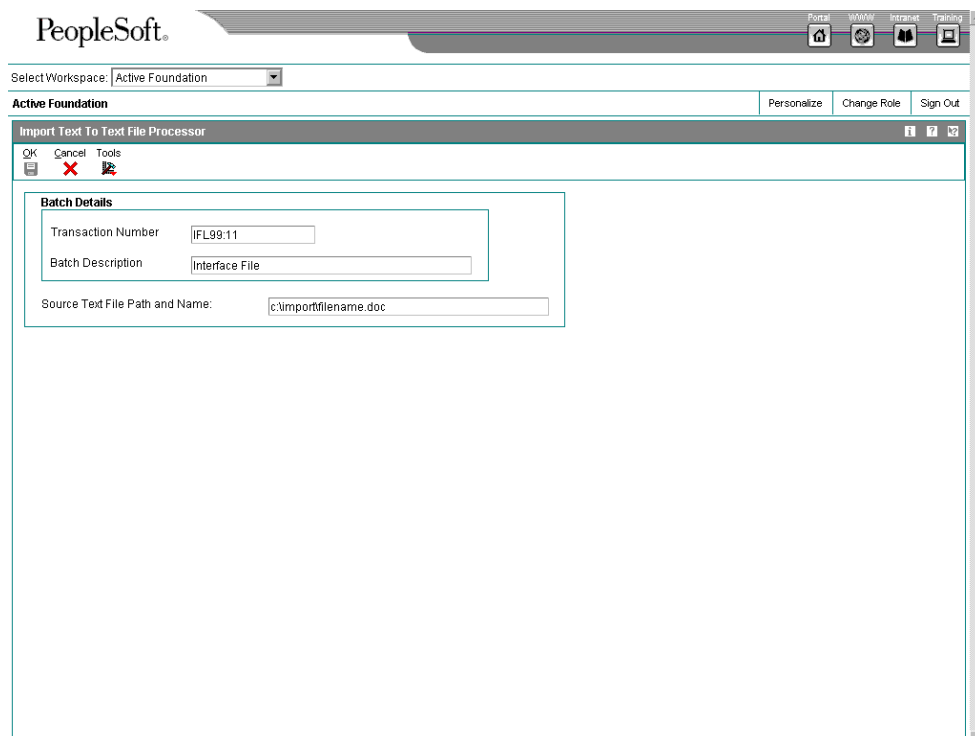

The screenshot shows the 'Import Text To Text File Processor' dialog box in the PeopleSoft system. The dialog box is titled 'Import Text To Text File Processor' and has a 'Batch Details' section. The fields in the 'Batch Details' section are:

- Transaction Number: IFL99:11
- Batch Description: Interface File
- Source Text File Path and Name: c:\importfilename.doc

2. On Import Text To Text File Processor, complete the following fields and click OK:
 - Transaction Number
 - Batch Description
3. Complete the following field and click OK:
 - Source Text File Path and Name:
4. On Work With Text Batches, click Find.

The system displays the new batch in the detail area. A value of 5 (Unprocessed/Inbound) in the Status Flag field indicates that the batch has been imported successfully.

Resetting a Text Batch in the Text File Processor

If you need to process a text batch a second time, you must first reset the batch. Resetting a batch updates the status flags in the Text Processor Header table (F007101). The system changes outbound statuses to blank (Unprocessed/Outbound) and changes inbound statuses to 5 (Unprocessed/Inbound).

► To reset a text batch in the Text File Processor

From the Text File Processor menu (G0071), choose Text File Processor.

1. On Work With Text Batches, complete either of the following fields and click Find:
 - User ID
 - Batch Number
2. In the detail area, choose the batch that you want to reset.
3. From the Row menu, choose Maintain Batch, and then choose Reset Batch.

Purging a Text Batch in the Text File Processor

You purge a text batch to remove it from the Text Processor Detail Table (F007111). You can purge only batches of processed transactions.

When you purge a batch from the Work With Text Batches form, the system calls version ZJDE0001 of the Purge Processed Transactions program (R007102). You can also run any version of this program from the Text File Processor menu (G0071).

You can use a processing option in the Purge Processed Transactions program to specify whether the system removes the records in the batch from the Text Processor Header table (F007101), as well as from table F007111.

If you do not remove records from table F007101 when you purge a batch, the processed flag for those records is changed from processed to purged.

When you purge a batch that was created through draft remittance, the system also runs the Purge Draft Remittance Records program (R03B673).

To set up an additional batch program to run when you purge a batch, enter the name of the additional batch program in the Additional Purge Process field (GPPR) in table F007101 . When you run the purge program on a batch that includes the name of a batch program in the Additional Purge Process field, the system runs version ZJDE0001 of that batch program.

► To purge a text batch in the Text File Processor

From the Text File Processor menu (G0071), choose Text File Processor.

1. On Work With Text Batches, complete either of the following fields and click Find:
 - User ID
 - Batch Number
2. In the detail area, choose the batch that you want to purge.

3. From the Row menu, choose Maintain Batch, and then choose Purge Batch.

Processing Options for Purge Processed Transactions (R007102)

Process Tab

Use this processing option to specify whether to delete header records.

1. Purge Header Records

Blank = Do not delete header records

1 = Delete header records

Use this processing option to determine whether to delete corresponding header records from the Text Processor Header table (F007101) along with detail records from the Text Processor Detail Table (F007101). Deleting only detail records updates the processed flag in the Text Processor Header file to 2 (purged/outbound) or 7 (purged/inbound). Records marked as purged cannot be reset to an unprocessed status. Valid values are:

1

Purge header and detail records

Blank

Purge only detail records
